

VOLUME 21

JUNE, 1933

NUMBER 6

PROCEEDINGS  
*of*  
**The Institute of Radio  
Engineers**



**Eighth  
Annual Convention  
Chicago, Illinois  
June 26, 27, 28, 1933**

**Form for Change of Mailing Address or Business Title on Page VIII**

**INSTITUTE OF RADIO ENGINEERS EIGHTH ANNUAL  
CONVENTION**

**HOTEL SHERMAN, CHICAGO, ILLINOIS**

**JUNE 26, 27, AND 28, 1933**

**CONDENSED PROGRAM**

**Sunday—June 25.**

**4:00 P.M.—6:00 P.M. Registration.**

**Monday—June 26**

**9:00 A.M. Registration.**

**9:00 A.M.—10:00 A.M. Inspection of exhibits.**

**10:00 A.M.—12 Noon. Official greetings at ladies headquarters.**

**10:00 A.M.—12:30 P.M. Official welcome by L. M. Hull, President of the Institute, and J. Barton Hoag, Chairman of the Chicago Section and Convention Committee. These addresses will be followed by a technical session.**

**12:00 Noon—5:00 P.M. Ladies luncheon and bridge.**

**12:30 P.M.—2:00 P.M. Luncheon and inspection of exhibits.**

**2:00 P.M.—4:00 P.M. Technical session.**

**4:00 P.M.—6:00 P.M. Inspection of exhibits.**

**7:00 P.M. Informal Institute banquet.**

**Tuesday—June 27**

**9:00 A.M. Registration.**

**9:00 A.M.—10:00 A.M. Inspection of exhibits.**

**10:00 A.M.—12:00 Noon. Technical session.**

**10:00 A.M.—12:30 P.M. Ladies trip to NBC studios or Art Institute.**

**12:00 Noon—1:30 P.M. Luncheon and inspection of exhibits.**

**1:30 P.M.—3:00 P.M. Ladies luncheon and style show, Marshall Field and Company.**

**1:30 P.M.—3:30 P.M. Technical session.**

**1:30 P.M.—3:30 P.M. Informal technical conference.**

**3:00 P.M.—4:00 P.M. Ladies shopping tour.**

**4:00 P.M. Trip to Fair.**

**4:00 P.M. Sections Committee meeting.**

**6:00 P.M. Exhibition closes for day.**

**Wednesday, June 28**

**9:00 A.M. Registration.**

**9:00 A.M.—9:30 A.M. Inspection of exhibits.**

**9:30 A.M.—11:30 A.M. Technical session.**

**9:30 A.M.—12:00 Noon. Ladies sight-seeing trip around Chicago.**

**12:00 Noon. Trip to Fair.**

**12:30 P.M.—1:30 P.M. Luncheon at the Fair.**

**1:30 P.M.—6:00 P.M. World's Fair.**

**6:30 P.M. Engineering societies banquet, Stevens Hotel.**

PROCEEDINGS OF

# The Institute of Radio Engineers

Volume 21

June, 1933

Number 6

Board of Editors

ALFRED N. GOLDSMITH, *Chairman*

R. R. BATCHER

H. H. BEVERAGE

F. W. GROVER

G. W. PICKARD

L. P. WHEELER

L. E. WHITTEMORE

WILLIAM WILSON

K. S. VAN DYKE

## CONTENTS

### PART I

Condensed Program of Eighth Annual Convention . . . . .	Cover II
Frontispiece, Bal Tabarin . . . . .	742
Institute News and Radio Notes . . . . .	743
Eighth Annual Convention . . . . .	743
May Meeting of the Board of Directors . . . . .	761
Election Notice . . . . .	762

### PART II

#### *Technical Papers*

The Optical Behavior of the Ground for Short Radio Waves . . . . .	
. . . . . C. B. FELDMAN	764
A Radio Range Beacon Free from Night Effects . . . . .	H. A. CHINN 802
On the Solution of the Problem of Night Effects with the Radio Range Beacon System . . . . .	H. DIAMOND 808
Theoretical Notes on Certain Features of Television Receiving Circuits . . . . .	G. D. ROBINSON 833
Dynamic Measurement of Electron Tube Coefficients . . . . .	W. N. TUTTLE 844
Class B Amplifiers Considered from the Conventional Class A Standpoint . . . . .	J. R. NELSON 858
Discussion on "A Practical Analysis of Parallel Resonance," by Reuben Lee . . . . .	W. J. SEELEY AND REUBEN LEE 875
Book Reviews: "Handbook 17. Code for Protection Against Lightning," U. S. Department of Commerce . . . . .	H. H. BEVERAGE 877
"Modern Connectors for Timber Construction," U. S. Department of Commerce . . . . .	T. A. M. CRAVEN 877
Radio Abstracts and References . . . . .	878
Contributors to this Issue . . . . .	883

# The Institute of Radio Engineers

---

## GENERAL INFORMATION

**INSTITUTE.** The Institute of Radio Engineers was formed in 1912 through the amalgamation of the Society of Wireless Telegraph Engineers and the Wireless Institute. Its headquarters were established in New York City and the membership has grown from less than fifty members at the start to almost six thousand by the end of 1932.

**AIMS AND OBJECTS.** The Institute functions solely to advance the theory and practice of radio and allied branches of engineering and of the related arts and sciences, their application to human needs, and the maintenance of a high professional standing among its members. Among the methods of accomplishing this need is the publication of papers, discussions, and communications of interest to the membership.

**PROCEEDINGS.** The PROCEEDINGS is the official publication of the Institute and in it are published all of the papers, discussions, and communications received from the membership which are accepted for publication by the Board of Editors. Copies are sent without additional charge to all members of the Institute. The subscription price to nonmembers is \$10.00 per year, with an additional charge for postage where such is necessary.

**RESPONSIBILITY.** It is understood that the statements and opinions given in the PROCEEDINGS are views of the individual members to whom they are credited, and are not binding on the membership of the Institute as a whole. Papers submitted to the Institute for publication shall be regarded as no longer confidential.

**REPRINTING PROCEEDINGS MATERIAL.** The right to reprint portions or abstracts of the papers, discussions, or editorial notes in the PROCEEDINGS is granted on the express condition that specific reference shall be made to the source of such material. Diagrams and photographs published in the PROCEEDINGS may not be reproduced without making specific arrangements with the Institute through the Secretary.

**MANUSCRIPTS.** All manuscripts should be addressed to the Institute of Radio Engineers, 33 West 39th Street, New York City. They will be examined by the Papers Committee and the Board of Editors to determine their suitability for publication in the PROCEEDINGS. Authors are advised as promptly as possible of the action taken, usually within two or three months. Manuscripts and illustrations will be destroyed immediately after publication of the paper unless the author requests their return. Information on the mechanical form in which manuscripts should be prepared may be obtained by addressing the secretary.

**MAILING.** Entered as second-class matter at the post office at Menasha, Wisconsin. Acceptance for mailing at special rate of postage is provided for in the act of February 28, 1925, embodied in Paragraph 4, Section 412, P. L. and R., and authorization was granted on October 26, 1927.

---

Published monthly by

**THE INSTITUTE OF RADIO ENGINEERS, INC.**

Publication office, 450-454 Ahnaip St., Menasha, Wis.

BUSINESS, EDITORIAL, AND ADVERTISING OFFICES

Harold P. Westman, *Secretary*

33 West 39th Street, New York, N. Y.

## INSTITUTE SECTIONS

- ATLANTA—Chairman, H. L. Wills; Secretary, Philip C. Bangs, 23 Kensington Road, Avondale Estates, Ga.
- BOSTON—Chairman, E. L. Chaffee; Secretary, G. W. Kenrick, Tufts College, Mass.
- BUFFALO-NIAGARA—Chairman, L. Grant Hector; Secretary, E. C. Waud, 235 Huntington Avenue, Buffalo, N. Y.
- CHICAGO—Chairman, R. M. Arnold; Secretary, Donald H. Miller, McGraw-Hill Publishing Company, 520 N. Michigan Ave., Chicago, Ill.
- CINCINNATI—Chairman, W. C. Osterbrock; Secretary, Helen Klein, Crosley Radio Corporation, Cincinnati, Ohio.
- CLEVELAND—Chairman, P. A. Marsal; Secretary, R. P. Worden, 1629 Cordova Ave., Cleveland, Ohio.
- CONNECTICUT VALLEY—Chairman, H. W. Holt; Secretary, C. B. De Soto American Radio Relay League, 38 La Salle Rd., W. Hartford, Conn.
- DETROIT—Chairman, G. W. Carter; Secretary, E. C. Denstaedt, Detroit Police Department, Detroit, Mich.
- LOS ANGELES—Chairman, J. K. Hilliard; Secretary, N. B. Neely, 1569 Munson Ave., Los Angeles, Calif.
- NEW ORLEANS—Chairman, Pendleton E. Lehde; Secretary, Anton A. Schiele, 1812 Masonic Temple, New Orleans, La.
- PHILADELPHIA—Chairman, H. W. Byler; Secretary, G. C. Blackwood, 243 E. Upsal St., Mt. Airy, Philadelphia, Pa.
- PITTSBURGH—Chairman, R. T. Griffith; Secretary, C. K. Krause, 1541 Princess Ave., Pittsburgh, Pa.
- ROCHESTER—Chairman, A. E. Soderholm; Secretary, John J. Long, Radio Station WHAM, Sagamore Hotel, Rochester, N. Y.
- SAN FRANCISCO—Chairman, A. R. Rice; Secretary, K. G. Clark, Department of Commerce, 328 Custom House, San Francisco, Calif.
- SEATTLE—Chairman, H. H. Bouson; Secretary, Howard Mason, 2709-4th West, Seattle, Wash.
- TORONTO—Chairman, R. A. Hackbusch; Secretary, G. E. Pipe, Rogers-Majestic Corporation, Toronto, Ont., Canada.
- WASHINGTON—Chairman, H. G. Dorsey; Secretary, C. L. Davis, Patent Department, Radio Corporation of America, 1227-1233 National Press Building, Washington, D.C.

## GEOGRAPHICAL LOCATION OF MEMBERS ELECTED MAY 3, 1933

### Elected to the Associate Grade

California	Los Angeles, 1632 Shenandoah St.	Dine, F. E.
	Los Angeles, 1616 S. Bonnie Brae	Edwards, B. E.
	Pasadena, 1953 Rose Villa St.	Phillips, N. V.
Illinois	Chicago, 5129 Wentworth Ave.	Streich, F. W.
Maine	Kittery, 20 Whipple Rd.	Remich, E. C.
Maryland	Baltimore, Blackstone Atps., N. Charles & 33rd Sts.	Fricker, J. N.
Nebraska	Omaha, 1451 S. 15th St.	Myers, A. F.
New Jersey	Camden, 1060 Liberty St.	Sanske, E. A.
New York	Jackson Heights, 3748-92nd St.	Davis, K. E.
	New York City, 1997 Davidson Ave.	Bergman, W. J.
	Schenectady, 1274 Baker Ave.	Barhydt, C. R.
	Watertown, 266 E. Main St.	Protzman, F. W.
Pennsylvania	Bethlehem, Dept. of Elec. Eng., Lehigh Univ.	Lucas, F. B.
Vermont	Windsor, S. Main St.	Osgood, R. E.
Washington	Seattle, 4302 N.E. 12th St.	Allan, F. S.
Brazil	Rio de Janeiro, Servico Telegrafico, Quartel General Exer- cito	Medeiros, L. A. D.
Canada	Charny, P. 2, 78 Poirier St.	Worwood, W.
	Charlottetown, P.E.I., Radio Station CFCY	Adams, J. Q.
	St. Catharines, Ont., C. K. T. B. Welland House	Switzer, S.
	Toronto 5, Ont., 48 Jackes Ave.	Armstrong, D.
	Toronto 12, Ont., 3 Hoyle Ave.	Hawkins, R. M.
	Toronto, Ont., 10 Maitland St.	Young, W. L.
England	Liverpool, 43 Parkfield Rd.	White, S. E.
	London, S.W.1, 172/3 Chandos House, Buckingham Gate, Westminster	Booth, C. T.
	London, S.W.12, 54 Hazelbourne Rd., Balham	Gilbert, J. C. G.
	London, S.W.1, Sorrell-Booth Labs., 172/3 Chandos House, Buckingham Gate	Sorrell, G. H.
France	Smethwick, Staffs, "Westbourne," Broomfield Rd.	Norman, F. A.
Mexico	Bois-Colombes, 6 Rue Marie-Laure	Satzelle, S. R.
Scotland	Mexico City, Apartado Postal 130	Hard, J. M. B.
South Africa	Ayrshire, Ballantrae	Cunningham, H.
	Johannesburg, Transvaal, 84 Dunbar St., Bellevue	Du Preez, H.
	Kenilworth, Kimberley, 23-1st Ave.	Reynolds, H. W.
Sweden	Stockholm, c/o Braathen, Arhillerigatan 77 <sup>1</sup>	Rydbeck, O. E. H.

### Elected to the Junior Grade

Washington	Cheney	Lean, B. W.
------------	--------	-------------

### Elected to the Student Grade

California	Berkeley, Bowles Hall, Univ. of Calif. Campus	Bergwall, P. H.
	Berkeley, 2021 Channing Way	Brown, R. S.
	El Monte, 750 Peck Rd.	Hayes, E.
	Oakland, 5814 Merriewood Dr.	Welge, V.
	San Francisco, 170 Hearst Ave.	Hortig, F. J.
	San Francisco, 3775 California St.	Snow, J.
Connecticut	Hamden, 57 James St.	Dukat, F. M.
	New Haven, Box 607, Yale Station	Dewey, C. S.
	New Haven, 352 Temple St.	Nelson, A. B.
Massachusetts	Melrose, 119 W. Wyoming Ave.	Ulrich, V. K.
	North Abington, 49 Harrison Ave.	Gilman, T. W.
Michigan	Ann Arbor, 851 Tappan Ave.	Culver, R. H.
Missouri	Kansas City, 3327 College Ave.	Kelley, E. K.
New Jersey	Englewood, 268 Chestnut St.	Amend, A., Jr.
	Rutherford, 197 Mountain Way	Bailey, W. F.
Pennsylvania	State College, Box 328	Kulberg, L. E.
Washington	Seattle, 4123-11th N.E.	Schuchard, E. A.
	Seattle, 2051 W. 64th St.	Yeager, W. V.
	Seattle, 420 Terry Ave.	Young, H. H.



## APPLICATIONS FOR MEMBERSHIP

Applications for transfer or election to the various grades of membership have been received from the persons listed below, and have been approved by the Committee on Admissions. Members objecting to transfer or election of any of these applicants should communicate with the Secretary on or before June 30 1933. Final action on these applications will be taken on July 5, 1933.

### For Election to the Associate Grade

California	Hollywood, 7765 Fountain Ave.	Hilchey, W. L.
	Sunnyvale, 287 Arques St.	Hoehn, F. M.
Connecticut	Hartford, 378 New Britain Ave.	Bennett, J. S.
Illinois	Chicago, 1832 Nelson St.	Waltman, H.
Indiana	West Lafayette, 718 Evergreen St.	Buckley, M., Jr.
New York	Brooklyn, C. S. "Joseph Henry," Army Supply Base.	Lechman, O.
	Dongan Hills, S.I., 273 Alter Ave.	Polomene, J.
	Great Kills, S.I., 75 Hillcrest Ave.	Campagna, C. F.
	New York City, 32-6th Ave.	Dayton, B. L.
Ohio	Tiffin, Ohio Power Co.	Stewart, W. J.
Oregon	La Grande, 1501 "T" Ave.	Fosterling, A. W.
Pennsylvania	Turtle Creek, 404 Highland Ave.	Sheaks, C. T.
Texas	Houston, Geophysical Division, The Texas Co.	Dodge, C.
Washington	Vancouver, 3201 Drummond St.	Simson, A. G.
Argentina	Monte Grande, Radioestacion.	Lafon, J. B.
England	Bedlington, Northumberland, 4 Hirst Ter.	Davies, H.
	Bristol 2, Gloucester, 79 City Rd.	Coates, C.
	Cricklewood, c/o Erie Resistor Ltd., Waterloo Rd.	Dyson, A. A.
	London N.W.1, 104 Regents Park Rd.	Gardiner, E. L.
	Manchester, College of Technology.	Chen, T. K.
	Potters Bar, Middlesex, 22 Ladbroke Dr.	Bowden, H. F.
	Yorkshire, 8 Frances St., Fulford Rd.	Dunk, A. T.
India	Bombay, Plot 742, A, Dader Parsi Colony.	Bhathena, P. S.
South Africa	Johannesburg, Transvaal, Box 4432.	Dee, E.

### For Election to the Junior Grade

Ohio	Dayton, 113 Riegel St.	Apple, R. C.
------	------------------------	--------------

### For Election to the Student Grade

California	Oakland, 372-29th St.	Ott, D. E.
	Stockton, 1249 S. Madison St.	Willette, J. I.
Indiana	Fort Wayne, 1239 Kinsmoor Ave.	Kowalski, C. A.
New York	Ithaca, 401 Boldt Tower.	Duncan, R. S.
Pennsylvania	Malvern.	Haines, J. G.
	Philadelphia, 3243 Sansom St.	Spielman, S. C.



## OFFICERS AND BOARD OF DIRECTORS, 1933

(Terms expire January 1, 1934, except as otherwise noted)

*President*

L. M. HULL

*Vice President*

JONATHAN ZENNECK

*Treasurer*

MELVILLE EASTHAM

*Secretary*

HAROLD P. WESTMAN

*Editor*

ALFRED N. GOLDSMITH

*Directors*

M. C. BATSEL

J. V. L. HOGAN

C. M. JANSKY, JR.

R. H. MANSON, *Junior Past President*

E. R. SHUTE

A. F. VAN DYCK

WILLIAM WILSON

Serving until January 1, 1935

W. G. CADY, *Junior Past President*

O. H. CALDWELL

C. W. HORN

E. L. NELSON

Serving until January 1, 1936

R. A. HEISING

H. M. TURNER

F. A. KOLSTER



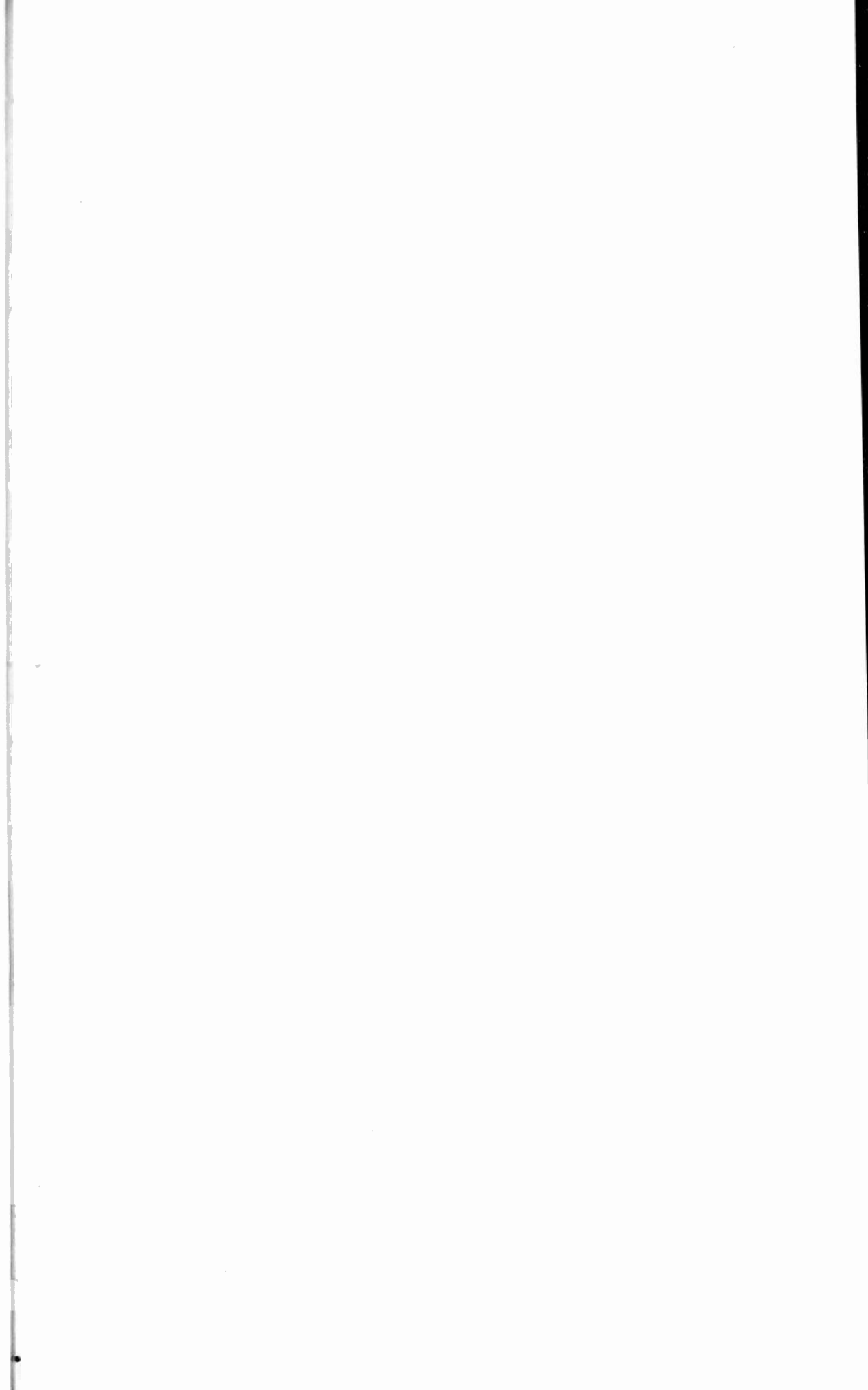

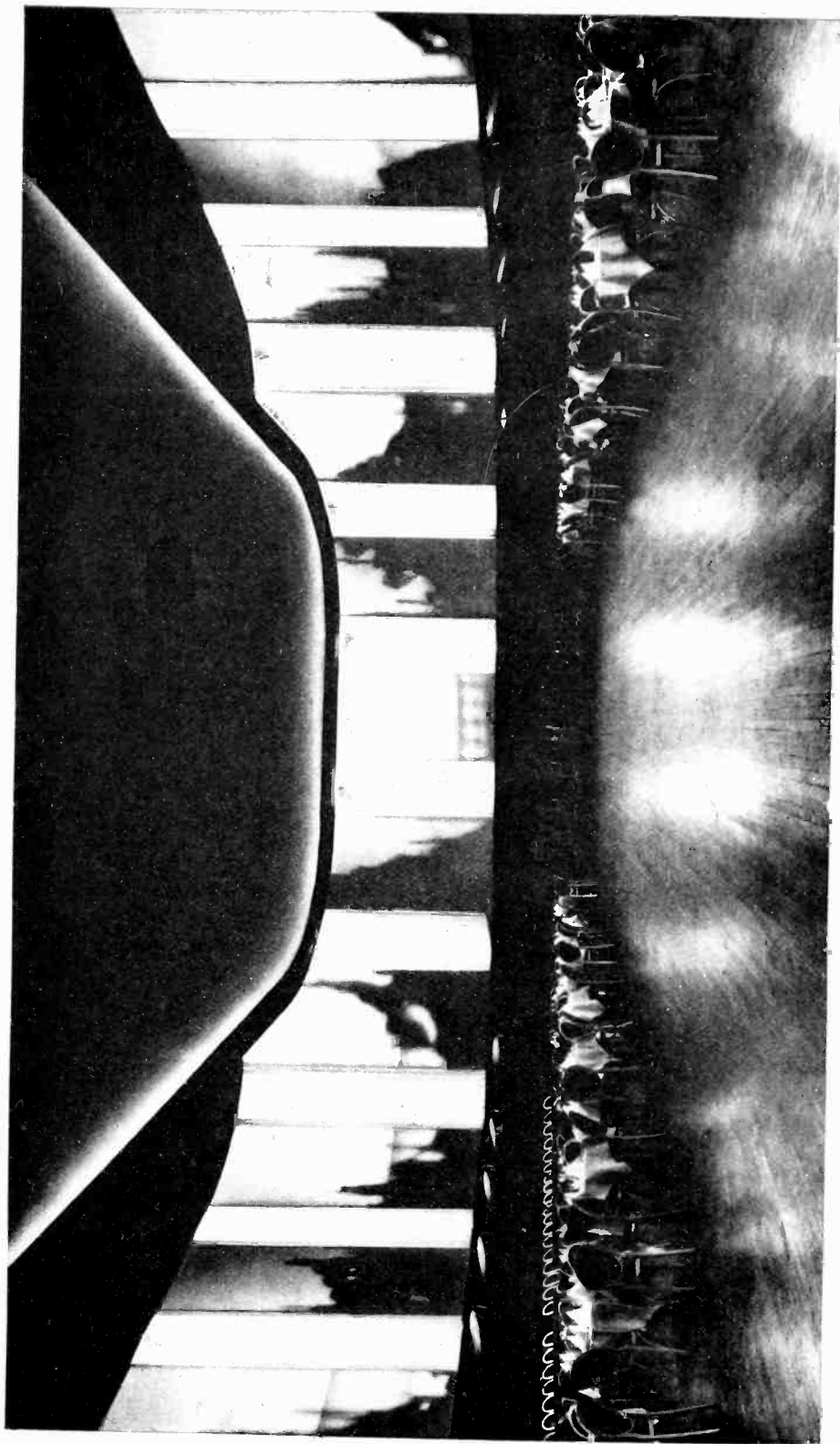

The Bal Tabarin, which will be the place of the informal banquet, is located in the Hotel Sherman, the convention headquarters.

## INSTITUTE NEWS AND RADIO NOTES

### Eighth Annual Convention

Because expositions of international importance occur infrequently, it is altogether logical for the Institute to have chosen Chicago as the location for its Eighth Annual Convention. In that city the Century of Progress-World's Exposition will be held from June to November.

On the first day of June, the exposition will be officially opened. The starting impulse will be a beam of light which left the star, Arcturus, in 1893 during the last World's Fair held in Chicago. This light beam will be focused by one of the country's largest telescopes upon a photo-electric cell and the resultant electrical output will be amplified and transmitted electrically to the site of the World's Fair to initiate a series of events which will officially open the exposition. This is indicative of the part which modern science will play in making this event of great engineering and scientific interest to the world.

Numerous buildings will be devoted to exhibitions of important developments in science, industry, and art which have never been assembled before for such convenient and rapid inspection. The engineer who is interested in broadening his knowledge, who finds stimulation in following developments in allied fields, and who is alert to the possibilities of advances in his own field being suggested by methods and devices characteristic of other industries cannot help but find a visit to the Century of Progress Exposition of inestimable value.

The fact that the World's Fair is offering so much of an educational nature has not resulted in a reduction in the technical treatment of communication problems which has been the basis of all Institute conventions. Over ten hours of time during the three days of the meeting is being devoted to technical sessions. A substantial group of papers will be presented in full, and our own showing of developments in radio equipment in the form of a Component Parts Exhibition will be held. A reasonably complete, though still not final program, is given below. While it is subject to change, such changes as are made will be minor in nature.

#### SUNDAY, JUNE 25

4:00 P.M.-6:00 P.M. Registration

#### MONDAY, JUNE 26

9:00 A.M. Registration

9:00 A.M.-10:00 A.M. Inspection of exhibits

10:00 A.M.-12 Noon Official greetings at ladies headquarters

10:00 A.M.-12:30 P.M. Official welcome by L. M. Hull, President of the Insti-

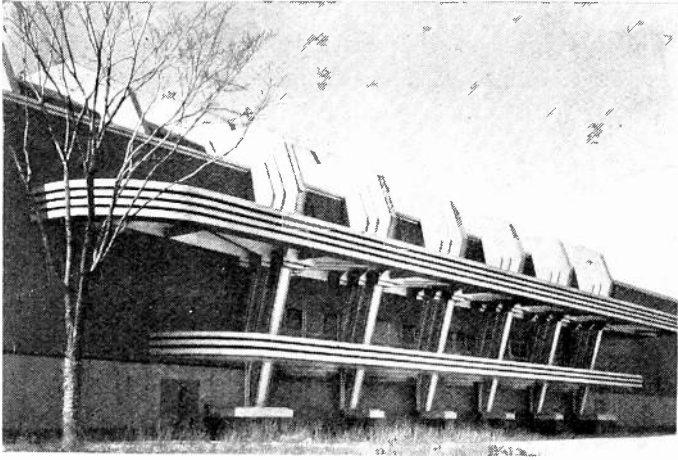

The Travel and Transport Building is almost a thousand feet long.

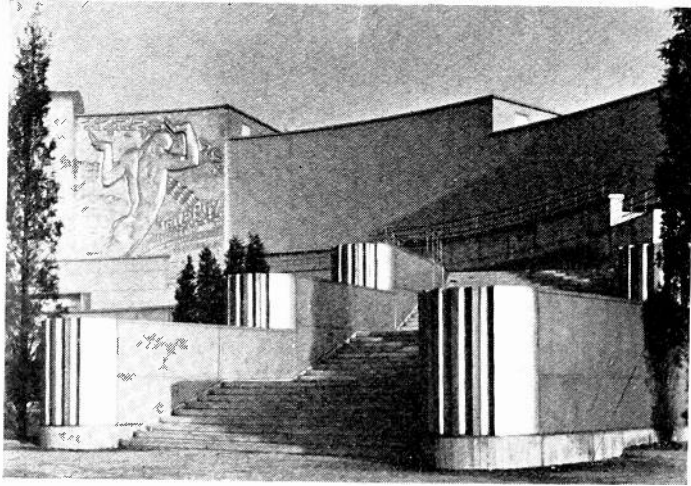

Entrance to the Electrical Building.

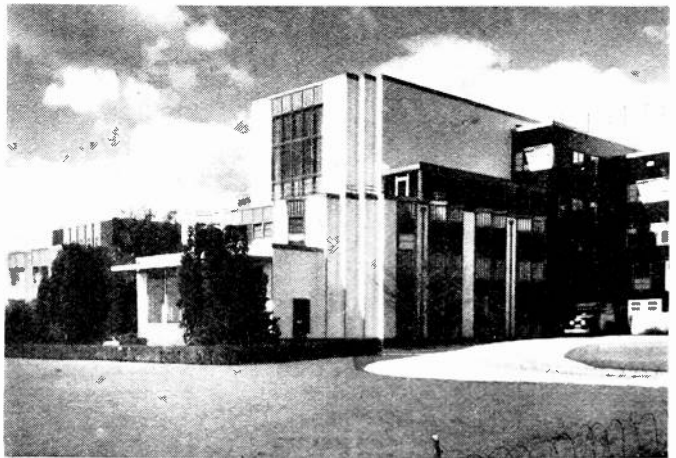

This modernistic structure is the Administration Building.

tute, and J. Barton Hoag, Chairman of the Chicago Section and Convention Committee.

**Technical session**

"Some Aspects of Radio Law," by J. Warren Wright, Navy Department, Washington, D. C.

"Patent Relations of the Engineer to His Employer," by Leonard Garver, Jr., Larbach and Garver, Cincinnati, Ohio.

"The Radio Patrol System of the City of New York," by F. W. Cunningham, Bell Telephone Laboratories, New York City, and T. W. Rochester, New York Police Department, New York City.

"The Iconoscope—A New Version of the Electric Eye," by V. K. Zworykin, RCA Victor Company, Camden, N. J.

12:00 Noon—5:00 P.M.

Ladies luncheon and bridge, Hotel Sherman

12:30 P.M.—2:00 P.M.

Luncheon and inspection of exhibits

2:00 P.M.—4:00 P.M.

**Technical session**

"Vacuum Tubes for Use at Extremely High Frequencies," by B. J. Thompson and G. M. Rose, Jr., RCA Radiotron Company, Harrison, N. J.

"Vacuum Tube Characteristics in the Positive Grid Region by an Oscillographic Method," by H. N. Kozanowski and I. E. Mourontseff, Westinghouse Electric and Manufacturing Company, East Pittsburgh, Pa.

"Application of Graphite as an Anode Material to High Vacuum Transmitting Tubes," by E. E. Spitzer, RCA Radiotron Company, Harrison, N. J.

"Determination of Dielectric Properties at Very High Frequencies," by J. G. Chaffee, Bell Telephone Laboratories, New York City.

4:00 P.M.—6:00 P.M.

Inspection of exhibits

7:00 P.M.

Informal Institute Banquet

**TUESDAY, JUNE 27**

9:00 A.M.

Registration

9:00 A.M.—10:00 A.M.

Inspection of exhibits

10:00 A.M.—12:00 Noon

**Technical session**

Symposium on Cost vs. Quality in Broadcast Receiver Design

"Tubes," by W. M. Perkins, National Union Radio Corporation, Newark, N. J.

"Coils," by F. N. Jacob, Meissner Manufacturing Company, Chicago, Ill.

"Speakers," by H. S. Knowles, Jensen Radio Manufacturing Company, Chicago, Ill.

"Condensers," by R. O. Lewis, P. R. Mallory Company, Indianapolis, Ind.

"Resistors," by D. S. W. Kelly, Allen Bradley Company, Milwaukee, Wis.

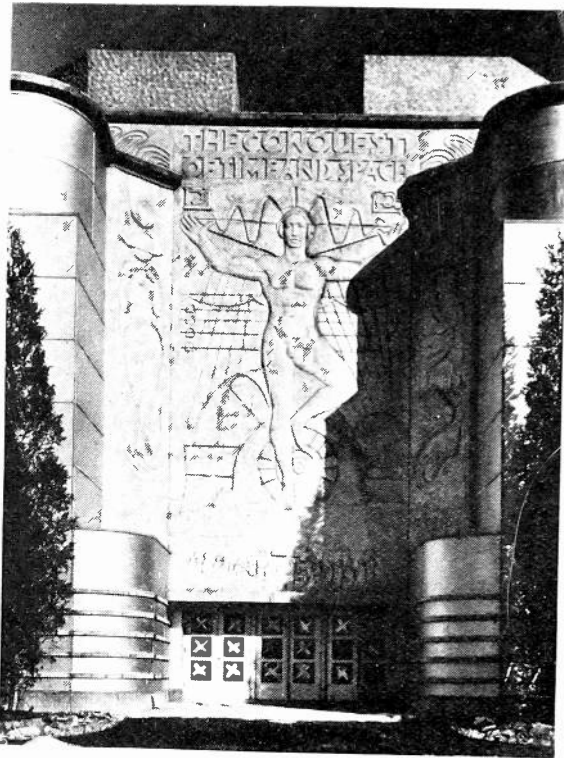

Visitors to the Communications Building, which is part of the Electrical Group, will pass through this entrance.

A part of the Travel and Transport Building is this modernistic structure, the roof of which is hung from cables.

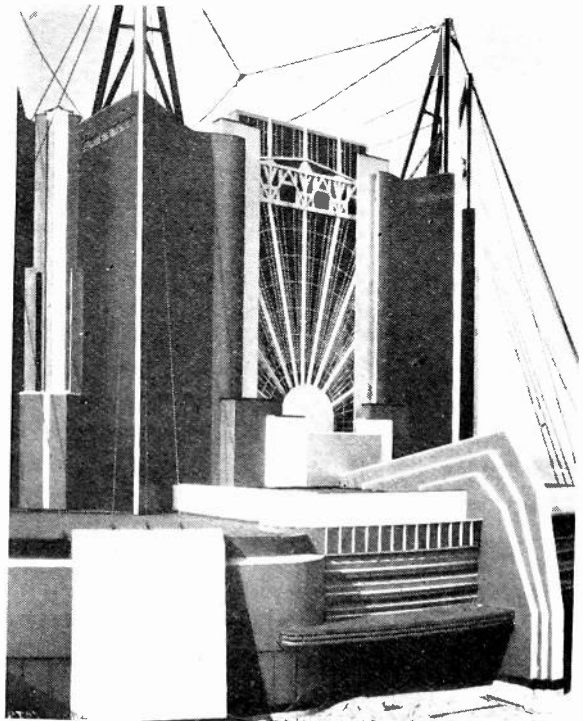

- 10:00 A.M.-12:30 P.M. "Transformers," by W. J. Leidy, Chicago Transformer Corporation, Chicago, Ill.
- 12:00 Noon-1:30 P.M. "Circuits," by H. D. Mysing, Grigsby-Grunow Company, Chicago, Ill.
- 1:30 P.M.-3:00 P.M. Ladies trip to NBC Studios or Art Institute.
- 1:30 P.M.-3:30 P.M. Luncheon and inspection of exhibits.
- 1:30 P.M.-3:00 P.M. Ladies luncheon and style show, Marshall Field and Company.
- 1:30 P.M.-3:30 P.M. **Technical session**  
 "Studies of the Ionosphere and Their Application to Radio Transmission," by S. S. Kirby, L. V. Berkner, and D. M. Stuart, Bureau of Standards, Washington, D. C.  
 "Electrical Disturbances of Extraterrestrial Origin," by K. G. Jansky, Bell Telephone Laboratories, New York City.  
 "Attenuation of Overland Radio Transmission in the Frequency Range of 1.5 to 3.5 megacycles," by C. N. Anderson, American Telephone and Telegraph Company, New York City.  
 "Note on a Multi-frequency Automatic Recorder of Kennelly-Heaviside Layer Height," by T. R. Gilliland, Bureau of Standards, Washington, D. C.  
 "Determination of the Direction of Arrival of Short Radio Waves," by H. T. Friis, C. B. Feldman, and W. M. Sharpless, Bell Telephone Laboratories, New York City.
- 1:30 P.M.-3:30 P.M. Informal technical conference on "Criteria for the Introduction of New Tubes," led by J. C. Warner, RCA Radiotron Company, Harrison, N. J.
- 3:00 P.M.-4:00 P.M. Ladies shopping tour
- 4:00 P.M. Trip to Fair
- 4:00 P.M. Sections Committee meeting
- 6:00 P.M. Exhibition closes for day

WEDNESDAY, JUNE 28

- 9:00 A.M. Registration
- 9:00 A.M.-9:30 A.M. Inspection of exhibits
- 9:30 A.M.-11:30 A.M. **Technical session**  
 "A Study of Reflex Circuits and Associated Tube Properties in Modern Receivers," by David Grimes and W. S. Barden, RCA License Laboratory, New York City.  
 "A New Cone Loud Speaker for High Fidelity Sound Reproduction," by H. F. Olson, RCA Victor Company, Camden, N. J.  
 "A Life Test Power Supply Utilizing Thyatron Rectifiers," by H. W. Lord, General Electric Company, Schenectady, N. Y.  
 "Radio Cabinet Design and Consumer Acceptance," by

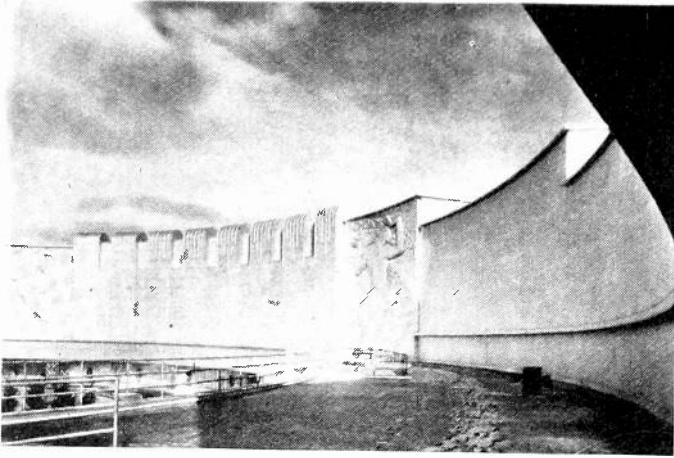

The central portion of the Electrical Building  
faces the lagoon.

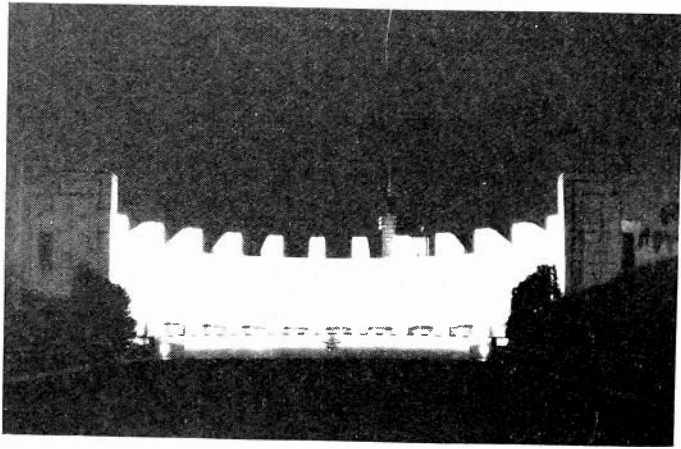

The north approach of the Hall of Science  
as seen at night.

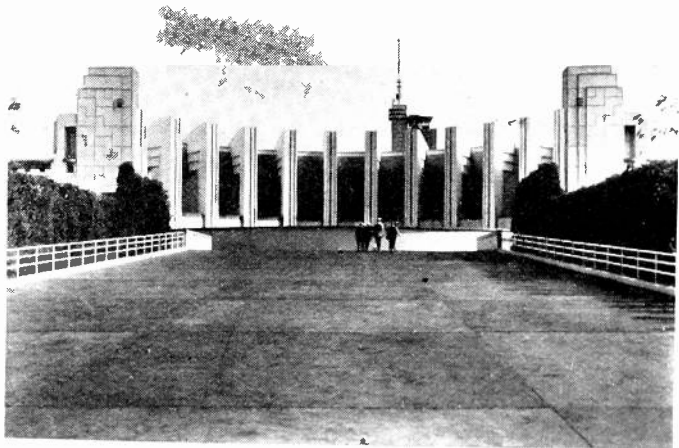

The Hall of Science showing the twelve pylons com-  
prising the north wall.



	H. I. Van Doren, Van Doren and Rideout, Industrial Designers, Toledo, Ohio.
9:30 A.M.—12:00 Noon	Ladies sight-seeing trip around Chicago
12:00 Noon	Trip to Fair
12:30 P.M.—1:30 P.M.	Luncheon at the Fair—Blue Ribbon Casino
1:30 P.M.—6:00 P.M.	World's Fair
6:30 P.M.	Engineering Societies Banquet, Stevens Hotel

### Technical Papers

A change of policy is being inaugurated this year in the handling of technical papers. The most important change has been a decision to dispense with the preprinting of papers. Consequently, all papers will be presented in full, and sufficient time will be available for their discussion.

Because papers are not being preprinted, it is quite possible that a number of those which will be presented may not appear in the PROCEEDINGS at a later date. While an effort will be made to obtain manuscripts of all papers to be presented, their eventual publication is not guaranteed. Summaries of the papers are given at the end of this report to indicate more clearly and completely than the title, the matter which they treat.

### Informal Technical Conferences

A new type of meeting which has been named an informal technical conference has been planned with the thought that it will be of substantial benefit to a specialized group of members. This meeting will be held in a comparatively small room and it is anticipated that it will be attended by only twenty or thirty persons who are particularly interested in the subject to be discussed. No formal papers are to be presented but the time will be devoted entirely to informal discussions by all in attendance. A leader has been appointed to guide the discussion along such lines as will give the greatest interchange of knowledge.

### Inspection Trips

No regular organized trips have been arranged for the inspection of manufacturing or other businesses. All of the time which has normally been devoted in past conventions to inspection trips will be spent at the Century of Progress Exposition.

The first trip to the Fair will be made on Tuesday afternoon at 4:00 P.M., and buses will be provided to transport everyone from the hotel to the Fair grounds. Because no concessions are made in the sale of large quantities of tickets for the Fair, members will purchase tickets



The image of the patron saint of Tibet smiles from its pedestal in the interior of the Golden Pavilion.

This fine example of Chinese Lama architecture is a replica of the Golden Pavilion of Jehol.

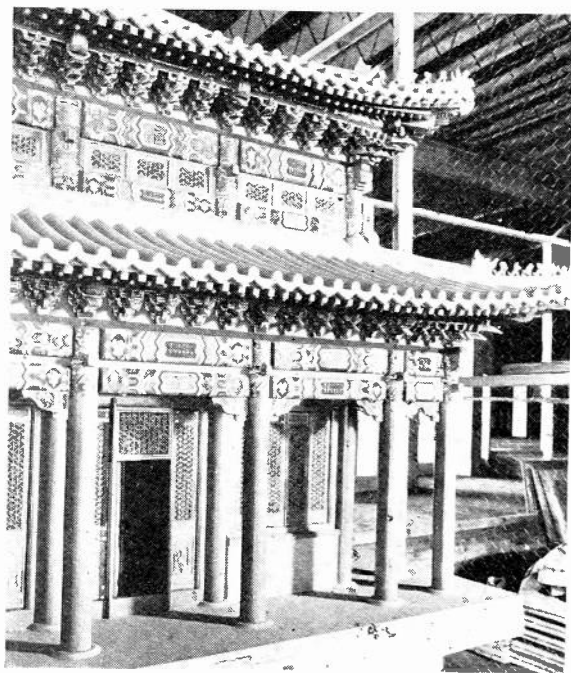

individually at the Fair. The general admission charge is seventy-five cents per person.

No provision has been made for official activities on Tuesday evening; this will permit those attending the Fair to see it during the last few daylight hours, to have dinner at any of its several restaurants, and to spend the evening there.

The visit to the Exposition on Wednesday is scheduled for noon, and again buses will be available for transportation from the hotel to the Fair grounds. Lunch at the Blue Ribbon Casino is entirely informal and no advance registrations need be made. Plans are simply for those who are interested to have luncheon at the same place which will permit small groups to travel about together after luncheon and make their visit more pleasant and instructive.

### **Engineering Week**

The week of June 26 will be known as "Engineering Week" at the Fair, and during it, practically every major engineering organization in the country which meets regularly will be holding a convention. It is anticipated that several thousand engineers will be visiting Chicago during that week and efforts will be made to see that the exposition is made of as great interest to engineers as possible.

Wednesday, June 28, will be known as "Engineers' Day" and some special events have been scheduled at the Fair. The final program of the Fair for this day has not been completed and some changes may be made in our own program to conform with it.

A banquet to be attended by engineers in all fields has been scheduled for Wednesday evening at the Stevens Hotel. It is probable that only a limited number of tickets will be available, and those desiring to attend should request tickets at their earliest convenience.

### **Exhibition**

An exhibition of component parts, manufacturing aids, and measuring devices will again be a major portion of the convention. Because the exhibition will be restricted to items which are of general interest to engineers and the showing of broadcast radio receivers, as such, prohibited, the engineer will find his time valuably occupied. An excellent opportunity is therefore afforded the engineer to discuss his problems with representatives of the manufacturer whose products he uses.

### **Banquet**

An informal banquet will be held in the Bal Tabarin in the Hotel Sherman. Those who had the pleasure of attending the banquet held

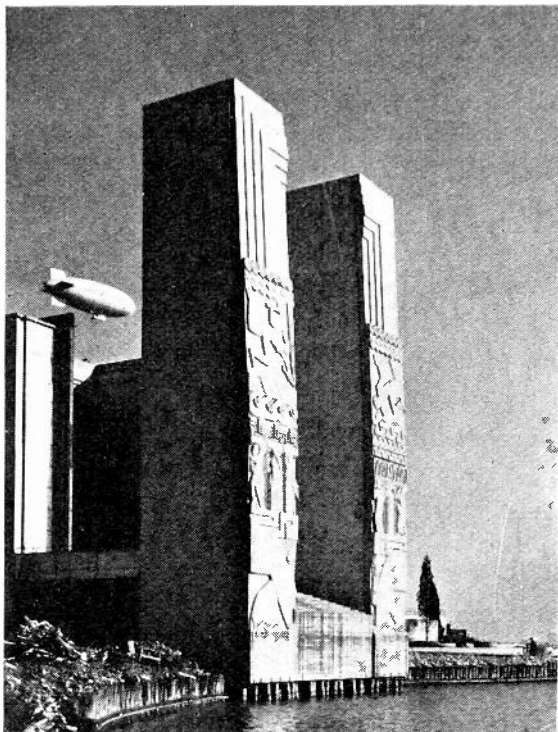

At the edge of the lagoon one finds these massive twin pylons guarding the water gate to the Electrical Building.

This is the interior of the courtyard which lies within the semicircular structure of the Hall of Science.



during the 1931 Convention will want to renew their acquaintance with that interesting place, the walls of which are decorated by means of light only. An interesting program of entertainment has been prepared, and all who attend are assured of an enjoyable evening. Banquet tickets should be purchased on Monday morning and will be on sale at the registration booth at \$3.50 each.



The Grand Ballroom, in which the technical sessions will be held, is equipped with a public address system.

### **Reduced Railroad Rates**

As one of the organizations affiliated with the American Association for the Advancement of Science, the Institute has been granted reduced railroad rates on the certificate plan. When purchasing one-way tickets to Chicago for members of the Institute and their families, requests should be made of the railroad ticket agent for a certificate issued for the meetings of the American Association for the Advancement of Science and the Institute of Radio Engineers as an affiliated organization. These certificates must be presented at the convention and will be validated by a representative of the railroads. When presented to the railroad ticket agent, a return ticket over the same route traveled to Chicago may be purchased for one third of the regular rate. This reduction in rate applies only to the railroad ticket and does not cover pullman reservations. Further details will be mailed to the membership a week or so prior to the convention.

## SOME ASPECTS OF RADIO LAW

J. WARREN WRIGHT

(Radio Division, Navy Department, Washington, D.C.)

## SUMMARY

The Radio Act of 1927 was passed to regulate all forms of interstate radio communication and any transmission by electrical energy without wires. The case of *Whitehurst vs. Grimes* extended the application of the Act by establishing a presumption of law that any radio transmission is interstate in character or imposes a burden on such commerce.

The radio cases proceed on the theory that radio transmission is commerce within the meaning of the Constitution, but the Supreme Court has not passed directly on this question. The radio cases are differentiated from the telephone and telegraph cases, and radio broadcasting is compared with advertising by billboard. As it may be open to question whether all radio transmission is commerce, the right of the Federal Government to regulate radio under ancillary powers is pointed out in support of its sole power over such transmission.

The present tendency to regard the public reception for profit of copyright material broadcast by radio as an infringing performance is discussed.

The doctrine of *Utah Company vs. Pfof* is applied to radio to show the power of the several states to regulate certain phases of radio, not connected with the licensing of transmission, particularly as to regulations passed pursuant to their police powers.

It is also shown that the courts do not regard a license to broadcast as granting immunity to a broadcast station from liability for damages for libel published over the station.

Few new legal principles seem to be involved, but engineers and lawyers should cooperate so that radio law develops in accordance with fact situations.

## PATENT RELATIONS OF THE ENGINEER TO HIS EMPLOYER

LEONARD GARVER, JR.

(Larbach and Garver, Cincinnati, Ohio)

## SUMMARY

There are three different situations involved:

*First:* Where the employee conceives the idea and develops it on the time of the employer using his laboratory.

*Second:* Where the employee conceives the idea but develops it on his own time, using his own personal apparatus.

*Third:* Where the employee conceives the idea either on his own time or during his hours of employment, but develops it on his own time, however, using his employer's apparatus.

All these involve different rights, and, therefore, different provisions should be made in each class of cases if good feeling is to prevail between the employer and the engineer.

## THE RADIO PATROL SYSTEM OF THE CITY OF NEW YORK

F. W. CUNNINGHAM AND T. W. ROCHESTER

(Bell Telephone Laboratories, Inc., New York City, and New York Police Department,  
New York City)

### SUMMARY

The application of radiotelephony to municipal police work in New York City is described from the organization viewpoint. Brief references are made to historical backgrounds and description of apparatus, and the steps taken to select a receiver suitable for local conditions are outlined. The method of controlling the patrol force by radio is described in some length with examples, and a summary of results during the first year is given to show the value of this means of communication to police work.

## THE ICONOSCOPE—A MODERN VERSION OF THE ELECTRIC EYE

V. K. ZWORYKIN

(RCA Victor Company, Inc., Camden, N.J.)

### SUMMARY

This paper gives a preliminary outline of work with an electric eye—Iconoscope—as a pick-up for television and similar applications. It required ten years to bring the original idea to its present state of perfection.

The iconoscope is a vacuum device with a photo-sensitive surface of a unique type. This photo-sensitive surface is scanned by a cathode ray beam which serves as a type of inertialess commutator. A new principle of operation permits very high output from the device.

The sensitivity of the iconoscope, at present, is approximately equal to that of photographic film operating at the speed of a motion picture camera. The resolution of the iconoscope is high, fully adequate for television.

The paper describes the theory of the device, its characteristics, and mode of operation.

In its application to television the iconoscope replaces mechanical scanning equipment and several stages of amplification. The whole system is entirely electrical without a single mechanically moving part.

The reception of the image is accomplished by a kinescope or cathode ray receiving tube described in an earlier paper.

The tube opens wide possibilities for applications in many fields as an electric eye, which is sensitive not only to the visible spectrum but also to the infra-red and ultra-violet region.

## VACUUM TUBES FOR USE AT EXTREMELY HIGH FREQUENCIES

B. J. THOMPSON AND G. M. ROSE, JR.

(RCA Radiotron Company, Inc., Harrison, N.J.)

### SUMMARY

This paper describes the construction and operation of very small triodes and screen-grid tubes intended for reception at wavelengths down to 60 centimeters with conventional circuits.

The tubes represent nearly a tenfold reduction in dimension as compared with conventional receiving tubes, but compare favorably with them in trans-

conductance and amplification factor. The interelectrode capacitances are only a fraction of those obtained in the larger tubes.

The triodes have been operated in a conventional feed-back oscillator circuit at a wavelength of 30 centimeters with a plate voltage of 115 volts and a plate current of 3 milliamperes.

Receivers have been constructed using the screen-grid tubes which afford tuned radio-frequency amplification at 100 centimeters and 75 centimeters, a gain of approximately four per stage being obtained at the longer wavelength.

### VACUUM TUBE CHARACTERISTICS IN THE POSITIVE GRID REGION BY AN OSCILLOGRAPHIC METHOD

H. N. KOZANOWSKI AND I. E. MOUROMTSEFF

(Westinghouse Electric and Manufacturing Company, East Pittsburgh, Pa.)

#### SUMMARY

A method of determining "complete" plate and grid characteristics of vacuum tubes in the positive grid region by means of oscillographic recording has been developed. A condenser of high capacity furnishes a single pulse of grid excitation which can be made to cover the entire region from any desired positive grid voltage to zero. Due to the rapidity of this excitation instantaneous power input to the tube of twenty to thirty times nominal rating has been recorded without danger to the tubes.

Several typical complete charts of plate and grid characteristics obtained by this method for an experimental tube of so-called "50-watt" type are given. The experimental procedure in obtaining these characteristics is discussed in detail. The circuit for obtaining oscillographically the highly important "composite diode line," with  $E_p = E_g$ , is described. The inadequacy of the usual logarithmic extrapolation of zero-grid characteristics into the positive grid region is discussed.

The complete plate and grid current charts, which can be obtained accurately only by an oscillographic method, are practically indispensable in pre-calculation of class B and class C performance. The method has been successfully used in studying the characteristics of the smallest and the largest existing tubes in this country.

### APPLICATION OF GRAPHITE AS AN ANODE MATERIAL TO HIGH VACUUM TRANSMITTING TUBES

E. E. SPITZER

(General Electric Company, Schenectady, N.Y.)

#### SUMMARY

The requirements of a material suitable for construction of anodes for high vacuum radiation-cooled transmitting tubes are discussed. The major factors are: (1) Adsorbed gases; (2) Radiation emissivity; (3) Mechanical properties; (4) Vapor pressure; (5) Electrical conductivity. Molybdenum, a typical material which has been widely used for anodes in the past, is discussed with these factors in mind. The application of graphite as an anode material is then discussed. In comparing graphite with molybdenum it is found that with proper pretreatment the greater initial gas content of graphite does not offer any serious manufacturing problems. Graphite has a higher radiation emissivity, resulting



in lower glass temperatures and therefore less danger of glass electrolysis and strain cracking. The mechanical properties of graphite render manufacture easy. Its low tensile strength must be compensated for by using thicker walls. The resulting increase in heat conductivity prevents hot-spotting and warping so that graphite anode tubes have greater electrical uniformity, not only from tube to tube, but also for the same tube at various load conditions. Grades of graphite are available which are suitable from the standpoint of vapor pressure and electrical conductivity. With proper manufacturing methods, there is no sacrifice in tube life when graphite is substituted for molybdenum.

### **DETERMINATION OF DIELECTRIC PROPERTIES AT VERY HIGH FREQUENCIES**

**J. G. CHAFFEE**

(Bell Telephone Laboratories, Inc., New York City)

#### **SUMMARY**

A simple method of determining the dielectric constant and power factor of solid dielectrics at frequencies as high as 20 megacycles with an accuracy which is sufficient for most purposes, is described. The major sources of error are discussed in detail, and several precautions which should be observed are pointed out.

### **COST VERSUS QUALITY IN BROADCAST RECEIVER DESIGN**

#### **SUMMARY**

As is indicated in the listing of technical papers, the above subject will be treated in the form of a symposium. Various major components of broadcast receivers will be discussed by engineers who have specialized in their design, production, and application. All design problems are treated with full consideration of the cost of the ultimate broadcast receiver as well as the approach to a theoretically ideal design.

### **STUDIES OF THE IONOSPHERE AND THEIR APPLICATION TO RADIO TRANSMISSION**

**S. S. KIRBY, L. V. BERKNER, AND D. M. STUART**

(Bureau of Standards, Washington, D.C.)

#### **SUMMARY**

During the past three years the Bureau of Standards has made observations of the ionosphere with the pulse method. A technique has been developed whereby a large number of measurements on frequencies which return reflections could be made, holding time essentially constant. In this manner critical frequencies have been studied.

It is found that the E-layer critical frequency shows a regular diurnal variation and a slight seasonal variation in noon maximum, indicating that the sun is the chief source of ionizing forces in the day. The seasonable variation of ion content is about 25 per cent of the maximum. In addition, sporadic increases of E-layer ionization to abnormally high values occur at random, and most frequently at night from some ionizing force apparently independent of direct radiation from the sun. Comparison of terrestrial magnetic data and electrical dis-

turbances such as thunderstorms, show no apparent relation to such irregularities so far observed.

The F region is found to be composed of two definite strata or layers in the daytime as evidenced by a second critical frequency. This critical frequency denoted as  $F_1$  critical frequency is approximately 1000 kilocycles higher than the E critical frequency, and is found to vary diurnally and seasonally in phase with the E critical frequency. Heights for the  $F_1$  layer can only be estimated as 185-190 kilometers and may be somewhat in error. The boundary between the  $F_1$  (lower F) and  $F_2$  (higher F) becomes indistinct in midwinter and at night. Certain changes near the  $F_1$  critical frequency are compared with terrestrial magnetic data.

The  $F_2$  region is found to be composed of one or more irregular and changing strata without regular seasonal or diurnal characteristics.

The  $F_2$  critical frequency is found to have less regular characteristics than the E or  $F_1$  critical frequency, but shows definite diurnal characteristics which change with season, the maximum occurring near noon in the winter and after sunset in the summer. The maximum value of this critical frequency is higher during the winter noon than during the summer noon. This and other evidence shown indicates that the  $F_2$  critical frequency does not measure maximum  $F_2$  layer ionization but is limited by total absorption rather than penetration. Conditions for which this is true are shown experimentally. From the evidence it is indicated that daytime and possibly night skip distances are absorption phenomena, as suggested by T. L. Eckersley, rather than penetration phenomena. On the basis of this fact, certain radio transmission characteristics are discussed. An estimate of daytime ionization from maximum critical frequencies indicates an ion content in excess of  $2 \times 10^6$  electrons per cubic centimeter for the  $F_2$  layer.

### ELECTRICAL DISTURBANCES OF EXTRATERRESTRIAL ORIGIN

KARL G. JANSKY

(Bell Telephone Laboratories, Inc., New York City)

#### SUMMARY

Electromagnetic waves of an unknown origin were detected during a series of experiments on atmospherics at high frequencies. Directional records have been taken of these waves for a period of over a year. The data obtained from these records show that the horizontal component of the direction of arrival changes 360 degrees in about 24 hours in a manner that is accounted for by the daily rotation of the earth. Furthermore, the time at which these waves are a maximum and the direction from which they come at that time changes gradually throughout the year in a way that is accounted for by the rotation of the earth about the sun. These facts lead to the conclusion that the direction of arrival of these waves is fixed in space; that is, that the waves come from some source outside the solar system.

### ATTENUATION OF OVER-LAND RADIO TRANSMISSION IN THE FREQUENCY RANGE 1.5 TO 3.5 MEGACYCLES PER SECOND

CLIFFORD N. ANDERSON

(American Telephone and Telegraph Company, New York City)

#### SUMMARY

It has been recognized for many years that the attenuation of radio transmission over-land (ground wave) is much higher than over water. It was not,

however, until recently that it was generally appreciated that the effect of the ground per mile varies with distance from the transmitter, and that the effect is different for a given amount of land when the transmission is entirely over land, or when the land is adjacent to either the radio transmitter or receiver, or intermediate (nonadjacent). Several papers in recent years have discussed one or more phases of the effect of land on radio transmission and it is the purpose of this paper to present various data in the 1.5- to 3.5-megacycle range, which have been accumulated during the past few years chiefly in connection with various site surveys, and to show the relation of these data to a more generalized picture of over-land attenuation.

Nearly all of the data previously published on over-land attenuation of radio transmission have been concerned with transmission on frequencies in the broadcast range and for cases where the transmission path is entirely over land. The data described in this paper are for frequencies above the broadcast range and treat of various combinations of over land and over-water transmission, as well as entirely over land. These additional data in the higher frequency range enable one to form a clearer over-all picture of the effect of frequency on over-land attenuation.

The generalizations herein are chiefly in the form of curves which enable one to make approximations of field strengths to be expected in the 1.5- to 3.5-megacycle frequency range with transmission paths consisting entirely of sea water, entirely of land, and various combinations of land and water.

Curves are also shown which enable field strength approximations to be made for entire over-land transmission using other frequencies. In obtaining these curves, use was made of published data on ground attenuation in the broadcast frequency range. When plotted with distance on a logarithmic scale, the curves of apparent absorption are, in general, quite similar for the various frequencies and beyond a critical distance, which varies approximately inversely with the square of the frequency, the absorption per mile varies approximately inversely with its distance from the transmitter.

#### NOTE ON A MULTIFREQUENCY AUTOMATIC RECORDER OF KENNELLY-HEAVISIDE LAYER HEIGHT

T. R. GILLILAND

(Bureau of Standards, Washington, D.C.)

##### SUMMARY

A system is described which gives a curve of virtual height of the Kennelly-Heaviside layer against frequency. The equipment consists of a transmitting and receiving set which are automatically varied in frequency from 2500 to 4400 kilocycles at a uniform rate of 200 kilocycles per minute. The virtual height is recorded photographically by an oscillographic recorder of the type previously used for fixed frequency work.

Records are given which show the characteristics for different times of day and night. In the daytime during the period of these tests three strata were usually indicated. As a rule the E layer with a virtual height of about 120 kilometers is found to return energy for frequencies below 300 kilocycles. Between 3000 and 3600 kilocycles reflections are likely to come from the F<sub>1</sub> region with a virtual height of about 200 to 240 kilometers, while above 3600 kilocycles the F<sub>2</sub> region at 280 kilometers and higher returns energy. These values vary

considerably from day to day. Of particular interest is the character of the change observed when passing from one stratum to another as the frequency is increased. Although, at times, when passing from E to  $F_1$  reflections may drop out completely for a short interval, frequently the curve is continuous and the time retardation will reach a high value just before the appearance of the  $F_1$  reflection. When passing from  $F_1$  to  $F_2$  the virtual height frequently reaches 800 or 900 kilometers. As evening approaches reflections no longer come from the E layer and the long retardation between  $F_1$  and  $F_2$  becomes less pronounced. By sunset the curve is almost straight and there is little change of height with frequency. Later at night the highest frequencies cease to be returned and long retardations again occur. The phenomenon of double refraction is in evidence at this time.

This system offers a more convenient method than the manual methods previously employed. Besides the advantages from the standpoint of economy in personnel it is possible to obtain a record where time is essentially constant. The curves contain many important details which the manual operator would find it impossible to record.

#### DETERMINATION OF THE DIRECTION OF ARRIVAL OF SHORT RADIO WAVES

H. T. FRIIS, C. B. FELDMAN, AND W. M. SHARPLESS  
(Bell Telephone Laboratories, Inc., New York City)

##### SUMMARY

The paper deals with methods and technique for the determination of the direction of arrival of short waves at a receiving site, and with data obtained on the reception of transatlantic signals.

#### A STUDY OF REFLEX CIRCUITS AND ASSOCIATED TUBE PROPERTIES IN MODERN RECEIVERS

DAVID GRIMES AND W. S. BARDEN  
(RCA License Laboratory, New York City)

##### SUMMARY

Reflexed r-f:i-f, and a-f:i-f circuits, are considered from both practical and analytical standpoints. These considerations include the effect of tube properties on the reflexed signals, and the factors which are found to minimize effectively signal interaction and circuit interaction.

#### A NEW CONE LOUD SPEAKER FOR HIGH FIDELITY SOUND REPRODUCTION

HARRY F. OLSON  
(RCA Victor Company, Inc., Camden, N.J.)

##### SUMMARY

Economic conditions which are involved in every product designed for the multitudes have prevented the adoption of the various elaborate types of wide range sound reproducers. A consideration of this problem shows that the loud speaker is one of the component parts which has limited the range of radio and phonograph reproduction. This paper describes the result of a program of devel-

opment on the production of a wide range cone loud speaker capable of delivering large acoustic outputs, and at the same time retaining a system free from the complexities of construction usually associated with wide range electro-acoustic transducers. The wide range cone loud speaker consists of a voice coil and coil cylinder segregated into masses and compliances and connected to a cone suitably corrugated to present an impedance to the driving system which would yield uniform response from 80 to 10,000 cycles. Objective and subjective performance tests indicate that this loud speaker is suitable for high fidelity sound reproduction, and substantiates the theoretical analysis.

## A LIFE TEST POWER SUPPLY UTILIZING THYRATRON RECTIFIERS

H. W. LORD

(General Electric Company, Schenectady, N.Y.)

### SUMMARY

Thyratron rectifiers for supplying high voltage direct current to radio transmitting tube life test racks are superior to motor-generator sets where quietness, flexibility, low operating cost, and safe operation over long intervals of time are desirable.

An installation for supplying typical voltages, in conjunction with usual forms of electric power supplies is described. This consists of two high power rectifiers for 425- and 1000-volt direct-current plate supplies and a low power 125-volt direct-current rectifier for bias voltage. A control circuit provides complete protection against faults, detrimental to tube operating conditions such as low filament voltage, low bias, and resumption of power after failure, insuring a maximum of life testing hours available consistent with safe operation.

---

## May Meeting of the Board of Directors

The regular monthly meeting of the Board of Directors was held on May 3 at the Institute office and was presided over by President Hull. Melville Eastham, treasurer; O. H. Caldwell, Alfred N. Goldsmith, R. A. Heising, J. V. L. Hogan, C. W. Horn, C. M. Jansky, Jr., E. L. Nelson, E. R. Shute, H. M. Turner, A. F. Van Dyck, William Wilson, and H. P. Westman, secretary, were present.

Approval was granted of thirty-three applications for Associate membership, one for the Junior grade, and nineteen for Student membership.

Upon recommendation of the Awards Committee, the Medal of Honor for 1933 was awarded to Sir J. A. Fleming for the conspicuous part he played in introducing physical and engineering principles into the radio art.

The Morris Liebmann Memorial prize was awarded to Heinrich Barkhausen for his work on oscillation circuits, and particularly on that type of oscillator which now bears his name.

The Nominations Committee submitted its recommendations and the Board prepared its slate of candidates for officers. These candidates are listed in the announcement immediately following this report.

The Institute accepted an invitation by the Executive Committee of the American Section of the International Scientific Radio Union to act as joint sponsor of the spring meeting which that organization has held in Washington in April during the past several years.

In order to reduce the overhead expense of the Emergency Employment Service which the Institute is maintaining and to bring the Board of Directors more intimately into contact with its administration, the Emergency Employment Committee was dissolved and the operation of this service was transferred to the office of the Institute under the supervision of the secretary reporting directly to the Board.

---

### Election Notice

In accordance with requirements of the Constitution, Article VII is published herewith.

#### ARTICLE VII

##### NOMINATION AND ELECTION OF PRESIDENT, VICE PRESIDENT, AND THREE DIRECTORS AND APPOINTMENT OF SECRETARY, TREASURER, AND FIVE DIRECTORS

Sec. 1—On or before July 1st of each year the Board of Directors shall call for nominations by petition and shall at the same time submit to qualified voters a list of the Board's nominations containing at least two names for each elective office, together with a copy of this article.

Nominations by petition shall be made by letter to the Board of Directors setting forth the name of the proposed candidate and the office for which it is desired he be nominated. For acceptance a letter of petition must reach the executive office before August 15th of any year, and shall be signed by at least thirty-five Fellows, Members, or Associates.

Each proposed nominee shall be consulted and if he so requests his name shall be withdrawn. The names of proposed nominees who are not eligible under the Constitution, as to grade of membership or otherwise, shall be withdrawn by the Board.

On or before September 15th, the Board of Directors shall submit to the Fellows, Members, and Associates in good standing as of September 1st, a list of nominees for the offices of President, Vice President, and three Directors. This list shall comprise at least two names for each office, the names being arranged in alphabetical order and shall be without indication as to whether the nominees were proposed by the Board or by petition. The ballot shall carry a statement to the effect that the order of the names is alphabetical for convenience only and indicates no preference.

Fellows, Members, and Associates shall vote for the officers whose names appear on the list of nominees, by written ballots in plain sealed envelopes, en-

closed within mailing envelopes marked "Ballot" and bearing the member's written signature. No ballots within unsigned outer envelopes shall be counted. No votes by proxy shall be counted. Only ballots arriving at the executive office prior to October 25th shall be counted. Ballots shall be checked, opened, and counted under the supervision of a Committee of Tellers, between October 25th and the first Wednesday of November. The result of the count shall be reported to the Board of Directors at its first meeting in November and the nominees for President and Vice President and the three nominees for Directors receiving the greatest number of votes shall be declared elected. In the event of a tie vote the Board shall choose by lot between the nominees involved.

Sec. 2—The Treasurer, Secretary, and five appointive Directors shall be appointed by the Board of Directors at its annual meeting for a term of one year or until their successors be appointed.

In accordance with the above, the Board of Directors lists as its candidates the following members who meet the constitutional requirements for such offices and who have signified their acceptance as candidates.

For President	C. M. Jansky, Jr. A. F. Van Dyck
For Vice President	Balth. van der Pol Hidetsugu Yagi
For Directors	Alfred N. Goldsmith J. V. L. Hogan E. R. Shute J. C. Warner W. C. White William Wilson

Ballots will be mailed to all qualified voters in accordance with the constitutional requirements indicated above.



TECHNICAL PAPERS

THE OPTICAL BEHAVIOR OF THE GROUND FOR  
SHORT RADIO WAVES\*

BY

C. B. FELDMAN

(Bell Telephone Laboratories, Inc., New York City)

*Summary*—The rôle of the ground in radio transmission is first considered generally. In short-wave propagation taking place via the Kennelly-Heaviside layer only the ground in the vicinity of the antennas is involved, and its effect may be included in antenna directivity. The utility of so ascribing the ground effect exclusively to the terminals of a radio circuit rests on the applicability of simple wave reflection theory in which the distance between the terminals does not appear. For this purpose reflection equations, similar to Fresnel's equations for a nonconducting dielectric, are employed with a complex index of refraction.

The paper describes experiments undertaken to determine the limits of applicability of these optical reflection equations and discusses the results. Particular emphasis is placed on the identification of direct and reflected waves. The existence of a surface wave, foreign to simple reflection theory, is recognized with vertical antennas, when the incident wave is not sufficiently plane. At angles of incidence between grazing and the pseudo-Brewster value the requirements of planeness are severe. The relation of optics to Sommerfeld's theory is discussed. The experiments include tests made with the aid of an airplane.

For short-wave communication via the Kennelly-Heaviside layer, use of the modified Fresnel equations is shown to be justified. These equations fail only at substantially grazing incidence and then merge into the Sommerfeld ground wave solution. The ground effect is always to discriminate against radiation or reception at very low angles.

Two methods of determining the electrical constants of the ground are described. One comprises measurements of the elliptical polarization of the ground wave, and is based on Sommerfeld's propagation theory. The other is a method of measuring, at radio frequencies, the conductivity and dielectric constant of samples of ground removed from the natural state. Suitable agreement between the two methods is found if the nonuniformity and stratification of natural ground is considered. The sample method is also used to determine the conductivity of ocean water.

I. INTRODUCTION

IN going from the simple to the complex let us consider first an infinitely conductive plane surface above which is a transmitting antenna. The effect of the conducting plane on the field above the boundary is obtained readily by satisfying the boundary conditions,

\* Decimal classification: R113. Original manuscript received by the Institute, January 26, 1933.



and proves to be precisely the same as that of an "image" of the antenna, replacing the surface. If, however, the conductivity is finite, the effect of the surface is,<sup>1</sup> in general, no longer that of an image.

A number of attempts have been made theoretically to describe the field associated with an antenna situated over a plane homogeneous ground, those of Sommerfeld<sup>2</sup> and of Wise<sup>3</sup> being notable. Sommerfeld's work is mainly applicable to the field established near the surface by a vertical electric doublet located on the surface. Wise treats elevated vertical and horizontal doublets and describes the field at a great distance from them at any vertical angle. All mathematical investigations indicate that the effect of the ground is to influence the mode of propagation and that this effect depends upon the dielectric and conductive properties of the ground, upon the type of radiating antenna and its elevation, and upon the position in space with which one is concerned. Thus, Sommerfeld shows that the field along the surface of the ground due to a vertical electric doublet is a complicated wave whose attenuation law and other properties vary with distance.

Those theoretical workers who have extended their investigations above the surface of the ground all agree in their expressions for the field, in the limit as the distance from the radiator is increased. The field, in terms of antenna current, is in that case a spherical wave equivalent to the sum of a wave propagated directly from the antenna, ignoring the ground, and another wave regularly reflected from the ground surface with the reflection coefficient for a *plane* wave. This result follows from a consideration of the reciprocal theorem, the imaginary exploring receiver being replaced by a similar transmitter. The field from such a transmitter, as the distance approaches infinity, is a spherical wave of infinite radius, or, simply, a plane wave. The influence of the ground in terms of electric field at the antenna location is then merely the regular reflection of a plane wave from an infinite plane-surfaced conducting dielectric. Optical theory has long ago provided the solution of this problem.

Thus far we have discussed the relation of the ground to the field from a transmitting antenna in terms of the current in the antenna. Two additional effects of the ground are its influence upon the current distribution in the antenna, and upon the power required to establish the current. The dependence of these effects upon the particular values

<sup>1</sup> A mathematical surface which suffices to give the effect of an image in the perfectly conductive case has no effect if the conductivity is finite; thickness is then essential.

<sup>2</sup> Bibliography (1). The 1909 paper.

<sup>3</sup> Bibliography (7). In this connection Hoerschelmann (2), Weyl (4), and, more recently, Strutt (8), may be mentioned.

of the ground properties has been found, in many practical cases, unimportant, and will not be discussed in this paper.

In considering the relation of the ground to a receiving antenna one must necessarily assume the existence of the transmitting case to produce the field. No matter what may be the mode of propagation from transmitter to receiver, if the influence of the ground is completely described in connection with the transmitting case, the field at the receiver is determined and the rôle of the ground in reception is merely its influence on the circuital properties of the receiving antenna, i.e., its effect on current distribution and resistance.

If, however, the propagation takes place via the Kennelly-Heaviside layer it is only the ground in the vicinity of the transmitting and receiving antennas which is of importance, and it is distinctly useful to divide the problem into two parts and to consider the ground near the transmitter as it influences upward radiation and that near the receiver as it affects downcoming waves. The utility of this view depends on the assumption that the radiation above a grazing angle is described at the distance of the Kennelly-Heaviside layer, by plane-wave reflection locally from the transmitting site, and that, reciprocally, reception involves substantially plane waves suffering local ground reflections. Thus, the ground effect is associated exclusively with the terminals of the radio circuit.<sup>4</sup>

With wavelengths and distances for which the propagation is mainly independent of the Kennelly-Heaviside layer, the ground over the entire path is more or less involved and its effect is logically assigned wholly to the transmitter. Even then, if the reception of atmospheric noise is important, a ground effect assigned to the receiving terminal is useful since plane-wave reflection describes the effect of the ground on such noise.

It is the terminal effect of the ground with which this paper is mainly concerned. In particular, the propagation of ultra-short waves involving diffraction effects is neglected.

## II. PLANE-WAVE REFLECTION<sup>5</sup>

The mathematical postulation of the existence of a plane transverse electromagnetic wave incident upon a plane homogeneous ground demands the presence of the familiar triplet: the incident, the reflected, and the refracted wave, of which the second is also plane and transverse. The refracted wave, which is lost in the ground, will not be discussed here. Boundary conditions determine the complex ratio of

<sup>4</sup> Intermediate ground reflections which may be involved in Kennelly-Heaviside layer propagation do not, of course, detract from the utility of the terminal effect consideration.

<sup>5</sup> Bibliography (6).

reflected to incident vectors. Two different solutions occur according to how the incident wave is polarized. If the electric vector is parallel to the plane of incidence the case designated in Fig. 1 by  $\parallel$  occurs; the case in which the electric vector is perpendicular to the plane of incidence is noted by  $\perp$ . Components of both types present simultaneously are, of course, treated separately. The solutions are unique if the wave is strictly plane.

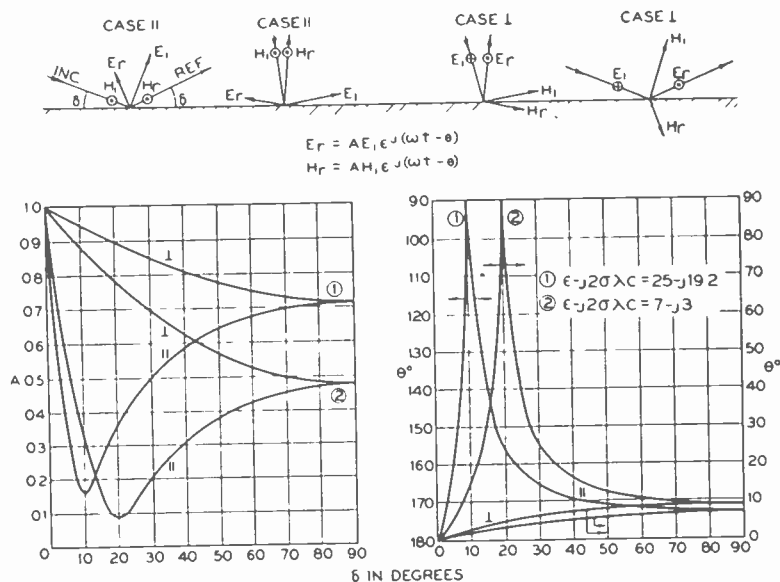

Fig. 1—Optical reflection coefficients.

Fresnel's equations for the case of reflection from a nonconducting dielectric are in the nomenclature of this paper for Case  $\parallel$ ,

$$A\epsilon^{i\theta} = \frac{\epsilon \sin \delta - \sqrt{\epsilon - \cos^2 \delta}}{\epsilon \sin \delta + \sqrt{\epsilon - \cos^2 \delta}}$$

and, for Case  $\perp$ ,

$$A\epsilon^{i\theta} = \frac{\sqrt{\epsilon - \cos^2 \delta} - \sin \delta}{\sqrt{\epsilon - \cos^2 \delta} + \sin \delta}$$

Here,

$A$  = ratio of reflected to incident intensity.

$\theta$  = phase shift accompanying reflection.

$\delta$  = angle of incidence measured from the plane surface. This is the complement of the angle usually referred to, in optical literature, as the angle of incidence.

$\epsilon$  = dielectric constant.

Corresponding to the index of refraction ( $=\sqrt{\epsilon}$ ) occurring in Fres-

nel's equations, the conducting dielectric case involves as the only modification, a complex number,  $\sqrt{\epsilon - j2\sigma\lambda c}$ , in which

$$\begin{aligned}\epsilon &= \text{dielectric constant (e.s.u.)}, \\ \sigma &= \text{conductivity (e.m.u.)}, \\ \lambda &= \text{wavelength (cm)}, \\ c &= 3 \times 10^{10}, \text{ and} \\ j &= \sqrt{-1}.\end{aligned}$$

Thus, for  $\epsilon = 20$ ,  $\sigma = 10^{-13}$  (corresponding to a resistivity of 10,000 ohm-cm) and  $\lambda = 30$  meters, the complex index is  $\sqrt{20 - j18}$ . The magnetic permeability of the ground is assumed to be unity throughout this paper. To consider permeability generally leads to equations differing from Fresnel's in that permeability, unlike conductivity, cannot be included exclusively in a modified refraction coefficient as above. Permeability affects differently the equations for Cases  $\parallel$  and  $\perp$ . We have no reason to believe that earth is magnetically susceptible, and accordingly avoid great complications by assuming that it is not. The experimental results apparently justify the assumption.

The complex ratio of reflected to incident vectors, separated into an amplitude ratio and a phase angle is plotted in Fig. 1 for two typical types of ground encountered in our work. The wavelength is assumed to be about 15 meters.

Another correspondence with Fresnel's equations for a nonconducting dielectric is the existence, in Case  $\parallel$ , of a critical angle of incidence, which, if  $\sigma = 0$ , becomes the Brewster angle. The critical angle for conducting ground is herein referred to as the pseudo-Brewster angle. In passing through this angle the phase angle undergoes a change approaching 180 degrees and is, by definition, 90 degrees at the pseudo-Brewster angle.

We have elected to describe the phase angle in reference to its value for the perfect ground case ( $\sigma = \infty$ ), making  $\theta = 0$  for such a case. Thus, in Case  $\parallel$ , the only change in the wave due to reflection from perfect ground is the change in vector direction in space. The horizontal electric components at the surface are opposed while the vertical components are additive, as shown in Fig. 1. As the angle of incidence,  $\delta$ , increases to 90 degrees the vectors become wholly horizontal, and the electric field vanishes at the surface. At normal incidence Cases  $\parallel$  and  $\perp$  are, of course, indistinguishable. If, then, the polarization is rotated 90 degrees, and  $\delta$  is reduced from 90 degrees, Case  $\perp$  results, and we have rid the reflection of a 180-degree phase shift usually associated with Case  $\perp$ . We have instead considered a reversal of amplitude introduced by the geometry and have preserved the continuity of the phase angle.

The sense of the phase angle plotted in Fig. 1 is that of a lag such as would occur if reflection with zero phase change occurred below the surface a depth appropriate to the plotted value. The geometry of the reflection must, however, be referred to the actual surface.

A striking feature of reflection theory, apparent from Fig. 1, is that destructive interference between the incident and reflected waves occurs near the ground for angles of incidence less than the pseudo-Brewster angle. At grazing incidence the field vanishes everywhere. Remembering that the incident wave was postulated to be *plane*<sup>6</sup> permits one to escape the disturbing conclusion that transmission along the ground is impossible. Indeed, Sommerfeld has not only justified the experimental fact that such transmission may occur but has shown that the wave is then neither plane nor spherical.

The assignment, to the antenna terminals of a radio circuit, of a local ground effect is merely to apply plane-wave optical reflection theory. Inasmuch as plane waves are, strictly speaking, impossible physically, and as optical theory leads to an absurdity at grazing incidence, a considerable amount of experimentation was desirable to determine the limits of applicability.

Before describing the experimental study we shall proceed to use the theory to calculate for discussion the reception characteristics of a vertical and of a horizontal electric doublet as a function of angle of incidence. Such calculations involve merely the vector addition of the vertical or horizontal components of the incident and reflected fields at the doublet location. They result in the following formulas:

For the vertical doublet (Case ||),

$$I = \cos \delta \sqrt{1 + 2A \cos \left( \frac{4\pi d}{\lambda} \sin \delta + \theta \right) + A^2} \quad (1)$$

and, for the horizontal doublet (Case  $\perp$ ),

$$I = \sqrt{1 - 2A \cos \left( \frac{4\pi d}{\lambda} \sin \delta + \theta \right) + A^2} \quad (2)$$

where,

$I$  is proportional to the electric field acting on the doublet and denotes received current,

$A$  and  $\theta$  are given in Fig. 1,

$d/\lambda$  is the elevation of the doublet in wavelengths.

<sup>6</sup> This refers to reception. The escape in the transmitting case lies in the specification that only in the limit as the distance is increased to infinity does plane-wave reflection describe the field.

These equations are plotted in Fig. 2 for  $d/\lambda = 0.25$ , employing the reflection curves labeled (2) in Fig. 1. There are also plotted the corresponding curves for perfect ground got by putting  $A = 1$  and  $\theta = 0$ . The reduced amplitudes of the imperfect ground curves represent reduced power received from a given incident field intensity or, reciprocally, denote reduced radiated field intensity if the doublet is transmitting.<sup>7</sup>

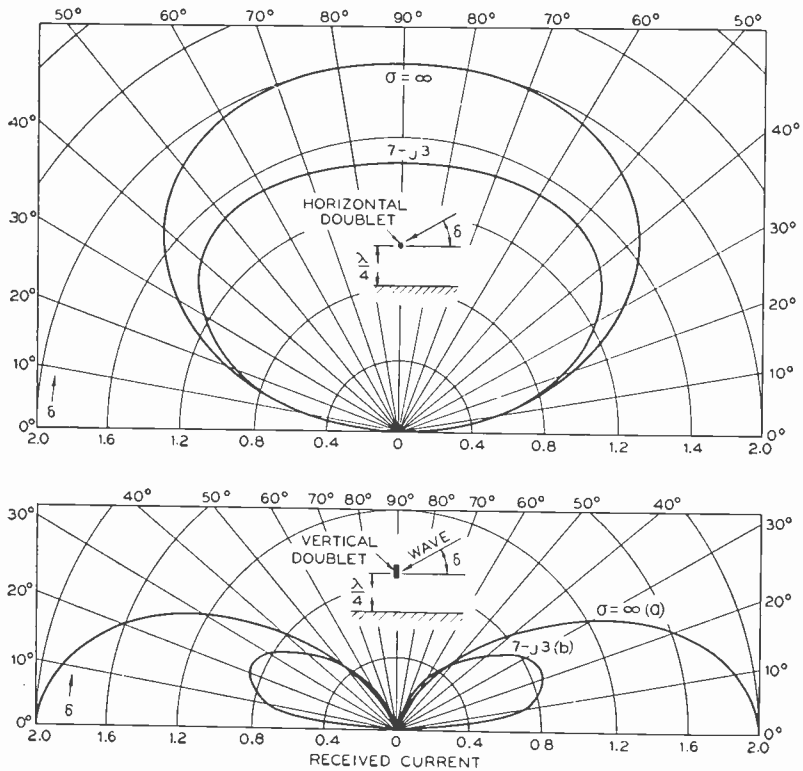

Fig. 2—Vertical plane directional characteristics of electric doublets calculated for  $(7-j3)$  ground (curve 2 of Fig. 1) and for perfect ground. The curve for the horizontal doublet refers to the median plane.

Considering these polar curves from the standpoint of radiating characteristics will make the following discussion easier.

For the horizontal case the perfect ground curve and the  $(7-j3)$  curve require no special attempt at reconciliation. The vertical case, however, exhibits a difference below the pseudo-Brewster angle which demands attention. The difference in the horizontal case is one of degree; in the vertical case it is of kind rather than of degree. If an ex-

<sup>7</sup> If, as is approximately true for elevated antennas, the resistance of the doublet is the same over imperfect ground as over perfect ground, the received power is proportional to the square of the amplitudes shown; in transmitting, the same power establishes fields proportional to the amplitudes.

ploring receiver is carried up through an arc in an effort to measure such characteristics, it is found that while in Case  $\perp$  good agreement is obtained, in Case  $\parallel$  the discrimination against grazing incidence is wholly or partially missing. As the arc radius is increased, however, the experiment could be expected to show increasingly better agreement with curve (b). As will be discussed later, the attenuation along the ground is greater than inverse distance, approaching, in fact, inverse square, while at any fixed angle above the ground the attenuation will finally be free of the effect of the ground and will approach the inverse distance law. Thus, increasing the distance discriminates against propagation along the ground (unless the ground is *perfect*), and curve (b) becomes qualitatively plausible. That the optical reflection view finally agrees with the perfect ground result may be imagined by observing the trend with conductivity of the reflection

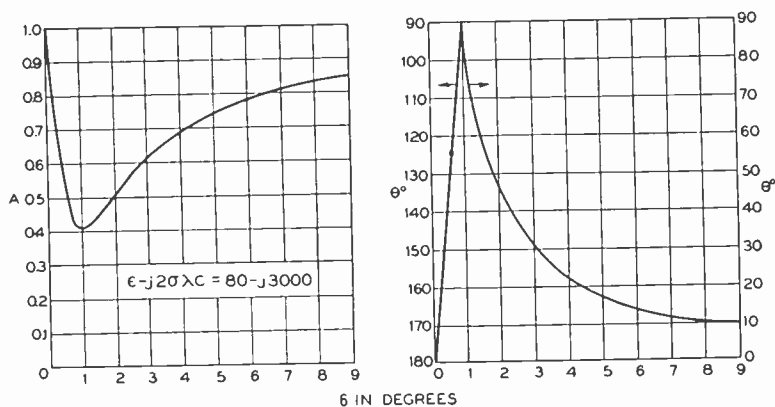

Fig. 3—Optical reflection coefficients for ocean water and a wavelength of 10 meters. (Case  $\parallel$ .) Note that the scale of abscissas is one tenth of that shown in Fig. 1.

curves. The pseudo-Brewster angle approaches zero as the conductivity is increased. For ocean water it is of the order of one degree. Reflection curves for ocean water ( $\sigma = 5 \times 10^{-11}$ ,  $\epsilon = 80$ ,  $\lambda = 10$  meters) are shown in Fig. 3.

An essential difference exists in the physical conditions for horizontally polarized and vertically polarized propagation along the ground. A "surface wave," foreign to the plane-wave optical assumption, may exist in the vertically polarized case. In the horizontally polarized case the boundary conditions are unfavorable for a surface wave. The situation is analogous, perhaps, to propagation along a wire. In such a case the wave is always polarized approximately normal to the wire surface.

With these general ideas pertaining to the subject we shall proceed to the experimental study.

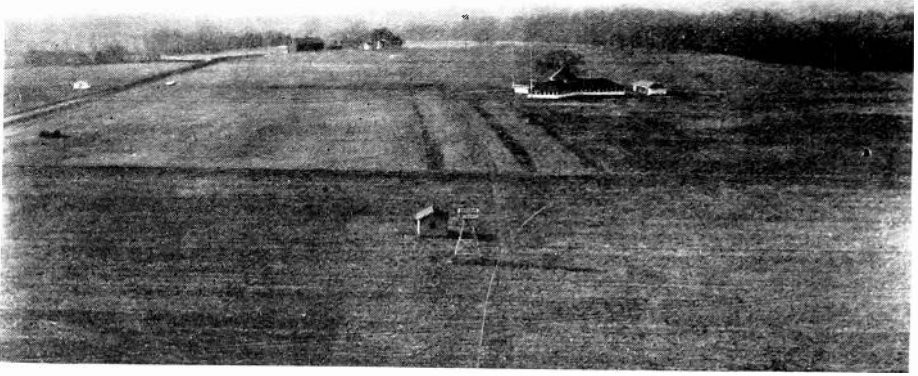

Fig. 4—View from the top of the 100-foot tower showing the flat character of the ground at the Holmdel receiving laboratories.

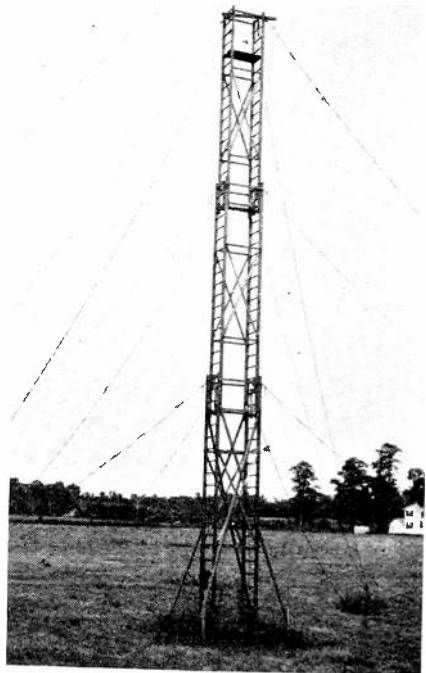
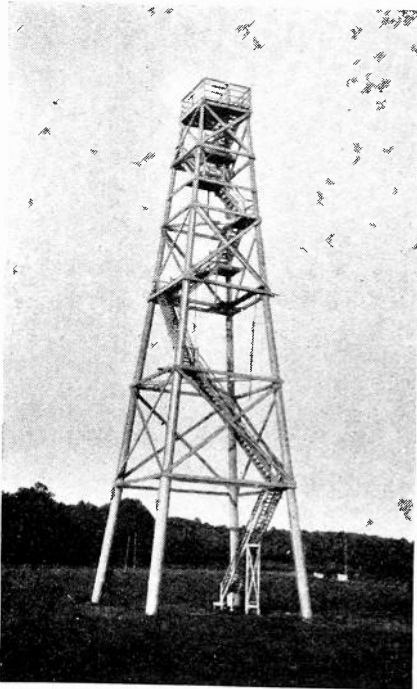

Fig. 5—A 100-foot rigid tower (left) and a 50-foot telescoping portable tower (right) used in the ground study. Both are of wood construction. The 50-foot tower is equipped with a rope tackle for elevating a receiving set.



## III. EXPERIMENTAL STUDY

Methods of measuring ground constants were first developed, and the order of magnitude of the constants at the experimental ground site was determined.<sup>8</sup> Experiments with waves were then performed, attention being focused on their optical interpretation. Particular efforts were made to identify direct and reflected waves. A few of these experiments are described in the following paragraphs.

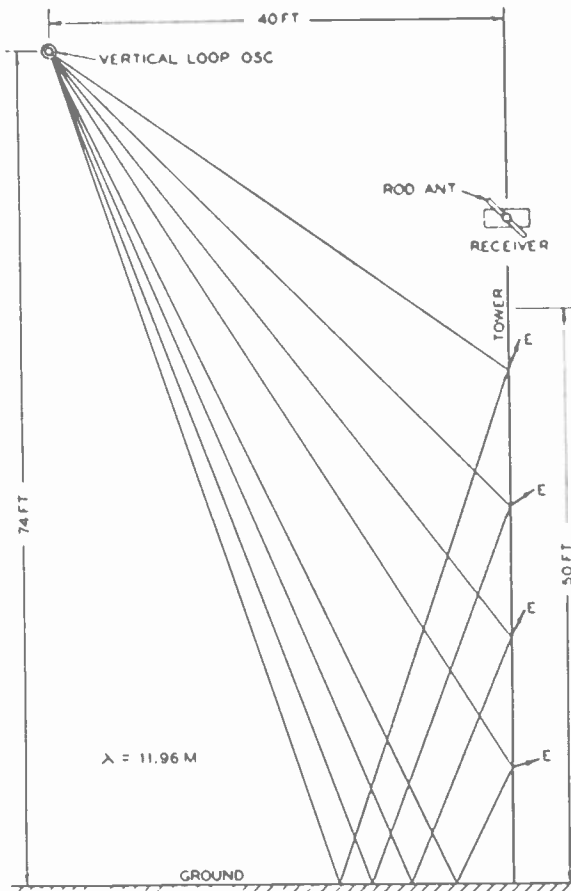

Fig. 6—Scale drawing of a wave null experiment. (Case II.) The lines represent direct, incident, and reflected wave paths.

#### Wave Null Experiments.

A type of experiment which yielded significant results is that depicted in Figs. 6 and 7. A self-contained oscillator was mounted on a pole and a receiving set was moved up and down on a tower. An operator manipulated the set from a position behind it, on the tower. With the oscillator equipped with a loop antenna and the receiver with a short rod antenna (electric doublet), as shown in Fig. 6, Case II

<sup>8</sup> These methods are described in Section IV.

could be studied. The manipulation consisted in moving slowly up or down the tower while rotating the receiving antenna to locate the deepest minimum. Interpreted optically, the height adjustment constitutes a variation of relative phase of a direct and a reflected wave, while the antenna rotation permits equalization of the amplitudes. In other words, at the null positions the polarization is linear, and the small antenna will indicate a null when set perpendicular to the field vector.

The use of a horizontal doublet transmitting antenna and a loop receiving antenna, shown in Fig. 7, corresponds to Case  $\perp$ .

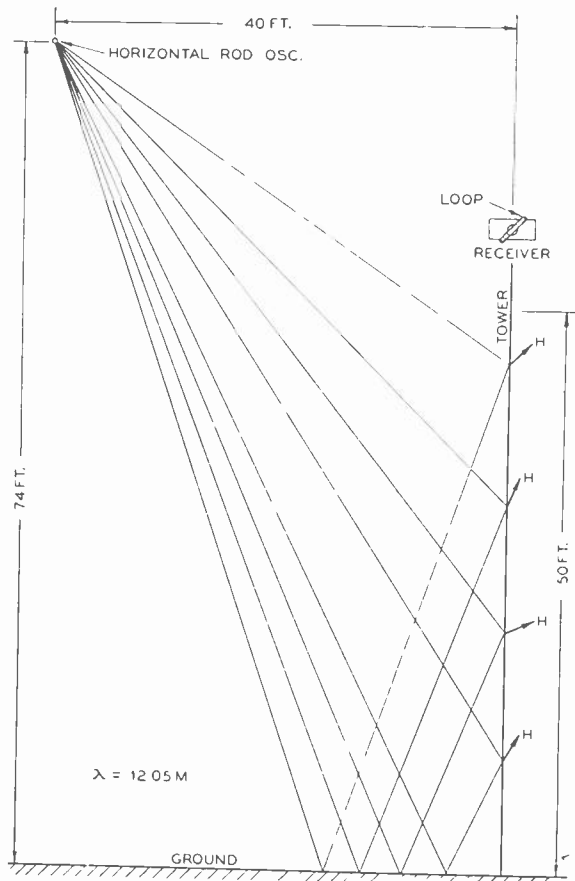

Fig. 7—Scale drawing of a wave null experiment. (Case  $\perp$ .) The loop receiving antenna, shown in an edge view, is rotatable about an axis perpendicular to the plane of incidence.

In both cases, for three wavelengths between 9 and 17 meters deep nulls were found at appropriate heights. In no instance was the minimum amplitude as much as one per cent of the maximum measured by rotating the antenna 90 degrees. The location of the minima could easily be determined within six inches, and the antenna could be set to

a degree. The difference in path length of the direct and reflected waves determines the phase change at the ground, and the angularity of the antenna with respect to the direct and reflected paths determines the ratio of amplitudes. Applying an inverse distance correction for the difference in distance should yield the reflection ratio at the ground.<sup>9</sup>

Figs. 6 and 7 are scale drawings of the geometry of the experiment for an intermediate wavelength. The arrows represent the direction of the resultant field at the null points. (The sense of the arrow is, of course, without significance.) The loop antenna used in Fig. 7 was imperfectly balanced to the extent that the null positions (both angle and height) did not coincide exactly when the loop was reversed. Average values were used in the computations. The rod antenna was, however, very well balanced and no "turnover" could be detected. The results of the null experiments are summarized in Table I.

TABLE I

$E \perp$ or $\parallel$	Osc.	Wavelength $\lambda$ Meters	Refl. Path -Inc. Path	Phase Change at Reflection $\theta$	$\theta$ Degrees	$A$	
$E \parallel$	V loop	9.56	0.45 $\lambda$	0.05 $\lambda$	18	0.41	
			0.93	0.07	25	0.65	
			1.41	0.09	32	0.51	
			1.93	0.07	25	0.67	
			2.40	0.10	36	0.65	
	11.96	0.45	0.05	18	0.52		
		0.95	0.05	18	0.72		
		1.44	0.06	22	0.50		
		1.93	0.07	25	0.68		
	16.30	0.47	0.03	11	0.58		
		0.95	0.05	18	0.74		
		1.41	0.09	32	0.42		
	$E \perp$	H Rods	12.05	0.45	0.05	18	0.75
				0.94	0.06	22	0.48
				1.44	0.06	22	0.75
1.92				0.08	30	0.46	
16.50			0.48	0.02	7	0.75	
			0.97	0.03	11	0.49	
1.48	0.02	7	0.60				
	$E \parallel$	V Loop	11.96	0.45	0.05	18	0.60*
0.93				0.07	25	0.67*	
$E \perp$	H Rods	12.05	0.45	0.05	18	0.67*	
			0.94	0.06	22	0.72*	

The apparent reflection ratios obtained at adjacent nulls differ by more than experimental error in settings, and some study was directed to learn the reason for this.

The rough correlation between the high and low values of  $A$  and the angle of the resultant field vector with respect to the vertical

<sup>9</sup> This correction involved the total lengths of the direct and reflected paths and was applied as a factor, independently of the amplitude change at the ground.

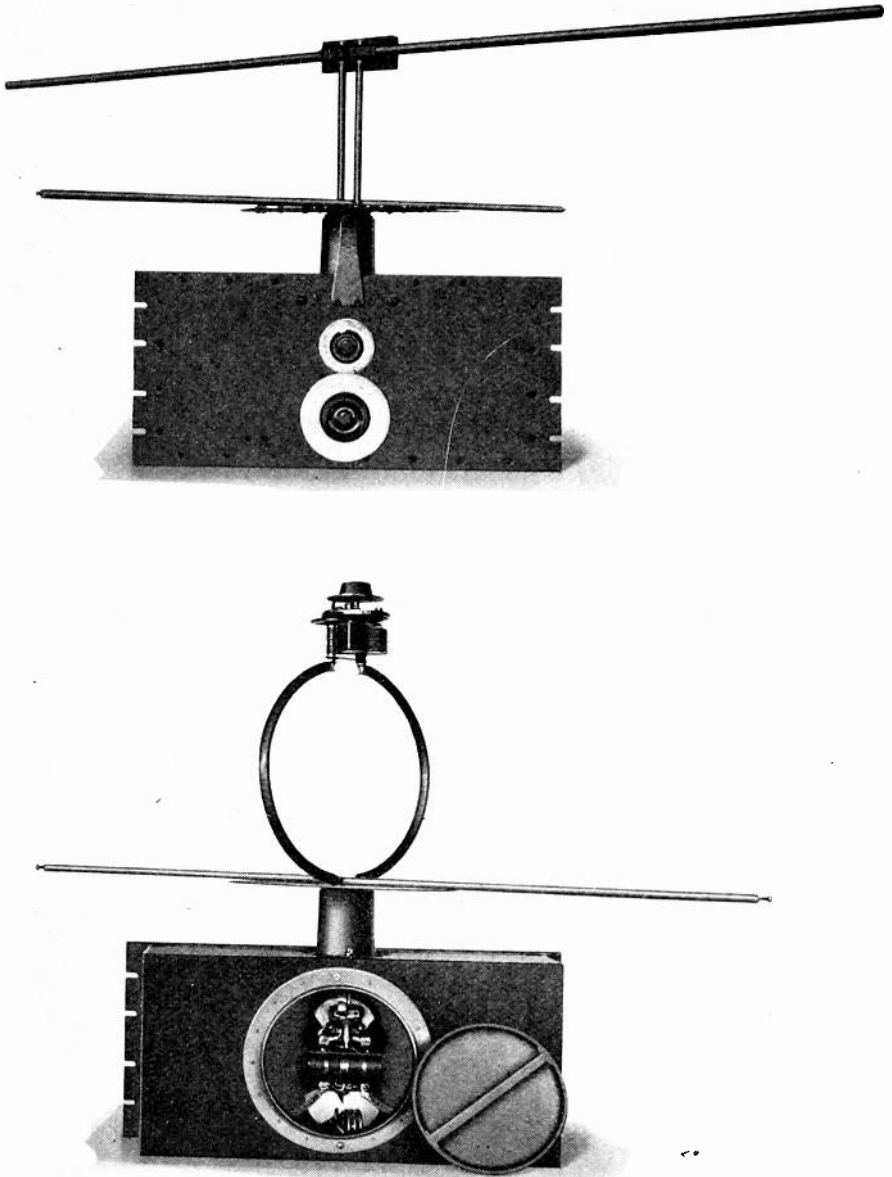

Fig. 8—High-frequency panel of the receiver used in the ground study, showing the loop antenna and the short rod antenna. The wavelength range is from 8 to 18 meters.

The antennas are interchangeable with no alteration in the coupling circuits other than varying the condensers. The loop condenser is set from a calibration curve for the frequency desired and is not changed during the tuning of the coupling circuits. The setting corresponds to resonance if the loop terminals are short-circuited. The receiver used with this panel is of the double detection type employing an intermediate-frequency attenuator. For details see Bruce and Friis, *Proc. I.R.E.*, vol. 14, pp. 507-520; August, (1926).

suggests that the receiving set was distorting the field in the vicinity of the antenna. Measurements were repeated with the set in a different position. These are marked by asterisks in Table I and show unmistakably different results. The calculated optical value of  $A$  should be about 0.7.

Concerning the phase change at reflection the measurements are probably uncertain by about  $0.01\lambda$  owing to experimental error. The determination of the ground plane is somewhat doubtful also. The surface of the turf was employed but perhaps a surface 2 or 3 inches deeper would have been more representative of an equivalent optical surface. Despite those uncertainties the measurements serve to show the expected sense of the phase shift.

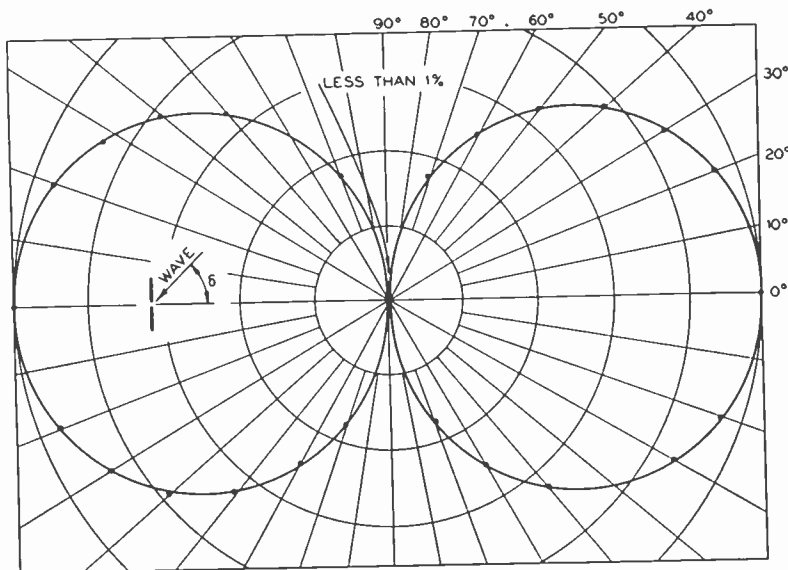

Fig. 9—Measured directional characteristics of the short rod antenna shown in Fig. 8. The plotted points were obtained with a ground wave by rotating the antenna in a plane perpendicular to the direction of propagation. The curve applies for wavelengths between 8 and 18 meters.

The one-turn loop is less perfectly balanced. Slight asymmetry is present and the minima are as much as 5 per cent of the maxima.

The apparent increase in the phase angle as higher null positions are employed is believed not to be experimental error. It can be partially explained by a more rapid change of phase near the oscillator than farther away. Hertzian doublet theory indicates that a wavelength is shorter (referred to phase) near the doublet than far away. Between one and three wavelengths away from the doublet a disparity of six degrees is calculated to exist.

The use of a loop oscillator in Case II was desirable on account of its being nondirectional in its own plane, but was really necessary because

of the end-on electric field associated with a short rod radiator at short distances. Considerable trouble in early work with rod oscillators had been traced to this "capacitive coupling" effect of the end-on field. At a distance of one wavelength the end-on component of a Hertzian doublet in free space is computed to be about 30 per cent of the broad-side component.

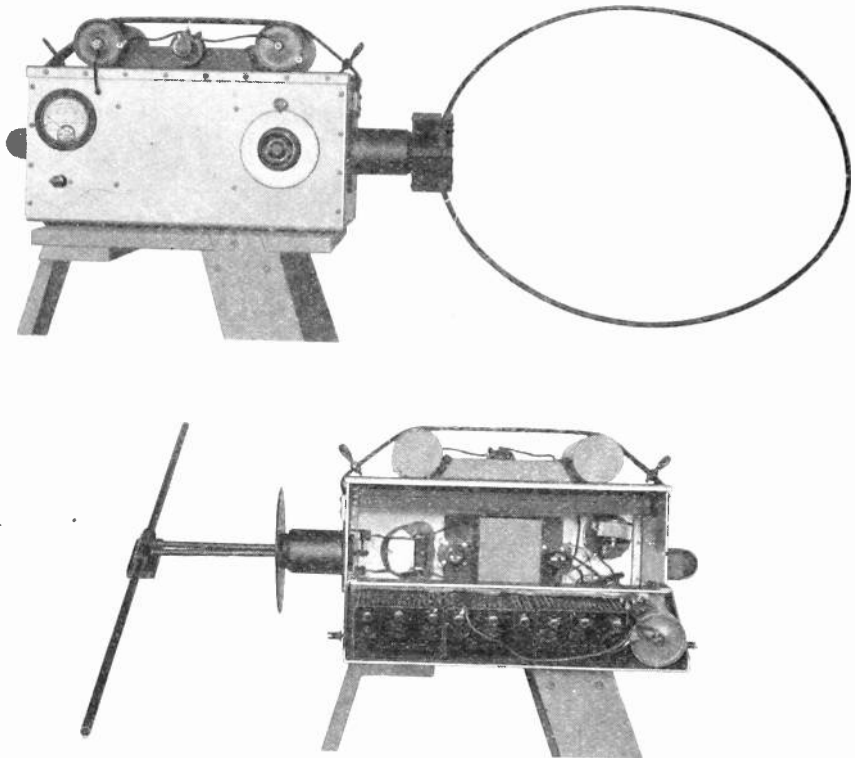

Fig. 10—The self-contained field oscillator used in the ground study. The loop and short rod antenna are interchangeable. The oscillator is of the push-pull type employing dry cells.

Apparently, these experiments indicate that plane-wave reflection theory is applicable with practically no limitations as to the "plane-ness" of the waves, if  $\delta$  is well above the pseudo-Brewster angle.

These wave null experiments were repeated with angles in the vicinity of the pseudo-Brewster angle, but with negative results. Greatly improved apparatus, practically unattainable, would be required to detect the nulls on account of the unfavorable geometry of such experiments.

#### *Inverse Distance Experiments with Case $\perp$ .*

With horizontal waves a significant experiment, suitable for low angles of incidence, employed the arrangement shown in Fig. 11. A



In some of the preliminary work a receiver, equipped with a vertical rod antenna, was located about two feet above the ground, and a vertical loop transmitter was moved up and down on a distant pole. It was ascertained that the radiating current was the same for all heights of the oscillator. The curves shown in Fig. 12 resulted. Fig. 13 shows additional data and illustrates some of the inexplicable vagaries

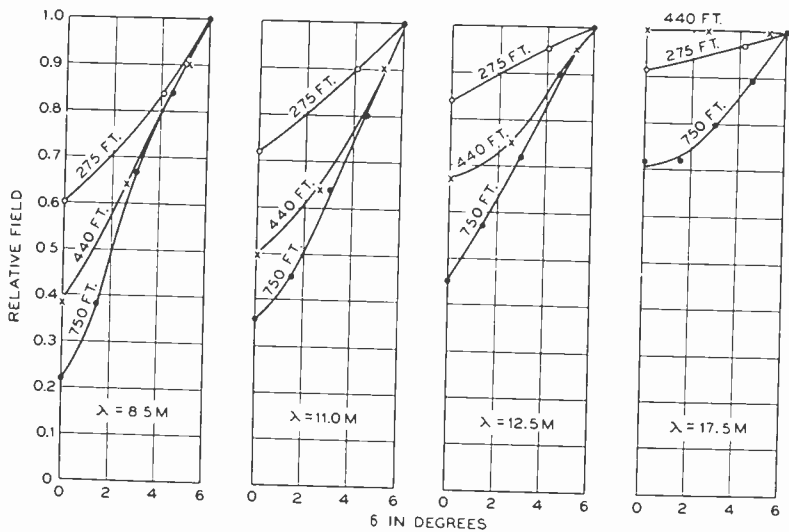

Fig. 12—Curves resulting from receiving with a vertical rod antenna near the ground, as the height of the transmitting loop was varied. The heights are expressed as incident angles. The distances between transmitter and receiver are shown on the curves. The relative fields for the twelve experiments made to coincide at the highest angle common to all.

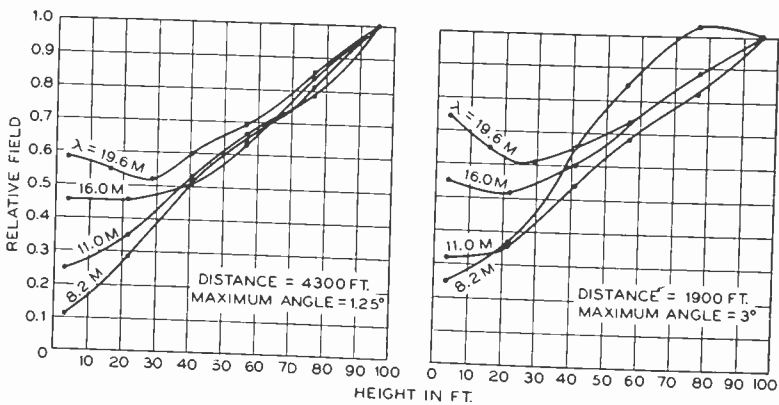

Fig. 13—Curves resulting from receiving with a vertical half-wave antenna as the height of the transmitting loop was varied. The relative fields are arbitrarily made to coincide at the maximum height.

of the propagation. In this case a vertical half-wave antenna was used for receiving. Another set of data obtained with the procedure used for the data of Fig. 12 is plotted in Fig. 14, to show the manner in which



inverse distance attenuation is approached at various low angles. The curves are plotted on logarithmic scales with distances times field as

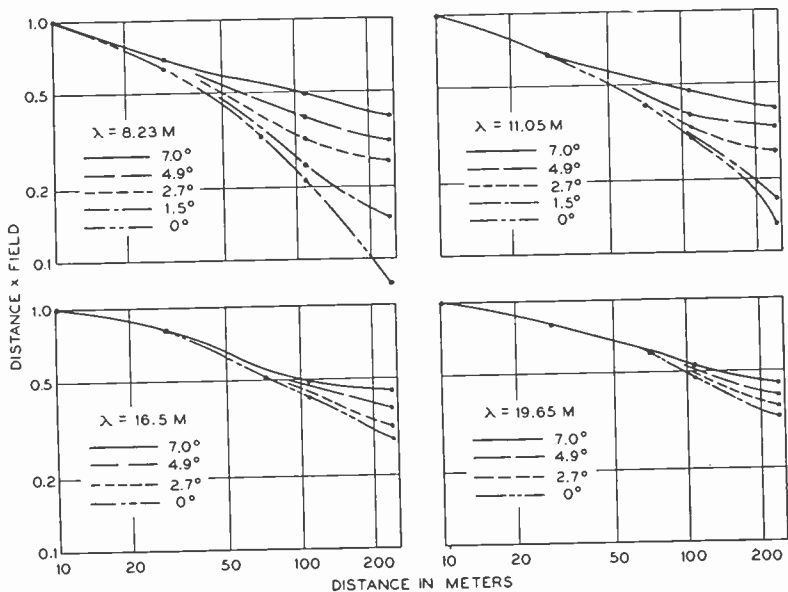

Fig. 14—Data similar to that shown in Fig. 12, plotted to show the approach to inverse distance attenuation for a fixed angle. The fields for all angles were equal at a distance of ten meters. The ordinates of the four sets of curves are, however, unrelated.

ordinates so that a horizontal line indicates inverse distance attenuation, and a line sloping downward at 45 degrees denotes inverse square

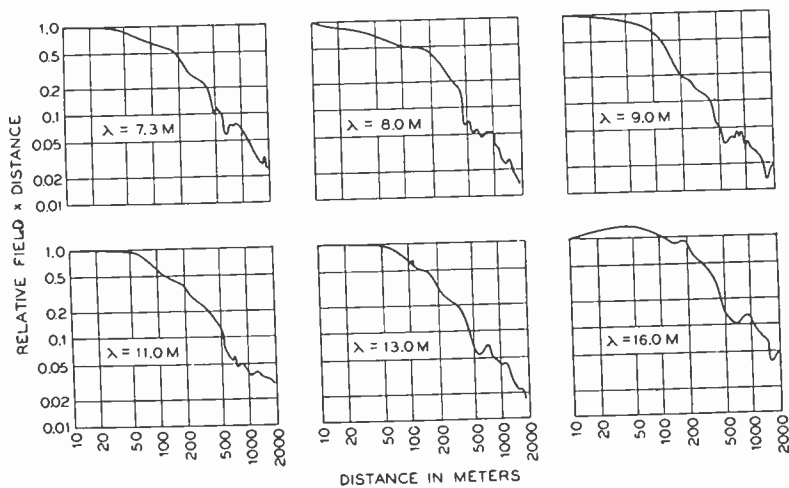

Fig. 15—Ground wave attenuation curves.

attenuation. Distances were insufficient to reach the final inverse distance region but the approach is apparent. Data, to be described

later, obtained with an airplane show unmistakably the inverse distance attenuation at a fixed angle.

On the other hand, at grazing incidence, i.e., along the ground surface, the field variation approaches rapidly, for short waves, an approximately inverse square relation. The data plotted in Fig. 15 were obtained by moving a portable vertical rod oscillator away from a fixed receiver equipped with a vertical half-wave antenna. The ground, shown in Fig. 4, is uncommonly flat and wholly free from trees. The irregularities in the curves displayed at the greater distances were found to be real. Measurements made with the receiver located several hundred meters removed from its original position on the path showed that the irregularities remained fixed with respect to the ground. With better conducting ground, such as salt marsh, the first part of the attenuation is more definitely inverse distance and persists farther as the conductivity is increased.<sup>10</sup> Thus, in the limit, as the conductivity is increased, the discrimination against low angle waves disappears and the perfect ground case results.

Comparing the results of the preceding miscellaneous experiments with optical reflection theory fails to show complete agreement. In order to facilitate the comparison an approximate expression incorporating a simplified reflection coefficient is useful. Fig. 16 depicts the geometry and shows the approximations for interpreting such experiments. For the ground at Holmdel it is legitimate to neglect certain terms in the optical reflection coefficient and to reduce  $A$  and  $\theta$  to the following simplified forms (Case  $\parallel$ )

$$A \doteq 1 - \sin \delta \sqrt{2\epsilon} \sqrt{\sqrt{1+n^2} + 1} \quad (3)$$

$$\theta \doteq \pi - \tan^{-1} [\sin \delta \sqrt{2\epsilon} \sqrt{\sqrt{1+n^2} - 1}] \quad (4)$$

<sup>10</sup> Tests have verified this. The distance at which the transition from inverse to inverse square attenuation occurs is approximately the "critical distance" and is greater for salt marsh. See footnote (11).

It seems in place here to digress briefly from Case  $\parallel$  and consider the attenuation of horizontally polarized waves. In this case attenuation becomes inverse square very near the transmitter, closely obeying the laws of reflection for Case  $\perp$ . As a result, the small vertical component usually present in a horizontal antenna will usually predominate at great distances. Even if the antenna is perfectly balanced the ground surface is usually sufficiently skew to introduce a normal component which will persist to distances where the horizontal component is negligible. At intermediate distances, the field is neither wholly vertical nor wholly horizontal, but is elliptical in a plane perpendicular to the direction of propagation.

in which,

$$n = 2\sigma\lambda c / \epsilon$$

$$2\sigma\lambda c < \text{about } 50$$

$$\epsilon > \text{about } 20$$

$$\delta < \text{about } 3 \text{ degrees.}$$

Replacing  $\sin \delta$  by  $(H+h)/D$  and calculating the vertical component of the resultant field as in Fig. 16

$$R = \frac{H+h}{D} \sqrt{\left( U_\theta - \frac{2\pi}{\lambda} \frac{2Hh}{H+h} \right)^2 + U_A^2} \tag{5}$$

where,

$$U_\theta = \sqrt{2\epsilon} \sqrt{\sqrt{1+n^2} - 1}$$

$$U_A = \sqrt{2\epsilon} \sqrt{\sqrt{1+n^2} + 1}$$

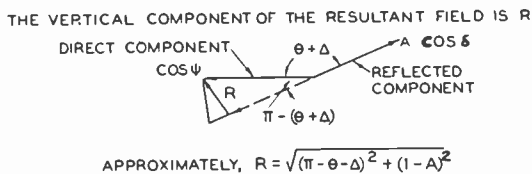
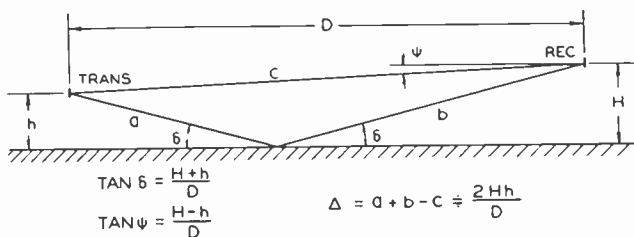

Fig. 16—Geometrical approximations useful in analyzing low angle experiments.

This calculation of the resultant ignores the inverse variation with  $D$  of the direct and reflected intensities;  $D$  is involved in (5) only in so far as the angles are concerned.

For  $\epsilon = 25$  electrostatic units and  $2\sigma\lambda c = 25$  electromagnetic units, appropriate values for Holmdel ground at 20 meters wavelength are  $U_\theta = 4.55$  and  $U_A = 11.0$ . At a wavelength of 10 meters,  $U_\theta = 2.36$  and  $U_A = 10.3$ .

Inspection of (5) using the above values of  $U_\theta$  and  $U_A$  reveals that optical reflection does not, by any means, explain the curves of Fig. 13. Neither the variations with height nor with wavelength, predicted by (5), are found experimentally.

If the finite heights of the antennas involved in the attenuation experiments are considered, (5) predicts an inverse square attenuation. In addition to the  $1/D$  variation of (5) a second inverse distance term occurs in the direct and reflected waves, resulting in inverse square variation. The predicted effect of varying the height of one or both antennas is contrary to experience, however. Little or no effect results, usually, from varying the height within a half or quarter wavelength from the ground.

These and other discrepancies between experience and optical reflection theory suggest strongly that a "surface wave" plays an important rôle in such cases.

Sommerfeld's solution for the ground wave appropriate for short "numerical distances," i.e., for distances short compared with the "critical distance,"<sup>11</sup> contains a surface wave term characterized by exponential attenuation *upward* from the ground, and exponential attenuation together with inverse square-root attenuation along the ground. While we have found no case in which this term can be said to predominate experimentally, the attenuation upward found in some experiments suggests that the propagation involves some such term.

Although Sommerfeld's analysis of the ground wave is allegedly not applicable for appreciable angles above the ground or great heights, it is of interest to observe that his inverse square equation fitting cases of great "numerical distance"<sup>11</sup> contains a height factor not entirely out of line with experience. For cases in which the dielectric constant is great compared with unity his equation reduces to

$$E_y = \frac{J}{r^2} \left[ 1 + \frac{2\pi y}{K\lambda} e^{j(\gamma - \pi/2)} \right] \quad (6)$$

where,

$J$  = constant independent of  $y$

$E_y$  = vertical component of electric field

$y/\lambda$  = height in wavelengths

$r$  = distance from transmitting doublet

$(1/K)e^{j\gamma}$  has the same meaning as in the wave tilt discussion (Fig. 21).

$K$  usually lies between 10 and 100, and  $\gamma$  is always between 0 and  $\pi/4$ .

For heights greater than several wavelengths this equation predicts an approximately linear increase of field with height.

<sup>11</sup> The "numerical distance" is a distance introduced by Sommerfeld to characterize the nature of his solution. It is proportional to actual distance but is a function of the ground constants and the wavelength. The "critical distance" is that distance at which the numerical distance is unity.

Sommerfeld's attenuation theory, as interpreted by Rolf,<sup>12</sup> does not wholly explain the experimental attenuation curves. There appears, however, to be some question concerning Rolf's interpretation applied to short waves.<sup>13</sup> The nonuniformity of the ground also accounts for some of the discrepancies.

*Airplane Experiments. Case II.*

In order to increase the physical scale of experiments over that possible with poles the use of an airplane was obtained to measure the

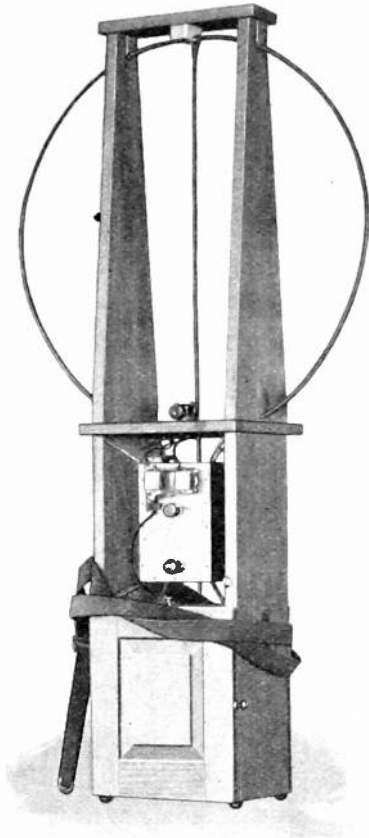

Fig. 17—The shockproof transmitter carried in the airplane. The oscillator feeds a screen-grid buffer amplifier, and the combined unit is suspended from the wood frame by means of rubber binders.

directional characteristics of a half-wave and a one-wave antenna. A special shockproof loop transmitter shown in Fig. 17 was carried in the rear cockpit of a small wooden monoplane (Aeromarine Klemm).

<sup>12</sup> See bibliography (11).

<sup>13</sup> See bibliography (12).

Round-trip flights were made over the antenna at seven altitudes varying from 125 feet to 4000 feet. The speed of the airplane and its altitude were determined from ground observations. The intermediate-frequency attenuator in the receiver was adjusted manually to keep the

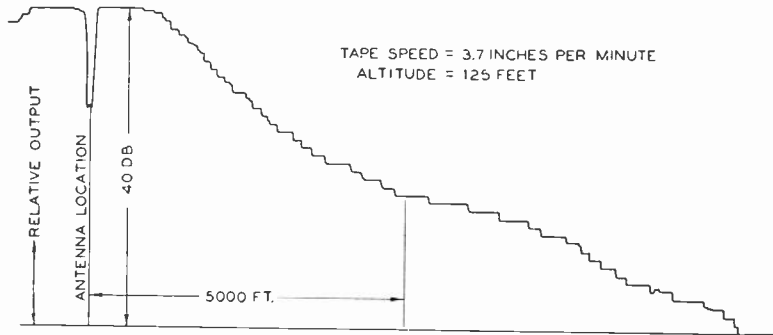

Fig. 18—A sample of the tape record obtained from the airplane experiments. The steps represent changes of one decibel in the attenuator setting.

receiver output constant. The received signal level was recorded on a spring-driven tape by a pen connected to the attenuator adjustment knob. The record was synchronized with the airplane by marking the overhead position on the tape. A sample record is shown in Fig. 18.

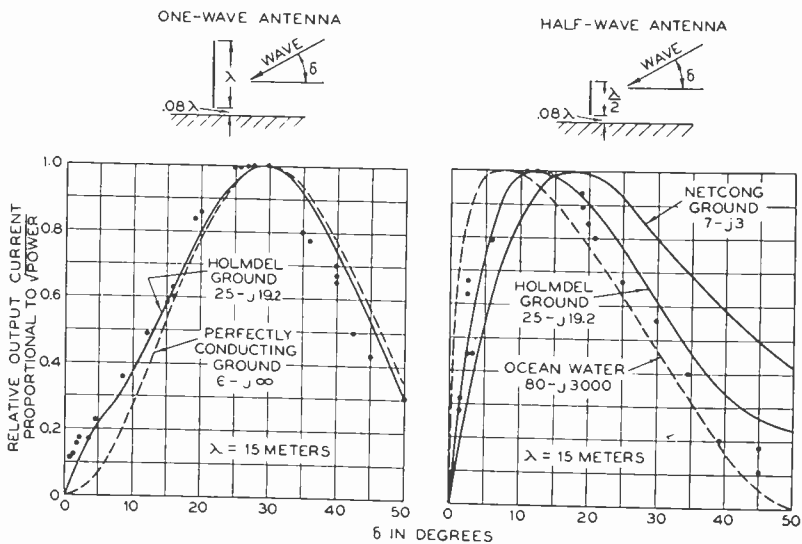

Fig. 19—The airplane data plotted as a directional characteristic. The curves are calculated from optical reflection theory for various kinds of ground.

The directional characteristics of the antennas were obtained from the recorded data by plotting the received levels versus angle for an arbitrary radial distance. Such a procedure yields one point for each flight. A radius of 5000 feet was selected. Fig. 19 shows these points and

includes numerous additional points picked at random from the flight records, and corrected by the inverse distance law to 5000 feet. The more dependable portions of the record show definitely the inverse distance relation. Attenuation curves for several angles, obtained from the records, are plotted in Fig. 20. The curves of Fig. 19 were calculated by the method described in the appendix.

Because the one-wave antenna is comparatively insensitive to the properties of the ground it served to test the experimental technique rather than determine the ground effect. The half-wave antenna measurements indicate definitely that, of the three calculated curves, only the "Holmdel ground" curve is appropriate.

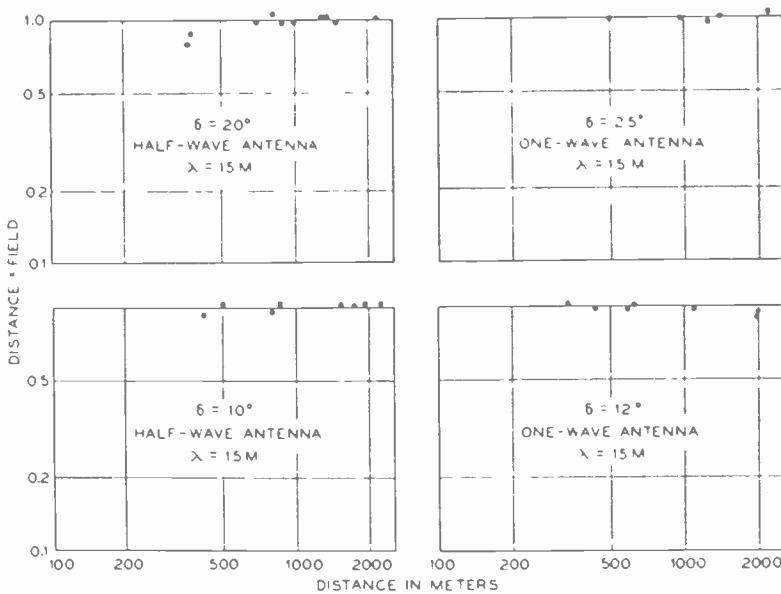

Fig. 20—Attenuation data obtained from the airplane experiments, plotted to correspond to Fig. 14.

In view of the previously described experiments with horizontally polarized waves and the airplane measurements by other investigators, it was not considered necessary to employ Case  $\perp$ .

#### IV. DETERMINING THE GROUND CONSTANTS

##### *Wave Experiments.*

While many experiments with waves may be devised to study the ground, but few are capable of yielding numerical values of the ground constants to predict, with sufficient accuracy, its optical behavior in Case  $\parallel$ .

The shape of the ground wave attenuation curve has enabled some

experimenters to deduce values for the ground constants. We have had little success with that method. The nonuniformity of the ground found in our work seriously interfered with the interpretation of attenuation curves. Such attempts as we have made to obtain ground constants by comparing measured attenuation curves with the Sommerfeld-Rolf curves suggest a value of dielectric constant much too low.

An important criterion of the optical behavior is the pseudo-Brewster angle. To measure this angle in an experiment involving the optical mechanism is difficult and requires, except for ultra-short waves, an airplane or balloon technique. Sommerfeld's analysis indicates, however, that the optical mechanism is not required. Suitable determinations can be made from simple measurements of the ground wave.

The pseudo-Brewster angle may be expressed in implicit form as

$$\delta_m = \sin^{-1} \sqrt[4]{\frac{(\epsilon - \cos^2 \delta)^2 + (2\sigma\lambda c)^2}{[\epsilon^2 + (2\sigma\lambda c)^2]^2}} \quad (7)$$

which is obtained from the optical expression for  $\theta$  putting  $\theta = \pi/2$ .

The Sommerfeld ground wave is characterized by the existence of a small horizontal component of electric field in addition to the main vertical component. These components are in general not quite in phase and result in a rotating, elliptical field in the vertical plane of propagation. The ratio of horizontal to vertical components is

$$\frac{E_x}{E_y} = \frac{1}{\sqrt[4]{\epsilon^2 + (2\sigma\lambda c)^2}} e^{j \frac{\tan^{-1} \frac{2\sigma\lambda c}{\epsilon}}{2}} \quad (8)$$

for distances short compared with the critical distance, and the almost equivalent expression

$$\frac{E_x}{E_y} = \sqrt[4]{\frac{1 - \frac{2\epsilon - 1}{\epsilon^2 + (2\sigma\lambda c)^2}}{\epsilon^2 + (2\sigma\lambda c)^2}} e^{j \frac{\tan^{-1} \frac{2\sigma\lambda c}{\epsilon} - \tan^{-1} \frac{2\sigma\lambda c}{\epsilon^2 + (2\sigma\lambda c)^2 - \epsilon}}{2}} \quad (9)$$

for distances long compared with the critical distance.<sup>14</sup>

If the dielectric constant is greater than 10 electrostatic units inspection of (7), (8), and (9) shows that, to a useful degree of accuracy, the sine of the pseudo-Brewster angle is equal simply to the absolute

<sup>14</sup> Here again the "critical distance" is the distance for which the numerical distance (footnote 11) is equal to unity.



magnitude of  $E_x/E_y$  occurring in the ground wave. This ratio is readily measurable.

The intimate relation between the ground wave and optical reflection theory goes further. It seems permissible to digress here to discuss this relation. The elliptical polarization at the ground surface, resulting from the combination of a direct and a reflected wave in Case II, expressed as a complex ratio of horizontal to vertical components of electric field is

$$\frac{E_x}{E_y} = \frac{\sqrt{\epsilon - \cos^2 \delta - j2\sigma\lambda c}}{(\epsilon - j2\sigma\lambda c) \cos \delta} \tag{10}$$

Comparing (10) with (8) or (9) shows that if  $\epsilon > 10$  the field form calculated optically is substantially the same, at low angles of incidence, as that for the ground wave. This similarity of the polarization has been verified experimentally. In obtaining the data shown in Fig. 13 the complex ratio  $E_x/E_y$  (measured by methods to be described later) at

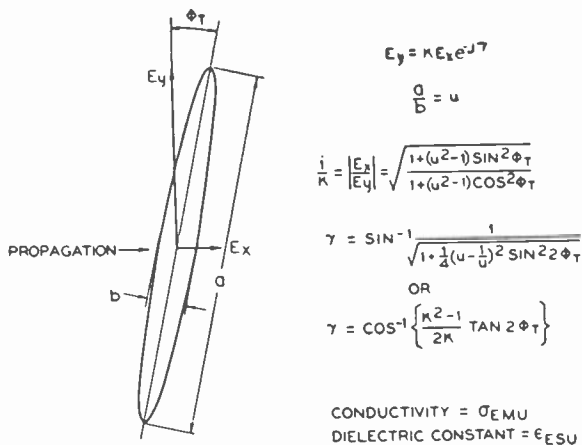

Fig. 21—Geometrical properties of an ellipse applied to elliptical polarization of the ground wave. The measurable quantities are  $\phi_T$ ,  $K$ , and  $u$ . The desired quantities are  $K$  and  $\gamma$ .

the ground was measured with the oscillator at the top and at the bottom of the tower, 4300 feet distant. It was found to be the same although the amplitude was, as shown, vastly different.

Thus, the ground wave appears to merge smoothly into the optically calculated field.

Measurements of  $E_x/E_y$  can be made to yield more than the pseudo-Brewster angle if, in addition to the magnitude, the phase angle of the ratio is also determined. Referring to Fig. 21, if either  $K$  and  $\phi_T$  or  $u$  and  $\phi_T$  are measured it is possible to calculate, with significant ac-

may be used to find the velocity profiles  $U$  and  $w$  with  $\rho$  and  $\mu$  as functions of  $T$  and  $P$  and  $\rho$  and  $\mu$  as functions of  $T$  and  $P$  respectively. The velocity profiles  $U$  and  $w$  are plotted in figures 1 and 2. The velocity profiles  $U$  and  $w$  are plotted in figures 1 and 2.

As a result of the numerical procedure with the computer, the velocity profiles  $U$  and  $w$  are plotted in figures 1 and 2. The velocity profiles  $U$  and  $w$  are plotted in figures 1 and 2.

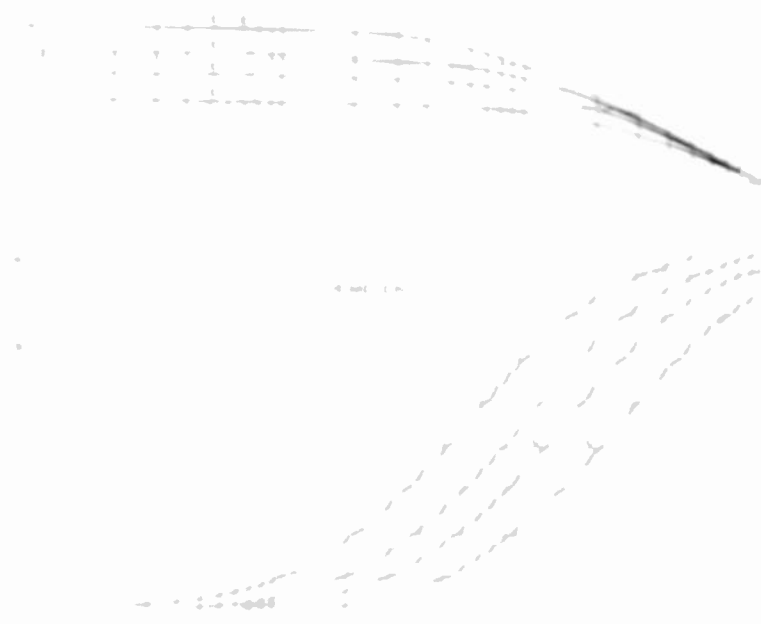

Fig. 1. Velocity profiles  $U$  and  $w$  for  $\beta = 0.01$  and  $\gamma = 0.01$ .

The general velocity profiles  $U$  and  $w$  are plotted in figures 1 and 2. The velocity profiles  $U$  and  $w$  are plotted in figures 1 and 2. The velocity profiles  $U$  and  $w$  are plotted in figures 1 and 2. The velocity profiles  $U$  and  $w$  are plotted in figures 1 and 2.

The profiles  $U$  and  $w$  are plotted in figures 1 and 2. The velocity profiles  $U$  and  $w$  are plotted in figures 1 and 2. The velocity profiles  $U$  and  $w$  are plotted in figures 1 and 2. The velocity profiles  $U$  and  $w$  are plotted in figures 1 and 2.

variations of the polarization often occur. These are presumably due to nonuniformities in the ground such as sloping or broken strata of clay beneath a uniform top soil. Varying the wavelength at fixed locations sometimes exhibits curious variations of polarization also.

If a survey, comprising numerous measurements, is made it has been found possible to "iron out" the irregularities and obtain satisfactory values for the constants. Such a procedure yielded, for Holmdel ground at the airplane experiment site, the following values measured at 16 meters wavelength:  $\phi_T = 10.5$  degrees,  $u = 20$ ,  $K = 5.3$ . From these values  $\gamma$  is calculated to be 15 or 16 degrees. The curves of Fig. 22 determine the ground constants to be  $\epsilon = 25$  and  $\sigma = 1.5 \times 10^{-13}$ . At other Holmdel sites somewhat lower values of  $\epsilon$  and  $\sigma$  were found. For shorter wavelengths slightly lower values of  $\epsilon$  and slightly higher values of  $\sigma$  were usually found.

Constants of an entirely different order of magnitude were found at Neteong, N. J. For a wavelength of 16 meters the following values were measured:  $\phi_T = 19$  degrees,  $u = 20$ ,  $K = 2.9$ . These measurements yield a value for  $\gamma$  of 9 degrees. The corresponding ground constants are approximately  $\epsilon = 8$  and  $\sigma = 0.3 \times 10^{-13}$ .

#### *Sample Measurements.*

In addition to the ground wave method of determining ground constants, a sampling method, not based on any propagation theory, was evolved. This method also permitted a detailed study of the uniformity of natural ground.

A gold plated concentric cylinder type condenser which can be filled with earth is employed. The impedance of this earth cell is compared with a parallel combination of adjustable resistance and adjustable capacity. The earth cell and the comparison unit are shown in Fig. 23. A tuned circuit loosely coupled to a shielded oscillator serves to indicate the identity of the earth cell impedance and that of the simulating unit. With the unknown earth cell impedance plugged into the circuit, the tuned output voltage and the tuning condenser setting are noted. The unknown is then replaced by the simulating unit and the latter is adjusted until the same resonant output voltage occurs at the *same tuned* setting of the condenser. In the circuit shown in Fig. 24,  $C_2$  is the tuning condenser.  $C_1$  is not varied during the comparison but is adjusted to transform the impedance to an appropriate series value, consistent with sensitivity and selectivity. A double detection receiver was usually used instead of a simple tube voltmeter. This permitted weak coupling to a small oscillator and provided adjustable gain to give a suitable output deflection for all ground samples.

The simulating unit consists of a 350- $\mu\text{mf}$  condenser and a variable pencil lead resistance. Both this unit and the earth cell are equipped with jacks which fit into plug terminals.

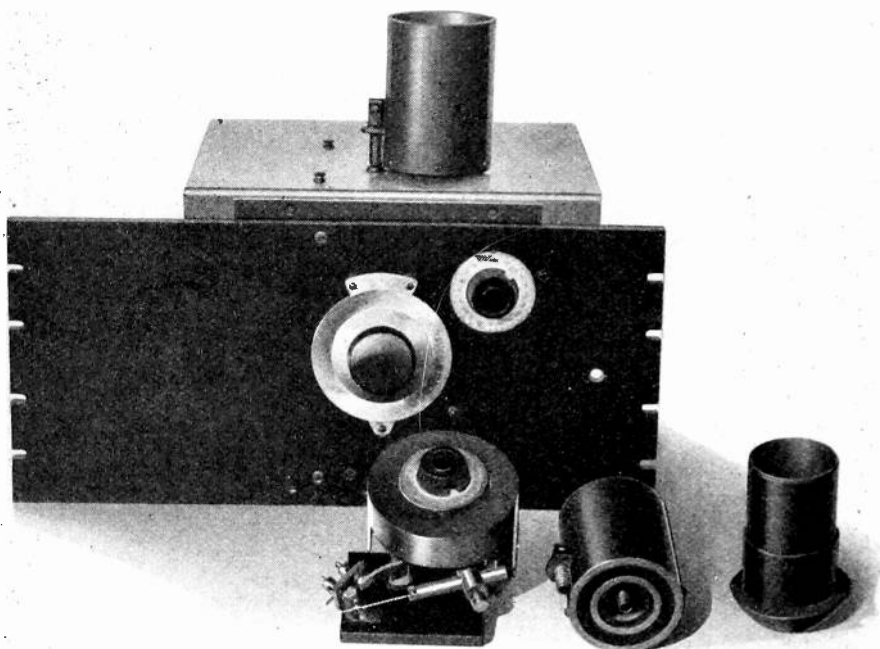

Fig. 23—Apparatus used in the sample measurements. An earth cell appears mounted on the panel. In the group appearing in the foreground the simulating unit is on the left, an earth cell is shown in the center, and the sampling cup appears on the right. A graphite resistance is shown in place in the simulating unit.

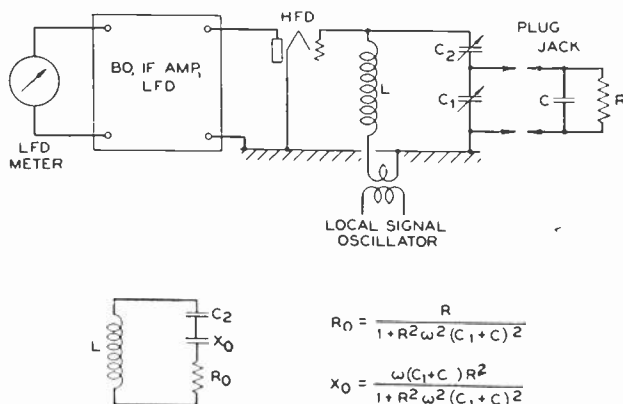

Fig. 24—Circuit used with earth cell. The double detection receiving set is a convenience rather than a necessity. A tube voltmeter may be used if sufficient flexibility of the input voltage can be obtained.

The interpretation of the measured values of capacity and resistance in terms of dielectric constant and specific conductivity follows

the conventional method. Let the capacity of the empty earth cell be

$$C_a = C_0 + C \quad (11)$$

where  $C$  is that portion of  $C_a$  which is increased  $\epsilon$ -fold when the cell is filled with a substance whose dielectric constant is  $\epsilon$ . If the capacity of the filled cell is

$$C_b = C_0 + \epsilon C \quad (12)$$

then the measurement of the increase in capacity due to filling the cell serves to determine the dielectric constant

$$\epsilon = \frac{C_b - C_a}{C} + 1. \quad (13)$$

$C$  was determined to be  $15.0 \mu\mu f$ .

The presence of conductivity in the dielectric does not affect the method of determining the dielectric constant. Consideration of the meaning of the terms conductivity and dielectric constant, as they appear in Maxwell's theory, makes this clear and also leads to the following way of determining the conductivity from the shunt resistance  $R^{15}$ .

Assuming that the lines of current-flow in the dielectric coincide with the lines of electric flux in the empty cell, the resistance  $R$ , the capacity  $C$ , and the specific conductivity  $\sigma$  are related by

$$\sigma = \frac{0.885}{R_{\text{ohms}} C_{\mu\mu f}} 10^{-10} \text{ e.m.u.} \quad (14)$$

or for the earth cell ( $C = 15$ )

$$\sigma = \frac{59}{R} 10^{-13} \text{ e.m.u.} \quad (15)$$

The assumptions underlying these equations are valid if the high-frequency distribution of current is the same, in the earth sample, as the low-frequency distribution—in other words, if skin effect is small. The conductivity of ground and even of sea water is so low that skin effect is scarcely conceivable.

In order to extend the wavelength range of the measuring technique down to eight meters it was necessary to series tune the resistance branch of the simulating unit. Also, the capacity calibration of the simulating unit had to be corrected for "inductance" of the condenser. Distilled water, alcohol, and carbon tetrachloride were used in the earth

<sup>15</sup> Jeans, "Electricity and Magnetism," 5th edition, p. 351; Debye, "Polar Molecules," Chemical Catalog Company, p. 99.

cell to calibrate the condenser. The calibration curves derived are shown on Fig. 25.

To simulate the natural degree of compactness of earth, a sampling cup was used to remove from the natural state an amount of earth just sufficient to fill the cell.

For measurements on ocean water the cell is used only partly filled (recalibrated). Wire resistances of the order of one ohm are used in-

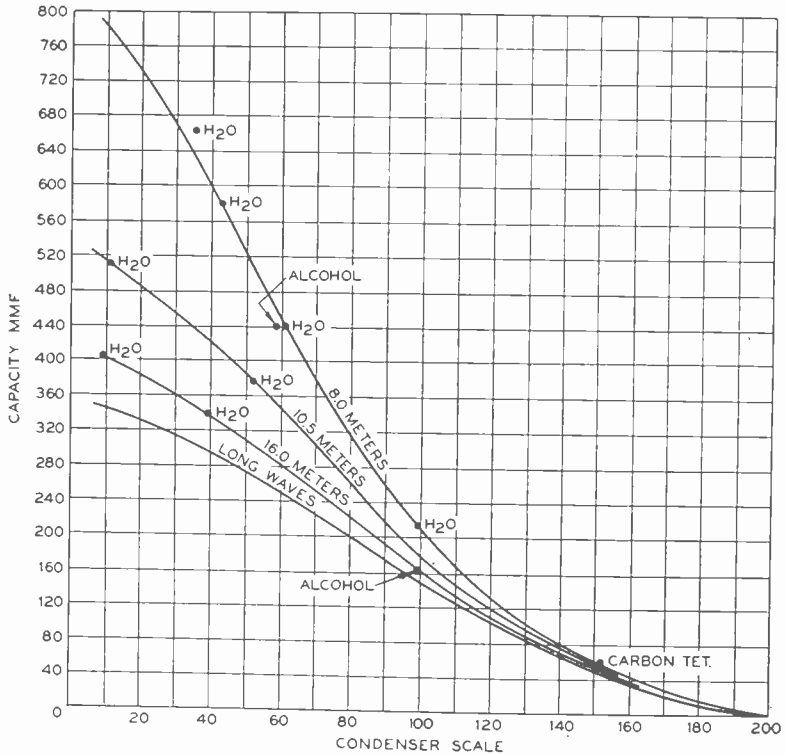

Fig. 25—Calibration of condenser used in the earth simulating unit. The wavelength error is due to inductance in the condenser which varies from 0.029 microhenry at the maximum capacity setting to 0.036 microhenry at the minimum.

stead of the pencil leads which are unsatisfactory below about ten ohms.

Extensive testing and experience have shown that this method is capable of determining ground constants of the usual magnitudes with an error of not more than 10 to 15 per cent at wavelengths from 10 to 50 meters. With long wavelengths or for salt marsh or ocean water the conductivity only can be determined, the capacity effect being thoroughly short-circuited.<sup>16</sup>

<sup>16</sup> Fortunately, for optical purposes, the dielectric constant is then unimportant.

Tables II and III give some results of measurements made upon ground and ocean water.

TABLE II  
CONDUCTIVITY AND DIELECTRIC CONSTANT OF EARTH

Site	Location	Depth Feet	Description	$\sigma$ e.m.u. $\times 10^{-13}$	$\epsilon$ e.s.u.	$\lambda$ meters	Remarks
A	Holmdel, N.J.	$\frac{1}{2}$	black loam	0.80	17	32	cultivated land
				0.95	16	16	
A		1 $\frac{1}{2}$	sandy	0.22	11	32	recent rain
				0.30	11	16	
A		3	wet clay	1.2	32	32	
				1.5	29	16	
B	2	dry subsoil clay	0.98	14.5	16	}	
			1.04	15.0	10.5		
			1.09	13.5	8		
B	1	dry topsoil	1.4	14.5	16	{	
			1.4	13	10.5		
			1.4	12	8		
B	1	same, very wet	1.5	23	16	}	
			1.6	23	10.5		
			1.7	23	8		
B	2	subsoil, very wet	1.5	28	16	} after two-day rain	
			1.5	28	10.5		
			1.5	28	8		
C	1	dry topsoil	0.84	15	32	}	
			0.93	13	16		
			0.98	12.7	10.5		
			0.98	12	8		
			1.28	26.5	32		
C	2	some clay, dry	1.55	23.5	16	}	
			1.85	21	10.5		
			1.95	19.5	8		
A	Netcong, N.J.	1 $\frac{1}{2}$	dry clay with stone chips	0.27	9	16	} uncultivated, uniform, rocky
				0.30	8.5	10.5	
				0.33	8	8	
A		$\frac{1}{2}$	same	0.26	9	16	
				0.29	9	10.5	
				0.30	9	8	
B	1 $\frac{1}{2}$	same	0.10	7	16		
			0.14	7	10.5		
			0.12	7	8		
B	$\frac{1}{2}$	same	0.15	10	16		
			0.16	10	10.5		
			0.15	10	8		
	Distilled Water			—	78	8 to 100	} NaCl added
	Distilled Water			5.0	78	8	

TABLE III  
CONDUCTIVITY OF OCEAN WATER<sup>17</sup>  
(Number of  $10^{-11}$  e.m.u.)

Sample	$\lambda = 130\text{m.}$	100	60	35	30	23	16
Deep Water	4.4	4.4	4.4	4.6	5.0	5.0	5.2
Beach Water				4.7		5.0	
River Water (Tide in) <sup>18</sup>					4.3	4.4	4.2
Synthetic (3.5 per cent NaCl)		5.6		6.1			6.8
0.1 Normal KCl <sup>19</sup>		1.18		1.23			1.37

<sup>17</sup> Atlantic Ocean, coast of New Jersey.

<sup>18</sup> Pirsson and Schuckert's "Introductory Geology," (1924), p. 91, gives 3.5 per cent salt of which 78 per cent is sodium chloride.

<sup>19</sup> At the measuring temperature of 21 degrees centigrade the "Handbook of Chemistry and Physics," Chemical Rubber Company, 14 edition, p. 944, gives  $\sigma = 1.19 \times 10^{-11}$ .

The considerable degree of stratification shown in the above table of ground measurements makes the assignment of any pair of values of  $\sigma$  and  $\epsilon$  open to question. Both Sommerfeld's theory and optical reflection theory indicate that the ground at a considerable depth influences its behavior. Thus, for  $\sigma = 10^{-13}$  electromagnetic units and  $\epsilon = 20$  electrostatic units and for wavelengths shorter than about 50 meters, the field at a depth of 12 feet is calculated to be about 0.2 of its value just beneath the surface. The *vertical* penetration is substantially the same for the ground waves and for plane waves of any incident angle.

For practical purposes, however, a single pair of values of  $\sigma$  and  $\epsilon$  is probably satisfactory. Precise values are hardly justified in view of the effect of rainfall.

The increase of conductivity and the decrease of dielectric constant with increasing frequency, displayed by some ground samples (sample C, two feet deep, for instance) is believed to be real. Ground wave measurements have indicated similar trends. Likewise, the variation of the conductivity of ocean water is believed to be real. False effects are possible in sample measurements at high frequencies, however, and to be absolutely certain of the reality of these apparent variations would require check measurements made with totally different apparatus in which any unknown false effects would likely be different. Variations of the conductivity and dielectric constant of ground are, however, plausible, considering the granular structure of earth.<sup>20</sup>

In determining the values of ground constants to be employed in optical calculations the ground wave measurements are perhaps more satisfactory than sample measurements. Since the ground wave is influenced by underlying strata it probably yields "effective" values for the ground site.

Correlation between ground wave determinations and sample measurements has been as close as could be expected for Holmdel farm land, in view of the stratification. The values determined by ground wave measurements, given in the preceding section, agree very well with the sample measurements of subsoil. The ground wave data from Neteong showed unmistakably that both  $\sigma$  and  $\epsilon$  had lower values there than at Holmdel and, in fact, yielded values surprisingly close to those in Table II. The Neteong site is located on a well-drained plateau and appears to have little stratification.

The calculation of reflection curves such as those shown in Fig. 1 is a rather lengthy process. Knowing the ground constants it is possible to sketch reflection curves for any wavelength by locating the

<sup>20</sup> Bibliography (38) and (39).



minimum value of  $A$  at the pseudo-Brewster angle and locating the values of  $A$  and  $\theta$  for normal incidence ( $\delta = 90$  degrees). To facilitate this procedure the families of curves shown in Figs. 26 and 27 may be used to obtain these points.

Discussion of practical features of the application of ground theory to reception experience is outside the scope of this paper. The reader is referred to a paper on this subject by Potter and Friis.<sup>21</sup>

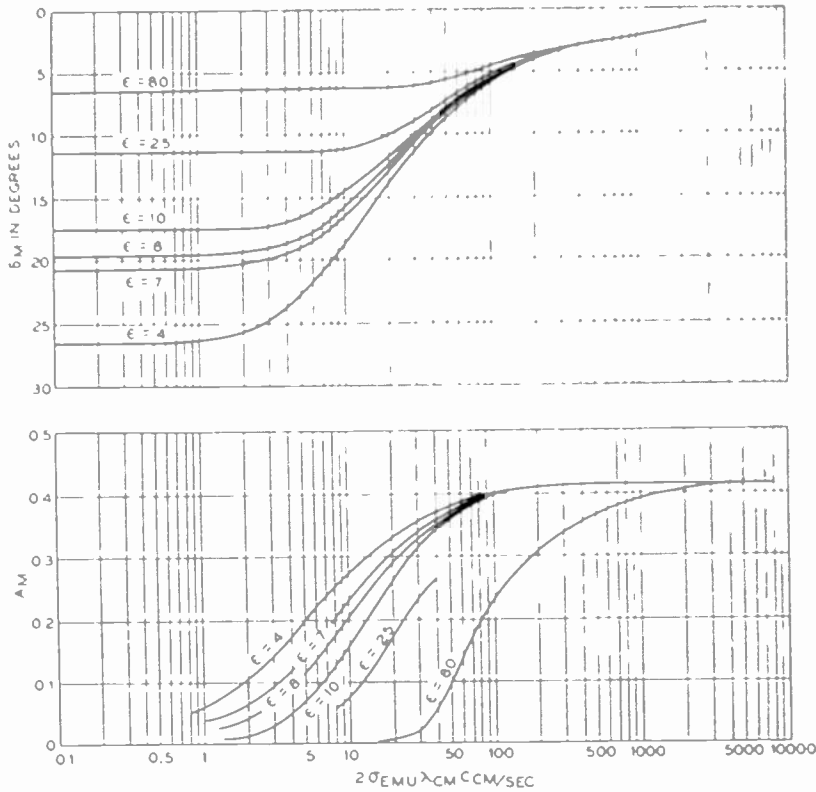

Fig. 26—Curves relating the pseudo-Brewster angle,  $\delta_m$ , and the corresponding (minimum) value of amplitude ratio,  $A_m$ , with the ground constants.

#### ACKNOWLEDGMENT

In conclusion, the writer wishes to express his appreciation to Messrs. H. T. Friis and C. R. Englund for their many helpful suggestions, and to Mr. W. M. Sharpless for his valuable experimental assistance.

#### APPENDIX

The vertical plane directional characteristic of a receiving antenna may be calculated with the aid of the reciprocal theorem, in terms of the transmitting current distribution.

<sup>21</sup> Bibliography (24).

Consider an antenna used for receiving, transferring power into a load impedance  $Z$ .

Let,

$E(x)$  = distribution of induced e.m.f.

$I$  = current through  $Z$  due to  $E(x)$ .

$i(x) = I_0 F(x)$  = distribution of current when  $E(x)$  is replaced by an impedanceless e.m.f.  $E'$ , in series with  $Z$

$I_0$  = value of  $i(x)$  flowing through  $Z$  at the antenna terminals.

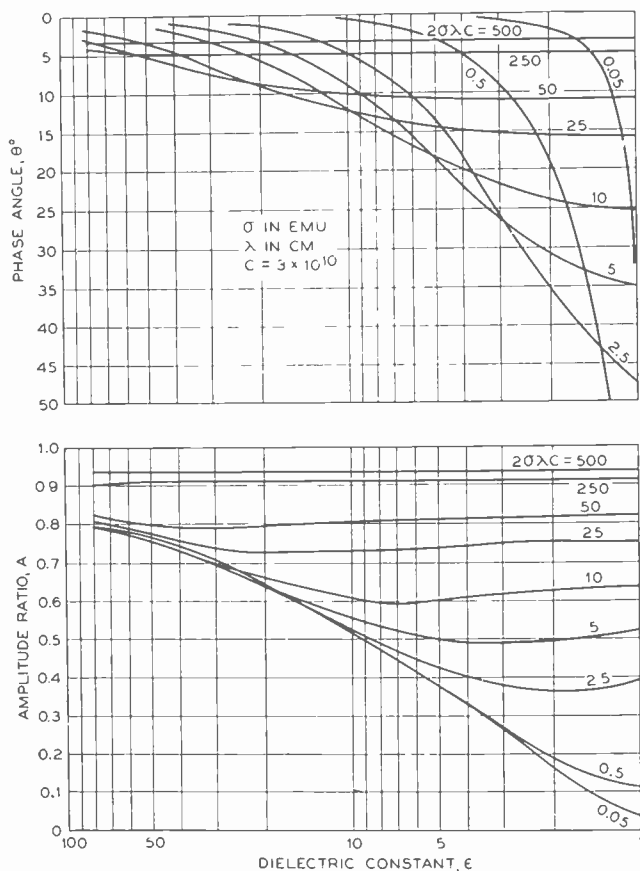

Fig. 27—Curves for normal incidence relating the amplitude ratio and the phase angle with the constants.

The reciprocal theorem yields the following equation:

$$I = \frac{1}{E'} \int_a^b E(x)i(x)dx = \frac{I_0}{E'} \int_a^b E(x)F(x)dx, \quad (1)$$

the limits  $a$  and  $b$  including all portions of the antenna exposed to  $E(x)$ .

However,

$$\frac{I_0}{E'} = \frac{1}{Z + Z_A},$$

where  $Z_A$  = the antenna impedance appearing at the load terminals.

Thus,

$$I = \frac{1}{Z + Z_A} \int_a^b E(x)F(x)dx. \quad (2)$$

For the half-wave and one-wave antennas we may assume a sinusoidal distribution of current:  $F(x) = \sin 2\pi x/\lambda$ .

$E(x)$  is the complex sum of the direct and ground reflected intensities acting on the wire at the point  $x$ .

For the vertical half-wave antenna the integration results in

$$I = \frac{1}{Z + Z_A} \frac{\lambda}{2\pi \cos \delta} [1 + e^{-j\pi \sin \delta}] \left[ 1 + Ae^{-j\left(\frac{4\pi D \sin \delta}{\lambda} + \theta\right)} \right] \quad (3)$$

or, if the amplitude only is desired:<sup>22</sup>

$$|I| = \frac{\lambda}{\pi\sqrt{2}(Z + Z_A)}$$

$$\left\{ \sec \delta \sqrt{[1 + \cos(\pi \sin \delta)] \left[ 1 + A^2 + 2A \cos\left(\frac{4\pi D \sin \delta}{\lambda} + \theta\right) \right]} \right\}. \quad (4)$$

For the vertical one-wave antenna the integration results in:

$$I = \frac{1}{Z + Z_A} \frac{\lambda}{2\pi \cos \delta} [1 - e^{-j2\pi \sin \delta}] \left[ 1 - Ae^{-j\left(\frac{4\pi D \sin \delta}{\lambda} + \theta\right)} \right] \quad (5)$$

$$|I| = \frac{\lambda}{\pi\sqrt{2}(Z + Z_A)}$$

$$\left\{ \sec \delta \sqrt{[1 - \cos(2\pi \sin \delta)] \left[ 1 + A^2 - 2A \cos\left(\frac{4\pi D \sin \delta}{\lambda} + \theta\right) \right]} \right\}. \quad (6)$$

In these equations  $D$  is the height of the mid-point of the antenna, expressed in the same units as the wavelength,  $\lambda$ .

The curves of Fig. 19 were calculated from the "brace" terms in (4) and (6). The maximum amplitudes were arbitrarily made equal to unity.

The brace quantities in (4) and (6) may also be derived from the transmitting point of view by integrating over the radiating current and applying the same ground reflection coefficient. The equations corresponding to (4) and (6) then give the electric field distribution over a hemisphere of great radius.

<sup>22</sup> The phase of the antenna output, calculable from these equations, is referred to the phase of the wave front passing through the top of the antenna.

## Bibliography

1. Sommerfeld, "The propagation of waves in wireless telegraphy," *Ann. der Phys.*, vol. 28, no. 4, pp. 665-736, (1909); also vol. 81, pp. 1135-1153, (1926).
2. Hoerschelmann, "On the manner of operation of the Marconi antenna in wireless telegraphy," *Jahr. der draht. Teleg. u. Teleph.*, vol. 5, pp. 14-34 and pp. 188-211, (1911).
3. Van der Pol and Niessen, "The propagation of electromagnetic waves over a level ground," *Ann. der Phys.*, vol. 6, series 5, no. 3, pp. 273-294, (1930).
4. Weyl, "Propagation of electromagnetic waves over a plane conductor," *Ann. der Phys.*, vol. 60, pp. 481-500, (1919).
5. Epstein, "Charts of lines of force for the propagation of the waves in wireless telegraphy under consideration of the nature of the ground," *Jahr. der draht. Teleg. u. Teleph.*, vol. 4, pp. 176-187, (1910).
6. Pedersen, "The Propagation of Radio Waves," (book in English), G. E. C. Gad, Vimmelskaflet 32, Copenhagen.
7. Wise, "Asymptotic dipole radiation formulas," *Bell Sys. Tech. Jour.*, vol. 8, no. 4, October, (1929).
8. Strutt, "Radiation of antennas under the influence of the properties of the ground," *Ann. der Phys.*, vol. 1, series 5, no. 6, pp. 721-772, (1929); also vol. 4, no. 1, pp. 1-16, (1930).
9. Fry, "Plane waves of light," *Jour. Opt. Soc. Amer.*, vol. 15, pp. 137-161; September, (1927); and vol. 16, pp. 1-25; January, (1928).
10. Ballantine, "The Lorentz reciprocity theorem for electric waves," *Proc. I.R.E.*, vol. 16, no. 4, pp. 513-518; April, (1928).
11. Rolf, "Numerical discussion of Sommerfeld's attenuation formula," *Ingeniors Veterskaps Akademien Handkirgen*, no. 96, (1929); also *Proc. I.R.E.*, vol. 18, no. 3, pp. 391-403; March, (1930).
12. Wise, "Note on the accuracy of Rolf's graphs of Sommerfeld's attenuation formula," *Proc. I.R.E.*, vol. 18, no. 18, pp. 1971-1972; November, (1930).
13. Wise, "The grounded condenser antenna radiation formula," *Proc. I.R.E.*, vol. 19, no. 9, pp. 1684-1689; September, (1931).
14. Barfield, "The attenuation of wireless waves over land," *Jour. I.E.E. (London)*, vol. 66, no. 374, pp. 204-218; February, (1928).
15. Barfield and Munro, "The attenuation of wireless waves over towns," *Jour. I.E.E. (London)*, vol. 67, no. 386, pp. 253-264; February, (1929).
16. Smith-Rose and McPetrie, "The attenuation of ultra-short radio waves due to the resistance of the earth," *Proc. Phys. Soc. (London)*, vol. 43, part 5, no. 240, pp. 592-620; September, (1931).
17. Munro, "The attenuation of short wireless waves at the surface of the earth," *Jour. I.E.E. (London)*, vol. 71, no. 426, pp. 135-143; June, (1932).
18. Smith-Rose and McPetrie, "The propagation along the earth of radio waves on a wavelength of 1.6 meters," *Proc. Phys. Soc. (London)*, vol. 44, part 4, no. 244, pp. 500-508; July, (1932).
19. Strutt, "Reflection measurements of very short electric waves and of acoustic waves," *E.N.T.*, vol. 7, no. 2, p. 65; February, (1930).
20. Ives, "The vectorial photo-electric effect in thin films of alkali metals," *Phys. Rev.*, vol. 38, series 2, pp. 1209-1218; September, (1931).
21. Wilmotte, "General formulas for the radiation distribution of antenna systems" and "The radiation distribution of antennae in vertical planes," *Jour. I.E.E. (London)*, vol. 68, no. 405, pp. 1174-1204; September, (1930).
22. T. L. Eckersley, "Short wave wireless telegraphy," *Jour. I.E.E. (London)*, vol. 65, no. 366, pp. 600-644; June, (1927).
23. McPetrie, "A method for determining the effect of the earth on the radiation from aerial systems," *Jour. I.E.E. (London)*, vol. 70, no. 423, pp. 382-390; March, (1932).
24. Potter and Friis, "Some effects of topography on short-wave reception," *Proc. I.R.E.*, vol. 20, no. 4, pp. 699-721; April, (1932).
25. Eve, Steele, McEwan, Thompson, and Olive, "Reception experiments in Mount Royal tunnel," *Proc. I.R.E.*, vol. 17, no. 2, February, (1929).
26. Eve, Keys, and Lee, "The penetration of rock by electromagnetic waves and audio frequencies," *Proc. I.R.E.*, vol. 17, no. 11, November, (1929).

27. Lange, "Note on earth reflection of ultra short radio waves," *Proc. I.R.E.*, vol. 17, no. 4, April, (1929).
28. Verman, "Reflection of radio waves from the earth," *Proc. I.R.E.*, vol. 18, no. 8, August, (1930).
29. Hochgraf, "The radiation characteristics of grounded vertical "I," and "T" antennas," *Rensselaer Polytech. Inst. Bul.*, Eng. and Science Series, no. 22, July, (1929).
30. Whitehead, "Practical experiments in ultra short wave communication," *E.W. & W.E.*, vol. 7, no. 86, November, (1930).
31. Glas, "On the effects of the ground on downcoming space waves," *E.W. & W.E.*, vol. 6, no. 75, December, (1929).
32. Martin, "Laying a foundation for aircraft communication," *Bell Lab. Rec.*, April, (1929).
33. Drake and Wilmotte, "On the daylight transmission characteristics of horizontally polarized and vertically polarized waves from airplanes," *Proc. I.R.E.*, vol. 17, no. 12, December, (1929).
34. Bäumlér, Krüger, Plendl, and Pfitzer, "Radiation tests on short-wave directional aeriáls of the long-distance radio station in Nauen," *Jahr. der draht. Teleg. u. Teleph.*, vol. 36, no. 1, pp. 1-13; July, (1930).
35. T. L. Eckersley, "Direct-ray broadcast transmission," *Proc. I.R.E.*, vol. 20, no. 10, pp. 1555-1579; October, (1932).
36. Strutt, "The effect of the earth on the properties of electromagnetic waves," *Hochfrequenz. und Elek.*, vol. 39, pp. 177-185; May, (1932); and pp. 220-225; June, (1932).
37. Stratton and Chinn, "The radiation characteristics of a vertical half-wave antenna," *Proc. I.R.E.*, vol. 20, no. 12, pp. 1892-1913; December, (1932).
38. Fricke, "The electric capacity of suspensions with special reference to blood," *Jour. Gen. Physiology*, November 20, (1925).
39. Fricke and Morse, "The electric resistance and capacity of blood for frequencies between 800 and  $4\frac{1}{2}$  million cycles," *Jour. Gen. Physiology*, November, 20, (1925).
40. Jolliffe, "A study of polarization capacity and resistance at radio frequencies," *Phys. Rev.*, vol. 22, p. 293, (1923).
41. Southworth, "The dielectric properties of water for continuous waves," *Phys. Rev.*, vol. 23, p. 631, (1924).
42. McCarty and Jones, "The index of refraction of water for short continuous waves," *Phys. Rev.*, vol. 29, p. 880, (1927).
43. Ratcliffe and White, "Negative attenuation of wireless waves," *Nature*, June 21, (1930).
44. Ratcliffe and Shaw, "A determination of the dielectric constant of the ground," *Nature*, October 19, (1929).
45. Ratcliffe and Shaw, "The electrical properties of the soil at radio frequencies," *Phil. Mag.*, series 7, no. 65, October, (1930).
46. Lattey and Gatty, "The determination of the dielectric constants of imperfect insulators," *Phil. Mag.*, series 7, no. 47, June, (1929).
47. Strutt, "Measurements of the electrical properties of the ground at frequencies between 20 and  $2 \times 10^7$  cycles per second," *E.N.T.*, October, (1930).
48. Pal, "The dielectric polarization of liquid mixtures and association," *Phil. Mag.*, series 7, no. 63, August, (1930).

## A RADIO RANGE BEACON FREE FROM NIGHT EFFECTS\*

BY

HOWARD ALLAN CHINN

(Formerly, Round Hill Research Division, Massachusetts Institute of Technology, South Dartmouth, Mass.; at present, Columbia Broadcasting System, New York City)

*Summary*—A radio range beacon, suitable for the guidance of aircraft along established airways, which is entirely free from atmospheric variations or "night effects", is described. Advantage is taken of the phenomenon that waves of frequencies higher than 30 megacycles per second, or thereabouts, are not usually refracted back to the earth by the Kennelly-Heaviside layer. Multiple path transmission, variation in signal intensity and in polarization are thus avoided. A four-course aural beacon operating on 34.6 megacycles per second was employed for the experimental work. Results and applications are discussed.

### INTRODUCTION

RADIO direction finding transmitters or radio range beacons operating at relatively low frequency (250 to 375 kilocycles) have been extensively applied to the airways of this country. Experience has definitely established the utility of this radio aid to aerial navigation. The ever increasing use of these beacons in all kinds of weather, during both the day and the night, has made it imperative that these systems be devoid of any atmospheric variations or "night effect." The limitation of the range of usefulness at night of the radio range beacons employing cross-coil antennas has been pointed out,<sup>1</sup> and, although many improvements have been made in the equipment and the methods of establishing a radio range beacon, the present radiating systems, are, for the most part, of the original crossed-coil form. The problem of reducing or eliminating atmospheric variations in radio direction finding transmitters has been seriously considered only recently although its existence has been recognized for a number of years.

In the fall of 1931 it became evident that the existing range beacon system was giving unsatisfactory service at night and an immediate change in design was necessary in order that these night variations might be eliminated. To this end a research program<sup>2</sup> was undertaken

\* Decimal classification: R113.3 × R521. Original manuscript received by the Institute, October 26, 1932. Presented before New York meeting May 3, 1933.

<sup>1</sup> H. Pratt, "Apparent night variations with crossed-coil radio beacon," Proc. I.R.E., vol. 16, p. 652; May, (1928).

<sup>2</sup> This program of research was initiated by F. G. Kear of the Aeronautics Branch who spent the academic year (1931-32) at the Massachusetts Institute of Technology. Mr. Kear's work dealt with the general problem of the elimination of night effects. Papers to be published later will deal with various results of the program.

at Round Hill in coöperation with the Research Division, Aeronautics Branch of the Department of Commerce, and an experimental study was made of the characteristics of several range beacon systems which theoretical considerations indicated would be free from night effects.

The range beacon described herein is one of those resulting from this research program.

#### GENERAL METHOD EMPLOYED

The effect of atmospheric variations may be overcome through the suppression of all radiation to the upper atmosphere, or by means of a system of reception that would discriminate against the sky wave in favor of the ground wave. Another possibility is to employ a wave of a frequency such that the effect of the Kennelly-Heaviside layer upon its propagation would not be detrimental for the purpose under consideration. It is generally recognized that under prevailing atmospheric conditions waves of a frequency higher than 30 to 40 megacycles fulfill this last requirement since they are not refracted back to the earth by the Kennelly-Heaviside layer but on the other hand penetrate it. Thus by using sufficiently high frequency it is possible to avoid the necessity of having to receive waves that have suffered rotation and multiple path transmission since at these higher frequencies even the tangent ray strikes the lower boundary of the ionized medium at an angle greater than the critical angle and therefore will not be returned to earth but will be refracted into space. Transmission is then effected entirely by the "direct wave", and the intensity and polarization of the received signal are substantially independent of the condition of the upper atmosphere.

#### EXPERIMENTAL WORK

In order to determine experimentally the characteristics of a radio range beacon operating at high frequencies, a four-course beacon was placed in operation at the Round Hill Airport. Crossed loops were employed because of their convenience in this particular instance although the use of vertical antennas would undoubtedly have proved more efficient. This work was carried on at a frequency of 34.6 megacycles and the simplest form of transmitter that would provide satisfactory operation was employed. Briefly it consisted of a 75-watt, self-excited triode oscillator operating at 17.3 megacycles. The output of this tube was inductively coupled to the input of two 75-watt tetrode amplifier tubes having their grid circuits in parallel and acting as "frequency doublers." The radio-frequency outputs of these tubes were fed directly into the loop antennas which were tuned to 34.6

megacycles by means of variable series condensers. Each tube fed one of the loops, and the customary interlocked "A-N" characteristic was obtained by the synchronized keying of each tube. In effect one tube supplied the "A" loop and the other the "N" loop. The interlocked keying arrangement placed one tube in operation while the other was idle and vice versa thus keeping a uniform load on the oscillator and creating negligible frequency shift with keying despite the simple circuit arrangement. A modulated signal was obtained by employing 500 cycles alternating-current plate power.

In actual service a more elaborate transmitter would be indicated for good frequency stability. Also provision could readily be made to modulate each output tube with the frequencies which are to be employed for visual radio range beacons in this country.

Adequate shielding is necessary in order to minimize radiation from the circuit elements. In the experimental transmitter, the oscillator was placed within a copper shield which, in turn, was placed within a second shield which also contained the amplifier tubes and associated apparatus. This double shielding of the oscillator together with the use of frequency doublers effectively prevented undesirable radiation from the generating and amplifying equipment.

The crossed-loop antennas employed with the experimental beacon were triangular in shape and approximately two feet on a side. They were mounted directly on the frame containing the transmitter and the entire assembly was rotated when a change in the course was desired.

Reception of the beacon signals was accomplished by means of either tuned radio-frequency or superregenerative receivers. Obviously any of the usual systems of reception for use at this frequency may be adopted.

## RESULTS

Continuous day and night observations over a period of several months failed to reveal the presence of any atmospheric variation whatsoever in the high-frequency beacon. The "on-course" position remained fixed at all times in the direction it was orientated. The results generally experienced in this portion of the high-frequency spectrum indicate that if refraction phenomena were encountered, they would occur during the daytime when the Kennelly-Heaviside layer is usually the thickest and closest to the earth, rather than at night. However, had such results been obtained during this experimental work, it would merely have been necessary to operate the beacon at a higher frequency to avoid this undesirable effect.



Because of the so-called quasi optical nature of the waves at the frequency utilized, the tests on the ground were confined to within 35 miles of the transmitter. Flight tests (over great distances) indicate that the range over which the signals can be used is greatly in excess of that which the quasi optical relationship would suggest.<sup>3</sup>

The lack of prominent elevations in the vicinity of the experimental transmitter on which to locate the receiver limited the distance over which the ground tests could be made. It was found that when the transmission was entirely over sea water, or when it was to an air-

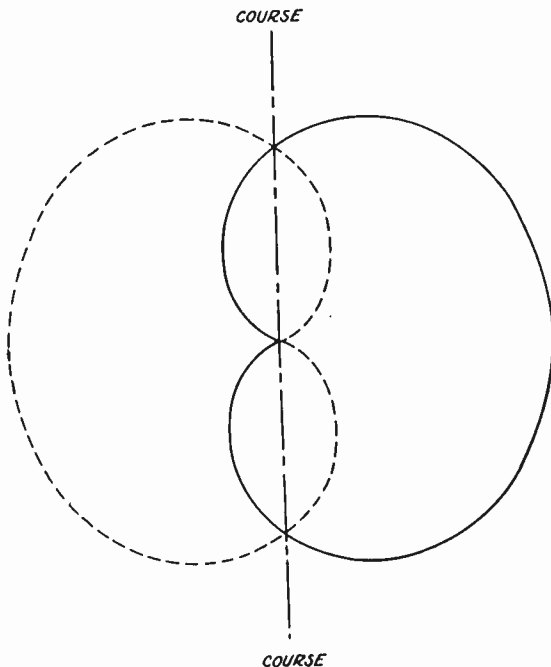

Fig. 1—Two courses—symmetrical.  
Spacing:  $\frac{1}{4}$  wavelength  
Phasing:  $\frac{1}{4}$  period

plane in flight, the range that could be obtained was greatly in excess of that indicated by optical considerations taking into account the curvature of the earth. The flight tests indicated that it would be feasible to locate high-frequency beacons at the same intervals now used on the established airways of this country and thus to provide satisfactory service to aircraft flying at entirely reasonable altitudes.<sup>4</sup>

<sup>3</sup> Range (miles) =  $1.225\sqrt{h_T} + \sqrt{h_R}$   
 $h_T$  = transmitter height in feet.  
 $h_R$  = receive height in feet.

<sup>4</sup> Department of Commerce regulations require transport airplanes to effect an immediate landing if conditions require flight below 500 feet.

## ADVANTAGES AND APPLICATIONS

It is well known<sup>5</sup> that, by employing two vertical antennas properly operated as to time and space phasing, it is possible to create a radio beacon with any practical number of courses having almost any desired orientation. A few of the possibilities are illustrated in Fig. 1. The use of high frequencies makes the erection of vertical antennas of dimensions comparable to the wavelength, and thus relatively small, entirely feasible. The radiation efficiency that is thereby realized is greatly in excess of that obtained with the present loop antenna systems.

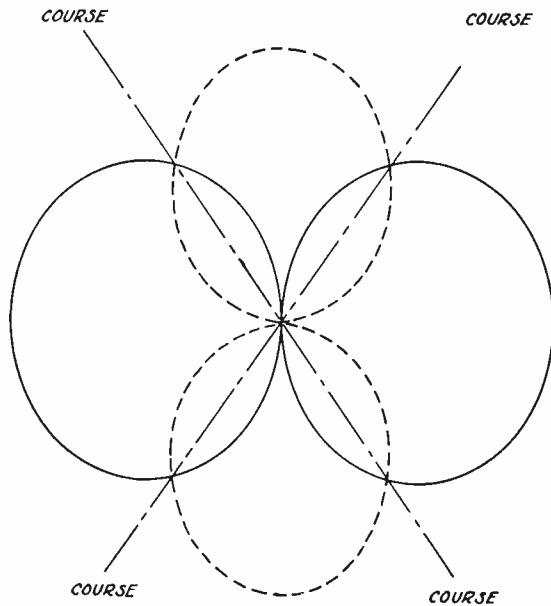

Fig. 2—Four courses dissymmetrical.  
Spacing:  $\frac{1}{2}$  wavelength  
Phasing: 0 and  $\frac{1}{2}$  period

The small size of a complete short-wave beacon makes it entirely practicable to locate them immediately adjacent airports without creating a major hazard to aerial traffic.

In general, vertical receiving antennas are used on airplanes for radio range beacon reception. The length of such antennas is limited by the conditions imposed by the airplane dimensions. Their practical length, although electrically too short for most efficient reception of the prevailing low-frequency beacons, becomes electrically appropriate for the high-frequency beacon described here. It is worthy of note that the use of a vertical receiving antenna is imperative if the maximum range is to be obtained with these high-frequency transmissions.

<sup>5</sup> R. M. Foster, "Directive diagrams of antenna arrays," *Bell, Sys. Tech. Jour.*, vol. 5, p. 292; April, (1926).

For runway localizing beacons as aids to landings in thick weather, the use of high frequencies is a decided advantage particularly because of the simplicity of the equipment and the unlikelihood of interference between adjacent airports. For such use the entire beacon can be

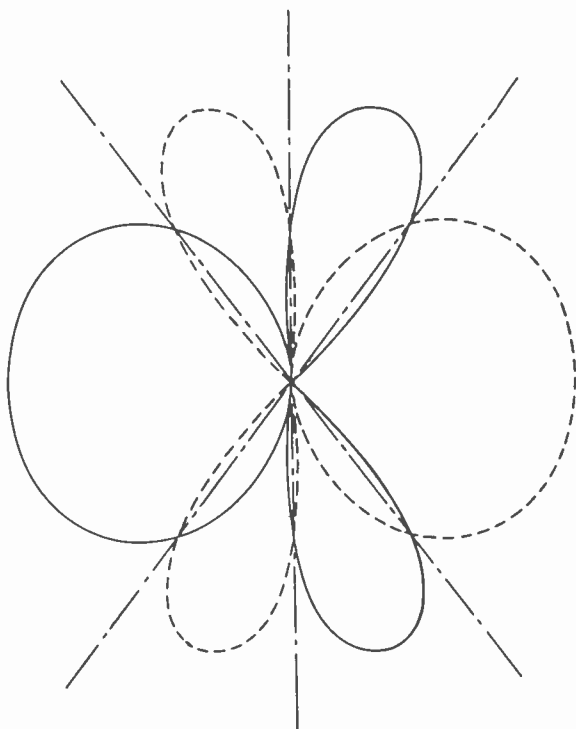

Fig. 3—Six courses—dissymmetrical  
Spacing:  $\frac{3}{4}$  wavelength  
Phasing:  $\frac{1}{4}$  period

readily installed upon a small truck and transported to the location at the airport as dictated by prevailing weather and ground conditions. Inasmuch as an airplane using a high-frequency runway localizing beacon would be at a relatively low altitude, there is little possibility of interference from similar beacons operating at airports a reasonable distance away.



## ON THE SOLUTION OF THE PROBLEM OF NIGHT EFFECTS WITH THE RADIO RANGE BEACON SYSTEM\*

BY

H. DIAMOND

(Bureau of Standards, Washington, D. C.)

*Summary*—A new antenna system is described for use at radio range beacon stations which eliminates the troublesome night effects hitherto experienced in the use of the range beacon system. Considerable data, comprising ground and flight measurements, are given on both aural and visual type range beacons using the present loop transmitting antennas, which show the severity of the night effects encountered. Because of the magnitude of these effects, particularly in mountainous country, the range beacon course often becomes of no value beyond about thirty miles from the beacon station. With the new antenna system developed, referred to as the transmission-line antenna system, the beacon course is satisfactory through its entire distance range, the night effects becoming negligible. Experimental data are given comparing the performance of the transmission-line and loop antenna systems under nearly identical conditions. The paper includes a theoretical analysis of the phenomena underlying the occurrence of night effects and how to eliminate them.

### I. INTRODUCTION

NIGHT variations in the indicated direction are inherent in practically every system of radio direction determination which makes use of the directional properties of the loop antenna. The problem of night effects has been the subject of considerable study and experimental work for some time, notably in England. Night effects in connection with the use of the radio range beacon system in the United States were first observed by Pratt,<sup>1</sup> in 1927, in night flights on the aural type beacon at Bellefonte, Pa. These effects take the form of rapid and irregular variation of the indicated beacon courses, so that an airplane following the true course will receive, in varying amounts, off-course indications to the right, off-course indications to the left, and on-course indications. These course variations are usually quite severe, particularly in mountainous country, where they begin at distances from twenty to fifty miles from the range beacon station and where the magnitude of the fluctuations is often such that the beacon courses become of no value beyond about thirty miles from the station. Since the required useful distance range for most range beacon

\* Decimal classification: R521. Original manuscript received by the Institute, October 27, 1932. Publication Approved by the Acting Director of the Bureau of Standards of the U. S. Department of Commerce. Presented before New York Meeting, May 3, 1933.

<sup>1</sup> H. Pratt, "Apparent night variations with crossed-coil radio beacons," PROC. I.R.E., vol. 16, pp. 652-657; May (1928).

stations is at least 100 miles, the need for eliminating night effects is self-evident. This paper presents the results of a large number of measurements of the indicated beacon courses at night for range beacon stations using the present loop antenna system and also for two experimental stations using a new transmitting antenna system which successfully eliminates the presence of night effects. A brief analysis of the theory underlying the occurrence of night effects and details of the new transmitting antenna system are also given. In addition, data are given on the state of polarization of the indirect wave at a given receiving point corresponding to transmission from both the loop and the new antenna systems. The new antenna system was developed by the Research Division, Aeronautics Branch, Department of Commerce, as a result of an intensive research program on this problem, carried on during the past year. For reasons which will become apparent from the description of the new system it has been named the transmission-line antenna system (abbreviated T-L antenna).

## II. TYPICAL DATA ON NIGHT COURSE VARIATIONS

### (1) *Ground and Flight Observations*

The data given in Fig. 1 represent night effects obtained during a night flight on the Bellefonte, Pa., visual type range beacon using conventional loop transmitting antennas. The graph shows clearly the manner of variation of the night effects with distance from the range beacon station. The results of a large number of similar flight tests showed that, up to the limit of distance from the beacon station at which readings were taken, (about 100 miles), the magnitude and frequency of occurrence of the night effects tended to increase with increasing distance from the station. A large number of factors, in addition to distance from the transmitting station, exert an influence on the magnitude of night course variations at a given instant of time. Some of these are time of day, season of the year, nature of the terrain over which the radio wave is transmitted, location of the transmitting and receiving points, and form of the receiving antenna. A qualitative measure of the degree of influence of these factors will appear from the data given in this paper. The importance of each factor is about the same as in radio direction finding, thus bearing out conclusions by Smith-Rose<sup>2</sup> on the reversibility of night effects in directional reception and transmission. The variable nature of the night course variations is well indicated in Figs. 2(a) and (b), which represent data taken on separate nights at McConnellsburg, Pa., on the Washington, D. C.,

<sup>2</sup> R. L. Smith-Rose, "Radio direction finding by transmission and reception," Proc. I.R.E., vol. 17, pp. 425-478; March, (1929).

and Bellefonte, Pa., aural beacons and on the College Park, Md., and Bellefonte, Pa., visual beacons. McConnellsburg is approximately eighty miles northwest of Washington and seventy miles south of Bellefonte. Note that the behavior of the night course variations was far from the same on the two nights. Note also that the magnitude of the course variations for each range beacon changed from time to time. A large number of records similar to those shown in Figs. 2(a) and (b) indicated that the magnitude of night effects was the same for both types of beacons studied; viz, aural and visual.

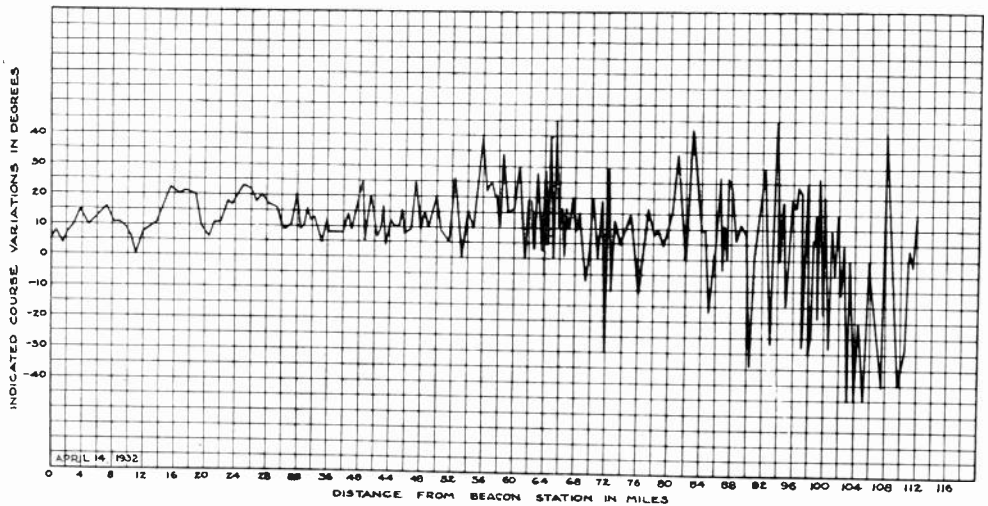
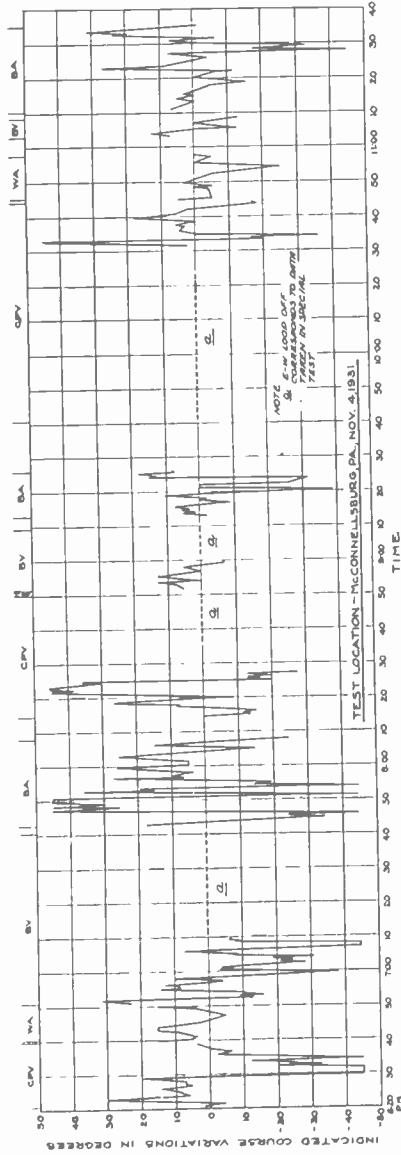

Fig. 1—Night observations in an airplane showing magnitude of night course variations as a function of distance from the station.

(2) *Special Test to Determine Phenomena Underlying Night Course Variations*

The portions of the graphs of Figs. 2(a) and (b) marked "E-W loop antenna off" correspond to a special test made to assist in determining the nature of the phenomena underlying the occurrence of night effects. A theoretical analysis of the problem showed that the night effects could be set up by a virtual rotation of the beacon space pattern at night due to horizontally polarized electric field components (in the sky wave) radiated from the horizontal elements of the loop transmitting antennas. This analysis will be outlined briefly in Section III. The special test was devised to determine whether other factors, such as selective fading of the two modulation frequencies of the visual type beacon (65 and  $86\frac{2}{3}$  cycles), contributed to the production of night effects. The test consisted in observing the apparent beacon course produced at a distant receiving point when only one loop antenna was being used for transmission, the loop antenna current being modulated



Legend - COLLEGE PARK VISUAL RADIO RANGE-BEACON (290 KC)  
 WA - WASHINGTON AURAL RADIO RANGE-BEACON (272 KC)  
 BV - BELLEFONTE VISUAL RADIO RANGE-BEACON (314 KC)  
 BA - BELLEFONTE AURAL RADIO RANGE-BEACON (284 KC)

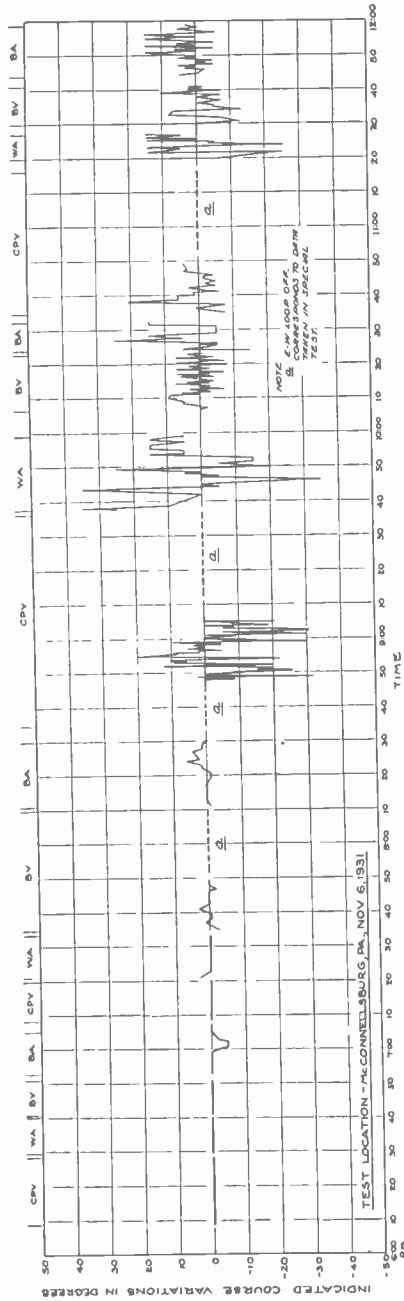

Legend: - COLLEGE PARK VISUAL RADIO RANGE-BEACON (290 KC)  
 CPV - WASHINGTON AURAL RADIO RANGE-BEACON (272 KC)  
 WA - BELLEFONTE VISUAL RADIO RANGE-BEACON (314 KC)  
 BV - BELLEFONTE AURAL RADIO RANGE-BEACON (284 KC)

Fig. 2—Observation taken on two aural type and two visual type radio range beacons using loop antenna transmission. Receiving point approximately equidistant from the four beacon stations.

in equal amounts at the two beacon modulation frequencies. For this condition, an on-course reading should be obtained at the receiving point at all times (night or day), unless selective audio fading or some other similar phenomenon occurred. Since the figure-of-eight space patterns corresponding to the two beacon modulation frequencies coincided, rotation of the transmission characteristic could result only in equal changes in the intensity of the two audio-frequency signals received, the two signals remaining equal to each other throughout. The results obtained showed no apparent course variations, indicating definitely that the rotational phenomenon was the only factor of importance in the production of night effects. The recording of night effects (with the beacon operating normally) immediately before and/or after this special test insured that the test was being carried on under conditions conducive to the production of night effects. The presence of fading of the received signal intensity during this test corroborated this conclusion.

In the records already given and in those to follow, it will be noted that the maximum course variations shown are plus or minus forty-five degrees. This is accounted for by the method used for securing the data. The method consisted in recording at approximately ten-second intervals the indicated beacon course as heard in the headphones (for the aural beacons) or as observed on the visual indicator (for the visual beacon). In both cases the maximum off-course indication which can be obtained is forty-five degrees. A swing off-course greater than forty-five degrees by a given amount gives the same course indication as a swing less than forty-five degrees by the same amount. Thus a sixty-degree swing is of necessity recorded and plotted as a thirty-degree swing.

An interesting point to be noted from the records of Figs. 1 and 2 and also from those to follow, is that even when the night course variations are relatively small, it is not possible to secure a correct course indication by averaging a number of successive readings, unless the averaging process is carried on over an appreciable time period. The time period required is usually greater than is permissible in the use of the range beacon system by aircraft.

### (3) *Automatic Recording of Night Course Variations*

To facilitate securing considerable data on night effects without undue strain on personnel, and also to eliminate the personal equation, an arrangement was devised for recording the night effects automatically. This method is applicable only to measurements on the visual type beacon. It makes use of a reed converter connected in the output



of the beacon receiving set, the reed converter output in turn operating a modified Leeds and Northrup frequency recorder of the bridge-circuit type. The recorder is adjusted so that the pen is in a central position when an on-course signal is received by the reed converter, and moves up or down proportionally to the degree of off-course indication to the right or left of the course. Fig. 3 is a typical record obtained with this arrangement. This record represents a continuous twenty-four-hour run on the Daggett, California, range beacon taken on December 5 and 6, inclusive, 1931. The receiving station was at Kingman, Arizona, a distance of 175 miles from Daggett. This record is of particular interest in that it shows the magnitude of the course variations as a function of time of day (during the late fall season). Sunset and sunrise are indicated in the figure. Note that the night effects begin about two hours before sunset and occur throughout the night until about one hour after sunrise. This represents the usual conditions during the late fall and the winter seasons. On the other hand, during the late spring and the summer seasons, the night effects generally begin from one to two hours after sunset and cease at about sunrise. It should, of course, be recognized that these are for average conditions. The graphs of Fig. 2 have already shown how night effects may vary from day to day. Indeed, periods of two to four nights at a time were encountered in the months January to May, 1932, during which no course variations of appreciable magnitude could be obtained. In several of these cases the night effects just before or just after these periods were quite severe.

### III. ANALYSIS OF OCCURRENCE OF NIGHT COURSE VARIATIONS

#### (1) Theory

The theory underlying the production of night variations in the indicated course with the radio range beacon system is readily understood by reference to Fig. 4. The current  $I$ , passing through the vertical and horizontal wires of the loop antenna produces an electric field, whose intensity and state of polarization along any direction line  $l$  is represented by the vector  $E$ . The total electric field  $E$  may be resolved into two component electric fields  $E'$  and  $E''$ ; the former is polarized in a vertical plane containing the direction line  $l$ , and the latter in a horizontal plane perpendicular to this plane. The component  $E'$  may in turn be resolved into the two right-angle components  $E_v'$  and  $E_h'$ . It is important to note that  $E'$  is produced by the current passing through both the vertical and horizontal wires of the loop antenna and  $E''$  by the current passing through the horizontal wires only. The intensity of the component  $E'$  is of the same value for all angles of eleva-

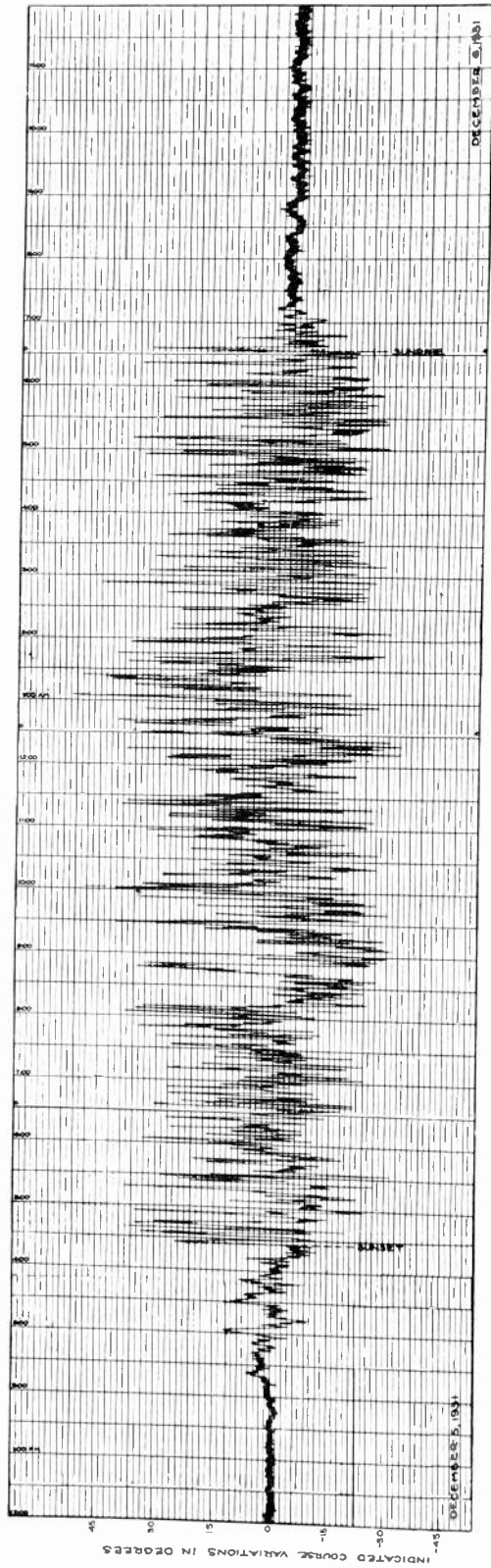

Fig. 3—Twenty-four-hour automatic record of night course variations on Daggett, California, visual type radio range beacon using loop antenna transmission. Receiving point 175 miles from Daggett.

tion but is proportional to the cosine of the azimuth angle of direction, while the intensity of the component  $E''$  is proportional to the sine of the angle of elevation and also to the sine of the azimuth angle. The intensity of the component  $E''$  is therefore zero in the ground wave radiated from the loop antenna, but is of appreciable value in the sky wave, increasing with increasing angles of radiation. As will be shown, the presence of the horizontally polarized component  $E''$  in the transmitted wave is responsible for the occurrence of night effects.

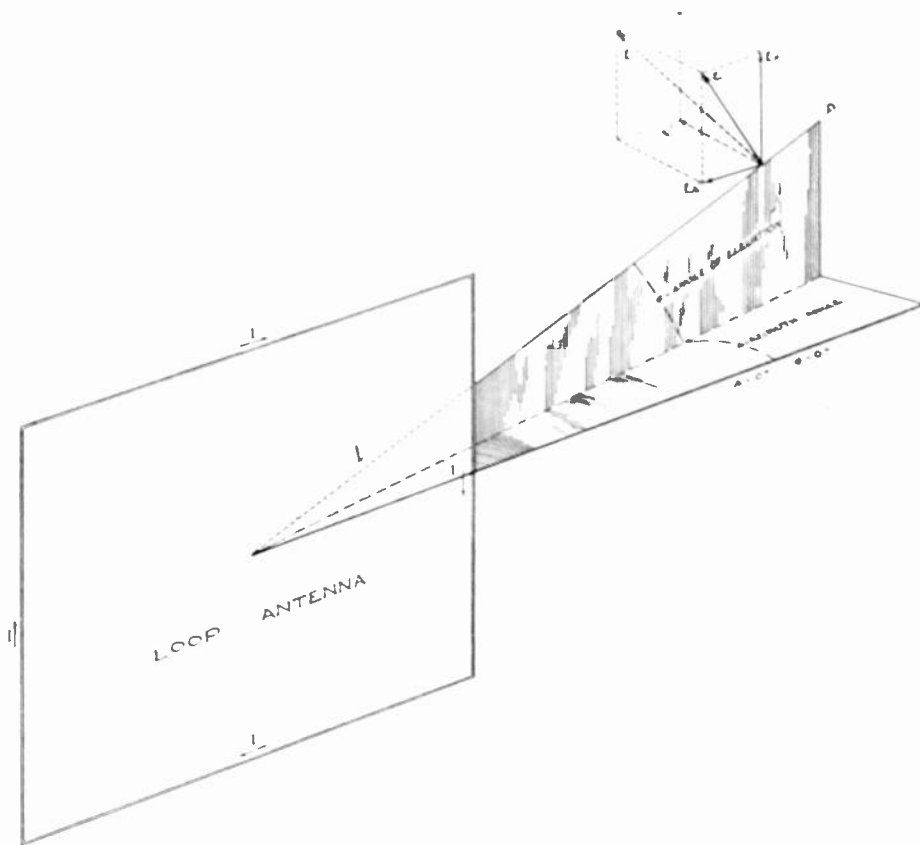

Fig. 4—Diagram for use in explanation of theory of night course variations.

At any distant receiving point having a substantially small angle of elevation with respect to the transmitting antenna, only the vertically polarized component is received during the daytime, while both the horizontally and vertically polarized components are received whenever a reflected wave is present (for example, at night). The loop antenna transmission characteristic, as determined at the receiving point, is, therefore, a cosine function of the azimuth angle of direction during the daytime and a function intermediate between a cosine and a sine function at night. The net result during the nighttime is a virtual

rotation in space of the loop antenna transmission characteristic. The magnitude and direction of rotation varies irregularly with time as the ratio of horizontally polarized electric field to vertically polarized electric field at the receiving point varies.

In the radio range beacon, which employs two crossed loop antennas, two crossed cosine characteristics (each characteristic being referred to the plane containing its loop antenna as zero angle) are produced in the daytime. The four points of intersection of the two characteristics, constitute the four beacon equisignal zones or courses. Assume that the receiving point is located along one of the equisignal zones. At night the variable ratio of horizontally polarized to ver-

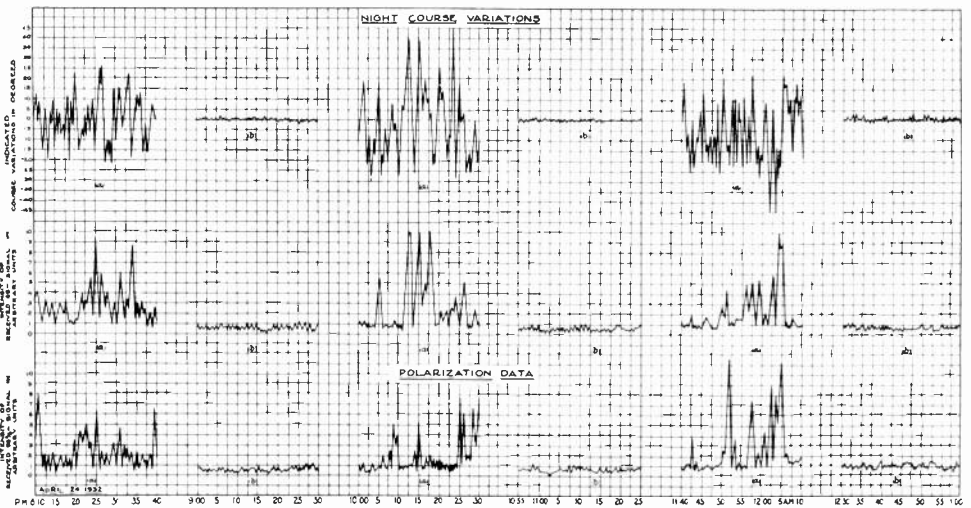

Fig. 5—Automatic records on Bellefonte, Pennsylvania, visual radio range beacon showing night course variations and polarization of received wave for both loop and T-L antenna transmission. Receiving point at Sunbury, Pennsylvania, fifty miles east of Bellefonte.

- (a) Loop-antenna transmission
- (b) T-L-antenna transmission

tically polarized fields in the received wave produces (in so far as the receiving point is concerned) an apparent rotation or swinging of the two crossed figure-of-eight characteristics, accompanied by a swinging of the beacon equisignal zone or course. This conception of a swinging beacon course is not strictly correct. For example, while the indicated course at the receiving point may show the equisignal zone to be, say, thirty degrees to the right, actually an on-course indication may not be obtained (at the same instant of time) at a point thirty degrees to the right of the receiving point. In order for the entire beacon space pattern to rotate or swing in space it would be necessary for the conditions governing the reflection of the sky wave at the Kennelly-Heavi-

side layer to be the same in all directions about the range beacon station. However, the instantaneous radiation distribution about the range beacon is of no importance to the problem; what is desired is a knowledge of the behavior of the course indication at the receiving point. The analysis outlined therefore gives a fair conception of the actual mechanism involved in the production of night effects.

On the basis of the above analysis, it might appear that to eliminate the effect of the horizontally polarized component it is only necessary to employ a receiving antenna which would not be influenced by a horizontally polarized electric field. A vertical receiving antenna satisfies this requirement. The introduction of the vertical pole receiving antenna in 1927 by the Research Division was found to provide some reduction in night errors. Their elimination was not complete for the following reason. Upon reflection of the sky wave from the Kennelly-Heaviside layer, a rotation of the components of the sky wave takes place, so that the original horizontal component ( $E''$ ) becomes vertical in part and can affect a vertical receiving antenna. It follows that the only solution is to eliminate the radiation of the horizontally polarized component at the transmitting end. Since this component is produced by the current passing through the horizontal elements of the transmitting loop antennas, radiation from these elements must be prevented.

#### (2) Means For Eliminating Horizontally Polarized Component ( $E''$ ) In Transmitted Wave

The influence of the horizontal elements of a loop antenna upon the production of night effects was determined a number of years ago in application to direction finding systems using loop antennas for reception. An antenna having the same directional properties as the loop antenna but free from the effects of the horizontal elements was described in a British patent<sup>3</sup> issued to Frank Adcock in 1919. Adcock was apparently the first to make experiments based on the principle. T. L. Eckersley has also described a similar arrangement.<sup>4</sup> The application of the same principle to directional transmitting antennas appeared in a British patent<sup>5</sup> issued to J. Robinson, H. L. Crowther, and W. H. Derriman in 1923. Considerable study and experimental work on the development of this type of antenna system for direction finding purposes<sup>6</sup> and for use with the rotating beacon transmitter<sup>7</sup>

<sup>3</sup> British Patent 130,490.

<sup>4</sup> T. L. Eckersley, "The effect of the Heaviside layer on the apparent direction of electromagnetic waves," *Radio Review*, vol. 2, pp. 60 and 231, (1921).

<sup>5</sup> British patent 198,522.

<sup>6</sup> R. L. Smith-Rose and R. H. Barfield, "The cause and elimination of night errors in radio direction-finding," *Jour. I.E.E.* (London), vol. 64, pp. 831-838,

has been carried on by Smith-Rose and Barfield since 1926. The transmission-line antenna system described in the present paper is based on the same fundamental principle. However, the arrangement employed differs in important particulars from ones previously used, and is the result of actual trial of a number of expedients. Several of the older arrangements were tried and found unsuitable.

### (3) *Experimental Confirmation of Theory*

Before proceeding to give details of the new transmission-line-antenna system developed for eliminating night course variations and the experimental work leading up to its development, it is of interest to analyze on the basis of the theory just outlined some comparative re-

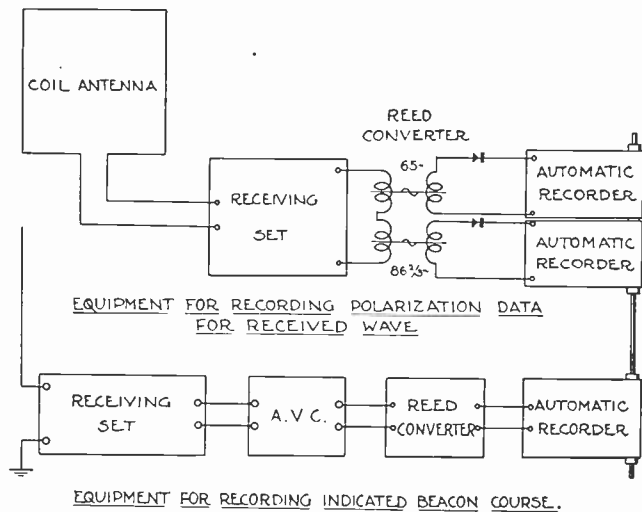

Fig. 6—Schematic of receiving test set-up used in securing records of Fig. 5.

sults obtained with the loop and transmission-line antenna systems. Fig. 5 gives the results of automatic records taken on transmissions from the Bellefonte, Pa., experimental visual range beacon installation. The receiving point was located at Sunbury, Pa., approximately fifty miles east of Bellefonte. The receiving test set-up employed is indicated schematically in Fig. 6. The test equipment comprised a receiving set and recording equipment (using the arrangement described in Section II) for securing automatic records of night course variations, and, in addition, a second receiving set and auxiliary equipment for securing data on the state of polarization of the downcoming sky wave

(1926); R. H. Barfield, "Recent developments in direction finding apparatus," *Jour. I.E.E.* (London), vol. 68, pp. 1052-1069, (1930).

<sup>7</sup> R. L. Smith-Rose, "A theoretical discussion of various possible aerial arrangements for rotating beacon transmitters," *Jour. I.E.E.* (London), 66, pp. 270-274, (1928).

received at Sunbury. The second receiving set was connected to a loop receiving antenna the plane of which was oriented perpendicular to the direction of the range beacon station. The received signal was therefore zero in the daytime. At night, however, the horizontally polarized electric field components present in the downcoming sky wave affected the horizontal elements of the receiving loop antenna, producing a signal in the receiving set output. This signal was applied to a reed converter having two units tuned to the two modulation frequencies used at the beacon station, and the output voltage of each unit of the reed converter applied to an automatic recorder. These recorders thus took separate records of the instantaneous intensity of the horizontally polarized components present in the received wave. One of the records corresponded to one beacon modulation frequency and the second to the other beacon modulation frequency. For ease in comparison, the paper drives for the two recorders were mechanically synchronized with the paper drive of the recorder measuring the night course variations. Fig. 7 shows a photograph of the test set-up. The receiving set, reed converter, and two automatic recorders for taking polarization data are shown at (a), (b), and (c), respectively, while the receiving set, automatic volume control unit, reed converter, and automatic recorder for taking data on night effects are shown at (d), (e), (f), and (g).

Referring to Fig. 5, loop antenna transmission was used at Bellefonte during the periods 8.10–8.40 P.M., 10.00–10.30 P.M., and 11.40–12.10 A.M. while the new transmission-line antenna system was employed during the periods 9.00–9.30 P.M., 10.55–11.25 P.M., and 12.30–1.00 A.M. Quite large night course variations occurred for each period of loop antenna transmission while negligible course variations were had corresponding to T-L antenna transmission. An examination of the polarization data shows that, for loop antenna transmission, the night course variations were invariably accompanied by horizontally polarized components in the received wave while, for T-L antenna transmission, the intensity of the received horizontally polarized components was quite small. In fact, the intensity of these components was at all times less than the prevailing noise and "static" level, whereas a slight rotation of the loop antenna about its vertical axis would result in a received signal of high intensity.

Before proceeding to draw conclusions from the data given in Fig. 5, it is to be recognized that the horizontally polarized electric field affecting the loop receiving antenna in these tests does not correspond entirely to the component  $E''$  in the transmitted wave (see Fig. 4). If rotation of the vector  $E$  of Fig. 4 about the direction line  $l$  can be assumed to occur during reflection or refraction of the sky wave from the

Kennelly-Heaviside layer, three horizontally polarized components may be present which can affect the loop receiving antenna. These are: (a) the portion of  $E''$  still remaining in its original state of polarization, (b) the component of  $E_v'$  now horizontally polarized perpendicular to the direction of propagation, and (c) the component of  $E_h'$  similarly polarized. Referring to Fig. 5, the rapid irregular variation in the intensity of the 65- and  $86\frac{2}{3}$ -cycle signals in the output of the loop antenna receiving set may be accounted for on the basis of combination of these three components in varying magnitude and phase relationship.

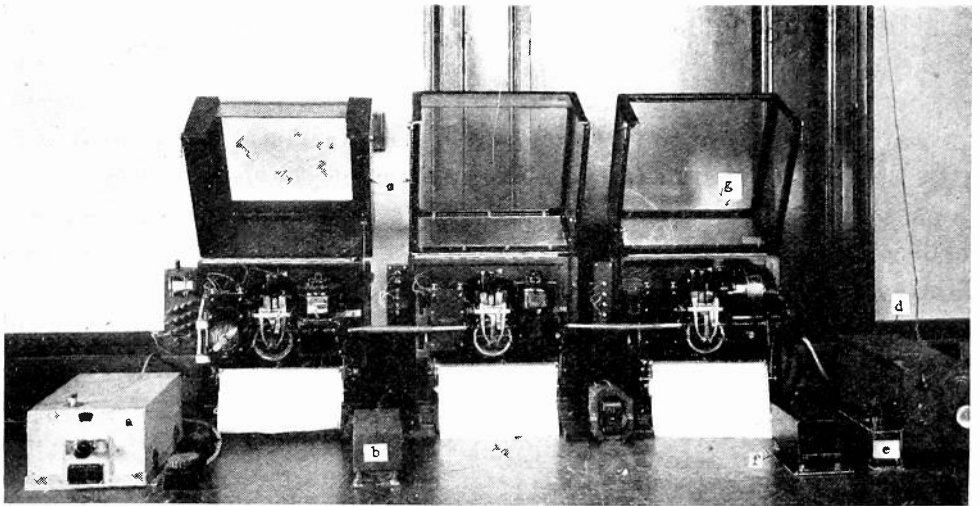

Fig. 7—Photograph of receiving test set-up shown schematically in Fig. 6, in which (a), (b), and (c) represent, respectively, the receiving set, reed converter, and automatic recorder for taking polarization data, while (d), (e), (f), and (g) represent the receiving set, automatic volume control unit, reed converter, and recorder for taking the data on night effects.

The lack of synchronism in the variation of intensity of the 65- and  $86\frac{2}{3}$ -cycle signals also follows, once we analyze the test conditions. The Bellefonte loop antennas are oriented N-S and E-W, respectively. The receiving point at Sunbury, Pa., is nearly due east of Bellefonte so that the vertically plane polarized component  $E'$  received at Sunbury comes almost entirely from the E-W loop transmitting antenna while the horizontally plane polarized component  $E''$  comes almost entirely from the N-S antenna. To orient a beacon course on Sunbury, the currents in the two antennas are modulated equally at the two modulation frequencies. However, the goniometer characteristic<sup>8</sup> is such that the currents in the two antennas modulated at say 65 cycles are in time

<sup>8</sup> J. H. Dellinger and H. Pratt, "Development of radio aids to aviation," Proc. I.R.E., vol. 16, pp. 890-920; July, (1928); see p. 908, equations (2) and (3).



phase while the currents in the two antennas modulated at  $86\frac{2}{3}$  cycles are 180 degrees out of time phase. Therefore, in the transmitted wave, the 65-cycle components of  $E'$  and  $E''$  are in time phase, and the  $86\frac{2}{3}$  cycle components of  $E'$  and  $E''$  are 180 degrees out of time phase. The combinations of  $E'$  and  $E''$  in the receiving loop antenna, corresponding to the varying state of polarization of the received wave, will consequently result in nonsynchronous variation in the intensity of the received 65- and  $86\frac{2}{3}$ -cycle signals.

To complete the foregoing analysis it is necessary to explain the almost complete absence of horizontally polarized components in the

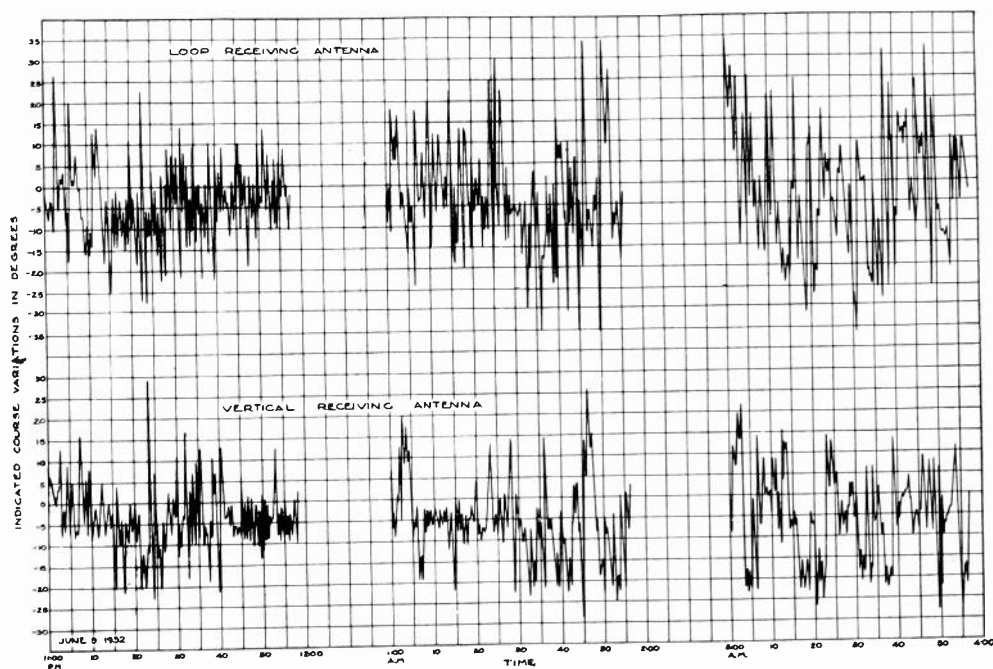

Fig. 8—Simultaneous records of night course variations on loop antenna transmission using vertical and loop receiving antennas. Observations on Bellefonte, Pennsylvania, visual radio range beacon. Receiving point at Sunbury, Pennsylvania, fifty miles east of Bellefonte.

received wave when T-L antenna transmission is employed. This is due to a marked reduction in the intensity of the sky wave with this antenna system. The elimination of the electric field component  $E''$  in the sky wave has already been mentioned. As will be explained in Section IV in connection with the operation of this type of antenna, the electric field component  $E'$  is also markedly reduced. The reduction factor as compared with loop antenna transmission is  $\cos^2 E$ , where  $E$  is the angle of elevation for the sky wave. Corresponding to the receiving location at Sunbury, Pa., and for an assumed ionized layer height of fifty miles, the numerical value for the reduction factor is 0.2.

A second set of interesting data secured at Sunbury, Pa., is given in Fig. 8, which corresponds to simultaneous records of the night effects obtained from loop antenna transmission when using a vertical receiving antenna and a loop receiving antenna. The plane of the latter antenna was directed toward the range beacon station. It will be noted that a marked difference exists in the magnitude and frequency of occurrence of the night effects corresponding to the two types of receiving antennas. The greater magnitude of course variations with the loop receiving antenna has been explained by Smith-Rose<sup>2</sup> in connection with loop antenna reception on signals from the rotating type beacon on the basis that with downcoming waves arriving at the earth's surface the resultant horizontal magnetic field (operating on the loop antenna) is of greater intensity than the vertical electric field (operating on the vertical antenna). In our analysis this is the same as stating that the electric field arriving polarized in the plane of propagation is greater than its vertical component, which is of course true. The more frequent occurrence of night effects with the loop receiving antenna is, however, not as readily explained. The question of difference in phase of the downcoming wave for the two receiving antennas is not involved, since the two antennas were only eight feet apart and when a second vertical antenna was substituted for the loop antenna synchronous night course variations were obtained. An extension of the analysis given in this paper is now in progress in an attempt to explain this phenomenon and will be published in a forthcoming paper.

#### IV. EXPERIMENTAL WORK ON EARLY TRANSMITTING ANTENNA ARRANGEMENTS

The two principal older arrangements which were considered for possible use with the radio range beacon are shown in Figs. 9(a) and (b). In each case only one half of the complete antenna system required for a range beacon installation is shown, and thus corresponds to one loop antenna of the present range beacon installations. Fig. 9(a) represents the original antenna of Adeock except that loading coils are inserted in each vertical antenna circuit to resonate it to the radio frequency of the transmitter. It will be observed that the two vertical antennas are so coupled to the transmitter that the current in one antenna is in opposite direction to the current in the other antenna. This corresponds exactly to the conditions in the vertical wires of the loop antenna and results in the transmission of the vertical electric field component ( $E'$ ) only. The horizontal component is not transmitted with much intensity since the currents in the horizontal wires of the antenna arrangement of Fig. 9(a) nearly cancel each other, as may be

seen by reference to the figure. The transmission characteristic for this antenna is therefore the same whether only the ground wave or both the ground and sky waves are received. As noted under Section III, the component  $E'$  in the sky wave is reduced with this type of transmitting antenna, being  $\cos^2 \epsilon$  times that produced by the loop antenna system (where  $\epsilon$  is the angle of elevation for the sky wave). One of the cosine factors is due to the directivity in the vertical plane of a single vertical antenna, and the second cosine factor due to the differential action of the two vertical antennas of a pair. An antenna of the type shown in Fig. 9(a) was constructed at College Park, Md., but was not used extensively because of difficulties of adjustment. In order that

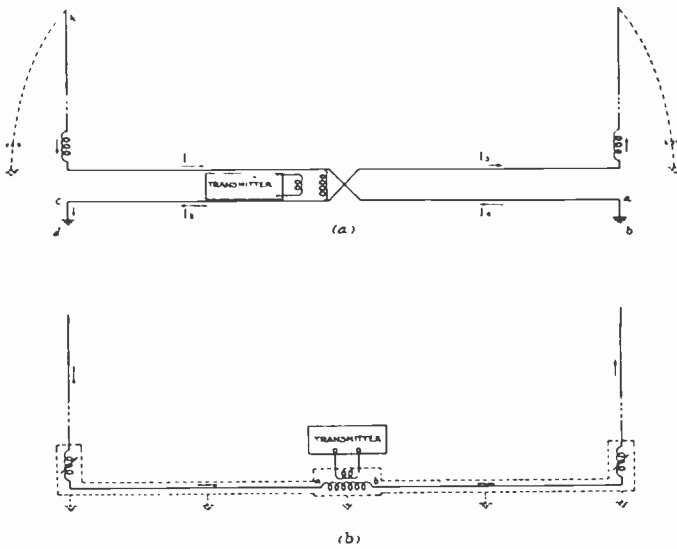

Fig. 9—Early transmitting antenna arrangements tried at College Park, Maryland, but found unsuitable.

- (a) Adcock arrangement  
 (b) Marconi adaptation of Adcock antenna

$I_1 = I_2$  and  $I_3 = I_4$  (the condition for neutralization of radiation from the horizontal conductors), it was necessary to insert balancing impedances in the ground leads  $ab$  and  $cd$ . The procedure required for determination of the correct values for these impedances was considered too difficult for practical use.

Fig. 9(b) represents an adaptation of the Adcock antenna by the British Marconi Company, except for the addition of the loading coils for tuning the vertical antennas. The two vertical antennas are fed in series by means of the coupling coil  $ab$  which may be the goniometer rotor winding. To prevent radiation from the horizontal lead, it is completely inclosed in a metallic conductor which is grounded at regular intervals. Because of the high resistance of the ground encountered, the

shielding of the horizontal feeder was found insufficient, even when extensive ground wire systems were provided. This resulted in residual course variations of one third to one half the magnitude of those obtained when using the loop antenna system. This arrangement also presented difficulties of adjustment, particularly in the tuning of a pair of antennas to the frequency of the transmitter. The adjustment of inductance in a given vertical antenna would not only affect the resonance frequency of the pair but also the voltage of the two vertical antennas above ground. This in turn would result in a departure of the currents in the two vertical antennas from equality in magnitude, and from their proper 180 degree phase relationship. It was therefore necessary to tune the two antennas of a pair simultaneously.

#### V. TRANSMISSION LINE ANTENNA SYSTEM

The antenna arrangement finally adopted is given in Fig. 10. As in Figs. 9 (c) and (d) only one half of the complete transmitting ant-



Fig. 10. Transmission line antenna system developed at College Park, Maryland.

enna system is shown. The significant element of the system is the particular means employed to confine the radiation to the four vertical antennas. A two-wire parallel conductor transmission line is used to feed power from the goniometer to each vertical antenna, these transmission lines being of such a nature as not to radiate. The efficient means for eliminating horizontal radiation thus provided makes it feasible to reduce the residual course variations to much smaller values than was possible with any of the early arrangements. The use of transmission lines also affords efficient transfer of power from the goniometer to the vertical antennas.

##### (1) *Electrical Circuit Arrangement*

Each transmission line is coupled to its vertical antenna by means of an impedance-matching transformer. The secondary winding of this transformer is tapped to permit accurate matching of its input impedance to the surge impedance of the transmission line. In this way, reflection from the load end and consequent radiation from the line

are minimized. The electrical circuit arrangement for connecting the transmission lines to the range beacon transmitting set is given in Fig. 11. The transmitting set and goniometer are unaltered. The change lies in the addition of means for transferring the radio-frequency power from the rotor windings of the goniometer to the transmission lines. (With the present loop transmitting antenna system each rotor winding is connected directly to one of the two loop antennas.) Referring to Fig. 11 each rotor winding is connected in a tuned series circuit which, in conjunction with the radio-frequency transformer shown, has two functions: (a) to transfer power from the rotor winding to a pair of transmission lines, and (b) to match the impedance of the rotor winding to the impedance of the two transmission lines in parallel. It

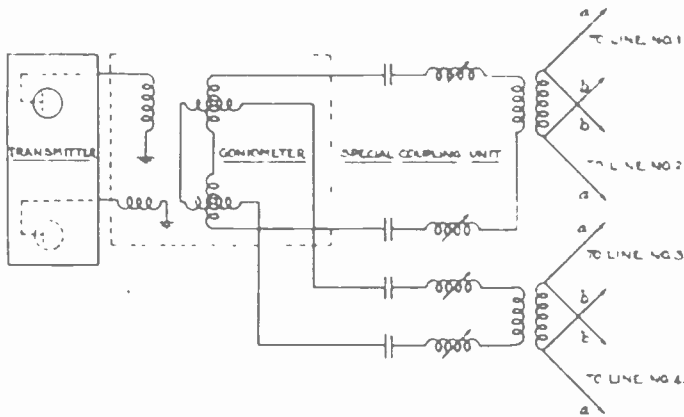

Fig. 11—Circuit arrangement showing electrical connections of the transmission lines to the range beacon transmitting set.

will be observed, by reference to the letters *a*, *b*, etc., on the leads to the transmission lines that, for each pair of lines, the connections of one transmission line to the radio-frequency transformer are reversed with respect to the connections for the other transmission line. This insures that the currents in the vertical antennas of a pair flow in opposite directions.

## (2) Experimental Installations

Two experimental installations of the transmission-line antenna system were made and thoroughly tested, one at College Park, Md., where it was developed, and the second at Bellefonte, Pa. The latter installation afforded an opportunity to test the operation of the system in mountainous terrain. A perspective view of the installation at Bellefonte is given in Fig. 12. The four vertical antennas shown are spaced at the corners of a square, the pair (1, 2) working together in place of one loop antenna of the present range beacon antenna system and

the pair (3, 4) in place of the second loop antenna. Special attention is paid to increasing the effective capacitance of each vertical antenna to ground, thereby securing as great an antenna current as possible. To this end, each vertical antenna consists of six vertical wires arranged as elements of a cylinder four feet in diameter. The vertical antennas are approximately seventy-five feet high, the two antennas of a pair being spaced 400 feet apart. To insure a fixed low ground resistance, an individual ground-wire system (not shown in Fig. 12) is provided at the base of each vertical antenna. Each ground system consists of two concentric circles, one seventy-five feet and the other 150 feet in diameter: the two circles are interconnected by eight radial spokes which join di-

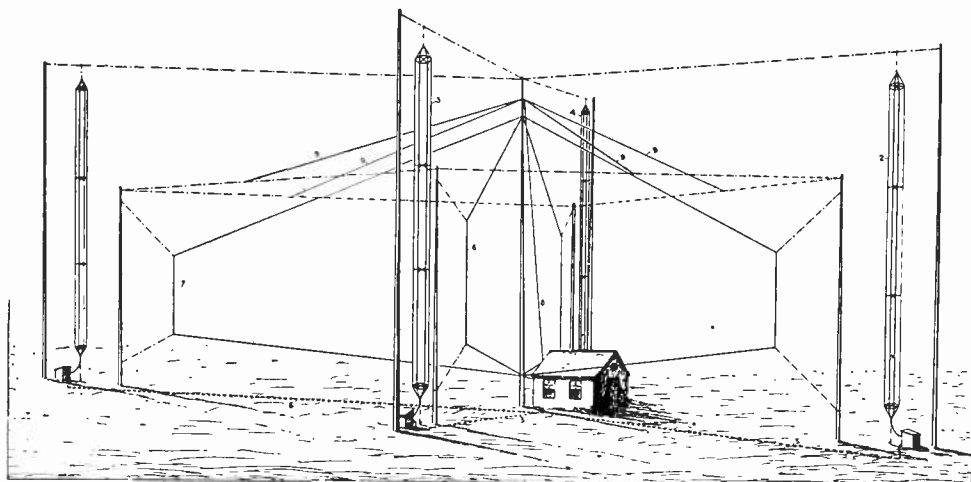

Fig. 12—Perspective view showing the experimental transmission-line antenna installation at Bellefonte, Pennsylvania, and also the old loop antenna system together with the central course-bending antenna. This installation provided means for measurements of night course variations alternately from the two antenna systems. The numerals 1, 2, 3, and 4 designate the vertical elements of the T-L-antenna system; 5, the transmission lines feeding these elements; 6 and 7, the loop antennas; 8, the down-lead for the course-bending antenna; and 9, the flat-top elements for this antenna.

rectly under the vertical antenna. With this set-up, approximately four amperes was obtained at the base of each antenna, the radiated field intensity being approximately seventy-five per cent of that obtained with the conventional loop antenna. To secure greater field intensity and also a more permanent antenna structure, installations of this antenna system on the airways will employ insulated steel towers, 125 feet high and spaced 500 feet apart.

The tuning boxes which house the antenna loading coils and the transmission line coupling transformer are located each near the base of one vertical antenna, and are provided with complete shielding to preclude the possibility of stray radiation. The transmission lines con-

sist of ordinary two-conductor 600-volt cable with a lead sheath, and are buried about eighteen inches below the ground surface. The lead sheath provides mechanical protection. Special care must be taken that the lead sheath (particularly that portion near the antenna end) is not electrically connected to the ground-wire system, except by way of its continuous connection with the earth; otherwise, the ground return currents concentrate along the lead sheath thereby reintroducing some night effects.

In addition to the transmission-line-antenna system, Fig. 12 shows the old loop antenna system together with the central course-bending antenna which were employed at the Bellefonte visual range beacon station. This installation was left intact to facilitate comparison of the night effects produced by the loop and transmission-line antenna systems. Means were provided for rapid switching of the goniometer output circuits to either antenna arrangement.

### (3) *Operational Features*

The use of the transmission-line-antenna system involves the problem of accurate control of the time phase angle between the currents in the two vertical antennas of each pair. When the time phase angle is 180 degrees, a true figure-of-eight space pattern is obtained; when it is 180 degrees minus the space phase angle between the two vertical antennas, a cardioid is obtained. For phase angles intermediate to these two values, a space pattern intermediate to the true figure-of-eight and cardioid results. This affords a convenient means for alignment of the four beacon courses with airway routes converging on an airport at arbitrary angles. Altering the space pattern radiated by one or both of the directional antennas changes the points of intersection of the two patterns and, in consequence, the angular direction of the four equisignal zones or courses. The requirement for a central open-type course-bending antenna, such as is employed with the loop antenna system, is thus obviated.

The property of the new antenna system which permits alteration of its radiated space pattern, while thus seen to be of technical and economic advantage, also imposes a special operational requirement on the system. Obviously, unless the phase angle between the currents in the two vertical antennas of a pair is kept constant within rather close limits, the angular direction of the beacon courses will vary from time to time. Keeping close control of the phase angle requires special design of the vertical antennas, the antenna tuning and coupling units, the transmission lines and the means for transferring power from the goniometer to the transmission lines. Special means for quick phase checking are also required. Experimental work is now in progress on

the development of a system for securing automatic control of the phase angle with provision for automatic compensation for any change in the predetermined phase angle for no matter what reason.

## VI. COMPARISON OF NIGHT EFFECTS WITH LOOP AND T-L ANTENNA SYSTEMS

### (1) *Ground Measurements*

An idea of the effectiveness of the transmission-line-antenna system in eliminating night course variations may be had by reference to Fig. 13, which corresponds to measurements on the College Park, Md., installation taken at a receiving point, Fort Royal, Va., located in the Blue Ridge Mountains about sixty-five miles west of College Park. Fig. 14 represents simultaneous readings, on a right-angle course, taken at Richmond, Va., about 100 miles south of College Park. The graphs of Figs. 13 and 14 designated by the letter (a) are for readings on the College Park service beacon, which uses loop antennas for transmission and operates on 290 kilocycles. The graphs designated (b) are for the experimental installation, using the T-L antenna system and operating on 320 kilocycles.

Similar data on the Bellefonte installation are given in Fig. 15. The measurements were made with an automatic recorder at Sunbury, Pa., about fifty miles east of Bellefonte. Loop antennas were used for transmission at Bellefonte from 9 to 10 p.m. and 11 to 12 p.m. The T-L antenna system was employed from 8 to 9 p.m. and 10 to 11 p.m. The frequency of operation was 326 kilocycles. Twenty-four-hour runs, taken at Sunbury, corresponding to transmission from the Bellefonte loop and T-L antenna systems, are shown respectively in Fig. 16 (a) and (b). Times of sunset and sunrise are indicated on the graphs. While these runs were not taken simultaneously, they may be used for a direct comparison of performance of the two antenna systems since other observations (on the Bellefonte aural beacon) showed that the night effects were of about the same magnitude and duration on both nights.

### (2) *Flight Tests*

Fig. 17 represents typical results of measurements of the indicated beacon course taken in night flights on the Bellefonte visual range beacon. Fig. 17 (a) is for the outgoing trip during which loop antennas were used at the beacon station, while Fig. 17 (b) is for the return trip on the same night during which the T-L antenna system was used for transmission. The airplane followed as closely as possible the route marked out by the beacon course during a day flight. The variations



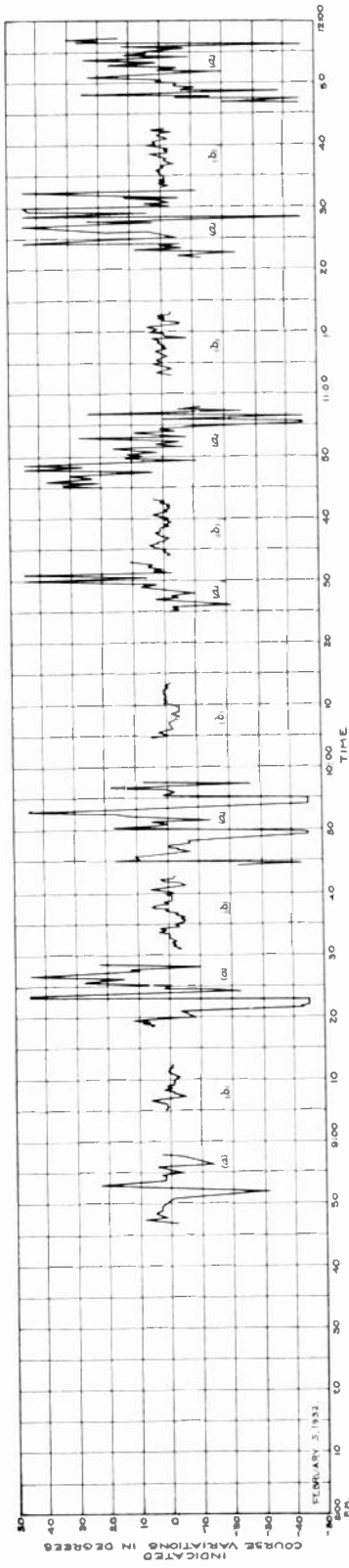

Fig. 13—Comparative night course variations from loop and T-L antenna systems at College Park, Maryland. Receiving point at Front Royal, Virginia, sixty-five miles west of College Park.  
(a) Loop antenna transmission  
(b) T-L antenna transmission

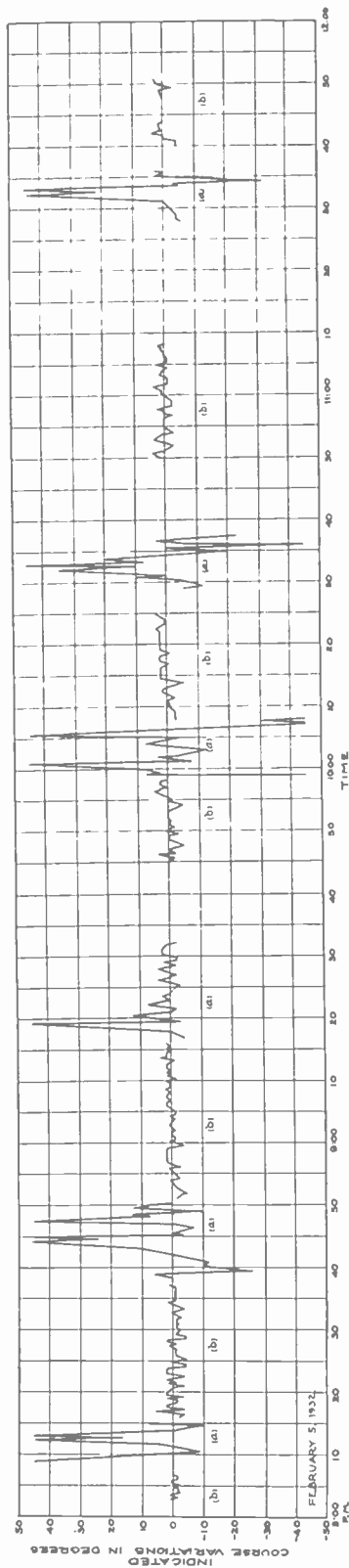

Fig. 14—Comparative night course variations from loop and T-L antenna systems at College Park, Maryland. Data taken at Richmond, Virginia, 105 miles south of College Park.  
(a) Loop antenna transmission  
(b) T-L antenna transmission

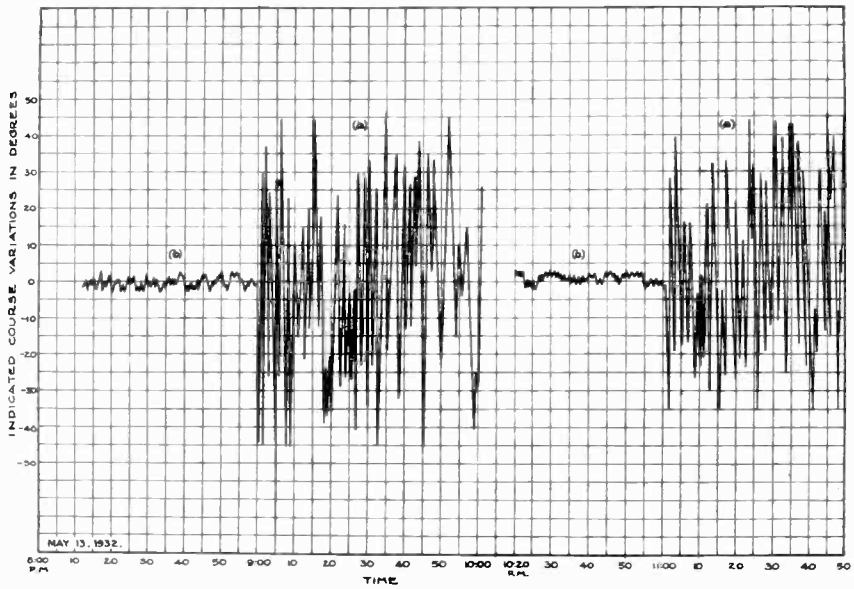

Fig. 15—Comparative night course variations from loop and T-L antenna systems at Bellefonte, Pennsylvania. Receiving point at Sunbury, Pennsylvania, fifty miles east of Bellefonte.

- (a) Loop antenna transmission
- (b) T-L antenna transmission

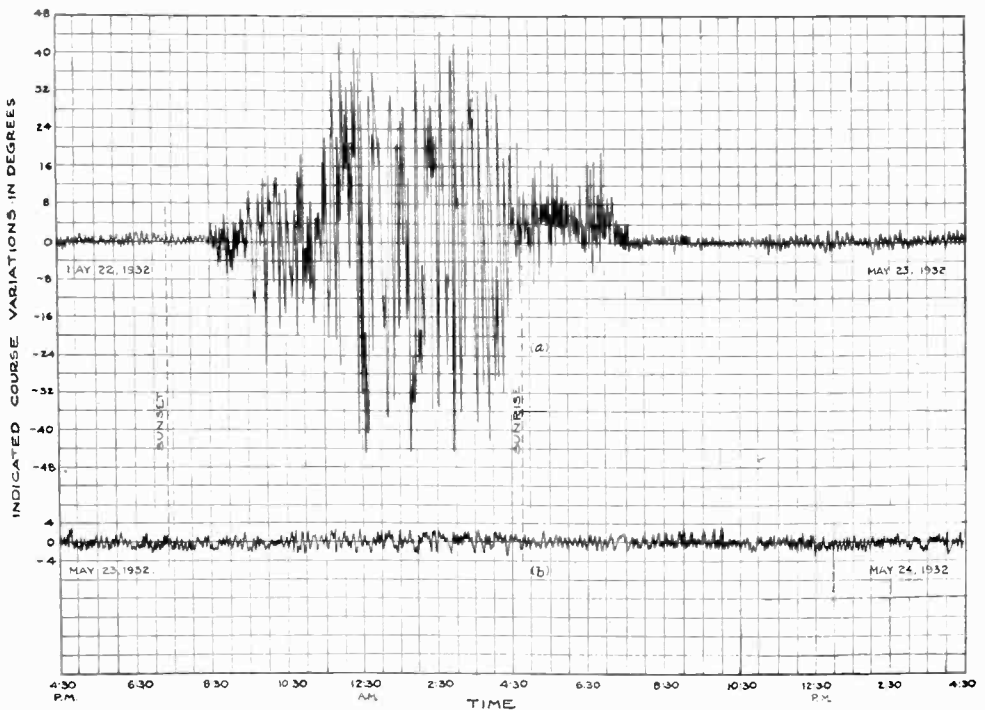

Fig. 16—Twenty-four-hour automatic records of night course variations on Bellefonte visual range beacon, taken at Sunbury, Pennsylvania.

- (a) Corresponds to loop antenna transmission
- (b) Corresponds to T-L antenna transmission

shown for the first eighteen miles are departures of the airplane from the straight course, not night effects. A comparison of the results with the two systems shows that while the beacon course became of no further value beyond forty-five miles from the station when using loop antenna transmission, it was perfectly satisfactory throughout the whole distance traveled when the T-L antenna system was in operation.

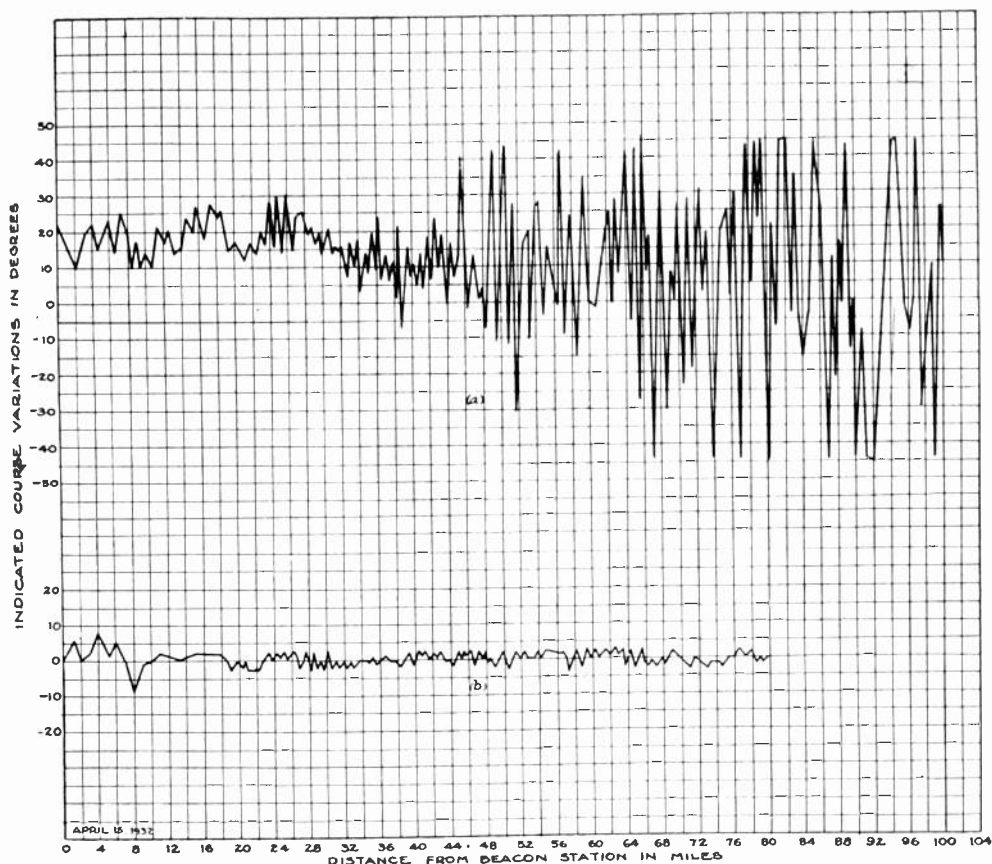

Fig. 17—Night observation in an airplane showing night course variations from Bellefonte visual range beacon.

- (a) Corresponds to loop antenna transmission
- (b) Corresponds to T-L antenna transmission

## VII. ACKNOWLEDGMENT

The author desires to acknowledge the parts played in this development by his coworkers in the Bureau of Standards and others. Appreciation is extended to G. H. Wintermute and H. M. Horsman for research in the operation of the experimental transmitting set-ups and for many measurements in the field, to G. L. Davies for the data se-

conducted on the Midcontinent Airway and for assistance in the theoretical analysis of the results obtained, to W. S. Hinman for field set-ups and tests, to E. G. Keat for the design of the transmission line coupling units, and to W. T. Jackson (Airway Division) for suggestions and discussions of results. Special acknowledgment is due to Colonel H. H. Blee, director of aeronautic development, Aeronautics Branch, for his inspirational direction of this project, to Dr. J. H. Dellinger, chief of the radio section, Bureau of Standards, for many helpful suggestions during the progress of the work, and to Captain E. C. Hingsburg, chief engineer of the Airways Division, for cooperation in the provision of test facilities and equipment.



THEORETICAL NOTES ON CERTAIN FEATURES  
OF TELEVISION RECEIVING CIRCUITS\*

BY

GORDON D. ROBINSON

(United States Naval Academy, Annapolis, Maryland)

*Summary* Four main items are treated in these notes. The first is the determination of the product of capacity and resistance required in a television amplifier in order that the distortion of low-frequency flat-topped waves shall not exceed a specified percentage, the wave being passed through a single stage of resistance coupled amplification. The influence of multiple-spiral scanning systems is mentioned. The second item deals with the addition of small amounts of inductance to the circuit of a resistance coupled amplifier. A set of generalized graphs are presented for the purpose of greatly expediting computation of the best amount of inductance to use for given conditions. One pair of curves shows results for a simple case, without inductance, corresponding to the resistance coupled amplifier. One curve of the pair is used for the amount of amplification, the other for the phase shift which corresponds to this. A second pair of curves deals with the condition of added inductance best suited to minimum phase shift, while a third pair deals with the condition obtained with the amount of inductance best suited to constant amplification. The third item shows the use of these curves by applying them to specific cases. The fourth item refers to the use of a type of push-pull detector circuit useful for minimizing the by-passing of desired high-frequency currents in the output of a detector.

VARIOUS statements concerning the present limits of the fidelity of amplifiers in the frequency range required for television operation undoubtedly are unduly pessimistic. While on the one hand we have published characteristics of single stages of resistance coupled amplifiers indicating that a solution has not been provided, on the other hand we have demonstrations of operation of television equipment which show that some sort of a solution has been provided. The conclusion that should be drawn from this apparent contradiction is thought to be that no *simple* and accurate solutions to the problems of television amplification have been published.

This article deals with the simple resistance coupled amplifier and certain simple but important modifications thereof. Its object is to provide information permitting the design of an amplifier having substantially constant amplification and small phase shift over any desired wide band of frequencies required for television circuits. It does not attempt to deal with the better-known solutions to problems such as the prevention of self-oscillation.

\* Decimal classification: R583. Original manuscript received by the Institute, September 20, 1932.

In the ideal television transmission system the illumination of the entire field at the receiver during reception will be under the complete control of the transmitter, so that, for example, the entire field could remain at maximum intensity or completely black as long as desired. Such control requires that the "low-frequency" amplifiers at both the transmitter and receiver shall be of the direct-current type so that a small direct voltage applied to the input will maintain a corresponding direct current in the output for any desired length of time. At the present time television receivers are so made that the *average* illumination of the field of the picture is controlled at the receiver, and cannot be changed by anything occurring at the transmitter. In this case it is recognized that, for stationary pictures, the lowest frequency which must be amplified either at the receiver or the transmitter is the picture frequency of, say, 20 per second. A resistance coupled amplifier to transmit frequencies as low as this with negligible distortion will have somewhat unusual constants.

The unusual constants necessary to meet the low-frequency requirements, with a resistance coupled amplifier, may be approximately determined by considering the action of such an amplifier when a steady square-topped voltage wave is applied to its input. Assuming that the alternating-current input consists of plus and minus alternations which are exactly alike except for sign, the "flat-topped" alternating-current component of the output will be distorted by having a slanting top decreasing in amplitude towards the end of each alternation. An approximate expression for the undesired variation during the "flat" portion of such a wave may be obtained. This expression is based upon the time constant of the path through which the coupling condenser discharges. It may be seen that this discharge occurs through a resistive path consisting of the grid leak resistance in series with a parallel path containing the coupling resistor and the internal plate resistance of the tube. Call the resultant resistance of this series-parallel path  $R_3$  and the coupling capacity  $C_3$ . Let  $n$  be the number of pictures per second. Then the percentage variation (per stage) introduced by the proximity of the low-frequency cut-off will not exceed  $50/nC_3R_3$  per cent. This is a per cent of the amplitude of the flat-topped alternating-current component. The units used in the equation are the fundamental units, or, more conveniently,  $C_3$  in microfarads and  $R_3$  in megohms.

If the flat-topped alternations are of unequal amplitude and duration but of the same average value as before, the percentages will be different but the actual variations will be the same. During the transient immediately following a sudden change in picture the variations

may be as much as twice as large as indicated above. Progressive picture movement also may increase the duration of the flat-topped alternation. Since the lowest frequency is apt to be required mostly by the background of a picture, and the background seldom changes suddenly, it may be satisfactory to neglect this transient condition. Experience will indicate necessary allowance for these.

Dividing the maximum percentage variation assumed to be permissible by the number of stages of amplification and substituting the result in the preceding equation, a value for the product of  $C_3$  and  $R_3$  can be obtained. This product will be on the safe side. Note that, as an approximation,  $R_3$  equals the resistance of the grid leak, the remaining resistance item frequently being small compared to the grid leak.

If the amplifier is to be used with a system having more than one spiral in the scanning disk the theoretical requirement for lowest frequency remains the same. However, the distribution of light calling for this lowest frequency, with a multiple-spiral disk, is very unlikely to occur, and the chances are that but little will be lost if in place of  $n$  we use  $n$  multiplied by the number of spirals.

It is generally known that as the frequency applied to a resistance coupled amplifier is increased some value will be reached at which the loss in amplification will be appreciable. This is known in a general way, but apparently not in detail. Theoretical considerations indicate that, at least with screen-grid tubes, uniform amplification may be obtained up to higher values than any need is seen for. In the simple resistance coupled amplifier and with high frequencies this is expensive since it involves constants which produce but little amplification per stage.

One object of this article is to draw attention to a type of correction to be applied to resistance coupled amplifiers to decrease the variation in amplification and the phase shift at relatively high frequencies. This correction is provided by adding small amounts of inductance which may be obtained at little or no additional cost. This inductance will generally be in series with, or actually in, the plate coupling resistor. The use of inductance in such a location is not new, but, so far as is known, no information concerning the exact amount to use has been published. This inductance may be chosen to reduce the phase shift introduced by the amplifier to a minimum or it may be chosen to reduce the variation of amplification to a minimum. The values required for these two conditions are substantially different. The use of the best amount for either purpose will improve the other characteristic simultaneously. In either case the relative improvement varies with the quality of performance required of the amplifier, being greatest where

the variations tolerated are the smallest. Depending upon this condition and considering only uniformity of amplification, the highest satisfactory frequency for operation will be around two and one half to ten times what it would be without the inductance. If only phase shift is considered, the improvement is greater. For small phase shifts, the highest frequency is ten to one hundred times as high when using the inductance.

An additional characteristic of this corrected amplifier which may frequently be useful is provided by an amplification which rises at the higher frequencies if the correction is the best for minimum phase shift. This may be used to correct for deficiencies elsewhere in the system, or if not wanted, it will simply be so placed that it occurs at a higher frequency than is to be used. If many stages are used this same characteristic may make trouble due to a tendency to oscillate at some frequency higher than the desired operating range.

In the case of best correction for phase shift, the apparent capacity from grid to plate of a three-element tube remains practically constant as the frequency is varied until the amplification starts to increase. It follows that this correction may be applied to a three-element tube circuit almost as well as to a screen-grid circuit.

Consider the elementary circuit shown in the upper left-hand corner of Fig. 1. In order that  $Z$  may appear to be nonreactive the inductive susceptance of the  $R$  branch should be made equal to the susceptance of the capacity branch. This may be done exactly for any one frequency. Fortunately, it may also be done, to a very close approximation, for a wide range of frequencies. The susceptance of the  $C$  branch is  $2\pi fC$ . With  $L$  in series with  $R$ , the susceptance of the  $R$  branch is  $2\pi fL/(R^2 + (2\pi fL)^2)$ . Comparison of these shows that if  $(2\pi fL)^2$  is small compared to  $R^2$  both of these susceptances vary directly with the frequency  $f$ . If then the two expressions are equated to each other,  $(2\pi fL)^2$  being dropped out, the equation may be solved for the relationship required in order that the two susceptances may be substantially equal, so long as  $X_L$  is relatively small enough. This solution gives  $L = CR^2$  in fundamental units; i.e.,  $L$  in henries,  $C$  in farads, and  $R$  in ohms. If preferred,  $L$  may be used in microhenries and  $C$  in microfarads without change in result.

To show in a general manner, not involving specific values of  $L$ ,  $R$ ,  $C$ , and  $f$ , the variation of the impedance of this circuit, a plot has been made showing the relation between  $Z/R$  and  $f/f_0$  where  $f_0$  is defined as the frequency which causes  $X_C$  to be equal to  $R$ . This ratio  $f/f_0$  is also equal to the ratio between the resistance  $R$  and the reactance  $X_C$ .



Fig. 1 shows the variation of  $Z/R$  for three different values of  $L$ , in terms of  $C$  and  $R$ . Points to the left of the sheet correspond to relatively low values of frequency. The curves marked  $L=0$  represent the case of simple  $R$  and  $C$  in parallel, as found in a simple resistance coupled amplifier. These  $L=0$  curves in connection with the others show the result of introducing more or less  $L$  in series with  $R$ . The curve marked  $L=CR^2$  (and  $Z/R$ ) shows the variation of impedance with frequency for the amount of inductance determined above as giving the smallest values for phase shift. The  $Z/R$  curve marked  $L=0.414 CR^2$  is intended to show the results with the largest value of  $L$  which does *not* cause any rise in  $Z$  with increase of frequency. The value 0.414 was obtained by a cross-plotting method and is open to some doubt as to exact value. This curve shows the results of the best correcting for constant values of  $Z/R$ .

The three curves starting in the lower left-hand corner and marked "Phase Shift" show the angle of lag of the impedance  $Z$  and/or the lag of voltage behind current in the circuit. The auxiliary scale across the top of the sheet is for convenience in converting the logarithms at the bottom of the sheet to actual values, or vice versa.

In applying these curves to the design of an amplifier take the value of the plate resistor as  $R$  and the total apparent capacity in shunt with this resistor as  $C$ . If the values of  $R$  and  $L$  to give certain frequency characteristics are to be found, the influence of the internal plate resistance and grid leak resistance cannot be directly and simply included. A change in the predicted values of phase shift and amplification are produced by including the effects of the internal plate resistance and grid leak resistance. The phase shift is always reduced while the final drop in amplification, due to capacity effects at high frequencies, is moved to higher frequencies by including them. For values of  $X_L$  and  $1/X_C$  small compared to  $R$ , the percentage drop in amplification at a given frequency may be corrected by multiplying the  $Z/R$  value taken from the curve by a correction factor  $R_1/(R_1+R)$ . In this expression  $R_1$  is the mathematical result of considering the internal plate resistance and the grid leak resistance in parallel.  $R$  is the resistance of the coupling resistor. This ratio may be utilized either by starting a design with larger tolerance figures than wanted, or else by a cut-and-try process. For constants leading to large phase shifts and large changes in amplification, the influence of these resistances may be obtained by the ordinary complex algebra of alternating current, applied to a suitable one of the equivalent tube circuits. If a compensating increase in the tolerance is to be assumed before computing  $R$  and  $L$  it will be based on the tube constants and an estimated value for the

coupling resistor. For example, if the coupling resistor is estimated to be twice  $R_1$  and a drop in amplification no greater than 1 per cent is to be tolerated in the final result, the computation may be started with  $R/Z$  equal to 97 per cent instead of 99 per cent. Note that with screen-grid tubes this correction ratio is apt to be nearly unity, and its neglect may cause no more error than the random variation of constants from one tube to another.

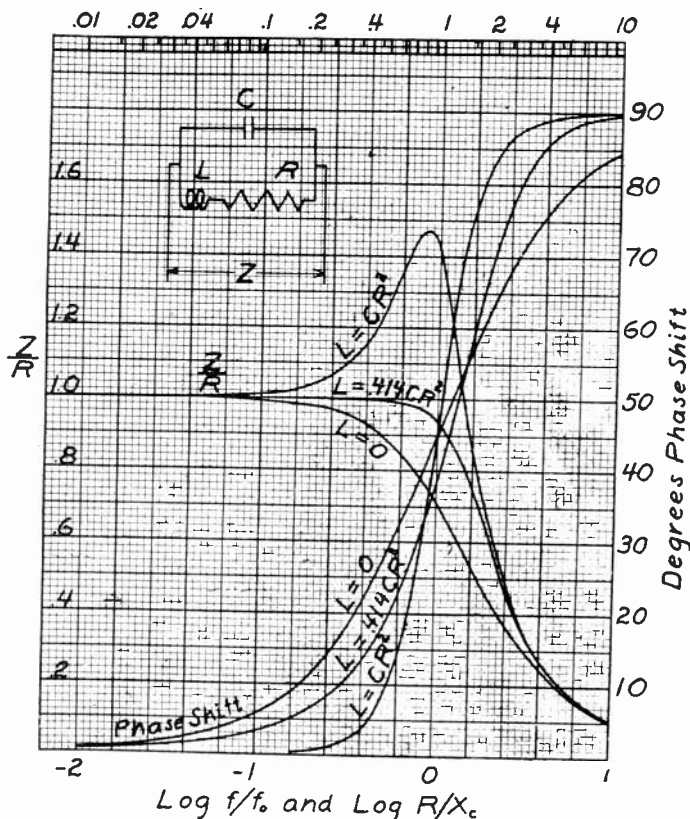

Fig. 1

Although not immediately obvious, the same approximate constant,  $R_1/(R_1+R)$ , may be applied to obtain the actual amplification from the first approximation given by  $R \times g_m$ . The lack of accuracy of this second approximation depends only upon the neglect of the effects of  $L$  and  $C$ .

This parallel treatment in the preceding paragraphs may best be understood by considering the equivalent *parallel* circuit of the amplifier.<sup>1</sup>

<sup>1</sup> For a description of this see "Electronics," p. 105; September, (1931).

To illustrate the application of the curves of Figs. 1 and 2, assume that an amplifier is to be designed, using type -24 screen-grid tubes, in which it is desired to keep the phase shift at a minimum and in which an increase of amplification of 5 per cent per stage will be tolerated at the upper frequency limit of 100 kilocycles. Looking at the  $L = CR^2(Z/R)$  curve in Fig. 1 or 2,  $Z/R = 1.05$  when  $R/X_C$  is approximately 0.22.  $X_C$  is due to the output capacity of one tube plus the input capacity of the following tube plus (an estimated value)  $5\mu\text{mf}$  for

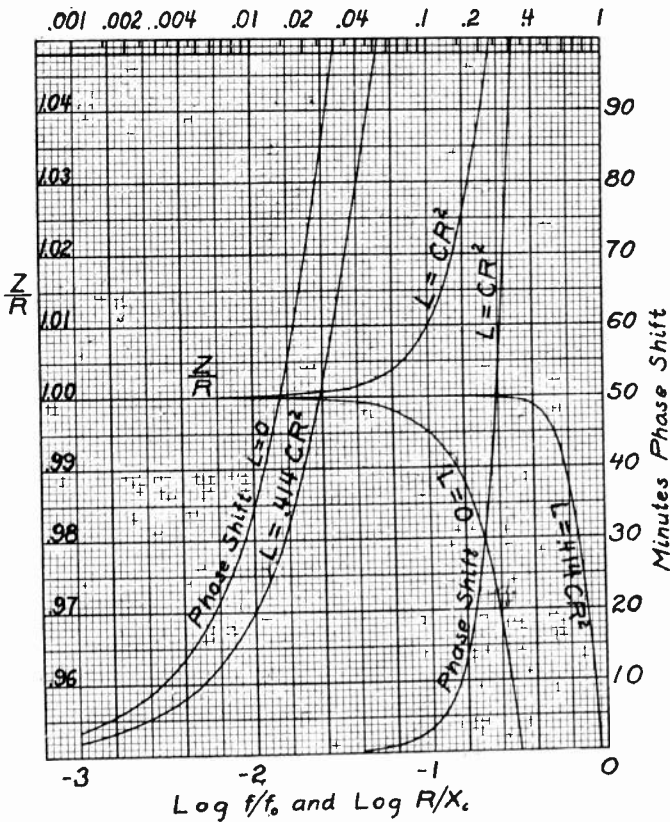

Fig. 2

the distributed capacity of coupling and wiring.  $X_C$  then is the reactance of  $20\mu\text{mf}$  at 100 kc, which is 79,600 ohms. Therefore,  $R/79,600 = 0.22$  or  $R = 17,500$  ohms.  $L = CR^2 = 0.00612$  henries or 6.12 mh. Throughout the range within which the curves show that  $Z/R = 1$  (neglecting low-frequency cut-off) the amplification will be nearly  $17,500 \times 1,050 \times 10^{-6}$  or 18.4 per stage. At any high frequency for which  $Z/R$  is not unity, the amplification will be approximately  $18.4 \times Z/R$ . The phase shift at 100 kilocycles is just about 40 minutes. If  $L$  were omitted the phase shift at 100 kilocycles would be about 12.5 degrees. It should be noted that a tube such as the type -24 will introduce

distortion due to the curvature of its plate-current—grid-voltage characteristic with relatively small input to the grid.

If, in the preceding assumed case, phase shift had been less important, the value for  $R/X_c$  might have been taken from the  $L=0.414 CR^2$  curve, giving about 0.9 instead of 0.22 for  $R/X_c$  and consequently  $R=71,600$ . This would result in several times as much amplification, and a maximum phase shift for each stage about fifty times as great as before, on a basis of 5 per cent drop in amplification instead of 5 per cent increase.

Another application of the curves which requires illustration is the treatment of a triode circuit, involving apparent increases in capacity which are neglected with screen-grid tubes, and further illustrating the influence of grid leak and internal plate resistances. For the sake of this illustration consider a resistance coupled amplifier utilizing one triode tube feeding another. The shunt capacities to be fed by the first amplifier tube space path include the distributed capacity of wiring and coupling apparatus, the plate-to-filament and plate-to-grid capacities of the first tube, and the grid-to-filament and grid-to-plate capacities of the second tube. The voltage actually existing across the grid-to-plate capacity in each tube will be greater than that across the other capacities. To allow for this, these capacities will be increased to an "apparent value" greater than the actual capacity. If there is no phase shift this increase may be made simply and accurately. The accuracy of the simple computation decreases with phase shift, but only slowly for small phase shifts. The increase of capacity to an apparent value depends upon the voltage amplification actually produced in each tube. Let  $\mu_1$  be the actual voltage amplification for the first tube and  $\mu_2$  that for the following tube in the amplifier, then the grid-to-plate capacity of the first tube should be multiplied by  $(1+1/\mu_1)$  and that of the second tube should be multiplied by  $(1+\mu_2)$ . The first correction is apt to be unimportant, while in triodes the second may be very important. Where circuit constants are such that high amplification per stage is obtained this apparent grid-to-plate capacity of the tube which acts as a load may be ten times as large as all of the rest of the capacities put together. It apparently follows that for high grade performance with television amplifiers using triodes the amplification per stage must be kept down to moderate values.

To continue with the triode example consider an amplifier using -27 type tubes and assume that it is desired to keep the amplification nearly constant and the phase shift as small as reasonably possible. Also assume that the increase in amplification as 30 kilocycles is approached shall not exceed 1.25 per cent. To make an approximate

allowance for the influence of internal plate resistance and grid leak resistance, assume that their combined (parallel) resistance will be one third as much as the value of the plate resistor.  $R_1/(R_1+R)$  then equals  $1/4$  and, to make allowance for this, the computation will be started by using an amplification variation tolerance of  $1.25 \div 1/4$ , or 5 per cent. The following tube or circuit constants will be used: Capacity from grid to plate,  $C_{gp} = 3.3 \mu\mu\text{f}$ ; capacity from plate to cathode,  $C_{pf} = 2.8 \mu\mu\text{f}$ ; capacity from grid to cathode,  $C_{gf} = 3.6 \mu\mu\text{f}$ ; distributed capacity of wiring and coupling between tubes measured or assumed to be  $5 \mu\mu\text{f}$ ; amplification factor of tube 9, internal plate resistance 9,000 ohms, and mutual conductance 1,000 micromhos. Sufficient plate supply voltage will be used to maintain the latter constants regardless of loss of voltage in the coupling resistor. For most accurate results it is suggested that the preceding tube capacities should have been measured with the tubes in their sockets and any shielding in place. The so-called tube constants would then include some additional capacity such as that in the socket.

Due to the fact that the apparent capacity from grid to plate depends upon the amplification obtained and the amplification in turn depends upon the apparent capacity, it appears necessary to utilize a sort of cut-and-try method to determine the constants to be used with the tube to get the desired results. This may be done by making a trial computation using an estimated value of amplification in computing the apparent capacities. By combining the apparent capacities with the others, to obtain  $C$ , and then proceeding as in the first example a resulting value of amplification may be obtained. If this result does not agree with the estimated value, new estimates and new trials may be made until the resulting amplification turns out to be equal to the estimate. To avoid the large number of computations which might be required by this process use may be made of a graph. After having made two computations for two estimated values, plot the estimated values as ordinates and the corresponding computed values of amplification as abscissas. Since this graph is almost a straight line, two points will permit a section of the graph to be drawn. From this graph pick off the point where the estimated value equals the computed value, and make a third computation using this value for capacity corrections. This will provide the values for the resistor and the inductance and at the same time will permit a check on the accuracy of the graphic method.

Applying the graphic process to the preceding problem the amplification per stage is found to be 6.85. The following is the final computation:

Apparent $C_{gp}$ of first tube	$3.3 \times (1 + 1/6.85) =$	$3.8 \mu\mu\text{f}$
Apparent $C_{gp}$ of second tube	$3.3 \times (1 + 6.85) =$	$25.9 \mu\mu\text{f}$
$C_{pf}$ of first tube		$2.8 \mu\mu\text{f}$
$C_{of}$ of second tube		$3.6 \mu\mu\text{f}$
Distributed capacity of wiring and coupling		$5.0 \mu\mu\text{f}$
		—
Total shunt capacity $C$		$41.1 \mu\mu\text{f}$

At 30 kc  $X_c = 129,000$  ohms. From curve, for  $Z/R = 1.05$ ,  
 $R/X_c = 0.22$ . Therefore  $R = 129,000 \times 0.22 = 28,400$  ohms.

Neglecting effect of grid leak,

$$\mu_1 = 9 \times 28,400 / (28,400 + 9,000) = 6.83 \quad (\text{This check is close enough.})$$

$$L = CR^2 = 41.1 \times 10^{-12} \times 28,400^2 = 0.0332 \text{ h or } 33.2 \text{ mh.}$$

Note that since low-frequency requirements will necessitate the use of a very high resistance grid leak, the influence of the grid leak has been neglected when computing the amplification.

If no error has been made in the computation, the change in amplification and the phase shift from medium frequencies up to 30 kilocycles, neglecting influence of internal plate circuit resistance and grid leak resistance, must be the values originally shown on the curves; i.e., 5 per cent increase in amplification and about 40 minutes phase shift.

In determining the correction factor  $R_1/(R_1+R)$  the effect of the grid leak will be slight but it will be included to show the procedure. Assuming the grid leak resistance to be 5 megohms,  $1/R_1 = 1/9,000 + 1/5,000,000$ . Consequently,  $R_1 = 8,840$  ohms and  $R_1/(R_1+R) = 8,840/(8,840 + 28,400) = 0.237$ . This is close enough to the originally assumed value of 0.25 so that no further computation should be required. If this value had turned out to be substantially different from the original assumption, a new computation would be made with a new estimated value for the correction factor.

If the accuracy of the correction factor  $R_1/(R_1+R)$  is open to suspicion, the parallel (or other) equivalent circuit may be solved by complex algebra after the circuit constants have been determined as above. This will show accurately the results to be expected with the constants selected.

The inductance for use in series with the plate coupling resistors may be built directly into the resistors. At least one manufacturer of wire-wound resistors will supply them inductively wound at the same price as the standard noninductive units. The amount of inductance thus obtainable will be suitable in some cases. It can be reduced by

several steps by winding a portion of the unit noninductively. Any inductance used outside of the resistor should be of as low distributed capacity as possible and of course should be "air-cored."

In a detector plate circuit, particularly in the case of the second detector in a superheterodyne, the radio-frequency by-pass condenser that is usually considered to be necessary may have a serious by-passing effect on the useful high-frequency response. The need for this condenser may be practically eliminated by using a pair of detector tubes with push-pull input and simple parallel output. This also gives a more favorable ratio of resistance to capacity, based on tube constants.<sup>2</sup> Somewhat similar results should be obtainable with the Wunderlich tube, except that it is not available for plate detection.

<sup>2</sup> An illustration of this push-pull detector scheme will be found in Proc. I.R.E., p. 250, fig. 2; February, (1931).



## DYNAMIC MEASUREMENT OF ELECTRON TUBE COEFFICIENTS\*

BY

W. N. TUTTLE

(General Radio Company, Cambridge, Massachusetts)

*Summary*—Circuits are described for the dynamic measurement of amplification factor, electrode resistance, and transconductance; and are shown to be suitable for the measurement of both positive and negative values of all three coefficients over wide ranges. The circuits are analyzed for the general case in which the grid is conductive and the grid current is appreciably affected by variations in plate voltage. It is shown for each circuit that if the impedances of the test voltage sources are sufficiently low, the method employed for balancing capacitance currents introduces no error regardless of the value of the plate resistance. Under the same condition no correction need be applied for the impedance of the measuring apparatus. The analyses are for the grid-to-plate coefficients of a triode but are directly applicable to the measurement of grid-circuit coefficients or of coefficients relative to any pair of electrodes of a multielement tube.

A description is given of a measuring instrument in which the three circuits are incorporated.

### INTRODUCTION

CIRCUITS<sup>1,2,3</sup> which have been generally employed for dynamic measurements on electron tubes have proved satisfactory in most cases where values of electrode resistance are encountered which are small in comparison with the reactances of the interelectrode capacitances. Large errors are possible if this condition is not satisfied. This limitation was not serious at the time the circuits were developed, as low impedance tubes were then generally employed.

The increasing use in recent years of tubes having high plate resistance has made it desirable to give consideration to the problem of adequately compensating for the currents through the stray capacitances. It has seemed desirable also to consider circuit modifications to minimize the effect on the results of the impedance of the measuring apparatus, and to permit the measurement of negative as well as positive values of the coefficients.

Improvements in these directions have been found to make possible the use of a single test instrument for the measurement of the

\* Decimal classification: R330. Original manuscript received by the Institute, October 20, 1932.

<sup>1</sup> J. M. Miller, "A dynamic method for determining the characteristics of three-electrode vacuum tubes," Proc. I.R.E., vol. 6, pp. 141-148; June, (1918).

<sup>2</sup> S. Ballantine, "The operational characteristics of thermionic amplifiers," Proc. I.R.E., vol. 7, pp. 129-153; April, (1919).

<sup>3</sup> Standardization Report, YEAR BOOK, I.R.E., pp. 144-176, (1931).



three usual coefficients over wide ranges of values. Since negative coefficients can be measured without change of procedure, such an instrument is applicable to measurements referred to any pair of circuits of a multielement tube.

#### ANALYSIS OF MEASURING CIRCUITS

Each circuit to be considered makes use of three alternating test voltages derived from a single source. In the analysis, the apparatus for the production of these voltages will be replaced by three independent voltages,  $e_1$ ,  $e_2$ , and  $e_3$ , in series with their respective equivalent internal resistances,  $R_1$ ,  $R_2$ , and  $R_3$ . The conditions which must be fulfilled by the voltage sources will be developed in the analysis. The circuit arrangement for the production of the test voltages will then be considered separately.

#### *Amplification Factor*

The circuit employed for the measurement of amplification factor is shown in simplified form in Fig. 1. The electron tube is represented by the equivalent circuit, as developed by Chaffee,<sup>4</sup> for the general case in which the control grid is conductive, and the grid current is appreciably affected by variations in plate voltage.

The quantity  $\nu$  introduced by Llewellyn<sup>5</sup> is defined for the grid circuit in the same way that  $\mu$  is defined for the plate circuit. This factor is the negative of the quantity  $\mu_g$  employed by Chaffee in the derivation of the equivalent circuits. In view of the many complex tube structures now in use, it seems desirable to employ a symmetrical form of the equivalent circuit.

The external circuits with the exception of the capacitance-balance branch,  $e_3 - jX_b$ , are seen to be functionally the usual arrangement in which a voltage  $e_1$  is introduced into the grid circuit and the fictitious internal plate voltage  $\mu e_g$  is balanced against the external voltage  $e_2$ . At balance the amplification factor is equal to the ratio  $e_2/e_1$ .

This relation depends first of all on the grid voltage  $e_g$  being equal in phase and magnitude to the introduced voltage  $e_1$ . This condition is satisfied if  $R_1 i_g \ll e_g$ .

The expression for the grid current does not involve  $e_3$ , since at balance there is no voltage across the telephones. The general expression can be written down in terms of the introduced voltages  $e_1$  and  $e_2$ ,

<sup>4</sup> E. L. Chaffee, "Equivalent circuits of an electron triode and the equivalent input and output admittances," Proc. I.R.E., vol. 17, pp. 1633-1648; September, (1929).

<sup>5</sup> F. B. Llewellyn, "Operation of thermionic vacuum tube circuits," *Bell Sys. Tech. Jour.*, vol. 5, pp. 433-462; July, (1926).

but the treatment is considerably simplified without loss of generality if the calculation is made in terms of  $e_g$  and  $e_p$ , the voltages actually present at the grid and plate. The voltage drop due to grid current is thus given by

$$R_1 i_g = \frac{e_g R_1}{r_g} + \frac{\nu e_p R_1}{r_g} - \frac{e_p R_1}{-jX_{gp}} + \frac{e_g R_1}{-jX_{gf}} + \frac{e_g R_1}{-jX_{gp}}. \quad (1)$$

If we substitute the approximate balance condition  $e_p = -\mu e_g$  and require that each term shall be negligible in comparison with  $e_g$ , we obtain

$$\frac{e_g R_1}{r_g} \ll e_g \quad \text{or} \quad R_1 \ll r_g \quad (2)$$

$$\frac{\mu \nu e_g R_1}{r_g} \ll e_g \quad \text{or} \quad R_1 \ll \frac{r_g}{\mu \nu} \quad (3)$$

$$\frac{\mu e_g R_1}{X_{gp}} \ll e_g \quad \text{or} \quad R_1 \ll \frac{X_{gp}}{\mu}. \quad (4)$$

The conditions corresponding to the last two terms of (1) are included in a more general condition which will be employed later, namely that  $R_1$ ,  $R_2$ , and  $R_3$  shall be negligible in comparison with the capacity reactances. This may be abbreviated,

$$R_1, R_2, R_3 \ll X_{gf}, X_{gp}, X_{pf}, X_b. \quad (5)$$

If relations (2) to (5) are satisfied,  $e_1 = e_g$ , and if further use is made of (5), the condition can readily be written down that the sum of the currents through the telephones shall be equal to zero. The analysis is much simplified by the fact that the telephones may be regarded as having zero impedance, since there is no voltage across them at balance.

From the inphase components, keeping the first-order correction terms,

$$\mu = \frac{e_2}{e_1} \left( 1 + \frac{R_2 r_p^2}{X_p^2 (R_2 + r_p)} + \frac{R_2 r_p^2 (1 + X_{gp}/X_{pf})}{\mu X_{gp}^2 (R_2 + r_p)} \right) \quad (6)$$

in which  $X_p$  is the reactance of the grid-to-plate and plate-to-filament capacitances in parallel. The equation relating the quadrature terms is

$$\frac{e_3}{X_b} = \left( \frac{r_p}{R_2 + r_p} \right) \left( \frac{e_1}{X_{gp}} + \frac{e_2}{X_p} \right). \quad (7)$$

It is seen from (6) that the correction terms will be negligible and the amplification factor will be accurately given by the ratio  $e_2/e_1$  pro-

vided that  $R_2$  is sufficiently small. In addition to (5) the conditions on  $R_2$  are seen to be

$$R_2 \ll X_p^2(R_2 + r_p)/r_p^2 \tag{8}$$

$$R_2 \ll \frac{\mu X_{op}^2(R_2 + r_p)}{r_p^2(1 + X_{op}/X_{pf})} \tag{9}$$

It is to be noted that regardless of the value of the plate resistance no correction is necessary if  $R_2$  satisfies these conditions. The situation is quite different when balance is obtained by the familiar method of introducing a small quadrature voltage  $je_q$  in series with the voltage  $e_2$ . In this case, if it is assumed that (8) and (9) are satisfied, a similar analysis gives for the balance conditions

$$\frac{e_2}{R_2 + r_p} - \frac{e_q}{X_p} \left( \frac{r_p}{R_2 + r_p} \right)^2 - \frac{\mu e_1}{R_2 + r_p} = 0 \tag{10}$$

$$\frac{e_q}{R_2 + r_p} + \left( \frac{e_2}{X_p} + \frac{e_1}{X_{op}} \right) \left( \frac{r_p}{R_2 + r_p} \right) = 0. \tag{11}$$

Solving (11) for  $e_q$  and substituting in (10)

$$\mu = \frac{e_2}{e_1} \left[ 1 + \frac{r_p^2}{X_p^2} \left( \frac{r_p}{R_2 + r_p} \right) \right] + \frac{r_p^2}{X_p X_{op}} \left( \frac{r_p}{R_2 + r_p} \right). \tag{12}$$

Equation (12) shows that this method of balancing quadrature currents requires that the plate resistance shall be small in comparison with the tube reactances. This condition cannot be controlled and is much more serious than that imposed by the circuit of Fig. 1, in which

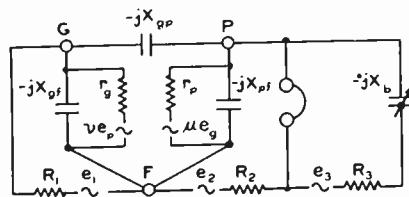

Fig. 1—Equivalent circuit for measurement of amplification factor.

the internal resistances of the voltage sources, rather than the plate resistance, must be small compared with the capacity reactances. In the new circuit, consequently, the conditions can be satisfied once for all in the measuring equipment by proper design of the voltage sources.

*Measurement of Electrode Resistance*

The three test voltages used for the measurement of amplification factor are used also for the measurement of electrode resistance and mutual conductance. The circuit for resistance measurement is shown in Fig. 2. For the sake of definiteness in the analysis it will be assumed that the plate resistance of a triode is being measured.

In this circuit the current through the telephones due to  $e_2$  acting through the plate resistance is balanced by the current due to  $e_1$  acting through a standard resistance  $R_s$ . The quadrature current through the tube capacitances is balanced by the current due to  $e_3$  acting through the variable condenser.

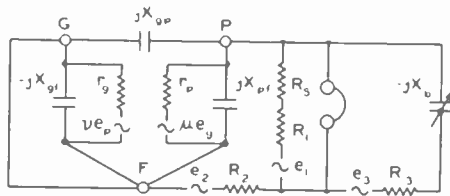

Fig. 2—Equivalent circuit for measurement of electrode resistance.

As before, the sum of the currents through the telephones due to the three voltages  $e_1$ ,  $e_2$ , and  $e_3$  is equated to zero, giving,

$$\frac{e_2}{R_2 + r_p(-jX_p)/(r_p - jX_p)} - \frac{e_1}{R_1 + R_s} + \frac{e_3}{R_3 - jX_b} = 0 \quad (13)$$

where, as in (6),  $X_p$  is the reactance of the total plate capacitance.

Assuming as before that condition (5) is satisfied, the last term of (13) is purely in quadrature, so that the real part of the first term is to be equated to the second term. This gives,

$$\frac{e_2[R_2r_p^2 + X_p^2(R_2 + r_p)]}{(R_2r_p)^2 + X_p^2(R_2 + r_p)^2} = \frac{e_1}{R_1 + R_s} \quad (14)$$

Under conditions (5) and (8) this becomes,

$$e_2/(R_2 + r_p) = e_1/(R_1 + R_s) \quad (15)$$

which reduces to the desired relationship

$$r_p = R_s e_2 / e_1 \quad (16)$$

under the further conditions,

$$R_2 \ll r_p \quad (17)$$

$$R_1 \ll R_s \quad (18)$$

If these conditions are satisfied, the circuit of Fig. 2 makes it possible to determine electrode resistance in terms of a single standard resistance and the voltage ratio  $e_2/e_1$ . The input attenuator of Fig. 4 will consequently be direct reading in electrode resistance, provided that the value of the standard resistance  $R_s$  is some power of 10.

Measurement of Mutual Conductance

It is evident from (13) that plate conductance instead of plate resistance may be measured by the circuit of Fig. 2, by interchanging the voltage sources  $e_1$  and  $e_2$ . Equation (16) then becomes

$$1/r_p = e_2/e_1 R_s \quad \text{or} \quad s_p = S_s e_2/e_1 \tag{19}$$

when  $s_p$  and  $S_s$  denote the unknown and standard conductances, respectively.

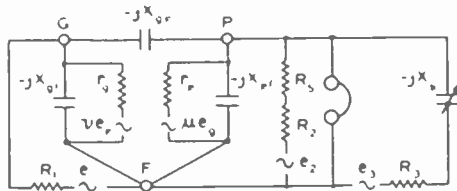

Fig. 3—Equivalent circuit for measurement of transconductance.

To measure mutual conductance in place of electrode conductance it is necessary only that the voltage  $e_1$  be placed in the grid circuit instead of in the plate circuit. This results in the arrangement shown in Fig. 3.

It will be seen that the telephones are connected directly between plate and filament, so that at balance there is no alternating voltage on the plate. With this arrangement, therefore, the impedance of the measuring apparatus in the plate circuit cannot affect the operation of the tube.

The conditions limiting the operation of the circuit, moreover, are much simplified. Since the alternating plate voltage is zero, it cannot act through the grid-plate capacitance to affect the grid voltage, and the equivalent voltage  $ve_p$  in series with the grid resistance becomes zero. Relations (2) and (5) of those derived for the case of amplification factor are thus the only conditions necessary to insure that the grid voltage shall be equal to the introduced voltage  $e_1$ . The only additional restriction is the obvious one,

$$R_2 \ll R_s. \tag{20}$$

## SOURCE OF TEST VOLTAGES

In Fig. 4 is shown the arrangement for obtaining the three test voltages required for the measuring circuits just considered. It will be seen that transformers are employed in such a way that the three output circuits are insulated from one another for direct current. This makes it possible to connect batteries and power-supply voltages for the tube directly at the cathode rather than at the high potential side of the alternating test voltage. The capacitances from the power supply to ground do not, therefore, augment the effective electrode to filament capacitances. For this reason, the difficulties in neutralizing the effects of these capacitances are much reduced.

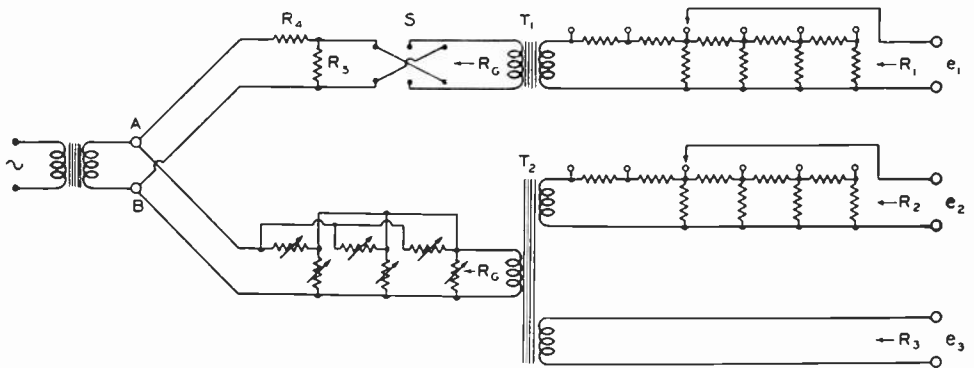

Fig. 4—Circuit arrangement for supplying the test voltages.

In the apparatus which has been constructed, the attenuator on the primary side of the transformer  $T_2$  has three dials, giving to three significant figures the ratio  $e_2/e_1$ . The settings of the step attenuators on the secondary side determine the position of the decimal point and hence the order of magnitude of the quantity being measured.

It will be observed that the decimal-reading attenuator varies  $e_3$ , the capacitance-balancing voltage, as well as  $e_2$ . In the measurement of amplification factor and electrode resistance this results in making the capacitance-balance adjustment nearly independent of the in-phase balance, since in these two measurements the greater part of the current through the telephones due to stray capacitances is caused by the voltage  $e_2$ . In the case of the third measurement, that of transconductance, only the grid-plate capacitance of the three interelectrode capacitances results in current through the telephones. Since quadrature current from this source is usually relatively small, the ease with which the bridge may be adjusted in this measurement is not appreciably affected by the interdependence of the inphase and quadrature balances.

Since each electron tube coefficient is obtained as a constant times the ratio  $e_2/e_1$ , it follows that negative values may be measured if the relative phase of  $e_2$  and  $e_1$  is reversed. This may be accomplished by the switch  $S$  shown in Fig. 4 in the input circuit of the transformer  $T_1$ . Thus no change of procedure is required for the measurement of negative coefficients.

The use of an independent transformer in each of the lines supplying the test voltages has been shown to permit several improvements and simplifications of the measuring circuits. Such an arrangement has apparently been deliberately side-stepped in the past due to the difficulty in taking into account the losses and phase shifts which are always present to some extent when transformers are used. In the circuits described, it is necessary both that  $e_1$  and  $e_2$  be in phase, and that their ratio be accurately determinable. To satisfy these conditions it is not necessary that the losses and phase shifts shall be negligible, but merely that they shall be the same in each transformer.

These effects depend on several factors, corresponding to the several properties of the so-called ideal transformer which are imperfectly realized in practice. An ideal transformer is one having perfect coupling, no copper or iron losses, and an infinitely high ratio of inductance to external circuit resistance. In any actual transformer phase shifts are caused by magnetic leakage and by insufficiency of the inductance.

The problem is further complicated in the case of an iron-core transformer by the fact that both inductance and iron losses vary with the applied voltage. In order that there shall be no relative phase shifts or differential losses between two iron-core transformers, therefore, it is not sufficient that they be identical and that the impedances of the input and output circuits be equal. It may also prove necessary to maintain equality of the applied voltages.

In the apparatus constructed the transformers are alike except for the winding supplying the capacitance-balancing voltage. This winding draws negligible current. The decimal-reading attenuator ahead of the transformer  $T_2$  has a constant output resistance  $R_G$  for all settings. The L-pad,  $R_4$ ,  $R_5$  presents this same resistance to the transformer  $T_1$ . The step attenuators on the secondary side are identical, and their input resistance is not appreciably affected by the relatively high impedance of the tube circuits connected at the output terminals.

It was found not to be necessary to maintain equal voltages across the two transformers, due to the low flux densities employed. The applied voltages are of the same order of magnitude, however, as the decimal-reading attenuator varies the voltage over a range of only ten to one.

The statement that the transformers work out of equal generator impedances requires amplification. Since we care about accurately determining only the ratio  $e_2/e_1$ , it is not necessary to consider impedances to the left of  $A$  and  $B$ , the junction points of the lines to the two transformers. Voltage drops or phase shifts in these impedances will affect equally  $e_1$  and  $e_2$  and will not change their ratio. In designing the attenuators, therefore, points  $A$  and  $B$  are regarded as the terminals of a generator having zero internal impedance. Both the decimal-reading attenuator and the L-pad preceding transformer  $T_1$  are designed to have an output impedance  $R_G$  when worked from a zero-impedance generator.

The precautions which have been considered insure that the test voltages shall be in phase and that their ratio shall be accurately determinable. It is necessary, further, that the resistances  $R_1$ ,  $R_2$ , and  $R_3$  of the three output circuits of Fig. 1 be sufficiently low so that conditions (2) to (5), (8), (9), (17), (18), and (20) are satisfied.

These conditions may be most simply treated by considering certain numerical values employed in apparatus which has been constructed. Condition (5) is the only restriction on  $R_3$ . This requires that  $R_3$  shall be small in comparison with the reactance of the balancing condenser and of the stray capacitances. In the apparatus constructed the former has a value 0.0005 microfarad and the latter considerably less. Since this gives approximately 300,000 ohms for the minimum reactance, values of  $R_3$  at least up to 1000 ohms are permissible. There is thus no difficulty in satisfying relation (5) with respect to  $R_3$ , and likewise with respect to  $R_1$  and  $R_2$ .

The step attenuators controlling  $e_1$  and  $e_2$  are identical in the case being considered. The output resistance is approximately 23 ohms on the first tap, 9 ohms on the second, and about 0.9 ohm on the remaining four taps. From (6) it is seen that the low voltage, and consequently low resistance points of the attenuator governing  $e_1$  are used in the measurement of large amplification factors. Relation (4) is thus readily satisfied. This is all the more true since tubes of large amplification factor are usually constructed with low grid-to-plate capacitance.

Condition (2) requires that  $R_1$  shall be negligible in comparison with the grid resistance. This requirement is of course satisfied in cases where the control grid is negatively biased. When tubes are operated so that the grid takes current, it is possible in exceptional cases that allowance should be made for the reduction of grid voltage by  $R_1$ . This must be true of any type of tube-measuring circuit unless the test voltage is measured directly at the grid.

Requirement (3) is satisfied whenever (2) is satisfied, because the product  $\mu\nu$  is of the order of unity, regardless of the value of  $\mu$ .



Conditions (18) and (20) can be met by suitably choosing the standard resistance. In the apparatus constructed a single fixed standard of 100,000 ohms has been found entirely satisfactory for measurements both of resistance and of transconductance. This value amply satisfies (18) and (20).

In regard to condition (17) it will be seen from (16) that in apparatus having the characteristics given,  $R_2$  decreases with the value of  $r_p$ , being measured; so that the error from this source is less than one per cent for values of electrode resistance between 100 and 1000 ohms, and less than one tenth of one per cent for higher values.

It remains to consider requirements (8) and (9). Condition (8) is more severe than (17) only when the reactance of the plate capacitance is less than the plate resistance. Even in this case there is little difficulty. If, for example, the capacitance is 100 micromicrofarads or 1.6 megohms reactance at 1000 cycles, the plate resistance must be greater than 1000 megohms before the error from this source exceeds one per cent.

Condition (9) becomes more difficult to satisfy than condition (8) when amplification factors less than unity are to be measured. The numerical example just given shows that even in such cases requirement (9) will cause little difficulty.

#### FURTHER DESIGN CONSIDERATIONS

In the construction and testing of apparatus embodying the circuits described it has been found that the factors limiting the range of operation arise from practical design difficulties rather than from failure to meet the theoretical restrictions on the use of the circuits. As an instance of this, it is desirable, in order to obtain sufficient sensitivity, to employ an amplifier in conjunction with the measuring equipment. If both the amplifier and the cathode of the tube under test are to be at ground potential, it is necessary that a shielded output transformer be employed. The use of a transformer or choke coil in the output circuit is desirable further in order that high impedance for the test voltage may be obtained with low resistance for the direct plate current.

The use of an output transformer or choke brings in difficulties due to magnetic coupling from the other three transformers employed and from the oscillator supplying the test voltage. In a laboratory layout of measuring apparatus where considerable space is available, no great difficulty need be encountered from this source. When it is attempted, however, to construct a self-contained instrument for measurements over extreme ranges of the coefficients, extensive precautions may be

necessary to maintain accuracy of the measurements. In the apparatus constructed it was found necessary to make simultaneous use of three usual methods for reducing magnetic coupling; namely shielding, spacing, and orientation.

The circuit arrangement for producing the test voltages provides a convenient means of testing for magnetic coupling to the output transformer. Fig. 4 shows that if the voltages  $e_1$  and  $e_2$  are simultaneously reduced by a factor of ten by means of the step attenuators, the voltage on the input transformer and on the transformers  $T_1$  and  $T_2$  will be unchanged, and any magnetic coupling to the output transformer will not be affected. This procedure will consequently multiply by ten the effect on the results of stray magnetic coupling, and will generally reveal the presence of any error from this cause.

Figs. 5, 6, and 7 are more complete schematic diagrams of the three measuring circuits. It will be noted that the cathode and one side of each battery is connected to ground. The step attenuators determining the order of magnitude of the voltages  $e_1$  and  $e_2$  are indicated by the blocks marked  $A_1$  and  $A_2$ , respectively. The decimal-reading attenuator for the numerical determination of the ratio of these voltages is indicated by  $A_2'$ . As noted above, the standard resistance  $R_s$  shown in Figs. 6 and 7 has the value 100,000 ohms in the apparatus referred to. This value is roughly the geometric mean of the extreme values of electrode resistance usually measured.

In the diagrams, the output transformer is shown tuned by a condenser across the primary. This arrangement provides selectivity against power-supply hum and other disturbances, and permits the direct-current resistance of the primary to be further reduced relative to the alternating-current impedance.

A refinement contributing principally to operating convenience concerns means for reversing the phase of the capacitance-balancing voltage. A switch is indicated for this purpose. An alternative method of reversing the phase, which was finally adopted in the apparatus constructed, is by the use of a double winding on the transformer in conjunction with a double-stator balancing condenser. This method, in addition to being more convenient, permits the balance current to be varied through zero. This is not possible with the simpler arrangement shown, because of the finite minimum capacitance of the condenser.

The three circuits described have been incorporated in a single test instrument so that any of the three coefficients may be measured. A six-pole three-position switch makes the necessary changes in the connections in going from one measurement to another. The panel ar-

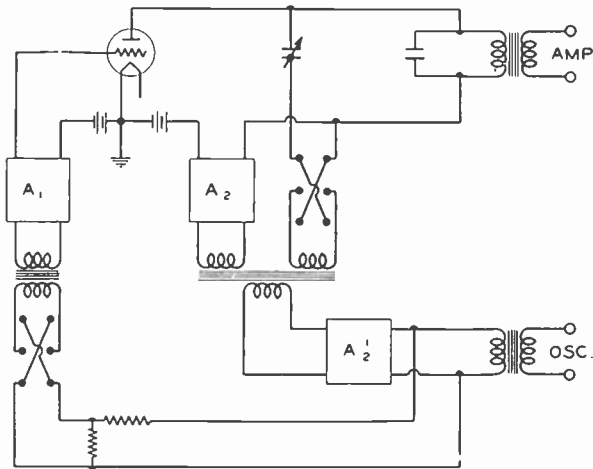

Fig. 5—Complete circuit for measurement of amplification factor.

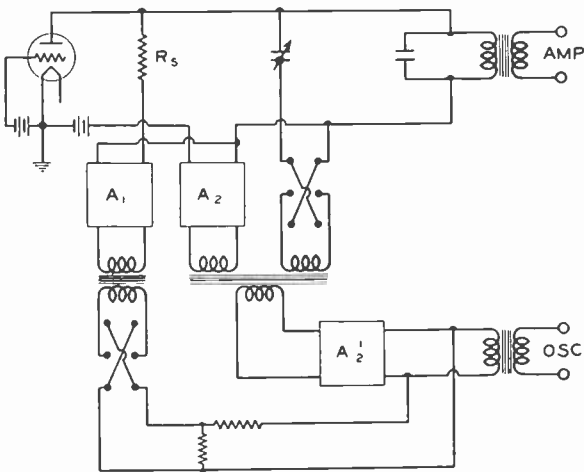

Fig. 6—Circuit for measurement of electrode resistance.

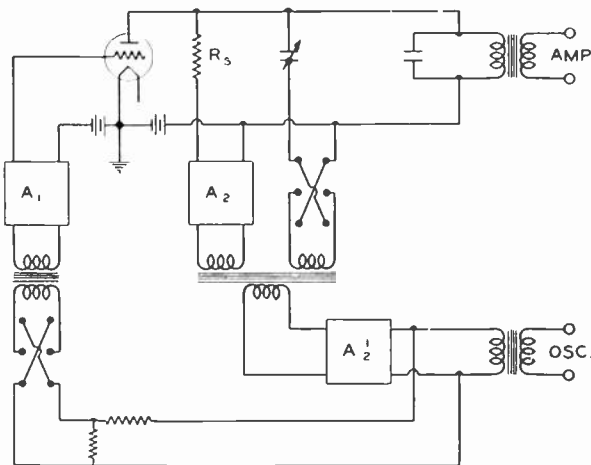

Fig. 7—Circuit for measurement of transconductance, showing rearrangement of the apparatus of Fig. 6.

arrangement is shown in Fig. 8. The upper half of the panel contains the tube-control apparatus, and the lower half, below the meter, the controls for the measuring circuits. The three decade switches at the bottom of the panel vary the attenuator in the primary of transformer  $T_2$ . The "MULTIPLY BY" and "DIVIDE BY" switches control the step attenuators in the output circuits of transformers  $T_1$  and  $T_2$ , respectively.

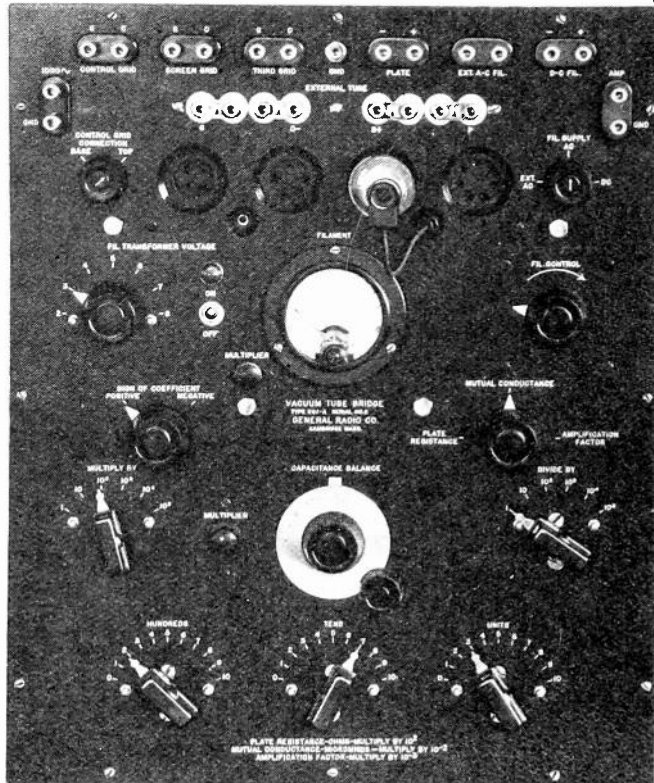

Fig. 8—Panel arrangement of instrument embodying the three circuits described.

By the arrangement shown, each coefficient is measured by exactly the same procedure. The three-position switch is turned to whichever quantity is desired, the multiplier switches are set at the appropriate values for the tube under test, and balance is obtained by varying the three decades and the dial of the capacitance-balancing condenser. At balance the decades give directly to three significant figures the quantity being measured.

#### EXPERIMENTAL CHECKS

Several different types of tests may be employed conveniently in studying the performance of electron tube measuring equipment of the

type described. Resistance measurements on fixed resistors will quickly indicate any error in the ratio of the test voltages. A very satisfactory over-all check may be obtained by measuring the three coefficients of a tube independently and comparing the measured value of transconductance with the ratio of amplification factor to plate resistance. The component parts of the circuits can, of course, be tested independently for phase shift and attenuation.

Measurements of known resistances were made with the apparatus considered for values ranging from 50 ohms to 50 megohms. Between 100 ohms and one megohm it was found that there is little difficulty in maintaining an absolute accuracy of about one per cent. At higher values of resistance, losses in insulating materials in certain parts of the bridge become appreciable. These losses are equivalent to a high resistance in parallel with the resistance being measured, and may be determined separately by an additional measurement. If this effect is corrected for, the useful operating range of the bridge may be very greatly extended, since for resistance values up to 50 megohms there is no difficulty in obtaining balance to the third significant figure.

Measurements on tubes of various types indicate that transconductance and amplification factor may be determined within approximately the same limits as resistance. The discrepancy between the measured transconductance and the ratio of the other coefficients is usually less than two per cent. Some care is necessary in making this test due to the variation of the coefficients with time. It has been found that amplification factor and plate resistance tend to vary together and that transconductance varies relatively little. As short an interval as possible should, therefore, separate the measurements of the two former quantities.

The ranges of values of transconductance and amplification factor which can be satisfactorily measured are wide. Measurements of transconductance from 0.02 micromho to 20,000 micromhos and of amplification factors from 0.001 to 10,000 can be made without difficulty.



## CLASS B AMPLIFIERS CONSIDERED FROM THE CONVENTIONAL CLASS A STANDPOINT\*

By

J. R. NELSON

(Raytheon Production Corporation, Newton, Mass.)

*Summary*—The wave form of the output current of an ideal tube is analyzed when plate current cut-off occurs between zero and 180 degrees of the cycle. The theory thus developed is applied to practical tubes, and it is shown that one of the tubes operated in series may be represented as a hypothetical class A amplifier provided that twice the plate load resistance cuts off the plate current for the input voltage used. It is also shown that a diagram may be constructed from the characteristics of a tube for any operating condition from class A to class B with half the wave cut off. The load resistance used may then be transferred back to the characteristic. This load resistance shows conditions under which each tube is operating and explains why it is possible to obtain more than twice the power output under some conditions with two tubes than with one tube under the same conditions.

THE fundamental method of calculating the maximum undistorted power output of triodes as introduced by Brown<sup>1</sup> and further considered by Warner and Loughren<sup>2</sup> is well known and works satisfactorily for class A amplifiers where even harmonics only are present in appreciable percentages. A method of taking into account the presence of odd harmonics has been considered by the writer.<sup>3</sup> The latter paper also included a method of treating tubes in series under class A conditions.

The fundamental methods of calculating the power output and distortion of two tubes in series under class B conditions consist in calculating these quantities from the dynamic  $I_p - E_o$  curves taken with a fixed load and plate voltage or from the static  $I_p - E_p$  curves by drawing in various load lines. The correctness of these methods has been questioned because of reasons explained below. The theory of a single class B tube operating as a radio-frequency amplifier with the output circuit tuned to the fundamental has been considered in some detail by Fay.<sup>4</sup> Tubes used as class B audio-frequency amplifiers where the out-

\* Decimal classification: R363. Original manuscript received by the Institute, December 6, 1932. Presented before Rochester Fall Meeting, November 14, 1932.

<sup>1</sup> W. J. Brown, *Proc. Phys. Soc.* (London), vol. 36, part 3, p. 28; April, (1924).

<sup>2</sup> J. C. Warner and A. V. Loughren, "The output characteristics of amplifier tubes," *Proc. I.R.E.*, November, (1926).

<sup>3</sup> J. R. Nelson, "Calculation of output and distortion in symmetrical output systems," *Proc. I.R.E.*, November, (1932).

<sup>4</sup> C. E. Fay, "The operation of vacuum tubes as class B and class C amplifiers," *Proc. I.R.E.*, vol. 20, p. 548; March, (1932)

put is not tuned have not been considered in much detail although Barton<sup>5</sup> gave a general discussion of the problem along with a method of finding optimum conditions experimentally.

The experimental method described by Barton consisted in taking the  $I_p - E_p$  curves with the plate voltage constant and connecting various resistors in the plate circuit. It was then stated that the output choke or transformer would act as a step-up transformer so that the secondary load should be four times the optimum load found from the  $I_p - E_p$  curves. The other tube then gives an exactly similar half sine wave the next half cycle, etc. The same results may be obtained by working with the  $I_p - E_p$  curves and drawing in various load lines so that the optimum conditions for a given input voltage may be found. Both of these methods assume that one tube furnishes power for one-half cycle and the other for the next half cycle so that there is a period during which the load is transferred over to the other tube by the output choke or transformer.

The above concepts seem satisfactory enough from a physical standpoint. Several objections to the above methods arise when the subject is examined more closely. The most serious one is that one-half the power obtainable with two tubes using a load resistance of  $4R_L$  cannot be obtained with a single tube using a load resistance  $R_L$  whether shunt fed or not, whereas in the case of a class A stage half the power obtainable with two tubes may be obtained with one tube and half the load resistance. This makes it impossible to start with one tube and a load resistance  $R_L$  and check the results obtained with two tubes and a load resistance of  $4R_L$ . Another objection is that the experimental method of measuring the  $I_p - E_p$  curves with fixed values of load resistance and plate voltage does not apparently take into account the change of direct current with signal which occurs with class B stages. It seems illogical to say that the equivalent resistance in the plate circuit of a single tube in class A is one half the load resistance for two tubes while that of a single tube in class B is one quarter of the load resistance.

This study will inquire into the subject of tubes operated under class B conditions in an endeavor to answer the following questions.

1. Is it possible to treat a tube under class B conditions by a method similar to that used under class A conditions?
2. Are the conventional methods of calculating power output and distortion from characteristic curves correct under class B conditions?

<sup>5</sup> Loy Barton, "High audio output from relatively small tubes," Proc. I.R.E., vol. 19, p. 1131; July, (1931).





resistance  $R_L$  are given in Fig. 2A. If the tube is biased to some voltage  $e$  and a sinusoidal input voltage of amplitude  $4E_p - e$  is applied the instantaneous current is represented by Fig. 2B. The reference line of Fig. 2B is taken as the horizontal line passing through  $I_0$ . When  $x$  is  $\pi/2$  the output current wave form is sinusoidal and is similar to the wave form of the exciting voltage. If  $x$  is less than  $\pi/2$  the wave form is distorted. When  $x$  is equal to zero the tube is biased to class B conditions so that conditions from class A to class B with plate current cut off one half the cycle is represented by the diagram as the angle  $x$  is varied.

The distorted output wave form for any value of  $x$  may be represented by a Fourier series. The values of  $I_p$  for the various intervals are

$$\begin{aligned} I_p &= KE \sin \theta & -\pi < \theta < -\pi + x \\ I_p &= I_0 & -\pi + x < \theta < -x \\ I_p &= KE \sin \theta & -x < \theta < +\pi \end{aligned} \tag{1}$$

$$i_p = \frac{A_0}{2} + \sum_{n=1}^{n=\infty} (A_n \cos nx + B_n \sin nx) \tag{2}$$

where,

$$\begin{aligned} A_n &= \frac{KE}{\pi} \int_{-\pi}^{-\pi+x} \sin \theta \cos n\theta d\theta - \frac{1}{\pi} \int_{-\pi+x}^{-x} I_0 \cos n\theta d\theta \\ &+ \frac{KE}{\pi} \int_{-x}^{+\pi} \sin \theta \cos n\theta d\theta \end{aligned} \tag{3}$$

$$\begin{aligned} B_n &= \frac{KE}{2\pi} \int_{-\pi}^{-\pi+x} \sin \theta \sin n\theta d\theta - \frac{1}{\pi} \int_{-\pi+x}^{-x} \sin n\theta d\theta \\ &+ KE \int_{-x}^{+\pi} \sin \theta \sin n\theta d\theta \end{aligned} \tag{4}$$

$$\frac{A_0}{2} = \frac{KE}{2\pi} \int_{-\pi}^{-\pi+x} \sin \theta d\theta - \frac{1}{\pi} \int_{-\pi+x}^{-x} I_0 d\theta + \frac{KE}{\pi} \int_{-x}^{+\pi} \sin \theta d\theta \tag{5}$$

when  $n$  is odd,  $A_n$  is zero and when  $n$  is even,  $B_n$  is zero.

$$A_n = \frac{2I_0}{\pi} \frac{\sin nx}{n} + \frac{KE}{\pi} \frac{\cos(1-n)}{1-n} + \frac{KE}{\pi} \frac{\cos(1+n)x}{1+n} \tag{6}$$

$$B_n = \frac{2I_0}{\pi} \frac{\cos nx}{n} + \frac{KE \sin(1-n)x}{\pi(1-n)} - \frac{KE \sin(1+n)x}{\pi(1+n)} \tag{7}$$

When  $n$  is one, the above expression for  $B_n$  is indeterminate. The value for  $n$  equal to one may be found directly in (1) and is

$$B_1 = \frac{2I_0}{\pi} + \frac{KE}{\pi} \left[ \frac{\pi}{2} + x - \frac{\sin 2x}{2} \right]. \quad (8)$$

The value of  $A_0$  is

$$\frac{KE \cdot A_0}{2} = \frac{KE}{\pi} \left[ \cos x + \frac{I_0}{KE} \left( x - \frac{\pi}{2} \right) \right]. \quad (9)$$

The various components of the distorted wave form are shown plotted in Fig. 3. The fundamental is shown plotted in terms of  $I_{\max}$

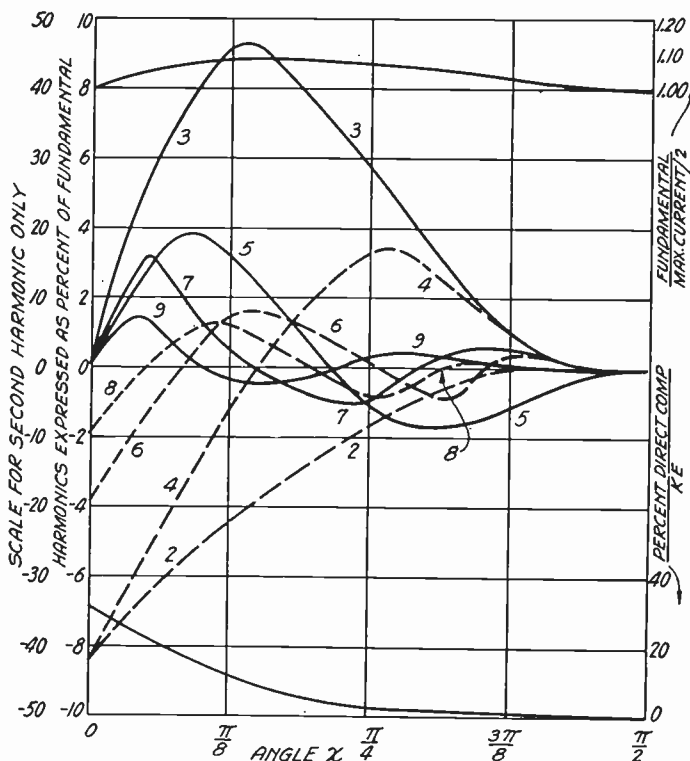

Fig. 3—Components of wave form shown in Fig. 2B plotted vs. angle  $X$ .

and the other terms are expressed as percentages of the fundamental. The fundamental is exactly one half the value of the total current or  $I_{\max}$ , when  $x=0$  and  $x=\pi/2$ . Between these values the fundamental rises to something over one half or over one hundred per cent taking the value at  $x=0$  or  $x=\pi/2$  as the reference value of 100 per cent. It should be noted that the sum of  $I_1 - I_3 + I_5 - I_7$ , etc., is approximately one half  $I_{\max}$  or 100 per cent for all values of  $x$ . Use will be made of this fact later.

The point where  $x$  is zero is of interest here as this condition is taken as the starting point for the experimental study of class B amplifiers. If  $x$  is made zero the equation for the plate current is

$$i_p = \frac{KE}{\pi} + \frac{KE}{2} \sin \omega t - \frac{2KE}{\pi} \left[ \frac{\cos 2\omega t}{3} + \frac{\cos 4\omega t}{15} + \frac{\cos 6\omega t}{35} + \dots \right]. \quad (10)$$

The root-mean-square value of the alternating-current components is

$$I_{\text{rms}} = \frac{KE}{\sqrt{2}} \sqrt{(0.5)^2 + \left(\frac{2}{3\pi}\right)^2 + \left(\frac{2}{15\pi}\right)^2 + \left(\frac{2}{35\pi}\right)^2 + \dots} = 0.545 \frac{KE}{\sqrt{2}}. \quad (11)$$

The plate current for the ideal tube will be independent of the load resistance  $R_L$  for values from zero to the value of  $E_0/I_{\text{max}}$  as a study of Fig. 1 will show. It will be assumed that the value of  $R_L$  in the plate of the tube is less than the maximum value of  $R_L$ , i.e.  $E_0/I_{\text{max}}$ , so that the values of plate current used will be given by the preceding equations for all values of  $R_L$  used.

Figs. 4A and 4B show the types of circuits in which the tubes will be used. It will be assumed that the values of condensers and inductances are such that the tube works into essentially a pure resistance load. If the output is tuned to the fundamental the output voltage will be practically sinusoidal. The fundamental component only will contribute to the power. The value of the fundamental current from (10) is  $KE/2 \sin \omega t$ , hence the power is

$$P = \left(\frac{KE}{2\sqrt{2}}\right)^2 \times R_L \text{ or } \bar{K}^2 \bar{E}^2 \times 0.125 R_L. \quad (12)$$

The output circuit in general will not be tuned and this case will be the one considered in the following remarks. The root-mean-square value of the current is given by (11). The power in this case will be

$$P = \left(\frac{KE}{\sqrt{2}}\right)^2 (0.545)^2 R_L \text{ or } \bar{K}^2 \bar{E}^2 \times 0.148 R_L. \quad (13)$$

The usual method of calculating the power output under class B conditions will now be discussed. Refer to Fig. 1. The load resistance,  $R_L$  passes through  $E_0$  and  $I_{\text{max}}$  or  $KE$  so the peak current is  $KE$  for one half the cycle. It is assumed that the other tube gives an exactly similar current wave shape the next half cycle and that each tube works into a step-down transformer having a turn ratio of two. The sinus-

oidal current in the output will have a peak amplitude of  $KE/2$  and hence the power will be

$$P = \left( \frac{KE}{2\sqrt{2}} \right)^2 \times 4R_L \text{ or } (KE)^2 \times 0.5R_L. \quad (14)$$

The approximate validity of (14) may be checked experimentally quite readily. The theoretical validity of this equation is obvious under the conditions assumed here. It is quite obvious from (12), (13), and

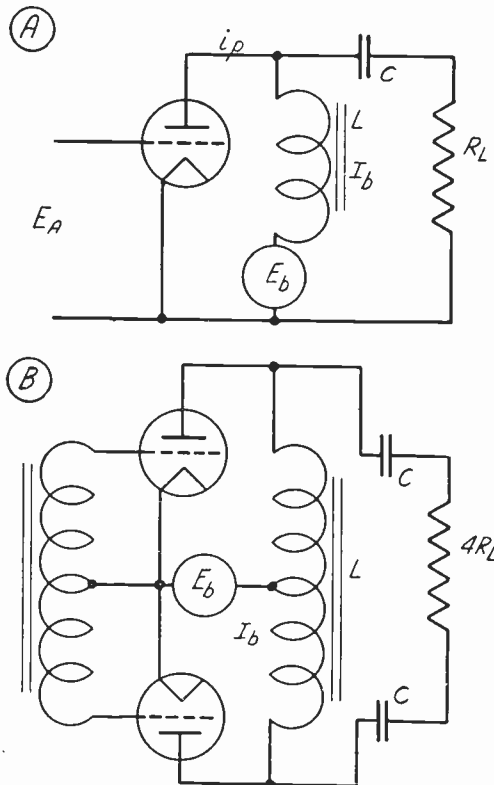

Fig. 4—Schematic diagram of tube circuits.

(14) that we cannot measure one half the power with a single tube having a load resistance of  $R_L$  that we can measure with two tubes working into a load resistance of  $4R_L$ . If the output is tuned the power for a single tube is only one quarter the power as is shown by (12) and (14). Thus, to obtain one half the power, we would need a load resistance of  $2R_L$  or one half the load resistance for two tubes which is exactly the same ratio as assumed for class A conditions. The power for a single tube with a load resistance of  $R_L$  is only  $(0.148/0.5) \times 100$  or 29.6 per cent of that obtained with two tubes as shown by (13) and (14). If we wish to measure one half the power the load resistance for a

single tube must be  $50/29.6$  or  $1.69 R_L$  as the power is proportional to the load resistance under the conditions assumed.

Equations (13) and (14) show why it is impossible to measure one half the power using a single tube with a load resistance of  $R_L$  that may be obtained with two tubes working into a load resistance of  $4R_L$ . If we wish to make power measurements using only one tube so as to measure one half the power output from two tubes the load resistance should be  $1.69 R_L$  or expressed otherwise the load resistance for a single tube should be  $(1.69/4) \times 100$  or 42.25 per cent of the value for two tubes. The load resistance  $1.69 R_L$  is shown plotted in Fig. 1. The load resistance is plotted through the direct current of  $KE/\pi$  which holds for the input voltage assumed. The load resistance  $1.69 R_L$  does not intersect the plate current curve for  $+1$  units at the same point  $B$  as does the load resistor  $R_L$ . It is thus seen that the ratio of 1.69 to 1 for one half the power will not quite hold except in the ideal case.

If the  $I_p - E_g$  curves are taken with a direct-current resistance of  $1.69 R_L$  in the plate, the drop across the resistor should be compensated for by bringing up the plate voltage as is done under class A conditions. For example in Fig. 1 the voltage added should be equal to  $G - E_0$ . It is to be noted, however, that the current depends upon the operating voltage and hence the plate voltage will depend upon the assumed input voltage. The operating grid bias should then be considered  $E_g/\pi$  which gives the value of direct current shown in Fig. 1. If the load resistance  $R_L$  is used it will not be necessary to compensate for the drop as one half the wave will be given by the drop across the load resistor  $R_L$ .

The above results give a clue to the construction of a characteristic diagram obtained from the measured characteristics by means of which the power output and distortion may be calculated under class A conditions. For example we found that if the output were tuned a load resistance of  $2R_L$  in a single tube would give one half the power obtainable with two tubes and a load resistance of  $4R_L$ . In class B the even harmonics are balanced out and the sum of the odd harmonics including the fundamental is one half the value of  $I_{max}$  or  $KE$ . An auxiliary diagram utilizing the above facts may be constructed on Fig. 1. The resistor  $R_L$  passes through the points  $B$  and  $E_0$ . A resistor  $2R_L$  would pass through the points  $BCD$ . If the operating point is taken as  $C$  or  $I_{max}/2$  we can calculate the power output of a single tube having such characteristics by the usual methods. The points for the other voltages  $E_g$ , etc., are found by projecting the intersection of  $R_L$  with the curves to  $2R_L$  as shown. The output of two tubes will be twice that of a single tube so that this method gives the same results as found previously.

The point  $C$  does not exist physically as the direct-current point  $I_0$  will be  $I_{\max}/\pi$  rather than  $I_{\max}/2$  as shown by  $C$ . The efficiency may be calculated quite readily from the data given here as the direct-current power supplied is  $E_0 \times I_0$  and the alternating-current power may easily be calculated. The efficiency will be a maximum for the ideal tube when a load line such as  $ACF$  passes through the intersection of zero plate voltage, and a given input voltage under this condition is

$$\text{Eff.} = \frac{\frac{I_{\max}}{4} \times E_0}{\frac{I_{\max}}{\pi} \times E_0} \times 100 \text{ or } \frac{\pi}{4} \times 100 = 78 \text{ per cent.} \quad (15)$$

This value of efficiency is the same value as obtained by the usual analysis of class B systems. As mentioned before the hypothetical operating point of  $I_{\max}/2$  at the voltage  $E_0$  does not actually exist in the tube. If a tuned circuit is used in the output the other plate current components actually flow in the tube. Also the same thing occurs in a push-push stage because the harmonics, while balanced in the output, still flow in the tube. Thus the assumed operating point is fictitious and the alternating-current components actually vary about the direct-current value  $I_0$ . We are in effect taking a fundamental and even harmonics from a tube and applying them to a circuit which balances out the even harmonics leaving only the fundamental. We know from the diagrams between which limits this fundamental must lie so that we can locate it on the auxiliary diagram.

The use of the load line  $2R_L$  is justified by (10) for the case considered. Thus in the procedure we taken only one of the components, the fundamental, from the tube and work with this component. This duplicates what actually happens in practice when two tubes are used in series or when a single tube is used with the output tuned to the fundamental. The power output obtained from the ideal tube is the same as if we had a class A amplifier having a static characteristic of  $I_{\max}/2$  for zero bias. The current in this class A tube would change according to the input voltage so that it would vary between  $I_{\max}/2$  and zero as the input voltage varied between zero and  $4E_g$ . The current is the same in the other tube and the push-push connection would be represented by Fig. 4B. The peak current in the load resistance  $R_L$  would be  $I_{\max}/2$ . The power would thus be

$$\text{Power} = \frac{I_{\max}^2}{4 \times 2} \times 4R_L = \frac{I_{\max}^2}{2} R_L \text{ or } KE^2 \times 0.5R_L. \quad (16)$$

If we calculate the power by assuming that the current  $I_{\max}$  flows a half cycle in each tube and that the choke acts as a step-down ratio transformer we have a peak current of  $I_{\max}/2$ . The load is  $4R_L$  so that we obtain exactly the same power as before. The wave shapes are exactly the same in the two cases so the experimental method given by Barton is correct as regards output conditions as long as the current with no signal is small and is not zero. The wrong picture of what goes on in the tube is apt to be obtained however, unless we visualize the breakdown of the wave shape obtained graphically into its various components. We cannot say that a current of  $I_{\max}$  flows in each tube half a cycle, however, as the fundamental flows during the entire cycle. This does not need to concern us in our experimental work, however.

If another similar tube is used the diagram drawn in Fig. 1 may be used for the tubes in series by multiplying the voltage values by two which gives a diagram of a single tube working into a load resistance  $4R_L$ . This of course does not mean that the voltage swing is  $2E_0$  but that when one voltage swing is  $+E$  counting from  $E_0$  the other will be  $-E$  so that the total resultant swing will be  $2E$  and we would have to put a direct voltage of value  $2E$  on the equivalent tube in order to obtain the same power output. The diagram thus modified is the same type of equivalent diagram as was derived previously for class A conditions.<sup>3</sup>

An interesting point to note is that with the ideal tube under class A conditions, the  $I_p - E_p$  curve as shown for  $2E_0$  would be obtained with zero bias and if grid swing were  $2E_0$  so as to work within the limits shown we could work backwards on the diagram and obtain the right power from a class B study of the tube, assuming an input voltage of  $4E_0$  provided that the input voltage reduced the plate current to cut-off.

The method developed here is applicable for conditions intermediate to class A and class B conditions also. Assume that the tube is biased to some value  $e$  as shown in Fig. 2 and that the alternating-current swing in the input will be  $4E_0 - e$  the current will flow for more than 180 degrees but less than 360 degrees. The average current must be less than  $I_{\max}/2$  and greater than  $I_{\max}/\pi$ . In a series output stage the even harmonics will be balanced out and the area on each side of the fundamental will be equal so the fundamental will vary about a line  $I_{\max}/2$  as before. Some odd harmonics will be present but to a first approximation the power will be found by assuming that the peak value of the fundamental is  $I_{\max}/2$  and proceeding as in the previous case. The power and harmonics may be found experimentally by the same method as was used for class B if the direct-current drop in the

resistor is added to the voltage  $E_b$  and the resulting wave form is analyzed. The value of the load resistor  $R$  in Fig. 3 will change from  $R_L$  under class B conditions to  $2R_L$  under class A conditions as the bias voltage is varied from class B to class A conditions. This study shows that the output performance of tubes biased between class A and class B conditions may be studied by similar diagrams and that there is no mysterious break or transition point changing from class B to class A under the conditions assumed here.

### EXPERIMENTAL RESULTS

Practical tubes differ considerably from the theoretical tubes studied thus far. The theory developed will be applied to several types

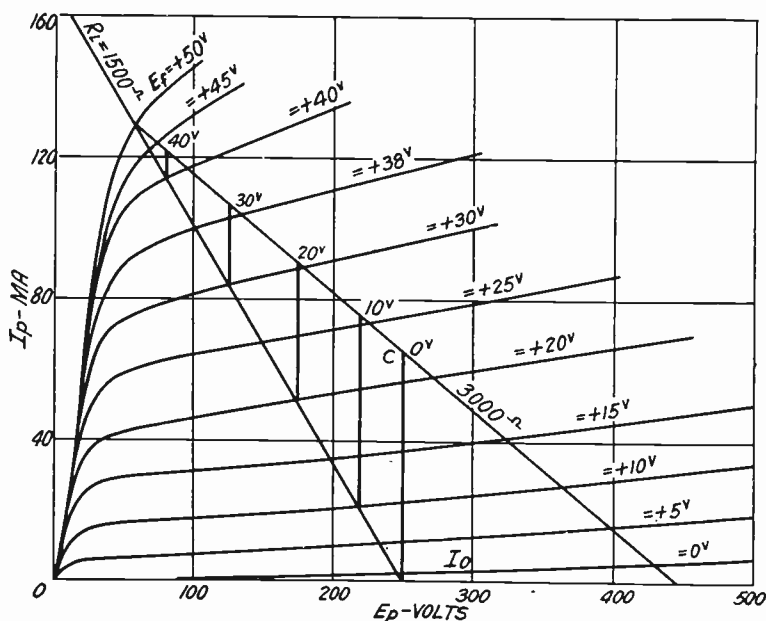

Fig. 5— $I_p - E_p$  characteristic curves experimental zero bias tube similar to  $E_R-46$  outer grid to control or inner exit.

of commercial tubes in an effort to predict the power output and distortion obtainable with these tubes. Fig. 5 shows the  $I_p - E_p$  curves of an experimental zero bias tube similar to the 46 type. The curve for zero bias is practically zero at 250 volts plate so that the class B theory developed for the ideal tube may be applied. A 1500-ohm load line is shown plotted in from 250 volts. For a 50-volt swing the maximum value of current will be 129 milliamperes. Half of this or 64.5 will be taken as the new operating point corresponding to  $C$  in Fig. 1. The 40-volt point is located on the 3000-ohm load line by taking half the current where the 1500-ohm load line intersects the 40-volt curves and



adding this to 64.5. Thus the current is 114 milliamperes, and half this is 57 which gives 121.5 milliamperes. Actually the 40-volt point is the projection on the 3000-ohm load line of the 1500-ohm load line and the curve for 40-volts. The other intersections are found in the same manner. The part below *C* will be similar to the part above.

The power calculated for a 50-volt swing is 13.4 watts against 13.2 measured while the per cent third calculated was 3.3 and the measured value was 2.8. The same 3000-ohm load line may be used for the calculation of other input voltages. For example suppose that we keep the same operating point *C* and put on a 30-volt signal. The power calcu-

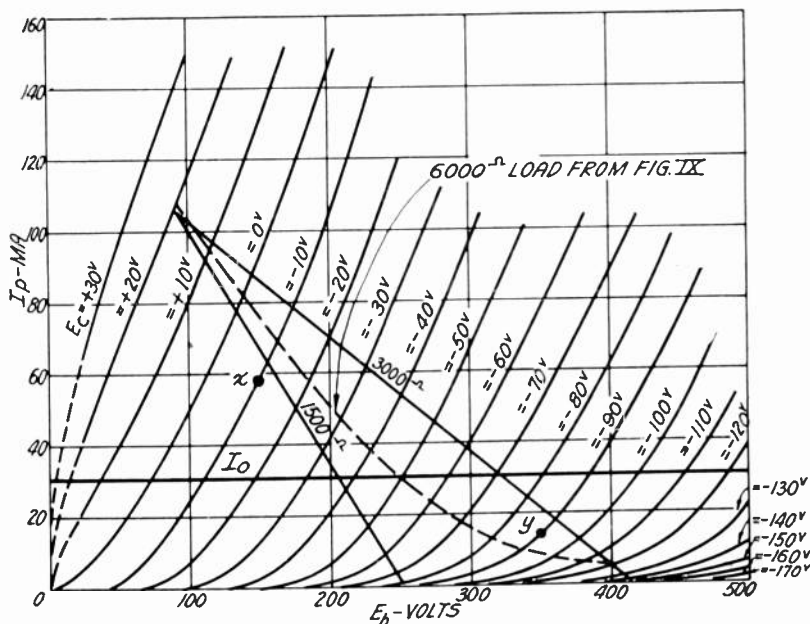

Fig. 6— $I_p - E_p$  characteristics R-45 tube.

lated is 5.04 while the measured is 4.92 watts and the calculated third was 2.2 per cent while the measured was 2.6 per cent. The values of power and percentage of third harmonic were calculated by the same method as was used in the previous paper.<sup>3</sup> Any method may be used however.

Fig. 7 shows the measured power output and distortion obtained from two type 245 tubes having plate characteristics reasonably close to those shown in Fig. 6. The applied voltage was equal to 250 volts plus the direct-current drop in the choke and the alternating-current load resistance was 6000 ohms. The peak voltage input was equal to the grid bias plus 20 volts in all cases. A load resistance of 1500 ohms was used for the calculations and was drawn in from 250 volts as shown on the diagram. A load line for 3000 ohms was drawn in from the inter-

section of the 1500-ohm load line and the +20-volt curve as shown. Auxiliary load lines not shown were drawn in from the intersection of the 1500- and 3000-ohm load lines and passed through the intersections of the various bias curves with 250 volts. The latter lines were used to divide the 3000-ohm line proportionally in order to calculate the harmonics. It will be noted that with 40 volts bias and a 60-volt swing the plate current is not cut off so that the theory derived here will not hold and the power is considerably less than the calculated value. The curve

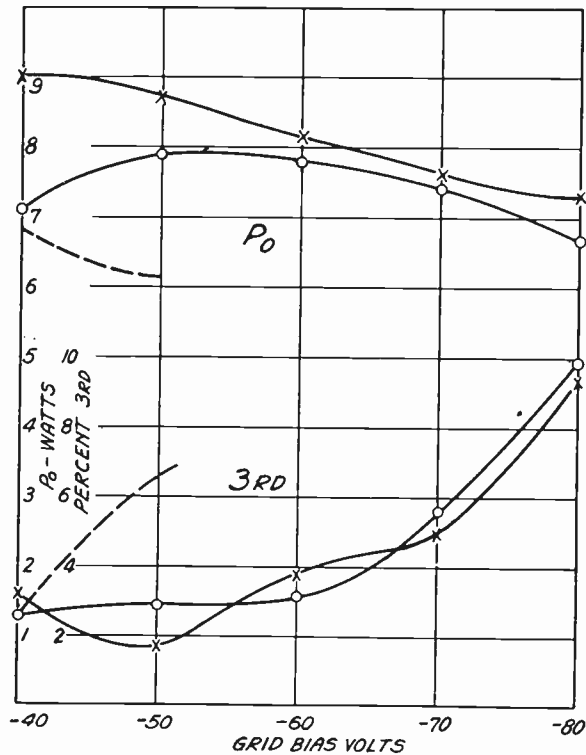

Fig. 7— $P_0$  and distortion vs.  $E_{c0}$ .  
 $R$ -45 stage,  $E_b = 250$  volts,  $R_L = 6000$  ohms.  
 $E_{ac}$  peak =  $E_{c0} + 20$  volts  
 (O)—measured  
 (X)—calculated  
 - - -calculated class A conditions

for  $-50$  volts bias is just cut off so that the measured and calculated values ought to agree fairly closely and they do. The agreement is better for bias voltages of 60, 70, and 80 volts where the plate current has completely cut off part of the cycle.

The power output and distortion were calculated under the conventional class A conditions by finding the fundamental and third harmonic for a single tube and multiplying the result by two. The agreement as shown in Fig. 6 was fair at  $-40$  volts and poor at 50

volts. The conventional class A conditions give a good check at bias voltages less than  $-40$  volts while the method developed here gives a good check at bias voltages greater than  $-50$  volts where the plate current is cut off during part of the cycle.

Fig. 8 shows an interesting curve taken with two type 46 tubes connected as shown in Fig. 4B. The power output is plotted against input voltage with the load resistance 6000 ohms. One tube was removed and the load resistance was adjusted to give one half the power. The ratio of this load resistance to 6000 ohms is shown plotted in this figure also. The theoretical ratio is 1.69.

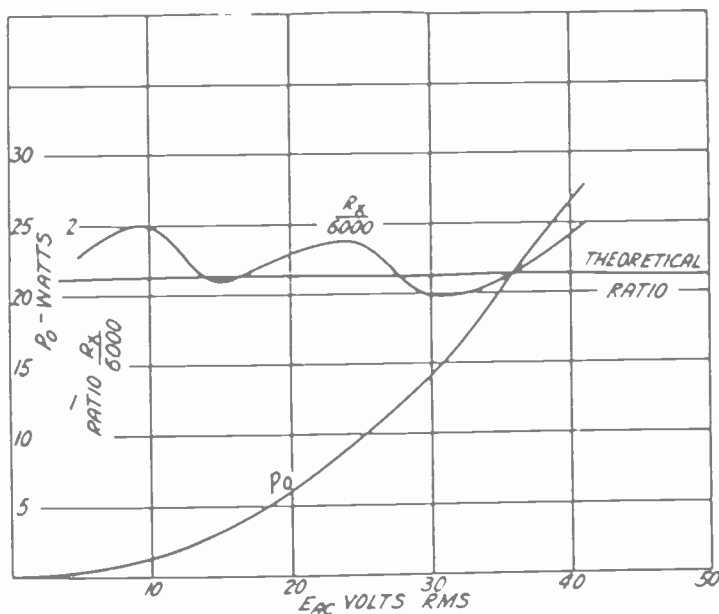

Fig. 8--  $P_o$  two tubes in series and ratio of  $R_L$  6000 of a single tube to give one half the power in the circuit shown in Fig. 4B. ER-46 tubes  $E_b = 400$  volts.

#### MODIFICATION OF PREVIOUS THEORY

The theory developed here explains the defects of the method given previously<sup>3</sup> and explains why it did not work when one tube was at cut-off. B. J. Thompson of the RCA Radiotron Company has written to the writer criticizing the method given previously on the basis that it did not take into account the mutual coupling. The previous method only partially took into account the mutual coupling. Thompson has also developed a method which takes into account the mutual coupling and shows conditions on the tube characteristics. The writer desired to develop a method which shows conditions in the output or load circuit rather than in the tube itself.

<sup>3</sup> *Loc. cit.*, pp. 1768 and 1769.

Fig. 3 showed that the sum of the fundamental and odd harmonics is one half the maximum value so that the value of load current used which was one half the sum of the two currents was justified in the previous paper. It also shows further that equal plate swings must occur in each tube. This being the case the auxiliary diagram<sup>3</sup> Fig. 5 may now be drawn in a slightly different manner. If  $E_o$  is changed by increments  $\pm e$  the plate voltage changes are taken equal and the current is equal to the sum of the changes divided by two. For example

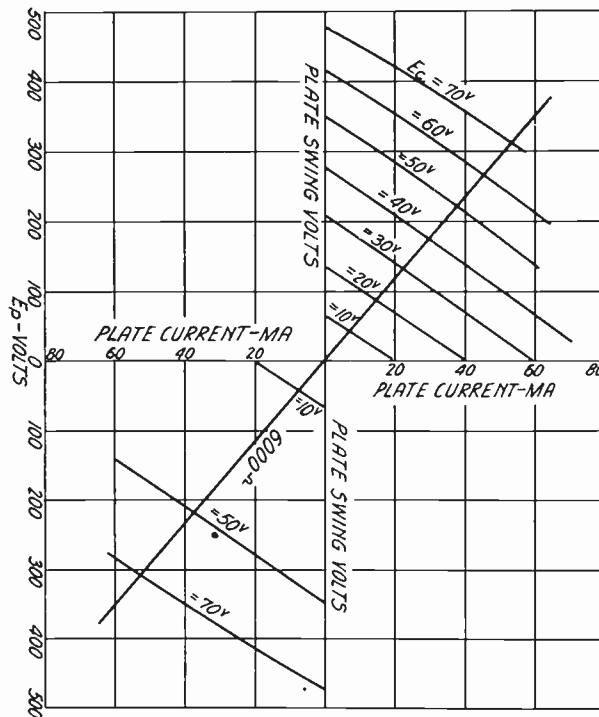

Fig. 9—Auxiliary  $I_p - E_p$  diagram. Two R-45 tubes in push-pull derived from Fig. 6.

refer to Fig. 6 which is the same as Fig. 4 of the previous article and assume a 40-volt bias change and a 100 plate voltage change, that is, from  $-50$  and  $250$  we find points  $x$  and  $y$  with point  $x$  giving 58.0 milliamperes and point  $y$  giving 14 milliamperes or a difference of 44 milliamperes and half of this is 22.0 milliamperes. This point  $A$  is located on the auxiliary diagram like Fig. 5 of the previous article or the new diagram Fig. 9 of this paper. Similarly the other values are located on this diagram.

A load resistance of 6000 ohms is shown plotted on Fig. 9 and shown transferred back to Fig. 6 by the dotted lines. This is transferred by

taking the intersection of the load line with any value of grid bias, dividing the plate voltage by two and locating it by plus and minus the value from the operating point  $I_0$  on Fig. 6. The dotted line represents the load resistance of each tube when the external load resistance is 6000 ohms. The load line shows why class A theory does not apply in this case for if we pass a 3000-ohm load line through  $I_0$  and multiply the power calculated by two we do not obtain the true power of the two tubes in series, while if we use the dotted line we obtain the true power from one tube. We may only use the conventional theory when the transferred load line is straight. The writer is not the first to use the conception of the curved load line but he believes that its true significance has not been thoroughly appreciated. A study of the two load lines reveals the reason for measuring more than twice the power with two tubes than may be obtained with a single tube.

The auxiliary diagram as constructed here will give accurate results under any conditions from class A to class B at cut-off. As a matter of interest the power calculated for -50 volts and 70 volts peak input as shown in Fig. 7 was checked by using Fig. 9 and found to be 8.2 watts. The value calculated by the conventional formula was 6.3 and by the value calculated by the class B theory developed here was 8.4 while the measured value was 7.8 watts. The agreement is good when the auxiliary diagram of Fig. 9 is used. The other values of power output at -50-, -60-, -70-, and -80-volt biases also checked reasonably close to the measured values.

### CONCLUSIONS

The question asked at the beginning may now be answered. The treatment for all the questions is of course derived for an ideal tube but the results applied to practical tubes indicate that the methods give reasonable accuracy even if the characteristic is curved instead of linear as was the case with the ideal tube.

1. It is possible to treat a tube under class B conditions by the same method as is used under class A conditions by analyzing the wave form.
2. The conventional methods of calculating the power output and distortion under class B conditions from characteristic curves are correct as regards results but do not give in themselves a true picture of what occurs.
3. It is shown that the output and distortion of tubes in series under class B conditions may be calculated by means of the characteristic curves and an auxiliary load line.

4. It is shown that the method given for tubes under class B conditions is also applicable to cases between class B and class A conditions, and that the only restrictions are that not more than half the wave be cut off and that the plate current be cut off for twice the plate load resistance.

5. It is also shown that the auxiliary diagram previously developed may be constructed so as to be valid for all conditions from half the wave cut off to any class A condition.



## DISCUSSION ON "A PRACTICAL ANALYSIS OF PARALLEL RESONANCE"

REUBEN LEE

**Walter J. Seeley:**<sup>1</sup> In speaking of resonance in a parallel circuit, such as shown in Fig. 1 of Mr. Lee's article, it is necessary to specify just what kind of resonance is meant, as there are sometimes two different conditions of resonance, both of which may or may not be satisfied at the same time. What constitutes resonance is a matter of a correct definition. One definition states that resonance is the condition which makes the total reactance of the circuit equal to zero; and this is the condition which results in unity power factor. The other definition states that resonance is the condition which makes the total impedance of the circuit a maximum. Only under certain conditions will these two result in the same circuit adjustment.

Mr. Lee clearly points out that, under certain methods of tuning, the adjustment for resonance has been very puzzling to many an operator, due primarily to a lack of understanding of the resonance condition sought. It is very unfortunate that this is not made clearer in the definitions in the Standardization Rules of the Institute, so as to be more forcibly brought out in the Institute's literature. The various definitions and conditions have been analyzed, however, and many discussions of the subject are available. I previously pointed out<sup>2</sup> that from an analysis of the various conditions of the circuit of Fig. 1, the two conditions of unity power factor and maximum impedance were identical at all frequencies, when the circuit was tuned by varying the capacitance; that the two conditions were practically identical at radio frequencies when the circuit was tuned by varying the inductance if the resistance were below 100 ohms; and that at low frequencies the two conditions were not the same, except as noted for "all frequencies" above.

These differences have been pointed out in the following text books:

Magnusson, "Electric Transients," page 187.

Morecroft, "Principles of Radio Communication," page 94, second edition.

Mellvain and Brainerd, "High Frequency Alternating Currents," page 50.

Everitt, "Communication Engineering," page 54.

A study of these last two texts will yield considerable information on this most interesting subject.

**Reuben Lee:**<sup>3</sup> Mr. Seeley's list of reference texts on the subject of parallel resonance confirm the statement made at the beginning of my paper, that the mathematical treatment of this subject is usually complex and does not emphasize the physical side of the tuning process. This is no criticism of the texts, which are recognized as standard, but rather illustrates the comparative simplicity of graphical methods when they can be used.

As Mr. Seeley implies, a definition of parallel resonance must distinguish not only between unity power factor and maximum impedance, but also between the kinds of resonance arrived at by tuning with different circuit ele-

\* Proc. I R E., vol 21, pp. 271-281; February (1933).

<sup>1</sup> Electrical Engineering Department, Duke University, Durham, North Carolina.

<sup>2</sup> "Parallel resonance and anti-resonance," *Jour. A.I.E.E.*, p. 662, September, (1928).

<sup>3</sup> Westinghouse Electric and Manufacturing Company, Chicopee Falls, Massachusetts.

ments. If inductance is used for tuning, the definition must further state whether the resistance generally in series with the inductance varies or not, and if it varies, in what way. The case considered in the paper, namely a constant ratio of inductance to resistance, is probably the simplest way in which the resistance may vary. Perhaps the reason for lack of standard definitions lies in the difficulty of expressing all these conditions by definition alone. This suggestion is not made with the idea of justifying the present confusion, however. A suitably phrased set of definitions might do a great deal to clarify the situation.

Such a set of definitions would not be complete unless the natural frequency of the circuit were included. This frequency can be stated in the same way as the frequency for unity power factor:

$$f = \frac{1}{2\pi} \sqrt{\frac{1}{LC} - \alpha^2}$$

where  $\alpha^2 = R^2/L^2$  for unity power factor and  $\alpha^2 = R^2/4L^2$  for the natural frequency. Although the natural frequency was of wider importance in the days of damped waves, it still has a practical bearing.

It should not be gathered from Mr. Seeley's discussion that unity power factor and maximum impedance are practically the same at radio frequencies if the resistance is below 100 ohms, regardless of the values of  $L$  and  $C$ . This certainly would not be true if  $X_L = X_C = R = 90$  ohms. The volt-ampere/watt ratio is the real measure of the closeness of these two conditions, as mentioned on page 280 of the PROCEEDINGS in which the paper appeared.

The chief value of Mr. Seeley's discussion seems to be in his pointing out the lack of definiteness in the Institute's Standardization Rules on this subject. Therefore, I suggest that both discussions be forwarded to the Standardization Committee for consideration at their next meeting.





## BOOK REVIEWS

**Handbook of the Bureau of Standards No. 17.** Published by the United States Printing Office, Washington, D. C. 93 pages, 3 figures. Price 15 cents.

This handbook is entitled "Code for Protection Against Lightning." The subject matter is divided into three parts. The first part deals with the protection of persons, the second part with the protection of buildings, and miscellaneous property, and the third part with the protection of structures containing inflammable liquids and gases. There are also two appendixes, the first discussing the origin, characteristics, and effects of lightning; the second containing a very complete bibliography.

In spite of the value of lightning rods in the protection of property, their use has undoubtedly at times not produced the best results, owing to a general lack of information as to the best methods of protection. This publication sets up definite standards which have been found to be effective in practice. It also outlines the general principles involved in adequate lightning protection, which should enable the reader to work out the best arrangements to suit special conditions.

The appendix contains a great deal of interesting and valuable information relative to the different types of lightning, the source of the static charge, its voltage, energy, maximum current, duration, and induced effects.

This handbook should be of value to anyone interested in protecting any kind of property from lightning damage, including radio towers and antennas.

\*H. H. BEVERAGE

\* R.C.A. Communications, Inc., New York City.

**Modern Connectors for Timber Construction.** Published by U. S. Department of Commerce.

The United States Department of Commerce recently has published a booklet on the subject of Modern Connectors for Timber Construction, this booklet being the report prepared jointly by the National Committee on Wood Utilization, the United States Department of Commerce, and the Forest Products Laboratory of the Forest Service, United States Department of Agriculture.

This booklet, aside from its informatory value to engineers generally with respect to the methods that should be used in modern timber construction, is of particular value to radio engineers in that it shows the type of connectors that should be used for wooden radio masts. Illustrations are given of wooden radio masts over 300 feet in height, such height being made possible by the additional strength accorded by the particular type of connectors.

Radio engineers concerned with the erection of wooden masts to support their antennas should be familiar with the information contained in this booklet.

\*T. A. M. CRAVEN

\* Consulting radio engineer, Washington, D. C.

## RADIO ABSTRACTS AND REFERENCES

THIS is prepared monthly by the Bureau of Standards,\* and is intended to cover the more important papers of interest to the professional radio engineer which have recently appeared in periodicals, books, etc. The number at the left of each reference classifies the reference by subject, in accordance with the "Classification of Radio Subjects: An Extension of the Dewey Decimal System," Bureau of Standards Circular No. 385, obtainable from the Superintendent of Documents, Government Printing Office, Washington, D.C. for 10 cents a copy. The classification also appeared in full on pp. 1433-1456 of the August, 1930 issue of the PROCEEDINGS of the Institute of Radio Engineers.

The articles listed are not obtainable from the Government or the Institute of Radio Engineers, except when publications thereof. The various periodicals can be secured from their publishers and can be consulted at large public libraries.

### R000. RADIO (GENERAL)

- R004 J.E. Smith. Radio receiver design. *Radio Engineering*, vol. 13, pp. 20-22; March, (1933).

A statement of the equivalent circuit arrangements useful in broadcast receiver design.

- R051 A. W. Ladner and C. R. Stoner. Short-Wave Wireless Communication (book). Published by J. Wiley & Sons, Inc., New York, N. Y. (1933). Price \$3.50.

This book deals especially with short-wave communication. Principles common to both short and long waves have been introduced where the matter is necessary for the clearer explanation of the main subject. Short-wave transmitters and receiving circuits are discussed, and a full analysis of the independent drive system of transmitters is given. The theory and practice of high-frequency feeders is dealt with at length, as also are aerials, beam array systems, and ultrashort waves.

### R100. RADIO PRINCIPLES

- R113 H. Rukop. Der Stand der Wellenforschung in der oberen Atmosphäre. (The position of wave research in the upper atmosphere.) *Elek. Nach. Tech.*, vol. 10, pp. 41-58; March, (1933).

This paper gives a survey of the information obtainable from the ionosphere by high-frequency methods. Many references are given.

- R113 H. Zuhrt. Bei Beeinflussung elektromagnetischer Wellen durch Hochspannungsfreileitungen. (The influence of high voltage free conductors on electromagnetic waves.) *Elek. Nach. Tech.*, vol. 10, pp. 25-38; January, (1933).

It is shown that a mast or tower of conducting material such as a high voltage transmission line tower constitutes a T antenna. The effect of such masts on electromagnetic waves is investigated theoretically.

- R113 V. Fritsch. Ausbreitung elektromagnetischer Felder längs Flussläufen. (Propagation of electromagnetic fields along river

\* This list compiled by Mr. A. H. Hodge and Miss E. M. Zandonini.

courses.) *Hochfrequenz. und Elektroakustik*, vol. 41, pp. 100-104; March, (1933).

Experiment shows that low frequencies are absorbed less in mountains than high frequencies. It is shown further that high frequencies (40 to 80 meters) are propagated better along water.

- R113 J. Hollingworth. Some characteristics of short-wave propagation. *Jour. I.E.E.* (London), vol. 72, pp. 229-251; March, (1933).

A description is given of the phenomena observed when using a cathode-ray direction finder on closed coils for examining received signals on frequencies of the order of 10,000 kilocycles per second. The two outstanding features are the systematic appearance of certain cyclic forms, and the large values obtained for the horizontally polarized electric components.

- R113.1 Selektive Schwunderscheinungen und Höhenmessungen der  
 × R113.6 Ionosphäre. (Selective fading and height measurements of the ionosphere.) *Elek. Nach. Tech.*, vol. 10, pp. 76-92; March, (1933).

With two radio receivers, whose antennas are at right angles to each other, and a Braun tube, selective fading due to rotation of the plane of polarization is studied. Results of comparing linear and circularly polarized radiations are given. Impulses were received and compared with and without suppression of direct radiation. Several references are given.

- R113.55 H. E. Paul. Beobachtungen an den Kennelly-Heaviside-Schichten während der Sonnenfinsternis am 31 August 1932. (Observations on the Kennelly-Heaviside layers during the solar eclipse of August 31, 1932). *Hochfrequenz. und Elektroakustik*, vol. 41, pp. 81-83; March, (1933).

The above paper gives a report of reflection measurements on the Kennelly-Heaviside layers during the solar eclipse. A small decrease in the ionization of the upper Kennelly-Heaviside layer in contrast to the normal condition was found which could be considered as a result of the corpuscular eclipse. On this occasion an interesting phenomena was found, i.e., a "night concentration" of the upper layer.

- R113.55 J. R. Martin and S. W. McCuskey. Observations in transmission during the solar eclipse of August 31, 1932. *Proc. I.R.E.*, vol. 21, pp. 567-573; April, (1933).

This paper is a report of the result of tests on transmission during the solar eclipse of August 31, 1932. Signals in the 7500-kilocycle band were transmitted from a point in the path of totality and were recorded in Cleveland, Ohio. The records show a slow rise in level until a few minutes before totality when a sharp increase was observed. At totality the signals suddenly dropped to a very low level, then increased slowly until the end of the eclipse, when a second rise in intensity took place. This peak continued for several minutes and then fell to the normal level.

- R113.6 G. Goubau and J. Zenneck. Eine Methode zur selbsttätigen Aufzeichnung der Echos aus der Ionosphäre. (A method of automatic recording of echoes in the ionosphere.) *Hochfrequenz. und Elektroakustik*, vol. 41, pp. 77-80; March, (1933).

An arrangement of automatic recording of echoes in the ionosphere is described. It has no mechanical moving parts, and supplies automatically a height scale simultaneously with the echoes.

- R113.61 P. Wolf. Messungen an den Kennelly-Heaviside-Schichten nach einer kontinuierlich registrierenden Methode. (Measurements on the Kennelly-Heaviside layer with a continuously recording method.) *Hochfrequenz. und Elektroakustik*, vol. 41, pp. 44-53; February, (1933).

A method of studying and recording the apparent height of the Kennelly-Heaviside layer is described. The pulse transmitter and receiver are described. The results are shown by a large number of photographs. A bibliography of 21 references is given.

- R113.61  
×R113.55 G. W. Kenrick and G. W. Pickard. Observations of the effective height of the Kennelly-Heaviside layer and field intensity during the solar eclipse of August 31, 1932. *Proc. I.R.E.*, vol. 21, pp. 546-566; April, (1933).

The result of observations of the effective height of the Kennelly-Heaviside layer on frequencies of 1640, 3942.5, and 4550 kilocycles are described. On the higher frequencies two height maxima, one before and one after totality, are observed. These maxima occur at approximately 50 per cent totality. Field intensity observations on 6095, 940, and 16.1 kilocycles taken at Tufts College are also described.

- R113.61  
×R113.55 H. R. Mimno and P. W. Wang. Continuous Kennelly-Heaviside layer records of a solar eclipse. *Proc. I.R.E.*, vol. 21, pp. 529-545; April, (1933).

A new type of apparatus, which makes a continuous automatic record of the varying heights of the Kennelly-Heaviside layers over a long period of time, has been designed. The history and the preliminary experiments are mentioned briefly. Two models are described and illustrated. The first model is a fixed piece of radio transmission laboratory equipment, designed for maximum flexibility in operation. The second model is a light, compact, portable recorder designed for field use. Results of observations made during the August 31, 1932, eclipse are given.

- R113.62 G. Goubau. Echomessungen an den ionisierten Schichten der Atmosphäre. (Echo measurements on the ionized layers of the atmosphere). *Elek. Nach. Tech.*, vol. 10, pp. 72-74; February, (1933).

The results of some echo measurements are discussed in connection with the variation of the apparent height of the Kennelly-Heaviside layer. Some graphs show the sunrise and sunset phenomena.

- R133 Barkhausen-Kurz-Schwingungen: Neue Gesichtspunkte (Barkhausen-Kurz oscillations: New points of view.) *Hochfrequenz. und Elektroakustik*, vol. 41, pp. 56-61; February, (1933);

The properties of the *B-K* oscillations, the validity of formula  $\lambda^2 E_0 = \text{const.}$ , the Whiddington and magnetron oscillations, and the generating mechanism of the oscillations are discussed.

- R134 C. B. Aiken. Theory of the detection of two modulated waves by a linear rectifier. *Proc. I.R.E.*, vol. 21, pp. 601-629; April, (1933).

In this paper there is developed a mathematical analysis of the detection by a linear rectifier of two modulated waves. Solutions are obtained which are manageable over wide ranges of values of carrier ratio and degrees of modulation. These solutions are of greater applicability and are more convenient than those previously obtained, and give a full treatment of the action of an ideal linear rectifier under the action of two modulated waves.

- R138 M. Benjimin and H. P. Rooksby. Emission from oxide-coated cathodes. *Phil. Mag.* (London), vol. 15, pp. 810-829; April, (1933).

Results of an X-ray analysis of coating material show only the monoxides. Conditions of poisoning and reactivation are discussed. Sputtering with ions of argon or mercury was used as one method of recovering activity.

- R170  
×R270 C. R. Barhydt. The radio noise meter and its application to the measurement of radio interference. *Gen. Elec. Rev.*, vol. 36, pp. 201-205; April, (1933).

A radio noise meter which detects radio noise, measures its intensity and locates its source is described. Calibration and method of use are discussed.

## R200. RADIO MEASUREMENTS AND STANDARDIZATION

- R201.5 W. Lyons. Experiments on electromagnetic shielding at frequencies between one and thirty kilocycles. *Proc. I.R.E.*, vol. 21, pp. 574-590; April, (1933).

This paper describes a method used in measuring the ratio of magnetic field intensities within conducting cylindrical and spherical shells to that outside, values

being given for various frequencies between 1000 and 30,000 cycles per second of the exciting field and various lengths and radii. A theoretical derivation of a shielding formula is given for a thin spherical shell and a cylindrical one of infinite length.

- R214 E. Giebe and A. Scheibe. Über Leuchtresonatoren als Hochfrequenznormale. (Light resonators as high-frequency standards.) *Hochfrequenz. und Elektroakustik*, vol. 41, pp. 83-96; March, (1933).  
Four different types of longitudinal oscillating light resonators of the Reichsanstalt (Germany) are described. These differed in orientation of the quartz plate to the crystal axis and by their holders. An accuracy of the order of one part in a million is claimed.
- R220 Th. W. Schmidt. Eine neue Methode zur Messung von Kapazitäten bei hohen Frequenzen. (A new method of measurement of capacities at high frequencies.) *Hochfrequenz. und Elektroakustik*, vol. 41, pp. 96-98; March, (1933).  
A capacity measurement method is described which uses the variation in the anode current of a quartz controlled oscillator as a measure of the capacity which is placed in the oscillating circuit.
- R280 A. Schneider. How "Ferrocart" is made. *Wireless World*, vol. 32, p. 203; March 17, (1933).  
The method of manufacturing "Ferrocart" is described. Reasons for its high efficiency as core material are stated.
- R280  
×R382 A. Schneider. Iron content cores for high-frequency coils. *Wireless Engineer & Experimental Wireless* (London), vol. 10, pp. 183-185; April, (1933).  
Method of manufacturing "Ferrocart" is described. The low loss is explained.
- R300. RADIO APPARATUS AND EQUIPMENT
- R330  
×R360 N. E. Wunderlich. An inter-carrier noise suppression system. *Radio Engineering*, vol. 13, pp. 7-9; March, (1933).  
The use of a new vacuum tube in a 7-tube superheterodyne circuit is described. The tube is known as the "B" tube and is similar to the Wunderlich tube except for an extra anode which is brought out to a cap connector. Inter-carrier noise suppression, sensitivity control and amplified automatic gain control are features of the superheterodyne which is to be manufactured.
- R330 Tubes of the month. *QST*, vol. 17, p. 16; April, (1933).  
Data on the 77, 78, 75, and 53 vacuum tubes are given.
- R330 J. R. Nelson. Detector tube performance curves. *Radio Engineering*, vol. 13, p. 15; April, (1933).  
Curves showing the performance of several detector tubes are given.
- R330 New multiple purpose tubes for 1933 radio receivers. *Radio Engineering*, vol. 13, pp. 10-11; April, (1933).  
The following vacuum tubes are described: Hygrade-Sylvania Corporation type 15, 85; Raytheon 2A6, 2B7 6B7; National Union 6F7; RCA 2B7, 2A7, 79; and the Hexode.
- R330 The 77 as a biased detector with 100 volts plate supply. *Radio Engineering*, vol. 13, p. 18; April, (1933).  
A method of using the 77 vacuum tube in small universal receiving sets is described.
- R330 E. C. S. Megaw. A magnetron oscillator for ultra-short wavelengths. *Wireless Engineer & Experimental Wireless* (London), vol. 10, pp. 197-202; April, (1933).  
This paper describes the characteristics and performance of a magnetron oscillator. This oscillator is primarily intended for wavelengths between 1 and 10 meters, but can be used on both longer and shorter wavelengths. An output of 40-50 watts is obtainable.

- R330 New tubes—New tube materials. *Electronics*, vol. 6, p. 93; April, (1933).  
The following tubes are described: 6C6, 6D6, 2A6, 6Z-3, 6Z-4, 6Z-5, 12Z-3, and 25Z-3.
- R330 J. R. Nelson. Considerations on detector-output tube systems. *Electronics*, vol. 6, pp. 94-95; April, (1933).  
The possibilities and advisability of using more complex vacuum tubes are considered.
- R355.7 B. J. Thompson. Graphical determination of performance of push-pull audio amplifiers. *Proc. I.R.E.*, vol. 21, pp. 591-600; April, (1933).  
A relatively simple method is presented which consists in combining the plate-current—plate-voltage characteristics of the tubes to form a family of composite characteristics. This may be used to determine the performance for any load resistance in the same manner as is done for single tubes.
- R355.9 C. T. Grant. Two new oscillators for the radio-frequency range. *Bell Laboratories Record*, vol. 11, pp. 237-240; April, (1933).  
Descriptions are given of two oscillators, type W-10414 and W-10465.

#### R400. RADIO COMMUNICATION SYSTEMS

- R423.5 P. J. H. A. Nordlohne. Broadcasting on 7.85 meters—Experimental work in Amsterdam. *Wireless Engineer & Experimental Wireless* (London), vol. 10, pp. 186-196; April, (1933).  
Transmitting and receiving apparatus and results of transmission tests are described. It is concluded that a one-half-kilowatt transmitter on wavelengths of 7 to 8 meters can give reliable service and high quality over a densely populated area.
- R423.5 The Marconi short-wave telephone-telegraph installation of the League of Nations. *Marconi Review*, No. 40, pp. 13-26; January-February, (1933).  
The Marconi type S.W.B. 7 short-wave transmitter together with control tables, protective circuits, tube cooling plant, feeders, and antennas are described.
- R423.5 G. Marconi. Radio communications by means of very short electric waves. *Marconi Review*, No. 39, pp. 1-6; November-December, (1932); No. 40, pp. 1-12; January-February, (1933).  
A complete communication system which uses very short waves is described. Many tests are described and distances over which successful communication has been achieved are given.

#### R500. APPLICATIONS OF RADIO

- R526.3 H. H. Blee. A system of radio aids for fog landings. *Aero Digest*, vol. 22, pp. 27-29, March; p. 17, April, (1933).  
A radio system for landing airplanes is described. An installation consists of a runway localizing beacon, a set of two marker beacons, and a landing beam. With this system it is possible for a pilot to locate the landing field and land without seeing any landmarks. In Part II the use of the system is described. Performance data are given.

#### R800. NONRADIO SUBJECTS

- 621.313.7 P. G. Weiller. Notes on the manufacture of mercury-vapor rectifier tubes. *Electronics*, vol. 6, pp. 99-101; April, (1933).  
It is pointed out that in order to make vapor tubes of very long life large low voltage filaments are essential. The coating of the filament limiting to a large degree the life of the tube. The relation between the gas pressure, inverse peak voltage and life is discussed. Thorough exhaust is emphasized.

**CONTRIBUTORS TO THIS ISSUE**

**Chinn, Howard A.:** Born January 5, 1906, at New York City. Attended Polytechnic Institute of Brooklyn; received B.S. degree, Massachusetts Institute of Technology, 1927; M.S. degree, 1929. Research assistant, Round Hill Research Division, Massachusetts Institute of Technology, 1927-1932; research associate, 1932-1933; radio engineer, Columbia Broadcasting Company, 1933. Associate member, Institute of Radio Engineers, 1927.

**Diamond, H.:** Born February 12, 1900, at Quincy, Massachusetts. Received B.S. degree, Massachusetts Institute of Technology, 1922; M.S. degree, Lehigh University, 1925. Engaged in research work in mechanical engineering, General Electric Company, 1922-1923; instructor in electrical engineering, Lehigh University, 1923-1927; summer work, General Electric, B. F. Sturtevant, and Boston Elevated Companies. Associate radio engineer, Bureau of Standards, 1927-1928; radio engineer in charge of development of radio aids to air navigation, Bureau of Standards, 1928 to date. Member, A.I.E.E. Associate member, Institute of Radio Engineers, 1926; Member, 1930.

**Feldman, Carl B.:** Born March 26, 1902, at St. Peter, Minnesota. Received B.S. degree, University of Minnesota, 1926; M.S. degree, 1928. Bell Telephone Laboratories, Inc., 1928 to date. Associate member, Institute of Radio Engineers, 1926.

**Nelson, J. R.:** Born October 27, 1899, at Murray, Utah. Power inspector, Western Electric Company, 1922-1923. Received B.S. degree in electrical engineering, University of Southern California, 1925. Engineering Record Office, Bureau of Power and Light, Los Angeles, 1925; radio test, Radio Development Laboratory and Tube Research Laboratory, 1925-1927. Received M.S. degree in electrical engineering, Union College, 1927. Engineering department, E. T. Cunningham, Inc., 1927-1928; research laboratory, National Carbon Company, 1928-1930; Raytheon Production Corporation, 1930 to date. Associate member, Institute of Radio Engineers, 1927; Member, 1929.

**Robinson, Gordon D.:** Born May 21, 1892, at Maywood, Illinois. Received M.E. degree in electrical engineering, Cornell University, 1914; M.S. degree in electrical engineering, Massachusetts Institute of Technology and Harvard University jointly, 1915. Continental Can Company, working on cam design, Pennsylvania-Paoli railroad electrification; inventory of overhead equipment, Commonwealth Edison Company, Chicago. Instructor, department of electrical engineering, Pennsylvania State College, 1916-1917; instructor-associate professor, department of electrical engineering and physics, United States Naval Academy, 1917 to date. Active charge of Radio Laboratory, United States Naval Academy, 1918 to date. Associate member, A.I.E.E., U.R.S.I., S.P.E.E. Associate member, Institute of Radio Engineers, 1919.

**Tuttle, W. N.:** Born March 29, 1902, at Croton-on-Hudson, New York. Received A.B. degree, Harvard University, 1924; S.M. degree in electric communication engineering, Harvard, 1926; Ph.D., Harvard, 1929. Whiting Fellow in Physics, 1927-1929. Instructor and tutor in physics, Harvard, 1929-1930. Engineer, General Radio Company, 1930 to date. Member, American Physical Society and Acoustical Society of America. Associate member, Institute of Radio Engineers, 1926.

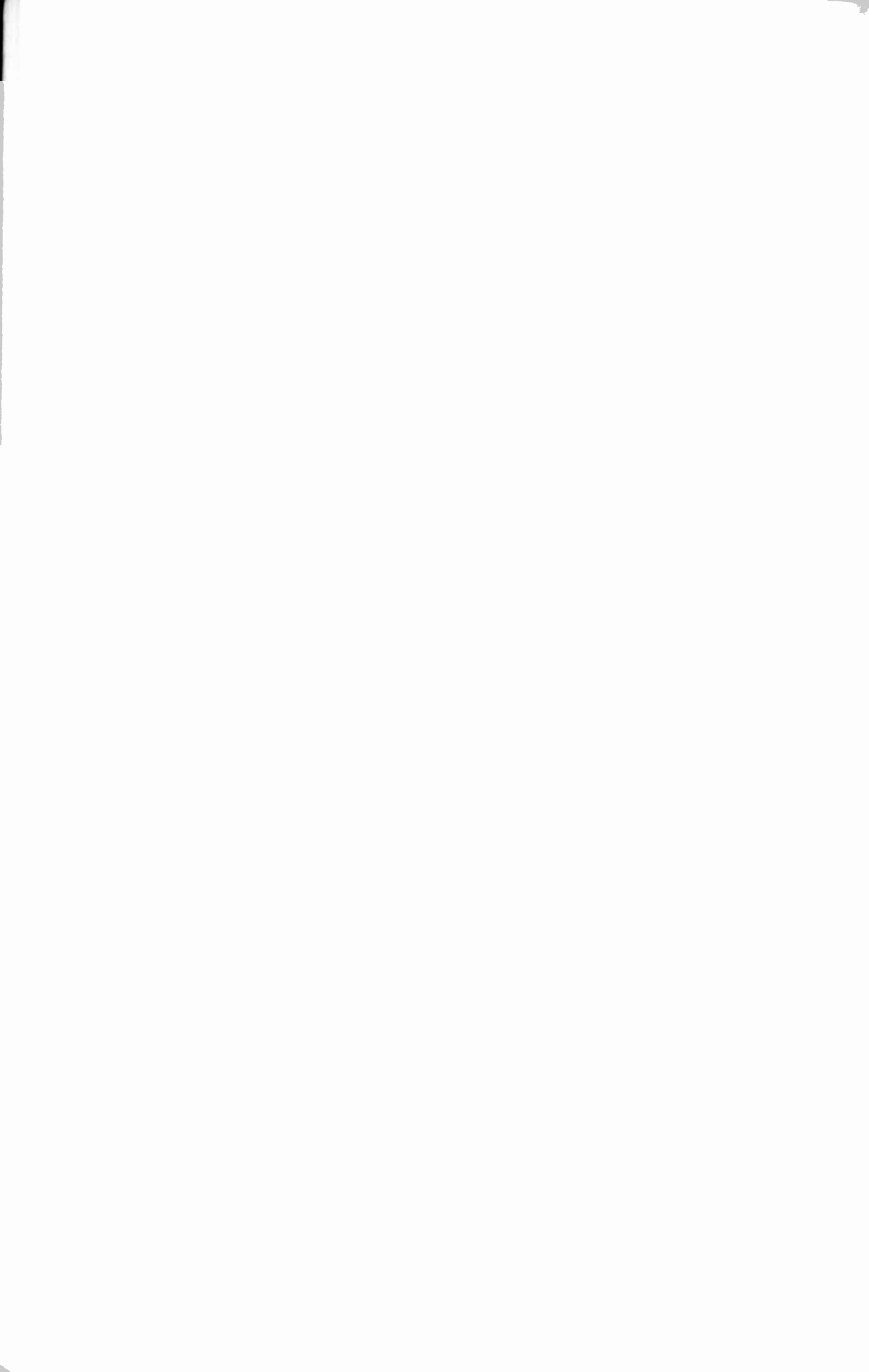





## *Pulling . . .*

### *Their weight in the boat*

Absentee owners have never controlled the Hygrade Sylvania Corporation.

The men who own the major portion of the stock are all active in managing the business. They pull their weight in the boat. This unswerving loyalty to one ideal is why Hygrade Sylvania has increased its financial and dealer strength, even during the years of depression. Throughout 1930, 1931, 1932 . . . and today . . . the company's credit rating has always been AAA1.

The radio set owner has been given a high quality, carefully inspected tube. The radio set manufacturer has had expert technical help and advice. Hygrade Sylvania first pioneered the development of more efficient tubes for automobiles . . . and later, the application of this new 6.3 volt group of tubes to general use.

The support of a company like this can mean much to your business. Write us for further details. Hygrade Sylvania Corporation, Sylvania Division, Emporium, Pa.



# *Sylvania*

REGISTERED U. S. PAT. OFF.

## THE SET-TESTED RADIO TUBE

---

*When writing to advertisers mention of the PROCEEDINGS will be mutually helpful.*

# CHANGE IN MAILING ADDRESS OR BUSINESS TITLE

Members of the Institute are asked to use this form for notifying the Institute office of a change in their mailing address or the listing of their company affiliation or title in the Year Book.

The Secretary,  
THE INSTITUTE OF RADIO ENGINEERS,  
33 West 39th Street,  
New York, N.Y.

Dear Sir:

Effective ..... please note change in my address  
(date)  
for mail as follows:

FROM

.....  
(Name)

.....  
(Street Address)

.....  
(City and State)

TO NEW ADDRESS

.....  
(Street Address)

.....  
(City and State)

Please note following change in my Year Book listing.

.....  
(Title)

.....  
(Company Name)

.....  
(Company Address)

*When writing to advertisers mention of the PROCEEDINGS will be mutually helpful.*



**TELEPHONE LINES** . . . putting her in instant two-way communication with a larger world—broadening her interests and extending her influence—rendering more simple the important business of managing a household. No item of home equipment contributes more to the security, the happiness and the efficiency of millions of women than the telephone.

There are times when being "in touch" is vital, urgent . . . a sound in the night, a whiff of smoke, a sudden illness. There are times when

the mere convenience of the telephone gives it an important place among life's necessities . . . to shop from your home, to chat with a friend, to handle, quickly and efficiently, the varied duties of a busy household. And there are times—many times daily—when the telephone is the indispensable right arm of business.

To make this possible, the Bell System provides millions of miles of wire and the services of an army of trained employees. They stand ready to answer your call; they offer you the service of a friend.

**AMERICAN TELEPHONE AND TELEGRAPH COMPANY**



*When writing to advertisers mention of the PROCEEDINGS will be mutually helpful.*

The resistance value of ERIE RESISTORS is remarkably constant under a wide variety of conditions.

Changes due to moisture, temperature and applied voltage are temporary provided maximum temperature and voltage limits are not exceeded, and the resistance quickly returns to normal.

**ERIE RESISTORS**



ERIE RESISTOR CORPORATION, ERIE, PA.  
Factories in Erie, Pa., Toronto Can., and London, Eng.

*When writing to advertisers mention of the PROCEEDINGS will be mutually helpful.*

# The Institute of Radio Engineers

Incorporated

33 West 39th Street, New York, N. Y.

## APPLICATION FOR ASSOCIATE MEMBERSHIP

(Application forms for other grades of membership are obtainable from the Institute)

To the Board of Direction

Gentlemen:

I hereby make application for Associate membership in the Institute of Radio Engineers on the basis of my training and professional experience given herewith, and refer to the members named below who are personally familiar with my work.

I certify that the statements made in the record of my training and professional experience are correct, and agree if elected, that I will be governed by the constitution of the Institute as long as I continue a member. Furthermore I agree to promote the objects of the Institute so far as shall be in my power, and if my membership shall be discontinued will return my membership badge.

.....  
(Sign with pen)

.....  
(Address for mail)

.....  
(Date)

.....  
(City and State)

### References:

(Signature of references not required here)

Mr. .... Mr. ....

Address ..... Address .....

City and State ..... City and State .....

Mr. ....

Address .....

City and State .....

The following extracts from the Constitution govern applications for admission to the Institute in the Associate grade:

#### ARTICLE II—MEMBERSHIP

Sec. 1: The membership of the Institute shall consist of: \* \* \* (c) Associates, who shall be entitled to all the rights and privileges of the Institute except the right to hold any elective office specified in Article V. \* \* \*

Sec. 4: An Associate shall be not less than twenty-one years of age and shall be a person who is interested in and connected with the study or application of radio science or the radio arts.

#### ARTICLE III—ADMISSION AND EXPULSIONS

Sec. 2: \* \* \* Applicants shall give references to members of the Institute as follows: \* \* \* for the grade of Associate, to three Fellows, Members, or Associates; \* \* \* Each application for admission \* \* \* shall embody a full record of the general technical education of the applicant and of his professional career.

*ENTRANCE FEE SHOULD ACCOMPANY APPLICATION*



# When QUALITY costs less —why pay this extra price?

One set returned to the factory because of *Resistor Failure* costs you more in actual dollars and cents, to say nothing of good will, than can be saved on 500 chassis by taking the risk of questionable resistor quality!

Continental—the oldest and largest exclusive manufacturer of molded radio resistors—offers you but one quality of product, the best resistor years of specialized effort can produce. Their uniform high grade is saving money for a constantly increasing number of leading manufacturers.

No sub-standard seconds or “odd lots” leave the Continental plant to aid in the fabrication of sets to be offered at demoralizing prices. Use the coupon below for test samples.

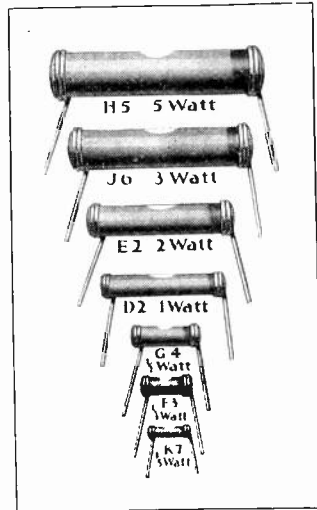
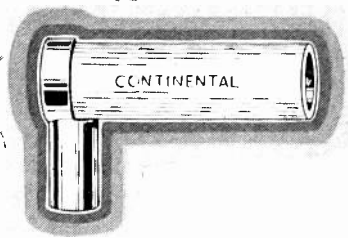

## Continental Resistors

Electrical characteristics alone do not express the full superiority of Continental Molded Resistors. The high mechanical strength of the Composition Resistor assures freedom from mechanical failure, a factor fully as important as electrical performance. Power ratings from 1/5 to 5 watts are available in a complete range of resistance values. Standard or special tolerances may be specified.

## A New Continental Suppressor

The Continental Type S-12 is now added to provide an easily installed, effective and durable unit for Buick, Packard, and other cars where there is but small space at the spark plugs. The Isolantite housing used in all Continental Suppressors has proven its ability to withstand heat, oil, moisture, and vibration better than any other insulating material.

Complete sets including distributor suppressors and generator filter condenser, or separate units, are available. Write for samples.

**CONTINENTAL CARBON Inc.**

13900 Lorain Ave. - Cleveland, Ohio  
Toronto, Ont.

Put these Samples  
on test

Continental Carbon Inc.  
13900 Lorain Ave., Cleveland, Ohio.  
Please send samples for test

( ) Resistors ( ) Suppressors

Firm

Name

Address

When writing to advertisers mention of the PROCEEDINGS will be mutually helpful.

# PRODUCTS OF ADVANCED

RESEARCH



ENGINEERING



MANUFACTURING



Some of the significant advances in tube design and construction initiated by Radiotron-Cunningham engineers, and incorporated in tubes introduced during the past several months, are listed here with further evidence of Radiotron-Cunningham leadership.

Dome Bulbs  
Improved Heater Insulations  
Low-Hum Heaters  
Elimination of Grid Emission  
Extensive Use of  
Suppressor Grids  
More Efficient Detectors and  
Amplifiers  
More Rugged Electrode Designs  
Greater Uniformity  
Increased Cathode Efficiencies  
Voltage-Doubling Rectifiers  
High - Power Output Tubes  
Special Tubes for  
Special Services

## RCA RADIOTRON CO., INC. E. T. CUNNINGHAM, INC.

HARRISON, N. J.

*When writing to advertisers mention of the PROCEEDINGS will be mutually helpful.*



# EMPLOYMENT PAGE

Advertisements on this page are available to members of the Institute of Radio Engineers and to manufacturing concerns who wish to secure trained men for positions. All material for publication on this page is subject to editing from the Institute office and must be sent in by the 15th of the month previous to the month of publication. (June 15th for July PROCEEDINGS IRE, etc.) Employment blanks and rates will be supplied by the Institute office. Address requests for such forms to the Institute of Radio Engineers, 33 West 39th Street, New York City, N.Y.

**MANUFACTURERS** and others seeking radio engineers are invited to address replies to these advertisements at the Box Number indicated, care the Institute of Radio Engineers. All replies will be forwarded direct to the advertiser.

---

**ASSOCIATE MEMBER** of the Institute with one and one half years experience in installation and service of talking picture equipment, three months in charge of salvage department of large radio manufacturing concern. Six months trouble shooting in sets on production line, one year radio service, motor repair and electric refrigeration service, one year in engineering course at a western school of engineering, and nine years experience in amateur radio. Age 25. Single. Will travel. Box 145.

---

**DEVELOPMENT ENGINEER.** Taught Electrochemical Engineering for seven years. Has had thirteen years of commercial experience. Has been in charge of the laboratories of a large organization engaged in the manufacture of telephone and radio apparatus, for about six years. Is familiar with the design and testing of communication apparatus. Age 42. Married. Will travel. Box 146.

*When writing to advertisers mention of the PROCEEDINGS will be mutually helpful.*

# PROFESSIONAL ENGINEERING DIRECTORY

For Consultants in Radio and Allied Engineering Fields

## FOR ADVANCED TRAINING

in:

Practical Radio Engineering  
Practical Television Engineering

write to

## CAPITOL RADIO ENGI- NEERING INSTITUTE

Riggs Bank Bldg.  
Washington, D.C.

## Cathode Ray Tubes and Associated Equipment For All Purposes

*Write for Complete  
Technical Data*

ALLEN B. DUMONT  
LABORATORIES  
UPPER MONTCLAIR, N.J.

## FOR MANY YEARS

the Professional Engineering Directory has helped consulting engineers, designers, and laboratory men make the right contacts in the radio industry. Perhaps we can help you with your problems too. For further information write to

*Advertising Department*

## INSTITUTE OF RADIO ENGINEERS

33 West 39th St.  
NEW YORK CITY, N.Y.

## LITTELFUSE LABORATORIES

*Specialists in*

**Delicate Equipment Protection**

**INSTRUMENTS and METERS**

**RADIO RECEIVERS**

**RADIO AMPLIFIERS**

**RADIO TRANSMITTERS**

*Write for new Technical Bulletin No. 5*

1764 Wilson Ave., Chicago, Ill.

*For the Engineering Consultant*

*who can handle a little extra business this year*

*For the designer*

*who can manage some additional work*

*For the Patent Attorney*

*who is anxious to develop a larger clientele*

we suggest the Professional Engineering Directory of the PROCEEDINGS I.R.E. Manufacturers and organizations with special problems who need services such as yours come to the Professional Engineering Directory for information. Your name and special services announced here will tell them what you do and where to find you. Further information will be furnished on request. Special rates to members of the Institute.

*When writing to advertisers mention of the PROCEEDINGS will be mutually helpful.*



## THERE IS A CORNELL CONDENSER FOR EVERY CONDENSER REQUIRE- MENT AND—AT THE RIGHT PRICE

The quality of Cornell products is so generally recognized that they are used by the leading radio and industrial organizations throughout the United States and Canada.

Dry Electrolytic Condensers in Cardboard Containers

Dry Electrolytic Condensers in Rectangular Metal Cans with Mounting Flanges

Dry Electrolytic Condensers in Round Metal Cans

Industrial Condensers

Transmitting Condensers

Paper Condensers, By-Pass and Filter

Auto and Marine Engine Ignition Condensers

Renewal Condensers, Filter Blocks and Kits

*WRITE US YOUR REQUIREMENTS  
AND GET OUR PRICES*

### THE CORNELL CATALOG

It illustrates and describes the complete Cornell line of Cub Condensers, Electrolytic Condensers, Paper Dielectric Capacitors for radio, television and ignition, and Resistors for radio and television. Write for a copy.

## CORNELL ELECTRIC MFG. CO., Inc.

*Manufacturers of*

**CORNELL "CUB" CONDENSERS**

*Filter and By-Pass Condensers, Interference Filters and  
All Types of Paper Dielectric Capacitors and Resistors*

**LONG ISLAND CITY, NEW YORK**

*When writing to advertisers mention of the PROCEEDINGS will be mutually helpful.*

---

---

## *Alphabetical Index to Advertisements*

<b>A</b>		<b>I</b>	
American Tel. & Tel. Co. ....	IX	I.R.E. ....	VIII, XI, XII, Inside Back Cover
<b>C</b>		<b>P</b>	
Central Radio Laboratories .....	XX	Professional Eng. Directory ....	XVI
Continental Carbon, Inc. ....	XIII		
Cornell Electric Mfg. Co. ....	XVII		
<b>E</b>		<b>R</b>	
Employment Page .....	XV	RCA Radiotron Co. Inc. ....	XIV
Erie Resistor Corp. ....	X		
<b>G</b>		<b>S</b>	
General Radio Co..Outside Back Cover		Stackpole Carbon Co. ....	XIX
<b>H</b>		<b>W</b>	
Hygrade Sylvania Corp. ....	VII	Weston Elec. Inst. Corp. ....	XXI

---

---

## PROCEEDINGS BOUND VOLUMES

Volume 20 (1932) of the Proceedings is now available in bound form to members of the Institute. It may be obtained in Buckram or Morocco leather for \$9.50 and \$11.00 respectively.

Bound copies of volumes 18 and 19 (1930 and 1931) are also available at the same price.

*When writing to advertisers mention of the PROCEEDINGS will be mutually helpful.*

# Stackpole Announces . . .

*A New, Improved*

*Type of Molded Carbon*

*Volume Control*

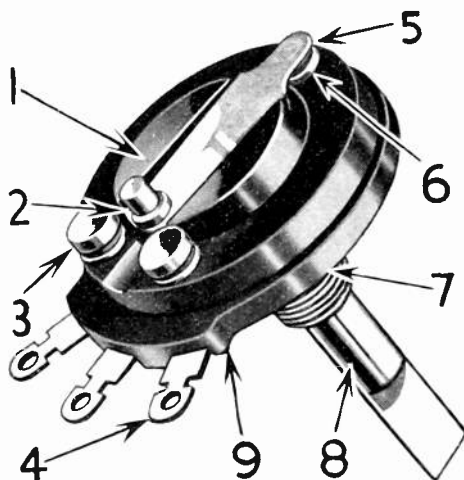

1 INSULATED BUSHING AND SHAFT. This bakelite hub carries the spring arm and the contact for the moving element and the shaft is molded into the other end of this bakelite hub, so the mounting bushing and shaft are fully insulated from the entire control resistor.

2 SWITCH OPERATING CAM. The cam dog which operates the A.C. switch on the switch type variable resistors, is assembled as a composite part of the moving arm member assuring accurate operation of the switch in respect to the resistance curve or hop-off value.

3 RUGGED STOP PINS. These rugged stop pins are accurately located through the resistor element and the bakelite frame and hold the entire assembly into one solid form.

4 LUGS EASY TO SOLDER TO. The three lugs on the variable resistor, as well as the two on the A.C. switch, are tin dipped to make it very easy to solder the connecting wires to them.

5 CONSTANT SPRING TENSION. The exact amount of downward tension is always maintained on the rotating shoe by this one-piece, special tempered spring arm.

6 SMOOTH ACTION—ABSENCE OF NOISE. This nickle chrome sliding shoe is

highly polished, cannot corrode and assures smooth and easy rotation of the arm of the variable resistor.

7 STANDARD ONE-HOLE MOUNTING. The standard  $\frac{3}{8}$ " brass bushing is fully insulated from the arm and resistor element.

8 NON-RUSTING SHAFT. This shaft is of cadmium plated steel and fits perfectly in the bored brass bushing to provide smooth and quiet operation.

9 MOLDED CARBON RESISTOR ELEMENT on bakelite frame. The thick molded carbon resistor element is made much like the permanent carbon resistors and is fired at high temperatures, resulting in a hard, glass-like surface impervious to temperature, humidity and hard usage. Made in any value from a few hundred ohms to a couple of megohms with any desired resistance taper and any hop-off or fixed value of resistance at either or both ends. It is the first control of its type and the first compact variable resistor which is Permanent, Unaffected by Humidity, Will Carry Considerable Current, Free of Capacity Effect, Smooth and Quiet in any Circuit and having Low Heat and Voltage Coefficient.

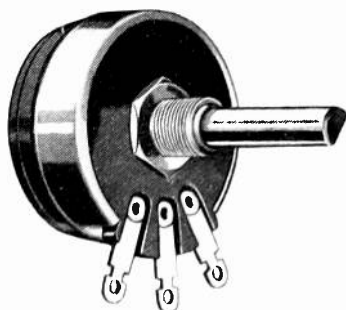

## Stackpole Carbon Co.

St. Marys, Pa., U.S.A.

Stackpole switch type variable control shown here is only  $\frac{15}{16}$ " from face of assembly nut to the rear of the A.C. switch. Just the thing to save space in the new A.C.-D.C. small chassis. Can be supplied with very short mounting bushing to save further space and any length of shaft.

*Write for Booklet*

• We have just published an interesting 12-page booklet on Stackpole CONTROLS—RESISTORS—SUPPRESSORS which contains complete descriptions and technical data on these three important products. Included are circuit diagrams indicating the correct application of VOLUME & TONE CONTROLS to every type of tube and circuit. A copy of this booklet will be gladly sent to you, upon request.

*When writing to advertisers mention of the PROCEEDINGS will be mutually helpful.*



»»»» with **Centralab**  
**MOTOR RADIO SUPPRESSORS**

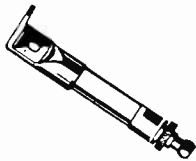

The unique one piece construction "Baptized with Fire" in the making, guarantees absolute permanence regardless of operating temperature or humidity.

An automobile distributor reports 11.8 miles per gallon with his car equipped with ordinary suppressors. After substituting CENTRALAB, the mileage was 15.8 per gallon—an increase of 34 per cent.

Many motors show decreased mileage and power when spark suppressors are used. This results from the high D.C. resistance needed to suppress radio interference. Centralab's greater effectiveness at radio frequencies permits much lower D.C. resistance, insuring full motor efficiency on all cars.

**CENTRAL RADIO  
 LABORATORIES**  
 MILWAUKEE, WISCONSIN

*When writing to advertisers mention of the PROCEEDINGS will be mutually helpful.*



You won't learn much about Chicago during the Institute's Convention but you will be able to

**MEET** many of those active in the radio engineering field,

**LISTEN** to and participate in discussing the dozen and a half of technical papers,

**EXAMINE** new developments as displayed at our Component Parts Exhibition, and

**SEE** the many interesting and educational exhibits at the Century of Progress Exposition.

Come to Chicago for our Eighth Annual Convention,  
June 26, 27 and 28, 1933.





# FOR DESIGNING - TESTING HIGH-FREQUENCY RECEIVERS



3-10  
MEGACYCLES

Designers of short-wave receivers—in the region around 5 meters, especially—have been handicapped by the lack of a standard test signal. The Type 604-B Test-Signal Generator supplies this lack, and puts the design of short-wave receivers on a definitely reproducible quantitative basis.

The new instrument supplies an adjustable, measured signal at any frequency between 3 megacycles (100 meters) and 100 megacycles (3 meters). An internal 400-cycle oscillator supplies modulation, and external modulation up to 20,000 cycles can be used.

The difficult problem of coupling the test-signal generator to the receiver has been solved by providing for coupling by means of a rod-type antenna as well as the conventional shielded cable. In this way the reaction of the coupling impedance on the performance of a regenerative receiver is eliminated.

All batteries are self-contained. All inductors are included with the instrument, and space for storing them is provided inside the cabinet.

PRICE \$300.00

WRITE FOR DATA on all the instruments described on this page. A request for Bulletin EX-3302-R will bring it. Address

**GENERAL RADIO COMPANY**  
CAMBRIDGE, MASSACHUSETTS

GEORGE BANTA PUBLISHING COMPANY, MENASHA, WISCONSIN