

VOLUME 20

MAY, 1932

NUMBER 5

Walter Malcolm
W A W

PROCEEDINGS

of

The Institute of Radio
Engineers



Form for Change of Mailing Address or Business Title on Page XXIX

Institute of Radio Engineers

Forthcoming Meetings

CINCINNATI SECTION

May 17, 1932

DETROIT SECTION

May 20, 1932

June 17, 1932

LOS ANGELES SECTION

May 17, 1932

June 21, 1932

NEW YORK MEETINGS

May 4, 1932

June 1, 1932

WASHINGTON SECTION

May 12, 1932

PROCEEDINGS OF
The Institute of Radio Engineers

Volume 20

May, 1932

Number 5

Board of Editors

ALFRED N. GOLDSMITH, *Chairman*

R. R. BATCHER

H. H. BEVERAGE

F. W. GROVER

G. W. PICKARD

L. E. WHITTEMORE

WILLIAM WILSON

K. S. VAN DYKE

CONTENTS

PART I

Frontispiece, C. P. Edwards, Vice President of the Institute, 1931	756
Institute News and Radio Notes	757
March 30 Meeting of the Board of Directors	757
Radio Signal Transmissions of Standard Frequency	758
Committee Work	760
Institute Meetings	762
Personal Mention	766

PART II

Technical Papers

Application of Quartz Plates to Radio Transmitters . . . O. M. HOVGAARD	767
A New Water-Cooled Power Vacuum Tube I. E. MOUROMTSEFF	783
The Vibrations of Quartz Plates R. C. COLWELL	808
A Study of Class B and C Amplifier Tank Circuits . . . PERRY H. OSBORN	813
The Reception of Frequency Modulated Radio Signals. VICTOR J. ANDREW	835
Field Intensity Measurements at Frequencies from 285 to 5400 Kilocycles per Second S. S. KIRBY AND K. A. NORTON	841
Phase Shift in Radio Transmitters W. A. FITCH	863
Discussion on "Amplitude, Phase, and Frequency Modulation," by Hans Roder D. G. C. LUCK AND HANS RODER	884
Booklets, Catalogs, and Pamphlets Received	888
Radio Abstracts and References	889
Contributors to this Issue	896

The Institute of Radio Engineers

GENERAL INFORMATION

INSTITUTE. The Institute of Radio Engineers was formed in 1912 through the amalgamation of the Society of Wireless Telegraph Engineers of Boston, Massachusetts, and the Wireless Institute of America of New York City. Its headquarters were established in New York City and the membership has grown from less than fifty members at the start to almost seven thousand by the end of 1931.

AIMS AND OBJECTS. The Institute functions solely to advance the theory and practice of radio and allied branches of engineering and of the related arts and sciences, their application to human needs, and the maintenance of a high professional standing among its members. Among the methods of accomplishing this need is the publication of papers, discussions, and communications of interest to the membership.

PROCEEDINGS. The PROCEEDINGS is the official publication of the Institute and in it are published all of the papers, discussions, and communications received from the membership which are accepted for publication by the Board of Editors. Copies are sent without additional charge to all members of the Institute. The subscription price to nonmembers is \$10.00 per year, with an additional charge for postage where such is necessary.

RESPONSIBILITY. It is understood that the statements and opinions given in the PROCEEDINGS are views of the individual members to whom they are credited, and are not binding on the membership of the Institute as a whole.

REPRINTING PROCEEDINGS MATERIAL. The right to reprint portions or abstracts of the papers, discussions, or editorial notes in the PROCEEDINGS is granted on the express condition that specific reference shall be made to the source of such material. Diagrams and photographs published in the PROCEEDINGS may not be reproduced without making specific arrangements with the Institute through the Secretary.

MANUSCRIPTS. All manuscripts should be addressed to the Institute of Radio Engineers, 33 West 39th Street, New York City. They will be examined by the Papers Committee and the Board of Editors to determine their suitability for publication in the PROCEEDINGS. Authors are advised as promptly as possible of the action taken, usually within two or three months. Manuscripts and illustrations will be destroyed immediately after publication of the paper unless the author requests their return. Information on the mechanical form in which manuscripts should be prepared may be obtained by addressing the secretary.

MAILING. Entered as second-class matter at the post office at Menasha, Wisconsin. Acceptance for mailing at special rate of postage is provided for in the act of February 28, 1925, embodied in Paragraph 4, Section 412, P. L. and R., and authorization was granted on October 26, 1927.

Published monthly by

THE INSTITUTE OF RADIO ENGINEERS, INC.

Publication office, 450-454 Ahnaip St., Menasha, Wis.

BUSINESS, EDITORIAL, AND ADVERTISING OFFICES

Harold P. Westman, *Secretary*

33 West 39th Street, New York, N. Y.

INSTITUTE SECTIONS

- ATLANTA—Chairman, H. F. Dobbs; Secretary, Philip C. Bangs, 23 Kensington Road, Avondale Estates, Ga.
- BOSTON—Chairman, George W. Pierce; Secretary, Melville Eastham, 30 State Street, Cambridge, Mass.
- BUFFALO-NIAGARA—Chairman, L. Grant Hector; Secretary, E. C. Waud, 235 Huntington Avenue, Buffalo, N. Y.
- CHICAGO—Chairman, J. Barton Hoag; Secretary, Donald H. Miller, McGraw Hill Publishing Co., 520 N. Michigan Ave., Chicago, Ill.
- CINCINNATI—Chairman, C. E. Kilgore; Secretary, H. G. Boyle, Crosley Radio Corp., Cincinnati, Ohio.
- CLEVELAND—Chairman, E. L. Gove; Secretary, Deane S. Kintner; 3622 Lindholm Rd., Cleveland, Ohio.
- CONNECTICUT VALLEY—Chairman, L. F. Curtis; Secretary, George Grammer, American Radio Relay League, 38 La Salle Rd., W. Hartford, Conn.
- DETROIT—Chairman, H. L. Byerlay; Secretary, Samuel Firestone, Detroit Edison Co., 2000 Second Avenue, Detroit, Mich.
- LOS ANGELES—Chairman, E. H. Schreiber; Secretary, H. W. Andersen, 2332 Lake View Ave., Los Angeles, Calif.
- NEW ORLEANS—Chairman, Pendleton E. Lehde; Secretary, Anton A. Schiele, 1812 Masonic Temple, New Orleans, La.
- PHILADELPHIA—Chairman, G. W. Carpenter; Secretary, G. C. Blackwood, 243 E. Upsal St., Mt. Airy, Philadelphia, Pa.
- PITTSBURGH—Chairman, J. G. Allen; Secretary, J. G. McKinley, West Penn Electric Co., 14 Wood St., Pittsburgh, Pa.
- ROCHESTER—Chairman, H. A. Brown; Secretary, M. A. Wood, 175 Winbourne Ave., Rochester, N. Y.
- SAN FRANCISCO—Chairman, Ralph M. Heintz; Secretary, F. E. Terman, Stanford University, Calif.
- SEATTLE—Chairman, Leslie C. Austin; Secretary, Herbert H. Bouson, 2225-33rd Ave., Seattle, Wash.
- TORONTO—Chairman, F. K. Dalton; Secretary, W. F. Choat, 355 King St. W., Toronto, Ont., Canada.
- WASHINGTON—Chairman, J. H. Dellinger; Secretary, Major Hugh Mitchell, Signal Corps, Office Chief Signal Officer, Munitions Building, Washington, D.C.

**GEOGRAPHICAL LOCATION OF MEMBERS ELECTED
MARCH 30, 1932**

Transferred to the Member Grade			
Massachusetts	Framingham, State Police.....	MacAdam, M. L.	
New Jersey	Merchantville, 6160 Grant Ave.....	Hopkins, A. R.	
Elected to the Member Grade			
Dist. of Columbia	Washington, 3165-18th St. N.W.....	Windmuller, L.	
Elected to the Associate Grade			
Arkansas	Fort Smith, The Goldman Hotel.....	Doan, L. W.	
California	Baldwin Park, 218 W. Covina Blvd.....	Ganzenhuber, J. H.	
	Berkeley, 2028 Francisco St.....	Bartholomew, L.	
	Crockett, Men's Club.....	Hale, W. S.	
	Hollywood, 621 N. Stanley Ave.....	LeMon, M. L.	
	Los Angeles, 1837 N. Alexandria Ave.....	Denechaud, R. G.	
	Los Angeles, 475 E. 48th St.....	Sarkin, H.	
	Palo Alto, P. O. Box 1053.....	Roebuck, F. G.	
	San Bernardino, U. S. Dept. of Commerce, Star Route 76401.....	Brooks, D.	
	San Bernardino, 1272 King St.....	Thorne, H. A.	
	San Diego, 4460-36th St.....	Coburn, H. E.	
	San Francisco, 45 Pinehurst Way.....	Boyd, F. A.	
	San Francisco, 2512 Customhouse.....	Fullaway, F. L.	
	Illinois	Belleville, 118 Wabash.....	Mueller, R. A.
		Chicago, 5149 Agatite Ave.....	Hallmark, C. E.
		Chicago, 2625 Farwell Ave.....	Krueger, R. M.
Chicago, 1831 S. Millard Ave.....		Root, J. J.	
East St. Louis, 2920 Virginia Pl.....		Chartrand, F. M.	
East St. Louis, 1359 N. 41st St.....		Stetson, R. W.	
Rantoul, Section D, Chanute Field.....		Biel, G. M.	
Rantoul, Radio Section, Chanute Field.....		Monaghan, H. E.	
Fort Wayne, 219-223 E. Washington Blvd.....		Curry, A. A.	
Indianapolis, Route 17, Box 409 "A".....		Stewart, R. R.	
Iowa	Davenport, 1712 Farnum St.....	Fogle, C. E.	
Kansas	Wichita, 226 S. Sedgwick Ave.....	Clark, T. H.	
Maryland	Salisbury, 1001 E. Church St.....	Akin, J. T.	
Michigan	Ann Arbor, 321 E. Ann St.....	Marlow, W. C., Jr.	
	Detroit, 1199 Collingwood Ave.....	Clarke, J. C.	
Mississippi	Laurium, Box 53.....	Jackson, W.	
Missouri	Hattiesburg, 618 Walnut St.....	Austin, F. J.	
	Afton, Rambler Dr., Box 173.....	Burrows, L. W.	
	Ferguson, 60 Harvey Ave.....	King, F. W.	
	St. Louis, 1962 Semple Ave.....	Buss, R. R.	
	St. Louis, 1010 Pine St., Rm. 1804.....	Cloyd, L. W.	
	St. Louis, 7200 Delta Ave., Richmond Heights.....	Cummings, G. M.	
	St. Louis, 5469 Enright Ave.....	Embree, J. N.	
	St. Louis, 841 Bell Telephone Bldg.....	Haywood, W. E.	
	St. Louis, 4069 S. Spring Ave.....	Liggett, F. S.	
	St. Louis, 4091 Toenges St.....	Myers, W. P., Jr.	
	St. Louis, 5625 Cates Ave.....	Payne, B. C.	
	Montana	Great Falls, Box 1555.....	Parker, J. E.
	New Jersey	Newark, 242 Broad St.....	Sprague, R. M.
		Ridgewood, 123 Phelps Rd.....	Soukup, J. E.
	New York	Brooklyn, 52 Clark St.....	Koonz, J. C.
Brooklyn, 208 Floyd St.....		Senkow, W. J.	
New York City, 267 W. 17th St.....		Hartley, S. H.	
Ohio	New York City, 536 W. 114th St.....	Sprague, V. G.	
	Woodhaven, 90-12 Jamaica Ave.....	Coppola, P.	
	Cincinnati, 867 Lexington Ave.....	Shapiro, P.	
Oregon	Cleveland Heights, 2600 Mayfield Rd.....	Frederick, P. E.	
	Corvallis, Phi Sigma Kappa.....	Smith, R. W. K.	
Pennsylvania	Portland, 2568 Shaver St.....	Stewart, R. P.	
	Philadelphia, 517 Midvale Ave.....	Craven, C. L.	
	Philadelphia, 1835 Arch St.....	Cunningham, R. M.	
	Philadelphia, 1246 N. Sartain St.....	Vogt, G. W.	
	Schuylkill Haven, 624 Leonard St.....	Mellor, J. R.	
Rhode Island	Newport, 60 Kay St.....	Nielson, W. C.	
South Carolina	Providence, 196 Congress Ave.....	Docherty, C. G.	
Tennessee	Greenville, 150 Perry Rd.....	Nicholson, L. E.	
	Chattanooga, American Lava Corp.....	Howar, C. R.	
Virginia	Nashville, 744 Benton Ave.....	Killman, R. T.	
Washington	Quantico, Signal School Co., Signal Bn.....	Stillwell, R. R.	
Canada	Tacoma, 602 N. C St.....	Fisher, R. C.	
	London, Ont., 390 Dundas St.....	Bach, J. R.	
	London, Ont., 113 Thornton Ave.....	Kells, W.	
	Ottawa, Ont., 68 Grange Ave.....	LaPointe, J. L.	
Toronto, Ont., 49 Bathurst St.....	Peiffer, J. T.		

Geographical Location of Members Elected March 30, 1932

China	Shanghai, 78 Heng Foong Lee, Scott Rd.....	Wang, M. C. H.
Czechoslovakia	Prague, Na Zderaze 3, Prague II.....	Ficek, F.
England	Chesham, Bucks, "Kolbran," Hampden Ave.....	Holley, L. C.
	Gateshead, 24 Bell St.....	Quinn, J.
	Halifax, Yorks, 13 A. Clover Hill Rd.....	Uttley, H.
	Hull, B. W. M. S., Marconi House, Commercial Rd.....	Felle, E. C.
	North Kensington, London W. 10, 19 Barlby Rd.....	Sudos, A.
Ireland	Dublin, 12 Philipsburgh Ave., Fairview.....	Phillips, A. W.
Italy	Florence, Via Ghibellina 63.....	Fagnoni, I. E.
Japan	Tokio, Tokio Central Broadcasting Station, Atagoyama, Shi- baku.....	Habu, E.
Territory of Ha- waii	Schofield Bks., 1st Bn. 8th F. A.....	Bennett, A.

Elected to the Junior Grade

California	Los Angeles, 1421 W. 12th St.....	Logan, D. C.
	San Francisco, 1450 Washington St., Apt. 3.....	Christman, F. L., Jr.
Illinois	Chicago, 2816 Greenvew Ave.....	Patelke, R. A.
	Rantoul, Section D, Aircorps Technical School.....	Johnson, B. D.
Missouri	Warrentown, Box 364.....	Haviland, R. P.
Wisconsin	Beloit, R. R. 7.....	Purcell, J. S.

Elected to the Student Grade

California	Berkeley, 2535 Channing Way.....	Katzmaier, J. F.
	Stanford University, Box 2145.....	Sharp, J. M., Jr.
Connecticut	New Haven, Naval Reserve Unit, Yale Station.....	Furth, F. R.
	New Haven, Naval R.O.T.C., Yale Unit.....	Goulett, W. B.
	New Haven, Box 1231.....	Schlitt, R. C.
Utah	Salt Lake City, 726 Hawthorne Ave.....	Irvine, L. K.



APPLICATIONS FOR MEMBERSHIP

Applications for transfer or election to the various grades of membership have been received from the persons listed below, and have been approved by the Committee on Admissions. Members objecting to transfer or election of any of these applicants should communicate with the Secretary on or before May 28, 1932. These applicants will be considered by the Board of Directors at its June 1 meeting.

For Election to the Associate Grade

Arkansas	Blytheville, 819 W. Ash St.	Dedman, R. L.
California	Fillmore, Box 201	Briggs, L. G.
	Long Beach, 1530 E. 3rd St.	Frye, G. D.
	Los Angeles, 2802 W. Ave. 32	Blasier, H. E.
	Los Angeles, 2253 La Verna	Dressen, D. D.
	Los Angeles, 2720 S. Normandie Ave.	Hare, R. J.
	Los Angeles, 1332 1/2 Sutherland St.	Jarvis, L. P.
	Los Angeles, 1237 W. 4th St.	Minnikin, S. J.
	Oakland, 61 Santa Clara Ave.	Simmons, H. W.
	San Francisco, Matson Navigation Co., Pier 32	Morrison, A. C.
	San Francisco, 140 New Montgomery St.	Pering, A. V.
	Santa Monica, 1327 Ocean Park Blvd.	DeLong, H. G.
	Durango, Box 592	Masterson, B.
Colorado	Atlanta, 80-12th St. N.E.	Akerman, B.
Georgia	Atlanta, 933 Center St. N.W.	McKee, C. W.
	Atlanta, Southern Bell Tel. Co.	Von Hoene, C. A.
Illinois	Chicago, 906 Edgecomb Pl.	Doan, R. O.
	Chicago, 53 W. Jackson Blvd.	Inman, J. F.
	Chicago, 3719 Montrose Ave.	Nickell, R. R.
	Chicago, 1515 W. Monroe St.	Siamis, T.
	Evanston, 1413 Wesley Ave.	Briggs, R. B.
	Hinsdale, 49 N. Grant St.	Murray, F. H.
Iowa	Ottumwa, 427 W. 4th St.	Grubbs, G. E.
Kansas	Pratt, 202 N. Jackson	Schreck, J. W.
Louisiana	Opelousas, P.O. Box 231	Seale, R.
Maryland	Baltimore, School of Engineering, Johns Hopkins University, Homewood	Hamburger, F., Jr.
	Baltimore, 4021 Wilsby Ave.	Hintenach, R. B.
Massachusetts	Boston, 159 W. Canton St.	Boisvert, R. A.
Missouri	St. Louis, 5073 Tholozan	Alcorn, E. B.
	St. Louis, 7263 St. Andrews Rd.	Coe, R. L.
	St. Louis, 6817 Michigan Ave.	Graham, H.
	St. Louis, 2601 S. Broadway	Pashoff, L.
	St. Louis, 1804 Telephone Bldg., 1010 Pine St.	Valier, C. E., Jr.
Montana	Butte, c/o Barrenstein Apts., 512 S. Montana St.	Kerns, R. L.
New Jersey	Audubon, 259 E. Atlantic Ave.	Beckmann, A.
	Belleville, 402 Washington Ave., Apt. B-6	Lane, W. C., Jr.
	Bogota, 174 Central Ave.	Rossee, R. L.
	East Orange, 183 William St.	Winstow, T. P.
	Haddonfield, 8 Tanner St.	Braddock, E.
	Haddonfield, 316 Kings Highway E.	Haydock, J. G., Jr.
	Jersey City, 451 Bergen Ave.	Butler, S. E.
New York	Brooklyn, 59 Pineapple St.	Bloch, I.
	Brooklyn, 1062 Park Pl.	Brimberg, M. M.
	Brooklyn, 1453-84th St.	Goldstein, G. H.
	Far Rockaway, 1711 Redfern Ave.	Schneider, F. J.
	New York City, RCA Communications, Inc., 66 Broad St.	Brown, A. L.
	Riverhead, RCA Communications, Inc.	Hansell, G. E.
Ohio	Cleveland, 1014 Lakeview Rd.	Banfer, K. J.
	Lakewood, 13926 Lake Ave.	Forrest, P. A.
	Marion, 500 Forest St.	Manley, F. A.
Pennsylvania	Allentown, 1036 Chew St.	Schaeffer, L. C.
	Carbondale, 9 Reyshanhurst	Rude, W. F.
	Emporium, 207 E. 4th St.	Espersen, G. A.
	Jersey Shore, Lock Box 116	Zarr, H. F.
	Philadelphia, 116 W. Abbottsford St., Germantown	Lusk, D. L.
	Wilkinsburg, 442 Rebecca Ave.	Place, W. P.
S. Carolina	Charleston, 18 Pitt St.	Ogilvie, E. F.
Utah	Ogden, 650-26th St.	Stevenson, R. S.
Washington	Chehalis, 903 1/2 Market St.	Windley, J. K.
	Seattle, Radio Engineering Co., 2319-2nd Ave.	Kish, S.
	Tacoma, 3812 S. Sheridan Ave.	Wallace, J. W., Jr.
Australia	Victoria, 45 Watt St., Box Hill E. 11	Glover, G.
Bermuda	Devonshire, c/o G. H. Wingate, "Seabright"	Barden, A. T.
Canada	Edmonton, Alberta, 10138-107th St.	Betty, W. H.
	London, Ont., Box 572	Aveling, A.
	Toronto, Ont., 1244 Dufferin St.	Yoder, D. L.

Applications for Membership

England	Bridlington, East Yorkshire, 6 York Rd.	Patten, T.
	London, W. C., 15/16 Alfred Pl.	Prince, H. S.
	London, S. E. 19, "The Cottage," 197 Church Rd.	Scroggie, M. G.
France	Watford, Herts, 107 Harwoods Rd.	White, H. D.
	Paris 7, 46 Ave. de Breteuil.	Gibson, W. T.
Hawaii	Paris, Consulat Chinois, 5 Ave. Daniel Lesueur.	Wang, T. S.
India	Pearl Harbor, c/o Radio Material Office, Navy Yard.	Zimmerman, P. R.
Japan	Calcutta, 8-2 Sankaripara Rd., Bhowanipur.	Sinha, S. K.
North Ireland	Tokio, 125 Yoyogi-Sanya.	Okada, M.
Peru	Belfast, 5 Queens Arcade.	Scott, R.
Philippine Islands	Lima, c/o All America Cables.	Paice, V. K.
Portuguese East Africa	Manila, P.O. Box 2822.	Valiente, J. B.
Russia	Lourenco Marques, P.O. Box 444.	Cruz, A. A. D.
	Moscow 40, Krasnoarmeiskaya 17.	Davidov, F. I.

For Election to the Junior Grade

Louisiana	Gretna, 630 Chalmette Ave.	Fabre, F. J.
-----------	------------------------------------	--------------

For Election to the Student Grade

California	Oakland, 2918 E. 19th St.	Butler, A. G.
	Redwood City, 812 Brewster Ave.	Barnes, R. B.
	Stanford University, Box 855.	Pickles, S. B.
Connecticut	New Haven, Box 1004-a, Yale University.	Wright, A. M., Jr.
New York	Albany, 11 Alden Ave.	Marsch, P. F.
	Ithaca, 306 Highland Rd.	Bachman, W. S.
Washington	Pullman, 812 Linden Ave.	Pile, D. H.
	Tacoma, 513 S. 56th St.	Boyles, R. M.



OFFICERS AND BOARD OF DIRECTORS, 1932

(Terms expire January 1, 1933, except as otherwise noted)

President

W. G. CADY

Vice President

E. V. APPLETON

Treasurer

MELVILLE EASTHAM

Secretary

HAROLD P. WESTMAN

Editor

ALFRED N. GOLDSMITH

Directors

ARTHUR BATCHELLER

LEE DE FOREST, *Junior Past President*

J. V. L. HOGAN

WILLIAM WILSON

C. M. JANSKY, JR.

H. W. HOUCK

R. H. MARRIOTT

Serving until January 1, 1934

L. M. HULL

R. H. MANSON, *Junior Past President*

A. F. VAN DYCK

Serving until January 1, 1935

O. H. CALDWELL

E. L. NELSON

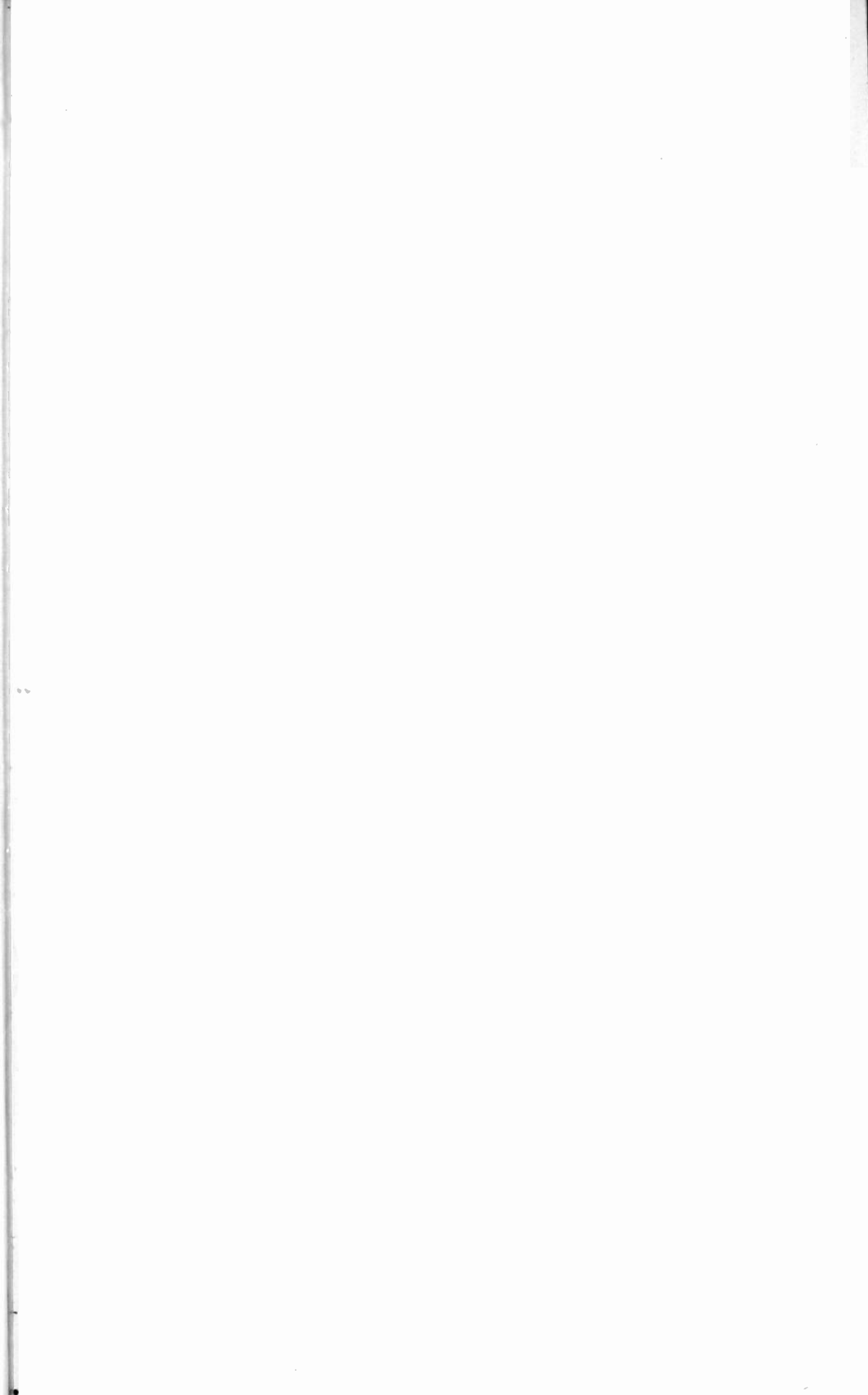



C. P. EDWARDS

Vice President of the Institute, 1931

Charles Peter Edwards was born in Chester, England in 1885. After studying electrical engineering at Arnold Radio School at Chester, he joined the Marconi Wireless Telegraph Company of London, England, in 1903 as junior technical assistant and took their training school course for wireless engineers. He was transferred to the Canadian Marconi Company in 1905 and was associated with the erection and maintenance of the Gulf of St. Lawrence, East Coast, and Labrador networks established for the Canadian and Newfoundland Governments. In 1909 he was selected by the Civil Service of Canada for the appointment of Director of Radio, Department of Marine, which position he has held since that date.

Under the jurisdiction of his division comes the construction and operation of the Canadian Government coast station networks, ship stations, direction finding stations, and radio beacons. In addition, the division is charged with the administration of the Canadian legislation in regard to radio in Canada and on Canadian ships, and is responsible for the licensing and inspection of all private, commercial, and amateur stations in Canada, the licensing of radio operators, and the administration of the East Coast visual reporting service. He has been the representative of the Dominion of Canada at all important international communication conferences since 1912. During the war the Radio Division was transferred to the newly created Department of Naval Affairs and he became a Lieutenant-Commander in the R.N.C.V.R. At the close of the war he was awarded the Order of the British Empire for services rendered and in 1919 was transferred back to the Department of Marine.

Mr. Edwards is a member of the Lighthouse Board of Canada, the Engineering Institute of Canada of which body he was Councillor for 1921-22 and Chairman of the Ottawa branch in 1920, Member of the Main Committee of the Engineering Standards Association, Chairman of the Radio Panel of the Canadian Electrical Code, Member and ex-Councillor of the Professional Institute of Civil Servants of Canada, and of the Professional Engineers of the Province of Ontario. He became a Member of the Institute of Radio Engineers in 1913, transferring to the grade of Fellow in 1915.

INSTITUTE NOTES

Meeting of the Board of Directors

A meeting of the Board of Directors of the Institute was held on March 30 and was attended by W. G. Cady, president; O. H. Caldwell, R. H. Manson, R. H. Marriott, E. L. Nelson, A. F. Van Dyck, and H. P. Westman, secretary. Lewis Windmuller was elected to the grade of Member and A. R. Hopkins and Mark L. MacAdam were transferred to the grade of Member. Seventy-eight applications for the Associate grade, six for the Junior grade, and six for the Student grade of membership were approved.

The Emergency Employment Committee report disclosed that contributions from the membership in response to a second general request totaled \$1200 which was approximately the sum expended in carrying on this work during the month of March. In order to raise additional funds to carry on this work, the committee was authorized to offer for sale certain tabulations of answers received through the broadcast reception survey which has been made to supply employment for a number of those members of the Institute in need.

It will be necessary this year for the membership to elect in addition to the president and vice president, three directors for terms of three years each, one director for a term of two years, and one director for a term of one year. In accordance with the By-Laws to the Constitution, the Nominations Committee submitted to the Board three recommended candidates for each of these offices. This report was accepted and the Board at its May 4 meeting will make its choice of these candidates, which list will be brought to the attention of the membership so that the names of additional candidates may be submitted by petition if such is desirable.

At a recent meeting, the Board of Editors requested an increase in personnel and the following new members were appointed: K. S. Van Dyke of Wesleyan University, L. P. Wheeler of the Naval Research Laboratory, and Irvin Wolff of R.C.A. Victor. Messrs. J. B. Dow of the Navy Department and E. W. Kellogg were appointed to replace Drs. Wheeler and Wolff on the Papers Committee.

An invitation from the Chicago Section of the Institute to hold the 1933 Convention in Chicago was accepted. J. B. Hoag, chairman of the Chicago Section, was appointed chairman of the Convention Committee and William Wilson, chairman of the Papers Committee, was appointed chairman of the Convention Technical Papers Committee. The precise dates for the convention have not been set but it is probable

that it will be held during the week of June 25 which has been designated "Engineering Week." The Century of Progress Exposition will be in progress at this time and it is anticipated that members of the Institute will find this choice of convention place particularly pleasing.

An invitation from the American Standards Association to the Institute to be represented on the newly formed Sectional Committee on Noise Measurement was accepted, and Irving Wolff was appointed the Institute's representative.

C. E. Brigham was appointed the Institute's representative on the Joint Coördination Committee on Radio Reception of the National Electric Lighting Association, National Electrical Manufacturers Association, and the Radio Manufacturers Association.

The dates for the 1933 Rochester Fall meeting which had previously been set for November 7, 8, and 9 were found to include election day and accordingly the dates were changed to November 14, 15, and 16.

Radio Transmissions of Standard Frequency

The Bureau of Standards transmits standard frequencies from its station WWV, Washington, D. C., every Tuesday. The transmissions are on 5000 kilocycles, and are given continuously from 2:00 to 4:00 P.M., and from 10:00 P.M. to 12:00 midnight, Eastern Standard Time. (From October, 1931, to March, 1932, inclusive, the evening schedule was two hours earlier.) This service may be used by transmitting stations in adjusting their transmitters to exact frequency, and by the public in calibrating frequency standards and transmitting and receiving apparatus. The transmissions can be heard and utilized by stations equipped for continuous-wave reception throughout the United States although not with certainty in some places. The accuracy of the frequency is at all times better than one cycle (one in five million).

From the 5000 kilocycles any frequency may be checked by the method of harmonics. Information on how to receive and utilize the signals is given in pamphlets obtainable on request addressed to the Bureau of Standards, Washington, D. C.

The transmissions consist mainly of continuous, unkeyed carrier frequency, giving a continuous whistle in the phones when received with an oscillatory receiving set. For the first five minutes there are transmitted the general call (CQ de WWV) and announcement of the frequency. The frequency and the call letters of the station (WWV) are given every ten minutes thereafter.

Supplementary experimental transmissions are made at other times.

Some of these are made with modulated waves, at various modulation frequencies. Information regarding proposed supplementary transmissions is given by radio during the regular transmissions, and also announced in the newspapers.

The Bureau desires to receive reports on the transmissions, especially because radio transmission phenomena change with the season of the year. The data desired are approximate field intensity, fading characteristics, and the suitability of the transmissions for frequency measurements. It is suggested that in reporting on intensities, the following designations be used where field intensity measurement apparatus is not used: (1) hardly perceptible, unreadable; (2) weak, readable now and then; (3) fairly good, readable with difficulty; (4) good, readable; (5) very good, perfectly readable. A statement as to whether fading is present or not is desired, and if so, its characteristics, such as time between peaks of signal intensity. Statements as to type of receiving set and type of antenna used are also desired. The Bureau would also appreciate reports on the use of the transmissions for purposes of frequency measurement or control.

All reports and letters regarding the transmissions should be addressed to the Bureau of Standards, Washington, D. C.

Preprints of Convention Papers

A limited number of copies of the papers presented at the Twentieth Anniversary Convention are available to members upon application at Headquarters. Further information concerning these preprints will be found on page XXVII in the advertising section of this issue.

Proceedings Binders

Binders for the PROCEEDINGS, which may be used as permanent covers or for temporary transfer purposes, are available from the Institute office. These binders are of handsome Spanish grain fabrikoid, in blue and gold. Wire fasteners hold each copy in place and permit removal of any issue from the binder in a few seconds. All issues lie flat when the binder is open. Each binder will accommodate a full year's supply of the PROCEEDINGS and they are available at one dollar and seventy five cents (\$1.75) each. Your name, or PROCEEDINGS volume number, will be stamped in gold for fifty cents (50c) additional.

Bound Volumes

The twelve issues of the PROCEEDINGS published during 1931 are now available in blue buckram binding to members of the Institute at nine dollars and fifty cents (\$9.50) per volume. The price to nonmembers of the Institute is twelve dollars (\$12.00) per volume.

1931 Index to the Proceedings

The 1931 Index to the PROCEEDINGS was issued as a supplement to the January, 1932, issue. The Institute will mail extra copies upon request.

Committee Work

BOARD OF EDITORS

A meeting of the Board of Editors held on March 17 at the office of the Institute was attended by Alfred N. Goldsmith, chairman; R. R. Batcher, H. H. Beverage, William Wilson, L. E. Whittemore, H. S. Rhodes, assistant editor, and H. P. Westman, secretary.

In view of the large number of manuscripts which must be reviewed and edited each year, it was the opinion of the committee that additional personnel would be desirable, and its recommendations are given under the report of the meeting of the Board of Directors.

In an effort to reduce publication expenses, the general make-up of the PROCEEDINGS was reviewed and a number of changes are to be made in the mechanical arrangement to conserve space.

A new report of reader form on which members of the Papers Committee report to the Board of Editors their opinions and comments on manuscripts was established.

A number of decisions were made concerning minor editorial matters.

NOMINATIONS COMMITTEE

A meeting of the Nominations Committee was held at the office of the Institute on March 30 and was attended by R. H. Manson, chairman; E. L. Nelson, A. F. Van Dyck, and H. P. Westman, secretary.

The committee prepared a list of suggested candidates for the offices to be voted upon by the membership later in the year. These recommendations were submitted to the Board of Directors and will be given final consideration by that body in May.

STANDARDIZATION

TECHNICAL COMMITTEE ON FUNDAMENTAL UNITS
AND MEASUREMENTS—IRE

A meeting of the Technical Committee on Fundamental Units and Measurements of the Institute's Standards Committee was held at 10 A.M. on March 15 at the office of the Institute. Those present were H. M. Turner, chairman; E. T. Dickey, C. R. Englund, R. F. Field, G. C. Southworth, H. B. Marvin, and B. Dudley, secretary.

The committee reviewed a portion of the definitions which come within its scope and appear in the present standards report.

It then considered matters concerning measurements at high frequency, distortion at audio frequencies, and the measurement of radio frequencies.

TECHNICAL COMMITTEE ON RADIO RECEIVERS—IRE

A subcommittee on Signal Generators operating under the Technical Committee on Radio Receivers of the Institute held a meeting on March 24 in the office of the Institute. The members present were E. T. Dickey, chairman; Malcolm Ferris, Lincoln Walsh, H. A. Wheeler, C. E. Worthen (representing A. E. Thiessen), and B. Dudley, secretary.

The subcommittee gave critical consideration to a report concerning the characteristics and requirements of the two signal generators essential in making a two-signal measurement of selectivity. In addition it gave some further consideration to the matter of testing automatic volume controls.

TECHNICAL COMMITTEE ON TRANSMITTERS AND ANTENNAS—IRE

Two meetings of the Technical Committee on Transmitters and Antennas of the Institute were held in March on the 16th and 31st, respectively. The first meeting was attended by William Wilson, chairman; J. Blanchard (nonmember), Raymond Guy, H. E. Hallborg, J. C. Schelleng (nonmember), and B. Dudley, secretary. Those present at the second meeting were B. Dudley, acting chairman and secretary, H. E. Hallborg, J. Blanchard (nonmember), Raymond Guy, and J. C. Schelleng (nonmember).

At these two meetings the committee considered a number of reports that various members had prepared and made various revisions and additions to them. These reports covered such items as key clicks, carrier noise, comparison antennas, radiation equations, absorption constants, spurious radiation, distortion, and measurement of harmonics.

Institute Meetings

BOSTON SECTION

A meeting of the Boston Section was held on March 23 at Harvard University, G. W. Pierce, chairman, presiding.

The paper of the evening was on "Half-Wave Vertical Antennas and Broadcast Station Coverage," and was presented by P. A. de Mars, technical director of the Shepard Broadcasting Company.

The paper was actively discussed by G. W. Kenrick, E. A. Laport, H. R. Mimno, and G. W. Pickard.

The meeting was attended by 98 members and guests, a number of whom were present at the informal dinner which preceded it.

CHICAGO SECTION

The February 11 meeting of the Chicago Section was held in the Western Society of Engineers rooms and presided over by J. Barton Hoag, chairman.

A paper on "The Circuits and Acoustical Properties of Dual Speaker Installations" was presented by Hugh Knowles, chief engineer of the Johnson Radio Manufacturing Company.

The speaker pointed out that improvements in broadcast transmitters, the use of new types of microphones, and advances in radio broadcast receivers and loud speakers should result in a marked improvement in the fidelity of reproduction in 1932.

In discussing multiple speaker installations, he pointed out that the use of more than one speaker to obtain satisfactory reproduction was not new and had been covered a number of years ago in various papers on the subject. He then outlined some of the difficulties involved in accomplishing desirable results. The distortion of the high frequencies caused by the use of pentodes and the use of output tubes giving substantial amounts of power output were cited to illustrate the problems confronting the speaker design engineer.

The paper was well illustrated with oscillograms and was so lengthy and complete that little discussion from the floor took place.

The meeting was attended by 200 members and guests.

CINCINNATI SECTION

A meeting of the Cincinnati Section was held on March 16 at the University of Cincinnati, C. E. Kilgour, chairman, presiding. Hugh Knowles, chief engineer of the Johnson Radio Manufacturing Company, presented a paper on "Steady State and Transient Phenomena of Dual Speaker Installations."

The paper opened with a general consideration of the normal single speaker and the defects it presents due to the fact that it is in reality trying to do an almost impossible job in covering the full band of audio frequencies. A general summary was given of the things which might be done to a speaker to give pleasing or passable performance at all except its resonant frequencies which was followed by a discussion of nodes and their effects, as well as the distortion they introduced. A number of slides were projected showing basic mathematical formulas predicting the various types of decaying distortion for the steady state, and oscillograms of the actual occurrence. It was shown that phasing and resonant points in two speakers closely associated and of similar physical proportions could be made to balance out many of the defects of a single unit.

Messrs. Boyle, Felix, Glessner, Osterbrock, and Rockwell of the 48 members and guests who attended participated in the discussion of the paper.

CLEVELAND SECTION

The Cleveland Section held a meeting at the Case School of Applied Science on February 19, E. L. Gove, chairman, presiding.

Two papers were presented at this meeting, the first on "Talking Motion Pictures While You Wait" was by E. S. Carpenter of the Escar Motion Picture Service and the second on "16-Millimeter Movies for Educational Work" was presented by W. S. Blackburn of Electrical Research Products.

Mr. Carpenter outlined methods used in taking, developing, and reproducing pictures, and demonstrated the speed with which these processes can be accomplished. Several members present were induced to act as subjects for the taking of some talking pictures and somewhat later in the evening the completed film was projected employing a new type of RCA projector. A standard thirty-five millimeter film was employed in this case.

J. H. McCall of the Engineering Service Division of the RCA pointed out that the maximum frequency limit for film reproduction was about 9000 cycles and the minimum about 60 cycles. Commercially the former factor had been around 6000 cycles. The increase in range was accomplished by increasing the rate of projection of the film from 60 to 90 feet per minute to provide more effective room for sound recordings.

The second paper of the evening was a description of the 16-millimeter Western Electric unit of very compact size which was described and demonstrated by Mr. Blackburn. Because of the narrowness of the

film it was found impracticable to place both sight and sound on it and the sound accompaniment was recorded on a synchronized disk.

Both speakers pointed out that when making talking motion pictures, the sight is recorded on one film and the sound on another. This isolation is of importance as it permits each film to be developed to proper density without regard to the exposure of the other. In printing, the sound strip is superposed upon the sight film. The sound film is made of very fine texture so as to permit the recording of the higher frequencies. In the case of the 16-millimeter film additional space for sound track has been provided in some instances by eliminating the sprocket holes along one edge of the film. During the discussion, Charles H. Shipman of the Dodd Company gave some interesting sidelights on the three practical methods by which clear motion picture films are produced.

Through the use of lantern slides and blackboard sketches Professor Martin of Case School discussed the advantages and limitations of the variable-mu tube which was designed to overcome certain types of distortion inherent in the screen-grid tubes of previous types.

The meeting was attended by 94 members and guests.

DETROIT SECTION

The March meeting of the Detroit Section was held at the University of Michigan on the fifteenth and was a joint meeting with the American Institute of Electrical Engineers. J. J. Shoemaker, chairman of the Detroit-Ann Arbor Section of the A.I.E.E., presided.

The paper of the evening on "Vacuum Tubes and Their Application" was presented by E. H. Vedder of the Westinghouse Electric and Manufacturing Company.

The speaker confined his talk to a discussion of tubes as they are used commercially and pointed out some of the reasons why tubes are useful in the industrial field. In many cases they perform new functions such as high speed circuit interruption as employed in spot welding control while in other cases they provide better and cheaper methods of performing older functions such as in the control of theater lights.

He then outlined briefly the theory of operation of light sensitive tubes, high vacuum tubes, and gaseous discharge tubes, presenting an interesting series of slides showing these tubes and associated apparatus as employed in typical industrial applications. A demonstration of the stroboglow and the lighting control relay followed. In conclusion the speaker invited the audience to inspect and operate the various pieces of equipment on display.

An informal discussion followed the presentation of the paper and the attendance was approximately 450.

PHILADELPHIA SECTION

The February meeting of the Philadelphia Section was held on the 18th at the Engineers Club, G. W. Carpenter chairman, presiding. H. W. Jones of the RCA Photophone Company presented a paper on "Tricks in Sound Photography."

The author traced the early development of talking pictures from the time when the motion pictures were coördinated with phonographs to the present types of recordings. He then discussed the development of moving picture cartoons, describing methods used in dubbing-in of sound effects, and the development of equipment for sound picture work.

A general discussion followed the presentation of the paper and a number of the 101 members and guests in attendance participated therein.

ROCHESTER SECTION

A meeting of the Rochester Section was held on March 11 at the Sagamore Hotel, Virgil M. Graham presiding.

The paper of the evening on "Recent Receiving Tube Developments" was prepared by E. W. Ritter and Max Stinchfield of the RCA Radiotron Company.

The meeting was attended by 62 members and guests, a number of whom were from out of town.

TORONTO SECTION

The March 9 meeting of the Toronto Section was held at the University of Toronto, Chairman F. K. Dalton presiding.

The paper on "Characteristics, Purpose, and Limitations of the Two New Types of Tubes Developed by RCA Radiotron Corporation" was presented by E. W. Ritter of that organization and elaborated upon by Max Stinchfield also of RCA Radiotron Corporation.

The author of the paper outlined the characteristics, purpose, and limitations of two new types of tubes developed for radio broadcast receivers employing class B audio amplification. Characteristic curves of these new tubes were shown, and Mr. Stinchfield presented a mathematical explanation of the development and operation of them.

The discussion which followed the presentation of this material was participated in by Messrs. Andrea, Bircell, Hackbusch, Northover, Parker, and Price of the 101 members and guests in attendance.

WASHINGTON SECTION

A meeting of the Washington Section was held on March 10 at the Continental Hotel, J. H. Dellinger, chairman, presiding.

The paper of the evening was presented by W. F. Diehl of the RCA Victor Company and was entitled "A Completely A-C operated Precision Beat Frequency Oscillator."

This paper described a laboratory type beat frequency oscillator which will deliver 5 watts of power to loads of 2 to 8000 ohms over a continuously variable frequency range of 30 to 10,000 cycles per second. The instrument operates from a 60-cycle alternating voltage source and requires 375 watts. The output is practically constant over the frequency range, is extremely low in harmonic content, contains no radio-frequency voltage, and is independent of line voltage variations over a wide range. The instrument is capable of maintaining a high degree of stability and calibration over a long period of time. The frequency control is provided with a truly logarithmic scale which is direct reading and designed for a curve drawing attachment. The circuit diagram and constructional features were discussed, and curves indicating actual performance were shown.

By courtesy of the Chesapeake and Potomac Telephone Company, Washington, D. C., two short motion picture films were shown. These films covered views of installations and operating equipment necessary for long-distance telephony.

A general discussion followed the presentation of the paper and 44 members and guests were in attendance at this meeting.

Personal Mention

H. H. Bouson has retired from the Navy as Lieutenant Commander and has established a consulting practice in Seattle, Washington.

Graham Madgwick, formerly with the Peruvian Administration of Posts and Telegraphs, is now with Imperial and International Communications, Ltd. His services have been loaned to the Hong Kong Government as engineer-in-charge of the Hong Kong Wireless Service.

Previously with Wired Radio, J. L. Cassell has become associated with the Insuline Corporation of America in New York City.

Formerly with General Motors Corporation, W. S. Harman has joined the radio engineering staff of United Air Cleaner Corporation of Chicago.

C. F. Maylott has joined the Department of Physics and Electrical Engineering of Clarkson College of Technology leaving the Bell Telephone Laboratories.

Previously with the N'Changa Copper Mines, T. M. Yule has become radio engineer for the Rhodesian Katanga Company, Ltd., of Kansanshi, N. Rhodesia.

TECHNICAL PAPERS

APPLICATION OF QUARTZ PLATES TO RADIO
TRANSMITTERS*

By

O. M. HOVGAARD

(Bell Telephone Laboratories, Inc., New York City)

Summary—This paper discusses the disturbing elements encountered in the application of quartz plates to broadcast and aircraft radio transmitters. A general procedure for minimizing such effects is considered from a circuit standpoint as well as in the light of practical experience. The degree to which maintenance may affect performance and the necessity for automatic equipment are shown by data obtained in the field. Apparatus and systems which enable the operating staff to meet modern frequency stability requirements by monitoring the emitted carrier are also described.

AS A result of the rapid expansion in the applications of radio, it has been necessary to improve the frequency stability of the emitted carriers in order to assure satisfactory operation of the increasing number of transmitters. One of the most effective means for accomplishing this is the quartz controlled vacuum tube oscillator in which the quartz plate is relied upon to obtain adequate frequency adherence. For this reason, it is necessary that all possible precautions be taken to prevent external factors from affecting its period of vibration.

This paper is primarily concerned with the methods of securing stable operating conditions for the quartz plate, which will be considered as a circuit element whose characteristics can be predetermined. This implies that it has been manufactured from suitable material, free from mechanical and optical defects, such as veils and twinning, and assumes that it has been cut with due regard for its orientation with respect to the crystallographic axes of the natural crystal, and that its dimensions are so chosen that no undesirable couplings exist between the various modes of vibration.

In its practical applications, the important factors which are likely to affect the performance of a quartz plate are:

1. Personnel element in maintenance.
2. Variations in (a) Ambient temperature; (b) The physical rela-

* Decimal classification: R355.65. Original manuscript received by the Institute, March 1, 1932. Presented before New York meeting, December 2, 1931.

tionship of the quartz plate to its electrodes; (c) The pressure upon the quartz plate; (d) The oscillator tube supply voltages.

3. Replacements of the oscillator tube.

Other causes for variations exist but they need not be considered except in connection with standards of reference.

All of these sources of irregularity exist to some extent in commercial equipment, but if the stability requirements are not too rigorous, and a reasonable amount of maintenance diligence is shown on the part of the operating personnel, it has usually been possible to assure adequate performance. From an operating standpoint, maintenance must always be a drawback, and the necessity for it should, therefore, be made as small as possible. This will reduce operating expense and also lessen the chances of trouble should the maintenance be neglected. Automatic equipment naturally suggests itself since it is continuous in

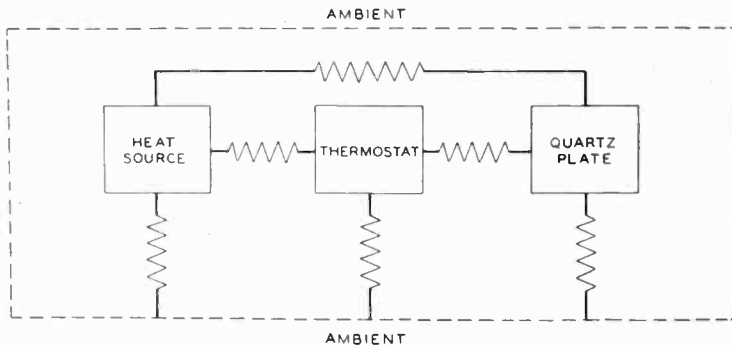

Fig. 1—Schematic thermal circuit.

its vigilance, and its performance capability is largely a matter of initial cost. Its applicability to installations permitting only infrequent inspection and maintenance, such as in aircraft, also makes it attractive.

Experience and experimental investigations have shown that the major disturbing factor in the frequency stability of a quartz plate is temperature variation and it is, therefore, necessary that a temperature control system be provided. This consists essentially of a heat generating element and a temperature responsive device enclosed together with the quartz plate in a thermally insulated chamber. The behavior of such a system is best realized by referring to the thermal schematic circuit shown in Fig. 1, wherein is indicated the heat source, the thermostat and the quartz plate, all surrounded by the ambient, and interconnected by various thermal impedances. In practice there are two sources of heat, the heater and the quartz plate proper. The heat generated by the quartz plate is due to viscous dissipation as it oscil-

lates and may amount to as much as 15 per cent of the heat required for temperature maintenance. The ambient is the sink into which must ultimately flow all the heat furnished, and it is the function of the thermostat to balance the supply of heat from these two sources so that the temperature of the quartz plate is sufficiently constant to meet operating requirements. The design problem is further complicated by the fact that a thermostat, of necessity, must have an operating differential of temperature which must be small enough to allow the thermostat to compensate properly for the heat generated by the quartz plate. In its operation, the thermostat may function so as to vary the amount of heat generated, by temporarily reducing or discontinuing the supply of power to the heater. This obviously will result in a steady-state flow of heat having superposed fluctuations whose magnitude depends on the sensitivity of the thermostat and the thermal impedance between it and the heat source. In general, this impedance should be as low as possible in order to minimize "overshooting" and the thermostat should be as sensitive as possible consistent with reliability.

Thermostats are usually either bimetallic strips or of mercury-in-glass construction. The former has been widely used on account of the facility with which its operating point may be adjusted, a characteristic not generally found in mercury-in-glass thermostats. However, a price is paid for the adjustment feature since intimate thermal contact cannot be obtained between the thermostat and the heat source and, as a consequence, the thermal impedance between them is quite high. A mercury-in-glass thermostat on the other hand permits intimate thermal contact to be made with the surrounding medium through the use of such substances as mercury, fusible metals, or powdered graphite as the particular design may dictate.

The thermal impedance between the thermostat and the quartz plate should have the characteristics of a low-pass filter in order to reduce the effects of the temperature fluctuations occasioned by the operation of the thermostat. Owing to the long period of these fluctuations, the filter becomes practically a "brute force" type and in practice takes the form of a series of thermal discontinuities. Impedance to the steady-state flow of heat must however be low. All the other impedances, with the exception of that between the heater and the ambient, must be as high as economically possible, the magnitude of the impedance between the heater and the ambient being dictated by the power loss which is acceptable and other design considerations, such as the ability of the device to radiate sufficiently at high ambient temperatures. The above requirements may be met by suitable choice

of materials¹ and proper relative disposition of the various elements.

In striving for a high order of precision, it is essential that the quartz plate remain fixed in its position with respect to its electrodes. This requirement is based on a number of considerations. Motion of the quartz plate with respect to the electrodes is likely to cause a change in the capacity across it, the pressure upon it or the length of the air space between it and the electrodes. These variables are all serious when high precision is desired or when the carrier frequency is obtained by harmonic generation. They appear to be most readily eliminated by clamping the quartz plate rigidly between electrodes

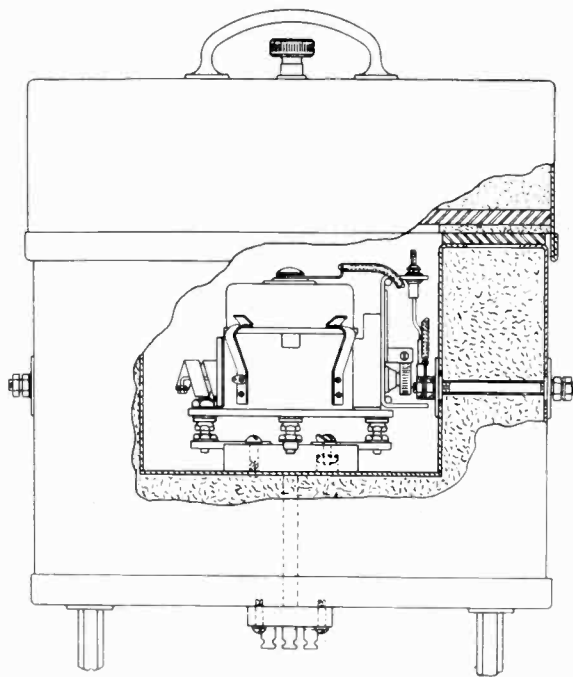

Fig. 2—Conventional temperature control chamber.

which only touch it at a few points. This method prevents the plate from moving and at the same time introduces air gaps on both sides of the plate which are not affected by such minor changes as the possible slight warping of the electrodes. It is essential that the pressure on the plate be fairly constant, since any damping of the motion of the plate affects the frequency. This necessitates the use of a spring of some kind, since an entirely rigid assembly would produce wide variations in pressure with changes in temperature. The effects and the control of other variables will be discussed later.

Whenever considerations of space and weight are not paramount,

¹ W. A. Marrison, "Thermostat design for frequency standards," Proc. I.R.E., vol. 16, pp. 976-980; July, (1928).

the requirements outlined above can be approximately realized. The benefits gained by their application may possibly best be brought out by a comparison of the characteristics of recent frequency control equipment with those of its predecessor in Western Electric transmitters.

This older equipment is shown in Fig. 2 and consists of a thermally insulated, temperature controlled compartment containing the quartz plate which rests on an anvil into which projects a bimetallic thermostat and a thermometer. This equipment is an integral part of the transmitter, the quartz plate being manufactured separately and calibrated in a similar device. The operator is informed of the correct operating

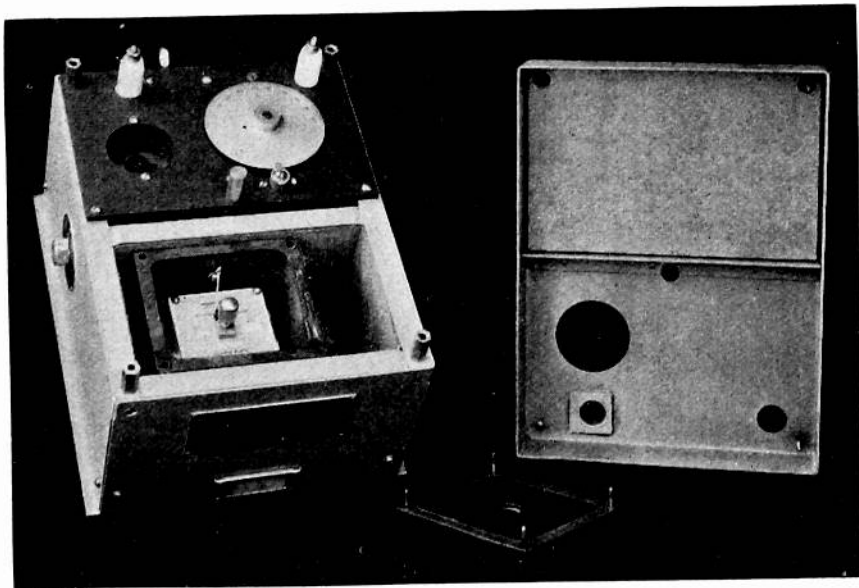

Fig. 3—Recent broadcast oscillator—interior.

temperature, which is then maintained by adjusting the operating point of the thermostat to compensate for variations in the ambient temperature. While this type of equipment has proved satisfactory in meeting a ± 500 -cycle requirement, it is, however, limited in its performance and would require unusually diligent and skillful personnel to meet satisfactorily the present-day requirements. The reasons for this are quite obvious if we consider the possible sources of variation. Since the quartz plate is manufactured separately, differences in operating and assigned frequency are caused by manufacturing variations in the assembly since these change both the electrical and thermal characteristics. Furthermore, the only variable over which the operator has control is the temperature as read on the thermometer, which may be erroneous due to parallax in the reading, improper seating of the holder on the anvil, or even changed calibration of the thermometer

itself. When it is realized that the thermometer in effect is the station's standard of frequency and that it is capable of giving only very limited information regarding the thing controlled, it becomes obvious that to meet modern requirements a totally different technique must be established.

With this in mind, Bell Telephone Laboratories has developed a new frequency control system for use with radio broadcast transmitters. An interior view of the oscillator for this system is shown in Fig. 3. The assembly is divided into two sections. One section, which is thermally insulated, contains the mounted quartz plate and the temperature control equipment; the other section contains the circuits associated with the oscillator tube. The quartz plate is mounted in a heavy copper casting which simulates a thermally equipotential shell. The heat source is embedded in the bottom wall which projects internally so as to form an anvil of sufficient thickness to receive the bulb of the thermostat, the stem of which is enclosed in the housing just visible on the right side of the casting. The thermal filter is located between the anvil and the mounted quartz plate.

The thermostat used is of the mercury-in-glass type and intimate contact between it and the copper casting is obtained by packing the space between them with powdered graphite. Its operating differential, in cycles of a minute or more, is less than 0.05 degree Centigrade and the resulting temperature fluctuations at the quartz plate are of the order of one thousandth of a degree. It is to be observed that with this construction, the requirements for a temperature control system are closely adhered to since the thermal paths from the quartz plate to the ambient and directly to the heat source involve air gaps which if properly proportioned offer a very high impedance. Since it is not possible to adjust this type of thermostat, it is necessary that the temperature control system should be able to compensate properly for any range of ambient temperature that would be encountered in practice. A measure of how well this is accomplished is the ratio of a change in the ambient temperature to the corresponding change in the operating temperature of the quartz plate. Depending somewhat on the amount of circulation associated with the ambient, this ratio is in excess of 150.

The dial shown is the control for the plate inductance to permit the proper value to be obtained for any frequency in the broadcast band. The upper right terminal is the output terminal of the oscillator, output being obtained from the radio-frequency drop in potential across a small resistor connected in series with the plate circuit of the oscillator tube. As this resistor is designed to have a minimum of reactance,

the effect of load variations on the frequency is negligible. The upper left terminal gives direct access to the grid of the oscillator tube to which is also connected a small variable air condenser which is in parallel with the quartz plate. These facilities permit adjustments of the oscillator frequency should occasion demand it, as would be the case should control equipment be added for common frequency or synchronized operation. This is an elegant method of changing the frequency, since the response to capacity change is instantaneous, and adjustment therefore is a rapid and simple matter contrasting quite

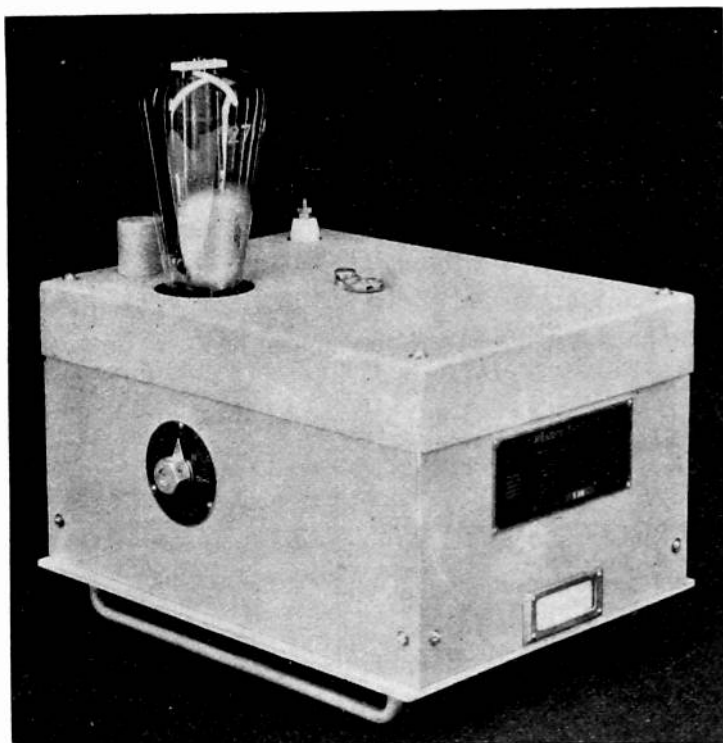

Fig. 4—Recent broadcast oscillator—side view.

sharply with the cumbersome procedure involved should the same result be attempted through a variation of the thermostat operating point. In this connection, it should be noted that the more perfect the temperature control system, the slower it will respond to variations in the thermostat operating point and the more difficult it becomes to make adequate frequency corrections in this manner.

The assembled oscillator is shown in Fig. 4. It will be seen that for ordinary purposes the grid terminal is shielded by a grounded metal cap to prevent possible changes in frequency due to the proximity of other equipment not present when the oscillator was calibrated. The frequency dial shown indicates the setting of the condenser shunting

the quartz plate. The tube used is a heater type tube of approximately 5 watts rating. All power supply connections are made to finger contacts on the bottom of the unit and these are protected against mechanical injury by the skates shown in the photograph.

The unit type of construction permits the calibration of the quartz plate in association with the elements with which it is to be used. This is obviously an advantage since the unit may be sealed and installation is reduced to the insertion of the oscillator tube before the oscillator is placed in the transmitter.

From a laboratory standpoint, a reasonable picture of the improvement effected in a new design as compared with its predecessor may be obtained from a study of the possible effects of the variables which can affect the operation of the equipment in the field. A measure of these effects, the "deviation capability," can be obtained by considering that all of the variables occur simultaneously and cumulatively. The deviation capability under stipulated operating conditions thus represents the maximum deviation that might reasonably be expected in the absence of any apparatus failure. For the two oscillators discussed, the deviation capabilities and their components are listed in the following table.

TABLE I

Variables	Variations in Cycles per Million	
	Older Equipment	New Equipment
Change of Ambient—70° F to 130° F.....	300	14.1
10% Change of Oscillator Plate Pot.....	3.5	2.6
10% Change of Oscillator Fil. Pot.....	0.1	0.1
Thermostat Cycle.....	0.1	0.1
Oscillator Tube Change.....	15	7.5
Division Capability.....	318.7	24.4

In tabulating the information for the older equipment it is to be noted that the full effect of the maximum range of ambient temperatures has been used. At a first glance this might be considered incorrect, but any smaller variation immediately implies a specified minimum of maintenance. Experience has not enabled us to obtain a trustworthy measure of maintenance and as a consequence maximum deviations must be used. The deviation capabilities listed indicate that the new equipment should be about twelve times as stable as the older equipment but this is as far as it is permissible to predict, since only by actual field experience can sufficiently accurate information be obtained to indicate the performance to be expected.

For this purpose, a field study of frequency deviations has been made by Bell Telephone Laboratories, the results of which are given

graphically in Fig. 5, which shows the percentage of measurements within various deviation limits. The absolute, rather than the percentage, deviations have been used as the basis of these curves, since this is in conformity with the measure used in regulation and therefore of greatest practical interest. Curve *A* is the result of 700 measurements made of 47 stations over a period of two years. This curve ultimately reaches 97 per cent for a 500-cycle deviation.

In order to give some idea of the range of performance, the measurements of a station showing materially better than average results, were selected from the data on hand. This is replotted in curve *B*. Interest naturally is aroused as to the reason for the superior perform-

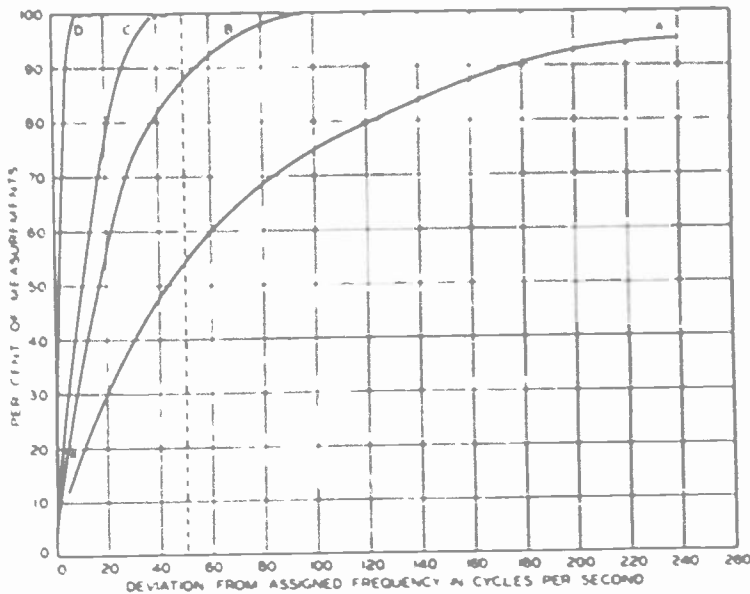

Fig. 5—Frequency deviations of broadcast stations.

ance. To some extent, since absolute deviation is the unit of measure, the stations operating at low frequencies have an easier task since the effects of temperature changes on their quartz plates will in general be less. The data for curve *B* are at a frequency not far from the middle of the broadcast band and, therefore, the superior performance cannot be accounted for on this basis. It was believed that maintenance efficiency must be the factor responsible but no ready means are available to measure this quantity.

During the latter part of 1930, however, the governmental scrutiny of frequency deviations and the increasing certainty of more rigorous stability requirements resulted in a greater effort on the part of the operating personnel to obtain maximum performance from existing equipment. The gradual improvement is amply indicated by the data

published in the Radio Service Bulletins but this gives no clue as to the methods through which the improvement was attained. Further records were therefore made of the high performance station of curve *B* to see if further improvements took place. The results for the first six months of 1931 are depicted in curve *C*, the improvement being self-evident.

Since the equipment in use at all the stations measured was identical, the only variable capable of producing the results shown must have been operating staff diligence, and the data forcibly suggest the necessity for automatic equipment.

The new oscillator has as nearly automatic temperature control equipment as can be economically justified. Field performance data which are shown in curve *D* indicates the type of performance that results when the effects of all of the variables have been made extremely small.

In order to meet adequately a given stability requirement and at the same time have some factor of safety, it is necessary to strive for maintenance within a much smaller deviation. Assurance of reaching such an objective immediately makes it desirable that means be provided which will indicate the instantaneous cumulative effects of all variables, and naturally leads to the monitoring of the frequency itself. Fundamentally, there are two methods of accomplishing this. Reference may be had to a standard of frequency a great deal more stable than the maximum acceptable maintenance deviation, or a system of similar oscillators may be set up which can be compared on a statistical basis. The first method appears difficult to justify economically but the second is entirely feasible.

Standard broadcast transmitters are equipped with either one or two quartz plates, in the latter case one being a spare. To establish a statistical system, a reference oscillator is necessary and means must be provided for comparing it with other oscillators of approximately the same frequency. Several alternative methods exist for making such comparisons, but with the subaudible deviations usually involved, visual means for directly indicating the frequency difference in cycles seem most suitable.

For transmitters having two oscillators a statistical system can be established by graphically recording at suitable intervals the difference in frequency between the oscillators in the transmitter and the reference oscillator. These two readings will, of course, also by simple subtraction give the difference in frequency between the two transmitter oscillators. The plotted data will result in three curves which in general will show the same tendencies to drift up and down with ambient

variations and other influencing factors. Small erratic differences will also exist which are not the same for all three comparisons but they are of no particular concern, usually being of the order of one or two cycles. Should one or more of the curves start to show a constantly increasing or decreasing difference, it is a certain sign that one of the oscillators in the system is not functioning properly. As a single example, suppose it was found that the difference between the two oscillators in the transmitter remained essentially constant but the difference between them and the reference oscillator was changing. Laboratory investigations indicate that it is most unlikely that two oscillators should depart from their proper operating frequency and assume approximately the same deviations even if the disturbing causes were identical. The natural inference, therefore, would be that the reference oscillator should be checked.

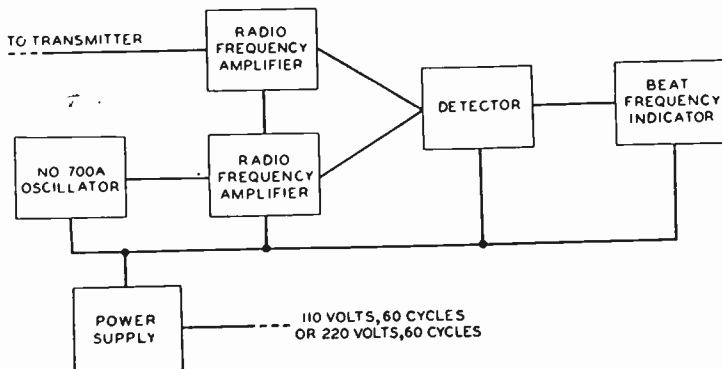

Fig. 6—Frequency monitoring unit schematic.

In the case of installations when there is only one oscillator in the transmitter, the statistical methods are more limited in the amount of information which they can convey. A graph can be made of the difference indicated by the monitoring device and as long as this difference remains sensibly constant the system is probably functioning satisfactorily. If however the difference varies between wide limits or continually increases, the system is not functioning satisfactorily, but the record cannot indicate which oscillator is at fault. Recourse must then be had to a check of the frequency of the emitted carrier in terms of some reliable standard, thus reestablishing the system of reference.

The statistical methods outlined have the advantage that long before deviations become a serious matter they are called to the attention of the operating personnel who can then take the proper steps to correct the system. If at the time the station's carrier frequency is measured, the oscillator in use is also measured with the monitoring device, it is possible to reset the monitor, by means of the variable condenser

described above, to indicate the measured deviation. This having been done, the station's reference oscillator must be in agreement with the standard used in the measurement of the carrier. At the earliest convenient opportunity, the oscillator or oscillators in the transmitter are made to agree with the reference and a new graphical record can be initiated.

A block diagram of a frequency monitoring device suitable for the system outlined is shown in Fig. 6. It will be seen to consist of an oscillator, two radio-frequency amplifiers, a detector and indicator and its power supply. The oscillator is the same as is furnished for transmit-

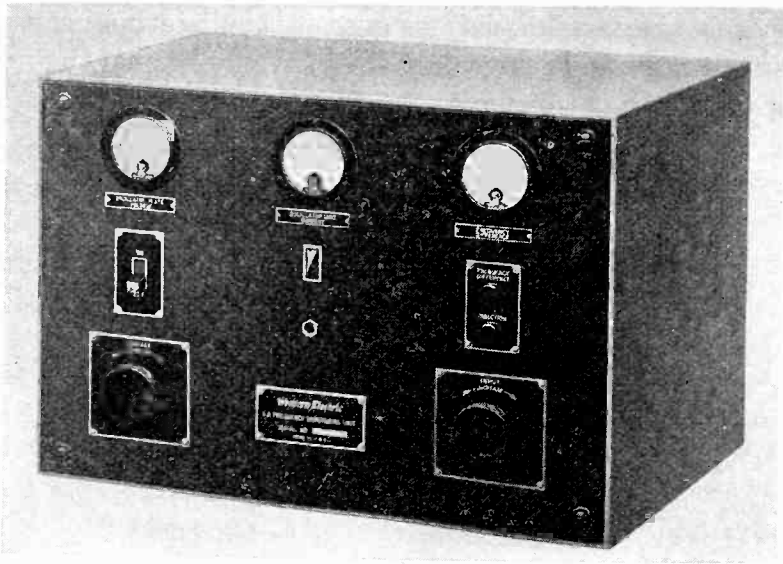

Fig. 7—1-A frequency monitoring unit.

ters. The amplifiers are for the purpose of decreasing the mutual impedance between the oscillators being compared, as well as to assure sufficient signal intensity on the grid of the detector. Among other frequencies, the output of the detector will contain the difference of the frequencies being compared and this is isolated and applied to a polarized relay. The tongue of this relay is connected to a condenser which, as the relay is operated, is alternately charged from a source of constant potential and discharged through a suitable current indicating device. It is obvious that the average current through the indicating device is directly proportional to frequency and hence a direct-current meter will read frequency directly. A control is provided to give the device a sense of sign. It consists of a small condenser inserted across the quartz plate of the reference oscillator thereby enabling the operator to decrease the frequency slightly. Obviously if there is an in-

crease in the difference frequency indicated when this capacity is inserted, the oscillator under comparison must have a higher frequency and vice versa.

The commercial form of this device, which is shown in Fig. 7, possesses a number of interesting features. The oscillator is similar to those furnished for Western Electric transmitters, thereby lending flexibility to the system since they can be interchanged in case of failure thus giving assurance of continuity of operation. The meter to the left indicates the plate supply potential to the oscillator tube. This potential may be regulated by the rheostat below, and the circuit is so arranged that when this potential is adjusted to a specified value, indicated by a marker on the meter dial, all other potentials in the instrument also assume their correct values. This is important since the accuracy of indication of the frequency meter is directly proportional to the accuracy to which the condenser charging potential is maintained. If for instance the voltage is maintained to 2 per cent of the specified value, this will be the error of indication of the frequency meter and for the usual small deflections will amount to less than half a cycle. This is well within the 2 per cent of full-scale accuracy to which the frequency indicating meter is manufactured.

Input to the monitoring device is controlled by the potentiometer at the right so that any voltage from 0.5 to 100 volts may be used. Since modulation does not affect the indication of the meter, there are practically no limitations placed on the source from which the operating potential may be obtained. Since the unit contains its own power supply and need only be connected to 110-volt, 60-cycle circuit, it may be operated from any radio receiver capable of delivering 3.0 volts to the monitor. This makes it possible to monitor the frequency at remote points. For use near the transmitter, the input impedance is 40 ohms and connections may be made through a transmission line which can be placed in conduits with other conductors at the time of installation. Since the line may have any reasonable length up to several hundred feet, the unit can be installed anywhere on the transmitting premises.

A frequency control and monitoring system, such as described above, would appear to embody all the features necessary to establish a frequency maintenance technique that should adequately meet any requirements that may be expected in the immediate future. While it was developed primarily for broadcast installations, its application is obviously not limited to this field. As a matter of fact, these oscillators are now standard equipment for fundamental frequencies up to 4000 kc.

In a number of applications of quartz plates, the limitations placed

on the size and weight of the frequency control equipment seriously increase the difficulties which face the designer. A particularly interesting application occurs in transmitters for use in aircraft. For this purpose there have been developed the two units shown in Fig. 8. These are complete temperature controlled ovens containing the quartz plate and the only auxiliary equipment needed is a small relay to control the flow of energy to the heater. In spite of their compact size,

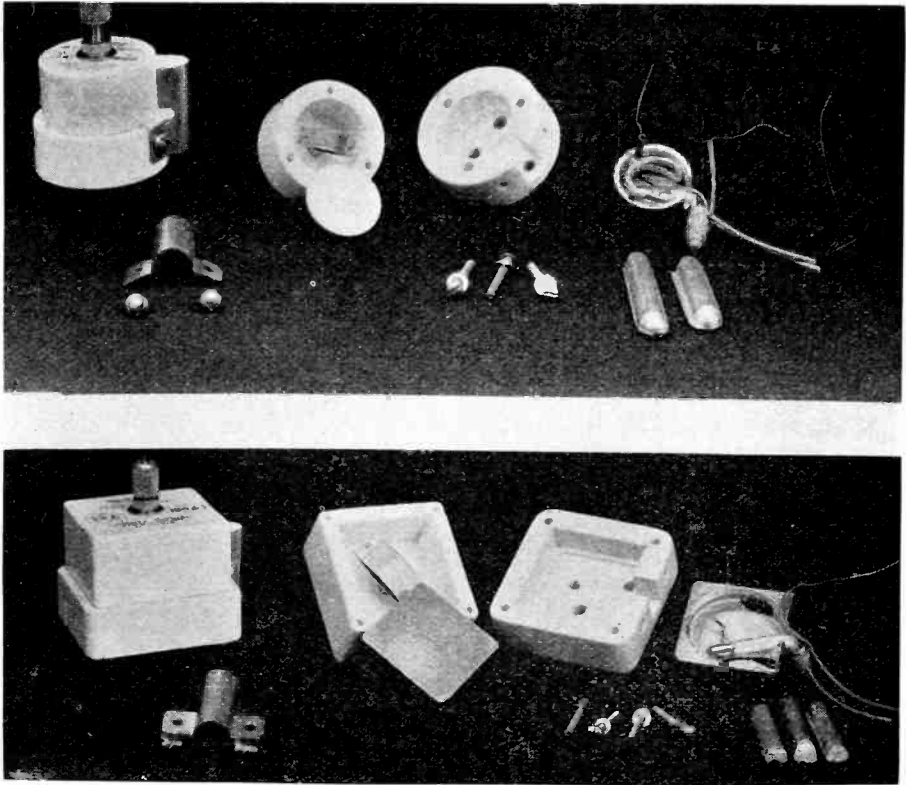

Fig. 8—Aircraft-type frequency controls.

they embody many of the principles applied to larger units. One electrode is hollow and in it are placed the heater and the thermostat. To insure good thermal contact, the cavity is then filled with low melting point alloy. The surfaces of the electrodes adjacent to the quartz plate are so designed that they only touch the quartz plate over a limited area and the construction of the housing is such as to prevent any displacement of the quartz after the unit has been assembled and the spring pressure applied. In the case of the circular oven, the rim of the electrode is raised, while in the square oven the four corners form the proper lands.

In this type of equipment, the quartz plate has to be adjusted to

give the correct operating frequency when used with a specific thermostat assembly. With proper technique it is, however, feasible to obtain an accuracy of adjustment better than 0.01 per cent. The requirements for aircraft equipment being 0.025 per cent, there is ample allowance for such variables as transmitter and oscillator tube differ-

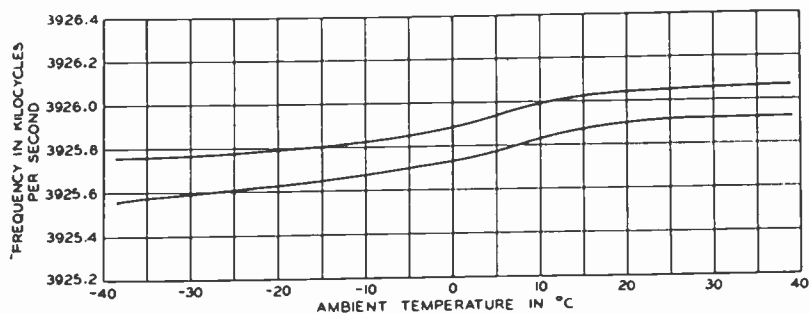

Fig. 9—Temperature characteristic of aircraft frequency controls.

ences and changes in ambient temperature. The temperature requirements are rather wide, being from -40°C to $+40^{\circ}\text{C}$, but they are adequately met as indicated in Fig. 9. The weight of the circular unit is only $5\frac{1}{2}$ ounces, while the square unit weighs just under 1 pound.

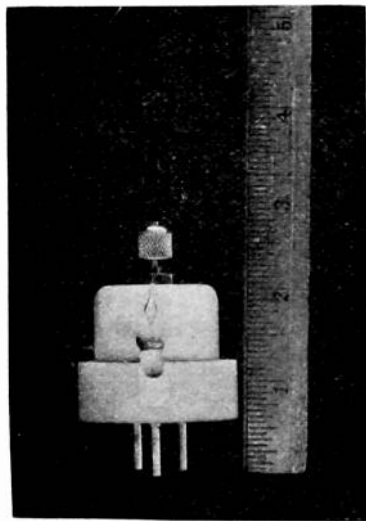

Fig. 10—Aircraft temperature controlled oven for high frequencies.

The size may be judged from Fig. 10. To limit the amount of equipment in aircraft apparatus, it is necessary that each component part be worked at its highest efficiency. In the case of the oscillator, this implies a high potential on the grid of the tube and maximum activity on the part of the quartz plate. To obtain adequate activity at low

frequencies and at the same time enjoy the advantages of rigid clamping, it is necessary to use a quartz plate of sufficiently large area. An economical balance must, of course, be attained between the use of a number of different sizes of plates to cover a given frequency band and the real advantages gained. It was found practicable to cover the range from 750 kc to 8000 kc with but two sizes of plates, the square unit serving for all frequencies below 2000 kc. Experience obtained with these units during the past two years has yielded much valuable information with respect to operating requirements. This information, coupled with the necessity for even greater stability on account of the increased number of stations in operation, has made possible further developments in this equipment. Models of a new design are now undergoing tests and promise performance characteristics comparable to that found in the latest equipment for broadcast transmitters.

CONCLUSION

In closing the author would like to point out that while present-day technique has largely been developed as the result of broadcast requirements, the tremendous growth of the commercial utilization of the higher frequencies forecasts requirements for these applications which will be equally rigorous. Further developments along the lines indicated above will be necessary and the engineer will be faced with many intriguing problems.



A NEW WATER-COOLED POWER VACUUM TUBE*

BY

I. E. MOUROMTSEFF

(Westinghouse Electric and Manufacturing Company, East Pittsburgh, Pa.)

Summary—Part I. The evolution of transmitting tubes is outlined. The ever present desirability of using a single tube for a given power output instead of paralleling several smaller tubes leads finally to the design and construction of tubes with 100-kw output, or larger. The design of a tube for 100- to 200-kw output is described. A basically new feature of the tube is a water-cooled grid, consisting of a column of flat molybdenum disks. With such a structure, grid emission and dynatron effect are eliminated completely. The specific features in the manufacture of larger tubes are discussed.

Part II. Curves are given showing the operation of the tubes as Class A, B, and C amplifiers.

PART I

INTRODUCTION

RESTRICTED power dissipation of the plate is the main limiting factor for power output with so-called "air-cooled" or "glass vacuum tubes" having all parts mounted within a glass envelope. With an efficiency of 66 per cent, which is a common and reasonable figure for regular transmitters, the maximum output from a tube is twice the maximum plate dissipation. The latter, if referred to a unit area of the anode, cannot be allowed to become more than 3 or 4 watts per square centimeter lest the anode temperature rise too much, and the adjacent glass parts become too hot. Also, with an increased anode temperature, the radiation from the inner parts of the tube diminishes, which is bad for both the filament and the grid, as overheating of these can be detrimental to the tube operation and the tube itself. From this point of view the maximum output from a tube is limited by the area of its plate. However, an arbitrary increase of the anode dimensions is prevented by mechanical requirements of a simple and rugged structure which is usually supported at one end, and which must not be out of proportion to the size of the filament, the latter being prescribed by the required electronic emission, a specified operating voltage, usually 11 or 22 volts, and the necessary mechanical strength. For a given filament diameter there is a maximum length which can be allowed without fearing that it will sag.

* Decimal classification: R335. Original manuscript received by the Institute, October 27, 1931. Presented before Twentieth Anniversary Convention, Pittsburgh, Pa., April 9, 1932.

All these conditions bring about the fact that a good glass tube can successfully be designed for an output up to 1- or 2-kw, but for larger outputs tubes become bulky, expensive, and inefficient. This is the reason why, from a very early period in the existence of transmitting tubes, attempts were made to build tubes with artificial cooling of the anodes by means of flowing water or oil. The main obstacle was the difficulty of making reliable vacuum-tight joints between the metallic anode and the glass bulb. Some constructors tried to use ground joints¹ and to leave a tube continuously connected to an exhaust system. Though such tubes are actually in use in France, the practicability of attaching an exhaust system to every transmitter, disregarding its power, is questionable. Tube engineers in this country tried to solve the problem by means of developing a permanent metal-to-glass seal which would be vacuum-tight *per se*. In 1922, due to the discovery of Houskeeper,² such joints became a real fact. He succeeded in fusing glass to copper after machining the end of a copper anode to a very thin edge—a few thousandths of an inch—so that, notwithstanding the large difference in thermal expansion, the mechanical stresses in the glass do not reach a dangerous limit at any temperature. Since that time, the leading companies manufacturing transmitting tubes have developed this seal to such a degree that it is practically as reliable as a glass-to-glass joint, and, as a result, the present 10- or 20-kw water-cooled tubes are not materially more expensive than 1- or 2-kw glass tubes and are a necessary part of all transmitting stations with more than 2-kw power.

The cylindrical anode of a water-cooled tube forms a part of a vacuum-tight envelope. It is fused to the glass blank which encloses the tube at the other end and serves as insulation between the anode and the inner structure—the grid and the filament—the latter being supported by a flare fused to the outer end of the glass blank. Usually water, but sometimes oil, is used as cooling fluid. In the case of water, a dissipation as high as 50 to 70 watts per square centimeter of the active anode area can be allowed. Even higher values are practicable, depending on the rate of water flow and uniformity of the distribution of the electronic bombardment over the anode area. The main problem in making water-cooled tubes is that of heat treatment for outgassing of the metal parts without causing the seals to crack. This is utterly impossible if the glass is fused directly to a heavy-walled anode of a material with a thermal expansion distinctly different from that of glass. Copper was chosen for anodes primarily because it forms a good

¹ Holweck tube described by Elwell, *Jour. I.E.E.* (London), August, (1927).

² Houskeeper, *Bell Syst. Tech Jour.*, July, (1922).

joint with all usual sorts of glass; also, because of its good thermal and electrical conductivity, low cost, the possibility of making anodes by the process of drawing, and finally, because of its diamagnetic properties. Another solution of the same problem of making vacuum-tight joints can be found in using metals, or rather alloys, with a low coefficient of expansion, equal to that of glass. This has been done by some European firms. In the latter case there is no necessity for machining the anodes to a very thin edge, but those alloys, as a rule, possess a comparatively low thermal and electrical conductivity and show, to some extent, magnetic properties which can become troublesome, especially at higher frequencies.

Since the time when the water-cooled tubes were first introduced, their number in the same transmitter, operated in parallel or in a push-pull arrangement, has steadily increased, due to the fact that the high power of a transmitter is a reliable and simple means of reducing the detrimental effect of static and fading in reception. However, operating too many tubes in parallel represents a certain inconvenience, because the tube characteristics may vary from tube to tube, causing nonuniform distribution of load among the tubes as well as parasitic oscillations. Besides, a transmitter with a large number of tubes must be shut down proportionally more frequently for replacing defective tubes. A logical way out of this situation was an increase of power per individual tube, the result of which was the design of tubes of 100- to 200-kw output. This is the latest development in the field of radio power tubes. One type of such high power tubes has been designed and built by the Research Department of the Westinghouse Electric and Manufacturing Company under the name of the "AW-220 Tube" and will be described here.

CONSTRUCTION OF AW-220 TUBE

The tube of this denomination has been designed for 100-kw normal output. Its general appearance is shown in Fig. 1. The tube is of the "double-end" structure and has a water-cooled anode and a water-cooled grid. Its over-all length is 64 inches; its weight—including the water jacket and all water connections—about 60 lbs. A window through the jacket and the anode, which one can notice in the picture, was made in this particular tube for exhibiting the relative position of the inner parts of the tube. The copper anode forms the central part of the tube and is separately shown in Fig. 2. There is a glass blank sealed to each end of it. The grid-filament structure can be seen in Fig. 3. It is rigid in the transverse direction, is supported at both ends of the tube, with provision for longitudinal travel, to allow for thermal

expansion. The filament current is supplied through the press leads on the upper end of the tube, while the grid is supported and connected to the outside circuits at the other end.

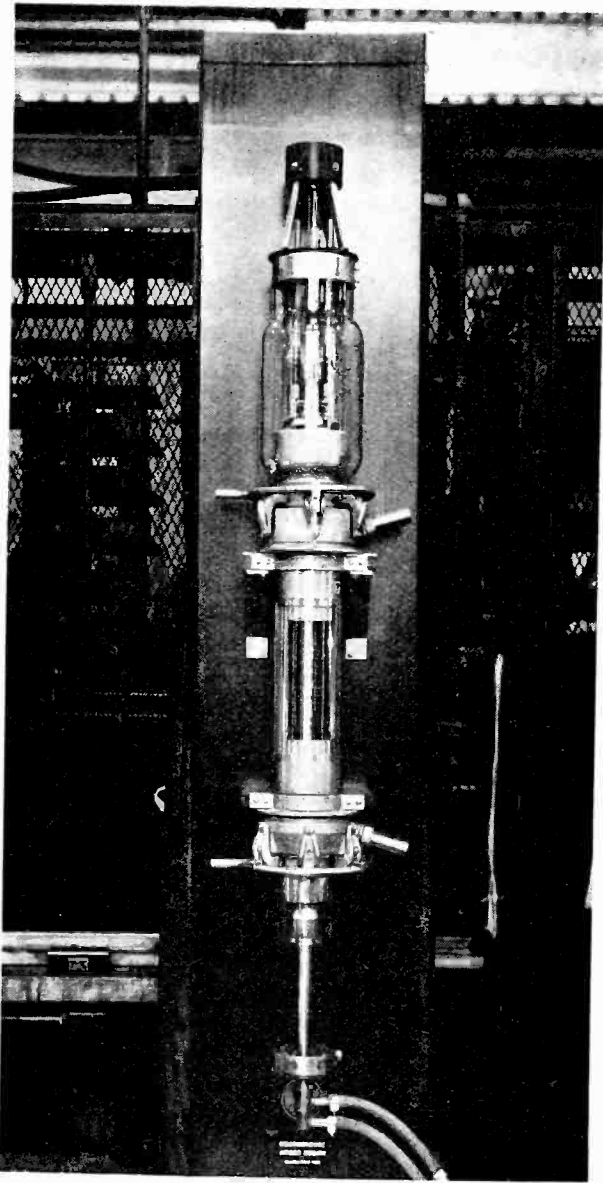

Fig. 1

Anode

The anode is made of copper pipe and is 26 inches long and 4 inches inside diameter. Both ends of the pipe are machined to an edge 0.003 to 0.005 inches thick, to which the glass is fused. The outside of the

cylinder is fluted to compel the cooling water to flow in strictly parallel streams, also increasing the cooling surface and establishing a minimum distance between the anode and the inner water jacket, which in no circumstances can become less than the depth of the grooves. The

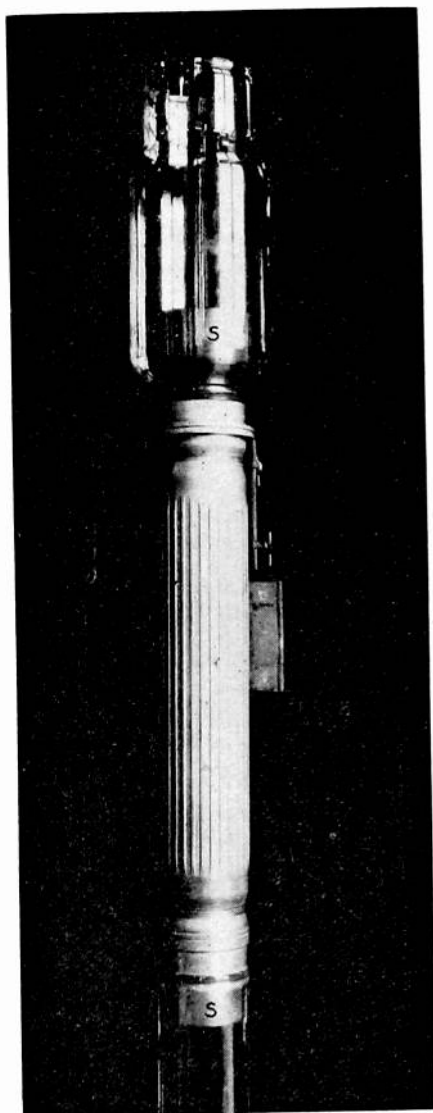

Fig. 2

principle advantages of this arrangement could, of course, also be obtained by fluting the inner surface of the water jacket. With a rate of flow of 15 gallons per minute this anode is able to dissipate as much as 150 kw if the tube is working as an oscillator or class-C amplifier.

The anode shields, *S*, are screwed into both ends of the anode and are necessary for protecting the glass-to-copper seals having sharp

metal edges imbedded in the glass from excessive dielectric stresses which, if allowed, will easily cause the glass to puncture at this place.

Water Jacket

The water jacket can be seen in Fig. 1, but an enlarged view is

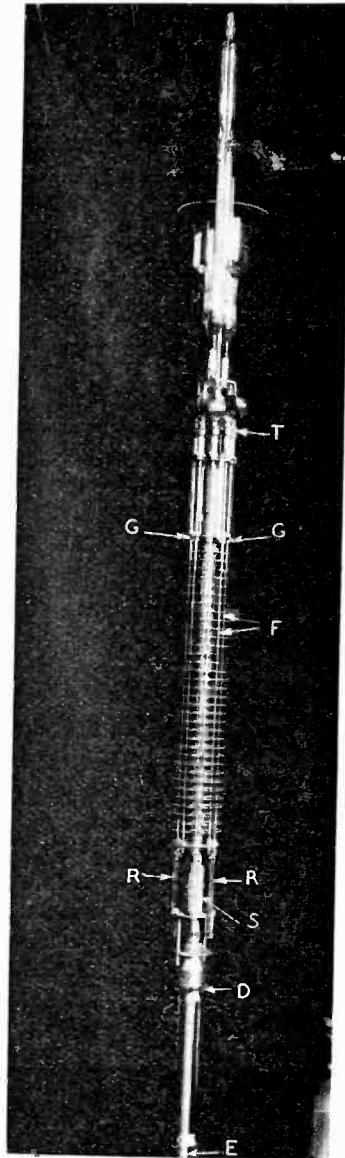

Fig. 3

shown in Fig. 4. It consists of two distinctly separate parts: (1) inner jacket and (2) outer jacket. The first one, designated by *A*, is seen projecting slightly from behind the outer jacket. It has a simple cylindrical form and has the purpose of establishing a definite annular space

around the anode, about $\frac{1}{8}$ inch thick. The inner jacket does not need to be water-tight and can even be composed of two semicylinders to make its assembly simple. The outer jacket, *CBBC*, must be water-

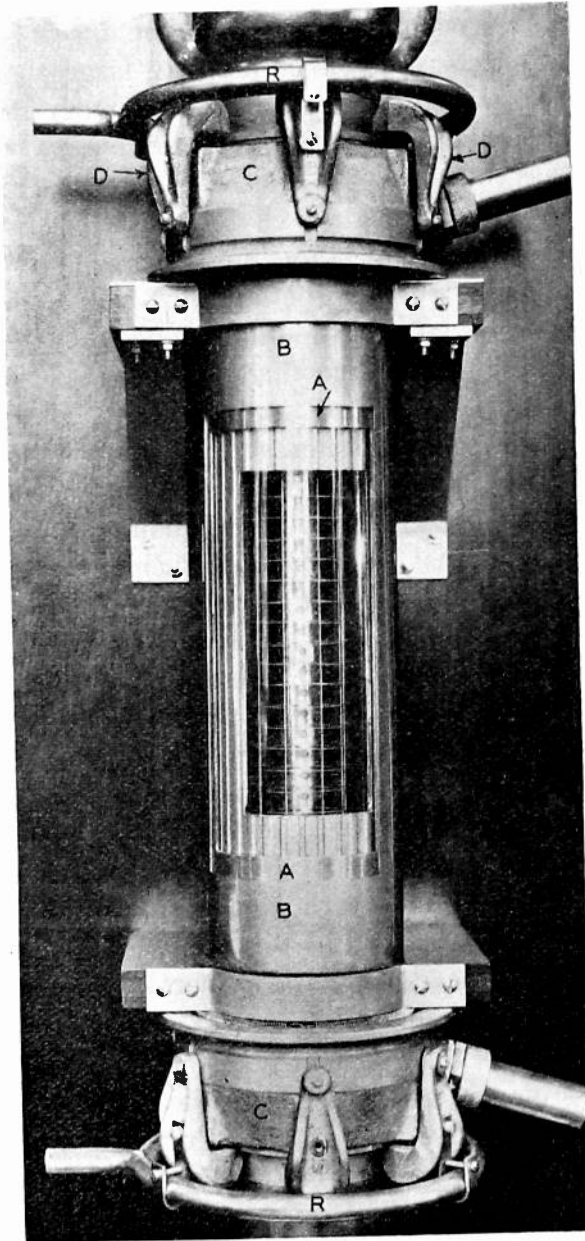

Fig. 4

tight and is clamped to the anode by means of rubber gaskets and specially designed clamps, *DD*, with fine adjustment of clamping pressure around the anode. This jacket has two cast heads and a middle

cylindrical part of thin brass sheet. The connection between the middle part and each cast head is made by an elastic annular diaphragm of very soft copper which allows the outer water jacket to adapt itself to the actual shape of the anode and inner water jacket without causing dangerous mechanical stresses in the anode seals. The inside diameter of the outer jacket is sufficiently large to allow assembly by slipping it over the end of the tube with smaller glass blank. Each cast head has a chamber of comparatively large cross section for establishing a uniform pressure at the ends of the active part of the anode. The cooling water enters the lower chamber, is accelerated through the narrow annular space between the inner jacket and the anode, and leaves by way of the upper chamber and its water connection. The necessity of the narrow space can be understood from the following considerations: For more efficient cooling, the amount of water present at any moment in the jacket is not important. Of prime importance is the amount of water coming in immediate contact with the anode surface per unit time, because water possesses very poor thermal conductivity. For increasing the efficiency of cooling, the layer of water nearest to the anode must be continuously changed, which is possible only if the velocity of water is sufficiently high to cause a flow turbulent in the plane perpendicular to the anode surface. These conditions can be fulfilled by narrowing the channel through which water flows. High velocity is desirable also from another viewpoint. With an intense anode dissipation, bubbles of steam may be formed at the anode surface and stick to it tightly. If such a bubble stays on one place for any appreciable time, the copper becomes overheated at this point, and even a puncture of the anode wall can ensue. With a high velocity of water, the bubbles are readily torn from the surface and carried away. Practically, the velocity is from 0.5 to 1.0 m/sec. Finally, high velocity of water flow prevents a detrimental mineral deposit upon the anode in the case of minerals in solution.

The metal rings, *R*, having many perforations on the side turned toward the glass blanks, are attached to the jacket for the purpose of blowing air on the glass, thus keeping its temperature down. The cooling of the glass is necessary only when higher plate voltages are used, 20 kilovolts or higher. The source of heating of the glass walls of the tube is the heat radiated and reflected from the inner parts of the tube, and also the heat resulting from dielectric loss in the glass itself due to the high-frequency electric field. Though the hard glass used for the tube construction has a very low power factor, this increases with the temperature, and the heating can become cumulative. In the absence of any artificial cooling, the local temperature at certain

points can rise to the softening point of the glass, and then, the outside atmospheric pressure may cause puncturing of the glass blank. The grid end requires about one fourth of the amount of air-blowing used for the filament end. The latter is about 10 cubic feet per minute at 2 inches pressure.

Water-Cooled Grid

Past experience has shown that the grid of an oscillating tube often becomes a source of the limitation of the tube output, due to the grid emission, or as it has sometimes been called, "dynatron action." Therefore, the grid of the AW-220 tube was designed so as to minimize the

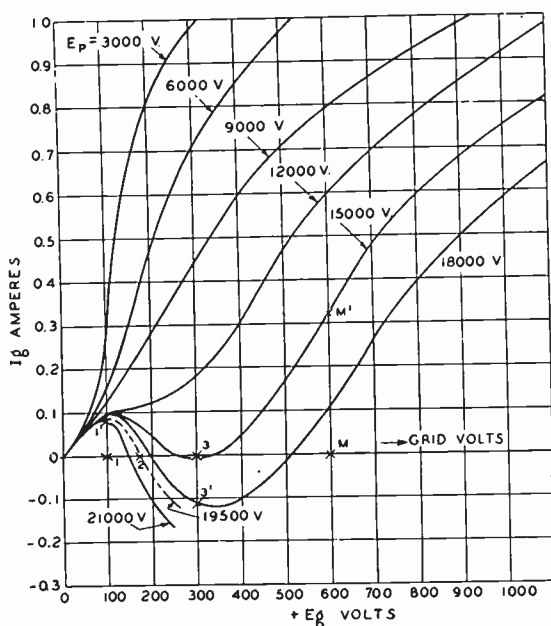

Fig. 5—Grid emission of AW-220 tube:

possibility of emission, secondary as well as primary. For keeping its temperature down, it is internally cooled by water. Its shape minimizes secondary emission at any temperature. The grid structure (Fig. 3) consists of a column of molybdenum or tantalum disks fitting tightly on and supported by a central copper tube. Each disk has 8 peripheral holes for 8 filament strands located within the grid. The center pipe is sealed at its base to a glass support, *D*, and is closed at the other end, approximately at the level *GG*. Water at the rate of 1 or 2 gallons per minute is introduced into the copper support through an axial concentric pipe *E*, open at its upper free end, strikes the very top of the grid support, and returns by way of the annular space between the support and the axial pipe. The grid is able to dissipate more than 15 kilowatts without endangering the tube.

The grid characteristics of an AW-220 tube are given in Fig. 5. They show that a depression peculiar to the presence of secondary emission appears only with very high plate voltages—not below 12 kilovolts—while with a conventional wire-wound grid this usually happens at much lower values of plate voltage—at 2 or 3 kilovolts. The detrimental effect of secondary emission is connected with the negative slope of the grid characteristic. Due to it, self-oscillations can easily be started in the circuits associated with the grid. Furthermore, analyzing a family of static curves of Fig. 5 in that section where the secondary emission is pronounced, one can see that a grid subject to secondary emission can eventually give birth to parasitic oscillations even without attaching to it an oscillating circuit. Indeed, when a tube oscillates, its grid voltage is 180 degrees out of phase with the plate voltage; and, while the first voltage changes from zero through the values 1–2–3 to its maximum (see Fig. 5, point *M*) the plate voltage varies from its higher to lower positive levels with corresponding figures, 21–19.5–18–15 kilovolts. Then, the grid current, which is zero with zero grid voltage, changes to a positive value 1–1'; then again to zero (point 2); becomes negative, –3–3'; then reaches a positive maximum, –*M*–*M'*. On the downward swing of the grid voltage, the process repeats itself in inverted order. Thus, during the time when the grid is positive, which is only a part of a half cycle of fundamental frequency, the grid current passes through $2\frac{1}{2}$ cycles of its variation. One must note that, though the curves of an AW-220 tube were here used for discussion and demonstration of the phenomenon of forced parasitic oscillations, the AW-220 tube is actually free from this danger, because even a slight insight into realizable cases of the tube performance can show that positive grid voltages never combine in this tube with sufficiently high plate voltages able to produce secondary emission. It is also easy to see that the danger is the greater, the lower the plate voltage at which the secondary emission starts.

The secondary emission can decrease the grid bias, thus allowing more electrons to fall on it, which in turn will produce additional quantities of secondary electrons. The phenomenon can become cumulative, and, to a great degree, impair the tube performance. Finally, due to the heating caused by an increasing number of primary electrons striking the grid, its temperature may rise to such a degree that it will start emitting thermal electrons of its own. The higher the μ of the tube, the more pronounced may become the evil of the grid emission, particularly if the tube is operated as a class-B amplifier, where the positive grid voltage combines with high values of the plate voltage. A special shape and artificial cooling of the grid completely

eliminate the trouble connected with grid emission in the AW-220 tube.

Filament

The filament of the AW-220 tube consists of 8 parallel strands of tungsten wire 14 inches long (*FF* in Fig. 3), electrically making four

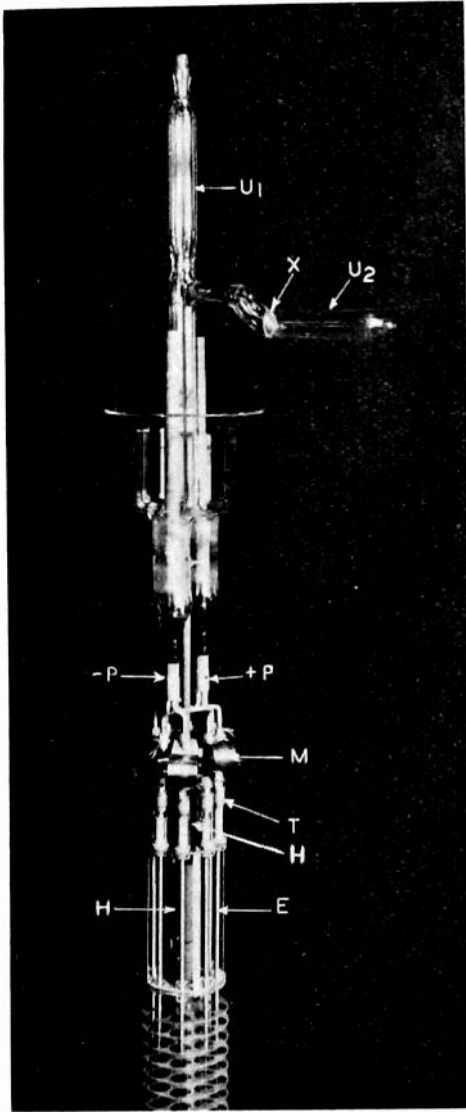

Fig. 6

parallel loops each carrying about 80 amperes at 30 volts. Each strand is located strictly axially within one of the peripheral holes in the grid structure. The whole set of filaments is kept in tension by a spiral spring, *S*, made of 0.125-inch tungsten rod, located upon the water-cooled grid support, which prevents an overheating and consequent

weakening of the spring. As the spring is in electrical contact with the grid, it is insulated from the filament strands by means of four quartz rods, *R*, which are part of the filament structure. To prevent sagging of the individual strands in the event of some inequality in expansion each of them is held in tension by an additional smaller tungsten spring, *T*, shown in Fig. 6 at the opposite end.

Except for a slight longitudinal motion with respect to each other, allowed by the spiral springs, the filament and the grid make one solid structure, being insulated from each other by the above four quartz rods, *R*, at the "grid end" of the tube, and by a heavy solid quartz rod, $\frac{5}{8}$ inch in diameter, at the other, or "filament end" of the tube. In Fig. 6 this rod is screened from the view by two electrostatic skirt-shields, *HH*.

The current to each filament strand is supplied through several thin U-shaped molybdenum ribbons, *M*, each being attached by one end to a threaded filament end-rod, *E*, and by the other end to one of the two filament press rods, *P*, according to its polarity. As there are four filament loops, four sets of ribbons are connected to each press rod. The ribbon connection is sufficiently rigid in the transverse direction; at the same time it allows for some longitudinal motion of the grid-filament structure with respect to the anode with its glass ends, which eliminates dangerous stresses in the glass when the temperature of the tube part varies. The filament press leads, *P*, have to carry through the glass 325 amperes for heating the filaments; therefore, they are made of $\frac{1}{2}$ -inch molybdenum rods sealed through the glass by means of specially developed glass-disk presses, which can stand even larger currents. The same leads also give a reliable mechanical support to the filament end of the inner tube structure.

From all previous descriptions it follows that the inner structure of the tube, Fig. 3—including the grid with its copper support and glass flare, filament with springs, connecting ribbons, and the filament press,—represents a beam held rigidly by the end flares in the position which is given to it during sealing in, with a certain flexibility in the longitudinal direction.

The described filament press can easily stand a large temperature variation. Thus, the leads can be heated to red heat without damaging the glass parts. Nevertheless, in operation it is customary to use artificial cooling of the filament leads by applying a slight air blast to them inside the reëntrant portion of the press.

AW-220 Tube Manufacturing

Considering the size of the tube, the weight of its parts, and the mass of metal inside the tube which must be outgassed, the manu-

facture of an AW-220 tube represents a much more complicated and expensive problem than the manufacture of any other tube of smaller size. Thus, making of glass-to-copper seals and sealing the heavy inner structure into the anode, with proper centering, has required development of adequate glass blowing machinery.

Special precautions must be taken to protect the large seals from failing during the severe heat treatment of the tube in the baking oven.

Considerable variation in length of the anode and its glass ends with the temperature resulted in the designing of a *floating* exhaust system, in which the manifold and the pumps readily follow every motion of expanding or contracting parts of the tube, the latter being firmly supported by a special stand inside the oven. Such an arrangement eliminates the possibility of the development of undesirable stresses in the glass parts of the pumping system which can otherwise be easily ruined. A similar problem does not exist with smaller tubes, because they can be sealed directly to a glass manifold, without any additional supports, and are free to expand or contract without doing any damage to the pumping system or to themselves.

The requirement of a most perfect outgassing of the metal parts and the inconvenience of using too high voltage on tubes in the baking oven brought about a scheme of divided treatment of the tube. The first part is a *heat treatment* in a baking oven where the tube is heated to a temperature of 400 degrees C and subjected to a bombardment with comparatively *low voltage*, about 4000 volts. The second part is *high voltage* and *high-frequency* treatment during which a tube is aged in an oscillating circuit with full load at gradually increasing operating voltage, and during which the tube is also *continually connected to an exhaust system*. For avoiding a loss of vacuum, acquired during the first stage of the tube treatment, while transporting and sealing the tube to the new system, the tube is originally assembled with a double tubulation (Fig. 6): the axial tubulation, U_1 , is used in the baking oven during the heat treatment; the side tubulation, U_2 , has an inner partition, X , which is broken by means of a magnetic bullet, located in the manifold, only after the tube has been sealed to the second exhaust system, and the manifold sufficiently evacuated. As a result of a divided treatment schedule, the aging period can be considerably reduced, and the vacuum obtained is more perfect.

PART II

TUBE CHARACTERISTICS

The AW-220 tube was originally designed for work in oscillating circuits as an oscillator or high-frequency power amplifier (class-C);

but it can also be used as a modulated high-frequency amplifier (class-B), or plate modulator (class-A). Its conventional current-voltage plate characteristics are shown in Fig. 7, where the curves are greatly extended in the direction of the I_p -axis. From these curves one can calculate the amplification factor, μ , which is about 10.5; the plate resistance, R_p , which at zero grid and $I_p = 4$ amperes equals 350 ohms, and the mutual conductance, $g_m = 30$ milliamperes per volt.

The normal filament current of the tube is 325 amperes at 30 volts. The total electronic emission at this condition is approximately 65 amperes.

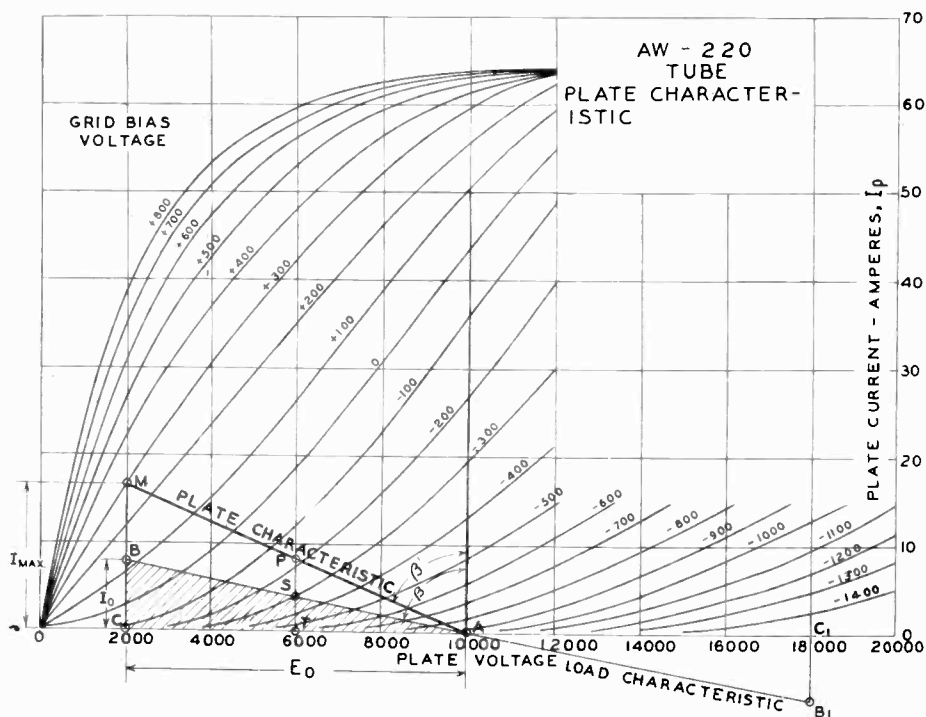

Fig. 7

The tube works normally with a plate voltage from 18 to 20 kilovolts, but it can be used as an unmodulated oscillator, or as a class-B amplifier with 22 kilovolts on the plate, provided that the cooling of the anode takes care of the power to be dissipated. Since the class-B scheme is at the present time in vogue for high power transmitters, we shall start with the description of the tube used as a class-B amplifier.

AW-220 TUBE AS CLASS-B AMPLIFIER

In a great number of modern broadcast transmitters the last or output stage is used for amplification of modulated high-frequency

power, the Heising or plate modulation being applied to one of the previous stages, where 100 per cent modulation can easily be obtained. In this case the power tube in the last stage performs the duty of a class-B amplifier, the required feature of which is the proportionality between the plate voltage of the modulated stage and the tank current of the output stage, which is equivalent to a proportionality between the grid excitation voltage and tank current of the power amplifier, the latter being proportional to the square root of the output power. This is accomplished by operating the tube with a negative grid bias such that the plate current is practically zero with no grid excitation (the bias is equal to the cut-off voltage), so that by applying excitation grid voltage the plate current is sent through the tube during each upper half cycle of the grid voltage. The grid usually goes positive

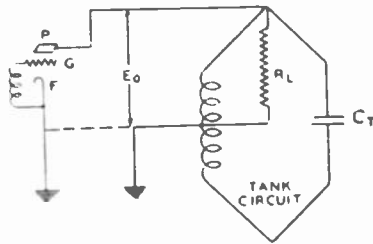

Fig. 8

during a smaller or greater part of a half cycle, but must not reach values at which the proportionality between the output and input ceases, due to a flattening of the plate current wave.

The high-frequency dynamic characteristics of the power amplifier, for any given load resistance, R_L , can be plotted on a chart similar to that of Fig. 7. In further discussion the load resistance, R_L —no matter how it can be connected to the oscillating circuit in reality—is always assumed to be reduced to an equivalent "parallel load resistance," connected between the plate and filament of the tube (Fig. 8). The oscillating circuit has only the duty of keeping the high-frequency voltages strictly sine-shaped.

Let A , in Fig. 7, be the cut-off point (a comparatively low voltage of 10,000 volts is chosen here for convenience of discussion). Since the current through the parallel resistance, R_L , is at any instant proportional to the voltage, E , across it, which is the high-frequency plate voltage, the dynamic characteristic of the load can be plotted as a straight line, BAB' , such that its reciprocal slope is

$$\tan \beta = R_L.$$

This characteristic is symmetrical with respect to the point A , because the current flows through the resistance during both the positive and

negative half cycle of oscillation. The high-frequency power consumed in R_L is then equal to

$$P_L = \frac{E_0 I_0}{2} \quad (1)$$

where E_0 designates the voltage, and I_0 the current amplitude. On the chart, P_L is represented by the area of the triangle ABC , because $AC \doteq E_0$ and $BC = I_0$.

The dynamic characteristic of the tube can be determined from the following consideration. As has been mentioned, due to the bias chosen, the current flows through the tube only during one half cycle, corresponding to the upper grid swing. Designating the maximum value of the plate current by I_{\max} , and assuming the sine shape of the current, we can write the expression of the plate output

$$P_0 = \frac{E_0 I_{\max}}{2 \times 2} \quad (2)$$

where E_0 is the common voltage amplitude across the plate and the load resistance. Evidently, for a state of equilibrium the power delivered by the tube must be equal to the power consumed in the load. Therefore,

$$I_{\max} = 2I_0. \quad (3)$$

Thus, the locus of I_{\max} values for $R_L = \text{const.}$ will be a straight line, AM , plotted so that

$$\tan \beta' = \frac{R_L}{2}. \quad (4)$$

The particular value of I_{\max} in each case will be given by the intersection of AM with a definite static curve, if the grid excitation is known (it is 300 volts in the drawing); or by the intersection with a vertical line corresponding to a certain desired voltage amplitude, E_0 , or a desired minimum plate voltage, $E_{\min} = E_p - E_0$, (2000 volts in the drawing), which is equivalent to a predetermined power output, the latter being measured by the area of the triangle ABC , or half of the area AMC . The high-frequency plate characteristic is strictly represented by a straight line, such as AM , only for the case, when the plate current is a pure sine wave. Otherwise, the ratio I_{\max}/I_0 becomes variable alongside the characteristic, can eventually reach the value of 2.5 (instead of 2, as shown in (3)), and then the plate characteristic becomes a curved line. Nevertheless, the above consideration is close enough in any case for an approximate precalculation of the tube performance.

The same line, AM , also in the case of a sine wave, represents also the *modulation path* of the tube operated as a class-B amplifier. In this kind of service the operating point P must be so chosen that, with no modulation, an output (measured by the half of the area of the triangle PTA) equal to 25 per cent of the desired peak value is steadily delivered by the power amplifier; this is the *carrier output*. The amplitude of the carrier voltage, AT , is then equal to $\frac{1}{2}$ of the peak amplitude, AC . With 100 per cent modulation, the high-frequency plate voltage varies up to the maximum amplitude, AC , during the positive swing of the audio-frequency voltage, and down to zero during the negative half

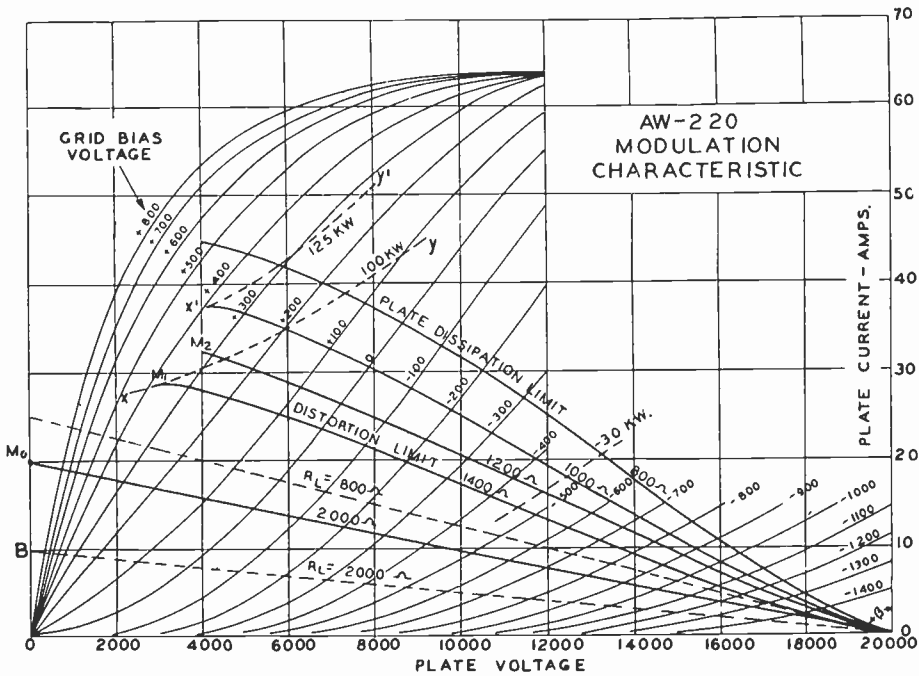

Fig. 9

cycle (point A). Accordingly, the power output varies between the values 4 times the carrier output and zero. With modulation less than 100 per cent, the plate amplitude and power variation will, of course, be smaller and stay within the indicated limits. The chart of Fig. 9 contains several precalculated modulation characteristics for different values of the load resistance, R_L , with 20 kilovolts on the plate. The curve, XY , connects the points with 100 kilowatts, and $X'Y'$ with 125 kilowatts output. In order to decide which characteristic gives better operating conditions one must analyze the limitations imposed on a tube as a class-B amplifier. In this respect the following three factors must be considered: (1) The maximum allowable distortion in power amplification; (2) Safe plate dissipation; (3) Grid emission.

The distortion, or the relative amount of harmonics in the power amplification, is connected with flattening of $\sqrt{P_0}$ versus excitation curves, which is mainly due to the grid swinging too much into the positive region (modulation characteristics extend too much to the left, Fig. 9). This limitation becomes more pronounced with large load resistances, R_L , or with modulation characteristics having a larger angle β . From previous considerations, it is clear that, for a *prescribed peak power output*, P_0 , the largest imaginable value of R_L which could be used with any tube is to be found from the expression

$$R_{\text{lim}} = \frac{E_p^2}{2P_0} \quad (5)$$

by which it is assumed that the plate voltage amplitude, E_0 , is equal to the d-c plate voltage E_p . The line AM_0 is plotted so that the area of the triangle AM_0O is proportional to an output of 100 kilowatts; R_{lim} must then be equal to 2000 ohms. The efficiency, in this case,—if calculated from the geometrical relation of a sine line diagram,—would be the maximum ever possible for a class-B amplifier and equal to $\pi/4$ or about 78 per cent. But such a case is unrealizable, because no current would flow with zero volts on the plate ($E_p - E_0 = 0$). In fact the lowest practical modulation characteristic will be located so much higher that, with the same area of the power triangle, the efficiency is not over 66 per cent, the efficiency being proportional to the ratio of the plate voltage amplitudes E_0'/E_p . In the case of an AW-220 tube the lowest modulation characteristic is AM_1 which is calculated for 100 kilowatts peak output; the required resistance is 1400 ohms. For 120 kilowatts output, AM_2 is the limiting curve with $R_L = 1200$ ohms.

On the other hand, the smallest parallel load resistance, which can be allowed (the steepest modulation line) is determined by the safe plate dissipation for a prescribed carrier output, P_c . If P_h designates the safe plate dissipation, the carrier efficiency can be calculated from

$$\eta_c = \frac{P_c}{P_c + P_h} \quad (6)$$

For $P_c = 30$ kilowatts and $P_h = 80$ kilowatts, the lowest limit of the efficiency with which the tube can still operate is 27.3 per cent. Knowing η and E_p , one can calculate the carrier amplitude from the relation

$$\frac{E_0}{E_p} = \frac{0.273}{0.78} \quad (7)$$

for $E_p = 20,000$ volts, $E_0 = 7000$ volts. Hence, the limiting value of R_L can be found from

$$R_L = \frac{E_0^2}{2P_0} = \frac{7000^2}{2 \times 30,000} = 800 \text{ ohms.} \quad (8)$$

The power limitation connected with grid emission was analyzed above. It is particularly dangerous for class-B amplifiers, especially for those having high μ , because the greater part of the dynamic characteristic then runs through the region of positive grid, and grid

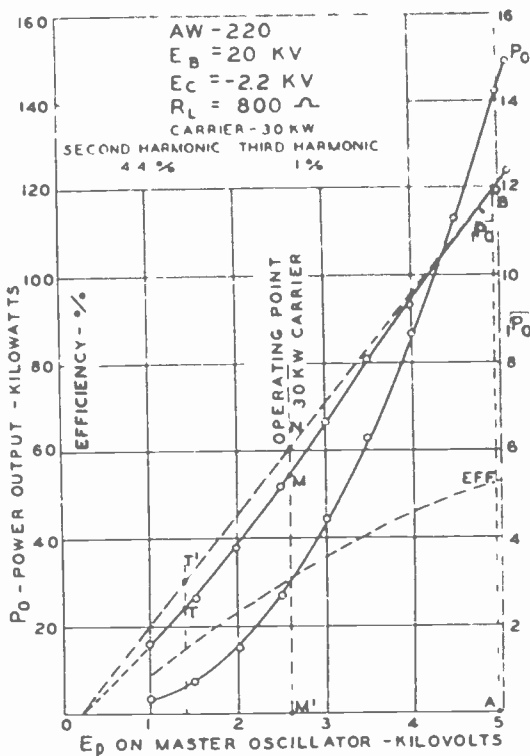

Fig. 10

voltages of several hundreds of volts combined with comparatively high plate voltages give the most unfavorable condition for secondary emission. The AW-220 tube, as has been mentioned, is completely free from this defect.

Figs. 10 and 11 contain curves for power amplifier output P_0 , versus plate voltage of the modulated stage, E_p , taken experimentally on an AW-220 tube with 20 kilovolts on the plate. The load resistances were 900 and 800 ohms, respectively. Similar curves for $E_p = 18$ kilovolts are shown in Figs. 12 and 13. The square-root-power curves and efficiency curves are plotted on the same drawings. 30 kilowatts carrier is taken as an operating condition with 20 kilovolts, and 25 kilowatts

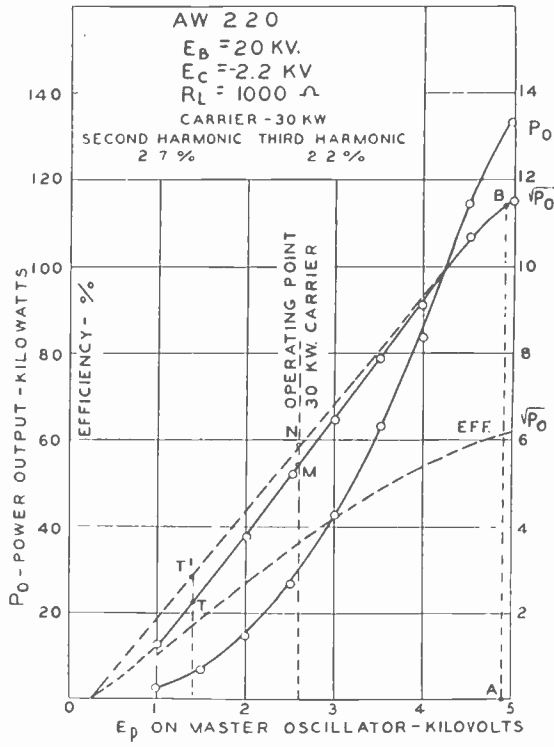

Fig. 11

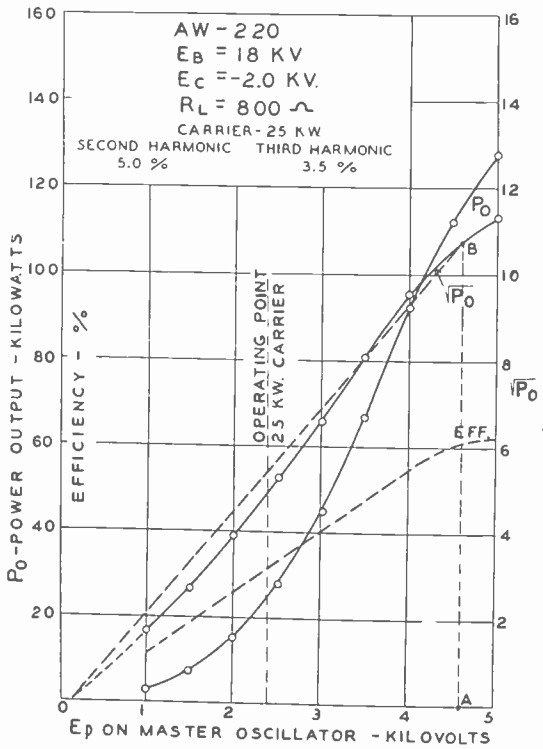

Fig. 12

carrier with 18 kilovolts on the plate, though in the first case 35 kilowatts carrier is also possible. The amount of distortion, mainly as second harmonic, is calculated for each case by subtracting the ordinates of a $\sqrt{P_0}$ -curve, at the operating point from the ordinate of the straight line connecting the ends of the portion of the characteristic which is actually used. The latter must correspond to a symmetrical swing of the excitation voltage, with respect to the operating point. The ordinate difference, MN , represents the full swing of the second harmonic, and its ratio to the total swing of the fundamental frequency,

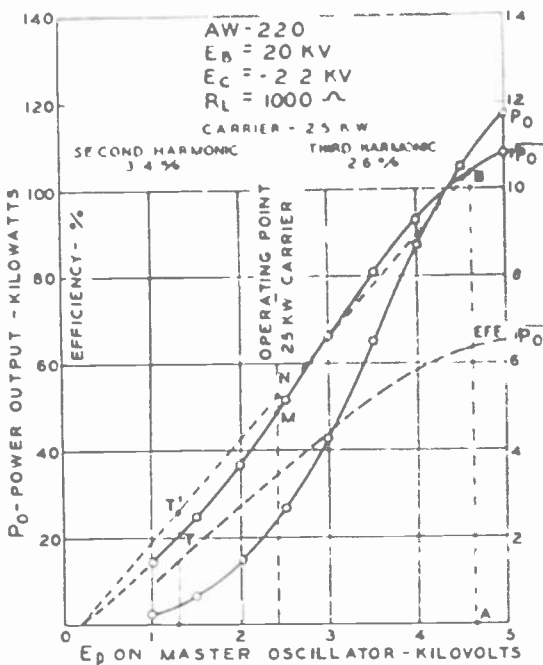

Fig. 13

AB gives the percentage of the second harmonic. In every case it falls below the figure of 5 per cent which is usually allowed. A small amount of the third harmonic is figured from the remaining ordinate difference, at point T , halfway between M and O , after subtracting the ordinate belonging to the second harmonic.

AW-220 TUBE AS CLASS-C AMPLIFIER

A class-C amplifier must deliver an output proportional to the square of its plate voltage; i.e., the tank current must be proportional to the plate voltage. This is accomplished by operating the tube with a negative bias considerably higher than the cut-off voltage so that the plate current flows during only a part of the upper half cycle of the grid excitation voltage. Output curves taken on an AW-220 tube with variable voltage are shown in Fig. 14. With the exception of a slight

bending at very low voltages, the square-root-power characteristic is a straight line, which is a necessary condition for a distortionless plate modulation.

As to the maximum peak output, it must be admitted that the highest output which can be generally expected from a tube as class-C amplifier or an oscillator—disregarding the limitation of the plate dissipation—

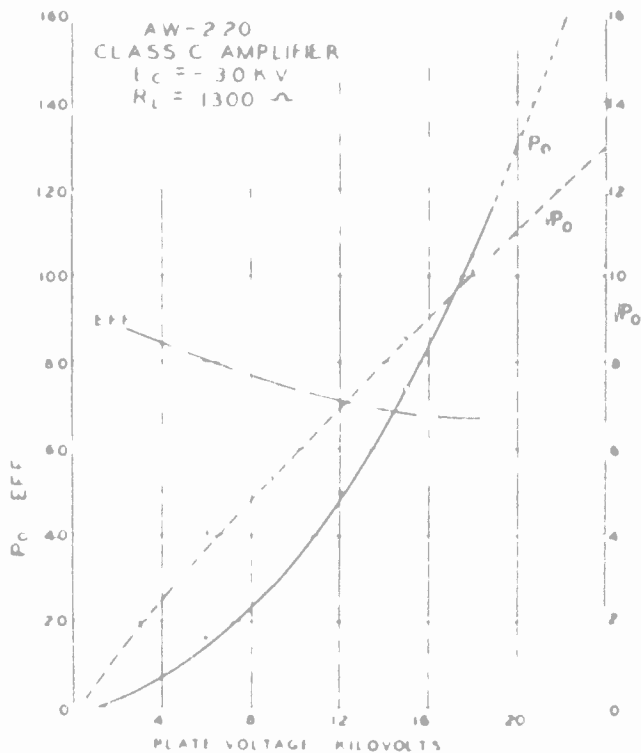

Fig. 14

amounts to $\frac{1}{6}$ to $\frac{1}{5}$ of the product of operating plate voltage \times filament emission:

$$P_{\max} = \frac{E_p I_e}{6} \approx \frac{E_p I_e}{5}$$

This is connected with the fact that neither the d-c plate voltage, nor the available emission can be utilized to 100 per cent, which is due to the shape of the static characteristics in the vicinity of the zero plate voltage and their curvature near the saturation point. Therefore, the maximum output which is theoretically possible, $E_p I_e / 4$, is never reached but must be reduced by the factor $0.9 \times 0.9 = 0.8$ or $0.8 \times 0.8 = 0.64$. With AW-220 tubes, P_{\max} is therefore $(0.64 \times 22 \times 60) / 4 = 220$ kilowatts, which can be actually realized, using 22 kilovolts on the plate. The curves of the Figs. 15 and 16 show the output and efficiency as function of the input resistance E_p / I_p , keeping the grid excitation constant.

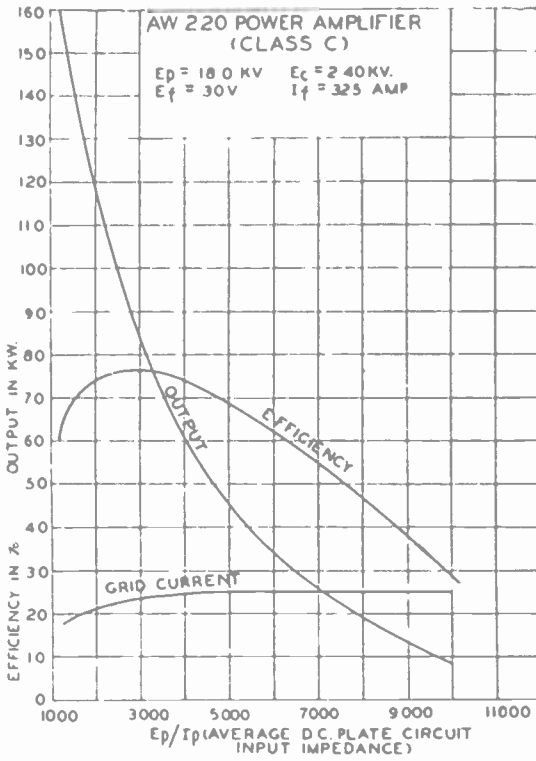

Fig. 15

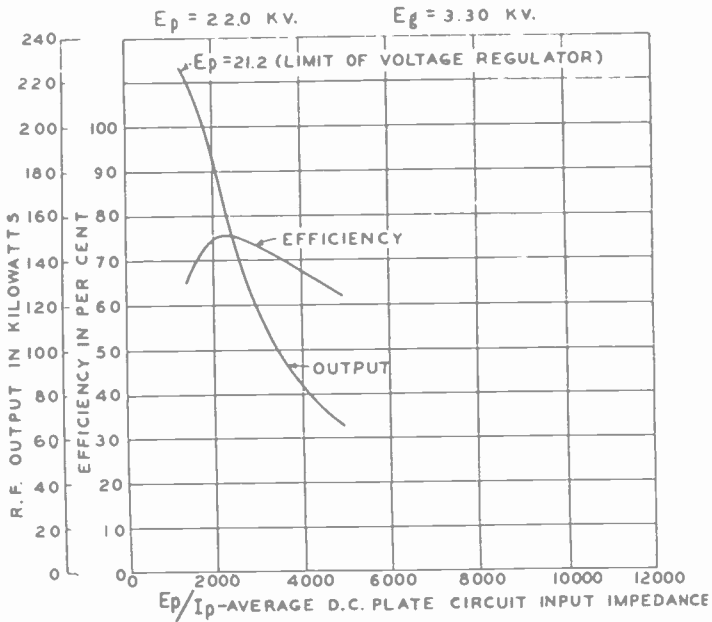

Fig. 16—Power amplifier characteristics. (Class C, AW-220 tube.)

AW 250 Tube as Plate Modulator

The AW 250 tube makes an excellent plate modulator in a conventional Heising modulation scheme because of its low impedance. The chart of Fig. 17, calculated from a set of static curves shows all possible operating conditions of an AW 250 tube as modulator with 10,000 volts on the plate and the grid never swinging above zero. The modulator plate current I_{p0} is plotted on the X axis and the oscillator input current I_o on the Y axis. For any constant value of the two one can find the pertinent values of the percentage of modulation,

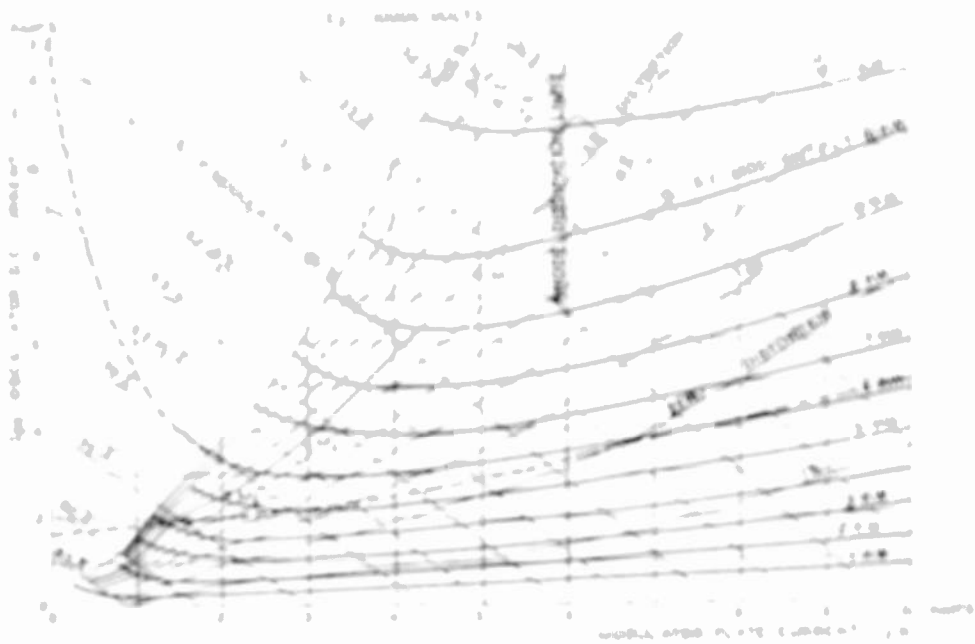

Fig. 17

η and the distortion δ from the two families of characteristics (by η and δ as parameters) the η characteristics are straight lines and the distortion is represented by curved lines converging toward the origin point. Let us consider, for instance, a 40-watt oscillator using AW 250 tubes with 10,000 volts on the plate. Assuming 60 per cent oscillator efficiency, we shall find the value of the modulator plate current as being equal to $(40/0.60) \times 10 = 67$ amperes. For an input of such an input and allowing 5 per cent distortion, one can use the AW 250 tube with $I_{p0} = 2.5$ amperes at about 50 per cent modulation point M (Fig. 17). Or for larger modulation one can split the modulator load and take two modulator tubes. Then each must take care of 37.5 amperes oscillator input current at the percentage of modulation will be 67 per cent (point M_1 in the chart). Or finally one can use

three tubes with $I_{po} = 2.5$ per modulator tube and $\eta = 72$ per cent. Of course, there is an infinite variety of combinations of the quantities involved in the performance of a modulator by allowing greater or smaller percentages of modulation and distortion.

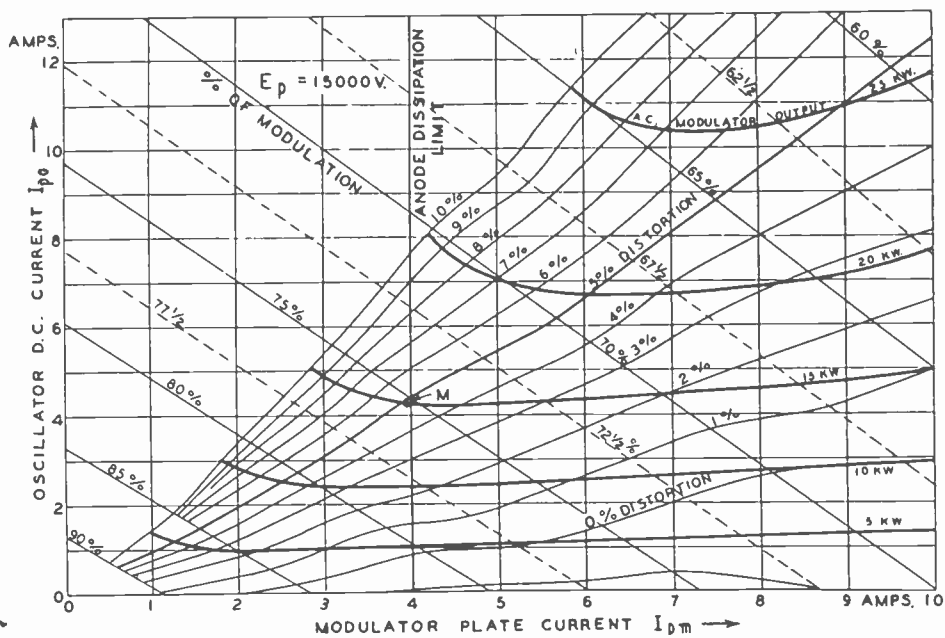

Fig. 18

The chart of Fig. 18 is similar to the one just discussed, with the exception that it is calculated for 15,000 volts on the modulator plate. It can be used in combination with oscillators composed of AW-220 or similar high power tubes. From the chart one can see that with the limiting conditions of the plate dissipation and percentage of distortion, one AW-220 tube as plate modulator can take care of an oscillator output equal to $4 \times 15 = 60$ kilowatts (point M).



THE VIBRATIONS OF QUARTZ PLATES*

BY

ROBERT CAMERON COLWELL

(Department of Physics, West Virginia University, Morgantown, West Virginia)

Summary.—By vibrating quartz crystals in an electric circuit Wright and Stuart have shown that the crystals break up into different parts while oscillating. The nodal lines thus formed are made visible to the eye by lycopodium powder. In the present paper it is pointed out that the mathematical theory of Chladni plates gives a general equation,

$$A \cos \frac{m\pi x}{a} \cos \frac{n\pi y}{a} + B \cos \frac{n\pi x}{a} \cos \frac{m\pi y}{a} = 0,$$

for the nodal lines of square plates. This equation is also applicable to quartz plates in so far as the forms of the nodal lines are concerned. It gives no information regarding the manner of vibration of the quartz.

Chladni plates both square and round have been vibrated by mechanical impact from a vacuum tube oscillator circuit. A few of the figures thus obtained are shown and may be compared with those of Wright and Stuart. The nodal lines for circular quartz plates do not in general resemble those of circular Chladni plates.

IT HAS been shown by Wright and Stuart¹ that a flat quartz crystal under the action of the electric oscillation in the circuit breaks up into segments; these segments are separated by nodal lines which may be made visible to the eye by the use of sand or lycopodium powder. Many of the figures shown by them resemble very closely the nodal lines on a Chladni plate excited at audible vibrations. An approximate mathematical theory of the Chladni lines has been given by Wheatstone² and Ritz.³

For a square plate of sides length a , the lines parallel to the x and y axes, respectively, are

$$\cos \frac{n\pi y}{a} = 0, \quad \cos \frac{m\pi x}{a} = 0 \quad (1)$$

in which m and n are integers and the origin is taken at the lower left-hand corner of the square plate. These equations represent straight lines parallel to the sides of the plate. The two equations may be combined into the form

* Decimal classification: 537.65. Original manuscript received by the Institute, January 20, 1932.

¹ Wright and Stuart, *Bureau of Standards Journal of Research*, vol. 7, No. 3, pp. 519-553.

² Rayleigh, "Sound," vol. 1, Art. 227.

³ Ritz, *Ann. der Phys.*, vol. 28, p. 737 et seq., (1909).

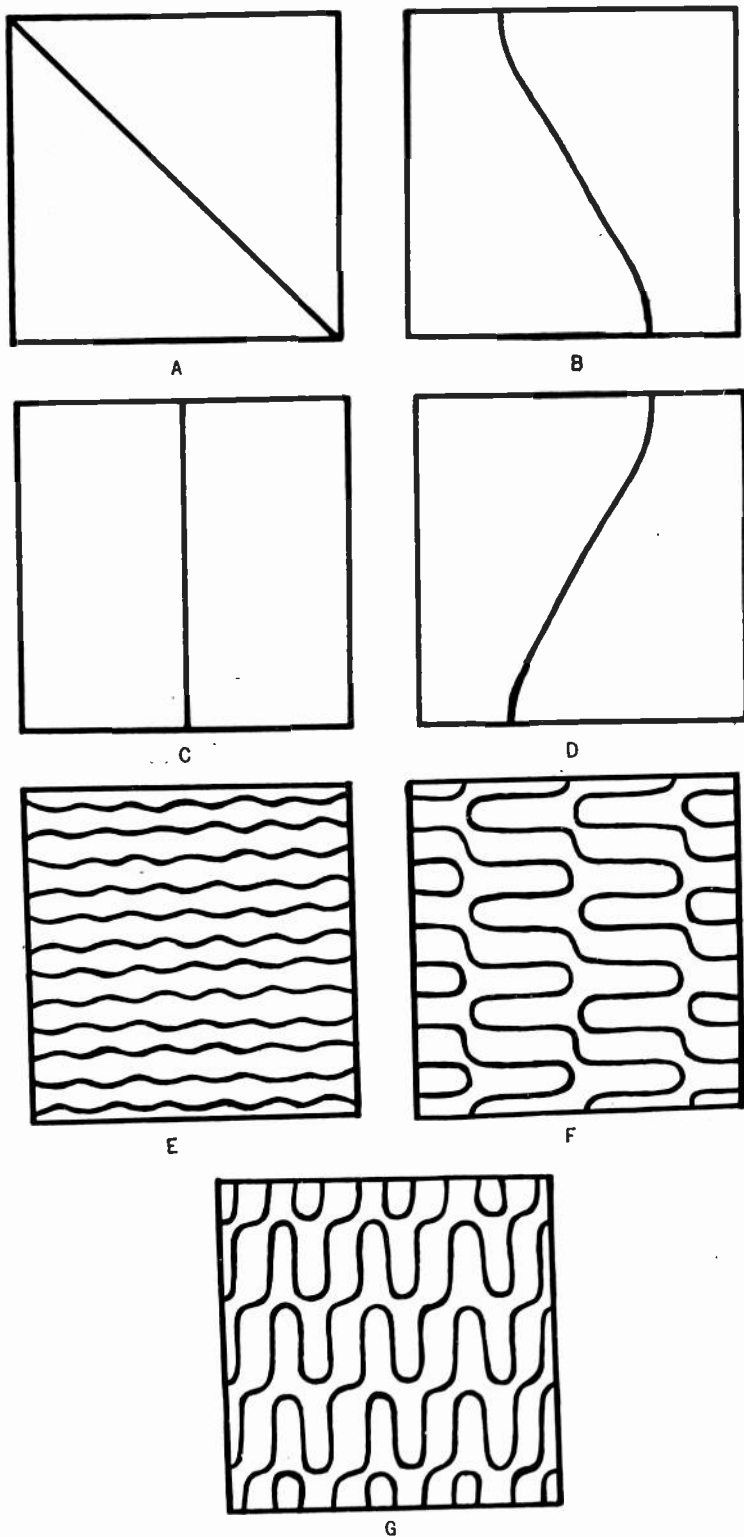

Fig. 1—Theoretical nodal lines for vibrating plates of isotropic material.

	<i>A</i>	<i>B</i>	<i>m</i>	<i>n</i>
1a	10	10	1	0
1b	10	6	1	0
1c	10	0	1	0
1d	10	— 6	1	0
1e	20	1	0	12
1f	10	1	3	10
1g	10	1	11	4

$$\cos \frac{m\pi x}{a} \cos \frac{n\pi y}{a} = 0. \quad (2)$$

This equation gives a series of squares when $m = n$, and of rectangles when $m \neq n$. For instance when $n = 0$ and $m = 1$ $\cos m\pi x/a = 0$ and $m\pi x/a = \pi/2$ or $x = a/2$. This gives a single line through the center parallel to the y axis. For $m = 2$, there are two lines equally spaced across the plate and parallel to the y axis. The other equation $\cos n\pi y/a = 0$ introduces lines parallel to the x axis. The two sets together give a series of rectangles.

Equation (2) in turn may be extended to the form

$$A \cos \frac{m\pi x}{a} \cos \frac{n\pi y}{a} + B \cos \frac{n\pi x}{a} \cos \frac{m\pi y}{a} = 0. \quad (3)$$

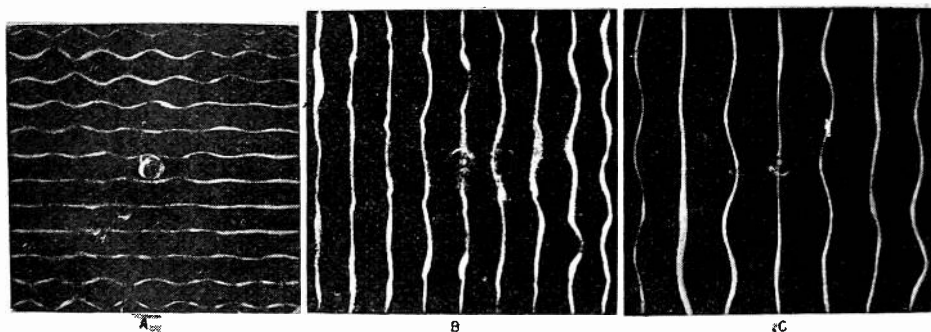

Fig. 2—Observed nodal lines for brass plate 10'' \times 10'', thickness $\frac{1}{16}$ ''; with approximate solutions.

	A	B	m	n
2a	20	0	0	12
2b	1	0	9	0
2c	1	0	7	0

This equation will give some of the more complicated figures for a Chladni plate or a vibrating square crystal. A few curves are shown which have been produced by vibrating a Chladni plate 10 inches by 10 inches at audible frequencies from four to ten kilocycles per second. It has been possible to find the equations for some of these curves by substituting in (3) values of A , B , m , and n given under the plates in Figs. 1 and 2. The curves of Fig. 3 have not yet been solved but are shown here because of their resemblance to the curves on quartz plates.

Circular plates were also vibrated with audible frequencies. Several of these are shown in Fig. 4, but only the first resembles the lycopodium lines of Wright and Stuart. Kirchhoff's solution for circular plates allows only for circles and diameters or combinations of these, so some other theory must be advanced to explain the nodal lines shown in Fig. 3 and in the paper of Wright and Stuart.

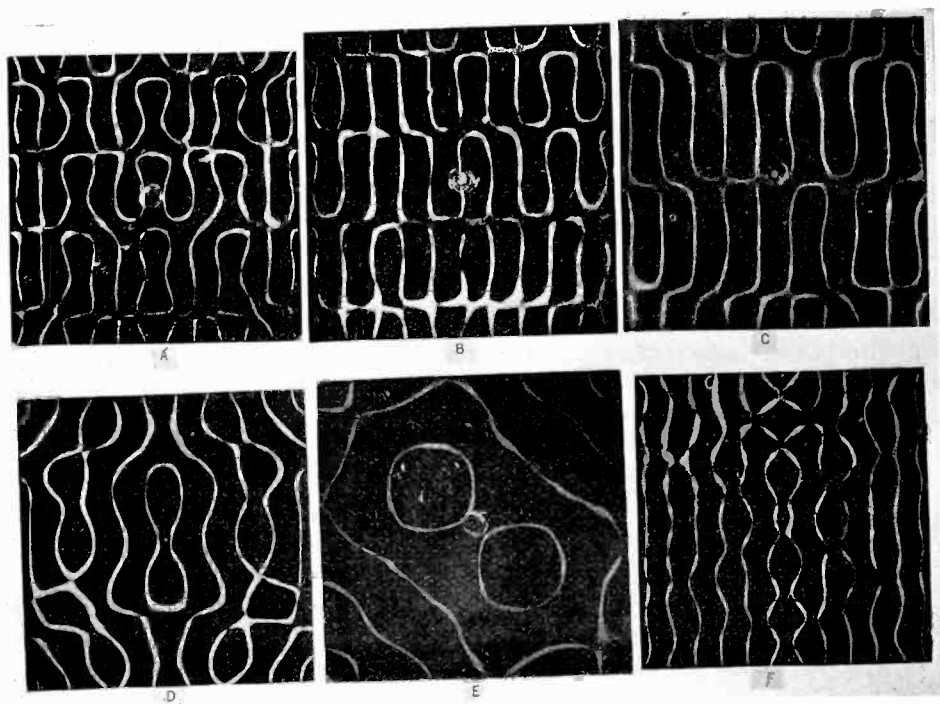

Fig. 3—Observed nodal lines for brass plate 10" × 10" square thickness $\frac{1}{16}$ ".

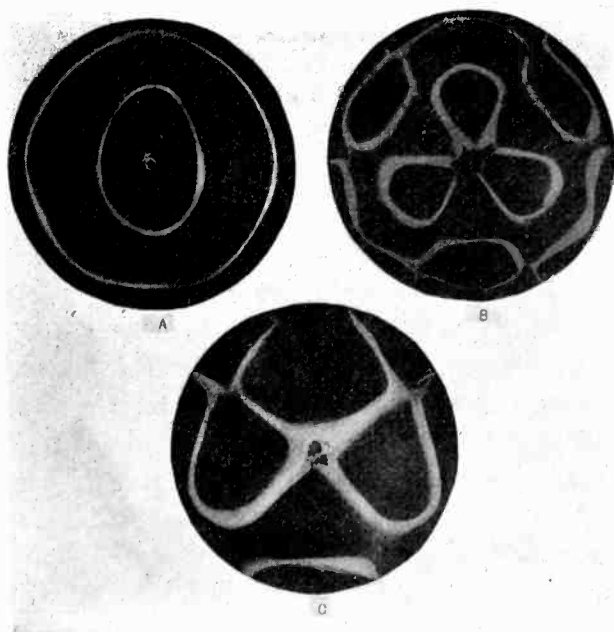

Fig. 4—Nodal lines on circular brass plate 10" in diameter, $\frac{1}{16}$ " thick; experimental.

The most important fact brought out in this paper is that the theory of Chladni figures applicable to square brass plates 10 by 10 inches at audible vibrations from 4 to 10 kilocycles per second is also valid for square quartz plates at superaudible frequencies from 60 to 280 kilocycles.

The method, however, is limited to the determination of the form of the figures and throws no light upon the modes of vibration of the crystals or plates. Thus the Chladni plate is presumably isotropic while the quartz crystal is anisotropic. This theory does show that both the plates and crystals break up into segments while oscillating.



A STUDY OF CLASS B AND C AMPLIFIER TANK CIRCUITS*

By

PERRY H. OSBORN

(Radio Development Engineering Department, Westinghouse Electric and Manufacturing Company, East Pittsburgh, Pa.; Physics Department, University of Pittsburgh, Pittsburgh, Pa.)

Summary—An investigation was made of the relations between the constants L , C , and R of a power amplifier output tank circuit. Experimental data were taken on an amplifier excited at a frequency of 480 cycles per second. An indication of the harmonic content of the output was obtained by means of a cathode ray oscillograph.

The results of the experimental data show that the output power and voltage and the efficiency depend only on the output circuit impedance and are independent of the L/C ratio. However, for a given output, the second harmonic in the output voltage increases with the L/C ratio.

It is shown both experimentally and theoretically that the per cent of second harmonic in the output is a function of the volt-ampere-to-watt ratio existing in the circuit. With a very large value of this ratio, the tank circuit will have a large flywheel effect so that the current amplitude will not follow the modulation closely at the higher modulating frequencies. A formula for calculating this effect is developed.

It is demonstrated that, for class B and C amplifiers the tube cannot be considered as a generator having a fixed internal resistance and generated voltage with any degree of exactness.

I. INTRODUCTION

IN radio transmitting equipment, either class B or C amplification is used for all radio-frequency amplification. By a class B amplifier is meant one which is operated under such conditions that the power output is proportional to the square of the grid exciting voltage. The tube is usually biased to approximately the cut-off point so that the plate current wave shape is close to a half sine wave. By a class C amplifier is meant one which is operated with a high grid excitation all of the time and usually biased beyond the cut-off point so that plate current flows for less than one-half cycle and goes to a high peak value. This peaked current wave introduces more harmonics in the output circuit than the half sine wave current of the class B amplifier. Both these classes of amplifiers use tuned circuits, commonly called tank circuits, for both output and input circuits. In such a circuit, the constants L , C , and R may bear various relations to each other. The product LC must have a definite fixed value corresponding to the frequency being used, but the ratio L/C and R may vary over rather wide ranges without seriously affecting the operation of the amplifier.

* Decimal classification: R363. Original manuscript received by the Institute, September 4, 1931.

There are, however, various conditions which will determine optimum values such as the allowable harmonic content of the output, the circuit losses, and modulation distortion.

Engineers who design such circuits usually keep in mind certain values for L/C and the power factor which they try to use in designing power amplifiers of these types. The values used by different engineers do not agree and there seems to be no theoretical or experimental work available to show what the best values are and how various conditions affect them. It was the purpose of this investigation to see what determines the relation between the circuit constants, to find out the limitations on their variation, and to determine if possible how to choose them for a tank circuit to meet certain given requirements.

II. EXPERIMENTAL WORK

A. Apparatus Used

The experimental work was carried out at a frequency of 480 cycles per second. It was desired to use a relatively low frequency so that the effect of stray capacity and inductance would be small and also so that the constants could be measured with more accuracy. The value of 480 was chosen because it is a multiple of 60 and so could easily be compared with the 60-cycle power supply by means of the cathode ray oscillograph. Thus an accurate check on the frequency was available as often as found necessary.

For the tube, the UV-211 type was chosen. This is a convenient size and has the advantage that there are three tubes of the same general type, but each having different characteristics. This made this particular size very well adapted to this work for the purpose of determining the effect of the tube characteristics on the operation of the output circuit. The nominal characteristics of the three tubes are given in Table I.

TABLE I

Tube	Amplification Constant	Plate Impedance Ohms
UV-203-A	25	5000
UV-211	12	3400
UV-845	5	2100

The amplifier was set up according to the diagram shown in Fig. 1. The inductance coil was an air-cored coil wound with 1450 turns of No. 12 D.C.C. copper wire in 50 layers. The winding space was three inches long and 8 3/8-inch I.D. \times 16-inch O.D. It was tapped at three points with approximately the same number of turns between taps.

The inductance and resistance of the coil were measured on a bridge at 480 cycles per second, and the results are given in Table II.

TABLE II

Taps	Inductance in Henries	Resistance in Ohms	X_L Ohms	X_L/R
1-2	0.0421	2.83	127.0	44.9
1-3	0.1677	8.83	505	57.1
1-4	0.3865	22.34	1168	52.2
1-5	0.6366	30.95	1920	62.0

For the tuning condenser, a decade condenser box was used. The voltage rating of this box necessitated the limiting of the plate voltage to 200 volts. It is true that this is far below the rated voltage of the

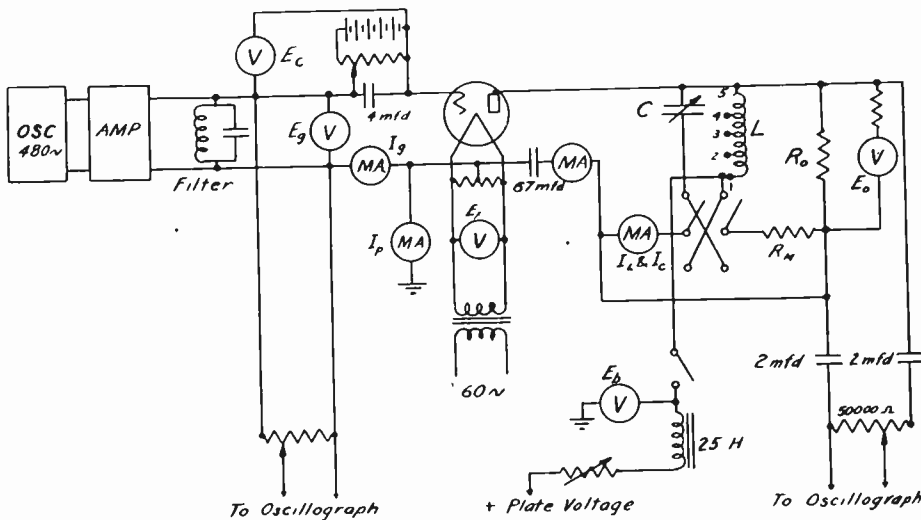

Fig. 1—Diagram of amplifier circuit showing positions of meters and connections to oscillograph.

tubes but as this work had to do primarily with the output circuit this low voltage was not objectional. In fact, it had the advantage that a wide range of output impedances could be used without danger of exceeding the safe plate dissipation of the tube. Also the power was so small that the coil, condenser, and load resistance did not heat enough to affect their resistances.

In obtaining the data for this paper, the load resistance was connected in parallel with the tank circuit. The parallel rather than a series resistance was chosen because of the tuning capacity remaining the same for all values of load resistance. With the series load, a new value of capacity is required for maximum impedance tuning for every change in resistance. Very often in output circuits where the load is coupled to a portion of the inductance, the equivalent load resistance cannot be represented truly by either one or the other, but the parallel

load probably represents the conditions as well or better than the series load.

The excitation voltage was obtained from a General Radio audio oscillator. The oscillator output was fed into a push-pull amplifier using two UX-250 tubes. A parallel resonant filter circuit was connected across the amplifier output. This combination supplied a very pure sine wave voltage to the grid even though the grid current was considerable.

The bias voltage for the low- μ tubes was supplied directly from a battery in series with the grid. For the high- μ tube where the bias was so low that one-cell steps in battery voltage was too great, the bias was taken from a potentiometer across a battery. In this case, the potentiometer was shunted by a four- μ f condenser to eliminate any a-c voltage drop from occurring across it.

In order to read both coil and condenser currents in the tank circuit on the same meter, the meter was connected in one branch and an equivalent resistance in the other branch. By means of a double throw switch as shown in the diagram, the meter and resistance could be interchanged. Although the equivalent meter resistance increased the resistance of the circuit, it was necessary in order that the currents would not change when shifting the meter from one side to the other.

A cathode ray oscillograph was used for determining the amount of distortion in the output voltage wave. The excitation, which was a very good sine wave, was connected to one pair of deflecting plates and the output voltage through coupling condensers and a potentiometer to the other pair. With a pure sinusoidal output voltage, the resulting figure is a straight line or an ellipse symmetrical about the axis. As the per cent of second harmonic increases, the figure becomes unsymmetrical as shown in the typical figures in Figs. 7 and 8. The coupling condensers were so large that their reactance was small as compared to the potentiometer resistance. Their effect on the wave shape could be entirely neglected and the oscillograph circuit could be considered as a pure resistance in its effect on the amplifier circuit.

B. Procedure

Something should be said about choosing the operating conditions and taking the data. First, the bias was adjusted to a value near the cut-off point as is usually done for class B amplifiers. On the first tube, the UV-211, the excitation voltage was chosen such that the tube was operating near the upper limit of the range of class B operation; that is, it was operated near the upper limit of the approximately linear relation between the exciting voltage and the square root of the power

output. As this point is somewhat indefinite, another basis was chosen for adjusting the excitation on the other tubes. After finding the proper bias for each tube, exciting voltages were used which gave approximately the same positive peak grid voltage on all three tubes. The bias and excitation were kept constant while taking all the data on any one tube.

The circuit was tuned by the variable tank condenser when there was no load across the output circuit so that the tuning was sharper and could be detected more accurately. Preliminary work was done to find the best method of detecting the tuned condition. It was found with the help of an oscillograph that the plate current wave form was the most symmetrical and the least distortion in the output occurred when the circuit was tuned for minimum d-c plate current. This is the usual method of tuning radio-frequency amplifiers. The plate efficiency of the tube was also a maximum when tuned for this condition. It was found in every case that the reactances of the condenser and inductance were equal within the error of measurements. Thus, in this paper whenever the symbol X is used in referring to the tuned circuit, the reactance of either the capacity or the inductance is meant as both are equal. The impedance of the circuit was also practically pure resistance when tuned in this way, and it will be considered as a resistance in the rest of the paper.

With each tube, complete sets of current and voltage readings and traces of the output voltage wave shapes on the oscillograph were taken. For each of four values of inductances, readings were taken with parallel load resistance values from infinity down to values far below the operating conditions that are ever used. Oscillograms were made by laying a piece of graph paper over the screen of the cathode ray tube and tracing the curve with a pencil. A set of typical oscillograms are shown in Figs. 7 and 8. The equivalent curves are shown on a linear time axis which is the more familiar form.

In obtaining the scales for the oscillograms, only sinusoidal voltages were used. For the output voltage scale, the load was removed from the circuit and the grid excitation reduced to give a reasonable deflection for the particular potentiometer setting. By a reasonable deflection is meant one large enough to be measured accurately but not so large as to reach into the distorting region near the edge of the screen. Under this condition, the voltage had practically a pure sine wave form and the peak deflection was assumed equal to 1.41 times the voltage as read on the thermovoltmeter. As the grid excitation voltage was sinusoidal all of the time, no special readings were necessary to obtain the scale for it.

C. Computation of Results

The data have been worked up and plotted in Figs. 2-6. The method of calculating the various quantities requires some explanation.

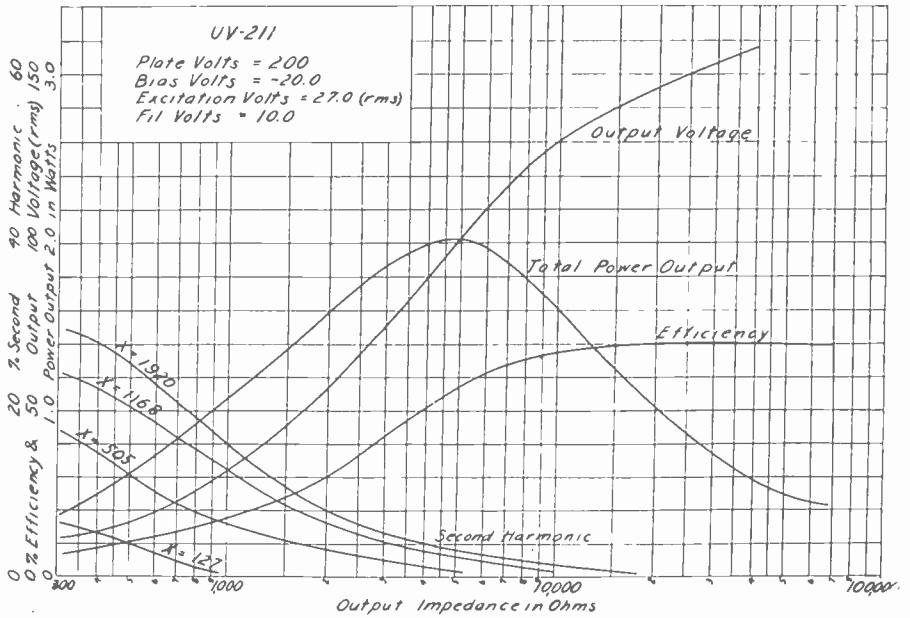

Fig. 2—Output curves for UV-211 tube.

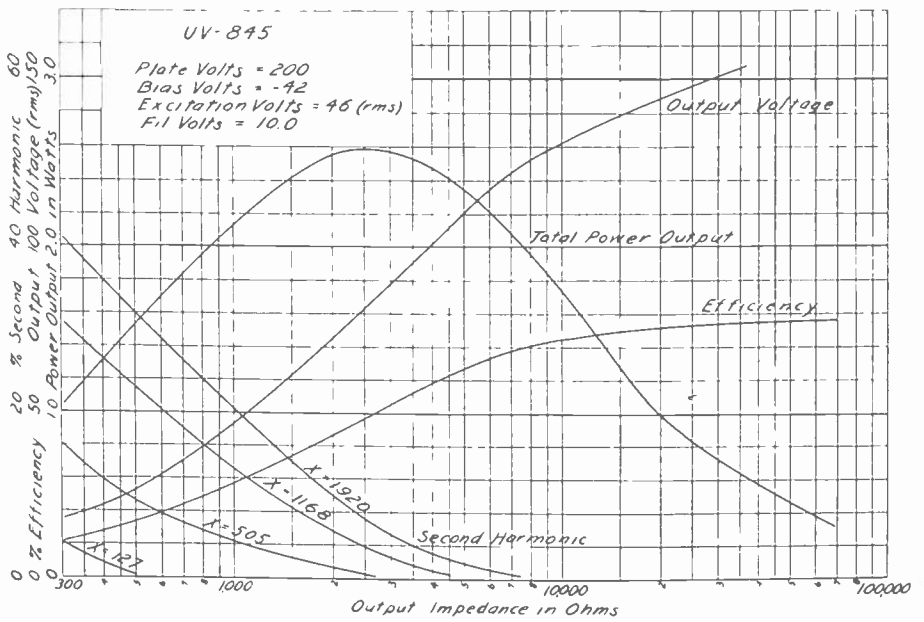

Fig. 3—Output curves for UV-845 tube.

The output circuit impedance was made up of three approximately pure resistances in parallel. The first was the tuned circuit equivalent

resistance, the second the voltmeter and its multiplier resistance, and the third the oscillograph potentiometer resistance.

The tuned circuit equivalent resistance was calculated from the formula,¹

$$R' = \frac{R_C R_L (R_C + R_L) + R_C X_L^2 + R_L X_C^2}{(R_L + R_C)^2 + (X_L - X_C)^2}$$

which in most cases simplifies to

$$R' = \frac{X_L^2 (R_L + R_C)}{(R_L + R_C)^2} = \frac{X_L^2}{R_L + R_C}$$

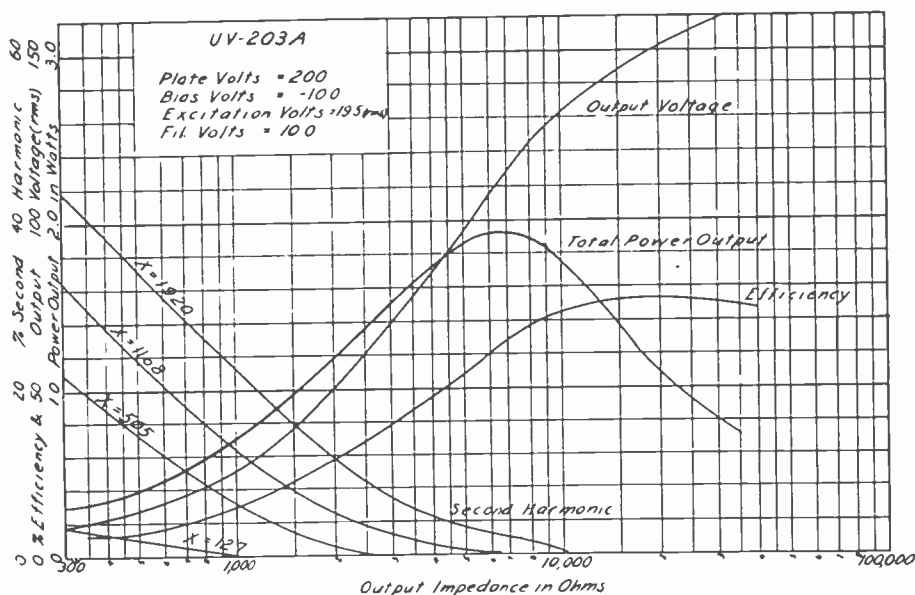

Fig. 4—Output curves for UV-203-A tube.

- as,
- $X_L = X_C$ and X_L is large as compared with R_L and R_C where,
 - R' = equivalent resistance of circuit
 - R_C = the sum of the condenser and meter resistances
 - R_L = the sum of the coil and meter resistances
 - X_L = coil reactance
 - X_C = condenser reactance

The power output was considered as the total power in the circuit including the losses in the coil, condenser, meters, and oscillograph potentiometer and the power in the load resistance. These separate losses were calculated from the values of current, voltage, and resistance of individual parts of the circuit. The total power was checked by dividing

¹ See J. H. Morecroft, "Principles of Radio Communication," page 83, 2nd edition, (1927), John Wiley and Sons, Inc., New York.

the square of the output voltage by the combined effective resistance of the circuit. The agreement was very good in nearly all cases.

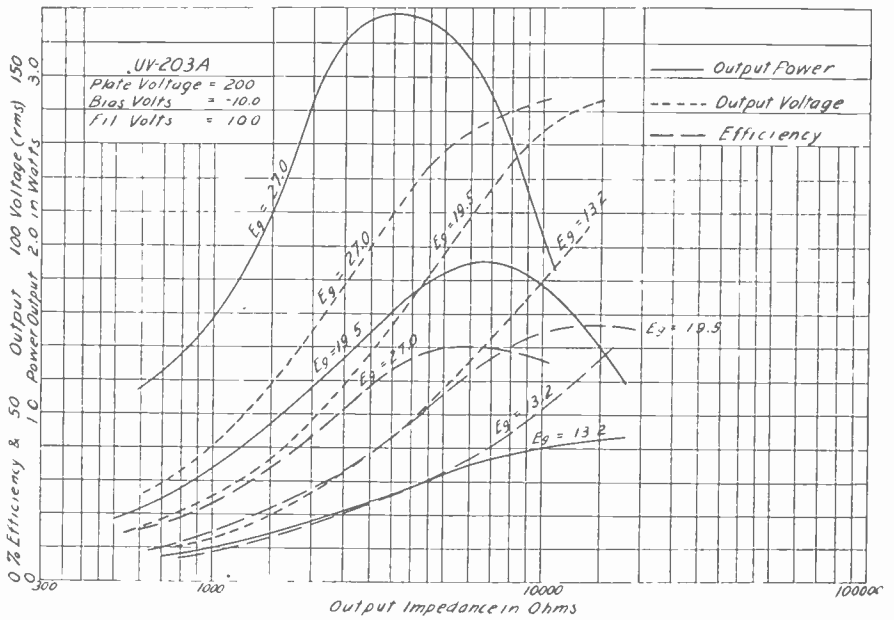

Fig. 5—Output characteristics of UV-203-A for three different values of excitation showing the shift of maximum output with excitation.

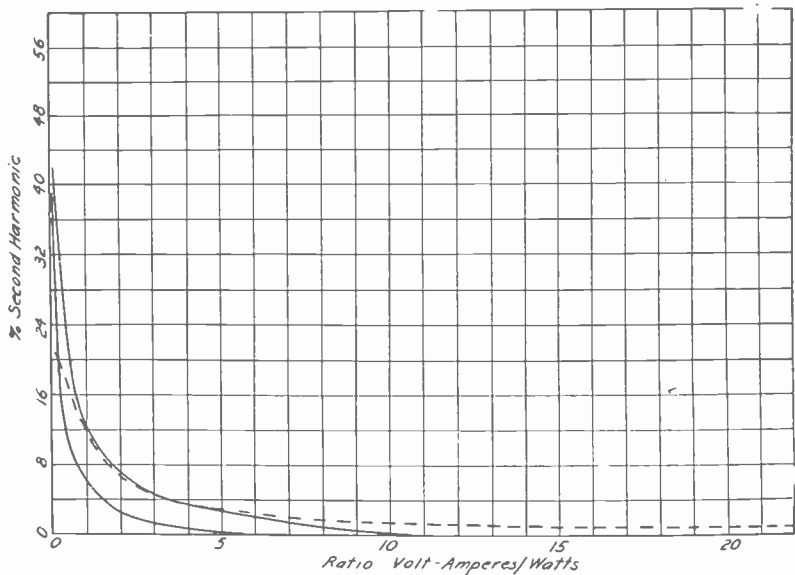

Fig. 6—Curves showing per cent second harmonic in output voltage as a function of the volt-ampere-to-watt ratio in the circuit. Experimental values for all three tubes, for different L/C ratios and for different excitation voltages all lie between the two curves shown by solid lines. The dotted curve shows the values calculated from the circuit impedance for the second harmonic frequency and the second harmonic component of the plate current.

In order to get some simple measure of the distortion of the output voltage wave shape from the oscillograms, the approximate percentage of second harmonic was calculated from the maximum deflections above and below the axis. The usual formula for figuring the second harmonic distortion in audio amplifiers and modulators is²

$$\text{Per cent distortion} = \frac{\frac{D_a + D_b}{2} - D_a}{D_a + D_b} \times 100$$

where,

D_a = maximum deflection above axis

D_b = maximum deflection below axis.

This formula, however, assumes that the distortion is due to the fact that the area under the curve on one side of the axis differs from that on the other side so that a d-c component is added. In this work, as the oscillograph was coupled through condensers, there can be no d-c component. The second harmonic in this case will be, then

$$\text{Per cent second harmonic} = \frac{\frac{D_a + D_b}{2} - D_a}{\frac{D_a + D_b}{2}} \times 100.$$

III. INVESTIGATION OF HARMONICS IN THE OUTPUT

In Figs. 2, 3, and 4 are shown for the three tubes the total power output of the tube, the r-m-s voltage across the output circuit, the plate efficiency of the tube, and the per cent second harmonic, all plotted against the impedance of the output circuit. The power output, the output voltage, and the efficiency curves for the four L/C ratios lie so close together that a single average curve was shown for each. The percentage second harmonic however, differs considerably for different L/C ratios. It is clearly shown by these curves that as L/C becomes larger the distortion is greater for the same output. This is as would be expected. A high L/C means that C is small and, therefore, the energy stored in the condenser when charged to the peak voltage is small. As this energy must supply the energy loss in the circuit and the output for approximately one-half cycle, the ratio of peak stored energy to the energy dissipated in a half cycle must be large if the voltage is to be maintained near the sine wave value that it would have if there were

² Hanna, Sutherlin, and Upp, "Development of a new power amplifier tube," Proc. I.R.E., vol. 16, p. 465; April, (1928).

no dissipation. The output, voltage, and efficiency do not change with L/C as long as the circuit impedance remains the same. This is obvious as these quantities depend on the value of the output impedance only and not on the reactive power in the condenser.

It would be expected that the distortion would be a function of the ratio of the volt-amperes in the tank circuit to the total power dissipated in the circuit and load. To see if this were true, the percentage of second harmonic was plotted as a function of the ratio, volt-amperes/watts output, for all L/C ratios and for all three tubes. The points fell in the region between the two solid line curves shown in Fig. 6. Considering the possible errors in the method of measuring the second harmonic, these limits are close enough together to say that the distortion is a function only of the ratio, volt-amperes/watts output. This distortion would, of course, be much less for the same ratio if the circuit were excited by a push-pull combination of tubes. It would also be somewhat different if the bias and excitation were adjusted as is usually done for class C operation, that is, so that the plate current flows for less than one-half cycle and has a more peaked wave form. This would tend to increase the higher and less important harmonics but probably would not affect the second harmonic very much. The higher harmonics in the plate current are less important because they are almost completely suppressed by the tank circuit.

When certain assumptions are made, the distortion can be calculated from the constants of the circuit.³ The plate current wave shape is assumed to be a rectified sine wave for one-half cycle. This is very nearly true over the range of loading where appreciable distortion occurs if the bias is adjusted near the cut-off value. At large values of output impedance the plate voltage may have such a low minimum that the current wave has a dip in the center or may even go to zero at the point of the normal maximum. This would tend to introduce more harmonics in the output but the power being drawn from the circuit in such a case is small and the power factor low. The filtering action of the circuit is therefore high and the resulting harmonics are small. A very slight effect however may be noticed in the oscillogram shown in Fig. 7 (a). There is a small loop in one end of the original tracing which can barely be seen in the corresponding curve drawn with a linear time axis. The other assumption is that the coil and condenser branches have no losses in themselves. Although this is not the case, it apparently does not affect the results seriously. The resistance of the coil and condenser might be taken into account but it would make the calculations much more difficult and does not seem to be

³ See Appendix I.

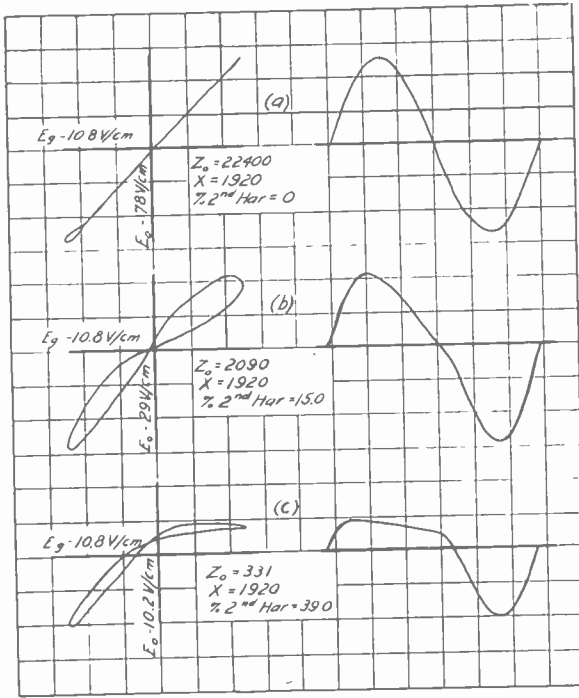

Fig: 7

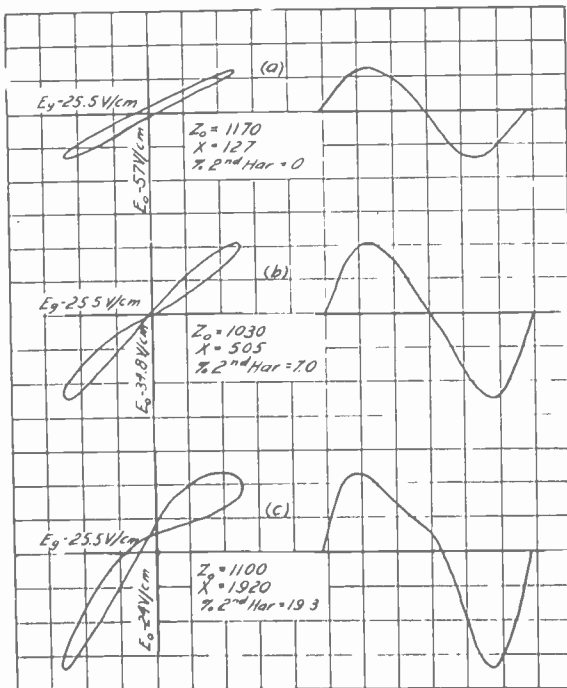

Fig. 8

justified. In the simpler form, the percentage of second harmonic works out as

$$\frac{4}{3\pi\sqrt{4 + 9S^2}}$$

where S is the ratio of volt-amperes to watts in the circuit or the ratio of the combined impedance of the circuit to the reactance of the coil or condenser. The dotted curve in Fig. 6 represents this formula. It is seen to agree fairly well with the experimental data.

By examining the output voltage wave shape, we can see just how the distortion is brought about. In Figs. 7 and 8 are shown the actual wave shapes of the output voltage for several cases. Fig. 7 shows what happens as the load resistance across the output circuit is reduced while L and C remain the same. Fig. 8 shows the effect of decreasing L/C while the output impedance remains approximately the same. Upon examining these wave forms, several interesting things can be seen. In Fig. 8 (c), the inductance is large and the capacity small. Then as the grid voltage reaches the cut-off value, the plate current stops flowing and the large inductance tries to maintain the current that had been flowing through it. The result is that it forces current into the condenser. The condenser voltage rises rapidly because of its small capacity. The rate of rise in (c) of Fig. 8 is easily seen to be greater than in (b), and (b) greater than in (a). As the voltage of the condenser gets higher the load current increases and the charging current reduces and finally becomes zero at the point of maximum voltage. Immediately the condenser starts to discharge back through the inductance and through the load resistance. Because of the high inductance, the condenser discharges slowly as is shown by the long slow falling part of the voltage wave. This slow discharge causes the positive part of the cycle to last about 210 degrees. When the grid voltage becomes such that appreciable plate current flows again, the increasing current flowing through the inductance causes the voltage to drop very rapidly to its minimum value and the condenser charges up in the other direction. The falling-off of the plate current and the discharge of the condenser through the tube and inductance causes a rapid rise in plate voltage. The condenser is completely discharged and is charged in the opposite direction again by the energy stored in the inductance and the cycle repeats itself.

It must be remembered that in this work, the push-pull or balanced amplifier is not considered. In such an amplifier, the distortion would be greatly reduced. Of course, if the tubes and both output and input circuits were perfectly balanced, there would be no second or other

even harmonics. Odd harmonics would, however, still exist as before. It should also be kept in mind that this considers only the distortion of the voltage across the output circuit or the current in a parallel load resistance. As usually used, the actual load is an antenna or other tuned circuit which is coupled in some manner to the output circuit of the tube. This results in considerable additional filtering so that the harmonic content of the voltage across the actual load is considerably less than that in the output tank circuit.

From what has been said in regard to distortion, it would seem that the larger the tank circuit condenser the better it would be. As would be expected, we cannot go on increasing the size of the condenser without limit without meeting some other limitations. One of the first limits usually reached in practice is the economical limit for the condenser, especially for high power circuits. If the condenser has an air dielectric the space required for a large capacity for high voltage becomes very large. If the dielectric be any available solid or liquid dielectric, the volume and surface area must be large to dissipate the heat as the condenser losses depend on the volt-amperes in the condenser. With a large capacity, the tank current is large and for a high power circuit it may be difficult to build an inductance which will carry the current without excessive losses.

There is another limit to the value of the capacity because of another form of distortion. If the ratio of volt-amperes to power is very large, the tank circuit will act like a large flywheel so that the voltage amplitude will drop off very slowly when the exciting voltage is removed. Likewise it will take some time for the amplitude to build up after applying the excitation. Now if it is desired to modulate this output voltage at a moderately high frequency, it is obvious that with too large a flywheel effect the voltage will not follow the modulated excitation. This will have the effect of reducing the per cent modulation at the high modulating frequencies and to a lesser degree at lower frequencies. In other words, the results on the output of the radio receiver is a reduction of the amplitude of the high frequencies. This distortion may be calculated as is done in Appendix II. In this calculation, the distortion is defined as the ratio of the voltage amplitude at the end of one half of a cycle of the modulating frequency to the peak amplitude when the excitation is zero over this half cycle. This distortion may be calculated by the formula,

$$\frac{1}{S} = 1.48 \frac{f_2}{f_1} \log \frac{100}{D}$$

where,

S = volt-ampere-to-watt ratio

f_1 = frequency of carrier

f_2 = modulating frequency

D = per cent distortion as defined above.

As an example, if we assume 5 per cent distortion

$$S = 0.52 f_1/f_2.$$

Suppose the carrier frequency is 550 kilocycles and the highest audio frequency is 5000 cycles, then S must not be greater than

$$0.52 \frac{550}{5} = 57.2.$$

Of course, for a higher carrier frequency this limit for S will be higher. If we take 1500 kilocycles, the upper broadcast frequency, the limit for S is $0.52 (1500/5) = 160$, which is much higher than is ever considered for an output circuit in a power amplifier.

In the usual output circuit the reactance of the inductance and capacity is not small enough to cause appreciable modulation distortion. Thus, the two limits described above still leave considerable leeway for the value of reactance. So far, the losses in the circuit have not been considered. One would expect that the efficiency of the circuit might depend on the volt-ampere-to-watt ratio. Assume a tank circuit having an inductance L , a capacity C , and a circuit resistance R representing circuit losses. Let r be the load resistance in parallel with the circuit, E_0 the voltage across the circuit, and X the reactance of the condenser or inductance.

Then,

$$\begin{aligned} S &= \frac{E_0^2/X}{E_0^2/r + E_0^2RC/L} \\ &= \frac{rL}{X(L + rRC)} \end{aligned}$$

since the parallel circuit impedance exclusive of the load r is very nearly L/RC .

The impedance of the complete circuit is

$$Z = \frac{1}{1/r + RC/L} = \frac{rL}{L + rRC}.$$

In an amplifier circuit, Z is fixed by the type of tube, the operating conditions, the output, and the efficiency desired. This will be men-

tioned again in the next section. If only harmonics in the output are considered as determining S , its value should be as large as possible. Then S/Z will be a sort of figure of merit of the circuit.

$$\frac{S}{Z} = \frac{rL}{X(L + rRC)} \times \frac{L + rRC}{rL} = \frac{1}{X}$$

The loss in the circuit is $E_0^2 RC/L$.

Then as X , which is equal to $\sqrt{L/C}$, is varied X^2/R must remain constant for a constant loss. Therefore if $R = KX^2$, where K is a proportionality constant, the loss will be the same no matter what the value of X . This means that the condenser should be as large as the limitation due to modulation distortion or economic reasons would allow.

It is quite probable that the ratio X^2/R will become slightly smaller as X is decreased. We might assume that

$$R = KX^n$$

and calculate the efficiency of the circuit. The useful output = E_0^2/r .

$$\begin{aligned} \text{Loss} &= E_0^2 R/X^2 = E_0^2 KX^n/X^2 \\ &= KE_0^2/X^{2-n}. \end{aligned}$$

Then the efficiency

$$\begin{aligned} &= \frac{E_0^2/r}{E_0^2/r + KE_0^2/X^{2-n}} \\ &= \frac{1}{1 + Kr/X^{2-n}} = \frac{X^{2-n}}{X^{2-n} + Kr}. \end{aligned}$$

The way in which R will actually depend on X will vary widely with the size and form of the coil, the condenser, and connecting leads. For this reason it is impossible to give any relation for the efficiency which will be at all general. Usually, if the tank circuit losses are important, it is best to use as high reactance as the limitations of the harmonic content of the output will allow.

IV. COMPARISON OF OUTPUT CIRCUIT AND TUBE IMPEDANCES

In the preceding sections, the relations between the circuit constants has been considered only from the standpoint of the harmonic content of the output, the modulation distortion, and the circuit losses. The idea of the necessity of a definite circuit impedance for given output requirements has been mentioned, but nothing has been said about

how to determine this required impedance. Because of the fact that the effective tube impedance must be known in designing an output circuit for a required output from a given tube, it was attempted to see what could be found out from the available data in regard to this impedance.

When a tube is used as a class A audio amplifier, it is customary to consider the tube as a generator having a definite internal impedance. Here, there is a plate current flowing throughout the cycle and it is easy to see that there must be some average tube impedance which can be taken as the equivalent generator impedance. However, in the case of a class B or C amplifier, conditions are quite different. For about a half cycle for class B or more for class C the plate current is zero while the plate voltage is high so that the impedance for this portion of the cycle is infinite. During the remainder of the cycle the tube impedance varies from a very low value to a very high value. The average for the cycle would then be infinite. Obviously, the tube does not act like an infinite impedance generator. It can be seen that the determination of the effective tube impedance from the instantaneous values would be an involved process if at all possible.

As would be expected from the above considerations, no fixed equivalent tube impedance can be found experimentally which will hold for all conditions of operation. However, it is conceivable that for any given plate voltage, bias voltage, and exciting voltage there might be some such equivalent impedance which would remain constant as the output impedance is varied. If this is so and this impedance and the equivalent generator voltage can be found, then the output impedance for any required output can be calculated. It is a well-known fact that when a generator having internal resistance and generating a constant voltage supplies power to an external resistance, maximum power output is obtained when the external and internal resistances are equal. At this point the efficiency is 50 per cent and the output voltage is one half of the generated voltage. It can be seen in Figs. 2 to 5 that there is a distinct point of maximum output for each tube and for each exciting voltage. It will be noticed that at this point of maximum output, the efficiency is greater than 50 per cent. This indicates that the analogy between the tube and a generator should not be carried too far.

It was attempted to see how closely the experimental data could be checked on the basis of the equivalent generator theory. The output impedance for maximum output was obtained from Figs. 2 to 5 and the tube impedance was assumed equal to it. The generated voltage was taken as twice the output voltage at this point. From these two

quantities, the output voltage was calculated for other output impedances by the formula

$$E_0 = \frac{Z_0}{R_p + Z_0} E_{\text{gen}}$$

where,

E_0 is the output voltage

Z_0 is the output impedance

R_p is the equivalent tube impedance = Z_0
at maximum output

E_{gen} is the generated voltage in the circuit
= $2E_0$ at maximum output

The results are shown in Tables III and IV for the three tubes and for two different excitations on the UV-203-A.

TABLE III
UV-211 UV-845

Output Impedance	$R_p = 4800, E_{\text{gen}} = 198$ $E_c = 20, \text{Excit.} = 25 \text{ r-m-s}$		$R_p = 2600, E_{\text{gen}} = 164$ $E_c = -42, \text{Excit.} = 46 \text{ r-m-s}$	
	Actual	Cal.	Actual	Cal.
500	16.5	18.7	26.5	26.4
1000	32	34.2	46	45.5
2000	56	58.2	72	71.2
4000	89	90.0	100	99.5
8000	122.5	124	124.5	124
16000	142	152	139	141
30000	153.5	171	150	151

TABLE IV
UV-203-A

Output Impedance	$R_p = 3500, E_{\text{gen}} = 220$ $E_c = -10, \text{Excit.} = 27 \text{ r-m-s}$		$R_p = 7000, E_{\text{gen}} = 234$ $E_c = -10, \text{Excit.} = 19.5 \text{ r-m-s}$	
	Actual	Cal.	Actual	Cal.
700	29	36.6	18	21.3
1000	40	49	25	29.2
2000	74	80	48	52.0
4000	118	117	84	85.1
8000	140	153	125	125
12000	145	170	140	148

It may be seen from these tables that although the agreement between the actual and calculated voltages is fairly good in one or two cases, it is not good for the others. The tube and output impedances might also be taken equal when the efficiency is 50 per cent. This was tried but the results were found to be even less satisfactory. A value of equivalent impedance might be obtained graphically or analytically from a set of static curves on which the dynamic curves could be plotted. Then if a constant impedance cannot be assumed, some law of variation might be found. This would be a tedious process and difficult

S = volt-ampere-to-watt ratio

f_1 = frequency of carrier

f_2 = modulating frequency

D = per cent distortion as defined above.

As an example, if we assume 5 per cent distortion

$$S = 0.52 f_1/f_2.$$

Suppose the carrier frequency is 550 kilocycles and the highest audio frequency is 5000 cycles, then S must not be greater than

$$0.52 \frac{550}{5} = 57.2.$$

Of course, for a higher carrier frequency this limit for S will be higher. If we take 1500 kilocycles, the upper broadcast frequency, the limit for S is $0.52 (1500/5) = 160$, which is much higher than is ever considered for an output circuit in a power amplifier.

In the usual output circuit the reactance of the inductance and capacity is not small enough to cause appreciable modulation distortion. Thus, the two limits described above still leave considerable leeway for the value of reactance. So far, the losses in the circuit have not been considered. One would expect that the efficiency of the circuit might depend on the volt-ampere-to-watt ratio. Assume a tank circuit having an inductance L , a capacity C , and a circuit resistance R representing circuit losses. Let r be the load resistance in parallel with the circuit, E_0 the voltage across the circuit, and X the reactance of the condenser or inductance.

Then,

$$\begin{aligned} S &= \frac{E_0^2/X}{E_0^2/r + E_0^2 RC/L} \\ &= \frac{rL}{X(L + rRC)} \end{aligned}$$

since the parallel circuit impedance exclusive of the load r is very nearly L/RC .

The impedance of the complete circuit is

$$Z = \frac{1}{1/r + RC/L} = \frac{rL}{L + rRC}.$$

In an amplifier circuit, Z is fixed by the type of tube, the operating conditions, the output, and the efficiency desired. This will be men-

tioned again in the next section. If only harmonics in the output are considered as determining S , its value should be as large as possible. Then S/Z will be a sort of figure of merit of the circuit.

$$\frac{S}{Z} = \frac{rL}{X(L + rRC)} \times \frac{L + rRC}{rL} = \frac{1}{X}$$

The loss in the circuit is $E_0^2 RC/L$.

Then as X , which is equal to $\sqrt{L/C}$, is varied X^2/R must remain constant for a constant loss. Therefore if $R = KX^2$, where K is a proportionality constant, the loss will be the same no matter what the value of X . This means that the condenser should be as large as the limitation due to modulation distortion or economic reasons would allow.

It is quite probable that the ratio X^2/R will become slightly smaller as X is decreased. We might assume that

$$R = KX^n$$

and calculate the efficiency of the circuit. The useful output = E_0^2/r .

$$\begin{aligned} \text{Loss} &= E_0^2 R / X^2 = E_0^2 K X^n / X^2 \\ &= K E_0^2 / X^{2-n} \end{aligned}$$

Then the efficiency

$$\begin{aligned} &= \frac{E_0^2/r}{E_0^2/r + K E_0^2 / X^{2-n}} \\ &= \frac{1}{1 + Kr/X^{2-n}} = \frac{X^{2-n}}{X^{2-n} + Kr} \end{aligned}$$

The way in which R will actually depend on X will vary widely with the size and form of the coil, the condenser, and connecting leads. For this reason it is impossible to give any relation for the efficiency which will be at all general. Usually, if the tank circuit losses are important, it is best to use as high reactance as the limitations of the harmonic content of the output will allow.

IV. COMPARISON OF OUTPUT CIRCUIT AND TUBE IMPEDANCES

In the preceding sections, the relations between the circuit constants has been considered only from the standpoint of the harmonic content of the output, the modulation distortion, and the circuit losses. The idea of the necessity of a definite circuit impedance for given output requirements has been mentioned, but nothing has been said about

how to determine this required impedance. Because of the fact that the effective tube impedance must be known in designing an output circuit for a required output from a given tube, it was attempted to see what could be found out from the available data in regard to this impedance.

When a tube is used as a class A audio amplifier, it is customary to consider the tube as a generator having a definite internal impedance. Here, there is a plate current flowing throughout the cycle and it is easy to see that there must be some average tube impedance which can be taken as the equivalent generator impedance. However, in the case of a class B or C amplifier, conditions are quite different. For about a half cycle for class B or more for class C the plate current is zero while the plate voltage is high so that the impedance for this portion of the cycle is infinite. During the remainder of the cycle the tube impedance varies from a very low value to a very high value. The average for the cycle would then be infinite. Obviously, the tube does not act like an infinite impedance generator. It can be seen that the determination of the effective tube impedance from the instantaneous values would be an involved process if at all possible.

As would be expected from the above considerations, no fixed equivalent tube impedance can be found experimentally which will hold for all conditions of operation. However, it is conceivable that for any given plate voltage, bias voltage, and exciting voltage there might be some such equivalent impedance which would remain constant as the output impedance is varied. If this is so and this impedance and the equivalent generator voltage can be found, then the output impedance for any required output can be calculated. It is a well-known fact that when a generator having internal resistance and generating a constant voltage supplies power to an external resistance, maximum power output is obtained when the external and internal resistances are equal. At this point the efficiency is 50 per cent and the output voltage is one half of the generated voltage. It can be seen in Figs. 2 to 5 that there is a distinct point of maximum output for each tube and for each exciting voltage. It will be noticed that at this point of maximum output, the efficiency is greater than 50 per cent. This indicates that the analogy between the tube and a generator should not be carried too far.

It was attempted to see how closely the experimental data could be checked on the basis of the equivalent generator theory. The output impedance for maximum output was obtained from Figs. 2 to 5 and the tube impedance was assumed equal to it. The generated voltage was taken as twice the output voltage at this point. From these two

in most cases because available static curves do not cover the full range over which the tube operates. This method requires further study and does not come within the scope of this paper.

From the output curves, it can be seen that under the conditions used, namely that of the same peak positive grid excitation, that the UV-845 had the maximum output at the lowest and the UV-203-A at the highest output impedance of the three. Thus the apparent equivalent impedance is higher for the tube with the higher nominal plate impedance. The ratios however, are not the same and for other operating conditions they would be even more erratic. Without further study of the problem there seems to be no way of determining accurately except by experiment the output impedance that is necessary for a given output from a certain tube. Of course, if the impedance for maximum output and output voltage is known, the output voltage can be calculated for other impedances as above with an error of not over 20 to 25 per cent.

V. CONCLUSION

The effects of the circuit constants on harmonics in the output were studied experimentally and theoretically. Curves plotted from the data show clearly that for the same output impedance, as the L/C ratio is increased, the percentage of second harmonic increases. The distortion is found to be a function of the ratio of volt-amperes to the watts dissipated in the circuit.

The percentage second harmonic can be calculated on the basis of a simple circuit made up of a capacity, an inductance, and a resistance in parallel. The calculated results agree with the actual measurements closely enough for practical use. It appears that with a single tube biased to just the cut-off point, the volt-ampere/watt ratio should not be less than 10 or 12 for a percentage second harmonic of not over one per cent. For a push-pull circuit the ratio could be considerably decreased for the same second harmonic percentage.

If the volt-ampere-to-watt ratio is too high another form of distortion occurs when modulation is attempted. Due to the large fly-wheel effect of the circuit, the voltage amplitude does not follow the modulation and there is a discrimination against the higher audio frequencies. A formula for calculating this effect was developed.

The loss in the tank circuit will usually depend on the reactance of the condenser but varies with the power factor of the coil and condenser used.

In a class B or C amplifier, the tube cannot be represented accurately by a generator with internal impedance for all conditions of

operation. For a given bias, excitation voltage and plate voltage and a variable output impedance, the output voltage can be calculated with a maximum error of 20 to 25 per cent on the basis of a constant internal impedance and generated voltage. It will require further study in order to predict the output impedance that is necessary to obtain a certain output from a given tube under specified operating conditions

APPENDIX I

Calculation of Harmonics in Output Voltage

If certain assumptions are made, the ratio of the harmonic to the fundamental amplitude of the voltage across the output circuit can be calculated. The assumptions made are as follows:

- (1) The plate current wave shape is that of the positive half of a sine wave, the current being zero for the other half cycle.
- (2) The tank circuit consists of a pure inductance, a pure capacitance, and a pure resistance in parallel.

Then the a-c component of the plate current will flow through the output circuit. The product of the harmonic components of the current and the corresponding impedance will give the voltages across the load impedance for the corresponding harmonic frequencies.

The symbols to be used are as follows:

L = inductance of coil L

C = capacity of condenser C

r = resistance of load r

$p = 2\pi$ times the frequency

$p_n = 2\pi n$ times the fundamental frequency

Z = impedance of output circuit

Z_n = impedance of output circuit at n times fundamental frequency

i = instantaneous plate current

I_m = peak plate current

$$X = \sqrt{\frac{L}{C}} = pL = \frac{1}{pC}$$

$$S = \frac{r}{x}$$

$$1/Z = \frac{1}{r} - j \frac{1 - p^2LC}{pL}$$

$$1/Z^2 = \frac{1}{r^2} + \frac{(1 - p^2LC)^2}{p^2L^2}$$

from which we get

$$Z = \frac{prL}{\sqrt{p^2L^2 + r^2(1 - p^2LC)^2}}$$

Let $p = np_0$ where $p_0^2LC = 1$ and $n = \text{any positive integer}$ then

$$Z_n = \frac{nrX}{\sqrt{n^2X^2 + r^2(1 - n^2)^2}}$$

The a-c component of plate current can be expressed in a Fourier series of the form

$$\frac{1}{I_m} = A_1 \cos \theta + A_2 \cos 2\theta + A_3 \cos 3\theta + \dots$$

where,

$$A_n = \frac{2}{\pi} \int_0^\pi f(\theta) \cos n\theta d\theta$$

$$f(\theta) = -\cos \theta \text{ from } \pi/2 \text{ to } \pi \\ = 0 \text{ from } 0 \text{ to } \pi/2$$

then,

$$A_1 = -\frac{2}{\pi} \int_{\pi/2}^\pi \cos^2 \theta d\theta = -\frac{1}{2}$$

$$A_2 = -\frac{2}{\pi} \int_{\pi/2}^\pi \cos \theta \cos 2\theta d\theta = \frac{2}{3}\pi$$

$$A_3 = -\frac{2}{\pi} \int_{\pi/2}^\pi \cos \theta \cos 3\theta d\theta = 0$$

$$A_4 = -\frac{2}{\pi} \int_{\pi/2}^\pi \cos \theta \cos 4\theta d\theta = -\frac{2}{15}\pi$$

$$A_5 = 0$$

$$A_n = 0 \text{ when } n \text{ is odd}$$

$$A_n = -\frac{2}{\pi} \left[\frac{1}{2(1-n)} + \frac{1}{2(1+n)} \right] (-1)^{(n/2+1)}$$

where n is even

$$i/I_m = -\frac{\cos \theta}{2} + \frac{2 \cos 2\theta}{3\pi} - \frac{2 \cos 4\theta}{15\pi} + \dots$$

Then the voltage across the load resistance will be

$$\begin{aligned}
 iZ &= i \frac{nrX}{\sqrt{n^2X^2 + r^2(1 - n^2)^2}} \\
 &= -\frac{r}{2} I_m \cos \theta + \frac{2}{3\pi} \frac{I_m 2rX \cos 2\theta}{\sqrt{4X^2 + 9r^2}} \\
 &\quad - \frac{2I_m 4rX \cos 4\theta}{15\pi \sqrt{16X^2 + 225r^2}} + \frac{2I_m 6rX \cos 6\theta}{35\pi \sqrt{36X^2 + 1220r^2}} \dots
 \end{aligned}$$

from which we get the fundamental voltage amplitude

$$E_1 = \frac{I_m r}{2}$$

the second harmonic

$$E_2 = \frac{4I_m rX}{3\pi \sqrt{4X^2 + 9r^2}}$$

the third harmonic

$$E_3 = 0$$

the fourth harmonic

$$E_4 = \frac{8I_m rX}{15\pi \sqrt{16X^2 + 225r^2}}$$

On taking the ratios of each amplitude to the fundamental and substituting $S = r/X$ we get

$$E_2/E_1 = \frac{4}{3\pi \sqrt{4 + 9S^2}}$$

$$E_3/E_1 = 0$$

$$E_4/E_1 = \frac{16}{15\pi} \frac{1}{\sqrt{16 + 225S^2}}$$

APPENDIX II

Calculation of Distortion in Modulated Tank Current Due to Too Small Decrement

If the decrement of the tank circuit is too low and the excitation or plate voltage on the amplifier tube is being modulated, the tank current amplitude will not follow the modulation. This distortion is calculated below. In this calculation, D will represent the per cent distortion and is defined as follows: Assuming that the modulation would be 100 per cent if the decrement were high, the carrier amplitude will

not go to zero with a low decrement circuit. One half of a modulating cycle after the point of maximum carrier amplitude, this carrier amplitude should be zero but instead it has not had time to go to zero which would theoretically take an infinite time. D is, then, the ratio expressed in per cent of the carrier amplitude at the point one half of a modulating cycle after the point of maximum amplitude to this maximum amplitude. It is assumed that there is no excitation over this half cycle.

Let,

f_1 = frequency of the carrier

f_2 = frequency of the sinusoidal modulating voltage

r = equivalent resistance of output circuit, including load and circuit losses.

X = reactance of the capacity or inductance, both being assumed equal

d = logarithmic decrement of the circuit

$$= \pi X/r$$

n = number of f_1 cycles in $1/2$ of an f_2 cycle

$$= \frac{1}{2} \frac{f_1}{f_2}$$

s = ratio of volt-amperes to watts in circuit

$$= r/X$$

Then,

$$e^{nd} = \frac{E_{\max}}{E_{\min}} = \frac{100}{D}$$

$$\log_e \frac{100}{D} = nd = \frac{d}{2} \frac{f_1}{f_2}$$

$$d = \frac{2f_2 \log_e 100/D}{f_1} = \frac{2 \times 2.303f_2}{f_1} \log \frac{100}{D}$$

$$= \pi X/r = \pi/s$$

or,

$$\frac{1}{S} = 1.48 \frac{f_2}{f_1} \log \frac{100}{D}$$



THE RECEPTION OF FREQUENCY MODULATED RADIO SIGNALS*

BY

VICTOR J ANDREW

(Ryerson Physical Laboratory, University of Chicago, Chicago, Ill.; formerly Westinghouse Electric and Manufacturing Co., Cicopee Falls, Mass.)

Summary—The reception of frequency modulated signals by means of various adjustments of a tuned circuit is discussed nonmathematically. The simplest method consists in analyzing the signal into a carrier and side bands, and calculating the response of the tuned circuit to each component. The maximum power response is found to be 0.09 of the response with an amplitude modulated transmitter of the same power. There is an inherent discrimination in the receiver against the lower modulation frequencies which just balances a similar discrimination in the transmitter against the higher modulation frequencies.

THE common type of radio signal consists of a radio-frequency carrier, the amplitude of which varies according to an audio frequency which it is desired to transmit. For several years a method of transmission known as frequency modulation has been discussed, in which the amplitude of the carrier frequency remains constant, but its frequency varies up and down with the rise and fall in voltage of the modulation frequency.

For most purposes it is more convenient to treat amplitude modulation as a carrier and two side bands, each of constant amplitude and frequency, which is readily shown to be the mathematical equivalent of a carrier of constantly varying amplitude. A similar analysis of a frequency modulated carrier into an equivalent carrier and side bands of constant amplitude and frequency has been published by Carson,¹ van der Pol,² and Roder.³ The side bands are on each side of the carrier frequency and are separated from it by one, two, three, etc., times the modulation frequency. If the shift in frequency during modulation is small compared to the modulation frequency, only the first side band on each side of the carrier is strong enough to be important.

There follows a nonmathematical description of the reception of these two kinds of modulated signals, for various tuned circuits.

Amplitude modulation, broad resonance curve, analysis with side bands. The carrier and two side bands pass through the tuned circuit

* Decimal classification: R111.6. Original manuscript received by the Institute, October 3, 1931.

¹ J. R. Carson, "Notes on the theory of modulation," Proc. I.R.E., vol. 10, p. 57; February, (1922).

² Balth. van der Pol, "Frequency modulation," Proc. I.R.E., vol. 18, p. 1194; July, (1930).

³ Hans Roder, "Amplitude, phase, and frequency modulation," Proc. I.R.E., vol. 19, p. 2145; December, (1931).

and are impressed on the detector. Each combination of two frequencies produces a beat in the detector. The two beats between the side bands and the carrier are in phase and their amplitudes add. The beat between the two side bands produces a second harmonic of the modulation frequency which is usually very weak.

Amplitude modulation, broad resonance curve, analysis with a carrier of varying amplitude. The carrier of varying amplitude is impressed on the tuned circuit. The broad resonance curve is the result of rather high resistance in the tuned circuit. The resistance dissipates the energy very soon after it enters the tuned circuit. The oscillating current in the tuned circuit, therefore, rises and falls almost immediately with the rise and fall of the impressed carrier. The oscillating current, rectified in the detector, becomes a direct current pulsating with the rise and fall of the carrier amplitude.

Amplitude modulation, sharp resonance curve, analysis with side bands. If the resonance curve is sufficiently sharp, no two of the three separate frequencies can pass the tuned circuit with sufficient amplitude to produce a strong beat in the detector.

Amplitude modulation, sharp resonance curve, analysis with a carrier of varying amplitude. A sharp resonance curve is the result of a low resistance tuned circuit. When the carrier frequency is impressed on the tuned circuit, the oscillating current will build up until a considerable amount of energy is stored up. When the amplitude of the impressed carrier changes, the oscillating current will not change much within the length of time of one cycle of modulation frequency, and the amplitude modulation will, therefore, disappear.

Frequency modulation, broad resonance curve, analysis with side bands. The two side bands, which are of equal intensity, pass through the tuned circuit with the carrier and are impressed on the detector. Two modulation frequency beat notes are produced which are of equal amplitude and opposite phase. They oppose each other and no signal is heard.

Frequency modulation, broad resonance curve, analysis with a carrier of varying frequency. The tuned circuit, because of its high resistance, contains little energy in oscillating current, and will respond quickly to changes in frequency as well as changes in amplitude of the impressed carrier. The carrier is therefore impressed on the detector at all times, and the d-c output is constant. No signal is heard.

Frequency modulation, intermediate resonance curve, analysis with side bands. Assume the receiver tuned so that the carrier lies about half-way down one side of the resonance curve, one side band is between the carrier and the peak of the curve, and one is between the carrier and

the base of the curve. The side band near the peak of the curve will be transmitted to the detector with considerably more amplitude than the one near the base, and will, therefore, produce a stronger beat with the carrier. The two modulation frequency beats will oppose each other, but the difference between their amplitudes will constitute a signal. This is the method which is used in reception of frequency modulation, and will be discussed more fully later.

Frequency modulation, intermediate resonance curve, analysis with a carrier of varying frequency. As the frequency of the carrier changes, it will approach and recede from the peak of the resonance curve. The amplitude impressed on the detector will thereby vary, and a signal will be heard.

Frequency modulation, sharp resonance curve, analysis with sidebands. As with amplitude modulation, the side bands will not pass through the sharply tuned circuit and no signal will be heard.

Frequency modulation, sharp resonance curve, analysis with a carrier of varying frequency. The energy in the oscillating current in the low resistance tuned circuit will be so large that it will not respond quickly to changes in frequency of the impressed carrier. A carrier constant in frequency and amplitude will, therefore, be impressed on the detector, and no signal will be heard.

It has often been suggested that the resonance curve for reception of frequency modulated signals should be just wide enough so the straight portion on one side can include the carrier over the range of frequencies through which it shifts. If the shift is small compared with the modulation frequency, the side bands will be well outside the resonance curve, and the condition described in the two preceding paragraphs will result. No signal will be heard. The correct breadth of curve is such that the carrier and one side band will pass with large amplitude and the other side band will pass with little or no amplitude, in order that the difference between the two side bands will be a maximum.

Fig. 1 shows the response to a carrier and side bands in a broad resonance curve. If the side bands are due to frequency modulation since they are passed with equal amplitude, no signal will be heard. Fig. 2 shows a resonance curve of about the right sharpness, but the receiver is tuned so the carrier is at the peak of the curve. The two side bands are passed with equal amplitude, and no signal is heard.

In Fig. 3 the resonance curve is adjusted to obtain the maximum response from a frequency modulated signal. The carrier and one side band are near the peak of the curve, and the other is near the base. Fig. 4 is the adjustment usually used. Since the side bands are both

kept on the straight portion of the resonance curve, the difference in amplitude of the two side bands is proportional to the modulation fre-

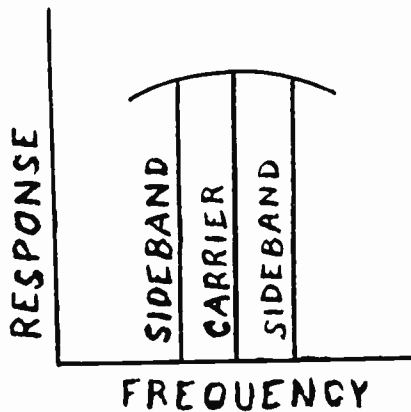

Fig. 1

quency. This proportionality is necessary for faithful reproduction, since the writers referred to previously have shown that the ampli-

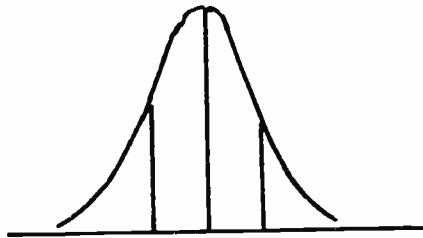

Fig. 2

tude of the side bands originating in the transmitter are inversely proportional to the modulation frequency.

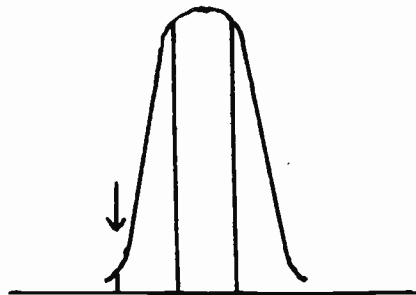

Fig. 3

Figs. 5 and 6 show two other possible methods of obtaining faithful reproduction. The amplitude of one of the side bands is kept constant, on the flat portion of the curve either at the base or at the top, and the amplitude of the other varies with modulation frequency.

With the resonance curve of Fig. 3, the response has one half the amplitude it would have with both side bands in amplitude modulation, if the carrier and side bands were transmitted with the same am-

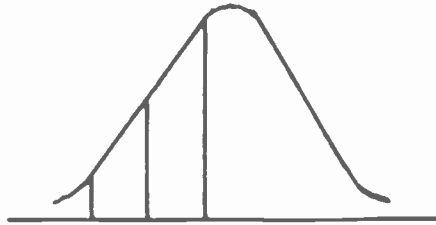

Fig. 4

plitude as for frequency modulation. With frequency modulation, the maximum product of the carrier and one side band is obtained when the carrier is 0.77 times and the side band 0.40 times the amplitude of

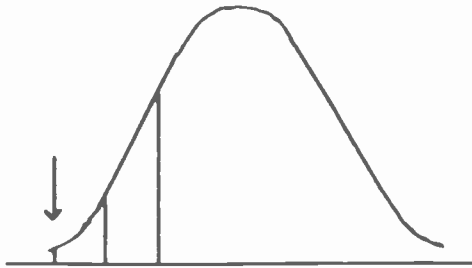

Fig. 5

the unmodulated carrier. The product is 0.31. With amplitude modulation the carrier may maintain its unmodulated amplitude and the side bands reach a value of 0.5 times it. The maximum possible signal

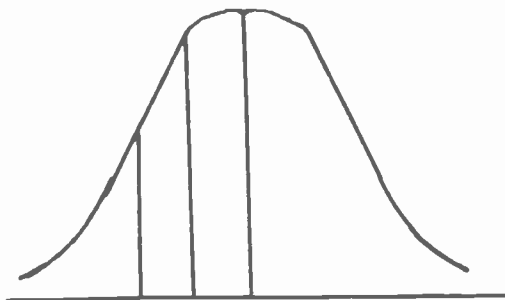

Fig. 6

amplitude with frequency modulation is therefore $\frac{1}{2} \times 0.31 / 0.5 = 0.31$ times the amplitude with amplitude modulation, or $0.31^2 = 0.09$ times the power.⁴ The frequency shift necessary to produce these strong side bands will also produce a second pair of side bands of 0.25 times the

⁴ The author is indebted to Mr. Landon for a large part of the calculations involved here.

amplitude of the first pair. If this is not permissible, a smaller shift with still less signal intensity must be used.

If the shift is large enough to produce appreciably higher side bands, calculations similar to those outlined above are still possible. The fundamental and harmonics of the modulation frequency are then each composed of several components, each resulting from a particular combination of side bands, which must be added with proper consideration of their phase. The sum may sometimes vanish. For instance, with the curve of Fig. 4 and a square-law detector, one value of shift frequency to modulation frequency makes the second harmonic of the modulation frequency disappear. The third harmonic is then 0.1 times as strong as the fundamental. If a transmitter were adjusted so that the frequency shift was proportional to the modulation frequency, the undesirable harmonics might be kept very small.



FIELD INTENSITY MEASUREMENTS AT FREQUENCIES FROM 285 TO 5400 KILOCYCLES PER SECOND*

BY

S. S. KIRBY AND K. A. NORTON

(Bureau of Standards, Washington, D.C.)

Summary—Radio field intensities were measured at distances of only a few wavelengths from a transmitting station on a wide range of frequencies, including the broadcast band, in order to determine the distance at which ground absorption became appreciable. At a distance of 2.4 kilometers, there was no appreciable absorption for frequencies below about 1000 kc; above this frequency, the absorption became appreciable and increased as the frequency was increased. Measurements made at greater distances on broadcast transmissions, airways phones, and airways beacons show that field intensities fall off to one per cent of what the inverse distance law with no absorption would give at distances from 100 to 400 kilometers depending on the frequency and the nature of the ground. The experimental data were compared with Rolf's attenuation graphs in order to determine the electrical constants of the land east and west of the Allegheny Mountains. East of and including the mountains (Maryland, Pennsylvania, and New Jersey) the conductivity and dielectric constant were found to be 3.35×10^{-14} e.m.u. and 13, respectively; west of the mountains (near Chicago) they were found to be 1.07×10^{-13} e.m.u. and 13, respectively. Using these constants theoretical values of field intensity were graphed for these two types of ground and for broadcast frequencies.

The experimental data were also compared with results given by the Austin-Cohen transmission formula. It was found that for overland transmissions in the range of frequencies observed this formula did not satisfactorily give the variations in field intensity as the distance was changed or as the frequency was changed.

THE measurements reported in this paper are part of a research on the accuracy of means of measurement of radio field intensity. Measurements of received field intensities at broadcast frequencies, at a distance of about 3 km from a radio transmitting station, were compared with values calculated from the simple radio transmission formula. Let F_m represent the measured value of field intensity and F_c the value calculated from the simple transmission formula in which the earth is assumed to be perfectly conducting. It was found that the ratio F_m/F_c decreased at this distance as the frequency increased. The transmission formula used was the familiar inverse distance formula

$$F_c = \frac{377hfI}{cd} \text{ volts/cm} \quad (1)$$

* Decimal classification: R270. Original manuscript received by the Institute, February 5, 1932. Publication approved by the Director of the Bureau of Standards of the U. S. Department of Commerce.

where,

h = the effective height of transmitting antenna in centimeters

f = the frequency in cycles per second

I = current in transmitting antenna measured in amperes

c = velocity of propagation of electromagnetic waves (3×10^{10} cm/sec.)

d = distance in centimeters from transmitter to the point at which the field intensity was measured.

The field intensities were measured with a commercial field intensity measuring set, which had been checked against measuring sets constructed by the Bureau. The transmitting antenna used was a condenser antenna 114 cm high and with a 750-cm radius. The value used for h was the actual distance between the plates of this arrangement. The transmission path was almost entirely over river water, the transmitting and receiving stations being located on opposite shores of the Potomac River. The fact that the ratio F_m/F_c decreased as the frequency increased was interpreted to mean that there was an appreciable absorption at these frequencies over even this short path. These observations were checked with a vertical wire antenna and a loop antenna with similar results.

In order to check the conclusion that absorption was appreciable over distances of a few kilometers at broadcast frequencies the field intensity measuring set was put on a boat so that its distance from the transmitter could be varied in a straight line and so as to obtain uniform ground conditions. The transmitter was set at the water's edge at low tide and was over water at high tide. A loop antenna was used with the transmitter in this case. Measurements were made at distances of 1 to 2 wavelengths and at the distance of 3.15 km (corresponding to 5 to 16 wavelengths) from the transmitting station. The ratio of F_m/F_c at the greater distance was divided by that ratio at the nearer distance to get the "attenuation factor" A which we define as

$$A \equiv \frac{Fd}{F_1d_1} \quad (2)$$

where F_1 is the field intensity measured at a distance d_1 kilometers which is so near the transmitter that absorption has not yet become appreciable, and F is the measured field intensity at any greater distance d kilometers. All conditions at the transmitter (i.e., antenna current, tide, frequency, etc.) are the same when these two measurements are made. The results of these measurements are shown by the upper

graph of Fig. 1. The lower graph of Fig. 1 shows attenuation factors obtained in a similar manner over a land path of 4.15 km.

The ratios of F_m/F_c (not A) were also determined for eight different distances over the water path and for several different frequencies from 590 to 5400 kc. The results of these measurements are shown in Fig. 2. For frequencies up to 1100 kc no appreciable absorption could be detected at distances up to 2.4 km. The accuracy of the measurements was about five per cent and ratios differing from unity by less than this amount indicated no appreciable absorption. At higher

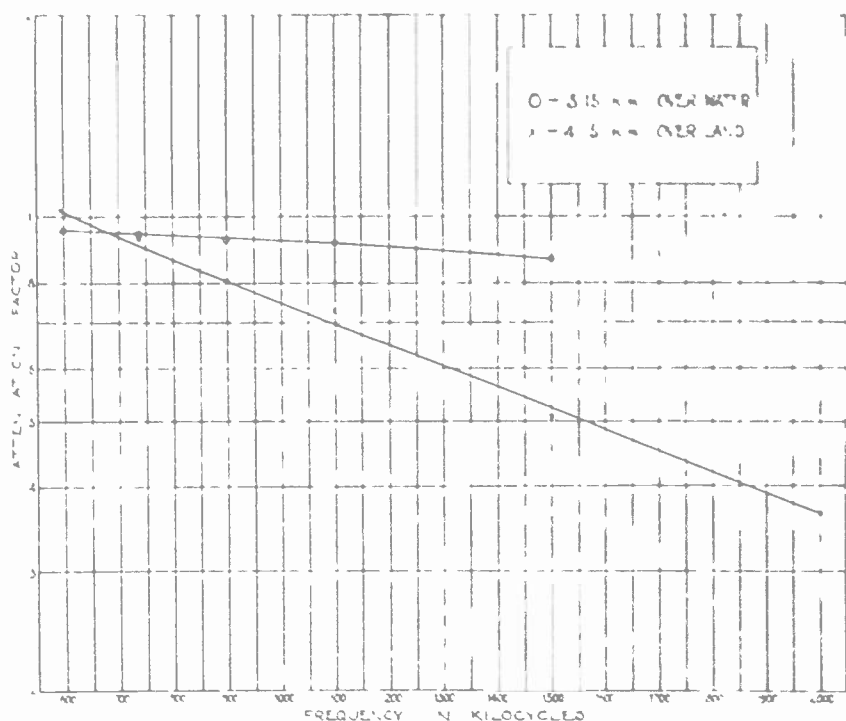

Fig. 1—Attenuation factor vs. frequency. The upper one for $D = 3.15$ km over fresh water and the lower one for $D = 4.15$ km over land.

frequencies the absorption became appreciable and increased as the frequency increased.

The results of these two experiments showed that if field intensity measurements were made around a transmitting station to determine the actual radiation, they should be made fairly close to the transmitter, say within 5 wavelengths, for frequencies in the broadcast band, in order to avoid errors due to absorption. The maximum distances at which such measurements should be made depend on the nature of the transmission path. Over highly conducting ground such measurements could be made farther from the transmitting station than over poorly conducting ground.

Later daytime field intensity measurements were made of transmissions from twelve broadcast stations, three airways phones, one airways radio range beacon, and the Bureau of Standards experimental beacon, at various distances, from 1 to 3 km out to several hundred

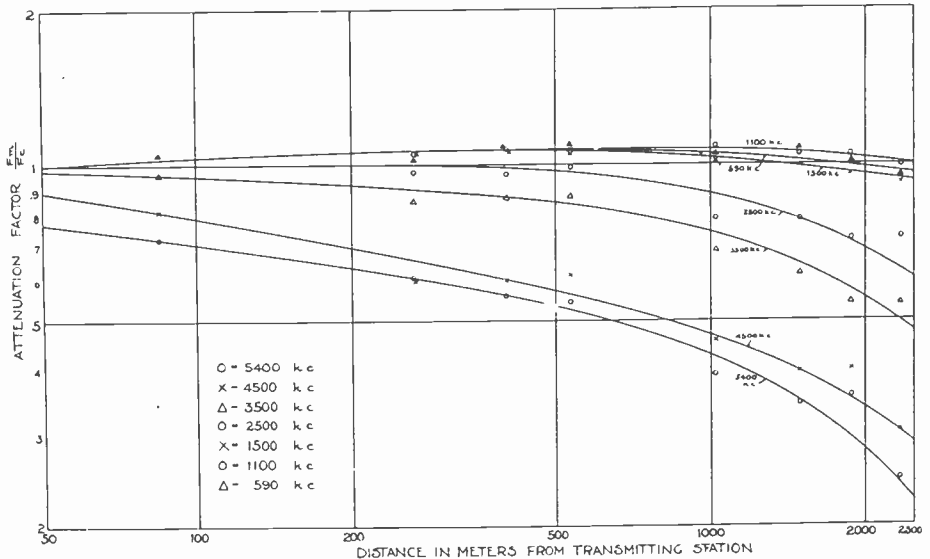

Fig. 2—Attenuation factor F_m/F_c vs. distance for various frequencies with a water path. (Graphs are not theoretical as are some of the later graphs.)

kilometers from the transmitting station. Usually the near-by measurements were taken within the distance at which absorption began as was determined by Figs. 1 and 2. Two trips were made with a field in-

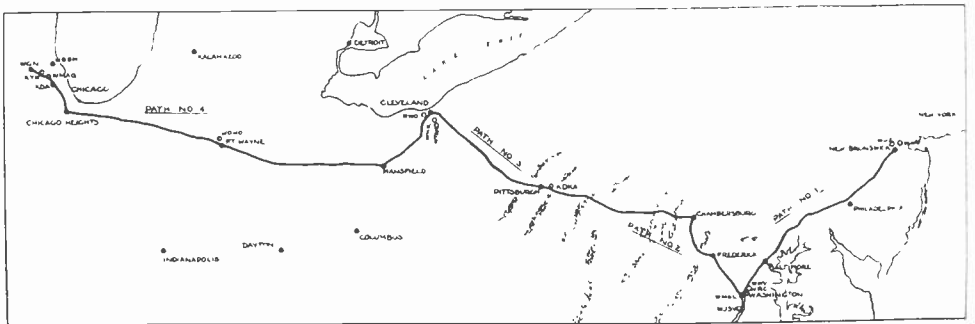

Fig. 3—Paths over which field intensity measurements were made of transmissions from broadcast and airways stations.

tensity measuring set in a laboratory truck. The first trip was made June 2 to 7, 1930, over path No. 1 as shown in Fig. 3. The second trip was made November 3 to 19, 1930, over paths 2, 3, and 4. The stations measured were

Station	Frequency, kc	Location
WWV	290	College Park, Md., near Washington.
WWU	338	New Brunswick, N. J.
WVO	344	Cleveland, Ohio.
KDA	350	Maywood, Ill., near Chicago
WMAL	630	Washington, D. C.
WMAQ	670	Addison, Ill., near Chicago.
WGN	720	Elgin, Ill.
WJZ	760	Bound Brook, N. J.
WBBM	770	Glenview, Ill., near Chicago.
WRC	950	Washington, D. C.
KDKA	980	Pittsburgh, Pa.
KYW	1020	Bloomington, Ill., near Chicago.
WTAM	1070	Brecksville, Ohio, near Cleveland.
WOWO	1160	Fort Wayne, Ind.
WHK	1390	Cleveland, Ohio.
WJSV	1460	Mt. Vernon Hills, Va., near Washington, D. C.

The field intensity measurements made on these trips are plotted on Figs. 4 to 10 inclusive. In order to give some idea of the variations in the field intensities from day to day, the measurements made on station WGN are listed in Table I. It may be seen that the measurements on the trip into Chicago agree very well with those made on the trip out of

TABLE I
WGN—720 KC. FIELD INTENSITY $\mu\text{v}/\text{METER}$

D in km.	Going	Returning
3.86		356,000
13		124,900
29		49,950
36.5		34,000
45.7		25,200
61.5		14,595
78.5	8650	8,720
92.0		7,140
109.3	4275	4,010
131		1,854
150	1192	1,269
192.5	600	614
243	317.5	318
281	237.0	230
326	183.9	184
375	146.1	155
414	89.5	87.8
456	61.9	61.1
492	54.7	
496		36.7
513		43.4
532		23.4
595		9.6

Chicago. It may be of some interest to mention at this point that the field intensities were not calculated from the data until the trip was finished. This allowed some irregularities to enter the measurements which might otherwise have been avoided, because there was no further opportunity to check and find the cause of any apparently inconsistent

measurements. However, the results are now much less liable to psychological errors.

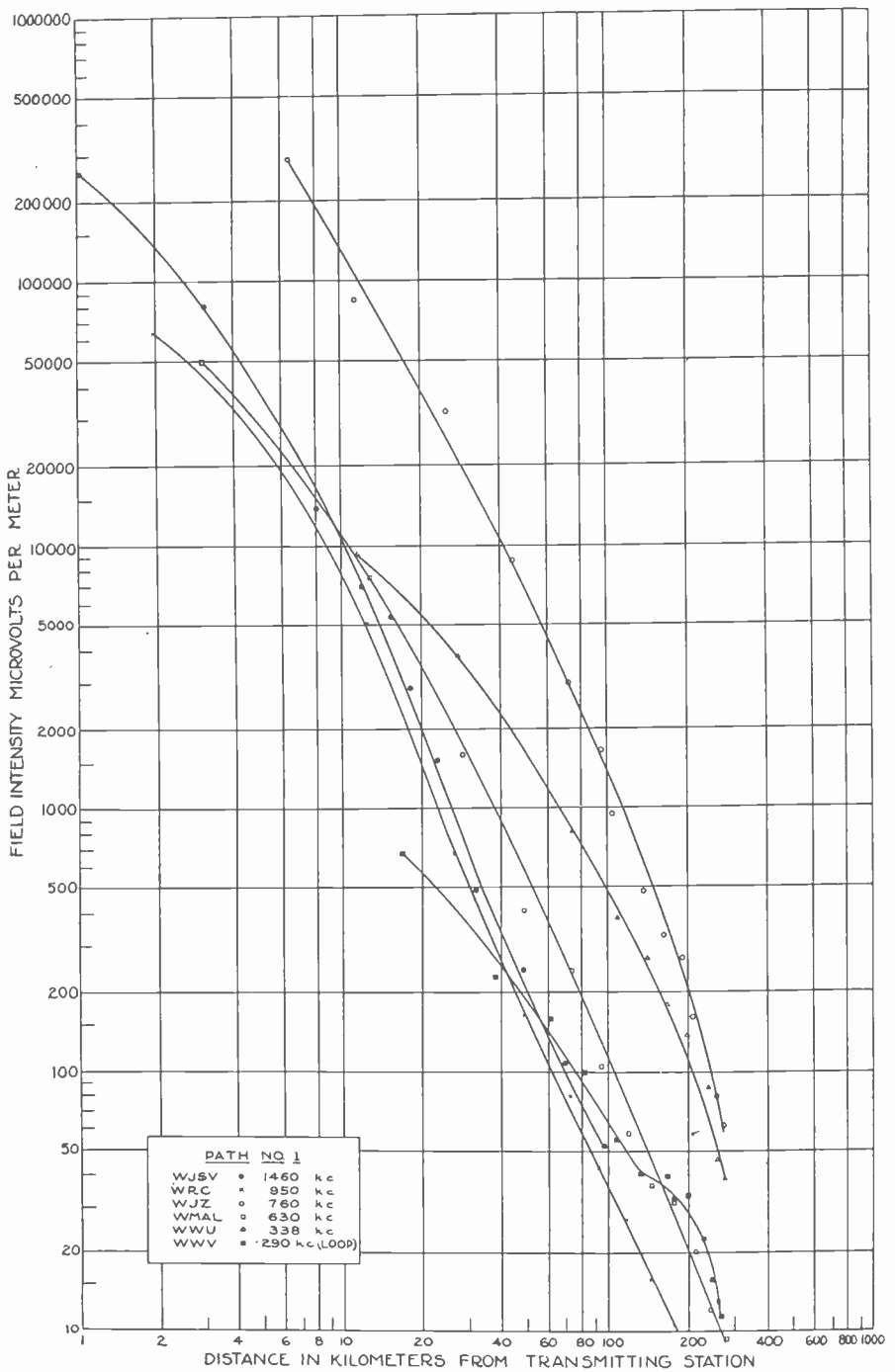

Fig. 4—Field intensity measurements over path No. 1.

Some points of interest stand out on these graphs, notably the fact that the lower frequency transmissions, as illustrated by the airways

phones, are attenuated much more slowly than the higher frequency transmissions. However, it is difficult to compare the absorption at

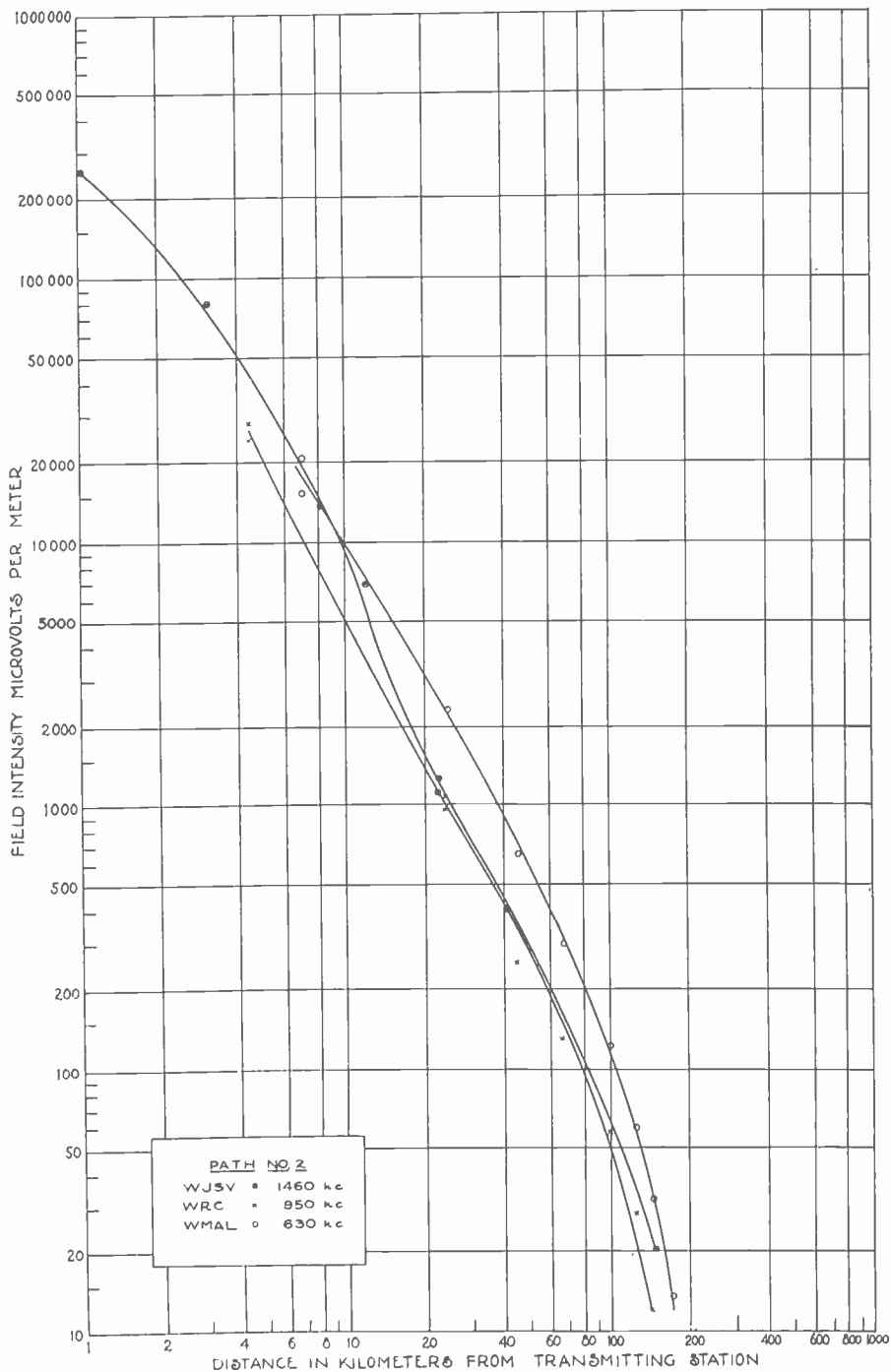

Fig. 5—Field intensity measurements over path No. 2.

various frequencies and over different paths by means of such graphs because the radiated power differed so much.

It should be noted at this point that the attenuation factor as defined by (2) is independent of the power used by the transmitting

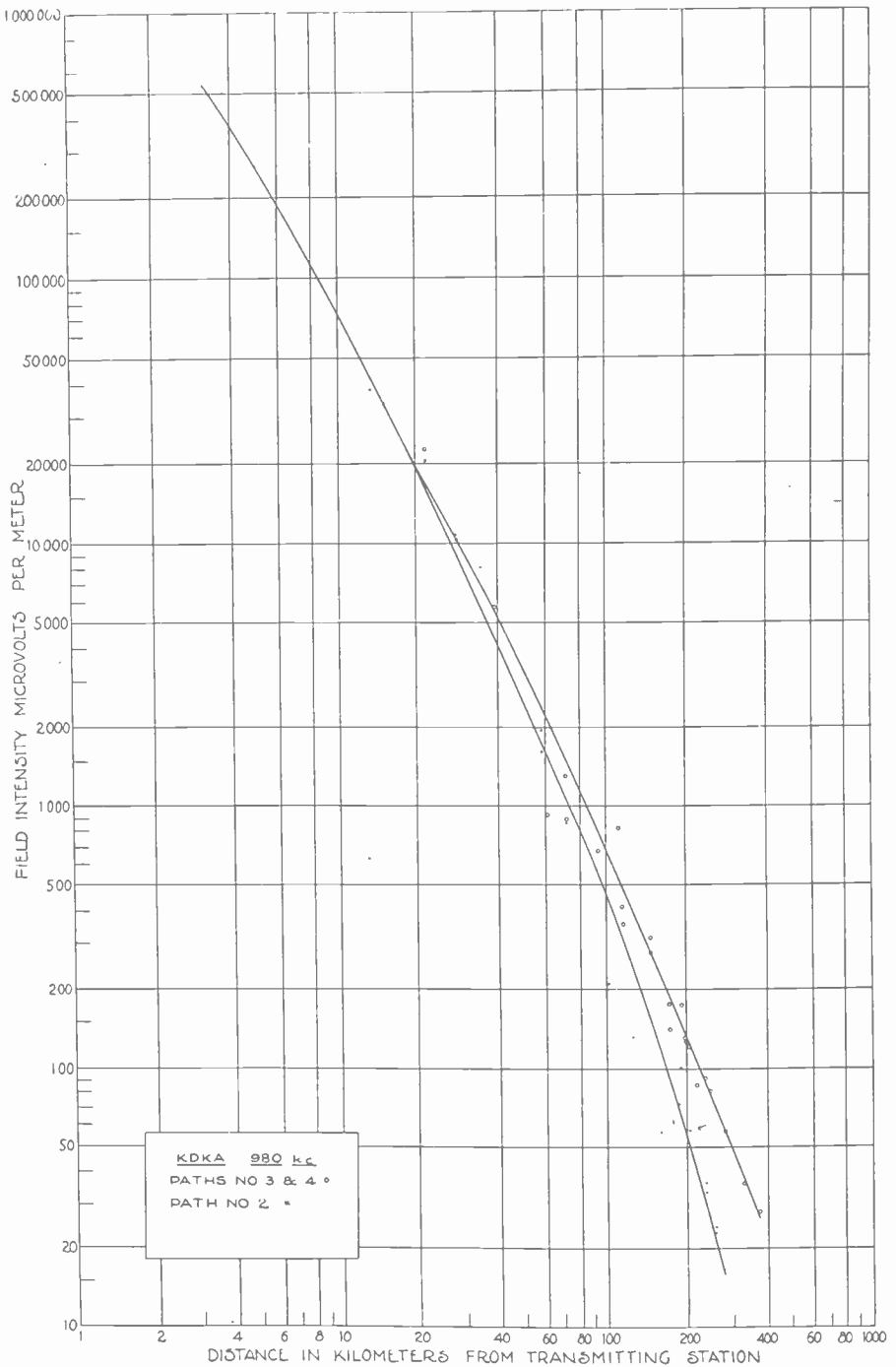

Fig. 6—Field intensities for KDKA on 980 kc.

station provided the same power is radiated when the measurement at d is made as when the measurement at d_1 is made. The stations meas-

ured usually maintained their antenna current at a fairly constant value during the measurements, and consequently the values of A may

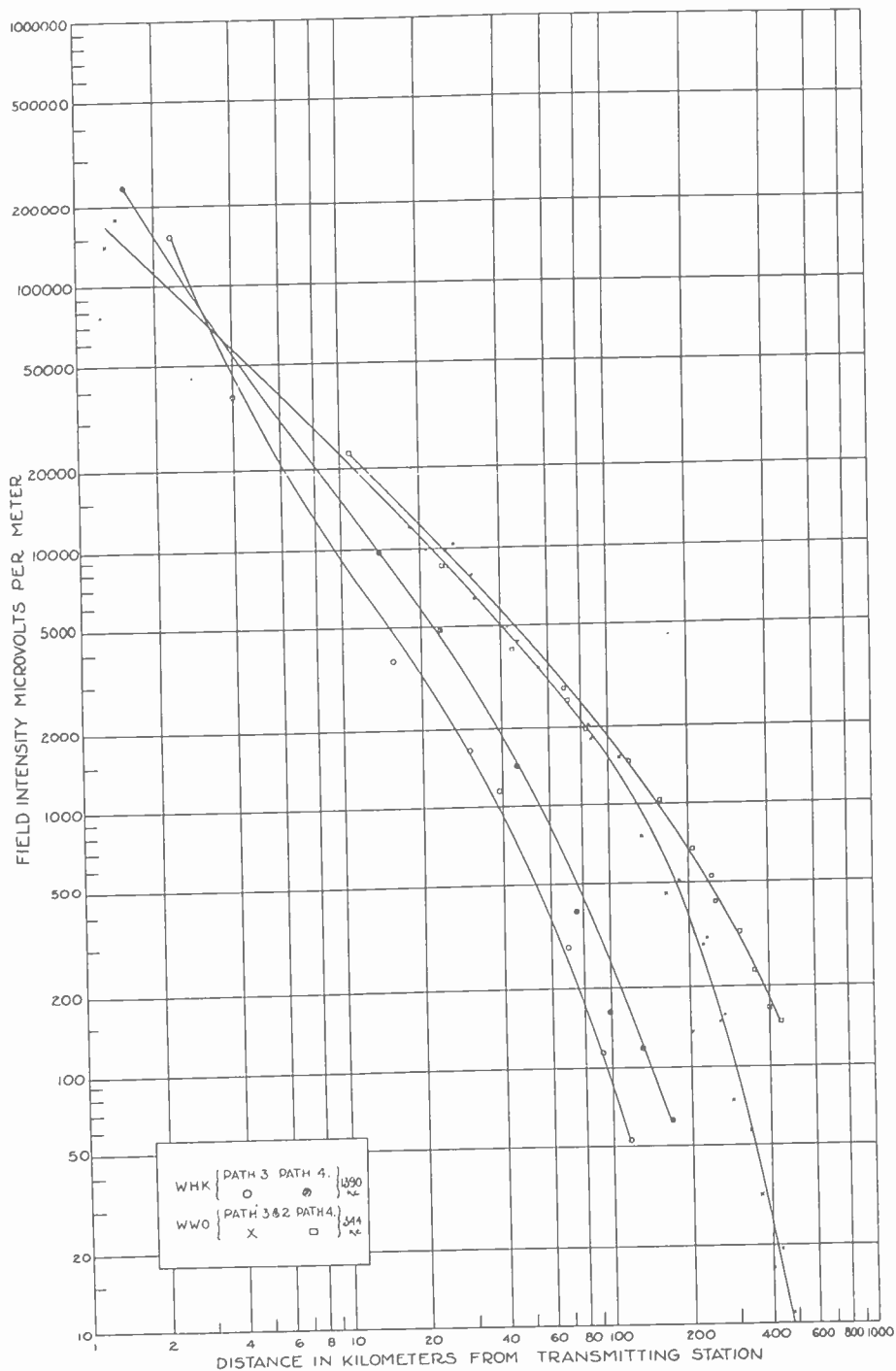

Fig. 7—Field intensity measurements for paths Nos. 3 and 4.

be considered to represent the average characteristics of a radio transmission path for any given frequency. These values of A for most of

the experimental results described are determined from the measurements by means of (2) and are plotted in Figs. 11 to 16. The experi-

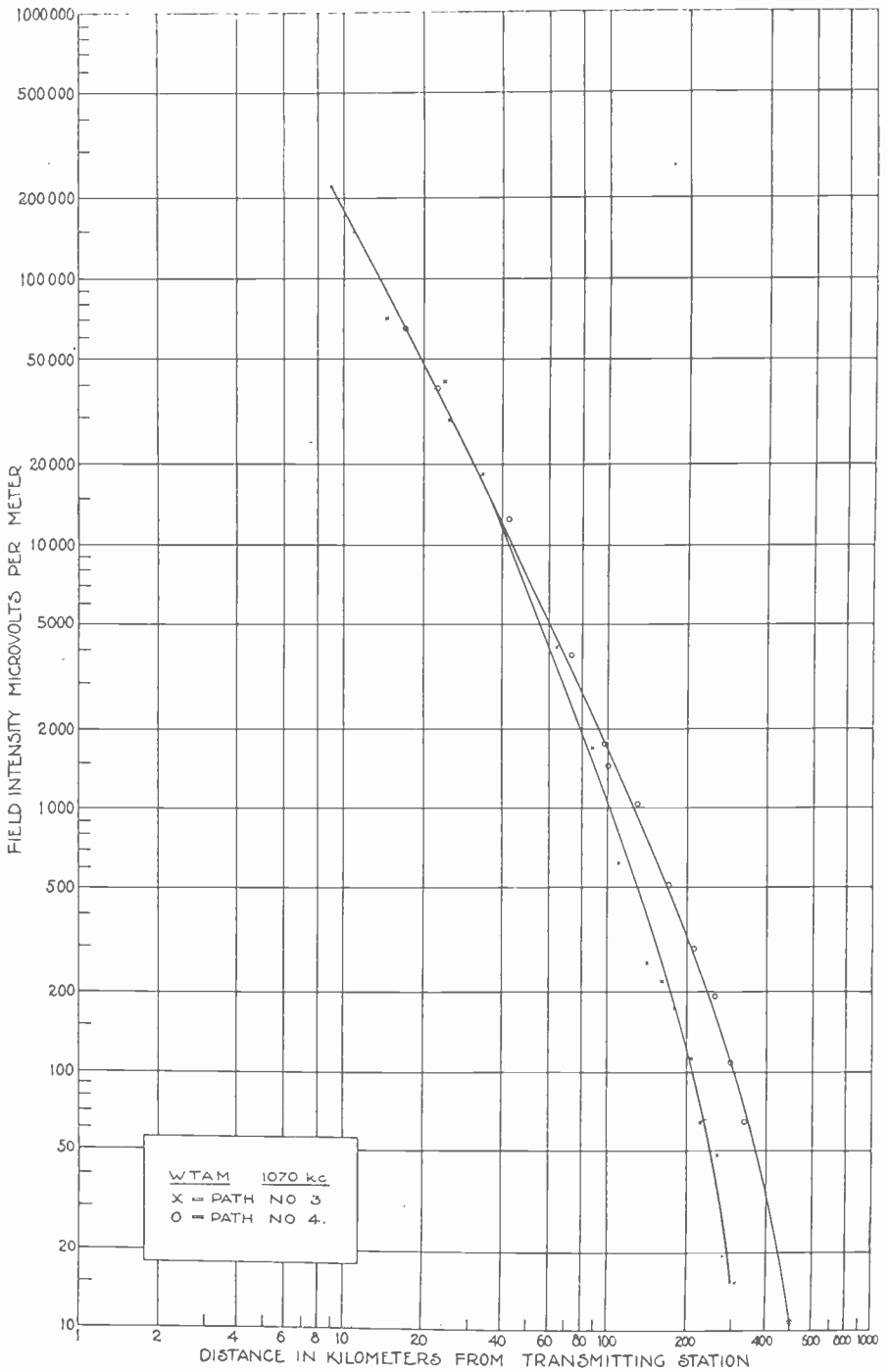

Fig. 8—Field intensities for WTAM on 1070 kc.

mental results are represented by the points plotted; the graphs are theoretical and will be discussed in the following.

In the past various attempts have been made to develop a theory which would be useful in predicting the attenuation of radio waves

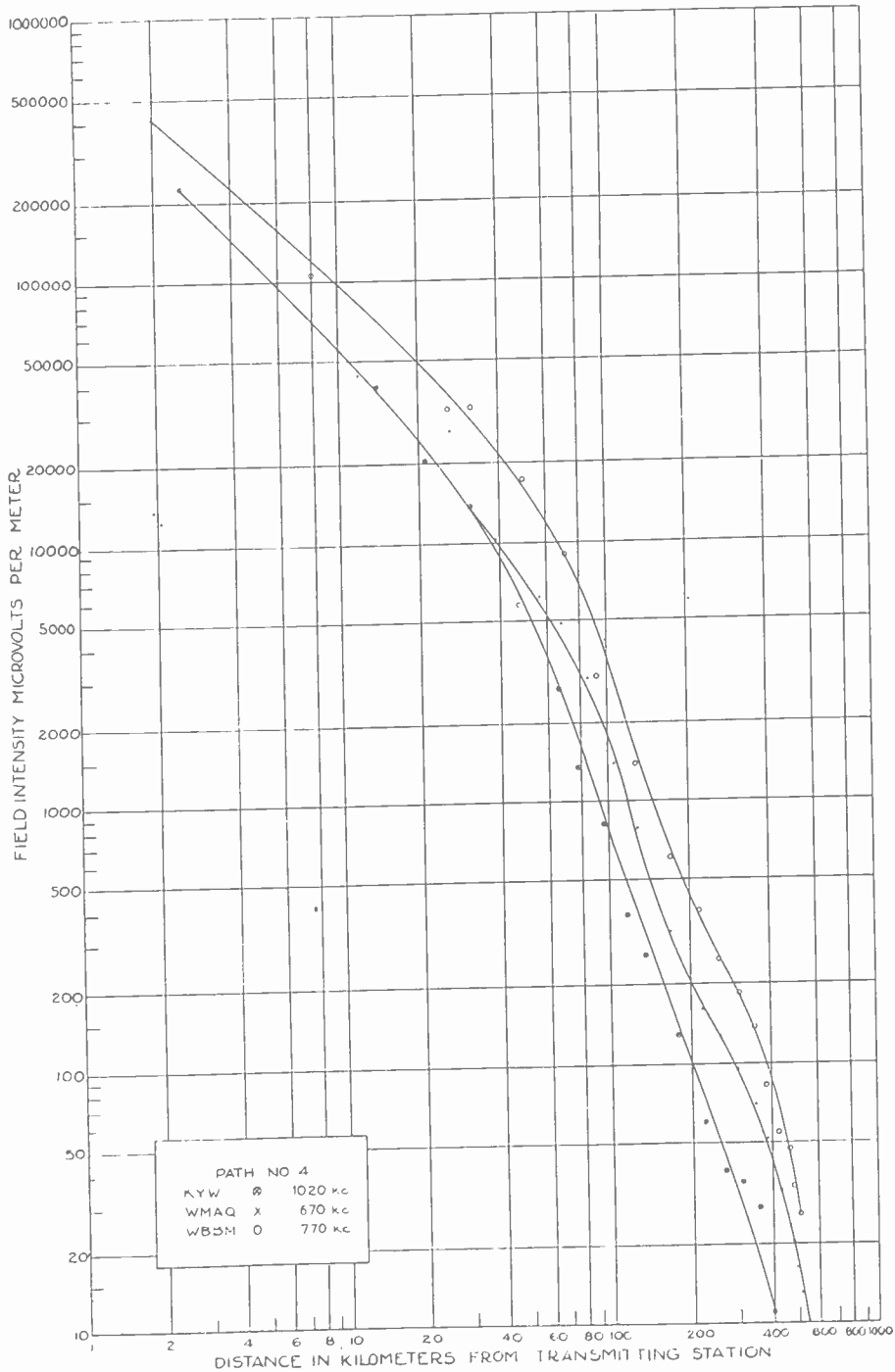

Fig. 9—Field intensity measurements on path No. 4.

along the surface of the earth. In 1909, Sommerfeld published his paper "The propagation of waves in wireless telegraphy."¹ However, the

¹ *Ann. d. Physik*, (4), vol. 28, pp. 665-736, (1909).

analysis was quite involved and very little use was made of it until in recent years. In 1911, the empirical Austin-Cohen formula² was pub-

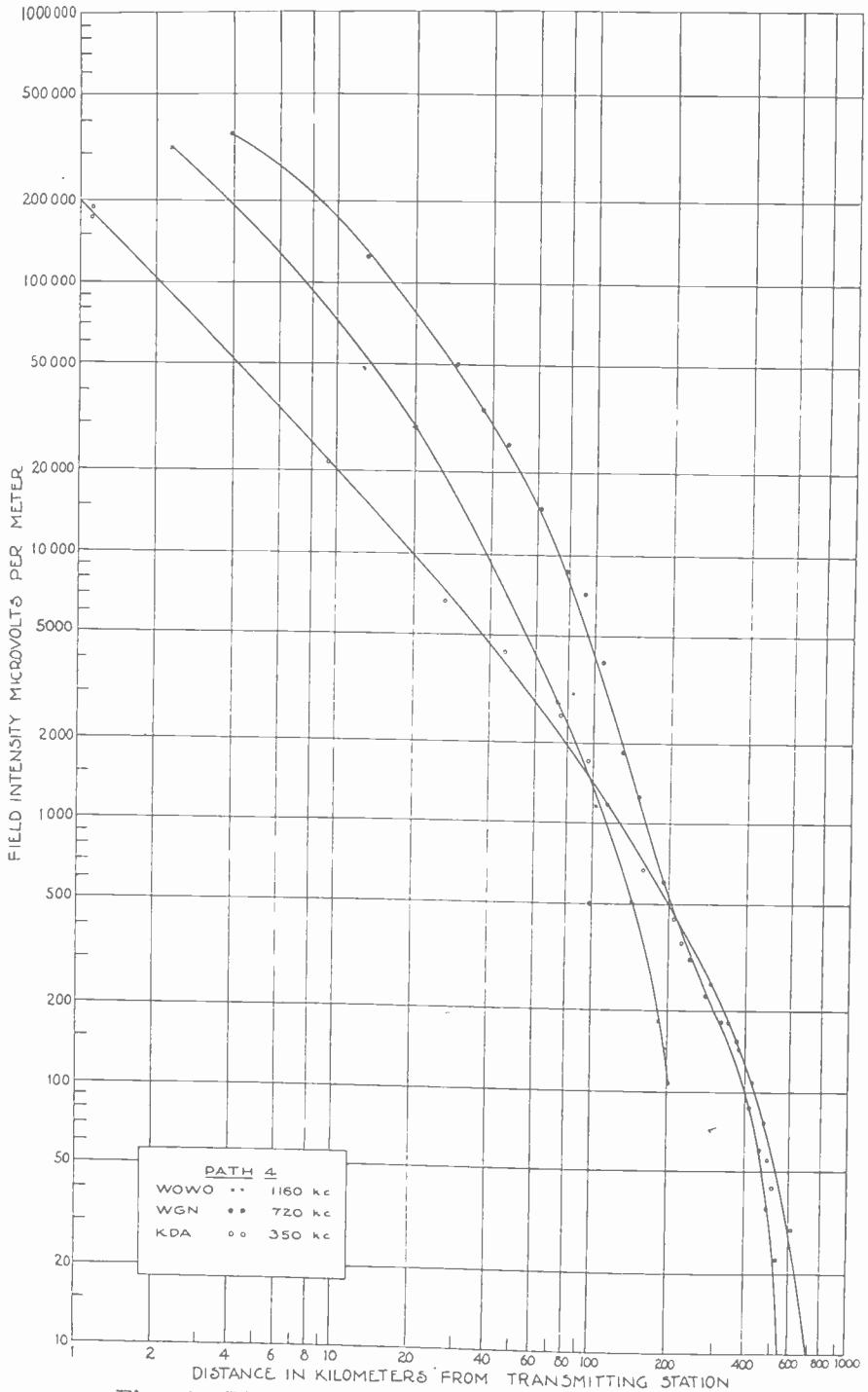

Fig. 10—Field intensity measurements on path No. 4.

² L. W. Austin, "Some quantitative experiments in long distance radio telegraphy," *Bulletin of Bureau of Standards*, vol. 7, p. 315, (1911). B.S. Scientific Paper 159.

lished. The data on which it is based were obtained in the daytime over sea water and for frequencies less than 1000 kilocycles and for distances up to 1900 km. Since it was published it has been used quite extensively for overland as well as overwater paths and over a wide range of frequencies and distances. It should be emphasized that many of these conditions were far different from those for which the Austin-Cohen formula was derived. No evidence which contradicts this formula for the conditions under which it was derived is presented in this paper. We

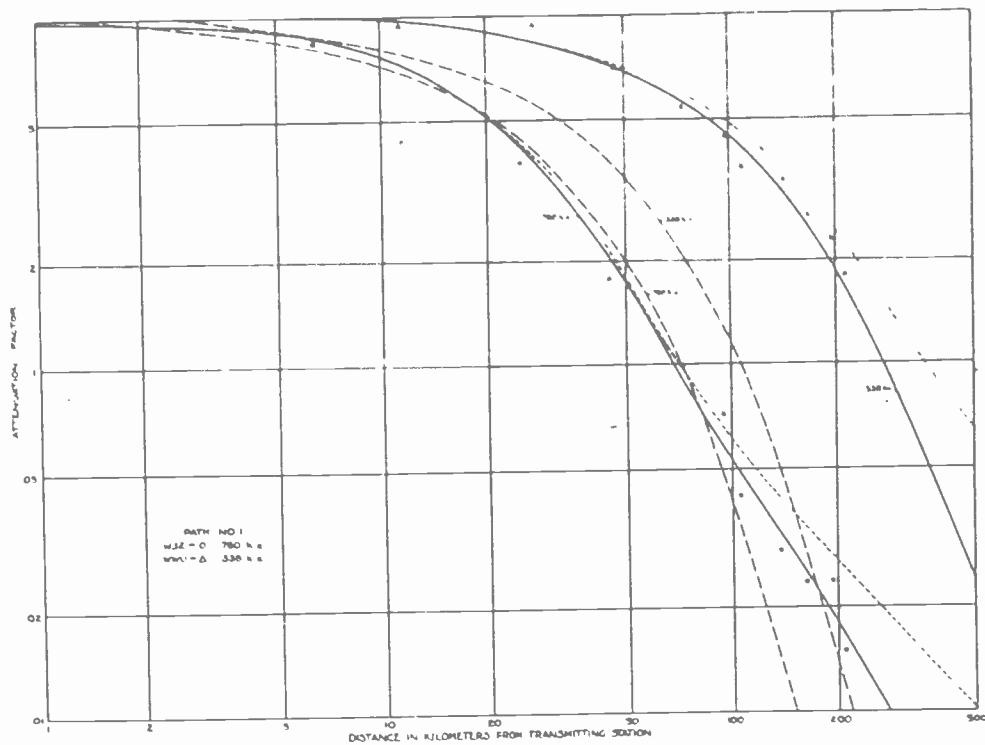

Fig. 11—Rolf's graphs corrected for curvature of the earth are shown by the solid lines. Rolf's graphs uncorrected for curvature of the earth are shown by the short dash lines. Graphs with long dashes represent Austin-Cohen formula plotted with the average α of Table II.

do, however, present data which show that this formula is not usable for overland transmissions at broadcast frequencies. Our data also indicate that, in the absence of downcoming waves, the Sommerfeld theory represents the facts fairly well.

In the Austin-Cohen formula the attenuation factor is given by:

$$A = e^{-\alpha\sqrt{f} D} \quad (3)$$

f = frequency in kilocycles per second

D = distance from transmitting station in kilometers.

If a formula of this type correctly represented the law of decay, it would be possible to determine an α for any given radio transmission path (supposed electromagnetically homogeneous) which would then determine the proper attenuation factors at any point of the path and for any frequency. From our experimentally determined values of A (see (2)), a value of α is determined for each measurement made by substituting in (3). The values of α so determined for the measurements on path No. 1 are given in Table II. These values are then averaged giving a value of $\alpha = 0.00116$ which should represent the ab-

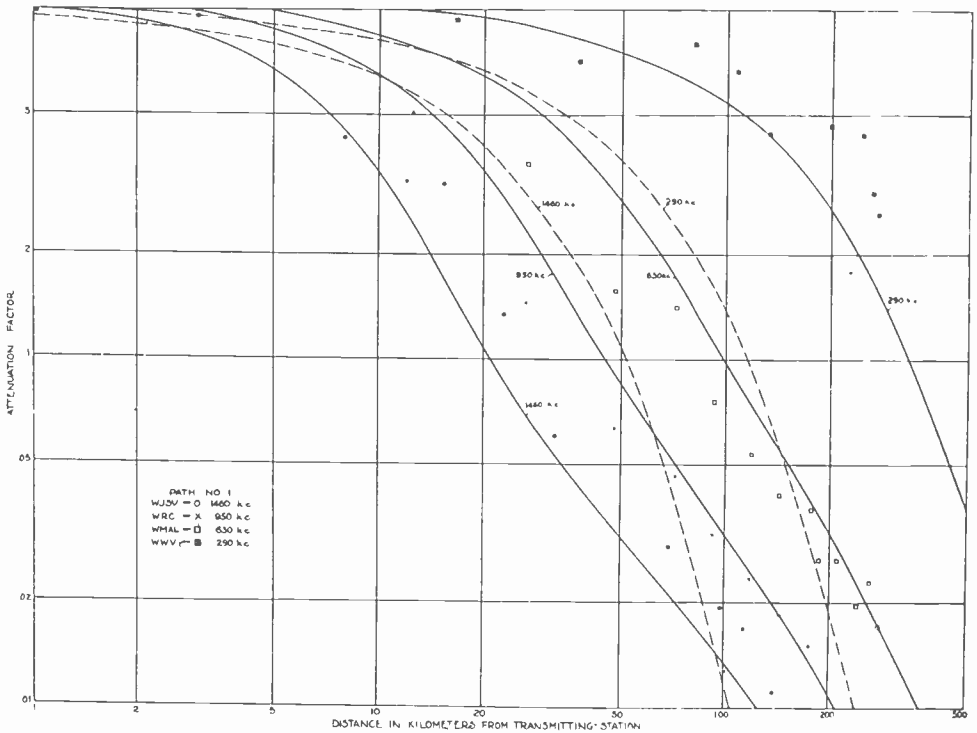

Fig. 12—Rolf's graphs corrected for the curvature of the earth are shown by the solid lines. The dashed graphs represent the Austin-Cohen formula plotted with the average α of Table II.

sorption characteristics of this path. Using this value of α in (3) the attenuation graphs are determined for 290, 338, 760, and 1460 kc and are plotted in the dotted graphs of Figs. 11 and 12. It may be seen that the experimental points do not fit the graphs, in some cases the points are 24 times too far above the graphs, while in other cases the graphs are 3.5 times too far above the points. Similar errors would be indicated if the formula were plotted for the other paths using the average values of α as determined from our measurements. The average value of α used to plot these graphs might be questioned because the values of α determined from the field intensity varied both with the distance and

TABLE II

D km	WJZ = 760 kc		WWU = 338 kc		WMAL = 630 kc		WRC = 950 kc		WJSV = 1460 kc		WWV = 230 kc	
	α	D	α	D	α	D	α	D	α	D	α	D
25	0.00122	73.1	0.000417	11.96	0.000497	4.79	0.00289	3.07	0.000318	37.5	0.000433	
40	0.00147	97.6	0.000419	12.8	0.00133	8.1	0.00311	8.05	0.00275	60.4	0.000156	
73	0.00108	109	0.000474	28.5	0.00165	10.82	0.00163	12.03	0.00244	81	0.000251	
90	0.00100	132.6	0.000396	48	0.00167	12.5	0.00174	13.35	0.00195	107	0.000365	
104	0.00102	167.6	0.000411	72.5	0.00116	15.43	0.00211	18.1	0.00231	132.6	0.000335	
137	0.000895	190.2	0.000396	93.5	0.00116	20.35	0.00208	22.8	0.00225	165.2	0.000193	
170	0.000762	214.7	0.000425	120	0.00102	22.4	0.00233	32	0.00230	176	0.000233	
191	0.000693	238.3	0.000419	145	0.000915	26.5	0.00237	48	0.00169	199	0.000159	
210	0.000704	259	0.000402	177	0.000741	48	0.00186	68.5	0.00136	228	0.000202	
240	0.000647	273	0.000458	188	0.000766	72	0.00138	97.5	0.00106	247.5	0.000254	
255	0.000647			211.5	0.000681	92	0.00122	113	0.000947			
267	0.000647			240.5	0.000651	118	0.00101	138	0.000855			
				260	0.000577	144	0.000901					
				277	0.000583	177	0.000764					

with the frequency. However, it may be seen from Figs. 11 and 12 that such graphs would not fit the experimental data for any value of α chosen; the graphs do not have the proper curvature, thus giving incorrect attenuation factors as the distance is varied, and they do not have enough separation to give proper attenuation factors as the frequency varies. We thus see that for this range of frequencies and for land paths, another formula must be used.

This is offered by the Sommerfeld theory for which graphs have been made by Bruno Rolf.³ These graphs apply to ground wave trans-

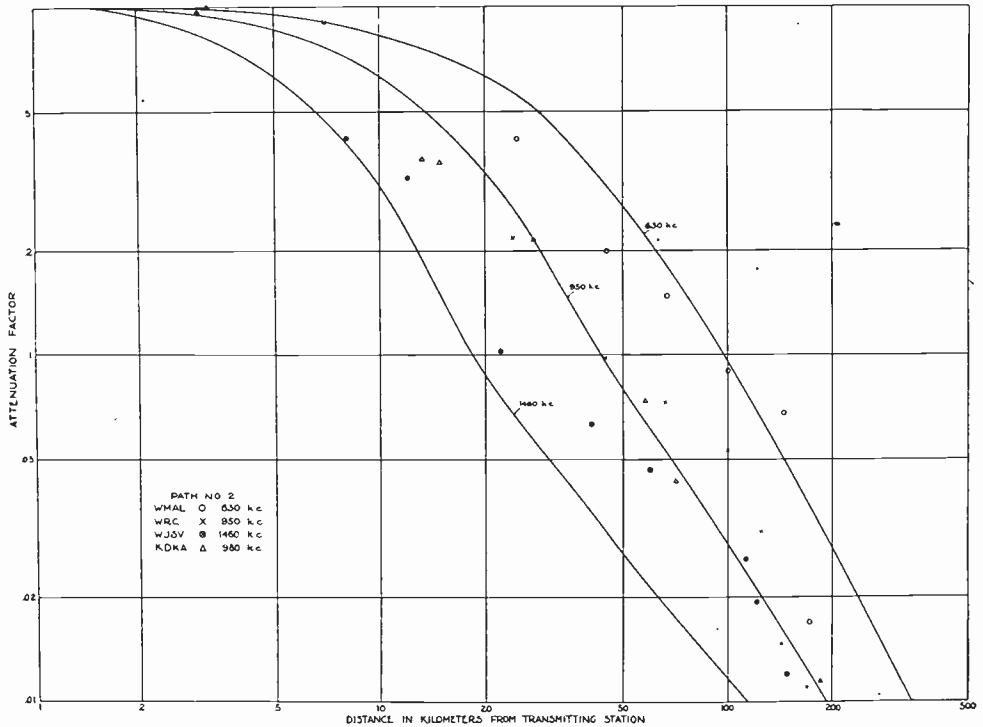

Fig. 13—Rolf's theoretical graphs compared with experimentally determined attenuation factors.

mission only. Sommerfeld obtained the solution by determining the propagation along the plane surface bounding regions (air and earth) of conductivity σ_1 and σ_2 , dielectric constant ϵ_1 and ϵ_2 , and permeability μ_1 and μ_2 . Rolf has graphed the values of A for the case, $\sigma_1=0$, $\epsilon=1$, $\mu_1=\mu_2=1$, while ϵ_2 and σ_2 are variable and represent the earth constants for the particular path involved. Thus we see that our problem becomes one of determining the average values of the radio-frequency dielectric constant and conductivity of the ground for the various paths over which measurements were made. The method of determining these was that described by Rolf.

³ "Ingeniors Vetenskaps Akademiens Handlingar" Nr. 96, (1929); Proc. I.R.E. vol. 18, pp. 391-402; March, (1930).

For path No. 1 the WJZ attenuation factors were plotted and one of Rolf's graphs was fitted to them, thus determining the average conductivity and dielectric constant for path No. 1. Rolf's 10-degree graph was found to fit satisfactorily after the correction⁴ for the earth's curvature was made. (See solid line graph marked 760 kc in Fig. 11.) The dotted graph just above shows the 10-degree graph before the earth's curvature correction was made. The dielectric constant was determined to be 13 by means of Rolf's abac. The conductivity was then determined to be 3.35×10^{-14} e.m.u. by means of (1) of Rolf's

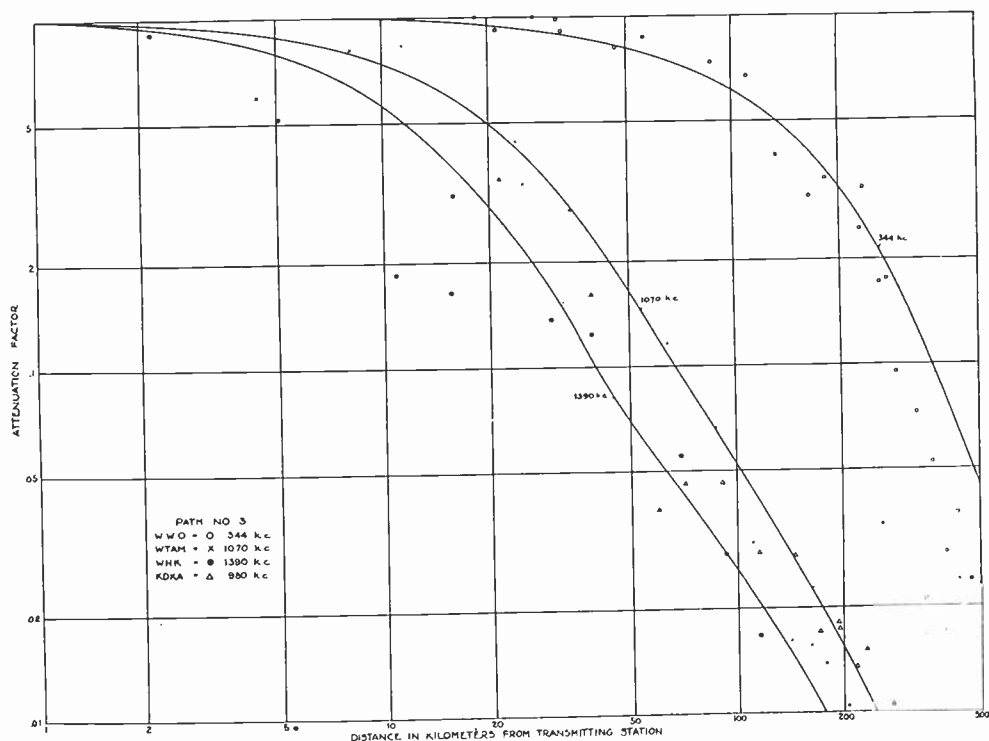

Fig. 14—Rolf's theoretical graphs compared with experimentally determined attenuation factors.

paper. These values of dielectric constant and conductivity were considered as average values for the whole path and determine the attenuation factor graphs for any other frequency over the same path. The theoretical graph for 338 kc is also plotted in Fig. 11, the dotted graph just above showing Rolf's graph for that frequency, dielectric constant, and conductivity before correction is made for the curvature of the earth. Theoretical graphs for the other frequencies measured over this path are given in Fig. 12 for these same values of dielectric constant and conductivity. It should be noted that when Rolf's theoretical graph for 760 kc was selected the theoretical graphs for the other fre-

⁴ See equation (4) of Rolf's Proc. I.R.E. paper.

quencies over path 1 were automatically determined. Over this path the extreme error given by any graph was 48 per cent of the measured value. Usually the discrepancies between the measured values and the graphs were much less than this. Considering the point-to-point variability of the path, the possibilities of variations of transmitting antenna current, together with the possibility of smaller errors in the measurements, it is believed that the agreement between measurement and theory is very good.

For path No. 2 the WRC attenuation factors were used to deter-

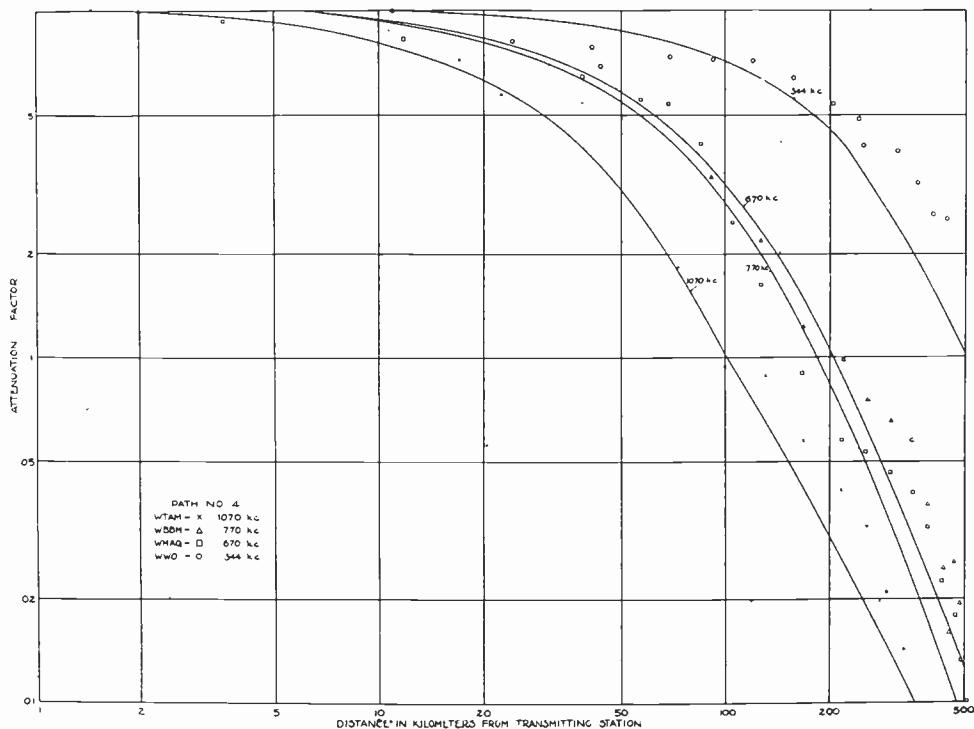

Fig. 15—Rolf's theoretical graphs compared with experimentally determined attenuation factors.

mine the dielectric constant and conductivity which were found to be $\epsilon = 12$, $\sigma = 3.22 \times 10^{-14}$ e.m.u. The theoretical graphs were then drawn in Fig. 13 for the three frequencies measured over this path. Attenuation factors of transmissions over path No. 2 from KDKA, 980 kc, were plotted in this figure although the west end of the path was quite mountainous while the eastern end was rolling land. The attenuation factors were found to fit very well the 950-kc graph for this path. Thus the absorption over the mountains was no greater than over the land east of the mountains for corresponding frequencies. In general the locations at which field intensity measurements were made in the mountains were selected in open spaces so as to eliminate as far as

possible any local shadow effects. However, in two cases this was not done. In a deep valley (Turtle Creek) east of Pittsburgh and about 200 km from Cleveland, WWO's transmission on 344 kc measured less than half the normal value, Fig. 7. In this same location WTAM on 1070 kc measured just about normal. On the east side of and halfway up a mountain at a distance of about 280 km from Cleveland, WWO's transmission measured about 25 per cent below normal while WTAM's transmission was again nearly normal, Fig. 8.

For path No. 3 the WTAM attenuation factors were used to

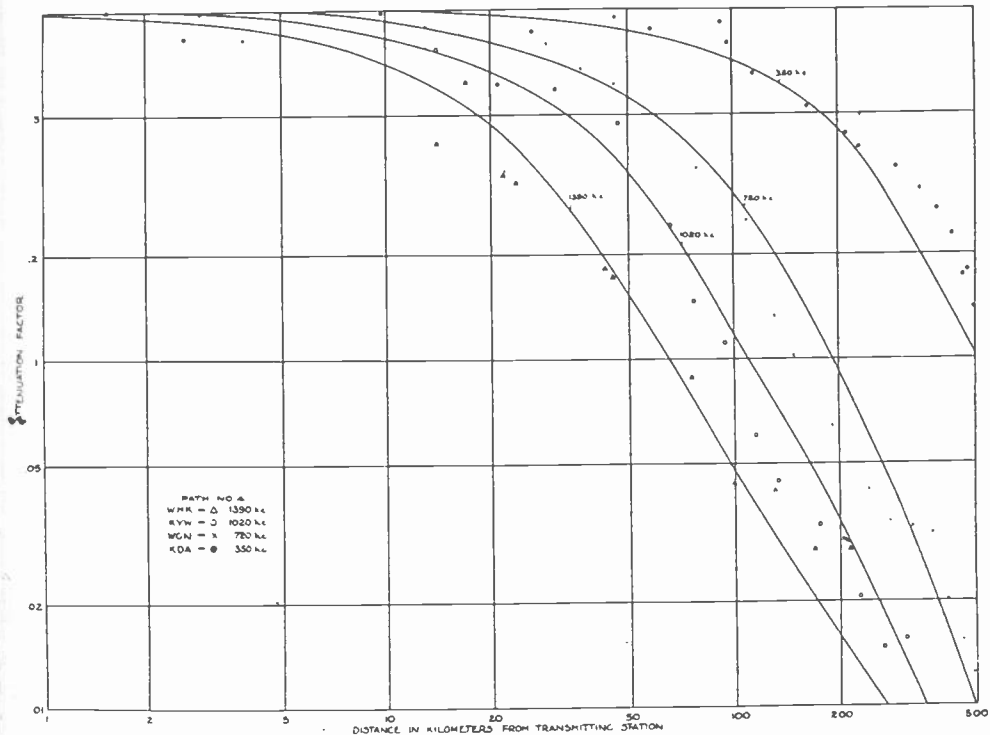

Fig. 16—Rolf's theoretical graphs compared with experimentally determined attenuation factors.

determine the dielectric constant and conductivity which were found to be $\epsilon = 12$, $\sigma = 7.75 \times 10^{-14}$ e.m.u. This path was not uniform (see Fig. 14) as it was mountainous at the east end and fairly flat at the west end. The transmissions were not absorbed so much over the western part of this path as over the eastern part (probably due to a lower conductivity at the eastern end rather than the mountains since path 2 showed no greater absorption than path 1); this caused the more distant WTAM and WWO points to fall below their respective graphs. The measured attenuation factors for KDKA on this path were also plotted. No theoretical graph was drawn, however, since the path from KDKA west was not thought to be similar to that from

Cleveland east. It may be noted that the attenuation factors which were obtained in the mountains lie below the 1070-kc graph while those that were obtained near Cleveland lie above this graph, thus indicating a different type of ground conditions (conductivity) in the mountains from those near Cleveland.

For path No. 4 the WGN attenuation factors were used to determine the dielectric constant and conductivity which were found to be $\epsilon = 13$, $\sigma = 1.07 \times 10^{-13}$ e.m.u. It is easily seen in Figs. 15 and 16 that the various frequencies measured over this path are not absorbed as much as corresponding frequencies over paths Nos. 1 and 2. The authors believe that this difference is due almost entirely to the difference in the radio-frequency conductivity of the two paths and not so much to the fact that path No. 4 is over more level ground. The fact that the land for paths Nos. 1 and 2 is more wooded⁵ than the others might lead to lower values of the conductivity there.

In order to provide a convenient means of estimating the field intensity of the ground wave for any frequency in the broadcast band and for paths east or west of the west side of the Alleghenies, in the latitudes covered by these measurements, graphs are drawn in Fig. 17 giving the field intensity versus distance for 300, 600, 1000, and 1400 kc. Using the conductivity and dielectric constant as determined for path No. 1, Rolf's graphs were used to determine the proper attenuation factors for the above frequencies east of the Alleghenies (paths 1 and 2); for the frequencies west of the Alleghenies, the conductivity and dielectric constant as determined for path No. 4 were used. These graphs were drawn for an assumed radiated power of about 11 kw, which corresponds to a field intensity of $10^6 \mu v/\text{meter}$ at a distance of one kilometer from the transmitting station. For any other radiated power P_r , given in kilowatts, the given field intensities must be multiplied by a factor:

$$K = 0.3\sqrt{P_r} \quad (4)$$

It should be noted at this point that the radiated power is always somewhat lower than the power input to the antenna and for frequencies in the broadcast band the radiated power is usually less than half the rated power. If field intensity measurements have been made near the transmitting station the radiated power may be approximately determined by means of the formula:

$${}^6\text{Radiated power} = P_r = (FD/3A)^2 10^{-10} \text{ kilowatts} \quad (5)$$

⁵ Barfield, *J.I.E.E.* (London), vol. 66, p. 204, (1928).

⁶ Pierce, "Electrical Oscillations and Electric Waves." Ch. 9.

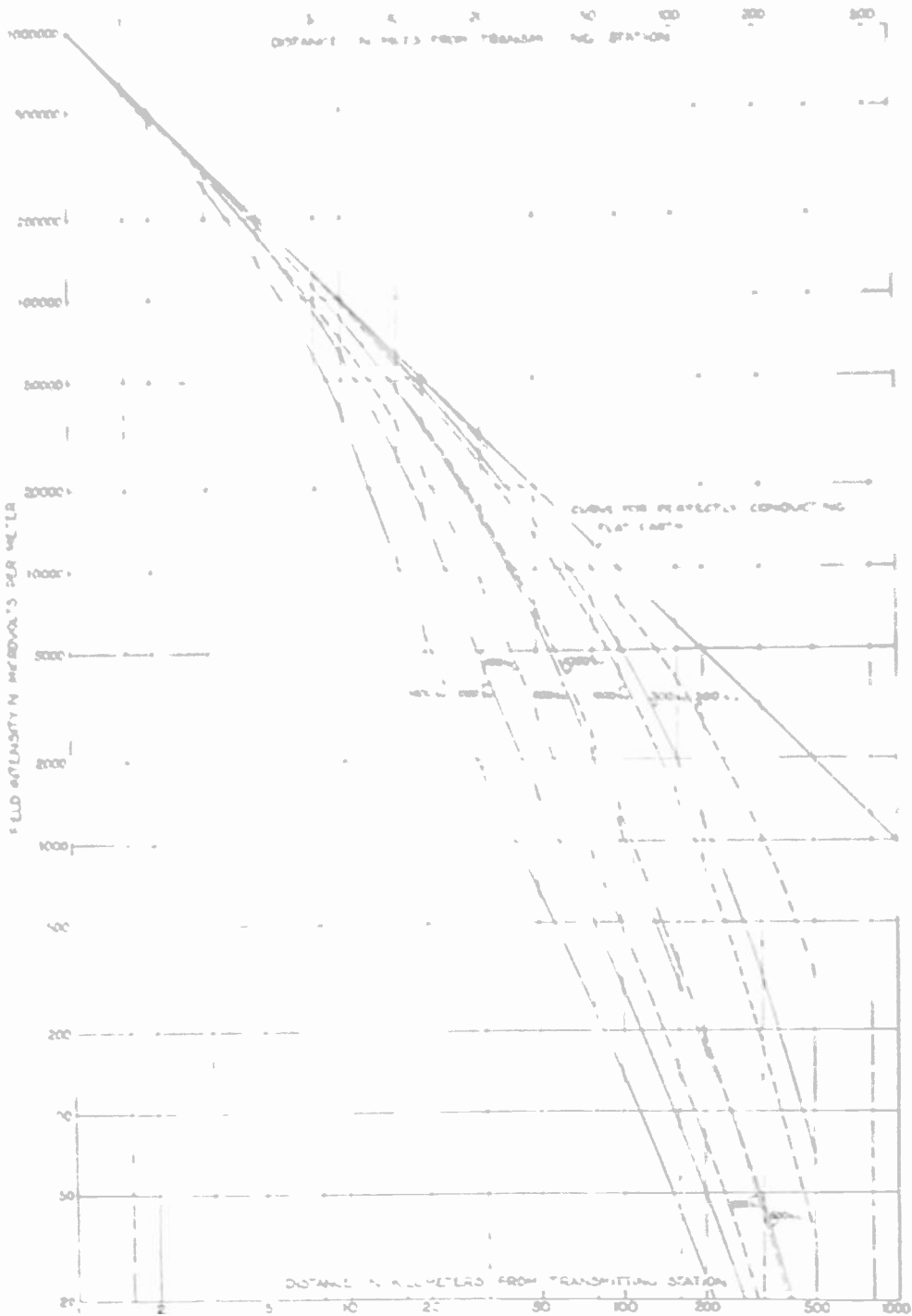

Fig. 17—Solid graphs predict the field intensity of the ground wave for $\epsilon = 12$, $\sigma = 3.22 \times 10^{-14}$ e.m.u. paths 1 and 2. Dashed graphs predict the field intensity of the ground wave for $\epsilon = 13$, $\sigma = 1.07 \times 10^{-14}$ path 4.

where,

F = field intensity in microvolts per meter

D = distance from transmitting station in kilometers

A = attenuation factor.

The attenuation factor to be used may be determined for any given path, frequency, and distance from Figs. 11 to 16 inclusive. Thus in order to determine the daytime (ground wave) field intensity in any direction and at any distance from the transmitter for broadcast stations east of Chicago, it is merely necessary to make a single measurement of the field intensity in the direction from the transmitting station in which other values are to be estimated. This, together with the value of A as determined from the graphs, assuming the constancy of the ground conductivity with time⁷ may be substituted in (5) to give the power radiated in that direction. The factor K may then be determined from (4); this factor when multiplied by the field intensities in Fig. 17 gives the required field intensity.

⁷ Continuous automatic field intensity records of transmissions from WJZ (760 kc) Bound Brook, N. J., over a path 275 km long show total variations of daytime field intensities of about 30 per cent over a period of a year.



PHASE SHIFT IN RADIO TRANSMITTERS*

By

W. A. FITCH

(General Electric Company, Schenectady, N. Y.)

Summary—This paper describes a type of distortion present to some degree in most modulated transmitters. A method of measuring phase shift using the cathode ray oscillograph is shown. Also oscillograms are shown which were taken on a short-wave broadcast transmitter. It is shown that the detuning of tank circuits causes phase shift. The tank circuit of the modulated stage is especially susceptible in this regard. Other causes of phase shift are also shown. The effects of phase shift are treated mathematically, the most serious result being the creation of adjacent channel interference. The amplitude of the second order side band is roughly one per cent of the first order side band per degree of phase shift.

IT HAS been observed that when the frequency spectrum near the carrier frequency of a high power broadcast station is explored with a highly selective receiver not only the ordinary upper and lower side bands are emitted but also extra frequencies located at a considerable distance from the carrier frequency.

It was suggested that possibly some of this extra side band radiation was being caused by "phase shift" of the carrier. In order to understand more clearly what is meant by this term let us investigate the construction of the modern broadcast transmitter.

The service requirements of broadcast transmitters demand high output frequency stability. Therefore the radio-frequency oscillations commonly originate in a piezo-electric crystal controlled master oscillator. This crystal oscillator excites a system of amplifiers which raises the carrier to a voltage level suitable for modulation. After modulation the energy may be amplified further or fed directly to the antenna. Now the antenna carrier voltage bears a certain phase relation to the crystal oscillator output voltage. It was suspected that this phase angle between the antenna voltage and the crystal oscillator voltage might be varying during the modulation cycle. An investigation was therefore undertaken to find out if this phase angle actually did vary and if so determine the following:

1. Method of accurately measuring the phase shift angle.
2. Causes of phase shift.
3. Effects of phase shift.

The problem will be considered in the above order.

* Decimal classification: R241. Original manuscript received by the Institute in thesis form, May 29, 1931. Copy for publication received by the Institute, February 24, 1932.

MEASUREMENT OF PHASE SHIFT

There are a number of ways of measuring the phase difference between two voltages. One method used frequently is to place the two voltages on separate elements of an ordinary oscillograph and take a picture of the two voltages. This method is applicable only to frequencies below approximately 10,000 cycles per second.

The idea presented itself of using the cathode ray oscillograph since this will follow radio frequencies accurately. This method involves application of a voltage derived from the output of the transmitter to one of the pairs of deflector plates of a cathode ray tube, while across the other pair is supplied an unmodulated voltage taken from the crystal oscillator stage. The cathode ray beam then moves in such a manner that the position of the spot is always proportional to the voltage on each axis. The result of this movement is a figure known as a Lissajous figure. However, as is usually the case with Lissajous figures, an analysis of the figure is necessary to determine just what is happening. It was desired to develop a simple expression for the value of the angle of phase displacement of the applied voltages based on the shape of the figure produced. This development follows.

In Fig. 1, E_1 represents the voltage on the vertical axis of the cathode ray tube and E_2 the voltage on the horizontal axis. These voltages individually will produce the vertical and horizontal lines as shown. However, if they are both placed on the cathode ray tube simultaneously an ellipse will be formed if the two voltages are out of phase or a single straight line if the two voltages are in phase. It is of course assumed that E_1 and E_2 are of the same frequency.

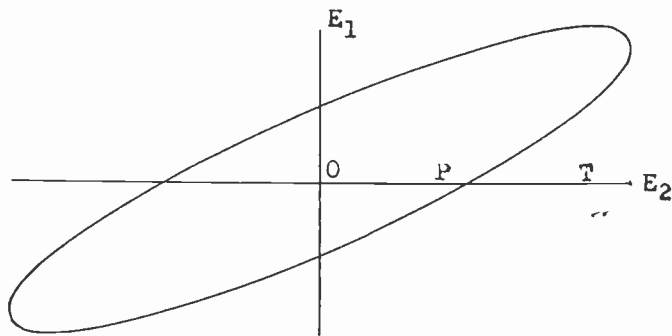

Fig. 1

$$e_1 = E_1 \sin wt$$

$$e_2 = E_2 \sin (wt + \phi) \quad \phi = 30^\circ$$

Let the voltage on the vertical axis be

$$e_1 = E_1 \sin wt \tag{1}$$

Let the voltage on the other axis be e_2 which is displaced some angle ϕ from e_1 .

$$e_2 = E_2 \sin (wt + \phi). \quad (2)$$

The equation of the Lissajous figure formed by the above two voltages will be

$$e = e_1 + e_2 = E_1 \sin wt + E_2 \sin (wt + \phi). \quad (3)$$

Fig. 1 shows the ellipse formed when E_1 is 1, E_2 is 2, and ϕ is 30 degrees. Now where this ellipse crosses the E_2 axis we know that the quantity $E_1 \sin wt$ must be zero. Therefore the voltage at the point P will be represented by

$$e = E_2 \sin (wt + \phi). \quad (4)$$

We also know that wt at this instant must be zero since $E_1 \sin wt$ is zero; therefore $e = E_2 \sin \phi$ or

$$\phi = \sin^{-1} \frac{e}{E_2}. \quad (5)$$

The problem of measuring the phase angle between E_1 and E_2 therefore simply resolves itself into measuring the distance OP , dividing it by OT and looking up the arc sine of this quantity.

It is apparent that this method is applicable only for phase angle displacements less than 90 degrees but this will be no handicap for the purpose in mind.

This same procedure may easily be extended to measuring the dynamic phase shift of a transmitter; that is, the maximum phase shift during the modulation cycle. Suppose we put the crystal oscillator voltage E_1 , on the vertical axis of the cathode ray oscillograph and the transmitter output (antenna) voltage on the horizontal axis. If the antenna voltage is not modulated, the Lissajous figure will be an ellipse like Fig. 1, if E_1 and E_2 are out of phase or a straight line if they are in phase. This straight line will be tilted an angle ϵ from the vertical axis where

$$\epsilon = \tan^{-1} \frac{E_2}{E_1}. \quad (6)$$

Now if the plate voltage on the modulated stage is raised 100 per cent corresponding to 100 per cent modulation, the straight line will be tilted more away from the vertical. The new angle will be

$$\epsilon' = \tan^{-1} \frac{2E_2}{E_1}. \quad (7)$$

It is easily seen that when modulation occurs an infinite number of straight lines are produced and for 100 per cent modulation ϵ will take on all values between zero and ϵ' . The Lissajou figure will therefore appear as in Fig. 2. It is of course assumed that E_1 and E_2 remain in phase during the modulation cycle. Now if the modulated antenna

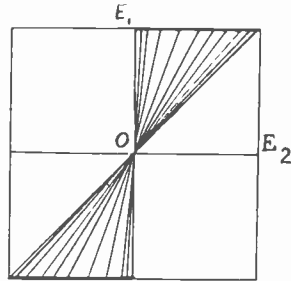

Fig. 2

$$\begin{aligned} e_1 &= E_1 \sin wt \\ e_2 &= E_2(1 + m \sin at) \sin wt \end{aligned}$$

voltage does not remain in phase with the crystal oscillator voltage during the modulation cycle, the Lissajou figure will be a combination of Fig. 1 and Fig. 2 which is Fig. 3. The dynamic phase shift may be obtained directly from this figure and is,

$$K = \sin^{-1} \frac{OP}{OT} \quad (8)$$

The phase shift as represented by Fig. 3 is 21.2 degrees.

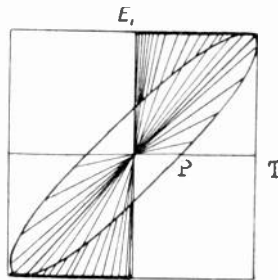

Fig. 3

$$\begin{aligned} e_1 &= E_1 \sin wt \\ e_2 &= E_2(1 + m \sin at) \sin [wt + K \sin (at + \phi)] \\ K &= \text{phase shift} = 21^\circ 15' \end{aligned}$$

The only error in this method of measurement lies in making the cathode ray beam or spot small enough. A phase shift of one degree can be detected.

Using the above method, measurements were made on transmitter W2XAF at the South Schenectady developmental station. The results of these measurements showed that the phase shift of this transmitter was zero. However, it was found possible to introduce phase shift by

either detuning the tank circuit of the modulated stage or by introducing feed-back in the transmitter by coupling part of the antenna voltage into one of the lower power stages. The amount of feed-back voltage necessary to cause any appreciable phase shift is considerable and not likely to occur except in very poorly designed transmitters. More will be said about these causes of phase shift in the next section.

Fig. 10 shows the phase shift caused by detuning the tank circuit of the modulated stage. Figs. 11 and 12 show 50 per cent and 100 per cent modulation respectively with the transmitter perfectly in tune and no phase shift present.

For these measurements the crystal oscillator voltage was not placed directly on the cathode ray oscillograph since in W2XAF the crystal oscillator frequency is 2382.5 kilocycles whereas the output (antenna) frequency is 9530 kilocycles. A two-stage frequency multiplier was constructed which doubled the crystal frequency twice to 9530 kilocycles and the output of this multiplier was connected to the vertical axis of the cathode ray oscillograph. It was of course realized that phase shift might be introduced in this multiplier but this is not likely since it was very well shielded to eliminate any possibility of pick-up from stray fields. A separate power supply was also used as a precaution. The use of this multiplier also provides an easy means of making E_1 in phase with E_2 for the static balance, that is, in taking a phase shift measurement, a straight-line Lissajous figure is first obtained with modulation off. Then modulation is put on and the measurement of OP and OT made. The static balance may easily be obtained by simply detuning slightly one of the tank circuits of the multiplier. Fig. 13 shows the front view of this unit.

CAUSES OF PHASE SHIFT

As mentioned previously, it is only rapid changes of phase that we are interested in; that is, changes of phase at the modulation-frequency rate. Slow changes of phase occur due to gradual heating of the different circuits of the transmitter thereby changing their constants but this does not produce any apparent change either in the radiated wave or the received signal. However, it will be shown that the detuning of a tank circuit will indirectly cause phase shift if the detuned stage is modulated.

EFFECT OF TANK CIRCUIT

A "tank circuit" is the name given to the LC circuit used as a coupling device between two successive stages of the transmitter, and is normally tuned to resonance. The voltage for exciting the succeeding stage is obtained by coupling to this circuit. Fig. 4 shows a typical transmitter stage with its tank circuit.

It may be proved¹ that the operation of an amplifier stage, such as Fig. 4, can be represented by a circuit as shown in Fig. 5 in which r_p is the plate resistance of the triode and $-\mu e_g$ is a fictitious voltage equal

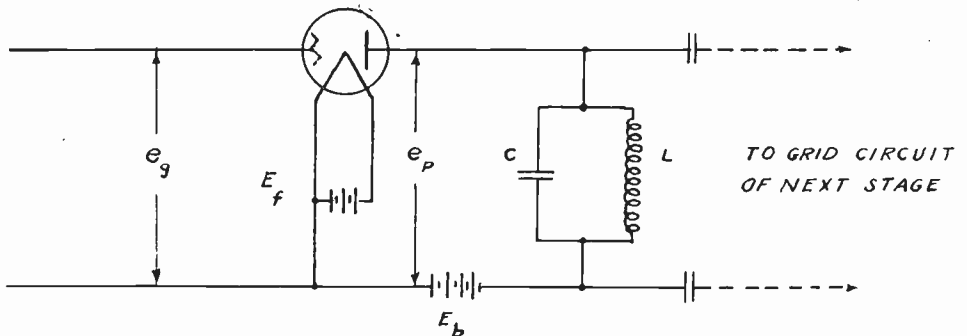

Fig. 4

to the product of the a-c grid voltage and amplification factor of the triode. Let us investigate the phase relation between $-\mu e_g$ and e_p , the plate voltage, in the circuit shown in Fig. 5.

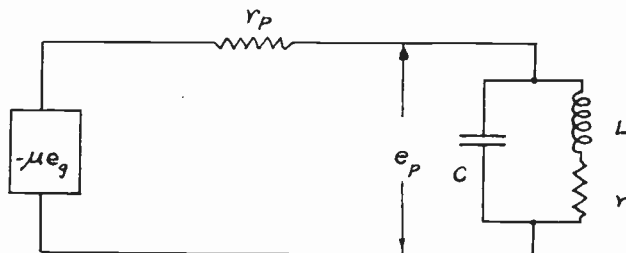

Fig. 5— μ = amplification factor of triode
 r = effective tank resistance

Let the impedance looking from the generator $-\mu e_g$ be z where

$$z = r_p + z_1 \quad (9)$$

and,

$$z_1 = \frac{(r + pL) \frac{1}{pC}}{r + pL + \frac{1}{pC}} = \frac{(r + jwL) \frac{1}{jwC}}{r + j \left(wL - \frac{1}{wC} \right)} \quad (10)$$

$$z_1 = \frac{-\frac{j}{wC}(r + jwL) \left[r - j \left(wL - \frac{1}{wC} \right) \right]}{r^2 + \left(wL - \frac{1}{wC} \right)^2} \quad (11)$$

¹ See Bibliography No. 4.

$$z_1 = \frac{-\frac{j r^2}{\omega C} - \frac{r}{\omega C} \left(\omega L - \frac{1}{\omega C} \right) + \frac{r L}{C} - \frac{j L}{C} \left(\omega L - \frac{1}{\omega C} \right)}{r^2 + \left(\omega L - \frac{1}{\omega C} \right)^2} \quad (12)$$

$$z_1 = \frac{\frac{r L}{C} - \frac{r}{\omega C} \left(\omega L - \frac{1}{\omega C} \right) - j \left[\frac{r^2}{\omega C} + \frac{L}{C} \left(\omega L - \frac{1}{\omega C} \right) \right]}{r^2 + \left(\omega L - \frac{1}{\omega C} \right)^2} \quad (13)$$

$$z_1 = r' + j X' \quad (14)$$

$$r' = \frac{\frac{r}{\omega^2 C^2}}{r^2 + \left(\omega L - \frac{1}{\omega C} \right)^2} \quad (15)$$

$$X' = \frac{-\left(\frac{r^2}{\omega C} + \frac{\omega L^2}{C} - \frac{L}{\omega C^2} \right)}{r^2 + \left(\omega L - \frac{1}{\omega C} \right)^2} \quad (16)$$

$$z = r_p + z_1 = r_p + r' + j X' \quad (17)$$

Let the phase angle between $-\mu e_p$ and e_p be ϕ_0 , then

$$\tan \phi_0 = \frac{X'}{r_p + r'} = - \frac{\left(\frac{r^2}{\omega C} + \frac{\omega L^2}{C} - \frac{L}{\omega C^2} \right)}{r_p \left[r^2 + \left(\omega L - \frac{1}{\omega C} \right)^2 \right] + \frac{r}{\omega^2 C^2}} \quad (18)$$

$$\tan \phi_0 = - \frac{\omega^2 C^2 \left[\frac{r^2}{\omega C} + \frac{\omega L^2}{C} - \frac{L}{\omega C^2} \right]}{r_p \left[\omega^2 C^2 r^2 + \omega^2 C^2 \left(\omega L - \frac{1}{\omega C} \right)^2 \right] + r} \quad (19)$$

$$\tan \phi_0 = - \frac{\omega(r^2 C + \omega^2 L^2 C - L)}{r_p \left[\omega^2 C^2 r^2 + \omega^2 C^2 \left(\omega L - \frac{1}{\omega C} \right)^2 \right] + r} \quad (20)$$

The condition for $\tan \phi_0$ or zero displacement between $-\mu e_p$ and e_p is

$$r^2 C + \omega^2 L^2 C - L = 0 \quad (21)$$

or,

$$\omega^2 = \frac{L - r^2C}{L^2C}$$

$$\omega = \sqrt{\frac{1}{LC} - \frac{r^2}{L^2}} \quad (22)$$

which is the well known condition for resonance.

Therefore, if (22) is satisfied (the tank circuit tuned to resonance), the plate voltage will be in phase with $-\mu e_v$ or 180 degrees out of phase with e_v , the grid voltage. If the tank circuit is not tuned to resonance the phase angle between grid and plate voltages will be given by (20), except with the negative sign changed to positive.

Equation (20) may be rewritten,

$$\phi_0 = \tan^{-1} - \frac{K_1}{r_p K_2 + r} \quad (23)$$

where,

$$K_1 = + \omega(r^2C + \omega^2L^2C - L)$$

and,

$$K_2 = \omega^2C^2r^2 + \omega^2C^2 \left(\omega L - \frac{1}{\omega C} \right)^2.$$

In (23) everything is constant if the triode (Fig. 4) is not modulated. When the plate voltage, (E_b), on the modulated stage is varied during the modulation cycle, a variable is introduced, due to the fact the r_p varies when E_b varies. A shifting of the phase of the carrier is therefore the result.

If the tank circuit is tuned below resonance ϕ_0 will be a negative angle and a positive angle if tuned above resonance. Also from (23) we see that if r_p increases (due to E_b changing) ϕ_0 will approach zero. That is, an increase of r_p will rotate the vector representing the carrier frequency clockwise if the tank circuit is tuned above resonance and counterclockwise if tuned below resonance.

The variation of r_p with E_b is a complex function and depends on several things including the excitation voltage e_v , the filament voltage E_f , the bias voltage E_c , and the geometry of the elements making up the triode. It is evident however that the variation of ϕ_0 with r_p (or ϕ_0') is some function λ of E_b . The variation of E_b during modulation is $E_b = m \sin at$

where m is the percentage modulation factor and $at/2\pi$ is the modulating frequency. We have therefore the following expression for ϕ_0'

$$\phi_0' = \lambda m \sin (at + \phi). \quad (24)$$

ϕ is a constant angle that depends on whether the tank circuit is tuned above or below resonance and is also a function of λ .

EFFECT OF FEED-BACK VOLTAGE

The effect of a feed-back voltage on the phase of the transmitter output will now be studied.

Suppose in Fig. 6 the vector $e_1 = E_1 \sin wt$ represents the a-c grid voltage on some stage ahead of the modulated stage and a voltage is fed back, say from the antenna represented as

$$e_2 = E_2(1 + \sin at) \sin (wt + \alpha)$$

α is the phase displacement between e_1 and e_2 .

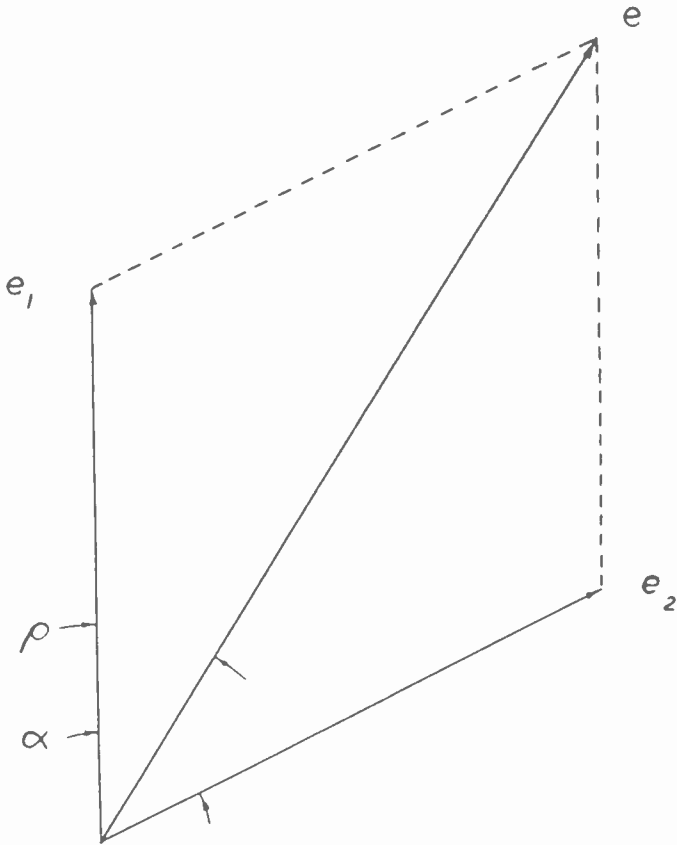

Fig. 6

The resultant grid voltage will be the vector sum of e_1 and e_2 or

$$e = E_1 \sin wt + E_2(1 + \sin at) \sin (wt + \alpha) \quad (25)$$

It is apparent that the phase angle, ρ , between e and e_1 will vary because of the amplitude variation of e_2 . However, it will be shown that the variation of ρ (or phase shift of e) is small unless α approaches 90 degrees. Furthermore, it will be shown that when feed-back voltages do exist, α is usually near zero or 180 degrees and hence feed-back voltages normally have little effect in introducing phase shift.

Expanding (25) we obtain

$$e = E_1 \sin wt + E_2(1 + \sin at)(\sin wt \cos \alpha + \cos wt \sin \alpha) \quad (26)$$

$$e = \sin wt [E_1 + E_2(1 + \sin at) \cos \alpha] + \cos wt [E_2(1 + \sin at) \sin \alpha] \quad (27)$$

$$e = \left\{ \sqrt{[E_1 + E_2(1 + \sin at) \cos \alpha]^2 + [E_2(1 + \sin at) \sin \alpha]^2} \right\} \sin (wt - \rho) \quad (28)$$

$$\rho = \tan^{-1} \frac{E_2(1 + \sin at) \sin \alpha}{E_1 + E_2(1 + \sin at) \cos \alpha}$$

The minimum value of ρ is seen to be zero and occurs when

$$at = \frac{3\pi}{2}$$

the maximum value of ρ occurs when $at = \pi/2$ and is

$$\rho_{\max} = \frac{2E_2 \sin \alpha}{E_1 + 2E_2 \cos \alpha} \quad (29)$$

The phase shift is given by $\rho_{\max} - \rho_{\min} = \rho_{\max}$.

From (29) we see that the phase shift is zero when α is either zero or 180 degrees and is a maximum when $\alpha = 90$ degrees. If we assume that $\alpha = 90$ degrees (the worst possible condition) then

Maximum possible phase shift $= K = \tan^{-1} 2E_2/E_1$.

The magnitude of E_2 in standard transmitters is seldom over 10 per cent of E_1 . If E_2 is greater than this amount it usually can be easily reduced. Assuming that this is the worst condition we find that

$$K = \tan^{-1} \frac{2}{10} = 11^\circ 19'$$

It can be easily shown however that α is usually either near zero or 180 degrees. There are only two ways in which the voltage E_2 may be fed back. It may feed back either through inductive or capacitive coupling. Either of these methods of coupling tend to make α either 0 degrees or 180 degrees as will now be shown.

The coil L_2 (Fig. 7) represents the tank inductance of one stage which is feeding back a voltage e' to the grid inductance L_1 of some other stage. e_1 and e_2 are the normal voltages in L_1 and L_2 neglecting the feed-back voltage e' . The voltage e_2 will set up a flux ϕ which induces a voltage e' in L_1 . The phase relation between e_2 , e' , and ϕ (neglecting losses which are small) are shown in Fig. 8.

It is therefore seen that the feed-back voltage e' is approximately 180 degrees out of phase with e_2 . Thus an inductive feed-back gives a

180-degree phase relation between e_2 and the feed-back voltage e' . This does not necessarily mean that α will be 180 degrees because e_1 might not be in phase with e_2 . It so happens, however, that the grid voltage in one stage is normally 180 degrees out of phase with the plate voltage

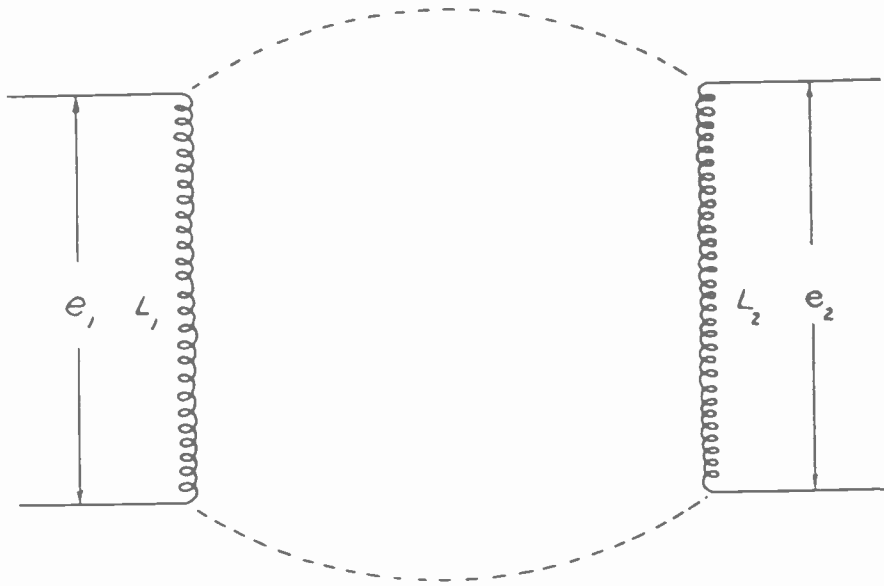

Fig. 7

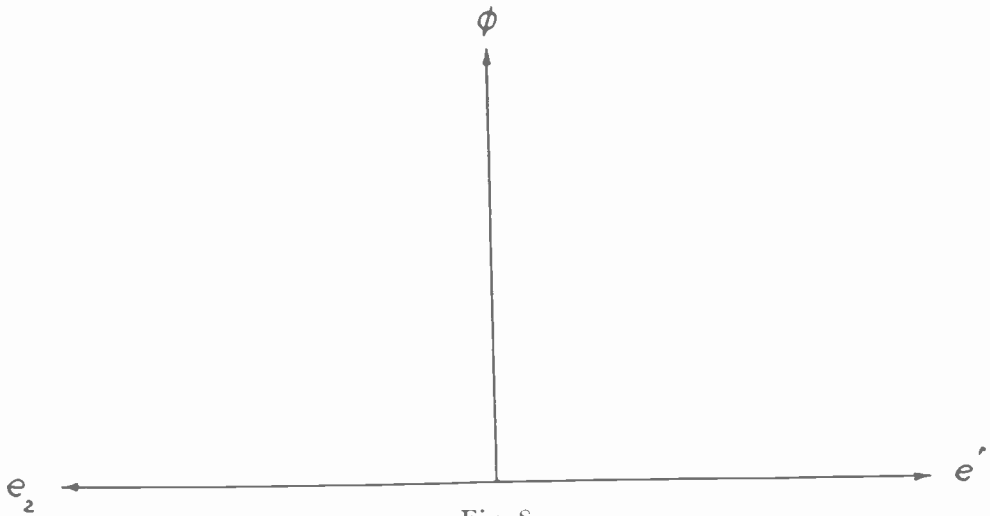

Fig. 8

in that stage and therefore unless some stage of the transmitter is out of tune each part of one stage will be 180 degrees out of phase with the corresponding part of the next stage. Hence, with inductive feed back α will be near zero or 180 degrees depending on the stage from which it is fed back. In a similar manner it may be shown that with capacitive feed-back α will be near zero or 180 degrees.

There is the possibility of other than the ideal conditions given above, but in general, feed-back alone does not cause appreciable phase shift unless the magnitude of the voltage fed back is considerable in which case more careful transmitter design or adjustment will remedy this.

EFFECT OF IMPEDANCE VARIATION

There are other minor causes of phase shift such as an impedance variation of a tank circuit caused by a fluctuating grid load. Fig. 4 shows the tank circuit of one stage which is coupled to the grid circuit of the following stage. It is evident that if the grid impedance fluctuates it will reflect a fluctuating impedance into the tank circuit and cause it to be detuned. The grid impedance of a triode does change considerably when the amplitude of the grid voltage is varied (modulated). Therefore, if the modulated stage instead of feeding directly into the antenna, excites another amplifier which in turn excites the antenna, we may expect some phase shift due to this cause. This can be corrected, however, by connecting a stabilizing resistor in the grid circuit which loads down the grid circuit so that the impedance variation is small. This is ordinarily done in practice.

EFFECTS OF PHASE SHIFT

The most satisfactory method of investigating the effects of phase shift is by a mathematical treatment which compares the radiated signal of a transmitter with phase shift to that of an "ideal transmitter."

An ideal transmitter may be defined as one that emits a signal of this type:

$$e = E_1(1 + m \sin at) \sin (wt + \theta). \quad (30)$$

This may be expanded as follows:

$$e = E_1 \sin (wt + \theta) + \frac{mE_1}{2} \{ \cos [(w - a)t + \theta] - \cos [(w + a)t + \theta] \} \quad (31)$$

carrier lower side band upper side band

The signal comprises a carrier and two side bands symmetrical in amplitude and in phase. The modulation coefficient m may vary from zero to unity. The audio and radio angular velocities are represented by a and w respectively. The angle θ is a constant.

A transmitter with phase shift will emit a signal similar to the above ideal signal except that θ is no longer a constant but a variable. That is,

$$\theta = K \sin (at + \phi) \quad (32)$$

where K is the maximum angle of phase shift and ϕ is a constant.

Substituting (32) in (30) we obtain the phase shift equation.

$$e = E_1(1 + m \sin at) \sin [wt + K \sin (at + \phi)] \quad (33)$$

This may be resolved into its component frequencies similarly to (31). Expanding (33)

$$e = E_1(1 + m \sin at) \{ \sin wt \cos [K \sin (at + \phi)] + \cos wt \sin [K \cos (at + \phi)] \} \quad (34)$$

$$\cos [K \sin (at + \phi)] = J_0(K) + 2J_2(K) \cos 2(at + \phi) + 2J_4(K) \cos 4(at + \phi) + \dots \quad (35)$$

$$\sin [K \cos (at + \phi)] = 2J_1(K) \cos (at + \phi) - 2J_3(K) \cos 3(at + \phi) + 2J_5(K) \cos 5(at + \phi) - \dots \quad (36)$$

where $J_0(K)$, $J_1(K)$ \dots $J_n(K)$ are Bessel's coefficients.

$$\sin wt \cos K[\sin (at + \phi)] = J_0(K) \sin wt + 2J_2(K) \sin wt \cos 2(at + \phi) + 2J_4(K) \sin wt \cos 4(at + \phi) + \dots \quad (37)$$

$$\cos wt \sin [K \cos (at + 0)] = 2J_1(K) \cos wt \cos (at + \phi) - 2J_3(K) \cos wt \cos 3(at + \phi) + 2J_5 \cos wt \cos 5(at + \phi) - \dots \quad (38)$$

expanding (37) we obtain

$$\sin wt \cos [K \sin (at + \phi)] = J_0(K) \sin wt + J_2(K) \{ \sin [(w + 2a)t + 2\phi] + \sin [(w - 2a)t - 2\phi] \} + J_4(K) \{ \sin [(w + 4a)t + 4\phi] + \sin [(w - 4a)t - 4\phi] \} + \dots \quad (39)$$

likewise,

$$\cos wt \sin [K \cos (at + \phi)] = J_1(K) \{ \cos [(w + a)t + \phi] + \cos [(w - a)t - \phi] \} - J_3(K) \{ \cos [(w + 3a)t + 3\phi] + \cos [(w - 3a)t - 3\phi] \} + \dots \quad (40)$$

Combine (39) and (40).

$$\begin{aligned} \sin wt \cos [K \sin (at + \phi)] + \cos wt \sin [K \cos (at + \phi)] = & J_0(K) \sin wt \\ & + J_1(K) \{ \cos [(w + a)t + \phi] + \cos [(w - a)t - \phi] \} \\ & + J_2(K) \{ \sin [(w + 2a)t + 2\phi] + \sin [(w - 2a)t - 2\phi] \} \\ & - J_3(K) \{ \cos [(w + 3a)t + 3\phi] + \cos [(w - 3a)t - 3\phi] \} \\ & + J_4(K) \{ \sin [(w + 4a)t + 4\phi] + \sin [(w - 4a)t - 4\phi] \} \\ & + J_5(K) \{ \cos [(w + 5a)t + 5\phi] + \cos [(w - 5a)t - 5\phi] \} \\ & + J_6(K) \{ \sin [(w + 6a)t + 6\phi] + \sin [(w - 6a)t - 6\phi] \} \\ & - J_7(K) \{ \cos [(w + 7a)t + 7\phi] + \cos [(w - 7a)t - 7\phi] \} \dots \end{aligned} \quad (41)$$

now multiply (41) by $m \sin at$

$$\begin{aligned}
 & m \sin at \{ \sin wt \cos [K \sin (at + \phi)] + \cos wt \sin [K \cos (at + \phi)] \} \\
 &= \frac{m}{2} J_0(K) \{ \cos (w - a)t - \cos (w + a)t \} \\
 &+ \frac{m}{2} J_1(K) \{ \sin [(w + 2a)t + \phi] - \sin (wt + \phi) + \sin (wt - \phi) \\
 &- \sin [(w - 2a)t - \phi] \} \\
 &+ \frac{m}{2} J_2(K) \{ \cos [(w + a)t + 2\phi] - \cos [(w + 3a)t + 2\phi] \\
 &+ \cos [(w - 3a)t - 2\phi] - \cos [(w - a)t - 2\phi] \} \\
 &- \frac{m}{2} J_3(K) \{ \sin [(w + 4a)t + 3\phi] - \sin [(w + 2a)t + 3\phi] \\
 &+ \sin [(w - 2a)t - 3\phi] - \sin [(w - 4a)t - 3\phi] \} \\
 &+ \frac{m}{2} J_4(K) \{ \cos [(w + 3a)t + 4\phi] - \cos [(w + 5a)t + 4\phi] \\
 &+ \cos [(w - 5a)t - 4\phi] - \cos [(w - 3a)t - 4\phi] \} \\
 &+ \frac{m}{2} J_5(K) \{ \sin [(w + 6a)t + 5\phi] - \sin [(w + 4a)t + 5\phi] \\
 &+ \sin [(w - 4a)t - 5\phi] - \sin [(w - 6a)t - 5\phi] \} \\
 &+ \frac{m}{2} J_6(K) \{ \cos [(w + 5a)t + 6\phi] - \cos [(w + 7a)t + 6\phi] \\
 &+ \cos [(w - 7a)t - 6\phi] - \cos [(w - 5a)t - 6\phi] \} \\
 &- \frac{m}{2} J_7(K) \{ \sin [(w + 8a)t + 7\phi] - \sin [(w + 6a)t + 7\phi] \\
 &+ \sin [(w - 8a)t - 7\phi] - \sin [(w - 8a)t - 7\phi] \} \\
 &\quad \vdots
 \end{aligned} \tag{42}$$

The final equation for e is the sum of (41) and (42)

$$\begin{aligned}
 e &= J_0(K) \sin wt + \frac{m}{2} J_0(K) [\cos (w - a)t - \cos (w + a)t] \\
 &+ \frac{m}{2} J_1(K) [\sin (wt - \phi) - \sin (wt + \phi)] \\
 &+ J_1(K) \{ \cos [(w + a)t + \phi] + \cos [(w - a)t - \phi] \}
 \end{aligned}$$

$$\begin{aligned}
& + \frac{m}{2} J_2(K) \{ \cos [(w + a)t + 2\phi] - \cos [(w - a)t - 2\phi] \} \\
& + \frac{m}{2} J_1(K) \{ \sin [(w + 2a)t + \phi] - \sin [(w - 2a)t - \phi] \} \\
& + J_2(K) \{ \sin [(w + 2a)t + 2\phi] + \sin [(w - 2a)t - 2\phi] \} \\
& + \frac{m}{2} J_3(K) \{ \sin [(w + 2a)t + 3\phi] - \sin [(w - 2a)t - 3\phi] \} \\
& - \frac{m}{2} J_2(K) \{ \cos [(w + 3a)t + 2\phi] - \cos [(w - 3a)t - 2\phi] \} \\
& - J_3(K) \{ \cos [(w + 3a)t + 3\phi] + \cos [(w - 3a)t - 3\phi] \} \\
& + \frac{m}{2} J_4(K) \{ \cos [(w + 3a)t + 4\phi] - \cos [(w - 3a)t - 4\phi] \} \\
& - \frac{m}{2} J_3(K) \{ \sin [(w + 4a)t + 3\phi] - \sin [(w - 4a)t - 3\phi] \} \\
& + J_4(K) \{ \sin [(w + 4a)t + 4\phi] + \sin [(w - 4a)t - 4\phi] \} \quad (43) \\
& - \frac{m}{2} J_5(K) \{ \sin [(w + 4a)t + 5\phi] - \sin [(w - 4a)t - 5\phi] \} \\
& - \frac{m}{2} J_4(K) \{ \cos [(w + 5a)t + 4\phi] - \cos [(w - 5a)t - 4\phi] \} \\
& + J_5(K) \{ \cos [(w + 5a)t + 5\phi] + \cos [(w - 5a)t - 5\phi] \} \\
& + \frac{m}{2} J_6(K) \{ \cos [(w + 5a)t + 6\phi] - \cos [(w - 5a)t - 6\phi] \} \\
& + \frac{m}{2} J_5(K) \{ \sin [(w + 6a)t + 5\phi] - \sin [(w - 6a)t - 5\phi] \} \\
& + J_6(K) \{ \sin [(w + 6a)t + 6\phi] + \sin [(w - 6a)t - 6\phi] \} \\
& + \frac{m}{2} J_7(K) \{ \sin [(w + 6a)t + 7\phi] - \sin [(w - 6a)t - 7\phi] \} \\
& - \frac{m}{2} J_6(K) \{ \cos [(w + 7a)t + 6\phi] - \cos [(w - 7a)t - 6\phi] \} \\
& - J_7(K) \{ \cos [(w + 7a)t + 7\phi] + \cos [(w - 7a)t - 7\phi] \} \\
& + \frac{m}{2} J_8(K) \{ \cos [(w + 7a)t + 8\phi] - \cos [(w - 7a)t - 8\phi] \} \\
& - \frac{m}{2} J_7(K) \{ \sin [(w + 8a)t + 7\phi] - \sin [(w - 8a)t - 7\phi] \} \\
& \quad \vdots
\end{aligned}$$

An inspection of (43) would seem to indicate that phase shift causes a great number of side bands extending almost an unlimited distance from the carrier frequency. However a determination of the Bessels coefficients for the different side bands shows that side bands of higher order than $(w-3a)$ are negligible unless the phase shift is extraordinarily high. This fact is evident from the table of Bessel's coefficients given in Table I. K is the maximum phase shift in radians.

TABLE I

K	Phase shift in degrees	$J_0(K)$	$J_1(K)$	$J_2(K)$	$J_3(K)$	$\frac{J_1(K)}{J_0(K)} \times 10^2$	$\frac{J_2(K)}{J_0(K)} \times 10^3$
0.01	0.573	0.999975	0.005	0.0000125		0.5	
0.02	1.148	0.9999	0.01			1.0	
0.03	1.72	0.999775	0.015			1.5	
0.04	2.295	0.9996	0.02			2.0	
0.05	2.865	0.999375	0.025	0.0003125		2.5	0.03125
0.06	3.44	0.9991	0.03			3.0	
0.07	4.01	0.998775	0.035			3.5	
0.08	4.59	0.9984	0.04			4.0	
0.09	5.16	0.998	0.045			4.51	
0.10	5.73	0.9975	0.05	0.001249	0.0000207	5.01	0.125
0.11	6.31	0.9967	0.055			5.52	
0.12	6.88	0.9964	0.0599			6.02	
0.13	7.46	0.99578	0.0649			6.525	
0.14	8.025	0.995	0.0698			7.025	
0.15	8.60	0.9944	0.0748	0.002705	0.00007035	7.503	0.272
0.16	9.18	0.9936	0.0797			8.03	
0.17	9.75	0.9928	0.0847			8.503	
0.18	10.31	0.9919	0.0896			9.04	
0.20	11.48	0.9900	0.0995	0.0049835	0.0001662	10.04	0.503

We see from the above table that when the phase shift is slight (K small), $J_0(K)$ approaches unity and $J_1(K), \dots, J_n(K)$ approach zero. Hence (43) approaches (31) as would be expected. As K increases, the magnitude of the side bands of higher order than $(w+a)$ increase which causes interference on the frequency channels next to the $(w+a)$ channel. This is called adjacent channel interference and is objectionable because it mars reception with the transmitter on the adjacent channel.

Let us investigate the $(w+2a)$ side bands and compare their magnitude with the $(w+a)$ side band. Referring to (43), there are three side bands of the order $(w+2a)$, each displaced the angle from the next one. Only the first one of these need be considered however since $J_2(K)$ is less than 5 per cent of $J_1(K)$ for moderate amounts of phase shift and $J_3(K)$ is smaller yet. Similarly there are three side bands of the order $(w+3a)$ but only the first one need be considered because $J_3(K)$ and $J_4(K)$ are very small in comparison. Fig. 9 shows the relative ratios of the second and third order side bands based on these assumptions.

It is apparent that phase shift does cause adjacent channel interference, in fact, with a phase shift of only 5 degrees the power radiated

in the $(w+2a)$ side band is about 0.19 per cent of the power radiated in the $(w+a)$ side band. This is not only wasted power but it also causes interference with other transmitters. It should not be understood however, that phase shift is the only cause of adjacent channel interference. It is only one of the contributing causes which nevertheless becomes more important as higher power transmitters are used and better transmission service is demanded.

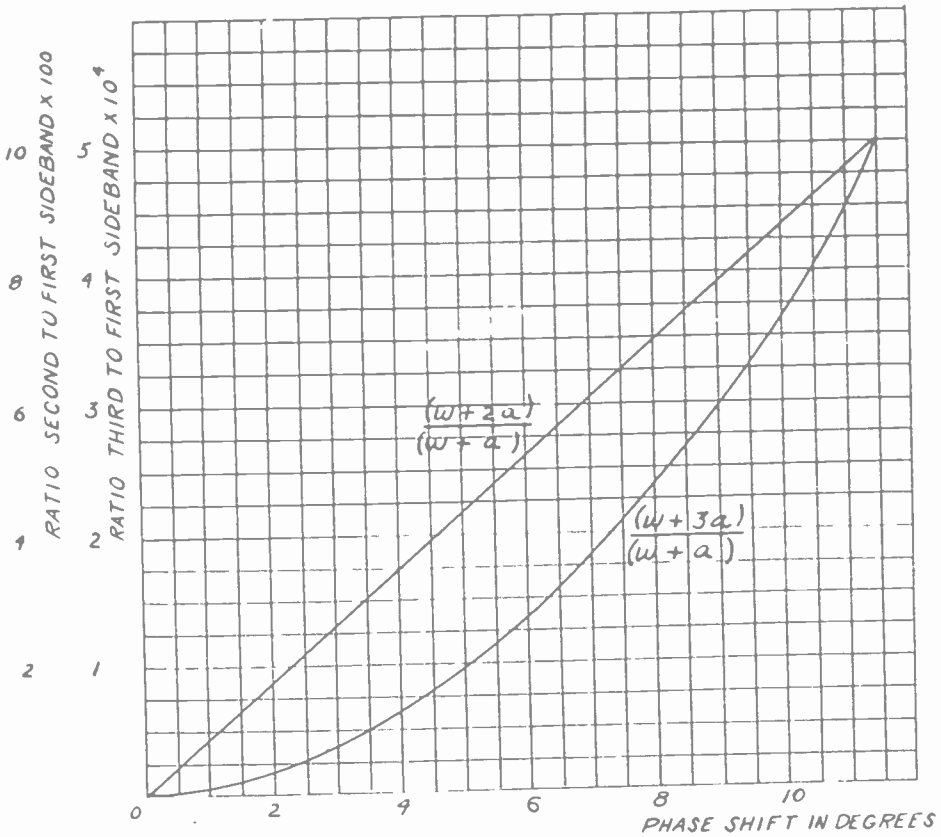

Fig. 9—Adjacent channel interference caused by phase shift of carrier.

DETECTION OF SIGNAL WITH PHASE SHIFT

In any modern broadcast system it is very important that the audio signal received will be a close reproduction of the music or speech transmitted. The following investigation will show that phase shift does not affect the quality of the received signal.

In the first place, the detector in a radio receiver is an amplitude device which is sensitive only to changes at an audio rate. The detector plate current follows the envelope of the radio-frequency wave. For instance, if the ideal signal as given by (30) is detected, the detector

plate current will be proportional to the coefficient of the radio frequency term, or

$$e_a = KE_1(1 + m \sin at) \quad (44)$$

K is the detection constant.

Let us see how the phase shift signal as given by (33) differs from the ideal signal as given by (30). It has the same amplitude coefficient $(1 + m \sin at)$ and the only difference is that the phase of the radio-frequency carrier is changing. This changing phase does not affect the amplitude of the signal, therefore the detector plate current will be the same as given in (44). This line of reasoning assumes that the receiver is not very selective. That is, all of the side bands as given in (43) are received with equal attenuation. This is not strictly true in practice but the distortion is very slight even if we disregard the higher order side bands. Suppose for instance we use only the first order side bands in (43), or

$$\begin{aligned} e = & J_0(K) \sin wt + \frac{m}{2} J_0(K) [\cos (w - a)t - \cos (w + a)t] \\ & + \frac{m}{2} J_1(K) [\sin (wt - \phi) - \sin (wt + \phi)] \\ & + J_1(K) \{ \cos [(w + a)t + \phi] + \cos [(w - a)t - \phi] \} \\ & + \frac{m}{2} J_2(K) \{ \cos [(w + a)t + 2\phi] - \cos [(w - a)t - 2\phi] \}. \end{aligned} \quad (45)$$

Equation (45) may be written in this form

$$e = A \sin wt + B \cos wt$$

$$\text{where } A = J_0(K)(1 + m \sin at) - mJ_2(K) \sin (at + 2\phi) \quad (46)$$

$$B = mJ_1(K) \sin \phi + 2J_1(K) \cos (at + \phi)$$

Equation (46) may be rewritten

$$e = \sqrt{A^2 + B^2} \sin (wt + \beta) \quad \beta = \tan^{-1} \frac{B}{A} \quad (47)$$

The detector plate current is given by the amplitude coefficient $\sqrt{A^2 + B^2}$. Using Table I, we see that for phase shifts less than 10 degrees the above coefficient is to a close approximation simply $J_0(K)(1 + m \sin at)$. It is also noted that for a phase shift of 10 degrees, $J_0(K)$ is 0.9975, which makes the detector plate current to a very close approximation the same as given by (44). We may, therefore, assume

that even though the receiver is selective enough to cut out all but the first order side bands, no noticeable change in quality will be apparent for moderate shifts of phase.

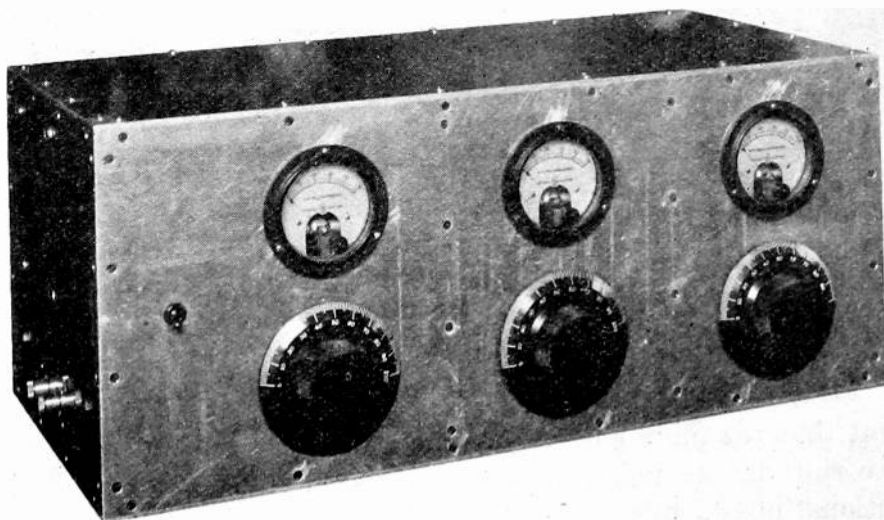

Fig. 10—Frequency multiplier for phase shift measurements.

PHASE SHIFT TESTS ON COMMERCIAL TRANSMITTER

A commercial transmitter designed for short-wave telephone communication was tested for phase shift using the cathode ray oscillograph and frequency multiplier previously described. This transmit-

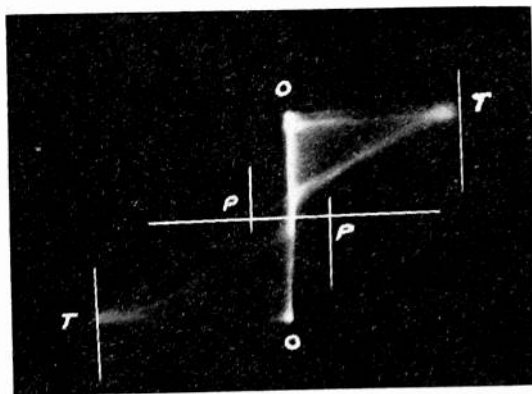

Fig. 11—Cathode ray oscillogram of W2XAF showing phase shift of 12.5 degrees. Modulation percentage = 100.

ter was adjustable to operate on any frequency from 16 to 45 meters. It had an output of about 12 kw, and was capable of being modulated 100 per cent.

It was found that when all tank circuits were tuned to resonance a phase shift of $4\frac{1}{2}$ degrees was present with 100 per cent modulation. Most of this was probably due to a slight regeneration of feed-back in the transmitter. When the modulated stage was detuned to such an

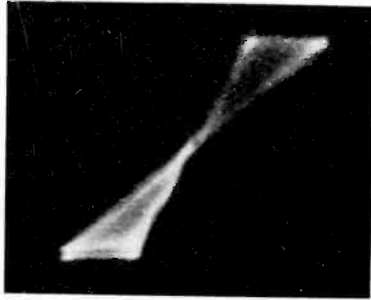

Fig. 12—Cathode ray oscillogram of W2XAF. Modulation percentage = 50.
Phase shift = 0.

extent that the plate current on that stage increased 25 per cent the phase shift in the transmitter was increased to 15 degrees. Thus an additional phase shift of $10\frac{1}{2}$ degrees was added due to detuning the tank circuit of the modulated stage.

This transmitter had an amplifier stage following the modulated stage which raised the power up to the final level. When the tank cir-

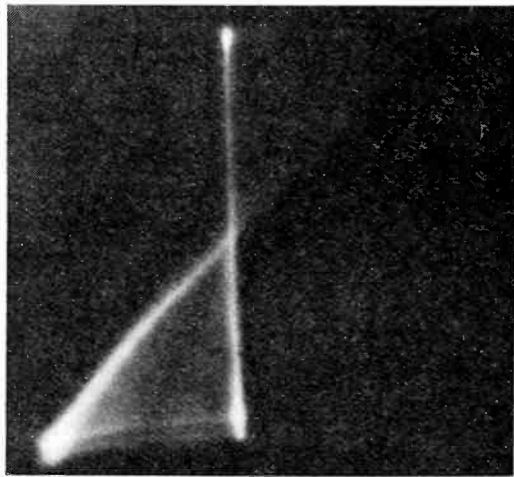

Fig. 13—Cathode ray oscillogram of W2XAF. Modulation percentage = 100.
Phase shift = 0.

cuit of this stage was detuned the phase shift was only increased to $6\frac{1}{2}$ degrees. In other words, detuning this stage caused an additional shift of only 2 degrees. It seems evident then that the modulated stage is quite sensitive to detuning compared to the other stages. This sub-

stantiates the theory that any change in phase shift when a circuit other than in the modulated stage is detuned is a result of a change in α . (See Fig. 6.)

CONCLUSION

In conclusion it may be stated that the most noticeable effect of phase shift is the creation of adjacent channel interference. The amplitude of the second order side band is roughly one per cent of the first order side band per degree of phase shift.

Phase shift may be caused in a number of different ways but in general, if care is taken in tuning the transmitter and if the transmitter does not have excessive feed-back, the phase shift will be below an objectional amount.

Bibliography

- (1) C. B. Aiken, "The detection of two modulated waves which differ slightly in carrier frequency," *PROC. I.R.E.*, vol. 19, p. 120, (1931).
- (2) S. Ballantine, "Detection at high signal voltages," *PROC. I.R.E.*, vol. 17, p. 1153, (1929).
- (3) J. R. Carson, "Notes on the theory of modulation," *PROC. I.R.E.*, vol. 10, p. 57, (1922).
- (4) E. L. Chaffee, "Equivalent circuits of an electron triode and the equivalent input and output admittances," *PROC. I.R.E.*, vol. 17, p. 1633, (1929).
- (5) B. van der Pol, "Frequency modulation," *PROC. I.R.E.*, vol. 18, p. 1194, (1930).
- (6) R. K. Potter, "Transmission characteristics of a short-wave telephone circuit," *PROC. I.R.E.*, vol. 18, p. 581, (1930).



DISCUSSION ON "AMPLITUDE, PHASE, AND FREQUENCY
MODULATION"*

HANS RODER

David G. C. Luck:¹ While Mr. Roder has given a comprehensive account of the analysis of the modulation process, the many misconceptions which have arisen in this field seem to justify the placing of further emphasis on the physical foundation of such analysis.

The usual oscillatory electrical quantities may be represented by projections of vectors of constant length rotating with constant angular velocity ω_0 , 2π times the frequency, where

$$\omega_0 = \varphi/t \quad (1)$$

φ being the angle turned through in time t . The confusion in the case of "phase" and "frequency" modulation, in which the angular velocity is not constant, has arisen from the naïve attempt to retain equation (1), whereas the circumstances require the use of the instantaneous angular velocity, defined in elementary kinematics as

$$\omega = d\varphi/dt \quad (2)$$

which is 2π times the "instantaneous frequency." This last seems a more natural term for what Carson² has called "generalized frequency"; it is, of course, the physically observable variable frequency.

The simplest example of the use of this definition is the siren with uniform angular acceleration.³ Such devices are being used increasingly in radio measurements.⁴ Here

$$a = A \sin \varphi \quad (d^2\varphi/dt^2 = \alpha = \text{constant}) \quad (3)$$

from which,

$$\omega = 2\pi f = \int (d^2\varphi/dt^2) dt = \omega_0 + \alpha t. \quad (4)$$

This is the observable angular velocity, and gives by another integration

$$\varphi = \int \omega dt = \phi_0 + \omega_0 t + \frac{1}{2}\alpha t^2 \quad (5)$$

or,

$$a = A \sin (\phi_0 + \omega_0 t + \frac{1}{2}\alpha t^2) \quad (3a)$$

where,

ω_0 and ϕ_0 are constants of integration.

The quantity a might be the alternating photocell voltage in a "photo siren."

The case of sinusoidal frequency modulation is completely and correctly discussed by Roder.* However, his method of attack on sinusoidal "phase" modulation is incorrect, in that the solution is obtained by allowing an integra-

* H. Roder, "Amplitude, phase, and frequency modulation," Proc. I.R.E., vol. 19, p. 2145, 1931.

¹ Department of Physics, Massachusetts Institute of Technology, Cambridge, Mass.

² J. R. Carson, "Notes on the theory of modulation," Proc. I.R.E., vol. 10, p. 57, 1922.

³ H. Salinger, "Zur Theorie der Frequenzanalyse mittels Suchtons," *E.N.T.*, vol. 7, p. 488, 1930.

⁴ W. Schäfer and G. Lubszynski, "Measuring frequency characteristics with the photo-audio generator," Proc. I.R.E., vol. 19, p. 1242, 1931.

tion constant to vary with time. The correct procedure is, as always, the integration of a frequency, which inspection of Roder's results shows should be

$$\omega_p = 2\pi f_p = \omega_0 + \mu m_p \cos \mu t. \tag{6}$$

This clearly shows this phenomenon to be merely "frequency" modulation with the frequency variation range increasing linearly with modulation frequency, thereby explaining the pernicious effects of "phase" modulation as regards interference production.

The relation (due to the use of (1) for frequency modulation)

$$e = E \sin [(1 + \Delta\omega_0/\omega_0 \sin \mu t)\omega_0 t] \tag{7}$$

which was shown by Carson² to be completely erroneous, leads directly to extremely high frequencies for large values of t , and so is physically absurd. This

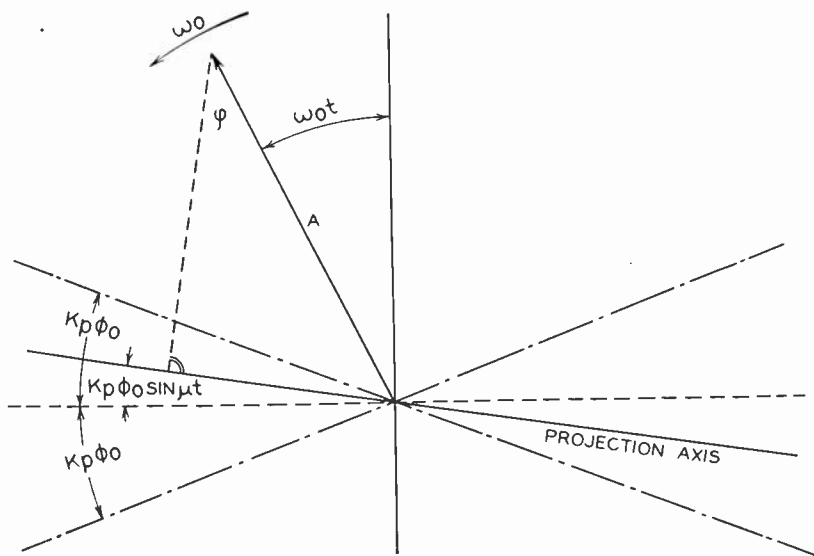

Fig. 1

was pointed out to the author in 1929 by Theodore M. Edison, yet equation (7) has appeared at least twice in reputable journals in 1931.

All the above considerations are implicitly contained in Carson's original article.²

Hans Roder:⁵ The writer wishes to thank David G. C. Luck for calling attention to the physical fundamentals of phase or frequency modulation.

Mr. Luck's statement that an improper method of deriving the expression for phase modulation (equation (10) of the paper*) has been used is correct. However, his suggestion to start always with the integration of a frequency is not generally applicable. When attacking the problem of phase modulation we initially do not know what the instantaneous frequency (equation (6)) will be. In H. Salinger's treatment of the siren, which was cited above the analysis is started from the uniform angular velocity which is the only known magnitude. Consequently, the proper procedure to analyze phase modulation is to use the fundamental equation:

⁵ Radio Engineering Department, General Electric Company, Schenectady, N. Y.

$$i = A \sin \varphi. \quad (8)$$

In the simplest case, φ increases in linear proportion with time. Then we may write

$$\varphi = \omega_0 t \quad (9)$$

where ω_0 is a constant denoting the number of radians per second. As next step, when superimposing a sinusoidal oscillation to the linear function in (9), we may put:

$$\varphi = \omega_0 t + k_p \phi_0 \sin \mu t. \quad (10)$$

This may graphically be interpreted as shown in Fig. 1.

The vector A rotates with constant angular velocity, ω_0 , while the projection axis is subjected to a slow sinusoidal oscillation $k_p \phi_0 \sin \mu t$. Then the current i becomes:

$$i = A \sin \varphi = A \sin (\omega_0 t + k_p \phi_0 \sin \mu t) \quad (11)$$

which is the expression for phase modulation. Of course, (11) will also be obtained mathematically from (8) and (10). However, the relation

$$\omega = \frac{d\varphi}{dt} = \omega_0 \left(1 + \frac{\mu m_p}{\omega_0} \cos \mu t \right) \quad (12)$$

which follows from (2) and (10), shows that we may call the expression given in (11) as well a frequency modulation. This fact that a phase modulation also means some kind of frequency modulation and vice versa, has been clearly emphasized in the paper* (Table A and Fig. 6).

In order to overcome this difficulty in terminology let us consider the following three types of modulation. We use (10) and put:

For the first type:

$$\varphi = \omega_0 t + m_p \sin \mu t$$

Then,

$$\omega = \frac{d\varphi}{dt} = \omega_0 \left(1 + \frac{\mu m_p}{\omega_0} \cos \mu t \right)$$

$$\alpha = \frac{d^2\varphi}{dt^2} = -\mu^2 m_p \cos \mu t$$

$\alpha \dots$ angular acceleration.

For the second type we put:

$$\frac{d\varphi}{dt} = \omega_0 (1 + m_f \sin \mu t).$$

Then,

$$\varphi = \omega_0 t - \frac{m_f \omega_0}{\mu} \cos \mu t + \phi_0$$

$$\omega = \omega_0 (1 + m_f \sin \mu t)$$

$$\alpha = \mu m_f \cos \mu t.$$

For the third type we put:

$$\frac{d^2\varphi}{dt^2} = \alpha_0 (1 + m_\alpha \sin \mu t).$$

Then,

$$\varphi = \omega_0 t + \frac{1}{2} \alpha_0 t^2 - \frac{\alpha_0 m_\alpha}{\mu^2} \sin \mu t + \phi_0$$

$$\omega = \alpha_0 t - \frac{\alpha_0 m_a}{\mu} \cos \mu t + \omega_0$$

$$\alpha = \alpha_0(1 + m_a \sin \mu t).$$

This third type would represent a modulated "photo siren."

Inspection of these expressions shows: We may call the first and second type either a phase or frequency modulation, while the third type may be called a phase, or frequency, or, if we wish so, an "angular acceleration modulation." But, in the writer's opinion, it would be the most logical way to name these types of modulation after that magnitude for which the amplitude of the oscillatory term is independent of the audio radian frequency μ . This definition is chosen in analogy to amplitude modulation for which the peak value of the amplitude variation is proportional to the amplitude of the audio signal, but is independent of the frequency of the audio signal. Thus, the first type is a phase modulation, the second type a frequency modulation, while the third type might be called an "angular acceleration modulation."

Perhaps two examples showing the mutual relations between phase and frequency modulation may be of interest. We consider a frequency modulated transmitter (Fig. 2). Between audio amplifier and transmitter we insert a dis-

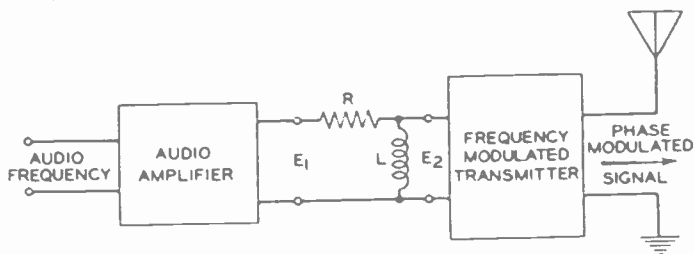

Fig. 2.

torting device, which simply consists of a resistor and an inductance such that $R \gg \mu L$ for the entire audio-frequency band. Then,

$$E_2 = E_1 \frac{L}{R} \mu.$$

Referring to (16), (17), and (18) of the paper, k_f is found to be proportional to E_2 , and m_f is found to be independent of μ . Thus according to the above definition and (10) and (11) of the paper the output of the transmitter is a phase

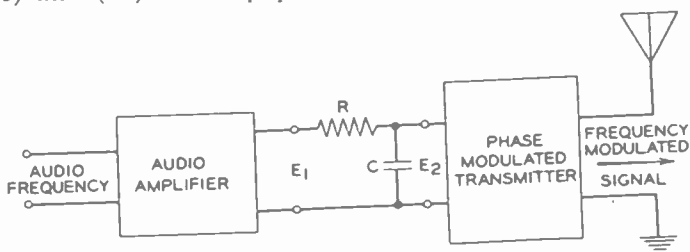

Fig. 3.

modulated signal. On the other hand if we use a phase modulated transmitter (Fig. 3) and use a capacitor in place of $L (R \gg 1/\mu C)$ then the output of the transmitter becomes a frequency modulated signal.

BOOKLETS, CATALOGS, AND PAMPHLETS RECEIVED

Copies of the publications listed on this page may be obtained gratis by addressing a request to the manufacturer or publisher.

Several bulletins have recently been issued by the Kenyon Transformer Co., 122-124 Cypress Ave., New York City, describing various types of transformers. Audio transformers, filter chokes, and power transformers for radio receivers are described in Bulletin No. 111. Transformers for supplying power to filament and plate circuits of transmitting tubes are described in Bulletin No. 112, and a number of step-down transformers for industrial purposes are described in Bulletin No. 113.

The 1932 catalog of the Clarostat Manufacturing Co. of 285 North Sixth St., Brooklyn, N.Y., contains detailed descriptions of the various volume controls, attenuators, phonograph pick-ups, faders, line voltage regulators, and other types of fixed and variable Clarostat resistors.

Several bulletins recently issued by the Webster Electric Co., Racine, Wis., are available giving technical details of a number of faders, phonograph pick-ups, audio amplifiers, and related equipment for theater or hotel installations.

An eight-page bulletin (No. 12) of the Ohmite Manufacturing Co., 635 North Albany Ave., Chicago, describes 50-watt and 150-watt rheostats of small physical dimensions. These are available in resistance values of from 1 ohm to 35,000 ohms, the resistance wire being wound on porcelain, which is covered with vitreous enamel.

The 1932 Condenser and Resistor Manual and Catalog of the Aerovox Wireless Corporation, 70-82 Washington St., Brooklyn, N.Y., contains 48 pages of technical details and general information on Aerovox resistors and condensers for both receiving and transmitting purposes. In addition to the usual detailed specification, it contains much technical data, formulas, and other information of value to engineers, purchasing agents, servicemen, and experimenters.

"Federal Anti-Capacity Switches" is the name of a folder issued by the Federal Anti-Capacity Switch Corp., 42 Laird Ave., Buffalo, N. Y., describing several small switches similar to those used on telephone switchboards. Stock models of these switches are available in single, double, and quadruple pole and in either single or double throw types.

A portable microphone stand for talking picture recording equipment is shown in Bulletin No. 21 of Jenkins and Adair, Inc., 3333 Belmont Ave., Chicago, Ill. Bulletin No. 8C describes two volume indicators mounted on relay rack panels. The Type C volume indicator makes use of a high- μ vacuum tube and is calibrated in steps of 2 db from -12 db. to +12 db. The Type R1 volume indicator has a range of -16 db to +32 db and uses a copper-oxide rectifier rather than the vacuum tube detector.

RADIO ABSTRACTS AND REFERENCES

THIS is prepared monthly by the Bureau of Standards,* and is intended to cover the more important papers of interest to the professional radio engineer which have recently appeared in periodicals, books, etc. The number at the left of each reference classifies the reference by subject, in accordance with the "Classification of Radio Subjects: An Extension of the Dewey Decimal System," Bureau of Standards Circular No. 385, obtainable from the Superintendent of Documents, Government Printing Office, Washington, D.C., for 10 cents a copy. The classification also appeared in full on pp. 1433-56 of the August, 1930, issue of the PROCEEDINGS of the Institute of Radio Engineers.

The articles listed are not obtainable from the Government or the Institute of Radio Engineers, except when publications thereof. The various periodicals can be secured from their publishers and can be consulted at large public libraries.

R100. RADIO PRINCIPLES

- R111.6 C. B. Aiken. Further notes on the detection of two modulated waves which differ slightly in carrier frequency. *PROC. I.R.E.*, Vol. 20, pp. 569-578; March, (1932).

An analysis is given of detection of two modulated waves of slightly different carrier frequency under the conditions that the carrier amplitude of one is much smaller than that of the other and that the modulation of the larger wave is low. Shared channel interference is discussed.

- R113 Über die Beziehungen zwischen Störungen des Kurzwellenempfanges und den erdmagnetischen Störungen. (On the relation between disturbances of short-wave reception and earth magnetic disturbances.) *Elek. Nach. Tech.*, Vol. 9, pp. 71-74; February, (1932).

Evidence of the change of position of the Kennelly-Heaviside layer is obtained from studies of high-frequency phenomena. The relation between magnetic disturbances and disturbances on oversea reception of Transradio are studied. The disturbances of high-frequency reception are compared with the eleven-year sun spot cycle.

- R113
×R270 L. V. Berkner. Some studies of radio transmission over long paths made on the Byrd Antarctic expedition. *Bureau of Standards Journal of Research*, Vol. 8, pp. 265-278; February, (1932). Research Paper No. 412.

Field intensity measurements of high-frequency signals (9,000 to 15,000 kc) over long paths, taken at Dunedin, New Zealand, during the radio operations of the Byrd Antarctic expedition (1928-1930) are given. The relation of diurnal and seasonal changes in signal intensity to the changes of daylight and darkness along the path are discussed.

- R113.3 M. Dieckmann. Peil-Registrierungen des Nachteffekts. (Directional recording of night effects.) *Elek. Nach. Tech.*, Vol. 9, pp. 46-48; February, (1932).

The results of records of night effects taken at Graefelfing on a rotating Adcock antenna are given. Apparatus is briefly described.

- R113.5 H. Plendl. Über den Einfluss der elfjährigen Sonnentätigkeitsperiode auf die Ausbreitung der Wellen in der drahtlosen Telegraphie. (The

* This list compiled by Mr. A. H. Hodge and Miss E. M. Zandonini.

influence of the eleven-year solar period on radio wave transmission.) *Zeit. für Hochfrequenz.* Vol. 38, pp. 89-97; September, (1931). *Proc. I.R.E.*, Vol. 20, pp. 520-539; March, (1932).

Abstracted in the December, 1931, issue of the PROCEEDINGS of the Institute of Radio Engineers.

- R113.61 T. R. Gilliland and G. W. Kenrick. Preliminary note on an automatic recorder giving a continuous height record of the Kennelly-Heaviside layer. Research Paper No. 373. *Bureau of Standards Journal of Research*, Vol. 7, pp. 783-790; November, (1931). *Proc. I.R.E.*, Vol. 20, pp. 540-547; March, (1932).

Abstracted in the March, 1932 issue of the PROCEEDINGS of the Institute of Radio Engineers.

- R113.62 H. M. Dowsett. Echo signals in transatlantic picture telegraphy. *Jour. Television Soc.*, Vol. 1, pp. 84-97; December, (1931).

A general statement relative to echo phenomena is followed by the results of a series of facsimile echo tests.

- R120 J. Labus. Berechnung der Strahlungsenergie von Dipolantennen (Telefunken-richtantennen) nach der Poyntingschen Methode. (Calculation of the radiated energy of dipole antennas according to Poynting's method.) *Elek. Nach. Tech.*, Vol. 9, pp. 61-67; February, (1932).

The energy emitted by a dipole antenna is calculated by the use of Poynting's vectors. Results of this investigation are shown graphically.

- R125 F. Kiebitz. Versuche über die Abstimmung von Richtantennen bei kurzen Wellen. (Experiments with tuned short-wave directive antennas.) *Hochfrequenz. und Elektroakustik*, Vol. 39, pp. 8-10; January, (1932).

The effectiveness of a double-line antenna, similar to a Lecher wire system, was investigated. World-wide reception was accomplished with an experimental arrangement consisting of two wires having one-half meter spacing and a length of 180 meters. This type of antenna is highly directive and may be tuned over a wide range of frequencies.

- R125.1 T. L. Eckersley. The vertical polar diagram of a Marconi beam aerial. *Marconi Review*, Vol. 34, pp. 26-29; January-February, (1932).

A method of calculation based on the analysis given in a paper entitled, "Short Wave Wireless Telegraphy," Proceedings of the Institute of Electrical Engineers, 65, June, 1927, is described.

- R131
×R333 M. A. Acheson and H. F. Dart. Characteristics of the UV-858 power tube for high-frequency operation. *Proc. I.R.E.*, Vol. 20, pp. 449-60; March, (1932).

The need is indicated for high power vacuum tubes for high-frequency transmission. Important factors in a vacuum tube for high-frequency transmission are discussed. Actual design and resulting characteristics and ratings for the UV-858 Radiotron are given.

- R132 C. E. Fay. The operation of vacuum tubes as class B and class C amplifiers. *Bell Sys. Tech. Jour.*, Vol. 11, pp. 28-52; January, (1932). *Proc. I.R.E.*, Vol. 20, pp. 548-568; March, (1932).

A theoretical development of the action of a vacuum tube and its associated circuit when used as a B and C amplifier is given. Conditions for maximum output are indicated. Experimental data are shown which verify theoretical results.

- R133 H. Nyquist. Regeneration theory. *Bell Sys. Tech. Jour.*, Vol. 11, pp. 126-147; January, (1932).

A mathematical treatment of regeneration theory applied to oscillators.

- R133 G. Potapenko. Investigations in the field of the ultra-short electromagnetic waves. *Phys. Rev.*, Vol. 39, pp. 625-665; February 15, (1932).
A description of apparatus for the production of ultra-high-frequency undamped electromagnetic waves by the Barkhausen-Kurz method and results are presented.
- R133 F. B. Llewellyn. Constant frequency oscillators. *Proc. I.R.E.*, Vol. 19, pp. 2063-2094; December, (1931). *Bell Sys. Tech. Jour.*, Vol. 11, pp. 67-100; January, (1932).
Abstracted in the February, 1932, issue of the *PROCEEDINGS* of the Institute of Radio Engineers.
- R133 N. W. McLachlan. On the influence of valve resistance in oscillation generators. *Wireless Engineer and Experimental Wireless*, Vol. 9, pp. 129-135; March, (1932).
The effect of tube resistance on frequency is analyzed mathematically. Results of an experimental study are given.
- R133 R. Cockburn. Gill-Morell and Barkhausen-Kurz oscillations. *Nature* (London), Vol. 129, p. 202; February 6, (1932).
A set of observations is mentioned in which the Gill-Morell oscillations extend on both sides of the Barkhausen-Kurz.
- R143
×R386 F. S. Dellenbaugh, and R. S. Quimby. The important first choke in high-voltage rectifier circuits. *QST*, Vol. 16, pp. 14-19; February, (1932); pp. 26-30, March, (1932); pp. 33-40; April, (1932).
Filter problems peculiar to modern rectifiers are treated. Smoothing action of the filter system is given particular attention.
- R148.1 R. O. Carter. Distortion in screen-grid valves. *Wireless Engineer and Experimental Wireless*, Vol. 9, pp. 123-129; March, (1932).
Measurements made to determine the limits of distortionless operation both of a standard type of screen-grid high-frequency amplifying tube and also of the variable-mu tetrode are described. Causes of distortion are discussed.
- R149 Y. Rocard. Contribution à la théorie du redressement. (Contribution to the theory of rectification.) *L'Onde Electrique*, Vol. 11, pp. 23-44; January, (1932).
A mathematical presentation of the calculus of rectification. The calculations are accompanied by tables, graphs and charts.
- R161.5 H. A. Brooke. Microphonic feed-back phenomena in radio receivers. *Jour. I.E.E.*, (London), Vol. 70, p. 268; February, (1932).
Microphonic feed-back may be eliminated by careful attention to design of radio receiving sets.
- R163 E. V. Appleton and D. Boohariwalla. The mutual interference of wireless signals in simultaneous detection. *Wireless Engineer and Experimental Wireless*, Vol. 9, pp. 136-139; March, (1932).
It is shown that if strong and weak signals of carrier frequency intensities S and W respectively are simultaneously received with a linear detector, the modulation of the weak signal is reduced to a fraction $W/2S$ of its original value. An experimental investigation of the theory is described.
- R165 A. Forstmann. Über die rechnerische Behandlung mechanischer schwingungsfähiger Gebilde unter Benutzung äquivalenter elektrischer Ersatzschemen. (An analytical treatment of vibrating mechanical systems.) *Hochfrequenz. und Elektroakustik*, Vol. 39, pp. 11-18; January, (1932).
Fundamental relations between mechanical and equivalent electrical vibrating systems are derived. This equivalent electrical method is then applied to an analytical treatment of: (1) the electrodynamic speaker, (2) electromagnetic pick-up, and (3) the electromagnetic loud speaker.

- R170 A. Larsen. Eliminating interference caused by electrical equip-
 ×R430 ment. *QST*, Vol. 16, pp. 16-19; March, (1932).

Interference problems peculiar to amateur station operation are discussed.

R200. RADIO MEASUREMENTS AND STANDARDIZATION

- R210 A. Wainburg and L. Segebart. Ein objectives Verfahren zur Eichung der Wechselstromfrequenzen. (An objective method of measuring frequency.) *Elek. Nach. Tech.*, Vol. 9, pp. 1-5; January, (1932).
 A multivibrator is used to step the frequency down to a value that can be compared with another frequency by means of a stroboscope.
- R210 W. Fehr. Präzisionsverfahren zur Messung kurz und ultrakurzer Wellen. (Precision methods of measuring short and ultra-short waves.) *Elek. Nach. Tech.*, Vol. 9, pp. 57-60; February, (1932).
 The harmonics of high-frequency quartz resonators are used to measure high and ultra-high frequencies. The heterodyne method is used. Quartz resonators may also be used in the measurement of small capacities, self-inductance and mutual inductance.
- R220 R. Barton. A method of measuring small capacitance. *Rev. Sci. Instr.* Vol 3, pp. 123-132; March, (1932).
 A method is described by which a small capacitance of unknown value is alternately charged from a large condenser and discharged. The potential of the large condenser is restored after each sharing by means of a variable air condenser whose capacitance is gradually and continuously decreased during sharing process.
- R254 E. A. Laport. Broadcast transmitter measurement using a wave-meter. *Electronics*, Vol. 4, pp. 88-89; March, (1932).
 A method of measuring modulation characteristics of a transmitter with a wave-meter and oscillator.
- R261 J. F. Rider. Continuity tests of radio receivers. *Radio Engineering*, Vol. 12, pp. 26-32; March, (1932).
 An analysis of comments received relative to published information concerning continuity testing to be found in radio service manuals.
- R261.2 D. D. Israel. Sensitivity controls—manual and automatic. *PROC. I.R.E.*, Vol. 20, pp. 461-477; March, (1932).
 Requirements for an ideal automatic sensitivity control are set down and the various basic systems discussed.
- R262.9 A. W. Bulkley. How to build this new oscillator-tube tester. *Radio Craft*, Vol. 3, pp. 586-587; April, (1932).
 Construction details.
- R264.1 W. W. Gerstang. Methods of testing characteristics of electrolytic condensers. *Radio Engineering*, Vol. 12, pp. 24-25; March, (1932).
 Economical methods of measuring capacity, leakage, resistance, and power factor of electrolytic condensers are given.
- R265.2 M. J. O. Strutt. On the equivalent mass of driven loud speaker cones. *Wireless Engineer and Experimental Wireless*, Vol. 9, pp. 143-150; March, (1932).
 Results of an experimental study on the equivalent mass of cones in air as a function of frequency between 60 and 2000 cycles are given. Tables of data and a bibliography are included.
- R270 The field in the immediate neighborhood of a transmitting aerial. *Wireless Engineer and Experimental Wireless*, Vol. 9, pp. 119-122; March, (1932).
 The components of the electromagnetic field are calculated from the consideration of an oscillating dipole.

R300. RADIO APPARATUS AND EQUIPMENT

- R330 L. Martin. The latest radio tubes. *Radio Craft*, Vol. 3, pp. 588-589; April, (1932).
Four new tubes are described. A new '27, a mercury vapor '80, a general purpose pentode, and a '41.
- R330 M. Bareiss. An automobile tube of increased output. *Electronics*, Vol. 4, p. 96; March, (1932).
Eveready Raytheon type LA tube combines the advantages of the 238 and 247. Plate efficiency 70 per cent. Small filament current.
- R355.21 New fifty kilowatt transmitter for WGY. *Radio Engineering*, Vol. 12, p. 18; March, (1932).
A new transmitter with remote control is to be installed.
- R355.3 G. Grammer. A low-power 1715-kc CW transmitter. *QST*, Vol. 16, pp. 8-10; March, (1932).
Constructional data.
- R355.5 H. Straubel. Fundamental crystal control for ultra-high frequencies. *QST*, Vol. 16, pp. 10-13; April, (1932).
The uses of tourmaline crystal oscillators down to 1.2 meters are described.
- R355.9 The new music of electronic oscillations. *Electronics*, Vol. 4, p. 86; March, (1932).
Description of the latest instruments of Theremin, Ranger, and Miessner.
- R361 The Radio-Craft "Triple-Twin" Receiver. *Radio Craft*, Vol. 3, pp. 592-593; April, (1932).
Construction details for a receiving set using the new "triple-twin" tube.
- R361 E. Messing. Acoustic feedback in superheterodyne receivers. *Radio Engineering*, Vol. 12, p. 14; March, (1932).
Howl was eliminated by putting variable condenser in soundproof box, and mounting speaker loosely on sponge rubber.
- R361 A. Binneweg. Portable short wave receivers. *Radio Engineering*, Vol. 12, p. 23; March, (1932).
Factors that enter into the design of a short wave portable set of low cost are considered.
- R361 J. J. Lamb. Stabilizing superheterodyne performance. *QST*, Vol. 16, pp. 14-17; April, (1932).
Use of electron-coupled oscillators with heater-type tubes for stabilizing superheterodyne performance.
- R363 C. E. Kilgour. Problems of push-push amplification. *Electronics*, Vol. 4, pp. 82-83; March, (1932).
The push-push amplifier is compared with the push-pull amplifier. The characteristics and advantages of the push-push amplifier are given.
- R363.1 H. Bartels. Über die Resonanzverzerrung bei Widerstands-Verstärkern. (On the elimination of resonance distortion in resistance-coupled amplifiers.) *Elek. Nach. Tech.*, Vol. 9, pp. 26-30; January, (1932).
Circuit diagrams are shown by the help of which one may neutralize or produce distortion in resistance-coupled amplifiers. The original magnitude of amplification remains in the undistorted region. General applications are given.

- R366 Development of B-battery devices for auto radio. *Electronics*, Vol. 4, pp. 80-81; March, (1932).
Prices and data are given on several commercial B-battery devices.
- R382 C. E. Denton. I. F. coil design. *Radio Craft*, Vol. 3, pp. 596-597; April, (1932).
Design and construction of coils. Curves, charts, circuits, and data are given.
- R382.1 R. Gunn. A mechanically resonant transformer. *PROC. I.R.E.*, Vol. 20, pp. 516-519; March, (1932).
An audio-frequency transformer is described whose output is selective to frequency. The diaphragm of a telephone receiver is replaced by a tuned reed of magnetic material. The vibrating reed is used to generate potentials in another receiver unit adjacent to the tuned reed.
- R382.1 C. C. Henry and R. M. Stemm. I. F. transformers—cost vs. quality. *Electronics*, Vol. 4, p. 97; March, (1932).
Data which should be useful in designing compact receiving sets is given.
- R388 M. von Ardenne. Untersuchungen an Braunschens Röhren mit Gasfüllung. (Experiments with the gas-filled Braun tube.) *Hochfrequenz. und Elektroakustik*, Vol. 39, pp. 18-24; January, (1932).
Results of a detailed experimental investigation of the properties of gas-filled Braun tubes are reported. Static relations between gas pressure, anode voltage, and current are discussed.
- R388 J. B. Johnson. The cathode-ray oscillograph. *Jour. Franklin Inst.*, Vol. 212, pp. 687-717; December, (1931). *Bell Sys. Tech. Jour.*, Vol. 11, pp. 1-27; January, (1932).
Abstracted in the February, 1932, issue of the PROCEEDINGS of the Institute of Radio Engineers.

R400. RADIO COMMUNICATION SYSTEMS

- R400 I. F. Byrnes. The communication system of the Radiomarine Corporation of America. *PROC. I.R.E.*, Vol. 20, pp. 434-448; March, (1932).
The coastal facilities and shipboard apparatus used in the communication system of the Radiomarine Corporation of America are described.
- R412
×R510 C. N. Anderson and I. E. Lattimer. Operation of a ship-shore radiotelephone system. *PROC. I.R.E.*, Vol. 20, pp. 407-433; March, (1932).
A review is given of the essential physical and operating features of the land and ship terminals employed in giving the ship-shore radiotelephone service.

R500. APPLICATIONS OF RADIO

- R526 C. B. Carr. Wave lengths for aircraft communication. *Marconi Review*, No. 34, pp. 16-25; January-February, (1932).
A discussion is given of the variation of skip distance and transmission range with frequency variation. Specific problems encountered in aircraft communication are discussed.
- R526.1 F. G. Kear and G. H. Wintermute. A simultaneous radiotelephone and visual range beacon for the airways. Research Paper No. 341. *Bureau of Standards Journal of Research*, Vol. 7, pp. 261-287; August, (1931). *PROC. I.R.E.*, Vol. 20, pp. 478-515; March, (1932).
Abstracted in the October, 1931, issue of the PROCEEDINGS of the Institute of Radio Engineers.

- R581 F. Schröter. Die Übertragung von Halbtonbildern mittels kurzer Wellen. (The transmissions of half tone pictures by means of short waves.) *Elek. Nach. Tech.*, Vol. 9, pp. 49-56; February, (1932).
The results obtained with the canal-ray method of modulation are compared with those obtained by time modulation method.
- R583 P. G. Weiller. Television progress from an engineering viewpoint. *Radio Engineering*, Vol. 12, pp. 16-17; March, (1932).
A review of engineering elements of present-day television.
- R583 J. Dunsheath. Progress in television. *Radio Engineering*, Vol. 12, pp. 11-13; March, (1932).
A general survey of present status of television.
- R583 E. H. Traub. The German Post Office cathode-ray television system. *Jour. Television Soc.*, Vol. 1, pp. 75-81; December, (1931).
General description of system.
- R583 M. von Ardenne. Cathode-ray tube method of television. *Jour. Television Soc.*, Vol. 1, pp. 71-74; December, (1931).
Life of tube, quality of picture, experimental apparatus, and results are discussed.
- R583 Cathode-ray television. *Jour. Television Soc.*, Vol. 1, pp. 69-70; December, (1931).
Introduction to a series of papers on this subject by Prof. MacGregor-Morris.
- R583 C. E. C. Roberts. Vacuum photo-cell type transmitter. *Jour. Television Soc.*, Vol. 1, pp. 82-83; December, (1931).
A method of television is described whereby the subject is scanned and transmitted electrically without the use of mechanical parts.

R600. RADIO STATIONS

- R612.1 H. Staut. La nouvelle station de radiodiffusion Radio-Paris. (The new radio broadcasting station Radio-Paris.) *L'Onde Electrique*, Vol. 11, pp. 5-22; January, (1932).
A description of this new station 40 km from Paris.

R800. NONRADIO SUBJECTS

- 534.83 J. A. Slee. Reflection methods of measuring the depth of the sea. *Wireless Engineer and Experimental Wireless*, Vol. 9, pp. 20-22; January, (1932). *Jour. I.E.E.*, (London), Vol. 70, pp. 269-280; February, (1932).
The paper records the present state of perfection with which echo measurements can be carried out in practice. Methods and apparatus are described.
- 535.38 W. M. Roberds. An electronic high-speed timing device. *Electronics*, Vol. 4, pp. 90-91; March, (1932).
An electronic device for timing short intervals is described.
- 537.65 G. S. Parsons. Silvering electrodes on quartz crystals. *QST*, Vol. 16, p. 20; March, (1932).
Silvering of electrodes on quartz plates is described.
- 621.313.7 B. Ephriam. Electrical characteristics of the hot-cathode mercury vapor tube. *Radio Engineering*, Vol. 12, pp. 33-34; March, (1932).
The theory of the mercury vapor tube is treated from atomic and electronic hypotheses.
- 621.383.21 H. T. Hayden. Simplified remote control for amateur transmitters. *QST*, Vol. 16, pp. 27-28; April, (1932).
The use of remote control relays for amateur transmitting sets is described.

CONTRIBUTORS TO THIS ISSUE

Andrew, Victor J.: Born August 31, 1902, in Medina County, Ohio. Received B.S. degree, Wooster College, 1926; M.S. degree, University of Chicago, 1928. Amateur, experimenter, and operator, 1919 to date. Junior radio engineer, Signal Corps radio laboratories, Fort Monmouth, New Jersey, 1926-1927; radio engineer, Westinghouse Electric and Manufacturing Company, 1928-1930; graduate student and assistant, physics department, University of Chicago, 1930 to date. Associate member, Institute of Radio Engineers, 1925; Member, 1930.

Colwell, Robert C.: Born October 14, 1884, at Fredericton, N.B., Canada. Received A.B. degree, Harvard University; M.A. degree, University of New Brunswick; Ph.D. degree, Princeton University. Professor of physics, Geneva College, 1913-1923; Assistant director of radio laboratory, West Virginia University, 1924 to date. Member, American Physical Society, Franklin Institute, American Mathematical Society. Associate member, Institute of Radio Engineers, 1921; Member, 1929.

Fitch, W. A.: Born November 16, 1905, at Cleveland, Ohio. Received B.S. degree, Michigan State College, 1926; M.S. degree, Union College, 1931. Entered General Electric course, 1926; radio engineering department, General Electric Company, 1928 to date. Junior member, Institute of Radio Engineers, 1926; Associate, 1929.

Hovgaard, O. M.: Born 1899, at Copenhagen, Denmark. Amateur radio, 1915-1920. Radio operator on board ship, at coastal stations, and for Tropical Radio Telegraph Company, 1920-1923. Student, Massachusetts Institute of Technology, 1923-1926. Engineer, Acme Apparatus Company, 1926-1927; engineer, Briggs and Stratton Corporation, 1927-1928; development and manufacture quartz frequency controls, antenna design, and radio transmission studies, Bell Telephone Laboratories, 1928 to date. Associate member, Institute of Radio Engineers, 1924; Member, 1926.

Kirby S. S.: Born October 27, 1893, at Gandy, Nebraska. Received A.B. degree, College of Emporia, Emporia, Kansas, 1917; M.A. degree, University of Kansas, 1921. Signal Corps, U. S. Army, A.E.F., 1918-1919. High school teacher 1919-1921; professor of Physics, Friends University, Wichita, Kansas, 1921-1926; assistant physicist, Bureau of Standards 1923-1930; associate physicist, Bureau of Standards 1930 to date. Associate member, Institute of Radio Engineers, 1927.

Mouromtseff, Ilia Emmanuel: Born December, 1881, at St. Petersburg, Russia. Received M.A. degree, Engineering Academy, St. Petersburg, 1906; received Diploma-Ingenieur degree, Institute of Technology, Darmstadt, Germany, 1910. Radio laboratory, Russian Signal Corps, 1911. Technical member, Westinghouse Electric and Manufacturing Company, 1923 to date. Nonmember, Institute of Radio Engineers.

Norton, K. A.: See PROCEEDINGS for February, 1932.

Osborn, Perry H.: Born August 31, 1904, at Buskirk, N. Y. Received E. E. degree, Rensselaer Polytechnic Institute, 1926; M. S. degree, University of Pittsburgh, February, 1932. Westinghouse Electric and Manufacturing Company, 1926 to date; student training course, 1926-1927; in charge of high power tube test and development laboratory, 1927-1930; on development and design work in connection with high power transmitting equipment, ultra-short-wave generators, and broadcast problems, 1930-1932. Associate member, Institute of Radio Engineers, 1928.

EMPLOYMENT PAGE

Advertisements on this page are available to members of the Institute of Radio Engineers and to manufacturing concerns who wish to secure trained men for positions. All material for publication on this page is subject to editing from the Institute office and must be sent in by the 15th of the month previous to the month of publication. (April 15th for May PROCEEDINGS IRE, etc.) Employment blanks and rates will be supplied by the Institute office. Address requests for such forms to the Institute of Radio Engineers, 33 West 39th Street, New York City, N.Y.

MANUFACTURERS and others seeking radio engineers are invited to address replies to these advertisements at the Box Number indicated, care the Institute of Radio Engineers. All replies will be forwarded direct to the advertiser.

RADIO OPERATOR with four years' experience as ship operator desires work with commercial land, airways, or broadcast station. Holds first class commercial license. High school graduate. Age 23. Married. Will travel. Box 121.

RADIO ENGINEER with one year's experience working on vacuum tubes and photo-electric cells. Desires position as research or development worker on vacuum tubes or radio circuits. Seven years' college and post graduate work with A.B. in 1929. Age 25. Box 122.

RADIO ENGINEER employed for eight years by large set manufacturing concern as development and design engineer on radio receivers and for past six months working as engineer for parts manufacturing concern, wishes position doing laboratory or design work on receivers. Capable of handling electrical design of complete receiver and familiar with factory management and costs. College graduate 1918. Age 37. Will travel. Box 123.

SERVICEMAN with six years' experience in service work. Has specialized in short wave development and design during past two years. Desires any radio position where experience can be best utilized, especially development of high frequency receivers and television. High school graduate. Age 24. Married. Will travel. Box 124.

ENGINEER'S ASSISTANT with one year laboratory experience in all phases of radio receiver design and development including power supply, hum, audio systems, radio systems and general measurements and with experience as a tester for radio receivers desires position where his knowledge can be most useful. Is specially interested in a position in a radio laboratory. Pratt Institute E.E. graduate, 1928. Age 25. Single. Box 88.

When writing to advertisers mention of the PROCEEDINGS will be mutually helpful.

ENGINEERS • *if you want the last word in condenser design and construction* • SPECIFY the new ACRACON SEMI-DRY ELECTROLYTIC CONDENSER

Note These Features:

- peak operating voltage 500
- surge voltage 600
- low initial leakage
- leakage current at 500 volts less than .2 mils per mfd.
- constant capacity; does not decrease with age
- stable power factor; does not increase with age
- non-corrosive connections
- metal or fibre container
- standard and special sizes

Write Today for Descriptive Literature!

** Acracon Features are Protected by Patents Pending*

Condenser Corporation of America

259 Cornelison Ave., Jersey City, N.J.

Factory Representatives In:

Chicago Cincinnati St. Louis San Francisco Los Angeles Toronto

And Other Principal Cities

When writing to advertisers mention of the PROCEEDINGS will be mutually helpful.

Always a Market for **BETTER PRODUCTS**

LEADERSHIP, in any line, invariably is the result of high quality standards, produced at the lowest commensurate cost.

Hammarlund Precision Products have led their respective fields since the beginning of broadcasting.

Price-cutting epidemics come and go, but there is *always* a market for *better products*.

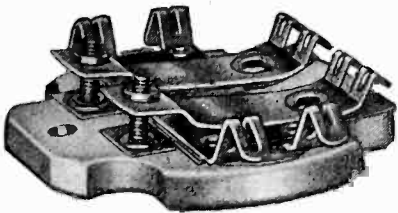

For Accurate Tuning of INTERMEDIATE TRANSFORMERS

Proved design—will not change in resistance or capacity from humidity, temperature or vibration. Specially tested Isolantite base mounts inside of transformer shield.

Self-aligning phosphor-bronze adjustable spring plates, double riveted. Selected mica insulation.

Forty ranges in single or dual models—10 mmf. to 2100 mmf.

*Mail Coupon
for Details
and Prices*

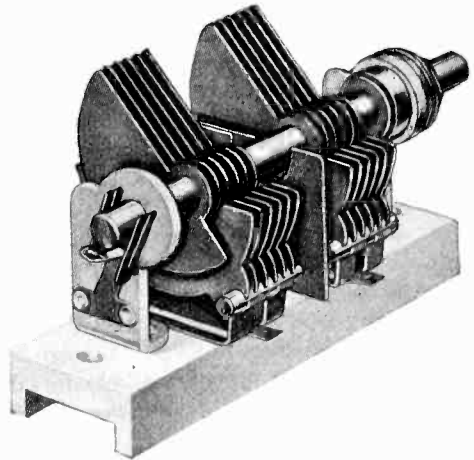

MIDGET CONDENSER *Defies Vibration*

Ideal for short-wave, airplane or automobile receivers, where compactness and freedom from vibration are essential.

Single and dual models—20 to 325 mmf. per section. Soldered brass plates, riveted frame, phosphor bronze rotor contact. Isolantite insulation.

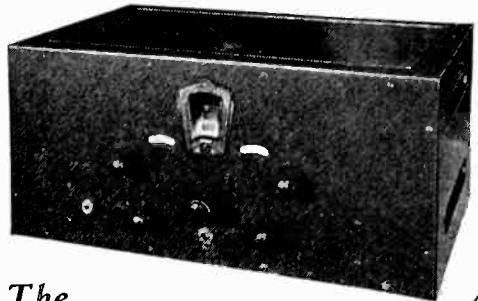

The COMET "PRO"

Super-efficient eight-tube super-heterodyne used by professional operators, airports and broadcasting stations. Experts say the "PRO" is the "finest short-wave receiver ever designed." Range, from 15 to 200 meters. Band-spread tuning system. Special oscillator for C.W. reception. Phone jack and speaker connections.

HAMMARLUND MANUFACTURING CO.,
424-438 W. 33rd St., New York, N. Y.

Please send details and prices of Midget and Intermediate Condensers—also Comet "Pro".

Name

Address

PE-5

For Better Radio
Hammarlund
PRECISION
PRODUCTS

When writing to advertisers mention of the PROCEEDINGS will be mutually helpful.

The peace that pennies buy

EACH DAY, after breakfast, you bid good-bye to your husband and he is gone. Miles of distance and hours of traveling may separate him from you, yet you do not fear. You have no feeling of his being far away—no sense of loneliness or isolation. For there, within reach of your hand, is your contact with all the world—the guardian of your home . . . your telephone.

All you see is the telephone instrument itself and a few feet of wire. Through the familiarity of use, you are likely to take it for granted in much the same manner as air and water and sunshine. Rarely do you think of the complicated exchanges, the almost endless stretches of wire and the hundreds of thousands of trained employees that are needed to interconnect, through the Bell System, nearly twenty million telephones in this country and twelve million in foreign lands. No

matter where you are you can command the full use of the telephone. It knows no class or creed. There is no distinction of position. All may share it equally.

Every time you lift the receiver you employ some part of the nation-wide Bell System. Yet the charge for residential use is but a few cents a day. For this small sum you receive a service that is almost limitless in convenience and achievement—so indispensable in emergencies that its value cannot be measured in terms of money.

Thinking of the peace and security it brings each home—of hurried calls to doctors and hospitals—of priceless, necessary talks with relatives and friends—of the many ways it saves you steps and time and trouble throughout the month, you will know why so many millions of people look on the telephone as a member of the family.



AMERICAN TELEPHONE AND
TELEGRAPH COMPANY



When writing to advertisers mention of the PROCEEDINGS will be mutually helpful.

Send for this New Catalog NOW!

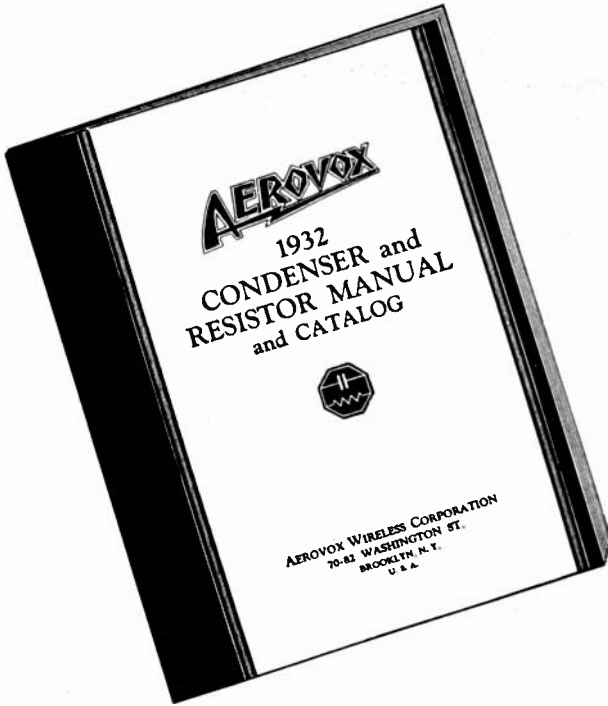

**It's
FREE**

Every Radio Engineer, Purchasing Agent, Manufacturer and Technician should have a copy of this latest manual and catalog. It contains 48 pages full of new, valuable and interesting data on condensers and resistors, listing the most complete line of condenser and resistor products for all radio and electrical applications. A request on the coupon below will bring your copy immediately.



Be sure to see the Aerovox Exhibit
at the RMA Trade Show
Booth 79—Exhibition Hall
Stevens Hotel
Chicago, Illinois

**AEROVOX
WIRELESS CORP.**
70 Washington Street
Brooklyn, New York

*Manufacturers of
The Most Complete Line of Con-
densers and Resistors in the Radio
and Electrical Industries*

When writing to advertisers mention of the PROCEEDINGS will be mutually helpful.

The Aerovox Research Worker is a free publication issued to keep radio engineers, technicians and experimenters abreast of the latest developments in radio practice, especially with the proper use of condensers and resistors. If you are not already receiving the Research Worker regularly, a request on the coupon below will place your name on the mailing list.

AEROVOX WIRELESS CORP.
70 Washington Street
Brooklyn, N.Y.

I.R.E. Proc.
May, 1932

Gentlemen:

Please send me without charge or obligation:

- Your 1932 Condenser and Resistor Manual
and Catalog.
 The Research Worker.

Name

Street

City State

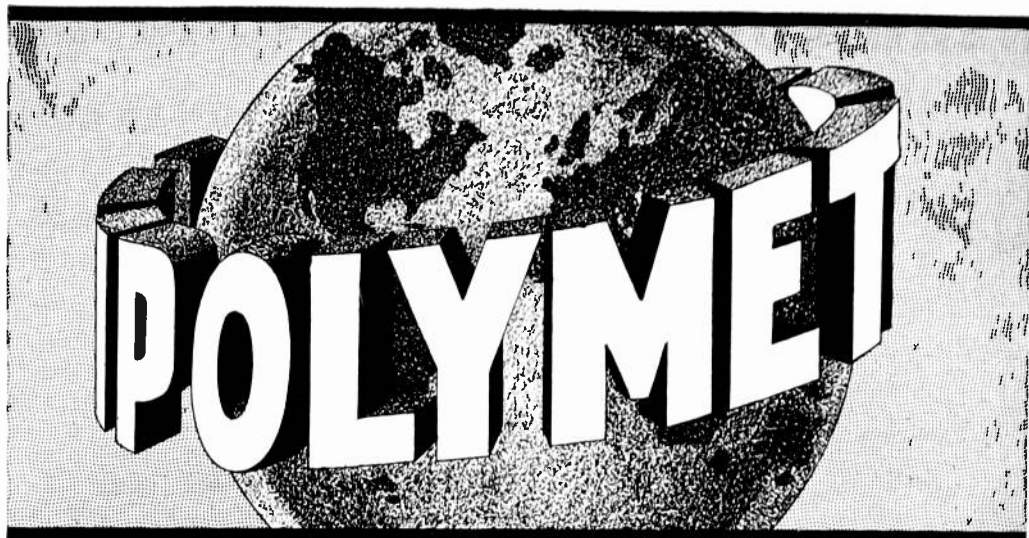

Polymet Products

"STANDARD OF THE INDUSTRY"

World-known and World-accepted

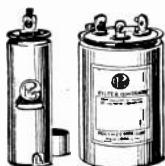

Condensers

- Paper
- Electrolytic
- Mica



Resistors

Volume Controls



Transformers



Choke Units



Coil Windings

Both manufacturers' and service requirements are assured prompt attention.



Catalog on request.



POLYMET MANUFACTURING CORP.

World's Largest Manufacturers of Radio Essentials

829-839 East 134th Street, New York City

Sales Representatives in all leading cities of the United States and in all principal countries of the world.



Special sales department for export, located at the address above, is prepared to cooperate closely with overseas manufacturers for their parts requirements.

When writing to advertisers mention of the PROCEEDINGS will be mutually helpful.

Take Your Choice

Every member of the Institute of Radio Engineers will want to wear one of these three attractive emblems. All of these emblems are appropriately colored to indicate the various grades of membership and each emblem is approximately the size of the following illustrations.



The **Lapel Button** is of 14k gold, with background enameled in the membership color, and with the lettering in gold. The screw-back on the back of this button fastens it securely to your coat.

\$2.75 postpaid—any grade.



The **Pin** is also of 14k gold. It is provided with a safety catch and is appropriately colored for the various grades of membership.

\$3.00 postpaid—any grade.



The **Watch Charm**, handsomely finished on both sides, is also of 14k gold. This charm is equipped with a suspension ring for attaching to a watch fob or chain.

\$5.00 postpaid—any grade.

Orders, accompanied by checks made payable to the Institute of Radio Engineers, should be addressed to

THE INSTITUTE OF RADIO ENGINEERS
33 West 39th Street
NEW YORK CITY, N. Y.

Send in your order now!

When writing to advertisers mention of the PROCEEDINGS will be mutually helpful.



AMERTRAN AUDIO Transformers

Recognized for 10 years as the Standard of Excellence for every amplifying application. The graph below illustrates a Representative Frequency Response Curve of an AmerTran Input Transformer.

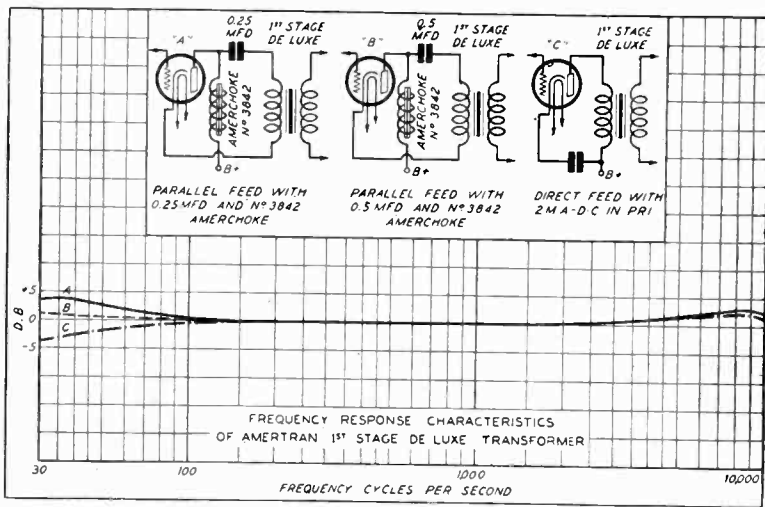

On request we will send you graphs giving similar curves on the following types of AmerTran Transformers —

- Output Transformers**
- Interstage Transformers**
- Impedance Matching Transformers**
- Mixer Transformers**

For further information write—

AMERICAN TRANSFORMER COMPANY
 Factory and Main Office—178 Emmet Street, Newark, N. J.
 New York Office—Hudson Terminal, 50 Church St., Room 1963

When writing to advertisers mention of the PROCEEDINGS will be mutually helpful.

15 Textolite laminated parts were used in this timing device

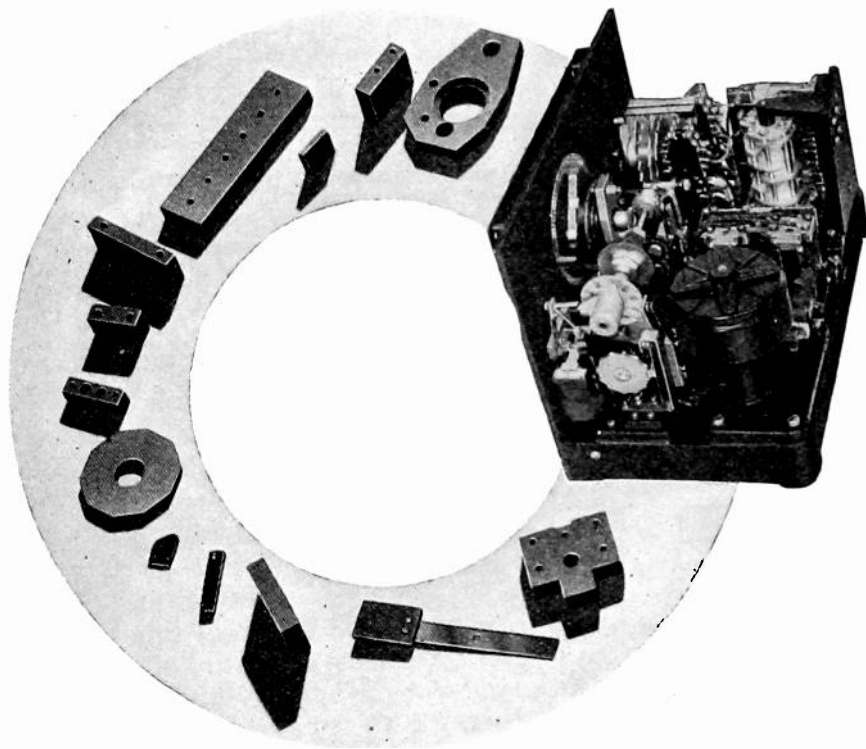

TEXTOLITE laminated, a General Electric product, manufactured in sheets, tubes, and rods, was chosen for the fabrication of these parts because of its dependable uniformity, high dielectric and mechanical strength, and the ease with which it can be fabricated.

OTHER PRODUCTS:
Textolite molded
Cetec cold-molded

EASTERN FABRICATOR
General Fabricating Co.
37 East 18th Street
New York City

WESTERN FABRICATOR
Electrical Insulating Corp.
308 Washington Street
Chicago, Ill.

An increasing number of manufacturers in the electrical, radio, and electronic fields are using Textolite laminated — it assures positive, dependable operation of their products.

Investigate Textolite laminated. By adapting it to your product, you may be able to effect great savings for your company.

Ask for a copy of GEA-1458. Simply address General Electric Company, Plastics Department, Meriden, Conn.

831-15D

GENERAL ELECTRIC

When writing to advertisers mention of the PROCEEDINGS will be mutually helpful.

SPECIAL ITEMS FOR RADIO MANUFACTURERS

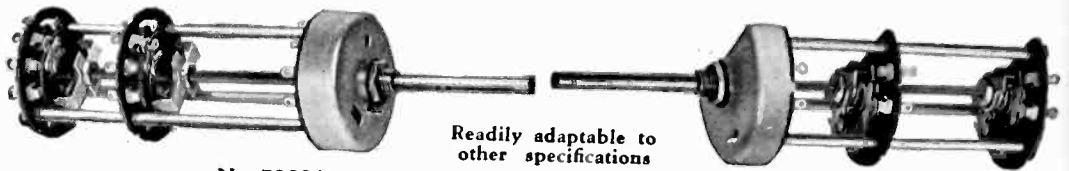

No. 7280A
3 gang, 4 positions
single circuit

Readily adaptable to
other specifications

No. 7260A
3 gang, 2 positions
2 circuits

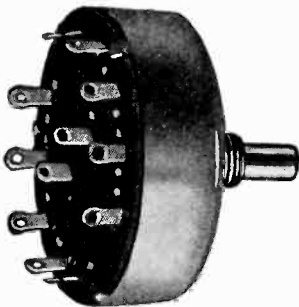

No. 7150A
5 positions, 2 circuits

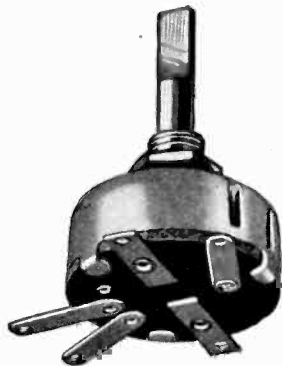

No. 7120A
Combined Acoustic and muting
switch 2 or 3 positions

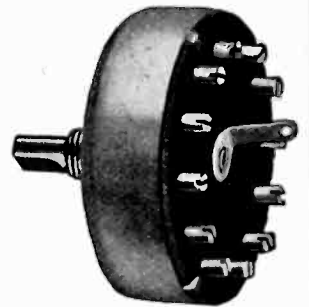

No. 7220A
12 positions, single circuit

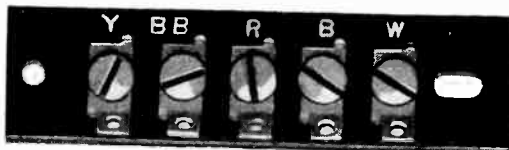

Terminal Strip
5 Lugs No. 6880A, 4 lugs No. 6990A



Terminal Strip
4 Clips, No. 6830A

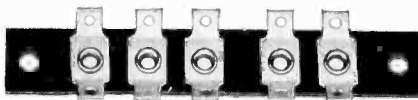

Terminal Strip
5 Lugs, No. 6950A

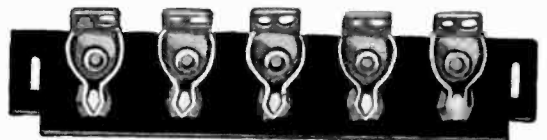

Terminal Strip
5 Clips, No. A6310AA, 4 Clips No. A6320AA

SORENG - MANEGOLD CO.

1901-9 Clybourn Avenue, CHICAGO, ILL.

1646 W. Adams St.
Los Angeles, Cal.

701 Stephenson Bldg.
Detroit, Mich.

245-5th Ave.
New York City

When writing to advertisers mention of the PROCEEDINGS will be mutually helpful.

TIME-INSURED QUALITY

CARDWELL variable condensers and CARDWELL-designed and built-to-order apparatus have, for considerably more than a decade, enjoyed a reputation for outstanding excellence won by conscientious adherence to an ideal of fair dealing and a determination to sponsor only *quality* products.

Look around. Somewhere, in the majority of the really fine radio installations and equipments in the country, governmental, broadcast, commercial or amateur, will be found some product of CARDWELL manufacture.

What better proof of the recognized excellence of CARDWELL apparatus could be offered?

The CARDWELL line of condensers includes transmitting condensers for high, medium and low power, and receiving condensers in infinite variety. The CARDWELL Midway Featherweight (all aluminum, none over 7 ounces in weight) for transmitting, receiving and neutralizing, is unequalled for aircraft and portable equipment.



May we send our literature?



CARDWELL CONDENSERS AND MANUFACTURING SERVICE

The Allen D. Cardwell Mfg. Corpn.
93 Prospect Street, Brooklyn, N.Y.

“THE STANDARD OF COMPARISON”

When writing to advertisers mention of the PROCEEDINGS will be mutually helpful.

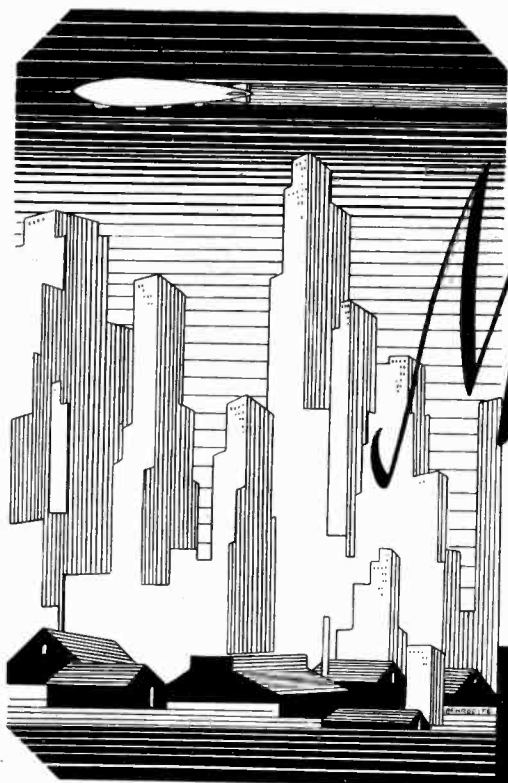

*Modern
methods*

ERIE RESISTORS are made under modern conditions with modern methods.

They are in every way equal to every demand made upon them in modern production work of the manufacturers who use them.

Enjoying the enviable reputation for accuracy **ERIE RESISTORS** are standard with manufacturers who are looking for excellent performance and minimum rejections.

May we send you samples and prices?

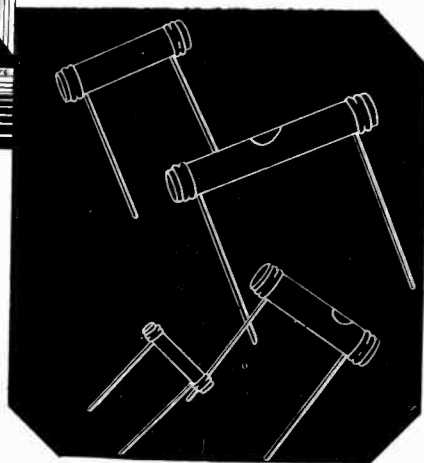
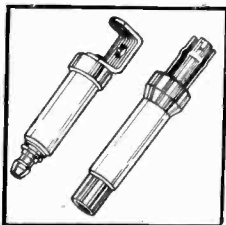

ERIE SUPPRESSORS

If you build an automobile radio set, ask for information on **ERIE SUPPRESSORS**. Made in lug, screw and distributor types.

ERIE RESISTORS



ERIE RESISTOR CORPORATION, ERIE, PA.
Factories In Erie, Pa., Toronto, Canada and London, Eng.

When writing to advertisers mention of the PROCEEDINGS will be mutually helpful.

XX

Selected for the

METROPOLITAN OPERA

. . . after careful tests of
all types of microphones

WIDESPREAD has been the favorable comment on the fine reproduction attained in the METROPOLITAN OPERA broadcasts. Complimentary, indeed, is this to the group of NBC engineers who are responsible for the success of these broadcasts.

Such success, however, is not surprising in light of their previous achievements. As the motivating force of the greatest of broadcasting organizations they have continuously led in the progress of a rapidly developing art.

Constant improvement in studio technique has been one reason for maintenance of this leadership; but another, equally important, has been an eager readiness to adopt for use the latest and most improved transmitting equipment.

To this end these engineers are continually



Deems Taylor's "Box" at the Metropolitan Opera House

subjecting various types of equipment to exhaustive tests. Microphones—as the singly most vital element in the broadcast chain—have occupied much of their attention.

For those most elite of all broadcasts from the Metropolitan Opera House special tests were made and various types of microphones compared. Tested were microphones of the latest and most widely pub-

licized types as well as models still in the laboratory stage.

Against such competition RCA Victor condenser microphones were chosen. They are now used exclusively—for orchestra, for soloists and chorus, for Deems Taylor's announcements—standard models identical to those in use in most of the prominent independent stations from coast to coast.

ENGINEERING PRODUCTS DIVISION

RCA Victor Company, Inc.

A Radio Corporation of America Subsidiary

CAMDEN, N. J.

“RADIO HEADQUARTERS”



When writing to advertisers mention of the PROCEEDINGS will be mutually helpful.

Piezo Electric Crystals

New Price List Effective Immediately

We are extremely pleased to announce **NEW REDUCED PRICES** for **HIGH GRADE CRYSTALS** for **POWER** use. Due to our **NEW** and **MORE EFFICIENT METHOD** of preparing these crystals, we are allowing you to share in the **LOWER COSTS** of producing these crystals.

We are proud of the confidence our customers have shown toward us, we extend to them our sincere thanks for their patronage thus making this reduction possible.

New prices for grinding **POWER** crystals in the various frequency bands as follows:

FREQUENCY RANGE	NEW LIST
100 to 1500 Kc	\$40.00
1501 to 3000 Kc	\$45.00
3001 to 4000 Kc	\$50.00
4001 to 6000 Kc	\$60.00

The above prices include holder of our Standard design, and the crystals will be ground to within .03% of your specified frequency. If crystal is wanted unmounted deduct \$5.00 from the above prices. Delivery two days after receipt of your order. In ordering please specify type tube, plate voltage and operating temperature.

Special Prices Will Be Quoted in Quantities of Ten or More

POWER CRYSTALS FOR AMATEUR USE

The prices below are for grinding a crystal to a frequency selected by us unmounted, (if wanted mounted in our Standard Holder add \$5.00 to the prices below) said crystal to be ground for **POWER** use and we will state the frequency accurate to better than a tenth of one per-cent. **IMMEDIATE SHIPMENT CAN BE MADE.**

1715 to 2000 Kc band.....	\$12.00 each
3500 to 4000 Kc band.....	\$15.00 each

LOW FREQUENCY STANDARD CRYSTALS

We have stock available to grind crystals as low as 13 Kilo-cycles. Prices quoted upon receipt of your specifications.

PIONEERS: POWER CRYSTALS SINCE 1925

This record is proof to you that you will get the best there is in Piezo Electric Power Crystals. Get the best. It is more economical.

Scientific Radio Service

"THE CRYSTAL SPECIALISTS"

124 Jackson Ave., University Park

Hyattsville, Maryland

The Institute of Radio Engineers

Incorporated

33 West 39th Street, New York, N. Y.

APPLICATION FOR ASSOCIATE MEMBERSHIP

(Application forms for other grades of membership are obtainable from the Institute)

To the Board of Direction

Gentlemen:

I hereby make application for Associate membership in the Institute of Radio Engineers on the basis of my training and professional experience given herewith, and refer to the members named below who are personally familiar with my work.

I certify that the statements made in the record of my training and professional experience are correct, and agree if elected, that I will be governed by the constitution of the Institute as long as I continue a member. Furthermore I agree to promote the objects of the Institute so far as shall be in my power, and if my membership shall be discontinued will return my membership badge.

.....
(Sign with pen)

.....
(Address for mail)

.....
(Date)

.....
(City and State)

References:

(Signature of references not required here)

Mr. Mr.

Address Address

City and State City and State

Mr.

Address

City and State

The following extracts from the Constitution govern applications for admission to the Institute in the Associate grade:

ARTICLE II—MEMBERSHIP

Sec. 1: The membership of the Institute shall consist of: * * * (c) Associates, who shall be entitled to all the rights and privileges of the Institute except the right to hold any elective office specified in Article V. * * *

Sec. 4: An Associate shall be not less than twenty-one years of age and shall be a person who is interested in and connected with the study or application of radio science or the radio arts.

ARTICLE III—ADMISSION AND EXPULSIONS

Sec. 2: * * * Applicants shall give references to members of the Institute as follows: * * * for the grade of Associate, to three Fellows, Members, or Associates; * * * Each application for admission * * * shall embody a full record of the general technical education of the applicant and of his professional career.

ENTRANCE FEE SHOULD ACCOMPANY APPLICATION

MODEL 150

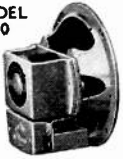

6 1/2 inch Dynamic Speaker

MODEL 152



10 1/4 inch Dynamic Speaker

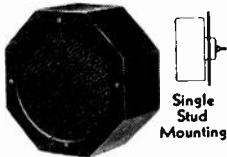

MODEL 154—Auto Speaker



MERSHON Electrolytic Capacitor

Stud Type Mounting

MAGNAVOX Electrolytic Capacitors

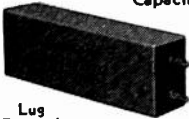

Lug Terminals

MAGNAVOX Electrolytic Capacitor



Flexible Lead Terminals

Magnavox SPEAKERS AND CAPACITORS

Mershon CAPACITORS

● MAGNAVOX SPEAKERS

Magnavox' 21 years of leadership in acoustics is significant. There is occasionally one manufacturer in an industry who will not compromise high standards of quality or performance, even in a price market and who continues to perfect and improve under all circumstances. The service which such a firm renders to the entire industry is apparent. Magnavox products which you may see at the R. M. A. Trade Show prove Magnavox' right to that position in the radio speaker industry.

● AUTO SPEAKERS

Magnavox engineering has mastered the tone problem—the most difficult in auto radio—and has added exclusive features assuring ease and simplicity of installation, with single stud mounting. Available in models 150 and 154, optional in wood or metal baffle cases.

● SPEAKER AND CAPACITOR COMBINATION

Illustration at the right shows the ideal adaption of capacitor and speaker combination mounting. Model 154 is shown with 9-8 Mfd. 450V. capacitors. This offers advantages both in space factor and ease of installing filter unit.

● MERSHON CAPACITORS

Improved, compact models in which space factor has been emphasized. Trouble-free—puncture-proof—self-healing—with a record of proven stability. Free from mechanical leakage. Made in several types of mounting for your convenience.

● MAGNAVOX CAPACITORS

Magnavox now offers a complete range of filter and By-Pass dry Electrolytic Capacitors in all standard capacities and voltages.

Magnavox engineering service is available to recognized manufacturers upon request, without obligation.

Welcome to the R. M. A. Trade Show
Speaker and Capacitor Headquarters

Stevens Exhibition Hall, Space 93-A, Stevens Demonstration Rooms,
104-A, 105-A, 106-A

MAGNAVOX MODEL 530 Dynamic Speaker

especially made and adapted for Class B radio sets. See and hear it at the R. M. A. Show.

MODEL 517

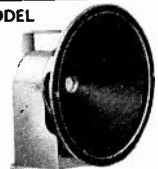

14 inch Dynamic Speaker

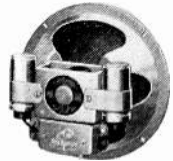

Speaker, Capacitor Combination

MERSHON Electrolytic Capacitors

Clamp Type Mounting



MAGNAVOX BY-PASS Electrolytic Capacitor

Magnavox Company Ltd.

ESTABLISHED 1911

GENERAL OFFICES AND FACTORY, FORT WAYNE, INDIANA

Subsidiaries

THE MAGNAVOX COMPANY, ELECTRO FORMATION, INC.,
MAGNAVOX (AUSTRALIA), LTD, MAGNAVOX (GREAT BRITAIN), LTD.

When writing to advertisers mention of the PROCEEDINGS will be mutually helpful.

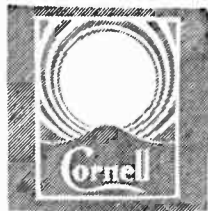

Cornell

TRADE MARK REG.

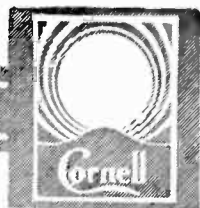

READY NOW!

OUR NEW

CATALOG "A"

DESCRIBING THE NEW CORNELL LINE OF
PAPER DIELECTRIC
CAPACITORS

FOR

RADIO, TELEVISION AND IGNITION

AND

RESISTORS

FOR

RADIO AND TELEVISION

SEND
FOR
YOUR
COPY
NOW

We recommend the articles described in this catalog with pride, knowing that their quality will give satisfaction in any instrument in which they are incorporated.

If you have not already received your copy of our new catalog, write for it today. You will find the data and information therein of great service to you.

CORNELL ELECTRIC MFG. CO., Inc.

Manufacturers of
CORNELL "CUB" CONDENSERS
Filter and By-Pass Condensers, Interference Filters and
All Types of Paper Dielectric Condensers

LONG ISLAND CITY, NEW YORK

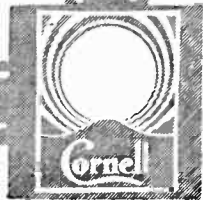
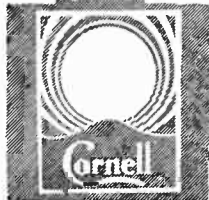

When writing to advertisers mention of the PROCEEDINGS will be mutually helpful.

Preprints Available



A LIMITED number of preprints of some of the papers presented at the technical sessions of the Twentieth Anniversary Convention of the Institute are available without cost to members of the Institute. They are as follows:

1. "Application of the Class B Audio Amplifier to A-C Operated Receivers," by L. E. Barton.
2. "Design of Resistors for Precise High-Frequency Measurements," by L. Behr and R. E. Tarpley.
3. "The Campbell-Shakelton Shielded Ratio Box," by L. Behr and A. J. Williams, Jr.
4. "Modern Radio Equipment for Air Mail and Transport Use," by A. P. Berejkoff and C. G. Fick.
5. "Circuit Relations in Radiating Systems and Applications to Antenna Problems," by P. S. Carter.
6. "Westinghouse Radio Station at Saxonburg, Pa.," by R. L. Davis and V. E. Trouant.
7. "Radio Dissemination of the National Standard of Frequency," (Abstract), by J. H. Dellinger and E. L. Hall.
8. "Radio Test Methods and Equipment," (Abstract), by W. F. Diehl.
9. "A New Circuit for the Production of Ultra-Short-Wave Oscillations," by H. N. Kozanowski.
10. "A New Water-Cooled Power Vacuum Tube," by I. E. Mourontseff.
11. "The Precision Frequency Measuring System of RCA Communications, Inc.," by H. O. Peterson and A. M. Braaten.
12. "Kennelly-Heaviside Layer Studies Employing a Rapid Method of Virtual-Height Determination," by J. P. Schafer and W. M. Goodall.
13. "Transmission Lines for Short-Wave Radio Systems," by E. J. Sterba and C. B. Feldman.
14. "Triple-Twin Tubes," by C. F. Stromeyer.
15. "Note on the Measurement of Resistance at High Frequency," by P. B. Taylor.
16. "Dynamic Symmetry in Radio Design," by Arthur Van Dyck.
17. "Two-Way Radiotelephone Circuits," by S. B. Wright and D. Mitchell.

Requests for copies of any of the above should be made to the Institute office, 33 West 39th Street, New York City.

When writing to advertisers mention of the PROCEEDINGS will be mutually helpful.

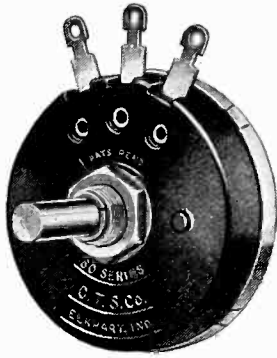

No. 80 Series Single Unit without switch.

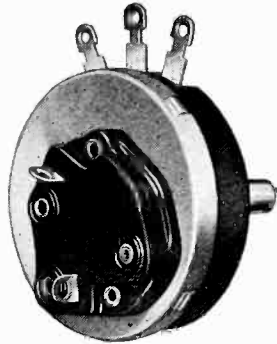

No. 80 Series Single Unit with S. P. S. T. low-torque snap switch.

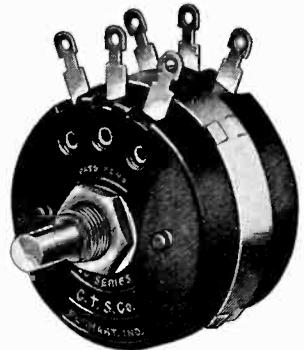

No. 2-80 Series Tandem Unit without switch.

At your service

Radio's most comprehensive line of Volume and Tone Controls

WITH the recent addition to our line of the three new No. 80 Series Volume and Tone Controls shown above, we are in a position to offer set manufacturers the most comprehensive line of these units now available. Our products and our engineering facilities *are at your service* to help you with your volume and tone control problems. *Every possible type, every conceivable style, every desired resistance gradient, in either wire wound or carbon element controls, in single or tandem units, with and without switch, are ready for you . . .* We believe our No. 80 Series is unique: Sturdy, noiseless in operation, economical for you to assemble. Capacity between thimble and shaft and live parts of unit is nil. Low-torque snap switch of our own construction has "cold" cam. Switch-equipped controls, when furnished with electrostatic shield, may be directly associated with grid circuit without possibility of pickup from power circuit . . . Write us today regarding your specific requirements.

CHICAGO TELEPHONE SUPPLY CO.
HERBERT H. FROST, Inc., Sales Division
GENERAL OFFICES AND PLANT
ELKHART, INDIANA

When writing to advertisers mention of the PROCEEDINGS will be mutually helpful.

CHANGE IN MAILING ADDRESS OR BUSINESS TITLE

Members of the Institute are asked to use this form for notifying the Institute office of a change in their mailing address or the listing of their company affiliation or title in the Year Book.

The Secretary,
THE INSTITUTE OF RADIO ENGINEERS,
33 West 39th Street,
New York, N.Y.

Dear Sir:

Effective please note change in my address
(date)
for mail as follows:

FROM

.....
(Name)

.....
(Street Address)

.....
(City and State)

TO NEW ADDRESS

.....
(Street Address)

.....
(City and State)

Please note following change in my Year Book listing.

.....
(Title)

.....
(Company Name)

.....
(Company Address)

Back Numbers of the Proceedings, Indexes, and Year Books Available

MEMBERS of the Institute will find that back issues of the Proceedings are becoming increasingly valuable, and scarce. For the benefit of those desiring to complete their file of back numbers there is printed below a list of all complete volumes (bound and unbound) and miscellaneous copies on hand for sale by the Institute.

The contents of each issue can be found in the 1909-1930 Index and in the 1931 Year Book.

BOUND VOLUMES:

- Vol. 10 (1922), \$8.75 per volume to members
- Vol. 18 (1930), \$9.50 to members

UNBOUND VOLUMES:

- Vols. 5, 6, 8, 9, 10, 11, 13, 14, 18, and 19 (1917-1918-1920-1921-1922-1923-1925-1926-1930-1931), \$6.75 per volume (1917-1926) and \$7.50 per volume (1927-1931) to members

MISCELLANEOUS COPIES:

- Vol. 1 (1913) July and December
- Vol. 2 (1914) June
- Vol. 3 (1915) December
- Vol. 4 (1916) June and August
- Vol. 7 (1919) February, April, August, and December
- Vol. 15 (1927) January, April, May, June, July, October, November, and December
- Vol. 16 (1928) February, March, April, May, June, July, August, October, November, December
- Vol. 17 (1929) January, February, March, April, May, June, July, August, September, November, and December.

These single copies are priced at \$1.13 each to members to the January, 1927, issue. Subsequent to that number the price is \$0.75 each. Prior to January, 1927, the Proceedings was published bimonthly, beginning with the February issue and ending with the December issue. Since January, 1927, it has been published monthly.

MEMBERS will also find that our index and Year Book supplies are becoming limited. The following are now available:

INDEX

The Proceedings Index for the years 1909-1930 inclusive is available to members at \$1.00 per copy. This index is extensively cross indexed.

YEAR BOOK

The 1932 Year Book is now available to members at \$1.00 per copy. This Year Book includes a current alphabetical catalogue of the I.R.E. membership, in which the mailing address and business affiliation of each member is listed, as well as current information on standard measurements for tubes and sockets and standard requirements for radio receivers.

Make remittances payable to the Institute of Radio Engineers and send orders to:

THE INSTITUTE OF RADIO ENGINEERS

33 West 39th Street
NEW YORK CITY, N. Y.

PROFESSIONAL ENGINEERING DIRECTORY

For Consultants in Radio and Allied Engineering Fields

FOR ADVANCED TRAINING

in:

Practical Radio Engineering
Practical Television Engineering

write to

CAPITOL RADIO ENGI- NEERING INSTITUTE

Riggs Bank Bldg.
Washington, D.C.

The J. G. White Engineering Corporation

Engineers—Constructors

*Builders of New York Radio
Central*

43 Exchange Place New York

ALLEN B. DU MONT

Consulting Engineer

Vacuum Tubes—Television
Experimental Cathode Ray Tubes
made to order

Phone	Office and Laboratory
Montclair	9 Bradford Way
2-2176	Upper Montclair, N.J.

For EXPORT of Material Manufactured
by:

American Transformer Co.
Allen D. Cardwell Mfg. Co.
Cornell Elec. Mfg. Co., Inc.
Corning Glass Works
P. R. Mallory
Radio Engineering Labs.
Ward Leonard Electric Co.
Weston Elec. Inst. Co.

Apply to

AD. AURIEMA, INCORPORATED
116 Broad St.
New York City, N.Y.

JENKINS & ADAIR, INC.

Engineers

Designers and manufacturers of apparatus essential to broadcasting, sound recording and sound measurement work.

3333 Belmont Ave., Chicago, U.S.A.

Cable Address: *Jenkadair*

Telephones: *Keystone 2130*

ELECTRICAL TESTING LABORATORIES

Tests of Inductances.
Condensers. Transform-
ers etc. Life and charac-
teristics of Radio Tubes

80th. Street and East End Ave.
• • NEW YORK, N.Y. • •

Greenleaf Whittier Pickard

Consultant

59 Dalton Road,
Newton Centre, Mass.

BEN J. CHROMY

Attorney at Law

Patents and Patent Causes
National Press Bldg.
WASHINGTON, D.C.

"Radio Patent Service"
Weekly

When writing to advertisers mention of the PROCEEDINGS will be mutually helpful.

Alphabetical Index to Advertisements

A

Aerovox Wireless Corp.....XIII
Allen-Bradley Co...Inside Back Cover
American Tel. & Tel. Co.....XII
American Transformer Co.....XVI
Arcturus Radio Tube Co.....XXXIV

C

Cardwell, Allen D., Mfg. Corp.....XIX
Central Radio Laboratories...XXXIII
Chicago Telephone Supply Co..XXVIII
Condenser Corp. of America.....X
Continental Carbon Co.....XXXV
Cornell Electric Mfg. Co.....XXVI

D

DeForest Radio Co.....XXXVI

E

Employment PageIX
Erie Resistor Corp.....XX

G

General Electric Co.....XVII
General Radio Co..Outside Back Cover

H

Hammarlund Mfg. Co.....XI

I

I.R.E.XV, XXIII,
XXIV, XXVII, XXIX, XXX

M

Magnavox Co., Ltd.....XXV

P

Polymet Mfg. Co.....XIV
Professional Eng. Directory....XXXI

R

RCA Victor Co., Inc.....XXI

S

Scientific Radio Service.....XXII
Soreng-Manegold Co.....XVIII

When writing to advertisers mention of the PROCEEDINGS will be mutually helpful.

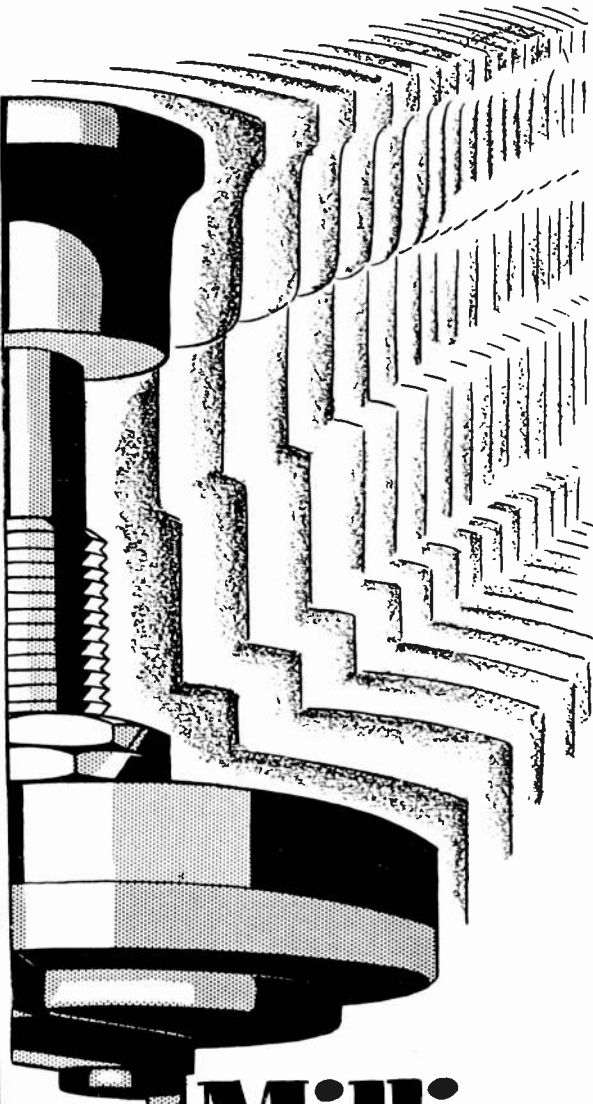

a Million
CENTRALAB (SWITCH
TYPE)
VOLUME CONTROLS
IN 1931

Centralab by pioneering the self-contained line switch on the Volume Control saved the radio industry thousands of dollars in 1931 and sup-

plied more than a million of that type assembly. That production volume proves Centralab reliability and assures a still more economical product this year.

CENTRAL RADIO LABORATORIES · MILWAUKEE, WIS.

When writing to advertisers mention of the PROCEEDINGS will be mutually helpful.

'Unitary Structure' in TRANSMITTING TUBES

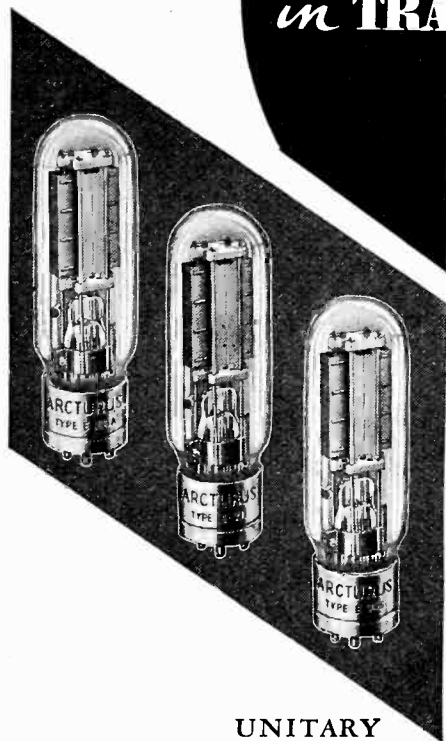

**assures matched
tubes . . . enduring
uniformity . . .
long-lived per-
formance**

Seldom have new products offered such a decided improvement over existing devices. The uniformity, performance and unique construction of Arcturus transmitting tubes establish a new basis for considering operation cost per hour.

The exclusive "unitary structure" principle employed in these tubes—the same as used in the well-known Arcturus Blue receiving tubes—assures unvarying uniformity even under most rigorous conditions. "Unitary structure" also insures matched tubes, so necessary for critical operation. These tubes are interchangeable with other makes whose last two digits are similar.

Write for technical data bulletins on the Arcturus Types E703-A, E711, E711-E, E745 (50-watt tubes) and E766 and E772 (mercury vapor rectifiers).

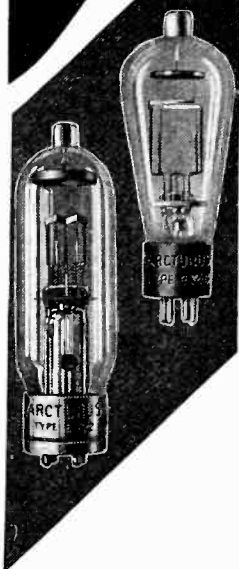

UNITARY STRUCTURE

Note the extreme rigidity of these tubes. The Unitary Structure principle of interlocking the elements maintains the precise interrelation of parts through interdependence. Each rugged element is securely clamped at the top and bottom and the complete assembly is a sturdy unit—insuring constant uniformity.

Arcturus
Radio
Tube Co.
Newark,
N. J.

ARCTURUS

*Quality Tubes for
Transmitting, Receiving
and Industrial Uses*

When writing to advertisers mention of the PROCEEDINGS will be mutually helpful.

CONTINENTAL RESISTORS AND SUPPRESSORS

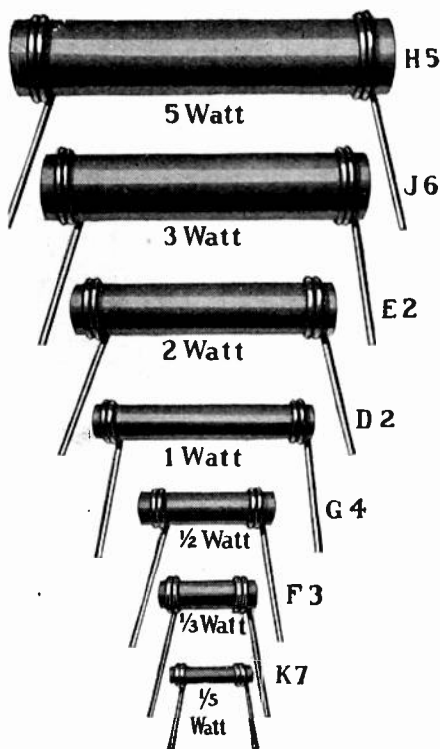

Shown Approximately One-half Size

Continental Resistors are made to exacting specifications under close manufacturing and laboratory control.

They pass the standard tests for first quality units and are in extensive use by principal radio manufacturers.

Continental units have been established leaders for eight years.

For satisfactory service use Continental Resistors.

Write for Information and Prices

CONTINENTAL CARBON INC.
13900 Lorain Avenue
CLEVELAND, OHIO



CONTINENTAL CARBON INC.
SCREW IN CABLE TYPE SUPPRESSOR

Continental Suppressors are standard units. They are made in three types, with regard to form of terminals, one of the most popular being the screw cable type shown above.

The merit of these superior units has been proved by their perfect performance.

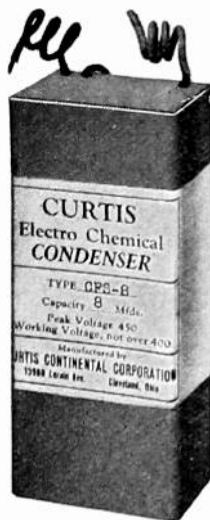

**CURTIS
ELECTRO-
CHEMICAL
CON-
DENSER**

*Made in
Round,
Square,
Rectangular,
Aluminum,
Tin or
Cardboard
Containers.*

Working Voltages Range
from 1 to 450 Volts

We invite comparative tests.

CURTIS-CONTINENTAL CORP.
13900 Lorain Avenue
Cleveland, Ohio

When writing to advertisers mention of the PROCEEDINGS will be mutually helpful.

De Forest

REDUCES PRICES

on these transmitting tubes

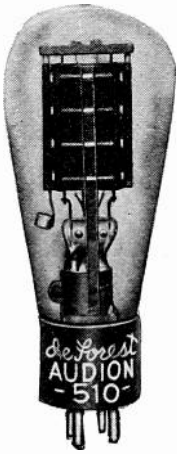

Type
510

7 1/2 Watt
Oscillator

~~\$1.20~~

NOW
\$4.20

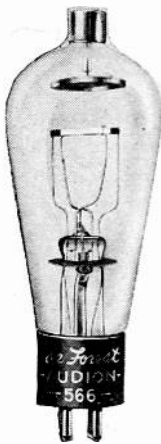

Type
566

Mercury
Vapor Rec.

~~\$0.85~~

NOW
\$4.00

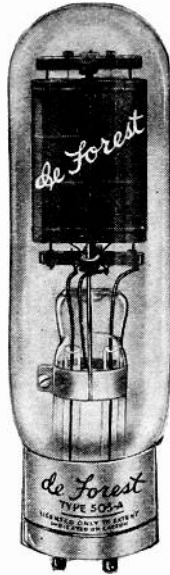

Type
503A

50 Watt
Osc. Amp.

~~\$25.00~~

NOW
\$15.00

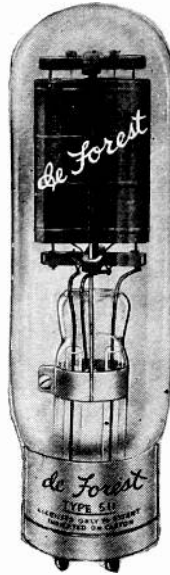

Type
511

50 Watt
Gen. Purpose

~~\$25.00~~

NOW
\$15.00

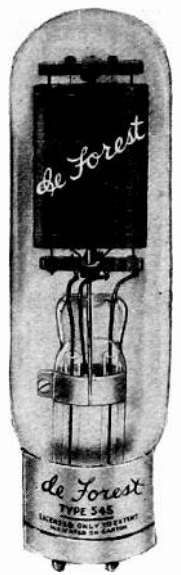

Type
545

50 Watt
Amp. Mod.

~~\$30.00~~

NOW
\$15.00

Increased demand, together with the use of new production equipment, has resulted in a marked reduction in manufacturing cost. The saving is now passed on to you.

These popular types are current production, incorporating latest advances and refinements. Steady de-

mand and steady production insure fresh, up-to-the-minute Audions at lowest prices consistent with highest quality.

LITERATURE covering DeForest transmitting and receiving Audions, will be sent on request.

DeForest Radio Company

Passaic

»

»

»

»

New York

When writing to advertisers mention of the PROCEEDINGS will be mutually helpful.

SOLID MOLDED RESISTORS

FOR MOTOR CAR RADIO



FOR CONSOLE RADIO

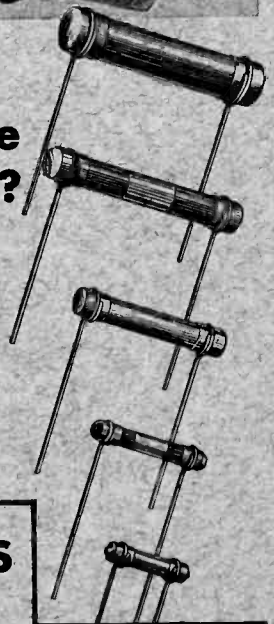
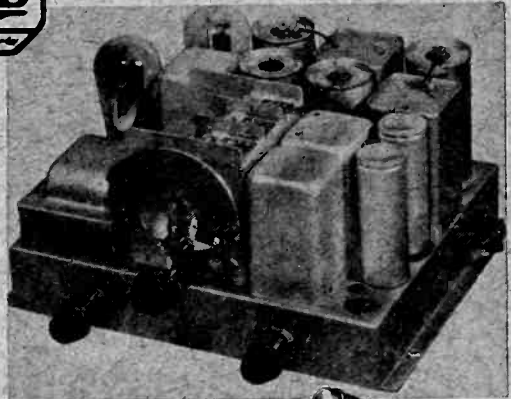
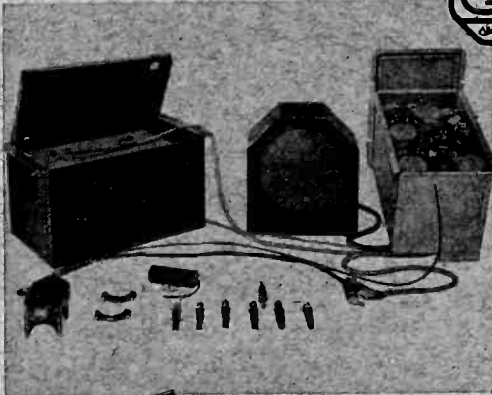

Do Your Sets go "Sour" in Service due to poor Resistors?

The satisfactory operation of your receivers depends to a great extent upon the accuracy of your fixed resistors. Bradleyunit Resistors are used by the world's largest radio manufacturers, because their resistance value is stable under varying conditions of load, temperature, and moisture. They are not subject to wide fluctuation due to long use. Don't risk the reputation of your receiver with poor resistors. Get an Allen-Bradley quotation on your next order.

Interference from ignition systems in radio-equipped motor cars is suppressed with Bradley Suppressors. When used with syllable by-pass condensers in ignition circuits, shielded ignition cables are unnecessary.



Type A, Single Bradleyometer



Type AA, Double Bradleyometer

BRADLEYOMETERS

The Bradleyometer is a potentiometer with approximately fifty solid resistance discs interleaved between metal discs.

The total number of discs can be arranged in accordance with any resistance-rotation curve.

One or more Bradleyometers can be arranged to operate with one knob. Mixer controls, T-pad and H-pad attenuators and other complex controls can be provided.



Type AAA, Triple Bradleyometer

Bradleyunit Resistors are made in five sizes, with or without leads, and are color coded to meet set manufacturers' specifications. These solid molded resistors are accurately calibrated and have great mechanical strength.

Allen-Bradley Co., 116 W. Greenfield Ave., Milwaukee, Wisconsin

ALLEN-BRADLEY RESISTORS

Produced by the makers of Allen-Bradley Control Apparatus

NEW G-R DECADE RESISTANCE BOXES FOR HIGH FREQUENCIES

A suitable resistance box for high-frequency measurements must have at least three important qualities: It must be stable electrically and mechanically; it must have a low switch resistance; and there must be an absolute minimum of reactance and skin effect.

The new General Radio Type 602 Decade-Resistance Boxes are even better with respect to these three qualities than the well-known Type 102 Boxes which they supersede.

A new method of winding the high-resistance units has been developed. This reduces reactance and skin effect without sacrificing stability of calibration. Hence the new boxes can be used at higher frequencies.

A new long-wear switch assembly mounted beneath the panel means smoother, more positive action with a lower resistance.

Shielding, furnished by the aluminum panel and the shielded cabinet, minimizes the effect of stray electric fields.

TYPE 602 Decade-Resistance Boxes

2, 3, 4, and 5
dial models

Decades with
unit steps of
0.1 to 10,000 ohms

Prices
\$25 to \$70

Write for a copy of
Ex-3203 describing
these new boxes and
giving detailed
performance
data

GENERAL RADIO COMPANY CAMBRIDGE, MASSACHUSETTS