

VOLUME 20

MARCH, 1932

NUMBER 3

PROCEEDINGS  
*of*  
**The Institute of Radio  
Engineers**



**Twentieth Anniversary  
Convention**

**Pittsburgh, Pennsylvania  
April 7, 8, 9, 1932**

**Form for Change of Mailing Address or Business Title on Page XXIX**

**TENTATIVE CONDENSED PROGRAM  
TWENTIETH ANNIVERSARY CONVENTION  
PITTSBURGH, PENNSYLVANIA  
APRIL 7, 8, AND 9, 1932**

**Wednesday—April 6**

2:00 P.M.-6:00 P.M. Registration.

**Thursday—April 7**

9:00 A.M.-10:30 A.M. Registration and inspection of exhibits.

10:30 A.M.-12:00 Noon. Opening session, Addresses of welcome by Walter G. Cady, President of the Institute and James G. Allen, Chairman of the Pittsburgh Section and Convention Committee. These addresses will be followed by a technical session.

11:30 A.M. Trip No. 1. Inspection trip for ladies to Heinz plant.

12:00 Noon-1:30 P.M. Official luncheon and civic welcome.

2:00 P.M.-6:00 P.M. Trip No. 2. Westinghouse Research Laboratories and Carnegie steel mill.

3:00 P.M. Trip No. 3. Ladies fashion show and tea.

8:00 P.M.-10:00 P.M. General lecture; subject and speaker to be announced.

8:00 P.M. Annual meeting of Sections Committee.

**Friday—April 8**

9:00 A.M. Opening of exhibition.

10:00 A.M.-12:00 Noon. Technical session.

10:30 A.M. Trip No. 4. Ladies sight-seeing trip.

12:00 Noon-1:30 P.M. Official luncheon.

12:30 P.M. Trip No. 5. Ladies luncheon-bridge.

2:00 P.M.-4:00 P.M. Technical session.

2:00 P.M.-5:30 P.M. Trip No. 6. Springdale Mine and West Penn Power Company and Research Laboratories of the Aluminum Company of America.

7:00 P.M. Birthday Party.

**Saturday—April 9**

9:00 A.M. Opening of exhibition.

10:00 A.M.-12:00 Noon.—Technical session.

10:00 A.M. Trip No. 7. Ladies sight-seeing or inspection trip.

12:30 P.M.-2:00 P.M. Official luncheon.

12:30 P.M. Trip No. 8. Ladies luncheon-bridge and trip to KDKA.

2:00 P.M.-4:00 P.M. Technical session.

4:00 P.M.-8:00 P.M. Trip No. 9. Inspection trip to KDKA.

PROCEEDINGS OF

**The Institute of Radio Engineers**

Volume 20

March, 1932

Number 3

Board of Editors

ALFRED N. GOLDSMITH, *Chairman*  
 STUART BALLANTINE  
 R. R. BATCHER  
 WILLIAM WILSON  
 G. W. PICKARD  
 L. E. WHITEMORE

CONTENTS

PART I

Condensed Program of Twentieth Anniversary Convention.....	Cover II
Frontispiece, William Penn Hotel.....	378
Institute News and Radio Notes.....	379
Twentieth Anniversary Convention.....	379
February Meeting of the Board of Directors.....	393
Radio Signal Transmissions of Standard Frequency.....	394
Committee Work.....	395
Institute Meetings.....	398
Personal Mention.....	403

PART II

*Technical Papers*

Operation of a Ship-Shore Radiotelephone System.....	
..... C. N. ANDERSON AND I. E. LATTIMER	407
The Communication System of the Radiomarine Corporation of America ..... I. F. BYRNES	434
Characteristics of the UV-858 Power Tube for High-Frequency Operation ..... M. A. ACHESON AND H. F. DART	449
Sensitivity Controls—Manual and Automatic.....	DORMAN D. ISRAEL 461
A Simultaneous Radiotelephone and Visual Range Beacon for the Airways ..... F. G. KEAR AND G. H. WINTERMUTE	478
A Mechanically Resonant Transformer.....	ROSS GUNN 516
Concerning the Influence of the Eleven-Year Solar Activity Period upon the Propagation of Waves in Wireless Telegraphy.....	H. PLENDL 520
Preliminary Note on an Automatic Recorder Giving a Continuous Height Record of the Kennelly-Heaviside Layer.....	T. R. GILLILAND AND G. W. KENRICK 540
The Operation of Vacuum Tubes as Class B and Class C Amplifiers.....	C. E. FAY 548
Further Notes on the Detection of Two Modulated Waves which Differ Slightly in Carrier Frequency.....	C. B. AIKEN 569
Book Reviews: "Radio Frequency Electrical Measurements," by Hugh A. Brown.....	HAROLD A. WHEELER 579
Report of the Radio Research Board for the Period Ended December, 1930.....	S. S. KIRBY 579
Radio Abstracts and References.....	580
Contributors to this Issue.....	588

# The Institute of Radio Engineers

## GENERAL INFORMATION

The PROCEEDINGS of the Institute is published monthly and contains papers and discussions thereon submitted for publication or for presentation before meetings of the Institute or its Sections. Payment of the annual dues by a member entitles him to one copy of each number of the PROCEEDINGS issued during the period of his membership.

Subscription rates to the PROCEEDINGS for the current year are received from nonmembers at the rate of \$1.00 per copy or \$10.00 per year. To foreign countries the rates are \$1.10 per copy or \$11.00 per year.

Back issues are available in unbound form for the years 1918, 1920, 1921, 1922, 1923, and 1926 at \$9.00 per volume (six issues) or \$1.50 per single issue. For the years 1913, 1914, 1915, 1916, 1917, 1919, 1923, 1924, and 1925 miscellaneous copies (incomplete unbound volumes) can be purchased for \$1.50 each; for 1927, 1928, 1929, 1930, and 1931 at \$1.00 each. The Secretary of the Institute should be addressed for a list of these.

Discount of twenty-five per cent is allowed on all unbound volumes or copies to members of the Institute, libraries, booksellers, and subscription agencies.

Bound volumes are available as follows: for the years 1922 and 1926 to members of the Institute, libraries, booksellers, and subscription agencies at \$8.75 per volume in blue buckram binding and \$10.25 in morocco leather binding; to all others the prices are \$11.00 and \$12.50 respectively. For the years 1929 and 1930 the bound volumes prices are: to members of the Institute, libraries, booksellers, and subscription agencies, \$9.50 in blue buckram binding; to all others, \$12.00. Foreign postage on all bound volumes is one dollar, and on single copies is ten cents.

The 1931 YEAR BOOK, containing general information, the Constitution and By-Laws, Standards Report, Index to past issues of the PROCEEDINGS, Catalog of Membership, etc., is available to members at \$1.00; to nonmembers, \$1.50.

Contributors to the PROCEEDINGS are referred to the following page for suggestions as to approved methods of preparing manuscripts for publication in the PROCEEDINGS.

Advertising rates for the PROCEEDINGS will be supplied by the Institute's Advertising Department, Room 802, 33 West 39th Street, New York, N.Y.

Changes of address to affect a particular issue must be received at the Institute office not later than the 15th of the month preceding date of issue. That is, a change in mailing address to be effective with the October issue of the PROCEEDINGS must be received by not later than September 15th. Members of the Institute are requested to advise the Secretary of any change in their business connection or title irrespective of change in their mailing address, for the purpose of keeping the Year Book membership catalog up to date.

The right to reprint portions or abstracts of the papers, discussions, or editorial notes in the PROCEEDINGS is granted on the express condition that specific reference shall be made to the source of such material. Diagrams and photographs published in the PROCEEDINGS may not be reproduced without making special arrangements with the Institute through the Secretary.

It is understood that the statements and opinions given in the PROCEEDINGS are views of the individual members to whom they are credited, and are not binding on the membership of the Institute as a whole.

All correspondence should be addressed to the Institute of Radio Engineers, 33 West 39th Street, New York, N.Y., U.S.A.

Entered as second class matter at the Post Office at Menasha, Wisconsin.

Acceptance for mailing at special rate of postage provided for in the Act of February 28, 1925, embodied in paragraph 4, Section 412, P. L. and R. Authorized October 26, 1927.

Published monthly by

**THE INSTITUTE OF RADIO ENGINEERS, INC.**

Publication office, 450-454 Ahnaip Street, Menasha, Wis.

BUSINESS, EDITORIAL, AND ADVERTISING OFFICES,

Harold P. Westman, *Secretary*

33 West 39th St., New York, N.Y.

# SUGGESTIONS FOR CONTRIBUTORS TO THE "PROCEEDINGS"

## Preparation of Paper

**Form**—Manuscripts may be submitted by member and nonmember contributors from any country. To be acceptable for publication, manuscripts should be in English, in final form for publication, and accompanied by a summary of from 100 to 300 words. Papers should be typed double space with consecutive numbering of pages. Footnote references should be consecutively numbered and should appear at the foot of their respective pages. Each reference should contain author's name, title of article, name of journal, volume, page, month, and year. Generally, the sequence of presentation should be as follows: statement of problem; review of the subject in which the scope, object, and conclusions of previous investigations in the same field are covered; main body describing the apparatus, experiments, theoretical work, and results used in reaching the conclusions and their relation to present theory and practice; bibliography. The above pertains to the usual type of paper. To whatever type a contribution may belong, a close conformity to the spirit of these suggestions is recommended.

**Illustrations**—Use only jet black ink on white paper or tracing cloth. Cross-section paper used for graphs should not have more than four lines per inch. If finer ruled paper is used, the major division lines should be drawn in with black ink, omitting the finer divisions. In the latter case, only blue-lined paper can be accepted. Photographs must be very distinct, and must be printed on glossy white paper. Blueprinted illustrations of any kind cannot be used. All lettering should be  $\frac{3}{16}$  in. high for an 8 x 10 in. figure. Legends for figures should be tabulated on a separate sheet, not lettered on the illustrations.

**Mathematics**—Fractions should be indicated by a slanting line. Use standard symbols. Decimals not preceded by whole numbers should be preceded by zero, as 0.016. Equations may be written in ink with subscript numbers, radicals, etc., in the desired proportion.

**Abbreviations**—Write a.c. and d.c. (a-c and d-c as adjectives), kc,  $\mu f$ ,  $\mu\mu f$ , e.m.f., m.h.,  $\mu h$ , henries, abscissas, antennas. Refer to figures as Fig. 1, Figs. 3 and 4, and to equations as (5). Number equations on the right in parentheses.

**Summary**—The summary should contain a statement of major conclusions reached, since summaries in many cases constitute the only source of information used in compiling scientific reference indexes. Abstracts printed in other journals, especially foreign, in most cases consist of summaries from published papers. The summary should explain as adequately as possible the major conclusions to a nonspecialist in the subject. The summary should contain from 100 to 800 words, depending on the length of the paper.

## Publication of Paper

**Disposition**—All manuscripts should be addressed to the Institute of Radio Engineers, 33 West 39th Street, New York City. They will be examined by the Committee on Papers and by the Editor. Authors are advised as promptly as possible of the action taken, usually within one month.

**Proofs**—Galley proof is sent to the author. Only necessary corrections in typography should be made. *No new material is to be added.* Corrected proofs should be returned *promptly* to the Institute of Radio Engineers, 33 West 39th Street, New York City.

**Reprints**—With the galley proof a reprint order form is sent to the author. Orders for reprints must be forwarded promptly as type is not held after publication.

## INSTITUTE SECTIONS

<i>Chairmen</i>	<i>Secretaries</i>
	<b>ATLANTA</b>
H. F. Dobbs	Philip C. Bangs, 23 Kensington Rd., Avondale Estates, Ga.
	<b>BOSTON</b>
George W. Pierce	Melville Eastham, 30 State St., Cambridge, Mass.
	<b>BUFFALO-NIAGARA</b>
L. Grant Hector	E. C. Waud, 235 Huntington Ave., Buffalo, N. Y.
	<b>CHICAGO</b>
J. Barton Hoag	Donald H. Miller, McGraw-Hill Pub. Co., 520 N. Michigan Ave., Chicago, Ill.
	<b>CINCINNATI</b>
C. E. Kilgour	H. G. Boyle, Crosley Radio Corp., Cincinnati, Ohio.
	<b>CLEVELAND</b>
E. L. Gove	Deane S. Kintner, 3622 Lindholm Rd., Cleveland, Ohio.
	<b>CONNECTICUT VALLEY</b>
L. F. Curtis	George Grammer, 334 South Quaker Lane, West Hartford, Conn.
	<b>DETROIT</b>
H. L. Byerlay	Samuel Firestone, Room 615, 2000 Second Ave., Detroit, Mich.
	<b>LOS ANGELES</b>
E. H. Schreiber	H. W. Andersen, 2332 Lake View Ave., Los Angeles, Calif.
	<b>NEW ORLEANS</b>
Pendleton E. Lehde	Anton A. Schiele, 1812 Masonic Temple, New Orleans, La.
	<b>PHILADELPHIA</b>
G. W. Carpenter	G. C. Blackwood, 243 E. Upsal St., Mt. Airy, Philadelphia, Pa.
	<b>PITTSBURGH</b>
J. G. Allen	J. G. McKinley, West Penn Electric Co., 14 Wood St., Pittsburgh, Pa.
	<b>ROCHESTER</b>
H. A. Brown	M. A. Wood, 175 Winbourne Ave., Rochester, N. Y.
	<b>SAN FRANCISCO</b>
Ralph M. Heintz	Frederick E. Terman, Stanford University, Calif.
	<b>SEATTLE</b>
Leslie C. Austin	Herbert H. Bouson, Staff Hdqts., 13th Naval District, Joseph Vance Bldg., Seattle, Wash.
	<b>TORONTO</b>
F. K. Dalton	W. F. Choat, 355 King St., W., Toronto, Ont., Canada.
	<b>WASHINGTON</b>
J. H. Dellinger	Hugh Mitchell, Signal Corps, Office Chief Signal Officer, Munitions Bldg., Washington, D. C.

## GEOGRAPHICAL LOCATION OF MEMBERS ELECTED FEBRUARY 3, 1932

### Transferred to the Fellow Grade

New York            New York City, 75 West St..... McCutchen, B. S.

### Transferred to the Member Grade

Missouri            St. Louis, 1921 Telephone Bldg..... Fritz, H. R.  
New Jersey        Harrison, RCA Radiotron Co., Inc., 415 S. 5th St..... Thompson, B. J.

### Elected to the Member Grade

Massachusetts     Boston, 50 Oliver St..... Meader, R. B.

### Elected to the Associate Grade

Alabama	Birmingham, 711-8th Ave. W.....	Grimmett, J. F.
California	Alhambra, 835 N. Marguerita Ave.....	Gilruth, M. T.
	Los Angeles, 1100 W. 84th Pl.....	Glassberg, L.
	Los Angeles, 5862 S. Hoover St.....	Hetzl, R. E.
	Palo Alto, 717 Cherry St.....	Goldrup, E. T.
	Placentia, R.R. No. 1, Box No. 210.....	Palmer, C. I.
	San Francisco, 1362-8th Ave.....	Besse, A. M.
	Santa Barbara, Station KDB.....	Moody, R. C.
Connecticut	New Haven, Southern New England Tel. Co.....	Millard, A. M.
Dist. of Columbia	Washington, 2023 N. Capitol St.....	Dunlap, W. J.
Florida	Opa Locka, Box B.....	Foley, D. H.
Idaho	Boise, 2607 Woodlawn Ave.....	Fletcher, H. H.
Indiana	Marion, 114 E. 19th St.....	Clark, R. R.
	Scottsburg.....	Manthei, L. F.
Kansas	Topeka, 947 Winfield Ave.....	Hart, H. T.
Kentucky	Covington, 3513 Carlisle Ave.....	Young, David L.
Maryland	Cumberland, 604 Shriver Ave.....	Bobo, J. W.
Massachusetts	Roxbury, 7 Ottawa St.....	Gilmore, T.
Michigan	Detroit, 1740 Collingwood Ave.....	Johnson, G. C.
	Ishpeming, 205 Oak St.....	Brozek, G. H.
Minnesota	Duluth, 411 Exchange Bldg.....	German, G. B.
Missouri	Kansas City, 4726 Terrace St.....	Burns, C. P.
	St. Louis, 6543 Marmaduke.....	Atchisson, C. H.
	St. Louis, 1477 Engelholm Ave.....	Castanie, W. F.
	St. Louis, 5106 Cologne Ave.....	Dungan, G. E.
	St. Louis, 3642 Watson Rd.....	Wood, P. E.
	St. Louis, 3822 N. Grand Blvd.....	Volk, J. A.
	University City, 559 Melville.....	Glaze, J. C.
	University City, 7418 Liberty Ave.....	Johnson, H. J.
New Hampshire	Dover, 165 Payne St.....	Watson, R. D.
New Jersey	Camden, 206 Cooper St.....	Ackerman, H.
	Collingswood, 151 New Jersey Ave.....	Hollahan, W. E.
	Harrison, 415 S. 5th St.....	Taylor, C. W.
	Newark, 375 Clifton Ave.....	Green, C. H.
	Wayne, Box No. 67.....	Donohoe, T. J.
New York	Brooklyn, 365-14th St.....	Morrissey, W.
	Buffalo, 117 Newburgh Ave.....	Huber, C. W.
	New York City, 463 West St.....	Atwood, J. B.
	New York City, c/o Polymet Mfg. Co.....	Clark, J. S.
	New York City, 250 W. 99th St.....	Cohen, A.
	New York City, c/o G. Gulbenkian and Co., 225-5th Ave.....	Rashduni, H. D.
	Niagara Falls, c/o Schwegler Bros., Inc.....	Fisher, H. F.
	Schenectady, 1066 Gillespie St.....	Miller, A. S.
	Schenectady, 1270 Dean St.....	Morey, D. P.
	Stapleton, S.I., U.S. Coast Guard, Section Base 2.....	Day, C. L.
N. Carolina	Wilmington, 118 Red Cross St.....	Grimes, J. S., Jr.
Ohio	Cleveland, Radio Station WGAR, Hotel Statler.....	Shipley, L.
	Dayton, 510 Kenwood Ave.....	Bonbright, C. F.
Pennsylvania	Newberry, 1928 Lacombe St.....	Morrison, R. L.
	Pittsburgh, 14 Wood St.....	Stickel, W. A.
Tennessee	Nashville, 2506 Westwood Dr.....	Woollard, J. R.
Texas	Fort Worth, 915 Summit Ave.....	Kimzey, T. I.
Australia	Sydney, N.S.W., 16 Stanley St., Waverley.....	Duffy, J.
	Sydney, c/o Mrs. C. Martin, 512 St. James Bldgs.....	Martin, B.
Canada	Guelph, Ont., 34 Division St.....	Robinson, C. A.
	Ottawa, Ont., 21 Butternut Terrace.....	Merriman, H. O.
	Toronto, Ont., 601 Lansdowne Ave.....	Clay, V. W.
England	Ramsgate, Kent, 17 The Paragon.....	Jennions, A. E.
	Sherwood, Nottingham, 9 Osborne Grove.....	Scotney, R.
Germany	Werder, Havel, 138 Hohewegstr.....	Baumann, K.
Japan	Kokura City, Kokura Hosokyoku.....	Kawakami, J.

*Geographical Location of Members Elected February 3, 1932*

Scotland	Markinch, Fife, 30 Commercial St.....	Gibb, W.
South Africa	Johannesburg, Transvaal, c/o Kinemas, Ltd., Jeppe St.....	Alexander, R. L.
Tanganyika Territory	Moshi, Post Office.....	Barker, F. J.

**Elected to the Junior Grade**

Kentucky	Bellevue, 524 Lafayette St.....	Werrmann, C. A.
Massachusetts	Boston, Army Radio Station, Army Base.....	Clark, W. R.
Canada	Toronto, Ont., 71 Benson Ave.....	Brown, N. E.





APPLICATIONS FOR MEMBERSHIP

Applications for transfer or election to the various grades of membership have been received from the persons listed below, and have been approved by the Committee on Admissions. Members objecting to transfer or election of any of these applicants should communicate with the Secretary on or before April 4, 1932. These applicants will be considered by the Board of Directors at its April 6 meeting.

For Transfer to the Member Grade

Massachusetts	Framingham, State Police	MacAdam, M. L.
New Jersey	Merchantville, 4742 Browning Rd.	Hopkins, A. R.

For Election to the Member Grade

Dist. of Columbia	Washington, 3165-18th St. N.W.	Windmuller, L.
-------------------	--------------------------------	----------------

For Election to the Associate Grade

Arkansas	Fort Smith, The Goldman Hotel	Doan, L. W.
California	Baldwin Park, 218 W. Covina Blvd.	Ganzenhuber, J. H.
	Berkeley, 2028 Francisco St.	Bartholomew, L.
	Crockett, Men's Club	Hale, W. S.
	Hollywood, 621 N. Stanley Ave.	LeMon, M. L.
	Los Angeles, 1837 N. Alexandria Ave.	Denechaud, R. G.
	Los Angeles, 475 E. 48th St.	Sarkin, H.
	Palo Alto, P.O. Box 1053	Roebuck, F. G.
	San Bernardino, U.S. Dept. of Commerce, Star Route 76401	Brooks, D.
	San Bernardino, 1272 King St.	Thorne, H. A.
	San Diego, 4460-36th St.	Coburn, H. E.
	San Francisco, 45 Pinehurst Way	Boyd, F. A.
	San Francisco, 2512 Customhouse	Fullaway, F. L.
Illinois	Belleville, 118 Wabash	Mueller, R. A.
	Chicago, 5149 Agatite Ave.	Hallmark, C. E.
	Chicago, 2625 Farwell Ave.	Krueger, R. M.
	Chicago, 1831 S. Millard Ave.	Root, J. J.
	East St. Louis, 2920 Virginia Pl.	Chartrand, F. M.
	East St. Louis, 1359 N. 41st St.	Stetson, R. W.
	Rantoul, Section D, Chanute Field	Biel, G. M.
	Rantoul, Radio Section, Chanute Field	Monaghan, H. E.
Indiana	Fort Wayne, 219-223 E. Washington Blvd.	Curry, A. A.
	Indianapolis, Route 17, Box 409 "A"	Stewart, R. R.
Iowa	Davenport, 1712 Farnum St.	Fogle, C. E.
Kansas	Wichita, 226 S. Sedgwick Ave.	Clark, T. H.
Maryland	Salisbury, 1001 E. Church St.	Akin, J. T.
Michigan	Ann Arbor, 321 E. Ann St.	Marlow, W. C., Jr.
	Detroit, 1199 Collingwood Ave.	Clarke, J. C.
	Laurium, Box 53	Jackson, W.
Mississippi	Hattiesburg, 618 Walnut St.	Austin, F. J.
Missouri	Afton, Rambler Dr., Box 173	Burrows, L. W.
	Ferguson, 60 Harvey Ave.	King, F. W.
	St. Louis, 1962 Semple Ave.	Buss, R. R.
	St. Louis, 1010 Pine St., Rm. 1804	Cloyd, L. W.
	St. Louis, 7200 Delta Ave., Richmond Heights	Cummings, G. M.
	St. Louis, 5469 Enright Ave.	Embree, J. N.
	St. Louis, 841 Bell Telephone Bldg.	Haywood, W. E.
	St. Louis, 4069 S. Spring Ave.	Liggett, F. S.
	St. Louis, 4091 Toenges St.	Myers, W. P., Jr.
	St. Louis, 5625 Cates Ave.	Payne, B. C.
Montana	Great Falls, Box 1555	Parker, J. E.
New Jersey	Newark, 242 Broad St.	Sprague, R. M.
	Ridgewood, 123 Phelps Rd.	Soukup, J. E.
New York	Brooklyn, 52 Clark St.	Koonz, J. C.
	Brooklyn, 208 Floyd St.	Senkow, W. J.
	New York City, 267 W. 17th St.	Hartley, S. H.
	New York City, 536 W. 114th St.	Sprague, V. G.
	Woodhaven, 90-12 Jamaica Ave.	Coppola, P.
Ohio	Cincinnati, 867 Lexington Ave.	Shapiro, P.
	Cleveland Heights, 2600 Mayfield Rd.	Frederick, P. E.
Oregon	Corvallis, Phi Sigma Kappa	Smith, R. W. K.
	Portland, 2568 Shaver St.	Stewart, R. P.
Pennsylvania	Philadelphia, 517 Midvale Ave.	Craven, C. L.
	Philadelphia, 1835 Arch St.	Cunningham, R. M.
	Philadelphia, 1246 N. Sartain St.	Vogt, G. W.
Rhode Island	Schuylkill Haven, 624 Leonard St.	Mellor, J. R.
	Newport, 60 Kay St.	Nielson, W. C.
	Providence, 196 Congress Ave.	Docherty, C. G.
South Carolina	Greenville, 150 Perry Rd.	Nicholson, L. E.

73

## Applications for Membership

Tennessee	Chattanooga, American Lava Corp.....	Hower, C. R.
	Nashville, 744 Benton Ave.....	Killman, R. T.
Virginia	Quantico, Signal School Co., Signal Bn.....	Stillwell, R. R.
Washington	Tacoma, 602 N. C St.....	Fisher, R. C.
Canada	London, Ont., 390 Dundas St.....	Bach, J. R.
	London, Ont., 113 Thornton Ave.....	Kells, W.
	Ottawa, Ont., 68 Grange Ave.....	LaPointe, J. L.
	Toronto, Ont., 49 Bathurst St.....	Pfeiffer, J. T.
China	Shanghai, 78 Heng Foong Lee, Scott Rd.....	Wang, M. C. H.
Czechoslovakia	Prague, Na Zderaze 3, Prague II.....	Ficek, F.
England	Chesham, Bucks, "Kolbran," Hampden Ave.....	Holley, L. C.
	Gateshead, 24 Bell St.....	Quinn, J.
	Halifax, Yorks, 13 A. Clover Hill Rd.....	Uttley, H.
	Hull, B. W. M. S., Marconi House, Commercial Rd.....	Fells, E. C.
	North Kensington, London W. 10, 19 Barlby Rd.....	Sudos, A.
Ireland	Dublin, 12 Philipsburgh Ave., Fairview.....	Phillips, A. W.
Italy	Florence, Via Ghibellina 63.....	Fagnoni, I. E.
Japan	Tokio, Tokio Central Broadcasting Station, Atagoyama, Shi- baku.....	Habu, E.
Territory of Ha- waii	Schofield Bks., 1st Bn. 8th F. A.....	Bennett, A.

### For Election to the Junior Grade

California	Los Angeles, 1421 W. 12th St.....	Logan, D. C.
	San Francisco, 1450 Washington St., Apt. 3.....	Christman, F. L., Jr.
Illinois	Chicago, 2816 Greenview Ave.....	Patelke, R. A.
Missouri	Rantoul, Section D, Aircorps Technical School.....	Johnson, B. D.
Wisconsin	Warrentown, Box 364.....	Haviland, R. P.
	Beloit, R. R. 7.....	Purcell, J. S.

### For Election to the Student Grade

California	Berkeley, 2535 Channing Way.....	Katzmaier, J. F.
Connecticut	Stanford University, Box 2145.....	Sharp, J. M., Jr.
	New Haven, Naval Reserve Unit, Yale Station.....	Furth, F. R.
	New Haven, Naval R.O.T.C., Yale Unit.....	Goulett, W. B.
	New Haven, Box 1231.....	Schlitt, R. C.
Utah	Salt Lake City, 726 Hawthorne Ave.....	Irvine, L. K.



## OFFICERS AND BOARD OF DIRECTORS, 1932

(Terms expire January 1, 1933, except as otherwise noted)

*President*

W. G. CADY

*Vice President*

E. V. APPLETON

*Treasurer*

MELVILLE EASTHAM

*Secretary*

HAROLD P. WESTMAN

*Editor*

ALFRED N. GOLDSMITH

*Directors*

ARTHUR BATCHELLER

J. V. L. HOGAN

H. H. HOUCK

C. M. JANSKY, JR.

R. H. MARRIOTT

WILLIAM WILSON

---

Serving until January 1, 1934

I. M. HULL

A. F. VAN DYCK

Serving until January 1, 1935

O. H. CALDWELL

E. L. NELSON

---

*Junior Past Presidents*

LEE DE FOREST

R. H. MANSON

---

### BOARD OF EDITORS, 1932

ALFRED N. GOLDSMITH, *Chairman*

STUART BALLANTINE

R. R. BATCHER

G. W. PICKARD

L. E. WHITTEMORE

WILLIAM WILSON

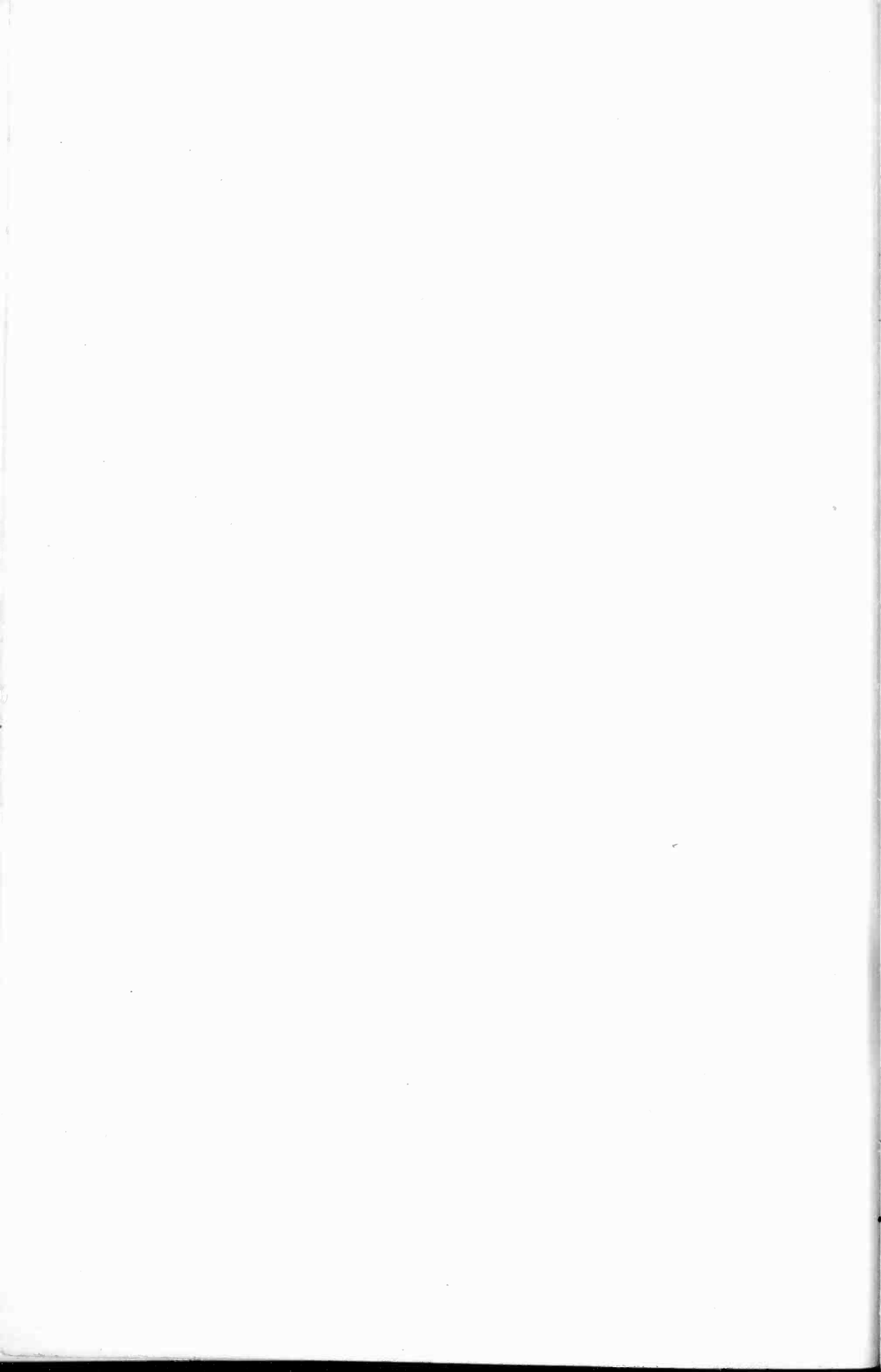

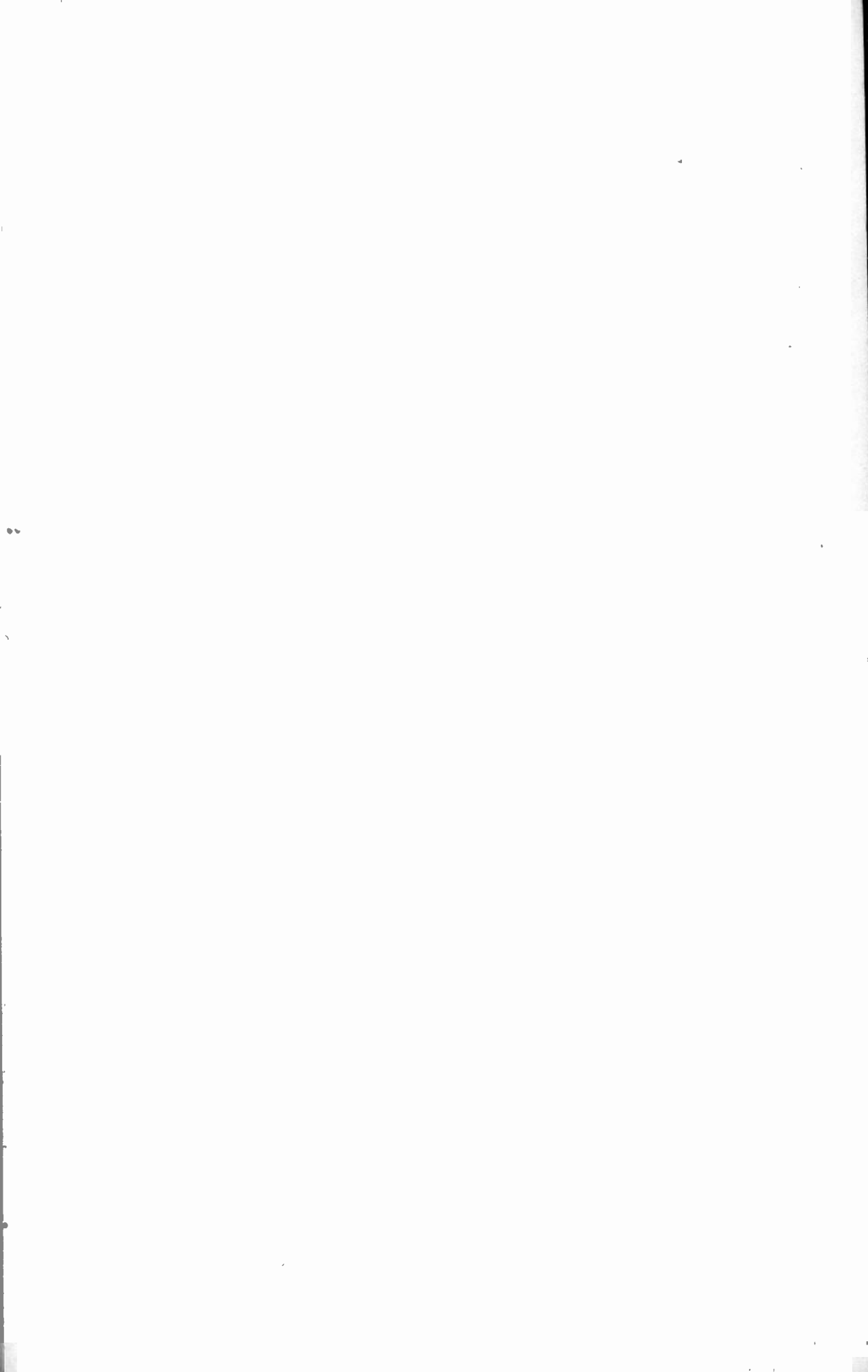



WILLIAM PENN HOTEL

The headquarters for the Twentieth Anniversary Convention of the Institute to be held on April 7, 8, and 9, 1932, in Pittsburgh, Pa.

## INSTITUTE NEWS AND RADIO NOTES

### Twentieth Anniversary Convention

The seventh annual convention of the Institute will be known as the Twentieth Anniversary Convention in commemoration of the founding of the Institute in 1912, and will be held under the auspices of the Pittsburgh Section on April 7, 8, and 9, with convention headquarters located at the William Penn Hotel in Pittsburgh. As is customary at Institute conventions, a number of technical papers on various aspects of radio engineering will be presented during the technical sessions, and for the benefit of those who desire to visit some of the points of interest associated with Pittsburgh, inspection trips have been arranged. Although it is not possible at this moment to give the final program, that given is as complete as possible, and for convenience a summary of it is printed on the inside front cover. It is probable that minor revisions will be made, and the final program will be forwarded to all members of the Institute, by mail, approximately two weeks before the meeting.

#### WEDNESDAY, APRIL 6

2:00 P.M.—6:00 P.M. Registration

#### THURSDAY, APRIL 7

9:00 A.M.—10:30 A.M. Registration and Inspection of Exhibits  
10:30 A.M.—12:00 Noon Opening Session, Addresses of Welcome by Walter G. Cady, President of the Institute, and James G. Allen, Chairman of the Pittsburgh Section and the Convention Committee.

#### Technical Session

“Radio Dissemination of the National Standard of Frequency,” by J. H. Dellinger and E. L. Hall, Bureau of Standards.

“Precision Frequency Checking System of the RCA Central Frequency Bureau and RCA Communications, Inc.,” by H. O. Peterson and A. N. Braaten, RCA Communications, Inc.

“Kennelly-Heaviside Layer Studies Employing a Rapid Method of Virtual Height Determination,” by J. P. Shafer and W. M. Goodall, Bell Telephone Laboratories.

11:30 A.M. Trip No. 1. Ladies trip to H. J. Heinz Company plant for inspection trip and luncheon.

12:00 Noon—1:30 P.M. Official luncheon and civic welcome.

2:00 P.M.—6:00 P.M. Trip No. 2. Inspection trip to Westinghouse Research Laboratories and manufacturing plant, and Carnegie Steel Company mill.

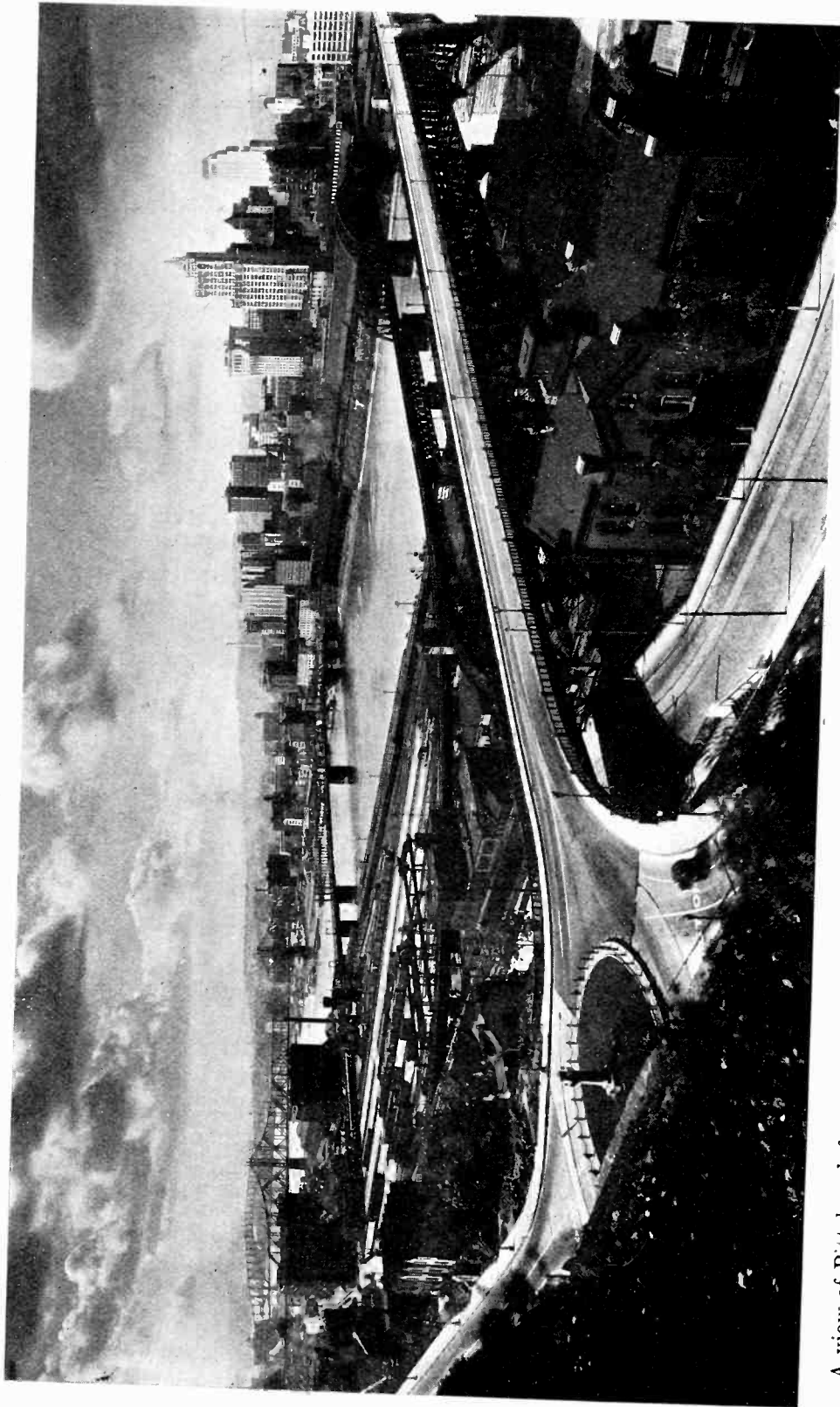

A view of Pittsburgh from the mouth of the Liberty tubes, a vehicular tunnel through Mount Washington. Liberty Bridge crossing the Monongahela River is in the foreground. The tip of the "Triangle" is the terminal for the most distant bridge in the picture.



- 3:00 P.M. Trip No. 3. Ladies fashion show and tea at Kaufmann's Department Store.
- 8:00 P.M.—10:00 P.M. Joint meeting with Pittsburgh Section of the American Institute of Electrical Engineers. Subject and speaker to be announced later.

FRIDAY, APRIL 8

- 9:00 A.M. Opening of exhibition.
- 10:00 A.M.—12:00 Noon **Technical Session**
- “Recent Trends in Receiving Tube Design,” by J. C. Warner, E. W. Ritter, and D. F. Schmit, RCA Radiotron.
- “Triple Twin Tube,” by Charles Stromeier, Cable Radio Tube Corporation.
- “Application of Class B Amplifiers to A-C Operated Receivers,” by L. E. Barton, RCA Victor Company.
- “Analysis and Reduction of Output Disturbances Resulting from the A-C Operation and the Heater of Indirectly Heated Cathode Triodes,” by J. O. McNally, Bell Telephone Laboratories.
- “Dynamic Symmetry,” by A. F. Van Dyck, Radio Corporation of America.
- “Radio Test Methods and Equipment,” by W. F. Diehl, RCA Victor Company.
- 10:30 A.M. Trip No. 4. Ladies sight-seeing trip around Pittsburgh.
- 12:00 Noon—1:30 P.M. Official luncheon.
- 12:30 P.M. Trip No. 5. Ladies luncheon and bridge at the University Club.
- Technical Session**
- 2:00 P.M.—4:00 P.M. “Modern Radio Equipment for Air Mail and Transport Use,” by C. G. Fisk, General Electric Company.
- “Two-Way Radiotelephone Circuits,” by S. B. Wright, American Telephone and Telegraph Company.
- “A New Field Strength Meter,” by P. B. Taylor, Westinghouse Electric and Manufacturing Company.
- “Campbell-Shackleton Shielded Radio Box,” by Leo Behr and A. J. Williams, Leeds and Northrup Company.
- 2:00 P.M.—5:30 P.M. Trip No. 6. Inspection trip to Springdale Mine and West Penn Power Company plant, and the Research Laboratories of the Aluminum Company of America.
- 7:00 P.M. Birthday party and entertainment.

SATURDAY, APRIL 9

- 9:00 A.M. Opening of exhibition.
- 10:00 A.M.—12:00 Noon **Technical Session**
- “A New Circuit for the Production of Ultra-Short-Wave Oscillation,” by J. H. Kozanowski, Westinghouse Electric and Manufacturing Company.

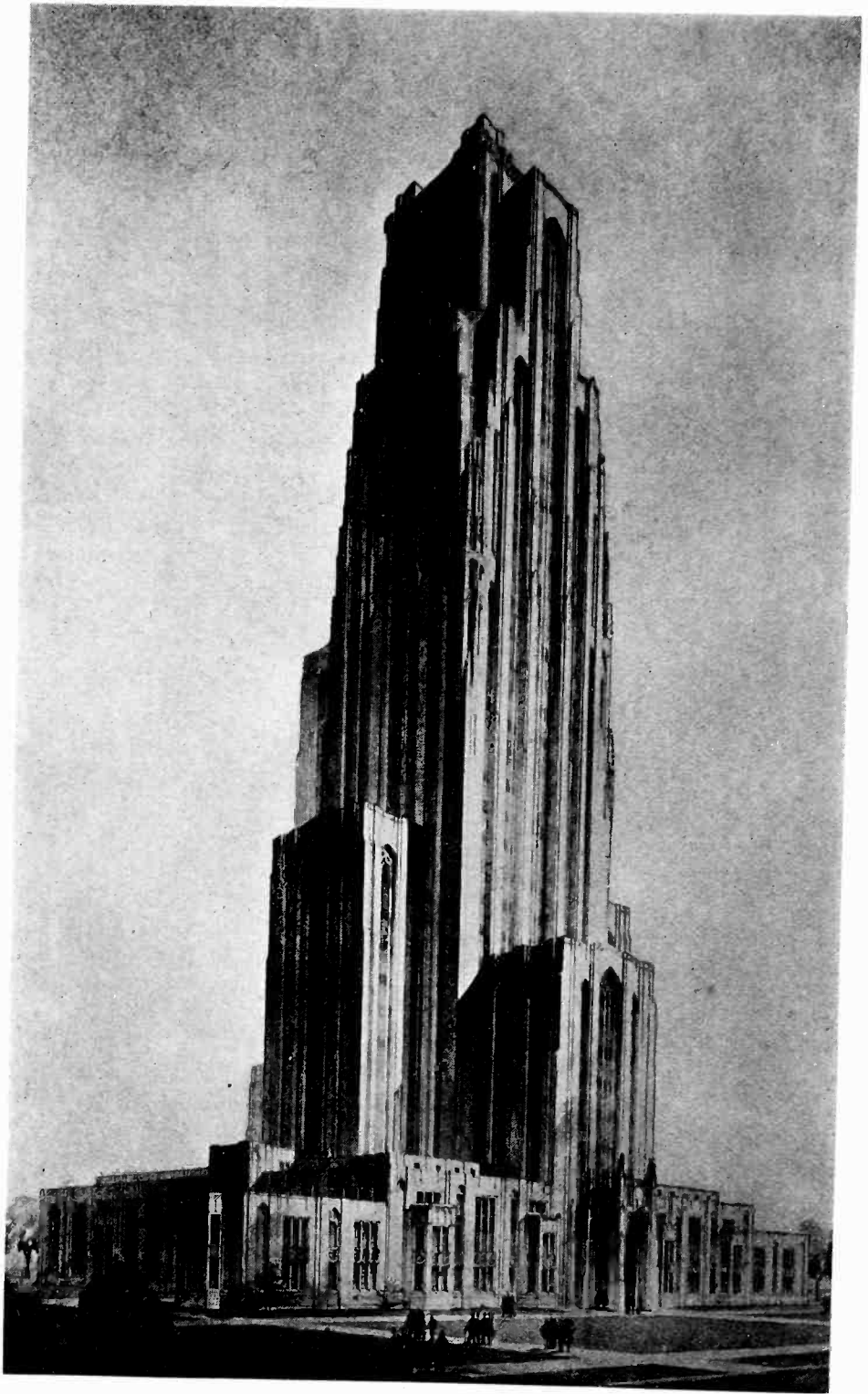

The Cathedral of Learning which houses the University of Pittsburgh. This is the first university to be housed in a single structure of such high proportions; the building is occupied exclusively by the University.

"A Standing Wave Type of High Power Ultra-Short-Wave Oscillator," by I. E. Mouromtseff and H. V. Noble, Westinghouse Electric and Manufacturing Company.

"Magneto-Static Tubes for Variation of Ultra Short Waves," by G. R. Kilgore, Westinghouse Electric and Manufacturing Company.

"Transmission Lines for Short-Wave Radio Systems," by E. J. Sterba and C. B. Feldman, Bell Telephone Laboratories.

"Calculation of Directivity and Mutual Effects in Directive Antenna Systems," by P. S. Carter, RCA Communications.

"Design of Resistors for Precise High-Frequency Measurements," by Leo Behr and R. E. Tarpley, Leeds and Northrup Company.

10:00 A.M.

Trip No. 7. Ladies sight-seeing or inspection trip.

12:30 P.M.—2:00 P.M.

Official luncheon.

12:30 P.M.

Trip No. 8. Ladies luncheon-bridge at Long Vue Country Club, and trip to KDKA transmitting station.

2:00 P.M.—4:00 P.M.

Technical Session

*KDKA Symposium*

"The Saxonburg Station of KDKA," by R. L. Davis, Westinghouse Electric and Manufacturing Company.

"A New Water-Cooled Power Vacuum Tube," by I. E. Mouromtseff, Westinghouse Electric and Manufacturing Company.

"Application of Transformer Coupled Modulators for High Power," by J. C. Hutchinson, Westinghouse Electric and Manufacturing Company.

4:00 P.M.—8:00 P.M.

Trip No. 9. Inspection trip to KDKA transmitting station.

**Technical Sessions**

It is anticipated that all technical papers will be available in preprint form for distribution at the registration desk. This will permit those in attendance to obtain copies of papers prior to their delivery so that they may have the opportunity of studying them and entering into the discussions held when they are presented during the technical sessions. Copies of papers will also be available at the sessions at which they are presented so it will not be necessary to obtain all preprints in advance upon registration.

Because of the limited time at these sessions and the number of papers on the program, it is essential that papers be presented in abstract form. This will allow the maximum amount of time for discussions which is the fundamental objective of presenting papers. Mem-

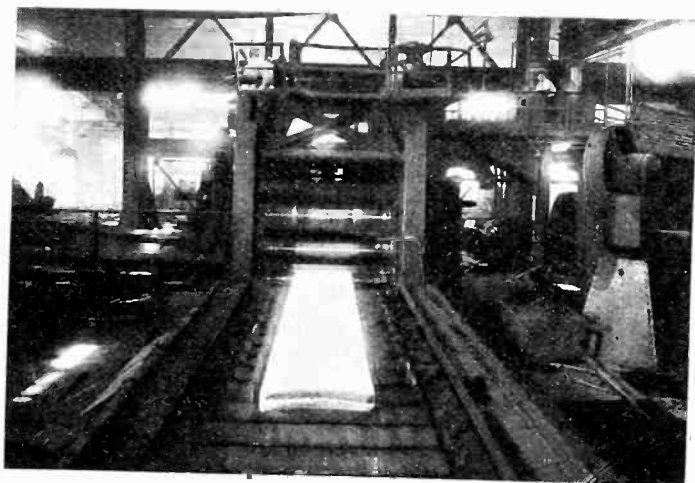

A steel rolling operation at the Carnegie Steel Company mill.



Loading one of the furnaces at the steel mill.

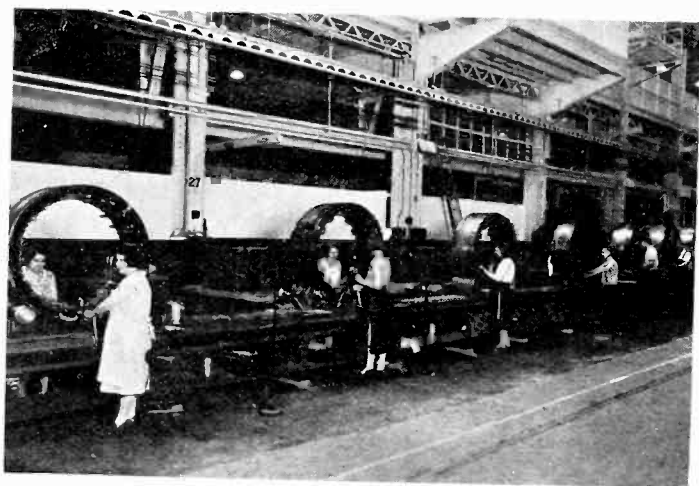

Assembling stators for electric locomotives at the Westinghouse plant.

bers are therefore requested to read the preprints and come to the technical sessions prepared to discuss those papers in which they are particularly interested. All technical sessions must be started on time or else some of the papers cannot be given, and the cooperation of all in prompt attendance is requested for this reason.

### **Inspection Trips**

A number of interesting inspection trips have been arranged and although it is apparent from the list that several of the places to be visited are not radio plants, some of them, such as the Carnegie Steel Works and the Aluminum Company of America Laboratory have contributed directly to radio manufacturing.

The Ladies Committee has prepared a number of trips which should be of interest and which will keep the ladies suitably occupied during the time when the men are attending technical sessions or on trips which are of particular interest to them only.

#### **Thursday April 7—Trip No. 1**

At 11:30 A.M. the ladies will start by bus for the H. J. Heinz Company plant where a luncheon will be served to them, and they will be taken on a tour of inspection through the plant.

#### **Trip No. 2**

##### **Westinghouse Research Laboratory and Homestead Works of the Carnegie Steel Company**

The Westinghouse Research Laboratories are housed in a large structure located at East Pittsburgh. In these laboratories developments are being carried on in many fields in addition to radio. Research in many branches of the electronic field is prosecuted. Among some of the nonradio developments are circuit breakers, studies of vibration in rotating equipment, of the magnetization of metals, electrical welding, magnetic iron, and many other subjects of general interest to the engineer.

The second portion of this trip will be through some of the manufacturing departments of the Westinghouse plant which is located at some distance from the research laboratories. Here one may see some of the largest electrical equipment manufactured in this country in process. It is probable that at the time of the convention the plant will still be working on a large order of electric locomotives for use by the Pennsylvania Railroad in its electrification project.



Westinghouse Research Laboratories at East Pittsburgh.

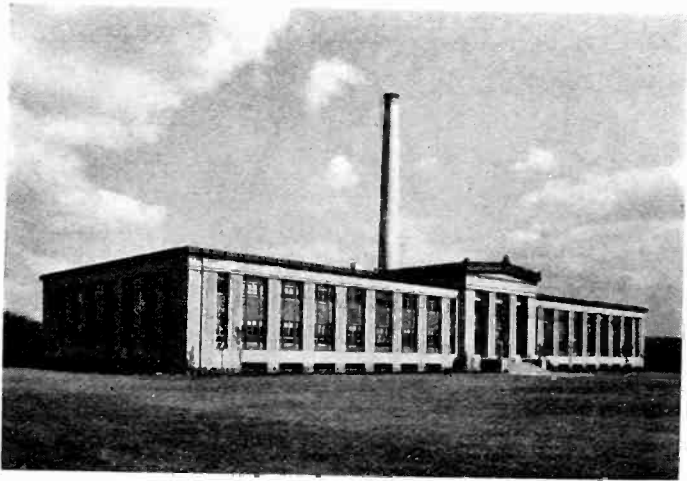

Research Laboratories of the Aluminum Company of America at New Kensington.



The home of "57 Varieties."

The third portion of this trip is through the Homestead Works of the Carnegie Steel Company. The various stages in the manufacture of steel will be seen and inasmuch as there are relatively few steel mills in this country, we are sure those in attendance will appreciate this opportunity of viewing one in operation.

### **Trip No. 3**

#### **Ladies Fashion Show and Tea**

Upon their return from Trip No. 1, the ladies will proceed to Kaufmann's Department Store where a fashion show will be given and afternoon tea will be served.

### **Friday, April 8—Trip No. 4**

#### **Ladies Sight-Seeing Trip**

At 10:30 A.M. the ladies will take busses for a sight-seeing trip around the city. Pittsburgh is located at the junction of the Allegheny and Monongahela Rivers where they become the Ohio River. It was one of the most historical French settlements during the colonial period of American history and was the scene of a decisive engagement in the struggle between England and France for possession of the continent. Upon its capture by the British in 1758, the settlement was named Pittsburgh in honor of William Pitt, then Prime Minister of England.

The metropolitan area today ranks fifth in population in the United States and in "The Golden Triangle" which is the section located at the junction of the Monongahela and Allegheny Rivers is annually transacted a total amount of business exceeded in only four cities of the United States.

### **Trip No. 5**

#### **Ladies Luncheon and Bridge**

When the ladies return from the sight-seeing trip around the city they will proceed to the University Club where a luncheon-bridge will be held.

### **Trip No. 6**

#### **Springdale Mine, West Penn Power Company, and Research Laboratory of the Aluminum Company of America**

The Springdale power station of the West Penn Power Company has a rated capacity of 170,000 kw obtained through five units, the largest having a 50,000-kw capacity.



The Golden Triangle—Pittsburgh's business center.

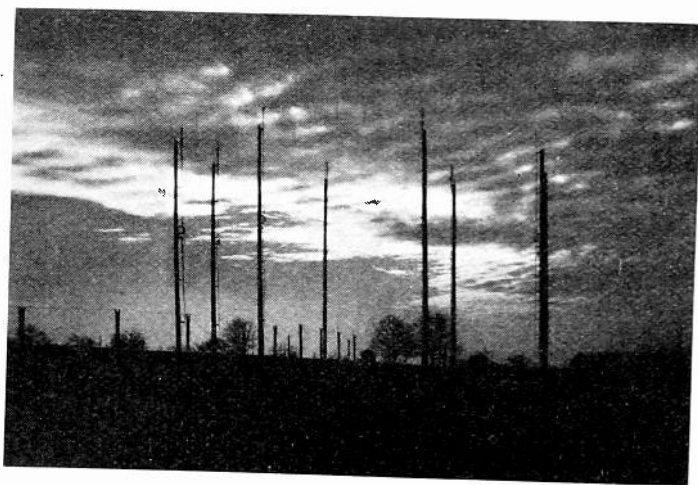

The high-frequency antennas at KDKA, Saxonburg.

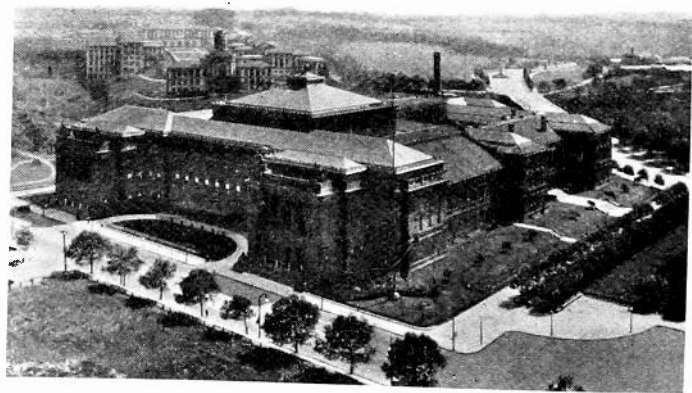

Carnegie Institute with Carnegie Institute of Technology in the background.



The mine from which the coal to supply the power station is obtained is located on the opposite side of the river and all of the coal is hauled through two tunnels, ninety feet beneath the river. At the shaft adjoining the power station it is crushed and distributed by belt conveyors to storage bunkers.

The Research Laboratory of the Aluminum Company of America is situated at South Kensington. Here will be found examples of many uses for aluminum and its alloys, both in science and art. Equipment for the experimental melting, casting, and rolling of aluminum alloys is available together with apparatus for the determination of the properties of these materials.

### **Trip No. 7**

#### **Ladies Sight-Seeing or Inspection Trip**

For Trip No. 7 the ladies may select any one of four alternatives. The first comprises a sight-seeing trip to the studios of four broadcast stations, KDKA, WCAE, WJAS, and KQV. The second trip is a journey to the Soldiers Memorial and Cathedral of Learning which is the forty-story skyscraper home of the University of Pittsburgh. The third alternative trip is a sight-seeing visit to the Municipal and Bettis Airports which serve Pittsburgh, and the fourth possibility is an inspection trip to Carnegie Institute which is one of Pittsburgh's outstanding art centers. At the Institute is held the only international annual art exhibit in the world.

### **Trip No. 8**

#### **Ladies Luncheon-Bridge and Trip to KDKA Transmitting Station**

Promptly at 12:30 P.M. busses will start from the hotel to transport the ladies to the Long Vue Country Club where a luncheon-bridge will be held. At 4 P.M. the party will proceed to Saxonburg to visit the transmitting station of KDKA. The inspection visit will be followed by a buffet supper provided through the courtesy of the Westinghouse organization.

### **Trip No. 9**

#### **KDKA Transmitting Station**

At 4 P.M. following the final technical session, busses will leave from the hotel to transport members to the Saxonburg transmitting plant of KDKA. After inspection of the equipment, a buffet supper will be served through the courtesy of the Westinghouse Company and the busses will return to the hotel at 8 P.M. which will allow sufficient time

for those intending to leave Pittsburgh to check out of the hotel and reach the railroad station in time to board night trains.

### Exhibition

This will be the third year at which exhibitions have been held as a part of the annual convention and it is anticipated that practically all of the important parts manufacturers and instrument and test equipment producers will be represented. The Grand Ballroom of the William Penn Hotel will be given over to this purpose. It is felt that the broadcast receiver manufacturer will find it particularly advantageous for his

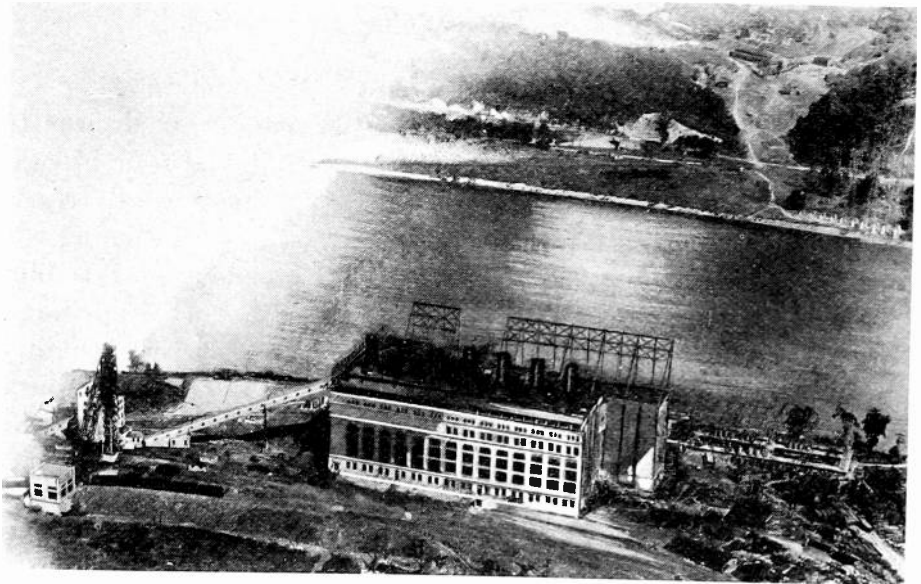

West Penn Power plant. Springdale mine is across the river and coal is transported under the river to the plant.

engineers to view this exhibition inasmuch as there is sufficient time to incorporate new products into 1933 models prior to their display at the Radio Manufacturers Association Trade Show which will be held in Chicago late in May.

As in the past, the exhibition will be devoted exclusively to component parts, measuring equipment, test equipment, and such other manufacturing and engineering aids. There will be no complete broadcast receivers displayed as a part of the exhibition. The opportunity that this exhibition will afford the engineer of discussing his problems with the manufacturer of component parts and the equipment which he may use makes his attendance at the convention and exhibition of utmost importance.

### Luncheons

Arrangements have been made for official group luncheons on each of the three days of the convention. These will tend to hold the convention together as a unit from the time of the first morning session to the

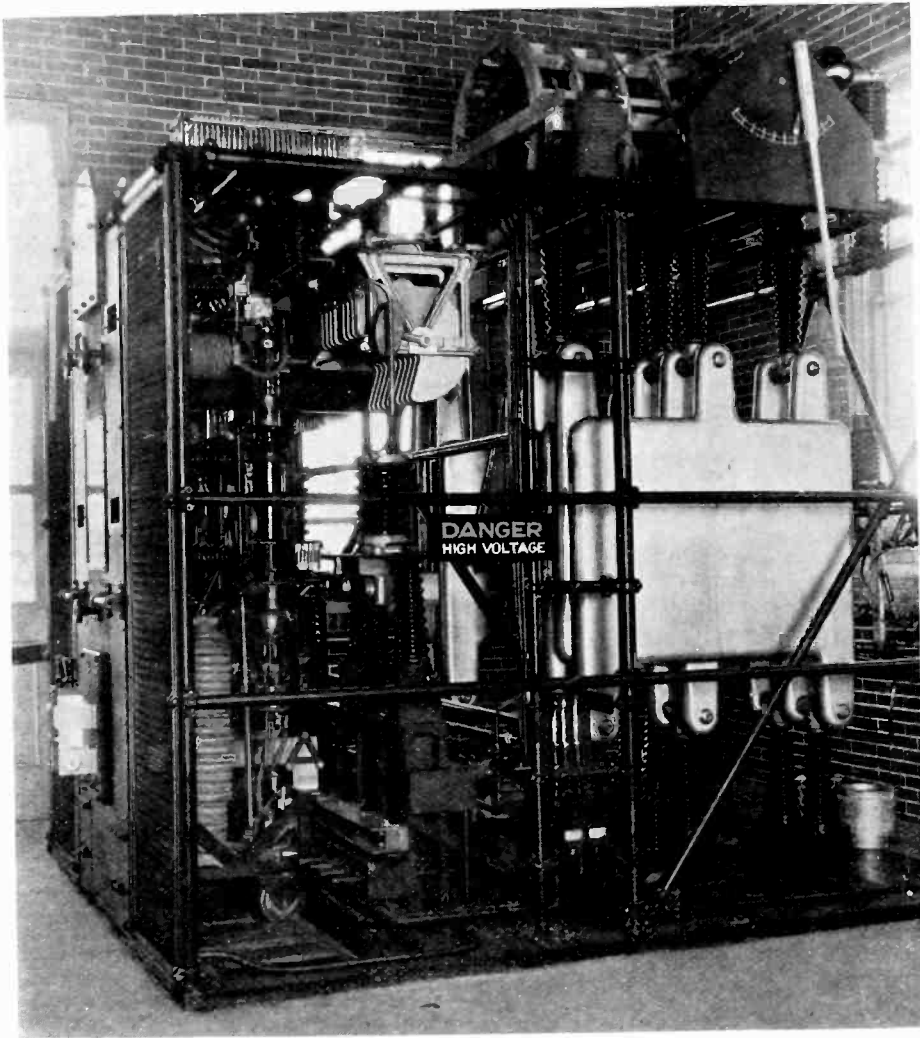

The output stage of the high power transmitter at KDKA.

end of the day. The price of each luncheon ticket will be \$1.25, and tickets should be obtained in advance upon registration.

### Birthday Party

The informal banquet which is normally a part of our conventions will this time take the form of a Birthday Party to commemorate the Twentieth Anniversary of the founding of the Institute. This will be held in the Urban Room of the William Penn Hotel.

During this function, the Institute Medal of Honor and the Morris Liebmann Memorial Prize for 1932 will be presented to the recipients who have not as yet been named. The decision in these matters will be made at the March meeting of the Board of Directors. A very interesting program of entertainment has been prepared and some special events will be included in the program in observance of the Institute's anniversary. Banquet tickets will be \$5.00 each and one may purchase a strip ticket for the banquet and three luncheons for \$8.00.

### **Golf**

In view of the early date, it was thought inadvisable to attempt to hold any organized golf tournament, but for the benefit of those who may desire to play golf, arrangements have been made whereby the various courses in and around Pittsburgh may be available. Just bring your clubs along and get in touch with the Golf Committee immediately after registration so that arrangements may be completed as early as possible.

### **Reduced Railroad Rates**

Arrangements are being made for reduced railroad rates on the certificate plan. This requires that all those traveling to the convention obtain, when they purchase their one-way railroad tickets to Pittsburgh, a certificate which will be validated at the convention, provided at least one hundred such certificates are presented. All are urged to request these certificates when purchasing railroad tickets even though they may not be particularly interested in the saving represented by the obtaining of the return trip ticket at one-half rate. It is necessary that one hundred certificates be deposited before anyone can obtain this reduced rate and even if it will result in a very small saving to you, your certificate will help those coming from much greater distances to secure their rebates.

### **Sections Committee Meeting**

The annual meeting of the Sections Committee will be held on Thursday at 8 P.M. at the William Penn Hotel. All Institute sections should be represented at this meeting and if your section has not appointed an official delegate to the meeting and you are one of only a few representatives from your section in attendance at the meeting, please get in touch with the secretary so that you may be enabled to attend this committee meeting and report upon the conditions existent in your section.

### February Meeting of the Board of Directors

The February meeting of the Board of Directors of the Institute was held on the 3rd and was attended by: W. G. Cady, president; Melville Eastham, treasurer; Alfred N. Goldsmith, editor; Arthur Batcheller, O. H. Caldwell, J. V. L. Hogan, H. W. Houck, C. M. Jansky, Jr., R. H. Marriott, E. L. Nelson, A. F. Van Dyck, William Wilson, and H. P. Westman, secretary.

B. S. McCutcheon was transferred to the Fellow grade and H. R. Fritz and B. J. Thompson were transferred to the Member grade.

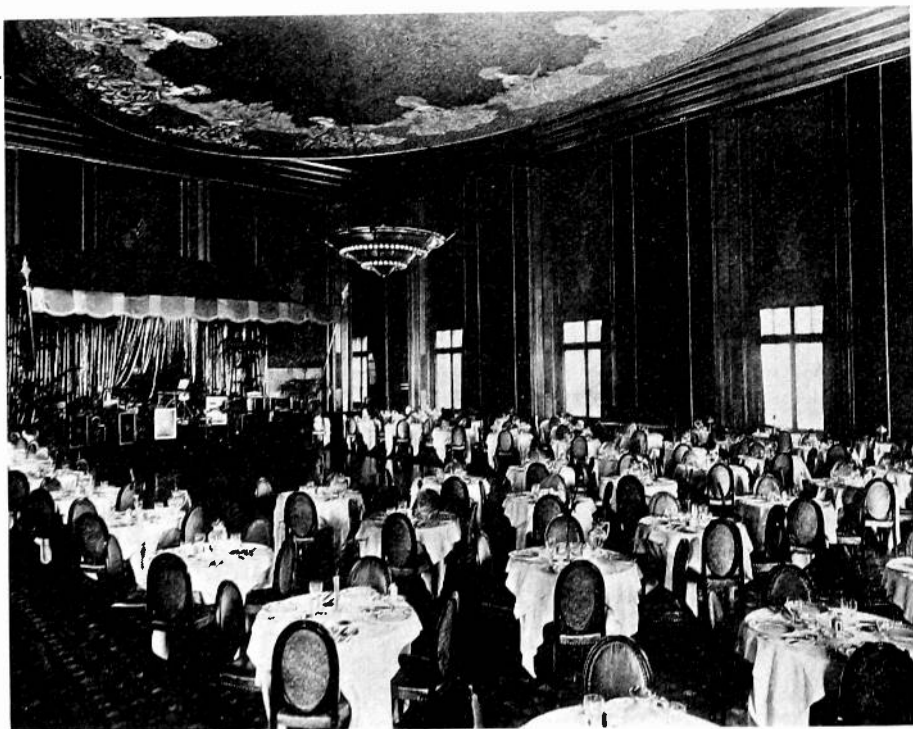

The Urban Room of the William Penn Hotel in which the technical sessions and the birthday party will be held.

R. B. Meader was admitted to the Member grade and sixty-four applications for the Associate grade and three applications for the Junior grade of membership were approved.

The personnel of all standing committees for 1932 was appointed by Dr. Cady with the approval of the Board and this list will appear in full in the April issue of the PROCEEDINGS.

The Secretary's Report for 1931 was accepted and that portion of it directed to the membership appears in the 1932 YEAR BOOK which is forwarded with this copy of the PROCEEDINGS to all members in good

standing. It was agreed that in so far as is practicable, the amount of editorial material published in the PROCEEDINGS during 1932 should equal that published during 1931.

The accountant's report for 1931 was considered and for the benefit of the membership a comparative balance statement is given in the Secretary's Report in the YEAR BOOK.

The activities of the Emergency Employment Committee were discussed in detail and it was agreed that the broadcast station coverage survey which is in progress be held in the strict confidence of the Board of Directors until such time as they may make further disposition of it. Two additional members, Alfred N. Goldsmith and J. V. L. Hogan, were appointed to the Emergency Employment Committee. Furthermore, it was agreed that the efforts of the committee be directed to the assistance of Institute members only.

A small contribution was made to the Engineering Societies Library to assist in the advancement of the worthy work of that organization. Institute members who desire to withdraw books from the library are permitted to do so upon the guarantee of the Institute that no loss will be incurred to the library through such loans.

---

### Radio Transmissions of Standard Frequency

The Bureau of Standards transmits standard frequencies from its station WWV, Washington, D. C., every Tuesday. The transmissions are on 5000 kilocycles, and are given continuously from 2:00 to 4:00 P.M., and from 10:00 P.M. to 12:00 midnight, Eastern Standard Time. (From October, 1931, to March, 1932, inclusive, the evening schedule was two hours earlier.) This service may be used by transmitting stations in adjusting their transmitters to exact frequency, and by the public in calibrating frequency standards and transmitting and receiving apparatus. The transmissions can be heard and utilized by stations equipped for continuous-wave reception throughout the United States, although not with certainty in some places. The accuracy of the frequency is at all times better than one cycle (one in five million).

From the 5000 kilocycles any frequency may be checked by the method of harmonics. Information on how to receive and utilize the signals is given in pamphlets obtainable on request addressed to the Bureau of Standards, Washington, D. C.

The transmissions consist mainly of continuous, unkeyed carrier frequency, giving a continuous whistle in the phones when received with an oscillatory receiving set. For the first five minutes there are transmitted the general call (CQ de WWV) and announcement of the

frequency. The frequency and the call letters of the station (WWV) are given every ten minutes thereafter.

Supplementary experimental transmissions are made at other times. Some of these are made with modulated waves, at various modulation frequencies. Information regarding proposed supplementary transmissions is given by radio during the regular transmissions, and also announced in the newspapers.

The Bureau desires to receive reports on the transmissions, especially because radio transmission phenomena change with the season of the year. The data desired are approximate field intensity, fading characteristics, and the suitability of the transmissions for frequency measurements. It is suggested that in reporting on intensities, the following designations be used where field intensity measurement apparatus is not used: (1) hardly perceptible, unreadable; (2) weak, readable now and then; (3) fairly good, readable with difficulty; (4) good, readable; (5) very good, perfectly readable. A statement as to whether fading is present or not is desired, and if so, its characteristics, such as time between peaks of signal intensity. Statements as to type of receiving set and type of antenna used are also desired. The Bureau would also appreciate reports on the use of the transmissions for purposes of frequency measurement or control.

All reports and letters regarding the transmissions should be addressed to the Bureau of Standards, Washington, D. C.

---

### Committee Work

#### ADMISSIONS COMMITTEE

A meeting of the Admissions Committee was held on February 3 at 10 A.M. and was attended by C. M. Jansky, Jr., chairman; C. N. Anderson, Arthur Batcheller, R. A. Heising, A. V. Loughren, A. F. Van Dyck, and H. P. Westman, secretary.

Five applications for transfer to the grade of Member were considered of which two were approved, two were rejected, and one was tabled pending additional information. Five of seven applications for admission to the grade of Member were approved, and one was rejected. The remaining application was tabled for further data.

#### BROADCAST COMMITTEE

At 7:30 P.M. on February 2 a meeting of the Broadcast Committee was held at the office of the Institute. Those in attendance were E. L. Nelson, chairman; Harry Dart, J. B. Coleman (representing B. R.

Cummings), P. A. Greene, J. V. L. Hogan, C. W. Horn, C. M. Jansky, Jr., E. H. I. Lee (representing Arthur Batcheller), and H. P. Westman, secretary.

The committee devoted its time to a consideration of the radio broadcast situation viewed as a systems proposition, divided the field into a number of subdivisions, and assigned specific problems to various members who are to prepare reports and submit them to the committee at future meetings. These reports when in acceptable form to the committee will be submitted to the Board of Directors for such use as that body may care to make of them.

## STANDARDIZATION

### TECHNICAL COMMITTEE ON ELECTRO-ACOUSTIC DEVICES—IRE

A meeting of the Technical Committee on Electro-Acoustic Devices was held at 10 A.M. on January 15 and was attended by E. D. Cook, chairman; L. G. Bostwick, C. R. Hanna, Benjamin Olney, W. N. Tuttle, and B. Dudley, secretary.

Another meeting of this committee was held at 10 A.M. on February 5, those in attendance being E. D. Cook, chairman; H. P. Westman, temporary acting chairman; L. G. Bostwick, E. W. Kellogg, H. B. Marvin, and B. Dudley, secretary.

At these two meetings the committee considered that portion of the 1931 Report of the Standards Committee devoted to electro-acoustic devices and made a number of changes in the definitions contained therein. It also made a number of recommendations regarding the editorial make-up of the section on "Performance Indexes and Tests of Electro-Acoustic Devices" which appears in the 1931 Report. It considered the advisability of revising the section on microphone calibration. The possibility of setting up some acceptable standards on equipment for measuring acoustic output of loud speakers and other electro-acoustic devices was discussed. It was thought that the time had not yet arrived when such test methods could be outlined with the hopes that they will fulfill with moderate success the need at the present time existent in this field.

### TECHNICAL COMMITTEE ON FUNDAMENTAL UNITS AND MEASUREMENTS—IRE

A meeting of the above technical committee was held at 10 A.M. on January 26 at the Institute office, those in attendance being H. M. Turner, chairman; E. T. Dickey, C. R. Englund, R. F. Field, H. B. Marvin, G. C. Southworth, and B. Dudley, secretary.



This meeting which is the first one held by this recently established committee was devoted chiefly to a survey of the work which the committee would be expected to perform and determination of suitable methods of attacking these problems. The committee will review all portions of the 1931 Standards Report which fall within its scope, and in addition set up an extensive program covering many new items which have not heretofore appeared in standards reports issued by the Institute. A number of subcommittees were designated to prepare individual reports on certain problems so that they could be considered at the next meeting of the committee and some determination made as to their fitness for adoption into the report of the committee.

#### TECHNICAL COMMITTEE ON RADIO RECEIVERS

A meeting of the Technical Committee on Radio Receivers was held at the office of the Institute at 10 A.M. on February 4, those in attendance being H. A. Wheeler, chairman; E. T. Dickey, Malcolm Ferris (representing C. M. Burrill), V. M. Graham, David Grimes, H. Heindel (representing F. A. Hinnners), R. H. Langley, A. E. Thiesen, L. P. Tuckerman (representing C. E. Brigham), and B. Dudley, secretary.

The committee discussed methods for determining and indicating the amount of interference and cross-talk that may be encountered by broadcast receivers. Methods of determining the response of receivers to high field intensities were discussed and methods of making such tests were considered.

A subcommittee was appointed to investigate the problem of signal generator requirements and design.

Another subcommittee was appointed to consider the problem of the measurement of the fidelity of a receiver with the loud speaker connected to the output circuit.

The problem of determining the selectivity of the receiver was considered and some more suitable methods than those used at present for the designation of this characteristic were discussed.

#### TECHNICAL COMMITTEE ON VACUUM TUBES—IRE

A meeting of the Technical Committee on Vacuum Tubes was held at 10 A.M. at February 2 at the office of the Institute, those present being M. J. Kelly, acting chairman; J. C. Warner, acting chairman; E. A. Lederer, L. M. Price, E. E. Spitzer, K. S. Weaver, P. T. Weeks, E. D. Wilson (representing Dayton Ulrey), and B. Dudley, secretary.

In the absence of the chairman, B. E. Shackelford, Messrs. Kelly and Warner acted as chairmen during different portions of the session.

The committee reviewed the definitions appearing in the 1931 Standards Report and spent a considerable amount of time on the study of the letter symbols for vacuum tubes given therein. A number of revisions of this material were recommended to be included in the report of the committee.

---

## Institute Meetings

### ATLANTA SECTION

A meeting of the Atlanta Section was held on January 27th at the Atlanta Athletic Club, Chairman Harry F. Dobbs presiding.

W. J. Holey, assistant radio inspector, presented a "Description of Equipment of Grand Island Monitoring Station" which was profusely illustrated by lantern slides. The paper was discussed by Messrs. Bangs, Dobbs, Van Nostrand, and Wills.

As this was the Annual Meeting, the election of officers for the forthcoming year was held with the following results: Chairman, H. L. Wills, Vice Chairman, K. P. Thompkins, and Secretary-Treasurer, P. C. Bangs.

It was agreed that the second Thursday of each month be established as the meeting date for the section and that the January meeting be the annual meeting.

The attendance at the meeting totaled thirteen.

### CHICAGO SECTION

A meeting of the Chicago Section was held on December 4th in the Engineering Building, Byron B. Minnium, chairman, presiding.

A paper by E. W. Ritter of RCA Radiotron Company on "The Use of Suppressor Grids in Pentodes" was presented. The speaker reviewed the early work of Price, Brown, Holtz and others. He then presented curves showing the characteristics of the new 239 radio-frequency pentode tube and discussed the advantages and disadvantages of it. The paper was followed by an unusually active discussion which was participated in by a large number of members and guests present, which totaled one hundred and fifteen.

Election of officers for the next year was held and the new Chairman is J. Barton Hoag, University of Chicago; Vice Chairman; R. M. Arnold, United Air Cleaner Corporation; Secretary-Treasurer; D. H. Miller, McGraw Hill Publishing Company.

The January meeting of the section was held on the fifteenth, J. Barton Hoag, chairman, presiding.

"Class B Audio-Frequency Amplifiers" was the subject of a paper by David Grimes of the RCA License Laboratory.

The speaker discussed the development of several output tubes and their adaptability to class B audio-frequency amplification. In addition to a number of slides which were shown, an extensive use was made of the blackboard by the speaker.

The meeting was attended by two hundred and fifty members and guests.

#### CINCINNATI SECTION

A meeting of the Cincinnati Section was held at the Hotel St. Nicholas on January 19th and was presided over by Chairman C. E. Kilgour.

The paper of the evening "The Electrolytic Condenser" was presented by W. W. Garstang of P. R. Mallory and Company. Mathematical formulas for the design of filter circuits were presented for ideal cases of perfect condensers. The variance of power factor and filtration due to the internal resistance of condensers and their effecting elements was then pointed out and types of effective filter circuits outlined. The economy of electrolytic condensers and their wide adoption was discussed, together with the probable normal life that might be expected for them. The paper closed with a description of the forming and test procedure, a discussion of the possible future improvements, and their future uses.

It was discussed by Messrs. Boyle, Daugherty, Ellison, Felix, Kilgour, and Osterbrok of the forty-five members and guests who attended the meeting. Thirteen of those present attended the informal dinner which preceded it.

#### CLEVELAND SECTION

The Case School of Applied Science was the meeting place for the January 22nd meeting of the Cleveland Section which was presided over by Edward L. Gove, chairman.

P. A. Marsal of the National Carbon Company presented a paper on "Receiver Measurement to Determine Sensitivity, Selectivity, and Fidelity." To illustrate his paper, the speaker used for demonstration purposes a tuned-radio-frequency receiver, audio- and radio-frequency oscillators, output meter and other associated equipment. The process of balancing and neutralizing receivers were reviewed.

The second paper of the evening on "Vacuum Tube Theory and Practice" was presented by John R. Martin, Professor at the Case School of Applied Science. Of particular interest in his paper was his reduction of abstruse statements regarding tube characteristics

and simple formulas readily understandable by the average man interested in radio.

The meeting was attended by thirty-four members and guests.

#### DETROIT SECTION

The January meeting of the Detroit Section was held in the Detroit News Conference Room on the 15th and was presided over by H. L. Byerlay, chairman.

N. H. Williams, Professor in the Department of Physics of the University of Michigan presented a paper on "Multigrid Tubes." He pointed out that the space-charge grid was used early in this country and abroad, but only in research work. The pliodynatron, acting as an oscillating detector, found some use in radiotelegraphy but the first multigrid tube to be widely used was a screen-grid tube. The other multigrid tubes described were three types of pentodes, the variable-mu tube, and the low grid current, or electrometer tube.

The speaker discussed the reasons for the development of these different tubes and the results accomplished by their introduction. He stated that the screen-grid reduced the interelectrode capacitance to about one per cent of that in the three-electrode tube making possible the use of impedance coupling and high amplification without self-oscillation. The power pentode has a grid near the plate which is held at the potential of the cathode to prevent secondary electrons from the plate reaching the control grid.

The variable-mu tube was compared with two tubes having quite different characteristics operated in parallel. When that part of the tube having high amplifying ability fails to transmit current because of high negative grid bias, the low amplifying portion of the tube continues to function thus avoiding current cut-off on large signals and its accompanying distortion.

The electrometer tube does not appear at the present time to be needed in the radio industry but certain types of research, notably photo-electric emission, are either not possible or very difficult with other apparatus. The tube is primarily intended for the measurement of very small currents in high resistance circuits.

The meeting was attended by one hundred and thirty-three members.

#### LOS ANGELES SECTION

A meeting of the Los Angeles Section was held at the Mayfair Hotel on January 19th, Chairman E. H. Schreiber presiding.

John Blackburn, research fellow at the California Institute of Technology presented a paper "The Other End of the Spectrum" which

was a discussion of the theory of electromagnetic radiation, including a review of some of the high voltage X-ray work that has been carried on at California Institute of Technology. The paper was illustrated with a number of slides, and some photographs of cosmic rays were available.

The meeting was attended by sixty-two members and guests of whom twenty-four were present at the informal dinner which preceded it.

#### PITTSBURGH SECTION

A meeting of the Pittsburgh Section was held on December 29th at the Fort Pitt Hotel, Chairman J. G. Allen presiding.

The first paper of the evening on "Audio- and Radio-Frequency Coupling Units" was presented by L. J. Peters. The speaker reviewed the design of audio-frequency amplifiers and exhibited experimental curves showing the results of various combinations of inductance and capacity in audio coupling units. Amplification as high as 250 was obtained by the use of screen-grid tubes. The theoretical limitations of crystal filter circuits were discussed.

The second paper of the evening, by R. D. Wycoff, was on "The Design of a Crystal Controlled 180-Meter Portable Transmitter," and the use to which such a radio transmitter is put in prospecting work where it transmits timing signals to several recorders was briefly outlined. The circuit diagram was given and it was pointed out that modulation was obtained by modulating the frequency doubling stage. An oscillograph record of the output showed excellent quality of modulation. The final amplifier stage was comprised of two type-'45 tubes in parallel and the entire transmitter was operated by batteries and designed compactly for portable use.

Both of the speakers were members of the Gulf Research Laboratory at Pittsburgh. The meeting was attended by forty-one members and guests.

The January meeting of the section was held on the 19th at the Fort Pitt Hotel, J. G. Allen, chairman, presiding.

A paper on "Thermionic Control of Theater Lighting" was presented by B. S. Burke, switchboard engineer of the Westinghouse Electric and Manufacturing Company.

The speaker outlined in detail the application of the grid-glow tube to lighting control. In this application the phase of the voltage applied to a type-226 tube is made to control the flow of direct current in the anode circuit of two grid-glow tubes. This direct current is passed through one winding of a reactor which carries the alternating current

which operates the lights under control. By varying the direct current through the reactor its reactance is varied due to the approach of magnetic saturation and in this manner the brilliancy of the lamps may be controlled from zero to full value. By means of small potentiometers and relays it was shown that any arrangement of three light colors could be set up and a sequence of five operations gone through without making any further adjustment.

The meeting was attended by twenty-eight members and guests.

#### SAN FRANCISCO SECTION

The San Francisco Section held a meeting on January 20th at the Bellevue Hotel, R. M. Heintz, chairman, presiding.

The paper of the evening was "Standard Frequency Apparatus and Field Strength Measuring Equipment" which was presented by B. H. Linden, Supervisor of Radio.

The chairman discussed the progress of a plan for the establishment of a radio museum and stated that arrangements had been made with the De Young Memorial Museum for space.

The success which the monthly seminar meeting for the discussion of current literature had had was called to the attention of those present.

Twenty-two of the forty-four members and guests in attendance participated in the informal dinner which preceded the meeting.

#### SEATTLE SECTION

George S. Smith, professor at the College of Engineering at the University of Washington presented a paper on "The Oscillograph" at the January 28th meeting of the Seattle Section held at the University of Washington and presided over by L. C. Austin, chairman.

Professor Smith described the working of the galvanometer type of oscillograph using slides to illustrate his remarks. This was followed with a projection on the screen of photographic records showing the characteristics of the five fundamental vowel sounds as spoken by a female voice and by a male voice. He pointed out the differences and the similarities in the two records indicating what effect intensity of sound, pitch, and sound itself had in making the record. He then discussed the cathode ray oscillograph, its principle of operation, and the relative advantages and disadvantages of these two types of oscillographs.

The paper was discussed by Messrs. Bouson, Tolmie, and Wilson of the one hundred and fifteen members and guests in attendance.

## WASHINGTON SECTION

The Washington Section held a meeting on January 14th at the Continental Hotel, J. H. Dellinger, chairman, presiding.

The paper of the evening was presented by C. T. Solt of the United States Coast Guard and was entitled "The Development and Application of Marine Radio Direction Finding Equipment by the U. S. Coast Guard." The paper will not be summarized here as it appeared in full in the February, 1932, issue of the PROCEEDINGS.

Messrs. Burgess, Coe, Dellinger, Diamond, Dorsey, and Robinson of the seventy-nine members and guests in attendance, participated in the discussion following the presentation of the paper.

---

**Personal Mention**

Greenleaf W. Pickard, formerly consulting engineer of the Wireless Specialty Apparatus Company and its successor, the RCA Victor Company of Massachusetts, has opened a consulting office in Newton Centre, Massachusetts.

Formerly with the DeForest Radio Company at Passaic, N. J., C. E. Himoe has established a consulting engineering practice in Los Angeles, Calif.

R. M. Arnold has left the Grigsby-Grunow Company to rejoin United Air Cleaner Corporation as vice president and chief engineer.

G. W. Carpenter has recently become a manager of engineering for the RCA Victor Company at Camden.

Previously with the Fox Film Company, E. H. Hanson has become chief engineer of the E. H. Hanson Laboratories of Los Angeles.

H. W. Houck formerly chief engineer of Dubilier Condenser Corporation has joined the International Communication Laboratories of Newark, N. J.

Lieutenant H. G. Moran, U.S.N., has been transferred from the *U. S. S. Houston* to the Naval Radio Station at Cavite, P. I.

E. R. Pfaff formerly with the International Broadcasting Equipment Company has become chief engineer of E. H. Scott Radio Laboratory, Chicago.

R. F. Roush has left National Union Radio Corporation to join the staff of RCA Radiotron Company of Harrison, N. J.

C. C. Shumard has been transferred to the RCA Radiotron Company Development Laboratory at Harrison, N. J.

Formerly a condenser engineer for the Magnavox Company, H. J. Tyzzer has joined the engineering staff of the Pilot Tube and Radio Corporation of Lawrence, Mass.

Previously district manager for Kolster Radio, D. C. Wallace has become Pacific Coast representative of Electric Specialty Company and Birnbach Radio Company.

Formerly engineer in charge of the research department of RCA Photophone, Julius Weinberger has joined the research division of the RCA Victor Company at Camden.





PART II  
TECHNICAL PAPERS

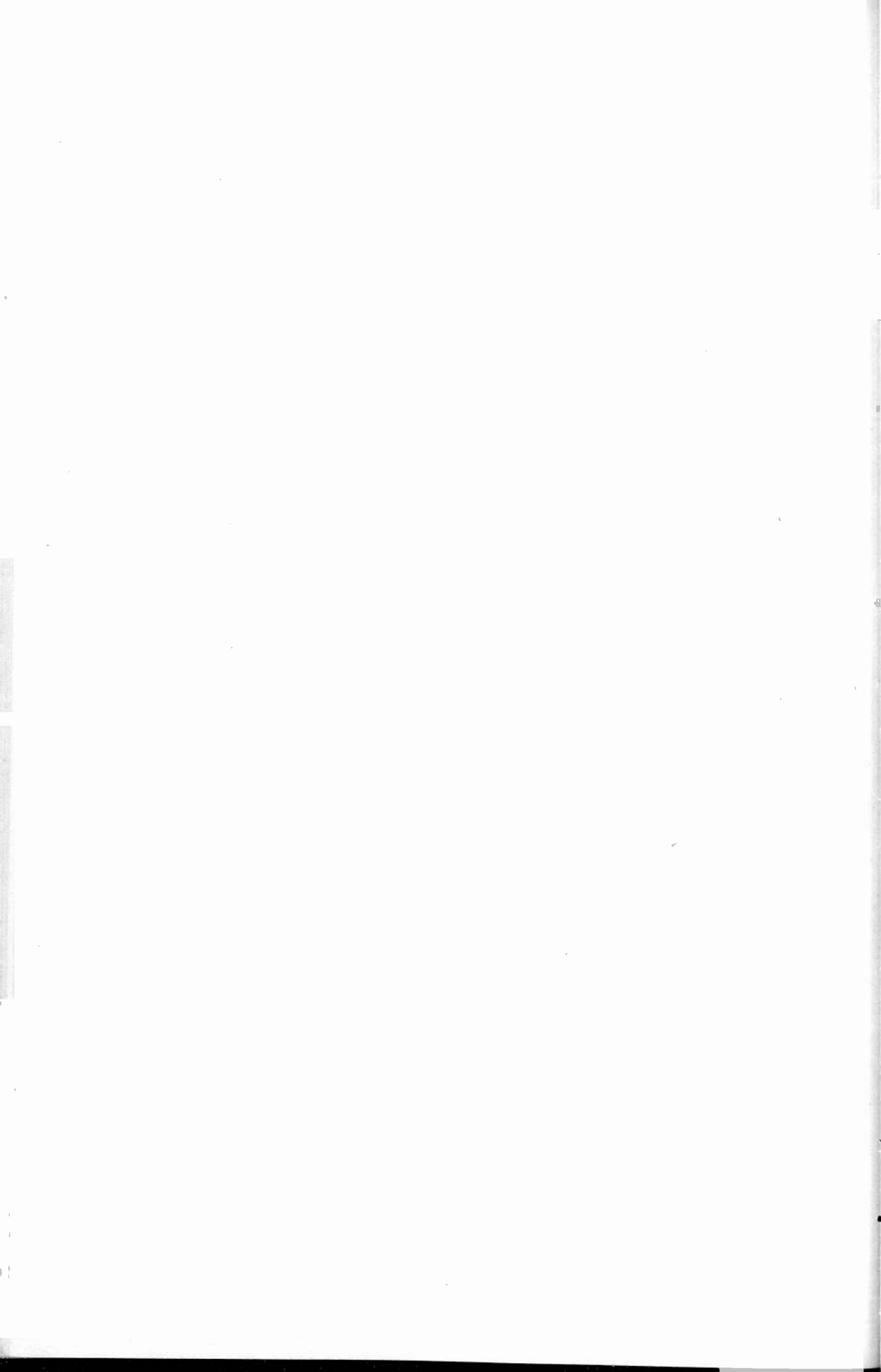

## OPERATION OF A SHIP-SHORE RADIOTELEPHONE SYSTEM\*

BY

C. N. ANDERSON AND I. E. LATTIMER

(American Telephone and Telegraph Company, New York City)

*Summary*—During the past two years, ship-shore radiotelephone service has been available with several of the large transatlantic liners. This service has been fairly reliable over distances up to about halfway across the Atlantic and some measure of service has been available all the way across. This paper reviews the essential physical and operating features of the land and ship terminals employed in giving this service.

Problems encountered in establishing and operating this service are discussed, together with measures applied for their solution. The most difficult problems have arisen in connection with adapting the ship terminal for operation under the limited space conditions encountered on shipboard. These conditions impose undesirable proximities between units of equipment and between antennas.

The operating plan used in coördinating the establishment of the contacts between ship and shore stations is discussed.

Considerable data have been collected during the past two years incidental to the operation of the system. Of interest are the contour diagrams indicating the variation of signal fields with time of day and with distance.

The variations of the grades of circuit at various distances obtained as a result of operation are shown. During the first six months of 1931, commercial grades of circuit were obtained in about 85 per cent of the contacts.

### I. INTRODUCTION

REGULAR ship-shore radiotelephone service with several of the large passenger vessels plying the North Atlantic has been available for nearly two years. At the present time the vessels equipped for this service are the steamships Leviathan, Majestic, Olympic, Homeric, Belgenland, and the Empress of Britain. On the American side the service is handled through the radio stations of the American Telephone and Telegraph Company and on the European side through the stations of the British General Post Office. Previous papers<sup>1,2,3,4</sup> have discussed the terminal arrangements, particularly on shore, and the general ship-shore plan more or less in detail. After reviewing these

\* Decimal classification: R412×R510. Original manuscript received by the Institute, October 1, 1931.

<sup>1</sup> W. Wilson and L. Espenschied, "Radiotelephone service to ships at sea," *Bell Sys. Tech. Jour.*, July, 1930.

<sup>2</sup> A. S. Angwin, "Ship and shore terminal equipment," *Electrical Communication*, July, 1930.

<sup>3</sup> A. G. Lee, "Radio communication services of British Post Office," *Proc. I.R.E.*, October, 1930.

<sup>4</sup> Miller, Bown, Oswald, and Cowan, Papers on "Transoceanic Telephone Service," *Trans. A.I.E.E.*, April, 1930.

terminal arrangements briefly, the present paper will concern itself with the general plan of operation and some of the results which have been obtained.

The steps in providing this ship-shore radiotelephone service have involved:

1. For the shore, essential duplication of the radio transmitting and receiving and voice-frequency terminal equipment of the short-wave point-to-point services such as the New York-London and New York-Buenos Aires services.
2. For the ship, provision of suitable radio transmitting and receiving equipment—either new or adapted—and overcoming the difficulties of two-way operation under conditions of small physical separation between the radiotelephone transmitter and receiver, and also between the radiotelephone and radiotelegraph equipment—which should preferably be able to work simultaneously.
3. Selection of several frequencies for radio transmission permitting coverage of the entire North Atlantic Ocean.
4. Development of an operating plan involving minimum delay in clearing traffic and at the same time providing for operation with both American and European shore terminals.

## II. CIRCUIT SET-UP

A general picture of a ship-shore radiotelephone circuit is shown in Fig. 1.<sup>1</sup> It will be noted that the circuit consists really of two separate one-way channels between the ship subscriber and the control position in New York City, where, in conjunction with special apparatus, the two channels are united and connected to the regular wire telephone plant, eventually reaching the shore telephone subscriber.

### *Ship Terminal*

The details of the installations on the various ships differ somewhat because of their being supplied by different concerns.† In general, however, the equipments on the various ships are similar.

The radio transmitters supply from 500 to 1500 watts of radio-frequency power, modulated approximately 80 per cent, to simple vertical antennas as in the case of the Leviathan, to doublets as on the steamships Olympic, Majestic, and Belgenland, or to "Marconi Beam Ele-

<sup>1</sup> *Loc. cit.*

† Concerns supplying ship equipments as follows: The Marconi International Marine Communication Co. Ltd., Steamships Homeric and Empress of Britain; International Marine Radio Company Ltd., Steamships Belgenland, Olympic, and Majestic; American Telephone and Telegraph Co. (Bell Telephone Laboratories), Steamship Leviathan.

ment" antennas as on the steamships *Homeric* and *Empress of Britain*. Air-cooled tubes are used in the final radio stage on the steamships *Leviathan*, *Homeric*, and *Empress of Britain* while water-cooled tubes are used on the steamships *Olympic*, *Majestic*, and *Belgenland*.

The radio receivers are generally of the double detection type carefully shielded and with a high degree of selectivity for discrimination against interference from the carrier of the local radiotelephone transmitter and interference from the ship's telegraph transmitter.

The voice-frequency equipment comprises, in general, one amplifier in the transmitting channel, one in the receiving channel, adjustable

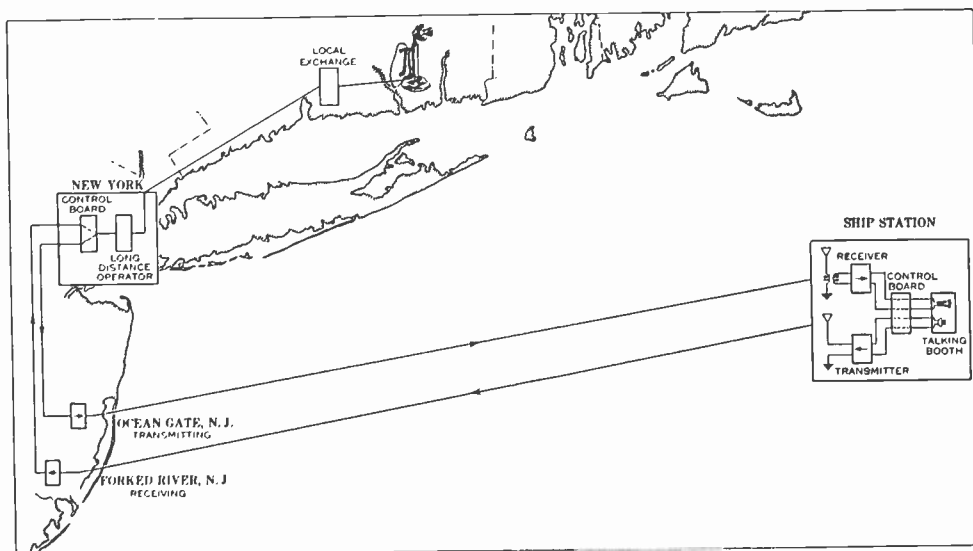

Fig. 1—General picture of ship-shore radiotelephone circuit.

gain controls to regulate both transmitted and received speech volumes, volume indicators, monitoring facilities and certain voice-operated devices which, when required, may be used to suppress the radio-frequency carrier when the ship subscriber is listening and to cut off the output of the ship receiver when the ship subscriber is talking. In most cases, the transmitting and receiving channels are kept separate throughout and terminate in a special (four-wire) telephone set in a small room, located close to the purser's office or in some other location convenient for the passengers, which is used as a telephone booth. Completing calls directly to the passengers' staterooms over the ship's wire telephone system can be provided for wherever warranted by using voice-operated devices similar to those employed at the shore terminal.

The conditions under which a ship radiotelephone system must operate differ considerably from those applying to a land station. On land,

receiving sites can be selected which will be free from serious electrical interference and which are miles distant from the transmitting sites. On shipboard, on the other hand, the equipment itself must be compact and there are imposed conditions of inadequate physical separation not only between the telephone transmitter and receiver, but also between the telephone and the telegraph systems. Even on the larger ships, such as the Leviathan, the greatest separation which could conveniently be obtained between the telephone and telegraph or between the radio transmitters and receivers is only about 500 feet. Nevertheless, on the Leviathan, through coöperation of the telephone and telegraph staffs, three radiotelegraph services and the radiotelephone have been operated simultaneously.

In addition to telegraph interference, a serious problem has been that of interference of the ship's telephone transmitter with the ship's telephone reception. This interference is of two kinds:

1. Carrier from the ship's telephone transmitter may overload the radio receiver.
2. Carrier from the ship's telephone transmitter may induce radio-frequency currents in stays and other metallic parts of the ship. Variable contacts at points in these current paths serve as secondary sources of radio noise which is picked up in the radiotelephone receiver. This noise does not occur continuously but becomes particularly bad when the rigging is covered with wet salt spray and when vibration is excessive.

In addition to interference from the radio equipment aboard, it was found that electrical machinery, such as ventilator fan motors, elevators and hoists caused considerable noise. Although the method of reduction of interference from electrical machinery is straightforward, nevertheless on account of the large number of units involved, the job was by no means a small one.

There are two general methods of dealing with the interference between transmitters and receivers. The first is effective in reducing the interference from either the telephone or telegraph transmitter and consists in obtaining the maximum possible physical separation between the transmitters and the receiver, obtaining the maximum feasible frequency separation between transmitting and receiving channels, bonding of the stays, and other measures. The second method is effective only in so far as interference from the associated transmitting carrier is concerned and consists of suppressing the carrier when receiving.

From the standpoint of simultaneous operation of telephone and telegraph and the effect of local carrier and stay noise, the best arrange-

ment would be to have all the radio transmitters—telephone and telegraph—grouped together and placed as far aft on the ship as is feasible (so as not to affect the radio compass) and to group all the radio receivers and place them as far forward as possible. Such an arrangement is, however, expensive to effect on ships which already have the telegraph equipment installed and have no special provision for radiotelephone.

The general arrangements of the radiotelephone equipment vary with the different ships. Excepting the *Leviathan*, the transmitter and the receiver are separated as far as practicable. In the case of the *Leviathan*, the radio transmitter and receiver are located in the same room to facilitate operation. The receiving antenna is about 75 feet aft of the radiotelephone room and is connected to it by means of a shielded transmission line. On all of the ships, the voice-frequency equipment is adjacent to the radio receiver. From this point the transmitting and receiving voice-frequency circuits extend to the subscriber's booth.

To prevent overloading of radio receivers from the transmitter carrier requires high selectivity in the receiving circuits, separation of the transmitting and receiving antennas, and a reasonable separation between the ship's transmitting frequency and the ship's receiving frequency. A minimum satisfactory frequency separation is considered to be about 3 per cent. To reduce the stay noise adequately requires a frequency separation of 5 or 6 per cent, or a physical separation of 300 feet or more. Welding or bonding the stays and packing the joints with graphite may also be helpful. The latter method is, however, expensive and there are usually some sources of disturbance which cannot be found, or that do not lend themselves to bonding. No simple permanent cure for this type of interference has yet been found.

The second method of overcoming trouble from stay noise and other effects of the local carrier, is to transmit the carrier only when modulated, that is, when the ship subscriber is talking. This is accomplished by use of a voice operated relay which removes an abnormal bias from either the primary oscillator or the radio-frequency amplifier when speech is being transmitted.

A system which necessitates cutting off the carrier, except when modulated, has certain disadvantages:

1. With automatic gain control at the shore receiver, the gain rises to a preadjusted maximum as soon as the ship subscriber stops talking, which brings up the received noise. This may not only be disconcerting to the shore subscriber, but may lock up the voice-operated devices on the receiving side at the shore control terminal, thereby preventing the shore subscriber from

talking out. To overcome this difficulty without sacrificing sensitivity and received volume involves the use of a carrier-operated device to cut off the voice-frequency output of the shore receiver when no carrier is being received from the ship.

2. During times when it is difficult to establish contact between the ship and the shore, it is not possible to have the ship leave its carrier on continuously and still monitor for the shore station. Even leaving the carrier on intermittently will delay the contact.

Notwithstanding its disadvantages, suppression of the carrier by voice-operated devices seems at present to afford about the simplest

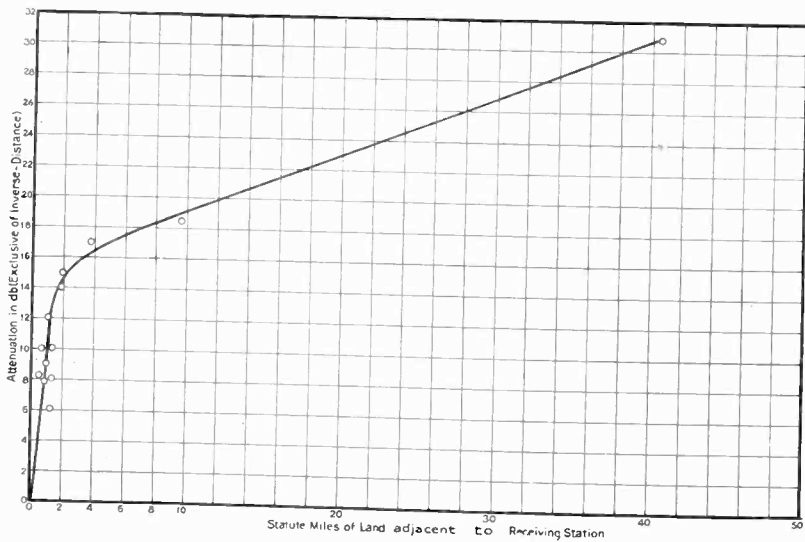

Fig. 2—Overland transmission on 4 mc from ships at sea. Measurements made at Forked River and vicinity, 1930.

way of avoiding the difficulties from stray noise and the overloading effect of the local carrier. All of the ships are now equipped for this method of operation whenever interference becomes sufficiently serious to warrant its use. At other times the system is operated without use of the carrier suppression relays.

The use of voice-operated devices to suppress the local carrier is, of course, not effective against interference produced by other telephone or telegraph transmitters on the ship and separation, both physical and in frequency, must be relied upon.

#### *Shore Terminal*

The shore radio transmitting and receiving stations are located at Ocean Gate and Forked River, New Jersey, respectively, about seven miles apart and about 60 miles south of New York on the New Jersey



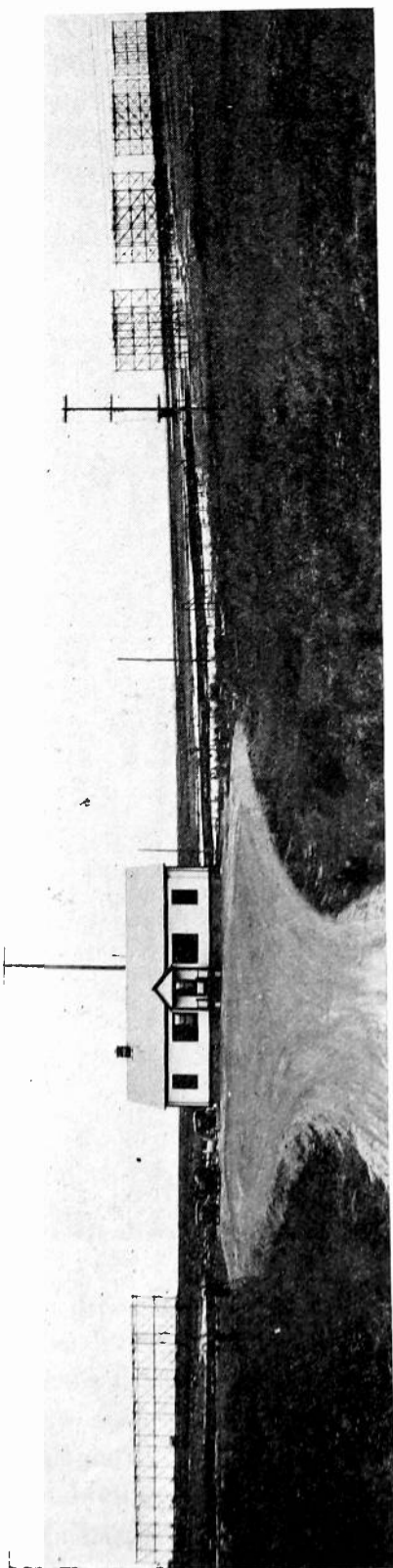

Fig. 3—Ship-shore radiotelephone receiving station at Forked River, New Jersey.

shore. The tract for the transmitting station is about 175 acres, and that for the receiving station, 377 acres. The location directly on the coast was the result of tests<sup>5</sup> indicating that overland attenuation of the ground wave, which is used for transmission out to distances of the order of 200 or 250 miles is quite high for even a small amount of land.

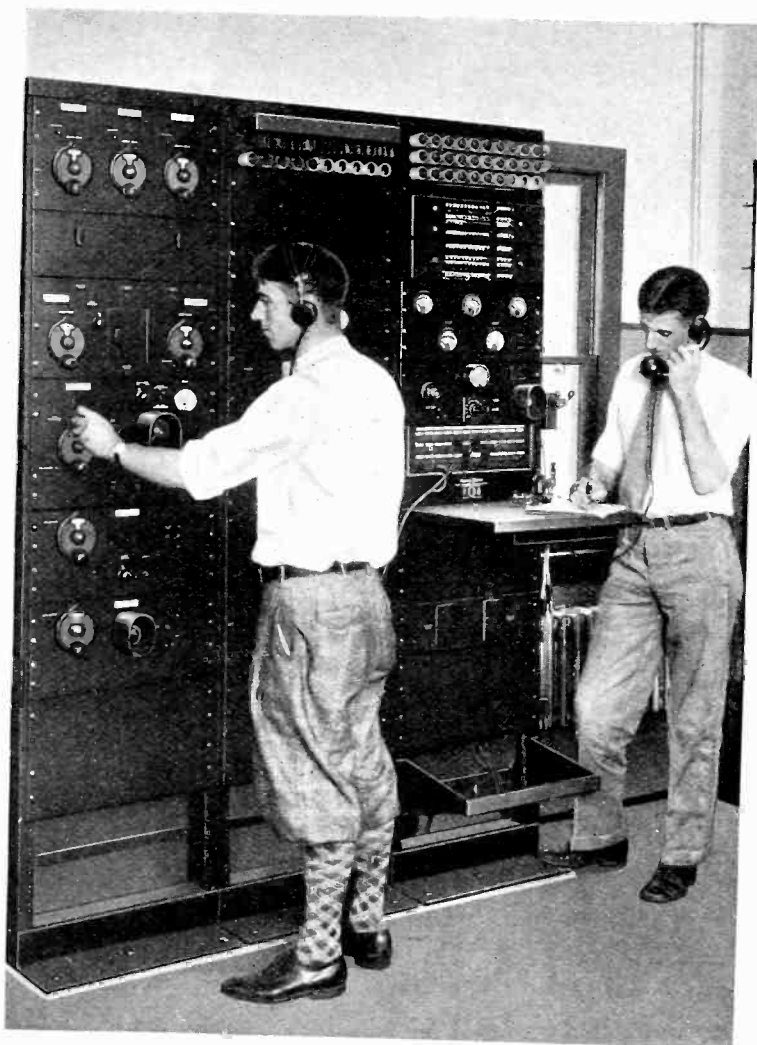

Fig. 4—Receiving set of a special type. This set is arranged to operate over a wide range of wavelengths and is provided with switching devices to permit connection to any one of several antennas.

A curve showing some results taken later at Forked River on 4392 kilocycles is shown in Fig. 2. This indicates that a mile of overland transmission results in 9 db less signal field strength than for transmission over one mile of water. Such a loss is equivalent to cutting down the

<sup>5</sup> R. A. Heising, "Effect of shore station location upon signals," Proc. I.R.E. 20, 77-87; January, 1932.

power radiated by the transmitter to one eighth. Except for the antennas, the shore stations are similar to those in use on the point-to-point services between New York and London and New York and Buenos Aires which have been described previously.<sup>4</sup>

The receiving station at Forked River with the 4-megacycle and 8-megacycle receiving arrays is shown in Fig. 3. For reception on 13 megacycles and 17 megacycles, a horizontal diamond shaped antenna is used.<sup>6</sup> The horizontal antenna is very effective in reducing interference from motor boat ignition systems, as this radiation appears to be largely vertically polarized. The radio receiver used is shown in Fig. 4 with a block schematic drawing in Fig. 5. As mentioned previously, a relay controlled indirectly by the carrier received from the ship, cuts

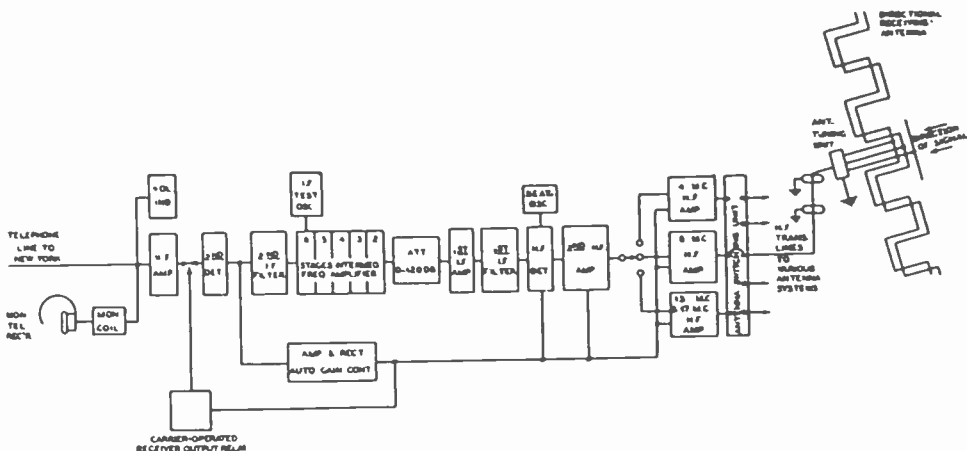

Fig. 5—Block schematic of radio receiving system at Forked River, New Jersey.  
 (1) Intermediate frequency filters adjusted to pass band 395 kc.  
 (2) Operation of carrier-operated receiver output relay is such that when a carrier is being received, the receiver output is "normal," but when no carrier is received, the output of the receiver is "cut off."

off the voice-frequency output of the shore receiver when the ship transmitting carrier is off. This prevents the high noise resulting from the increased receiver gain from being heard by the shore subscriber and simplifies the adjustments of the voice-operated relays at the control terminal. Several receivers are provided to permit monitoring on frequencies which are not being used at the moment for traffic, but on which some ship may call for a connection.

The radio transmitting station at Ocean Gate is pictured in Fig. 6. A view of the radio transmitter itself is shown in Fig. 7 with the corresponding block schematic diagram in Fig. 8. Because of the rather large geographical sector determined by the steamship lanes to which

<sup>4</sup> *Loc. cit.*

<sup>6</sup> E. Bruce, "Developments in short-wave directive antennas," Proc. I.R.E., August, 1931.

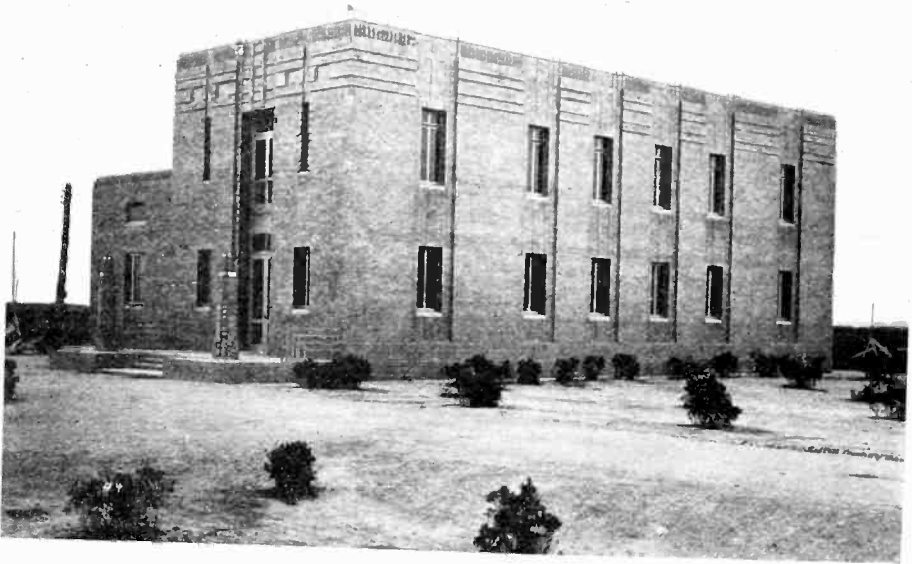

Fig. 6—Ship-shore transmitting building at Ocean Gate, New Jersey.

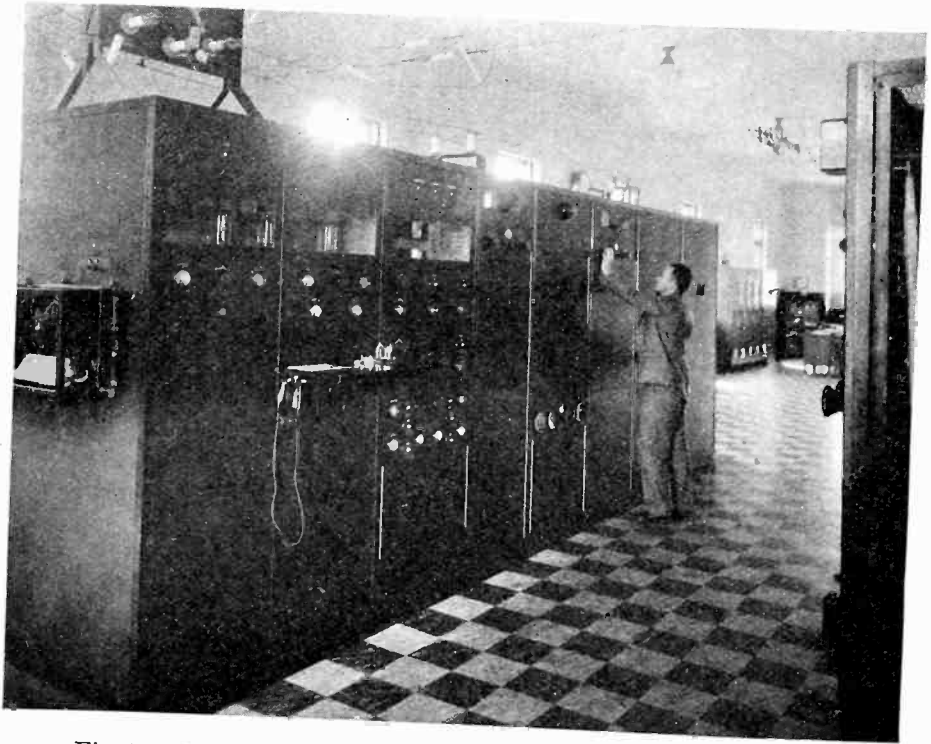

Fig. 7—Radiotelephone transmitter at ship-shore transmitting station, Ocean Gate, New Jersey.

service must be given (shown in Fig. 9) the antennas are not as directional as in point-to-point service nor are all the antennas directed in exactly the same direction, since they serve different regions. Two of

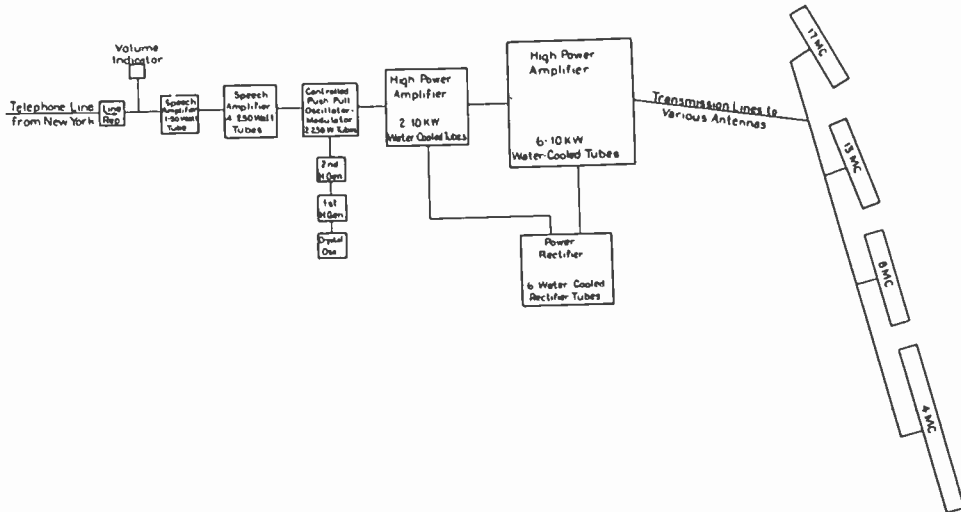

Fig. 8—Block schematic of radio transmitter at Ocean Gate, New Jersey.

the antennas (4 megacycles and 8 megacycles) are of the Bruce type, and two (13 megacycles and 17 megacycles) are of the saw-tooth type.

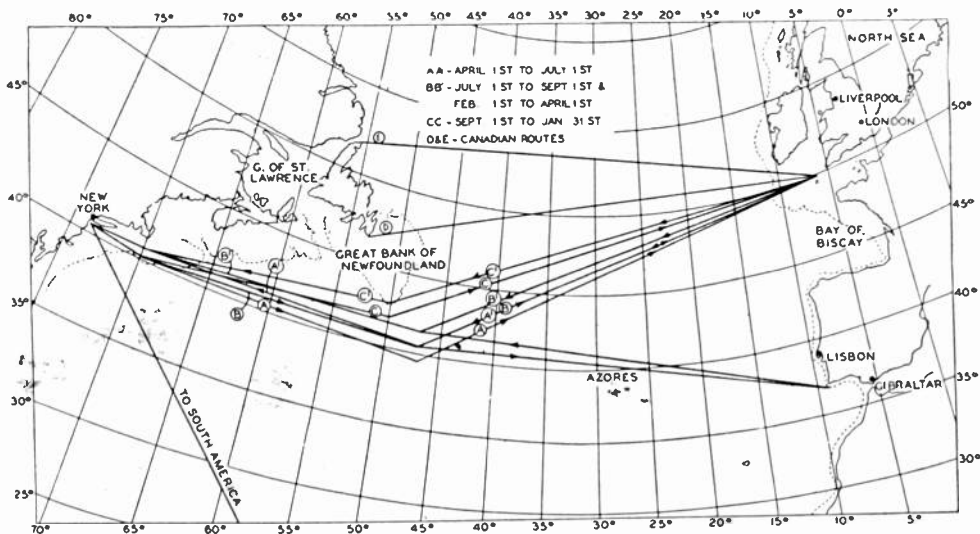

Fig. 9—North Atlantic Steamship lanes.

As indicated in Fig. 1, two pairs of conductors, one from the transmitting station and one from the receiving station, extend back to the ship-shore control position in New York.<sup>7</sup> This control position

<sup>7</sup> S. B. Wright and H. C. Silent, "The New York-London telephone circuit", *Bell Sys. Tech. Jour.*, October, 1927.

is one of the seven similar positions pictured in Fig.10, and used for various Bell System radiotelephone facilities terminating in and around New York. Fig. 11 shows the block schematic of the control terminal. This equipment consists essentially of amplifiers, volume indicators

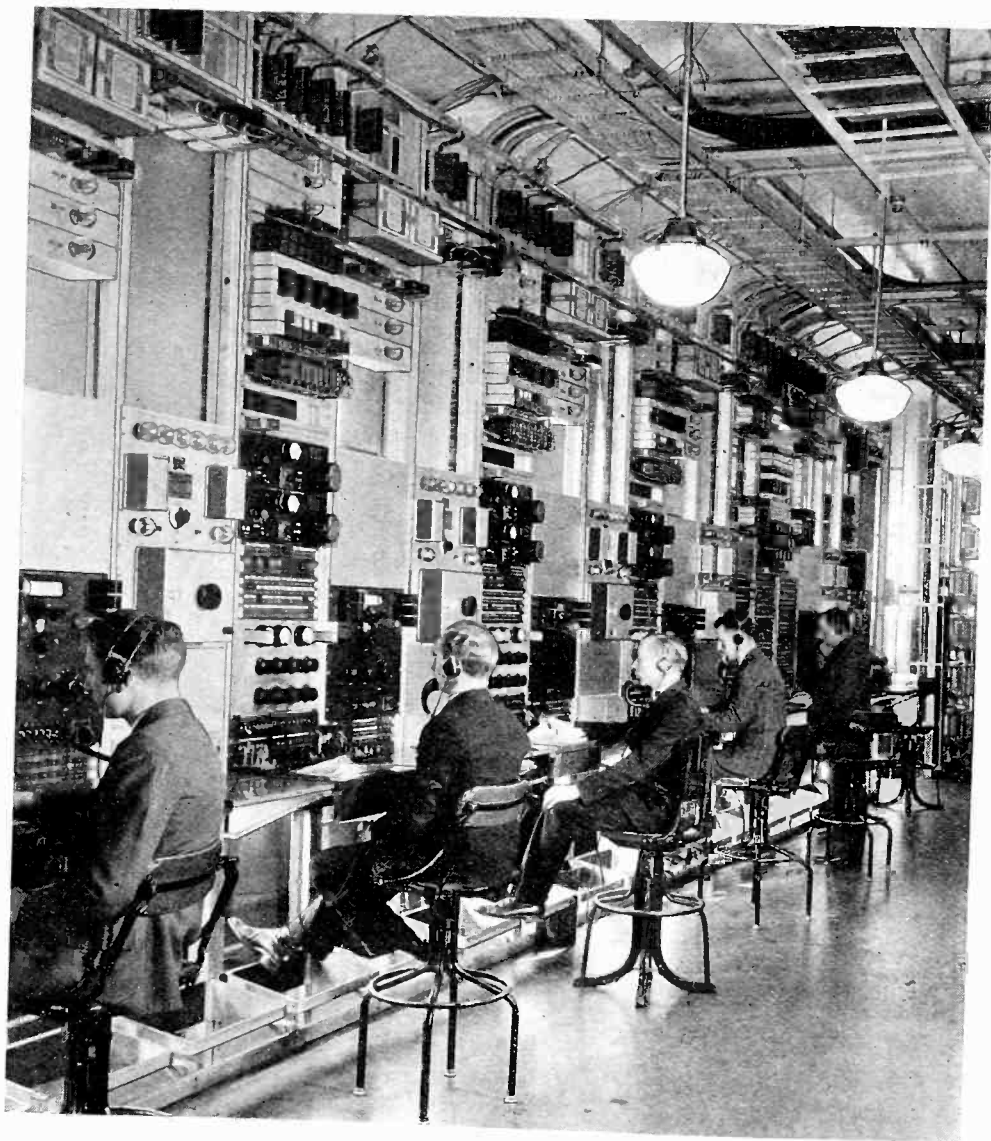

Fig. 10.

and gain controls for adjusting the receiving and transmitting speech volumes, a hybrid coil terminating set for combining the transmitting and receiving channels so as to enable the radiotelephone circuit to be connected into the regular wire telephone system, and, finally, the voice-operated relays with the associated equipment which automati-

cally make the circuit one-way transmitting or receiving, depending on whether the shore subscriber or the ship subscriber is talking, and thereby eliminate echoes, singing, and reradiation of noise.

With no speech in either direction the positions of the voice-operated relays are such that the circuit is in receiving condition. When speech is received from the ship the transmitting relays are rendered inoperative by the receiving echo suppressor relay insuring that the transmitting branch will remain shorted and suppress echoes of the received speech which would otherwise be radiated from the radio transmitter. When the ship subscriber stops talking and the shore subscriber

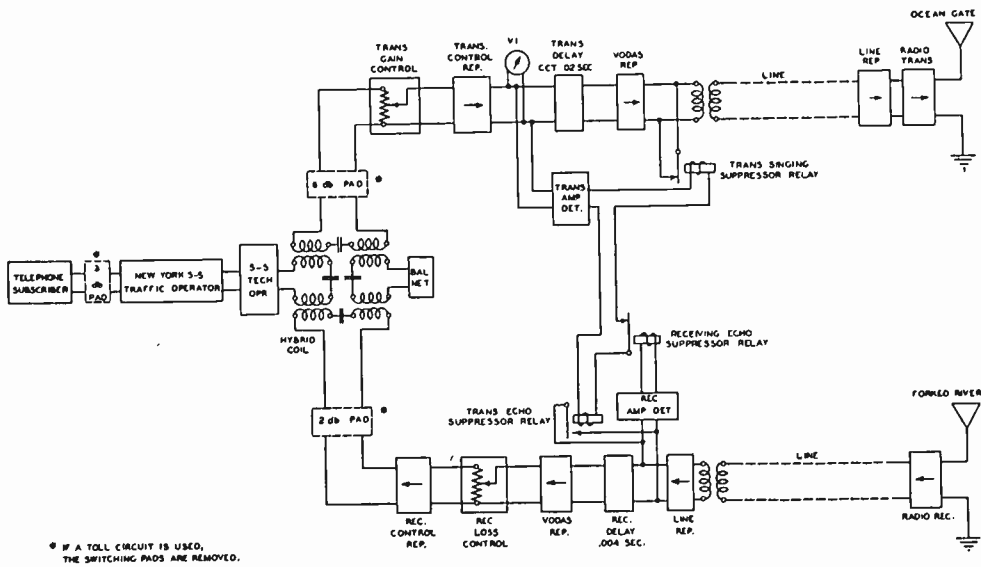

Fig. 11—Block schematic of control terminal and relation to radio stations and wire telephone system.

answers, the transmitting relays remove the short from the transmitting branch, permitting the speech to go on to the radio transmitter and at the same time disable the receiving branch and the receiving echo suppressor circuit. All these operations occur automatically and within a few thousandths of a second, so that they are unnoticed by the telephone subscriber.

From the technical operator's control position the circuit extends to the traffic operator's position (Fig. 12) which differs little from the ordinary toll traffic position, except in special monitoring facilities for timing the call and making proper allowances for repetitions or circuit interruptions, and so forth. At the traffic operator's position are facilities for reaching any one of 32,500,000 telephones, or over 90 per cent of the 35,000,000 telephones in the world.

### III. OPERATING PLAN

With shore stations and ships equipped for adequate transmission over the areas in which service was to be given and with provision made for extending the radio connections to the land telephone systems, there remained the problem of providing a satisfactory operating plan. This plan had to satisfy two general requirements:

1. Calls originating from or destined for ships anywhere in the North Atlantic should be completed with minimum delay.

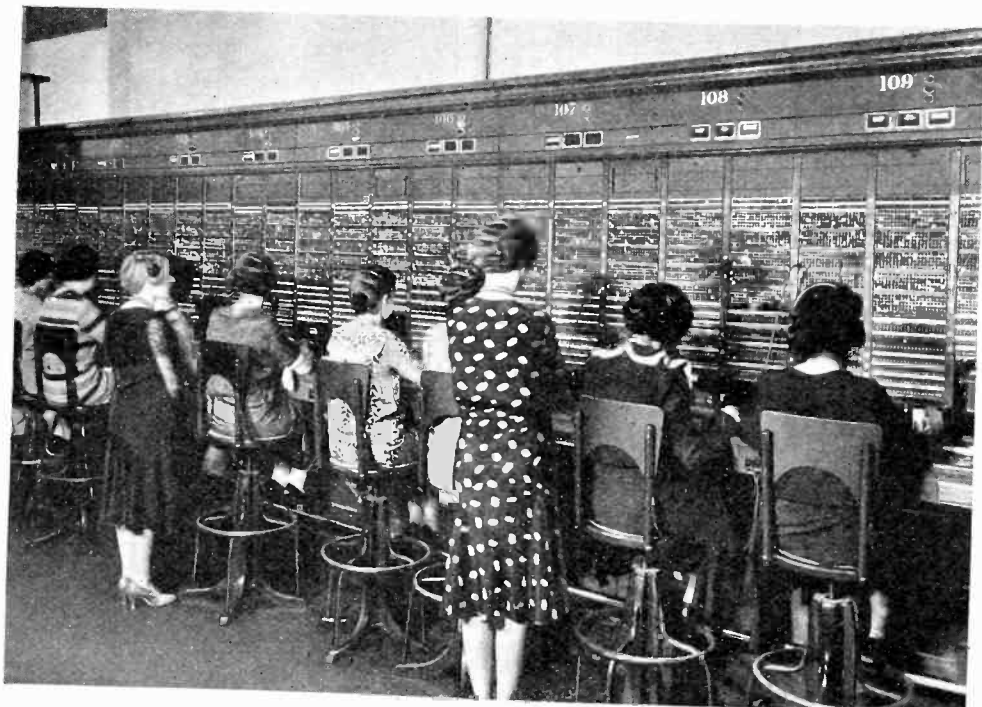

Fig. 12—Transoceanic and ship-shore traffic operating positions.

2. Provisions should be such that ships can work with both European and American shore stations.

Because of the desirability of keeping the ship transmitting and receiving frequencies separate, a pair of frequencies is required for each circuit. For the purpose of simplifying operation and for economy of frequency space, each pair of frequencies is considered as being associated with a particular shore station rather than any particular ship. In order to give service simultaneously from both the American and European shore stations, therefore, separate pairs of frequencies are required for each shore station. At the present time there are really only two such stations offering a general North Atlantic service whose operations must be coordinated; namely, that of the British General



Post Office (transmitting and receiving stations at Rugby and Baldoek, respectively), and that of the American Telephone and Telegraph Company. The shore stations always work on their respective frequencies in each mobile service frequency band and the boats change, depending on whether they wish to work London or New York.

For any given distance range there is a definite pair of frequencies for working with New York and another definite pair of frequencies for working with London.

The requirement of being able to work as continuously as possible across the Atlantic was a determining factor in deciding upon use at each station of four pairs of transmitting and receiving frequencies—one pair for each of the various distance ranges. The utility of the different frequency bands is given below.

TABLE I

Approximate Frequency in Megacycles per Second		Approximate Distance Range in Nautical Miles	
		Day	Night
Summer	4	0- 250	0- 700
	8	250- 700	700-2500
	13	700-1600	2500-3500
	17	1600-3500	—
Winter	4	0- 300	0-2500
	8	300- 800	2500-3500
	13	800-2000	—
	17	2000-3500	—

The actual frequencies which are now used are given in the table below.

TABLE II  
FREQUENCIES USED FOR SHIP-SHORE TELEPHONY

American Telephone and Telegraph Co.— Transmitting Station, Ocean Gate, N. J.	Ships Transmitting to		British General Post Office— Transmitting Station, Rugby, Eng.
	Forked River, N. J.	Baldoek, Eng.	
17120 kc.	17640 kc.	16440 kc.	17080 kc.
12840	13210	12380	12780
8560	8830	8860	8680
4752.5	4177.5	4430	4975

To change from one transmitting frequency to another requires changing coils, readjusting tuning, and connecting the transmitter to the proper antenna. Experience has shown that at Ocean Gate this can be done in as little as three or four minutes by coöperation of several station attendants, but that five to seven minutes are preferable in order to minimize chances of error in adjustment.

The use of two receivers at the shore station, one of which has two input circuits, including beating oscillators, each circuit tuned to a different frequency and connected to the proper antenna, makes it pos-

able to operate at three of the four frequencies without any changes in receiver adjustment. The flexibility of this shore receiving station is further enhanced by use of an antenna transmission line switching panel whereby any receiver can be connected quickly to any antenna.

With only one shore station the obvious plan of establishing contact is for each of the boats to have its transmitter prepared to operate on the frequency suitable for its particular distance from the shore station and to monitor continuously the frequency the shore station would use for that distance. The shore station would monitor all of the four frequencies (one for each of four zones). This would permit the shore station to call a ship at any time and receive an immediate answer and would permit a ship to call the shore and either receive an immediate answer or to be answered as soon as the shore station could change to the required transmitting frequency. To use this method with two shore stations makes operation less straightforward. In the first place, each ship would have to be equipped with two receivers, one for monitoring each of the two shore stations. Furthermore, unless the ship were equipped with two transmitting sets, it could not be prepared to answer immediately, since it would not be certain as to which shore station might call and, therefore, would not know which of two transmitting frequencies it would be required to transmit on. The additional ship equipment, the possible delay in the ship's changing frequency, and the possibility of both shore stations wanting to work the same ship at the same time, resulted in the working out of a zoning plan of operation which is now being used and which is essentially as follows:

1. The North Atlantic is divided along the 37° 30' meridian into two zones—the American and the European.
2. London works with ships in the European zone, during the time New York works with ships in the American zone.
3. Similarly, London works with ships in the American zone, during the time New York works with ships in the European zone.
4. Because the density of traffic is greater in the zone adjacent to the shore station, the length of time that London and New York work with ships in their respective home zones is set at 3 hours with intervening 2-hour periods to work with ships in their foreign zones. To keep this ratio but reduce the period of the cycle was not thought practical because of delays in establishing contacts—either due to time required for changing frequencies or to poor transmission.

The reduction of this to a definite operating scheme can be best discussed in conjunction with Fig. 13. This shows a chart for October 7,

1931, such as is used by the technical operators at the New York terminal. The abscissas indicate the space between New York and London, marked off both in degrees longitude and in nautical miles from Ambrose Channel Lightship. Time of day is plotted along the ordinate. The straight slanting lines represent the positions of the ships concerned at various times of the day. The slanting line marked "ship's noon" facilitates checking of the estimated position with that reported by the ship. The rectangular enclosures show the periods during which the New York terminal works with ships in either zone. These enclosures are divided by dotted lines, each portion containing a number

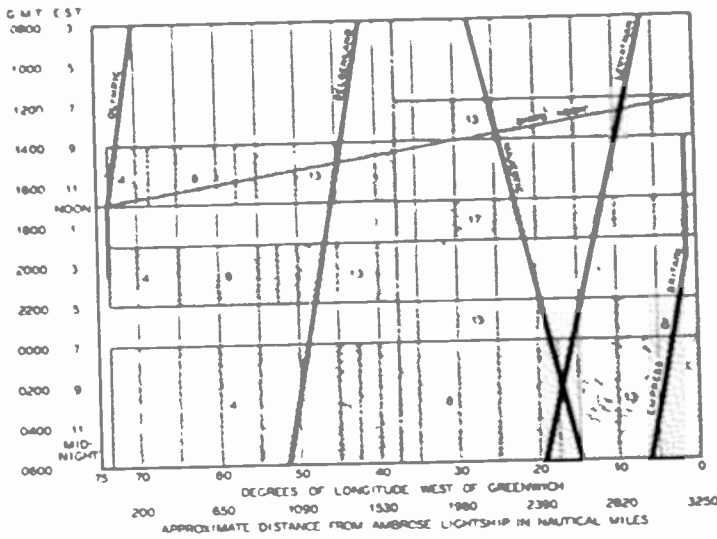

Fig. 13—Approximate ship positions for October 7, 1931.

which designates in megacycles the band in which the frequencies lie on which the ship and the shore station will make contact.

Up to 7:00 A.M. New York time, there is little demand for traffic with New York so no regular schedules are arranged with the ship. This period is London's forenoon and London is free to work any or all ships regardless of their geographical position. Between 7:00 A.M. and 9:00 A.M., New York works with ships whose positions are east of the  $37^{\circ} 30'$  meridian. Similarly and simultaneously, boats west of the  $37^{\circ} 30'$  meridian will work with London on frequencies designated by a somewhat similar chart. As indicated on this particular chart, from 7:00 A.M. to 9:00 A.M., New York works with the Steamships Leviathan and Majestic on 13 megacycles, while London works with the Olympic and Belgenland.

Between 9:00 A.M. and 12:00 noon, New York time, New York and London work ships in their respective adjacent zones; namely, London works with the Leviathan, the Empress of Britain, and the

Majestic, while New York works with the Olympic on 4 megacycles, and with the Belgenland on 13 megacycles.

Between 12:00 noon and 1:00 P.M., the shore stations work the further zones again and so on until 7:00 P.M. (midnight in London), after which there is little traffic demand in London and New York works with any ship regardless of its geographical position.

Recently the Empress of Britain has opened service with the Canadian Marconi Company stations near Montreal and utilizes the two one-hour periods, 11:00 A.M. to 12:00 M., and 4:00 to 5:00 P.M., New York time, regardless of the ship's position.

Knowing the geographical position of the ships, the operators on both ship and shore know exactly the periods in which they are ex-

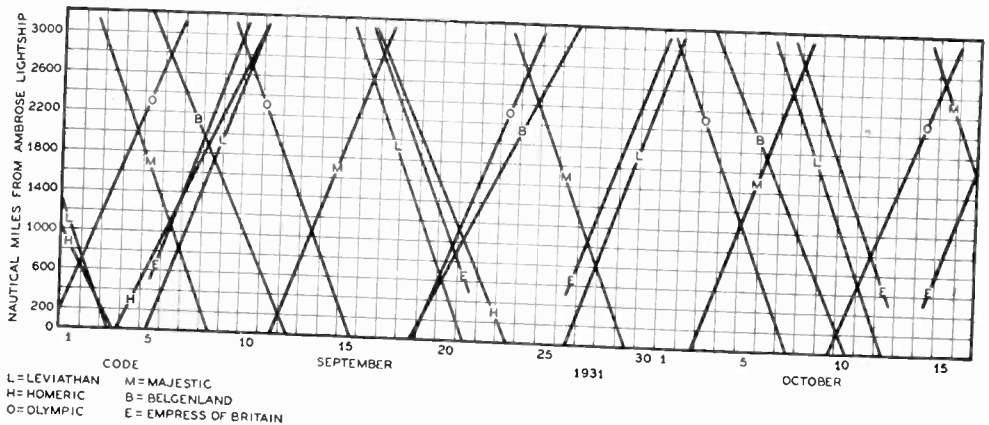

Fig. 14—Sailing schedules of ships with which ship-shore service is given.

pected to make contact, and on what frequency. During this period the ship ignores the other shore station entirely unless special arrangements have been made for exceptions to the plan.

The distribution of ships varies, of course, from day to day, as is seen from Fig. 14. This has distance along the vertical scale and days along the horizontal. The straight lines indicate the positions of the various ships from day to day. A line slanting downward from left to right indicates a ship coming from Europe to New York and a line slanting upward left to right indicates a ship bound for Europe from New York.

#### IV. OPERATING RESULTS

Some idea of the effectiveness of transmission on the various frequencies and the general reliability of the ship-shore service can be derived from Fig. 15. There is one chart for each of the four frequency bands and a summary of all frequencies at the bottom. Each chart

shows the percentage of the total observations when excellent, good, fair, uncommercial, and hopeless circuits were obtained for the various distances. The results shown were obtained on transmission from Ocean Gate, N. J., to all the ships during daylight hours for the period

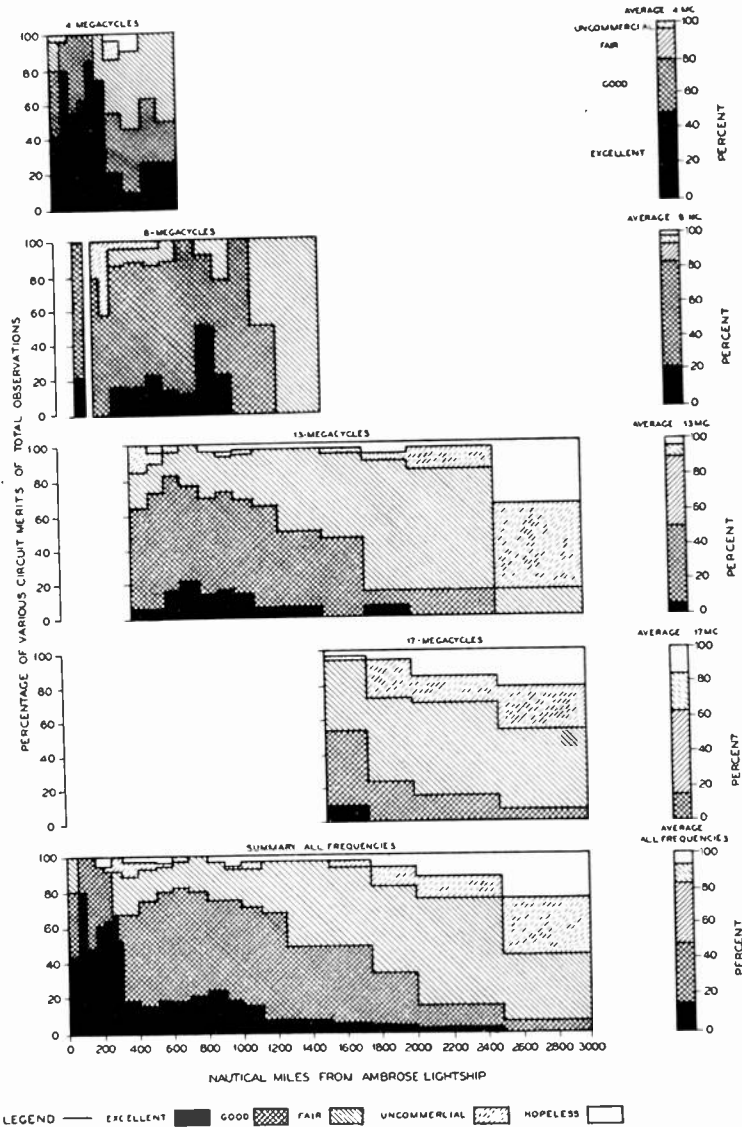

Fig. 15—Percentage of various circuit merits for various distances. Daytime transmission from Ocean Gate to all ships, January–June, 1931.

January–June, 1931, inclusive, the merit of the circuit being estimated by the operators on the various ships. The chart at the top is for transmission on a frequency of approximately 4 megacycles and indicates a high degree of reliability. The following three charts are for transmission on 8 megacycles, 13 megacycles, and 17 megacycles, respectively.

The summary chart at the bottom indicates that the reliability decreases with increasing distance but on the whole about 85 per cent of the contacts have resulted in commercial circuits.

Fig. 16 summarizes the performance of the circuit from ship to

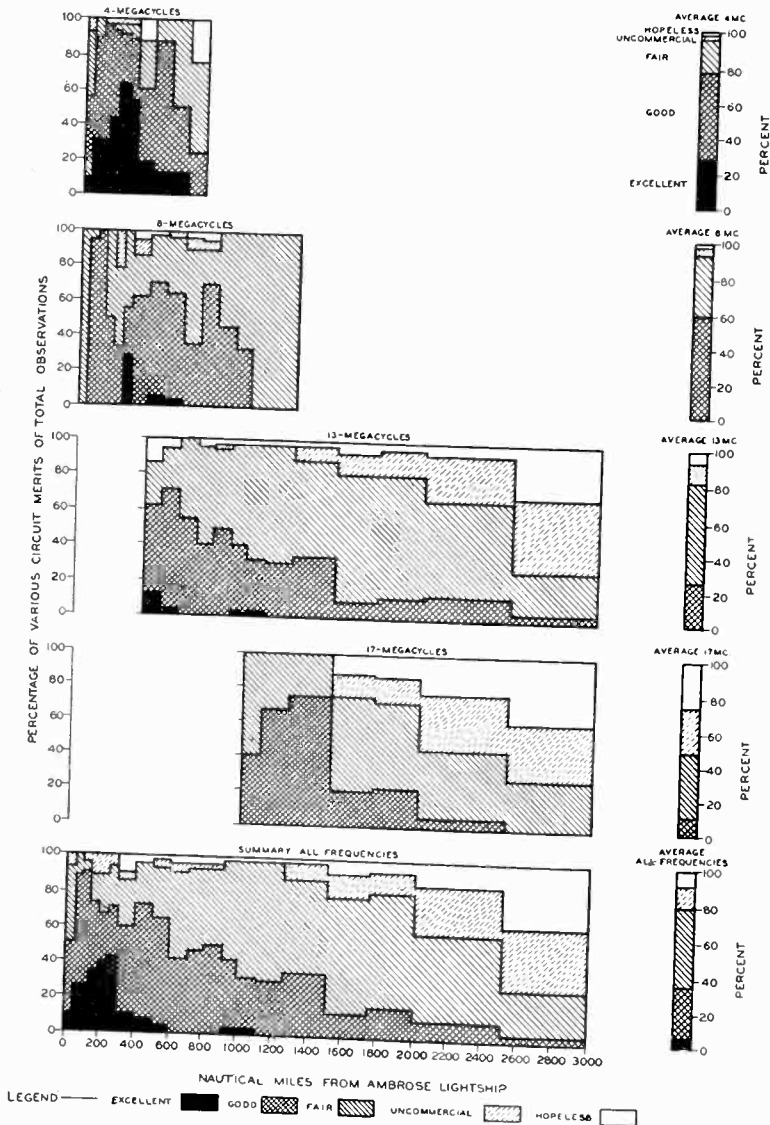

Fig. 16—Percentage of various circuit merits for various distances. Daytime transmission from all ships. Observations at Forked River, New Jersey, January-June, 1931.

shore at various distances in terms of circuit merits. These results are for transmission from all ships to the Forked River receiving station. The results are similar to those obtained for transmission from the shore, although generally poorer.

The distribution of calls with distance from New York is shown in Fig. 17. It is of interest to note that while traffic is handled over the entire distance, the greatest density of completed calls occurs at dis-

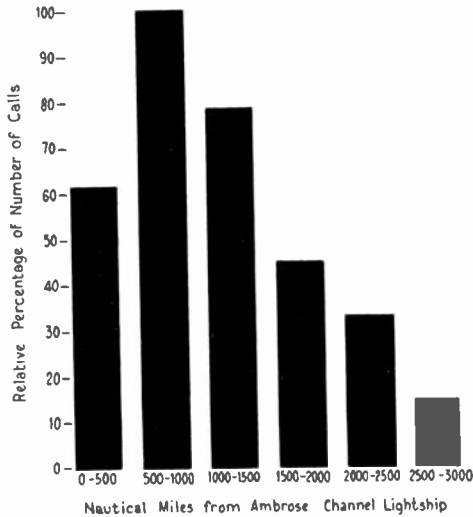

Fig. 17—Distribution of calls with distance, May, 1930-June, 1931.

tances between 500 and 1000 miles from New York, and that nearly 75 per cent of the calls occur within 1500 miles of New York. One factor which may possibly affect this distribution is the reliability of

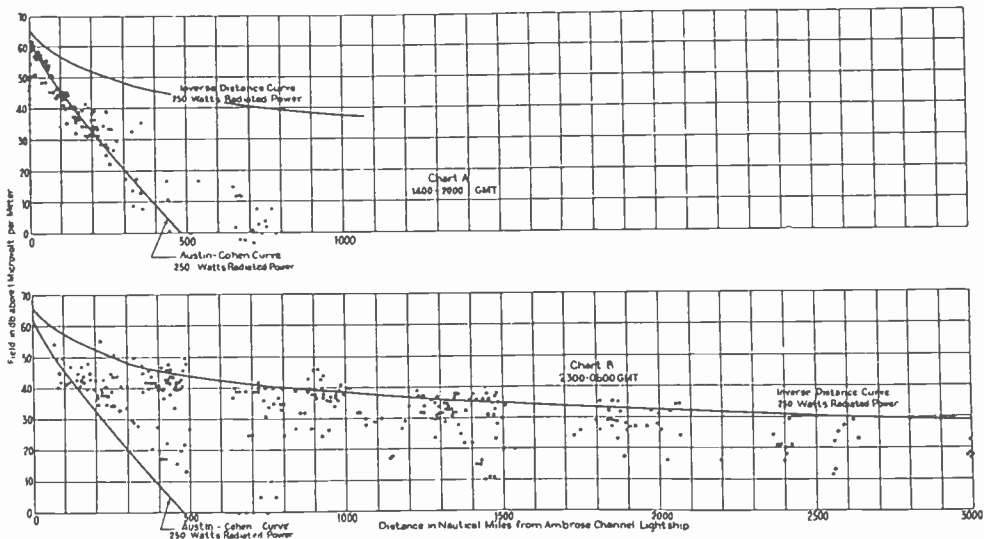

Fig. 18—Variation of radio field strengths with distance. Frequency 4 mc. November-February, 1929-1931. Transmissions from ships in North Atlantic steamship lanes to Forked River, New Jersey.

the circuits at different distances as shown in Figs. 15 and 16. The distributions on both inbound and outbound trips are essentially the same.

Radio field strength measurements have been made at Forked River on most of the daylight transmissions from the various ships. Fig. 18 shows a plot of some of the 4-megacycle fields as a function of distance. Chart A shows the variation of the fields for the hours 9:00 A.M. to 3:00 P.M., E.S.T., inclusive, in winter, (1400–2000 G.M.T.) and Chart B shows the same for the nighttime hours, 6:00 P.M. to 1:00 A.M. (2300–0600 G.M.T.). Within the accuracy of the data, the minimum daytime fields appear to be approximated reasonably well by the curve representing the Austin-Cohen values for transmission over sea water and assuming 250 watts radiated power. Correspond-

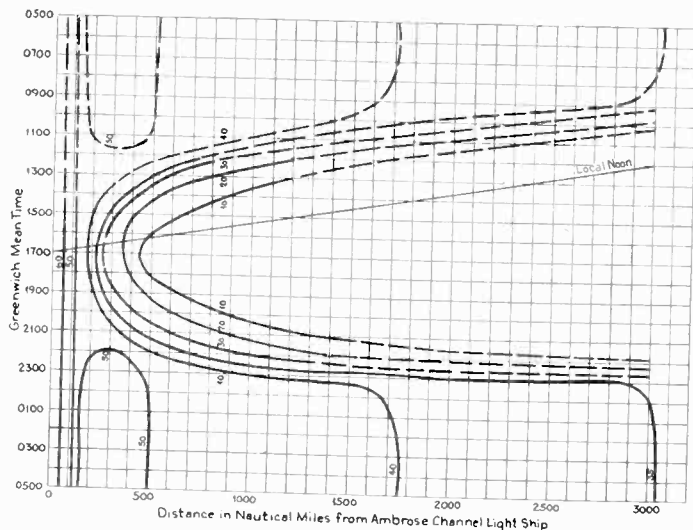

Fig. 19—Approximate variation of radio field strengths with distance and time of day. Contour lines indicate maximum expected field strengths in decibels above 1 microvolt per meter. Frequency 4 mc. Winter. Corrected to 1-kw radiated power.

ingly, the maximum night values are approximated by the inverse-distance law, also with 250 watts radiated power. The data at distances less than 50 miles from Ambrose lightship are unreliable as they involve some overland transmission.

From similar curves for the various hours of the day, the contour diagram shown in Fig. 19 was obtained. The contours represent the maximum values which may be expected, as the actual values may fluctuate from these maximum values to below the limit of measurement, depending upon the condition of the transmitting medium at the particular moment. This is shown in Fig. 18. Fig. 19, together with Figs. 20, 21, and 22, which show contour diagrams for other frequencies, gives some indication of the relative transmission on these frequencies for various distances and at various times of day. It is of interest to note that in the wintertime there appears to be no advantage from the



standpoint of maximum values of measured signal fields in using 17 megacycles, rather than 13 megacycles. There may be occasions, however, when maximum fields are realized on 17 megacycles, when they

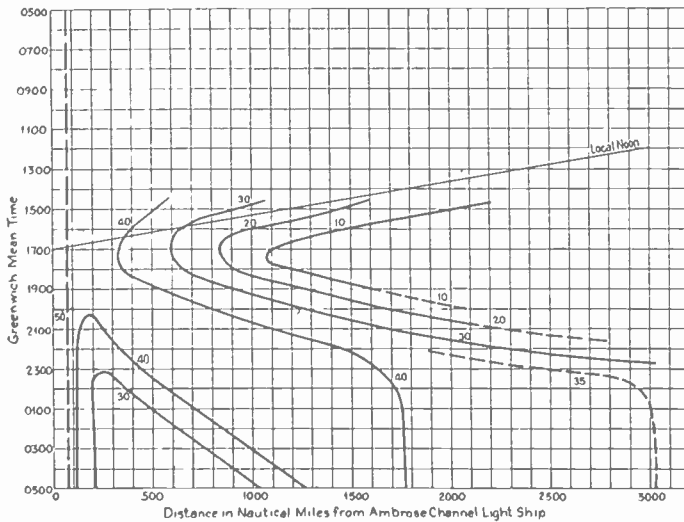

Fig. 20—Approximate variation of radio field strengths with distance and time of day. Contour lines indicate maximum expected field strengths in decibels above 1 microvolt per meter. Frequency 8 mc. Winter. Corrected to 1-kw radiated power.

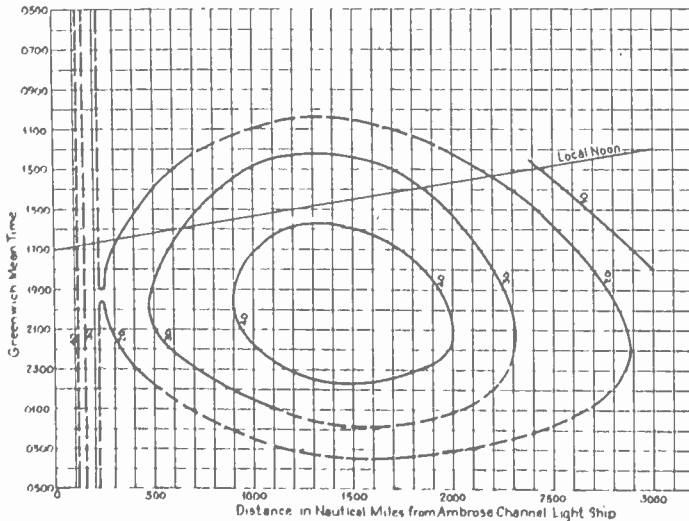

Fig. 21—Approximate variation of radio field strengths with distance and time of day. Contour lines indicate maximum expected field strengths in decibels above 1 microvolt per meter. Frequency 13 mc. Winter. Corrected to 1-kw radiated power.

are not realized on 13 megacycles, and of course, the lower noise obtaining on 17 megacycles has not been taken into account.

Although the contour diagrams give a fair representation of the

data as obtained, they should be regarded as subject to considerable reservations. First of all, the data are not as complete as desirable and it is to be remembered that the measurements have been made inci-

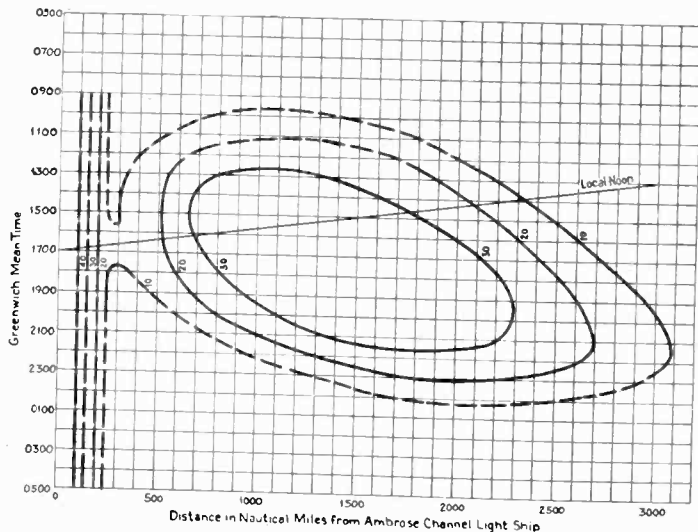

Fig. 22—Approximate variation of radio field strengths with distance and time of day. Contour lines indicate maximum expected field strengths in decibels above 1 microvolt per meter. Frequency 17-mc. Winter. Corrected to 1-kw radiated power.

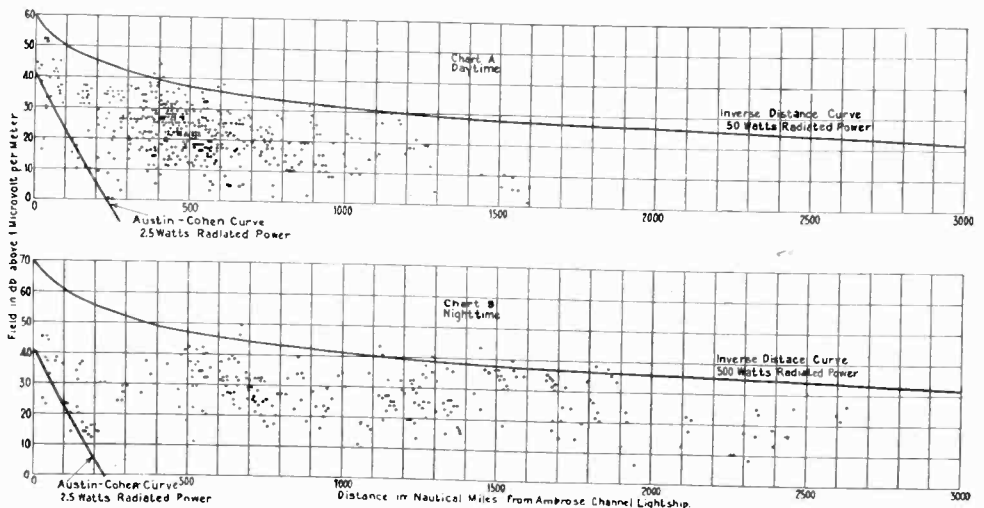

Fig. 23—Variation of radio field strengths with distance. Frequency 8 mc, June, 1930-June, 1931, inclusive. Transmissions from ships in North Atlantic steamship lanes to Forked River, New Jersey.

dental to the operation of the service and not as part of a laboratory experiment. There is evidence, furthermore, to show that the power outputs of some of the ship transmitters are subject to considerable fluctuation. Then there must be considered the possibility of errors in

measurements and in the analysis of the data which are very hard to eliminate entirely. After taking these matters into consideration there still remains the possibility that the directional characteristics of the

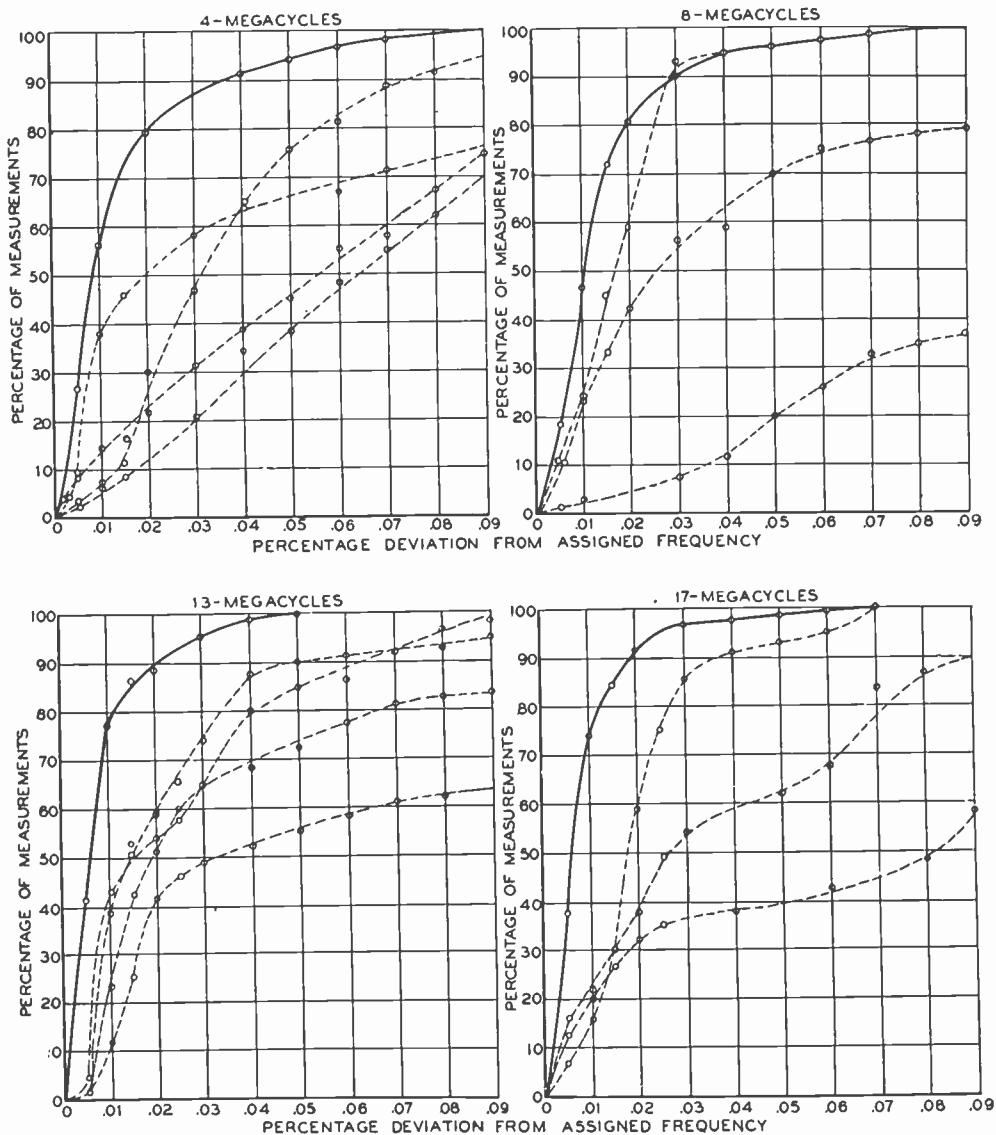

Fig. 24—Variation of transmitting frequency from the assigned. Percentage of measurements with deviations less than the abscissa value. Although curves indicate results for the period April, 1930–July, 1931, there was considerable improvement toward the latter part of the period. Solid curve—shore transmitting station. Dotted curve—ships.

transmitting and receiving antennas in the vertical plane may have affected the contour diagrams so as to make them applicable only in particular cases. Fig. 23 illustrates the point in question. This figure shows the daytime and nighttime fields for 8 megacycles transmission

plotted as a function of distance. It will be noted that the maximum values for daylight transmission indicate a power radiated which is about 10 db less than that indicated by the maximum night values. If it be assumed that the minimum daytime and nighttime fields (ground wave) be approximated by the Austin-Cohen formula, as appears to be the case for 4-megacycle transmission, the effective radiated power for this transmission is even less. One possible explanation is that the effective daytime sky wave and the ground wave for both day and night result from relatively low angle radiation (and reception), whereas the effective nighttime sky wave results from higher angle radiation (and reception) and from a more effective position of the antenna vertical directional characteristic.<sup>8</sup> The frequency at which this characteristic becomes apparent seems to be between 4 megacycles and 8 megacycles.

Fig. 24 shows the variations in frequency of the various transmissions involved in the ship-shore service for the period April, 1930 to June, 1931. There is one set of curves for each of the four frequency bands; namely, approximately 4 megacycles, 8 megacycles, 13 megacycles, and 17 megacycles, and each set shows the frequency deviations for the shore station at Deal and Ocean Gate and for four of the ships which have been in operation the greater portion of this period. For the shore station, practically 100 per cent of the frequency measurements lie within the 0.05 per cent allowable deviation. For the ship stations the results are not as good, however, and such deviations constitute one of the difficulties in facilitating prompt contact between the ship and shore. A gradual improvement has been made in frequency stability aboard ship, so that the results for the last few months of the above period have been considerably better than indicated. However, because of sacrifices in facilities for checking frequencies resulting from compactness of equipment, less personnel, and greater number of frequencies which have to be provided for, the results of frequency stability on the ships have not been as satisfactory as on shore.

## V. CONCLUSION

The major physical problems involved in the establishment of public telephone service from the land line network to large transatlantic liners have now been reasonably well solved. Experience over the past two years has shown it to be possible to maintain a fairly reliable serv-

<sup>8</sup> See also, R. K. Potter and H. T. Friis, "Some effects of topography and ground on short-wave reception," to be published in a forthcoming issue of the *Proc. I.R.E.*

ice over distances up to about halfway across the Atlantic and to give some measure of service all the way across. This means that transatlantic vessels can obtain fairly reliable telephone service to either the European or the North American continent during the entire transatlantic passage. The operating plan which has been developed enables the shore stations on either side of the Atlantic to establish scheduled contacts at frequent periods during the day with all ships.



## THE COMMUNICATION SYSTEM OF THE RADIOMARINE CORPORATION OF AMERICA\*

BY

I. F. BYRNES

(Engineering Department, Radiomarine Corporation of America, New York City)

*Summary*—The coastal facilities and shipboard apparatus used in the communication system of the Radiomarine Corporation of America, are described in this paper. Long-range communication obtainable from ship to shore with moderate power at high frequencies has resulted in the development of several new types of short-wave transmitters. In addition to serving the marine field as an important communication facility and safety-of-life factor, radio, through the direction finder, has become a valuable navigation aid. One of the standard Radiomarine direction finders is briefly described in this paper.

### INTRODUCTION

RADIO communication as applied to the marine field, began to receive general public recognition in the year 1909 when the *S. S. Republic* sent out a distress call after a collision off Nantucket. This event clearly proved the utility of radio as a safety-of-life service. As the radio art progressed technically, improvements were rapidly made in marine apparatus until today we find a large number of services performed through marine radio.

### CLASSES OF TRAFFIC

It is of interest to consider some of the classes of traffic now handled between coastal stations and shipboard installations. These may be listed as follows:

General public correspondence, such as message traffic by passengers.

Ship business, involving routing, cargo information, weather reports, and daily position reports. The owners and general public are kept informed of the position and arrival time of vessels through this service.

Press service, consisting of news transmitted daily to subscribing ships. The news is then printed and distributed to passengers.

Medical service which provides free emergency medical advice. This is especially valuable in cases where a doctor is not aboard ship.

Brokerage service, involving fast transmission of buying and selling orders, and also including quotation service.

\* Decimal classification: R400. Original manuscript received by the Institute, October 8, 1931. Presented before New York meeting October 7, 1931.

## COASTAL STATIONS

In order to provide both long- and short-distance radiotelegraph facilities to vessels communicating with the United States, the Radiomarine Corporation of America has a network of 16 coastal radiotelegraph stations throughout the country. The location of these stations is shown on the map in Fig. 1. Long-distance communication over the North and South Atlantic Oceans is furnished through the high power stations at Chatham, Mass., (WCC) and Tuckerton, N. J., (WCS). Printer circuits connect these stations to New York City and Boston through Western Union Telegraph facilities and all of the offices of Western Union are therefore available for pick-up or delivery of radio-



Fig. 1—Coastal radiotelegraph system of the Radiomarine Corporation of America.

grams. On the West Coast the station at Bolinas, Calif., (KPH) handles traffic over the Pacific Ocean. Ships in all parts of the world, which are equipped with short-wave apparatus, are able to maintain contact with one or more of these high power stations.

The primary function of the remaining coastal stations, which use medium power transmitters, is to provide service to coastal shipping or where the distances are less than approximately 500 miles. Communication facilities for vessels in the Great Lakes area are provided through the stations at Duluth (WRL), Chicago (WGO), Cleveland (WCY), and Buffalo (WBL). In New York City, harbor traffic consisting mainly of messages to incoming and outgoing transatlantic vessels is handled through station WNY.

The station at Chatham, Mass., is a typical example of one of the high power coastal installations. This is a duplex station, the receiving

apparatus being located at Chatham while the transmitters are remotely controlled at Marion, Mass., approximately 50 miles from the receiving station. This arrangement, by removing the receiving antennas from the strong local field of the transmitting antennas, permits simultaneous transmission and reception.

A view of the receiving station at Chatham is shown in Fig. 2. Horizontal doublets are used for short-wave reception. These are suspended

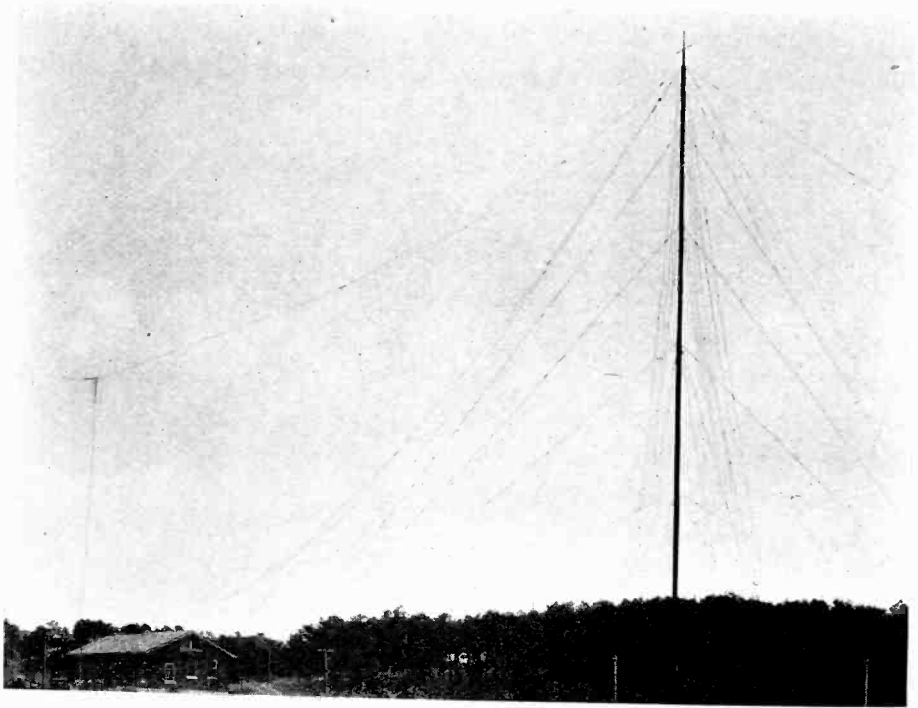

Fig. 2—Chatham receiving station.

between the high mast shown in the figure and a shorter steel tower which does not appear in the photograph. Intermediate- and long-wave reception is obtained from low Beverage antennas which are directed toward the East. A total of 15 receiver positions is available consisting of four long-wave superheterodyne units, one 600-meter superheterodyne, four intermediate-frequency receivers, and six short-wave receivers. During periods of heavy traffic 12 to 15 ships may be worked simultaneously.

The transmitting equipment at Marion is under control by the operators at Chatham for purposes of start-stop, wave-change, and switching from cw to icw in the 500-kilocycle band. Nine transmitters are available at Marion and provide the following frequencies and antenna power:



117 kc	5 kw
129 kc	5 kw
406 and 500 kc	5 kw
6360 and 11,220 kc	1 kw
5525 and 11,145 kc	200 watts
8450 kc	40 kw
16,900 kc	1 kw
6320	1 kw
12,645 kc	40 kw

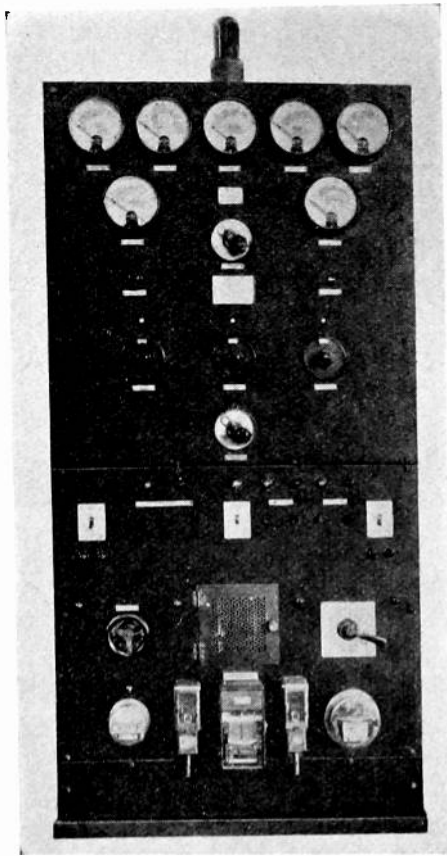

Fig. 3—40-kw power amplifier.

Both horizontal doublets and long antennas operated on their harmonics are available for the high-frequency transmitters. Quarter-wave antennas with suitable loading are employed for the intermediate and low frequencies. The high power, short-wave transmitters consist of a 1-kw crystal controlled exciter and a 40-kw power amplifier. A view of one of the 40-kw amplifier panels is shown in Fig. 3. Plate supply for the power amplifier is obtained from a 3-phase full-wave mer-

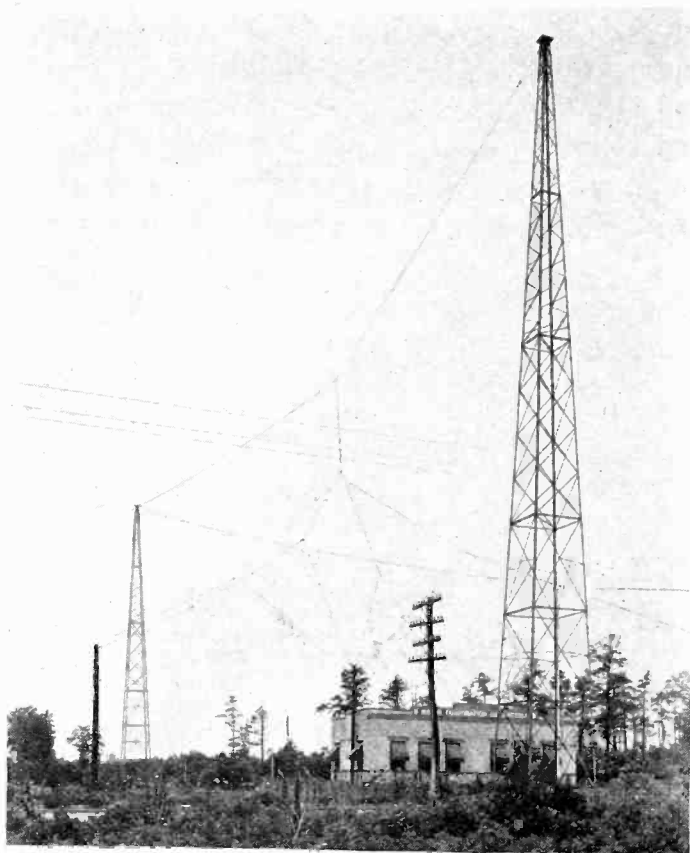

Fig. 4—Tuckerton receiving station.



Fig. 5—Tuckerton receiving station.

cury vapor rectifier which uses six UV-869 tubes, and has a full-load rating of 72 kw at 18,000 volts.

The station at Tuckerton, N. J., is in general similar to the Chatham-Marion layout and consists of complete short-, intermediate-, and long-wave transmitting and receiving facilities. The receiving station building and antennas at Tuckerton are shown in Fig. 4. The diamond-shaped antenna is a Bellini-Tosi system which is used for directive reception in the 500-kc band. An interior view of the operating room is shown in Fig. 5.

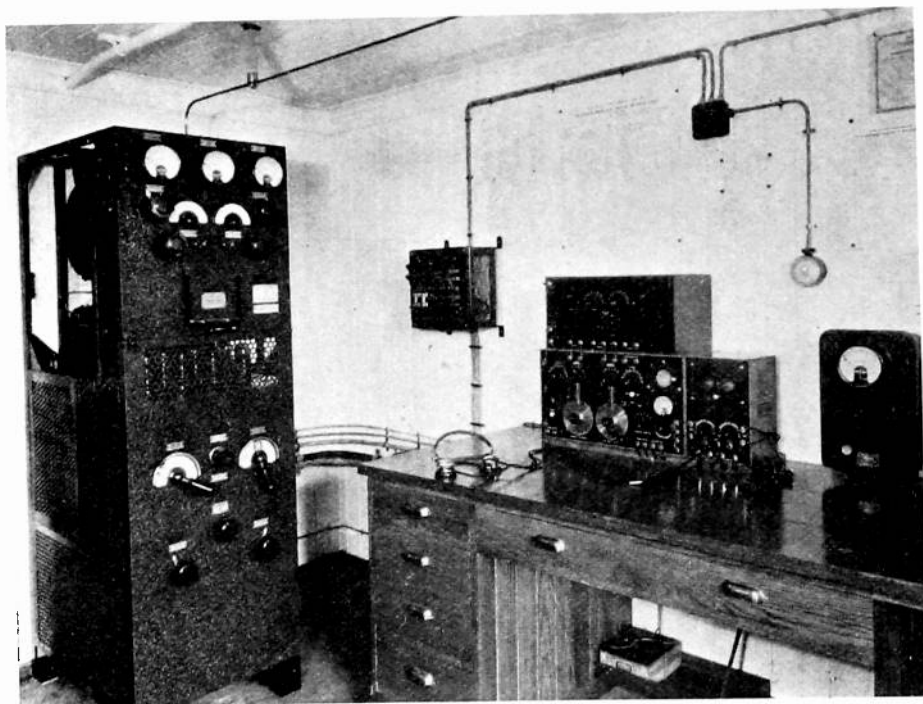

Fig. 6—ET-3626-C shipboard installation.

The transmitting station is located about five miles from the receiving station and provides eight vacuum tube transmitters as follows:

125 and 133 kc	3 kw
462 and 500 kc	5 kw
6350 kc	200 watts
8430 kc	40 kw
11,175 kc	200 watts
12,675 kc	40 kw
16,860 kc	1 kw
6340 kc	1 kw

Press is transmitted from the Tuckerton Station in the 8000-kilo-cycle band and also from a high-frequency alternator at 22.1 kilocycles.

## SHIPBOARD STATIONS

Apparatus for use aboard ship must be compact, rugged, resistant to marine weather conditions, provide good frequency stability, and permit quick wave change. A large number of types of transmitters have been developed to meet the requirements of different classes of shipping.

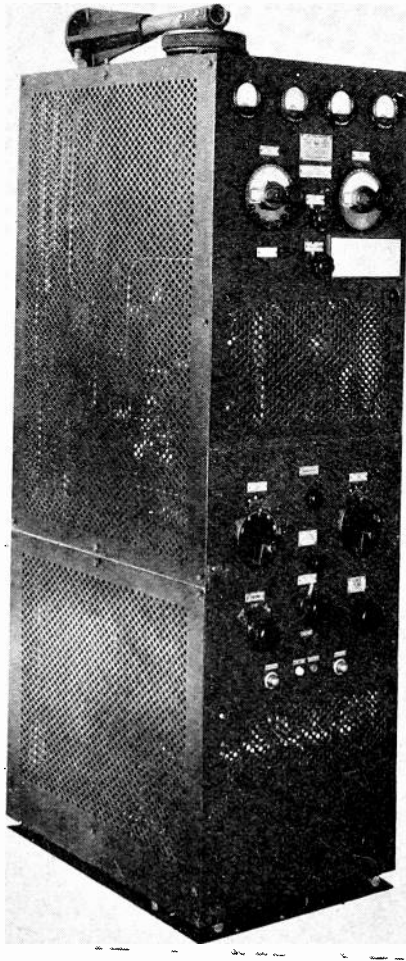

Fig. 7—ET-3674 combination transmitter.

A typical shipboard installation for operation in the intermediate-frequency bands is shown in Fig. 6. The transmitter, known as model ET-3626-C, covers the frequency ranges of 375 to 500 kilocycles and 125 to 167 kilocycles and delivers 500 to 750 watts to the antenna. The master oscillator power amplifier circuit is employed using 8 UV-211 tubes. One tube functions as a master oscillator, six as power amplifiers, and one as audio oscillator for icw. Automatic positioning devices are

used on the frequency control dials to enable the operator to adjust the transmitter quickly to any of its assigned frequencies. For reception the well-known IP-501-A receiver is used, which covers a frequency range of 16 to 1200 kilocycles. The small panel mounted on the bulkhead is used for charging the receiver storage batteries. The second panel

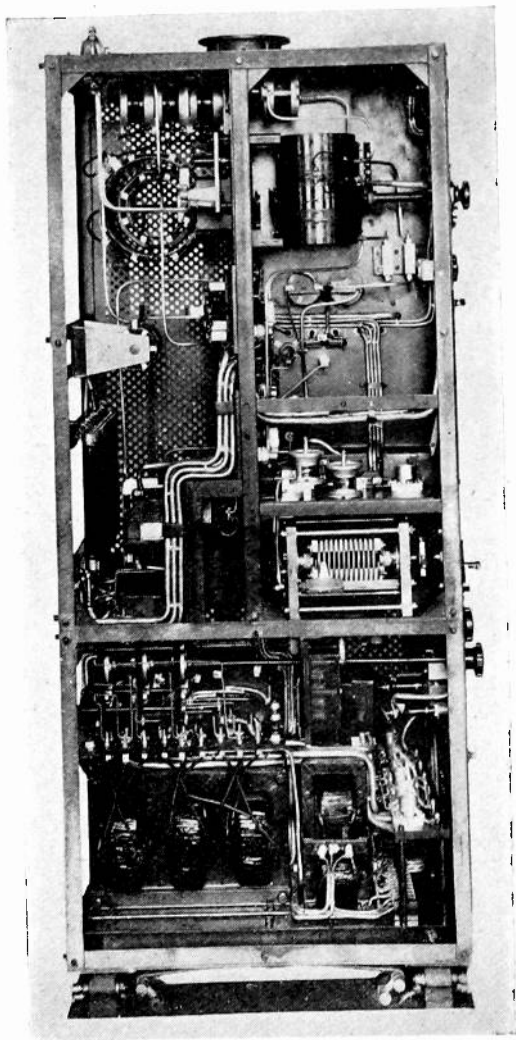

Fig. 8—ET-3674 combination transmitter.

near the operator's table provides start-stop for the transmitter 1000-volt motor generator set and control of the transmitter filament circuit.

The present standard receiver for short-wave reception on ship-board is known as the AR-1496-D. This receiver provides one stage of screen-grid amplification, regenerative detector, and two stages of audio amplification. Plug-in coils are used to cover a range of 2000 to 25,000 kilocycles.

A newly developed "combination" transmitter known as the ET-3674 is shown in Fig. 7. This transmitter provides two frequency bands, 375 to 500 kilocycles and 5500 to 17,150 kilocycles. A single compact unit of this type therefore provides medium distance transmission and the necessary distress wavelength in the 375- to 500-kilocycle band, while long-distance transmission is available through the use of high

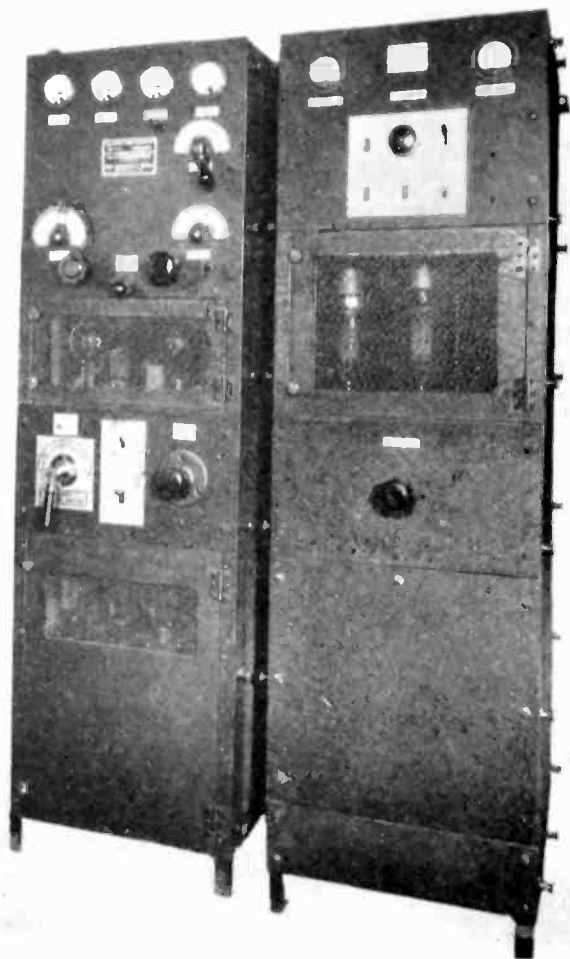

Fig. 9—ET-3666 short-wave telephone and telegraph transmitter.

frequencies in the second band. Four-element screen-grid tubes are used in the radio circuits, consisting of a UX-860 tube as master oscillator, a UX-861 tube as power amplifier, and a UX-860 tube as audio oscillator. The transmitter delivers 500 watts to the antenna.

Since the power amplifier tube in this transmitter operates at a plate voltage of 3000 volts, the transmitter is provided with a built-in rectifier. The rectifier in turn secures its power supply from a compact

rotary converter which changes the shipboard d-c supply to three-phase at 60 cycles. This arrangement eliminates all high voltage wiring external to the transmitter which is a very desirable feature for shipboard installations. The rectifier uses six UX-866 tubes in a three-phase, full-wave circuit.

A view of the left side of the transmitter is shown in Fig. 8. Of interest is the automobile-type spring suspension to minimize the effects

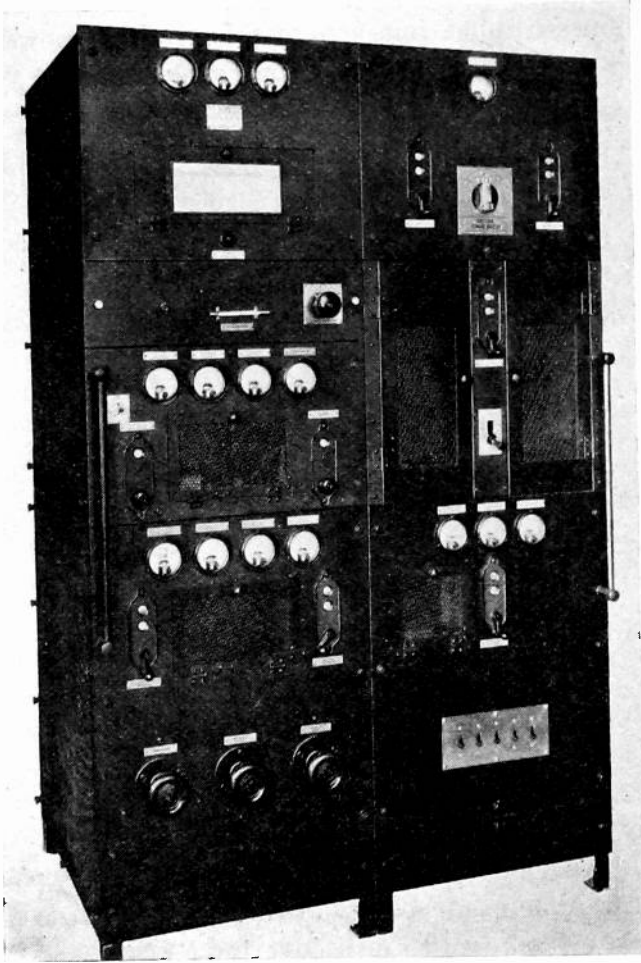

Fig. 10—ET-3656-A short-wave transmitter.

of ship vibration. The high-frequency circuits are continuously variable throughout their range through the use of the rotating coil mounted in the center section.

Large vessels handling a considerable amount of traffic are frequently arranged so that simultaneous transmission and reception in the intermediate- and high-frequency bands may be obtained. For these applications where a separate high-frequency transmitter is required

the model ET-3666, shown in Fig. 9, is provided. This unit has an output rating of 200 to 350 watts and uses one UX-860 tube as master oscillator and two similar tubes in parallel as power amplifiers. Plate voltage supply is obtained from a rotary converter which connects to a built-in rectifier using six UV-872 tubes. The rectifier has sufficient capacity to supply a suitable modulator unit also, this combination having found extensive application throughout the country as an airport transmitter.

For shipboard applications where a fairly high power transmitter is required for communication over long distances, the 1 kw ET-3656-

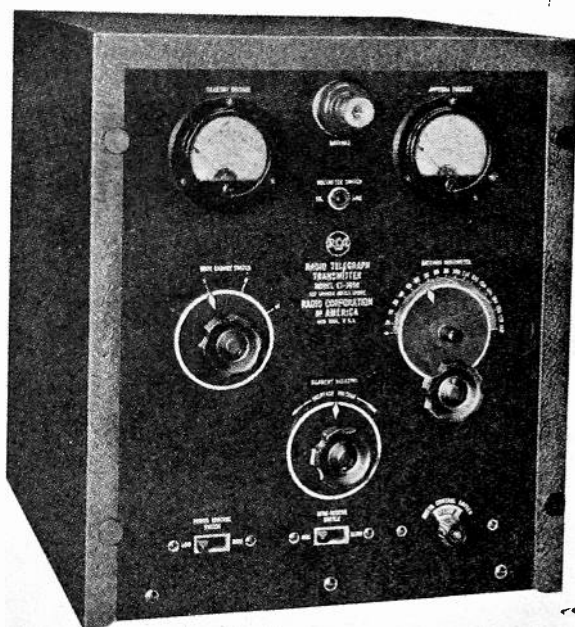

Fig. 11—ET-3650 emergency transmitter.

A transmitter may be used. A view of this transmitter is shown in Fig. 10. This is a crystal controlled unit covering a frequency range of 5500 to 17,150 kilocycles and has provision for using six crystals in a temperature controlled compartment. Some of the amplifier stages which follow the crystal oscillator are arranged to function as fundamental frequency amplifiers or as doublers, with the result that the six crystals provide 12 transmitting frequencies.

A standard arrangement on many steamships is to provide a small emergency transmitter which might be utilized in case of difficulty with the main transmitter, or for short-distance transmission when nearing port. The type ET-3650 transmitter shown in Fig. 11 has been devel-



oped for this purpose. Four UX-210 tubes are used which obtain their plate power from a 350-cycle motor generator set. This arrangement provides modulated transmission giving a 700-cycle note. The motor generator has the motor end designed so that a 12-volt storage battery may be used as a primary source of power supply. This machine is also built in 32- and 110-volt motor ratings. The transmitter is provided with a wave-change switch which is usually adjusted to four frequencies in the 375- to 500-kilocycle band.

Present-day practice on many large vessels provides a number of motor-driven lifeboats in addition to the regular lifeboats. These motor-driven lifeboats may be provided with complete radio installations

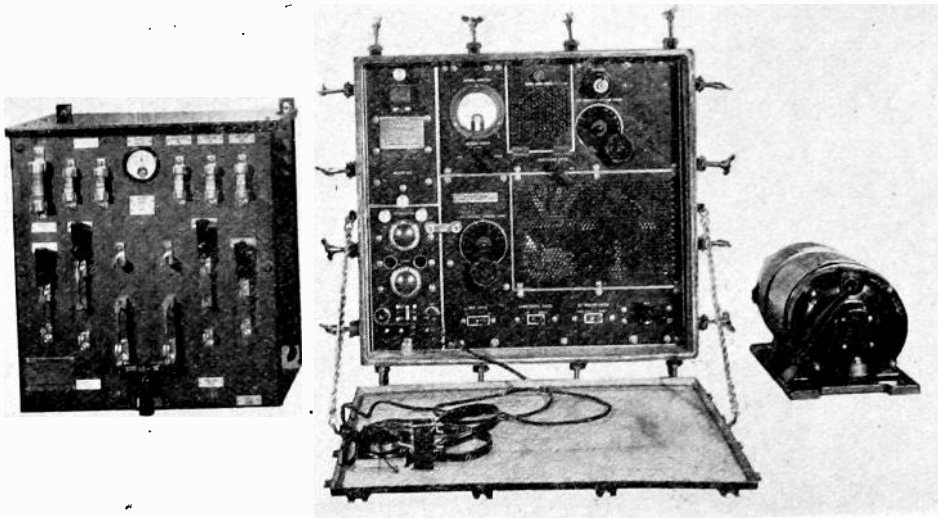

Fig. 12—ET-3677 lifeboat equipment.

designed especially for such service. The type ET-3677 lifeboat equipment is shown in Fig. 12. The unit at the left is a combined battery charging and switching panel and provides not only power control for the transmitter-receiver unit, but also control for a searchlight, a signal light, and various other lights throughout the lifeboat. The center unit is a combined transmitter and receiver mounted in a completely water-tight case. The transmitter provides two frequencies, one the standard distress frequency of 500 kilocycles and the other a frequency in the 5500-kilocycle band. Instant change from one frequency to another is obtained by a band switch on the panel. A regenerative receiver covering the intermediate-frequency band is provided in the left section of the panel.

One of the design problems in equipment of this type is to provide

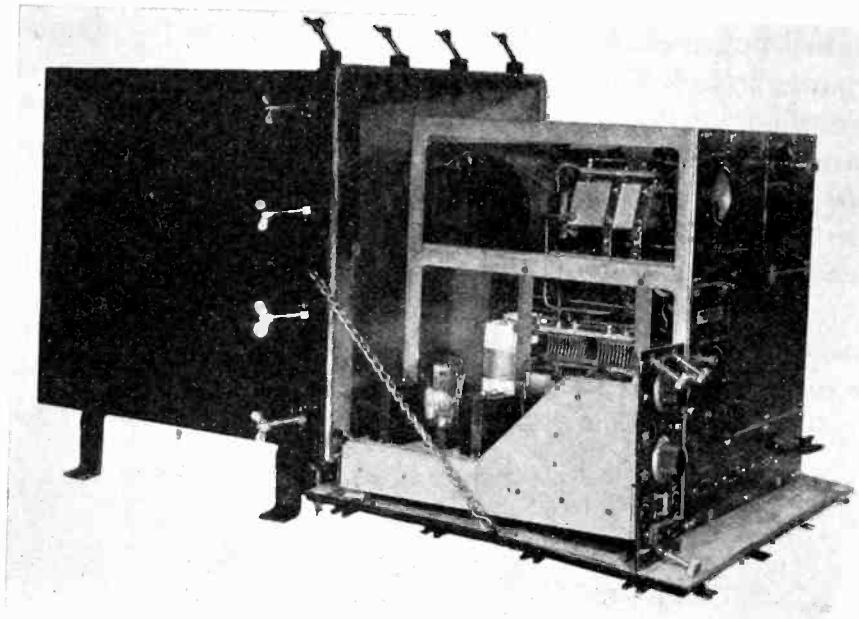

Fig. 13—ET-3677 lifeboat transmitter.

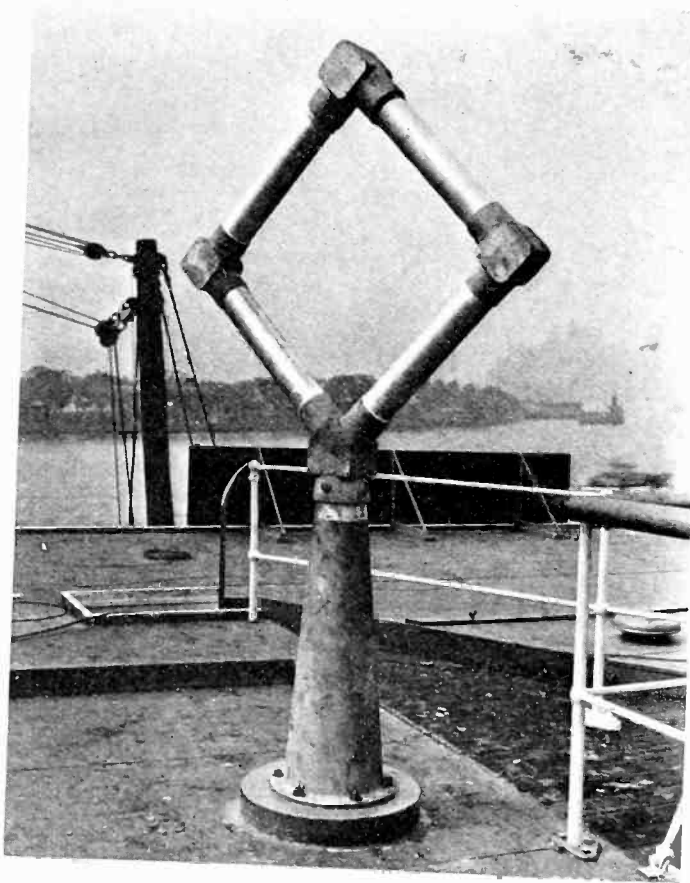

Fig. 14—Direction finder loop.

satisfactory operation with the very small antenna which may be erected on the lifeboat. This antenna usually consists of a single wire about 25 feet high and 20 feet long. By having transmission facilities in the 5500-kilocycle band comparatively long ranges may be obtained despite the small antenna. Power supply for the transmitter is obtained from a motor alternator which furnishes a 350-cycle output voltage to the plates of the tubes. Experience has shown that a properly maintained storage battery provides the most reliable source of emergency

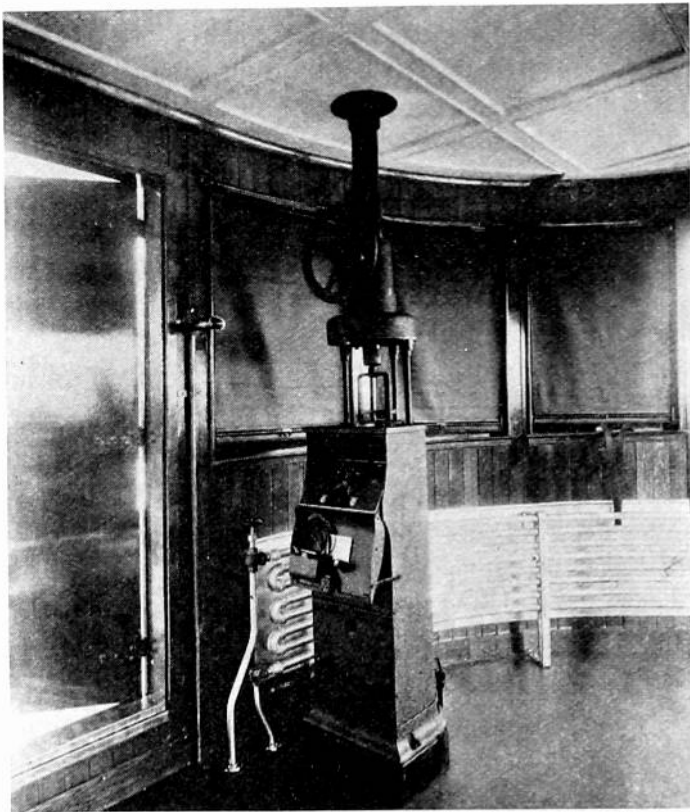

Fig. 15—ER-1455-B direction finder.

supply and it is for this reason that storage batteries are used. The lifeboat is provided with a suitable charging fitting and it is possible to trickle charge the battery continuously when the lifeboat is on the deck of the ship. The battery has sufficient capacity to operate the radio equipment, the lifeboat searchlight, and all other lights continuously for six hours. The charging panel is also arranged so that by throwing suitable switches the operator may use his telegraph key to signal with the searchlight or the "Morse light." Fig. 13 is a view of the transmitter-receiver unit withdrawn from the water-tight case.

Radio direction finders have become practically a standard aid to navigation on large numbers of ships. The type ER-1445-B direction finder has been designed for installation in the wheelhouse so that it may be used by the navigating officer at any time. A view of the rotatable loop used with this direction finder is shown in Fig. 14. Special precautions have been taken to make the loop weather-tight. The view in Fig. 15 shows a typical installation in the wheelhouse. The loop is rotated by the large handwheel. An automatic compensator is employed to correct the calibration of the loop, when deviations are caused by rigging and other objects aboard ship. At the top of the pedestal a dumb compass card may be mounted although provision is also made for connecting to a live gyroscope repeater. In order to provide sharp nulls and high selectivity a unicontrol superheterodyne circuit and a loop balancing arrangement are used. When it is necessary to determine the sense of the incoming signal an auxiliary antenna, coupled to the input circuit of the receiver, is utilized. This arrangement provides the well-known heart-shaped diagram when determining the sense of the incoming signal.

In order that the direction finder may not require undue attention by the navigating officer an automatic trickle charge circuit for the filament batteries is provided. When the observer is through using the instrument he closes the cover. This places the filament battery on charge and grounds the sense antenna.

Contributing companies in the design and manufacture of the equipment described in this paper, are: the RCA Victor Company, the General Electric Company, and the Westinghouse Electric and Manufacturing Company.



## CHARACTERISTICS OF THE UV-858 POWER TUBE FOR HIGH-FREQUENCY OPERATION\*

BY

M. A. ACHESON<sup>1</sup> AND H. F. DART<sup>2</sup>

(<sup>1</sup> General Electric Company, Schenectady, New York; <sup>2</sup> Westinghouse Lamp Company, Bloomfield, New Jersey.)

**Summary**—This paper indicates the need for high power vacuum tubes for high-frequency transmission, and discusses new factors most important in the design of a tube for this usage.

Older types of tubes were built with high efficiency, low-frequency use in view, with the result that when applied to high frequencies they were severely limited by allowable operating voltage and by large internal capacitances and inductances. However, by operating class B amplifiers and thus dispensing with the power modulator, and by minor sacrifices in efficiency in class B or class C operation, it is possible to design a tube having greatly increased high-frequency rating, although it has no usual advantage at low frequency.

The actual design of such a high-frequency tube and the resulting characteristics and ratings are given for the UV-858 Radiotron. From these data some of its important uses are indicated and its possibilities in such uses may readily be estimated.

Results of special tests involving new phenomena, possible for the first time with this tube, are given.

TRANSMITTING equipments designed for operation in the high-frequency band lying below 30,000 kilocycles, and approximately down to 10,000 kilocycles, have proven themselves thoroughly useful; such that present problems on these equipments are those of increasing power output, increasing simplicity and increasing reliability. The increase of power output, simplicity and reliability of these equipments is primarily a problem in vacuum tube design, since the vacuum tube is the deciding factor in power output and is the element about which and for which the high-frequency transmitter must be particularly built. Improvements in the transmitter follow improvements in the vacuum tube.

In the high power classification of vacuum tubes, the power output has been limited at high frequencies, principally because of close spacings of the elements; this close spacing leading to large interelectrode capacitances and to a limitation of operating plate voltage. The high interelectrode capacitances cause large circulating currents, difficult to handle in vacuum tube seals and elements and in connected circuits. They cause a limitation of inductance in the output circuits, such

\* Decimal classification: R131 X R333. Original manuscript received by the Institute, September 26, 1931. Presented before New York Meeting, November 4, 1931.

that transfer of power to a coupled circuit becomes difficult, output circuit losses are high, output circuit tuning becomes troublesome, and neutralizing may be difficult. The high interelectrode capacitances, in conjunction with the internal inductance of the tube elements and leads, limits the maximum frequency at which the tube will operate. Limitation of plate voltage is necessary, since large circulating currents and high dielectric losses at high frequency may quickly destroy the vacuum tube. However, to obtain higher power output, it seems a necessity to raise the plate voltage in view of inherent limitations in tube design, making it impossible to raise the current rating alone without, at the same time, increasing the length and size of the tube beyond that possible for a high-frequency device.

The UV-207 has been the most powerful tube available for use on high frequencies. This tube was limited by interelectrode capacitances and internal inductance to a maximum useful frequency, as an amplifier, of about 20,000 kilocycles. At this frequency the plate voltage was limited to 7500 volts for safe operation, such that the output was but 5.5 kilowatts per tube. Yet the UV-207 Radiotron at long wavelengths is rated at 15,000 volts maximum plate voltage, with an output of 20 kilowatts. Obviously, the maximum frequency is seriously limited and the output is cut drastically at the maximum frequency, principally because of close electrode spacings.

These close electrode spacings serve a purpose in vacuum tubes, such as the UV-207, in that maximum efficiency should be obtained as a class C amplifier<sup>1</sup> at low frequencies and that modulator and similar amplifier usage must be filled. Both these requirements are best met when space-charge drop through the tube is made a minimum. The minimizing of space-charge drop has usually been made the principal object in designing vacuum tubes, almost to the point that the principle of low space charge drop was applied blindly.

But the advent of class B transmission made modulators of high power output undesirable, since modulation at low power with subsequent amplification gave greater over-all efficiencies, lower transmitter costs, and higher modulation percentages. Investigation then indicated that, although low space-charge drop was an important factor in design of class A amplifier tubes or modulator tubes, in class B or class C amplifier tubes, space charge was only a minor factor in determining losses and efficiency and that it might be varied over a wide range without major effect on tube output. The space charge is a minor factor, since with sinusoidal plate voltage variations around the d-c

<sup>1</sup> For amplifier classifications see, "Standard definitions of terms used in radio," page 71, YEAR BOOK I.R.E., 1931.

plate voltage as an axis, the greatest loss of efficiency was due to carrying current through the tube when the plate voltage had risen considerably above its minimum; that is, above the space-charge drop of

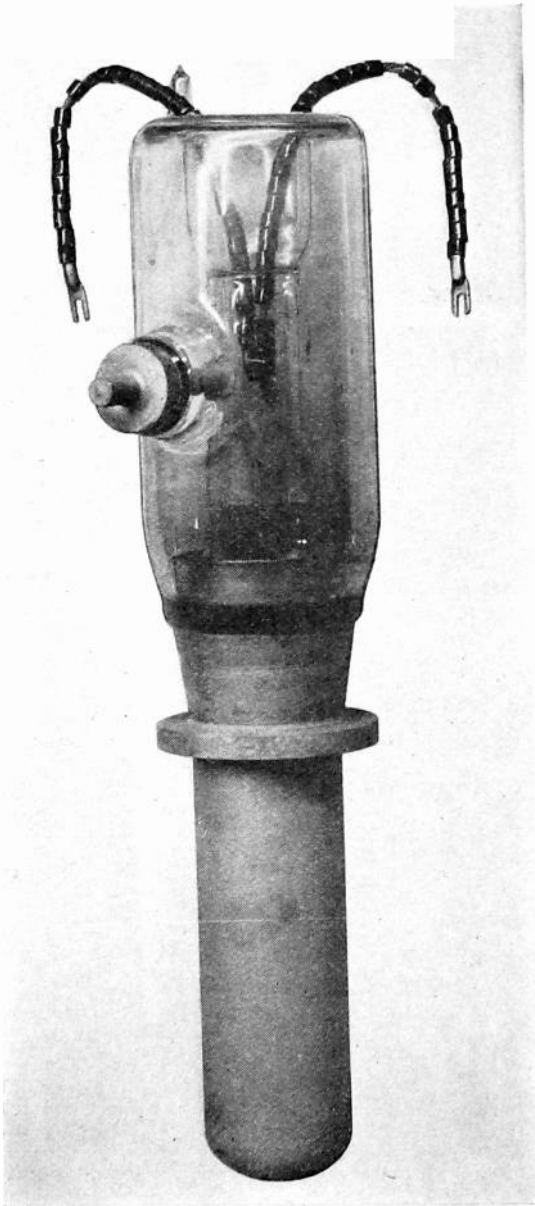

Fig. 1.

the tube on the increasing voltage sides of the sine wave plate voltage. Thus, a doubling of space-charge drop would double the instantaneous loss only during a short portion of the cycle when the plate voltage was minimum, but the total loss in the tube over the complete cycle would

be only slightly increased. The increased loss can be easily compensated for by raising the plate voltage supply a small percentage.

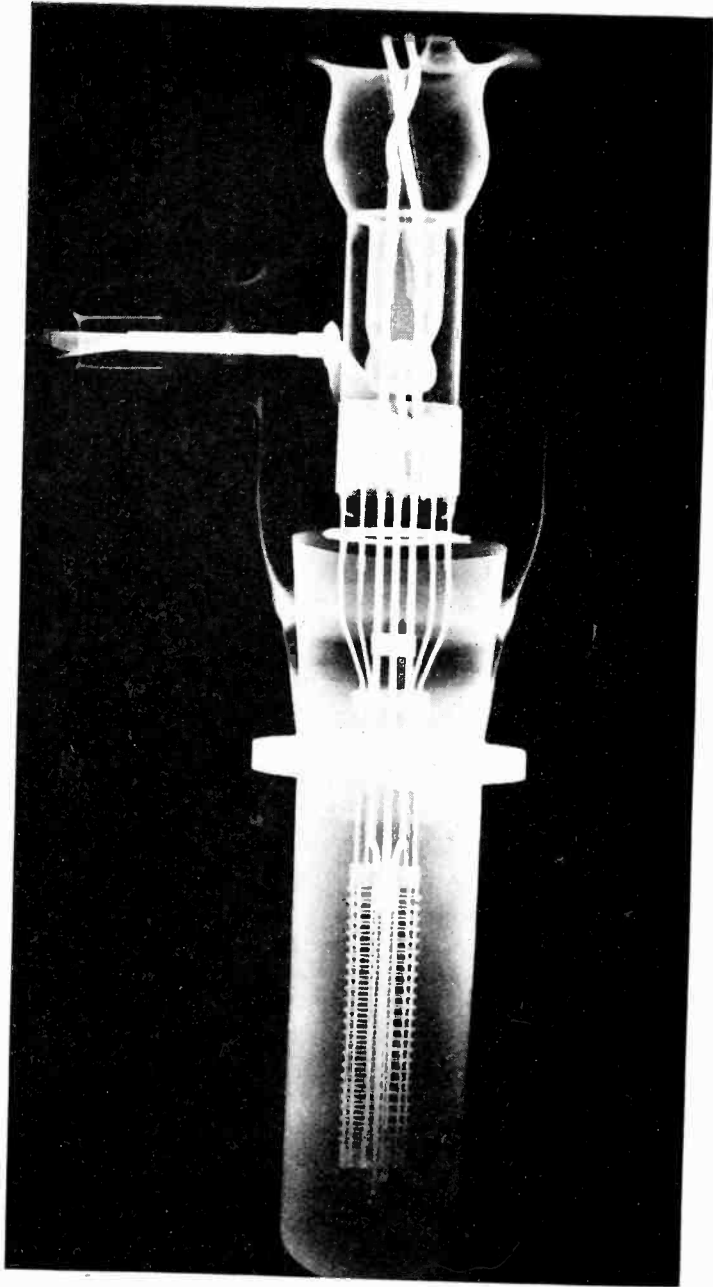

Fig. 2.

We have the possibility then of designing a tube with wide electrode spacings, which will be capable of operating at high frequencies



as a class B or class C amplifier; though it will be of little use for Class A amplifiers or modulators.

The UV-858 was therefore, designed as a class B or class C amplifier to provide a maximum of power output up to a frequency of 40,000 kilocycles, thus increasing especially the power possibilities in the band between 10,000 and 30,000 kilocycles, where demand had been most insistent that transmitters of high power be improved.

The tube is a high voltage, high power, water-cooled, three-electrode vacuum tube. It is designed primarily for use as an r-f power amplifier, class B or C. The electrodes are so arranged that the cylindrical copper plate forms the lower part of the outer shell, this plate being designed for clamping in the jacket for effective water cooling. The grid and filament electrodes are contained inside the plate, their leads being brought out through the upper insulating glass. The two upper leads are the filament leads and the single side lead is the grid lead. Fig. 1 illustrates the finished tube, while Fig. 2 is an X-ray picture of the tube, from which an idea of the internal structure may be had. It will be noted that the UV-858 is of the same general structure as previous types of water cooled tubes, except that spacings have been increased, and all other points have been designed with high-frequency, high power use in view.

Table I lists the major constants of the UV-858 and, for comparison, the constants of the UV-207, a lower frequency tube in the same output rating classification. The table also shows maximum and normal ratings of both tubes for certain conditions where full rating is obtainable. The output ratings given therein all apply to low frequency—below 1500 kilocycles—when the tube is operated singly or push-pull, not in parallel with other tubes. The ratings of both tubes at these low frequencies are approximately the same; for example, 24 kilowatts normal output on the UV-858 at 18,000 volts plate voltage in comparison with 20 kilowatts normal output on the UV-207 at 15,000 volts plate voltage, for class C operation. The difference in output in favor of the UV-858 is accounted for by the somewhat higher plate supply voltage allowable.

Since the active lengths of the two tubes are the same, the usable maximum plate currents are the same, leading to the use of the same filaments and filament ratings—22 volts and 52 amperes, with an average emission of 9.5 amperes. The use of a filament in the UV-858 which has been proved over a long period of time as to life and structure in another type of tube lends confidence to its use. The filament is of pure tungsten, as in all types of higher voltage vacuum tubes, arranged in

TABLE I  
RADIOTRON UV-207

<i>General</i>	
Main use—oscillator and r-f power amplifier	
Number of electrodes . . . . . 3	
Filament voltage . . . . . 22.0 volts	
current . . . . . 52.0 amperes	
type—tungsten	
Average characteristic values calculated at $E_p = 10000$ , $E_c = -310$ , $E_f = 22.0$ a-c	
Plate current . . . . .	0.75 ampere
Amplification factor . . . . .	20
Plate resistance . . . . .	3500 ohms
Grid-plate transconductance . . . . .	5700 micromhos
Approximate direct interelectrode capacities	
Plate to grid . . . . .	27 $\mu\text{f}$
Grid to filament . . . . .	18 $\mu\text{f}$
Plate to filament . . . . .	2 $\mu\text{f}$
Maximum over-all dimensions	
Length . . . . .	20-1/4 inches
Diameter . . . . .	4-5/32 inches
Base type number . . . . . 3906	
Type of cooling—Water	
<i>R-F Power Amplifier—Class B</i>	
Maximum operating d-c plate voltage . . . . .	15000 volts
Maximum unmodulated d-c plate current . . . . .	1.0 ampere
Maximum plate dissipation . . . . .	10000 watts
Maximum r-f grid current . . . . .	30 amperes
Typical operation; $E_p = 12$ kv, $E_c = -600$ , $E_f = 22.0$ a-c	
Unmodulated d-c plate current . . . . .	0.90 ampere
Peak output . . . . .	14000 watts
Carrier output—modulation factor 1.0 . . . . .	3500 watts
<i>Oscillator and R-F Power Amplifier—Class C</i>	
Maximum operating plate voltage . . . . .	
Modulated d-c . . . . .	12000 volts
Unmodulated d-c . . . . .	15000 volts
Maximum d-c plate current . . . . .	2.0* amperes
Maximum d-c grid current . . . . .	0.2 ampere
Maximum plate dissipation . . . . .	10000 watts
Maximum r-f grid current . . . . .	30 amperes
Typical operation; $E_p = 12$ kv, $E_c = -2200$ (approx.), $E_f = 22.0$	
Output . . . . .	15000 watts

\* If plate modulation is used, divide this figure by (1 + modulation factor) to get the maximum d-c plate current.

RADIOTRON UV-858

<i>General</i>	
Main use—oscillator and r-f power amplifier	
Number of electrodes . . . . . 3	
Filament voltage . . . . . 22.0 volts	
current . . . . . 52.0 amperes	
type—tungsten	
Average characteristic values calculated at $E_p = 18000$ , $E_c = -155$ , $E_f = 22.0$ a-c	
Plate current . . . . .	0.75 ampere
Amplification factor . . . . .	42
Plate resistance . . . . .	8700 ohms
Grid-plate transconductance . . . . .	4800 micromhos
Approximate direct interelectrode capacities	
Plate to grid . . . . .	18 $\mu\text{f}$
Grid to filament . . . . .	17 $\mu\text{f}$
Plate to filament . . . . .	2 $\mu\text{f}$
Maximum over-all dimensions	
Length . . . . .	24-1/2 inches
Diameter . . . . .	5-1/8 inches
Type of cooling—water	
<i>R-F Power Amplifier—Class B</i>	
Maximum operating d-c plate voltage . . . . .	20000 volts
Maximum unmodulated d-c plate current . . . . .	1.00 ampere
Maximum plate dissipation . . . . .	20000 watts
Maximum r-f grid current . . . . .	60 amperes
Typical operation; $E_p = 18$ kv, $E_c = -450$ , $E_f = 22.0$ a-c	
Unmodulated d-c plate current . . . . .	0.90 ampere
Peak output . . . . .	21600 watts
Carrier output—modulation factor 1.0 . . . . .	5400 watts
<i>Oscillator and R-F Power Amplifier—Class C</i>	
Maximum operating plate voltage . . . . .	
Modulated d-c . . . . .	16000 volts
Unmodulated d-c . . . . .	20000 volts
Maximum d-c plate current . . . . .	2.00* amperes
Maximum d-c grid current . . . . .	0.250 ampere
Maximum plate dissipation . . . . .	20000 watts
Maximum r-f grid current . . . . .	60 amperes
Typical operation; $E_p = 18$ kv, $E_c = -3500$ (approx.), $E_f = 22.0$	
Output . . . . .	22000 watts

\* If plate modulation is used, divide this figure by (1 + modulation factor) to get the maximum d-c plate current.

two V's in series. The filament seal is of the pinch type and supports the filament structure. The outside filament leads are of flexible stranded copper, ending in spade terminals arranged for quick changing. As is customary with high voltage, high power tubes, the filament can be operated from alternating current; but for telephone purposes, direct-current supply is more desirable in order to eliminate all possibility of carrier ripple.

The grid is made of such materials and so assembled that high grid temperatures and radio-frequency circulating currents may be encountered safely. The stay rods lead directly to a clamp in the upper portion of the tube and thence a lead runs to the grid seal, in a manner to keep inductance and losses at a minimum. Since the circulating current rating of the grid seal and circuit is 60 amperes, which value may be attained on higher frequencies, a grid seal designed for large radio-frequency currents is used.

The amplification constant of the UV-858 is 42, this high figure having been selected to fit class B and C usage best, where the lowest biases and lowest grid exciting voltages are desirable to keep grid losses at a minimum, to keep circulating currents as low as possible, and to reduce the size of biasing supplies. Even with an amplification constant of 42, it is unnecessary to use a close grid mesh and thus intercept high grid currents when the grid is positive. The mesh can be kept open and yet obtain a high  $\mu$ , since the grid-plate spacing is large. The plate impedance of the tube is made high by use of this high  $\mu$ , but since no modulator or class A amplification use is to be filled, the plate impedance has no real meaning for this tube, and is not a measure of its usefulness or applicability to any recommended operating conditions. Similarly, the mutual conductance has no meaning.

The plate of the tube is one piece of deep drawn copper, including the seal to the upper glass envelope; thus no soldered joints can cause slow leaks. The plate is arranged to clamp in a jacket such that a thin high-speed water wall can flow along the anode for effective water cooling. The maximum rated dissipation loss of the plate is 20 kilowatts, of which rating a major portion will be utilized when the tube operates at maximum voltage and output conditions. The jacket is arranged to prevent corona at high voltages and high frequencies, as arranged with an arc-over shield near the plate to glass seal to protect the seal from transient arc-overs, and is arranged to allow quick changing of tubes. The jacket can be built as a part of the neutralizing and plate tank condenser systems in order that stray capacity may be kept at a minimum, so that full advantage may be taken of the high frequency possibilities of the tube.

The glass envelope of the upper part of the tube is of hard Nonex glass, which approaches quartz in its properties, rather than the usual lead or lime glasses of low power tubes. This glass retains its low dielectric loss and low conductivity to much higher temperatures than common glasses; such that combined high voltage, high frequency and radiated filament heat have a minimum effect. The upper glass carries no base, since this would but add to dielectric losses and to tempera-

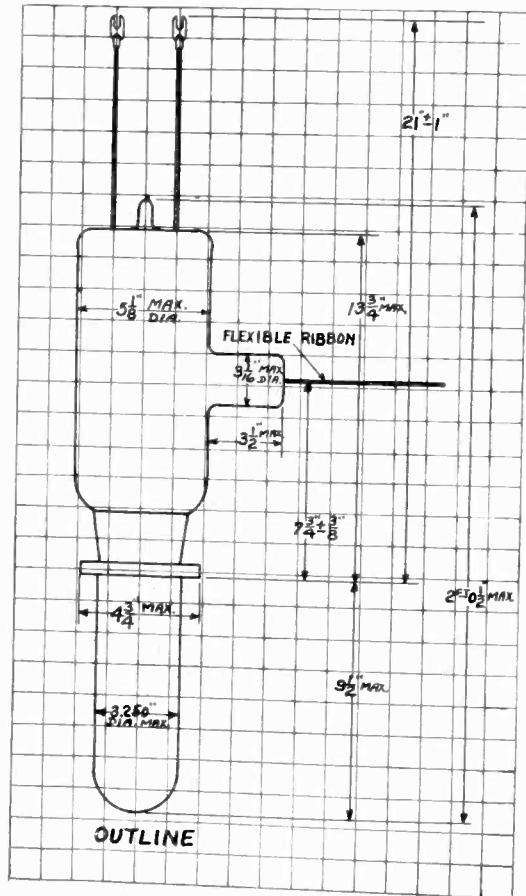

Fig. 3.

ture. Instead, each filament lead carries bead insulation. The glass portion of the tube is made as short as is consistent with safety from arc-over in order that leads may be brought from the tube at the point closest to the active elements to keep the inductance of the leads a minimum.

Static plate characteristics are given in Fig. 4. The values given there are most useful in determining approximate grid voltages for plate current cut-off. Since for both class B and class C usage the grid

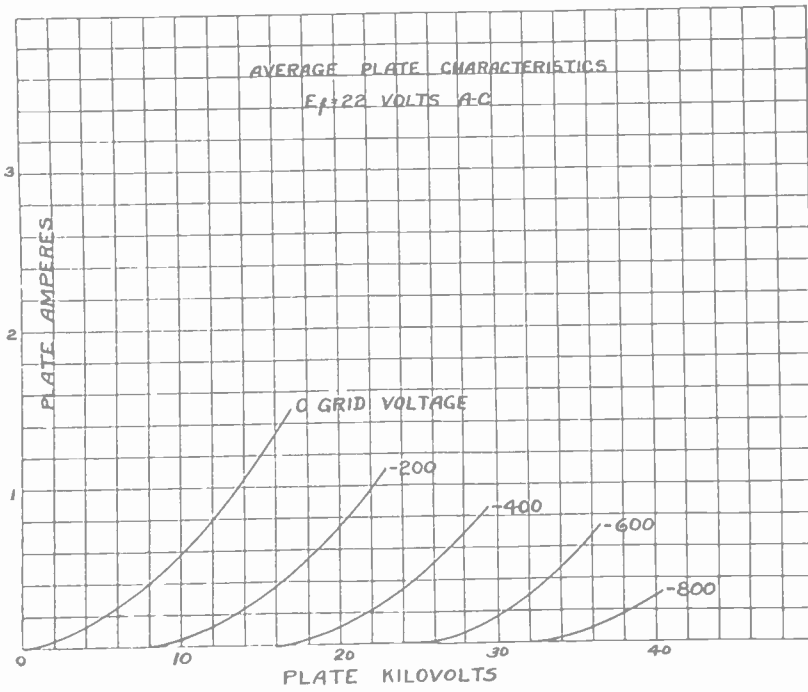

Fig. 4.

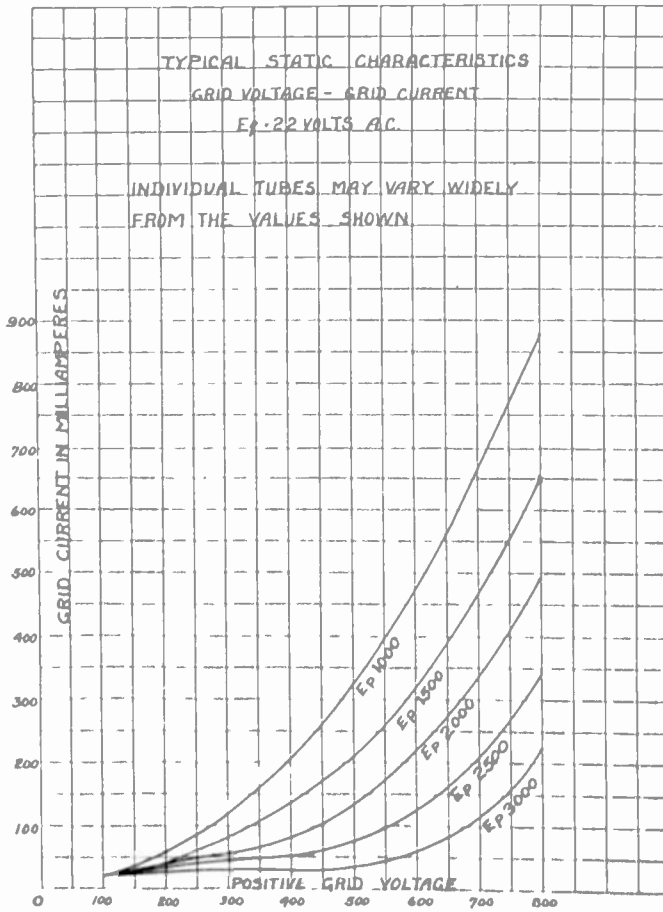

Fig. 5.

goes further positive than it is possible to take static characteristics, the characteristic given is of no value in determining class B and C operating conditions. Such a curve may, however, serve well to standardize tests, or to indicate variations from the average of individual tubes. Fig. 5 gives average grid current values for positive grid voltages—individual tubes may vary widely from the values shown.

The tube completed weighs approximately 8 pounds—when crated for shipment, approximately 23 pounds. The maximum length is  $24\frac{1}{2}$  inches, and the maximum diameter, excluding the grid arm, is  $5\frac{1}{8}$  inches. Other dimensions of interest are shown in Fig. 3.

In class B service, where the plate voltage is unmodulated, but modulated radio frequency is applied to the grid, the UV-858 is suitable for transmitters of power output of a few kilowatts, with 100 per cent modulation, and is especially suitable for high-frequency trans-

TABLE II  
(Modulation Factor = 1.0\*)

Frequency in kc	Max. d-c plate voltage	Normal Peak Output kw	Approx. Grid Bias Volts	Normal Values of		
				Carrier kw.	Plate amp.	Plate loss kw
1,500	20,000	27	500	6.75	1.0	13
10,000	18,000	24	450	6.0	1.0	12
20,000	15,000	20	375	5.0	1.0	10
30,000	12,500	14	320	3.5	0.85	7
40,000	10,000	9	250	2.25	0.7	5

\* The values given are for conditions such that a modulation factor of 1.0 can be used. The values themselves are those taken when no modulation is being applied, the output being pure carrier.

TABLE III

Frequency in kc.	Max. Plate Volts	Max. Output kw.	Normal Plate Amps.	Approx. Grid-Bias Volts
1,500	20,000	27	2.0	4000
10,000	18,000	24	2.0	3600
20,000	15,000	20	2.0	3000
30,000	12,500	14	1.7	2500
40,000	10,000	9	1.4	2000

mitters of this range. Table II indicates the maximum voltages and normal output ratings of the tube in various frequency ranges.

In class C service, where the plate voltage is either modulated or unmodulated, the UV-858 is especially useful at the higher frequencies. Table III indicates the maximum voltages and normal output ratings of the tube in various frequency ranges when the plate voltage is unmodulated. Table IV indicates the maximum voltages and normal output ratings of the tube in various frequency ranges when the plate voltage is modulated. The highest practical operating frequency is 40,000 kilocycles, at which 9 kilowatts output is obtainable, when unmodulated. Throughout most of the high-frequency range approximately 20

TABLE IV

Frequency in kc.	Max. Plate Volts	Max. Output kw.	Normal Plate Amps.	Approx. Grid- Bias Volts
1,500	16,000	18	1.7	4000
10,000	14,000	15.5	1.7	3500
20,000	12,500	13	1.7	3100
30,000	10,000	9	1.4	2500
40,000	8,000	5	1.2	2000

kilowatts output may be had, with a peak rating of 27 kilowatts output at low frequencies.

The UV-858 has been applied in radiotelephone sets, both at broadcast and at high frequencies. At broadcast frequencies the principal advantages found were in simplicity of arrangement, and in somewhat higher power output for tube size used. At the higher frequencies the simplification of the transmitter became quite an advantage and it became possible to extend considerably the maximum rating of such transmitters. In higher power telegraph transmitters the simplicity of arrangement and increase of maximum rating at high frequencies has made extended transmitter design possible. An incidental usage of the tube is that of driver for higher power tubes at low frequencies where plate voltages up to 20,000 volts may be used—the UV-858 will be able to operate directly from the high voltage plate supply.

Special tests have given some interesting and unlooked-for results when the UV-858 was used. In one test as an oscillator the tube operated as high as 65,000 kilocycles, without much output. At 50,000 kilocycles as an oscillator it was estimated that 5 to 10 kilowatts was being radiated when operated at a plate voltage of 8000 to 10,000 volts. In this test the circuit was only that of a half-wave antenna extended directly from the plate, that of the tube capacitance and that of a single loop of inductance in the grid circuit. The frequency and voltage were high enough so that an arc would form on the end of the antenna, extending perhaps 12 or 15 inches into space and sustained only by the high-frequency capacity currents flowing from the arc into space. The arc was distinctly not corona, since it was hot enough to vaporize a carbon electrode on the end of the antenna. In the intense field of the antenna it was even found possible to start such a single electrode arc into space from a parallel isolated rod acting as a receiving antenna.

Other tests indicated the tube could generate a considerable power as a Barkhausen oscillator, in which the grid was operated as the most positive element. No good estimate of the power radiated would be reliable, but at least the field strength was great enough so that quite large crystal rectified currents could be detected throughout the building. In this test it was noticed that nodes and loops of field

strength could be found only a few feet apart throughout the building due, undoubtedly, to interference patterns from waves reflected from the roof and walls.

In tests where 5 to 10 kilowatts were radiated at frequencies from 40,000 to 60,000 kilocycles it was noted that large space currents were circulating through all dielectrics within several feet of the set. These space currents were great enough to cause hot arcs between small rods of isolated metal, to illuminate isolated neon lamps at a distance of several feet and cause similar effects. More interesting was that parts of the human body, even though insulated, would heat to a fever heat at a distance of as much as 10 feet from the transmitter. When closer to the transmitter or when in contact with conductors it was possible to heat the entire body with ease. Later tests, in which the field was concentrated between plates, indicated that isolated wood blocks could be set on fire by dielectric loss, and that pop corn could be popped by dielectric loss. In all these heating tests it was noted that heat was generated internally in the dielectric, thus opening a speculative field as to what purposes such a novel method of heating might be applied.





## SENSITIVITY CONTROLS—MANUAL AND AUTOMATIC\*

By

DORMAN D. ISRAEL

(Formerly with Crosley Radio Corporation, Cincinnati, Ohio. At present with Grigsby-Grunow Company, Chicago, Illinois)

*Summary*—Control of sensitivity is a problem that must go hand in hand with improvement in sensitivity. A highly sensitive receiver requires a total attenuation of as much as 160 db. Of this 80 db may be called "sensitivity control" which is that portion of control that permits a one-volt carrier to be received without demodulator overload. The remaining 80 db may be called "level control" with which the loud speaker response is attenuated to the proper level.

The various basic manual control methods are discussed. Generally, manual control is accomplished in one or both of two ways; viz.,

1. Attenuate r-f input.
2. Alter vacuum tubes' characteristics.

The requirements for an ideal automatic sensitivity control are set down and the various basic systems discussed. High carrier level demodulator distortion as it affects certain systems is pointed out.

### GENERAL STUDY OF REQUIREMENTS

IT IS interesting to note that while broadcast receiver development engineers have devoted much study and effort to improvements in gain with the ultimate idea of improving sensitivity of receivers, there has always seemed to be a dearth of information available on methods of controlling this sensitivity. It is quite obvious that control of sensitivity is a problem which must go hand in hand with improvement in sensitivity.

If we assume that a broadcast receiver of extreme sensitivity will require a 30 per cent modulated signal of 1 microvolt to give an output of 20 volts, and if we further assume that with an input signal of 1 volt to the receiver, the maximum output permissible from the receiver with complete attenuation should not exceed  $\frac{1}{2}$  volt, we find that the total attenuation necessary in the sensitivity and level control is slightly less than 160 db.

This attenuation as mentioned above, should be divided into two groups. The first group might well be called "sensitivity control" which introduces that attenuation necessary with a maximum signal of 1 volt applied to the input terminals of the receiver to prevent overload of the demodulator with any degree of modulation. The second group which we shall call "level control" is that part of the attenuation

\* Decimal classification: R261.2. Original manuscript received by the Institute, September 25, 1931. Presented before Cincinnati Section, March 17, 1931.

which may be introduced if desired in the audio system to reduce the power output from the maximum value obtained when no overload occurs in the demodulator to the arbitrary figure set above as  $\frac{1}{2}$  volt. These two controls, sensitivity and level, combine to make up the 160-db total attenuation. It can be shown that for most receivers, the sensitivity control must attenuate about 80 db and the level control the remaining 80 db.

When a manual control means is provided, it is common practice to incorporate the complete attenuation figure into one control. If automatic sensitivity control is used, the automatic feature need have an attenuation of only 80 db, and the remaining attenuation can be obtained very simply through some sort of manual level control. In either case, manual or automatic, it has frequently been found desirable to use a "local-distance switch." This arrangement usually has an attenuation of about 40 db, which means that a complete manual control will still have to furnish 120 db of attenuation, while an automatic sensitivity control under these circumstances need have only 40 db.

#### I. MANUAL SENSITIVITY CONTROL

It is understood that by manual sensitivity control we mean a control which furnishes the complete attenuation of 160 db because it is not practicable to equip such a receiver with separate sensitivity and level controls. The local-distance switch attenuation will not be considered here. Generally speaking, there are two principles of obtaining manual sensitivity control.

- (a) Attenuate r-f input.
- (b) Alter vacuum tube characteristics.

The methods of obtaining r-f input attenuation will be discussed later, but an investigation of these methods will show that they have the advantage of furnishing a larger attenuation ratio, and they furthermore introduce no distortion if properly used and placed ahead of all tubes. The disadvantages of a control which attenuates the r-f input may be serious in some cases. Such a control usually introduces a detuning effect on the circuit in conjunction with which it operates. This detuning effect can be overcome, but usually at a loss in initial sensitivity or selectivity. Such controls will frequently cause a loss of selectivity at some stage of the attenuation process. Controls of this type furthermore constitute some form of load on the circuit to which they are connected and even at minimum attenuation their effect is noticeable and special precautions must be taken to minimize it.

The design of the control itself becomes a considerable problem if

complete attenuation is desired in this one control. It must be borne in mind that this control is directly in the carrier circuit and if the resistance gradient of the control is not extremely smooth, adjustments of the control will modulate the carrier, giving the familiar "noisy volume control" behavior. In order that distortion will not occur through the use of this control, it is common practice to place it in the circuit ahead of the vacuum tubes. Complete attenuation through the use of such a control, therefore, depends upon the efficiency of the shielding of those parts which carry r-f potentials following the control and the gain of the entire system following the control. When the control is placed ahead of any vacuum tubes, the background noise due to the gain of these tubes and their associated circuits is not reduced with the signal during the attenuation process. The effect, therefore, upon the listener is that the background noise is actually increasing because the ratio of noise to signal increases.

Arrangements of controls for altering the vacuum tubes' characteristics to obtain attenuation will be described later, but their advantages and disadvantages are outlined herewith. The attenuation may be made to take place simultaneously in all of the stages of amplification ahead of the demodulator and the background noise will thereby be eliminated in at least the same proportion as the signal. The resistance gradient in the volume control can be moderately irregular due to the fact that the control is not operated directly in the carrier circuit and also due to the fact that circuits in which it does operate have an inherent time constant because of the necessary bypassing. No appreciable detuning or loss of selectivity will result if such a control is properly used.

The disadvantages of controls which operate by altering the vacuum tube characteristics were very serious but can be effectively eliminated through the use of remote cut-off tubes provided these tubes have the proper characteristics. Assuming, however, that such tubes are not used or that the remote cut-off tubes used have improper characteristics, there are three spurious responses which can originate through overcontrol in the tube. These are:

- (1) Cross modulation in which the carrier of a weaker station is modulated by a stronger station. The stronger station is heard at the weaker station's frequency even though it bears no relation to that of the stronger station.

- (2) New frequency generation in which two moderately strong carriers combine and generate a new beat frequency equal to the sum or difference of the carriers giving a response in the receiver at either of these beat frequencies if they are in the tuning range of the receiver.

(3) Harmonic generation in which integral multiples of a strong carrier's frequency may be heard within the tuning range of the receiver.

With the usual type of tube, or defective remote cut-off tubes, the mutual conductance/grid bias, or mutual conductance/screen-voltage curves cut off very abruptly for low values of mutual conductance. This abrupt cut-off is unfortunately at a point where maximum attenuation is obtained and this attenuation is of the order used for strong local carriers. The resulting effect is violent distortion which allows the peaks of the modulated wave to break through the amplifier with comparatively high gain while the troughs of modulation are attenuated severely. The above two defects of controls which alter the vacuum tube characteristics combine to limit very seriously the attenuation possible unless a good quality remote cut-off tube is used.

#### MANUAL SENSITIVITY CONTROL METHODS

The possible circuit arrangements to obtain required attenuation for manual control seem to be unlimited. The basic systems for attenuating r-f input can be outlined schematically in the manner shown in Fig. 1. If we consider the places where r-f attenuation can be pro-

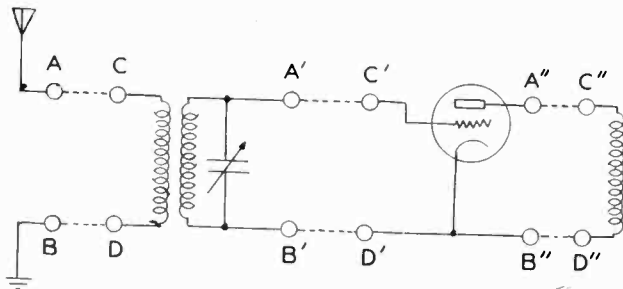

Fig. 1

duced, we shall find that this attenuation can be accomplished directly at the input to the set from the antenna to ground as shown by the terminals  $A-B$ . It can also be introduced at the input terminals to a vacuum tube as shown at  $A'-B'$ , or attenuation can be effected in the output circuit of the tube shown as  $A''-B''$ . As mentioned above, it seems highly advisable that attenuation be introduced ahead of any vacuum tube, and this would seem to eliminate the possibility,  $A''-B''$ . There are cases, however, where it has been used.

The fundamental attenuation networks are outlined schematically in Fig. 2. Fig. 2A illustrates the customary shunting resistor method. The points  $A-B$  could be substituted for antenna and ground, respectively, or for the input or output elements of the tube if desired.

Similarly, Fig. 2B typifies that arrangement in which the element controlled is shunted by a potentiometer. The input to the circuit is connected to higher or lower points on the potentiometer as the attenuation necessities may dictate. Fig. 2C indicates a potentiometer connected across the input while the output is connected across lower or

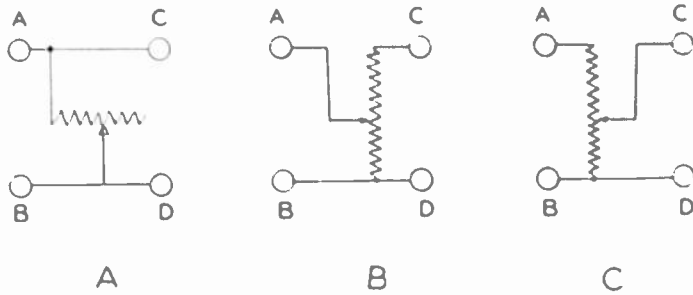

Fig. 2

higher values of resistance on the potentiometer. It can be seen very clearly that the system in Fig. 2A, if placed across a tuned circuit, will short-circuit it to a greater or lesser degree. This will introduce detuning of a variable nature and furthermore vary the selectivity of the circuit. The system in Fig. 2B, while it may not vary the load across a tuned circuit if used properly, will vary the capacity reactance across

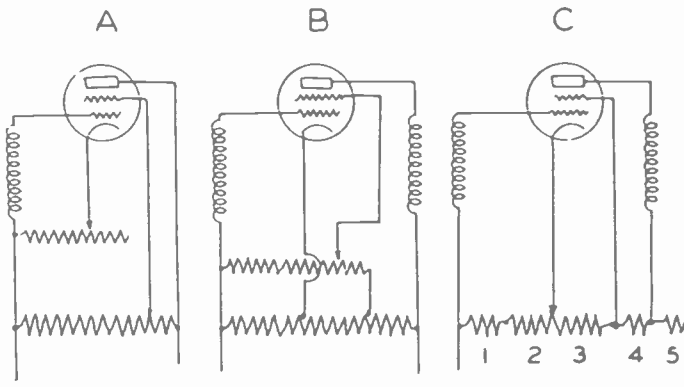

Fig. 3

this circuit and thereby alter both the tuning and selectivity. The system in Fig. 2C not only short-circuits the tuned circuit but alters the capacity reactance of the load as well. All three of these systems employ a permanently connected load which must be considered when designing the balance of the circuit. There are, of course, a great many combinations and variations of the three basic networks shown above, but their fundamental difficulties cannot be substantially overcome to the writer's knowledge.

Methods for altering the vacuum tube characteristics are also subject to many ramifications. Three basic arrangements are shown in Fig. 3. Fig. 3A obtains attenuation by altering the control-grid bias of one or more tubes. Fig. 3B accomplishes the same result by changing the screen-grid voltage. In Fig. 3C we have an interesting combination of systems *A* and *B* in which the control-grid and the screen-grid biases are altered simultaneously in the proper direction. All of these systems involve the same fundamental consideration, namely, that unless a good quality remote cut-off tube is used, the attenuation must be limited consistent with the characteristic of the vacuum tubes.

#### COMBINATIONS OF R-F ATTENUATION AND ALTERATION OF VACUUM TUBE CHARACTERISTICS

A study of the advantages and disadvantages of these two systems of manual control will indicate that an obvious arrangement would

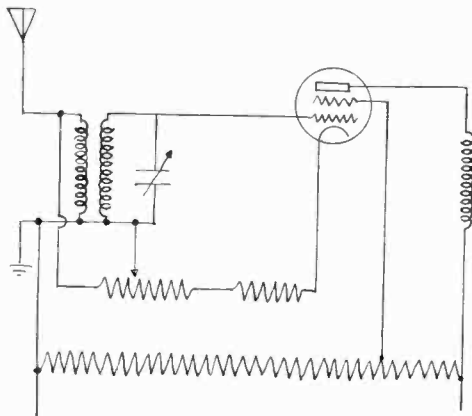

Fig. 4

be to combine the two systems of attenuation in such a manner that the initial steps are taken through altering the characteristics of the vacuum tubes. This would be carried on until just before the distortion point and then r-f attenuation could be introduced to complete the job. Methods of doing this are so numerous that it is not advisable to attempt to reproduce them all here. Most of these systems use more than one control unit on the same shaft. There is shown, however, in Fig. 4 a system in which this is done through the use of only one control potentiometer. This arrangement is very effective and economical and has been used successfully for some time.

It is a known fact that at the position of maximum attenuation the gain of a circuit varies in nearly direct proportion with the mutual conductance of the tube used. Fig. 5 illustrates the basic difference between the standard 224 tetrode and the new remote cut-off 235 tetrode

so far as this mutual conductance characteristic is concerned. It is quite obvious that with a given large signal input, serious distortion will result at the point near mutual conductance cut-off with the 224 tube. On the other hand the mutual conductance cut-off of the 235 tube is arranged to taper off very gradually and this difficulty does not exist. Attention should be called, however, to the fact that plate current cut-off is no indication of the ability of the tube to eliminate this distortion. It is quite possible to have a tube whose plate current never

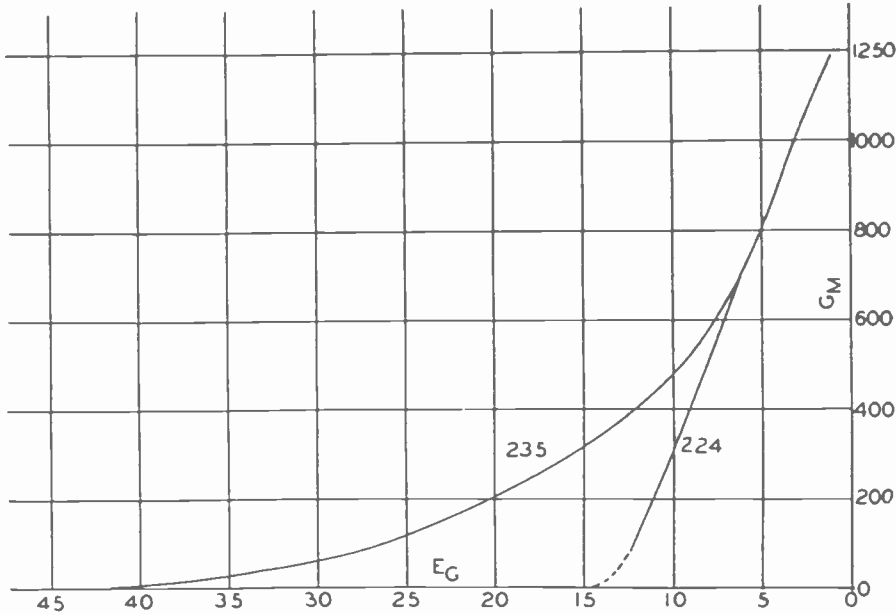

Fig. 5—Comparison between  $G_M$  curves, Type 224 and 235.  
 $E_p = 180$   $E_{SG} = 90$

cuts off but whose mutual conductance stops abruptly. This is a point worthy of careful consideration in testing remote cut-off tubes.

## II. AUTOMATIC SENSITIVITY CONTROLS

The same attenuation possibilities exist with automatic control as with manual. The chief difference rests in the fact that, as mentioned above, the attenuation need only be about 80 db. With the systems now in vogue and the tubes available at the present time, it is not a simple task to obtain attenuation of the r-f input although the writer has seen numerous successful examples of this in laboratory work. A special tube, possibly of the gas-vapor type, would make this entirely feasible commercially. On the other hand, it would be decidedly inadvisable to consider such a tube at present and therefore automatic sensitivity control arrangements as now used operate entirely through altering the vacuum tube characteristics.

It has been found desirable, in general, to accomplish this alteration through a variation of control grid bias because such a connection deals with a control circuit drawing no current. However, there is no reason why this could not be carried to the screen-grid circuit if desired. Since it is necessary in automatic sensitivity control to introduce 80 db of attenuation, it has been found that the remote cut-off tubes are highly essential if no local-distance switch is to be used. Some systems of control, however, have been developed in the past which do not have sufficient movement of the plate voltage to take care of the remote cut-off tubes (see Fig. 5) and it is therefore necessary that a revision of these systems be made.

The general practice in all automatic sensitivity controls with one or two exceptions is to use the vacuum tube voltmeter principle because the signal can be used quite effectively to produce the necessary current change in the control circuit which in turn can be made to flow through a load resistor giving the desired control grid bias change. Two variations from this practice are as follows:

- (1) Use of two-element demodulator (which is covered in this paper).
- (2) Use of delicate filament in a diode or triode in which the signal will operate to change its emission and thereby furnish the control voltage (not covered in this paper).

The general requirements of an ideal automatic sensitivity control can be outlined as follows:

- (1) It must exert no effect on overload curves up to 3 db from maximum undistorted output and then must function so that at all levels, the curve shows a horizontal or rising characteristic over the control range.
- (2) No overload may take place in circuits ahead of the manual level control under any conditions of carrier strength within the control range, or under any conditions of modulation percentage.
- (3) Control range must carry out to at least 1 volt of carrier impressed on receiver.
- (4) Normal change in output should not exceed 4 db over control range for any given modulation percentage or manual level control setting.
- (5) Must represent no load or detuning effect on circuit or components, unless necessary steps are taken to compensate for this.
- (6) Must introduce no distortion of the receiver output at any point in the control range under any conditions of carrier strength or modulation percentage.



(7) Time constant must be small enough so as not to introduce a disturbing transient response to atmospherics. 1/10 second is probably a satisfactory goal for which to strive.

(8) must be economical within reason.

Further explanation of these requisites follows from Fig. 6. A typical manual level and sensitivity control receiver might have an overload curve as indicated in curve *A*. Representative curves for this same receiver when equipped with automatic sensitivity control, will appear as curves *B*, *C*, *D* for different manual level control settings. In the case of curves *A*, *E*, and *F*, severe distortion and overload takes place beyond the peak of these curves. In the case of curves *B*, *C*, and *D*, dis-

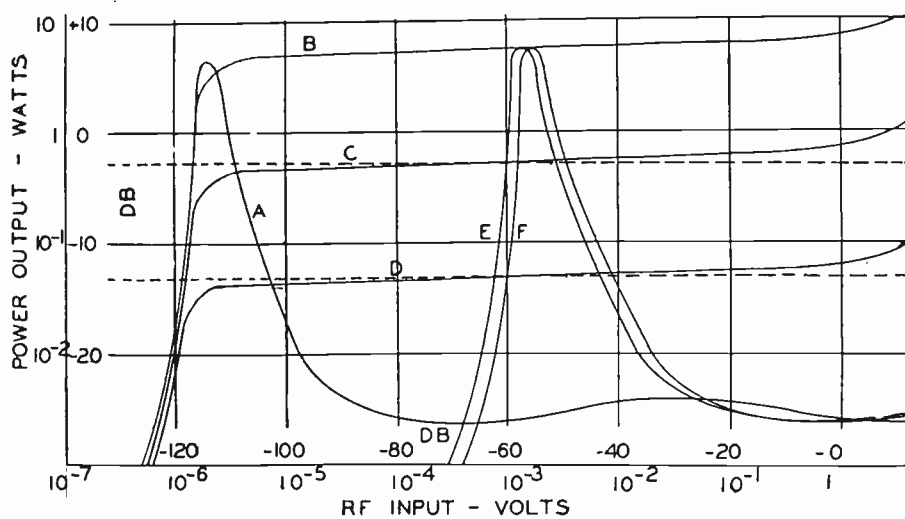

Fig. 6—Overload characteristics; manual vs. automatic sensitivity control.

tortion and overload may take place beyond 1 volt of signal. This is unusually evidenced by a rising characteristic as indicated in Fig. 6, largely due to harmonics and the way the usual r-m-s output voltmeter responds to them.

Let us suppose that a signal of approximately 1000 microvolts is tuned in and it is desired that this signal shall be heard at a level of 500 milliwatts. In the case of the nonautomatic receiver, the combination sensitivity and level control is adjusted so that the overload curve of the receiver becomes curve *E*, Fig. 6. In the case of the automatic sensitivity control receiver, the manual level control is adjusted so that the overload characteristic of the receiver becomes curve *C*. In either case, the desired signal will be heard at approximately 500 milliwatts output. The effect of automatic sensitivity control in reducing fading is quite apparent from these curves in that for a 4-db change in output, the car-

rier may swing from 9 microvolts to approximately 1 volt, while it might only swing from 950 to 1050 with the nonautomatic control.

If it is desired to hear the same station at approximately 50 milliwatts output, the manual sensitivity and level control is adjusted so that the overload characteristic becomes curve *F*, while in the case of the automatic receiver the overload characteristic is curve *D*.

#### AUTOMATIC SENSITIVITY CONTROL METHODS

In Figs. 7 through 14 are indicated some of the representative methods of obtaining automatic sensitivity control. Reference to the diagrams will show that in all cases *AC* is used to designate the automatic control tube when such a tube is incorporated in the system.

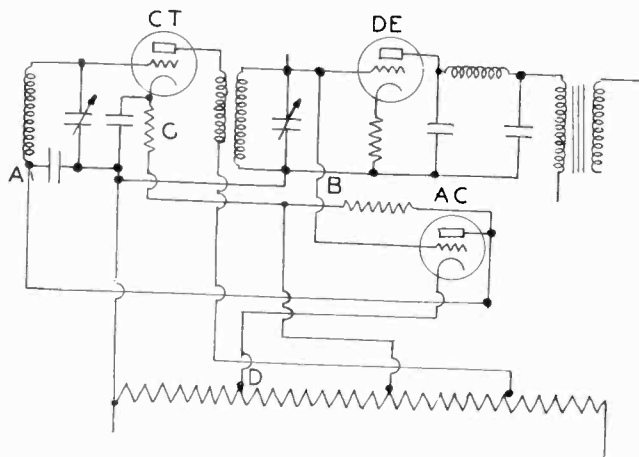

Fig. 7

*CT* is used to designate all of the controlled tubes. The diagrams, being schematic, will indicate only one controlled tube, but the controlled circuits for all tubes are, of course, in parallel, except that isolating filters are usually necessary. *DE* is used to represent the demodulator tube. In some systems the demodulator and automatic control tubes are one and the same and these, of course, are so indicated. *A* is used in all figures to represent the point at which the control voltage is applied. *B* represents a resistor through which control current flows, the drop across which resistor gives rise to the control voltage. *C* represents the resistor used in some cases to establish the normal bias on the controlled tubes. *D* indicates a point at which the proper voltage is obtained to make possible no control until a certain predetermined carrier is impressed on the receiver.

Fig. 7 represents one of the first systems of automatic sensitivity control devised. This system makes use of an extra tube for control purposes. The automatic control-tube grid is paralleled with the demodula-

tor grid. The cathode of the automatic control tube is, however, biased materially more positive than the cathode of the demodulator so that no current flows through the control resistor *B* until a certain predetermined carrier is impressed on the receiver. The automatic control tube then functions as the vacuum tube voltmeter and the current through resistor *B* increases. The control voltage across resistor *B* therefore increases with the carrier.

The automatic control introduces no load and the initial detuning can be taken care of easily through initial alignment. The available amount of control is limited by the mutual conductance of the tube available for automatic control purposes. This system is sensitive to plate current cut-off characteristic of the type of tube used for automatic control purposes.

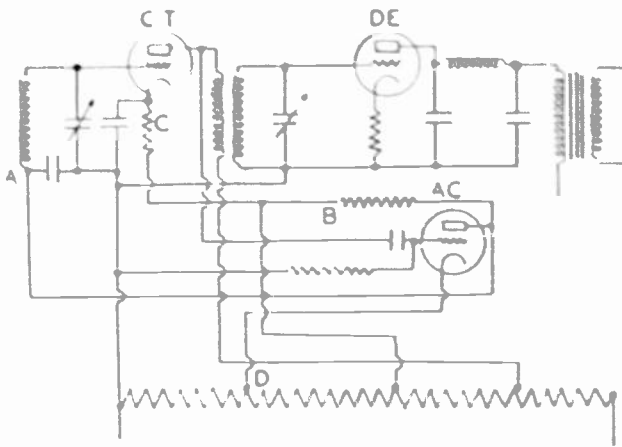

Fig. 8

Fig. 8 represents a system very similar to Fig. 7 except that the grid of the control tube receives its signal voltage from the plate circuit of the tube preceding the demodulator. This signal voltage is, therefore, less than that obtainable in Fig. 7 by the amount of the gain of the last r-f transformer. There is a load applied to the plate circuit of the last r-f tube because a shunting resistor is necessary to return the grid of the control tube to its own bias point. The operation of the system is comparable with that of Fig. 7 except that the available control is curtailed.

In Fig. 9 is indicated a system using an extra tube, but in this case the tube is used as a direct-current amplifier. The cathode bias resistor of the demodulator will have developed across it a voltage which increases as the carrier increases. This increasing voltage is used to bias the automatic control-tube grid more positive. The grid of the automatic control tube has applied to it a d-c voltage only. The cathode of the automatic control tube is returned to such a position that it is

biased materially more positive than the grid. The tube is, therefore, working normally beyond the plate current cut-off point, but as the demodulator cathode bias becomes more positive, the control tube commences to draw plate current and effectively biases the controlled tubes

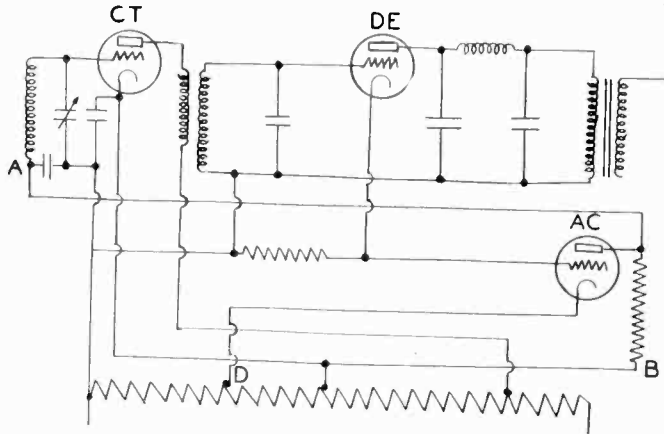

Fig. 9

in accordance with the carrier's strength. This system has perhaps the greatest control range of any so far developed. It is sensitive, however, to plate current cut-off characteristic of the automatic control tube and requires very careful design in the circuits accompanying it.

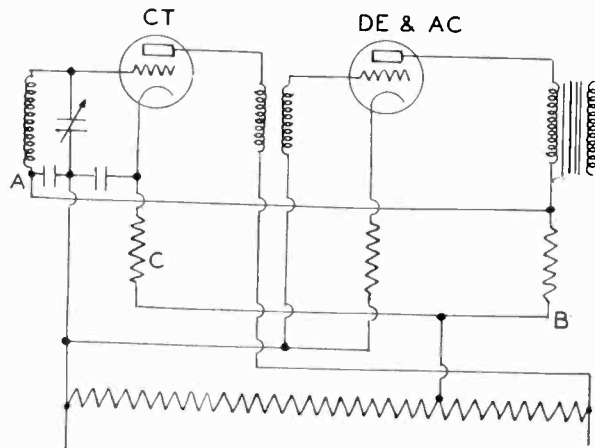

Fig. 10

Fig. 10 represents a more economical system in which the demodulator and automatic control tube are one and the same. With a signal impressed on the demodulator grid, the plate current will increase and if this plate current passes through resistor *B*, the voltage drop across this resistor will increase. By suitable connections as indicated in Fig.

10, this voltage drop across resistor *B* is made to function as the automatic bias. This system is, of course, quite economical and the loss in sensitivity due to the addition of resistor *B* to the demodulator plate circuit is not serious. On the other hand, control commences for any strength of carrier and is, of course, not as complete as the previously described systems, although it may be made to equal very nearly those of Figs. 7 and 8. The difficulty with the control's taking place immediately as the carrier is impressed on the receiver can be greatly reduced through the use of the self-bias resistor *C* as indicated in the diagram. The control applied to point *A* causes the plate current to decrease and therefore the voltage across resistor *C* will decrease. The combination of these two differential effects tends to hold the net grid bias of the

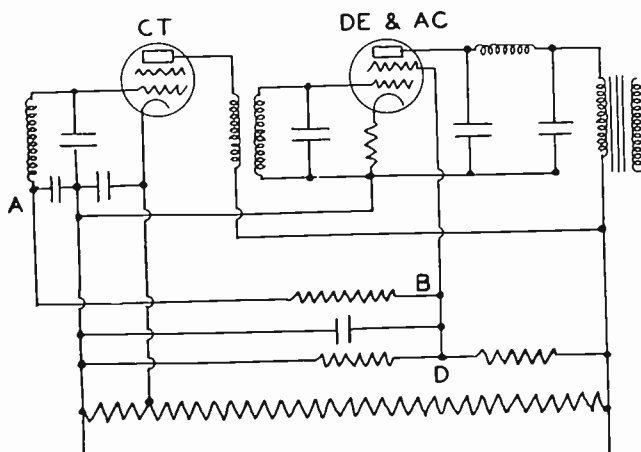

Fig. 11

controlled tubes constant over an interval up to the point where control voltage across resistor *B* becomes sufficiently large to take hold.

Fig. 11 represents another system in which demodulation and automatic control are obtained in the same tube. In this case a tetrode is used as the demodulator tube. Screen-grid current on this tube will increase as the carrier is increased so that the automatic control voltage applied to point *A* will increase also with carrier. This system is quite economical but is limited in control range. Furthermore, it operates through the use of screen-grid current which, in the ordinary type of screen-grid tube, is quite a variable, and should, therefore, not be relied upon for so important an effect as automatic sensitivity control.

Fig. 12 represents a system using the same tube for demodulator and automatic control by making use of the grid current drawn by the demodulator as it starts to overload. It is a known fact that serious distortion in the demodulator takes place at just about the same time that the electron grid current commences. The resistor *B* will have de-

veloped across it no voltage under ordinary no-load conditions except that due to the normal minute amount of electron or gas grid current of the demodulator tube. As the carrier is applied to the receiver and increased up to the overload point, there will be no change in the voltage present across resistor *B*. However, as soon as the carrier overloads the demodulator tube as evidenced by the presence of grid current, there will be developed across resistor *B* a voltage increasing as the carrier increases. This voltage across resistor *B* is fed back to point *A* to function as a control voltage. The voltage across resistor *B* also serves to increase the bias on the demodulator without subtracting this bias from the net plate voltage applied to the demodulator. This is in contrast to the voltage developed across the demodulator cathode bias re-

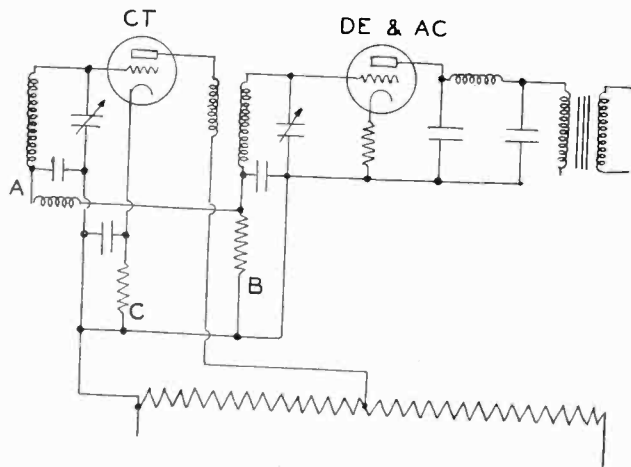

Fig. 12

sistor. With this system it is obvious that the control does not take hold until a certain predetermined overload point is reached. During the entire control period, however, the demodulator is drawing grid current and there must, therefore, be some degree of distortion. Tests have indicated that this distortion is not noticeable when the grid current is less than a certain amount or greater than a certain larger amount. That is to say that there is a range of grid current variation over which distortion is present. The distortion, while present, is not noticeable to the ear and measurements indicate that it is of a rather low value. The fact remains, however, that the system does introduce some distortion and therefore falls short of the ideal automatic sensitivity control. The tolerability of this failing, of course, is governed by the economies necessary.

Fig. 13 indicates a system using a diode combination demodulator and automatic control tube. During the half-cycle when the demodulator grid is positive, current will flow through resistor *B*. The voltage de-

veloped across resistor *B* is fed to a point *A* for control purposes. During the half of the cycle when the demodulator grid is negative no current flows and the voltage is, therefore, developed across the diode. This voltage is impressed on to the audio system to accomplish the

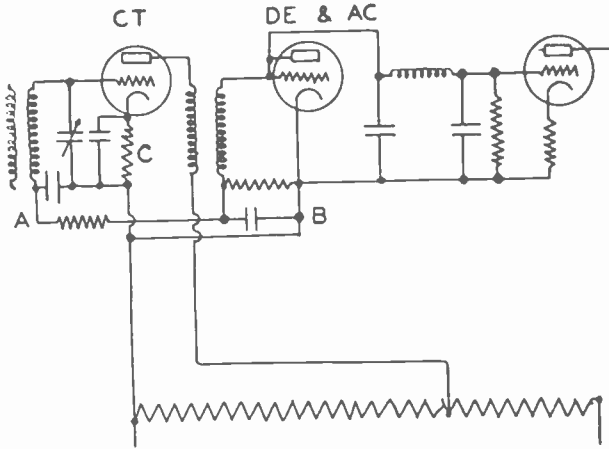

Fig. 13

necessary demodulation. Obviously, this diode may not be fed from a loose-coupled tuned circuit. It is, therefore, practice to precede the diode with a close-coupled stage of radio or intermediate frequency especially designed to furnish the power consumed in the diode and

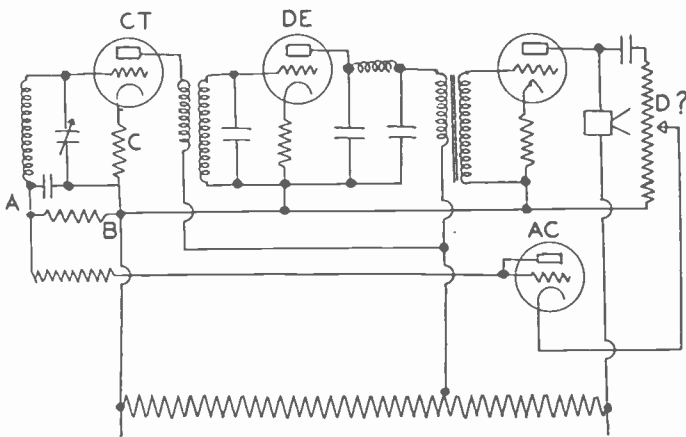

Fig. 14

control circuits. Furthermore, the efficiency of the diode as a demodulator is quite low and it has been found necessary to insert an additional stage of audio amplification to compensate for this lack of efficiency. It is apparent, therefore, that while the system does use one tube for both purposes, it makes necessary the addition of an r-f and a-f tube if selectivity and sensitivity are to be maintained. Control takes place im-

mediately on application of the carrier, and the control is furthermore less than that obtainable in triode circuits. The chief advantage of this system lies in the fact that it is not at all critical to vacuum tube cut-off or other characteristics. This is a feature which, in quantity production, is most important and tends to balance material cost increase when using this system.

Fig. 14 represents another system in which a diode is used as a control tube. It, however, works from the audio-frequency end of the receiver and is consequently independent of modulation percentage. Quite obviously, the control voltage developed across resistor *B* has a serious audio-frequency component and the time constant of the control circuits must therefore be quite high to avoid audio modulation of the carrier. Introducing this time constant works against requisite No. 7 previously laid down for an ideal automatic sensitivity control. Potentiometer *D* in this system becomes a level control. Control commences as soon as modulation takes place and during the interval when there is no modulation from the transmitter, the sensitivity of the receiver will build up to a maximum. The resulting background noise can, of course, be very objectionable.

The methods which have been shown in the above schematic circuit diagrams are for the most part fundamental and illustrate the principles involved. No attempt has been made to show the various deviations possible to accomplish certain specific ends. There are also numerous commercial factors entering into broadcast receiver design which make necessary deviation from the fundamental circuit.

#### DEMODULATION DISTORTION

There is one basic defect encountered in all control systems that operate from the carrier except the diode system in Fig. 13. This is due to the fact that the demodulator in an automatic sensitivity control receiver is working at a relatively high input just below the overload point. This is true throughout the entire control range of the receiver. Inasmuch as the audio harmonic output of the normal plate rectification demodulator increases quite rapidly as the carrier input is increased, it is obvious that the audio output of the detector contains considerable distortion throughout the control range.

It so happens that at very high audio levels distortion of the output system including both tubes and speaker is so great that the demodulator distortion is not apparent. It also happens that when the level is reduced somewhat, but still remains quite loud, the detector distortion and audio amplifier distortion are very apt to cancel each other. On the other hand, when the audio level is reduced to "easy-chair volume" of



approximately 10 to 100 milliwatts there is negligible distortion left in the audio amplifier, but the distortion from the demodulator is very noticeable and disagreeable. This is a point that seems to be seriously overlooked by many design engineers.

In the case of the diode system, Fig. 13, and the audio control system, Fig. 14, this is not true. In the former, the detector is a linear detector and throughout its operating range the distortion is quite small, being largest for very small inputs, which inputs are not included in the active control range. In the case of the latter system, the carrier is restrained considerably as the level control is reduced so that the demodulator is working with a relatively low input.

#### CONCLUSION

The author wishes to express his regret in not being able to give full acknowledgment to those who might be the rightful inventors of the various systems explained. It is easy to understand that at the present time it is difficult to give credit to the proper person or persons because, in the present state of the art, there are numerous claimants to the same circuits.

The writer wishes to take this opportunity to express his gratitude to Miss Helen Klein and Mr. Louis Willging for their invaluable help in assembling and compiling the information herein contained.



## A SIMULTANEOUS RADIOTELEPHONE AND VISUAL RANGE BEACON FOR THE AIRWAYS\*

BY

F. G. KEAR,†† AND G. H. WINTERMUTE†

†Bureau of Standards, Washington, D.C.; ††Massachusetts Institute of Technology, Cambridge, Mass.

**Summary**—Increased use of the airway radio services by transport operators has resulted in a demand for continuous range beacon service. At the same time the weather broadcast information has increased in importance and the interruptions to the beacon service have become more frequent. To eliminate difficulties arising from this conflict, a transmitting system has been developed which provides simultaneous transmission of visual range beacon and radiotelephone signals.

This system is designed to employ existing equipment so far as possible. By combining two transmitting sets into one the cost of buildings and antenna equipment is reduced. Continuous check on the operation of both systems can be obtained with less personnel than required at present.

The transmitting set consists of a two-kilowatt radiotelephone transmitter operating into a nondirective antenna system and an additional set of amplifier branches supplying power through a goniometer into two loop antennas. The two antenna systems are symmetrically disposed with respect to each other and coupling effects are balanced out to prevent distortion of the space pattern. The phase of the currents in the different antenna systems is controlled by a phase-shift unit and means for checking the adjustment of this phase relationship continuously is provided.

The equipment on the airplane to receive this service is changed only by the addition of a small filter unit which keeps the low-frequency reed voltages from reaching the head telephones and the voice frequencies from the reed indicator.

Numerous flight tests on the system have shown it to provide very satisfactory service under adverse interference conditions.

The distance range is the same as that provided by the present visual range beacon service.

### I. INTRODUCTION

IN ORDER to facilitate traffic over the airways of the United States, the Department of Commerce provides two types of radio aids to navigation. The first to be employed was the broadcast of weather information at regular intervals and later the radio range beacon marked out a radio path for the airplane to follow.

For some time the weather information was broadcast on a different frequency from the range beacon service, but this required constant tuning of the receiving set on the part of the pilot. At the request of the operating companies the weather broadcast from a given field was

\* Decimal classification: R526.1. Original manuscript received by the Institute, June 6, 1931. Published in *Bureau of Standards Journal of Research*, 7, 261-289; August, 1931. Publication approved by the Director of the Bureau of Standards of the U. S. Department of Commerce.

transmitted on the same frequency as the range beacon service from that field. In order to do this the length of the broadcast was reduced to a minimum and the range beacon shut down during this period. The cessation of the range beacon signals informed the pilot that the weather information was due, and the voice broadcast aided in identifying the station from which he was receiving guidance. This latter point is of great importance where several range beacon stations are located close together. Such identifying means as are now employed on the aural beacon service, for instance, a characteristic code letter transmitted at regular intervals, would not be readily applicable to the visual beacon transmitter. Because of this the voice broadcast is relied upon to a great extent for identification.

This second scheme operated fairly well until pilots began to depend upon the range beacon signals to locate their landing field. If the signals ceased when near the field it frequently meant missing the field entirely and a loss of time in reorientation. Furthermore, when a great number of airways converge at a field, the time taken up by the weather broadcast is a considerable percentage of the entire time, and in such installations some new scheme was imperative. As itinerant fliers began to equip their airplanes with radio, the problem becomes even more important. The intermediate-frequency phone station is the one which will handle messages from and to such itinerant pilots. If this traffic reaches any considerable size, the time during which the range beacon service is available would be very short indeed.

In order to provide these services satisfactorily, the Research Division, Aeronautics Branch, of the Department of Commerce commenced a research program for the development of a transmitting set which would furnish visual range beacon signals and speech modulation simultaneously without interruption of either service.

Such a system has been developed at the experimental flying field of the Bureau of Standards and is described in this paper. It supplies the pilot with continuous signals of the visual range beacon type and allows voice communication with the pilot at any time with no interruption to the range service.

This is accomplished with no changes in the installation in the airplane except the addition of a small filter unit to separate the speech frequencies from the reed frequencies. No new method of operation is required and no extra strain is imposed upon the pilot.

This system presents additional advantages over the present method of transmission. By combining the two transmitters into one unit, the total amount of equipment required is greatly reduced. The same building is employed for both services and much of the rotating

machinery is used simultaneously on both portions of the transmitter. Since a radio operator is constantly on duty at the phone station, the combined system insures a constant monitoring of the beacon operation which at the present time can only be done with additional personnel. Many similar advantages are readily apparent and consequently, from an economic viewpoint, the combined transmission is very desirable.

## II. PRELIMINARY WORK

During the preliminary development of the twelve-course visual range beacon in January, 1929, the idea of a simultaneous radiophone and range beacon transmitter first appeared. When the three amplifier branches of this type of radio range are excited with the radio frequency in time phase, the resultant carrier is suppressed by the goniometer and loop antenna system. The reason for this is readily apparent. Considering only the carrier current in each goniometer stator, these produce three figures-of-eight separated in space by 120 degrees. If the carrier currents are in time phase, the resultant field will be the sum of three equal vectors with 120-degree space phase. The resultant of three such vectors is zero at any point in space. The side bands, being of different frequencies, will not combine but will appear as true figures-of-eight at 120-degree space phase, giving the conventional space pattern. In order to utilize this signal, it is necessary to resupply the carrier, and it was proposed to erect a suitable open antenna symmetrically located with respect to the loop antennas and radiate carrier from this. It was suggested at this time that the carrier might well be modulated with voice for identification purposes and general communication with the pilots.

However, as work on the twelve-course system progressed it was found a simpler matter to use a 120-degree time-phase displacement in the beacon amplifiers to avoid suppression of the carrier. The need for a simultaneous transmission was not apparent at this time, so no further work was done along this line.<sup>1</sup>

In the fall of 1929 the necessity for providing continuous range beacon service became apparent and preliminary experiments were conducted to determine the feasibility of a simultaneous transmitting system. In order to secure some test data with as little change in existing apparatus as possible, the twelve-course experimental beacon was employed for this work.

The modulated amplifiers of this beacon were redesigned to receive

<sup>1</sup> H. Diamond and F. G. Kear, "A 12-course radio range for guiding aircraft with tuned reed visual indication," *Bureau of Standards Journal of Research*, 4, March, 1930.

a direct voltage on their plates in place of the alternating voltage previously supplied from the modulation frequency alternators. Each amplifier was provided with a Heising choke and the alternating volt-

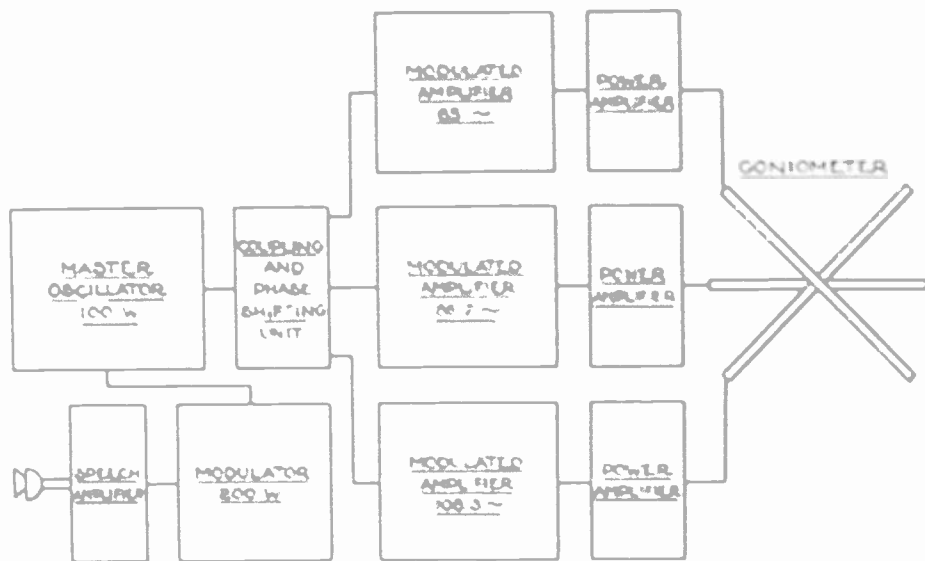

Fig. 1—Schematic circuit arrangement of 12-course radio range beacon with radiotelephone modulation.

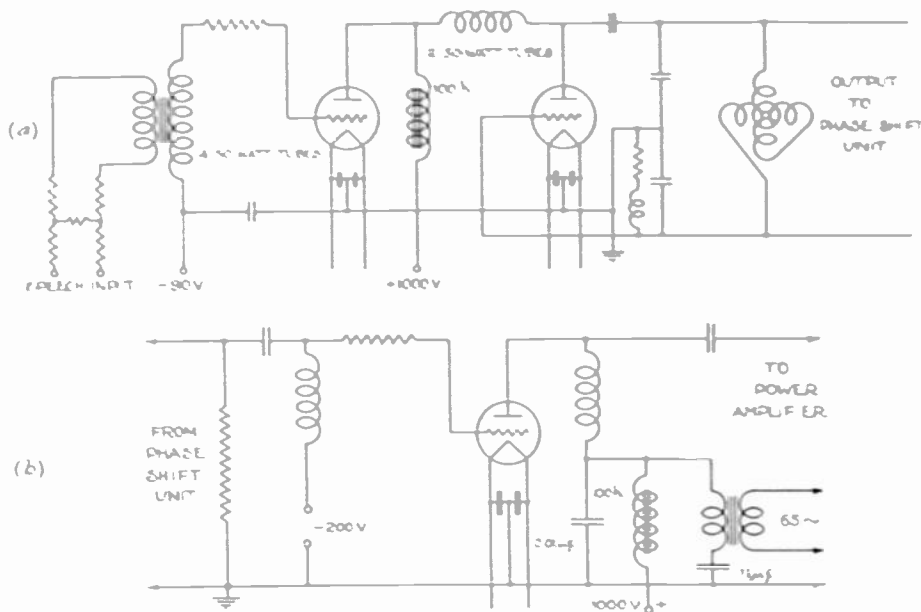

Fig. 2—Electrical circuit details of 12-course radio range beacon with radiotelephone modulation.

age applied across this choke. This voltage was so proportioned as to give a fifty per cent modulation of the radio frequency instead of the previous one hundred per cent.

The master oscillator of this beacon employed two fifty-watt tubes in parallel. A modulating amplifier consisting of four fifty-watt tubes in parallel was applied to this oscillator and the grids of these tubes excited from a three-stage speech amplifier. This combination modulated the carrier to a maximum of about forty per cent.

This voice modulated carrier was fed to each amplifier branch where it was further modulated by the reed frequencies and then radiated through the loop antenna system. The reed-frequency side bands still maintained their figure-of-eight pattern while the voice side bands were radiated circularly in the same manner as the carrier. Fig. 1 shows the schematic circuit while Fig. 2 shows details of the modulation units and intermediate amplifiers.

It is obvious that such a modulation system would produce a great number of extraneous frequencies as a result of cross modulation; however, it afforded a simple way of getting a rapid check on the possibilities of the project.

In the latter part of 1929, field tests were made on this system. The reed indicator operated with very little irregularity and the voice quality was much better than would have been expected.

Having found this scheme to be practicable, work was begun upon a transmitter which would reduce the number of extraneous audio frequencies and thereby improve the operation.

Two methods of attack were conceived at this time. The first required applying the voice modulation to the modulated amplifiers in series with the reed-frequency modulation already present. By properly proportioning the relative voltages, any desired modulation ratio could be obtained. This would reduce the number of unwanted frequencies to those introduced by the class C power amplifiers and it was felt that they would not be of serious magnitude.

The second method was that of a separate radio-frequency amplifier stage which received the voice modulation. This was to be of the balanced amplifier type and so connected as to suppress the carrier and supply only the voice side bands to an open antenna system symmetrically disposed within the loop antenna structure. This last means would eliminate all the cross modulation frequencies and in addition would provide a simple control of the modulation ratio.

It was evident that any system in which the major portion of the power was radiated by the loop antennas must be a highly inefficient solution and would require too great a loss of power to be practical as a final product. Therefore, instead of trying out these last two methods experimentally, it was decided that the tests already made had shown the idea to be practical, and, a transmitter should be developed of a

design which could be employed along the airways. In a conference with members of the Bell Telephone Laboratories, a schematic circuit arrangement of a suitable transmitter was developed. This is illustrated in Fig. 3. This circuit arrangement formed the basis of an investigation which has resulted in the development of a suitable transmitting system. This system has proved eminently satisfactory and provides simultaneous transmission of voice and radio range signals with a minimum of expenditure and alteration to existing stations. It is with this transmitter that the paper is most concerned.

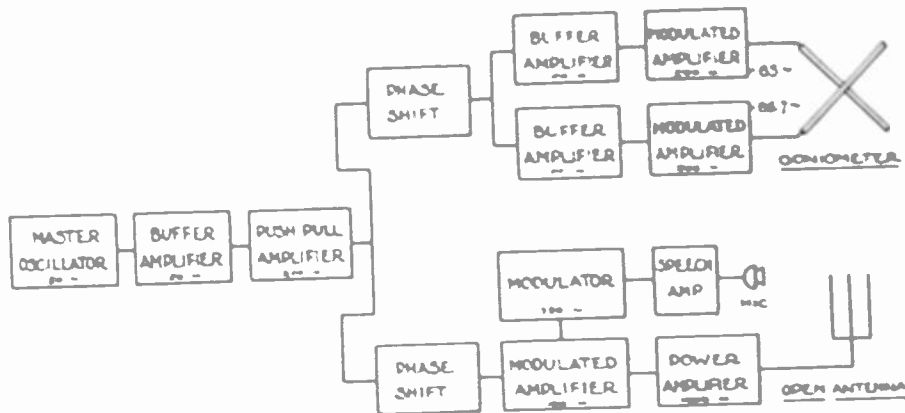

Fig. 3—Schematic circuit arrangement of simultaneous radiotelephone and visual range beacon.

### III. THE TRANSMITTING PROBLEM

#### 1. Factors Influencing the Design

In the design of the new transmitting system, it was not possible to start from purely theoretical considerations and so develop what would be, in the light of present radio technique, an ideal unit. Certain limiting factors entered and circumscribed the sphere of development.

The first consideration was that of power rating. The present range beacons and phone transmitters have demonstrated that they provide adequate service on the airways; hence any new unit must provide, as a minimum requirement, the same received signal voltages at a given point as the existing equipment.

The ratio of speech side band to range beacon side band is fairly well fixed. The present reed course indicator requires approximately six milliwatts of power or about 0 db absolute level. In order to insure intelligible speech in the airplane, the phones must have available 60 milliwatts or +10 db. This ratio must be attained in the field strength pattern at any point in space.

The antenna system was restricted in size on account of its location

near an airport. It would be undesirable to increase the obstruction hazard in order to increase antenna efficiency.

The equipment of the airplane to receive range beacon and weather broadcast information has reached a fair degree of standardization. Any system of communication requiring much additional apparatus or considerable change in present equipment would meet with great opposition from the operating companies. The ideal solution would be one requiring no change in existing installations.

The civil airways at the present time are rather comprehensively covered with a network of radiophone and range beacon installations. This equipment represents a considerable investment and to adopt a design which would render all existing stations obsolescent would be economically poor. The new system must employ a maximum amount of existing equipment in its design.

Finally, much of the apparatus employed will be operated by remote control. This necessitates a design of great inherent stability and freedom from variations due to changing weather conditions. These requirements are all met in the present design. The result is a unit which is well suited to the present needs of the airways.

The foundation for the preliminary design was the 2-kw radiophone transmitter which has been used on the airways for several years and has proved very satisfactory. When used with the type of antenna structure for which it was designed, this transmitter will produce a field intensity of  $6500 \mu\text{v}/\text{m}$  at a distance of ten miles over average terrain. This is modulated to a peak of approximately 60 per cent by the voice frequency.

Assuming square-law detection in the aircraft radio receiver, the detected voltage is proportional to the product of the percentage modulation and the square of the carrier field intensity.

$$i_d \propto m E^2$$

from which,

$$i_d \propto 0.6(6500)^2$$

$$\propto 25,000,000 \text{ approximately.}$$

As mentioned before, the reed indicator requires 0 db level or 6 milliwatts for an "on course" indication, and the head telephones with an average amount of noise present require a level of +10 db or 60 milliwatts. This corresponds to a voltage ratio of 3.16 to 1. Consequently, if the detected speech signal is proportional to  $25 \times 10^6$ , the reed signal must be proportional to approximately  $8 \times 10^6$ . This factor was used in calculating the required field intensity of the beacon side bands and flight tests have shown it to be satisfactory.



Employing this factor we find

$$i_{\text{rms}} \propto m E_0^2 \\ \propto m (6500)^2 \\ \propto 8 \times 10^6$$

whence  $m = 0.19$  or 19 per cent.

The expression for a modulated carrier is

$$E = E_0 \sin \theta + \frac{m E_0}{2} \sin (\theta - \phi) + \frac{m E_0}{2} \sin (\theta + \phi).$$

With the carrier suppressed this becomes

$$E_1 = \frac{m E_0}{2} \sin (\theta - \phi) + \frac{m E_0}{2} \sin (\theta + \phi).$$

If the field intensity is measured by the usual method this will be

$$E_{\text{eff}} = \sqrt{\left(\frac{m E_0}{2}\right)^2 + \left(\frac{m E_0}{2}\right)^2} \\ E_{\text{eff}} = \frac{m E_0}{\sqrt{2}}.$$

Substituting the known values for  $m$  and  $E_0$

$$E_{\text{eff}} = \frac{0.19 \times 6500}{\sqrt{2}} \\ E_{\text{eff}} = 874 \mu v/m.$$

Using loop antennas with the dimensions of those at the College Park experimental station, this field intensity is obtained with an antenna current of slightly less than 8 amperes. The loop antenna resistance being 8 ohms, the antenna power is approximately five hundred watts.

The beacon amplifier branches must, therefore, be capable of delivering five hundred watts of side band power to the loop antennas to secure the proper ratio of speech to beacon field intensity with the same useful range as the present airway equipment.

It is worthy of note at this point that if the computations were made on the basis of the field intensities of the present range beacon stations, the power required would be much less. For example, the four-course visual radio range beacon has a carrier field intensity of

734  $\mu\text{v}/\text{m}$  at ten miles. The detected voltage assuming 100 per cent modulation would then be proportional to  $(734)^2$  or 540,000. This value, being only one-sixteenth of that used in the foregoing, would mean much lower power in both beacon and phone amplifiers.

However, while this low figure is satisfactory for use with visual range beacon signals alone, when speech is supplied on the same channel, the increased sensitivity required in the radio receiver results in a very unfavorable static-to-signal ratio and the useful distance range is greatly reduced. Because of this the power calculations were made upon the basis of the radiophone transmitter performance instead of the range beacon transmitter data.

The transmitting system requirements, from a consideration of the foregoing factors, may be, therefore, summed up as follows:

Carrier and speech supply to consist of a 2-kw phone transmitter modulated sixty per cent peak and operating into an open antenna 75 feet high with four flat-top sections 80 feet long bisecting the angles of the loop antennas.

Range beacon supply to comprise two balanced amplifier branches supplied with carrier from the 2-kw unit. Modulation to be accomplished by the use of alternating current from special low-frequency alternators and the carrier to be suppressed by some suitable arrangement. The amplifier branches to operate through a conventional goniometer into two loop antennas. The antenna height to be 75 feet and the base of the loop antennas 300 feet long. Each amplifier to have sufficient capacity to deliver 500 watts of side band power to the loop antennas.

It was felt that this system would provide adequate transmission for the needs of the airways. The next problem was to construct a unit from available material and secure actual operating data.

## 2. The Experimental Transmitter

Since no equipment of the type employed on the airways was available for use in the experimental transmitter, an entirely new unit was constructed. This unit differs considerably in arrangement from the conventional type, but, all the limiting factors being considered, the relative performance is very similar.

In order to attain flexibility, the transmitter was built upon the individual unit plan. These units are as follows:

(a) A master oscillator which supplies push-pull radio-frequency power to the amplifiers. This is designed so that variations in load do not affect the frequency or balance of the push-pull amplifiers.

(b) A phase-shifting unit to control the phase of the radio frequency applied to the separate amplifiers.

(c) A radiophone and carrier amplifier branch which supplies carrier frequency power to a nondirectional vertical antenna, with provision for modulating the carrier with the voice frequencies.

(d) A speech amplifier which modulates the carrier to a maximum of 60 per cent, with a flat response from 300 to 6000 cycles, but which does not pass the low voice frequencies in the region of the reed modulation frequencies.

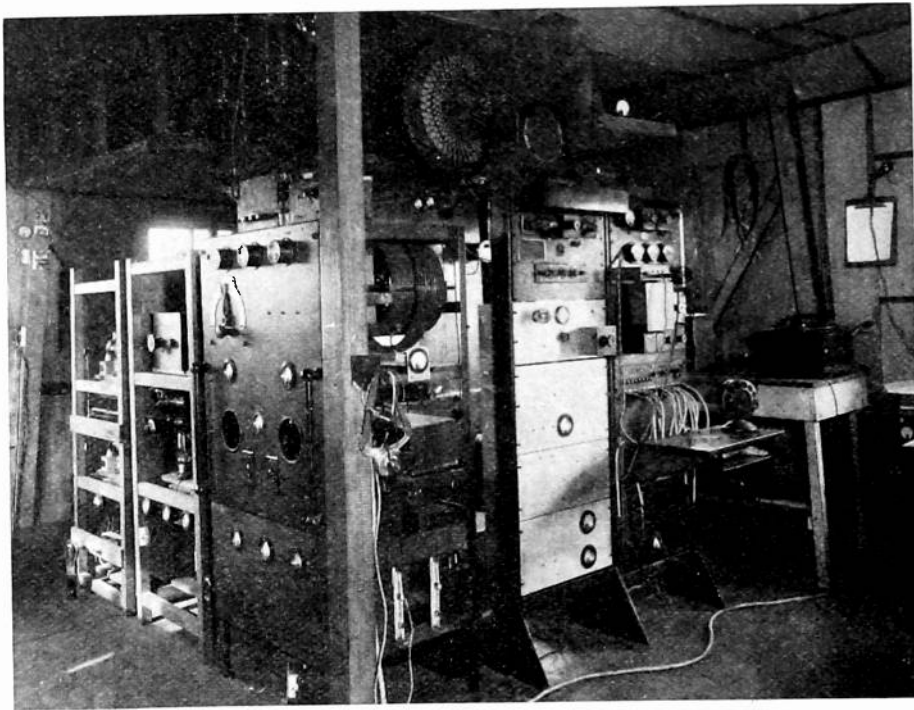

Fig. 4—General view of the experimental transmitting set at College Park.

(e) Two beacon amplifier branches, which receive the radio frequency from the master oscillator, modulate it with the desired reed frequencies and then, having suppressed the carrier, deliver the side bands to the goniometer.

(f) An antenna system providing directional transmission from the beacon amplifiers and nondirectional transmission from the carrier and speech amplifier.

These units were constructed, tested individually, and then modified to correct such deficiencies as were found in the tests.

Fig. 4 shows the installation at the College Park field station.

A description of the units as finally employed follows:

(a) *The Master Oscillator*—The master oscillator employs a fifty-watt tube with the Colpitts oscillating circuit. The frequency is adjustable by means of a variable inductor over the present aircraft beacon range of 235 to 350 kilocycles. A piezo-controlled unit has been designed to replace this in a permanent installation. This output in turn excites another fifty-watt amplifier through a high resistance feed

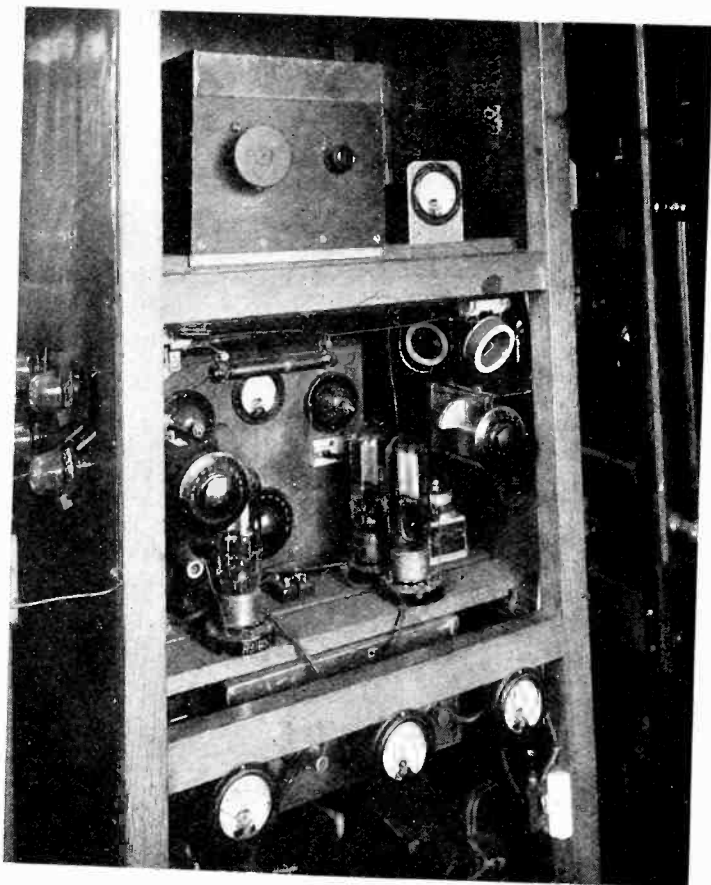

Fig. 5—Front view of master oscillator unit.

to prevent reaction due to change of load. The amplifier tube, through a coupling transformer, supplies a tuned circuit, the extremities of which are connected to the grids of a second amplifier, consisting of two sets of two fifty-watt tubes in push-pull. These are cross-neutralized. From the plates of these tubes is obtained the push-pull radio-frequency output. This unit is complete within itself and is thoroughly shielded. It is illustrated in Fig. 5.

(b) *The Phase-Shifting Unit*—In any system of carrier suppression where both side bands are radiated, it becomes necessary to resupply

the carrier in the proper phase in order to prevent distortion. This may readily be demonstrated as follows:

The conventional expression for a modulated radio-frequency signal is

$$E \sin \theta (1 + m \cos \phi)$$

where,

$$\theta = 2\pi f_c t \quad f_c \text{ being the carrier frequency}$$

$$\phi = 2\pi f_m t \quad f_m \text{ being the modulating signal frequency}$$

and  $m$  is the percentage of modulation.

This may be rewritten

$$E \left( \sin \theta + \frac{m}{2} \sin (\theta + \phi) + \frac{m}{2} \sin (\theta - \phi) \right)$$

the first term of this expression being the carrier and the last two the side bands.

In carrier-suppressed transmission the equation reduces to

$$E \left( \frac{m}{2} \sin (\theta + \phi) + \frac{m}{2} \sin (\theta - \phi) \right).$$

Assume the carrier to be resupplied at a slightly different angle  $\alpha$ . The transmitted wave now is

$$e_t = E \left[ \sin (\theta + \alpha) + \frac{m}{2} \sin (\theta + \phi) + \frac{m}{2} \sin (\theta - \phi) \right].$$

Assuming square-law detection

$$i_d = A e_t^2.$$

The components of the detected signal become

$$\begin{aligned} A E^2 \left[ \sin^2 (\theta + \alpha) + \frac{m^2}{4} \sin^2 (\theta + \phi) + \frac{m^2}{4} \sin^2 (\theta - \phi) \right. \\ \left. + m \sin (\theta + \alpha) \sin (\theta + \phi) + m \sin (\theta + \alpha) \sin (\theta - \phi) \right. \\ \left. + \frac{m^2}{2} \sin (\theta + \phi) \sin (\theta - \phi) \right]. \end{aligned}$$

The first three terms are radio frequencies and can be neglected. Expanding the fourth term:

$$\begin{aligned} m \sin(\theta + \alpha) \sin(\theta + \phi) &= \frac{m}{2} \cos(\theta + \alpha - \theta - \phi) - \frac{m}{2} \cos(\theta + \alpha + \theta + \phi) \\ &= \frac{m}{2} \cos(\alpha - \phi) - \frac{m}{2} \cos(2\theta + \alpha + \phi). \end{aligned}$$

Likewise expanding the fifth term:

$$\begin{aligned} m \sin(\theta - \alpha) \sin(\theta - \phi) &= \frac{m}{2} \cos(\theta + \alpha - \theta + \phi) - \frac{m}{2} \cos(\theta + \alpha + \theta - \phi) \\ &= \frac{m}{2} \cos(\alpha + \phi) - \frac{m}{2} \cos(2\theta + \alpha - \phi). \end{aligned}$$

Expanding the last term:

$$\begin{aligned} \frac{m^2}{2} \sin(\theta + \phi) \sin(\theta - \phi) &= \frac{m^2}{4} \cos(\theta + \phi - \theta + \phi) + \frac{m^2}{4} \cos(\theta + \phi + \theta - \phi) \\ &= \frac{m^2}{4} \cos 2\phi + \frac{m^2}{4} \cos 2\theta. \end{aligned}$$

Considering only the audio-frequency terms of the detected signal we find

$$i_d = AE^2 \left[ \frac{m}{2} \cos(\alpha - \phi) + \frac{m}{2} \cos(\alpha + \phi) + \frac{m^2}{4} \cos 2\phi \right]$$

or,

$$i_d = AE^2 \left[ m \cos \phi \cos \alpha + \frac{m^2}{4} \cos 2\phi \right].$$

Now if  $\alpha = 90$  degrees, the first term of the above expression will disappear, leaving only the double frequency term. If  $\alpha = 0$  degrees, the equation reduces to

$$i_d = AE^2 \left[ m \cos \phi + \frac{m^2}{4} \cos 2\phi \right]$$

which is the usual equation for a detected signal. Consequently, if the carrier is suppressed at the transmitter and then resupplied, it must have its original phase or the detected signal components will tend to cancel each other leaving a double frequency term. The degree of this cancellation will increase with an increase of phase difference.

In the four- and twelve-course radio range beacons, it was necessary to provide a phase shift in each amplifier to prevent carrier combina-

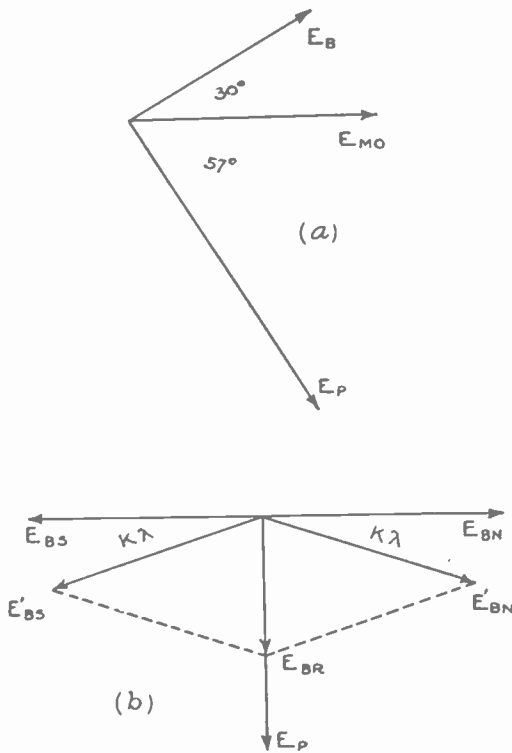

Fig. 6—Vector diagram showing phase relations in combined transmission.

(a) Phase relations within the transmitting set:

- $E_b$ —Voltage across beacon amplifiers.
- $E_{mo}$ —Voltage across master oscillator.
- $E_p$ —Voltage across carrier amplifiers.

(b) Phase relations at point of reception.

- $E_{bn}$ —Voltage across north end of loop antenna.
- $E_{bs}$ —Voltage across south end of loop antenna.
- $E'_{bn}$ —Voltage across north end retarded  $k\lambda$ .
- $E'_{bs}$ —Voltage across south end advanced  $k\lambda$ .
- $E_{br}$ —Resultant voltage induced by loop antenna.
- $E_p$ —Voltage due to open antenna.
- $k\lambda$ —Inherent phase shift of loop antennas.

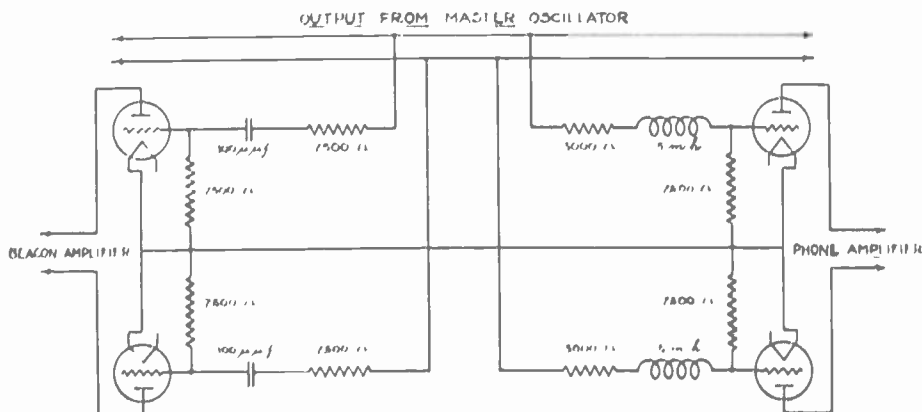

Fig. 7—Electrical circuit diagram of phase-shifting unit.

tion.<sup>2</sup> In the carrier-suppressed beacon this is no longer necessary. Since no carrier is radiated it cannot combine to distort the space pattern. Hence both beacon amplifiers are supplied in phase and the resultant pattern is the conventional crossed figures-of-eight.

The loop antenna introduces a phase shift of another sort. The re-

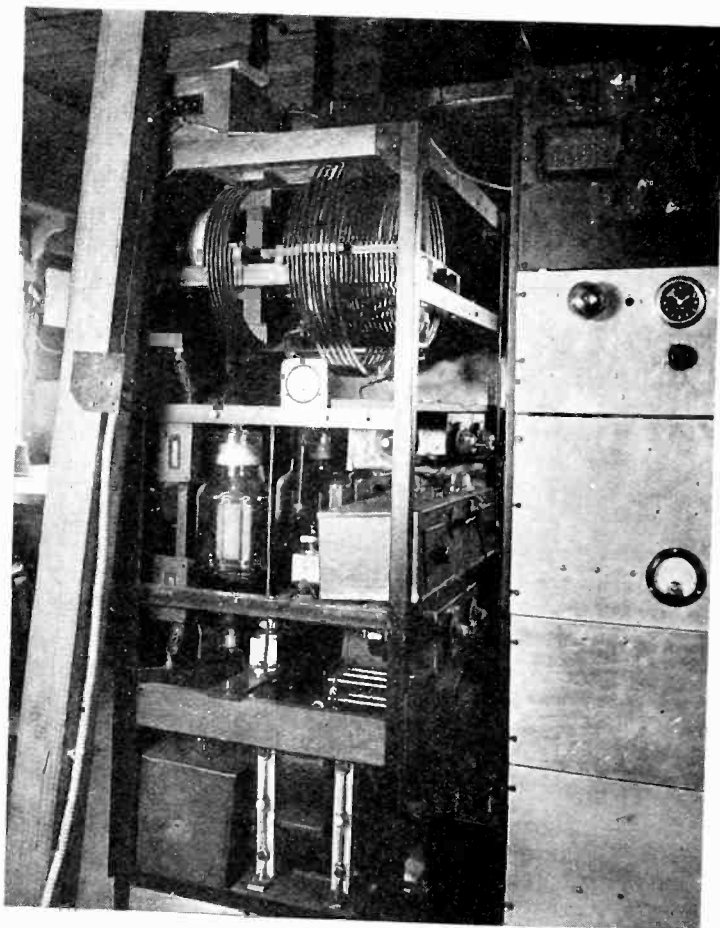

Fig. 8—Radiophone and carrier amplifier unit—side view.

ceived voltage at a given point in space is the vector sum of two voltages. One is induced by the one side of the loop antenna and one by the other. The currents in the two sides of a single loop antenna are 180 degrees out of phase when considered with respect to a distant receiving antenna and the vector sum of the induced voltages is in quadrature with these currents regardless of the point of reception.<sup>3</sup>

<sup>2</sup> H. Diamond, "Applying the visual double modulation beacon to the airways," *Bureau of Standards Journal of Research*, February, 1930; RP148; *Proc. I.R.E.*, 17, 258; December, 1929.

<sup>3</sup> See J. H. Morecroft, "Principles of Radio Communication," p. 709 *et seq.*



Since the carrier must be resupplied in the same phase as the beacon side bands, a phase shift must be introduced at the transmitting end. The phase relations existing in the transmitter are illustrated in Fig. 6. The first diagram shows the phase relations within the transmitter while the second shows those existing at the receiving point.

The 90-degree phase shift is accomplished in the same way as was

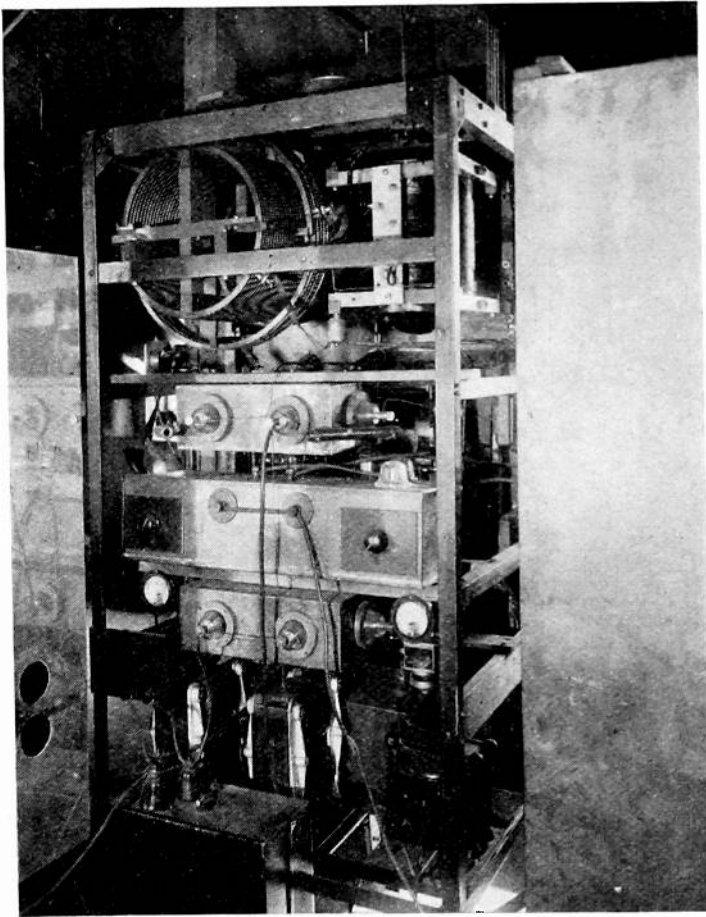

Fig. 9—Radiophone and carrier amplifier unit—rear view.

heretofore used in the four-course beacon. The circuit diagram (Fig. 7) is self-explanatory.

(c) *The Radiophone and Carrier Amplifier*—This amplifier receives its excitation from the master oscillator upon the grids of two fifty-watt tubes in push-pull. These are operated as class C amplifiers and their grids are shunted by a relatively low resistance to insure good regulation. These tubes are the modulated amplifiers and the Heising choke is incorporated into their plate circuit.

The output of these tubes is directly coupled to two one-kilowatt tubes in push-pull, operated as class B amplifiers to minimize distortion. The output of these tubes excites a high capacitance tuned circuit to which the antenna system is inductively coupled. One-half kilowatt of carrier power is supplied to the antenna system from this amplifier. This unit is shown in Figs. 8 and 9.

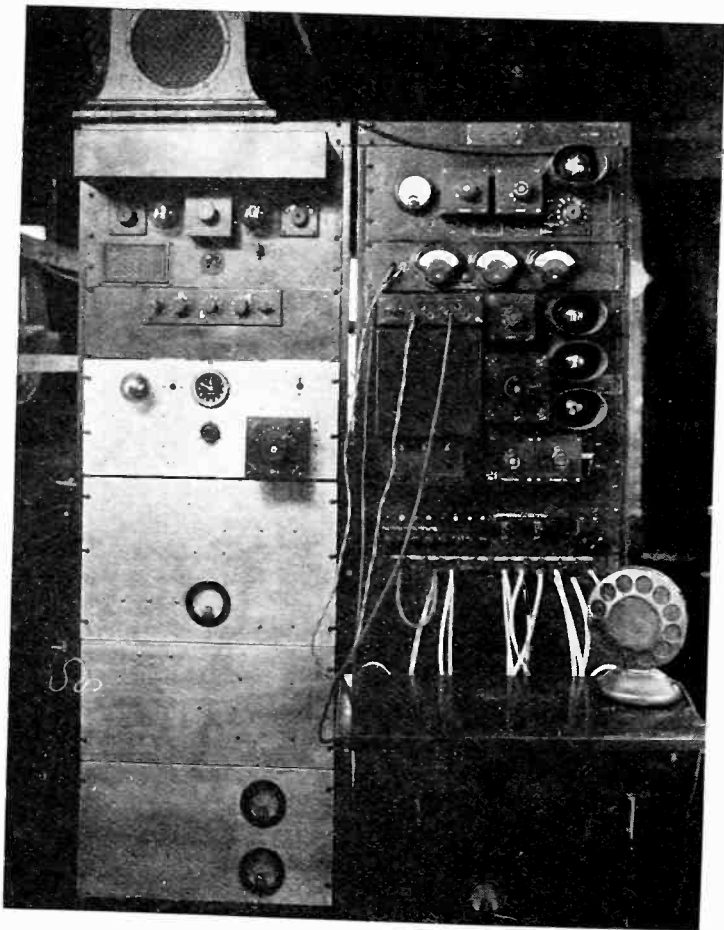

Fig. 10—Speech input equipment.

(d) *The Speech Amplifier*—This amplifier is supplied with speech frequency at a level of 3.75 mw ( $-2$  db) from a conventional two-button microphone and three-stage audio amplifier. The first tube is a fifty-watt tube which is coupled to a UV849 (250-watt modulator tube) through a filter section which rejects frequencies below 250 cycles. At an input level of 3.75 mw the modulation is 60 per cent peak on the modulated amplifiers. The speech input equipment is shown in Fig. 10.

(e) *The Beacon Amplifiers*—The beacon amplifiers are in duplicate

throughout to supply power to the two stators of the goniometer. In each amplifier branch, radio frequency from the master oscillator is supplied to the grids of two fifty-watt screen-grid tubes in push-pull. These tubes act only as buffer amplifiers to prevent reaction of the low reed frequencies on the speech and carrier amplifier.

These tubes are direct coupled to two  $\frac{1}{4}$ -kilowatt tubes operated as

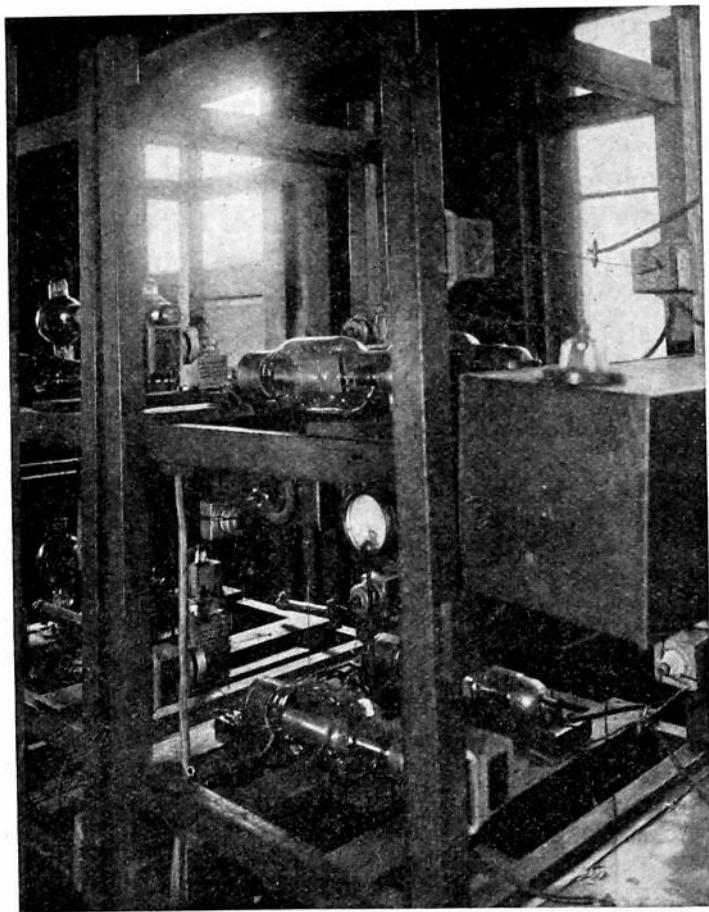

Fig. 11—Range beacon amplifiers.

class C amplifiers. The plates of these latter are fed in push-pull from transformers operated at the reed frequency. The output is taken off in parallel to the goniometer, thereby suppressing the carrier but radiating the side bands.

On account of the poor wave shape of the alternators employed, a filter is incorporated into each transformer output. This eliminates the higher harmonics of the reed frequencies which would cause serious interference in reception of speech signals. The general arrangement of the balanced amplifier is shown in Fig. 11. The upper branch carries

the 86.7-cycle modulation and the lower branch, 65-cycle modulation.

(f) *The Antenna System*—Since the building housing the equipment at the College Park installation is located on the flying field and adjacent to the main runway, the antenna employed was exceedingly limited in dimensions. The loop antennas have a 300-foot base and an apex 70 feet high. This is quite satisfactory for securing the required field intensity for the beacon side bands. The open antenna used during the major portion of the work was of the umbrella type and consequently a very poor radiator. It consisted of four sixty-foot vertical antennas along the main tower with four umbrella sections thirty feet long and at about a 40-degree angle to the vertical. This antenna radiated only about one-third as well as was necessary for satisfactory operation. Its field intensity at a distance of ten miles from the transmitter was  $1850 \mu\text{v}/\text{m}$  instead of the desired  $6500 \mu\text{v}/\text{m}$ . Consequently all preliminary work was done with greatly reduced loop antenna currents to maintain the proper voice-to-beacon signal ratio.

The later work was done with a somewhat better system. This consisted of four flat-top sections, each eighty feet long bisecting the angle of the loop antennas and four sixty-foot lead-in wires to the tower. This gave a field intensity of  $2500 \mu\text{v}/\text{m}$  and resulted in proportionately greater range of transmission.

This completed the transmitter. A detailed diagram of connections is shown in Fig. 12.

### 3. Tests on Completed Unit

The transmitter having been constructed, it was next necessary to carry out a comprehensive series of performance tests to determine its adaptability to the work for which it was designed. In addition to this, a system of routine tests was developed in order to enable a frequent check on the operation of the system as a whole. The more important of these tests are here somewhat briefly described.

*Phase-Shift Unit*—The problem of shifting phases has been covered quite thoroughly in recent papers on radio range beacons.<sup>1,2,4</sup>

On the basis of this work the phase calculations were carried out. Detailed methods of calculation and measurement of the phase displacements in various parts of the transmitter will be found in references (2) and (4). A stabilizing resistance was employed across the grid of each tube to minimize change in phase with changing tube characteristics.

<sup>1</sup> *Loc. cit.*

<sup>2</sup> *Loc. cit.*

<sup>4</sup> Jackson and Bailey, "Development of a visual type radio range transmitter," Proc. I.R.E., December, 1930.

GONIOMETER AND LOOP ANTENNAS

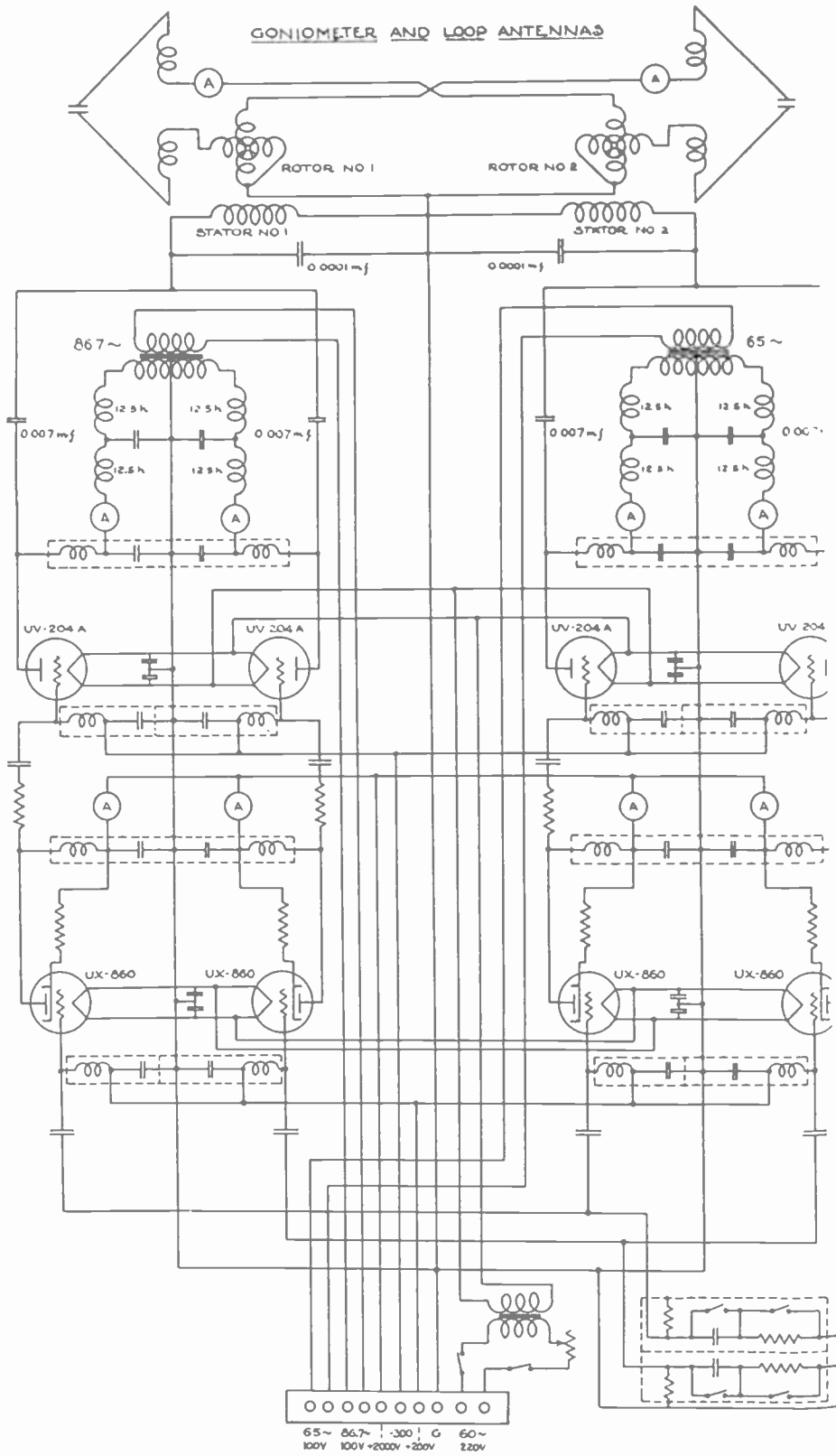

the 86.7-cy-

(f) The

ment at the

adjacent to

limited in d

apex 70 feet

field intensi

the major f

quently a v

antennas al

long and at

ated only a

operation. I

mitter was 1

all prelimin

currents to r

The later

sisted of four

of the loop

This gave a

ately greater

This com

is shown in I

The trans

carry out a c

adaptability

a system of r

check on the

of these tests

Phase-Shi

quite throug

On the ba

Detailed met

placements in

ences (2) and

of each tube

acteristics.

<sup>1</sup> Loc. cit.

<sup>2</sup> Loc. cit.

<sup>4</sup> Jackson a  
ter," Proc. I.R.

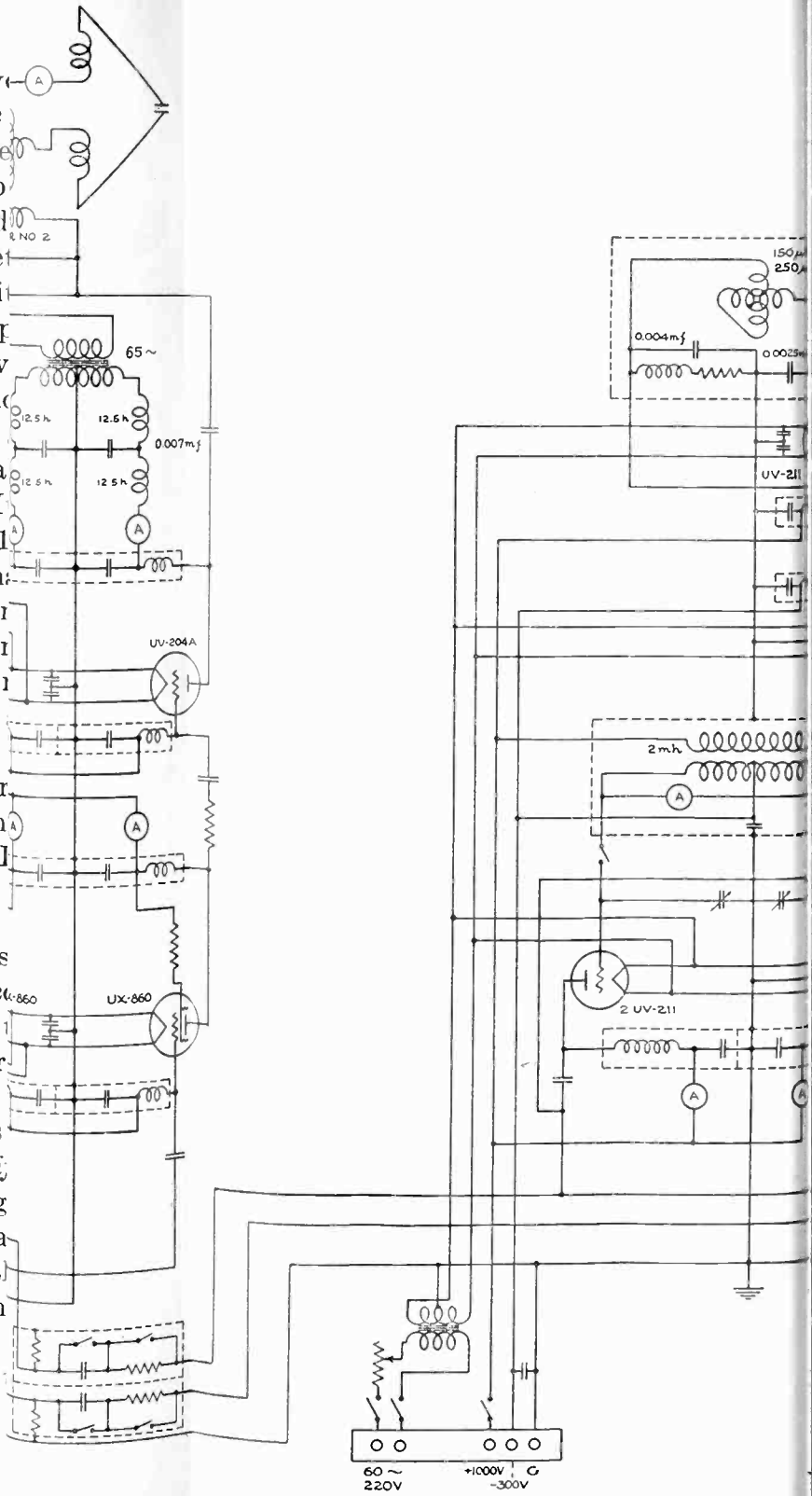
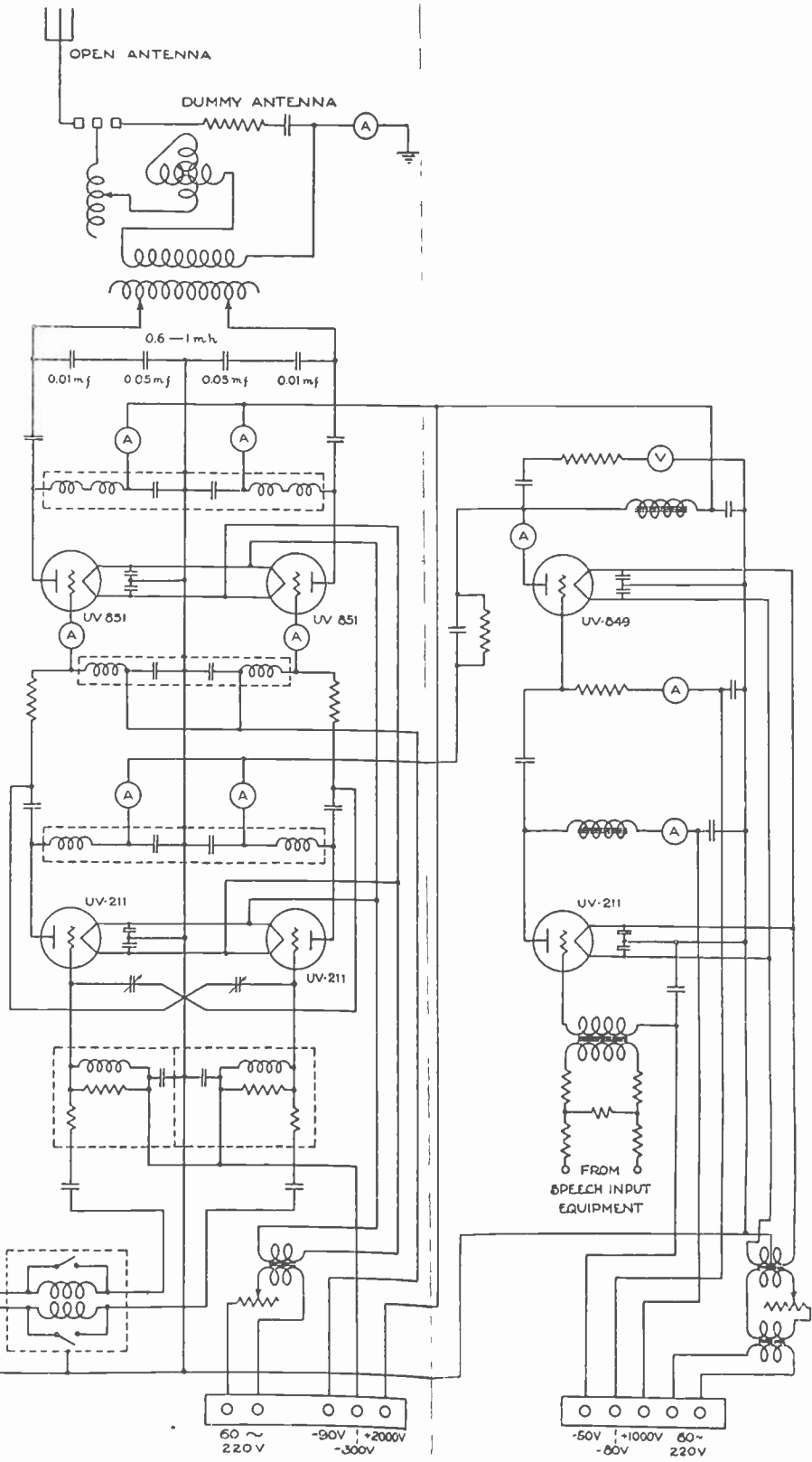
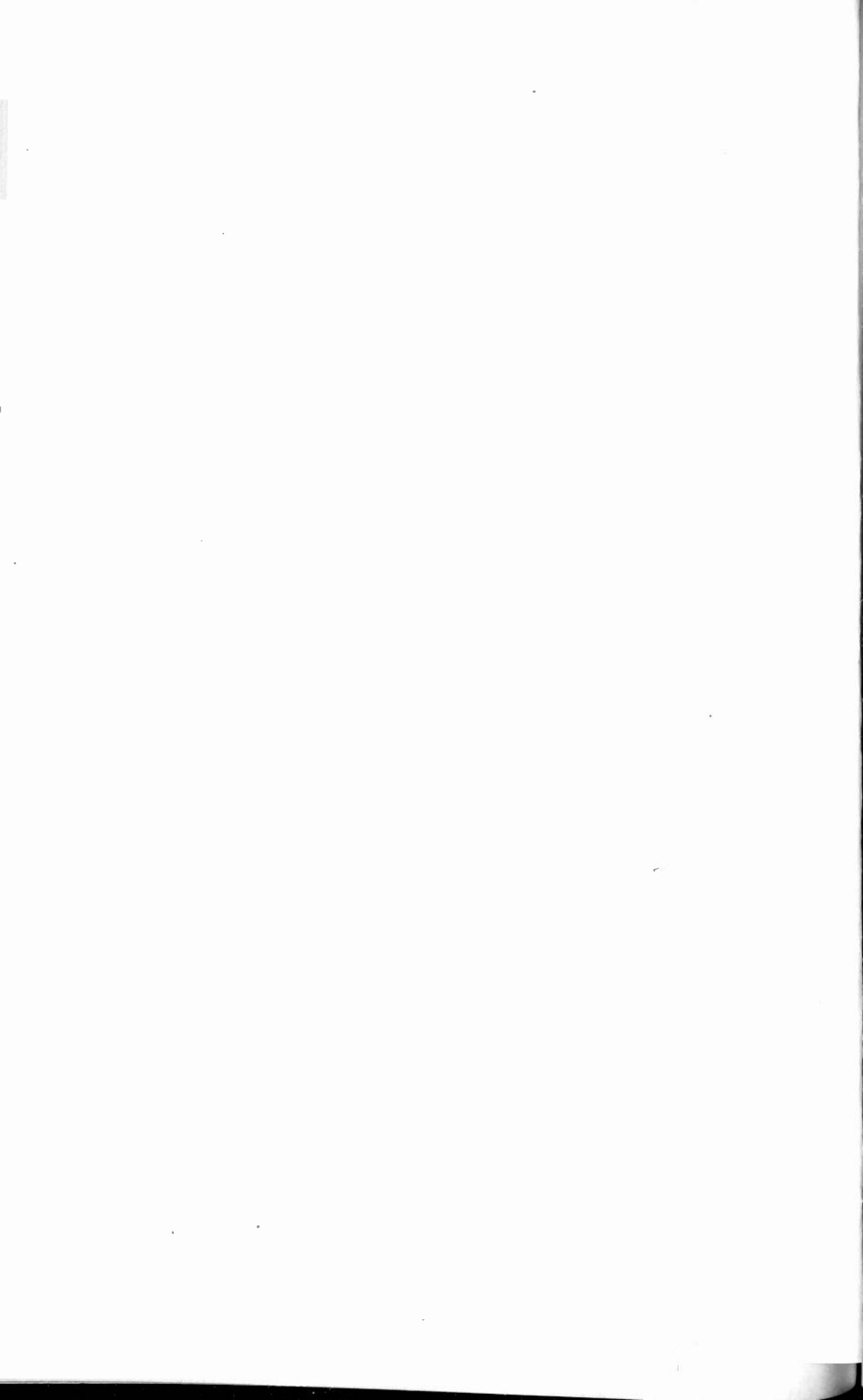

Fig. 12—Detailed electrical circuit diagram of experimental setup.



ing set.





A total phase shift of 90 degrees is required between the phone amplifiers and the range beacon amplifiers. Since tubes of relatively low input impedance were used in the phone amplifier, the major portion of the phase shift (approximately 60 degrees) was introduced into this circuit network. The remaining 30-degree shift was placed in the circuit network to the screen-grid buffer amplifiers.

Previous work on phase adjustments had shown the input impedance of a UV-211 tube acting as a class C amplifier to be approximately

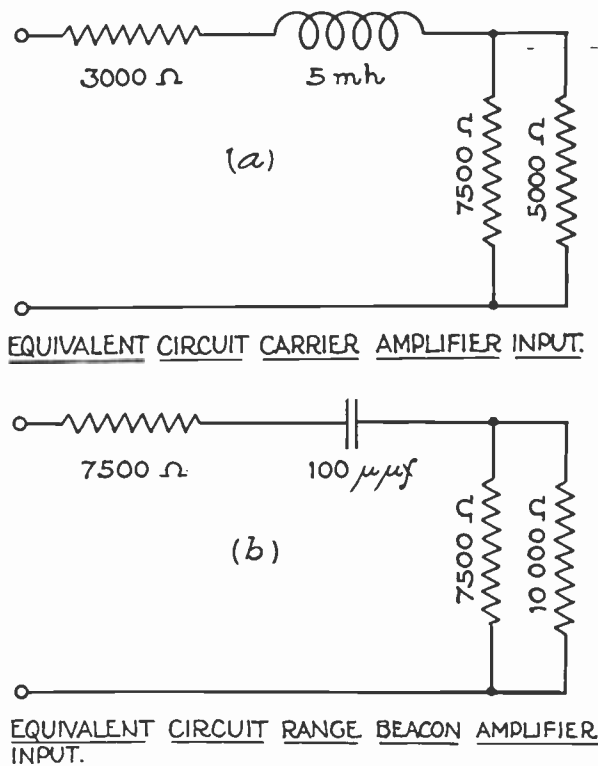

Fig. 13—Equivalent circuits.—(a) Carrier amplifier input. (b) Range beacon amplifier input.

5000 ohms. Likewise two UX-860 tubes in parallel have an input impedance of 10,000 ohms. Neglecting tube capacity, the equivalent circuit of the phone branch would be that of Fig. 13(a) and that of the range beacon branches Fig. 13(b). In the phone branch the total resistance equals 6000 ohms. The inductive reactance,  $X_2$ , equals 9100 ohms at 290 kc. The resultant phase angle ( $\theta_1$ ) is therefore 56 degrees. Similarly the beacon branches have an equivalent resistance of 9280 ohms. The capacitive reactance,  $X_c$ , equals 5500 ohms. The phase angle ( $\theta_2$ ) is therefore equal to 30 degrees. Consequently the total phase shift is 87 degrees or approximately 90 degrees. Since the resultant detected

signal varies proportionately to the sine of  $\theta$ , variations of a few degrees either way make no apparent difference in signal strength.

Methods of checking these phase adjustments by measurements have been referred to previously. However, it was found more convenient to utilize a method which has not heretofore been described. Since the detected signal strength is a function of the phase relationship, the first measurements were made by observing the reed indicator deflections for various phase angles. This provided a rough check and was very valuable in securing a rough adjustment to somewhere near

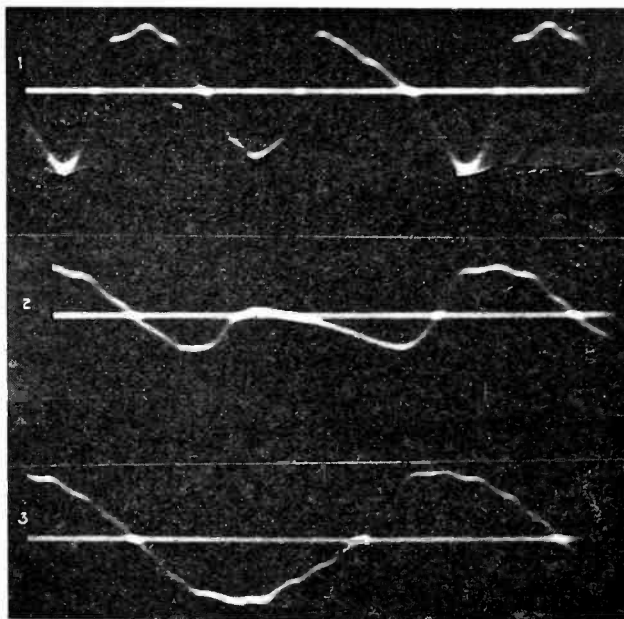

Fig. 14—Oscillograms showing means of checking phase relations:

- (1) Carrier approximately 5 degrees from correct phase. Successive peaks have almost same amplitude.
- (2) Carrier 30 degrees from correct phase. Note decided drop in center peak.
- (3) Carrier 90 degrees from correct phase. Center peak completely reversed.

the desired value. However, the fact already mentioned, namely that the variation is proportional to the sine of  $\theta$ , made a close adjustment impossible by this means.

In order to secure a sharper indication, the output of the receiving set was connected to an oscillograph. As the phase changes from the optimum value, the second harmonic term begins to predominate and when the phase is 90 degrees from the correct value, the double frequency alone will appear, as has been shown previously. Using the oscillograph in this manner, it was possible to check the previous data very closely. However, the presence of a second harmonic voltage, even at optimum conditions, made this check but little better than the use

of reeds. It was noticed during these measurements that the position of poorest phase relationship was quite critical. When the phase was exactly 90 degrees, the double frequency would be very sharply defined, but a slight shift would cause an immediate drop in the alternate voltage peaks.

It was decided to utilize this phenomenon, so a diode detector was closely coupled to the loop antenna system and to the open antenna system. Since the pick-up from the loop antenna was now purely inductive, the inherent phase shift introduced by radiation from the loop antenna did not occur. Consequently, when the phases were so adjusted as to give maximum detected signal in a distant receiver, they were giving the minimum or double-frequency signal in the output of

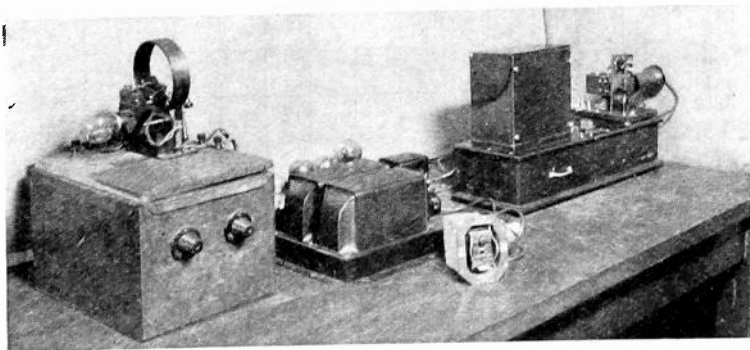

Fig. 15—Equipment used to check phase relations.

the local rectifier. This output was amplified and observed on an oscillograph. The indication of optimum conditions was now exceedingly sharp. This is shown in Fig. 14. Three different phase adjustments are shown. The ratio of carrier to side band was very high for the conditions under which these oscillograms were taken, and the detector was considerably overloaded with carrier in order to give a reasonable vibrator deflection. However, this is not important, since the phase is not determined by the wave shape but merely by the height of successive voltage peaks.

The equipment used to obtain these checks is illustrated in Fig. 15. A detector tube shown on the left in the photograph is coupled loosely to the two antenna systems by the coil shown immediately above it. This tube is operated as a Fleming valve and its output is amplified by means of the two-stage power amplifier to a magnitude sufficient to operate the oscillograph. It is necessary to locate the pick-up coil with some care in order that the ratio of carrier and beacon side bands shall be satisfactory.

In beacon installations along the airways, it would not be economically possible to install an oscillograph at each station for a continuous phase check. In such cases, after the adjustment is once made for optimum relationship, a reed indicator may be substituted for the oscillograph. The reed indicator is unaffected by the double frequency and so long as the indicator does not vibrate, the phase is well within the desired limits.

*Speech Amplifier and Phone Unit*—With the exception of a series of fidelity graphs, no special tests were made on the speech equipment. Fig. 16 shows a series of fidelity measurements at different points in the system. These tests were all made by means of a variable frequency

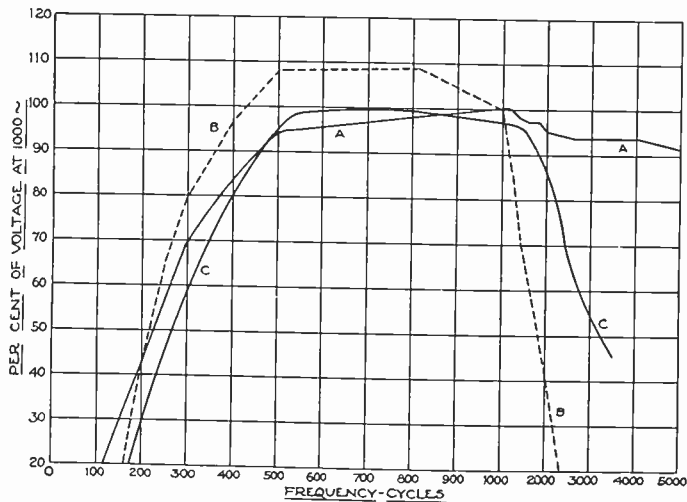

Fig. 16—Fidelity characteristics of speech equipment.

- (a) Characteristic of speech amplifier system.
- (b) Over-all received characteristic.
- (c) Over-all characteristic corrected for audio amplifier attenuation.

oscillator whose input to the speech equipment was held constant at 3.75 mw ( $-2$  db), while the frequency was varied from 100 cycles to 6000 cycles.

Graph A shows the speech input equipment characteristic as determined by measurement of the voltage across the Heising choke. The action of the filter section in attenuating the low frequencies in the neighborhood of the reed frequencies is quite marked. On the other hand, the reproduction of the higher frequencies in the intelligibility range is very good indeed.

Graph B shows the received signal under the same conditions, employing a standard aircraft receiver. The high frequencies are now attenuated to a considerable degree. This is intentional in the design of the receiver with the idea of reducing atmospheric noises. The intel-

ligibility of speech is dependent to a great degree upon the fidelity of reproduction in this range and the result is a considerable sacrifice of intelligibility in order to obtain some reduction of noise.

Graph *C* shows the received signal corrected for the poor audio-frequency characteristic of the radio receiver. The performance indicated in this graph should be the minimum requirement for aircraft receiving sets.

*Beacon Amplifier Branches*—There are three major requirements for successful operation of the beacon amplifier branches. These are (1) equality of phase shift in the two branches; (2) suppression of carrier in each branch; and (3) fidelity of reproduction of the modulation frequencies. In addition to these, the usual requirements of stability, efficiency, and freedom from parasitic oscillations must be met.

In carrier suppressed beacon transmission, it is essential that the phase of each set of side bands radiated from the loop antennas be identical. Any difference of phase introduced herein would result in a difference of phase between the resupplied carrier and one or the other sets of side bands. This would cause a change of course with variations in the phase of the carrier. Slight variations in carrier phase, due to detuning, are inevitable. Care must therefore be taken to prevent appreciable phase displacement between the two sets of beacon side bands. Consequently, it is necessary to insure that the amplifier branches and goniometer circuits produce the same phase shift, regardless of the goniometer position.

These phase relations are best checked by means of pick-up coils, coupled to the loop antennas and connected to a thermogalvanometer. The procedure is as follows:

With one amplifier branch excited, the goniometer is adjusted to supply current to both loop antenna systems. The coupling coils are then moved until the voltages induced by each loop antenna, as indicated by the galvanometer, are identical. The pick-up coils are then connected in series with the galvanometer, first aiding and then opposing. If the loop antenna currents are in phase, the currents in the two pick-up coils will also be in phase and in one case the current will double, while with the coils opposing no current will flow. This test may be repeated for several goniometer positions and indicates merely the proper operation of the goniometer system.

Both amplifier branches are now excited and modulated with the same reed frequency. The goniometer is set on either 0 or 90 degrees. This directs all of the output of one amplifier into one loop antenna and all of the other into the second loop antenna. Having equalized the pick-up in each coil, the currents are again measured aiding and op-

posing. If the reading of the meter is alternately double that due to one coil and zero, it may safely be assumed that the phase of the two amplifier branches is identical. This satisfies the first requirement. In making this test, it is necessary that the same modulation frequency be used.

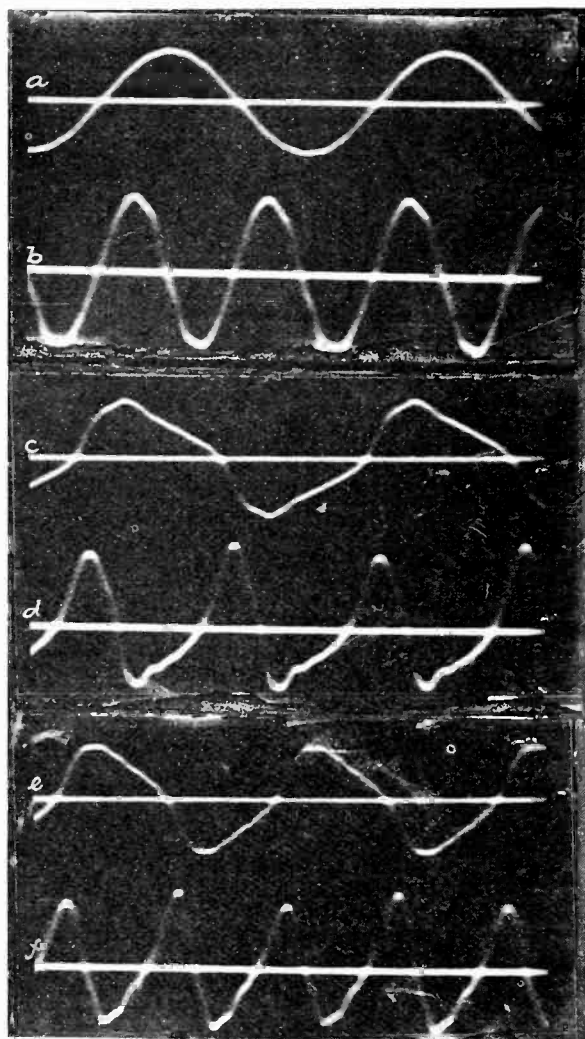

Fig. 17—Oscillograms showing operation of beacon amplifiers.

- (a) 60 cycles from mains applied to beacon amplifier.
- (b) Received signal side bands only.
- (c) 65-cycle alternator, rated load unity p.f.
- (d) Received signal side bands only.
- (e) 86.7-cycle alternator, rated load unity p.f.
- (f) Received signal side bands only.

Since the carrier does not appear in the loop antenna, only the side band frequencies can be compared and these must be the same for a phase measurement to be made.

In checking the percentage of carrier suppression, an oscillograph was connected to the output of a receiving set located some distance from the transmitter and the beacon amplifiers excited one at a time with the open-type antenna disconnected. When suppression was most nearly complete, the detected signal was a pure second harmonic of the reed frequency. Any unbalance would cause alternate voltage peaks to assume different amplitudes and when no suppression occurred, the fundamental frequency alone appeared. This test showed the amplifiers to give very good performance under wide variations of load.

The third test, that of fidelity of reproduction of modulation frequency, was also made with the oscillograph. The results of this test are shown in Fig. 17. These oscillograms were taken with carrier suppressed; consequently the received signal is the second harmonic of the reed-modulation frequency. Graphs *a* and *b* shows the result of applying the 60-cycle line voltage to the transformers modulating the amplifier. This gives a resultant signal which has an excellent wave shape. Graphs *c* and *d* shows the voltage of the 65-cycle alternator under normal load with the resultant badly distorted received signal. Graphs *e* and *f* shows the 86.7-cycle alternator under the same conditions with its resultant signal.

From these oscillograms, it is safe to assume that the amplifiers will produce a good wave form if supplied with a voltage of equally good wave form. A poor alternator, however, will cause audio-frequency harmonics in the transmitted signal, thereby producing frequencies which may interfere with the voice transmission. In spite of the irregular wave shape of the alternators employed in these tests, the resultant signal did not contain sufficient harmonics to impair the speech quality noticeably. It would be very desirable, however, to use alternators with as good a wave form as possible to insure a minimum of interference with the speech reception.

The transformer output in each beacon amplifier is provided with a filter circuit to eliminate frequencies above 200 cycles. However, the major harmonics are the second and third which are below the filter cut-off point. Consequently the filter is of little value. A filter to cut-off at a lower point would require coils whose loss would be excessive. Hence, the best solution is to employ alternators whose wave form is approximately sinusoidal.

Since most of the test work on the transmitter was carried on with the inefficient umbrella-type of open antenna, the output of the beacon amplifiers was proportionately reduced in order to maintain the proper voltage ratio of beacon to phone signals. The carrier field intensity of

this arrangement was  $1850 \mu\text{v}/\text{m}$  at ten miles distance from the transmitter. With a phone modulation of 60 per cent peak, the detected signal voltage is proportional to  $mE^2$  or  $0.6(1850)^2$ , giving a factor of approximately  $2.05 \times 10^6$ , or only ten per cent of that provided in the final design. To maintain the same ratio of beacon-to-phone signals  $E_1$  must equal  $0.19 \times E_0$  or 350 microvolts. The corresponding field intensity is

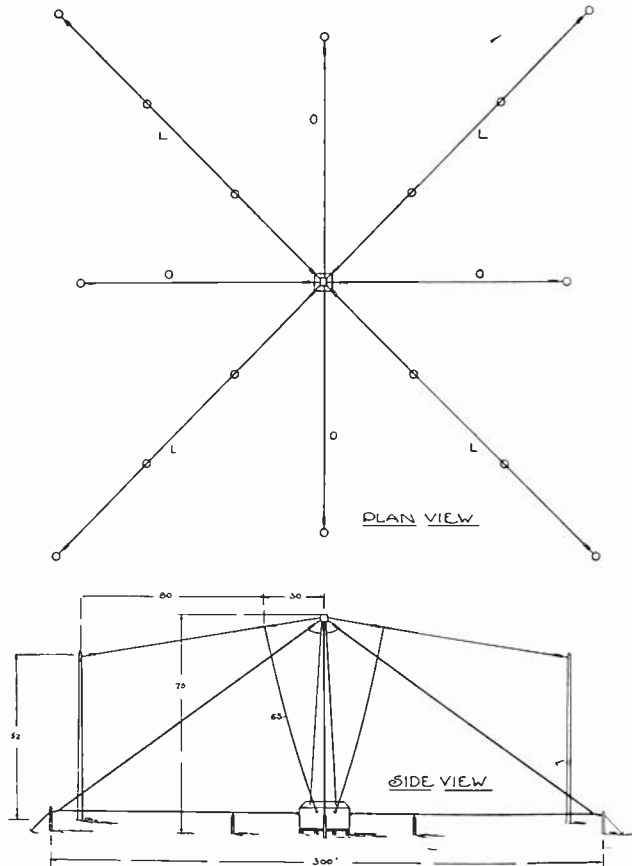

Fig. 18—Antenna system.

$350/\sqrt{2}$  or  $245 \mu\text{v}/\text{m}$ . This is obtained with a loop antenna current of 2 amperes. With this power output, test flights during the months of January, February, and March showed a reliable distance range for the combined transmission of 100 miles. It is estimated, however, that the equivalent distance range under summer conditions would be reduced to the order of 60–75 miles.

*Antenna System*—The type of antenna system employed has already been briefly described. A better idea of its construction may be gained by reference to Fig. 18.

The field intensities obtained from various transmitting systems



are listed in Table I. The approximate reliable service range of each type of transmission is also included in this tabulation.

It has been shown by Smith-Rose and others<sup>5</sup> that the Adcock type of antenna provides directional transmission with a marked reduction in night course shift errors over those due to the use of loop antennas.<sup>6</sup> This led to some consideration of this type of antenna for use with the combined phone and beacon. However, several serious difficulties were encountered and, in consequence thereof, it was not tested. The first of these was the necessity for very accurate control of frequency. A change of more than 100 cycles in 290 kilocycles would seriously affect their operation. While such control can be obtained, the necessity for close tuning of the antenna system introduces disadvantages in operation. A second objection was the high voltage gradient near the ground. The physical size of the antennas being limited, a great deal of loading would be necessary in the base of the down lead. This creates high potentials near the ground and a consequent change of antenna tuning with weather conditions. For these and other reasons the scheme was abandoned and the usual loop antennas used.

TABLE I  
FIELD INTENSITY CHART (VARIOUS TRANSMITTING ARRANGEMENTS)

Type of Transmitter	Antenna System	Nominal Power Rating	Location	Carrier Field Intensity at 10 Miles	Useful Distance Range
Radiophone	T, 125 feet high, 200 feet long	kw 2	Hadley Field, N. J.	$\mu\text{v}/\text{m}$ 6500	Miles 180
Aural Radio Range	Loop $\square$ , 40 feet high, 250-foot base	2	Hadley Field, N. J.	800	100
Visual Radio Range	Loop $\square$ , 40 feet high, 250-foot base	2	Detroit, Mich.	800	150
Visual Radio Range	Loop $\Delta$ , 65 feet high, 300-foot base	2	College Park, Md.	800	150
Simultaneous Phone Range	Loop $\Delta$ , 65 feet high, 300-foot base; vertical umbrellas, 60 feet high	3/4	College Park, Md.	1850	75
Simultaneous Phone Range	Loop $\Delta$ , 65 feet high, 300-foot base; vertical, 75 feet high, 180-foot flat top	3/4	College Park, Md.	2500	100
Simultaneous Phone Range	Loop $\Delta$ , 40 feet high, 300-foot base; vertical, 70 feet high, 160-foot flat top	3	College Park, Md.	6000 <sup>1</sup>	180 <sup>1</sup>

<sup>1</sup> Estimated value if 2-kw airway radiophone transmitter was employed.

Table I includes the field intensities obtained from these loop antennas for various amounts of current. Since the magnitude of the field intensity determines the percentage modulation at any point, it

<sup>5</sup> R. L. Smith-Rose and R. H. Barfield, "The cause and elimination of night errors in radio direction finding," *Jour. I.E.E.* (London), 64, 831-843; August, 1926.

<sup>6</sup> H. Pratt, "Apparent night variations with crossed-coil radio beacons," *Proc. I.R.E.*, 16, 653; May, 1928.

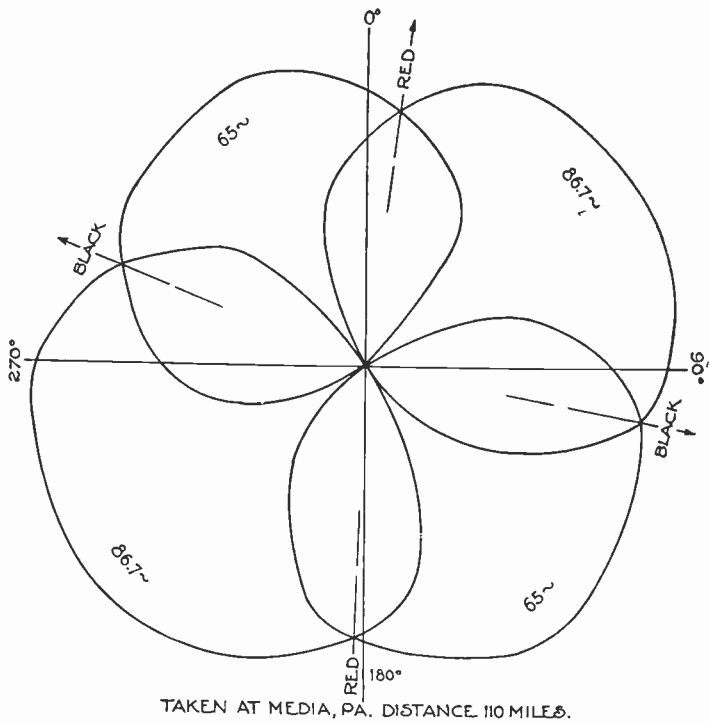
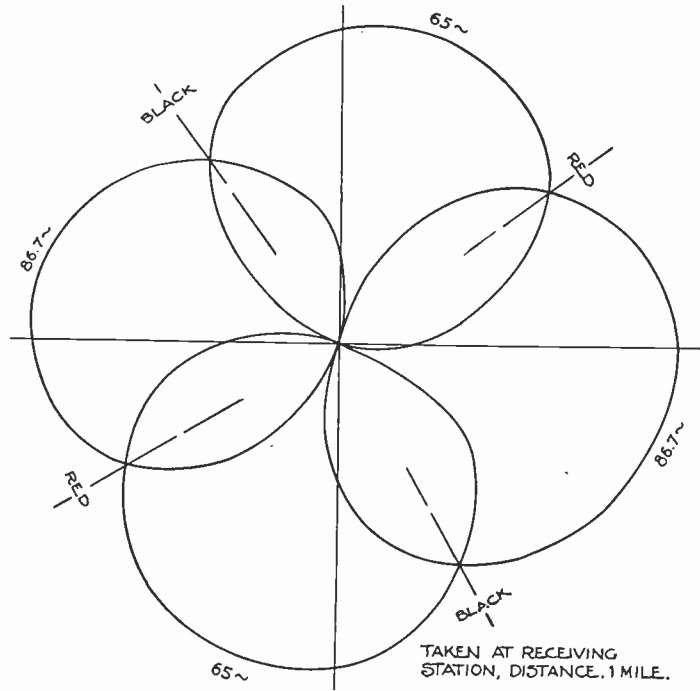

Fig. 19—Polar patterns for combined transmitting set.

may be well to point out that in a four-course beacon with no course bending employed, the field intensity of both pairs of side bands is independent of the angular relation with respect to the loop antennas. This means that the percentage modulation remains constant regardless of the airplane's position. Such a condition is necessary for satisfactory adjustment of the phone-to-beacon signal ratio.

The received space pattern of this type of beacon with carrier suppressed and resupplied by an open antenna consists of figures-of-eight of which the elements are circles rather than the ellipses secured with the usual visual range beacon. This results in broadening the equisignal zone by about fifty per cent. This is not objectionable, as other means of course sharpening may be employed if it seems advisable.

Two received space patterns are shown in Fig. 19. One of these was taken at approximately one mile from the transmitter and the other at about 110 miles. It will be noticed that these are very symmetrical and show no trace of undesirable lobes or irregularities.

An important consideration in the construction of the open antenna system is the prevention of coupling to the loop antennas. Any coupling present will distort the space pattern. In fact, it is this coupling effect which is employed to bend the courses of the airways radio range stations. Consequently the antenna structure must be rigidly anchored and braced against the wind. Any lead-in wires or tie wires must likewise be rigidly supported. The open antenna was supported as far away from the central tower as possible to prevent change of capacity due to weather conditions.

In all systems, no matter how symmetrically disposed, some coupling will be present. This must be balanced out, the balance being accomplished by swinging one antenna down lead until normal antenna current in the open system induced no current in either loop antenna. Once this was attained, the down lead was rigidly anchored in the zero coupling position. With a properly braced antenna system, no difficulty is encountered due to swinging antennas. Fig. 18 shows in detail the essentials of the antenna structure.

#### IV. THE RECEPTION PROBLEM

The problem of receiving the combined signals in the airplane and properly separating them required a different method of attack than that employed in the design of the transmitter. As previously mentioned, receiving set equipment on airplanes has become standardized to a certain degree and every effort was made to provide a transmission system which would require a minimum amount of change in the aircraft equipment. In addition to this, the limitations on receiving set

design because of weight and space considerations are quite severe. Present-day receiving sets are built to meet these limitations and it was felt that a change in design of any considerable extent would probably result in failure to meet the space and weight requirements. In spite of this handicap the problem has been dealt with quite satisfactorily with but little increase in the equipment carried in the airplane.

At the present time the antenna on the airplane is either a vertical pole, five to six feet in length, or a rigid flat-top antenna system whose effective height is approximately equivalent to that of the vertical pole. This, together with the comparatively low power output of the airways radiophone and range beacon transmitters, necessitates high sensitivity in the receiving set and a high static-to-signal ratio. A major advantage of the present visual beacon system is its freedom from interference even under severe atmospheric conditions. This, however, is true only so long as the receiving set is not overloaded by the combined signal and static voltages. In order to insure freedom from interference, a high overload factor must be provided. This is limited by the weight requirements, which necessitate low power tubes and small batteries or dynamotors. When receiving the combined signal with both voice and beacon modulation, the signal voltage handled by the receiving set is much greater than encountered in reception of the beacon modulation alone. This is true even when no voice modulation is supplied, due to the presence of the carrier which must be of sufficient strength to provide for both modulations at all times. This means that a receiving set, which is used to receive the combined transmission, operates much nearer to its overload point than when the same receiving set is used to receive the visual beacon signals alone.

It is true that the visual beacon signals are of low magnitude in proportion to the voice signals, so that in so far as voice reception or reception of aural beacon signals is concerned the overload point is altered but slightly in comparison with the point of overload for the combined transmission. Overloading of the receiving set in reception of voice or aural beacon signals is not serious since the ear does not notice distortion until it becomes quite severe. The reeds, though, will give erratic indications if the overload point is reached. However, there is present an effect which offsets to some extent this undesirable condition. When no voice signals are being transmitted, the percentage modulation of the received carrier is quite low. An interfering signal or atmospheric disturbance tends to modulate this carrier with its own frequency. So long as the sum of the modulations due to the reed frequencies and the interfering signal does not exceed 100 per cent, the

transient in the receiving set is of a minor nature and the reed indicator will not be disturbed. Flight tests have shown that in spite of the fact that the receiving set operates nearer to its overload point, the reeds are actually freer from flutter due to interfering signals than is the case in reception of the ordinary visual range beacon.

The preliminary receiving tests were made with a detector and two-stage audio amplifier and within a short distance of the transmitter.

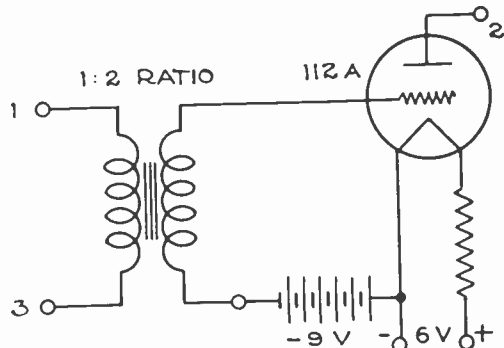

AMPLIFIER UNIT, FOR USE WITH STANDARD RADIO RECEIVER.

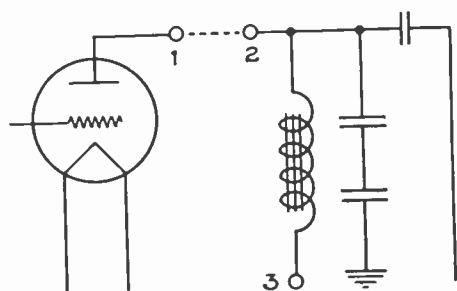

OUTPUT CIRCUIT OF AIRCRAFT RADIO RECEIVER SHOWING MEANS OF CONNECTING AMPLIFIER.

Fig. 20—Electrical circuit arrangement of amplifier for receiving set.

This gave very good results, and since weight was no object, the set was designed for high overload, consequently no difficulty was encountered.

When tests were made at a distance from the transmitter, a conventional aircraft receiving set was employed with a separate audio amplifier. This amplifier had a higher amplification than that normally employed, hence the detector signal voltage was lower than would otherwise be necessary. Results of these test were so free from overloading effects that it was felt that the conventional receiver could be employed for this work if the audio amplification were increased by the addition of a single amplifier stage. Accordingly an amplifier was built and connected to the receiver. Fig. 20 shows the circuit arrangement

and the method of connecting it to the receiving set employed. This amplifier required only a small C battery in addition to those already carried for the receiver and the percentage increase in load on the batteries was small in comparison with the increased overload capacity now available. No loss in stability was encountered in the use of this amplifier. The receiver operated in the normal manner with the exception of a decided increase in the permissible static-to-signal ratio.

During conditions of low static disturbance, even this amplifier is unnecessary and numerous flights have been made employing only the conventional radio receiver. However, it is felt that in order to retain the desirable freedom from interference which the visual range beacon provides, it is well worth while to include the extra amplifier as part of the receiving equipment. Tests on this system were all made with an

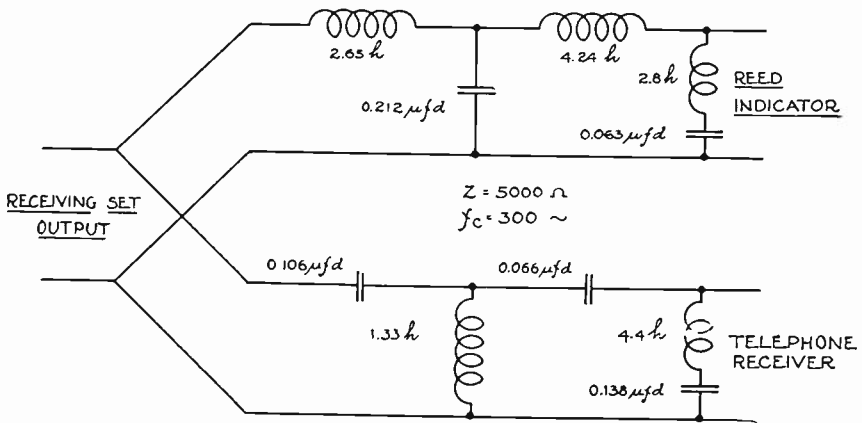

Fig. 21—Filter unit for use on airplane.

aircraft receiving set which was available at the time the research was begun. Since that time, several new receiving sets have been developed with higher overload points and improved audio-frequency characteristics. When such receiving sets are used to receive the combined service, the amplifier should not be necessary and the speech quality and general intelligibility should be greatly improved.

*Filter Units*—The output of the receiving set may be directly connected to a reed course indicator and head telephones with no additional apparatus. This will cause a low-frequency hum in the telephones and certain voice frequencies which are harmonics of the reed frequencies will cause a slight flutter in the indicator. Neither of these effects are serious and they can be neglected. They may be entirely eliminated by the use of a suitable filter circuit which provides the reeds with reed frequencies only and the head telephones with frequencies over 250 cycles only. A filter suitable for use with the receiving set employed is shown in Fig. 21. This has a cut-off at 300 cycles and a char-

acteristic impedance of 5000 ohms. Its use insures steady operation of the reed indicator and silence in the headphones during the period when no voice broadcast is made. Oscillographic studies show an additional advantage. By properly matching the impedance of the three components—the receiving set, the headphones, and the reed indicator—the distortion of the received signal is markedly reduced, resulting in better intelligibility. This advantage is quite important and recommends its employment whenever head telephones and reed indicators are to be connected simultaneously to a receiving set output.

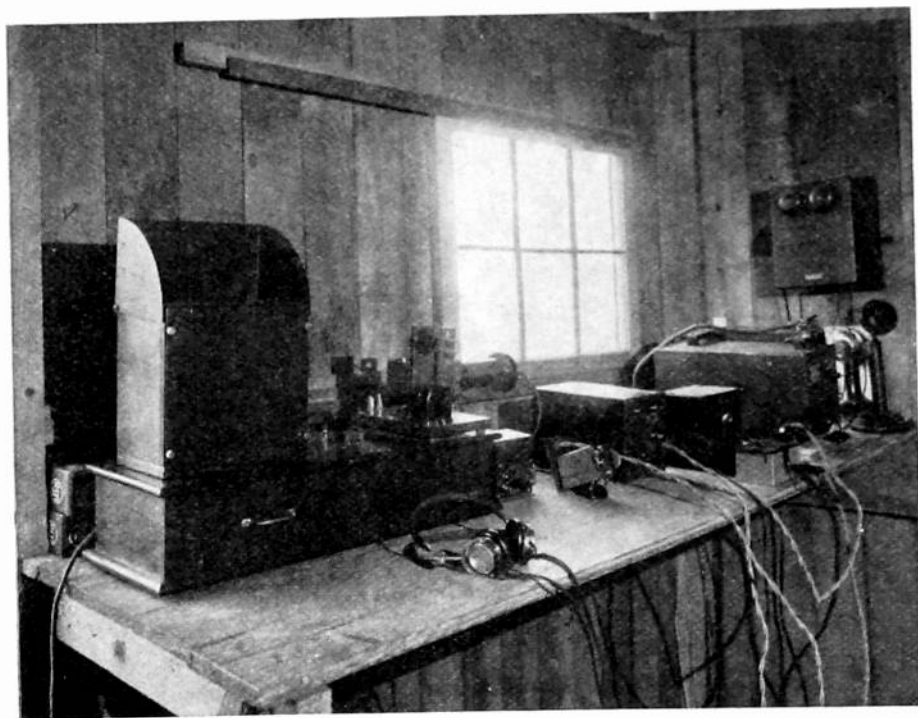

Fig. 22—Receiving station equipment.

In addition to this particular filter, several others were tried. The results indicated that wide latitude in design is permissible.

The use of a filter of this type is also advantageous in that it permits employment of automatic volume control, details of which have recently been published.<sup>7</sup> This type of volume control has a decided advantage over other systems since it is applicable regardless of whether signals are being received from the visual range beacons or the combined visual beacon and phone transmitter.

The equipment used at the receiving station during these tests is shown in Fig. 22. From right to left it shows the aircraft radio receiver,

<sup>7</sup> W. S. Hinman, "Automatic volume control for aircraft receivers," *Bureau of Standards Journal of Research*, 7, July, 1931, RP330.

the one-stage amplifier and the receiving set control box, the output filter unit, the reed indicator, an impedance matching transformer, and the oscillograph used to check the operation of the system. The filter unit and the one-stage amplifier are shown to better advantage in Fig. 23.

While it is assumed that the reed course indicator<sup>8</sup> will be used with this system, any other type of course indicator utilizing low-frequency alternating voltages for indication will serve equally well. For example, the reed converter, together with a zero-center pointer-type instrument,<sup>9</sup> has been successfully employed in various tests with no change in either the transmitting or receiving equipment.

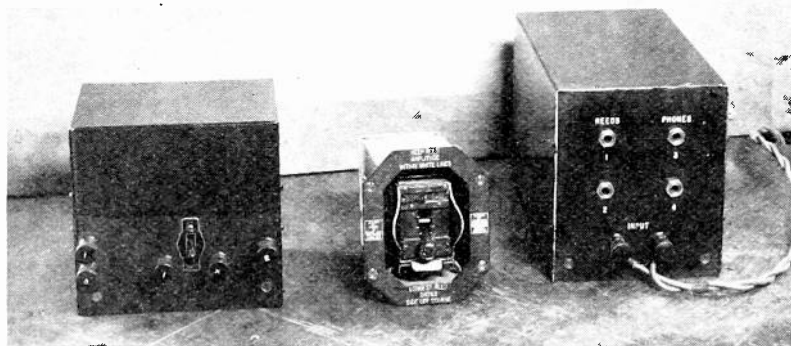

Fig. 23—Filter unit and amplifier.

## V. FURTHER WORK

### 1. Course Bending

The courses of the combined system may be adjusted to fit the airways in the same manner employed on the present beacon system.<sup>2</sup>

The open antenna system necessary for shifting the 90-degree courses is already in place. It is only necessary to apply a modulation of the proper reed frequency to the carrier supplied to this antenna. Since the phase of the radio-frequency voltages is already the optimum relation for shifting the course, no change is required other than proper control of the percentage modulation. However, the phase of the applied reed-frequency voltage must be such that it will add in the correct phase in the radio receiver. This can best be determined by the

<sup>8</sup> F. W. Dunmore, "A tuned reed course indicator for the four- and twelve-course radio range," Bureau of Standards Research Paper No. 160. Also Proc. I.R.E., 18, 963-982; June, 1930.

<sup>9</sup> F. W. Dunmore, "A course indicator of pointer type for the visual radio-range-beacon system," *Bureau of Standards Journal of Research*, 7, July, 1931; RP336.

<sup>2</sup> *Loc. cit.*



use of an oscillograph at the receiving point. By observation of the phase of the detected signal with and without modulation of the carrier, it is possible to make this adjustment quite accurately. The amount of modulation required on the carrier will be quite low, necessitating the use of small audio-frequency currents. The phase can, therefore, be controlled by chokes and condensers when necessary in the same manner as the radio-frequency phases are adjusted. The low percentage modulation required also insures that the voice frequencies will not be affected by its presence in the speech circuits.

## 2. Application of Simultaneous Transmission to the Twelve-Course Radio Range Beacon

While all of the recent work on simultaneous transmission has been performed on the four-course beacon, the same principle may be applied to the twelve-course beacon.

It has already been demonstrated that this may be accomplished by supplying the three amplifier branches in time phase, thereby suppressing the carrier. The carrier and voice would then be supplied over an open antenna system. This would probably be unsatisfactory due to goniometer coupling and general unavoidable dissymmetry. The preferred plan would be to utilize three amplifier branches modulated to the reed frequencies and suppressing the carrier within themselves. The three sets of side bands would then be supplied to the loop antennas through a three-stator goniometer. This method permits of a better check on carrier suppression and also permits course alignment without a reintroduction of carrier due to dissymmetry.

With such a system, it probably would be necessary to employ link circuits in the goniometer stators to prevent intercoupling. The action of these circuits has been described in detail in a previous paper.<sup>1</sup> With the exception of the use of these link circuits, it is apparent that no change in design is necessary to employ the twelve-course beacon.

The overloading of the receiving set would be increased due to the presence of a third unused frequency, but the percentage of this is so small compared with the amount of carrier present that the effect should be negligible.

## 3. Possible Modifications of Design

(a) *Carrier Suppression*—Several modified designs can be employed which would give substantially the same results. For example, it is unnecessary to use a complete balanced amplifier system. This was merely a matter of convenience in the installation at College Park. If the more

<sup>1</sup> *Loc. cit.*

usual single-sided amplifier is used, the carrier may be suppressed in the goniometer or in a tuned circuit within the amplifier. This is accomplished by supplying the grids of the modulated amplifiers in parallel and the alternating plate voltage in push-pull. The radio-frequency output is supplied to the extremities of a tuned circuit (or the goniometer) in push-pull. This method is probably somewhat simpler than that previously described. Either method will produce the same results.

(b) *Course Stability* The present method of modulation on the last tubes of the beacon amplifiers might profitably be changed in a final design. With this method of modulating, any change in plate voltage will produce a change in the course. In an experimental transmitter this made no difference as the voltage could be kept constant. In a remote-controlled installation, this would probably not be satisfactory.

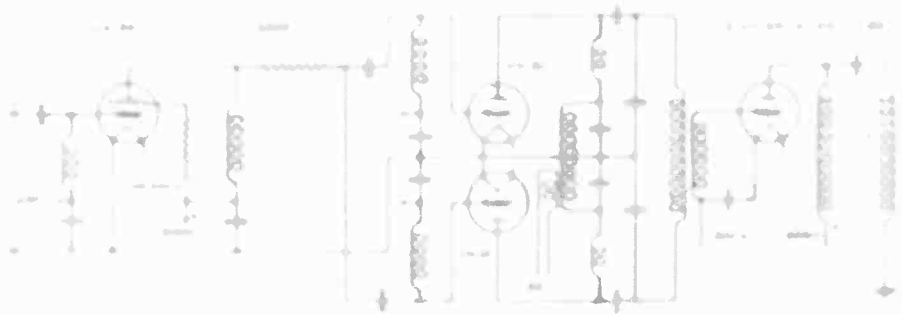

Fig. 24. Modified range beacon amplifier circuit showing: (1) carrier suppression in tuned circuit, (2) elimination of balanced amplifiers, and (3) class C power amplifier for stability.

unless voltage regulators were provided for the modulation frequency alternators. However, if the modulation and carrier suppression is accomplished in an intermediate stage and the last stage is a class C amplifier, then the courses will be independent of the alternator voltage. Furthermore, the plate voltage on the class C amplifiers being from the same source will vary the same amount on each amplifier branch. A change in this voltage will change the transmitted power but not the course. This is the method employed in the present range beacons to reduce the possibility of a course change.

Fig. 24 shows the modified beacon amplifier with modulation on an intermediate stage. It also illustrates the second means of carrier suppression without the use of balanced amplifiers.

The use of class C amplifiers after a modulating stage introduces harmonics which are undesirable. The increased stability of service offered by their use, however, may be sufficiently great to outweigh the effects of harmonic distortion.

## VI. FLIGHT TESTS

The proof of a satisfactory design for an airways transmitting system lies in the results of exhaustive flight tests. Such flight tests on the College Park installation have shown the service rendered to be consistently good. The quality of speech is superior to that usually encountered in aircraft reception and the freedom from interference in the reception of the beacon signals is very marked. On several flights over Aberdeen, Maryland, interfering code signals made the use of head telephones unbearable. At the same time the reeds were entirely free from flutter.

All test flights were made with an early model of commercial aircraft radio receiver. A filter unit was used but not the extra stage of amplification. This, together with the fact that flights were made along the Atlantic seaboard with excessive marine radio interference, meant that the ratio of signal to noise was very unfavorable. In spite of this, the beacon service was remarkably free from interruption, although frequently the interference completely blanketed the voice signals.

Since these tests proved so satisfactory, it is reasonable to assume that an airplane equipped with an amplifier in addition to the standard receiving set, or with a later type of aircraft radio receiver designed with a higher overload point, can expect to receive a thoroughly satisfactory radio telephone and range beacon service with the type of transmitting set herein described.

## VII. ACKNOWLEDGMENTS

The authors wish to acknowledge the assistance rendered by the other members of the Research Division of the Aeronautics Branch during the progress of this research.

Particular acknowledgment is made to Mr. H. Diamond's suggestions in initiating the work on the combined phone and beacon system, and for many subsequent suggestions in regard to circuit arrangements.

The assistance of the engineering staff of the Bell Telephone Laboratories in collaborating in the design of a circuit arrangement which formed the basis of the research is also acknowledged.

The speech input equipment used in the transmitter was furnished by the Chesapeake and Potomac Telephone Company. It was formerly part of the equipment of station WCAP at one time operated by them in Washington, D. C.

Credit is also due to Mr. Justus U. Steele for assistance in field measurement work and flight tests, and to Mr. H. M. Horsman for mechanical work in the construction of the various units.

## A MECHANICALLY RESONANT TRANSFORMER\*

By

ROSS GUNN

(Naval Research Laboratory, Bellevue, Anacostia, D.C.)

*Summary.*—A transformer for use in the audio-frequency band is described whose output potential is remarkably selective to frequency. In its simplest form the diaphragm of a telephone receiver is replaced by a tuned reed of magnetic material. When a frequency is applied to the receiver corresponding to the natural frequency of the reed it is set in vibration and its motion is employed to generate potentials in another receiver unit adjacent to the tuned reed. A typical transformer had a selectivity of 115 at a frequency of 1500 cycles.

THE technical progress made in the radio and allied fields during the past few years has made imperative the development of sharply selective audio-frequency filter chains and selectors. Devices which employed electrically tuned circuits have heretofore frequently been used in the output circuit of a radio receiving set to select the beat frequency of a desired transmitter and eliminate all other frequencies, including, perhaps, an appreciable amount of the received static interference. These selective systems have also been extensively employed in remote control problems when only a single communication channel is available, and several operations must be performed by the use of some form of frequency selection. Usually the transmitter is an audio oscillator capable of producing the selected frequencies and connected to the line or to the modulator of the radio transmitter. At the receiver the usual amplifiers and detectors are employed together with tuned audio selector units appropriately connected to their output circuits. There are certain objections to the audio selective systems which employ tuned electrical elements, particularly when one or more filter units are interconnected by vacuum tube amplifiers. Moreover, when the electrical units must be very sharply selective to frequency their size and cost of construction increase very rapidly.

In the present paper, there is described a resonant transformer which is particularly suitable for use in control work and can be modified in such a manner that it is useful in telegraphy if the transmitted and received heterodyne frequencies can be held sufficiently constant. The device is made up of three essential parts: (a) an exciting or motor unit, (b) a mechanically resonant system, (c) an excited or generator

\* Decimal classification: R382.1. Original manuscript received by the Institute, September 24, 1931.

unit. A compact and simple form of the transformer is shown in Fig. 1 in which both the exciting and excited units are similar telephone receivers while the mechanically resonant system is a tuned reed rigidly mounted on a ring and arranged to vibrate between the pole pieces of the telephone receivers. A typical set-up employing the new transformer is shown in Fig. 2 and if a constant a-c voltage of variable fre-



Fig. 1—Exploded view, showing tuned reed, motor, and generator units.

quency is impressed on the input of the first tube and the output voltage is plotted as a function of the applied frequency, then a curve of the type shown in Fig. 3 is obtained. This curve shows well the rather extraordinary frequency selectivity of the transformer and shows that on the low-frequency side of the peak that a frequency change of only 0.33 percent will double the response voltage. The usual definition for

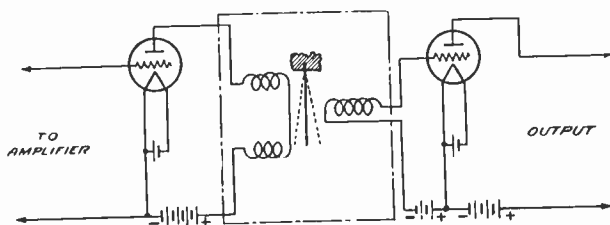

Fig. 2

the selectivity  $S$ , of a tuned system is given by  $S = f_r / f_1 - f_2$ , where  $f_r$  is the frequency of the tuned system at resonance,  $f_1$  the frequency above resonance where the oscillating current is 70.7 per cent that at resonance, and  $f_2$  the corresponding frequency below resonance. If we calculate the selectivity from this relation we find that the selectivity is 115, a value comparable to the selectivity of a moderately good radio circuit.

Reference to Fig. 3 shows that the response for frequencies only a few cycles different from the resonant frequency, is very small. This is

due in no small degree to the fact that the device has been so designed that there is no coupling between the input and output circuits except by way of the vibrating reed. This property of the transformer is particularly valuable because it may then be used as an interstage coupling transformer without fear of spurious oscillations being set up. The coupling between input and output is maintained at low values by arranging the exciting and excited units so that their magnetic circuits are substantially independent. For example, in the transformer shown in Fig. 1 the two telephone receivers are so placed that the pole pieces of the two units are nearly perpendicular and any stray flux from the exciting unit will not induce a resultant e.m.f. in the excited unit.

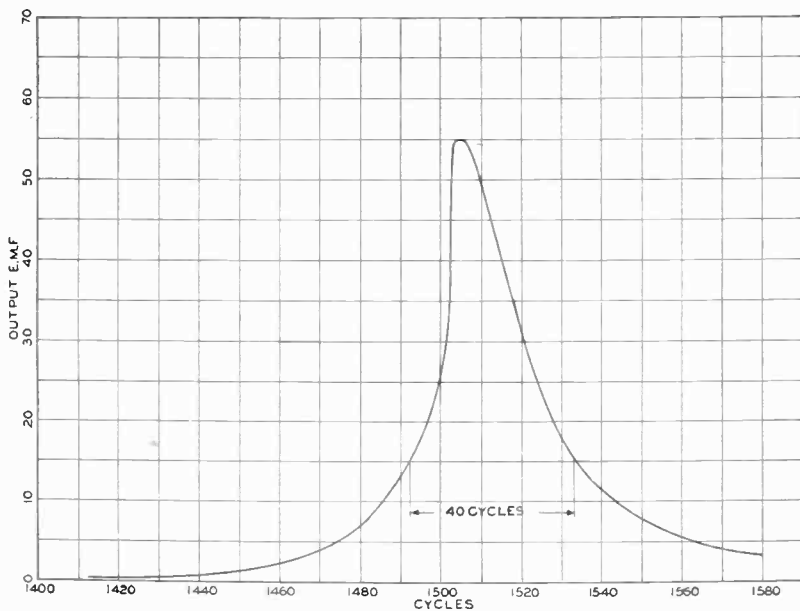

Fig. 3

On account of the sharply resonant nature of the mechanically tuned system it takes a few cycles of the impressed frequency to build up oscillations, and conversely the reed persists in vibrating or "ringing" when the impressed signal is cut off. This is both an advantage and a handicap; an advantage because the device is thereby made relatively insensitive to shock excitation by static or other nonperiodic interference, and a handicap because the low-frequency units cannot be readily adapted to very high speed telegraphy. Actual tests show that code signals are readily handled by the transformer just described up to about 30 words per minute at which speed the "tails" become noticeable to the operator and the dots become blurred.

The transformer finds its most important application, perhaps, in

radio control problems where several distinct operations are to be performed simultaneously. It is clear that a series of transformers may be employed, each tuned to a different frequency and each operating into a blocked vacuum tube with suitable relays in its plate circuit. When a signal is applied to a transformer corresponding to its resonant frequency, a large output e.m.f. is produced which permits the grid of the blocked tube to swing positive during part of the cycle; the plate current increases and the selected relay closes. A typical layout is shown in Fig. 4. The advantage of the system resides, of course, in its complete reliability; there are no contacts in the selective mechanism and if it functions at all it must function at a frequency set by the frequency of the tuned mechanical system.

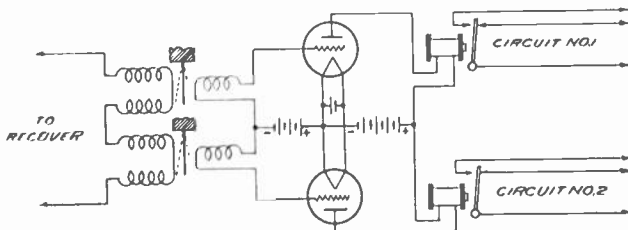

Fig. 4

The frequency of the tuned system evidently depends on the mass of the vibrating system and on the elastic properties of its support so that the resonant frequencies may be chosen anywhere within a comparatively large range. The effect of changing temperatures on the vibrating system can be reduced to very small values by employing material whose Young's modulus is independent of temperature. The width of the resonance curve which depends on the mechanical damping can be controlled to a degree at least by designing the reed so that air friction may play a part in the dissipation of the oscillating energy. In some cases the transformer shell has been made air-tight and the air pressure inside reduced or increased above atmospheric pressure. Such an arrangement permits, at will, either a reduction or increase of selectivity by increasing or decreasing the pressure.

It seems probable that an electrical device as sharply selective to frequency as the transformer here described will have many applications. The use of the device in radiotelegraph circuits will permit the spacing of channels to be as little as 75 cycles with a resulting increase in the number of channels available. Such close spacing is, of course contingent on the stability of the transmitted and received heterodyne frequencies.

## CONCERNING THE INFLUENCE OF THE ELEVEN-YEAR SOLAR ACTIVITY PERIOD UPON THE PROPAGATION OF WAVES IN WIRE- LESS TELEGRAPHY\*

BY

H. PLENDL

(German Experimental Institute for Aërial Navigation, Berlin, Germany)

*Summary*—Researches concerning the propagation of short and border waves, conducted by the German Air-Travel Research Laboratory during the years 1930 and 1931, reveal results which are not quite in harmony with similar, but far more complete, investigations carried out in the years 1927-28.

The suspicion arises that one is here dealing with an influence exerted by the eleven-year period of solar activity upon the propagation of short and border waves, especially as such an influence upon long waves has been repeatedly established. The present work deals with the explanation of these phenomena.

### I. INTRODUCTION

THE solar activity has a recognized average eleven-year period, to which may, for example, be ascribed the variation in sun spot frequency or the changes in the declination or variations in the intensity of the earth's magnetic field. These slow variations of the solar activity exert an influence on the wave propagations of radiotelegraphy. The influence of the eleven-year period of solar activity has been followed experimentally for several years. In the case of short waves, this influence has not so far been closely examined, for two reasons. The most important of these reasons is that the whole field of short-wave technique is still in its infancy. Another is that field strength measurements of short waves are more difficult than those of long waves. Nevertheless, as will be shown in the following, present knowledge of the wave propagation process and the summary of experiences from short-wave engineering permit an expression of opinion concerning the influence of the eleven-year sun period on short-wave propagation. Above all, it is hoped that this report may give suggestions for the collection of pertinent facts in order to consider adequately, later on, our concepts of this influence in the dimensioning of short-wave connections.

For the sake of a better understanding, the most significant of the

\* Decimal classification: R113.5. Original manuscript received by the Institute, July 6, 1931. Translation received by the Institute, September 21, 1931. Two hundred and forty-sixth Report of the German Aëronautical Research Institute, Berlin-Adlershof, Electrotechnical and Wireless Department. Published in *Zeit. für Hochfrequenz.*, 38, 89-97; September, 1931.



recognized evidences concerning solar activity will first be briefly reviewed in order to be able to refer subsequently to the influence of solar activity and its eleven-year period upon *long-wave* propagation. The influence upon *short-wave* propagation will be considered last of all.

## II. SOLAR ACTIVITY

The upper ionized atmosphere (ionization sphere) near the earth's surface plays an important rôle in connection with the propagation of radio waves. The shorter the wave within a range of about 30,000 meters to 10 meters the more evident is this influence of the ionization sphere; that is to say, variations in the conditions of this layer become all the more completely reflected in the propagated wave.

For the creation and composition of the ionization sphere, the sun is primarily responsible. From this is derived the explanation for the great difference in propagation by day and by night, and the significant effect of the season on propagation. But the yearly average of ionization power of the sun is not the same in all years. This power changes with the period of sun activity. It is great in years of great sun activity and less in those of weaker activity. A noticeable influence must consequently be exerted by the solar activity on the propagation of radio waves.

In so far as its origin in the sun is concerned, variations in the sun activity that cause the ionization of the upper atmosphere underly the changes in intensity.

Among such causes, the corpuscular and ultra-violet rays are of first importance.

In connection with corpuscular rays, the solar activity is to be thought of<sup>1</sup> as a swarm of electrically charged particles that are shot outward from the disturbed portion of the sun's surface (sun spots). Under certain conditions, these penetrate into the earth's atmosphere, chiefly in regions surrounding the poles. There they call forth mass movements of electrons and ionized molecules, which give rise to streams that disturb the earth's magnetic field. In the polar regions where magnetic and ionization influences are greatest, the northern lights, which are traced to a regathering after ionization, exhibit secondary evidence of this absorbed ionization. Concerning the nature of the corpuscular ray in its general aspect is the belief that this ray in its totality is nearly neutral, since it is composed of singly ionized calcium atoms surrounded by a swarm of electrons. Calculations show that these electrons reach a speed limit of about  $10^8$  cm./sec.,\* and can

<sup>1</sup> Figures refer to Bibliography.

\* This speed is comparable to the time interval of one to two days between the appearance of large sun spots and strong earth magnetic disturbances.

penetrate into the earth's atmosphere to within a height of 100 km from the earth's surface, which also corresponds to the lower limits of the polar lights. This ray, which emanates from radioactive substances in the sun, is able to penetrate into deeper layers the same as do the rays from the ultra-violet end of the solar spectrum.

In connection with the ultra-violet ray theory, H. B. Maris and E. O. Hulburt<sup>2</sup> believe that for short periods at certain places in the sun's outer surface the normally much hotter deeper parts of the sun's surface become exposed, so that at these spots a much higher temperature than the normal of 6000 degrees prevails. One consequence, among others, would be that these localities radiate an unusually strong ultra-violet light of shorter wavelength, causing the ionization of the atmosphere to penetrate deeper than would be the case without such solar activity. During solar activity the number of agitated and ionized atoms becomes much greater than under normal conditions. But the atoms and molecules which in consequence are hurled upward with great speed become rapidly ionized and as a result very soon come under the influence of the earth's magnetic field. They do not, therefore, attain great heights—even in the polar regions. The southerly spread of the polar lights to latitudes as low as 40 degrees—as has been actually observed during periods of strong solar activity—is in accord with this explanation. Only when the solar activity is at an end, can the numbers of atoms, which during sun activity attained great speeds, reach the higher altitudes and then drift in large numbers to the polar regions thus resulting in unusually strong polar lights.

### III. LONG-WAVE PROPAGATION

In the propagation of long waves, the field strengths of the sending station outside of its immediate neighborhood can be expressed as a function of the distance ( $d$ ) which has somewhat the following form:

$$E = \text{const} \frac{1}{d} \sqrt{\frac{\vartheta}{\sin \vartheta}} e^{-\kappa d} \quad (1)$$

wherein: constant =  $120\pi Jh/\lambda$ , the geocentric† angle,  $e^{-\kappa d}$  the attenuation element or absorption factor,  $\kappa$  = the attenuation constant, often written as  $\alpha/\sqrt{\lambda}$ .

This law of propagation applies to spherical or space propagation which for long waves is limited to a distance zone whose extension corre-

† Translator's note: The author doubtless refers to the angle subtended at the center of the sphere by the arc joining the transmitter and the receiver, in which case the term geocentric angle appears very apt.

sponds to a multiple of the height of the ionization sphere and depends on the vertical directional characteristics of the transmitting aerial, and with it, on the wavelength and the ground constants (conductivity  $\sigma_E$  and dielectric constant  $\epsilon_E$ ). At the end of this distance region, the spherical waves emanating from the sender reach the ionization sphere, and it is to be presumed that the high conductivity of this region is a factor in the further propagation of the essentially plane waves which are guided by the two conductive layers—the earth's surface and the ionization sphere (the electric field lines run almost vertically to the layers).

The law describing this plane propagation takes the following form:

$$E' = \text{const} \frac{1}{\sqrt{hd}} \sqrt{\frac{\vartheta}{\sin \vartheta}} e^{-\kappa' d} \quad (2)$$

The attenuation constant  $\kappa$  in (1) and  $\kappa'$  in (2) has, according to G. N. Watson<sup>3</sup> and R. Rüdénberg,<sup>4</sup> respectively, the following physical significance:

$$\kappa = \frac{1}{2h} \sqrt{\frac{\mu_E}{2c\lambda\sigma_E}} \quad (3)$$

$$\kappa' = \frac{1}{2h} \left( \sqrt{\frac{\mu_E}{2c\lambda\sigma_E}} + \sqrt{\frac{\mu_J}{2c\lambda\sigma_J}} \right) \quad (4)$$

wherein:  $\mu_E$  and  $\mu_J$  represent, respectively, the permeability of the earth and of the ionization sphere (dimensionless),  $\sigma_E$  and  $\sigma_J$  the conductivity of the earth and of the ionization sphere [sec./cm<sup>2</sup>],  $\lambda$  the wavelength (cm),  $c$  the velocity of light [cm/sec.], and  $h$  the height of the ionization sphere (cm). The dimensions of  $\kappa$  and  $\kappa'$ , respectively, are reciprocal lengths (1/cm) which when multiplied by the distance  $d$ (cm) give, as expected, dimensionless exponential quantities.

Experiment indicates that field strength measurements made during the daytime at very great distances are in good accord with results obtained from formula (1), so that for daytime it is not necessary to assume propagation according to formula (2). Night field strength values have frequently been measured<sup>5</sup> which are considerably greater than the values obtained from formula (1) for no loss propagation ( $e^{-\kappa d} = 1$ ,  $\kappa = 0$ ). This circumstance can hardly be explained otherwise than by assuming that at night, beyond the zone already referred to, the propagation is in accordance with formula (2). The reason is to be found in alterations of the height of the ionization sphere. By day the layer of the ionization sphere effective in long wave radiation is relatively

lower, i.e., in regions of relatively high atmospheric pressure so that their direct-current conductivity  $\sigma_J$  is proportionally small. It is:

$$\sigma_J = \frac{Ne^2}{m} \frac{\tau}{2} \quad (5)$$

where  $N$  equals the number of ions per  $\text{cm}^3$ ,  $e$  the charge and  $m$  the

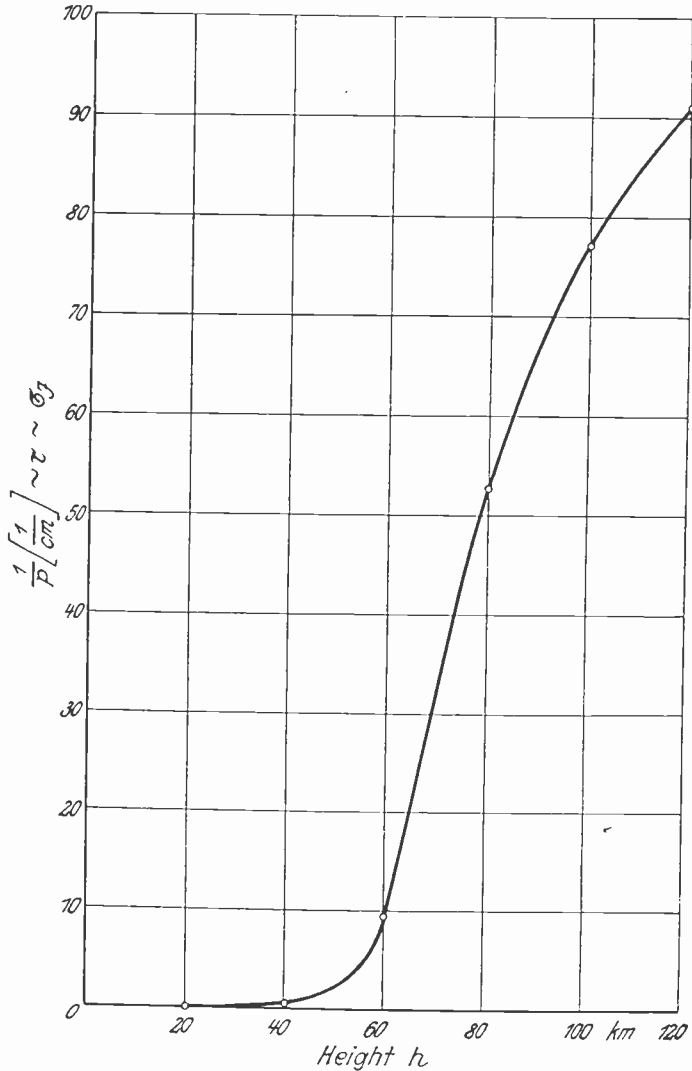

Fig. 1—Reciprocal of the air pressure  $1/p$  ( $\sim \tau$ ,  $\sim \sigma_J$ ) in  $[1/\text{mm Hg}]$  as function of the height  $h$  above the earth (km).

mass of the ion,  $\tau$  the time interval between two collisions of gas molecules ( $\tau$  is inversely proportional to the gas pressure  $p$ ). During the night this layer of the ionization sphere rises appreciably in height and its conductivity is quite markedly increased.

Fig. 1 shows changes in the value of  $\tau$  and therewith changes in the conductivity of the ionization layer in relation to the height above the

earth. As regards the proportional relation of  $\tau$  and  $\sigma$  with  $1/p$ , the dependence of the concentration and composition of the medium and the composition of the gases, upon the height of the layer, has, for sake of simplification, been disregarded for the zone under consideration.\* If we also consider the variations of these factors as functions of the height, the exponential change conductivity would appear more pronounced. Experiments carried out by different authorities show that during the day the height of the lower boundary of the ionization sphere, for long waves, is about 40–60 km; whereas by night, owing to the rapid deionization ( $\sim N$ ) in the lower layers, the height is about 90–120 km. Fig. 1 shows that for equal values of  $N$  and  $e/m$  the ratio of conductivity is approximately 1 to 130 for 40 km height as compared with 90 km, and 1 to 10 for 60 km as compared with a height of 120 km. Actually, when all factors are considered, still greater differences are to be noted. The difference in the propagation according to both formulas (1) and (2) in relation to the distance applies primarily for radiation during the night. By day, the absorption of the upper atmosphere, for reasons already stated, becomes so great that one can hardly speak of a perceptible transmission of the wave through the ionization sphere. Hence, during the day the formula for spherical radiation can be applied for all distances. The lines of the electric field do not any longer run vertical to the strongly absorbent ionization sphere; but rather, owing to the strong absorption, the waves partly penetrate into this layer and are dissipated after a relatively short interval (see formula (7)). A perceptible reflection (i.e., refraction) does not, therefore, as a rule, occur.

The results of measurements derived from various tests substantiate the above conclusions. For instance, the curves of M. Bäumler<sup>5</sup> show that for a wavelength of 16,400 meters ( $f$  equals 18.3 kc) at a distance of 6400 km, the maximum field strength by night was twice the value obtained for no-loss spherical propagation; whereas during the daytime the field strength remained considerably below this, and on the average attained only one-half of this value.

Fig. 2 gives a graphical representation of a portion of these field strength measurements in terms of  $\mu\text{v}/\text{m}$  as a function of the time of day.\*\* The horizontal line near  $233 \mu\text{v}/\text{m}$  corresponds to the field

\* Fig. 1 is plotted from a table by A. Wegener, *Thermodynamik der Atmosphäre* (Thermodynamics of the Atmosphere), published by Joh. Ambr. Barth, Leipzig, 1911.

\*\* The times of sunrise and sunset for Berlin and Rocky Point are indicated by short vertical lines underneath the axis of abscissas. The thinly drawn horizontal lines represent the period of sun exposure of one of the stations while the thick lines give the period of full darkness over the distance traversed. Times cited are Central European and American Eastern Standard.

strength for no-loss propagation as calculated from (1). The observation of considerably stronger fields (max.  $430 \mu\text{v}/\text{m}$ ) than would correspond to this value can be explained in this case, as in night transmission, by (2) for plane propagation, which gives notably higher values for ideal no-loss propagation. In view of this, if we apply (1) for spherical radiation up to a distance  $zh$  (km) ( $h$  equals height of the ionization

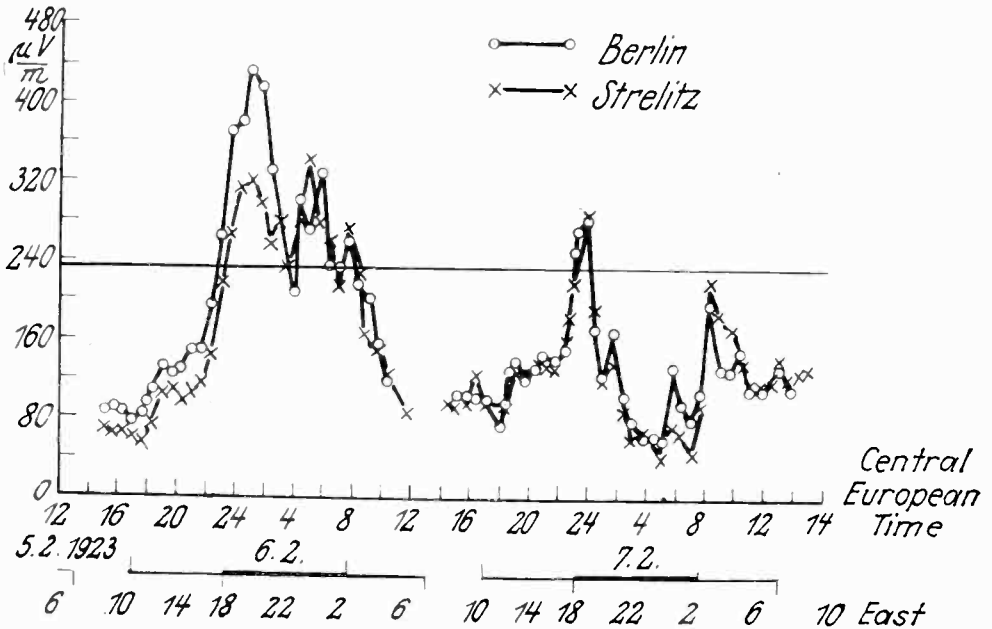

Fig. 2—Reception measurements of the sending station WQK (Rocky Point,  $\lambda = 16,400 \text{ m}$ ,  $f = 18.3 \text{ kc}$ ) in Berlin and Strelitz.

sphere at night) and only thenceforth begin to apply plane propagation (2), the following is obtained, on the assumption that  $h$  equals  $100 \text{ km}$ .

for	$z = 1$	$zh = 100 \text{ km}$	$E^{\infty} = 1860 \mu\text{v}/\text{m}$
	$z = 2$	$= 200 \text{ km}$	$= 1320 \text{ "}$
	$z = 3$	$= 300 \text{ km}$	$= 1080 \text{ "}$
	$z = 5$	$= 500 \text{ km}$	$= 835 \text{ "}$
	$z = 10$	$= 1000 \text{ km}$	$= 590 \text{ "}$

Fairly plausible values are thus obtained for ideal no-loss propagation, which can be immediately multiplied by a suitable attenuation factor in order to arrive at the maximum measured values.

Propagation such as is here considered with negative attenuation or even without attenuation is not considered to be reasonable. A so-called energy supply from the upper atmosphere—an expression frequently applied to the comparatively slightly attenuated indirect rays of short and border waves—can no longer be considered in connection with wavelengths of  $\lambda = 16,400 \text{ m}$ . In this case, there is no perceptible

detachment of waves from the earth's surface at the sending antenna, since for long waves in general  $2c \lambda \sigma_E \gg \epsilon_E$  ( $\epsilon_E$  = dielectric constant and  $\sigma_E$  = conductivity of the ground).<sup>6</sup>

By way of summary, the following may be said: Within a range interval corresponding to a multiple of the height of the ionization sphere, spherical radiation is to be reckoned with in the case of long waves. Beyond this region, spherical radiation can be counted on only when the conductivity of the lower layer of the ionization sphere is low, as is usually the case in daytime. The conductivity then is, on the one hand, too small to guide the waves and, on the other, large enough to absorb them on penetration. At night the lower layers lose their conductivity almost entirely. They then act as a low-loss insulator, and the waves reach up to the practically permanent layer of the ionization sphere (Kennelly-Heaviside layer) which is characterized by great conductivity. This layer serves as a guide for the wireless waves (long waves) so that beyond the range interval in question, the waves are to be considered as progressing in flat planes, bordered by two spherical shells, the earth's surface, and the ionization sphere.

Just as long-wave propagation is influenced by the change from day into night, so also is the range, and, for fixed distances, the field strength, influenced by the seasons of the year. The winter months, on the whole, yield greater average field strength values than in the summer; because in the winter time the conductive layer of the ionization sphere, owing to lessened solar radiation, occupies greater heights and, therefore, attenuation is then less than in the summer time.\*

The next point to be considered after the preceding observations of normal long-wave propagation will be a closer examination of the influence exerted on this type of propagation by solar activity. As already remarked, the attenuation, according to G. N. Watson<sup>3</sup> and T. L. Eckersley,<sup>1,7</sup> which the long waves suffer when passing through the ionization sphere, is proportional to  $1/\sqrt{\sigma_J}$  where  $\sigma_J$  represents the direct-current conductivity of the stratum, according to (5):

$$\sigma_J = \frac{Ne^2}{m} \frac{\tau}{2} \quad (5)$$

According to Eckersley, the influence which increased solar activity exerts on the ionization sphere can result in an increase of the electron

\* In the interpretation of measurement results, of which such a comparison is the object, it is necessary to note whether the respective observations were taken during an unfavorable time of day, somewhat in the sense that for one set of observations the season was at a minimum while the other set was taken at an ascending or descending portion of the day field strength curve.

density†  $N$ , without at the same time lowering the height of the layer and also leaving  $\tau$  constant. In this case the conductivity  $\sigma_J$  is increased and, according to (2), there results a reduction in the attenuation of the long-wave propagation. Should, however, the increased solar activity at the same time operate to lower the layer (i.e., bring it into regions of higher atmospheric pressure), a different effect upon the attenuation of long-wave propagation will result, according as the increase of  $N$  or decrease  $\tau$  is the more influential. In case  $N$  increases at a greater rate, the attenuation becomes reduced, but if  $\tau$  is reduced at a greater rate than the increase of  $N$ , the attenuation becomes larger. The first two cases, therefore, signify improvement in the long-wave propagation which then approaches the condition described by (2). The latter case occurs more rarely and indeed only under circumstances making for the abnormal penetration of particles or of waves from the ultra-violet end of the solar spectrum into the upper atmosphere.

The conclusion to be derived from these considerations is that in years of greater average solar activity the mean value of the attenuation for long-wave propagation is, in general, less than in years of weaker solar activity.

Only in years of strong solar activity, when there is present in considerable volume an intensely penetrating ray, can the attenuation factor experience a decline in spite of the increase in solar activity. It also follows from what has been said, that the influence of solar activity on a long-wave transmission path becomes greater the closer it is to the earth's magnetic poles and the greater the distance which it spans.

As will be shown, the above statements are in accord with experience. Systematic field strength measurements of long-wave stations, started as early as 1915 have been carried out by L. W. Austin.\* These measurements are illustrated in Fig. 3.<sup>8</sup> The upper curve represents the yearly mean value of day reception field strength in relation to the period (1915–1930) of the Nauen sending station DFW ( $\lambda = 12,800$  m,  $f = 23.4$  kc) as measured by the Bureau of Standards, Washington.\*\* The lower curve in Fig. 3 shows the corresponding average sun spot numbers during the years considered. The similarity of the two curves shows that the maximum yearly mean field strength value corresponds

† Translator's note: Literally "trager concentration" means medium concentration and as will be noticed at first this term was employed. However, it appears unsatisfactory as there is danger in confounding the "medium" with the gaseous composition. The author undoubtedly refers to the nature of the electrical charge carried by the gases and consequently the term has been changed to "electrical or electronic density."

\* Reference is here made only to the latest of the many reports of L. W. Austin.<sup>8</sup>

\*\* The great circle Nauen-Washington lies comparatively close to the earth's magnetic north pole (Boothia Felix).



approximately to the maximum yearly average value of sun spot numbers which occur during years of strong solar activity. Such were the years of 1917 and about 1927-1928. The year 1928 shows a decline in the yearly average field strength, the possible origin of which, as already intimated, might be ascribed to an excessive effect of the intensely penetrating solar radiation. Conversely, the low yearly average field strength values correspond to years of lesser solar activity. Such were the years around 1923 and prior to 1915.

Experience also indicates that, in accord with the above observations, a year of strong average solar activity results, as a rule, in a

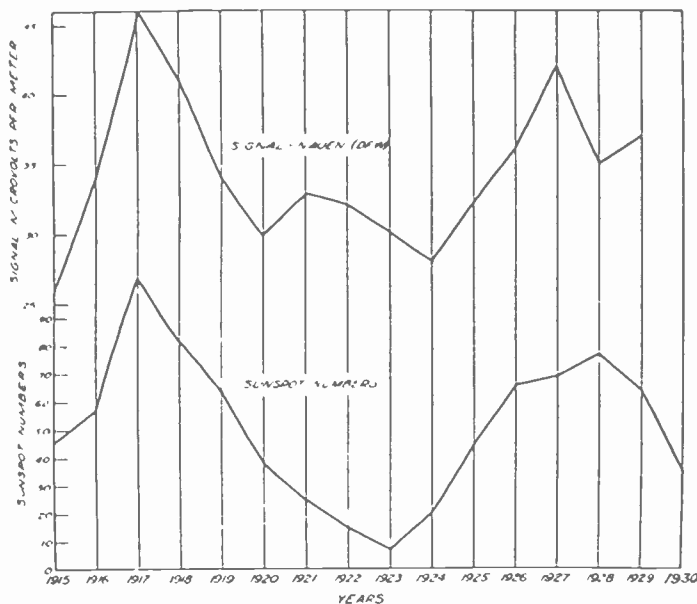

Fig. 3—Above: Yearly mean value of the daytime signal field strength of the Nauen sending station DFW ( $\lambda = 12,800$  m,  $f = 23.4$  kc) as measured in Washington.

Below: Yearly mean value of the corresponding sun spot numbers.

marked diminution of the attenuation of long-wave propagation and vice versa. The above is illustrated in Fig. 4, in which are plotted the monthly averages of daytime field strength values of the Lafayette sending station near Bordeaux (LY,  $\lambda = 23,000$  m,  $f = 13.0$  kc) for the years 1922 to 1928.<sup>9</sup>

The full-line curve represents the measurements taken at Washington, which is a distance of about 6000 km from the sending station; the dotted line shows measurements taken at Meudon near Paris (distance from sender about 500 km).\*

\* The plotted values of this curve were obtained by averaging the field strength measurements taken daily at the same hour (3 P.M.) over the period of a whole month.

In both curves the normal swings occasioned by the change of the seasons are very pronounced. The maximum field strength values occur here in the winter months, while the minimum values occur in the summer months. Underlying these oscillations is a gradual accrument of the yearly average of field strength, from 1922 to 1928, which, as was previously pointed out (Fig. 3), is to be ascribed to solar activity.

#### IV. SHORT- AND BORDER-WAVE PROPAGATION

In the case of short waves, there occurs a rapid disappearance of the waves which travel along the earth's surface (earth waves) owing

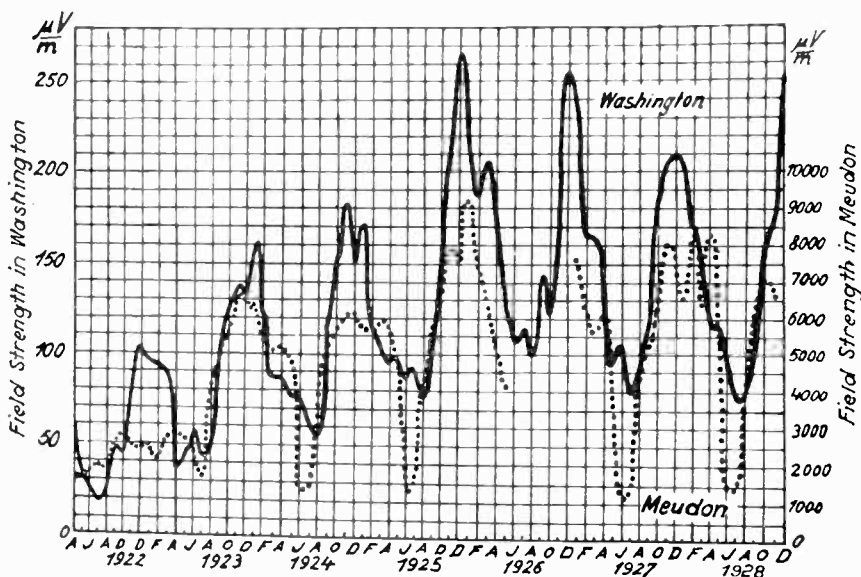

Fig. 4—Monthly average value of the daytime signal field strength of the sending station Lafayette (LY,  $\lambda = 23,000$  m,  $f = 13.0$  kc). Washington measurements (—) and Meudon measurements (.....).

to the high earth attenuation of short waves (see (1) and (2)). Consequently, when transmitting over distances extending beyond a specified small region in the immediate neighborhood of the transmitter, there are left essentially only those indirect waves which, leaving the transmitter at a definite angle in relation to the earth's surface, are bent back to the earth, owing to the refractive properties of the higher atmosphere.

The cause of the refraction of the ray is to be found in the reduced dielectric constant due to high electronic density in the ionization sphere, and the attendant increase in the phase velocity of the radio waves. From the fact that the propagation of short waves, for greater distances, takes place only in consequence of the ionization sphere, it may be assumed beforehand that the influence of solar activity and its period is proportionately very great.

As in the case of long waves, the attenuation for short waves occurs mainly in the deeper regions of the ionization sphere where the coefficient of absorption is greatest. It is to be assumed that the strongly attenuating layer lies beneath the other layer of higher density  $N$ , in which normally the bending of the rays occurs. The attenuation in the case of short waves is proportional to  $N/\tau$  (see (7)) where  $N$  again represents the electron density and  $\tau$  the average time interval between two collisions of ions occurring in immediate sequence.

Should the influence of solar activity result in an increase in the electron density  $N$  and at the same time the layer height be decreased (i.e.,  $\tau$  reduced), both factors would here operate in the same sense in contradistinction to the case of long waves. Short-wave attenuation would, therefore, always be increased as a result of strong solar activity.<sup>1</sup>

In the rarely occurring event of abnormally deep penetration of particles or waves from the ultra-violet end of the spectrum into the upper atmosphere, any general earth magnetic disturbance is absent, since the deeper the strongly ionizing sun rays penetrate into the upper atmosphere, the smaller becomes  $\tau$ , and correspondingly lower the conductivity of the ionization sphere. Consequently, the proportionately few electrons or ions, which here cause the high attenuation, are insufficient to cause the great mass movements necessary for noticeable magnetic disturbances.

Experience is in agreement with the above explanation.<sup>1</sup> Strong solar activity, as has frequently been established, can interrupt short-wave communication for hours and even days through complete and persistent fade-outs; whereas, the corresponding long-wave connections as a rule experience an improvement in the transmission conditions. The short-wave fade-outs (of this type) are very often accompanied by severe disturbances of the earth's magnetic field or so-called magnetic storms. However, continuous short-wave fade-outs can occur without being accompanied by any strong magnetic disturbances, as has already been indicated. Occurrences of this kind are comparatively rare but they often also adversely affect long-wave communications in that these then are also subject to increased attenuation. These abnormal increases in attenuation which interrupt the short- and the long-wave communications are, in general, of relatively limited duration. They are, therefore, to be traced to a very penetrating ray which ionizes the lower layers of the upper atmosphere which are under relatively high pressure. Consequently, reestablishment of normal conditions proceeds at a relatively rapid rate which is proportional to the recombination of electrons and positive ions.

Disturbances caused by magnetic storms are more frequent and violent in the neighborhood of the poles than in the equatorial regions and, therefore, short-wave rays that pass near the poles are more subject to continuous fade-outs than those which traverse equatorial regions. There is no marked difference in the frequency of occurrence and intensity of these short-wave fade-outs for the different wavelengths. It seems rather that all short waves are influenced in about the same degree. It has, however, been occasionally observed that waves above 25 m are less influenced than are shorter ones; whereas, on the other hand, after such a persistent fade-out, the shorter waves were the first to come through.

The bending of the short-wave rays through the ionization sphere becomes greater the larger the electronic density  $N$ , and the amount of curvature necessary for the return of the waves to earth at a particular angle becomes less the lower the ray-reflecting layer lies. The latter deduction follows from a simple geometric consideration which will not be further examined here. The following formula determines the index of refraction  $n$  (omitting from consideration the earth's magnetic field, the influence of which on short-wave refraction is relatively small).

$$n^2 = 1 - \frac{Ne^2\lambda^2}{\pi mc^2} \quad (6)$$

wherein:  $e$  equals charge,  $m$  equals mass of the carrier,  $c$  equals velocity of light,  $\lambda$  equals wavelength, and  $N$  the carrier concentration.

The smaller the value of  $n^2$  the greater is the refraction. Should  $N$  become greater and, eventually, the layer also be lowered under the influence of solar activity, both influences would increase the refraction of the short-wave rays in proportion to the wavelength.

In connection with long-wave propagation, it has already been pointed out that one is led to conclude as a result of the relative variations in field strength and solar activity that increased solar activity as a rule increases carrier concentration without noticeably lowering the height of the layer. Only in rare cases of unusually strong solar activity is the height of the layer simultaneously lowered. If in combination with this a larger carrier concentration occurs at heights considerably below 90 to 100 km, the attenuation will be increased to such an extent that noticeable reflection or refraction of short waves will, in general, no longer take place. From what has been said it becomes obvious that in years of greater average solar activity an increased refraction of the rays is to be expected and also occasional interruptions of the short-wave circuits when the solar activity increases beyond a certain limit. Furthermore, greater space attenuation is to be expected. Conversely,

in years of lesser solar activity, less refraction of the short-wave rays is to be expected; and for the same reason less attenuation and greater

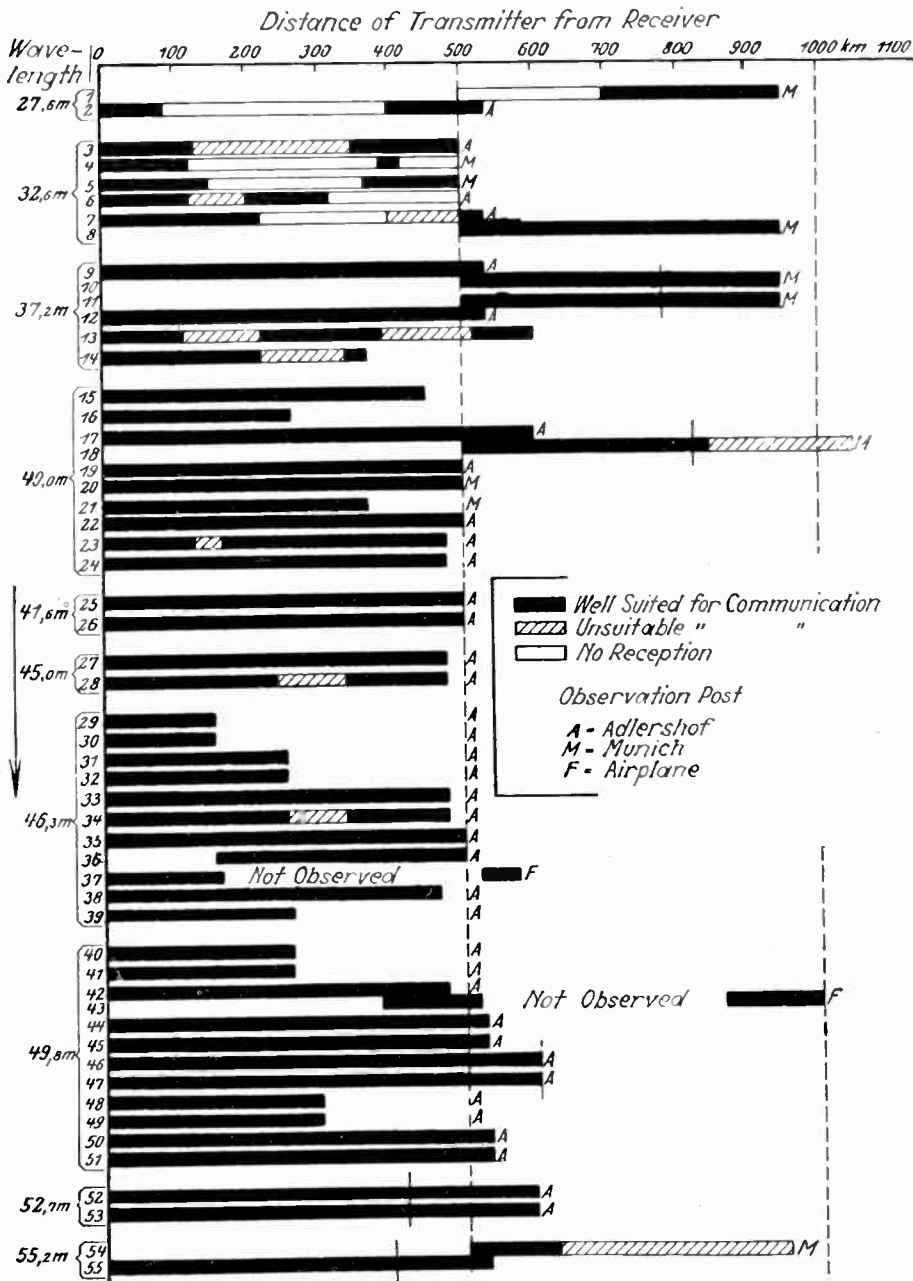

Fig. 5—Reception observations at various distances of an airplane 2-watt transmitter (taken in the years 1927-1928).

regularity of short-wave communication, in as much as solar activity at such times very seldom attains the degree necessary for continual fade-outs.

In years of strong solar activity, increased bending of the rays is made more evident by a pronounced shortening of the weak signal zones; i.e., "skip distance" zones, and conversely weaker refraction in years of reduced solar activity is apparent through a broadening out of these zones. E. V. Appleton<sup>10</sup> very early pointed out the influence of short period changes in solar activity upon the weak signal zones.

Observations from various sources made in recent years are in agreement with the foregoing views. During the years 1927-1928, which were years of maximum solar activity, the Deutschen Versuchsanstalt für Luftfahrt E. V. (German Aëronautical Research Institute) conducted experiments on the propagation of short waves, ranging from 27 to 55 m for distances ranging from 0 to 1000 km. It was found, among other things, that the shorter waves (27 m, 32 m) regularly showed weak signal zones, and waves of 37 m, 40 m, and 46 m occasionally showed these zones. With waves of 50-m length, weak signal zones began to disappear. This effect was even more pronounced in waves of 53 and 55 m (as shown in Fig. 5). Furthermore, definite ranges of average loud signals existed for particular waves—for example, 400 km for the 53-m wave. A few years later, in 1930, when the solar activity had quite noticeably diminished (see Fig. 3) the Deutschen Versuchsanstalt für Luftfahrt E. V. (German Aëronautical Research Institute) often observed, in similar experiments that even a 53-m wave showed extensive weak signal zones within a range of about 100 to 300 km from the transmitter. This occurred in a season when the ionizing power of the sun corresponded approximately to that above. As was to be logically expected, these later researches (in 1930) showed an increased loud signal range of about 700 km, as compared with about 400 km in the year 1928. This is a natural consequence of reduced refraction resulting from diminished solar activity. These observations were confirmed by many others in 1930 and 1931.

Similar results have also been obtained by others. Of especial interest in this connection are the research data of the Transradio A.G.<sup>12</sup> recently made public by H. Mögel. According to this report, the conditions for short-wave transmission in 1930 were worse than for any time since then. During that year only rarely could favorable reception amplitudes be reached, which for the same wavelengths and at the same periods of time in previous years were considered normal. An illustration of this is shown in Fig. 6, wherein the signal strengths as observed in Geltow, of 16-m waves sent from New York during June, 1929 (left), are compared with those received in June, 1930 (right). The ordinates of the black lines are proportional to the signal strength. As regards magnetic activity, the year 1930 shows almost continual disturbances,

but only of medium strength at most and without typical effects, whereas, in the previous years, in a virtually undisturbed period, there were present several pronounced disturbances of great amplitude. Later, H. Mögel further remarks that, in cases where disturbances were of long duration, the employment of somewhat longer waves for short-wave circuits—so-called carry-over waves—were of great advantage for daytime transmission. For instance, in Beelitz, the day waves

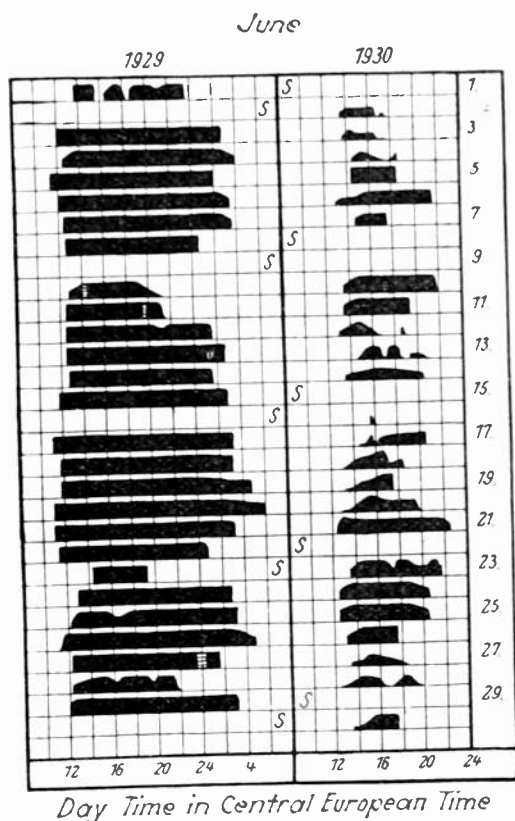

Fig. 6—Comparison of reception amplitudes in Geltow of a 16-m wave from New York in June, 1929, and in June, 1930.

(about 16 m) sent from New York were barely audible, while, at the same time, when 20-m waves were used, communication with New York could be carried on with certainty. To supplement the above observations, it should also be pointed out that in 1924 and 1925, which were three and two years, respectively, prior to the maximum year of solar activity, the weak signal zones, according to different observers,\* were found to be more pronounced (whence arose the expression “dead zones”) than in the years 1926, 1927, and 1928 in which confirmed ob-

\* E.g., A. H. Taylor, Regional distance chart, presented 1925 by R. A. Heising, J. C. Schelleng, and G. C. Southworth. Experiments in the year 1925.

servations raised doubts as to the existence of the "dead zones," so that the designation "weak zones" was introduced.<sup>7,10,13,15</sup>

To summarize, it may, therefore, be said that in years during which short-wave communications of all wavelengths were subjected, on the one hand, to especially strong disturbances due to solar activity, there prevailed, on the other hand, distinctly favorable conditions in the upper atmosphere for strong wave refraction. The reverse will be the case in years of minimum solar activity when the least disturbances (applying to all wavelengths), but also the smallest ray refraction, prevail. So that, for example, to meet this latter circumstance, somewhat longer wavelengths would have to be used to suit specific distances, seasons, and times of day, than were employed during years of stronger solar activity, and vice versa. How large this variation in wavelength to be employed to meet extreme conditions of solar activity would have to be cannot yet be determined for the reason that sufficient data are as yet unavailable owing to the fact that the whole field of short-wave technique is still in its infancy. The amount of this variation appears thus far to be not altogether inconsiderable, so that in choosing the operating waves for short-wave circuits this must be taken into consideration.

It might be roughly estimated that such a change would be from one-fourth to one-third of the wavelength. For example, if, in a year of maximum solar activity, a wave of 50 m shows absolutely no weak signal zones,<sup>11</sup> then, for a year of minimum solar activity—during the same season—a wave of about 65 m would equally show no weak zones.

Or, if in a year of maximum solar activity at a specified time of day and season, a specified distance can be spanned by the use of a wave of 15 to 16 m, it should be necessary in a year of minimum solar activity to employ a wave of about 20 m. Even the shortest wavelength is subject to a corresponding influence, its propagational path being directly refracted toward the earth's surface due to the refractive property of the ionization sphere. If such waves in years of maximum solar activity are about 10 m in length, they would range between 13 and 14 m during years of minimum solar activity.<sup>18</sup>

In the light of the above observations, judgment of the performance of short-wave communications in the year 1930 should be qualified in the sense that the poor performance of the short waves is only apparent and is to be taken as an indication that the waves, which for specific distances, time of day, and season were favorable in the years 1927–1928, have ceased to be equally favorable in the year 1930. In order to attain favorable conditions again for short-wave transmission in the year 1931 and the years following up to about 1935–1936, it will be necessary to



employ somewhat longer waves than heretofore.\* The average quality of transmission can thereby be so improved in comparison with the years 1926 to 1929, that it may be taken for granted that continual fade-outs will occur much less frequently in the next few years (1931 up to about 1935). Consequently, a more uniform transmission performance can be anticipated for the future.

What has been here said about short waves applies equally to border waves. The same considerations also apply to broadcast waves, as with those waves, just as in the case of short and border waves, a perceptible separation of the waves from the earth's surface has to be reckoned with. They are of importance only during night transmission, for, during day transmission, the indirect radiation through the low-lying ionization sphere is as a rule so strongly attenuated that it can no longer be bent back to the earth with perceptible amplitude. The following equation, which describes the energy loss  $k$  per cm distance in the ionization sphere, serves, as with short waves, to measure the attenuation of these indirect rays which penetrate the ionization sphere.

$$k = \frac{Ne^2}{\pi c^2 \tau m} \lambda^2 \quad (7)$$

(symbols same as for (5) and (6))

From this equation it is apparent that the indirect radiation on penetrating the ionization sphere, which for them is chiefly of a dielectric, i.e., ray-reflecting nature, experiences attenuation at a rate which increases as the square of the wavelength. Therefore, only the earth wave is essentially present during daytime propagation of broadcast waves.

#### V. SUMMARY

Prevailing conceptions concerning the nature of solar activity, the influence of the ionization sphere, as well as the influence of solar activity and its eleven-year period on the propagation of long waves, have been briefly presented.

The important feature of this paper is the investigation of the in-

\* It should be mentioned here, that the phenomena caused by the eleven-year period of solar activity under certain conditions can be extended somewhat, in time, by shorter sun periods. For example, there was a pronounced period of  $15 \frac{2}{3}$  months (19, 20) whose amplitude can amount to one-third the amplitude of the 11-year period. If, as was the case in 1930, there is a low minimum for the fifteen-month period in the descending branch of the eleven-year period, the change in radiation conditions may be especially great in such a year, but in the following year, under certain conditions, this will undergo a (weaker) return movement corresponding to the maximum of the fifteen-month period following the above-mentioned minimum.

fluence exerted by the eleven-year period of solar activity on the propagation of short and border waves. While the main effect of this period on long waves is a correspondingly gradual change of the absorption conditions, the effect on short and border waves is to be found primarily in a correspondingly gradual alteration in the conditions necessary for bending the ray. The change in the absorption conditions is taken into account as of secondary importance. In years of strong solar activity the bending of the short and border rays, on the average, will be increased and the attenuation be greater than in years of less solar activity. From this the conclusion is drawn that the poor performance of radio transmission with short and border waves, as was frequently observed in 1930, is only apparent. To obtain again favorable transmission conditions in the year 1931 and the years following up to about 1935, somewhat longer waves should be employed than those which were found to be optimum in the years 1927–1928. By so doing, more uniform transmission performance may be expected in the future, inasmuch as interruptions due to continual fade-outs will occur much less frequently.

#### Bibliography

1. T. L. Eckersley, "An investigation of short waves," *Jour. I.E.E.* (London), 67, No. 392, 992, 1926.
2. H. B. Maris und E. O. Hulburt, "A theory of auroras and magnetic storms," *Phys. Rev.*, 33, 413, 1929.
3. G. N. Watson, "Diffraction of electric waves by the earth," *Proc. Roy. Soc.*, 95, 83, 1918; 95A, No. A673, 546, 1919; *Sci. Abs.*, A, 1919; *Nature*, 102, 517, 1919; *Radio Rev.*, 1, 39, 1919.
4. R. Rüdenberg, *Aussendung und Empfang elektrischer Wellen*, Berlin, 1926, Julius Springer.
5. M. Bäumlner, "Neue Untersuchungen über die Ausbreitung der elektromagnetischen Wellen," *E.N.T.*, 1, No. 2, 41, 1924; *Proc. I.R.E.*, 13, 5, 1925.
6. M. J. O. Strutt, "Strahlung von Antennen unter dem Einfluss der Erdbodeneigenschaften," *Ann. d. Phys.*, 1, Series 5, No. 6, 721, 751, 1929; *Ann. d. Phys.*, 4, Series 5, No. 1, 1, 1930.
7. T. L. Eckersley, "Short wave wireless telegraphy," *Jour. I.E.E.* (London), 65, No. 366, 600, 1927.
8. L. W. Austin, E. B. Judson, and E. J. Wymore-Shiel, "Solar and magnetic activity and radio transmission," *Proc. I.R.E.*, 18, No. 12, 1998, 1930.
9. L. W. Austin, "Long-wave radio receiving measurements at the Bureau of Standards in 1928," *Proc. I.R.E.*, 18, No. 1, 101, 1930.
10. E. V. Appleton, "Magnetic storms and wireless transmission," *Electrician*, 98, 256, 1927.
11. K. Krüger und H. Plendl, "Die Ausbreitung der kurzen Wellen bei kleiner Leistung im 1000 km Bereich," *Zeit. für Hochfrequenz.*, 33, No. 3, 85, 1929; "The propagation of low power short waves in the 1000-kilometer range," *Proc. I.R.E.*, 17, 1296; August, 1929.
12. H. Mögel, "Ueber die Beziehungen zwischen Empfangsstörungen bei Kurzwellen und den Störungen des magnetischen Feldes der Erde," *Telefunken-Zeit.*, 11, No. 56, 14, 1930.
13. H. Fassbender, K. Krüger und H. Plendl, "Versuche über die Ausbreitung kurzer Wellen," *Naturwissenschaften*, 15, No. 15, 357, 1927.
14. H. Plendl, "Die Anwendung von kurzen Wellen im Verkehr mit Flugzeugen," *Zeit. für Tech. Phys.*, 11, No. 11, 456, 1927.

15. H. Fassbender, "Die Vorzüge des Kurzwellen-Verkehrs mit Flugzeugen," *Luftfahrtforschung*, 1, 121, 1928.
16. A. H. Taylor, "An investigation of transmission on the higher radio frequencies," *Proc. I.R.E.*, 13, 677, 1925.
17. R. A. Heising, J. C. Schelleng, and G. C. Southworth, "Some measurements of short-wave transmission," *Proc. I.R.E.*, 14, 613, 1926.
18. A. H. Taylor and E. O. Hulburt, "The propagation of radio waves over the earth," *Phys. Rev.*, 27, 189, 1926.
19. C. G. Abbot, "A group of solar changes," *Smithsonian Miscellaneous Collections*, 50, No. 2, 1927.
20. G. W. Pickard, "Note on the fifteen-month period in solar activity, terrestrial magnetism, and radio reception," *Proc. I.R.E.*, 19, 353; March, 1931.



## PRELIMINARY NOTE ON AN AUTOMATIC RECORDER GIVING A CONTINUOUS HEIGHT RECORD OF THE KENNELLY-HEAVISIDE LAYER\*

BY

T. R. GILLILAND† AND G. W. KENRICK‡

(†Bureau of Standards, Washington, D. C.; ‡Tufts College, Massachusetts)

**Summary**—This paper describes a preliminary installation of a continuous automatic recorder of virtual heights of the Kennelly-Heaviside layer. This installation requires that a chopper at the transmitter and a revolving mirror at the receiving station be driven by synchronous motors connected to the same power system. The group retardation method of Breit and Tuve is used with a few modifications which permit continuous records to be made. Suggestions are made for improvements which might be incorporated in a permanent installation.

### I. INTRODUCTION

DURING the last few years measurements of the virtual height of the Kennelly-Heaviside layer have commanded no little interest, and numerous papers have been published describing such observations. In America most of the workers have employed the group retardation or pulse method originated by Breit and Tuve in making the measurements reported.<sup>1,2,3</sup>

The principle employed in this method may be understood by reference to Figs. 1 and 2. A very short pulse or dot is transmitted

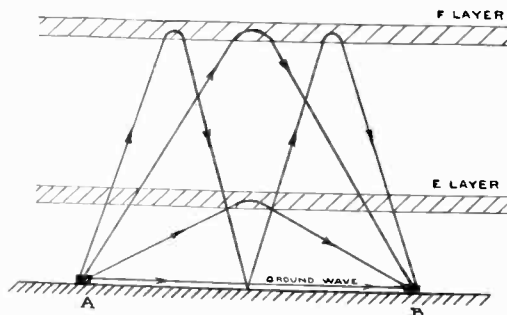

Fig. 1—Diagram showing various paths by which pulse may arrive at receiving station.

\* Decimal classification: R365.3×R113.61. Original manuscript received by the Institute, September 21, 1931. Published in *Bureau of Standards Journal of Research*, 7, 783-791; November, 1931. Publication approved by the Director of the Bureau of Standards of the U. S. Department of Commerce.

<sup>1</sup> See Breit and Tuve, *Phys. Rev.*, 21, 554-576, 1926; *Proc. I.R.E.*, 16, 1236-1239, 1928; R. A. Heising, *Proc. I.R.E.*, 16, 75-99, 1928; de Mars, Gilliland, and Kenrick, *Proc. I.R.E.*, 19, 106-113, 1931.

<sup>2</sup> For other methods see E. V. Appleton, *Proc. Royal Soc.*, 109, 621, 1925; 113, 450, 1926; 115, 291, 1927; 117, 576, 1928.

<sup>3</sup> For other American methods see Mirick and Hentschell, *Proc. I.R.E.*, 17, 1034-1041, 1929.

from point *A* and may arrive at point *B* by several paths as indicated in Fig. 1. The pulses arriving at the receiver over the ground and along the several paths result in several pulses at the receiver for each transmitted pulse. If the output of the receiving set is led to an oscillograph,

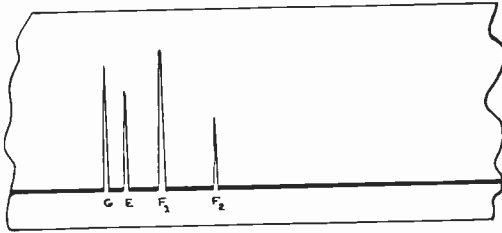

Fig. 2—Diagram showing type of oscillogram which may be obtained by the group retardation method.

*G*—ground pulse  
*E*—reflection from low (*E*) layer.  
*F*<sub>1</sub>—first reflection from high (*F*) layer.  
*F*<sub>2</sub>—second reflection from high (*F*) layer.

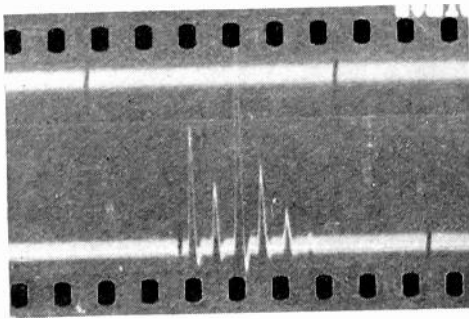

Fig. 3a—Actual oscillogram obtained by group retardation method showing impulses which have arrived by several paths.

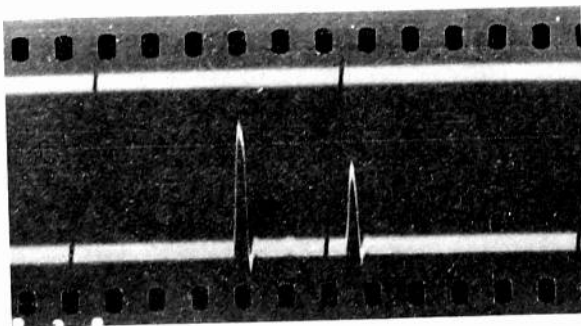

Fig. 3b—Oscillogram showing ground pulse and one reflection.

a record similar to that shown in Fig. 2 may be obtained. Fig. 3a is an actual oscillogram obtained by this method showing pulses which have arrived by several paths, while Fig. 3b shows the ground pulse and only one reflection. If the oscillograph film speed is known, the time

interval between the arrival of the ground pulse and any of the reflected pulses may be measured, and from this the virtual height of the layer may be computed.

The major difficulty with the method described above, and one which is common to most methods so far reported, is that each oscillogram taken gives the virtual height only over a brief period, usually a fraction of a second. In order to obtain a clear idea of the variation of the layer height over a considerable period, such as 24 hours for instance, it is necessary for the observer to remain at the apparatus and take frequent oscillograms, each of which gives him but a single point on his desired curve of virtual height as a function of time. Such observations hence require considerable resources in personnel and supplies (notably film) when more than a few fragmentary measurements

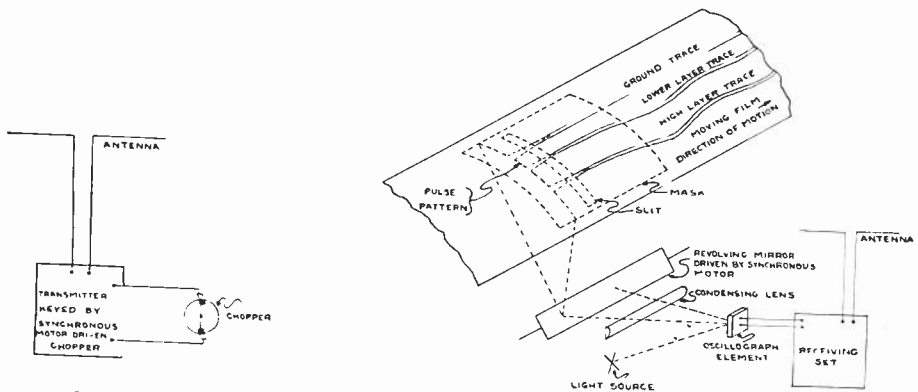

Fig. 4—Schematic diagram of system used with automatic Kennelly-Heaviside layer height recorder.

are to be made. In fact, several hundred feet of film are usually required for a 24-hour run, and as the labor of subsequent development and measurement of the oscillograms taken is considerable, it is probable that the entire time of no less than six workers would be necessary to secure a continuous record of layer height over any considerable period if such methods were employed. In order that the different pulses may be separated sufficiently for accurate measurement, it is necessary to use film speeds of the order of 10 feet per second. This means that sensitive film or a powerful light source must be used.

It is evident, therefore, that the development of some automatic device giving a height record is of major importance to any program which contemplates continuous measurements of layer height. This paper describes a preliminary set-up which has proved the practicability of a scheme for making continuous height records, and improvements are suggested which might be incorporated in a permanent installation.

## II. PRINCIPLE OF OPERATION OF THE RECORDER

With a few modifications, the group retardation method as described above may be used to give continuous automatic records. The general scheme may be best understood by reference to Fig. 4. The pulses are sent out from a transmitter which is keyed by a chopper driven by a synchronous motor. The chopper is so designed that the pulses will be of short duration (say,  $2 \times 10^{-4}$  seconds). At the receiving station the apparatus is very similar to that used in the original method with the exception that instead of directing the light from the oscillograph element directly on the moving film, the automatic recorder employs a rotating mirror which rotates in synchronism with the chopper so that a pattern similar to that of Fig. 2 may be viewed on a screen in the manner commonly used for viewing recurring phenomena with the oscillograph. The peak marked *G* in Fig. 2 should remain fixed in position on the screen if the chopper motor and the motor driving the rotating mirror are kept in synchronism, because the length of the path between transmitter and receiver for this impulse remains unchanged. However, if the Kennelly-Heaviside layer changes in height, the path lengths for the other impulses, (*E*, *F*<sub>1</sub>, and *F*<sub>2</sub>), will change, and these peaks will shift in position on the screen with respect to the ground peak *G*. If, in place of the screen, a mask is used with a slit parallel to and above the base line of the peaks, and if a film is caused to move slowly across the mask in a direction perpendicular to the slit, a trace will be recorded on the film for each of the peaks. The trace representing the ground pulse should be a straight line, while the other traces will vary in distance from the ground trace as the layer or layers move up and down. The distance from any of these traces to the ground trace will be a measure of the virtual height corresponding to that particular reflection.

## III. CONSTRUCTION DETAILS

The installation described here employed a crystal-controlled transmitter with the chopper connected in the grid circuit of the first amplifier. At the recording point a receiving set of the double-detection type was used, with the output of the second detector feeding into one stage of d-c amplification which operated the oscillograph. The system was similar to that used in previous installations with the exception that the receiving set was operated from the a-c mains.

In carrying on observations by the original method trouble was frequently encountered from interference coming in over the power lines. It was noted that these disturbances were quite often at power frequency, so that disturbance patterns could be made to remain

stationary on the oscillograph screen when the rotating mirror was driven directly by a synchronous motor. Obviously spurious results would be obtained from this source by an automatic recorder which employed a chopper and rotating mirror driven directly by synchro-

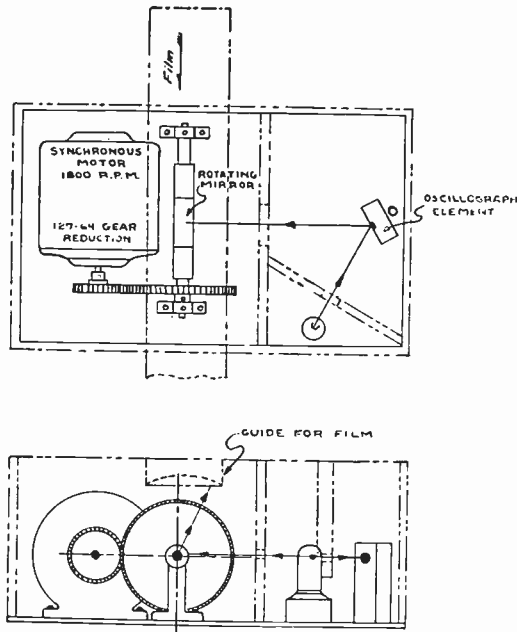

Fig. 5—Drawing of assembly of recorder with film drive and film container omitted.

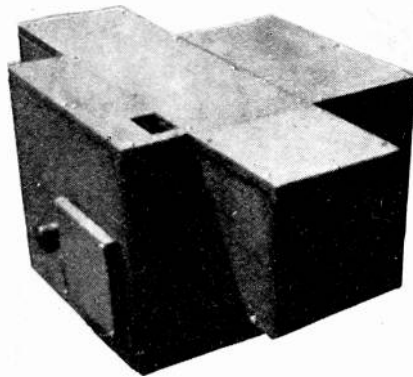

Fig. 6—Photograph of complete recorder with film container in place.

nous motors. In order to obviate this difficulty, the chopper and rotating mirror were geared to the synchronous motors by an odd gear ratio, namely, 127 to 64, so that any disturbance patterns occurring at power frequency would not remain stationary and thus give spurious traces



on the film, but would drift gradually across. However, the pulse patterns due to the transmitter remain stationary except for the relatively slow drift due to change in layer height, and the light on the film from these patterns is predominant over that from sources of disturbance.

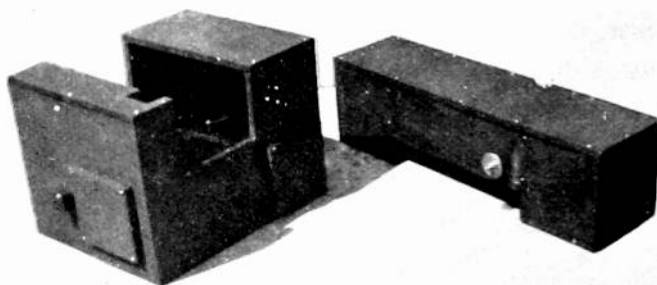

Fig. 7—Recorder with film container removed.

The film was driven through a system of gears by the same synchronous motor used for driving the rotating mirror. A film speed of 2.5 feet per 24 hours was used. A six-volt automobile lamp bulb was

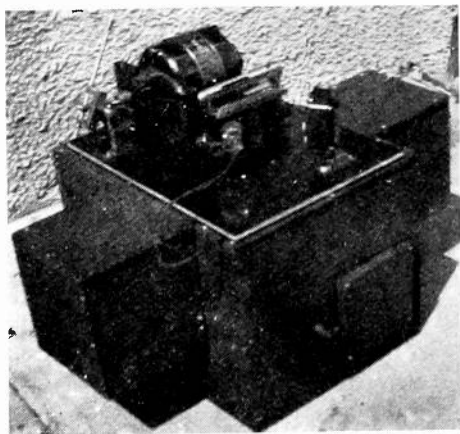

Fig. 8—Photograph of synchronous motor, rotating mirror, oscillograph element, and lamp. The gears for driving the film are shown at the left.

employed as a light source for the oscillograph. Fig. 5 is a drawing of the assembly with film drive and film container omitted. Fig. 6 is a photograph of the complete recorder with film container in place. Fig. 7 shows the film container removed while Fig. 8 is a photograph of the

synchronous motor, rotating mirror, oscillograph element, and lamp. The gears for driving the film are shown at the left.

Fig. 9 is a typical record which shows the variation in height over a period of  $8\frac{3}{4}$  hours. The frequency was 4045 kc and the distance from transmitter to receiver was 3 miles.

The advantages of this system may be enumerated as follows:

1. It gives a continuous automatic record.
2. It requires only a small fraction of the amount of film used by other methods. A less sensitive film and weaker light source may be used.
3. It requires little attention.
4. It will record heights of two or more layers simultaneously.
5. It is relatively free from power line and atmospheric disturbances.

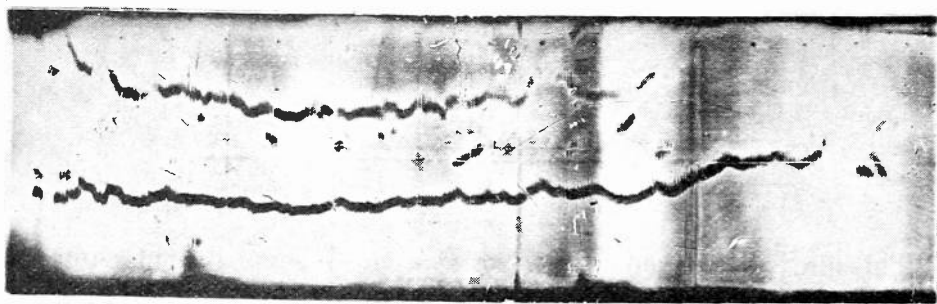

Fig. 9—Example of height record showing gradual rise of layer from 241 km to 399 km. Note also temporary appearance of other layers. Record runs from 5:30 P.M. to 2:15 A.M. June 13, 1931. Frequency 4045 kc. Ground trace appears at bottom of record.

#### IV. SUGGESTIONS FOR IMPROVEMENT

The chopper used in this installation was of the commutator type, and some trouble was experienced with wearing brushes and commutator disk. Better results might be obtained by using a photo-electric cell with a light chopper for making the pulses. It should be possible to use a grid-glow tube between the photo-electric cell and the transmitter.

With the apparatus as set up at present, some difficulty is experienced in getting the proper phase relation between chopper and rotating mirror. When the set is started, it may be found that the phase relation is such that the pulse pattern will not be on the film. In order to get the pattern in the proper position it is necessary to start and stop one of the synchronous motors a number of times until the proper phase relation is found. Once this adjustment is made, it will not change until the recorder is stopped. Obviously, the phase change could be made at the transmitter by shifting the chopper brushes. However, it

would be more convenient to make the adjustment at the receiving station, if possible.

It is advisable to devise some method for monitoring without stopping the recorder. This could be done most conveniently by introducing a prism in the optical system so that part of the light from the oscillograph element could be diverted to a viewing screen.

Some device for automatically recording the time on the record would also be convenient.

Investigations indicate that best results in the preliminary set-up are attainable by working at the extreme top of the peaks, thereby avoiding confusion due to the two lines corresponding to the two sides of the pulses. This is due to the fact that at high mirror speeds (giving high resolution) these lines may be some distance apart (in the absence of extremely sharp transmitted pulses and a very carefully designed receiver having negligible time constants). Developments are hence in progress to attain these desirable features in transmission and reception. These double lines are most confusing in the presence of multiple layers. Under such conditions it is difficult to recognize whether specific lines correspond to upward or downward motions of the light beam from the base line of the peaks. The tops of the peaks are readily maintained at a fixed height by arranging the resistance-coupled amplifier circuit so that the incoming signal reduces rather than increases the current through the element. It is readily possible with a high gain set such as employed in the experiments described, to reduce this current to practically zero when the incoming pulse has a moderate amplitude. This results in a fixed position of the top of the pulses which corresponds to the zero current position of the light beam. This position has the advantage of being practically unaffected by changes in the operating plate current of the last amplifier tube due to voltage fluctuations, etc.

#### V. CONCLUSION

Aside from developments for improving the reliability of the recording system so as to insure the continuity of records, it appears probable that problems arising in the interpretation of these records are likely to be of paramount importance. Thus, the complex records obtained in the presence of "split peaks," multiple reflections, and other intricate phenomena, greatly complicate the work of interpretation of the records. Reinforced and interpreted by supplementary records taken by the oscillographic methods previously employed, however, continuous records of this kind represent a distinct addition to the methods heretofore available for the study of Kennelly-Heaviside layer phenomena.

## THE OPERATION OF VACUUM TUBES AS CLASS B AND CLASS C AMPLIFIERS\*

BY

C. E. FAY

(Bell Telephone Laboratories, New York City)

*Summary*—A simple theoretical development of the action of a vacuum tube and its associated circuit when used as a class B or class C amplifier is given. An expression for the power output is obtained and the conditions for maximum output are indicated. The way in which the tuned plate circuit filters out the harmonics in the pulsating plate current wave is illustrated by a hypothetical example. A set of dynamic output current characteristics is developed graphically from a set of static characteristics. The class B dynamic curves are found to give a better approximation to a straight line than the class C curves because of a reversed curvature which appears at the lower ends. It is pointed out that the screen-grid tube should function similarly to a high  $\mu$  three-element tube in this type of operation. Experimental dynamic characteristics of a three element tube, Western Electric 251-A, and of a screen-grid tube, Western Electric 278-A, of identical dimensions are shown which verify the theoretical results. The screen-grid tube gives about the same output and efficiency as the three-element tube, but its dynamic characteristic tends to bend more rapidly at the upper end.

### INTRODUCTION

THE majority of modern radiotelephone installations in this country are designed for modulation at a low power level and amplification of the modulated carrier, so as to obtain up to 100 per cent modulation in the output stage. As far as the writer is aware there seems to be no very comprehensive material dealing with this phase of vacuum tube operation available from past publications. A treatment of the operation of such amplifiers seems particularly desirable from the standpoint of the design of vacuum tubes for such service.

Some of the fundamental considerations regarding class B or C operation were given by Morecroft and Friis,<sup>1</sup> and later, a more complete analysis of power oscillators by Prince.<sup>2</sup> Both of these, however, were primarily concerned with the attainment of steady output at high efficiency. Other papers<sup>3,4,5</sup> of more recent date have touched somewhat upon the subject.

\* Decimal classification: R132. Original manuscript received by the Institute, September 8, 1931. Presented before New York Meeting, November 4, 1931.

<sup>1</sup> J. H. Morecroft and H. T. Friis, "The vacuum tube as a generator of alternating current power," *Trans. A.I.E.E.*, 38, No. 2, October, 1919.

<sup>2</sup> D. C. Prince, "Vacuum tubes as power oscillators," *Proc. I.R.E.*, 11, Nos. 3, 4, 5, June, August, October, 1923.

<sup>3</sup> A. A. Oswald and J. C. Schelleng, "Power amplifiers in trans-Atlantic radio telephony," *Proc. I.R.E.*, 13, No. 3, June, 1925.

<sup>4</sup> E. E. Spitzer, "Grid losses in power amplifiers," *Proc. I.R.E.*, 17, No. 6, June, 1929.

<sup>5</sup> Y. Kusunose, "Calculation of characteristics and the design of triodes," *Proc. I.R.E.*, 17, No. 10, October, 1929.

This paper will deal particularly with the type of amplifier used for the amplification of the modulated carrier. It will be assumed that a linear relation between input voltage and output current is the desired characteristic of such amplifiers and that the more nearly this relation is attained, the less will be the distortion produced.

An approximate graphical method for the calculation of the dynamic output characteristic from the static characteristics of a tube is outlined which is capable of considerable accuracy. The exciting voltage is taken to be a sinusoidal voltage of varying amplitude, and only the fundamental component of the output current is considered. The very important question of the distortion introduced by the nonlinearity of the characteristic and by the resonance effect of the output circuit, as well as the question of the suppression of harmonics in the antenna circuit, is considered to be beyond the scope of this paper.

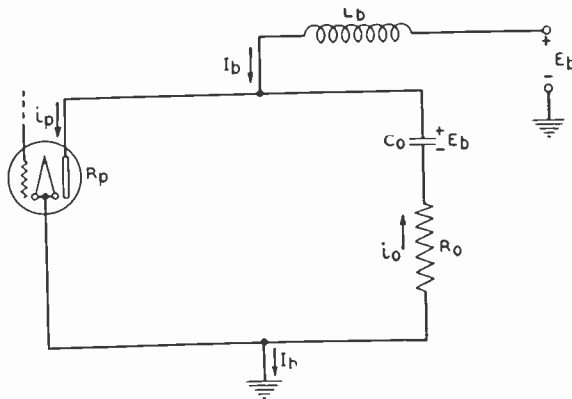

Fig. 1—Schematic of amplifier plate circuit with resistance load.

### THEORETICAL DEVELOPMENT

Class B amplifiers<sup>6</sup> have been defined as those which operate with a negative grid bias such that plate current is practically zero with no excitation grid voltage, and in which the power output is proportional to the square of the excitation voltage.

Class C amplifiers have been defined as those which operate with a negative grid bias more than sufficient to reduce the plate current to zero with no excitation grid voltage, and in which the output varies as the square of the plate voltage between limits.

There is actually very little distinction between the two types as the fundamental principles of operation are the same in that the plate current flows in pulses and becomes zero during part of the cycle; the class C type being merely the case where the duration of the pulses is shorter. For the purposes of this paper, a class B amplifier shall be re-

<sup>6</sup> 1931 Standardization Report, YEAR BOOK, I.R.E., 1931, p. 71.

garded as one in which the grid bias is either just sufficient or is not sufficient to reduce the plate current to zero with no excitation grid voltage, and a class C amplifier as one in which the grid bias is more than sufficient to reduce the plate current to zero with no excitation grid voltage.

Let us consider the plate circuit of a class B or C amplifier to be represented schematically in Fig. 1. We shall omit the grid circuit and assume that the excitation of the grid merely varies the internal tube resistance,  $R_p$ , which it does in effect. If at the start, the grid is so biased that no plate current flows, the condenser  $C_0$  will charge up to a potential  $E_b$  as indicated in Fig. 1. Let it be assumed that  $C_0$  is of sufficiently large capacity that it presents negligible impedance at the frequency of operation, or that the time constant of  $C_0$  and  $R_0$  is large compared to the time of one cycle of the operating frequency. In this event, then, the voltage across  $C_0$  will remain constant at  $E_b$  during a complete cycle. Let it also be assumed that the choke coil  $L_b$  is of sufficient inductance that the current  $I_b$  is maintained constant throughout the cycle.

Then by applying Kirchoff's laws to the circuit Fig. 1, remembering the assumptions regarding  $C_0$  and  $L_b$ , we find the following relations must hold at any instant:

$$E_b = i_p R_p + i_0 R_0 \quad (1)$$

or,

$$e_p = E_b - i_0 R_0 \quad (2)$$

and,

$$i_0 = i_p - I_b \quad (3)$$

also,

$$I_b = \text{average of } i_p \text{ over 1 cycle} \quad (4)$$

since the average current through  $C_0$  must be zero.

Then let it be assumed that the grid of the tube is excited and biased in such a manner that the plate current,  $i_p$ , will vary sinusoidally as illustrated in Fig. 2. When the resistance  $R_p$  is at its minimum value,  $i_p$  will be a maximum and will be the sum of  $I_b$  and  $i_0$ , ((1) and (3)). Also  $e_p$  will be a minimum, (2); see point 1, Fig. 2. As  $R_p$  is increased by the grid potential going in the negative direction,  $i_p$  will be reduced as also will  $i_0$ . At the instant when

$$i_p = I_b, \quad i_0 = 0$$

as illustrated by point 2, Fig. 2. Then as  $R_p$  is further increased,  $i_p$  becomes less and  $i_0$  starts to increase in the negative direction until  $i_p$  is zero at cut-off;

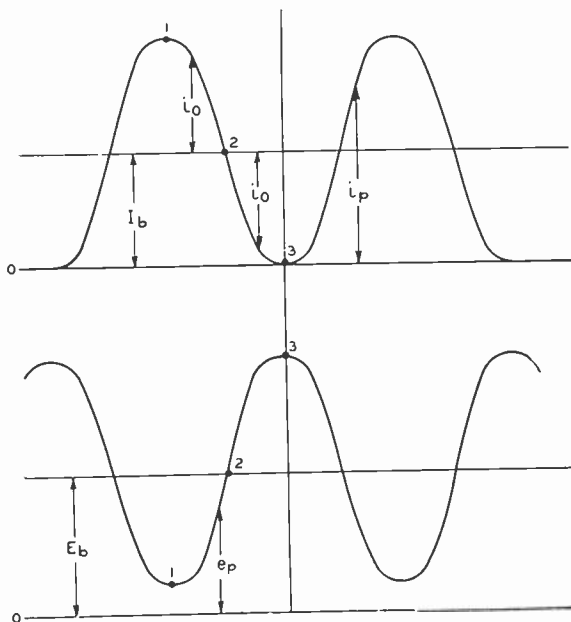

Fig. 2—Plate current and plate voltage relations for sinusoidal plate current in circuit of Fig. 1.

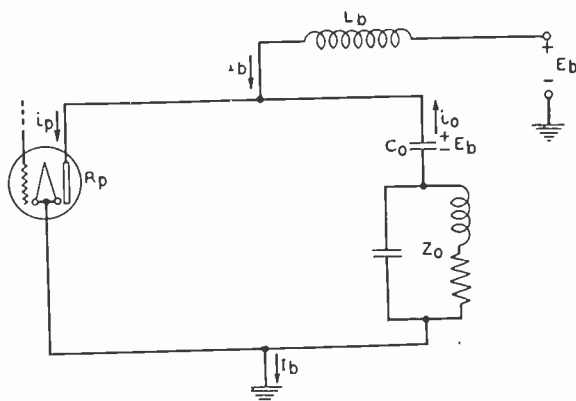

Fig. 3—Schematic of amplifier plate circuit with tuned output impedance.

$$R_p = \infty, \quad i_0 = -I_b \text{ from (3).}$$

Then from (2) and the above,

$$e_p = E_b + I_b R_0 \tag{5}$$

which is the peak value of  $e_p$ . Thus the power in  $R_0$  is  $i_0^2 R_0$  averaged over a cycle and the power dissipated in the tube is  $i_p^2 R_p$  averaged over a cycle.

In actual operation, the plate current is not sinusoidal but goes from zero to peak value and back to zero in about half the cycle and remains cut off during the rest of the cycle, as illustrated by Fig. 4A. Also, instead of being a pure resistance, the output circuit consists of a tuned tank circuit, Fig. 3, into which resistance is introduced either directly or by coupling in some way. Thus the impeduance of the output circuit will be a resistance to the fundamental frequency only. However, the same general principles will apply in this case as in the case of the sinus-

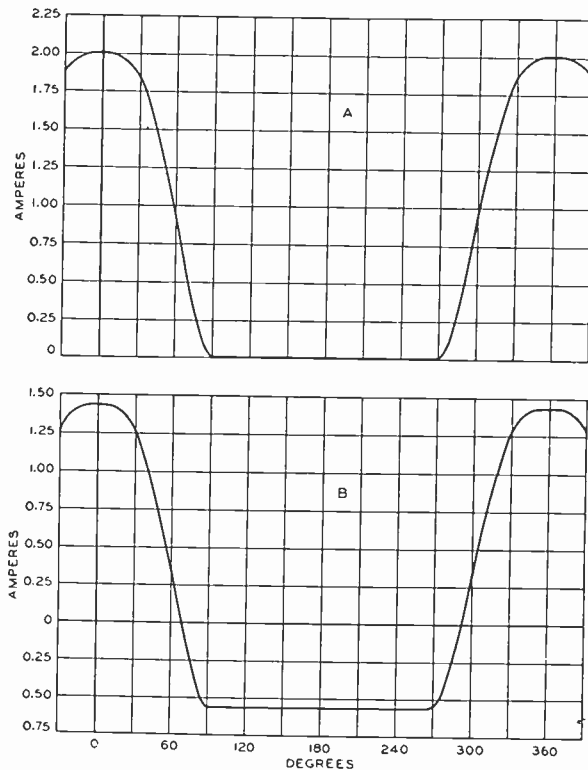

Fig. 4A—Pulsating plate current wave,  $i_p$ .

Fig. 4B—Alternating component of plate current,  $i_0$ .

oidal plate current and the pure resistance circuit. The equations will be of the same form except that  $Z_0$  must be substituted for  $R_0$  as follows:

$$E_b = i_p R_p + i_0 Z_0 \quad (1A)$$

$$e_p = E_b - i_0 Z_0 \quad (2A)$$

$$i_0 = i_p - I_b \quad (3)$$

$$I_b = \text{average of } i_p \text{ over 1 cycle} \quad (4)$$

In this case it must be remembered that the wave of  $i_p$ , and hence  $i_0$ , instead of being a simple sine wave, is a more complex wave consisting



of a fundamental frequency and numerous harmonics. Also  $i_0 Z_0$  is the sum of all such components multiplied by the respective impedances presented to them taken in their proper phases.

Considering the wave form of  $i_0$  shown in Fig. 4B, which is readily obtainable in practice, it should be evident from inspection that it can be considered a cosine wave containing odd and even cosine terms and may be expressed by

$$i_0 = I_1 \cos \omega t + I_2 \cos 2\omega t + I_3 \cos 3\omega t \\ + I_4 \cos 4\omega t + \dots + I_n \cos n\omega t.$$

By means of an harmonic analysis of this wave for the numerical values indicated in Fig. 4B, the coefficients were found to be approximately as follows:

$$I_1 = 0.96, \quad I_2 = 0.543, \quad I_3 = 0.140, \quad I_4 = -0.07, \\ I_5 = -0.105, \quad I_6 = -0.043.$$

The voltage produced across the output circuit by the wave,  $i_0$ , then will be the sum of the voltages produced by each one of the components of  $i_0$ . Let it be assumed that the reactances of the output circuit are 300 ohms each at fundamental frequency and that sufficient resistance has been inserted in the inductive branch to make the impedance to fundamental frequency 2000 ohms resistance. This will require about 45 ohms in series with the inductance. At second harmonic frequency, then, the impedance of the inductive branch in complex notation is  $45 + j600$  and that of the capacity branch  $0 - j150$ . Without introducing much error in the result we may as well write  $+j600$  and  $-j150$ , which in parallel give  $-j200$ . At third harmonic frequency we have  $+j900$  and  $-j100$  which in parallel give  $-j112.5$ . At fourth harmonic frequency we have  $+j1200$  and  $-j75$  which in parallel give  $-j80$ .

Thus the voltage produced by the fundamental will be

$$e_1 = 0.96 \times 2000 \cos \omega t = 1920 \cos \omega t,$$

and that produced by the second harmonic will be

$$e_2 = 0.54 \times 200 \cos (2\omega t - 90 \text{ degrees}) = 108 \cos (2\omega t - 90 \text{ degrees}),$$

and that produced by the third harmonic will be

$$e_3 = 0.14 \times 112.5 \cos (3\omega t - 90 \text{ degrees}) = 15.75 \cos (3\omega t - 90 \text{ degrees}),$$

and that produced by the fourth harmonic will be

$$e_4 = -0.07 \times 80 \cos(4\omega t - 90 \text{ degrees}) = 5.6 \cos(4\omega t + 90 \text{ degrees}),$$

etc. Fig. 5B shows to scale the fundamental and second harmonic voltages produced, and the dotted curve gives the sum. The higher har-

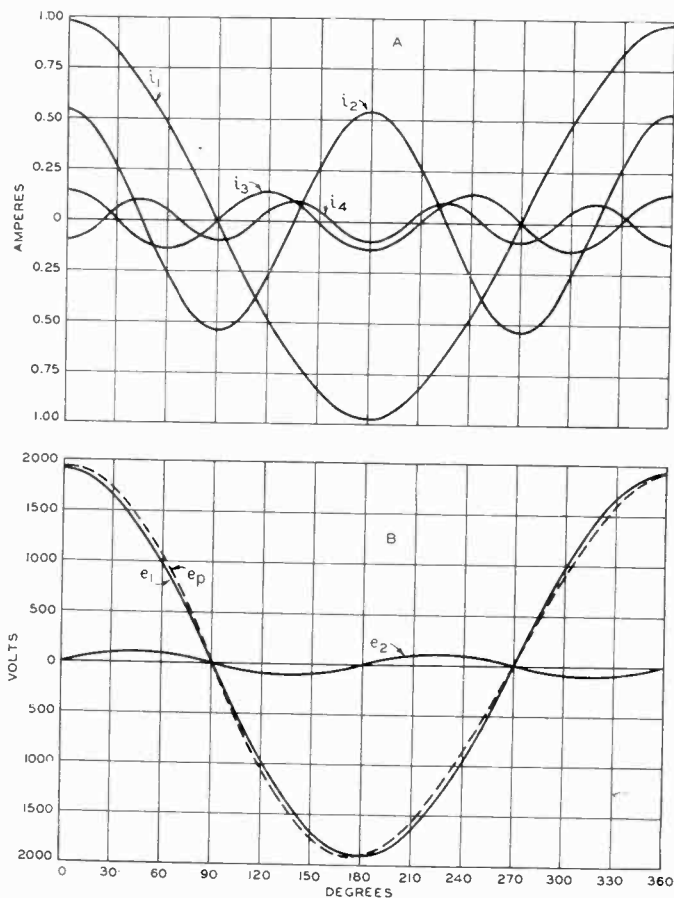

Fig. 5A—First four components of  $i_0$ , Fig. 4B.

Fig. 5B—Alternating components of plate voltage produced by  $i_0$  in output circuit.

monic voltages are too small to show on the plot. The resultant is seen to be very little different from a sine wave. Therefore even though the wave  $i_0$  departs radically from a sine wave, the voltage produced across the output circuit is very nearly sinusoidal. Then the output power at fundamental frequency is

$$W_0 = \frac{I_1^2 R_0}{2} \quad (6)$$

where  $I_1$  is the peak value of the fundamental component of  $i_0$ , and  $R_0$  is the effective resistance of the tank circuit at fundamental frequency.

The output power may also be expressed:

$$W_0 = \frac{(E_b - e_{pm})KI_p}{2} \quad (7)$$

if  $I_1 = KI_p$ .

For any constant value of grid voltage, the plate current will be some function of the plate voltage, so that for any peak value of  $e_g$  we may write

$$e_{pm} = f(I_p). \quad (8)$$

Substituting (8) in (7) we have

$$W_0 = \frac{[E_b - f(I_p)]KI_p}{2}. \quad (9)$$

In order for  $W_0$  to be a maximum,

$$\frac{dW_0}{dI_p} = 0.$$

Performing this operation on (9) and solving for  $I_p$  assuming  $K$  is constant, we get

$$I_p = \frac{E_b - f(I_p)}{f'(I_p)} = \frac{E_b - e_{pm}}{r_p} \quad (10)$$

since  $f'(I_p)$  is  $df(I_p)/dI_p$  which is obviously  $r_p$ , the differential plate resistance when  $I_p$  is flowing.

We may also write

$$R_0 = \frac{E_b - e_{pm}}{KI_p}. \quad (11)$$

Substituting (10) in (11) we obtain

$$R_0 = \frac{r_p}{K} \quad (12)$$

which gives the relation of  $R_0$  to  $r_p$  for maximum power output.

If we have the  $i_p - e_p$  curves for any tube we may approximate closely the point of maximum output at any peak grid voltage. This can be accomplished by a process of cut and try in finding where the quantity  $(E_b - e_{pm}) I_p$  becomes a maximum, since  $K$  remains fairly constant, depending mostly on the bias voltage and grid excitation

voltage, as will be shown later. Also, for any given output impedance and peak grid voltage, we may find the output from the  $i_p - e_p$  curves by cut and try by finding where

$$\frac{E_b - e_{pm}}{I_p} = KR_0 \quad (\text{from (11)})$$

is satisfied. It will be noticed from Figs. 4A and 5A that  $I_1/I_p = 0.48$ . In general  $K$  will be near this value for well loaded conditions. The actual value depends upon the exciting voltage and grid bias voltage, and at low values of excitation it may differ considerably from the value indicated above which may render the cut-and-try methods outlined subject to considerable error.

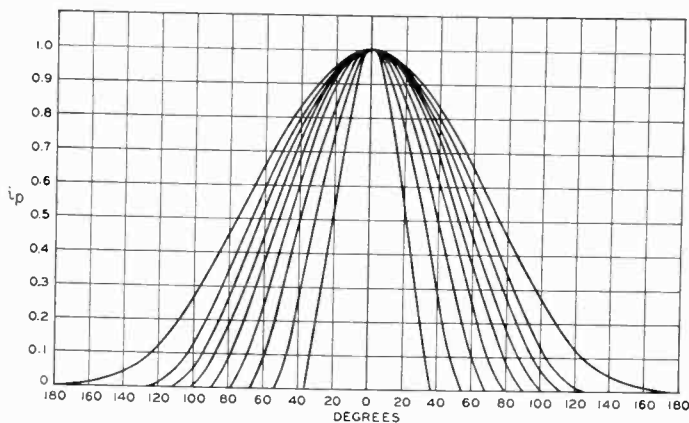

Fig. 6—Curves of  $i_p$  obtained from a three-halves power characteristic with sinusoidal exciting voltage for varying periods of plate current flow.

In addition to finding the maximum output for a given set of conditions, it is desirable to know what the shape of the curve of output current versus exciting voltage will be. The following method determines points on the output curve by the use of the static characteristic of the tube.

In Fig. 6 is shown a family of plate-current curves obtained by applying a sine wave grid voltage to a three-halves power characteristic with a plate voltage consisting of a steady voltage plus a sine wave 180 degrees out of phase with the grid voltage. The different curves show the relative shapes obtained by variation of the grid bias so that the portion of the cycle during which plate current flows is varied. It can be shown that for any tube, no matter what the actual values of voltages and currents are, as long as the portion of the characteristic under consideration obeys the three-halves power law, the plate-current waves will correspond to those of Fig. 6 in shape for the same respective periods of plate current flow. By means of harmonic

analyses, the value of  $K$  corresponding to each of these shapes was calculated and Fig. 7 shows the variation of  $K$  with the number of degrees during which plate current flows. Fig. 8 shows a comparison of three possible shapes for 180-degree flow with the corresponding values of  $K$ .  $A$  is the unsaturated curve of Fig. 6.  $B$  shows a curve for which the characteristic departs from the three-halves power law at its upper end, presumably due to the effects of grid current, etc. This curve if unsaturated would have a peak value about 17 per cent higher.  $C$  shows a curve for which the saturation is so pronounced that the grid current drawn has caused a depression.

In actual tubes the static characteristics do not follow the three-halves power law exactly, but for the purposes of this paper it is sufficiently accurate to assume that they do in the portion where grid current is not appreciable.

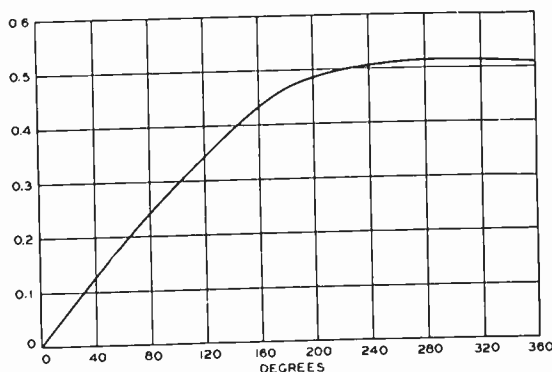

Fig. 7—Variation of  $K$  with period of flow for curves of Fig. 6.

With the information available from Figs. 6 and 7, and the static characteristic of a tube, we should be able to plot the dynamic characteristic for any value of output impedance. For an example, let Fig. 9 represent the static characteristics of a tube, (Western Electric No. 251-A). Then for some value of output impedance, say 2000 ohms, let us plot curves of constant  $K$  on the static characteristic assuming  $E_b = 3000$  volts. Points on these curves are found from

$$I_p = \frac{E_b - e_{pm}}{KR_0}$$

which is another form of (11). For example, to find where the  $K = 0.5$  curve crosses the  $E_p = 2000$  curve, we have  $e_{pm} = E_p = 2000$ ,  $E_b - e_{pm} = 1000$ , thus

$$I_p = \frac{1000}{0.5 \times 2000} = 1.0, \quad (\text{Fig. 9}).$$

The cut-off point, or the potential which the grid must have to make the plate current just zero is given by

$$e_g \text{ cut-off} = -\frac{E_b}{\mu} \quad (13)$$

If we bias the grid with this negative voltage, it may be said to be biased at cut-off, and if the grid voltage becomes more positive than this value, plate current will flow. Thus if we apply a sinusoidal exciting voltage, the plate current will always flow during 180 degrees, or

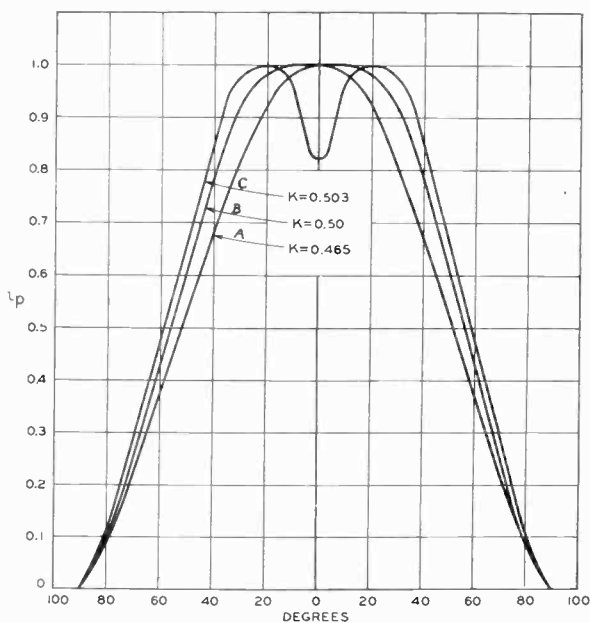

Fig. 8—Three typical shapes of plate current for 180-degree flow. *A*, unsaturated, *B*, slightly saturated, *C*, extremely saturated.

half the cycle, and for this condition  $K=0.465$  from Fig. 7, so the dynamic output current curve will be obtained by multiplying the ordinates of the  $K=0.465$  curve of Fig. 9, by 0.465. However, in the upper portion where the static characteristics depart appreciably from the three-halves power law,  $K$  will increase gradually (Fig. 8), so that it is more accurate to use slightly increasing values of  $K$  in this portion. (See Table I of calculations for  $E_c=300$ .)

If the grid bias is more negative than the cut-off point (i.e., if the tube is biased "below cut-off"), the plate current will not begin to flow until the grid potential has reached the cut-off point (13), and the portion of the cycle in which plate current flows will be determined by the number of degrees of the cycle in which the exciting wave is above the cut-off point. Thus in this case,  $K$  will depend on the amplitude of the

exciting wave compared to the difference between the bias and the cut-off point. When the amplitude becomes large compared to this difference, the period of plate current flow approaches 180 degrees but when the peak value of the exciting wave just reaches the cut-off point, the period of flow is zero. In this case  $K$  can vary from almost 0.465 to zero depending on the amplitude of the exciting wave, or if the exciting voltage is sufficient to produce a saturation effect in the plate current wave,  $K$  might exceed 0.465. This is the case of the class C amplifier.

If the grid bias is more positive than the cut-off point (i.e., if the tube is biased "above cut-off"), plate current flows during 360 degrees of the cycle until the amplitude of the exciting voltage is sufficient to reach the cut-off point. The period of flow continues to decrease until it approaches 180 degrees as the amplitude of the exciting voltage becomes large compared to the difference between the bias and cut-off potentials. Here  $K$  is always greater than 0.465; see Fig. 7. This is the case of the class B amplifier.

## SYMBOLS

- $E_b$  = d-c plate voltage
- $E_g$  = d-c grid voltage
- $E_s$  = screen-grid voltage (held constant)
- $e_p$  = instantaneous plate potential
- $e_g$  = instantaneous grid potential
- $e_{p0}$  = minimum plate potential
- $e_1$  = instantaneous value of fundamental frequency component of alternating plate voltage
- $e_n$  = instantaneous value of  $n$ th harmonic component of alternating plate voltage
- $I_b$  = d-c plate current
- $I_p$  = peak value of plate current
- $i_p$  = instantaneous value of plate current
- $i_0$  = instantaneous value of alternating component of plate current
- $i_1$  = instantaneous value of fundamental frequency component of alternating plate current
- $i_n$  = instantaneous value of  $n$ th harmonic component of alternating plate current
- $I_1$  = peak value of fundamental frequency component of alternating plate current
- $I_n$  = peak value of  $n$ th harmonic component of alternating plate current.
- $\mu$  = amplification factor of tube =  $[\Delta e_p / \Delta e_g]_{i_p \text{ constant}}$
- $K = I_1 / I_p$
- $W_o$  = power output in watts
- $Z_o$  = output impedance =  $R_o$ , a resistance at fundamental frequency
- $R_p$  = instantaneous internal resistance of the tube
- $r_p$  = differential plate resistance of tube at any point =  $[\Delta e_p / \Delta i_p]_{e_g \text{ constant}}$

Table I outlines the calculation of dynamic characteristics of both types from the static characteristics of Fig. 9. In these calculations, the cut-off point is assumed to be constant at  $-300$  volts and the value of  $K$  is obtained from Fig. 7 after determining the portion of the cycle in which the exciting voltage is above the cut-off point. For  $E_c = -300$  of course it is always 180 degrees. For  $E_c = -350$ , and a peak exciting voltage of 100 volts for example, the peak  $e_g$  will be  $-250$  which will give

120 degrees for the period of flow and thus  $K=0.345$  from Fig. 7. Then on the static characteristic, Fig. 9, taking  $e_p = -250$ , and by interpolating between the  $K=0.30$  and  $K=0.35$  curves to  $K=0.345$  we find  $I_p=0.112$ . Multiplying this by  $K$  we get  $I_1=0.0386$ . Changing to r-m-s value, squaring and multiplying by 2000 ohms we obtain 1.49 watts for the output power. It is then determined that this would represent a current of 0.0995 amperes in the 150-ohm dummy antenna which was used in the experimental work, and which was so coupled to the output tank circuit that the impedance into which the tube was working was of the value indicated.

TABLE I  
CALCULATION OF DYNAMIC OUTPUT CHARACTERISTICS  
No. 251-A TUBE  
 $E_b = 3000$  Volts;  $Z_o = 2000$  ohms

$E_c$ Volts	Peak Ex- citation Volts	Peak $e_p$ Volts	$K$	$I_p$ Amp.	$I_1$ Amp.	$I_1/\sqrt{2}$ Amp.	Watts Output ( $I_1/\sqrt{2}$ ) <sup>2</sup> $Z_o$	Output Cur- rent in 150 ohm Ant. Amp.
-300	100	-200	0.456	0.230	0.107	0.0756	11.5	0.276
	200	-100	0.465	0.575	0.267	0.1885	71	0.688
	300	0	0.465	1.01	0.47	0.332	222	1.218
	400	+100	0.465	1.49	0.692	0.490	480	1.790
	500	200	0.47	1.95	0.917	0.647	840	2.37
	600	300	0.48	2.30	1.07	0.756	1150	2.96
	650	350	0.49	2.45	1.20	0.848	1440	3.10
	-350	100	-250	0.345	0.112	0.039	0.027	1.49
200		-150	0.415	0.410	0.170	0.122	28.9	0.438
300		-50	0.435	0.810	0.352	0.249	124	0.907
400		+50	0.445	1.280	0.570	0.403	324	1.470
500		150	0.45	1.77	0.797	0.563	635	2.055
600		250	0.452	2.20	0.995	0.702	988	2.56
650		300	0.453	2.40	1.087	0.768	1180	2.80
-250		50	-200	0.51	0.220	0.112	0.079	12.6
	100	-150	0.505	0.375	0.190	0.134	36	0.490
	200	-50	0.492	0.760	0.374	0.265	140	0.966
	300	+50	0.483	1.220	0.590	0.417	348	1.525
	400	150	0.480	1.710	0.820	0.580	674	2.120
	500	250	0.477	2.137	1.020	0.721	1040	2.635
	600	350	0.475	2.475	1.173	0.830	1380	3.030

In the calculations of Table I, the cut-off point was assumed constant at  $-E_b/\mu$ . However, it actually varies as  $-e_p/\mu$  and will vary sinusoidally if  $e_p$  is sinusoidal. No error is introduced by this fact in the case of bias at cut-off ( $E_c = -300$ ). However, in the other two cases an error is introduced. In the case for bias below cut-off ( $E_c = -350$ ) the amount of error is indicated by the two points illustrated in Fig. 11. *A* is the case for a peak exciting voltage of 300 volts. From the static characteristics of Fig. 9 we find that  $e_{pm}$  will be about 2300 volts which will make  $-230$  volts, the peak of the real cut-off curve ( $-e_p/\mu$ ) and since it is a sine wave we can plot it as shown. The error in the period of flow then will be represented by the difference between where the  $e_p$  curve cuts the  $-300$ -volt line and where it cuts the  $-e_p/\mu$  curve. The actual period of flow is about 156 degrees instead of 160 degrees as found before which would make  $K=0.425$  instead of 0.435. *B* is the



case for a peak exciting voltage of 500 volts and by the same procedure we find  $K = 0.441$  instead of  $K = 0.45$ . These errors are quite small and do not alter the result appreciably in these cases.

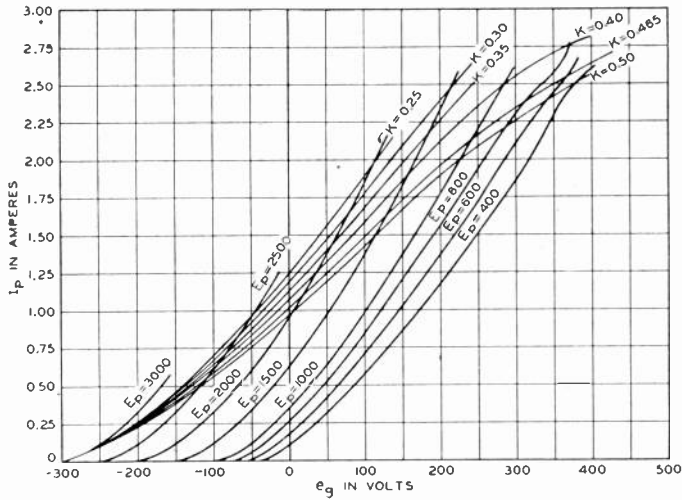

Fig. 9—Static characteristic with lines of constant  $K$  for 2000 ohms impedance. (Western Electric No. 251-A tube.)

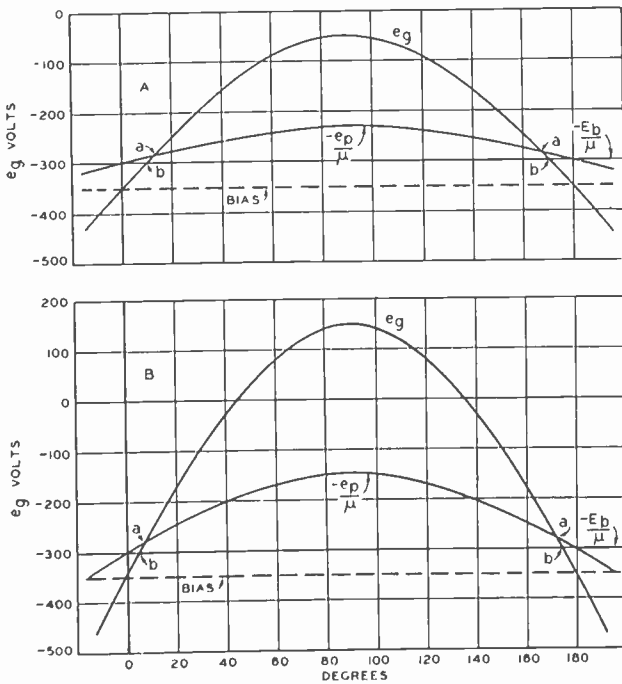

Fig. 10—Illustrating method of obtaining actual period of flow of plate current.  $a$ —actual cut-off point,  $b$ —cut-off point assumed in calculations.

The effect will be less pronounced, the higher the  $\mu$  of the tube, and more pronounced the further the bias voltage is moved from the cut-off point. For extreme cases in which more accuracy is desired,  $K$  will be

determined quite accurately by the second approximation method of Fig. 10. For the case of bias above cut-off where  $K$  is always greater than 0.465 the error in determining  $K$  will be considerably smaller as  $K$  does not vary greatly with the period of flow in this region; see Fig. 7. In the upper portion of the characteristic where departure from the three-halves power law becomes appreciable, the increase in  $K$  due to this saturation effect which must be estimated, (see Fig. 8), may be greater than the error produced by neglecting the varying cut-off. In this event it would hardly be worth while to use the method of Fig. 10,

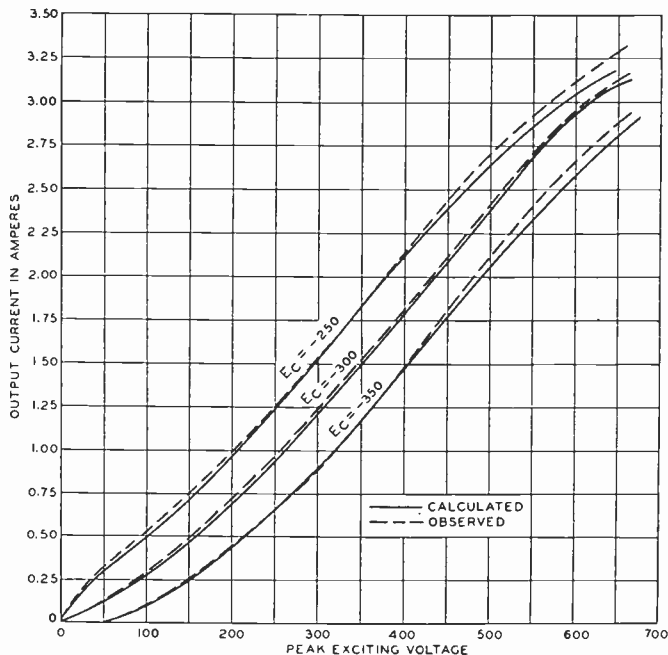

Fig. 11—Calculated and experimental dynamic characteristics of Western Electric No. 251-A tube  $E_b=3000$  volts,  $Z_0=2000$  ohms,  $\mu=10$ .

except in extreme cases where the bias differs greatly from the cut-off potential.

The dynamic output current characteristics calculated in Table I are shown plotted to scale in Fig. 11. It should be noted that for the case of bias above cut-off ( $E_c = -250$ ) the curvature of the dynamic is reversed at the lower end. This will tend to allow a better approximation to a straight line for the over-all curve than can be obtained for curves of bias below cut-off.

In general the highest output impedance admissible will give the straightest dynamic curve for a given tube. Comparing two tubes of equal power rating, the one with the highest mutual conductance will give the straightest dynamic characteristic with a given output impedance.

It will be noticed that the dynamic curves tend to show a saturation effect at their upper ends. This is predicted, however, from the static characteristics. If the grid excitation voltage is sufficient to allow the grid potential to approach the plate potential very closely, the electron current taken by the grid will increase rapidly. Since this current taken by the grid would have otherwise been taken by the plate, the result is a reduction in the value of  $i_p$  which causes the plate cur-

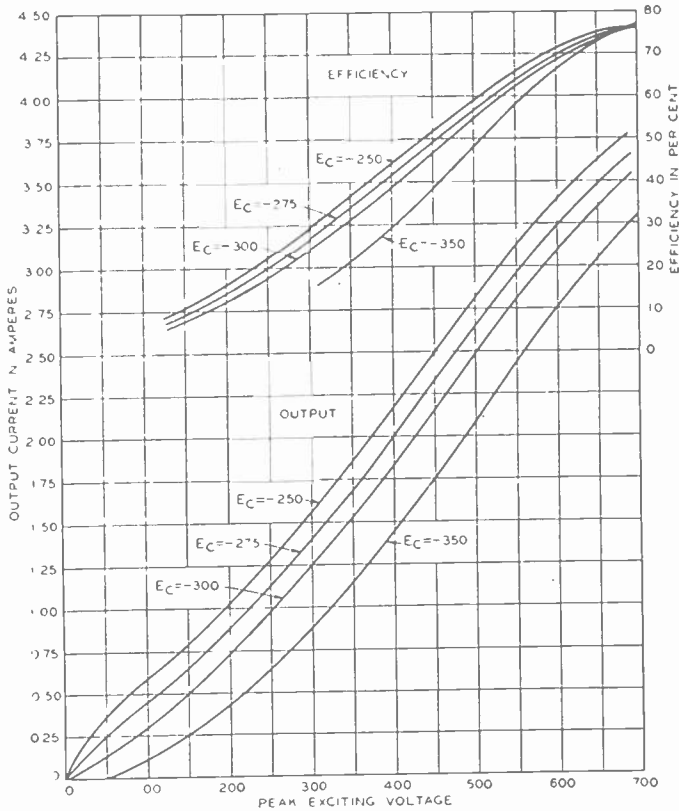

Fig. 12—Dynamic output and efficiency of a three-element tube.  
 $E_b = 3000$  volts,  $\mu = 10$ ,  $Z_0 = 1500$  ohms.

rent characteristic to depart from the three-halves power law. A slight saturation effect at the upper end of the dynamic curve may help the curve to approximate a straight line more closely. The output impedance may be chosen so as to realize this advantage providing the grid becomes positive during a sufficient portion of the cycle.

### THE SCREEN-GRID TUBE

The foregoing theory, with a few alterations, will apply equally well to the screen-grid tube. In any screen-grid tube where the screening is sufficient to reduce the grid-plate capacity to the point where operation

at high frequencies without neutralization is feasible, the screen voltage will determine the plate current at a given grid voltage almost entirely; the plate voltage having very little effect. In this case the cut-off point will be given approximately by

$$e_g \text{ cut-off} = - \frac{E_s}{\mu} \quad (14)$$

where  $\mu$  here is the  $\mu$  of a three-element tube with the plate in place of

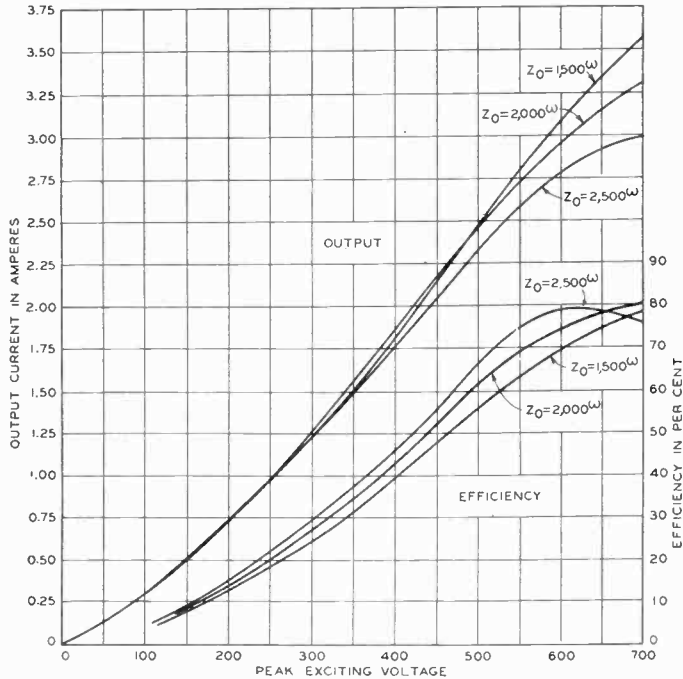

Fig. 13—Dynamic output and efficiency of a three-element tube.  
 $E_b = 3000$  volts,  $E_c = -300$  volts,  $\mu = 10$ .

the screen. A more exact formula would be

$$e_g \text{ cut-off} = - \frac{E_b + \rho E_s}{\mu(1 + \rho)} \quad (15)$$

where  $\mu$  is as defined above, and  $\rho$  is the amplification factor of a three-element tube considering the screen as the grid. However, if  $\rho$  is large compared to  $\mu$  and  $\mu$  is greater than 1, the cut-off point is given quite closely by (14).

In operation the screen is by-passed to ground by a large capacity so that the screen potential will remain practically constant at  $E_s$  to insure the effectiveness of the screening action. As the minimum plate potential approaches the screen potential, the screen will begin to draw appreciable current and thus cause a saturation effect in the character-

istic similar to that of the three-element tube when the minimum plate potential approaches the maximum grid potential. Also as the maximum grid potential approaches the screen potential, the grid will begin to draw current which will subtract from the plate and screen currents thus tending also to cause a saturation effect in the characteristic. It would seem desirable, therefore, that the screen voltage be chosen somewhere between the maximum grid potential and the minimum plate poten-

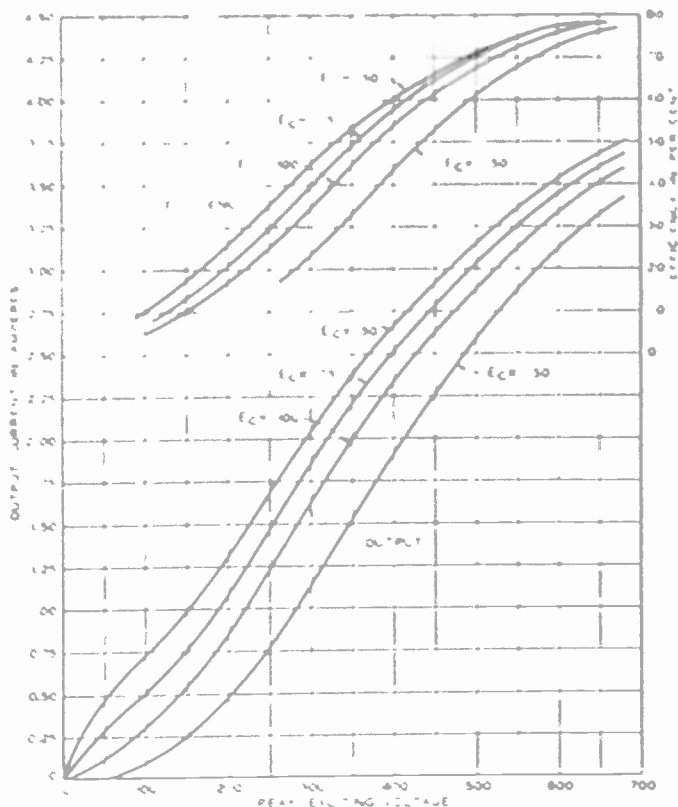

Fig. 14—Dynamic output and efficiency of a screen-grid tube.  $E_b = 3000$  volts,  $E_s = 400$  volts,  $Z_0 = 1500$  ohms.

tial, the actual point depending on whether grid current or screen current is the least desirable. In operation the screen-grid tube should give the same type of characteristics as indicated in Fig. 11, and have some advantage from the fact that as a high- $\mu$  tube it requires less driving voltage. However the dynamic characteristic may tend to saturate sooner than it would for the equivalent three-element tube because of the tendency of both the screen and the grid to absorb current under the conditions mentioned above.

### EXPERIMENTAL RESULTS

In Fig. 11 along with the curves calculated from the theoretical de-

velopment are shown the actual experimental curves obtained at 3000 kc for the same conditions.

The following dynamic output current and efficiency curves of the three-element tube, Western Electric, 251-A, and the screen-grid tube, Western Electric, 278-A, measured at 3000 kc are submitted to show the effects of various factors on the dynamic characteristic. They allow a direct comparison of the three-element tube and the screen-grid tube.

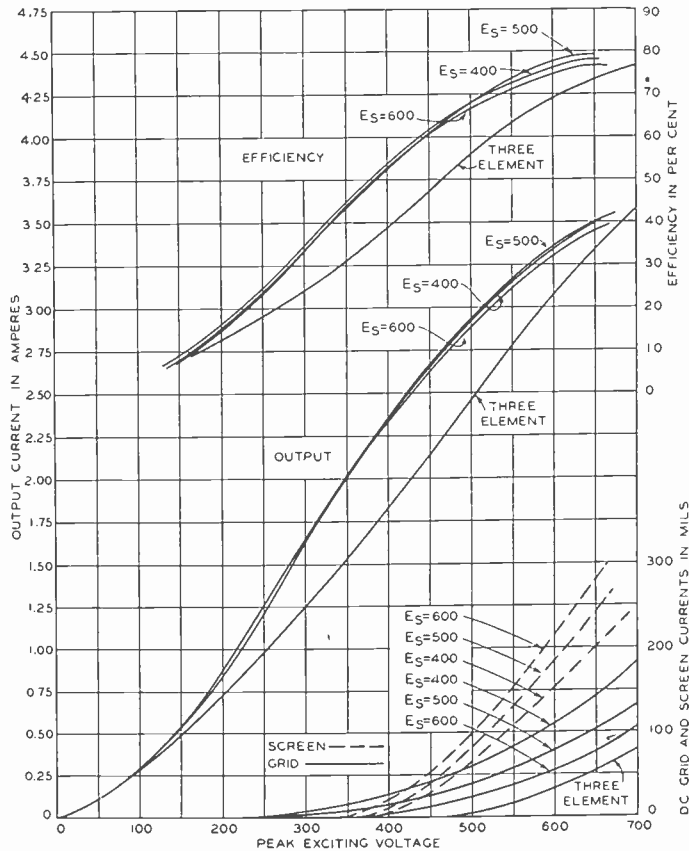

Fig. 15—Dynamic output and efficiency of a screen-grid tube compared to that of a three-element tube.  $E_b = 3000$  volts,  $E_c$  (at cut-off),  $Z_0 = 1500$  ohms.

The curves of Fig. 12 show the dynamic output currents and efficiencies obtained from the three-element tube for the conditions indicated. The upper portions of these curves show some saturation effect and they are practically identical except that they are displaced along the abscissa by approximately the differences in grid bias. Fig. 13 shows the effect of varying the output impedance for the case of bias at cut-off. The relative effect for other biases is practically the same as for the case shown.

Fig. 14 shows the dynamic output currents and efficiencies for a

screen-grid tube which is identical in construction with the three-element tube except for the addition of the screen between the grid and plate. The  $\mu$  of this tube, considering the screen to be the plate, is about 4, so that the cut-off bias is about  $-E_s/4$ . The curves of Fig. 14 were taken with the screen voltage and output impedance constant at 400 volts and 1500 ohms, respectively. It will be noted that these curves show the same general characteristics at the lower portions as the curves of the three-element tube, Fig. 12, but as predicted in the theoretical consideration, they tend to saturate more rapidly in the upper portion. The efficiencies appear to be about the same as obtainable from the three-element tube at the same outputs.

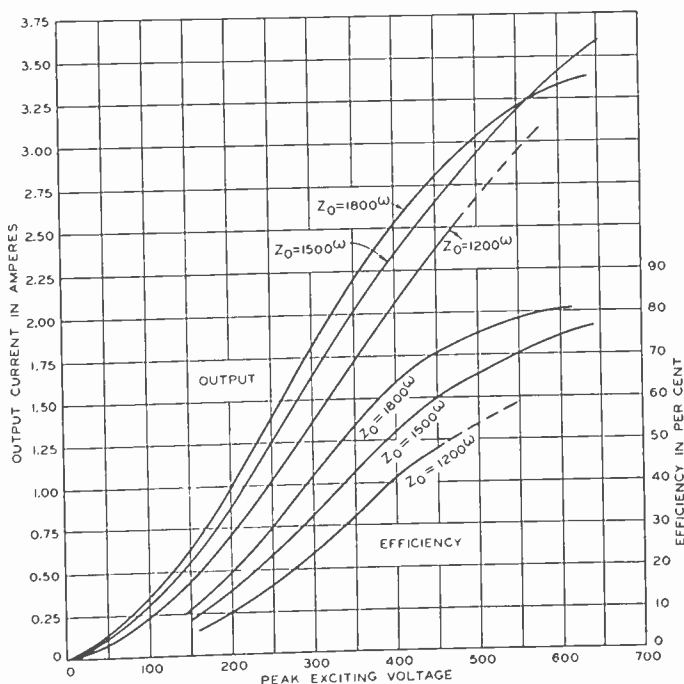

Fig. 16—Dynamic output and efficiency of a screen-grid tube.  
 $E_b = 3000$  volts,  $E_c = -100$  volts,  $E_s = 400$  volts.

Fig. 15 shows a comparison of the dynamic output curves at 1500 ohms impedance and bias at cut-off of the screen-grid tube for three different values of screen voltage, and of the three-element tube. In addition the d-c screen currents and grid currents are shown. The high- $\mu$  effect of the screen-grid tube is responsible for the steeper dynamic curve. The reason for the greater saturation effect at the upper portion of the curves for the screen-grid tube is apparent upon comparing the d-c screen and grid currents with the grid current for the three-element tube, since the plate is being robbed of the current taken by grid and

screen in one case, and only of the current taken by the grid in the other. In Fig. 16, the effect of the output impedance on the screen-grid dynamic curves is shown. The effect is seen to be similar to that for the three-element tube, though somewhat more pronounced.

### CONCLUSIONS

It has been shown from both theory and experiment that there is a marked difference between the dynamic output characteristics of class B and class C amplifiers as defined, particularly in the lower portion of the curves. This difference is the more pronounced the farther the grid-bias voltage is moved from the cut-off point. In general class C operation is more efficient than class B operation because the flow of plate current is limited to a smaller portion of the cycle which includes the portion in which the plate voltage is lowest.

It must be borne in mind that in a radiotelephone transmitter where modulation is effected at low power level and the modulated carrier amplified, the dynamic characteristic of the output current will be the resultant of the dynamic characteristics of all of the intermediate stages from the modulating stage through the final amplifier stage. In certain cases distortion in one stage might be fairly well compensated for by suitably shaping the characteristic of the following stage through choosing proper values of bias voltage and output impedance.

It may be concluded from both theory and experiment that the screen-grid tube functions in general similarly to the three-element tube and is capable of giving about the same output efficiency. It possesses the property of the high- $\mu$  tube in giving greater output for a given exciting voltage in the portion of the dynamic characteristic where saturation has not become noticeable, but the dynamic characteristic shows saturation much sooner than that of the three-element tube. The screen-grid tube also has the property that the output impedance has very little effect on the input circuit which will allow some shaping of the dynamic characteristic without affecting the driving power.

The fact should be mentioned that the so-called internal impedance, or plate impedance of the tube, such as might be measured on a bridge for small amplitudes of plate-current swing, bears no very close relation to the impedance of the output circuit into which it should work in class B or class C operation. Reference to this plate impedance is quite misleading unless the part of the characteristic from which it is taken is given, since it varies greatly over the characteristic. For the screen-grid tube mentioned the internal plate impedance is of the order of 100,000 ohms, whereas it was working with an output impedance of the order of 1500 ohms.



## FURTHER NOTES ON THE DETECTION OF TWO MODULATED WAVES WHICH DIFFER SLIGHTLY IN CARRIER FREQUENCY\*

BY

C. B. AIKEN

(Bell Telephone Laboratories, New York City)

*Summary*—The present paper deals with the analysis of the detection of two modulated waves of slightly different carrier frequency under the conditions that the carrier amplitude of one wave is much smaller than that of the other and that the modulation of the larger wave is low. These conditions apply in determining the interference which arises during the operation of two broadcast stations on the same frequency assignment when the stations are nonisochronous and transmit different programs. A discussion of the characteristics of shared channel interference is given, and it is shown that there are only two important components of this interference, one being the carrier beat note and the other being what has been designated as side band noise. This latter consists of two frequency spectra, one of which is similar to the spectrum of the modulating frequencies of the undesired station but is shifted upward by a constant amount equal to the difference between the carrier frequencies. The other spectrum is of a similar type but is shifted downward in frequency by the same amount.

THE interference which may occur in shared channel broadcasting is a matter of considerable interest at the present time. When two transmitters are widely separated it is possible for each of them to render satisfactory daylight service to reasonably large areas in the immediate vicinity of each transmitter. At night the normal service area of one or both transmitters may or may not be reduced by interference from a distant station, but such reductions are of frequent occurrence, particularly if the carrier frequencies of the two stations differ by several hundred cycles.

It is highly desirable to be able to describe the interference which occurs in shared channel operation in terms of the field strengths of the two stations, their degrees of modulation and the frequency of the carrier beat. These are definite quantities which can generally be ascertained by field measurements, and a knowledge of them is necessary to coverage studies of any type.

An analysis of the detection of two modulated waves having slightly different carrier frequencies has already been made,<sup>1</sup> and from this there have been obtained the results necessary for the description of

\* Decimal classification: R111.6. Original manuscript received by the Institute, October 16, 1931.

<sup>1</sup> C. B. Aiken, Proc. I.R.E., 19, 120-137, January, 1931.

shared channel interference. However, this analysis was limited to the cases of the square-law and the straight-line detectors and involves a wide latitude as to the possible ranges of modulation of the two stations.

When we are interested only in the operation of two stations which are definitely nonisochronous and which, in general, transmit different programs, there appear certain conditions which make it possible to recast the analysis into a somewhat clearer and more compact form and to deal with a generalized type of detector without restricting the consideration to the square-law and straight-line cases. These conditions are due to the fact that practically all of the serious interference will occur when the modulation of the desired station is very low. Furthermore, reception will be at all tolerable only when the ratio of the field strength of the undesired station to that of the desired station is quite small. It is these conditions of low field strength ratio and low modulation of the desired station which make possible a special form of the analysis.

In the earlier paper referred to<sup>1</sup> the results obtained for the square-law detector were valid for any ratio of field strengths and any degree of modulation, while those obtained for the straight-line detector were valid for field strength ratios of approximately 0.1 or less and for degrees of desired modulation ranging from 0.1 to 0.5.

The present paper deals with the analysis under the conditions stated above, as being characteristic of shared channel nonisochronous operation, and gives a physical interpretation of the results of the formula derived. The paper is divided into two parts the first of which assumes the results of the derivation which is given in the second part, and discusses the characteristics of the interference which occurs.

#### PART I

Let us assume that the strong or desired station is modulated at a radian velocity  $P$  and the weak or undesired station is modulated at a radian velocity  $p$ . Let it be further assumed that the amplitude of the desired carrier is  $E$  and that of the undesired carrier is  $e$  and that the degree of modulation of the two stations is  $M$  and  $m$ , respectively.  $M$  and  $m$  are expressed as decimal fractions. Then the total signal impressed upon the detector will be

$$E(1 + M \cos Pt) \cos \Omega t + e(1 + m \cos pt) \cos \omega t. \quad (1)$$

$\Omega$  and  $\omega$  are the radian velocities of the desired and undesired carriers, respectively.

<sup>1</sup> *Loc. cit.*

We shall assume that the detector may be of any type which has a continuous single valued characteristic such as is likely to occur in practice. It is shown in Part II that there will appear in the output of the detector only four audio frequencies of any importance provided that  $e/E$  and  $M$  are small, say of the order of 0.1 or less. One of these frequencies is the desired tone and is considerably weaker than the other three but is important because it is the frequency to which we wish to listen. The amplitudes and radian velocities of these four frequencies are shown in the following table.

TABLE I

Radian Velocity	Amplitude
$P$	$E^2MF_1'$
$u = \Omega - \omega$	$EeF_1'$
$p + u$	$\frac{Eem}{2}F_1'$
$p - u$	$\frac{Eem}{2}F_1'$

In the foregoing table  $F_1'$  is a function of  $E$  only, the form of the function being determined by the shape of the detector characteristic.  $F_1'$  is independent of  $e$ ,  $m$ , and  $M$ . This function is defined in Part II.

The above table contains data which permit us to make a fairly complete description of the interference phenomenon which is met with in shared channel broadcasting, and the physical interpretation of the various terms is a matter of considerable interest.

$P$  is the radian velocity of the tone from the desired station. The amplitude of this tone is directly proportional to the degree of modulation,  $M$ . The manner in which the amplitude of this tone varies with the amplitude of the desired carrier cannot be stated unless the form of  $F_1'$  is known, but this is not necessary in the present discussion.

The heterodyne whistle or beat note has a radian velocity  $u$  and an amplitude of  $eEF_1'$ . It will be noted that the intensity of the heterodyne whistle is directly proportional to the amplitude of the interfering carrier and is independent of the degree of modulation of both stations.

The radian velocity  $p + u$  represents a tone whose frequency is equal to that of the modulating tone of the interfering station plus the difference between the carrier frequencies.  $p - u$  represents a tone which is equal to that of the modulating frequency of the undesired station minus the difference between the carriers. These two tones taken together were referred to in the earlier paper as displaced side band interference but will hereafter be designated by the briefer term of side band noise. The amplitude of each of these terms is the same and is seen to be directly proportional to the amplitude and degree of modu-

lation of the interfering carrier. The ratio of the amplitude of either of these terms to the amplitude of the heterodyne whistle is  $m/2$ . Hence it follows that the importance of the side band noise relative to that of the carrier whistle will be dependent only upon the degree of modulation of the interfering station and upon the frequencies, both of the carrier beat and of the modulating tone of the undesired station.

If, instead of being modulated with a pure tone, the undesired station is modulated with speech or music having a complex frequency spectrum, then the side band noise will consist of two distinct audio-frequency spectra, one of which is of the same form as the spectrum of the modulation of the undesired station but is shifted upward from it in frequency by a constant amount equal to the difference between the carrier frequencies. The other side band noise spectrum will also be similar to that of the modulation but will be shifted downward in frequency by the same amount.

The side band noise will be of greatest importance when the modulation of the undesired signal is high, that is, during the peaks of modulation of the undesired program. The duration of these peaks will generally be short and consequently the side band noise will be less important than the beat note if the frequency of the latter is several hundred cycles or more. The theoretical determination of the relative importance of the carrier beat and side band noise involves psychological and other uncertain factors, but observations on modern transmitters employing deep modulation have shown that with a beat note of 400 cycles there is required for satisfactory reception a field strength ratio which is three or more times as large as that which is required when the carrier beat is subaudible. If the modulation of the interfering station is low, then a still larger improvement will be obtained by reducing the beat note to the subaudible range. Hence it is evident that a close control of the carrier frequencies is extremely advantageous.

No mention has so far been made of interference due to the normal program from the undesired station. This interference is due to modulation between the undesired carrier and undesired side band, both of which are weak in the present case. Consequently, this component of interference is extremely weak and may be neglected. It should be observed in passing that this small component of interference is the only one which may be properly designated as cross-talk, since it is the only component which is due entirely to the interfering station and which would be present were the desired station to go off the air.

It is evident that, in discussing interference in shared channel

operation, a distinction should be made between side band noise, which is due to beats between the carrier of one station and the side bands of the other, and cross-talk, which is due to beats between the undesired carrier and undesired side bands.

The distinction between side band noise and cross-talk may also be of use in considering the somewhat different problem of interference between stations operating on different channels. If the channels are 20 or more kilocycles apart, then the side band noise components will be supraaudible and the interference will be due entirely to cross-talk. This is true when the interfering station is considerably weaker than the desired station, and does not cover the case of high order modulation which may occur in the first tube of the radio-frequency amplifier.

If the stations are 10 kilocycles apart, the cross-talk may be audible as such but the side band noise will usually be more important. It here consists of an inverted speech or musical spectrum, the higher modulating frequencies from the undesired station being responsible for interference components of a lower audio frequency than those components which are due to the lower modulating frequencies of the interfering station. This side band noise shows itself as the familiar and extremely unpleasant "blats" which are so characteristic of interference from a station operating on an adjacent channel.

Summarizing, we may say that the only important components of the interference in shared channel operation are the heterodyne beat and the side band noise. If the frequency of the heterodyne beat is low, then the side band noise is the only important component of the interference. The heterodyne whistle may be considered to be inappreciable if the beat frequency is of the order of 50 cycles or less since the average ear is extremely insensitive to this range of frequencies and any residual reception of the beat frequency which might occur will be masked by the side band noise. The relative intensity of side band noise and carrier whistle is determined only by the degree of modulation of the interfering station. The absolute magnitude of the heterodyne beat note is directly proportional to the amplitude of the interfering carrier, while the absolute magnitude of the side band noise is directly proportional to the product of the amplitude and degree of modulation of the interfering carrier, that is, to the amplitude of the interfering side band.

A distinction should be made between side band noise and cross-talk. In the case of shared channel operation, the latter component is of negligible importance from the point of view of interference.

## PART II

The results listed in Table I are obtained from a consideration of the detection of two modulated waves under the conditions of very small modulation of the strong wave and a high ratio of the amplitudes of the two carriers. Under such conditions it is possible to carry through an analysis of the detection without specifying the form of the current-voltage characteristic of the detector. In order to do this there is employed a power series representation of the characteristic and in developing the analyses higher powers of the small quantities  $M$  and  $(e/E)$  are neglected.

Let us assume that the current voltage relation of the detecting system is

$$i_1 = a_0 + a_1v + a_2v^2 + a_3v^3 + \dots \quad (2)$$

This may be a Taylor's series involving an infinite number of terms or, if a Taylor's series cannot be obtained, it will nevertheless always be possible, according to Weierstrass' theorem, to represent the function  $i=f(v)$  to any desired degree of accuracy by means of a finite polynomial, in ascending powers of  $v$ , of a sufficient number of terms.<sup>2</sup>

Let  $v$  represent the total alternating voltage impressed upon the detector. In this case it is given by (1). It is possible, by trigonometric manipulation, to reduce this expression for  $v$  to the form of a single radio frequency having an amplitude and phase angle which are audio-frequency functions of time.  $v$  is then given by

$$v = V \cos(st + \phi). \quad (3)$$

$s$  is a radian velocity intermediate in value between  $\Omega$  and  $\omega$ .

$$V = \sqrt{A^2 + B^2 + 2AB \cos ut} \quad (4)$$

in which

$$A = E(1 + M \cos Pt) \quad (5)$$

$$B = e(1 + m \cos pt) \quad (6)$$

$$u = \Omega - \omega. \quad (7)$$

Substituting (3) into (2) we have

<sup>2</sup> A representation of this type has been used by Peterson and Llewellyn in their paper on "The operation of modulators from a physical viewpoint," *Proc. I.R.E.*, 18, 38-48; January, 1930. For a discussion of the representation of any continuous function by a power series see, Courant and Hilbert "Methoden der Mathematischen Physik," Vol. 1, 2nd edition, pp. 55-57.

$$i = a_0 + a_1V \cos (st + \phi) + a_2V^2 \cos^2 (st + \phi) + a_3V^3 \cos^3 (st + \phi) + \dots \tag{8}$$

and expressing  $\cos^n st$  in terms of multiple angles, we have

$$i = a_0 + a_1V \cos (st + \phi) + \frac{a_2V^2}{2} + \frac{a_2V^2}{2} \cos 2(st + \phi) + \frac{3}{4}a_3V^3 \cos (st + \phi) + \frac{a_3V^3}{4} \cos 3(st + \phi) + \frac{3}{8}a_4V^4 + \frac{a_4V^4}{2} \cos 2(st + \phi) + \frac{a_4}{8} \cos 4(st + \phi) + \dots + \frac{n(n-1) \dots (\frac{n}{2} + 1)(a_nV^n)}{2^n \lfloor n/2 \rfloor} \tag{6}$$

+ terms in  $\cos (st + \phi), \cos 2(st + \phi) \dots$

$n$  is even only.

Now all of the above terms, except those in the first vertical column, are of a radio frequency.<sup>3</sup> In considering the detecting action only the audio-frequency terms need be taken into account. Hence we shall treat with the first column above and write

$$I = a_0 + \frac{a_2V^2}{2} + \frac{3a_4}{8}V^4 + \frac{5}{16}a_6V^6 + \dots + \frac{n(n-1) \dots (\frac{n}{2} + 1)a_nV^n}{2^n \lfloor n/2 \rfloor} + \dots \tag{7}$$

$$I = F_1(V^2). \tag{8}$$

Now we shall assume that

$$\frac{e^2}{k^2} \ll 1 \quad \text{and} \quad M^2 \ll 1. \tag{9}$$

<sup>3</sup>  $\phi$  is an audio-frequency function of time and the quantity  $\cos (st + \phi)$  consists of a sum of radio-frequency terms one of which is of radian velocity  $S$  while the others make up side bands extending on either side of  $S$ .

Then,

$$B^2 \ll A^2. \quad (10)$$

From (4) and (10) it follows that

$$V^2 = A^2 + 2AB \cos ut. \quad (11)$$

Let

$$\theta = 1 + M \cos Pt \quad (12)$$

$$\gamma = 1 + m \cos Pt. \quad (13)$$

Then,

$$I = a_0 + \frac{a_2}{2} E^2 \theta^2 + \frac{3}{8} a_4 E^4 \theta^4 + \frac{5}{16} a_6 E^6 \theta^6 + \dots \quad (14)$$

$$+ a_2 E e \theta \gamma \cos ut + \frac{3}{2} a_4 E^3 \theta^3 e \gamma \cos ut + \frac{15}{8} a_6 E^5 \theta^5 e \gamma \cos ut + \dots,$$

in which there have been neglected all terms in  $e$  of powers higher than the first.

$$I = F_1(E^2 \theta^2) + E e \theta \gamma F_2(E^2 \theta^2) \cos ut \quad (15)$$

$$F_2(E^2 \theta^2) = a_2 + \frac{3}{2} a_4 E^2 \theta^2 + \frac{15}{8} a_6 E^4 \theta^4 + \dots, \quad (16)$$

Now,

$$F_2(E^2 \theta^2) = a_2 + \frac{3}{2} a_4 E^2 + \frac{15}{8} a_6 E^4 + \dots$$

$$+ 3a_4 E^2 M \cos Pt + \frac{15}{2} a_6 E^4 M \cos Pt + \dots, \quad (17)$$

in which terms in  $M^2$  have been neglected.

$$F_2(E^2 \theta^2) = F_2(E^2) + E^2 M F_3(E^2) \cos Pt + \quad (18)$$

$$F_3(E^2) = 3a_4 + \frac{15}{2} a_6 E^2 + \dots \quad (19)$$

Also,

$$F_1(E^2 \theta^2) = a_0 + \frac{a_2 E^2}{2} + \frac{3}{8} a_4 E^4 + \dots$$

$$+ a_2 E^2 M \cos Pt + \frac{3}{2} a_4 E^4 M \cos Pt + \dots \quad (20)$$

$$= F_1(E^2) + E^2 M F_2(E^2) \cos Pt + \dots \quad (21)$$



From the above it follows that

$$I = F_1(E) + E MF_2(E^2) \cos Pt \quad (23)$$

$$+ E \theta \gamma \cos ut [F_2(E) + E MF_2(E^2) \cos Pt]$$

Substituting the values of  $\theta$  and  $\gamma = 2\epsilon$  becomes

$$I = F_1 + E MF_2 \cos Pt + E \epsilon \cos ut + \frac{E \epsilon M}{2} (F_2 + E^2 F_2) \cos (P \pm u)t$$

$$+ \frac{E \epsilon m}{2} F_2 \cos (p \pm u)t + \frac{E \epsilon m M}{4} (F_2 + E^2 F_2) \cos (P \pm p \pm u)t. \quad (24)$$

in which terms in  $M$  are neglected. The double sign ( $\pm$ ) indicates two radian velocities, one containing the plus sign and one the minus. Where the double sign occurs twice inside of a parenthesis multiplying  $t$ , four radian velocities are indicated.

From (8) and (17) it is evident that

$$F = \frac{dF_1}{dE} F = F F_2'(F) \quad (25)$$

and from (19) it follows that

$$\frac{dF_2}{dE} = F F_3'(F) \quad (26)$$

$$\therefore F F_2'(F) = F \frac{d}{dE} \left[ \frac{1}{E} \frac{dF_1}{dE} \right] = \frac{d^2 F_1}{dE^2} - \frac{1}{E} \frac{dF_1}{dE}$$

$$F_2 + E F_2' = \frac{d^2 F_1}{dE^2} = F_1'' \quad (27)$$

(27) in (24) gives

$$I = F_1 + E M F_1' \cos Pt + \epsilon F_1' \cos ut + \frac{E \epsilon M}{2} F_1'' \cos (P \pm u)t$$

$$+ \frac{\epsilon m}{2} F_1' \cos (p \pm u)t + \frac{E \epsilon m M}{4} F_1'' \cos (P \pm p \pm u)t. \quad (28)$$

$F_1(E)$  is the d-c component of rectified current due to the application to the detector of the single unmodulated carrier  $E$ .  $F_1''$  is the second derivative of this d-c component with respect to  $E$ . This derivative will usually be much smaller than  $F_1$ . In the case of the linear and parabolic rectifiers,  $F_1''$  is zero, and it will be small in most physically realizable detectors.

The interference will be determined primarily by what occurs when  $M$  is quite small or zero. At such times we have

$$I = F_1 + F_1' \left[ EM \cos Pt + e \cos ut + \frac{em}{2} \cos (p \pm u)t \right]. \quad (29)$$

The term in  $\cos Pt$  is small but has been retained because it is the desired tone. The other terms of (28) determine the interference for any type of detector but (29) will be valid for larger values of  $M$  if  $F_1''$  is quite small compared to  $F_1$ .

It will be noted that (29) contains no term of radian velocity  $p$ . In other words, the interfering program or cross-talk is missing from the list of important interference components. This is because the term in  $p$  has an amplitude containing  $e^2$  as a factor, and all such terms are negligible.



## BOOK REVIEWS

**Radio Frequency Electrical Measurements**, by Hugh A. Brown, Assistant Professor of Electrical Engineering, University of Illinois. McGraw-Hill Book Company, 1931, 386 pages, price \$4.00.

This book is dedicated to the difficult problem of instructing the senior student, the junior engineer, or the more experienced amateur, in all of the more simple and more essential radio-frequency measurements. To this end, there are described about seventy measuring circuits for various purposes. The space is devoted to the measurement of frequency, voltage, antenna properties, vacuum tube characteristics, resistance, capacitance, and inductance, as well as field strength, amplifier distortion, and the performance of transmitters and receivers. The book is largely limited to radio-frequency measurements, but includes a few direct-current and audio-frequency measurements. The measuring circuits are accompanied in most cases by a helpful discussion of the theory and the limitations of the method.

As a textbook of radio measurements, the value of this book lies in the wide variety of the circuits which the author has collected from radio literature. This variety makes it useful also to those engineers who do not closely follow the advanced current radio literature, although the full utilization of most methods described requires reference to the original sources in the literature. This is one of the most up-to-date and authentic textbooks directed to this extensive subject.

\*HAROLD A. WHEELER

\* Hazeltine Corporation, Bayside, L. I., N. Y.

**Report of the Radio Research Board for the Period Ended December, 1930.** 90 pp. 41 fig. paper binding price 2s. Od. net. Obtainable from H. M. Stationery Office, Adastral House, Kingsway, London.

This report is a detailed review of the work of the Radio Research Board subsequent to that described in the 1929 report. This work includes a continuation of the study of the ionization of the atmosphere and its effect on the propagation of waves, by the frequency change method. Deductions are reported concerning the existence of one or more ionized regions of the upper atmosphere, the influence of magnetic storms on atmospheric ionization, the gradient of ionization in the upper atmosphere and the actual height reached by the waves. Several distances were worked over simultaneously. Measurements were made on the absolute atmospheric reflection coefficient. The work on atmosphericics was improved by the use of a cathode ray tube which gave a pattern of sufficient brightness to be photographed.

A portable field intensity measuring set for high frequencies is described. Theoretical and experimental studies of radiation characteristics of antennas are reported and applications made to directional antennas. Work was continued on the Adcock antenna for direction finding and beacon transmitting. The results obtained with the Orfordness marine beacon using a rotating loop antenna, are described.

Transmitting and receiving apparatus for high frequencies was developed. Important work was also done on the development of radio-frequency standards, the Schering high-frequency bridge, measurement of current at high frequencies and the measurement of the performance of amplifiers.

A complete list of papers giving the results of this work is included.

\*S. S. KIRBY

\* Bureau of Standards, Washington, D. C.

## RADIO ABSTRACTS AND REFERENCES

THIS is prepared monthly by the Bureau of Standards,\* and is intended to cover the more important papers of interest to the professional radio engineer which have recently appeared in periodicals, books, etc. The number at the left of each reference classifies the reference by subject, in accordance with the "Classification of Radio Subjects: An Extension of the Dewey Decimal System," Bureau of Standards Circular No. 385, obtainable from the Superintendent of Documents, Government Printing Office, Washington, D. C., for 10 cents a copy, which appeared in full on pp. 1433-56 of the August, 1930, issue of the PROCEEDINGS of the Institute of Radio Engineers.

The articles listed are not obtainable from the Government or the Institute of Radio Engineers, except when publications thereof. The various periodicals can be secured from their publishers and can be consulted at large public libraries.

### R000. RADIO

R009 The Work of the Radio Research Board. *The Wireless Engineer and Experimental Wireless*, 9, 1-2; January, 1932.  
Brief mention is made of the report of the work of the Radio Research Board (England).

R090 C. Crawley. Commercial wireless. *Wireless World and Radio Review*, 29, 730-732; December 30, 1931.  
A record of the year's progress in radio in England is given.

R090 W. H. Wenstrom. Historical review of ultra-short-wave progress.  
×R133 *Proc. I. R. E.*, 20, 95-112; January, 1932.  
This paper is a historical review up to the year 1931 of the more significant experiments with radio ultra-high frequencies. A selected bibliography is included.

R090 A chronological history of electrical communication—telegraph, telephone and radio. *Radio Engineering*, 12, 6; January, 1932.  
A history which records all important dates, discoveries, inventions, necrology, and statistics, with numerous contemporary chronological tie-in references to events in associated scientific events.

R090 Engineering achievements of 1931, radio. *Electric Journal*, 29, 36-37; January, 1932.  
The radio equipment of the Akron, three new commercial plane equipments, a portable radio beacon, and a giant audio transformer are mentioned.

### R100. RADIO PRINCIPLES

R113 E. Merritt. The optics of radio transmission. *Proc. I. R. E.*, 20, 29-39; January, 1932.

Radio transmission phenomena are compared with optical phenomena. The peculiarities and complexities of the optics of radio transmission are pointed out.

R113.1 K. Krüger and H. Plendl. Untersuchungen über Polarisations-  
×R113.6 fadings. (An investigation of polarization fading.) *Zeit. für techn. Physik*, 673-678, No. 12; 1931.

The authors conclude from the results of an experimental study at  $\lambda = 53$  meters, that that type of fading due to a rotation of the plane of polarization of the radiated wave as it passes through the earth's magnetic field or as it is reflected from the Kennelly-Heaviside layer, may be eliminated by using two crossed doublet antennas at either the sending or receiving station (preferably at the former).

\* This list compiled by Mr. A. H. Hodge, Mr. W. H. Orton, and Miss E. M. Zandonii.

- R113.1 H. Harbich and W. Hahnemann. Vorläufiger Bericht über Versuche zur Bekämpfung der Schwunderscheinungen im Rundfunk mit Antennengebilden üblicher Höhe ( $\lambda/4$ ) und grosserer Horizontalausdehnung. (Preliminary report on experiments in which the elimination of broadcast signal fading was attempted by means of antenna systems of usual height ( $\lambda/4$ ) and large lateral dimensions.) *Elektrotech. Zeits.* 52, 1545-1549; December 17, 1931.  
After a brief discussion of causes and possible elimination of fading, the results of a series of successful experiments are reported.
- R113.5 J. Cage. Do meteors cause static? *Radio News*, 13, 669; February, 1932.  
Flashes of light from meteorites and static were observed to occur simultaneously.
- R113.61 T. R. Gilliland, G. W. Kenrick, and K. A. Norton. Investigations of Kennelly-Heaviside layer heights for frequencies between 1600 and 8650 kilocycles per second. *Bureau of Standards Journal of Research*, 7, 1083-1104; December, 1931. Research Paper No. 390.  
The results of observations of the height of the Kennelly-Heaviside layer carried out near Washington, D. C. during 1930 are presented. The modification in the virtual height of the higher "F" layer produced by the existence of a lower "E" layer is investigated theoretically.
- R125.1 K. Krüger and H. Plendl. Strahlungsmessungen an einer modernen Telefunken-Richtantennen-Anlage der Grossfunkstelle Nauen. (Radiation measurements on a modern Telefunken directive-antenna system at Nauen.) *Zeit. für Hochfrequenz.*, 38, 205-209; December, 1931.  
The horizontal and vertical directive characteristics of a newly constructed antenna array, directed toward North America, were determined by means of field intensity measurements made in an airplane. The horizontal directivity was determined for each of three different altitudes. Experimental and calculated directive patterns are compared.
- R130 I. J. Saxl. Status of cold cathode tubes abroad. *Electronics*, 4, 17-19; January, 1931.  
Several types of cold cathode tubes and their methods of operation are described.
- R131 W. Patruschew. Die charakteristischen Flächen der Elektronenröhren "J-1." (The characteristic surfaces of the "J-1" vacuum tube.) *Zeit. für Hochfrequenz.*, 38, 231-232; December, 1931.  
A group of peculiar characteristic curves are recorded for this tube of Russian manufacture.
- R131 S. A. Obolensky. Über die Wirkung der Secundärelektronen auf den statischen Arbeitszustand der Eingitterröhre. (The effect of secondary emission on the static characteristics of the three-electrode vacuum tube.) *Archiv für Electrotechnik*, 25, 834-846; December, 1931.  
This is an experimental study of the effects of secondary emission in a small three-electrode vacuum tube.
- R132  
X R334 H. A. Robinson. An experimental study of the tetrode as a modulated radio-frequency amplifier. *Proc. I. R. E.*, 20, 131-160; January, 1932.  
The advantages and limitations of the tetrode employed as a modulated radio-frequency amplifier tube are considered and the results of an experimental study made upon one type of screen-grid tube are given. A method of modulation is described in which the modulating signal voltage is introduced in both the screen-

- grid and plate circuits, eliminating the detrimental effect of secondary emission and permitting the complete modulation of the radio-frequency carrier with a negligible degree of distortion, the tetrode performing in a manner similar to that of a neutralized triode.
- R133  
×R355.5 W. H. Wenstrom. An experimental study of regenerative ultra-short-wave oscillators. *Proc. I. R. E.*, 20, 113-130; January, 1932.  
A quantitative account is given of operating performance for two representative oscillator circuits, one of single tube type and the other of two-tube balanced type.
- R133  
×R355.9 F. Moeller. Versuche mit sehr langsamen durch die elektronröhre erzeugten elektrischen Schwingungen. (Experiments with very slow vacuum tube oscillations.) *Zeit. für tech. Physik*, 669-673, No. 12, 1931.  
Vacuum tube apparatus for generating and amplifying frequencies of the order of one cycle per second is described and the results of a study of phase relations existing in generator and amplifier are given.
- R135 R. A. Heising. Effect of shore station location upon signals. *Proc. I. R. E.*, 20, 77-86; January, 1932.  
Experiments are described for ascertaining the attenuation suffered by the unreflected wave in transversing relatively small amounts of land between the sea shore and hypothetical inland sites.
- R140 C. H. Smith. A cure for detector damping. *Wireless World and Radio Review*, 29, 687-688; December 16, 1931.  
A new method of minimizing the load on the preceding tuned circuit by the use of a grid-coupling condenser is described.
- R142 R. C. Clinker and T. H. Kinman. Some properties of coupled circuits. *Wireless Engineer and Experimental Wireless*, 9, 11-13; January, 1932.  
A device is described which automatically illustrates the discontinuous variation of current with capacity variation in the coupled circuit.
- R144 G. B. Robinson. Skin effect curves. *Radio Engineering*, 12, 30; January, 1932.  
A new manner of presenting skin effect data is described.
- R148.1 H. A. Brown, G. W. Pickels and C. T. Knipp. Detector distortion at low input voltages. *Radio Engineering*, 12, 21-23; January, 1932.  
The distortion characteristics of detector tubes at very low input potentials are investigated.
- R160 F. W. Schor. An untuned radio-frequency amplifier. *Proc. I. R. E.*, 20, 87-94; January, 1932.  
This paper outlines in brief a number of untuned radio-frequency transformers which have been used in the past. It discusses their characteristics and limitations. The construction of a transformer which makes high amplification possible is described.
- R161.1 F. M. Colebrook. Selectivity and tone correction. *Wireless World and Radio Review*, 29, 734-736; December 30, 1931; 14-16; January 6, 1932.  
The principles of tuned-circuit response to a modulated carrier wave are discussed. The difference between modulation and heterodyne interference is also discussed.
- R161.1 R. A. Hull. Selectivity in radiotelegraph reception. *QST*, 16, 8-15; January, 1932.  
Audio- and radio-frequency selectivity, the application of band-pass and low-pass filters, are discussed. Simplified design and construction methods are given.

- R163 G. Gorelik and G. Hintz. Über die Wirkung des Pendelrückkopplers. (Superregeneration.) *Zeit. für Hochfrequenz.*, 38, 222-228; December, 1931.  
A theoretical and experimental investigation of superregenerative action in ultra-high-frequency radio receiving sets is given. The existence of a multiple resonance phenomena is established.
- R165 H. Neumann. Ein- und Ausschwingvorgänge an electro-dynamischen Lautsprechern mit starken Magnetfeldern. (Building-up and decay transients in electrodynamic loudspeakers with strong magnetic fields.) *Zeit. für tech. Physik*, 627-632, No. 12, 1931.  
The use of very strong magnetic fields in electrodynamic loudspeakers permits increased damping of the membrane at its resonance frequency with a corresponding decrease of transients and improvement in fidelity.
- R165 H. Stenzel. Über die Theorie und Anwendung des Hornlautsprechers. (On the theory and application of the horn loudspeaker.) *Zeit. für tech. Physik*, 621-627, No. 12, 1931.  
After consideration of the theory involved it is pointed out that a properly designed horn loudspeaker has better response and efficiency than a cone loud speaker.
- R165 H. Vogt. Über die Erzeugung von Schallvorgängen durch das elektrostatische Feld. (On the production of sound by means of the electrostatic field.) *Zeit. für tech. Physik*, 632-639; No. 12, 1931.  
The author gives the results of an experimental study of the electrostatic loud speaker.
- R170 W. T. Cocking. Background noises. *Wireless World and Radio Review*, 29, 728-729; December 30, 1931.  
The causes and alleviations of background noises by careful attention to circuit design are discussed.

## R200. RADIO MEASUREMENTS AND STANDARDIZATION

- R210  
×R040 Address delivered November 4, 1931 by A. S. Angwin before the Wireless Section. *Jour. I.E.E.*, (London), 70, 17-35; December, 1931.  
The subjects of frequency measurement and control are discussed. A general survey of the work of the Post Office is given. The results obtained with tuning forks and piezo oscillators are outlined. The quartz plate holder and circuit are described. The quartz plate holder has a micrometer adjustable air gap.
- R223 W. Jackson. Losses in liquid dielectrics at radio frequencies. *The Wireless Engineer and Experimental Wireless*, 9, 14-17; January, 1932.  
Methods of measurement and results are given.
- R223 H. L. Andrews. A new method of dielectric constant measurement at radio frequencies. *Physics*, 1, 366-379; December, 1931.  
A new method of making dielectric constant measurements on gases at radio frequencies is described.
- R232 H. Klewe. Gegeninduktivitätsmessungen an Leitungen mit Erdrückleitung in Skillingaryd. (Measurements in Skillingaryd of the mutual inductance between lines having ground return circuits.) *Elek. Nach. technik*, 8, 533-538; December, 1931.  
Measurements of mutual inductance and inductive interference between power and communication lines in Sweden are compared with, and found to yield much higher values than similar measurements in Germany. The importance of local ground structure and conditions as a factor in inductive interference protection is discussed.

- R243.1 B. B. Bryant. A gooseneck type vacuum tube voltmeter. *Radio Craft*, 3, 466; February, 1932.  
A simple, yet serviceable, vacuum tube voltmeter is described. The tube is placed in a "gooseneck" in order to reduce length of grid leads.
- R245 C. E. Kilgour. Effects on reception of over-modulation. *Electronics*, 4, 9; January, 1932.  
×R148 The effects on reception of over-modulation are pointed out.
- R270 C. M. Jansky and S. L. Bailey. On the use of field intensity measurements for the determination of broadcast station coverage. *Proc. I. R. E.*, 20, 62-76; January, 1932.  
×R550 This paper discusses the importance of adapting uniform standards designed to express the coverage obtained by broadcast transmitters in terms of the field intensities produced, and discusses the methods used by the authors.
- R282.1 H. O. Cooper. Copper conductors. *Electrician*, 108, 5; January 1, 1932.  
Formulas for calculation of current-carrying capacity of copper conductors are given.
- R282.3 E. M. Guyer. The relative permeability of iron, nickel and permalloy in high frequency electromagnetic fields. *Jour. Frank. Inst.*, 213, 75-88; January, 1932.  
The author concludes that there is no anomalous variation in the relative permeability of iron, nickel and permalloy at frequencies corresponding to the band of wave lengths from 70-200 meters. There is no suggestion of absorption at or near 100 meters.
- R300. RADIO APPARATUS AND EQUIPMENT
- R330 L. Martin. New tubes for old. *Radio Craft*, 3, 458-459; February, 1932.  
A complete description of the "39," a variable- $\mu$  radio-frequency pentode is given.
- R330 New tubes. *Radio Engineering*, 12, 36; January, 1932.  
Data and uses are given.
- R330 R. W. Larsen. The design and development of the high-power oscillator or amplifier tube UV-862. *Radio Engineering*, 11, 18-22; December, 1931.  
An account is given of the development of the UV-862 transmitter electron tube, designed for class B and class C amplifier service.
- R335 R. de Cola. Choosing a screen-grid tube. *Radio Engineering*, 11, 15-16; December, 1931.  
The transconductance of a tube is not an accurate index to its operating characteristics. The value of  $\mu(R'/R' + R_p)$  gives a better indication of the quality of a tube.  $\mu$  is the voltage amplification factor,  $R'$  the d-c internal resistance,  $R_p$  the a-c internal resistance of the tube.
- R335 E. W. Ritter. A new use of the suppressor grid—The r-f pentode. *Electronics*, 4, 10-11; January, 1932.  
The advantages of the r-f pentode are indicated.
- R339 F. E. Henderson. The thyatron. *Wireless World and Radio Review*, 30, 29-32; January 13, 1932.  
The thyatron is described in connection with several useful circuits.
- R339 E. Lübecke. Gasgefüllte Verstärker- und Ionensteurröhren (Gas-filled amplifier and relay tubes.) *Elek. Zeit.* 52, 1513-1517; December 10, 1931.  
The physical properties, operating characteristics and industrial applications of gas-filled tubes are discussed.



- R355.7 C. L. Farrar. Class "B" audio power amplifiers. *Radio Engineering*, 12, 24-27; January, 1932.  
An engineering analysis of the performance of class A and class B amplifiers used in radio broadcast stations is given.
- R355.9 G. J. Kelly. The pentode oscillator. *Radio News*, 13, 680-681; February, 1932.  
Several circuits and uses of the pentode oscillator are described.
- R358 Boric acid fuses. *Electric Journal*, 29, 41-42; January, 1932.  
A fuse is described which is capable of breaking 20,000 amperes at 13,200 volts without making a spectacular arc. The arc is extinguished by water vapor which is generated in the fuse.
- R361 J. W. Berge. New motor radio design. *Radio News*, 13, 667-668; February, 1932.  
A new six-tube receiving set mounts on steering column by means of clamps and utilizes a condenser type of antenna mounted under either running board.
- R361.2 L. W. Martin. New all-wave super features—High gain design. *Radio News*, 13, 665-666; February, 1932.  
Six tuned intermediate frequency circuits and low loss design in both the radio frequency and i-f circuits provide unusual selectivity and high gain. The second oscillator permits cw reception and simplifies tuning of distant broadcast stations by the heterodyne beat method.
- R363 G. Taylor. Telephone booster. *Radio News*, 13, February, 1932.  
An amplifier that may be attached to a telephone as an aid to hearing.
- R363 H. Stanesby. The gain control and the decibel. *Wireless Engineer and Experimental Wireless*, 9, 18-19; January, 1932.  
Some circuits and tables of data which should be useful in designing gain control resistors are given.
- R365.22 M. G. Scroggie. Amplifier tone control circuits. *The Wireless Engineer and Experimental Wireless*, 9, 3-10; January, 1932.  
Data are presented for rapidly arriving at suitable circuit constants for compensating or modifying an audio frequency characteristic by means of a tone control in parallel with an intervalve resistance coupling.
- R366.3 P. G. Weiller. Grid-controlled vapor rectifiers. *Radio Engineering*, 11, 33-37; December, 1931.  
This article presents a review of the present state of development of rectifier tubes.
- R383 Two billion ohms. *Electric Journal*, 29, 42; January, 1932.  
The device, inclosed in a glass bulb, consists of a helix of glass rod surrounding a straight rod of carbon. A thin film of carbon is sputtered on the glass helix. With this as a leak a photo-electric current of one-ten millionth ampere can be amplified 10,000 fold.
- R385.5 A. Dinsdale. New moving coil microphone. *Wireless World and Radio Review*, 29, 683; December 16, 1931.  
A new type of coil microphone is described which has a uniform response up to 10,000 cycles, and is an improvement on the magneto-electric type used by the British Broadcasting Company.

## R400. RADIO COMMUNICATION SYSTEMS

- R423.21 K. Wigge. Das Modulationsverfahren des russischen Grossenders Schtschelkowo (Modulating the 100-kw Russian radio transmitter at Schtschelkowo.) *Zeit. für Hochfrequenz.*, 38, 231; December, 1931.  
A brief descriptive note with circuit diagram.

- R430 J. Herweg and G. Ulbricht. Über Art und Ursache der von Hochspannungsfreileitungen Ausgehenden Störungen des Rundfunkempfangs (On the cause and kind of broadcast reception interference from high tension power lines.) *Zeit. für Hochfrequenz.*, **38**, 228-230; December, 1931.  
Low-frequency induction, corona, and transients in the line were observed to be the main causes of broadcast interference. Methods for eliminating or reducing such interference are mentioned.
- R430 A. E. Teachman. An undesirable coupling link in radio receivers. *Radio Engineering*, **12**, 19-20; January, 1931.  
A suggested method of eliminating power line noises, carrier hum and other disturbances in electric receiving sets is described.
- ### R500. APPLICATIONS OF RADIO
- R526.3 F. Celler. Landing blind. *Aviation*, **30**, 699-700; December, 1931.  
A signaling device consisting of a series of concentric cables is used to inform the pilot of his position and approximate height above the field.
- R550 V. V. Gunsolley. Wireless synchronization. *Radio Engineering*, **11**, 26-29; December, 1931.  
Means are described whereby it is possible to control the frequency of a station wholly by the character of the resultant of the interfering waves of two broadcasting stations sharing the same channel.
- R566 J. Dunsheath. Continuous, instantaneous radio signaling systems for police cars. *Radio Engineering*, **12**, 11-12; January, 1932.  
Data and description of the use of radio by police are given.
- R583 E. Hudec. Zur Physiologie des Fernsehens (The physiology of television). *Elek. Nach.-technik*, **8**, 544-554; December, 1931.  
It is shown that, due to the logarithmic sensitivity curve of the human eye, a television picture can be made to appear much sharper than it really is. Methods for increasing the sharpness, and reproduction fidelity are discussed.
- R583  
× R361 H. G. Cisin. New television receiver. *Radio News*, **13**, 683-684; February, 1932.  
A home construction television receiving set which provides large images.
- R590 F. Schilgen and C. Starkloff. Die Lautsprecheranlage des Stadions der Technischen Hochschule Darmstadt (The public address system in the stadium of the Darmstadt technical school.) *Elek. Zeit.*, **52**, 1589-1591; December 31, 1931.  
A brief survey of the apparatus and circuit arrangement of the installation is given.
- ### R600. RADIO STATIONS
- R610 E. Qüack. Ten years of transradio—A retrospect. *Proc. I.R.E.*, **20**, 40-61; January, 1932.  
A review of the development of the "Transradio" system is given. References and descriptions of apparatus and antennas are included.
- R612.1 S. J. Ebert. The design and acoustics of broadcast studios. *Radio Engineering*, **12**, 13-16; January, 1932.  
The design and acoustical problems encountered in the construction of a present-day radio studio are treated.
- ### R800. NONRADIO SUBJECTS
- 534.83 J. A. Slee. Reflection methods of measuring the depth of the sea. *The Wireless Engineer and Experimental Wireless*, **9**, 20-22; January, 1932.

The paper records the present state of perfection with which echo measurements can be carried out in practice.

- 535.38  
×621.385.96 W. Kluge-Physikalische Eigenschaften und technische Gestaltung von Photozellen für tonelfilmzwecke (Physical properties and technical aspects of photoelectric cells for sound film purposes.) *Zeit. für tech. Physik*, 659-661, No. 12; 1931.  
After discussing their technical development, the author describes important improvements recently made in the alkali-type photo-electric cell.
- 535.38 W. J. Teitz and C. Paulson. Photoelectric cells in precision inspection work. *Electronics*, 4, 6-8; January, 1932.  
The use of the photoelectric cell in several automatic tests is given.
- 535.38 L. H. Mathias. Photoelectric relays. *Radio Engineering*, 11, 17; December, 1931.  
A description of a commercially available photoelectric relay is given.
- 537.26  
×R430 F. O. McMillan. Radio interference from insulator corona. *Electrical Engineering*, 51, 3-9; January, 1932.  
Laboratory tests show that the corona formation voltage and the initial radio interference voltage of clean, dry insulators are identical. Oscillograms are shown. Means for reducing the interference are suggested.
- 537.65 H. Osterberg. An interferometer method of studying the vibrations of an oscillating quartz plate. *Jour. Opt. Soc. of Amer.*, 22, 19-35; January, 1932.  
An expression involving the fringe brightness as a function of the amplitude of vibration is obtained for the case of a Michaelson interferometer in which one of the returning mirrors executes simple harmonic motion in a direction perpendicular to its plane. An interference method is suggested for distinguishing between flexural and longitudinal vibrations.
- 621.319.2 H. E. Hartig. Charts for transmission line problems. *Physics*, 1, 380-387; December, 1931.  
Charts to a reduced scale are presented from which it is possible to determine the vector voltage, current and impedance at any point of a transmission line with given terminations.
- 621.38 H. Decker. Eine Verzögerungsleitung für Messung und Vorfürung von Laufzeitwirkungen in Fernmeldesystemen (A delay network for measuring transit-time effects in telephone and telegraph systems.) *Elek. Nach.-technik*, 8, 516-527; December, 1931.  
A delay network, incorporating the principles of Poulson's telegraphone was used to study echo effects and allowable transmission time in long lines.
- 621.385.97  
×R133 H. E. Hollmann. Ein selbstanzeigendes raumakustisches Messgerät. (A direct reading acoustic measuring device.) *Elek. Nach.-technik*, 8, 539-543; December, 1931.  
An automatic direct reading device for measuring the reverberating time and thereby the acoustic qualities of sound-absorbing materials is described.



## CONTRIBUTORS TO THIS ISSUE

**Acheson, Marcus A.:** Born January 18, 1903, at Dennison, Texas. Received B.S. degree, Rice Institute, 1924. Research Laboratory, General Electric Company, 1924-1930; Vacuum Tube Engineering Department, 1930 to date. Associate member, Institute of Radio Engineers, 1930.

**Aiken, Charles B.:** Born October 6, 1902, at New Orleans, Louisiana. Marine radio operator, summers 1918-1921. Received B.S. degree in physics, Tulane University, 1923; M.S. degree, Harvard, 1924; M.A. degree, Harvard, 1925. Winner of Harvard Engineering School Prize Scholarship for 1923-1924, Whiting fellow in physics, 1924-1926. Research engineer, Mason, Slichter and Hay, Consulting Engineers, 1926-1928. Engineer, radio development department, Bell Telephone Laboratories, 1928 to date. Engaged in aircraft communication development, 1928-1929; broadcast receiver work, 1929 to date; supervisor, broadcast receiver development, Bell Telephone Laboratories. Associate member, Institute of Radio Engineers, 1925.

**Anderson, Clifford N.:** Born September 22, 1895, at Scandinavia, Wisconsin. Received Ph.B. degree, University of Wisconsin, 1919; M.S. degree, 1920. Supervising principal of schools, Amery, Wisconsin, 1913-1917. Ensign, Aircraft Radio, U.S.N.R.F., 1917-1918. Instructor, engineering physics, University of Wisconsin, 1919-1920; standardizing laboratory, General Electric Company, Lynn, Massachusetts, 1920-1921; Fellow to Norway, American-Scandinavian Foundation, 1921-1922; Department of Development and Research, American Telephone and Telegraph Company, 1922 to date. Associate member, Institute of Radio Engineers, 1919.

**Byrnes, Irving F.:** Born October 15, 1898, at Beacon, New York. Entered General Electric Test Department, 1918. Engaged in laboratory work on earlier types of tube transmitters, 1919-1921. Developed duplex radiophone equipment used on *S. S. America* for ship-to-shore tests in 1922. Developed crystal-control equipment now in use at stations WEAJ, WGY, KGO, and KOA. At present engaged in development work on commercial and military high-frequency transmitters, aircraft radio equipment, crystal-control, and train communication apparatus. Associate member, Institute of Radio Engineers, 1923.

**Dart, Harry F.:** Born October 20, 1895 at Forrest, Illinois. Received B.S. degree in E.E., Purdue University, 1917; E.E. degree, 1923. Telephone cable engineer, Western Electric Company, Chicago, 1917-1919. Served in Signal Corps School, College Park, Maryland, three months, 1918; at Signal Corps Radio Laboratory, Little Silver, New Jersey, summer, 1918; in charge, U. S. Signal Corps School for radio operators, Indiana University, September, 1918-January, 1919; radio Engineer, International Correspondence Schools, 1919-1920; instructor, electrical engineering, Rice Institute, 1920-1921; instructor and graduate student, Harvard University, 1921-1922. Radio engineer, Westinghouse Lamp Company, 1922 to date. Member, A.I.E.E. Associate member, Institute of Radio Engineers, 1920; Member, 1926.

**Fay, Clifford E.:** Born December 2, 1903, at St. Louis, Missouri. Received B.S. degree in E.E., Washington University, 1925; M.S. degree, 1927. Technical staff, Bell Telephone Laboratories, 1927 to date. Associate member, Institute of Radio Engineers, 1926.

Gilliland, T. R.: See Proceedings for February, 1932.

Gunn, Ross: Born May 12, 1897, at Cleveland, Ohio. Received B.S. degree in E.E., University of Michigan, 1920; M.S. in physics, 1921; Ph.D. in physics, Yale University, 1926. Amateur radio operator, 1912-1917; commercial radio operator, summers, 1915-1917. Special instructor in radio, University of Michigan, 1917-1918. Radio engineer, Glenn L. Martin Company, 1919. Instructor in engineering physics, University of Michigan, 1920-1922; radio research engineer for U. S. Air Service, 1922-23 and 1925; instructor in physics, Yale University, 1923-1927; in charge, high-frequency laboratory and graduate courses, Physics Department, Yale University, 1926-1927. Physicist, U. S. Navy, Aircraft Radio Section, Naval Research Laboratory, 1927-1928; assistant superintendent, Heat and Light Division, Naval Research Laboratory, 1928 to date; consulting radio engineer and physicist, 1924 to date. Nonmember, Institute of Radio Engineers.

Israel, Dorman D.: Born July 21, 1900, at Newport, Kentucky. Received E.E. degree, University of Cincinnati, 1923. Crosley Manufacturing Company, 1921-1923; chief engineer, Cleartone Radio Company, 1923-1929; chief development engineer, Crosley Radio Corporation, 1929-1931; chief engineer, Grigsby-Grunow Company, December, 1931 to date; at present, lecturer, Radio Engineering Evening College, University of Cincinnati. Associate member, Institute of Radio Engineers, 1923; Member, 1929.

Kear, F. G.: Born 1903 at Minersville, Pennsylvania. Received E. E. degree, Lehigh University, 1926; M.S. degree, Massachusetts Institute of Technology, 1928. Instructor, M.I.T., 1926-1928. Engaged in research on machine for solving differential equations by graphic methods. Assistant physicist, Bureau of Standards, 1928, associate physicist, 1930-1931, working on radio aids to air navigation. Graduate student, M.I.T., 1931-1932. Associate member, Institute of Radio Engineers, 1924; Member, 1931.

Kenrick, G. W.: See Proceedings for February, 1932.

Lattimer, Irving E.: Born August 28, 1888 at Hubbardston, Michigan. Received B.S. degree in E.E., University of Michigan, 1913. Instructor in electrical engineering, University of Michigan, summer, 1913. Engineering department, Chicago Telephone Company, 1913-1918; engineering department, American Telephone and Telegraph Company, 1918 to date. Associate member, A.I.E.E. Nonmember, Institute of Radio Engineers.

Plendl, Hans: Born December 6, 1900, at Munich, Germany. Studied at Technical High School of Munich, 1919-1923, becoming graduate engineer in 1923. Scientific work for Professor Zenneck at Physical Institute, Technical High School of Munich, 1923-1925, becoming doctor-engineer, 1925. With Professor Meissner in research laboratory, Telefunken Company, Berlin-Adlershof, 1925-1927; at present with Professor Fassbender, department for radio and electro-technics, German Experimental Institution for Air Traffic, Berlin-Adlershof. Nonmember, Institute of Radio Engineers.

Wintermute, G. H.: Born 1905. Class of 1926, Lehigh University, United Electric Light and Power Company, 1926-1927; New Jersey Bell Telephone Company, 1927-1929; Jenkins Television Corporation, 1929; U. S. Bureau of Standards, 1930 to date. Nonmember, Institute of Radio Engineers.



# EMPLOYMENT PAGE

Advertisements on this page are available to members of the Institute of Radio Engineers and to manufacturing concerns who wish to secure trained men for positions. All material for publication on this page is subject to editing from the Institute office and must be sent in by the 15th of the month previous to the month of publication. (February 15th for March PROCEEDINGS IRE, etc). Employment blanks and rates will be supplied by the Institute office. Address requests for such forms to the Institute of Radio Engineers, 33 West 39th Street, New York City, N.Y.

**MANUFACTURERS** and others seeking radio engineers are invited to address replies to these advertisements at the Box Number indicated, care the Institute of Radio Engineers. All replies will be forwarded direct to the advertiser.

---

**YOUNG MAN** with experience in construction, installation, and service of broadcast receivers and with knowledge of amateur transmitting and receiving equipment desires position where there is an opportunity for educational advancement. College and radio school training. Age 23. Will travel. Box 110.

---

**RESEARCH OR DEVELOPMENT**—M.S. in Physics, experienced in television development and 16 mm sound-on-film work, also has studio training for broadcasting or recording work. Desires development or research position along those or related lines, preferably in or near New York City. Age 29. Single. Box 107.

---

**COLLEGE GRADUATE** employed two years as laboratory assistant for well known manufacturer, with one year's experimental work on vacuum tubes and with two years work as field engineer handling installation and inspection of theatre sound apparatus. Interested in engineering work or in traveling for concern dealing in commercial applications on radio or electrical devices. E.E. 1929. Age 27. Married. Will travel. Box 102.

---

**RADIO ENGINEER** with five years technical work in connection with patent litigation, particularly in television field, for large set manufacturer, one year radio engineering work in research organization, and four years teaching radio in Midwestern College. Wishes work in television research or development short wave research with well established concern. B.S. in E.E. 1920. Member I.R.E. Age 34. Married. Will travel. Box 115.

---

**INSTRUCTOR AND ENGINEER** with three years experience on development and design audio frequency amplifiers and all component parts and three years experience teaching in New York City public schools desires engineering or teaching position. Qualified to teach general science in Junior High School or physics in High School. B.S. 1926. Post Graduate work in engineering and physics. Age 26. Box 116.

---

**BROADCAST OPERATOR** with five and one half years experience including announcing and construction of radio stations desires work as a broadcast operator or in radio factory. High school graduate with several courses in radio schools. Holds Government operator's license. Age 19. Will travel Box 117.

---

**RADIO BROADCAST TRANSMISSION ENGINEER**, well known, over twelve years experience, three being in high-power broadcast. Thoroughly capable efficiently managing all phases engineering and operation in the broadcast field, particularly cutting costs of expansion and maintenance of high standards at any power contemplated. Age 30. Box 118.

---

*When writing to advertisers mention of the PROCEEDINGS will be mutually helpful.*

# PRICELESS

are the voices of those we love



WHAT PRICE COULD BE SET ON THE VOICE AND LAUGHTER OF A LITTLE CHILD A THOUSAND MILES AWAY? WHAT PRICE ON THE BRIEF AND REASSURING PHRASE, "WE'RE ALL WELL"? WHAT PRICE ON A HUNDRED WORDS BETWEEN SEPARATED LOVERS?

WHAT price on a doctor's midnight directions, on the swift response of the fire department, on the relief of anxiety, the cementing of friendship, the unexpected greeting after a long silence?

What price on speed in business, on the smooth running of a household, on leisure or rest without neglect of duty, on shelter in a day of storm?

How can any one say what the telephone is worth to you? We set a value on such visible, physical things as wires, poles, switchboards, instruments, operation. We set a price on telephone service based on what it costs us to render it and to assure its continued growth.

These considerations are fairly exact. But they have little relation to the actual worth of the telephone in your home or office. That is frequently a thing of the spirit and cannot be measured in terms of money.

When you buy telephone service you buy the most nearly limitless service the world affords. Because of it you receive the thoughts and emotions of other people and express your own thoughts and emotions to them. There are no hindering handicaps of time or distance, place or circumstance. For a few pennies a day, you move out of your own little corner in the kingdom of ideas and are free to range where you will.

AMERICAN TELEPHONE AND TELEGRAPH COMPANY



*When writing to advertisers mention of the PROCEEDINGS will be mutually helpful.*



# ANNOUNCING THE MASLAND DIAPHRAGM ASSEMBLY FOR 1932

"TAILORED" exactly to meet your requirements. Every MASLAND DIAPHRAGM ASSEMBLY is manufactured specifically to meet your particular demand of response characteristic.

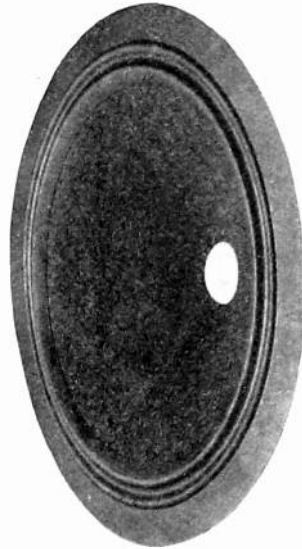

## *The Masland Diaphragm Assembly is*

### 1. Flexible

Maximum flexibility is obtained by the LETH-R-FLEX RING which is made of specially processed material and corrugated by us to insure perfect response, a process derived from years of experience.

### 2. Adaptable

Combining the proper LETH-R-FLEX RING with the proper DYN-A-TEX CONE PAPER gives the individual characteristic which is demanded. Many combinations may be effected, with practically no limitations, as LETH-R-FLEX RINGS and DYN-A-TEX CONE PAPERS are made in numerous weights and thicknesses.

### 3. Rigid

The MASLAND DIAPHRAGM ASSEMBLY may be manufactured with any desired rigidity—the entire diaphragm is ruggedly built from apex to edge. Apexes may be stiffened if desired. The entire diaphragm is designed and produced under strict engineering supervision.

### 4. Light

LETH-R-FLEX RINGS and DYN-A-TEX CONE PAPERS are developed in our laboratory and are carefully and skillfully engineered to produce a combination of bulk with relatively light weight—ideal conditions for a diaphragm.

### 5. Low in Cost

A low cost is maintained, altho the material and workmanship in MASLAND DIAPHRAGM ASSEMBLIES are of highest quality—material specifically developed for ideal acoustical properties. Our large production also benefits our customers.

**MASLAND MANUFACTURING CORPORATION**  
Amber and Willard Sts., PHILADELPHIA, PA.

*When writing to advertisers mention of the PROCEEDINGS will be mutually helpful.*

Chapter  
II  
in the  
Dramatic  
Story  
of the  
Centralab  
Fixed Resistor

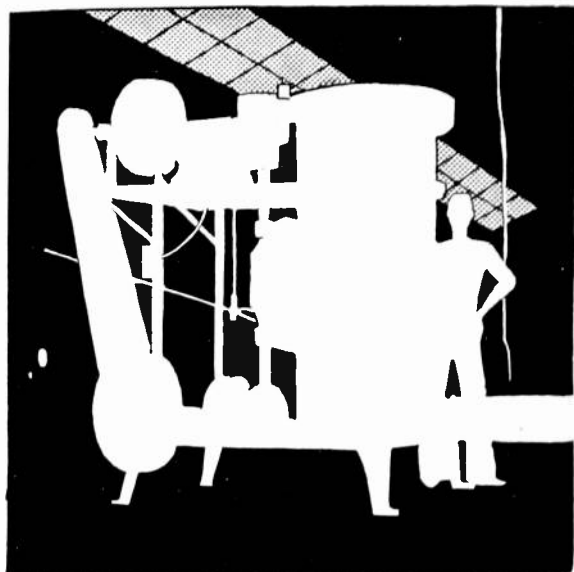

A truly different booklet, the "Baptism of Fire" which tells the dramatic story of how Centralab Fixed Resistors are made, is now ready for distribution. The bold, two-color modern illustrations and descriptive text tell a graphic story of these very different and superior resistors.

*Why not send for it today—it's free.*

Write to

**Centralab**  
CRL

E. Keefe Ave. & Humboldt Ave.

MILWAUKEE, WIS.

**CENTRALAB FIXED RESISTORS**

*When writing to advertisers mention of the PROCEEDINGS will be mutually helpful.*

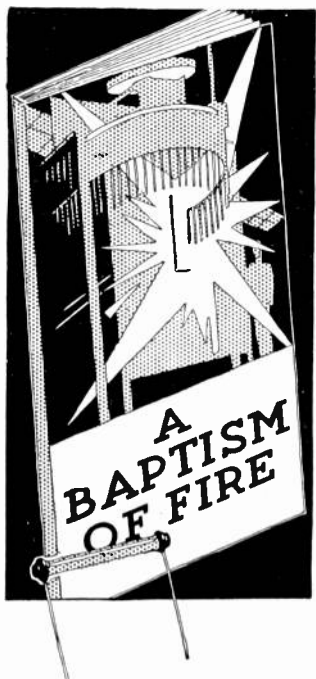

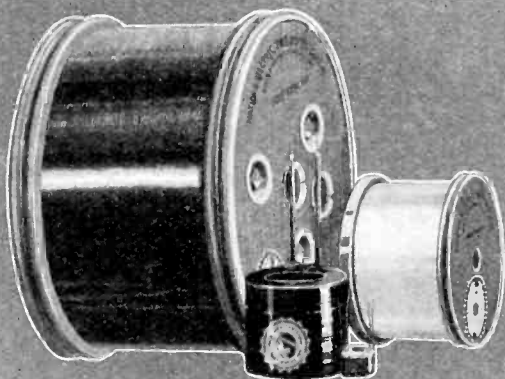

The  
**PREFERRED**  
SOURCE OF SUPPLY FOR  
MAGNET WIRE & COILS

No electrical or radio product is any better than the magnet wire and coils used in its construction.

Inca products are engineered and manufactured by pioneers in the copper wire industry . . . products reliable in quality and uniformity, and dependable in service.

These are some of the reasons why many of the country's leading manufacturers have adopted Inca as their preferred source of supply.

**INCA MANUFACTURING DIVISION**  
of National Electric Products Corporation  
Fort Wayne, Ind.



**INCA**

SYMBOLIC OF THE  
BEST IN COPPER  
WIRE PRODUCTS



*When writing to advertisers mention of the PROCEEDINGS will be mutually helpful.*

# The COMET "PRO"

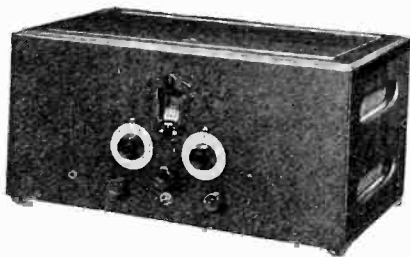

Handsome walnut cabinet, with "business-like" control panel

## The Hammarlund-Engineered High-Frequency Receiver for Professional Operators

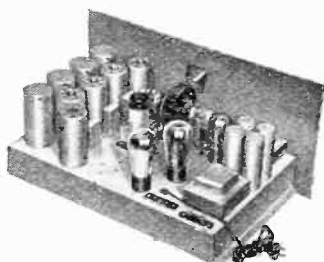

A clean-cut, accessible chassis

An eight-tube custom-built super-heterodyne, which will do all that the professional operator demands between 14 and 200 meters. Efficient band-spread tuning system, with special long-wave oscillator for sharp, clean C.W. reception; also simplifies tuning.

Quiet 227 tube output, with phone pack and speaker connections. Connection also for external amplifier.

Super-sensitive; super-selective.

*Write for details.*

## HAMMARLUND Precision PARTS For Short-Wave Construction



**ISOLANTITE Short-Wave COIL FORMS.** Lowest losses. Maximum sensitivity and selectivity. Non-slipping surface. No drilling. Flat-top handle for marking wavelengths. Winding surface, 2 1/2" long by 1 1/2" diameter. Four, five and six prongs to fit standard sockets or the new Hammarlund Isolantite Sockets.

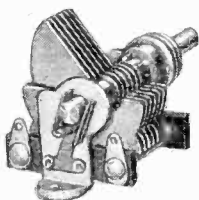

**Short-wave TUNING CONDENSER.** High capacity; wide range. Soldered brass plates, rugged frame. Double four-point wiping rotor contact. Isolantite insulation. Single and dual models; 20 to 325 mmf per section.



**ISOLANTITE SOCKETS.** Electrical efficiency not affected by temperature or humidity. Top and sides glazed. Perfect contact by reinforced side-gripping rustproof springs. Four, five and six prongs, with standard mounting centers.

*Mail the coupon*

HAMMARLUND MANUFACTURING CO.,  
424-438 West 33rd St., New York.  
Please send details of new Comet "Pro" Receiver, Short-Wave Coil Forms, Condensers, and Sockets.

NAME \_\_\_\_\_  
ADDRESS \_\_\_\_\_  
PE-3

For Better Radio  
**Hammarlund**  
PRECISION  
PRODUCTS

When writing to advertisers mention of the PROCEEDINGS will be mutually helpful.

# 12

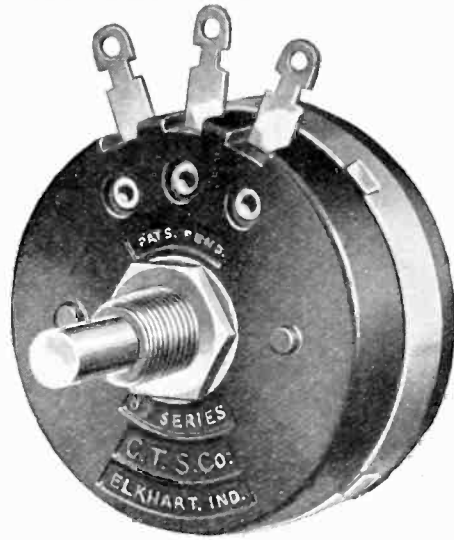

## *important reasons why the No. 80 Series leads the 1932 Volume Control field*

- 1** No pickup from power circuit even when control is directly associated with grid circuit.
- 2** *Low torque* snap switch, either S. P. S. T. or D. P. S. T.
- 3** Switches have low, uniform contact resistance.
- 4** Breakdown is in excess of 2000 volts.
- 5** Switch cam is "cold."
- 6** Positioning lugs prevent rotation of Control on panel.
- 7** Has rugged terminal construction.
- 8** Extremely quiet in operation.
- 9** Wiping contact practically eliminates corrosion on contacting member.
- 10** *Furnished in any desired resistance gradient.*
- 11** Less than 5 micro-mikes capacity between "live" parts of control and thimble and shaft.
- 12** Supplied with or without switch combination.

*Write us today for further details*

**CHICAGO TELEPHONE SUPPLY CO.**

HERBERT H. FROST, Inc., Sales Division  
GENERAL OFFICES AND PLANT  
ELKHART, INDIANA

*When writing to advertisers mention of the PROCEEDINGS will be mutually helpful.*

# SPECIAL ITEMS FOR RADIO MANUFACTURERS

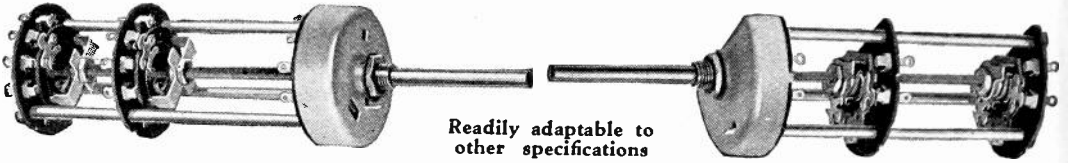

No. 7280A  
3 gang, 4 positions  
single circuit

Readily adaptable to  
other specifications

No. 7260A  
3 gang, 2 positions  
2 circuits

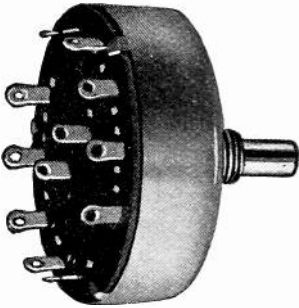

No. 7150A  
5 positions, 2 circuits

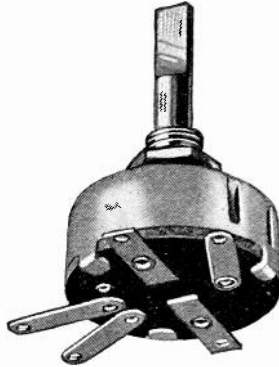

No. 7120A  
Combined Acoustic and muting  
switch 2 or 3 positions

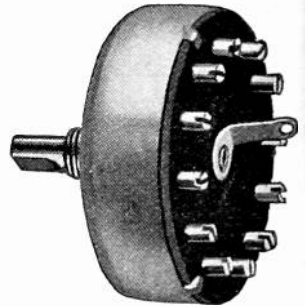

No. 7220A  
12 positions, single circuit

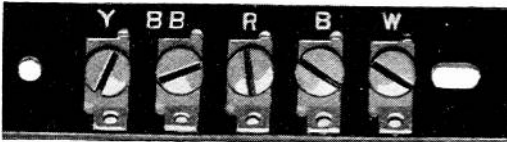

Terminal Strip  
5 Lugs No. 6880A, 4 lugs No. 6990A



Terminal Strip  
4 Clips, No. 6830A

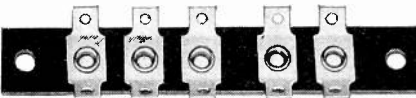

Terminal Strip  
5 Lugs, No. 6950A

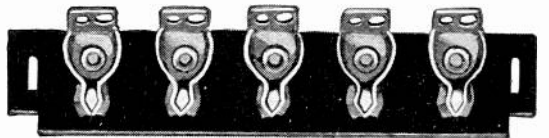

Terminal Strip  
5 Clips, No. A6310AA, 4 Clips No. A6320AA

## SORENG - MANEGOLD CO.

1901-9 Clybourn Avenue, CHICAGO, ILL.

1646 W. Adams St.  
Los Angeles, Cal.

701 Stephenson Bldg.  
Detroit, Mich.

245-5th Ave.  
New York City

*When writing to advertisers mention of the PROCEEDINGS will be mutually helpful.*

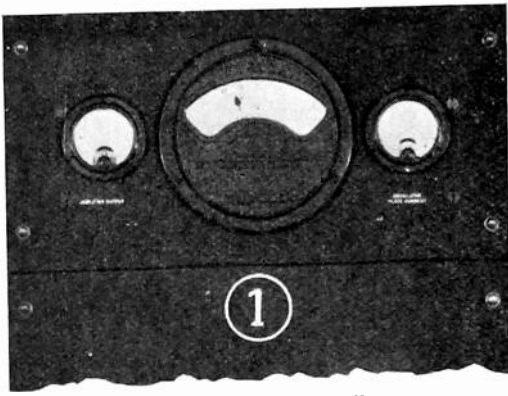

Upper portion of DeForest Frequency Monitor unit, showing large frequency meter.

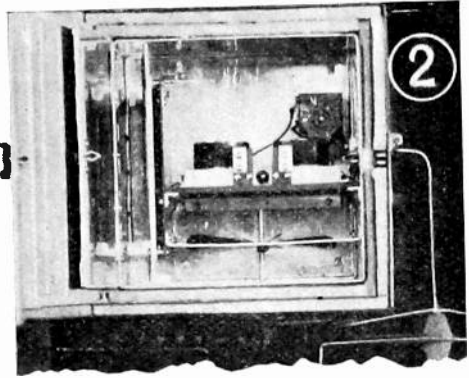

Crystal oven of DeForest Frequency Control unit, showing grouped members and fan.

## Frequency Control Refinements

To the designs and specifications of the Radio Research Company of Washington, D.C., DeForest adds unique refinements together with DeForest tubes matched to circuits at the factory and thoroughly tested for the particular installation. If you seek not only to meet but actually to excel the requirements of General Orders 116 and 119, insist on

- 1 Constant reading frequency indicating meter, readily read from almost any angle and part of control room because of large dial. Meter compensated for ambient temperature so as to be free from temperature variations. Controlled by frequency alone and absolutely independent of voltage fluctuations.
- 2 Thermostat and thermometer not only grouped together with the crystal but also in direct metallic contact with the crystal to operate in positive unison for the common temperature. Such arrangement assures taking into account the heat generated by the crystal itself. Air in crystal chamber must be kept in constant circulation.
- 3 Equipment must be mounted on standard rack to match other transmitting equipment and not in small box placed on table where it is certain to be in way. Also, equipment must necessitate no transmitter changes.

For further technical details, write on firm letterhead for our data on DeForest Frequency Monitor and Frequency Control units, as well as DeForest transmitters and amplifiers. Remember DeForest Audions—tubes for every transmitting, receiving, industrial, laboratory and scientific need.

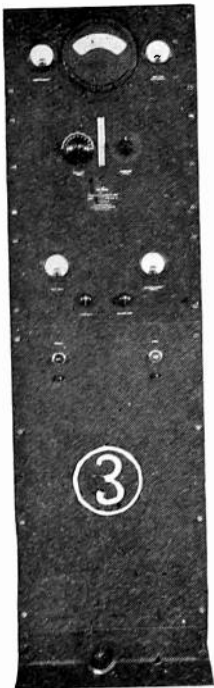

**DeForest Radio Company**  
 PASSAIC » » » NEW JERSEY

*de Forest*

*When writing to advertisers mention of the PROCEEDINGS will be mutually helpful.*

# AEROVOX HI-FARAD DRY ELECTROLYTIC CONDENSER

## THE MODERN HIGH CAPACITY CONDENSER

### 500 VOLTS PEAK LONG LIFE • LOW COST



The advanced processes and features in design, combined with the special electrolyte employed in Hi-Farad DRY Electrolytic Condensers insure efficient and reliable performance in all modern filter and bypass circuits. Hi-Farad condensers are made in a wide variety of types, sizes, capacities and voltage characteristics to meet various requirements.



AN AEROVOX CONDENSER AND RESISTOR FOR EVERY USE

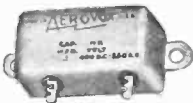

METAL CASE CONDENSERS

The AeroVox line includes the most complete line of condensers and resistors in the radio and electrical industries. No matter what your requirements are for fixed and tapped condensers or resistors, you are sure to find AeroVox units suited to your needs. In addition, we are equipped to supply special types and sizes of condensers and resistors to meet manufacturers individual requirements.



CARBON RESISTORS



CARTRIDGE CONDENSERS



PYROHM RESISTORS



MOULDED BAKELITE MICA CONDENSERS

Write for new 1932 catalog. Also ask to receive the AeroVox Research Worker, a monthly periodical which will be helpful and interesting to you.

## AEROVOX WIRELESS CORP.

70 Washington Street, Brooklyn, N. Y.

When writing to advertisers mention of the PROCEEDINGS will be mutually helpful.



# Cornell

TRADE MARK REG.

DUAL "CUB"  
CONDENSERS

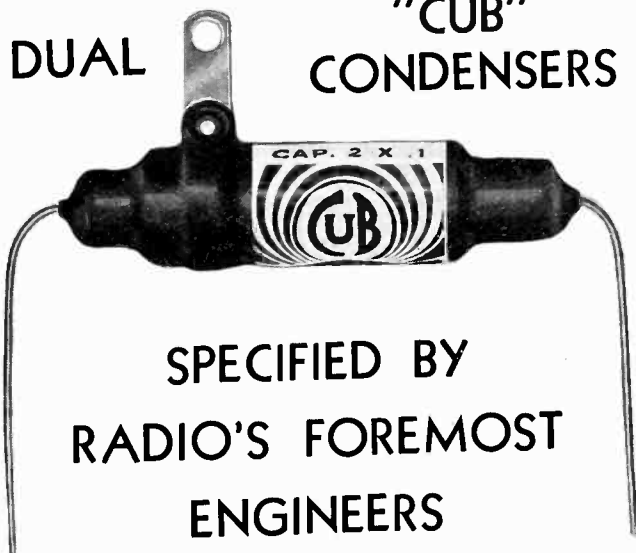

SPECIFIED BY  
RADIO'S FOREMOST  
ENGINEERS

Single mounting strap—can be attached to panel—the initial cost is less—most flexible and easiest mounting—no loss in efficiency—reduces costs by cutting assembly operations—high insulation resistance—extraordinary dielectric strength.

The Dual Cub Condenser is totally enclosed and hermetically sealed against exaggerated temperature and humidity. Light weight and compact. Capacities .00025 to .5 Mfd.

*Write for samples and let us know your requirements.  
We shall be glad to send you full particulars.*

**CORNELL ELECTRIC MFG. CO., Inc.**

*Manufacturers of  
CORNELL "CUB" CONDENSERS  
Filter and By-Pass Condensers, Interference Filters and  
All Types of Paper Dielectric Condensers*

LONG ISLAND CITY, NEW YORK

*When writing to advertisers mention of the PROCEEDINGS will be mutually helpful.*

# Piezo Electric Crystals

**New Price List Effective Immediately**

We are extremely pleased to announce **NEW REDUCED PRICES** for **HIGH GRADE CRYSTALS** for **POWER** use. Due to our **NEW** and **MORE EFFICIENT METHOD** of preparing these crystals, we are allowing you to share in the **LOWER COSTS** of producing these crystals.

We are proud of the confidence our customers have shown toward us, we extend to them our sincere thanks for their patronage thus making this reduction possible.

New prices for grinding **POWER** crystals in the various frequency bands as follows:

FREQUENCY RANGE	NEW LIST
100 to 1500 Kc	\$40.00
1501 to 3000 Kc	\$45.00
3001 to 4000 Kc	\$50.00
4001 to 6000 Kc	\$60.00

The above prices include holder of our Standard design, and the crystals will be ground to within .03% of your specified frequency. If crystal is wanted unmounted deduct \$5.00 from the above prices. Delivery two days after receipt of your order. In ordering please specify type tube, plate voltage and operating temperature.

*Special Prices Will Be Quoted in Quantities of Ten or More*

## **POWER CRYSTALS FOR AMATEUR USE**

The prices below are for grinding a crystal to a frequency selected by us unmounted, (if wanted mounted in our Standard Holder add \$5.00 to the prices below) said crystal to be ground for **POWER** use and we will state the frequency accurate to better than a tenth of one per-cent. **IMMEDIATE SHIPMENT CAN BE MADE.**

1715 to 2000 Kc band.....	\$12.00-each
3500 to 4000 Kc band.....	\$15.00 each

## **LOW FREQUENCY STANDARD CRYSTALS**

We have stock available to grind crystals as low as 13 Kilo-cycles. Prices quoted upon receipt of your specifications.

## **PIONEERS: POWER CRYSTALS SINCE 1925**

This record is proof to you that you will get the best there is in Piezo Electric Power Crystals. Get the best. It is more economical.

## **Scientific Radio Service**

*"THE CRYSTAL SPECIALISTS"*

124 Jackson Ave., University Park

Hyattsville, Maryland

*When writing to advertisers mention of the PROCEEDINGS will be mutually helpful.*

# The Institute of Radio Engineers Incorporated

33 West 39th Street, New York, N. Y.

## APPLICATION FOR ASSOCIATE MEMBERSHIP

(Application forms for other grades of membership are obtainable from the Institute)

To the Board of Direction

Gentlemen:

I hereby make application for Associate membership in the Institute of Radio Engineers on the basis of my training and professional experience given herewith, and refer to the members named below who are personally familiar with my work.

I certify that the statements made in the record of my training and professional experience are correct, and agree if elected, that I will be governed by the constitution of the Institute as long as I continue a member. Furthermore I agree to promote the objects of the Institute so far as shall be in my power, and if my membership shall be discontinued will return my membership badge.

.....  
(Sign with pen)

.....  
(Address for mail)

..... (Date) ..... (City and State)

### References:

(Signature of references not required here)

Mr. .... Mr. ....

Address ..... Address .....

City and State ..... City and State .....

Mr. ....

Address .....

City and State .....

The following extracts from the Constitution govern applications for admission to the Institute in the Associate grade:

### ARTICLE II—MEMBERSHIP

- Sec. 1: The membership of the Institute shall consist of: \* \* \* (c) Associates, who shall be entitled to all the rights and privileges of the Institute except the right to hold any elective office specified in Article V. \* \* \*
- Sec. 4: An Associate shall be not less than twenty-one years of age and shall be a person who is interested in and connected with the study or application of radio science or the radio arts.

### ARTICLE III—ADMISSION AND EXPULSIONS

- Sec. 2: \* \* \* Applicants shall give references to members of the Institute as follows: \* \* \* for the grade of Associate, to three Fellows, Members, or Associates; \* \* \* Each application for admission \* \* \* shall embody a full record of the general technical education of the applicant and of his professional career.

*ENTRANCE FEE SHOULD ACCOMPANY APPLICATION*



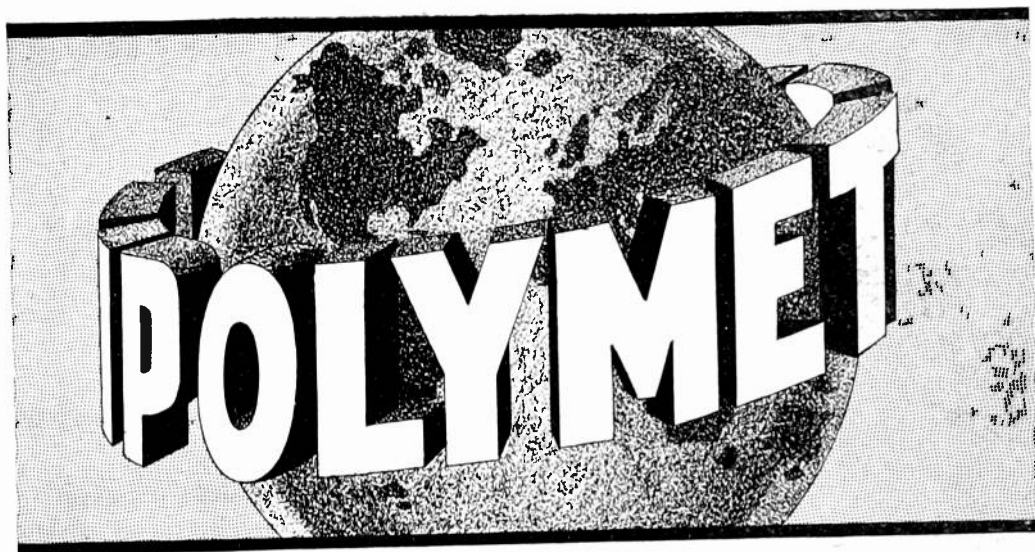

# Polymet Products

"STANDARD OF THE INDUSTRY"

World-known and World-accepted



## Condensers

- Paper
- Electrolytic
- Mica



## Resistors

## Volume Controls



## Transformers



## Choke Units

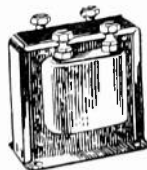

## Coil Windings



Both manufacturers' and service requirements are assured prompt attention.

Catalog on request.



# POLYMET MANUFACTURING CORP.

World's Largest Manufacturers of Radio Essentials

829-839 East 134th Street, New York City

Sales Representatives in all leading cities of the United States and in all principal countries of the world.



Special sales department for export, located at the address above, is prepared to cooperate closely with overseas manufacturers for their parts requirements.

*When writing to advertisers mention of the PROCEEDINGS will be mutually helpful.*

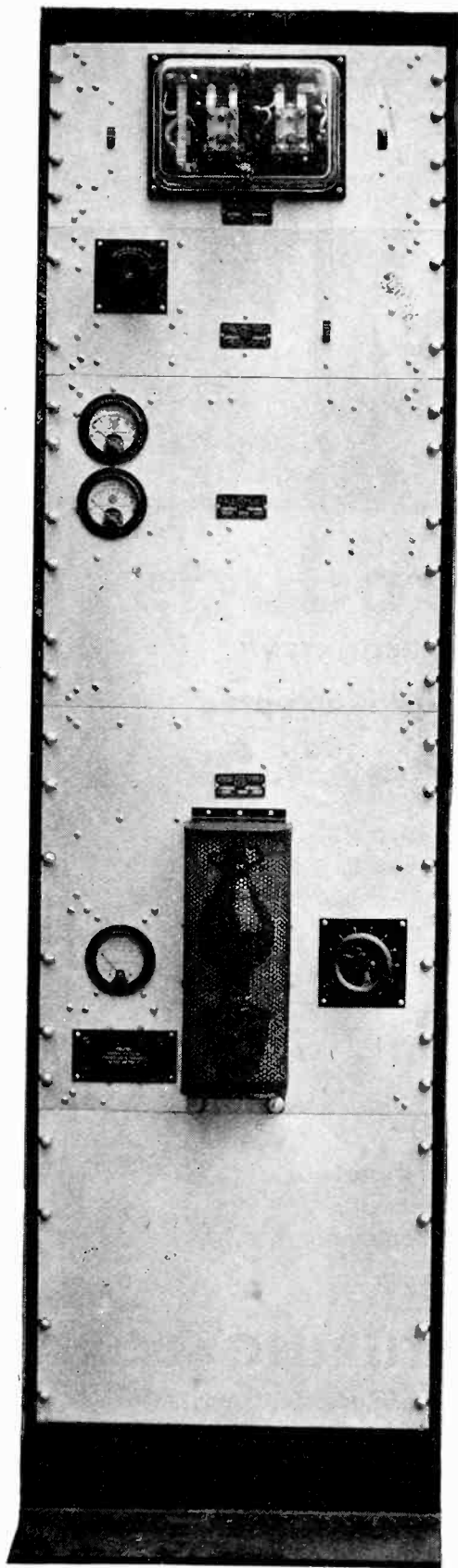

**“TIME-TESTED”**

**the New**

**AMERTRAN**

TRADE MARK REG. U.S. PAT. OFF.

## **Heavy Duty Filament Supply**

After two years of laboratory experimental work and with many units already giving over a year's satisfactory service in actual installations, the American Transformer Company announces the new AmerTran Heavy Duty Filament Supply System.

These systems have been designed to replace batteries in amplifiers (including low level and high gain amplifiers) and other places where pure direct current is required. They are a worthy companion to the AmerTran Type P-77 plate supply announced last fall.

Write for Technical Data Sheet D1 describing in detail AmerTran 10 Ampere “A” Supply System.



A Standard AmerTran 10 Ampere, 12 volt filament supply system (illustrated at left) which includes a power supply, filter system, voltage control and control relay. Similar units are available for D. C. outputs of 3-15-30-60 or 100 amperes at 12 volts or special sizes can be made to your specifications.

### **American Transformer Company**

Factory and  
Main Office—  
178 EMMET STREET  
Newark, N. J.

New York Office  
Room 1963  
HUDSON TERMINAL  
50 Church Street

*When writing to advertisers mention of the PROCEEDINGS will be mutually helpful.*

---

---

*It's Ready! The New*

# ACRACON\*

## DRY Electrolytic Condenser

**A**FTER months of exhaustive laboratory re-  
search and actual test work, the Condenser  
Corporation of America announces the latest addi-  
tion to the famous Acracon condenser line . . . the  
Acracon\* Dry Electrolytic Condenser.

*Note These Features:*

- peak operating voltage 500
- surge voltage 600
- low initial leakage
- leakage current at 500 volts less than .2 mils per mfd.
- constant capacity; does not decrease with age
- stable power factor; does not increase with age
- non-corrosive connections
- metal or fibre container
- standard and special sizes

*Write Today for Descriptive Literature!*

*\* Acracon Features are Protected by Patents Pending*

**Condenser Corporation of America**

259 Cornelison Ave., Jersey City, N.J.

Chicago Cincinnati St. Louis San Francisco Los Angeles Toronto  
*Factory Representatives In:*  
And Other Principal Cities

---

---

*When writing to advertisers mention of the PROCEEDINGS will be mutually helpful.*

---

---

ADJUSTABILITY and PERMANENCE Effectively  
Combined for STABLE CIRCUIT OPERATION

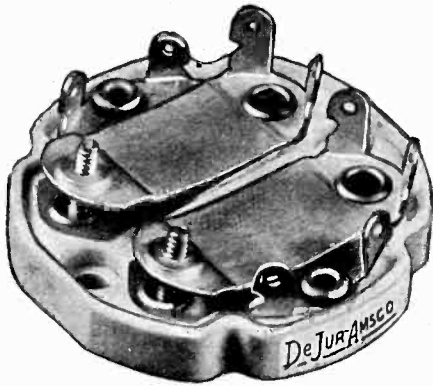

## VARITORS

SMALL FIXED  
VARIABLE  
CAPACITORS

The predominant present day usage of the duplex unit is in the tuning of primaries and secondaries of intermediate frequency transformers in modern superheterodyne circuits employing band-pass intermediate frequency amplifiers.

## VARIABLE CONDENSERS

For  
T. R. F.  
SUPERHETERO-  
DYNE  
and  
SHORT WAVE  
RECEIVERS

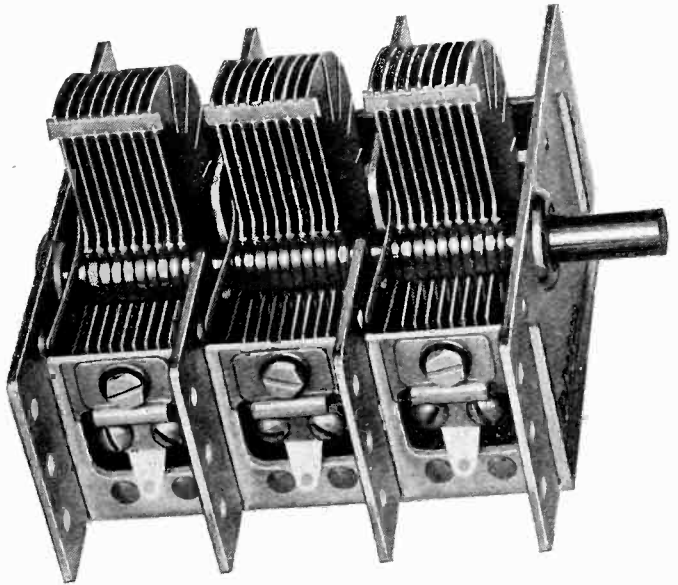

---

# DeJur-Amsco Corporation

95 MORTON ST., NEW YORK CITY

See Our Display at the I.R.E. 20th Anniversary Convention, Pittsburgh, April 7-8-9

---

---

*When writing to advertisers mention of the PROCEEDINGS will be mutually helpful.*



# CHANGE IN MAILING ADDRESS OR BUSINESS TITLE

Members of the Institute are asked to use this form for notifying the Institute office of a change in their mailing address or the listing of their company affiliation or title in the Year Book.

The Secretary,  
THE INSTITUTE OF RADIO ENGINEERS,  
33 West 39th Street,  
New York, N.Y.

Dear Sir:

Effective ..... please note change in my address  
(date)  
for mail as follows:

**FROM**

.....  
(Name)

.....  
(Street Address)

.....  
(City and State)

**TO NEW ADDRESS**

.....  
(Street Address)

.....  
(City and State)

Please note following change in my Year Book listing.

.....  
(Title)

.....  
(Company Name)

.....  
(Company Address)

# Back Numbers of the Proceedings, Indexes, and Year Books Available

**M**EMBERS of the Institute will find that back issues of the Proceedings are becoming increasingly valuable, and scarce. For the benefit of those desiring to complete their file of back numbers there is printed below a list of all complete volumes (bound and unbound) and miscellaneous copies on hand for sale by the Institute.

The contents of each issue can be found in the 1909-1930 Index and in the 1931 Year Book.

## BOUND VOLUMES:

- Vol. 10 (1922), \$8.75 per volume to members
- Vol. 18 (1930), \$9.50 to members

## UNBOUND VOLUMES:

- Vols. 5, 6, 8, 9, 10, 11, 13, 14, 18, and 19 (1917-1918-1920-1921-1922-1923-1925-1926-1930-1931), \$6.75 per volume (1917-1926) and \$7.50 per volume (1927-1931) to members

## MISCELLANEOUS COPIES:

- Vol. 1 (1913) July and December
- Vol. 2 (1914) June
- Vol. 3 (1915) December
- Vol. 4 (1916) June and August
- Vol. 7 (1919) February, April, August, and December
- Vol. 15 (1927) January, April, May, June, July, October, November, and December
- Vol. 16 (1928) February, March, April, May, June, July, August, October, November, December
- Vol. 17 (1929) January, February, March, April, May, June, July, August, September, November, and December.

These single copies are priced at \$1.13 each to members to the January, 1927, issue. Subsequent to that number the price is \$0.75 each. Prior to January, 1927, the Proceedings was published bimonthly, beginning with the February issue and ending with the December issue. Since January, 1927, it has been published monthly.

**M**EMBERS will also find that our index and Year Book supplies are becoming limited. The following are now available:

## INDEX

The Proceedings Index for the years 1909-1930 inclusive is available to members at \$1.00 per copy. This index is extensively cross indexed.

## YEAR BOOK

The 1932 Year Book is now available to members at \$1.00 per copy. This Year Book includes a current alphabetical catalogue of the I.R.E. membership, in which the mailing address and business affiliation of each member is listed, as well as current information on standard measurements for tubes and sockets and standard requirements for radio receivers.

Make remittances payable to the Institute of Radio Engineers and send orders to:

## THE INSTITUTE OF RADIO ENGINEERS

33 West 39th Street  
NEW YORK CITY, N. Y.

# Magnavox

## DYNAMIC SPEAKERS

Magnavox 1932 Speakers

*A size and performance  
for every use!*

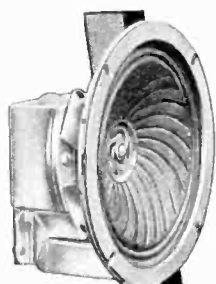

Model  
150

*6½ inch  
Dynamic  
Speaker,  
for small  
midget  
sets.*

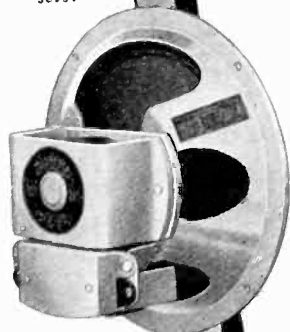

Model  
152

*10½ inch  
Dynamic  
Speaker, for  
midget or  
console sets.*

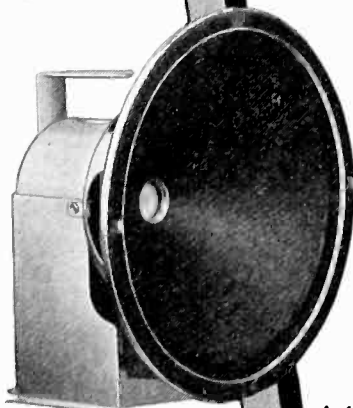

Model 517

*14 inch Dynamic  
Speaker, 110 Volt,  
D.C., for DeLuxe Con-  
soles and Public Ad-  
dress Systems.*

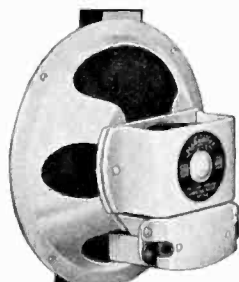

Model  
154

*8 inch  
Dynamic  
Speaker, for  
midgets or  
consolettes.*

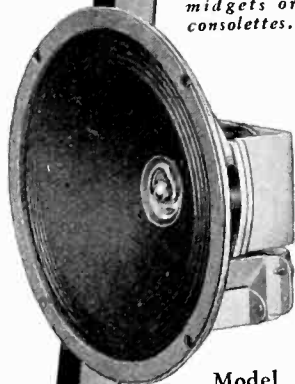

Model  
153

*12½ inch  
Dynamic  
Speaker, for  
consoles.*

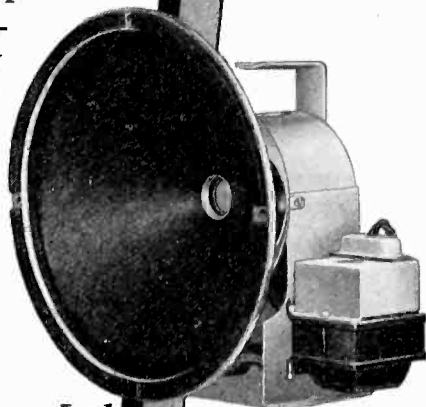

Model 521

*14 inch Dynamic  
Speaker, 110 Volt,  
A.C., for Public Ad-  
dress Systems.*

HERE is the new line, complete in size and price range for all set requirements,—midgets, consolettes, consoles or clock types, and an exceedingly practical model for automobile installations. Successful Dual Speaker arrangements are also obtainable. There are two powerful speakers for use in Public Address Systems. Each model offers richer tonal response throughout the entire frequency range—the result of continuous refinement.

*Investigate Magnavox Speakers. A model with complete engineering data will be furnished to recognized manufacturers without obligation. Write.*

**Magnavox Company Ltd.**

General Offices and Factory  
Fort Wayne, Indiana

Subsidiaries: The Magnavox Co., Electro  
Formation, Inc., Magnavox (Great Bri-  
tain) Ltd., Magnavox (Australia) Ltd.

*When writing to advertisers mention of the PROCEEDINGS will be mutually helpful.*

# COMPONENT PARTS EXHIBITION

at

## TWENTIETH ANNIVERSARY CONVENTION

### I. R. E.

From the engineering view-point the most interesting EXHIBITION of 1932 radio products will be held April 7-8-9, 1932, at the William Penn Hotel, Pittsburgh, Pa., in connection with the Twentieth Anniversary Convention of the Institute of Radio Engineers.

This EXHIBITION has been specially planned to help manufacturers of set components, measuring instruments, laboratory equipment, and other manufacturing aids, contact the radio engineer directly. This year our EXHIBITION is being held early so that manufacturers may explain their products to the engineer before his concern buys the necessary materials for their 1932 production.

I.R.E. members—prominent engineers and technical men—from all parts of the United States will be found in Pittsburgh in April. The good-will of these men toward your products will mean additional 1932 business for you. Better let your engineer tell them the special advantages of your materials in a booth at the Convention.

Thirty Booths have already been reserved by prominent parts manufacturers. If you haven't made your reservation, write for detailed information to:

**Institute of Radio Engineers**  
33 West 39th Street  
New York City, New York

# IT'S THE ALL-AROUND PERFORMANCE THAT COUNTS



FLASHING SPEED, pluck, individual skill, are not enough. A hockey team, to stay in the running, to win game after game, must also have team work, endurance—a combination of many qualities.

In a resistor too, it's the all-around performance that counts. *Permanence*—ability to function over long periods with but little change—means excellence in all qualities—not simply good in some.

Type "K" *Metallized* Resistors are built to meet all the varying conditions encountered in set operation—to go through the four seasons, year after year, with but slight change in resistance values. With Type "K," humidity

is no longer a problem. Low voltage coefficient, strength under overload, a ruggedness that has proved itself both in practice and in extreme laboratory tests—these are qualities that make for permanence. They have made Type "K" *Metallized* the accepted unit with radio's leaders.

## PERMANENCE



Supplied in special types and mountings to save assembly costs. We

devote our attention exclusively to resistors—and manufacture all units in our own plants. Before making up your specifications, consult us on your individual problems.

## INTERNATIONAL RESISTANCE COMPANY

PHILADELPHIA

Established 1923

TORONTO

ALSO PRECISION WIRE WOUND RESISTORS

**IRC**  
*Metallized*  
**RESISTORS**

*When writing to advertisers mention of the PROCEEDINGS will be mutually helpful.*

---

# Alphabetical Index to Advertisements

## A

Aerovox Wireless Corp. . . . . XX  
Allen-Bradley Co. . . . . Inside Back Cover  
American Tel. & Tel. Co. . . . . XII  
American Transformer Co. . . . . XXVI  
Arcturus Radio Tube Co. . . . . XXXVII

## C

Central Radiq Laboratories. . . . . XIV  
Chicago Telephone Supply Co. . . . . XVII  
Condenser Corp. of America. . . . . XXVII  
Cornell Electric Mfg. Co. . . . . XXI

## D

DeForest Radio Co. . . . . XIX  
DeJur-Amsco Corp. . . . . XXVIII

## E

Employment Page . . . . . XI  
Erie Resistor Corp. . . . . XXXVIII

## G

General Electric Co. . . . . XL  
General Radio Co. . . . . Outside Back Cover

## H

Hammarlund Mfg. Co. . . . . XVI

## I

Inca Division National Elec. Prod.  
Corp. . . . . XV  
International Resistance Co. . . . . XXXIII  
I.R.E. . . . . XXIII,  
XXIV, XXIX, XXX, XXXII

## M

Magnavox Co., Ltd. . . . . XXXI  
Masland Mfg. Corp. . . . . XIII

## P

Polymet Mfg. Corp. . . . . XXV  
Professional Eng. Directory. . . . .  
. . . . . XXXIV, XXXV

## R

RCA Victor Co., Inc. . . . . XXXIX

## S

Scientific Radio Service. . . . . XXII  
Soreng-Manegold Co. . . . . XVIII

---

*When writing to advertisers mention of the PROCEEDINGS will be mutually helpful.*

# 3

## ARCTURUS 50 WATT TUBES

*New, Rugged Design...  
Consistently Uniform*

Bringing to transmitting tubes the same skill and quality shown in its receiving tubes, Arcturus announces these newest additions to its line of high-power tubes.

New—not only in performance and stability—but in construction. In developing these new power tubes, Arcturus has incorporated the "unitary structure" principle made famous by the *blue* receiving tubes.

In uniformity, performance and construction, these Arcturus 50-watt tubes establish new standards. Seldom in the swiftly changing history of electronic research has a product been offered that represents such a decided improvement over existing devices. Yet these power tubes are interchangeable with corresponding type numbers, and their advantages are immediately applied to present apparatus.

Technical data bulletins on these three types, as well as Mercury Vapor Rectifiers E766 and E772, are available to interested parties on request.

Arcturus Radio Tube Company,  
Newark, N. J.

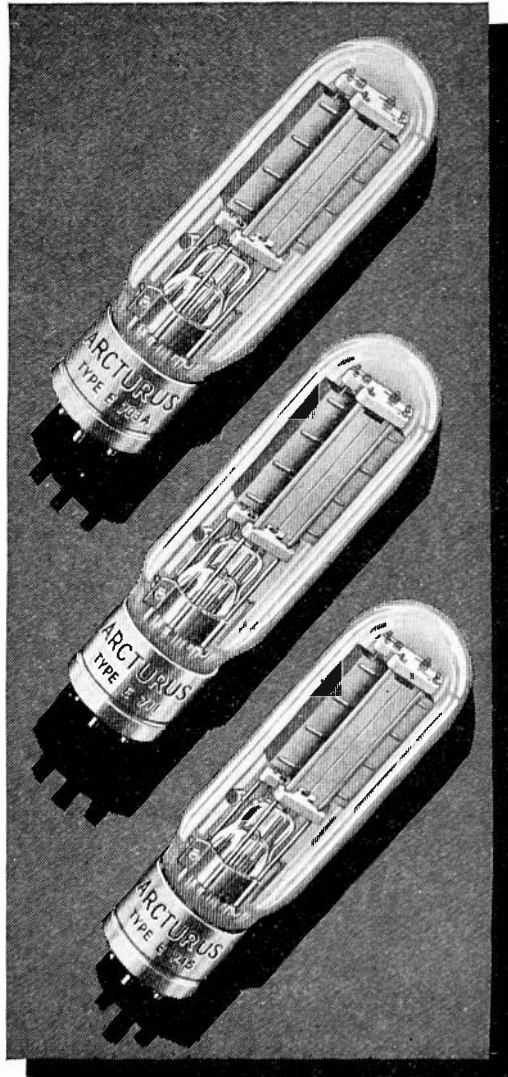

### EXCLUSIVE ARCTURUS CONSTRUCTION

Note the extreme rigidity of these tubes. The Unitary Structure principle of interlocking the elements maintains the precise interrelation of parts through interdependence. Each rugged element is securely clamped at the top and bottom and the complete assembly is a sturdy unit—insuring constant uniformity.

This compact unit is supported by a rugged rectangular structure.

The increased area of the plate provides generous heat dissipation resulting in cooler operating temperatures.

# ARCTURUS

*Quality Tubes for  
Transmitting, Receiving  
and Industrial Uses*

When writing to advertisers mention of the *PROCEEDINGS* will be mutually helpful.

# MILLIONS OF ERIE RESISTORS

have been used  
by manufacturers  
all over the world



**A**N enviable record for accuracy has been established by ERIE RESISTORS. In their use throughout world markets they have been subjected to every test. In the laboratory and in actual use their fitness for the work they have to do has been demonstrated.

Manufacturers have found ERIE RESISTORS consistently uniform in quality and service. We are informed by them that they have been able to effect savings due to the fact that rejections are so few that production is not interrupted.

ERIE RESISTORS are manufactured by specialists who know their job thoroughly. Each day continuous laboratory tests are made on the various manufacturing processes to insure constant quality.

●  
●  
●

*If you have need for moulded type resistors in your production work it will pay you to learn all about ERIE RESISTORS. They will help you cut production costs. May we send you samples and prices?*

## ERIE RESISTORS



ERIE RESISTOR CORPORATION, ERIE, PA.  
Factories in Erie, Pa., Toronto, Canada and London, Eng.

*When writing to advertisers mention of the PROCEEDINGS will be mutually helpful.*



# FROM "RADIO HEADQUARTERS"

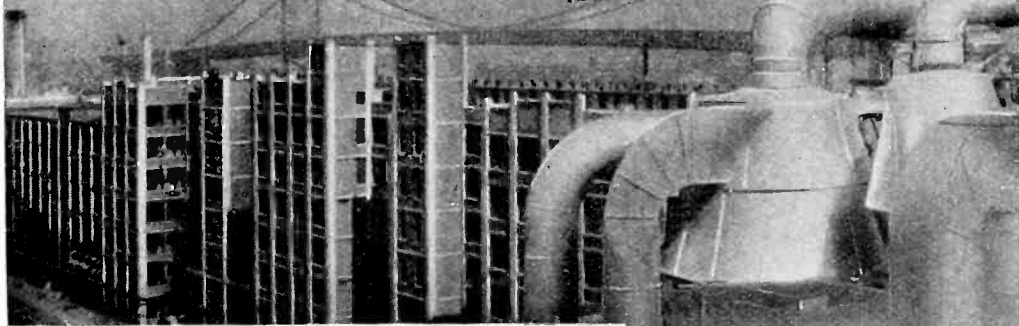

## To Radio Engineers

THE RCA Victor Company, Inc., with combined facilities consolidated in Camden, is admirably fitted to meet your requirements for component parts, laboratory instruments, etc.

These products are the result of many years of experience in the design, development and manufacture of radio equipment. Listed below are a few of the many products available to radio manufacturers:

*Loud Speakers · Magnetic Pickups*

*Automatic Record Changers*

*Faradon Capacitors*

*Precision Laboratory and Test Equipment*

*Phonograph Motorboard Assemblies*

*Your inquiries will receive our prompt and careful attention.*



Standard Signal  
Generator TMV-18

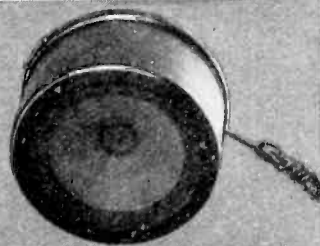

RL-43 Permanent  
Magnet Dynamic  
Loudspeaker

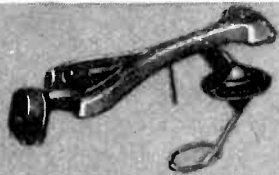

Magnetic Pickup and  
Inertia Tone Arm

INDUSTRIAL PRODUCTS SECTION  
**RCA Victor Company, Inc.**

*A Radio Corporation of America Subsidiary*  
CAMDEN, N. J.

"RADIO HEADQUARTERS"



*When writing to advertisers mention of the PROCEEDINGS will be mutually helpful.*

# Small Parts—But How Essential!

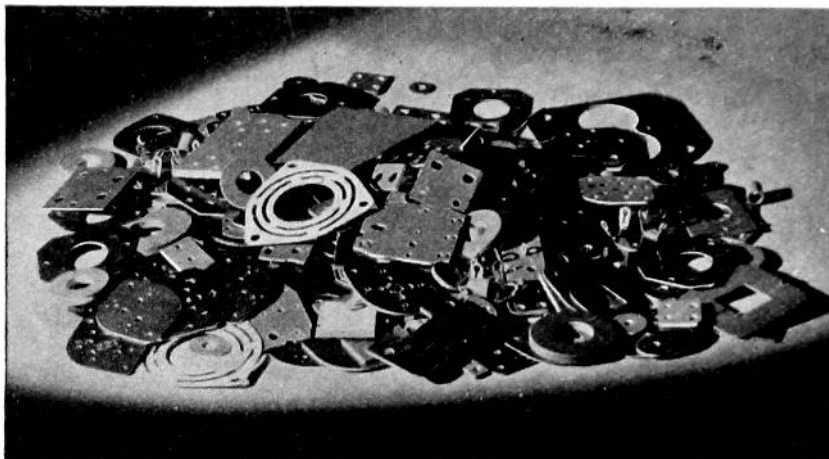

**S**MALL parts of innumerable sizes and shapes are fabricated from Textolite laminated sheets to meet the demands for better insulation in the radio, electrical, and electronic fields.

Textolite laminated is being used by many of the leading manufacturers in these fields, because they realize that the success of their products depends on the properties of the material used in these apparently insignificant "small parts."

A survey of the results of new applications of Textolite laminated during 1931 revealed an astonishing saving in time, space, and money to the progressive manufacturers who adopted this modern material.

*Also—*

**Textolite molded  
Cetec cold-molded**

**EASTERN FABRICATOR**  
General Fabricating Co.  
37 East 18th Street  
New York City

**WESTERN FABRICATOR**  
Electrical Insulation Corp.  
308 W. Washington Street  
Chicago, Ill.

JOIN THE "G-E CIRCLE"—SUNDAYS AT 5:30 P.M. E.S.T. ON N.B.C. NETWORK  
OF 54 STATIONS—WEEK-DAYS (EXCEPT SATURDAY) AT NOON

831-11D

**GENERAL**  **ELECTRIC**

PLASTICS DEPARTMENT, MERIDEN, CONNECTICUT

*When writing to advertisers mention of the PROCEEDINGS will be mutually helpful.*

# SOLID MOLDED RESISTORS

FOR MOTOR CAR RADIO



FOR CONSOLE RADIO

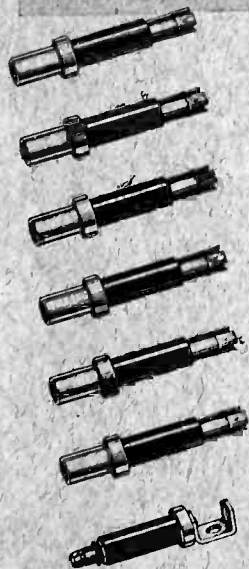

## Do Your Sets go "Sour" in Service due to poor Resistors?

The satisfactory operation of your receivers depends to a great extent upon the accuracy of your fixed resistors. Bradleyunit Resistors are used by the world's largest radio manufacturers, because their resistance value is stable under varying conditions of load, temperature, and moisture. They are not subject to wide fluctuation due to long use. Don't risk the reputation of your receiver with poor resistors. Get an Allen-Bradley quotation on your next order.

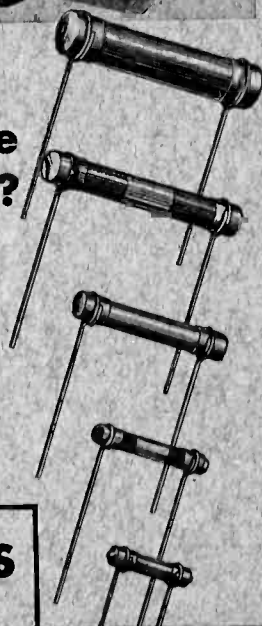

Interference from ignition systems in radio-equipped motor cars is suppressed with Bradley Suppressors. When used with suitable by-pass condensers in ignition circuit, shielded ignition cables are unnecessary.



Type A, Single Bradleyometer



Type AA, Double Bradleyometer

### BRADLEYOMETERS

The Bradleyometer is a potentiometer with approximately fifty solid resistance discs interleaved between metal discs.

The total number of discs can be arranged in accordance with any resistance-rotation curve.

One or more Bradleyometers can be arranged to operate with one knob. Mixer controls, T-pad and H-pad attenuators and other complex controls can be provided.



Type AAA, Triple Bradleyometer

Bradleyunit Resistors are made in five sizes, with or without leads, and are color coded to meet set manufacturers' specifications. These solid molded resistors are accurately calibrated and have great mechanical strength.

Allen-Bradley Co., 116 W. Greenfield Ave., Milwaukee, Wisconsin

## ALLEN-BRADLEY RESISTORS

Produced by the makers of Allen-Bradley Control Apparatus

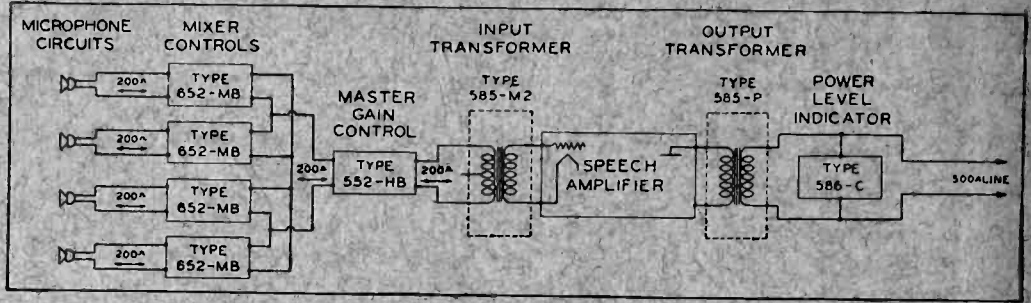

A speech-input unit made up from standard General Radio units.

## SPEECH-INPUT EQUIPMENT



Type 652-MB Volume Control  
Price \$12.50

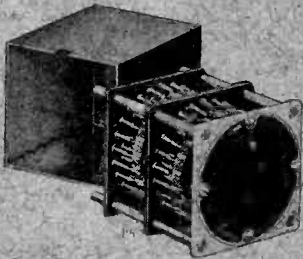

Type 552-HB Volume Control  
Price \$48.00



Type 586-CM Power-Level Indicator  
Price \$75.00

for high-quality broadcasting and recording circuits can be readily assembled from standard General Radio units. Each has been designed for such service.

The Type 652 Volume Controls, for instance, are compact and occupy a very small amount of panel space. Although they are of the wire-wound type they present a practically constant impedance to the circuits on either side and the "noise" is at a minimum.

Other General Radio equipment has the same kind of desirable characteristics. Mixing controls, master gain controls, speech-amplifier coupling transformers, and power-level indicators are carried in stock in a variety of sizes, a fact worth remembering when time is short.

**GENERAL RADIO COMPANY**  
CAMBRIDGE A MASSACHUSETTS