

W. J. MALONE WHAM WIDEI

VOLUME 19

OCTOBER, 1931

NUMBER 10

PROCEEDINGS
of
The Institute of Radio
Engineers



Form for Change of Mailing Address or Business Title on Page XLIII

Institute of Radio Engineers

Forthcoming Meetings

ROCHESTER FALL MEETINGS

November 9-10, 1931

Rochester, New York

CINCINNATI SECTION

October 13, 1931

LOS ANGELES SECTION

October 19, 1931

NEW YORK MEETINGS

October 7, 1931

Symposium on Ship-to-Shore Communication

November 4, 1931

PROCEEDINGS OF

The Institute of Radio Engineers

Volume 19

October, 1931

Number 10

Board of Editors

ALFRED N. GOLDSMITH, *Chairman*

STUART BALLANTINE	G. W. PICKARD
RALPH BATCHER	L. E. WHITTEMORE
W. WILSON	

CONTENTS

PART I	Page
Frontispiece, David Sarnoff, Secretary of the Institute, 1915-1917.....	1702
Institute News and Radio Notes.....	1703
Election Notice.....	1703
September Meeting of the Board of Direction.....	1703
Rochester Fall Meeting.....	1704
Radio Transmissions of Standard Frequency.....	1705
Changes in Cosmic Data Broadcasts.....	1706
Committee Work.....	1711
Institute Meetings.....	1711
Personal Mention.....	1712
PART II	
<i>Technical Papers</i>	
Communication with Quasi Optical Waves..... E. KARPLUS	1715
High-Frequency Atmospheric Noise..... R. K. POTTER	1731
Long-Wave Radio Receiving Measurements at the Bureau of Standards in 1930..... L. W. AUSTIN	1766
Development of Directive Transmitting Antennas by R. C. A. Communica- tions, Inc... P. S. CARTER, C. W. HANSELL, AND N. E. LINDENBLAD	1773
The Spokesman for the Radio Engineer..... S. C. HOOPER	1843
The Conduction of High-Frequency Oscillatory Energy..... H. O. ROOSENSTEIN	1849
Discussion on "High Audio Power from Relatively Small Tubes," by Loy E. Barton..... R. A. HEISING	1884
Book Review: "Aircraft Radio," by Myron F. Eddy..... S. S. KIRBY	1886
Booklets, Catalogs, and Pamphlets Received.....	1887
Radio Abstracts and References.....	1888
Contributors to this Issue.....	1894

The Institute of Radio Engineers

GENERAL INFORMATION

The PROCEEDINGS of the Institute is published monthly and contains papers and discussions thereon submitted for publication or for presentation before meetings of the Institute or its Sections. Payment of the annual dues by a member entitles him to one copy of each number of the PROCEEDINGS issued during the period of his membership.

Subscription rates to the PROCEEDINGS for the current year are received from nonmembers at the rate of \$1.00 per copy or \$10.00 per year. To foreign countries the rates are \$1.10 per copy or \$11.00 per year.

Back issues are available in unbound form for the years 1918, 1920, 1921, 1922, 1923, and 1926 at \$9.00 per volume (six issues) or \$1.50 per single issue. For the years 1913, 1914, 1915, 1916, 1917, 1919, 1923, 1924, and 1925 miscellaneous copies (incomplete unbound volumes) can be purchased for \$1.50 each; for 1927, 1928, and 1929 at \$1.00 each. The Secretary of the Institute should be addressed for a list of these.

Discount of twenty-five per cent is allowed on all unbound volumes or copies to members of the Institute, libraries, booksellers, and subscription agencies.

Bound volumes are available as follows: for the years 1922 and 1926 to members of the Institute, libraries, booksellers, and subscription agencies at \$8.75 per volume in blue buckram binding and \$10.25 in morocco leather binding; to all others the prices are \$11.00 and \$12.50 respectively. For the year 1929 the bound volumes prices are: to members of the Institute, libraries, booksellers, and subscription agencies, \$9.50 in blue buckram binding; to all others, \$12.00. Foreign postage on all bound volumes is one dollar, and on single copies is ten cents.

The 1931 YEAR BOOK, containing general information, the Constitution and By-Laws, Standards Report, Index to past issues of the PROCEEDINGS, Catalog of Membership, etc., is available to members at \$1.00; to nonmembers, \$1.50.

Contributors to the PROCEEDINGS are referred to the following page for suggestions as to approved methods of preparing manuscripts for publication in the PROCEEDINGS.

Advertising rates for the PROCEEDINGS will be supplied by the Institute's Advertising Department, Room 802, 33 West 39th Street, New York, N.Y.

Changes of address to affect a particular issue must be received at the Institute office not later than the 15th of the month preceding date of issue. That is, a change in mailing address to be effective with the October issue of the PROCEEDINGS must be received by not later than September 15th. Members of the Institute are requested to advise the Secretary of any change in their business connection or title irrespective of change in their mailing address, for the purpose of keeping the Year Book membership catalog up to date.

The right to reprint portions or abstracts of the papers, discussions, or editorial notes in the PROCEEDINGS is granted on the express condition that specific reference shall be made to the source of such material. Diagrams and photographs published in the PROCEEDINGS may not be reproduced without making special arrangements with the Institute through the Secretary.

It is understood that the statements and opinions given in the PROCEEDINGS are views of the individual members to whom they are credited, and are not binding on the membership of the Institute as a whole.

All correspondence should be addressed to the Institute of Radio Engineers, 33 West 39th Street, New York, N.Y., U.S.A.

Entered as second class matter at the Post Office at Menasha, Wisconsin.

Acceptance for mailing at special rate of postage provided for in the Act of February 28, 1925, embodied in paragraph 4, Section 412, P. L. and R. Authorized October 26, 1927.

Published monthly by

THE INSTITUTE OF RADIO ENGINEERS, INC.

Publication office, 450-454 Ahnaip Street, Menasha, Wis.

BUSINESS, EDITORIAL, AND ADVERTISING OFFICES,

Harold P. Westman, *Secretary*

33 West 39th St., New York, N.Y.

SUGGESTIONS FOR CONTRIBUTORS TO THE "PROCEEDINGS"

Preparation of Paper

Form—Manuscripts may be submitted by member and nonmember contributors from any country. To be acceptable for publication, manuscripts should be in English, in final form for publication, and accompanied by a summary of from 100 to 300 words. Papers should be typed double space with consecutive numbering of pages. Footnote references should be consecutively numbered and should appear at the foot of their respective pages. Each reference should contain author's name, title of article, name of journal, volume, page, month, and year. Generally, the sequence of presentation should be as follows: statement of problem; review of the subject in which the scope, object, and conclusions of previous investigations in the same field are covered; main body describing the apparatus, experiments, theoretical work, and results used in reaching the conclusions and their relation to present theory and practice; bibliography. The above pertains to the usual type of paper. To whatever type a contribution may belong, a close conformity to the spirit of these suggestions is recommended.

Illustrations—Use only jet black ink on white paper or tracing cloth. Cross-section paper used for graphs should not have more than four lines per inch. If finer ruled paper is used, the major division lines should be drawn in with black ink, omitting the finer divisions. In the latter case, only blue-lined paper can be accepted. Photographs must be very distinct, and must be printed on glossy white paper. Blueprinted illustrations of any kind cannot be used. All lettering should be $\frac{3}{16}$ in. high for an 8 x 10 in. figure. Legends for figures should be tabulated on a separate sheet, not lettered on the illustrations.

Mathematics—Fractions should be indicated by a slanting line. Use standard symbols. Decimals not preceded by whole numbers should be preceded by zero, as 0.016. Equations may be written in ink with subscript numbers, radicals, etc., in the desired proportion.

Abbreviations—Write a.c. and d.c. (a.c. and d.c. as adjectives), kc, μf , $\mu\mu f$, e.m.f., m.h., μh henries, abscissas, antennas. Refer to figures as Fig. 1, Figs. 3 and 4, and to equations as (5). Number equations on the right in parentheses.

Summary—The summary should contain a statement of major conclusions reached, since summaries in many cases constitute the only source of information used in compiling scientific reference indexes. Abstracts printed in other journals, especially foreign, in most cases consist of summaries from published papers. The summary should explain as adequately as possible the major conclusions to a nonspecialist in the subject. The summary should contain from 100 to 300 words, depending on the length of the paper.

Publication of Paper

Disposition—All manuscripts should be addressed to the Institute of Radio Engineers, 33 West 39th Street, New York City. They will be examined by the Committee on Papers and by the Editor. Authors are advised as promptly as possible of the action taken, usually within one month.

Proofs—Galley proof is sent to the author. Only necessary corrections in typography should be made. *No new material is to be added.* Corrected proofs should be returned promptly to the Institute of Radio Engineers, 33 West 39th Street, New York City.

Reprints—With the galley proof a reprint order form is sent to the author. Orders for reprints must be forwarded promptly as type is not held after publication.

INSTITUTE SECTIONS

<i>Chairmen</i>	<i>Secretaries</i>
	ATLANTA
H. F. Dobbs	Philip C. Bangs, 23 Kensington Rd., Avondale Estates, Ga.
	BOSTON
George W. Pierce	Melville Eastham, 30 State St., Cambridge, Mass.
	BUFFALO-NIAGARA
Stanley W. Brown	E. C. Waud, 235 Huntington Ave., Buffalo, N. Y.
	CHICAGO
Byron B. Minnium	J. Barton Hoag, Ryerson Laboratory, University of Chicago, Chicago, Ill.
	CINCINNATI
D. D. Israel	H. G. Boyle, Crosley Radio Corp., Cincinnati, Ohio.
	CLEVELAND
G. B. Hammon	P. A. Marsal, National Carbon Co., Inc., P.O. Box No. 400, Cleveland, Ohio.
	CONNECTICUT VALLEY
R. S. Kruse	George Grammer, 334 South Quaker Lane, West Hartford, Conn.
	DETROIT
Lewis N. Holland	Samuel Firestone, Room 615, 2000 Second Ave., Detroit, Mich.
	LOS ANGELES
T. E. Nikirk	L. Elden Smith, 345 N. Painter Ave., Whittier, Calif.
	NEW ORLEANS
Pendleton E. Lehde	Anton A. Schiele, 1812 Masonic Temple, New Orleans, La.
	PHILADELPHIA
W. R. G. Baker	G. C. Blackwood, 243 E. Upsal St., Mt. Airy, Philadelphia, Pa.
	PITTSBURGH
J. G. Allen	J. G. McKinley, West Penn Electric Co., 14 Wood St., Pittsburgh, Pa.
	ROCHESTER
Harry E. Gordon	Howard A. Brown, Rochester G. & E. Co., 89 East Ave., Rochester, N. Y.
	SAN FRANCISCO
C. H. Suydam	Frederick E. Terman, Stanford University, Calif.
	SEATTLE
Abner R. Willson	L. C. Austin, 540 N. 82nd St., Seattle, Wash.
	TORONTO
F. K. Dalton	G. E. Pipe, 335 Beresford Ave., Toronto, Ont., Canada.
	WASHINGTON
L. P. Wheeler	Herbert G. Dorsey, U. S. Coast and Geodetic Survey, Washington, D. C.

GEOGRAPHICAL LOCATION OF MEMBERS ELECTED SEPTEMBER 2, 1931

	Transferred to the Fellow grade	
Indiana	Marion, U.S. Radio and Television Corp.	Pressley, J. H.
	Transferred to the Member grade	
New York	Brooklyn, 2011 Newkirk Ave.	Callahan, J. L.
	Brooklyn, 121 Howard Ave.	Martin, L.
N. Rhodesia	Broken Hill, Post Office, Engineering Branch	Morris, R. P.
	Elected to the Member grade	
Massachusetts	Springfield, 683 State St.	Campbell, W. H.
New York	Pearl River	Baker, C. I.
England	Harrow, Middlesex, 29 The Gardens, Vaughan Rd.	Montgomery, A. W.
	Elected to the Associate grade	
California	Oakland, 2412 E. 15th St.	Lomba, E. J.
	San Francisco, 1346 Pine St.	Hartwick, F. C.
Florida	Miami Beach, Radio Station WIOD	Scott, M. C., Jr.
	Miami Springs, Box No. 236	Winter, C. W., Jr.
Illinois	Champaign, 602 W. Columbia Ave.	Hollister, J. B.
	Chicago, 4309 N. Whipple St.	Hume, J. M.
	Chicago, 2140 W. Harrison St., Station D	Perrotta, D.
	Chicago, 1429 Lunt Ave., Apt. No. 302, Rogers Park	Turner, U. G.
	Decatur, 2625 E. Garfield Ave.	Songer, C. K.
Kansas	Kansas City, P.O. Box No. 358	Francis, T. L.
Maryland	Baltimore, 3608 Frankford Ave., Hamilton	Taylor, W. E.
Massachusetts	Brighton, 1949 Commonwealth Ave.	Atwood, R. F.
Michigan	Detroit, 13858 Newbern	Bogard, B. W.
	Detroit, 3760 Jefferson, E.	Kaserman, F. S.
Mississippi	Rolling Fork	Gibbon, Q. D.
New Jersey	Camden, 3317 Pelham Pl.	Sinclair, A.
	Hillside, 429 Conant St.	Smith, L. D.
	Merchantville, 212 State St.	Seimes, M.
	Plainfield, 680 W. Front St.	Groves, A. J.
New York	New York City, Am. Tel. and Tel. Co., 195 Broadway	Bemis, I. S.
	New York City, 460 W. 54th St.	Bradshaw, D. Y.
	New York City, 195 Broadway, Rm. No. 2012	Durkee, L.
	New York City, c/o Amer. Tel. and Tel. Co., 195 Broadway	Ladner, H.
	New York City, 178 E. 205th St., Apt. No. 6-C	Townsend, J. H.
	Pelham, 305 6th Ave.	Looney, L. A.
	Rochester, Stromberg Carlson Mfg. Co.	Curtis, S. R.
	Rocky Point	Conklin, J. W.
	Warrensburg	Nodine, W. I.
Ohio	Cincinnati, 2731 Vine St.	Magly, J. W.
	Cincinnati, 955 Windsor St.	Neil, D. R.
Pennsylvania	Emporium, 338 W. 4th St.	Huchberger, A. P.
	Minersville, 136 Westwood St.	Rothermel, E. F.
	New Bethlehem, Penn St.	Collett, P.
	Philadelphia, The Atlantic Refining Co., 260 S. Broad St.	Munton, J. D.
	Philadelphia, 835 N. Newkirk St.	Weise, R. C.
	Pittsburgh, 5900 Ellsworth Ave.	Robin, G.
West Virginia	Bluefield, Box No. 618	Davison, L.
	Carolina, Box No. 236	Royal, J. E.
	Huntington, 115 Baer St.	Gilfilen, L. J.
Wisconsin	Milwaukee, 2009 W. Scott St.	Hanson, R. C.
Canada	Toronto, Ont., Radio Valve Co., 189 Dufferin St.	Cary, F. C.
	Toronto, Ont., 423 Dufferin St.	Dow, J.
England	Beaconsfield, Bucks, The Beacons, Reynolds Rd.	Woodbridge, F. L.
	Cookridge, Leeds, "The Moorings," Tinsill Rd.	Tetley, R.
	Derby, 2 Waverley Terrace, Moore St.	Prince, T.
	Halifax, Yorkshire, Wortleys Wireless House, Bull Green	Wortley, A.
	Harlesden, London N. W. 10, 1 Odessa Rd.	Cook, A. B.
	Hull, 51 Grafton St., Beverley Rd.	Wallace, R. H.
	London W. 14, 6 Lisgar Terrace	Elsner, C. W. R.
	London W. 1, 63 Curzon St.	Hughes, L. E. C.
	London, Mill Hill, 13 Goodwyn Ave.	Shorter, D. E. L.
	London, N. 17, Tottenham, 71 Winchelsea Rd.	Pryor, G. E.
	London, N. 21, Winchmore Hill, 61 Hoodcote Gardens	Dawe, F. W.
	Skegness, Lincolnshire, Beam Wireless Station	Frankis, E. E.
	Skegness, Lincolnshire, Beam Wireless Station	Pales, F. A.
	Whalley Range, Manchester, 25 Wood Rd.	Skaife, M.
Wales	Llanely, Llwynonn, Carmel	Davies, I. T.
Holland	Arnhem, 34 Van Lawick van Pabststraat	Hummeling, W. G.

Geographical Location of Members Elected September 2, 1931

New Zealand	Dunedin, University of Otago	Jack, R.
Philippine Islands	Manila, 1216 Gov. Forbes, Sampaloc	Escudero, S. H.
Rhodesia	Bulawayo, c/o Princes Kinema	Anolick, J.
Scotland	Glasgow, 15 Florida St., Mount Florida	Armour, C. D.
Territory of Hawaii	Honolulu, Fort Shafter	Larew, W. B.

Elected to the Junior grade

Colorado	Greeley, 514 6th St.	Isberg, R.
Kansas	Manhattan, 1201 Vattier St.	De La Mater, F.
North Dakota	New Salem	Hoffman, H. C.
Ohio	Cleveland, 5321 Julia Ave.	Melamed, S.
Pennsylvania	Erie, 528 W. 18th St.	Swaney, B. H.
New Zealand	Wellington, 27 Monro St., Seatoun	Morrison, C. W.



APPLICATIONS FOR MEMBERSHIP

Applications for transfer or election to the various grades of membership have been received from the persons listed below, and have been approved by the Committee on Admissions. Members objecting to transfer or election of any of these applicants should communicate with the Secretary on or before November 4, 1931. These applicants will be considered by the Board of Direction at its November 4th meeting.

For Transfer to the Member grade

Dist. of Columbia	Washington, 3618 Connecticut Ave. N. W.	Kear, F. G.
New York	Bayside, Hazeltine Service Corp., 209-71 26th Ave.	Case, N. P.
Pennsylvania	Avalon, 123 Harrison Ave	Allen, J. G.
	Upper Darby, 255 Lampport Rd.	Frazier, H. S.
Canada	Montreal, P. Q., 4327 Oxford Ave.	Weese, R.
England	Manchester, College of Technology, Sackville St.	Jackson, W.

For Election to the Member grade

Indiana	Fort Wayne, c/o Steinite Radio Co.	Victoreen, C. J.
New York	New York City, 195 Broadway	Gannett, D. K.
	New York City, Tropical Radio Telegraph Co., Pier 9, North River	Simon W. C.
	Schenectady, 121 Woodland Ave.	Marvin, H. B.
Czechoslovakia	Prague, 5 Husova	Siegel, E.
Siam	Bangkok, General Post Office	Aram, Phra

For Election to the Associate grade

Alabama	Anniston, c/o The Radio Service Shop, Box No. 449	Gray, J. M.
California	Berkeley, 2601 Durant Ave.	Hoag, L. J.
	Long Beach, 6132 California Ave.	Larsen, D. A.
	Los Angeles, 1225 W. 39th Pl.	Cutler, K. W.
	Los Angeles, 6565 Santa Monica Blvd.	Hooker, D. E.
	San Francisco, c/o KFRC, 1000 Van Ness Ave.	Bensberg, C. B.
	San Francisco, 1466 40th Ave.	Cormack, A. N.
Colorado	Denver, 3922 W. 32nd Ave.	Needs, W. C.
Florida	Miami, 15 N. W. 12th Ave.	Gilbert, J. C.
Illinois	Chicago, 816 N. Kedzie Ave.	Bradshaw, E.
	Chicago, 2711 N. Sayre Ave.	Holm, E. A.
	Chicago, 449 N. Ridgeway Ave.	Mack, G.
	Chicago, 5424 W. 64th St.	Scheer, G. H., Jr.
Indiana	Evansville, 1735 S. Garvin St.	Travis, F. E.
	Fort Wayne, 1114 Crescent Ave.	Fischer, F. W.
	Fort Wayne, 1930 Oakland St.	Wise, C. E.
	Parker	Clark, L. B.
Massachusetts	Malden, 1257 Salem St.	Bacon, D. H.
	Weston, Old Road	Bent, A. E.
Michigan	Bessemer, Box No. 802	Fauhl, W. B.
Missouri	Clinton, 306 S. Main St.	Mitchem, F. M.
	Richmond, 321 S. Shaw St.	Basham, R.
	St. Louis, 1509 Hickory St.	Varney, H.
New Jersey	Ashland	Hamilton, E. T.
	Belleville, 199 Adelaide St.	Katzen, M.
	Bloomfield, 46 Heinrich's Pl.	Cox, A.
	Camden, 204 Evergreen Ave., Woodlynne	Gerber, P.
	East Orange, 44 Sunnyside Terrace	Laube, H. W.
	Newark, 61 Sunset Ave.	Rotolo, N. V.
	Waldwick, Box No. 436	Clipp, R. W.
	West Orange, 24 Overlook Ave.	O'Neill, R. A., Jr.
New York	Brooklyn, P. O. Box No. 174, Times Plaza Station	Blanc, V.
	Brooklyn, 462 E. 28th St.	Christman, C.
	Brooklyn, 570 E. 26th St.	Gardner, L. H.
	Brooklyn, 239 Steuben St.	Garone, J. A.
	Elmira, 660 Cedar St.	Jenkins, H. F.
	New York City, 3834 Bailey Ave.	De Pasquale, R. H.
	New York City, 180 Varick St.	De Witt, J. H.
	New York City, Bell Tel. Labs., Rm. K-48, 463 West St.	Edwards, R. B.
	New York City, c/o Bell Tel. Labs., 180 Varick St.	Hight, S. C.
	New York City, 87 Barrow St.	Hooper, A.
	New York City, 179 Varick St.	Molyneux, C.
	New York City, Bell Tel. Labs., 463 West St.	Willard, G. W.
	Niagara Falls, 1509 Weston Ave.	Hohir, J. E.
	Oneonta, 14 Draper St.	Wendell, F. S.

Applications for Membership

New York	Rochester, University of Rochester, River Campus	Lawrence, H. E.
	Rome, 105 Francis St.	Fitch, J. A.
	Staten Island, Seaview Hospital	White, J. P.
North Dakota	Mandan, 506 1st Ave. N. W.	Richardson, O. H.
Ohio	Dayton, 1609 Detzen Ave.	Fleischer, E. F.
	Dayton, General Motors Radio Corp.	Hess, F. E.
Pennsylvania	Dayton, 1816 Rosemont Blvd.	John, A. R.
	Toledo, 1249 Dorr St.	Oaks, N.
	Monessen, 362 Park Way	Parenti, A. M.
	Philadelphia, 342 S. 2nd St.	Frederick, A.
	Tyrone, 1205 Logan Ave.	Kearney, H. B., Jr.
Tennessee	Nashville, 1704 Grand Ave. S. W.	Campbell, J. S.
Texas	Dallas, P. O. Box No. 2833	Johnson, W. D.
Virginia	Lynchburg, 4216 Fort Ave.	Strange, O. O.
	Richmond, 1720 Westwood Ave.	Havens, W. M.
West Virginia	Richmond, 3109 Lamb Ave.	Stephenson, J. W.
	Shinnston, Pike St.	Meek, G. L.
Australia	Melbourne, Victoria, 17 Inglisby Rd., Mont Albert E. 10	McKenzie, A. J.
Canada	Hamilton, Ont., 15 Bold St., Apt. No. 15	Madter, E. W. R.
	Quebec, P. Q., 141 des Franciscains St.	Guimond, A.
England	Quebec, P. Q., 66 Sault au Matelot	Messier, J. L.
	Burnley, 9 Carlton Rd.	Wade, A.
	Chesterton, Cambridge, 83 Hawthorne Way	Barnes, H. M.
	Heston, Middlesex, 34 Hogarth Gardens	Fayers, A. A.
	Kersal Bar, Manchester, Hope Bank	Garnett, S. A.
	London, Strand, Marconi Sounding Device Co., Marconi House	Shaxted, H. E.
	London E. 12, 350 Strone Rd., Manor Park	Snook, E. T.
	New Malden, Surrey, 63a Kingston Rd.	Dedman, E. A.
	Thornton Heath, Surrey, 184 Melfort Rd.	Smith, M. G.
	Wallington, Surrey, 18 West Ave.	Hodgson, A. D.
India	Worcester, "Radio House," Vincent Rd.	Porter, W. J.
	Multan Caultt, 412 Queen's Rd.	Prasad, J.
Japan	Ishikawa-ken, JOJK Nonoichi Sending Station, Nonoichi-machi	Tanaka, Y.
New Zealand	Kyoto, 1, Koyama-Horiike, Kamikyoku	Yoshioka, T.
	Christchurch, 447 Worcester St.	Benjams, W.
	Christchurch, 98 Office Rd.	Buckhurst, E. B., Jr.
South Africa	Dunedin, 12 Princes St., St. Kilda	Scott, T.
	Durban, Natal, Beach Grove Hotel, Beach Grove	King, C. L.
S. Australia	Adelaide, 60 Carlisle Rd., Westbourne Park	Elliott, H. R.

For Election to the Junior grade

New York	Hempstead, 2 Nassau Parkway	Fritzsche, E. H.
----------	-----------------------------	------------------



OFFICERS AND BOARD OF DIRECTION, 1931

(Terms expire January 1, 1932, except as otherwise noted)

President

RAY H. MANSON

Vice President

C. P. EDWARDS

Treasurer

MELVILLE EASTHAM

Secretary

HAROLD P. WESTMAN

Editor

ALFRED N. GOLDSMITH

Managers

ARTHUR BATCHELLER

J. H. DELLINGER

LLOYD ESPENSCHIED

HARRY HOUCK

C. M. JANSKY, JR.

Serving until January 1, 1933

J. V. L. HOGAN

R. H. MARRIOTT

Serving until January 1, 1934

L. M. HULL

A. F. VAN DYCK

Junior Past Presidents

A. HOYT TAYLOR

LEE DE FOREST

BOARD OF EDITORS, 1931

ALFRED N. GOLDSMITH, *Chairman*

STUART BALLANTINE

RALPH BATCHER

G. W. PICKARD

L. E. WHITEMORE

W. WILSON

COMMITTEES OF THE INSTITUTE OF RADIO ENGINEERS, 1931

Committee on Papers

W. WILSON, *Chairman*

Theory, Circuit, and General	Aircraft Radio
L. M. HULL	F. M. RYAN
Generating Apparatus and Theory	Stations and Operating, Broadcasting
B. R. CUMMINGS	E. K. COHAN
L. P. WHEELER	R. M. MORRIS
Receiving Apparatus and Theory	Television
C. E. BRIGHAM	D. E. REPLOGLE
H. A. WHEELER	Picture Transmission
Transmission Through Space	R. H. RANGER
G. W. KENRICK	Miscellaneous Communication Systems
R. K. POTTER	H. A. AFFEL
Measurements and Standards	Piezo-Electricity
J. K. CLAPP	W. G. CADY
E. L. HALL	Historical Bibliographies, Book Reviews
Miscellaneous Technical Papers	S. S. KIRBY
K. S. VAN DYKE	Radio Communication Systems
Vacuum Tubes and Thermionics	T. A. M. CRAVEN
W. C. WHITE	Radio Manufacturing
Aerials and Aerial Systems	G. G. THOMAS
G. C. SOUTHWORTH	Nonradio and Radio Law
Acoustics and Audio Frequencies	R. H. MARRIOTT
IRVING WOLFF	

Committee on Admissions

C. M. JANSKY, JR., *Chairman*

R. A. HEISING, *Vice Chairman*

C. N. ANDERSON	A. V. LOUGHREN
ARTHUR BATCHELLER	R. H. MARRIOTT
C. P. EDWARDS	E. R. SHUTE
H. C. GAWLER	J. S. SMITH
A. G. LEE	A. F. VAN DYCK

Chairman of each section, *ex officio*

Committee on Awards

ALFRED N. GOLDSMITH, *Chairman*

STUART BALLANTINE	MELVILLE EASTHAM
RALPH BOWN	A. HOYT TAYLOR

Committee on Bibliography

J. H. DELLINGER, *Chairman*

M. C. BATSEL	DONALD McNICOL
W. G. CADY	G. W. PICKARD
C. E. DEAN	B. E. SHACKELFORD
MELVILLE EASTHAM	E. R. SHUTE
G. W. GIBBS	H. M. TURNER
C. B. JOLLIFFE	A. F. VAN DYCK
A. E. KENNELLY	L. P. WHEELER
R. H. LANGLEY	W. C. WHITE
J. O. MAUBORGNE	L. E. WHITTEMORE

W. WILSON

Committee on Broadcasting

J. M. HULL, *Chairman*

ARTHUR BATCHELLER
B. R. CUMMINGS
P. A. GREENE
R. GUY
J. V. L. HOGAN

C. W. HORN
C. M. JANBY, JR. (S. L. BAILEY, al-
ternate)
R. H. MARRIOTT
E. L. NELSON

Committee on Constitution and Laws

R. H. MARRIOTT, *Chairman*

ARTHUR BATCHELLER
MELVILLE EASTHAM
W. G. H. FINCH

H. E. HALLBORG
R. A. HEISING
G. W. PICKARD

H. A. ZEAMANS

Committee on Membership

H. C. GAWLER, *Chairman*

W. W. BROWN
J. M. CLAYTON
I. S. COGGESHALL
DAVID GRIMES
F. A. KOLSTER
M. B. LONG

S. R. MONTCALM
A. F. MURRAY
M. E. PACKMAN
C. R. ROWE
J. E. SMITH
J. C. STROEBEL, JR.

A. M. TROGNER

Secretary of each section, *ex officio*

Committee on New York Programs

AUSTIN BAILEY, *Chairman*

M. C. BATSEL
H. C. GAWLER
L. M. HULL

R. H. RANGER
J. L. REYNOLDS
E. R. SHUTE

Committee on Nominations

J. H. DELLINGER, *Chairman*

ARTHUR BATCHELLER
C. P. EDWARDS

ALFRED N. GOLDSMITH
J. V. L. HOGAN

L. M. HULL

Committee on Publicity

C. E. BUTTERFIELD, *Chairman*

O. H. CALDWELL
O. E. DUNLAP
FRED EHLERT
W. G. H. FINCH

A. H. HALLORAN
LLOYD JACQUET
J. F. L. MAHER
DONALD McNICOL

K. B. WARNER

Committee on Sections

C. W. HORN, *Chairman*

AUSTIN BAILEY
W. R. G. BAKER
L. A. BRIGGS

D. H. GAGE
V. M. GRAHAM
R. H. LANGLEY

B. E. SHACKELFORD

Chairman of each section, *ex officio*

Committee on Standardization

J. W. HORTON, *Chairman*

STUART BALLANTINE
E. L. BOWLES
J. H. DELLINGER
W. E. DOWNEY
ALLEN DU MONT
C. P. EDWARDS
P. H. EVANS
MALCOLM FERRIS
A. N. GOLDSMITH
F. H. KROGER
C. M. JANSKY, JR.
H. M. LEWIS

D. G. LITTLE
E. L. NELSON
HARADEN PRATT
B. E. SHACKELFORD
J. C. SCHELLENG
H. M. TURNER
J. C. WARNER
K. S. WEAVER
H. A. WHEELER
L. E. WHITTEMORE
R. M. WILMOTTE
W. WILSON







DAVID SARNOFF
Secretary, 1915-1917

David Sarnoff, born on February 27, 1891, was brought to America as a child when his parents immigrated from Southern Russia. After attending public school he took a special course in electrical engineering at Pratt Institute.

He began his career in communications work as a boy with the Commercial Cable Company in 1906, entering the employ of the Marconi Wireless Telegraph Company of America later in the same year. In 1907 he became junior telegraph operator and in 1909, manager of the Marconi station at Seagate, N. Y. In 1910 he equipped the SS Beothic, making a trip as operator on her to the Arctic ice field on a seal fishing expedition. He then became a wireless operator at John Wanamaker's New York station and in 1912 became an inspector for the Marconi Company, and instructor in the Marconi Institute. He was successively, chief radio inspector, assistant chief engineer, contact manager, assistant traffic manager, and in 1917, commercial manager of the Marconi Company.

The Radio Corporation of America absorbed the Marconi Company in 1919 and he was appointed commercial manager. In 1921 he was made general manager and the next year vice president becoming an executive vice president in 1929 and in 1930 president of the Radio Corporation of America.

In 1927, St. Lawrence University conferred upon him the honorary degree of Doctor of Science.

Mr. Sarnoff is a member of the American Institute of Electrical Engineers, the New York Society for Electrical Development, a life member of the Veteran Wireless Operators Association, a Fellow of the American Geographical Society, an honorary member of the Radio Club of America, and a member of the Council of New York University.

He became an Associate member of the Institute in 1912, a Member in 1914, and a Fellow in 1917.

INSTITUTE NEWS AND RADIO NOTES

Election Notice

The Board of Direction of the Institute, at its meeting on September 2, 1931, placed the names of the following candidates in nomination for officers to be elected by the membership and take office in January, 1932.

For President	W. G. Cady
	L. E. Whittemore
For Vice President	E. V. Appleton
	B. van der Pol
For Managers—1932-1934	W. R. G. Baker
	O. H. Caldwell
	E. L. Nelson
	R. H. Ranger

The following is quoted from Article VII, Section 1 of the constitution as amended January, 1921.

“Nomination by Petition shall be made by letter, addressed to the Board of Direction, setting forth the name of the proposed candidate and the office for which it is desired he be nominated. For acceptance, a letter of Petition must reach the Board of Direction on or before October 15th of any year, and shall be signed by at least thirty-five Fellows, Members or Associates.”

September Meeting of the Board of Direction

The September 2nd meeting of the Board of Direction was attended by Ray H. Manson, president; Melville Eastham, treasurer; A. Hoyt Taylor, junior past president; Arthur Batcheller, J. H. Dellinger, Lloyd Espenschied, J. V. L. Hogan, H. Houck, L. M. Hull, C. M. Jansky, Jr., R. H. Marriott, A. F. Van Dyck, and H. P. Westman, secretary. Only three members of the Board of Direction were not in attendance.

The application of J. H. Pressley for transfer to the grade of Fellow was approved as were the applications of J. L. Callahan, Louis Martin, and R. P. Morris for transfer to the grade of Member. Applications for admission to the grade of Member in the names of C. I. Baker, W. H. Campbell, and A. W. Montgomery were also approved. Sixty-three new Associates and six new Juniors were elected.

The invitation from the Pittsburgh Section of the Institute that the 1932 Convention be held in Pittsburgh was accepted and the date of May 12, 13, and 14 was determined upon to commemorate the twentieth anniversary of the founding of the Institute on May 13, 1912.

Rochester Fall Meeting

The 1931 Rochester Fall Meeting will be held at the Hotel Sagamore in Rochester on November 9 and 10 under the auspices of the Rochester Section of the Institute.

The two-day session will be devoted almost entirely to the presentation of technical papers in the informal manner which proved so successful during the past meetings of this nature. The list of papers to be presented are as follows:

"Recent Developments in Amplification and Detection Systems," by P. O. Farnham, Development Engineer, Radio Frequency Laboratories.

"Advances in Ultra-Short-Wave Transmission and Reception," by Eduard Karplus, Research Engineer, General Radio Company.

"Battery Design Problems of the Air Cell Receiver," by F. T. Bowditch, Radio Engineer, National Carbon Company.

"Pentode Circuit Operation," by David Grimes, Engineer-in-Charge, RCA Lincensee Laboratory.

"Magnetic Cores for High Frequencies," by W. J. Polydoroff, Research Engineer, Johnson Laboratories.

"Correlation of Radio Tube and Receiver Designs," by Roger Wise, Chief Engineer, Hygrade Sylvania Corporation.

"Use of Suppressor Grids in Radio Tubes," by E. W. Ritter, Development Engineer, RCA Radiotron Company.

"An Examination of Selectivity," by R. H. Langley, Consulting Engineer.

"European Reception Conditions" by W. A. MacDonald, Chief Engineer, Hazeltine Service Corporation.

"Experimental Visual Broadcasting," by A. B. Chamberlain, Chief Engineer, Columbia Broadcasting System.

A new feature at this meeting will be the engineering sessions during which representatives of those organizations exhibiting will be permitted to address the audience and discuss briefly the products manufactured by their organization. It is hoped that this will supplement the exhibition of component parts and measuring equipment which will be a part of the meeting and make this exhibition of increased value.

A group luncheon will be held on Monday, November 9th, and an informal banquet will be given on Tuesday evening, November 10th.

It is anticipated that all of those who have attended past Rochester Fall Meetings will be present as well as many others who have only heard of them. It is desirable that advance registration be made for

hotel accommodations. These may be addressed to Mr. O. L. Angevine, at the Rochester Engineering Society, Hotel Sagamore, Rochester N. Y.

Radio Transmissions of Standard Frequency, October, November, and December, 1931

The Bureau of Standards announces a new schedule of radio transmissions of standard frequencies. This service may be used by transmitting stations in adjusting their transmitters to exact frequency, and by the public in calibrating frequency standards and transmitting and receiving apparatus. The signals are transmitted from the Bureau's station WWV, Washington, D.C., every Tuesday afternoon and evening. They can be heard and utilized by stations equipped for continuous-wave reception throughout the United States, although not with certainty in some places. The time schedules are different from those of previously announced transmissions. The only frequency utilized is 5000 kilocycles. The accuracy of the frequency is at all times much better than a part in a million.

The transmissions are by continuous-wave telegraphy at 5000 kilocycles. They are given continuously from 2:00 to 4:00 P.M., and from 8:00 to 10:00 P.M., Eastern Standard Time, every Tuesday throughout October, November, and December (except December 29). The dates are October 6, 13, 20, 27; November 3, 10, 17, 24; and December 1, 8, 15, 22.

The transmissions consist mainly of continuous, unkeyed carrier frequency, giving a continuous whistle in the receiving phones. The first five minutes of the transmission consist of the general call (CQ de WWV) and announcement of the frequency. The frequency and the call letters of the station (WWV) are given every ten minutes thereafter.

Information on how to receive and utilize the signals is given in Bureau of Standards Letter Circular No. 280, which may be obtained by addressing a request to the Bureau of Standards, Washington, D.C. From the 5000 kilocycles any apparatus may be given as complete a frequency calibration as desired by the method of harmonics.

Since the start of the 5000-kc transmissions at the beginning of this year the Bureau of Standards has been receiving reports regarding the reception of these transmissions and their use for frequency standardization, from nearly all parts of the United States, including the Pacific coast and Alaska. The Bureau is desirous of receiving more reports on these transmissions, especially because radio transmission phenomena change with the season of the year.

The data desired are approximate field intensity, fading, and the suitability of the transmissions for frequency measurements. It is suggested that in reporting upon field intensities for these transmissions, the following designations be used where field intensity measurement apparatus is not at hand: (1) hardly perceptible, unreadable; (2) weak, readable now and then; (3) fairly good, readable with difficulty; (4) good, readable; (5) very good, perfectly readable. A statement as to whether fading is present or not is desired, and if so, its characteristics such as whether slow or rapid, and time between peaks of signal intensity. Statements as to type of receiving set used in reporting on the transmissions and the type of antenna used are likewise desired. The Bureau would also appreciate reports on the use of the transmissions for purposes of frequency measurement or control.

The Bureau would also appreciate comment from all users of the service on the times of day when the transmissions are most useful. During July, August, and September, the evening transmissions were two hours later than in the schedule announced herein.

All reports and letters regarding the transmissions should be addressed Bureau of Standards, Washington, D.C.

Changes in Cosmic Data Broadcasts

There was published in this section of the September, 1930, issue of the PROCEEDINGS a considerable amount of material concerning the broadcasting of daily cosmic data. Certain changes in the transmission schedule and in the preparation of these messages, which are known as Ursigrams, are published here for the benefit of those interested in this service.

In addition to the material listed in the previous announcement, there will be transmitted data on the height of the Kennelly-Heaviside layer which is supplied by the U. S. Bureau of Standards. It will be noted that some changes have been made in the identifying code words.

TRANSMISSION SCHEDULE

The Ursigrams in code described below are transmitted by radiotelegraphy, using International Morse Code, daily including Sunday from Navy radio station, NAA, Arlington, at 22:00 Greenwich time (5 P.M. Standard time) on frequencies 12,040 and 4015 kilocycles.

TIME USED

Greenwich time, reckoned from midnight is used in the Ursigrams. This is variously known as Greenwich Mean Time (G.M.T.), Green-

wich Civil Time (G.C.T.), Universal Time, Weltzeit, etc. It is the time used by astronomers throughout the world since 1925 when they changed the astronomical day so that it begins at midnight instead of noon. Noon or 12:00 Greenwich time is 7 A.M. U. S. Eastern Standard time, etc.

CODE USED

The letters URSI are the distinguishing sign at the beginning of the cosmic data message. URSI are the initials of the Union Radio Scientifique Internationale (International Scientific Radio Union). Each class of data is coded separately and preceded by an identifying word: RAD for solar constant, MAG for terrestrial magnetism, SOL for sun spots, AUR for auroras, KHL for Kennelly-Heaviside layer heights. The data are expressed in a number code in groups of five, similar to that used in the transmission of meteorological information. Plain English will be added when extraordinary phenomena demand it. The message is signed SCIENSERVC, the cable address of Science Service. Unused figures are transmitted as X.

KHL (KENNELLY-HEAVISIDE LAYER)

First Group

First figure indicates the place of observation:

3 Washington, D.C. (U. S. Bureau of Standards)

5 Medford, Mass. (Tufts College)

Others to be announced.

Second, third, fourth, and fifth figures give the frequency, in kilocycles per second, divided by 10.

Second group

First figure indicates day of week:

1 Sunday

2 Monday

3 Tuesday

4 Wednesday

5 Thursday

6 Friday

7 Saturday

Second and third figures give the nearest hour of the observation in Greenwich time.

Fourth and fifth figures give the height of the Kennelly-Heaviside layer in kilometers divided by 10.

Third and Other Groups

Additional observations expressed in same code as second group.
Example: KHL 31348 61513. The observed Kennelly-Heaviside layer height at Washington, D. C., for a frequency of 13,480 kilocycles, on Friday at 15:00 Greenwich civil time was 130 kilometers.

KHL values are included in Ursigrams weekly beginning June, 1931.

AUR (AURORA)

First Group

First figure in first group shows day of week:

- 1 Sunday
- 2 Monday
- 3 Tuesday
- 4 Wednesday
- 5 Thursday
- 6 Friday
- 7 Saturday

Second figure of first group indicates character of day:

- 0 No aurora
- 1 Faint
- 3 Moderate
- 5 Strong
- 7 Brilliant
- 9 No observations or no observations possible on account of cloudiness.

Third and fourth figures of first group indicate number of hours during which the aurora is present, preceded by zero if number is less than 10.

Fifth figure of first group indicates cloudiness on scale of 0, 1, 2, . . . , 9, X; 0 indicates no clouds and X indicates completely overcast sky.

Second Group

First figure of second group indicates form of aurora:

- 0 Homogeneous quiet arcs without ray-structure
- 1 Homogeneous bands without ray-structure
- 2 Pulsating arcs without ray-structure
- 3 Diffuse luminous surfaces without ray-structure
- 4 Pulsating surfaces without ray-structure
- 5 Feeble glow without ray-structure
- 6 Varied forms without ray-structure
- 7 Flaming aurora
- 8 Varied without ray-structure and flaming

Second figure of second group indicates form of aurora:

- 0 Arcs with ray-structure
- 1 Bands with ray-structure
- 2 Draperies with ray-structure
- 3 Rays
- 4 Corona
- 5 Varied forms with ray-structure
- 6 Flaming aurora
- 7 Varied ray-structure and flaming

Third figure of second group indicates maximum area covered on a scale 1-5.

Fourth and fifth figures of second group indicate average altitude in degrees.

Third Group

First, second, and third figures of third group indicate general position of aurora, combinations being reckoned for included position in clockwise direction:

- 0 South
- 1 Southwest
- 2 West
- 3 Northwest
- 4 North
- 5 Northeast
- 6 East
- 7 Southeast
- 8 Zenith
- 9 Whole sky

Fourth and fifth figures of third group indicate the Greenwich mean hour, preceded by zero if the hour is less than 10, of the observed greatest display in the 24 hours preceding the time of filing report.

Example: AUR 15082 25355 57817 Sunday, day of strong auroral disturbance, aurora present during 8 hours, sky two-tenths overcast, pulsating arcs without ray-structure and varied forms with ray-structure, covering at maximum three-fifths of the visible sky, average altitude 55 degrees, from northeast to southeast to zenith, greatest display at 17:00 Greenwich time.

The auroral data are supplied by the Alaska Agricultural College and School of Mines from its auroral observatory at College, Alaska.

AUR values will be included beginning in the fall of 1931.

EXAMPLE OF COSMIC DATA MESSAGE

URSI RAD 79333 MAG 1535X 08407 SOL 10314 SCIENSERVC

OTHER DISTRIBUTION

Upon request, Science Service will transmit the cosmic data message telegraphically over commercial channels, tolls collect. If desired, the numerals will be rendered into the following syllable code to reduce tolls:

Code	{	1	2	3	4	5	6	7	8	9	0	X
		ba	de	fi	go	ku	am	en	ip	ot	ux	vy

Example above would be sent as:

URSI RAD ENOTFIFIFI MAG BAKUFIKUVY UXIPGOUXEN
SOL BAUXFIBAGO SCIENSERVC

Science Service compiles weekly in mimeograph form the data of the daily cosmic data messages and upon specific request distributes them by mail to those who can utilize or distribute the information further. The scientific magazine, *Terrestrial Magnetism*, published by Johns Hopkins Press (Editor: Jno. A. Fleming, acting director, Department of Terrestrial Magnetism, Carnegie Institution of Washington, Washington, D.C.) publishes summaries of the cosmic data.

Science Service also utilizes the information of the cosmic data messages in the preparation of its service to newspapers in such a way that the public will be kept informed of the occurrence of notable changes in the phenomena reported and the possible effects upon earthly conditions.

Those interested in correlating the cosmic data with other phenomena and in studying the literature upon the fields affected by the cosmic data reported will be placed in communication with competent authorities upon application to Science Service.

HISTORY OF AMERICAN URSIGRAMS

American Ursigrams began being distributed on Aug. 1, 1930, with solar constant, magnetic, and sun spot values included. Kennelly-Heaviside layer heights were included in June, 1931. Aurora data will be included in the fall of 1931. The Ursigrams are under the sponsorship of the Committee on Coöperation, American Section, International Scientific Radio Union, and Dr. A. E. Kennelly, chairman, has been instrumental in their inauguration and the establishment of contacts here and abroad. See SSRZ 6 for a list of others who have aided in the establishment of this service.

FRENCH URSIGRAMS

The French pioneered in the transmission of Ursigrams beginning in 1928. The French Ursigrams as copied by the U. S. Navy are given in the weekly summaries of Ursigrams issued by Science Service. Code and transmission schedules of French Ursigrams will be given in a later SSRA.

Committee Meetings

COMMITTEE ON ADMISSIONS

A meeting of the Committee on Admissions was held on Wednesday, September 2nd, with C. M. Jansky, Jr., chairman; Arthur Batcheller, H. C. Gawler, R. A. Heising, R. H. Marriott, E. R. Shute, A. F. Van Dyck, and H. P. Westman, secretary, in attendance. One application for transfer to the grade of Fellow was tabled pending further information. Six of the ten applications for transfer to the grade of Member were approved and six of the eleven applications for admission to Member were approved.

COMMITTEE ON MEMBERSHIP

The Committee on Membership held a meeting on September 2nd which was attended by H. C. Gawler, chairman; I. S. Coggeshall, C. R. Rowe, and A. M. Trogner.

The Committee reviewed the proposed new Constitution of the Institute to determine how best it might incorporate in an application form those policies of the proposed new Constitution concerning membership in the Institute.

COMMITTEE ON NOMINATIONS

A meeting of the Committee on Nominations, attended by J. H. Dellinger, chairman; Arthur Batcheller, and L. M. Hull, met on September 2nd to prepare a list of candidates whose names were presented to the Board of Direction for its consideration in making nominations for officers for 1932.

Institute Meetings

NEW YORK MEETING

The September 2nd New York meeting of the Institute was held in the Engineering Societies Building in New York City. The program under the heading "Activities of the Radio Division of the U. S. Naval Research Laboratory" comprised four short papers by members of the staff of the laboratory.

The first paper, "Functions of the Radio Division of the Naval Research Laboratory", was presented by Dr. A. Hoyt Taylor, Superintendent of the Radio Division of the Naval Research Laboratory.

Dr. Taylor was followed by Dr. L. P. Wheeler who outlined the "History of the Naval Research Laboratory."

"Precision Frequency Control of Transmitters" was the subject covered by L. A. Hyland, and R. B. Owens presented a "Study in Insulating Materials and the Measurement of Insulator Losses."

It is expected that these papers will be presented in an early forthcoming issue of the Proceedings.

The meeting was attended by one hundred and fifty members and guests, a number of whom entered into the discussion following presentation of the papers.

Personal Mention

S. D. Browning has been transferred from the Palo Alto, Calif., to the Newark, N. J., plant of the Federal Telegraph Company.

Rinaldo De Cola, formerly chief engineer of the Victoreen Radio Company has joined the research department of Tung-Sol Radio Tubes, Inc., of Newark, N. J.

Lieut. Paul F. Dugan, U. S. N., is now serving aboard the USS California.

M. W. Kenney, previously assistant chief engineer of the Grigsby-Grunow Company, is now electrical engineer in charge of radio laboratory of the Allen-Bradley Company at Milwaukee, Wis.

Lieut. J. J. Lavasseur has left the Postgraduate School of the U. S. Naval Academy for service aboard the USS Detroit.

H. K. Morgan, formerly of the RCA Victor Company, has joined the radio engineering staff of the Pilot Radio and Tube Company.

F. A. Rafferty, previously with the Zenith Radio Corporation has become a radio engineer in the Department of Police in Chicago.

G. M. Rose, Jr., formerly in the vacuum tube engineering department of the General Electric Company has become a research engineer for RCA Radiotron Company at Harrison, N. J.

G. W. Steane has been transferred from the British General Electric Company in Melbourne, Australia, to the wireless and talkie test department of the General Electric Company in Coventry, England.

H. E. Thomas has been transferred from the Inverness, Calif., to the Honolulu plant of RCA Communications.

N. E. Wunderlich, previously with the RCA Victor Company has become general manager of the radio division of the Bulova Watch Company in New York City.

PART II
TECHNICAL PAPERS

COMMUNICATION WITH QUASI OPTICAL WAVES*

BY

E. KARPLUS

(Engineer, General Radio Company, Cambridge, Mass.)

Summary—This paper deals with electromagnetic waves of from about 0.001 millimeter to 10 meters in wavelength. These waves are called quasi optical waves because their performance is very similar to the performance of visible light.

Due to scattering and absorption in the atmosphere, however, only two relatively small parts of that range can be used for communication, that is, between 5 centimeters and 10 meters and between 0.0008 and 0.002 millimeter.

In the first part of the paper the straight-line propagation characteristics of these high frequencies are discussed. The possibility of concentrating their radiation, and the apparent lack of all disturbances, either atmospheric or manmade, is also emphasized. The feasibility of modulating very high frequencies, and their advantages and disadvantages in various applications are pointed out. Different ways of producing these high frequencies and of detecting and of measuring them are discussed.

The second part of the paper deals in somewhat greater detail with the design of tube transmitters and receivers in the range of 5 centimeters to 10 meters. In this group of transmitters are tuned-circuit oscillators and electron oscillators of the Barkhausen type. In the group of receivers considered are detector, regenerative, and super-regenerative circuits.

INTRODUCTION

THE whole range of electromagnetic waves on a logarithmic scale is shown in Fig. 1.

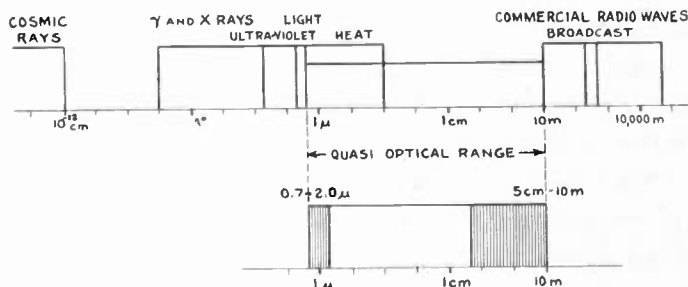

Only the two shaded parts can be used for communication

Fig. 1—Electromagnetic waves.

The range between 0.0008 millimeter and 10 meters bounded by visible light and commercial radio waves is what we call the quasi optical range.¹

* Decimal Classification: R111 X R423.5. Original manuscript received by the Institute, June 19, 1931. Presented before February 13, 1931, Boston Meeting; April 1, 1931, New York Meeting; and May 7, 1931, Toronto Meeting.

¹ The term has been suggested by F. Schroeter of the Telefunken Gesellschaft in his talk about Hertzian and infra-red waves before the Heinrich Hertz Gesellschaft, Berlin, November, 1929.

As that range contains more than twenty octaves, no uniform laws of performance can be expected, but still there is something common that does not apply to other waves. Communication is possible only when something like a direct path extends between transmitter and receiver. As everyone knows, that is essential in the optics and has no importance in radio of today. In the quasi optical range it becomes gradually more important when the wavelength is decreased.

PART I—QUASI OPTICAL WAVES

1. *Characteristics*

The outstanding characteristic of quasi optical waves is straight-line propagation. Between two points there is always only one line of propagation and for that reason all the phenomena of fading are unknown at quasi optical waves.

Another most important feature is the possibility of concentrating energy. Compared with the gain of optical systems of lenses and reflectors, the gain of the directive antenna systems of commercial short-wave stations is rather poor. The average gain of an optical reflector is 10^4 to 10^5 against 30 to 50 for the average antenna system at 20 meters. In the lower part of the quasi optical range we can use systems similar to the optical ones, but even at 50 centimeters we get into trouble because effective reflector systems should be some orders of magnitude larger than the wavelength.

Another most important fact is that the noise level is extremely low at quasi optical frequencies as compared with lower frequencies. That seems to be due to the fact that even Nature has some difficulty in starting these high frequencies and that they do not occur in man-made devices as in the broadcast range.

Another characteristic of importance in applications is the performance of quasi optical waves under different atmospheric conditions and their ability to penetrate humid air and fog. It has been proved by theory and practice that for the longer waves, let us say down to 5 centimeters, humidity, rain, or fog have no influence on propagation. Below 5 centimeters, however, we notice the humidity of the air and especially the content of CO_2 . Waves below 3 centimeters have no appreciable radiation in the atmosphere. They are absorbed and scattered in the immediate vicinity of the transmitter. Radiation of electromagnetic waves that would permit communication starts again only at the shorter heat waves and at the infra-red and light range. The attenuation of these waves is somewhat less than in the range of visible light.

So far as modulation is concerned, quasi optical waves are much better off than all other waves used in communication and that fact may

be of great importance when all the other difficulties that limit television today have been eliminated.

2. Applications

As the upper limit of quasi optical waves 10 meters has been assumed arbitrarily. It is impossible, of course, to draw distinct limits in Nature and it would probably be better to say 5 meters instead of 10, but the choice of 10 meters was dictated by the fact that waves below 10 meters only occasionally are reflected back from the upper atmosphere.

Beginning with the applications at these longest waves, the communication system in the Hawaiian Islands should be mentioned. The problem was to establish communication between the different islands of the group with distances up to 200 miles without interfering with existing communication channels. After some experiments, the Radio Corporation of America decided to use 7-meter waves. The experiments have been so successful that the system will be soon used commercially. Most of the transmitters and receivers are on mountain slopes, but there is nothing like an optical path between them.

The next field of commercial application probably will be short-wave broadcasting in cities. In that line rather successful experiments have been carried on by the Post Department in Berlin, Germany, in connection with the Telefunken and the Lorenz Gesellschaft. After some previous tests at 3 meters, the wavelength has been changed to 7 meters. A 1-kilowatt transmitter is located now on the roof of a building about 100 feet high, and satisfactory results have been attained up to a distance of five miles.

One part of the problem is to supply large cities, with their high-noise level and with local transmitters, with additional and better broadcast service. Another part of the problem is to supply cities without local transmitters with broadcast service when the field strength of other distant broadcast transmitters is too low to allow good receiving conditions.

There are two different ways to solve the problem. Both have been tried out and very valuable experience has been attained. One of the possible methods is to modulate the short wave directly with audio frequency. The other way is to modulate the short wave with a broadcast frequency which itself is modulated with audio frequency. The second way makes it possible to furnish with one short-wave transmitter not only one program, but several programs, as it is possible to modulate the short wave not only with one modulated broadcast frequency, but with several at the same time.

Another application of short waves is communication between the engineer on the locomotive and the conductor on the last car of a freight train. Different experiments carried on with longer waves showed a complete interruption of communication when one of the two stations was in a tunnel. It is easily understood that in a narrow tunnel wave propagation and radiation are only possible at waves short compared to the diameter of the tunnel. Difficulties, of course, might come up again when the tunnel does not extend in a straight line.

Some other examples are the application of the well-known radio beacon system in navigation where use of longer waves is impossible because of the interference that would be caused by the many ship and shore stations involved, and the interesting solution of the problem of fog landing of aircraft, developed by the United States Bureau of Standards.

In all of the applications mentioned above waves in the range of 5 centimeters to 10 meters are used. The conditions are somewhat different in the lower range. Communication is still more limited to short distances and the necessity of an optical path is more important. The most important applications are communication in fog on ships and airplanes, secret communication for military and police services, and other similar applications.

As pointed out before, most important in that range is the possibility of penetrating fog. In discussing the characteristics of quasi optical waves, it has been stated that attenuation of infra-red and heat in fog is somewhat less than the attenuation of visual light. It has been possible, for instance, to communicate through three miles of dense fog with a transmitter of only 100 watts input.

A most remarkable application of infra-red "communication" is the recently developed fog sextant. Instead of using visible light, the new device uses, by means of photo-electric cells and an amplifier, the infra-red radiation of the sun and permits locating the position of the ship even when the sky is covered with clouds or fog.

3. Generation

Fig. 2 shows the different ways of generating quasi optical waves and lists, without attempting to be complete, some of the more important investigators.

With tubes, waves have been generated down to 3 or 5 centimeters. Starting at longer waves, straight regenerative circuits are used. With these circuits it is possible to make tubes of special design oscillate at 0.5 meter. Circuits using negative resistance usually do not work below 10 meters as it is difficult to build resonant circuits with suffi-

ciently high impedance. Tubes operating in magnetic fields, using the so-called magnetron circuits, are effective down to about 0.5 meter and sometimes generate more energy than circuits without magnetic fields.

It is easily understood that straight regenerative circuits cannot be used at waves much shorter than 1 meter. The time required by an electron to get from one electrode inside of the tube to the other one approaches the order of magnitude of a period of the high-frequency

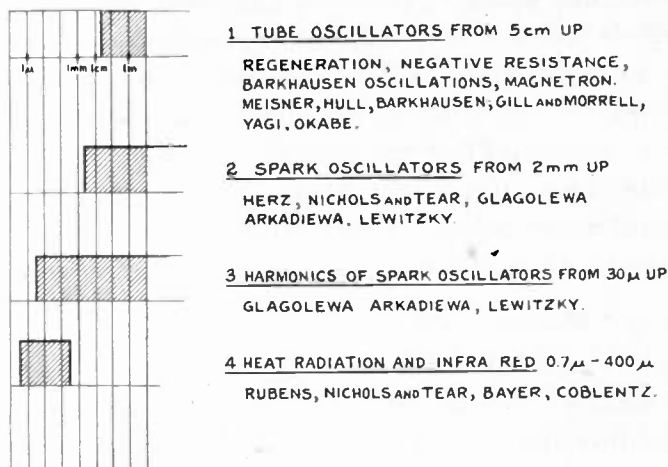

Fig. 2—Generation of quasi optical waves.

oscillations. The time, t , required at a distance, d , when the voltage between both electrodes is represented by E , equals

$$t = \frac{d}{\sqrt{10^{15} E}}$$

When we assume $d = 0.5$ centimeter, $E = 500$ volts, $t = 0.7 \times 10^{-9}$ second, we have to compare with that time the time, T , of a half period of a 1-meter wave.

$$f = 3 \times 10^8$$

$$T = 1.66 \times 10^{-9}$$

A solution of the difficulty was found first by H. Barkhausen. In his electron oscillations a cloud of electrons travels around the electrodes inside of the tube and charges and discharges them, producing changing voltages that can be applied to outside circuits and radiating systems. In this way it has been possible up to now to generate oscillations down to 3 centimeters.

The only means to generate still shorter waves is the way used by Hertz in the beginning of radio; that is, to excite oscillations in tuned

circuits or doublets by means of sparks. It is impossible, of course, to generate continuous waves with sparks, but the energy available is much greater than the energy that can be furnished by electron oscillations in tubes. Compared with 0.1 watt, which seems to be the highest energy attained with electron oscillations,² the output of a spark oscillator can be increased to 10 and even 50 watts, even at 20 centimeters, when the right material and the right shape of electrodes is used.

Glagolewa Arkadiewa succeeded in producing waves of 2 millimeters. In her experiments, sparks have been produced in a mixture of metal chips and oil. It has not been possible up to now to produce directly still shorter waves, but it has been possible to ascertain harmonics of waves produced by sparks up to wavelengths of about 0.03 millimeter. That means a range that belongs already to the heat waves.

On the other hand, it has been possible to ascertain heat waves up to roughly 0.5 millimeter. These waves can be produced in carbon flames and in electrically-excited gasses, especially mercury vapor.

4. Detection and Measurement

Methods of receiving and measuring waves down to 1 meter can be carried out without serious difficulty. It is even possible to speak of measuring frequencies, as it is possible to produce waves of 1 meter, or 300 megacycles, with such a stability that heterodyne methods can be applied. That, of course, is possible in the laboratory only, as oscillators without an elaborate master oscillator and temperature control could not be expected to maintain the frequency close enough.

In the range of electron oscillations, tubes cannot be used as ordinary detectors but it works out that the same tube circuits that are used as oscillators can be used just as well as receivers. Crystal detectors, too, can be used, but other materials are more efficient than the materials used at lower frequencies. To measure wavelengths, Lecher wires are mostly used whose accuracy is satisfactory enough today.

In the next following range of spark oscillators and their harmonics, the problem of ascertaining and measuring waves is much more complicated. Sparks between doublets are observed with a microscope. As these waves do not seem to have any importance in communication, very little has been done in that line. In addition, thermocouples, radiometers, and bolometers can be used to detect radiation, and wavelengths are measured by gratings and interference patterns.

In the next range of heat and infra-red, radiation is ascertained by the heat produced or by means of photo-electric cells that can be used

² In recent experiments of the International Telephone and Telegraph Company in England with waves of about 20 centimeters the energy attained seems to have been somewhat larger.

up to a few thousands of a millimeter. Wavelengths are measured the same way as in visible light.

PART II—TRANSMITTERS, RECEIVERS, AND WAVEMETERS FOR 5-CENTIMETER TO 10-METER RANGE

1. Straight Tube Oscillators, 1 Meter to 10 Meters

So far as starting of oscillations is concerned, no serious difficulties can be noted down to about 3 meters, especially when small tubes and low output are used. When larger tubes are used to increase the output or when it is desired still to increase the frequency of the small tubes,

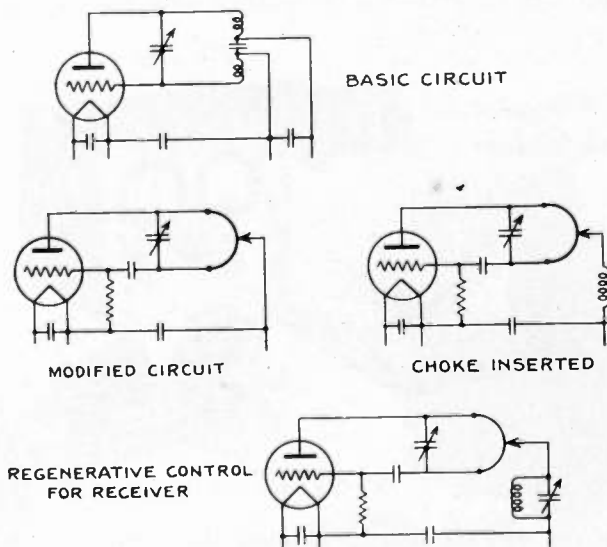

Fig. 3—Tube oscillators, 1-10 meters.

many difficulties come up. One of the most serious difficulties of large output is the protection from heat of those points of the glass tubes where the connections to the electrodes are sealed in. Due to the heavy capacitive currents, these connections heat up a great deal and must be made still heavier than in commercial short-wave tubes. Transmitters for 6 and 7 meters have been built with quartz controlled master oscillators and several stages of harmonic amplifiers with an output up to one kilowatt. When no master oscillator is used, the frequency stability, of course, is poor, but there is no reason why it should be worse than at low frequencies. Changes in temperature are the most important reasons for changes in frequency and it has to be considered that at the very high frequencies more heat is produced in most of the dielectric materials used in the circuit and even in the tube.

Fig. 3 shows schematic diagrams of tube oscillators for 1 meter to 10 meters. The upper sketch shows the basic circuit of exactly the same

characteristics as at any lower frequency. For convenience, the basic circuit can be changed into the modified circuit shown below. In this way the by-pass condenser in the coil is avoided. The grid is connected to the filament or to a suitable bias battery by means of a high impedance. Usually a circuit consisting only of a tube and the necessary connection between grid and plate would not oscillate, as the inductance of the circuit has been reduced too much compared with the capacitance.

By inserting an impedance in the circuit as is shown in the next sketch sometimes it is possible to make the tube oscillate again. The impedance that can be either a resistance or a choke coil provides the

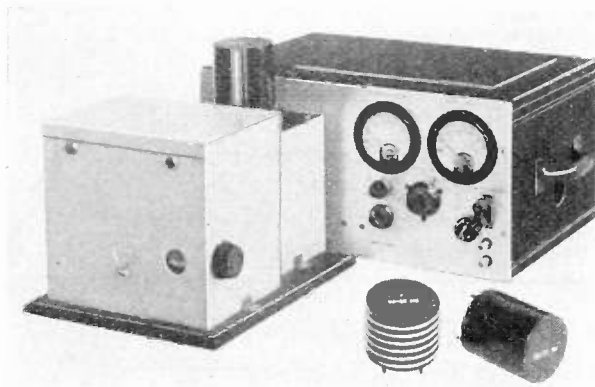

Fig. 4—30-200 mc oscillator.

right phase for regeneration by reducing the influence of stray capacities. The one choke used in the circuit of Fig. 3 separates entirely the oscillating circuit so that all the remaining connecting leads, especially filament supply, can be connected to ground. It does not seem necessary to use the many chokes recommended sometimes and it is quite an advantage when the chokes in the filament supply can be avoided.

A laboratory oscillator for 30 to 200 megacycles is shown in Fig. 4. It consists of a wooden case containing the B supply, filament and plate meter, switches and dials, and a second unit containing the oscillator itself. Most of the space in the second unit is taken up by the elaborate worm-gear drive for the condenser.

2. Circuits with More Tubes for 1 to 10 Meters

Instead of using one tube, it has been suggested to use more tubes and it is claimed that in this way it is possible to attain still higher frequencies and larger output. Of course, it is not possible to connect tubes in parallel. The only possible way is to connect them in series. When two tubes are used, the resulting circuit is a push-pull oscillator. It

seems perfectly reasonable that the output of such a circuit can be made larger than by using a single tube, but there is no reason why the frequency should be higher. It is true, of course, that so far as the tuned circuit is concerned the plate-to-grid capacities of the tubes are connected in series, but to reduce the plate-to-grid capacity of one tube a regular condenser could be used just as well as a second tube. Many transmitters are built this way; for instance, transmitters for fog landing at the Bureau of Standards in Washington.

To produce strong harmonics, push-pull circuits are very efficient when a circuit tuned to the second harmonic is inserted in the common plate connection.

3. Receivers for 1 to 10 Meters

The simplest receiver is a tuned circuit connected with a detector. The detector can be a tube or a crystal. Whenever field strength enough

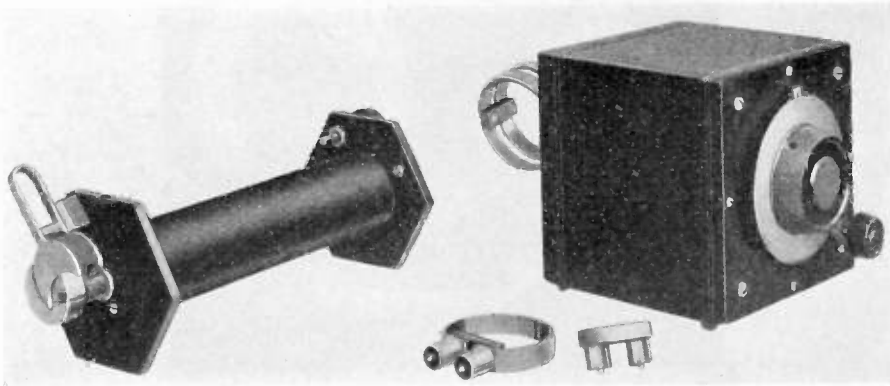

Fig. 5—Reaction wavemeters, 0.5–10 meters.



is available these receivers are very good. To increase gain and selectivity regenerative receivers can be used. A way to control the regeneration smoothly even at 1 meter is shown in Fig. 3. Instead of the choke inserted in a transmitter, a complete circuit is inserted in a receiver and the impedance of that circuit can be changed by a variable condenser.

Radio-frequency amplification is almost impossible at quasi optical waves today but it is possible that new tubes will be designed for these high frequencies.

Superheterodyne methods will not be successful until means are found to increase the stability of the transmitter and the local oscillator.

Superregenerative receivers are most useful in the quasi optical range as their gain can be increased to a value that cannot be reached by any other way.

4. Wavemeters for 1 to 10 Meters

Wavemeters in the range of 1 meter to 10 meters for the most part are just tuned circuits that are used as reaction wavemeters. Two of that kind are shown in Fig. 5; one from 0.5 to 1 meter and direct reading, the other from 1 meter to 10 meters with four different coils. When more powerful oscillations are to be measured an indicator on the wavemeter can be used as shown in Fig. 6. This wavemeter uses four coils to cover the range from 1 meter to 10 meters. Included in the box is a rectifier tube and a dry cell for filament supply.

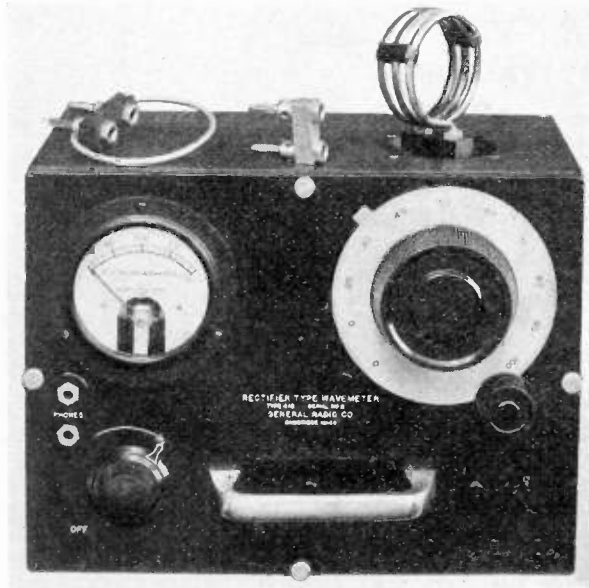

Fig. 6—Rectifier type wavemeter, 1–10 meters.

5. Electron Oscillations

Below one meter where straight oscillating circuits do not work any more, the only way to produce continuous waves is by electron oscillations. Electron oscillations were discovered by Barkhausen and Kurz and sometimes are called Barkhausen oscillations.

Fig. 7 shows the simplest form of electron oscillations. A two-filament tube is used, one filament being able to emit electrons when heated up. When a potential is applied between these two electrodes, the distribution of the electrostatic field in the tube is somewhat similar to the distribution shown in the cross-section in Fig. 7. *C* represents the heated cathode, *A* the anode. Most of the electrons, starting at the cathode, will follow the lines of highest field strengths and directly hit the anode, but some of them, starting at different points in the section of the cathode, might not follow the shortest way, and some of them

even would not hit the anode at all. They will pass it on one side and come back on the other side, as shown in the second section of Fig. 7. The theory of electron oscillations assumes that part of the electrons, starting at the cathode, do not reach the anode on the shortest way, but oscillate in some periodic way around it. This cloud of electrons charges and discharges the anode as it changes its distance and in this manner causes what we call electron oscillations.

What we have been speaking about now are only considerations in the tube alone. According to the theory, the frequency depends on the

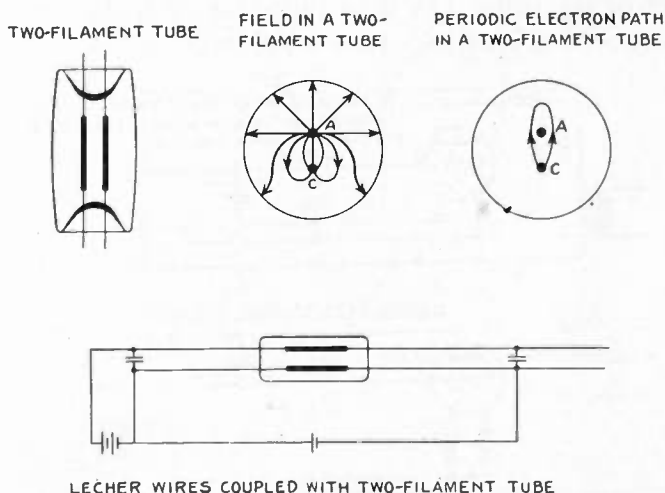

Fig. 7—Simplest form of electron oscillators.

voltage applied between both electrodes and the space between them.

$$\lambda\sqrt{E} = 1000d$$

For instance, $E = 100$ volts, $d = 0.5$ centimeter, $\lambda = 50$ centimeters. Of course, that theory neglects several facts which have to do with the determination of the frequency. That is, first, that the voltage on the plate is no longer constant when oscillations have started; and, second, of still greater importance, that both electrodes are connected with outside wires and in this way coupled to circuits of distinct frequencies.

The simplest way, again, to connect a tube with its batteries is shown in the lower part of Fig. 7. The two filaments of the tube are part of a system of Lecher wires and are arranged in the middle between two capacity bridges. Fig. 8 shows circuits for electron oscillations using three-element tubes. By means of a third electrode, the tubes can be operated either as a transmitter or a receiver. The electrode nearest to the filament still has the high potential. In the case of a three-element tube that is the grid. The plate is only used to modulate the tube when it is used as a transmitter, or to feed an audio amplifier when the tube

is used as a receiver. The next diagram in Fig. 8 shows the usual way of using three-element tubes for electron oscillations. The system of Lecher wires is connected to the plate and the grid instead of the grid and the filament, as in the case before, but that changes the conditions very little.

Fig. 8 shows in the lower part a special tube made up for electron oscillations. As we see, plate and grid have connections on the top of the tube where the radiating system or a doublet can be connected. But at the same time plate and grid are connected through chokes to the socket of the tube. The tube plugs into a regular socket through which all the necessary voltages are supplied.

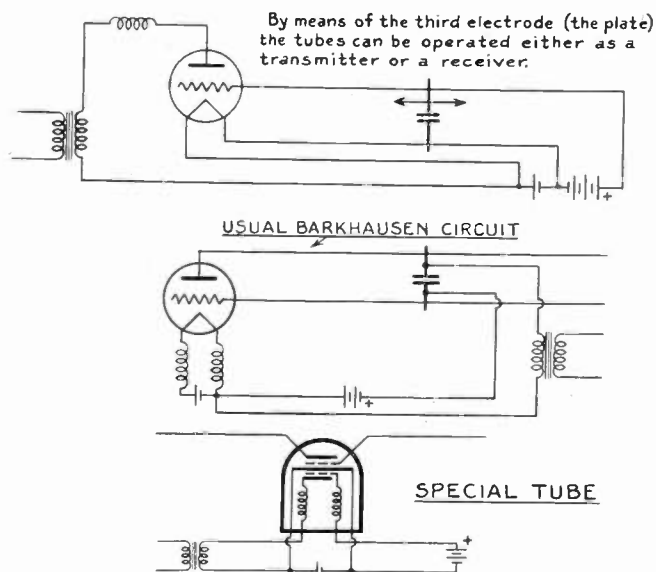

Fig. 8—Electron oscillations in three-element tubes.

Electrons starting at the filament will make only under certain conditions the necessary periodic paths around the anode and cause electron oscillations. These certain conditions occur only when a cloud of electrons around the filament causes space charge and it can be easily understood that the filament voltage has great importance in electron oscillations.

Fig. 9 shows a complete diagram of an electron oscillator with all the necessary instruments to control the voltage applied to filament, plate, and grid. Fig. 10 shows on the right side the complete outfit to produce electron oscillations and on the left side a receiver for electron oscillations. The oscillator is built for commercial tubes and three different socket adaptors can be used. The electron oscillator is mounted on the top and consists of the tube and a system of Lecher wires ex-

tending to the right of the tube. These Lecher wires are connected together by a capacity bridge in form of a disc that slides on both wires. The oscillator is built as laboratory apparatus and not as a transmitter. No means are provided to concentrate energy.

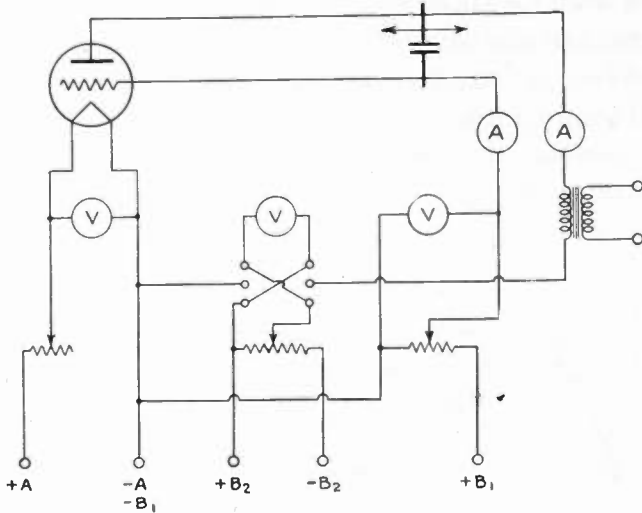

Fig. 9—Complete diagram of an electron oscillator:

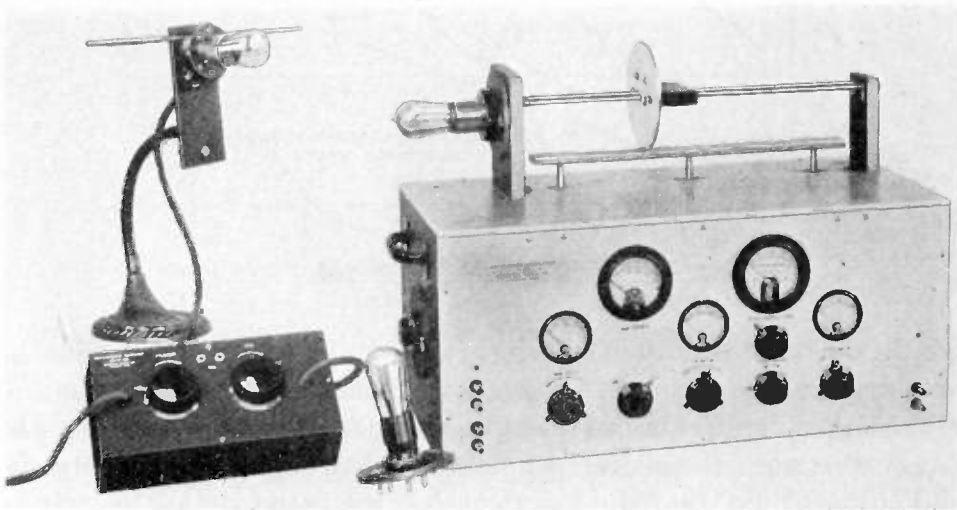

Fig. 10—Electron oscillator and receiver.

One of the difficult problems in electron oscillations is to increase the available energy. All different kinds of electrode arrangements have been tried, but it has never been possible to increase the energy very materially. Some investigators thought that only symmetrical arrangements could be used, but it has been proved that almost every arrangement can be used to start electron oscillations. It is interesting

to note, that it is possible to find electron oscillations even in a regular electric lamp. When the filament of the lamp is heated with direct current, the negative end of the filament acts as the cathode and the positive end of the filament as the anode. Of course, only lamps without gas can be used for these experiments.

By applying a magnetic field to the tube, conditions can be changed. The way an electron oscillator reacts when a magnetic field is applied has been used to prove the established theory.

We have mentioned before that the frequency of electron oscillations is not determined only by the design of the tube and the voltages applied. The characteristics of the connecting leads have an important

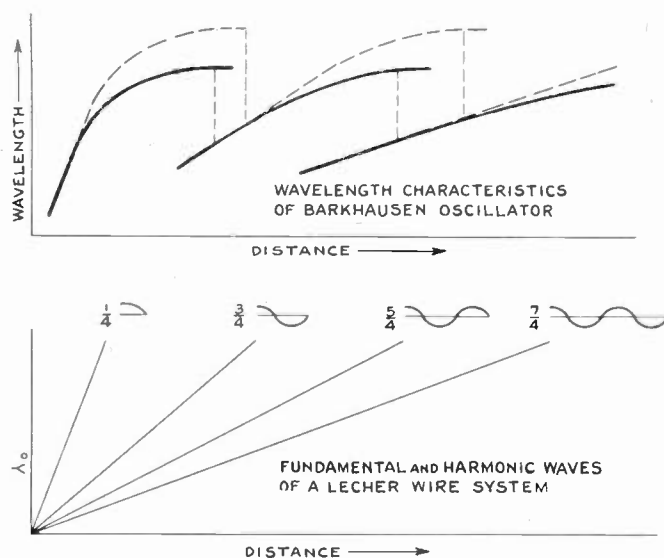

Fig. 11—Influence of tuning on electron oscillations.

role. In most cases Lecher wires are used, and Fig. 11 shows how the wavelength is changed when the length of the Lecher wire is changed. In the upper figure the wavelength produced is plotted against the distance between the sliding condenser and the tube. The first of the solid curves shows that the wavelength is increased almost linearly at first, but that at a certain point the curve starts bending and reaches a constant value. When that value is reached and the condenser is still moved in the same way, the wavelength suddenly drops to a smaller value, then starts to increase linearly again, bends, and then reaches the same constant value as before, as shown by the second solid curve. That procedure can be repeated over the whole length of the Lecher wires. The dotted lines represent the same effect when a lower voltage is applied to the plate or when the filament voltage has been decreased.

Two different ranges can be distinguished. The first range is the almost linear increase in wavelength and the second range is the part where the wavelength is almost independent of the tuning of the Lecher wire system. The lower diagram of Fig. 12 shows what is happening when the wavelength drops down from the higher to the lower value and starts increasing on the next curve. The linear parts of the different curves are nothing else than the straight lines of the lower diagram, representing the different wavelengths in which this system of Lecher wires can oscillate.

The middle diagram in Fig. 12 shows the output obtained in the different positions of the condenser.

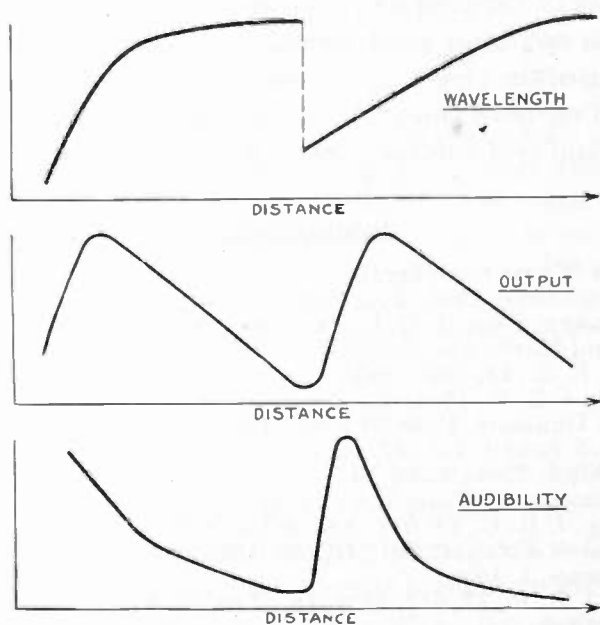

Fig. 12—Output and audibility.

As has been mentioned before, it has not been possible to increase the output of an electron oscillator over the order of magnitude of 0.1 watt. One limitation is the amount of heat that can be dissipated by the anode; in the case of a three-element tube, by the grid. Only a small part of the electrons emitted by the filament participates in exciting electron oscillations. Most of them go directly from the filament to the grid that is connected with the high voltage, but it has not been designed to dissipate any amount of energy. To increase energy, tubes must be used with heavy grids.

The old General Electric tube, CG-1162, with a tungsten filament can be used very well. Without overloading the grid, waves of about 50 centimeters can be obtained, using roughly 100 volts on the grid.

Many different kinds of tubes have been specially designed to increase the output. Systems with two plates or with two filaments have been suggested, but no really good results have been obtained.

To detect electron oscillations, a second electron oscillator can be used. The lower diagram in Fig. 12 shows at what point an electron oscillator must be set to give best audibility when used as receiver. No theory has as yet been established as to how it is possible to use an oscillator as a receiver, but, as experiments show, it is possible to receive even telephony of an electron oscillator with an output of about 0.1 watt at a distance of 20 miles. We would not expect to communicate with such a small power output at longer distances at any other frequency so far as the ground wave is concerned.

An electron oscillator used as receiver is shown on the left side of Fig. 10. Tuning of that receiver is done by setting the right length of the doublet shown on both sides of the tube and by setting with the two dials filament and grid voltage to their right value.

Bibliography

1. Quasi Optical Waves in General.
 Schroeter, *Elek. Nach. Tech.*, 7, 1, 1930.
 Esau Hahnemann, *Proc. I. R. E.*, 18, 471, 1930.
 Fassbender and Kurlbaum, *Jahrb. Drahtl. Tel.*, 33, 52, 1929.
 Uda, *Proc. I. R. E.*, 18, 1047, 1930.
 Jouaust, *Proc. I. R. E.*, 19, 479, 1931.
 Diamond and Dunmore, *Proc. I. R. E.*, 19, 585, 1931.
 Ardenne, *Jahrb. Drahtl. Tel.*, 37, 12, 1931.
 Gerth, *Elek. Nach. Tech.*, 8, 39, 1931.
2. *Straight Oscillators and Magnetron Circuits*
 Englund, *Proc. I. R. E.*, 15, 914; November, 1927.
 Bergmann, *Jahrb. d. Drahtl. Tel.*, 35, 148, 1930.
 White, *Electronics*, 1, 1930.
 Okabe, *Proc. I. R. E.*, 17, 652, 1929; 18, 1748, 1930.
3. *Electron Oscillations*
 Barkhausen and Kurz, *Zeits. f. Phys.*, 21, 1920.
 Scheibe, *Ann. d. Phys.*, 73, 54, 1924 and *Jahrb. d. Drahtl. Tel.*, 27, 1, 1926.
 Gill and Morrell, *Phil. Mag.*, 44, 161, 1922; 49, 369, 1925.
 Scheibe, *Jahrb. d. Drahtl. Tel.*, 27, 1, 1926.
 Kapzov and Gwasdower, *Zeits. f. Phys.*, 45, 114, 1927.
 Kohl, *Zeits. Techn. Phys.*, 9, 422, 1928.
 Hollmann, *Jahrb. d. Drahtl. Tel.*, 33, 1929 and 35, 1930, and *Proc. I. R. E.*, 17, 229, 1929.
 Moeller, *Jahrb. d. Drahtl. Tel.*, 34, 201, 1929 and *Elek. Nach. Tech.*, 7, 11, 1930.
 Kohl, *Jahrb. d. Drahtl. Tel.*, 36, 29, 1930.
 Strutt, *Ann. d. Phys.*, 4, 17, 1930.
 Gerber, *Jahrb. d. Drahtl. Tel.*, 36, 98, 1930.
 Wundt, *Jahrb. d. Drahtl. Tel.*, 36, 133, 1930.



HIGH-FREQUENCY ATMOSPHERIC NOISE*

By

R. K. POTTER

(American Telephone and Telegraph Company, New York City)

Summary—A method which has been employed in the measurement of high-frequency atmospheric noise is described. Using this method measurements of noise over the range from 5 to 20 megacycles made in different parts of the United States and at different times of the year, show a distinct diurnal change in intensity similar to that for long-range high-frequency signal transmission. Except during periods of severe local disturbance noise on the lower frequencies is high during the night while on the higher frequencies the maximum occurs during the day. Simultaneous observation of crashes on different frequencies also suggests that the received atmospherics are largely transmitted by overhead paths. The variation in high-frequency atmospheric noise intensity during the passage of local electrical disturbance centers is shown. It is suggested that the intensity of atmospheric noise generated by these centers of electrical disturbance is inversely proportional to frequency. Measurement data are included showing the effect of sunrise and sunset, an eclipse of the sun, and disturbances in the earth's magnetic field upon the intensity of high-frequency atmospheric noise. Diurnal characteristics of high-frequency atmospheric noise on directive antennas facing England and South America and the noise reduction obtained by these arrays is illustrated. The possible location of distant centralized noise sources is discussed briefly.

INTRODUCTION

DURING the past few years it has been increasingly evident that a better understanding of atmospheric noise over the range between five and twenty megacycles is desirable. In the upper half of this range the low average level of received noise energy introduces some measurement difficulties. Noise originating within the receiver is often comparable to that received. The receiver noise is, however, comparatively steady while that from atmospheric sources is made up of irregular peaks. Though the large majority of these peaks are of low amplitude a small number stand out prominently above the background level. The data to be described are based upon measurements of this smaller percentage of peak noise values.¹

The noise measurements based upon this peak method of measurement were obtained between April, 1930, and March, 1931. They were

* Decimal classification: R270×R114. Original manuscript received by the Institute, July 7, 1931. Presented before U.R.S.I., May 1, 1931, Washington, D.C.

¹ Since the presentation of this paper C. R. Burrows has given a paper before the I.R.E. Convention of June, 1931, entitled "The propagation of short radio waves over the north Atlantic." This paper includes a discussion of high-frequency noise measurements made by A. C. Jensen at New Southgate, England.

made at Netcong, New Jersey; Dania, Florida; and at Point Reyes and Sacramento in California. Simultaneous measurements were made at Netcong and Dania between the middle of July, 1930, and January, 1931. During April and May of 1930, measurements were made at Point Reyes and near Sacramento in California. On a few of the days during this time, measurements were also made at Netcong. In February and March, 1931, simultaneous measurements were made at Netcong and Point Reyes.

Following is a brief description of the sites at which the measurements were made:

Netcong, New Jersey—This site is located in the northern part of New Jersey at a distance of some fifty miles from the ocean. It is on the flat top of one of the subordinate ridges to the east of the Appalachian Mountain Range. The elevation at the site is about 1100 feet above sea level.

Dania, Florida—This site is about twenty-five miles north of Miami, Florida, on the Atlantic Coast. The country to the west is flat and swampy.

Point Reyes, California—This site is at the base of a peninsula at the north end of San Francisco Bay. The open Pacific is less than a mile to the west of where most of the measurements were made. To the east is a series of subordinate mountain ranges as far as the Sacramento Valley.

Sea Cliff at Point Reyes—The sea cliff at which some of the directional noise measurements in this locality were made is about three miles north of the receiving site at Point Reyes where the cliffs facing the ocean run nearly north and south. (See Fig. 24.)

Sacramento, California—The site at which the measurements in this vicinity were made is located about twenty miles northeast of Sacramento near the town of Roseville. Toward the west is the broad Sacramento Valley extending to the low mountains between this valley and the coast. To the east within a few miles are the foothills of the Sierra Nevada Mountain Range.

MEASUREMENT METHOD

As was mentioned previously the measurement of atmospheric noise at the higher frequencies is somewhat difficult because the level of the noise originating in the receiver itself is often comparable to that of the atmospherics. Even when the noise is relatively high there is often considerable disagreement between observers as to the average taken to represent a series of crashes of widely different amplitude and irregular spacing. The use of integrating devices is seriously

limited by the small amount of energy to be measured and the constant background of receiver noise.

The method of measurement which was employed for these tests may be described as a measurement of the average maxima, that is, only the peak crashes are considered in obtaining the intensity value. The measurements were made on a high-frequency field strength measuring set of a type which has been in use for some time.² The procedure is similar to that followed in the measurement of signal fields except that the observer is instructed to write down the major deflections on the second demodulator plate meter over a period of one minute and to use the arithmetic average of the highest ten as an equivalent signal deflection in the calculation of the noise field. The peak noise field is then expressed in decibels above a reference field of one microvolt per meter. The receiver gain is adjusted for successive measurements so that the meter deflections for these maximum crashes are approximately constant. The change in amplitude of the largest noise deflections over the interval between measurements is usually regular enough so that such an approximate adjustment is not difficult. The antenna used with the field strength measuring set was in most cases an eight-foot vertical rod calibrated in "effective height" over the range of measurement. When measurements were made on directive antennas the measuring set was coupled to the transmission line for optimum output.

The justification for assuming that the amplitudes of the peak crashes are representative of the atmospheric noise level as a whole, depends upon the constancy of the relation between the number of crashes and their relative intensity. Attempts have been made to determine the constancy of this relation, and it appears that except in rare cases the maxima may be taken as a representative measure of the total noise energy. Exceptional cases have occurred at times when "rain static" or atmospheric noise of a hissing character is in evidence. Although no concerted effort has been made to correlate the high-frequency noise field data so far obtained with their noise effect upon signal reception, there is some indication that the relation will be less complex than at the low frequencies.

The possibility of the receiver's being overloaded by the normal crashes in such a way that the measurements may be in error has been investigated. When measurements are made on two antennas which differ considerably in "effective height" (as determined by a relative calibration with an oscillator at some distance from the point of re-

² H. T. Friis and E. Bruce, "A radio field-strength measuring system for frequencies up to forty megacycles," *Proc. I.R.E.*, 14, 507; August, 1926.

ception) the strength of the crashes seems to be in direct relation to the antenna calibrations. If appreciable overloading were taking place such a relation would not hold. Incidentally, tests show that even with antennas of very low effective height the short-wave measuring set is sufficiently shielded to prevent the induction of appreciable noise at the intermediate frequency.

The frequency characteristic or band width of the receiver, the time constant of the second detector plate circuit, and the response of the meter in this circuit will obviously have an appreciable effect

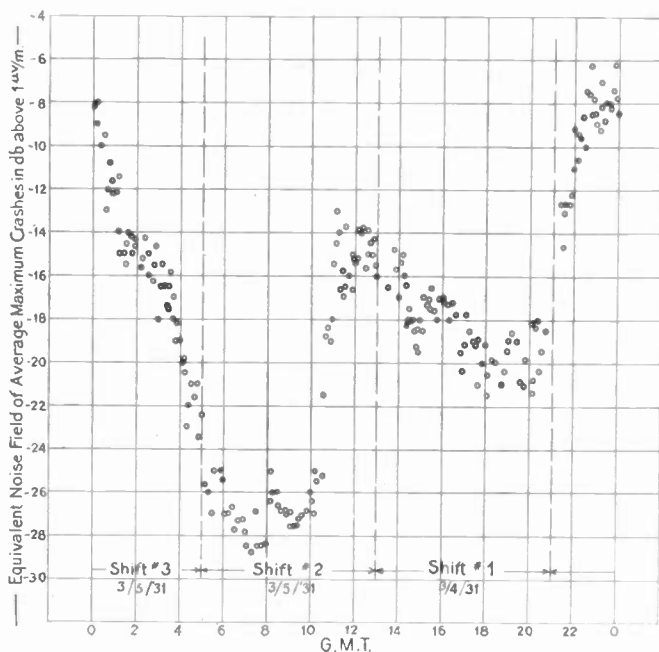

Fig. 1—Representative diurnal distribution of atmospheric noise measurements made at intervals of about five minutes during three eight-hour periods separated by eight-hour intermissions.

upon the measurements. To standardize such a method of noise measurement as has been described, it would, of course, be necessary to agree upon these influencing factors. In fact, the problem is similar to that of standardizing a volume indicator for the measurement of speech peaks.

The duplication of measurement possible by this method of determining the atmospheric noise fields is indicated by the successive values plotted in Fig. 1. In this case, the measurements were made over the usual period of one minute at approximately five-minute intervals. Although the observer was familiar with the use of the field strength measuring set he had had at this time comparatively little experience in the measurement of noise. The only instructions given him were

the simple directions already described. Since the personal factor in these measurements is small, values obtained by any other observer would have been in very close agreement with those shown. The variations of Fig. 1 fall within a band about two decibels wide, and it is not unlikely that the change in noise intensity within this range is to some extent real, for a close examination of the successive measurements often shows what appears to be a more or less regular distribution of the points. Measurements made during the passage of a local electric disturbance almost invariably show a very regular rate of change of the noise fields.

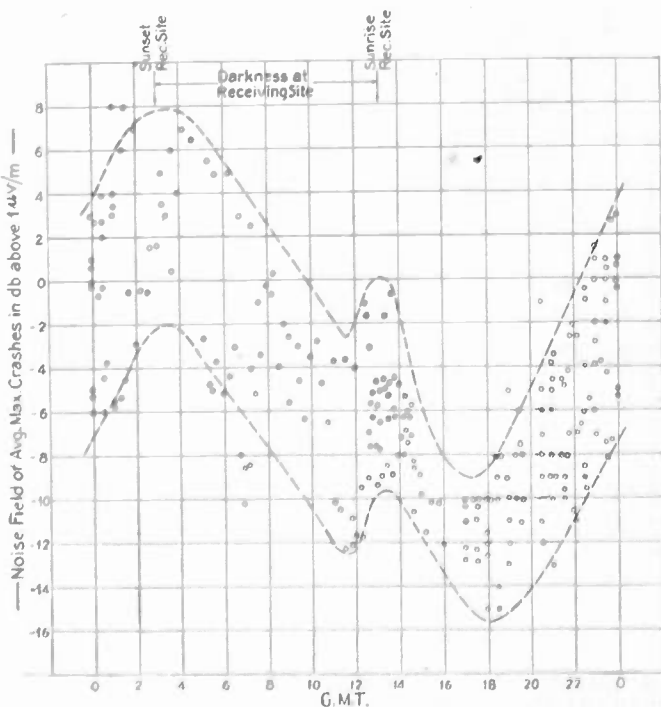

Fig. 2—Mass plot of 10-mc atmospheric noise measurements made at Point Reyes, California, April 7 to 28, 1930.

The change in shape of the diurnal "single frequency" noise characteristic from day to day is comparable to that experienced in the reception of long-range, high-frequency signals. During the summer season of thunderstorms characteristics obtained on successive days show the most appreciable deviation from what might be taken as the normal curve. However, in none of the data obtained thus far has the diurnal trend characteristic of overhead transmission been seriously obscured by atmospherics of local origin. The deviation in measurement values obtained over relatively long periods is shown by the mass plots of Figs. 2 to 5, inclusive. Very often measurements

on successive days will yield characteristics which are, except in small detail, identical. This is illustrated by the characteristic of Fig. 1 which is actually composed of measurements made during three eight-hour shifts separated by intervals of eight hours. There is little indication of discontinuity at the points (shown by vertical broken lines) where the measurement sequence has been interrupted.

MASS PLOTS OF 10-MEGACYCLE ATMOSPHERIC NOISE

In Figs. 2 and 3 are shown mass plots of 10-megacycle atmospheric noise as measured at Point Reyes, California, during April and May of

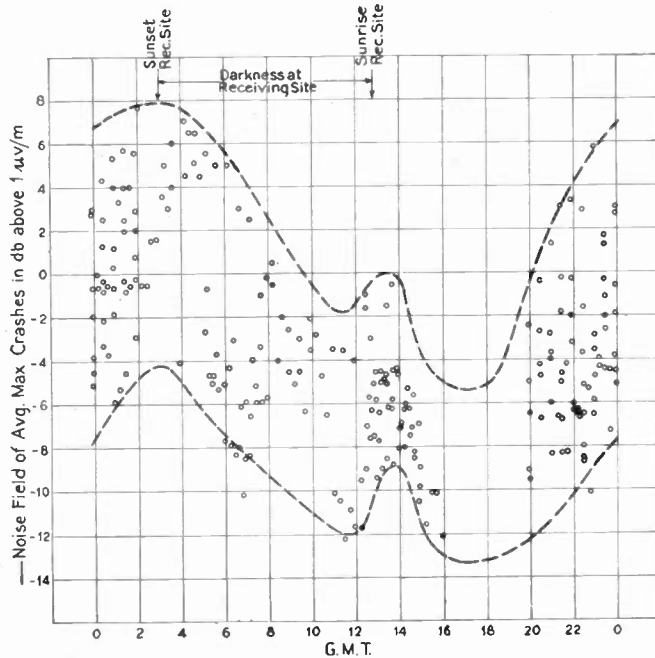

Fig. 3—Mass plot of 10-mc atmospheric noise measurements made at Point Reyes, California, May 5 to 29, 1930.

1930. In general, the 10-megacycle noise values fall within a band which shows an average maximum at about sunset at the receiving point and a minimum during the morning. It will be noticed that at sunrise in the vicinity of the receiver several points appear above the band, and in Fig. 2 there are two points above the band before sunset. The occurrence of this small rise in noise intensity during the sunrise and sunset periods will be discussed later under the section, "Sunrise and Sunset Effects."

Fig. 4 shows a similar mass plot of 10-megacycle noise made near Sacramento, California. The diurnal characteristic is similar to that of Figs. 2 and 3 with the exception that the maximum is broader and extends further beyond the sunset period. Several points appear above

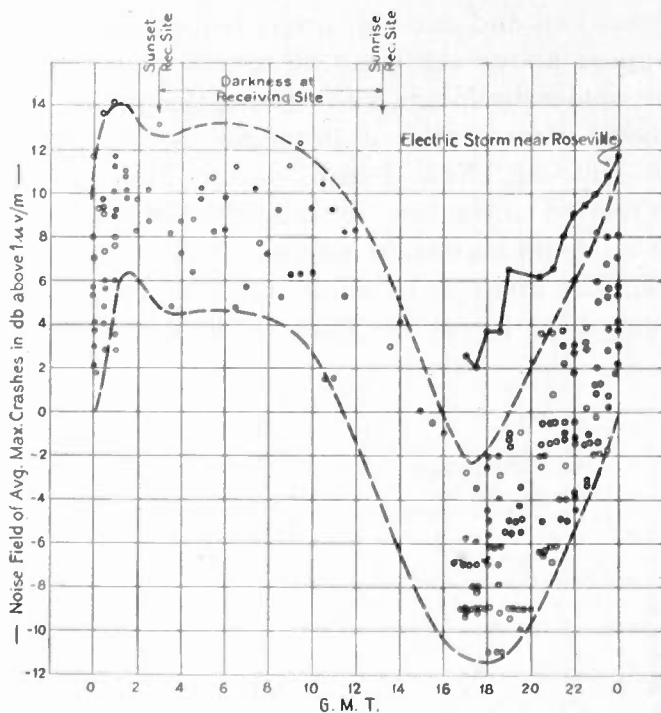

Fig. 4—Mass plot of 10-mc atmospheric noise measurements made near Sacramento, California, April 7 to 28, 1930.

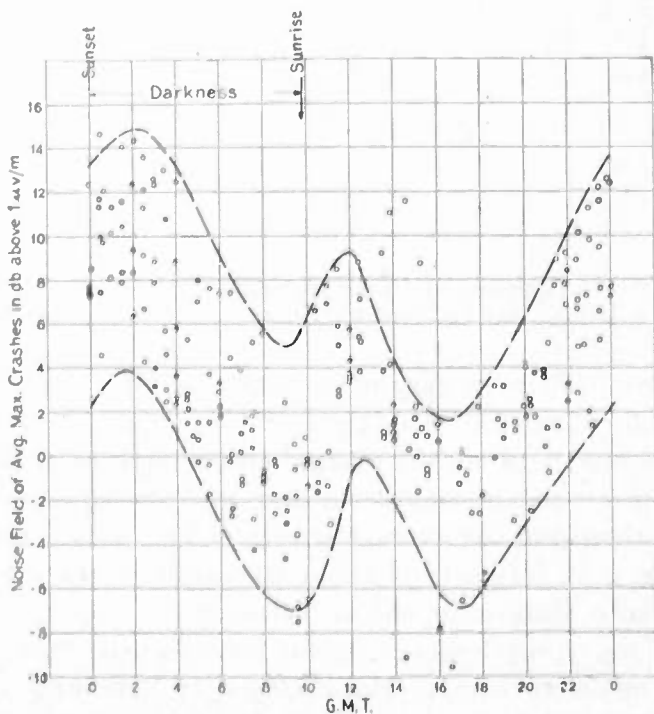

Fig. 5—Mass plot of 10-mc atmospheric noise measurements made at Netcong, New Jersey, May 9 to 19, 1930.

the band about two and one-half hours before sunset. The fact that no points appear above the band at sunrise is probably due to the small number of measurements made during this period.

Fig. 5 shows a mass plot of 10-megacycle atmospheric noise as measured at Netcong, New Jersey, during May, 1930. The band maximum is related to the time of sunset at the receiver in about the same way as the band maximum obtained for the measurements made in California. The increase in noise intensity following the sunrise period is much more prominent than in the measurements made on

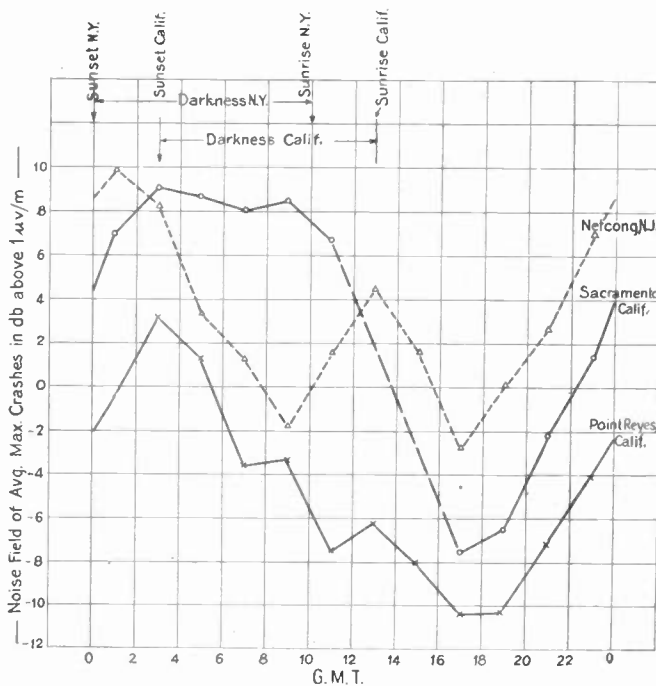

Fig. 6—Comparison of 10-mc atmospheric noise at Netcong, New Jersey, and California. (Note: See Figs. 2, 4, and 5).

the West coast. There is very little indication of a minor noise peak during the time of sunset.

The difference between the diurnal characteristics of the 10-megacycle noise measured in California and at Netcong, New Jersey, is shown more clearly in the average curves of Fig. 6. It is interesting to note that the peak intensity is about the same for the measurements near Sacramento, California, and at Netcong.

In Fig. 7 are shown average curves for measurements of 10-megacycle noise made at Dania, Florida, and at Netcong, New Jersey, between July 15 and September 1, 1930. For the most part these curves agree remarkably both in amplitude and the phase of the diurnal cycle.

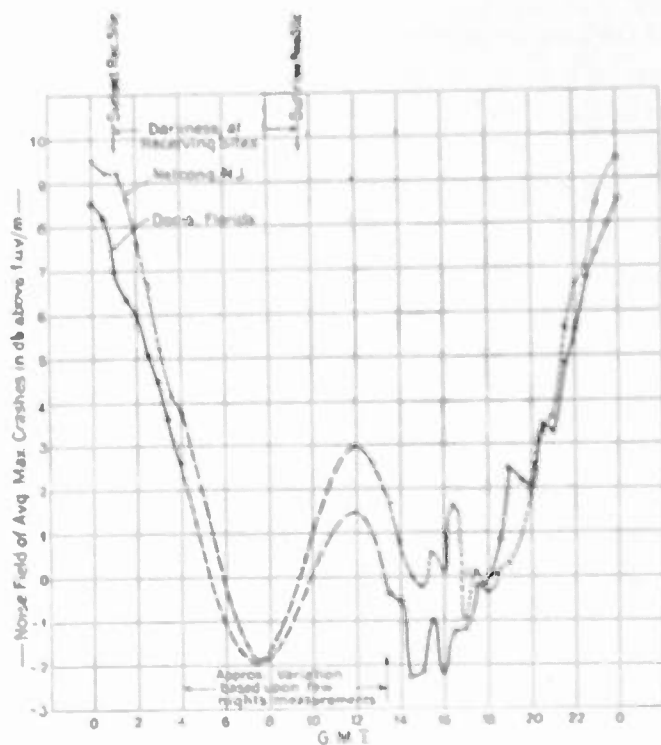

Fig. 7—Average 10-mc atmospheric noise measured at Netcong, New Jersey, and Dania, Florida, July 15 to September 1, 1930.

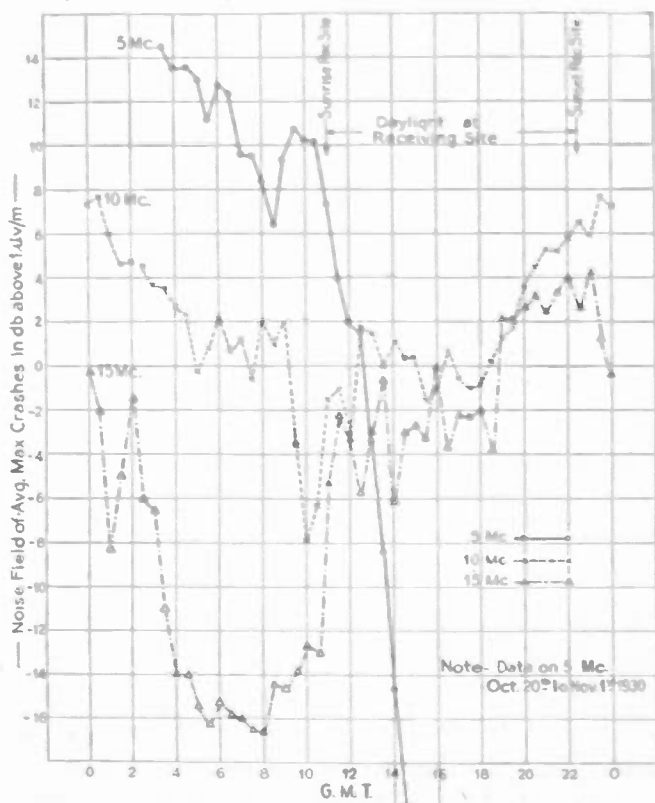

Fig. 8—Average 5, 10, and 15-mc noise measured at Dania, Florida, during October, 1930.

In both cases the major maximum occurs about an hour before sunset. There is a minor maximum about two hours after sunrise. No minor peak appears in the vicinity of the sunset period.

DIURNAL VARIATION OF ATMOSPHERICS ON 5, 10, AND 15 MC

Figs. 8, 9, and 10 are diurnal characteristics of 5-, 10-, and 15-megacycle noise as measured at Dania, Florida, during October, November, and December, 1930. The curves were obtained by averaging data over a period of one month. In all of these figures the 5-

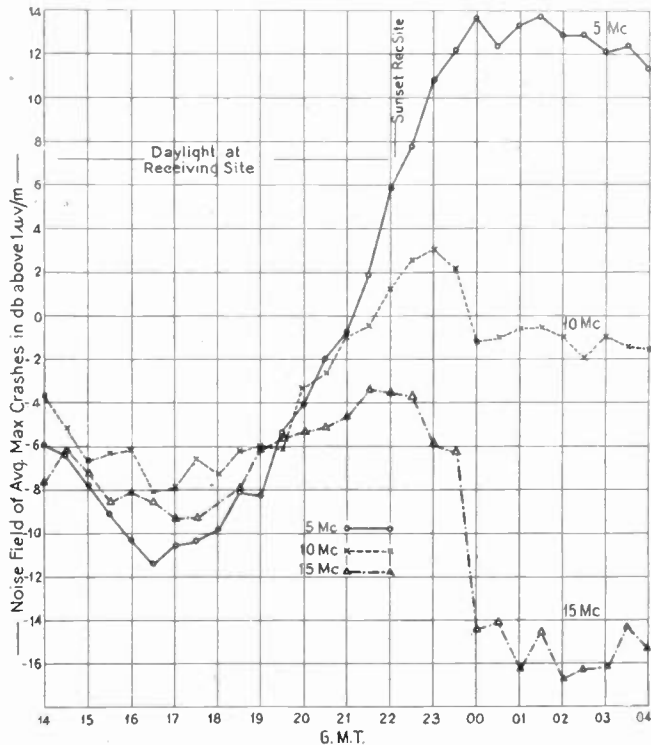

Fig. 9—Average 5, 10, and 15-mc atmospheric noise measured at Dania, Florida, November, 1930.

megacycle noise is much higher during the hours of darkness at the receiver, while the 15-megacycle noise is definitely low at this time. Such characteristics are indicative of long-range transmission, and of more or less centralized sources of atmospheric noise.

In Figs. 11, 12, and 13, are shown the 5-, 10-, 15-megacycle curves of Figs. 8, 9, and 10 grouped according to frequency. There is little change in the shape of the 5-megacycle characteristics of Fig. 11 between October and December. Before sunrise at the receiver there is a minor peak. On 10 megacycles, as shown in Fig. 12, there is a

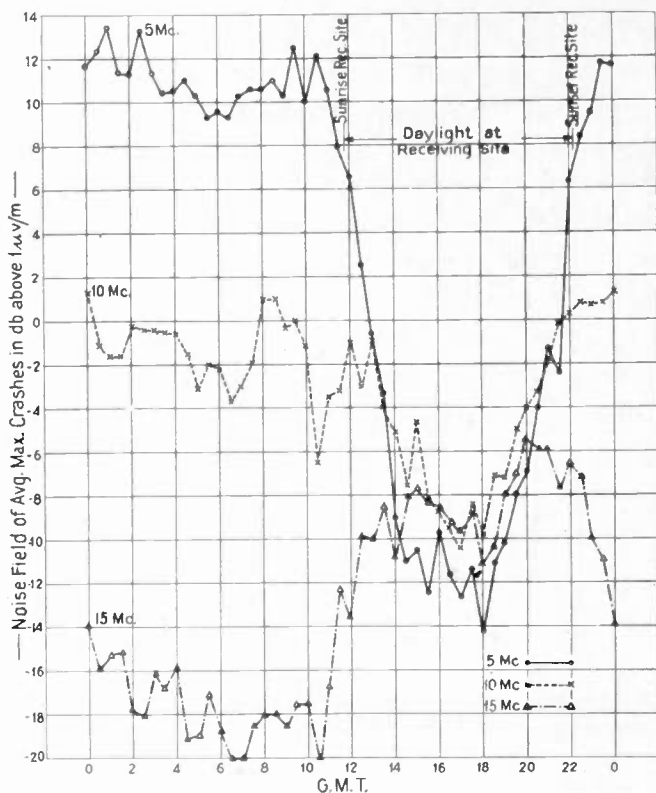

Fig. 10—Average 5-, 10-, and 15-mc atmospheric noise measured at Dania, Florida, December, 1930.

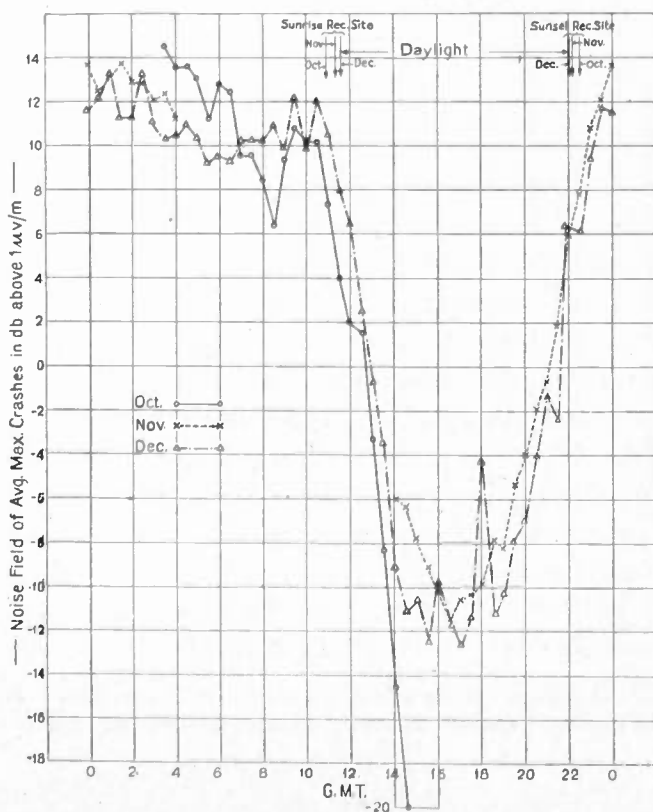

Fig. 11—Average 5-mc atmospheric noise measured at Dania, Florida, October, November, and December, 1930.

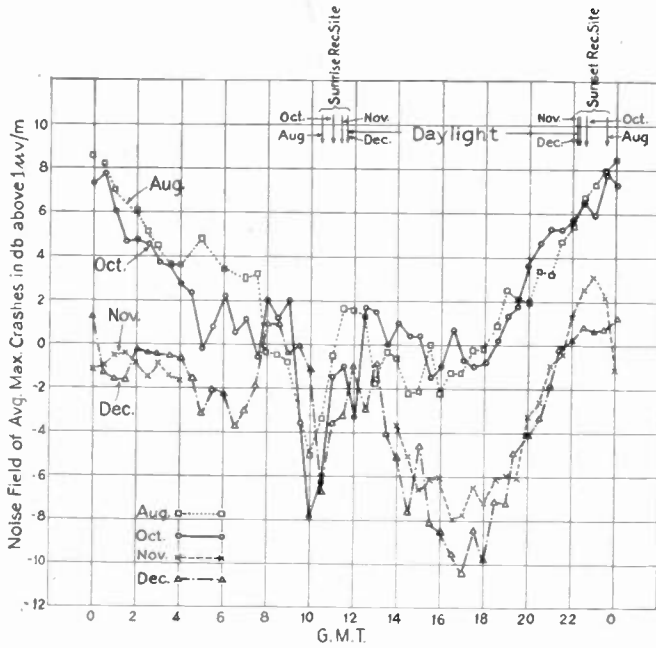

Fig. 12—Average 10-mc atmospheric noise measured at Dania, Florida, August, October, November, and December, 1930.

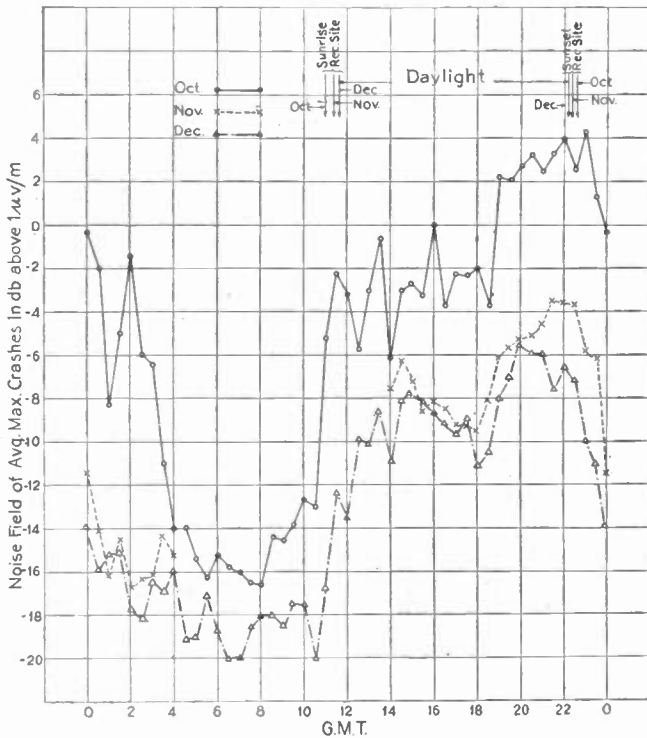

Fig. 13—Average 15-mc atmospheric noise measured at Dania, Florida, October, November, and December, 1930.

noticeable decrease in the winter noise at all times of the day except within a few hours of sunrise. In November and December there is a more pronounced minimum at the middle of the daylight interval. Minor maxima appear two hours or more before sunrise and an hour or two after, with a sharp depression between. There are no outstanding effects in the vicinity of the sunset period. On 15 megacycles the curves of Fig. 13 show a general decrease in noise between October and December. The peaks at time of sunrise are not as definite as those which appear on the three curves about two hours before sunset. During November and December there is a shallow depression around midday which suggests that the transmission on this fre-

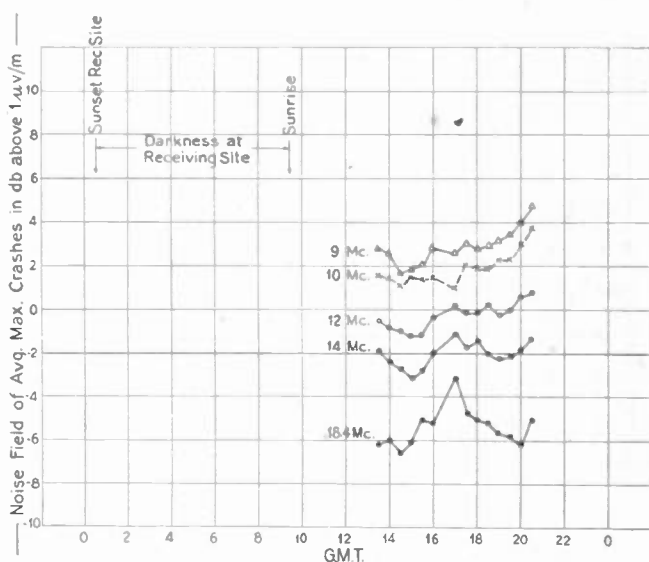

Fig. 14—Incomplete curves of average noise measured at Netcong, New Jersey, June 17–30, 1930, inclusive on 9, 10, 12, 14, and 18.4 mc.

quency is less suited to the transmission range and conditions of overhead ionization than a higher frequency might be.

During June, 1930, some noise measurements were made during the daytime on 9, 10, 12, 14, and 18.4 megacycles. The average curves obtained from these data are shown in Fig. 14. The curves show a more or less regular decrease in average noise intensity with frequency. Since June is one of the months during which local electric storms are known to contribute substantially to the total noise in this vicinity it is not surprising that the curves for the daytime appear in a rather uninteresting relation. Undoubtedly, a complete diurnal characteristic even at this time of year would have shown an increase in the low-frequency and a decrease in the high-frequency noise during the night.

Although simultaneous noise measurements were not made at

Netcong, New Jersey, covering the later months of measurement at Dania, Florida, the few scattered measurements that were made indicate that the average diurnal characteristics of 5, 10, and 15-megacycle noise at the two sites were approximately the same. As an example of some of the occasional measurements made at Netcong, partial diurnal noise characteristics obtained during October, 1930, for 5, 10, and 15 megacycles are shown in Fig. 15. In Fig. 16 are shown

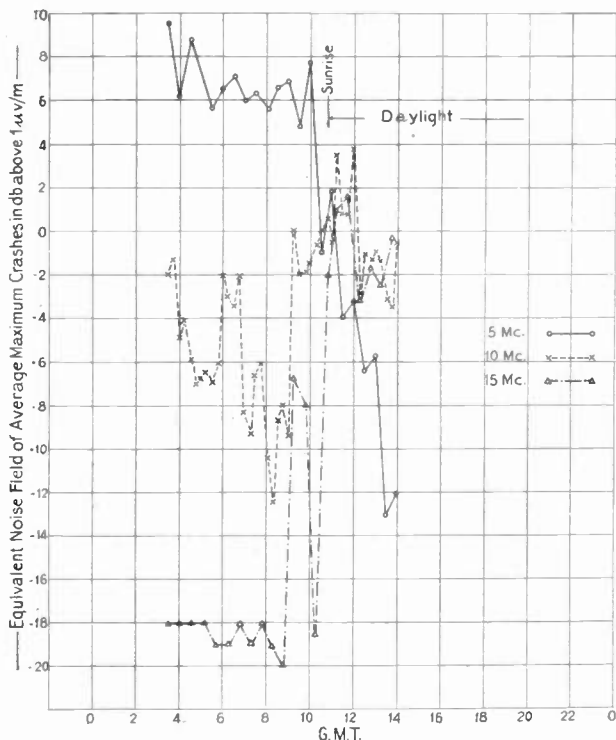

Fig. 15—Average 5, 10, and 15-mc atmospheric noise measured at Netcong, New Jersey, during October 22, 1930.

average 5-, 10-, and 15-megacycle diurnal noise characteristics as obtained from measurements made at Netcong during February and March, 1931. These curves are based upon a much smaller number of measurements than those representing average noise at Dania so that some detail has been sacrificed by averaging the data over two-hour periods. It is apparent, however, that the nighttime dip in the 5-megacycle noise curve of Fig. 15, has been replaced by a peak.

Aside from the many measurements of 10-megacycle noise made in California during the summer of 1930, some daytime measurements were made on 8 and 15 megacycles. An examination of these data shows that on the average the 15-megacycle noise fields were higher during the day and that as evening approached, the trend was

downward. On 8 and 10 megacycles the noise was lower during the day with a well defined rise as evening approached. There is very good reason to believe, therefore, that the usual characteristics of overhead transmission are in evidence during the summer months in California. In Fig. 17 are shown the characteristics of 5-, 10-, and 15-megacycle noise representing the average of data obtained toward

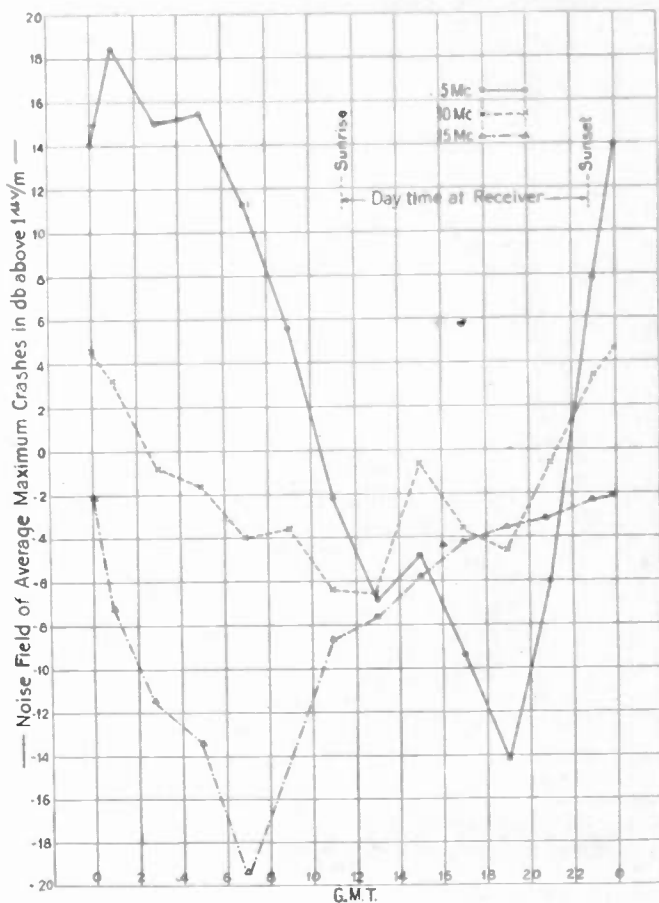

Fig. 16—Average noise on 5, 10, and 15 mc as measured on vertical antenna at Netcong, New Jersey, between February 24 and March 3, 1931.

the end of February and during the first part of March, 1931, at Point Reyes, California. Using the sunrise time at the receiver as a point of reference these characteristics are, in general, similar to those obtained in Florida during the fall and winter. However, the midday depression in both the 10- and 15-megacycle curves is noticeably deeper. It will also be noticed that around the time of sunset all three curves of Fig. 17 rise in about the same proportion indicating rather clearly the effect of local electric storms. These local disturbances are rather common at this time of day.

In Fig. 18 there is illustrated by means of a surface the diurnal variation in nondirectional atmospheric noise intensity for the frequency range between 5 and 18 megacycles. This surface was constructed by interpolation between characteristics obtained on several frequencies at Netcong, New Jersey, and Dania, Florida. Although its shape is based largely upon winter data it is fairly representative of the conditions throughout the year (and apparently in different parts of

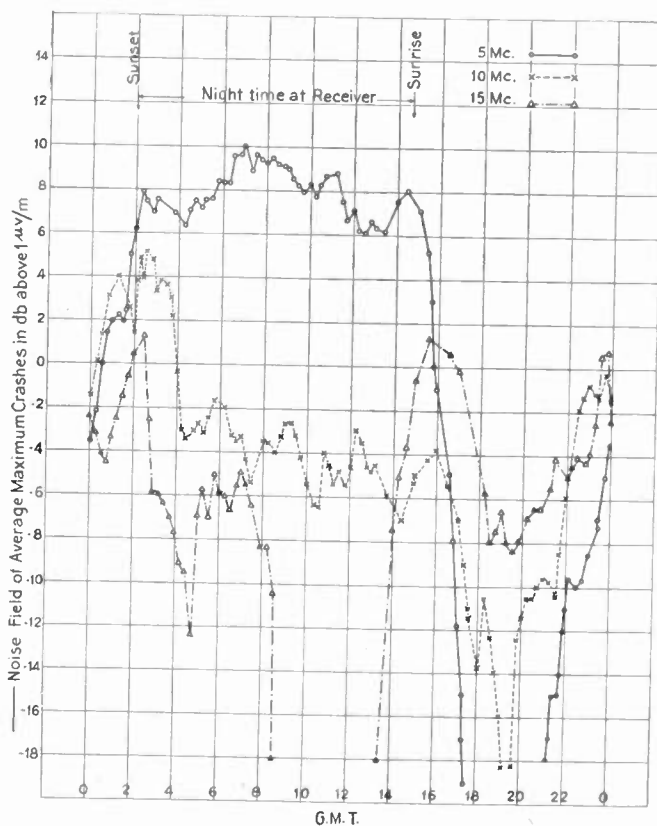

Fig. 17—Average noise on 5, 10, and 15 mc as measured on vertical antenna at Point Reyes, California, between February 25 and March 3, 1931.

the country) when considered in relation to the times of sunrise and sunset at the measurement site. The surface may be subjected to severe temporary distortion during the season when storms are prevalent in the vicinity of the receiver. Even in this season the average noise surface representing conditions over a period of several days will probably correspond approximately to that shown, except in the vicinity of the sunset ordinate. Here a distinct ridge will appear due to the evening storms. This ridge would slope toward the higher frequencies at a rate approaching an inverse frequency relation.

SIMULTANEOUS OBSERVATIONS OF ATMOSPHERICS ON DIFFERENT FREQUENCIES

The results of simultaneous observations made on atmospherics of different frequencies in the short-wave band are worthy of more consideration than can be given them at this time. In general, they substantiate the idea that except during local thunderstorms high-frequency atmospherics are largely received by overhead routes. Observations have been made on two field strength measuring sets tuned to different frequencies. A rather simple and effective way to make a

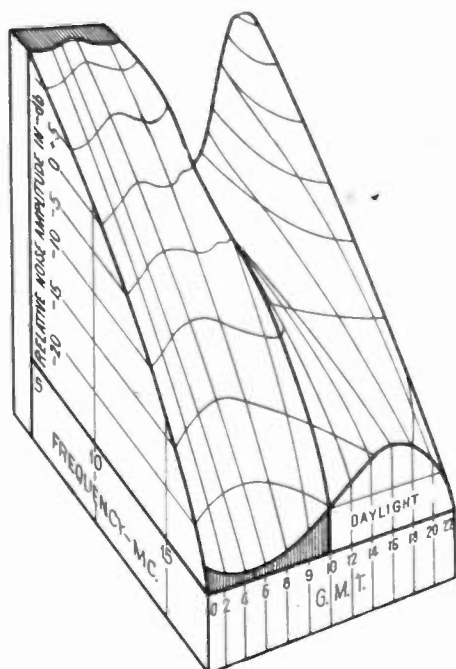

Fig. 18—Interpolated surface showing representative diurnal variation of nondirectional high-frequency atmospheric noise intensity for the short-wave frequency range.

qualitative comparison of this kind is to listen to the crashes in a set of headphones at the output of one receiver while observing the output meter deflections of another. The practice has been to use the headphones on the frequency which gives the lowest amplitude of crashes. By this method it is estimated that the simultaneous occurrence of crashes differing in intensity by as much as 20 or 30 decibels may be easily identified. The observer makes a check in one column for each crash which is seen on the meter and heard simultaneously, and in another a check for each occasion when the crashes are not identical.

During periods of local storm, atmospherics on widely different frequencies occur simultaneously. For example, it appears that simul-

taneous crashes on 2 and 20 megacycles are of local origin. During the winter season when local storms are absent there is very little relation between the atmospherics received on these two frequencies. At such times the percentage simultaneous occurrence of crashes on different frequencies varies, as might be expected, with time of day. There are also irregular variations in the relation which might be accounted for by a change in conditions at the noise sources.

Below are included some sample observations for the purpose of showing the trend in these results rather than to give specific data. In the second and third columns are given the two frequencies upon which the observations were made. In the last is the percentage of crashes that were apparently simultaneous on these two frequencies. It should be recognized that there is some possibility of error in these results due to the fact that even random crashes would occasionally appear to occur simultaneously.

TABLE I

Approximate Time of Observation	Observation Frequency Set No. 1	Observation Frequency Set No. 2	Percentage Simultaneous Crashes
Mid-day	4.5 mc	7.5 mc	100 per cent
"	4.5	10	95
"	4.5	12	35
"	4.5	20	under 5
"	10	10	100
"	10	11	67
"	10	12	58
"	10	15	14
"	10	20	15*
"	15	20	50
Midnight	5	10	47
"	2	5	98

* Note: Simultaneous crashes were of low intensity on both receivers. Strong crashes on one receiver were seldom heard on the other.

The data given above were obtained during the winter. The noise on the higher frequencies at night is so low when local storms are absent that it is difficult to get any very useful information in this range.

While making these observations of simultaneous crash occurrence some curious effects have been noticed. One of these is under certain conditions a distinct difference in the character of the simultaneous transients on different frequencies. A sharp and clearly defined click on the higher frequency is often heard simultaneously at a lower frequency as what might be described as a brief hiss. The transient is drawn out and corresponds to what is sometimes called "mushy static." Possibly this difference is produced by multiple reflections at the lower frequency.

Another possible effect concerning which there is as yet no substantial amount of evidence is that of an occasional appreciable and more or less regular interval between the occurrence of crashes on

different frequencies. To one accustomed to making atmospheric noise measurements the flick of the output meter needle on the receiver comes to bear a definite time and amplitude relation to the sound of the transient in the headphones. When the delay mentioned above occurs, there is a rather disconcerting lack of synchronism between the aural and visual perceptions. It was reported quite independently by two observers, once a short time before noon in a comparison of noise on 10 and 20 megacycles and on another occasion two hours after midnight on 5 and 10 megacycles. If it were not that the apparent delay persisted during several successive crashes it would have been disregarded as an accidental relation. During the day the delay appeared to be on the higher frequency while at night the reverse condition was reported. It is recognized that an apparent delay might be produced by a difference in the characteristics of the noise on the two frequencies as previously explained. Since this effect evidently occurs rather infrequently no serious attempt has as yet been made to obtain oscillographic records in order to study it more closely. The rather meager data concerning cases of its observation are included for the purpose of bringing it to the attention of others who may be interested in the subject of high-frequency atmospherics.

In addition to a very appreciable difference between the intensities of atmospherics received on two rather widely spaced frequencies there is reason to anticipate intensity variations of another character within extremely narrow limits. Thus it might be expected that in receiving high-frequency atmospherics of distant origin the instantaneous intensity or received energy at one frequency would be appreciably different than that received over a band of similar width less than a thousand cycles away. It may be shown by analysis that this would result from the same conditions which produce so-called selective fading in high-frequency signal transmission. To detect inequalities of noise energy within such narrow limits it would be necessary to select for comparison two spaced frequency bands which are only a hundred cycles or so wide. This may be accomplished by beating the noise down to a low frequency with a locally supplied carrier and selecting the bands with properly designed filters. Such a test is contemplated.

SIMULTANEOUS OBSERVATION OF ATMOSPHERICS ON SPACED RECEIVERS

When two receivers are spaced several wavelengths apart and tuned to the same frequency the atmospheric noise peaks always seem to occur simultaneously at the two outputs although there may be a noticeable difference in intensity. On these same spaced receivers a

carrier wave from a distant source fades in such a way that when the signal output of one almost disappears, that from the other may still be high. Since the difference in simultaneous atmospheric noise peaks received at the two points is never as great as that observed in the reception of the carrier it might be inferred that the atmospherics could not be of distant origin.

The reason for this apparent disagreement with other evidence is probably that the fading difference over the range of receiver separation employed is produced by wave interference. Therefore, the selective suppression of a single frequency might be practically complete whereas there would be little relative difference in the average level of a band of frequencies such as is represented by the atmospheric noise peak.

INTENSITY OF GENERATED ATMOSPHERICS VS. FREQUENCY

The intensity of received atmospherics is known to decrease with frequency. The electrical disturbance accompanying a lightning flash is probably in the shape of a steep fronted wave in which the peak is followed by a much less rapid decline. In an idealistic wave of this type the amplitude of the components varies in inverse proportion to the frequency. This suggests that the amplitude of the generated atmospheric noise may vary in the same relation. Under normal conditions this relation would not be expected to hold for received noise since it may be considerably modified by increased ground attenuation with frequency and the increasing importance of the overhead transmission at the higher frequencies. A test of the relation for generated atmospheric noise would have to be made at a time of local electrical storm.³

The variation in amplitude of received atmospheric noise with frequency could only be expected to agree very approximately with this inverse-frequency relation because of the wide variation in transmission conditions over the radio spectrum. To estimate the extent to which such a relation would hold for the noise as ordinarily received the signal field necessary for the same quality of reception on different frequencies might be taken as an indication. In such a comparison it would, of course, be necessary to assume similar transmission and reception conditions on all frequencies (that is, for example, transmission of the carrier and both side bands at the same percentage modulation and reception on a nondirectional antenna). If then noise were the only limitation upon quality of signal, it might be expected that a field of 10 microvolts per meter on a frequency of 20 megacycles would give about

³ Subsequent to the presentation of this paper measurements of noise on 2, 5, 10, and 15 mc during local storms have shown a very close agreement with the inverse frequency relation.

the same quality of circuit as 400 microvolts per meter at 500 kilocycles, or 2000 microvolts per meter at 100 kilocycles. While these values may be reasonable under the assumed conditions it is difficult to check them against experience in the communication and broadcast bands, due to the use of single side-band transmission and directive reception on the long waves and other quality limitations combined with directive reception in the short-wave region.

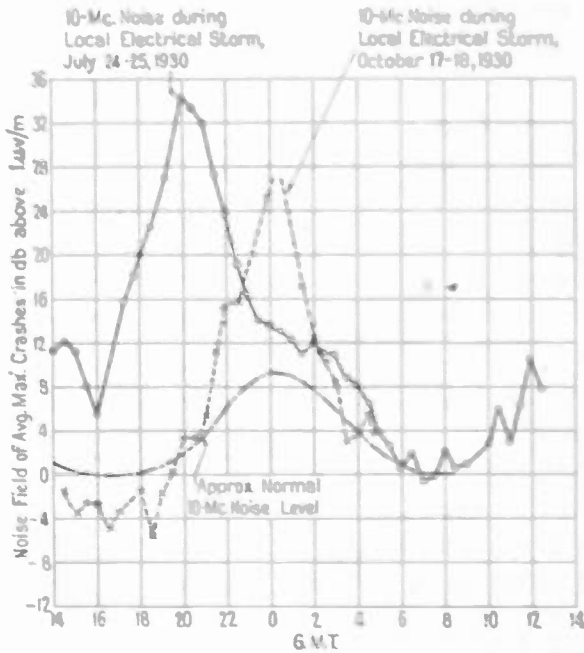

Fig. 19—Variation in 10-mc atmospheric noise during local electric storm at Netcong, New Jersey.

EFFECT OF LOCAL ELECTRIC STORMS

The average diurnal variation in atmospheric noise in the northern hemisphere is undoubtedly most affected by local electric storms during June, July, and August when such storms are most frequent. As these storms approach the point of reception they produce noise which is often a hundred times as intense as that received normally. In Fig. 19 are plotted measurements of noise on 10 megacycles taken during the passage of two local storms. (It is possible, though not evident in the curves, that some overloading may have been taking place in the receiver during the measurement of the higher values.) The two storm curves shown were selected for illustration because in both cases the storm center passed close to the receiving site at Netcong. During both of these storms frequent lightning flashes were visible within a radius of a few miles and thunder was almost continually audible.

The movement of the storms is graphically indicated by the rise and fall in intensity which corresponded roughly with the intensity and frequency of the thunder. In one case the receiver crashes at the peak of the curve were on the average about 30 decibels (or 30 times) the amplitude of the average crashes observed for this time of day and season of the year. If these lightning flashes occurred within a radius of,

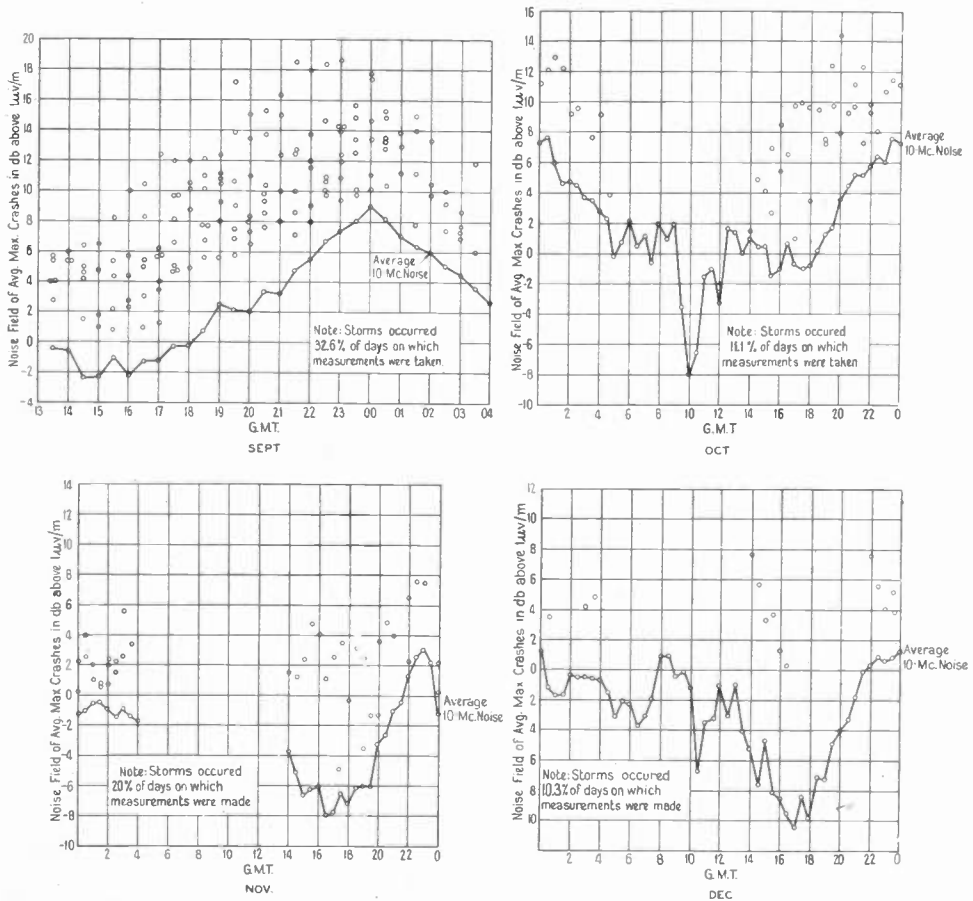

Fig. 20—10-mc atmospheric noise measurements during local thunderstorms at Dania, Florida, December, 1930.

say, two miles from the receiving site, and near the ground, experience with the attenuation of 10-megacycle ground signals suggests that they might be well below the average noise level at a distance of twenty miles. This range will not be materially increased for high-frequency wave trains originating in discharges in the upper cloud levels, for the rate of attenuation would, in this case, probably be determined by something between an inverse-distance and an inverse-distance-squared factor which gives approximately the same result.

This conclusion is also in reasonable agreement with a similar deduction based upon the probable rate of movement of the storm center and the interval occupied by the passage of the storm as shown by the curves of Fig. 19. These data suggest that for frequencies of 10 megacycles or higher the local area contributing to the received atmospheric noise level may be confined largely to a radius of perhaps fifty miles or less. The fact that there have been several cases in which the lightning of an approaching storm was occasionally visible before the noise level became noticeably higher also gives some support to such a conclusion.

The extent to which electric discharges which are visible at the point of measurement contribute to the atmospheric noise level is illustrated by Fig. 20. In this figure are plotted for different months, the measurements of 10-megacycle noise made at Dania, Florida, at times when electrical storms were visible. There is included the average curve to show how the intensity of the crashes originating locally compared with the average noise level. During July, August, and September, 1930, the number of local disturbances is relatively high. Storms occurred in 32.6 per cent of the days during which measurements were being made. The intensity of the local crashes are, on the average, some 10 db above the normal average curve. During the later months the local storms appear to decrease in both frequency and intensity. Following September electrical disturbances of local origin appear to have contributed but a small part of the average measured noise.

EFFECTS ACCOMPANYING SUNRISE AND SUNSET

The occurrence of sunrise and sunset at or between the points of origin and reception of atmospheric noise may result in a minor peak or depression in the average diurnal noise curve. The extent to which the sunrise and sunset effects are evident depends largely upon the relative location of the noise source and point of measurement and the frequency at which the measurements are made.

In Fig. 21 the conditions which are possibly responsible for the sunrise and sunset effects on short-wave noise are illustrated. The noise source and receiving point are shown respectively as "N" and "R". When both these points are in darkness the optimum range at a particular noise frequency may be beyond the receiving point as shown in diagram (A) of Fig. 21. As the sunrise wall approaches the receiving point "R" as shown in (B) of Fig. 21, the angle of incidence at the sunlight boundary is such that the noise is refracted back to the receiving point. As the sunrise progresses beyond "R" as shown under (C) the angle of incidence at the sunlight boundary decreases with the result that the noise is not sufficiently refracted to reach "R". Under (D) the

forward movement of the sunrise shadow has brought enough of the path into daylight so that the noise is again refracted to reach "R." A further increase in the daylight along the transmission path will cause the noise to be refracted to a point which falls short of the receiver, "R," as shown under (E). As a result of the progressive stages between (A) and (E) of Fig. 21 the cycle of amplitude change shown at the top of Fig. 21 is produced.

If the optimum range in the region of darkness is greater than the distance to the receiver, and that in daylight is less than this distance there will result a double peak as is shown at the top of Fig. 21. Such a double peak at sunrise is shown in the 10-megacycle curves for October

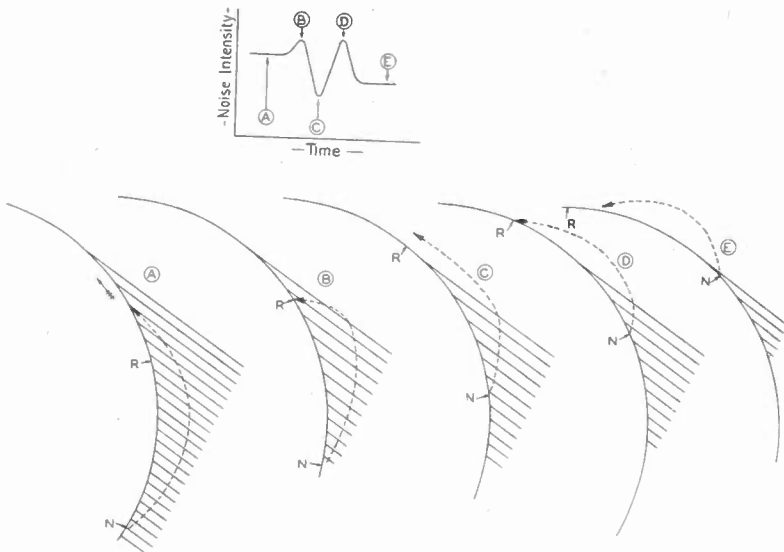

Fig. 21—Illustration of possible transmission path changes producing sunrise and sunset changes in noise intensity.

and December, in Fig. 12. For the condition under which the optimum range in either darkness or daylight corresponds to the range between the noise source and the receiver, only one peak will appear. Such is the case at the time of sunrise in the 5-megacycle curves of Figs. 10 and 17.

For convenience of illustration it has been assumed in explaining the sunrise and sunset effects that the noise came from a definite source. Such is probably only approximately the case during certain times of the year. When the noise comes from more than one direction the effects produced by sunrise or sunset upon the noise intensity as received on a nondirectional antenna become somewhat involved. In any case it might be expected that a change in the direction of arrival of predominate noise would take place. If the noise sources are, for example, both east and west of the reception point the change in pre-

dominate direction of arrival of the noise may be accompanied by a second distinct rise in noise intensity which can hardly be classed as a sunrise effect. Such is probably the condition which is responsible for the wide minor peak following sunrise in the Netcong curve for average 10-megacycle noise as measured during May, 1930. At Netcong the source of atmospheric noise during this time of year is toward both the east and west. At Point Reyes, California, the summer noise was definitely from one general direction—the east. Therefore, there is very little evidence of a wide minor peak following sunrise at Point Reyes in the summer measurements.

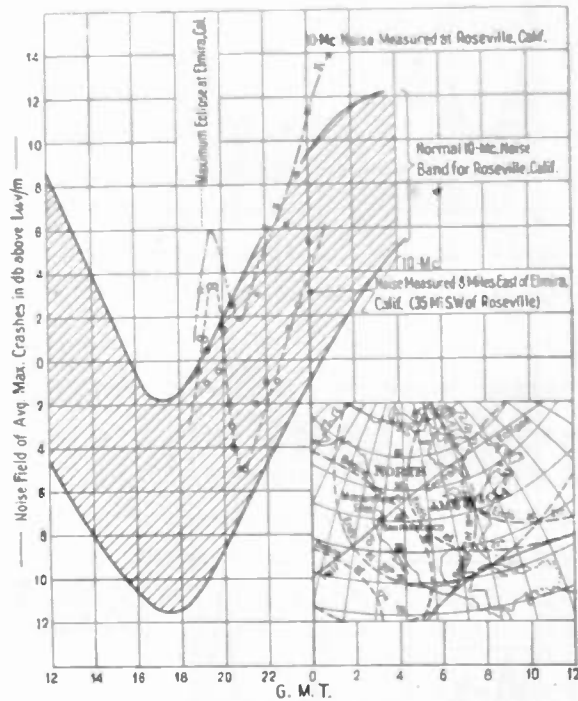

Fig. 22—Effect of solar eclipse on 10-mc atmospheric noise, April 28, 1930.

EFFECTS ACCOMPANYING A SOLAR ECLIPSE

During the eclipse of the sun that cast a shadow path across the continent from the vicinity of San Francisco to the southern end of Hudson Bay on April 28, 1930, measurements of 10-megacycle atmospheric noise were made at two points about thirty-five miles apart along and near the center of the shadow path in the vicinity of Sacramento, California. The insert of Fig. 22 shows the path of the eclipse. In Fig. 22 are also shown graphically the measurements made at the two points. The normal average noise level for this vicinity is represented by the broad shaded band which is taken from the mass plot of Fig. 4. Accompanying the passage of the eclipse shadow there was a

very noticeable rise in the intensity of the atmospheric noise. The maximum occurred some twenty minutes to half an hour after the time of totality. This maximum was followed by a rapid decline until the noise reached the normal level. From this point on the increase in noise intensity followed the normal diurnal variation.

The lag in the occurrence of maximum noise following totality at the receiver suggests that the source of the noise is toward the east. The distance to this source was such that the noise had the characteristics of overhead transmission.

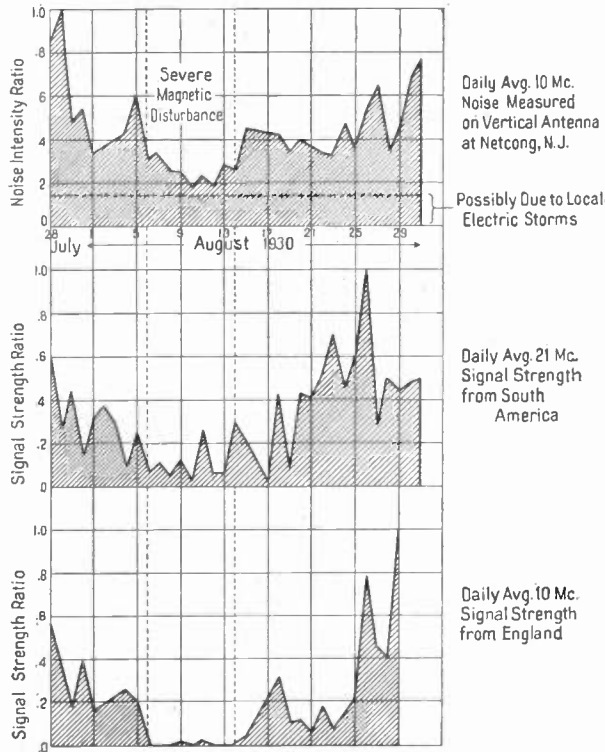

Fig. 23—Effect of disturbance in earth's magnetic field upon intensity of 10-mc noise received on vertical antenna and strength of signals from South America and England.

EFFECTS ACCOMPANYING MAGNETIC DISTURBANCES

During periods when the earth's magnetic field is disturbed there is an appreciable decrease in the intensity of high-frequency atmospherics. In Fig. 23 is shown the relation between the average evening intensity of 10-megacycle noise measured on a nondirectional antenna as compared to the strength of high-frequency signals from South America and England during a period including a rather severe magnetic disturbance. This disturbance occurred between August 5 and

15, 1930. During a good share of this time the signals from England were extremely low. Signals from South America were less affected. As is apparent in Fig. 23, there was a very noticeable decrease in the atmospheric noise. At the time of these measurements local electric storms were relatively frequent. Assuming that these local sources contribute a constant amount of noise such as is indicated by that below the dotted line across the 10-megacycle noise graph of Fig. 23 it is evident that the decrease in intensity of long-range noise due to the magnetic disturbance is quite comparable to the decrease in long-range signal strength. Actually the contribution of local electric storms is not constant; it may easily vary enough from day to day to produce minor irregularities in the noise intensity curve. The data of Fig. 23 support the theory that much of the high-frequency atmospheric noise, even during the season of local electric storms, is of distant origin.

It is very likely that the effect of magnetic disturbances upon noise would be much more evident if noise measurements were made on a directive array receiving over a great circle path at high latitudes. The effect might also be detected as a change in the predominant direction of noise arrival.

PREDOMINANT DIRECTIONS OF NOISE RECEPTION

During the course of a noise measurement program at Point Reyes, California, it was found that an antenna having a directional discrimination of some 4 to 6 decibels regularly indicated that the predominant direction of arrival of 10-megacycle atmospheric noise was from the east. To test this condition further the directive properties of a sea cliff facing the Pacific Ocean toward the west were utilized. A sketch of this cliff is shown in Fig. 24. It was over 100 feet high at the point where the measuring set was located. The set was placed about 10 feet from the practically vertical wall on the sandy beach. Another measuring set was situated about three miles away at the Point Reyes site where the surrounding country was fairly flat. Measurements were made on both sets of signals received from the east and west in the vicinity of 10 megacycles, and of atmospheric noise on 10 megacycles. It was found that signals from the west were received at about the same strength on both sets, while the signals from the east were consistently 15 to 20 decibels lower on the set at the base of the cliff. Throughout the day the 10-megacycle noise was lower on the set beneath the cliff in about the same proportion as were the signals from the east. This provided rather conclusive evidence that most of the noise was coming from the east.

It is of incidental interest that there were no indications of standing

waves produced by reflection from the face of this cliff. This was tested with an oscillator located near the water's edge, and by measuring at short intervals away from the cliff wall. The proximity of the wall had little effect unless the antenna were within two or three feet of the rock. This suggests that such a directive system is practically aperiodic over a wide reception range. When the measuring set was carried out about 100 feet from the cliff both the signals from the east and the noise increased in intensity some six to eight decibels.

The measurements at the base of the sea cliff were made during the first part of May, 1930. On May 28, 1930, through the courtesy of the Radio Corporation engineers, it was possible to make some noise meas-

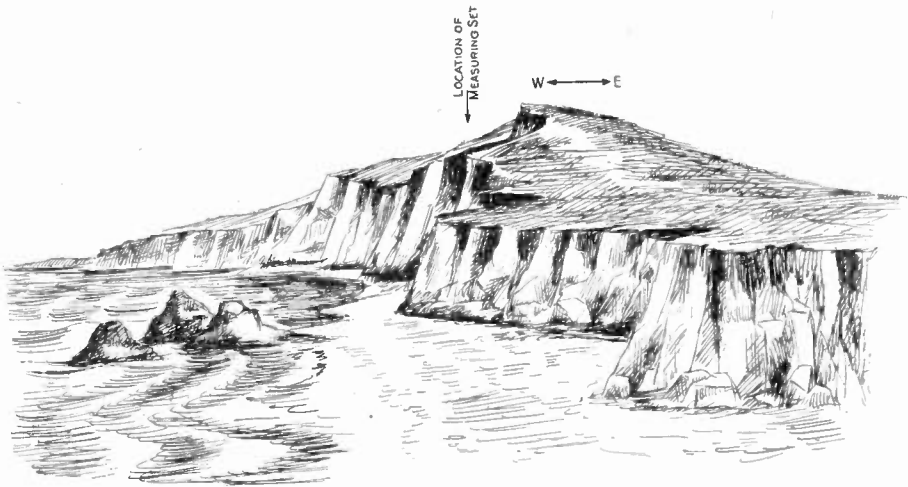

Fig. 24—Sketch of cliff behind which directional noise measurements were made. (North of Point Reyes, California.)

urements on two of their new "fishbone" antennas of the horizontal type located at Point Reyes. These two antennas were of the same design. One was terminated to receive from the east and the other from the west. Noise measurements made at 10 megacycles alternately on the two antennas showed the noise from the east to be on the average 15.5 decibels above that from the west. These measurements were made between 2300 and 0100 G.M.T.

Measurements of atmospheric noise made during May, 1930, in the vicinity of Sacramento, California, with an antenna having a 4- to 6-decibel directional discrimination, showed a maximum on the average toward the east and northeast, but it was much less consistent than on the coast. This suggests that much of the noise measured in California during May was of local origin. Lightning discharges in the mountains between Sacramento and the coast or possibly reflections must have

been responsible for the marked difference in the directional characteristic of noise on the coast and inland.

Noise direction measurements made at Netcong during four days of June, 1930, with an antenna having a directional discrimination similar to the one described above, indicated that the noise direction was quite variable from day to day on 10 megacycles. On June 23, noise from the southeast seemed to predominate to some extent. On June 24, 25, and 26 noise from the west was generally higher by a few decibels.

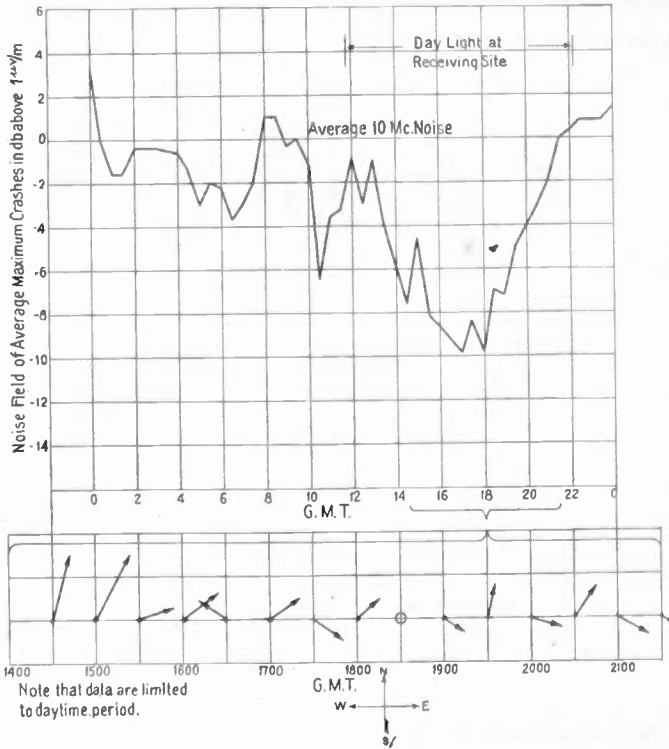

Fig. 25—Vector average of 10-mc directional noise measurements made at Dania, Florida, during 6 days in November and December, 1930.

A series of directional noise measurements on 10 megacycles made at Dania, Florida, during November and December, 1930, gave results that were quite variable due probably to their being made over a period of the day when the noise on this frequency is normally low. In Fig. 25 is shown the average diurnal noise intensity characteristic with the vector resultants of half-hourly measurements made on several days plotted below. During the first hours the directional tendency is toward the northeast. As the time of minimum noise on 10 megacycles approaches the direction becomes less definite. At 1830 G.M.T. the resultant is zero, the noise direction on different days being essentially random. Following this time the directional tendency is toward the

east. It is very likely that directional noise measurements made on 10 megacycles between sunset and sunrise would have shown more definite directions of reception.

The directional measurements of noise described above were limited to specific transmission problems and, therefore, show little more than the possibilities in this field. Interesting and useful data could be obtained by a general study of the diurnal directional characteristics of noise on different high frequencies, and during different seasons of the year. Obviously the directional factor must be included when considering noise in relation to its effect upon signals received with directive antennas.

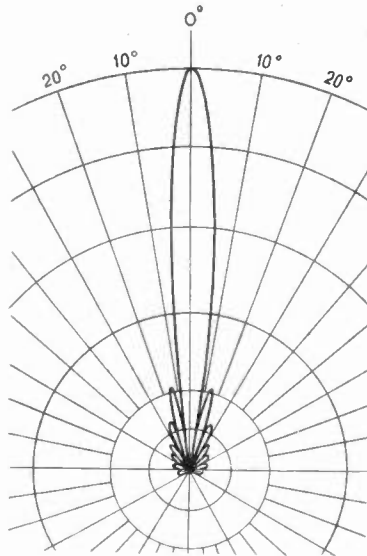

Fig. 26—Theoretical horizontal plane directional diagram of 6λ aperture arrays on which noise measurements were made for comparison with noise received on a half-wave vertical antenna.

MEASUREMENTS OF NOISE RECEIVED ON DIRECTIVE ARRAYS

During February and March, 1931, measurements of noise were made on several of the directive receiving arrays at Netcong, New Jersey. These arrays are used in connection with the high-frequency radiotelephone channels from England and South America. They are six wavelengths long in a direction perpendicular to that of reception and contain two curtains of 24 quarter-wave vertical conductors arranged a quarter wavelength apart.⁴ The theoretical directive pattern of these arrays in the horizontal plane is shown in Fig. 26. Measured

⁴ See G. C. Southworth, "Factors affecting gain of directive antennas," *Proc. I.R.E.*, 18, 1513; September, 1930.

patterns agree reasonably well with the calculated pattern shown except in the detail of minor lobes. The great circle direction from the Netcong site to the transmitters at Rugby, England, is N. $50^{\circ}20'$ E., and the direction to the transmitters near Buenos Aires, South America, is S. $13^{\circ}30'$ E.

In Fig. 27 is shown a series of representative diurnal noise characteristics as measured on several of these arrays. There is an obvious difference in the shape of the curves for noise of approximately the same frequency received in the two directions. The difference is most pro-

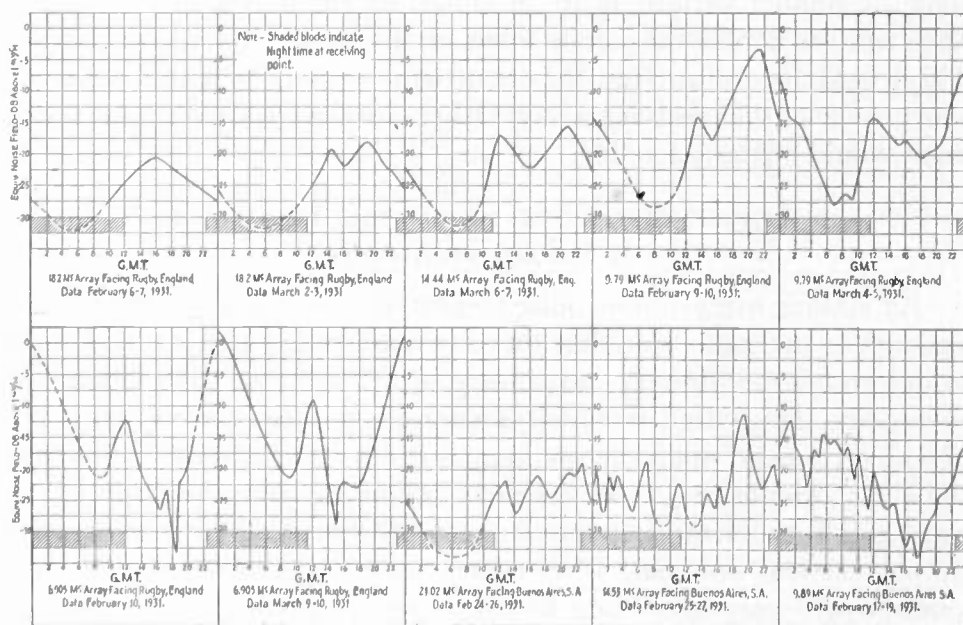

Fig. 27—Same average diurnal characteristics of atmospheric noise measured at Netcong, New Jersey, on 6λ aperture arrays facing Baldock, England, and Buenos Aires, South America, during February and March, 1931.

nounced in the curves for noise frequencies of about 10 megacycles. It is of interest in this connection that the noise measurements on a non-directional antenna show less difference between the night and day values on 10 megacycles than on 5 or 15 megacycles. A comparison of the curves for the 9.79-megacycle array facing England and the 9.89-megacycle array facing South America suggests that between 0400 and 1000 G.M.T. most of the noise on this frequency may be arriving from a southerly direction. From 1400 to 2000 G.M.T. the direction of arrival appears to have shifted toward the northeast. There is some suggestion of a maximum on both characteristics from 2100 to 0100 G.M.T., but the amplitude of the noise received on the array facing England is several decibels higher.

There is also an evident difference in the regularity of the characteristics representing noise received on the arrays facing England and South America. The curves for the measurements on the South American arrays show many minor peaks which appear to be superimposed upon the major variation. The interval between these peaks tends to decrease at the lower frequencies. No very satisfactory explanation of their existence has been formulated. They may be due to the relatively intermittent nature of the electrical disturbances in the direction of South America at this time of year. Another possibility is that the smaller variations are produced by the movement of disturbance centers across the minor lobes of the array directional pattern. This would necessitate that the disturbance centers be within relatively short range of the receiving array. Otherwise the required rate of movement would be unreasonable.

ATMOSPHERIC NOISE REDUCTION ADVANTAGE OF DIRECTIVE ARRAYS

By making atmospheric noise measurements on a vertical reference antenna at the same time that they are made on an array, it is possible to determine the directive advantage of the array in the reduction of such noise. The extent to which the noise is reduced by the array will, of course, depend upon the predominant direction of noise arrival and the array orientation. If all the noise is coming from the direction toward which the array is pointed there will be no advantage over the simple vertical antenna. If it comes from other directions the advantage will vary according to the receptive ability of the array in these directions. Actually the predominant direction of arrival of the noise varies from hour to hour so that as might be expected the noise reduction obtained by the directive reception varies accordingly.

In Fig. 28 are shown the diurnal characteristics of noise received on arrays facing England and South America as compared to similar characteristics for a vertical antenna. The curves representing actual noise fields as obtained on a vertical antenna by methods already described appear at the top of each block of Fig. 28. Drawn to the same scale are the curves for "equivalent noise fields" obtained by measurements on the arrays. These equivalent noise fields are obtained by applying a correction to the measured array noise values equal to the array advantage over the vertical antenna in the reception of a signal in the direction of array orientation. In effect this correction reduces the signal output of the array and vertical antenna to an equal basis so that the difference in the noise fields is a measure of the difference in signal-to-noise ratio. The lower curves in each of the blocks of Fig. 28

show the array advantage. Beneath each block of this figure is given the average array advantage in the reduction of noise for the entire 24-hour period. Since these arrays are only used during particular times of the day when the signal transmission on the frequency for which they are designed is satisfactory, the practical average advantage would be somewhat different than that for the 24-hour period. Accordingly there are included average values for assumed useful periods of the day. During a part of the time that the noise measurements on the array were in progress it was not convenient to make simultaneous

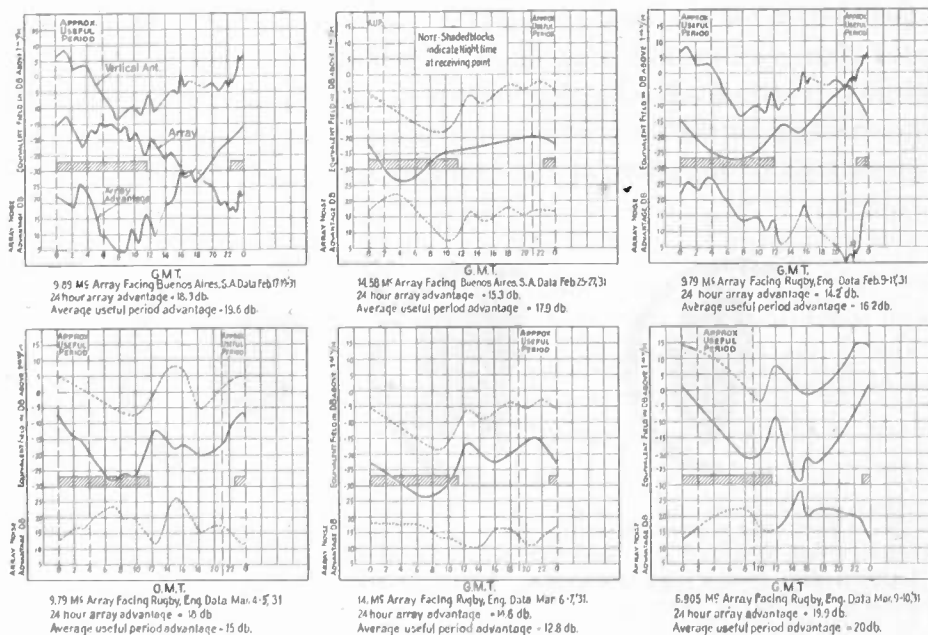

Fig. 28—Diurnal comparison of noise fields measured on a small vertical antenna and equivalent noise fields received on 6λ aperture arrays at Netcong, New Jersey.

measurements on the vertical antenna. The field values for these times were taken from averages for several days preceding and following. The error introduced by this method of comparison is probably small. Where such a method of comparison has been necessary the curves are shown in broken line.

The noise reduction advantage of the arrays on which these measurements were made is some 15 decibels over that of a nondirectional antenna as determined from the directional pattern in the horizontal plane for the condition that the direction of noise reception is random. If the noise were received from a particular direction and this direction were changed regularly and progressively the average noise advantage of the array would still be 15 decibels. The actual change in direction of

arrival of the noise during the course of the measurements illustrated in Fig. 28 seems to have been sufficient to approach this condition of equally distributed direction of noise reception. For all the measurements shown the average noise advantage of the Netcong arrays is 16.4 decibels when compared to the noise received on a nondirectional antenna.

The type of antenna upon which the measurements so far described were made is not as sharply directive in the vertical plane as some of the horizontal types being used in certain of the Bell System radio links.⁵ Although noise measurements of the kind discussed above have not yet been made on these antennas it is expected that they may show diurnal changes in noise advantage quite different from those for the vertical type of directive array and dependent upon the angle of tilt of the vertical directive pattern, the angle of signal arrival, and the range, as well as direction, of the predominant sources of noise.

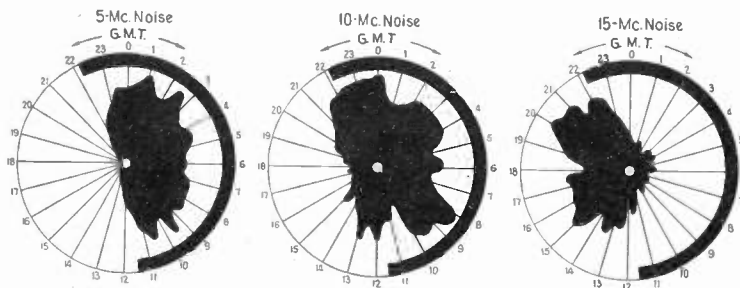

Fig. 29—Clock diagrams showing diurnal variation of atmospheric noise intensity as received on vertical antenna in the southeastern part of the United States during December, 1930. (Note: Shaded arc indicates nighttime at receiving point.)

CENTRALIZED ATMOSPHERIC NOISE SOURCES

Some evidence concerning the source of noise and the character of its transmission is available in a casual study of the average curves shown in Figs. 8 to 17 for noise received on a nondirective vertical antenna. In these curves the noise intensity variations are shown in the logarithmic or decibel relation since in this form the values are more readily adaptable to a practical comparison. If these curves are replotted with ordinates in direct proportion to the noise intensity a symmetry appears which is less apparent in the logarithmic plots. For example, in Fig. 29 are shown the curves of Fig. 10 (noise fields as measured during December, 1930 at Dania, Florida, using a small vertical antenna) replotted on clock diagrams with radii directly proportional

⁵ E. Bruce, "Developments in short-wave directive antennas," *Proc. I. R. E.*, 19, 1406; August, 1931.

to the noise field strength. Because of the considerable decrease in noise fields toward the higher frequencies the three diagrams are drawn to independent scales so that the patterns should not be construed as indicative of relative noise intensity on the different wavelengths.

The patterns for all three frequencies in Fig. 29 display a recognizable symmetry about the time of midday or midnight. This is strongly suggestive of centralized noise sources and long-range or overhead transmission. An approximate symmetry of this kind is characteristic of long-range, point-to-point signal transmission. Unless the transmission frequency happens to be optimum for either extreme of the effective overhead layer position, corresponding roughly to midday and midnight along the transmission path, there will be two points in the diurnal cycle when the maxima will occur. To illustrate, a maximum during the late evening along the transmission path might be expected to reappear during the early morning. That exact symmetry does not exist in most cases may be attributed to the direction of transmission in relation to the sunrise and sunset shadows, and an unsymmetrical rate of change of effective layer height either side of the midday mean. Other factors such as the distribution of sources, and a diurnal change in the intensity of generated atmospherics undoubtedly add to the distortion of these noise intensity patterns shown by the clock diagrams of Fig. 29. The number of peaks which appear on either side of the axes of symmetry in these patterns suggest that several major sources are contributing in varying degree throughout the day. The principal sources during the winter season represented by the diagrams of Fig. 29 are probably situated largely in the region of the tropics and beyond, where land areas have long been recognized as prolific centers of disturbance in the low-frequency band. The diurnal characteristics of the 5, 10, and 15-megacycle atmospheric noise curves are not in disagreement with the idea that these distant sources are responsible for a considerable part of the noise during this time of year.

ACKNOWLEDGMENT

This discussion is based upon the experience accumulated during several thousand noise measurements in which many observers have taken a part. Their coöperation has been appreciated. In particular I wish to acknowledge the assistance of S. S. Ramsay who had charge of the measurement work at Dania and more recently that at Point Reyes, and A. C. Peterson who has aided both in the collection of data and their coördination.

LONG-WAVE RADIO RECEIVING MEASUREMENTS AT THE BUREAU OF STANDARDS IN 1930*

By

L. W. AUSTIN

(Laboratory for Special Radio Transmission Research, Bureau of Standards, Washington, D. C.)

THIS report shows tables of the monthly average field intensities of various long-wave stations, and the corresponding atmospheric disturbances measured in Washington in 1930.

Table I gives the transmission data of the sending stations, from which signals have been received for measurement, as far as they have been reported.

TABLE I

Transmission Data						
Call	Location	Approximate Frequency and Wavelength		Approx. antenna current <i>I</i> amp.	Effective height <i>h</i> (m)	Distance from Washington <i>d</i> (kilometers)
		<i>f</i>	λ			
		kc	m			
FYL*	Bordeaux, France	15.9	18900	500	180	6160
FTT*	Ste. Assise, France	20.8	14400	350	180	6200
DFY*	Nauen, Germany	16.5	18100	400	170	6650
DFW*	Nauen, Germany	23.4	12800	400	130	6650
GBR*	Rugby, England	16.1	18600	700	185	5930
GLC	Carnarvon, Wales	31.6	9500	300	67	5840
IRB	Rome, Italy	20.8	14400	500	156	7160
PCG	Kootwijk, Holland	16.8	17800	325	156	6100
WII*	New Brunswick, N. J.	21.8	13750	650	68	281
WRT*	New Brunswick, N. J.	22.6	13265	630	68	281
WCI*	Tuckerton, N. J.	18.4	16300	900	96	251
WGG*	Tuckerton, N. J.	22.1	13573	690	57	251
WQK*	Rocky Point, N. Y.	18.2	16465	500	83	435
WSS*	Rocky Point N. Y.	18.8	15960	700	83	435
WSO*	Marion, Mass.	25.8	11620	500	66	660

* Antenna currents reported.

Tables II, III, and IV give the monthly average signal intensities of European stations. The signals marked A.M. are measured between 10 and 11 A.M., E.S.T., and represent in general all-daylight transmission paths, while the P.M. signals measured between 3 and 4 P.M., E.S.T., have paths lying partly in darkness.¹ Table V gives signal intensities at the Bureau of Standards from some of the American stations of the R. C. A. situated in New Jersey, on Long Island, and in Massachusetts.

Fig. 1 shows two typical recorder curves of the Tuckerton station WCI, one taken in Durham, N. C., by courtesy of Professor C. W. Edwards of Duke University, and the corresponding curve taken in

* Decimal classification: R113. Original manuscript received by the Institute, June 24, 1931. Publication approved by the Director of the Bureau of Standards of the U. S. Department of Commerce.

¹ See Proc. I.R.E., 18, 1481, 1930.

TABLE II
MONTHLY AVERAGE SIGNAL INTENSITY AND ATMOSPHERIC DISTURBANCES FOR BORDEAUX (FYL),
RUGBY (GBR), NAUEN (DFY), AND KOOTWIJK (PCG)
In Microvolts per Meter

Month 1930	10 A.M., E.S.T.					3 P.M., E.S.T.				
	FYL	GBR	DFY	PCG	Dist. 15 kc	FYL	GBR	DFY	PCG	Dist. 15 kc
Jan.	132	103	51	53	17	174	163	53	67	19
Feb.	126	111	54	45	13	173	154	67	64	18
Mar.	152	150	64	51	15	168	185	85	72	23
Apr.	184	187	78	62	18	178	188	86	70	61
May	156	148	70	44	20	150	152	61	41*	66
June	145	118*	71	50	50	117	120*	60*	43*	88
July	152	163*	75	70	89	80	80*	—	—	301
Aug.	197*	200	114	87	68	91*	132	—	43*	485
Sept.	160	148	75	63	70	105	107	63*	—	455
Oct.	204	197	109	105	40	206	207	103	92	71
Nov.	138	114	68	64*	29	188	157	82	80	48
Dec.	213	189	102	84*	19	228	226	123	100	27
Av.	163	152	78	65	37	155	156	78	67	138

* Less than ten observations.

TABLE III
MONTHLY AVERAGE SIGNAL INTENSITY AND ATMOSPHERIC DISTURBANCES FOR ROME (IRB),
STE. ASSISE (FTT), AND NAUEN (DFW)
In Microvolts per Meter

Month 1930	10 A.M., E.S.T.				3 P.M., E.S.T.			
	IRB	FTT	DFW	Dist. 23 kc	IRB	FTT	DFW	Dist. 23 kc
Jan.	39	32	33	14	56	42	46	14
Feb.	46	37	30	11	62	40*	45	14
Mar.	50	47	42	13	66	61	54	19
Apr.	73	54	52	15	76	53*	55	43
May	63	50*	44	15	61	39*	42	47
June	68	55	55	43	53	36*	34	87
July	75	65	58	71	—	—	—	237
Aug.	118	77	100	58	—	—	—	483
Sept.	74	61	63	66	—	—	—	447
Oct.	82	69	73	31	76	62	60	57
Nov.	42	49	41	24	59	49	46	44
Dec.	70	68	58	16	98	82	72	25
Av.	67	55	54	31	67	52	50	126

* Less than ten observations.

TABLE IV
MONTHLY AVERAGE SIGNAL INTENSITY AND ATMOSPHERIC DISTURBANCES
FOR CARNARVON (GLC)
In Microvolts per Meter

Month 1930	10 A.M., E.S.T.		3 P.M., E.S.T.	
	GLC	Dist. 33 kc	GLC	Dist. 33 kc
Jan.	17	13	18	13
Feb.	15	11	21*	14
Mar.	—	13	—	17
Apr.	—	15	—	43
May	—	13	—	38
June	—	33	—	59
July	—	35	—	193
Aug.	—	—	—	—
Sept.	13	44	—	—
Oct.	24	21	27*	37
Nov.	13	17	12	30
Dec.	16	13	18	19
Av.	16	23	19	46

* Less than ten observations.

TABLE V
MONTHLY AVERAGE SIGNAL INTENSITY FOR NEW BRUNSWICK, N. J. (WII AND WRT), TUCKERTON, N. J. (WGG AND WCI), ROCKY POINT, L. I. (WSS AND WQK), AND MARION, MASS. (WSO)
In Millivolts per Meter

Month 1930	10 A.M., E.S.T.							3 P.M., E.S.T.						
	WII	WRT	WGG	WCI	WSS	WQK	WSO	WII	WRT	WGG	WCI	WSS	WQK	WSO
Jan.	1.4	1.5	1.8	3.3	1.7*	1.4	0.7*	1.6	1.8	2.3	3.7	1.9*	1.6	0.9*
Feb.	1.1	1.2	1.7	2.4	1.1	1.3	—	1.3	1.4	1.9	3.1	1.2	1.6	0.7*
Mar.	1.4	1.5	1.9	2.6	1.4	1.4	0.7	1.7	1.9	2.3	3.1	1.7	1.7	0.9
Apr.	1.7	1.8	2.4	3.1	1.9	—	0.7	2.0	2.2	2.6	3.9	2.3	—	0.9
May	1.7	1.8	2.1	3.6	1.8*	1.9	0.7	1.9	2.1	2.6	3.8	2.3*	2.3	0.7
June	1.4	1.8	2.2	3.2	—	1.7	0.7	1.6	2.0*	2.3*	3.6	—	2.3*	—
July	2.1	2.1	2.4*	3.2	2.4	1.6	0.9*	1.9*	1.9*	—	3.4	2.4*	1.8*	0.8*
Aug.	2.3	3.2	—	3.3	—	—	—	2.8	3.0	—	3.4	—	—	—
Sept.	1.7	2.0	—	2.9	1.5*	1.1	—	—	2.0	—	3.2	—	—	—
Oct.	3.0	3.0	3.4*	4.1	2.2	1.8	—	2.8	3.0	3.9*	4.2	2.0	1.6	—
Nov.	—	3.5	—	4.7	2.2	1.7	—	2.9	2.7	—	4.4	2.0*	1.5	—
Dec.	4.2	5.0	5.4*	6.1	3.2	—	—	4.3	4.5	5.1	6.0	2.8*	—	—
Av.	2.0	2.4	2.6	3.5	1.9	1.5	0.7	2.3	2.4	2.9	3.8	2.1	1.8	0.8

* Less than ten observations.

Washington. The Durham curve, by its greater freedom from the fluctuations due to interference between the ground and sky wave, shows the diminution in strength of the ground wave, as compared with Washington. It is hoped that signals recorded in Durham will give a

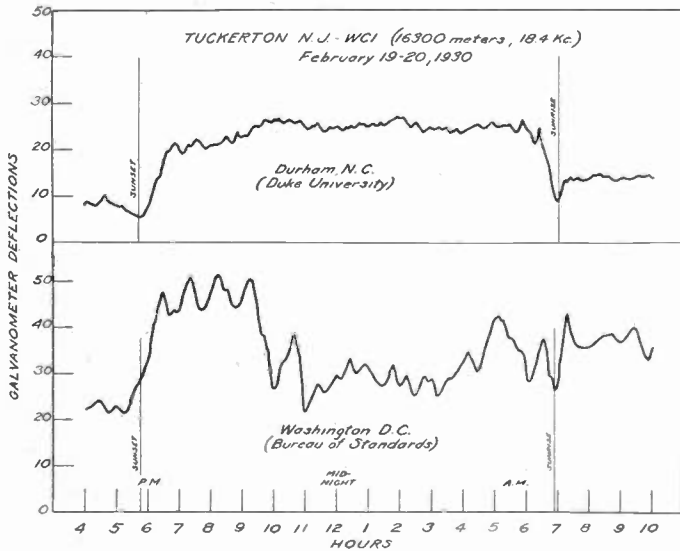

Fig. 1—Continuous record of signals from Tuckerton, (WCI), observed at Washington, D. C. (Bureau of Standards) and Durham, N. C. (Duke University). Distance of Tuckerton from Washington 251 km; from Durham, N. C. 584 km.

better means of study of the upper air conditions than is possible in Washington.

One of the chief objects of all these signal measurements is the study of the relations between radio wave propagation and other natural phenomena, especially solar activity and its connected phenom-

ena, terrestrial magnetic variations, earth currents and auroras. The present sun spot cycle is now drawing toward its minimum and signal measurements have been continued over a sufficient number of years so that it is now becoming possible to estimate a little more clearly than heretofore the probable degree of correlation between wave propagation and these phenomena.

Fig. 2 shows the annual averages of the 3 p.m. atmospheric disturbances measured in Washington at 12,500 meters wavelength, as

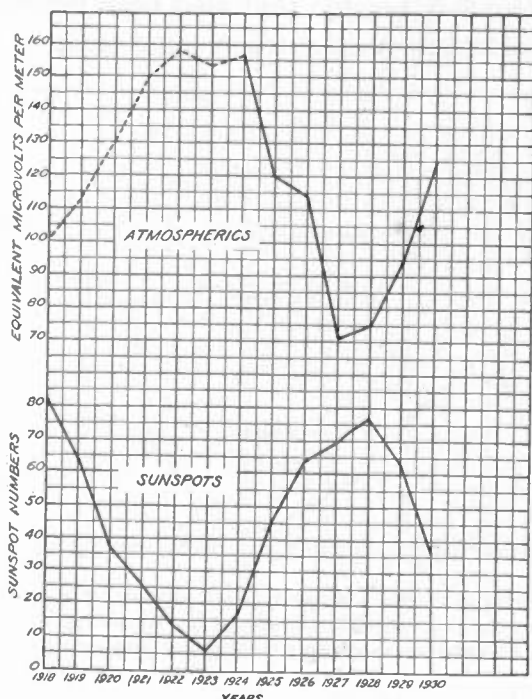

Fig. 2—Annual averages of atmospheric disturbances (12,500 meters wavelengths) at Washington 3 p.m., E.S.T.; and sun spot numbers from 1918 to 1930 inclusive.

compared with sun spot numbers from 1918 to 1930, inclusive. The dotted part of the disturbance curve was measured less accurately than the part represented by the solid line. The inverse relationship between the two curves is very striking. It must be remembered, however, that this applies only to daylight long-wave atmospherics; it is quite possible that the night correlation and short-wave correlation may be entirely different.

Fig. 3 shows the yearly daylight sun spot averages, 1915–1930. The signal measurements were taken at the Bureau of Standards, 1915–1923, on the 12,500-meter station at Nauen only. From 1924 the curve is made up from observations on several European stations of wavelengths between 12,000 and 20,000 meters. The observations before

1922 are less accurate than those in the later years. It will be noticed that the two curves follow each other in general, fairly well through 1929. In 1930, however, the signal curve suggests that some new influence has appeared which is increasing the strength of signals quite independently of solar activity.

The peculiarities of radio transmission in 1930 demand special consideration. Some time in March, the long-wave daylight transatlantic signals in Washington began to rise, and during the summer reached greater average monthly heights than had been before measured. The maximum was reached in August when some of the stations showed a

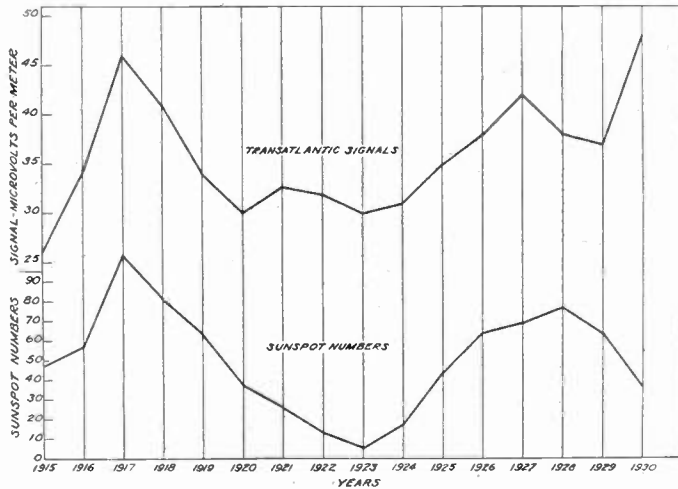

Fig. 3—Annual daylight signal averages from several European stations (12,000 to 19,000 meters wavelength) measured at Washington from 1915 to 1930, inclusive, with the corresponding averages of sun spot numbers.

monthly average nearly three times that of the corresponding month in 1929. Fig. 4 shows the monthly averages of several of the stations for the years 1929 and 1930, and illustrates the striking difference between the two years in long-wave propagation conditions. While daylight long-wave signals across the North Atlantic were so strong, A. H. Taylor reports that during the summer of 1930, short waves, below 20 meters, were on an average weaker than usual. In the intermediate and broadcast ranges of wavelength, nothing unusual has been observed in radio transmission.

The close of 1929 and all of 1930 has been a peculiar period, (see Fig. 6) in solar activity, in magnetic disturbances, and also in weather. December, 1929, showed the highest monthly average of sun spots of the present cycle, although the sun spot curve was past its maximum and well started in its descent toward its minimum. Early in the year the magnetic activity as measured by the magnetic character of days

observed at Cheltenham, Maryland, began to rise and continued high until the middle of the summer. The summer of 1930 also saw unusual weather conditions in the United States and in Central Europe.

It is impossible to say with our present knowledge whether these various phenomena are connected. The rise in magnetic activity in February and March was accompanied by decreasing sun spot numbers and it may seem improbable that it was connected with the ex-

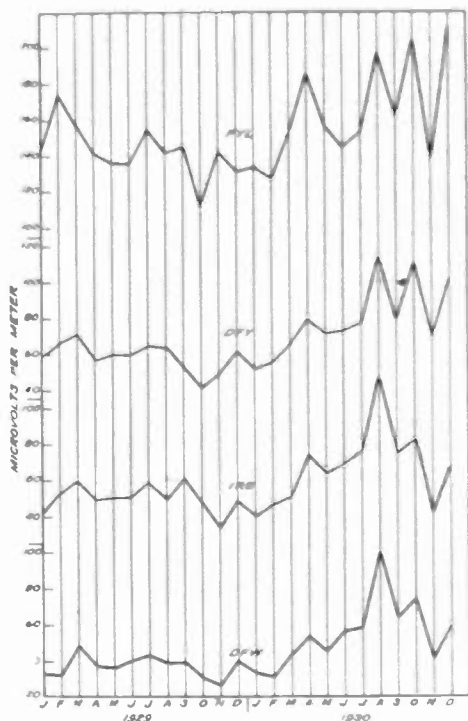

Fig. 4—Monthly daylight signal averages of Bordeaux (FYL), (18,900 meters); Nauen (DFY), (18,100 meters); Rome (IRB), (14,400 meters); and Nauen (DFW), (12,800 meters), measured at Washington from 1929 to 1930, inclusive.

tremely high solar activity of December, although similar cases of apparently delayed solar effects have been observed. The magnetic activity appeared to coincide roughly with the weakness of the transatlantic short-wave signals and the increase in intensity of the long-wave signals during the summer. The long-wave signals have, however, continued unusually strong after the magnetic activity returned to normal, and even now, in April 1931, are much stronger than in the same month in 1929. The unexplained strength of the long-wave signals at the Bureau of Standards has of course given rise to the suspicion that some changes may have taken place in the sensitiveness of the receiving set or in some of the other receiving conditions. Careful investigation has, however, failed to disclose any such changes.

Examination of Figs. 4 and 5 shows, that while the signal curves of both the European stations and the nearer American stations rose to unusual heights during the year, the increase in the signal strength of the American stations came much later, so it is difficult to imagine that

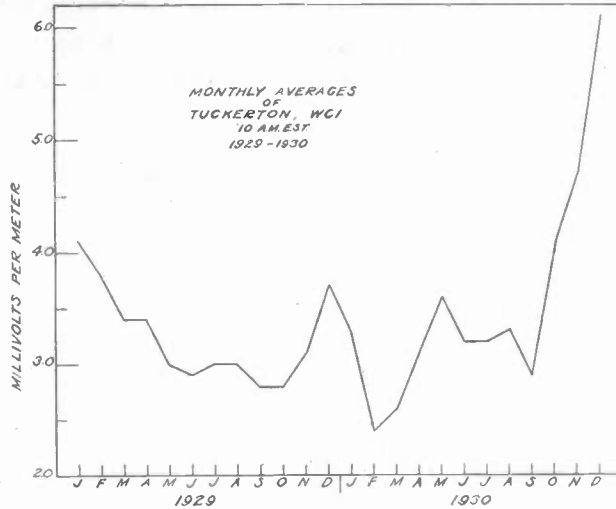

Fig. 5—Monthly A.M. signal averages of Tuckerton, N. J. (WCI) measured at Washington from 1929 to 1930, inclusive.

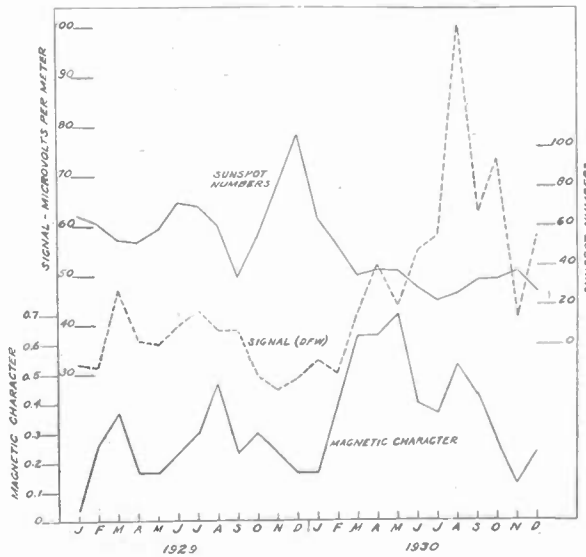

Fig. 6—Monthly daylight signal averages of Nauen, (DFW), (12,800 meters) measured at Washington with the monthly averages of sun spot numbers and magnetic character of days for 1929 and 1930.

the apparent signal changes are due to local conditions at the receiving station. Nevertheless, the changes in 1930 were so unusual that it must be considered an unfortunate circumstance that no other measurements on extremely long-wave European signals were made in the northeastern United States to corroborate those made at the Bureau of Standards.

DEVELOPMENT OF DIRECTIVE TRANSMITTING ANTENNAS BY R.C.A. COMMUNICATIONS, INC.*

BY

P. S. CARTER, C. W. HANSELL, AND N. E. LINDENBLAD

(R.C.A. Communications, Inc., Rocky Point, N. Y.)

Summary—Progressive stages in the development of short-wave directive antennas for long-distance communication are outlined. The scope of development described embraces the period from 1923, beginning with experiments on a transmitting wave antenna at Belfast, Maine, to the present commercial directive antennas used in the world-wide short-wave system of R.C.A. Communications, Inc.

Various types of directive antennas are theoretically analyzed and their performances under practical conditions studied. The effects of seasonal variations, heights above ground and polarization are considered. The radiation properties of simple wires and the radiation patterns of various combinations of wires are described in detail.

The economic aspects of these directive antennas as exemplified by the standard antenna models A, B, C, and D are developed.

INTRODUCTION

ACTIVE work on the development of directive transmitting antennas was begun by the engineers of the Radio Corporation of America¹ in 1923, at which time it was becoming apparent that wavelengths² of less than 200 meters might have important applications in radio communications. The application of these short wavelengths made it possible to deliver given amounts of signal power to distant receiving stations more economically by using directive antennas.

In setting out to develop directive transmitting antennas we had an ideal in performance to strive for represented by the wave antenna developed for long-wave reception by Beverage, Rice, and Kellogg.³ This antenna, in addition to being very directional, is simple in structure and is substantially aperiodic. A single structure may be used for operation over a wide range of wavelength without any tuning adjustments.

EARLY WAVE ANTENNA EXPERIMENTS

Due to realization of the great advantages of the wave antenna for reception it was natural to choose it for the first directive transmitting

* Decimal classification: R125. Original manuscript received by the Institute, March 19, 1931. Presented before Sixth Annual Convention of the Institute, June 6, 1931, Chicago, Illinois.

¹ The group of engineers whose work is related in this paper are now in R.C.A. Communications, Inc., a subsidiary of the Radio Corporation of America, under C. H. Taylor, vice president, engineering.

² Wavelengths are used in this paper instead of frequency because of the close relation between wavelength and the factors affecting the design and explanation of directive antennas.

³ "The Wave Antenna" by Beverage, Rice, and Kellogg, *Trans. A.I.E.E.*, 42, 258 et. seq., March, April, and May, 1923.

antenna experiments. On September 16, 1923, Beverage, Dean, and Hansell at Belfast, Maine, transmitted alternately with a plain antenna and a wave antenna while Peterson at Riverhead, Long Island, measured the strength of received signal.

The wave antenna used in these tests was three wavelengths long and was terminated at the distant end in a resistance equal to the characteristic impedance. A wavelength of 1650 meters was used.

Considering the current flowing in the input end of the wave antenna the apparent effective height, as determined by the signal measured at Riverhead, was more than twenty times the actual height of the antenna wires. This indicated considerable directivity.

The signal from the wave antenna was only about a quarter of that from the plain antenna, for approximately equal power, indicating low radiation efficiency. Still this first result seemed promising and a considerable amount of time was spent by Hansell, during the first half of 1924, at Belfast in studying the wave antenna for transmission.

The observations and conclusions made during this period will be briefly summarized as follows:

(1) The wave antenna gives a simple structure with considerable directivity both horizontally and vertically. The beam from it is inclined upward at an angle to the earth. A single structure may be used over a wide range of wavelengths without tuning adjustments.

(2) Except for end effect the useful radiation from the wave antenna, when used for transmitting, takes place only due to wave tilt produced by losses and low velocity of that portion of the field around the wires which enters the earth. Reducing the resistance and radiation losses in the earth also reduces the useful radiation so that high radiation efficiency does not result.

(3) To obtain efficient radiation without waste of energy in the ground it is necessary to employ an antenna structure which will itself produce a wave tilt. Such a structure is one in which the conductors carrying the waves have attached to them a series of radiators at right angles. These radiators then carry currents at right angles to the direction of the wave motion on the antenna and radiation takes place.

(4) In a receiving wave antenna the space waves can build up a continually increasing energy in the antenna as they sweep over it because they have a higher velocity than the antenna waves and so continually advance in phase relative to the antenna waves. Thus the counter electromotive force of the waves on the antenna cannot prevent the transfer of energy, because of its lagging phase.

When the same antenna is used for transmitting the conditions are reversed so that as soon as energy is transferred to the space waves it

advances in phase relative to the waves on the antenna and tends to return to the antenna. From this it is evident that a transmitting wave antenna should have a wave velocity greater than the velocity of waves in the medium in which it is used. For antennas operated in air this means that we should have a velocity greater than light. We cannot obtain real velocities greater than light but we can produce a structure in

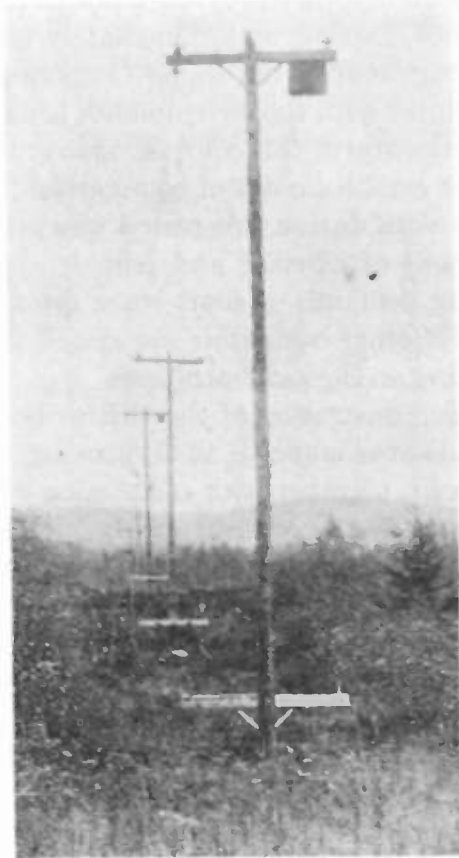

Fig. 1—Experimental wave antenna at Belfast, Maine.

which, under steady state conditions, we have an apparent or phase velocity greater than light.

(5) If a wave antenna can be given an actual velocity different from the wave velocity of the medium in which it is immersed this alone will produce a wave tilt which will result in radiation. If the actual velocity of waves on the antenna can be made greater than the velocity in the medium we can obtain considerable radiation, the amount of which increases with velocity, and which permits us to obtain very directive antennas which are also substantially aperiodic. Some interesting experiments have been made to bear out this theory by immers-

ing partially insulated radiator wires in water. In this case we do obtain an actual velocity on the wires greater than the velocity of waves in the water.

In a paper presented to the British Royal Society of Arts in July 1924,⁴ Guglielmo Marconi gave publicity to his work on the development of directive short-wave systems. This stimulated world-wide short-wave development, and influenced us to undertake a careful first-hand study of the contemporary progress made in this field in England, Germany, and France. During, and immediately following this period, the engineering department of the Radio Corporation, directed by C. H. Taylor, was occupied with the development of suitable transmitting equipment, the application of this equipment to studies of propagation phenomena, and the establishment of commercial long-distance short-wave circuits.⁵ The work during this period was primarily directed toward the development of efficient and reliable apparatus capable of meeting the exacting demands of short-wave communications. Meantime, the engineers of other companies associated with the Radio Corporation were working on the same problems.

The successful demonstration of the British beam circuit between England and Canada was made in 1926, proving the effectiveness of directivity. This result, together with completion of the initial apparatus development, caused us to concentrate on our study of propagation phenomena, and the development of directive antenna systems which would be efficient and sufficiently inexpensive to permit their use on a great number of our commercial long-distance circuits.

Lindenblad, who had specialized on antenna design, was added to the Rocky Point group to work exclusively on directive antenna development. He had assigned to assist him, at various times, Henry Tanck of the R.C.A., and C. F. Coombs and Paul Forrest of the General Electric Company.

In the four years which followed, four types of directive antennas were developed. These have been designated as Models A, B, C, and D. The model A system is of the broadside type, consisting of linear arrays of vertical radiators fed with a special transmission system having nearly infinite phase velocity. The model B antenna consists of one or more arrays of parallel long wires, in a vertical plane, which have their ends staggered in such a way as to give a unidirectional beam of ver-

⁴ Guglielmo Marconi, "Results obtained over very long distances by short wave directional wireless telegraphy, more generally referred to as the beam system," read at a meeting of the Royal Society of Arts, July 2, 1924.

⁵ Hallborg, Briggs, and Hansell, "Short-wave commercial long-distance communication," *Proc. I.R.E.*, 15, June, 1927; H. E. Hallborg, "The radio plant of R.C.A. Communications, Inc.," *Proc. J.R.E.*, 18, March, 1930; A. A. Isbell, "The RCA world wide radio network," *Proc. I.R.E.*, 18, October, 1930.

tically polarized waves. The model C antenna is similar to the model B but differs in that the radiator wires are arranged in a horizontal plane and give a unidirectional beam of horizontally polarized waves. The model D antenna system consists of radiating elements made up of long wires bent into the shape of horizontal V's which are used in an array giving a unidirectional beam of horizontally polarized waves.

DEVELOPMENT OF THE MODEL A ANTENNA

The development first followed the ideas brought out at Belfast, in that efforts were directed toward obtaining an efficient form of transmitting wave antenna. Great difficulty was encountered in attempting to control the velocity, current distribution, and radiation efficiency of wave antenna models.

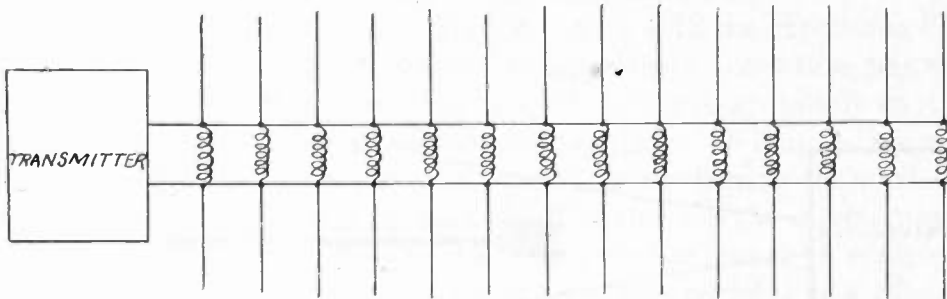

Fig. 2

In the course of the experiments there was erected a type of wave antenna similar to that shown in Fig. 2. In this antenna two parallel feeder lines or buses served to carry the waves. Attached to these feeders at frequent intervals were radiator wires set at right angles to the feeders. Across the feeders, at the radiator positions, were inductance coils intended to balance out the capacity of the radiators and a sufficient part of the feeder capacity to give a phase velocity slightly greater than the velocity of light.

In working with this model the procedure was to vary the phase velocity by varying the transmitter frequency. The current distribution in the antenna was checked and the field distribution pattern of the radiation was measured with a portable receiving antenna and sensitive thermocouple meter.

It was soon observed that if the frequency was sufficiently decreased, a point was reached where the phase velocity was substantially infinite and a good directive pattern, approximately at right angles to the antenna, was obtained. This broadside directivity was obtained so much more readily than the wave antenna effect that it was decided to build a full-scale working model of unidirectional antenna using this principle and to try it out for long-distance transmission.

The model was finished and first demonstrated by transmission from Rocky Point, New York, to Marshall, California, and Koko Head, Hawaii, on April 3, 1927.

An analysis of the power increase per unit cost for this type of antenna indicated that it could compete successfully with the British beam and other existing forms of directive antennas. It had a marked advantage in meeting our needs and permitted improvements in service by application of directivity to a large number of circuits at a moderate expense. Its use did not require risking a large loss of investment in antennas due to obsolescence.

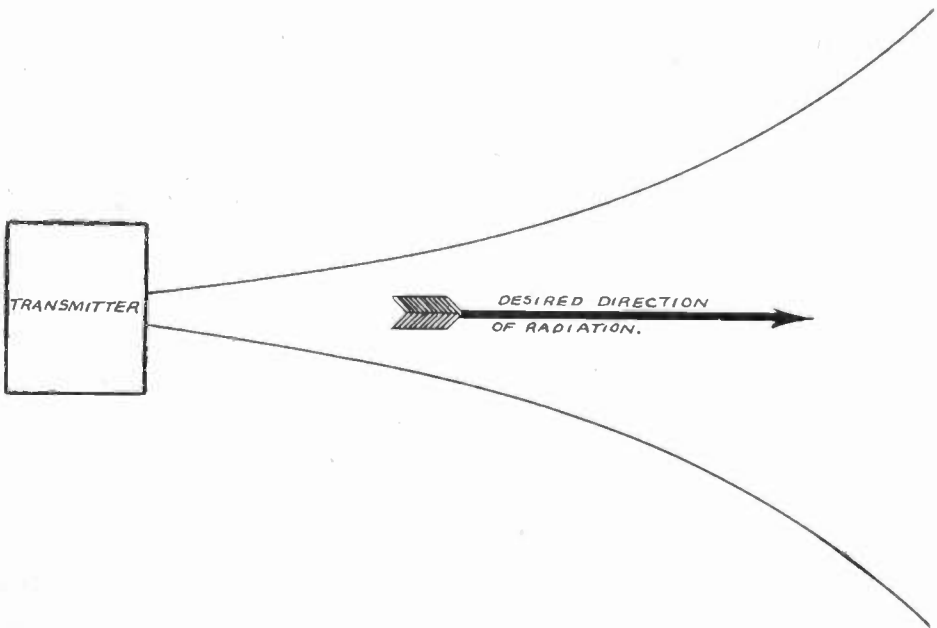

Fig. 3

The first commercial Model A antenna went into service in September, 1927. It was operated on a 16.2-meter wavelength and used the call letters 2XT and WTT. It was directed at Germany but was also useful to several other points in Europe. It soon proved itself to be a valuable addition to service and was operated successfully at traffic speeds up to 240 words per minute.

The designs of the first commercial Model A antenna system and additional antennas which were built in rapid succession were handled by Carter. Altogether 38 antennas of this type have been built and are still in use in the United States, Phillipines, Hawaii, China, Russia, and Norway.

DEVELOPMENTS OF MODELS B AND C ANTENNAS

During most of the period occupied by the demonstration and commercialization of the Model A antenna, in 1927 and 1928, Lindenblad was kept as free as possible to continue the forward looking development aimed at producing some practical form of transmitting wave antenna. During this period J. A. Biondo⁶ was his chief assistant.

Among other ideas investigated an attempt was made to obtain radiation attenuation and directivity from a transmission line having a continuously changing characteristic impedance or a continuously changing spacing as shown in Fig. 3. The idea behind the increasing spacing was to obtain a wave tilt to produce radiation and it was hoped that sufficient attenuation might be obtained to give us an aperiodic antenna with practically a unidirectional characteristic.

In these particular experiments the results with the expanding line antenna were not very satisfactory because the attenuation was not sufficiently great. However, they served to focus attention on the radiation efficiency and directive characteristics of long wires and caused Lindenblad to consider ways of combining them to obtain sharp unidirectional characteristics. As a result he devised the directive system employed in the models B and C projector antennas. A complete description of these models is given later in this paper. For a general idea of the form of construction used refer to Figs. 22 to 26.

A small model of his antenna system, which could be made vertical to correspond to the Model B or horizontal to correspond to the Model C, was built and tested on a six-meter wavelength with promising results. At the same time Carter was following up Lindenblad's experiments by mathematical calculation and analysis. Carter's results, in general, confirmed the experimental measurements. It was therefore decided to build full-scale models for test and demonstration between Rocky Point and Marshall.

The first large Model B antenna had been constructed and tuned by February 7, 1929 and long-distance tests were started on that date. From that time until about the first of April a series of tests was made resulting in improvements in the original model in respect to radiation efficiency and angle of the beam. At the same time information was collected to enable us to design commercial antennas with dimensions which would result approximately in optimum results per dollar of cost. The final results indicated that the new antenna would be a great improvement over the Model A not only in results per dollar of cost but also in simplicity and service reliability.

⁶ Mr. Biondo is now representing the R.C.A. in Italy in connection with the erection of a broadcast station in Rome.

During the early tests and demonstrations of the Model B antenna a Model C antenna was being constructed. It was finished and first used for long-distance tests on April 10, 1929. It was also carefully studied with the object of obtaining optimum economy in design and it too was found to be a great improvement over the Model A.

Since Model B and C antennas were ready for application to commercial construction at about the same time, it became necessary to make a choice between them. Upon first consideration it appeared that

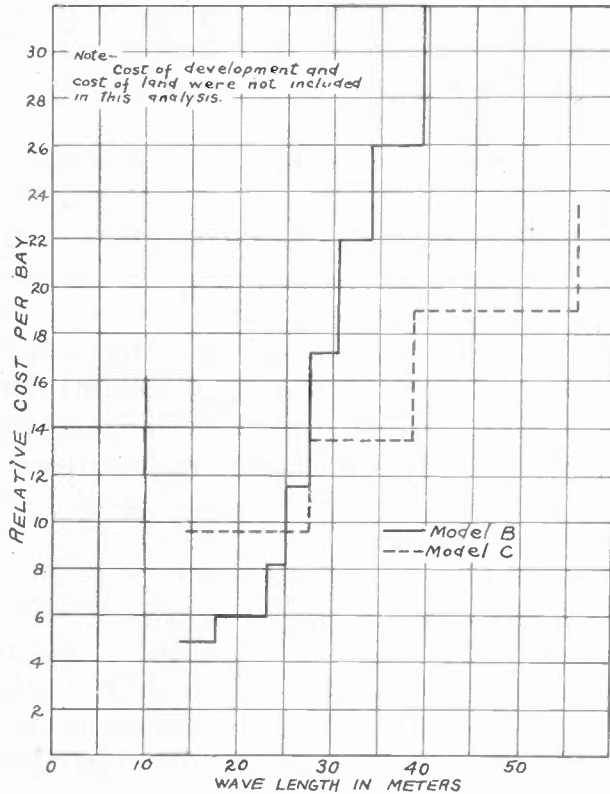

Fig. 4

one model would be discarded but an analysis of the gain in energy at the distant receiver per dollar of cost at the transmitter for various wavelengths indicated that both models should be used. The results of this analysis are shown graphically in Fig. 4. The vertical model B antenna was found to be more economical on wavelengths below 25 meters but more expensive than the horizontal Model C antenna on longer waves.

It was fortunate that this was true because the Model B antenna is better suited to increasing directivity by broadsiding several antennas to form one very directive system. A single section has sharp vertical directivity but its beam is quite broad horizontally. The broadsiding

increases only the horizontal concentration and this can be done without making the beam excessively narrow.

The beam from the Model C antenna, on the other hand, is broad vertically but very sharp horizontally, making it less suitable for broadsiding. Since the cost per section of directive antennas is high on the longer waves, where the Model C is used, there is less need for broadsiding a number of sections and the objection to the use of the Model C antenna is unimportant.

The first commercial Model B antenna was placed in service at Rocky Point on April 4, 1930. It has two broadsided sections directed on Madrid and is used on a 16.55-meter wavelength. Altogether there have been or are being built twenty-five of these antennas at Rocky Point, New York, New Brunswick and Tuckerton, New Jersey, Bolinas, California, and in the Hawaiian Islands. Sixteen of these antennas are being built by the Mutual Telephone Company of Honolulu. They are to be used for both transmitting and receiving in the system of telephone circuits to connect the islands on wavelengths of less than 10 meters.

The first commercial Model C antenna was placed in service on July 7, 1930. It has only one section, is directed on Buenos Aires and is used on a 28.22-meter wavelength. Altogether six of these antennas have been built at Rocky Point and New Brunswick.

DEVELOPMENT OF THE MODEL D ANTENNA

For a brief period the engineers of the group were inclined to believe that the Models B and C came close to the ultimate in simplicity and economy and that little further improvement was attainable. There being no further ideas recognized as holding promise of immediate economic gain, Lindenblad was assigned to carry on pioneering development in another field.

Carter, with the assistance of E. D. Thorne, continued the design of antennas for commercial construction. Some of his time was given to extended tests with the Models B and C, and to further mathematical analysis with the object of obtaining a better understanding of experimental results. He immediately became interested in other combinations of long wires for obtaining directivity and, before the end of 1929, was advocating the trial of a new type of antenna which, by requiring fewer supports, promised to have an economic advantage over the three previous models. This antenna, which has some resemblance to the expanding line shown in Fig. 3, is now known as the Model D. For a general idea of its construction refer to Fig. 36.

An experimental Model D antenna was built in the first part of 1930

and long-distance tests were started in April. These tests were continued throughout the summer and fall and have resulted in the adoption of the Model D for new construction. At the present time there are built, or being built, eleven antennas of this type located at Rocky Point, New York, Bolinas, California, and Kahuku, Hawaii. The antennas at Kahuku are of particular interest because they will be used as part of the first commercial transoceanic telephone station to be operated by R.C.A. Communications, Inc.

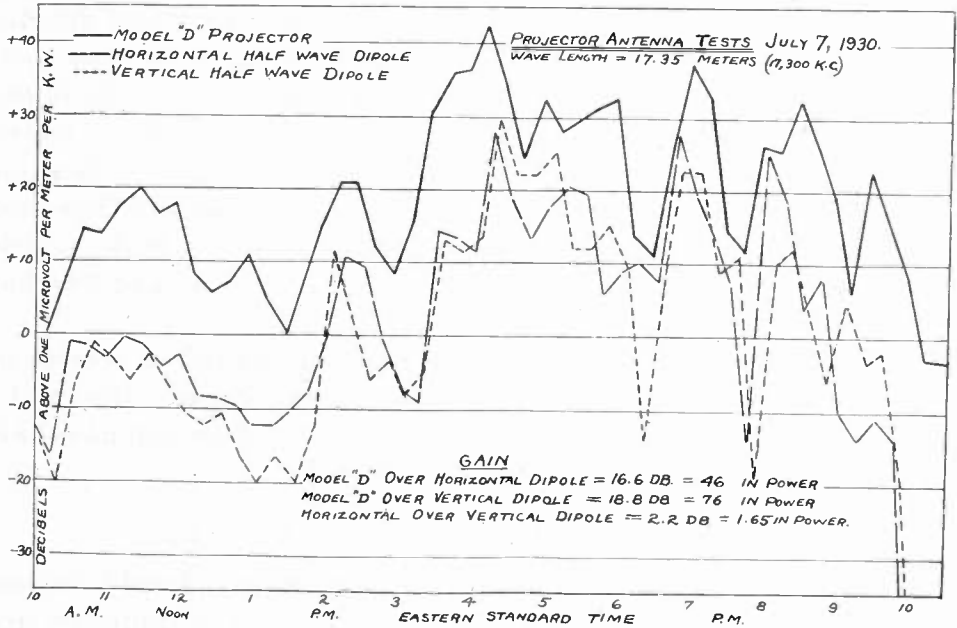

Fig. 5

METHOD OF TESTING ANTENNAS

All of the long-distance antenna tests have been made by switching the transmitter from one antenna to another, usually at five-minute intervals. A half-wave dipole at the same height and having the same polarization as the directive antenna under test has been used as a standard of reference. In addition, many tests have been comparisons of one model of directive antenna with another.

In all cases the transmitter power has been measured for each reading by subtracting the power carried away in the cooling water from the input to the last stage of amplifier.

The relative signal strength delivered to the receiver by the antennas being compared has been measured with a calibrated receiver in the

output of which a meter was used as an indicator to average out rapid fluctuations and eliminate possible errors in judgment of the operator.

The readings have been reduced to decibels above an arbitrary reference value, per kilowatt of transmitter power. The average received signal energy in decibels for the whole day is then determined for each of the antennas under test and the difference between these figures, which is ten times the logarithm of the power ratio, is taken as

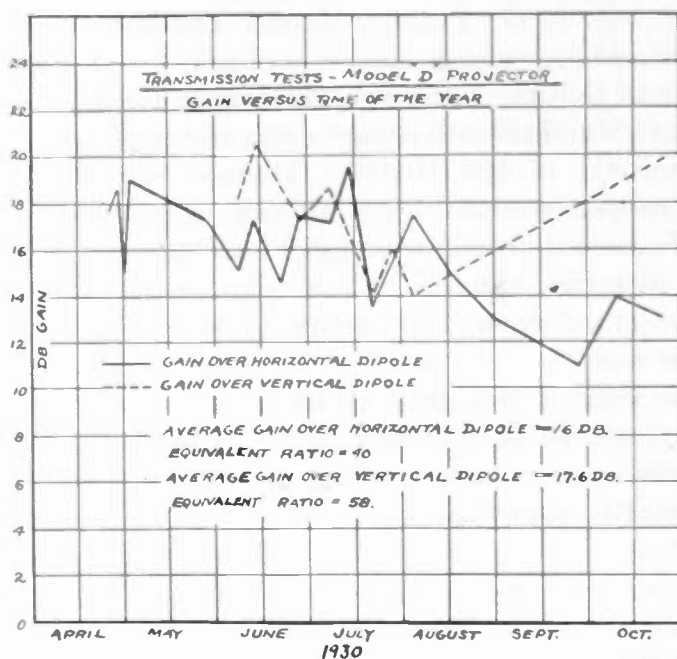

Fig. 6

the difference in effectiveness of the antennas on that day. We consider this the best method of arriving at a ratio for the extremely variable signals from short-wave antennas.

Fig. 5 shows the results of a typical day's run on a Model D antenna. Many days of tests of this sort have been made to arrive at a reliable figure of merit for each model.

Fig. 6 shows the seasonal variation in effectiveness of the Model D antenna when used for transmission from Rocky Point to Marshall on a wavelength of 17.3 meters.

We are greatly indebted to R. R. Beal of the Pacific Division and his staff, particularly I. C. Reid of the Marshall Station, for their co-operation in making thousands of signal strength measurements. The remarkable consistency of the average results in spite of the great variations in individual readings on short-wave signals indicates extraordinary care and patience on their part.

POWER CONCENTRATIONS OBTAINED

The increase in power, due to antenna directivity, of the signal received at a distant receiving station varies to some extent with the wavelength, time of year, and the particular circuit being observed. Our long-distance tests have, in most cases, been made on wavelengths of 16 to 17 meters and over the transcontinental circuit from Rocky Point to Marshall. Some additional tests have been made over the longer circuit from Rocky Point to Hawaii. The Model A antenna was tested by comparison with a half-wave dipole for transmission from Rocky Point to Geltow, Germany. These tests checked the measurements made at Marshall with remarkable exactness.

The directivity of the Model A antenna was also checked by comparison measurements with a pick-up antenna and a sensitive thermocouple meter located at from 500 to 2000 meters in front of the dipole and directive antenna. These short-distance measurements checked the long-distance measurements at Marshall and Geltow within 10 per cent.

Using the average of a great number of experimental determinations we have arrived at the following approximate figures for the increase in power, due to directivity, from one bay of each of the four models of directive antennas.

	<i>Decibels Gain Over Half-Wave Dipole</i>	<i>Power Ratio To Half-Wave Dipole</i>	<i>Directivity</i>
Model A	10	10	16.4
Model B	12	16	26.3
Model C	12.4	17.5	28.7
Model D	16	40	65.6

Where a number of bays is used the increase in power ratio is very nearly in proportion to the number of bays. We have used up to four bays of the Model A, two bays of the Model B, two bays of the Model C, and two bays of the Model D. This does not mean that no greater directivity should be used, and further discussion on this point will appear later in the paper.

STUDY OF DIRECTIVE CHARACTERISTICS REQUIRED

In all of the directive antenna development we have been troubled by lack of reliable information as to what directive properties an antenna should have. The uncertainties in this connection, which must also have troubled others, may be briefly summarized in the following questions:

(1) Should the beam from a directive antenna be made up of vertically polarized waves or would horizontal polarization be better?

(2) If unlimited vertical directivity is obtainable, how sharp should this directivity be made and what should be the angle of elevation of the beam with respect to the earth?

(3) Does the beam of radiation always follow the great circle path from transmitter to receiver or may it be variably deflected due to unequal refraction in the atmosphere in such a manner that very sharp horizontal directivity should not be used?

We must admit that we cannot give complete and reliable answers to these questions but we have obtained some information of practical value and have formed tentative conclusions which may be of interest to others.

In the early tests with Marshall and Koko Head a comparison was made of the signals delivered from horizontal and vertical dipoles. It was found that the horizontal dipole delivered considerably more power to Marshall but the vertical dipole was better by about an equal amount at Koko Head. Since Marshall is about 2600 miles and Koko Head 5,000 miles distant from Rocky Point, we concluded that difference in polarization was probably unimportant except in so far as it might affect the transmitting antenna efficiency and directivity. It might have a considerable effect upon the wavelength which would give best results over a given circuit at a given time of year and time of day but, throughout a year and averaging all conditions, would probably have little effect upon the average usefulness of an antenna. In general, it appears that horizontal polarization should be used on shorter circuits, or on shorter wavelengths than should vertical polarization. However, the data available are too meager to permit a reliable conclusion.

The Model B antenna has probably the greatest vertical directivity obtained in any commercial form of directive antenna. In a series of tests extending over about six months no evidence of widely varying power ratios from the sharp directivity was observed at Marshall. We are, therefore, inclined to believe that vertical directivity of the amount used in this antenna is safe so long as the correct angle of beam is used.

Since the vertical directivity of the Model B antenna is so great, it gave an opportunity to make an experimental check on the effect of elevation of the beam upon the signal received at a distance. Originally the British Marconi Company had given a rather high angle as the optimum elevation for the radiation and had indicated that their beam antennas were designed to give this high angle. Subsequently T. L.

Eckersley made a very complete and ingenious study of this problem from data obtained by facsimile transmission using vertically polarized waves and concluded that quite small angles should be used.⁷ Miessner and Rothe, in Germany, arrived at the same conclusion by means of experiments with horizontally polarized waves.⁸

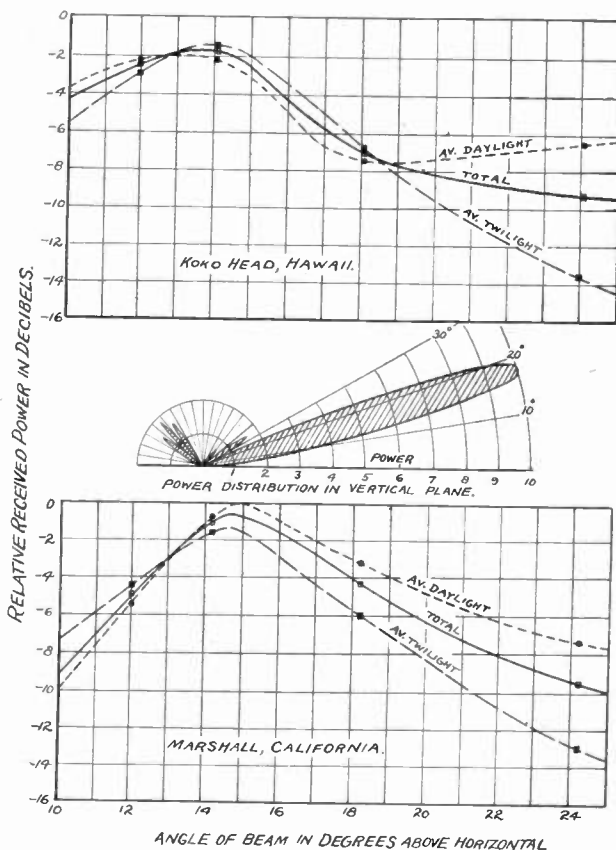

Fig. 7

Our experiments with the Model B antenna, which is vertically polarized, checked the conclusions of Eckersley and Miessner. The experimental results were more striking than those of Miessner because of the very sharp directivity of the Model B antenna.

In making our tests the elevation of the beam was varied by changing the angle of the antenna. For each angle the signal from the directive antenna was compared at Marshall and Koko Head with another antenna used as a standard. The results of the tests are shown in Fig. 7. In this figure the relative signal strengths are plotted against the true

⁷ T. L. Eckersley, "Multiple signals in short-wave transmission," *Proc. I.R.E.*, 18, 106, et. seq.; January, 1930.

⁸ Miessner and Rothe, "On the determination of the optimum radiation angle for horizontal antennas," *Proc. I.R.E.*, 17, 35, et. seq.; January, 1929.

angle of the line of maximum radiation. The sharpness with which the signal rose at Marshall may be partly due to increasing directivity from ground reflection but still it is obvious that the energy which reached the receiving station left the transmitting antenna at some low angle. The decrease in signal at very low angles is believed due to decreasing radiation efficiency and increasing ground losses near the transmitting antenna because, to get the lowest angle, the lower end of

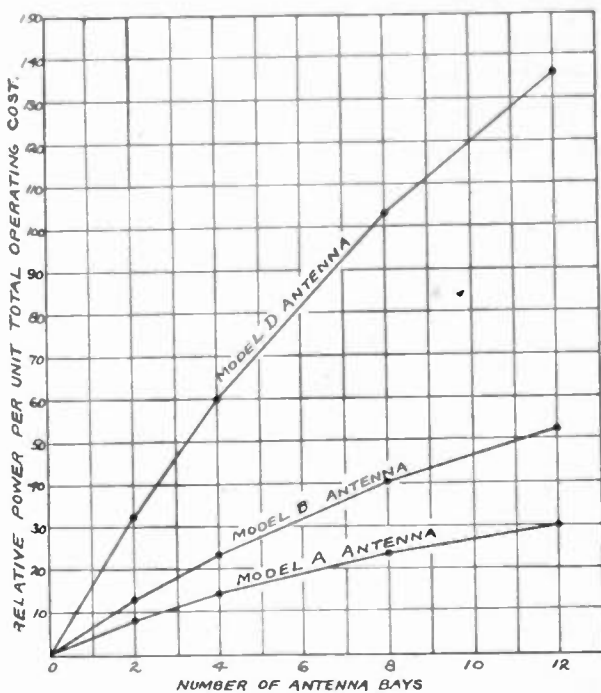

Fig. 8

the lowest radiator wire had to be run in a trench below the surface of the ground.

It will be noted that the lowest possible elevation of the beam which does not produce excessive losses in the ground is best. It may also be noted that the results at the two different distances are remarkably alike, indicating that the lowest obtainable angle is probably best for a large range of distances. Since horizontal radiation is cancelled by radiation reflected from the ground, it will be observed that the lowest obtainable angle for the center of the beam is several degrees above horizontal.

In connection with the third question we have never failed to obtain an improvement in proportion to the number of broadsided bays with any of the antenna models, except for one or two very rare and short periods. The observers at Marshall have not been able to detect any

difference in fading between a plain dipole and any of the directive antennas. It, therefore, seems probable that horizontal deflections of the beam, although they probably exist, are usually so small as to permit the use of great horizontal directivity.

ECONOMIC VALUE OF DIRECTIVE ANTENNAS

From an engineering point of view, the money spent upon a transmitting station for interest on investment, depreciation, power, taxes, operating personnel, etc., is chiefly for the purpose of delivering signal power to the input of the distant receiver. If, by using a directive antenna, the power delivered to the receiver can be greatly increased with relatively small increase in cost, the value and efficiency of the entire investment is greatly increased.

As an illustration of the way in which our directive antennas can be used to increase the value of a transmitting station having only one 20-kw transmitter operating on a wavelength of about 20 meters, refer to Fig. 8. In this figure is shown the calculated relative received power per dollar of total cost at the transmitter for various numbers of bays of each of three types of antenna.

These curves have been calculated on the assumption that the received power is increased in proportion to the number of bays used. We have proven this to be true up to four bays of the Model A and two bays of the Models B, C, and D. Since the economic value of directivity is so great, it is obvious that a large antenna system should be used. It is hoped that data can soon be made available to show the limit beyond which the received power does not increase in proportion to the size of the antenna and the way in which the results depart from proportionality.

In applying the curves of Fig. 8 to the design of any particular transmitting station, consideration must be given to many special factors which may affect the particular station. For example, if the station is required to handle traffic to two or more receiving stations at different angles, it may be more economical to use one high power transmitter on a relatively small antenna than to use several lower power transmitters on large antennas. For an operating agency handling many circuits from one point, such as R. C. A. Communications at New York and San Francisco, the benefit from large directive antennas must be balanced against the advantages of placing a large number of transmitters in one building. The number of transmitters in one building and the size of antennas determine the length of radio-frequency transmission lines which must be used. The power losses in these lines must be considered in designing for optimum over-all economy of operations.

From a slightly different point of view it may be noted that directive antennas make it possible to increase greatly the maximum obtainable signal power. At the present stage of development, 40 kilowatts is about the maximum practical power from any short-wave transmitter and this power radiated from a plain antenna might be insufficient for making some radio circuits commercial. By using a two-bay Model

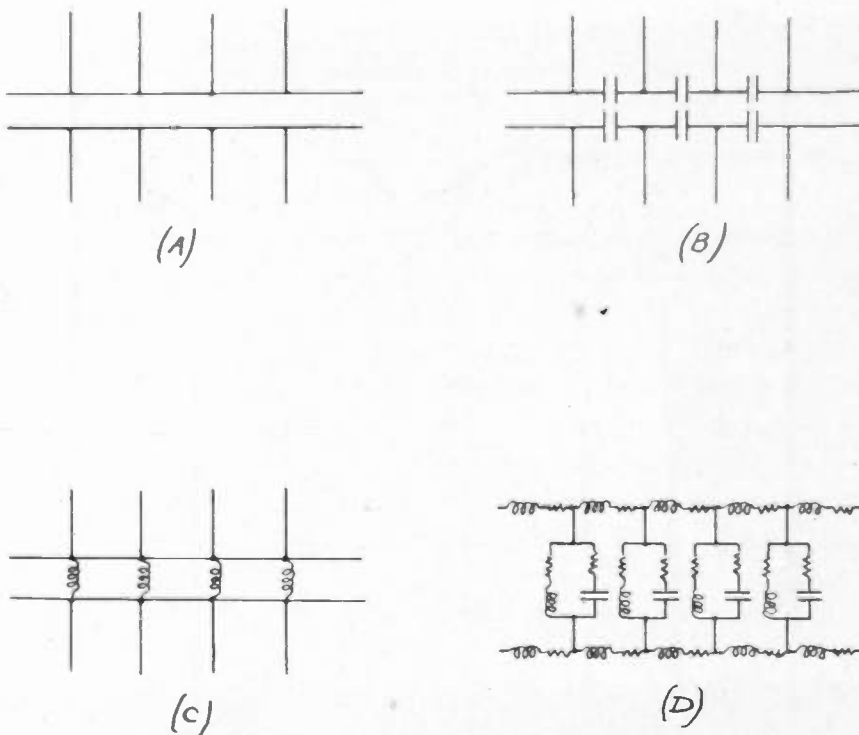

Fig. 9

D antenna, instead of a plain antenna, with a 40-kw transmitter, we may obtain an intensity in one direction equivalent to 3200 kilowatts.

It is conceivable that, before many years, the most important radio circuits may be equipped with transmitters and antennas capable of concentrating radiation in one direction equivalent to that which would be obtained in this direction with 25,000 kilowatts in a nondirective antenna.

DESCRIPTION OF THE MODEL A ANTENNA

This antenna is one in which linear arrays of vertical radiators are used. See Figs. 9 and 10. The features connected with the feeding of the radiating elements are somewhat unique. All radiators are fed in phase by a common feed line or bus system. In order that the radiators may be fed in phase, it is necessary that the velocity of phase propagation on the feed line be infinite. This does not mean that the feed energy

travels along the line at any such velocity. It merely means that by certain tuning procedure a phase phenomena can be produced which would be obtained were it possible to attain actual infinite wave velocity. Since the tuning and loading of the line is done with lumped values at regularly spaced intervals it may be proper to look at this antenna as a network rather than as a line. The choice of either viewpoint is a

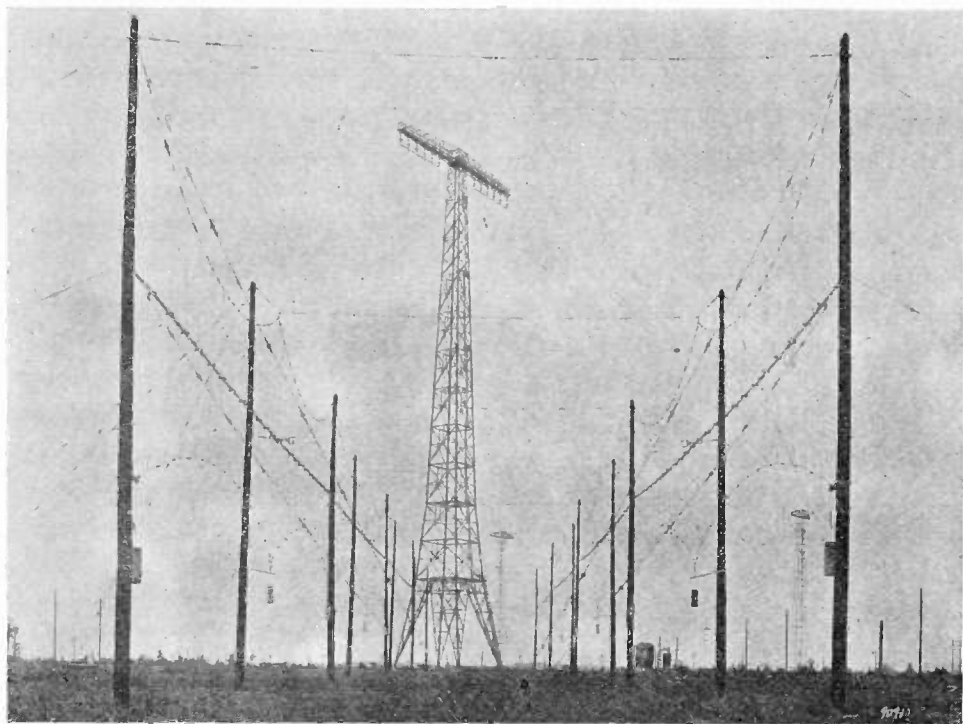

Fig. 10—Four-bay model A antenna.

matter of personal taste. It may be well to use both to obtain a conception which conforms more closely with what actually takes place.

In Fig. 9, (A) represents the radiating elements attached to a common feed line. In order to obtain the correct phase of the individual radiators, the line must be broken up by series condensers as shown in (B) or shunted by inductances as shown in (C). The use of shunt coils was preferred for practical reasons. In diagram (d) we have shown the equivalent network of arrangement (C). The method of obtaining infinite phase velocity along the feeder system is similar to that used in the Alexanderson multiple tuned antenna. In the case shown in (C), (D) the phase velocity is made to approach infinity by balancing out all capacity by means of inductive shunt reactances.

The determination of optimum constants in the design of this an-

tenna system was too complicated to be solved entirely by theoretical calculations and the dimensions adopted were arrived at chiefly by experiment. It was necessary to balance radiation efficiency against the length of the antenna which could be fed from one point, by proper choice of the length of radiators and the electrical constants of the feed line. The values finally arrived at are as follows:

Length of radiators (over-all).....	0.225	wavelength
Spacing between radiators.....	0.125	"
Maximum length of bus on each side of feed point.....	1.5	"
Volt ampere ratio between bus and radiators.....	5.	

The antenna is so designed that sleet melting current can be applied without interruption of operation.

In order to cover the necessary variation of tuning between certain standard dimensions of inductance coils, it was found convenient to make the capacity of the bus variable. This was accomplished by making each side of the line of two strips, the spacing of which was variable.

The complete antenna system includes two parallel rows of radiators placed at a spacing of five quarter wavelengths. Energy is fed to both rows of radiators of such a phase as to make the system unidirectional. The relatively large spacing between antenna and reflector elements is beneficial in reducing coupling between them. This reduces the difficulty of making the tuning adjustments and does not detract from the power gain due to directivity where both the antenna and reflector are fed from transmission lines.

The total gain in power per section of this antenna is 10 as compared with a half-wave dipole. Such a section is called a bay. We have not gone into detail in describing the action of this antenna because the general principles involved have been fully covered by Southworth.⁹

It has been found feasible to use open-wire transmission lines for feeding these antennas.¹⁰ They compare favorably in efficiency with other types of lines. The possibility of undesired coupling between the antennas and the lines can be avoided by adherence to symmetry and selection of neutral planes in the vicinity of the antenna.

PRINCIPLES OF LONG LINEAR RADIATORS USED IN ANTENNA MODELS B, C, AND D

The principles involved in the action of the three antennas whose descriptions are to follow are more or less similar and are based upon

⁹ G. C. Southworth, "Certain factors affecting gain of directive antennas," *Proc. I.R.E.*, 18, 1502-1536; September, 1930.

¹⁰ N. Lindenblad and W. W. Brown, "Main considerations in antenna design," *Proc. I.R.E.*, 14, 291 et. seq.; June, 1926.

the characteristics of a straight wire several wavelengths long. For this reason we shall discuss these characteristics in detail.

(a) *Distribution of Radiation*

It is well known that maximum radiation from a very short dipole or Hertz doublet takes place at right angles to the axis of the doublet and that the radiation in the line of the axis is zero. At a constant dis-

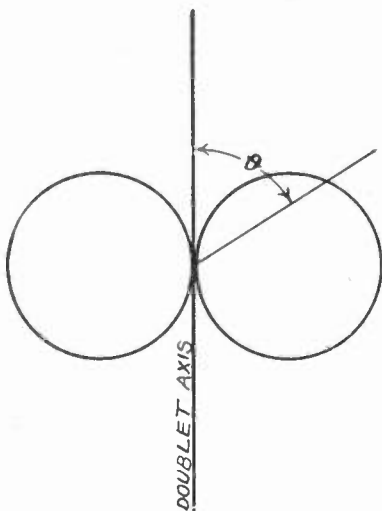

Fig. 11

tance the field intensity of the radiated wave is proportional to the sine of the angle to the axis. The plane polar diagram of relative field intensity is thus a figure eight as shown in Fig. 11. Since in a pure travel-



Fig. 12

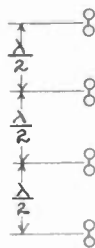

Fig. 13

ing wave the electric and magnetic intensities are equal and the intensity of energy flow is proportional to the square of either, we shall consider the electric intensity only in this discussion.

The fundamental natural frequency of oscillation for a wire in space is $c/2L$ where c is the velocity of light and L the length of the wire. Such

a wire also has natural periods corresponding to *all* multiples of the fundamental frequency. Thus the ratios of the length of the wire to the natural wavelengths are $1/2$, $2/2$, $3/2$, $4/2$, etc. The instantaneous values of the current along a wire having a length of two waves are as shown in Fig. 12. The wire is equivalent to four half-wave dipoles placed end to end with the current reversed in each succeeding dipole. For a qualitative analysis let us replace each half-wave dipole by a doublet as shown in Fig. 13. The radiation pattern of a doublet is sufficiently near that of a half-wave dipole for present purposes.

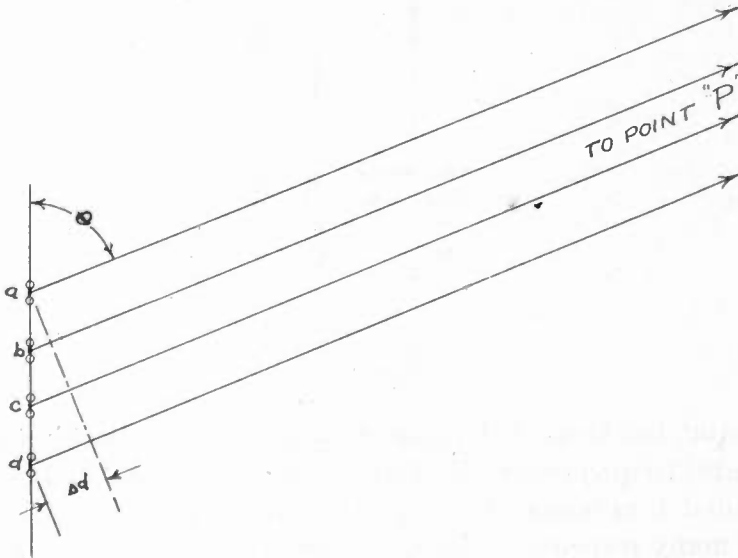

Fig. 14

Let us now go to a point P , Fig. 14, whose distance from the wire is so great in comparison with the length of the wire that the paths of wave travel may be considered parallel. The total instantaneous field at P must be the sum of the instantaneous fields due to the doublets. If the direction of P is at right angles to the wire, the field from each doublet is a maximum. Call this E . In other directions at the same distance, the field intensity for one doublet is $E \sin \theta$. Now, the distances from each doublet to P are unequal and, due to the fact that the waves travel with the velocity of light, the wave fronts will arrive at different times.

This difference in time is equivalent to a phase angle. There are similar phase differences between the waves from b and c with respect to a . The effective value of the total field at P is the vector sum of the four components.

In the direction at right angles to the axis, ($\theta = 90$ degrees) the total intensity is zero. In either direction along the axis the phase

angles between components are zero and the resultant intensity would be a maximum were it not for the fact the intensity of each component is zero. By calculation we would find a maximum at approximately 36 degrees, zero at 60 degrees, and a second maximum of lower intensity than the first at about 75 degrees.

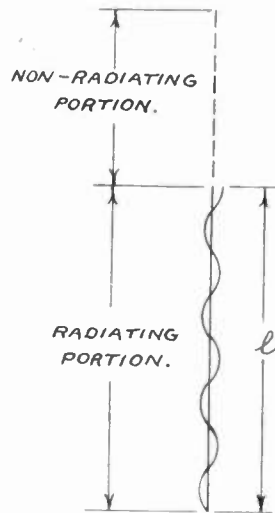

Fig. 15

Abraham¹¹ has treated the case of a grounded wire oscillating at one of its natural frequencies while Pierce¹² has quite completely analyzed the grounded L antenna. Although the case of a wire free in space is similar in many respects to the cases already treated, it will nevertheless be analyzed in detail here.

Consider a wire, the radiating portion of which has a length l . Assuming sine wave distribution the instantaneous current relationship is as shown in Fig. 15. Measuring the distance X from the free-end of the wire, the current is

$$i = I \cos \omega t \sin \frac{2\pi x}{\lambda} \quad (1)$$

where $I \cos \omega t$ is the current at the antinode. Let us consider the wire as being made up of a large number of very short elements of length dX and determine the electric field e at a point P on an imaginary sphere whose radius r_0 from O is so great in comparison with the length of the wire that lines from any points on the wire to P may be considered parallel. (See Fig. 16.)

The wave from dX will arrive at P ahead of the wave from O due to its traveling a distance r which is less than r_0 by the amount $X \cos \theta$.

¹¹ *Phys. Zeit.*, 2, 1904.

¹² *Electric Oscillations and Electric Waves.*

A disturbance originating at O at the time t will arrive at the time $t+r_0/c$ where c is the velocity of light. Hence a wave represented by $E \cos \omega t$ at O will be represented by $E \cos [\omega(t+r_0/c)]$ at P .

At great distances from the wire the electric and magnetic fields are equal. It can be shown from the electron theory¹³ that the magnetic field at any distance is the curl of Ψ where Ψ is the vector potential. At a great distance

$$\text{curl } \Psi = \frac{\delta \Psi}{\delta r} \sin \theta \tag{2}$$

if we neglect $1/r^2$ as compared to $1/r$.

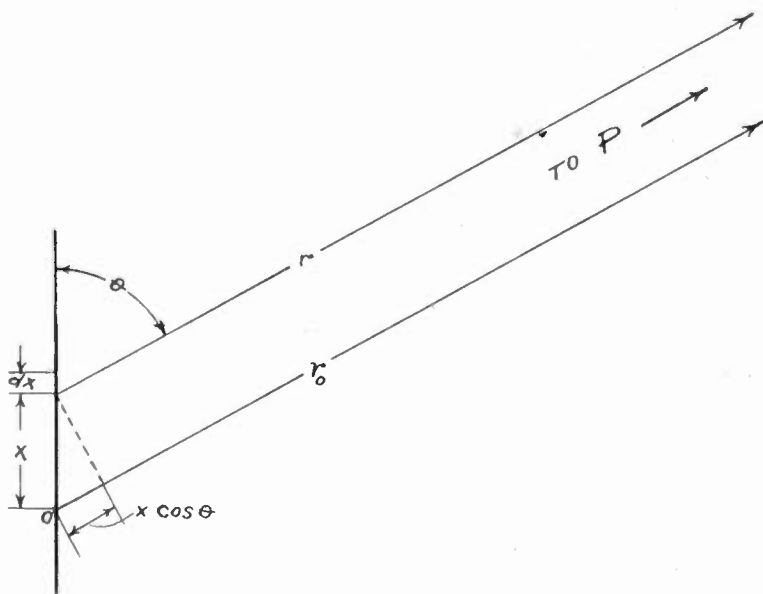

Fig. 16

Now,

$$\Psi = \frac{1}{c} \int_0^l \frac{[i]}{r} dx \tag{3}$$

where $[i]$ means that the time of travel must be properly taken into account. Hence

$$e = H = \text{curl } \Psi = \sin \theta \frac{\delta}{\delta r} \int_0^l \frac{I}{cr_0} \cos \omega \left(t - \frac{r}{c} \right) \sin 2\pi \frac{x}{\lambda} \cdot dx. \tag{4}$$

To simplify operations let $\cos \omega t$ be represented by the real part of $e^{j\omega t} = \cos \omega t + j \sin \omega t$. Then, since $\sin z = \frac{e^{iz} - e^{-iz}}{2}$

¹³ See Jeans', *Electricity and Magnetism*, or other treatments of electromagnetic theory.

$$\begin{aligned}
 e &= \frac{I}{2j\lambda cr_0} \sin \theta \int_0^l \frac{\delta}{\delta r} [\epsilon^{j\omega(t-r/c)} (\epsilon^{j2\pi x/\lambda} - \epsilon^{-j2\pi x/\lambda})] dx \\
 &= \frac{\pi I}{\lambda cr_0} \sin \theta \int_0^l \epsilon^{j\omega(t-r/c)} [\epsilon^{j2\pi x/\lambda} - \epsilon^{-j2\pi x/\lambda}] dx.
 \end{aligned} \tag{5}$$

Since,

$$r = r_0 - x \cos \theta, \quad \omega \left(t - \frac{r}{c} \right) = \omega \left(t - \frac{r_0}{c} \right) + 2\pi \frac{x}{\lambda} \cos \theta,$$

and,

$$e = \frac{\pi I}{\lambda cr_0} \sin \theta \epsilon^{j\omega(t-r_0/c)} \int_0^l [\epsilon^{j2\pi x/\lambda(1+\cos\theta)} - \epsilon^{-j2\pi x/\lambda(1-\cos\theta)}] dx \tag{6}$$

and, after performing the integration and several transformations, this becomes, after letting $2\pi l/\lambda = L$,

$$\begin{aligned}
 e &= (I/cr_0) \epsilon^{j\omega(t-r_0/c)} \{ \cos L \cos(L \cos \theta) + \cos \theta \sin L \sin(L \cos \theta) \\
 &\quad - 1 + j[\cos L \sin(L \cos \theta) - \cos \theta \sin L \cos(L \cos \theta)] \} / \sin \theta.
 \end{aligned} \tag{7}$$

When l is an even number of half waves $L = 2K\pi$ where K is an integer and,

$$e = \frac{2I}{cr_0} \cos(\omega t - \beta) \frac{\sin\left(\frac{L}{2} \cos \theta\right)}{\sin \theta} \tag{8}$$

When l is an odd number of half waves $L = (2K-1)\pi$ then $\cos L = -1$, and,

$$e = \frac{2I}{cr_0} \cos(\omega t - \beta) \frac{\cos\left(\frac{L}{2} \cos \theta\right)}{\sin \theta} \tag{9}$$

If n is the number of half waves on the wire $L = \pi n$ and $L/2 = n\pi/2$.

Hence, if E is the amplitude of e , we have the following two relations:

$$E = \frac{2I}{cr_0} \frac{\sin\left(n \frac{\pi}{2} \cos \theta\right)}{\sin \theta} \tag{10}$$

when the wire is an even number, n , of half waves long and

$$E = \frac{2I}{cr_0} \frac{\cos\left(n \frac{\pi}{2} \cos \theta\right)}{\sin \theta} \tag{11}$$

when the wire is an odd number, n , of half waves long.

Formula (7) is perfectly general and from it can be determined the field for any length whatever, but, for simplicity, we shall consider only the cases where the length is an exact multiple of a half wave.

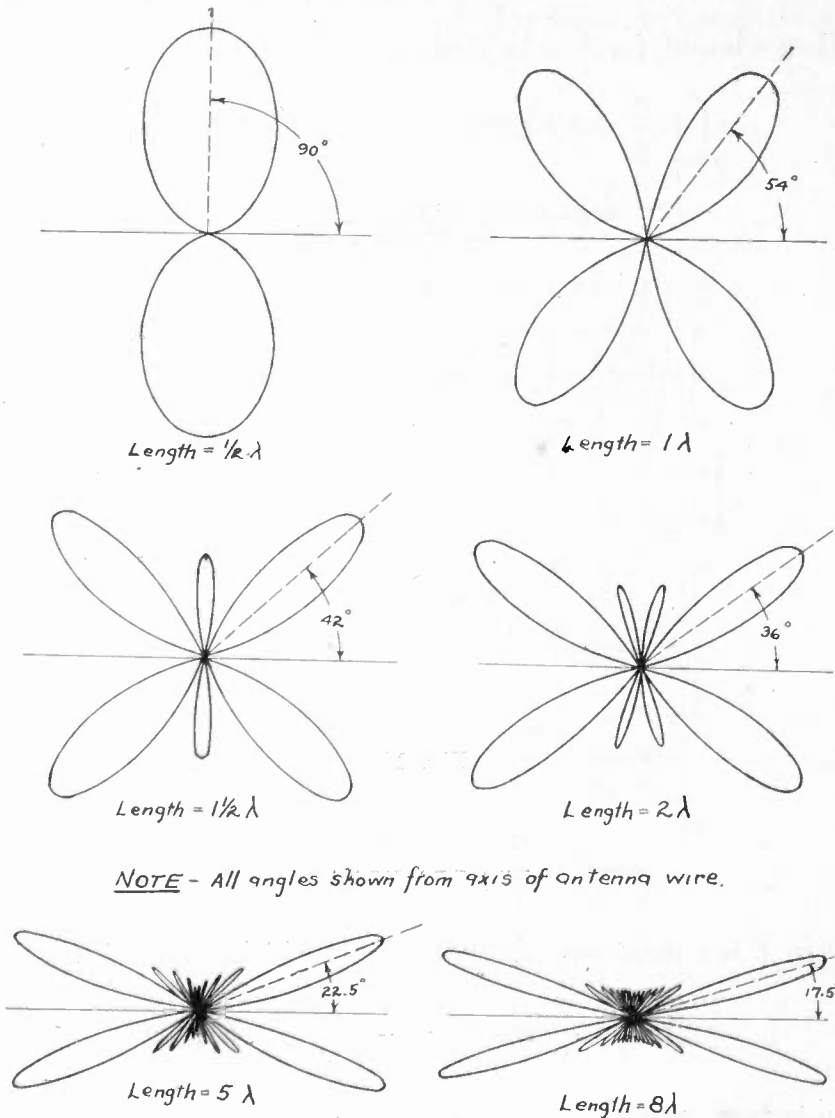

Fig. 17

Since the power flow is proportional to the square of the field amplitude, relative power distribution is obtained by squaring the values of E given by (10) or (11).

For any particular length of radiator we wish to know the angles of maximum radiation, the angles of zero radiation, and the relative amplitudes of the maxima. When n is even, for E to be zero:

$$\sin\left(n \frac{\pi}{2} \cos \theta\right) = 0, \quad n \frac{\pi}{2} \cos \theta = k\pi$$

where k is an integer and,

$$\cos \theta = 0, \frac{2}{n}, \frac{4}{n}, \dots, \frac{n}{n} \tag{12}$$

When n is odd, for E to be zero:

$$\cos \left(n \frac{\pi}{2} \cos \theta \right) = 0, \quad n \frac{\pi}{2} \cos \theta = (2k - 1) \frac{\pi}{2},$$

ANGLES OF MAXIMUM AND OF ZERO RADIATION OF THE LONG WIRE RADIATOR

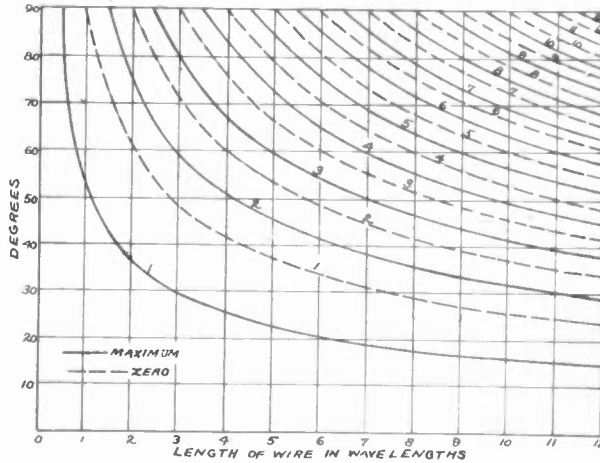

Fig. 18

and,

$$\cos \theta = \frac{1}{n}, \frac{3}{n}, \frac{5}{n}, \dots, \frac{n}{n} \tag{13}$$

When E is a maximum $dE/d\theta = 0$ from which we obtain:

$$\tan \left(n \frac{\pi}{2} \cos \theta \right) = -n \frac{\pi}{2} \tan \theta \sin \theta \tag{14}$$

when n is even, and,

$$\tan \left(n \frac{\pi}{2} \cos \theta \right) = n \frac{\pi}{2} \tan \theta \sin \theta \tag{15}$$

when n is odd

The values of θ for which E is maximum are obtained by solving these two equations graphically. The relative amplitudes of the maxima are obtained by substituting the values of θ obtained from (14) and (15) in (10) and (11). Fig. 17 shows several polar diagrams for wires of various lengths.

Fig. 18 is a chart showing the angles for which maximum and zero radiation takes place for all lengths of wire up to 14 wavelengths. Figs. 19 and 20 are charts showing the relative amplitudes of the maxima. These charts enable one to plot very quickly in a rough way the radiation characteristic for a wire of any length.

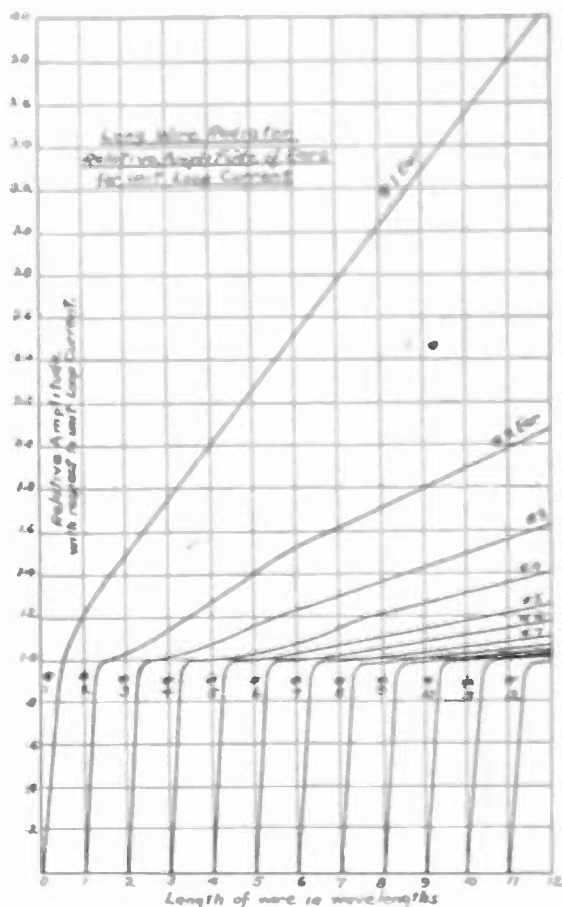

Fig. 19

(b) Radiation Resistance

The radiation resistance may be defined as the ratio of the total power radiated to the square of the current at a current antinode. All the power radiated must flow through such an imaginary sphere as we have been considering. Therefore, if we divide the surface of the sphere into small areas and sum up the power flowing through all these small areas we shall have the total power.

The power per unit area flowing through the surface of the sphere (Poynting's vector) is

$$P = \frac{c}{4\pi} e^2. \quad (16)$$

Hence, the total power, dW , flowing through a small area dS is:

$$dW = Pds = \frac{c}{4\pi} e^2 ds. \tag{17}$$

Our element of area is:

$$dS = 2\pi r^2 \sin \theta d\theta \tag{18}$$

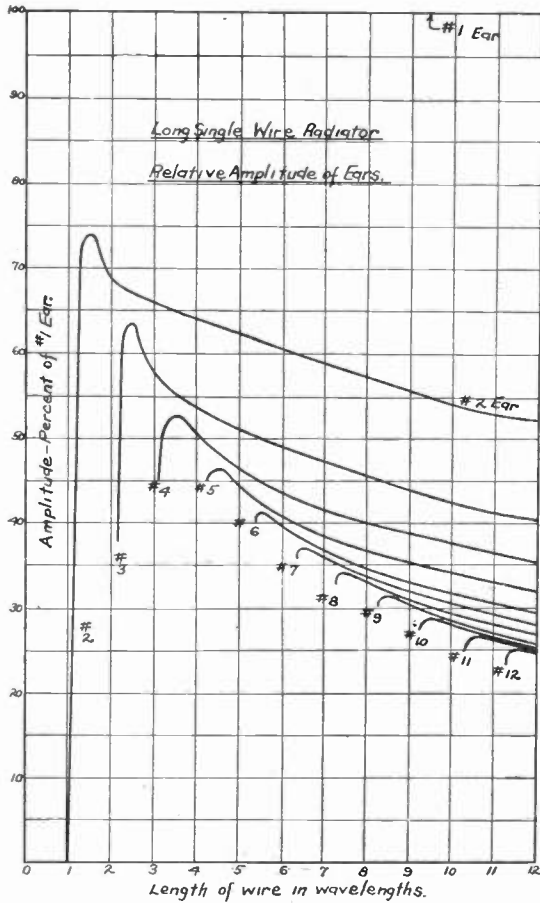

Fig. 20

hence,

$$dW = \frac{ce^2}{2} r^2 \sin \theta d\theta. \tag{19}$$

For the case of an even n we obtain, by substituting the value of e from (10) into (19):

$$dW = \frac{2I^2}{c} \sin^2(\omega t + \beta) \frac{\sin^2\left(n \frac{\pi}{2} \cos \theta\right)}{\sin \theta} d\theta. \tag{20}$$

The total power through the whole surface is then:

$$W = \frac{4I^2}{c} \sin^2(\omega t + \beta) \int_0^{\pi/2} \frac{\sin^2\left(n \frac{\pi}{2} \cos \theta\right)}{\sin \theta} d\theta. \quad (21)$$

To evaluate the above definite integral let $\cos \theta = u$. Then $du = -\sin \theta d\theta$ and $\sin \theta = \sqrt{1-u^2}$ and, calling the integral J ,

$$\begin{aligned} J &= \int_0^{\pi/2} \frac{\sin^2\left(\frac{n\pi}{2} \cos \theta\right)}{\sin \theta} d\theta = - \int_1^0 \frac{\sin^2\left(\frac{n\pi}{2} u\right)}{\sqrt{1-u^2}} \frac{du}{\sqrt{1-u^2}} \\ &= \int_0^1 \frac{\sin^2\left(\frac{n\pi}{2} u\right)}{1-u^2} du = \frac{1}{2} \int_0^1 \frac{1 - \cos n\pi u}{1-u^2} du \end{aligned}$$

but, since

$$\begin{aligned} \frac{1}{1-u^2} &= \frac{1}{2} \left[\frac{1}{1+u} + \frac{1}{1-u} \right] \\ J &= \frac{1}{4} \int_0^1 \frac{1 - \cos n\pi u}{1+u} du + \frac{1}{4} \int_0^1 \frac{1 - \cos n\pi u}{1-u} du \\ &= \frac{1}{4} \int_0^1 \frac{1 - \cos n\pi u}{1+u} du + \frac{1}{4} \int_{-1}^0 \frac{1 - \cos n\pi u}{1+u} du \\ &= \frac{1}{4} \int_{-1}^{+1} \frac{1 - \cos n\pi u}{1+u} du. \end{aligned}$$

Let $n\pi(u+1) = \phi$ then $n\pi u = \phi - n\pi$ and $du = d\phi/n\pi$, and

$$\begin{aligned} J &= \frac{1}{4} \int_0^{2\pi n} \frac{1 - \cos(\phi - n\pi)}{\phi} d\phi \\ &= \frac{1}{4} \int_0^{2\pi n} \frac{1 - \cos \phi}{\phi} d\phi \end{aligned}$$

since $\cos(\phi - n\pi) = \cos \phi$, and

$$W = \frac{I^2}{c} \sin^2(\omega t + \beta) \int_0^{2\pi n} \frac{1 - \cos \phi}{\phi} d\phi \quad (22)$$

or,

$$W = \frac{I^2}{c} \sin^2(\omega t + \beta) [\log_e 2\pi n + \gamma - Ci(2\pi n)] \quad (23)$$

where, $x = 0.5772 + \dots =$ Eulers constant, and

$$Ci(2\pi n) = \int_{\infty}^{2\pi n} \frac{\cos \phi}{\phi} d\phi.$$

Tables and curves of $Ci(x)$ are given in the appendix to Steinmetz' "Transient Electric Phenomena" and Jahnke-Emde's "Functiontafeln mit Formeln und Kurven."

For values of n greater than 2, $Ci(2\pi n)$ can be neglected in comparison with $\log_{\epsilon}(2\pi n)$ and

$$W = \frac{I^2}{c} \sin^2(\omega t + \beta) [\log_{\epsilon} 2\pi n + 0.5772] \quad (24)$$

(approximately) when $n > 2$.

The radiation resistance is then:

$$R = \frac{W}{I^2 \sin^2(\omega t + \beta)} \quad (25)$$

or,

$$R = \frac{1}{c} [\log_{\epsilon} 2\pi n + 0.5772 - Ci(2\pi n)] \quad (26)$$

in electrostatic cgs units, or,

$$R = \frac{1}{c} \cdot \frac{c^2}{10^9} [] = 30 [\log_{\epsilon} 2\pi n + 0.5772 - Ci(2\pi n)] \text{ ohms} \quad (27)$$

and,

$$R = 17.23 + 30 \log_{\epsilon}(2\pi n) \text{ ohms.} \quad (28)$$

(approximately) when $n > 2$.

A similar analysis for the case of a wire an odd number of wavelengths long results in formulas identical with those just given. A curve of radiation resistance versus length of radiator is shown in Fig. 21.

(c) Directivity

To date there has been no standard quantitative definition for directivity. For the present purpose we shall define this term as follows: "Directivity is the ratio of the power per unit solid angle flowing in the direction of maximum radiation to the average power per unit solid angle flowing in all directions from a radiating system." In this discussion we shall define unit solid angle as the solid angle subtended by unit area on a sphere of unit radius. Thus the total solid angle subtended by

any sphere is 4π . On a sphere of radius r the solid angle subtended by an area S is S/r^2 .

Poynting's vector, P , has already been defined as the power per unit area flowing through the surface of a sphere. Hence for any sphere of radius r the power per unit solid angle is Pr^2 . If P_m is the value of P in the direction of maximum radiation and W the total power radiated,

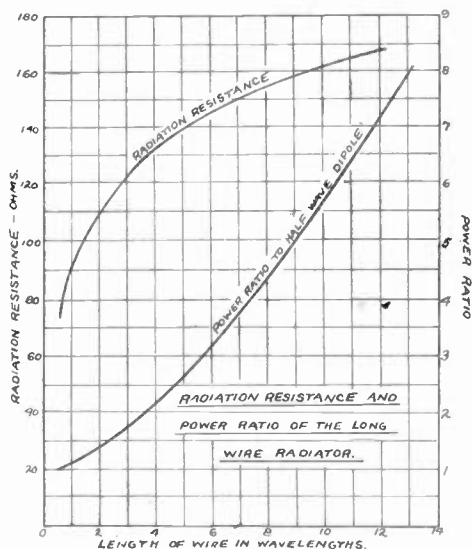

Fig. 21

then the average power per solid radian is $W/4\pi$ and, for the directivity, we have the relation:

$$D = \frac{4\pi r^2 P_m}{W} = \frac{cr^2 e_m^2}{W} \tag{29}$$

Since the total power W is the surface integral of P over the sphere and $P = c/4\pi e^2$ we obtain:

$$D = \frac{cr^2 e_m^2}{\frac{1}{4\pi} \iint_S ce^2 dS} = \frac{4\pi r^2 e_m^2}{\iint_S e^2 dS} \tag{30}$$

In the general case where the field intensity varies both with latitude and longitude, the element of area on the sphere is:

$$dS = r^2 \sin \theta d\theta d\phi.$$

In the particular case of a linear radiator where the intensity varies with the latitude only, we can take as our element of area a narrow zone for which $dS = 2\pi r^2 \sin \theta d\theta$.

Thus in the general case:

$$D = \frac{4\pi e_m^2}{\int_0^{2\pi} \int_0^\pi e^2 \sin \theta d\theta d\phi} \quad (31)$$

and in the special case of a single linear radiator:

$$D = \frac{4\pi r^2 e_m^2}{2\pi r^2 \cdot 2 \int_0^{\pi/2} e^2 \sin \theta d\theta} = \frac{e_m^2}{\int_0^{\pi/2} e^2 \sin \theta d\theta} \quad (32)$$

In practical work we use as a standard for comparing the relative directivity of directional systems the half-wave dipole. By using the value of e from (11) for $\theta = 90$ degrees (the angle of maximum radiation for the half-wave radiator) and the value of W from (23), and then substituting in (32) we obtain:

$$D = \frac{4}{\log_e 2\pi + 0.5772 - Ci(2\pi)} = \frac{4}{2.44} = 1.64 \quad (33)$$

for the half-wave dipole.

Incidentally, the radiation resistance determined by (28) is $30 \times 2.44 = 73.2$ ohms.

In some cases the very short dipole (Hertz doublet) is used as a standard of comparison. Its directivity is $3/2$.

From (10) and (28) the directivity of wires an even number of half wavelengths long is:

$$D = \frac{1}{\log_e 2\pi n + 0.5772 - Ci(2\pi n)} \frac{\sin^2\left(\frac{n\pi}{2} \cos \theta_m\right)}{\sin^2 \theta_m} \quad (34)$$

$$= \frac{120 \sin^2\left(\frac{n\pi}{2} \cos \theta_m\right)}{R \sin^2 \theta_m}$$

where θ_m is the angle of maximum radiation and R the radiation resistance in ohms.

For wires an odd number of half waves long the directivity is:

$$D = \frac{1}{\log_e 2\pi n + 0.5772 - Ci(2\pi n)} \frac{\cos^2\left(\frac{n\pi}{2} \cos \theta_m\right)}{\sin^2 \theta_m} \quad (35)$$

$$= \frac{120 \cos^2\left(\frac{n\pi}{2} \cos \theta_m\right)}{R \sin^2 \theta_m}$$

The power ratio to the half-wave dipole for any directional antenna system is $D/1.64$ or $0.61 D$. The power ratio to the Hertz doublet is $2/3 D$.

In Fig. 21 are shown curves of radiation resistance and power ratio to the half-wave dipole plotted as a function of length.

DESCRIPTION OF ANTENNA MODELS B AND C

(a) *General Description*

The antenna Models B and C are made up by combining long linear radiators in such a manner as to obtain a unidirectional characteristic.

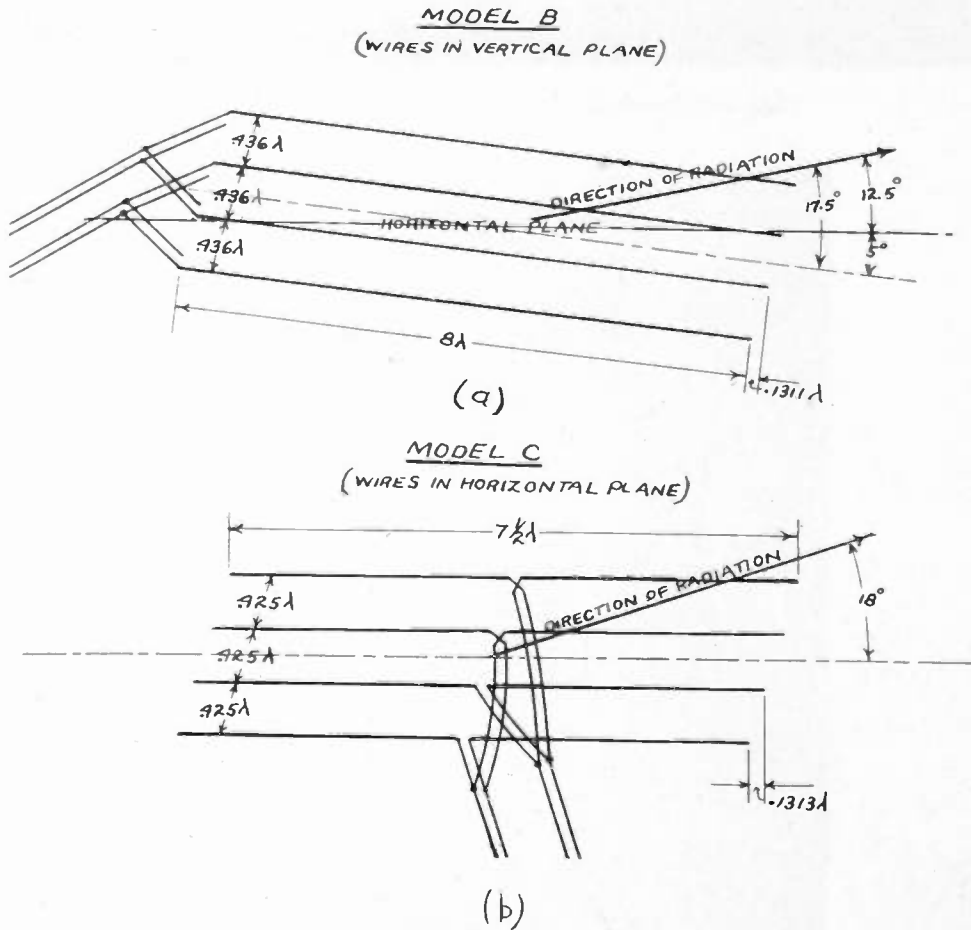

Fig. 22

The two models are very similar. The chief difference between them is that the Model B uses an array of wires in a vertical plane giving vertically polarized radiation whereas the radiators in the Model C are arranged in a horizontal plane and radiate horizontally polarized waves.

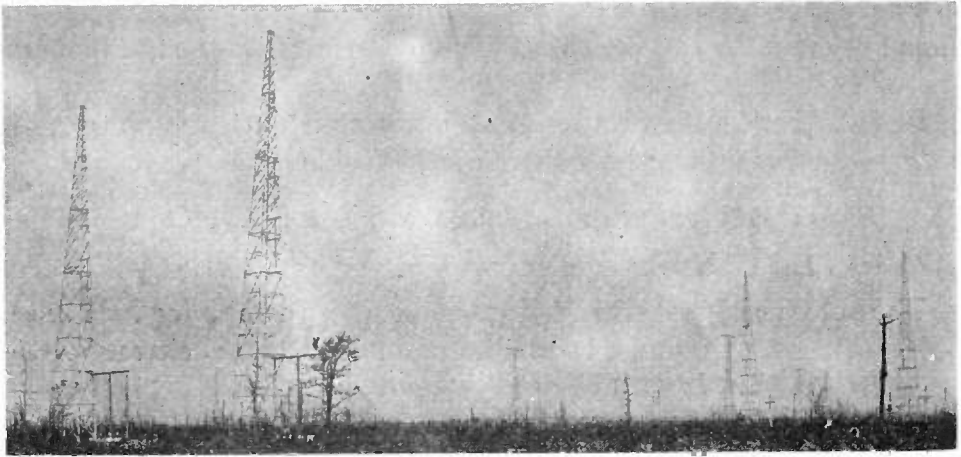

Fig. 23—A commercial type of Model B antenna:

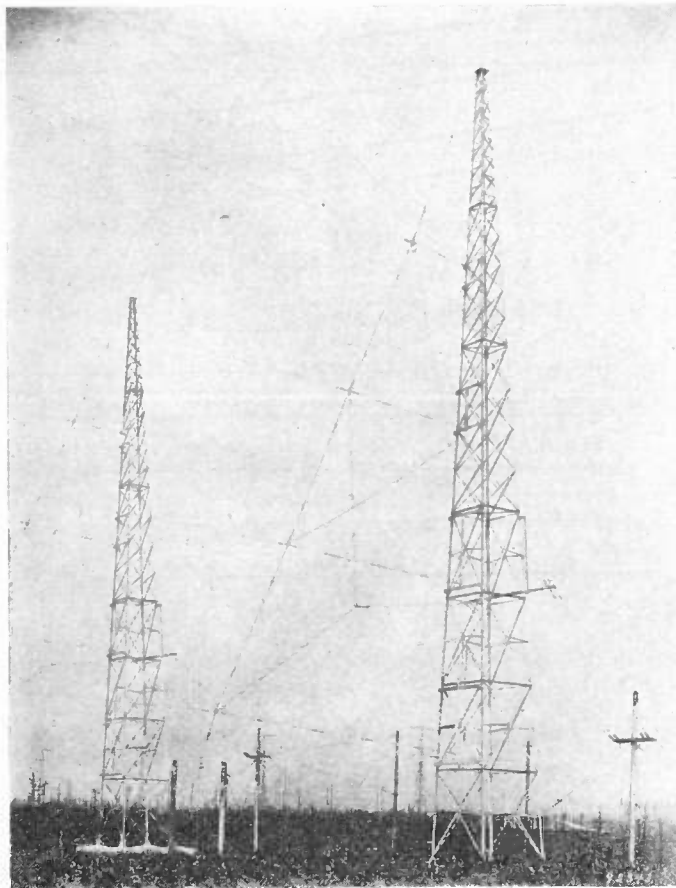

Fig. 24—Feeder details of Model B antenna.

According to the fundamentals of directive antenna technique, a certain concentration or gain of radiation in a special direction calls for

the spreading out over certain physical dimensions of the arrays of individual radiators. Therefore, the simpler the arrangement of these

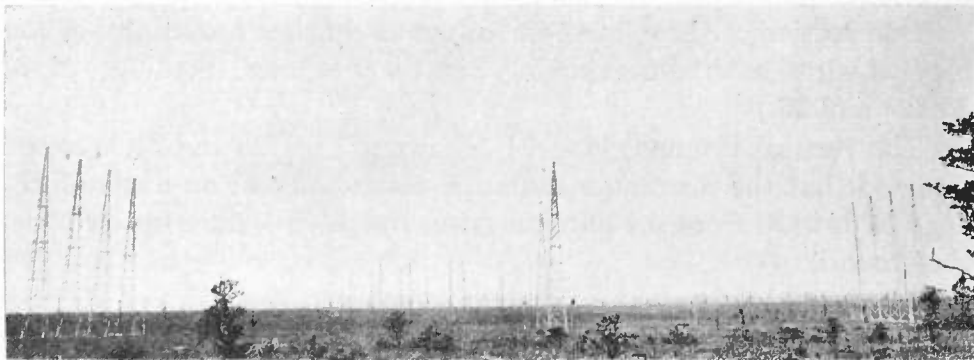

Fig. 25—A commercial type of Model C antenna.

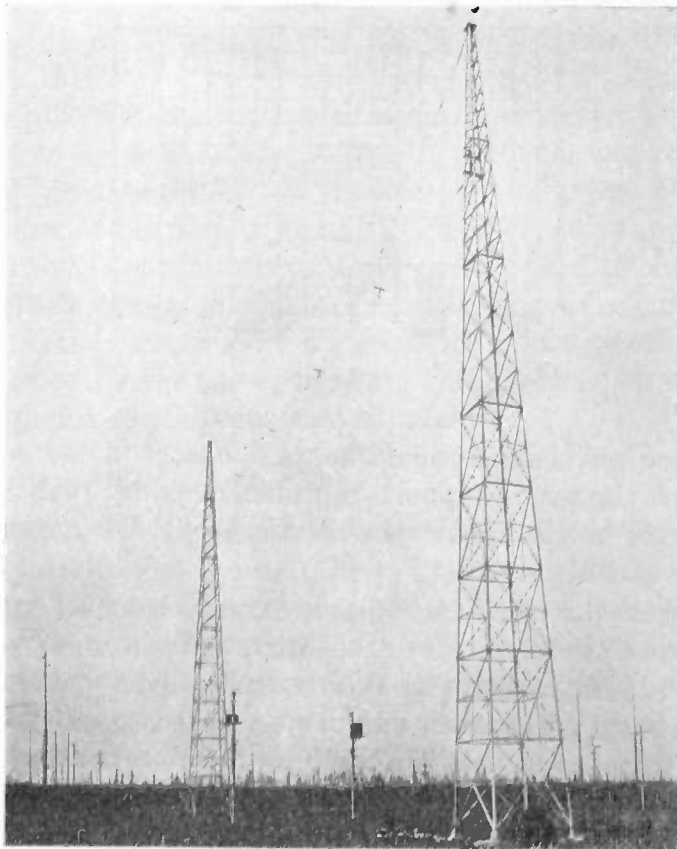

Fig. 26—Feeder details of Model C antenna.

arrays the less expensive will be the structure. The combination of several long linear radiators offers the simplest possible way of doing this. The antenna Models B and C resulted from an effort to obtain the

best possible combination of these radiators. In these models the wires are all in one plane and so staggered as to obtain a unidirectional characteristic.

One section, or bay, of these antennas consists essentially of four parallel wires, each approximately eight waves long. (See Figs. 22, 23, 24, 25, and 26.)

The vertical antenna, Model B, shown in Figs. 23 and 24, is so constructed that the maximum radiation takes place at an angle of 17.5 degrees upward from the antenna wires but 12.5 degrees upward from the ground.

The horizontal antenna, Model C, shown in Figs. 25 and 26, radiates at an angle of 18 degrees from the longitudinal center line of the antenna. The four wires are arranged in a plane parallel to the ground and at the most economical height. Tests have shown that a minimum

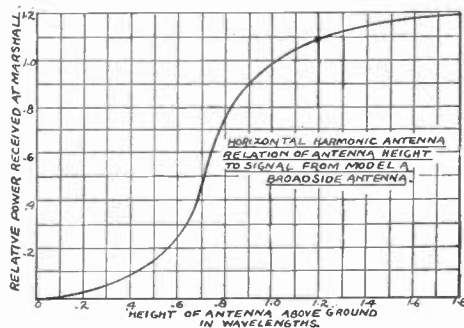

Fig. 27

height of one wavelength should be used, except in case of the longer waves, where the cost of supports is prohibitive. Fig. 27 shows the effect of varying the height above ground of a Model C antenna used on a wavelength of 16.7 meters.

When great directivity is required, several bays are broadsided on the same front at right angles to the direction of transmission and fed cophasially. In connection with the vertical model it was found particularly important to find the optimum spacing between bays. An experimental curve revealed that for two bays this spacing should be about two wavelengths. This was in accordance with the results of theoretical analysis.

It will be noted that the horizontal model may be broadsided either by a parallel arrangement or, in the case of an even number of bays, by reversing the stagger of every other bay, thus letting two adjacent bays form a "V." This gives a perfectly symmetrical layout and may, at times, fit in better with the shape of the available ground areas.

A special analysis of the possibilities of using steel towers was carried out.

The features in favor of steel towers are:

1. Saving of space (due to absence of guys)
2. Cleaner design
3. More permanent construction
4. Somewhat lower total cost

Of these points, Nos. 1, 2, and 3 are obvious. A careful detailed study of relative costs bore out point No. 4.

The outstanding objection to the use of steel towers was that they might affect the electrical characteristics of the antenna. It was believed that it should be possible to use steel towers without detrimental effects.

The tests carried out to verify this assumption consisted of imitating a steel tower by surrounding the wooden masts with cables in the form of a skirt.

It was found that the current set up in these cables was too small to be measured by ordinary measuring instruments and that it could be measured only by a tuned circuit indicator (a wave meter). It was attempted to produce particularly bad conditions by adjusting the length of the steel cables so as to tune to the frequency used. There was, however, very little effect obtained. Measurements of signal strength locally as well as at distant points showed the efficiency of the antenna to be unaffected by the presence of the steel cables. On the basis of these experiments steel towers were adopted.

(b) *Explanation of Action*

As previously explained, the radiation from a long linear radiator takes place in concentric cones. The radiation from a parallel pair of such radiators carrying currents of opposite phase will cancel in a direction perpendicular to the plane of these radiators. The radiation is then maximum in the plane of the wires and at angles coinciding with the angles of the cone.

With the pair of parallel radiators we get four main lobes of radiation, as shown in Fig. 28, having their maximum intensity in the plane of the wires. The intensity of these lobes in other planes through the axis AA decreases gradually to zero as we approach a plane perpendicular to the plane of the wires.

By staggering the ends of the wires, two of the four lobes are eliminated. This is done by arranging the two wires in the pair so that a line drawn through the ends of the wires forms an angle β with the axis

$A-A$, which is the complement of the angle α of maximum radiation with respect to the same axis. (See Fig. 29.)

In the direction B all points on one wire in the pair have a corresponding point on the other wire of opposite phase and on the same wave front in the direction B . Therefore, cancellation takes place in this direction. Cancellation also takes place in the direction opposite to

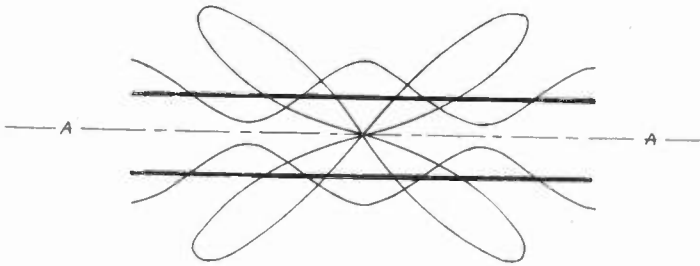

Fig. 28

B . The combination of two wires in this fashion constitutes the element on which the antenna Models B and C are based. The optimum spacing between the two wires is then the one which makes the radiation from two corresponding points on the pair add perfectly in the direction D of the remaining two lobes. This takes place when the distance $c = \lambda/2$.

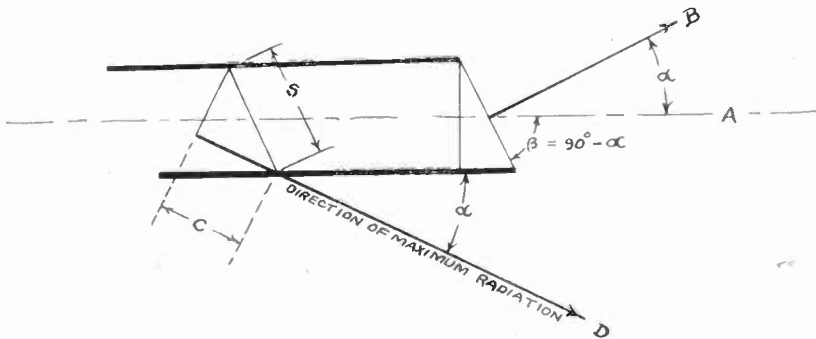

Fig. 29

The back ear is now eliminated by introducing a similar pair of wires at quarter-wave phase and quarter-wave space relation to the first pair. This is illustrated in Fig. 30(A).

The two antenna wires are designated by A and the two reflector wires by R . The pair A is identical with the pair R and both are identical with the pair previously described and shown in Fig. 29. One of the wires R (Fig. 30(A)) is sandwiched halfway between the wires A and the other falls outside one of these wires at an equal distance. The spacing between corresponding points on one reflector wire and its adjacent antenna wire then becomes $c/2$ or $\lambda/4$ in the chosen direction of radi-

tion. If R_1 leads A_1 by a 90-degree phase angle the space difference will cause cancellation of this lead in direction D and the two will add up their radiation in that direction. In the opposite direction the angle of lead is increased from 90 to 180 degrees due to the quarter-wave space difference, and cancellation will take place in that direction. A unidirectional beam is thus obtained.

One of the advantages of this arrangement wherein it differs from broadside methods, is that concentration is obtained both vertically and horizontally. This is a characteristic inherent with all end-on methods.

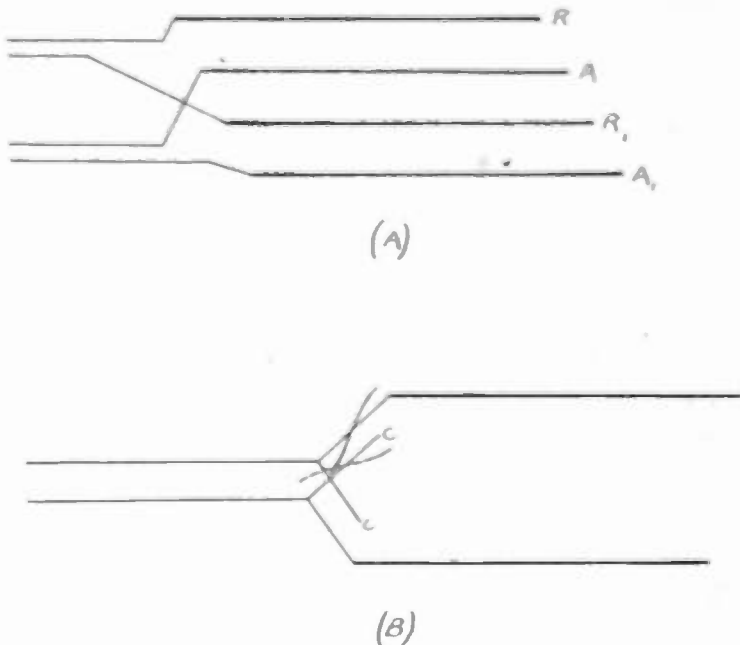

Fig. 30

As the wires in each pair are rather far apart, care must be taken that the connecting leads to the feeding transmission line do not cause unwanted radiation. One way to do this, which is the method used in the Model B antenna, is shown in Fig. 30(B). The length of the wires is so chosen as to produce opposing waves in the canceling sections C .

(c) *Tuning and Impedance Matching Circuits*

A convenient method by which tuning and phasing of the antenna circuits can be conveniently carried out has been developed. The arrangements used are shown in Fig. 31.

The short circuits S_1 and S_2 are so adjusted as to tune the antenna and connecting feed lines. The distance a is adjusted so that the

impedance at p_1 matches that of the quarter wave long connection between p_1 and p_2 . Thus there will be no reflection on this line and it will have only traveling waves. This being the case, it acts as a phase rotator giving a rotation of 90 degrees between p_1 and p_2 . The distance b is so adjusted that the antenna and reflector carry equal currents. The distance c is so adjusted that there is no reflection on the line from the transmitter. The short circuit S_3 is always kept one-quarter wavelength from point p_4 to kill end effect.

For the longer waves the dimensions of this form of tuning circuit become inconvenient and the more compact matching devices consisting of lumped inductances and capacities are used.

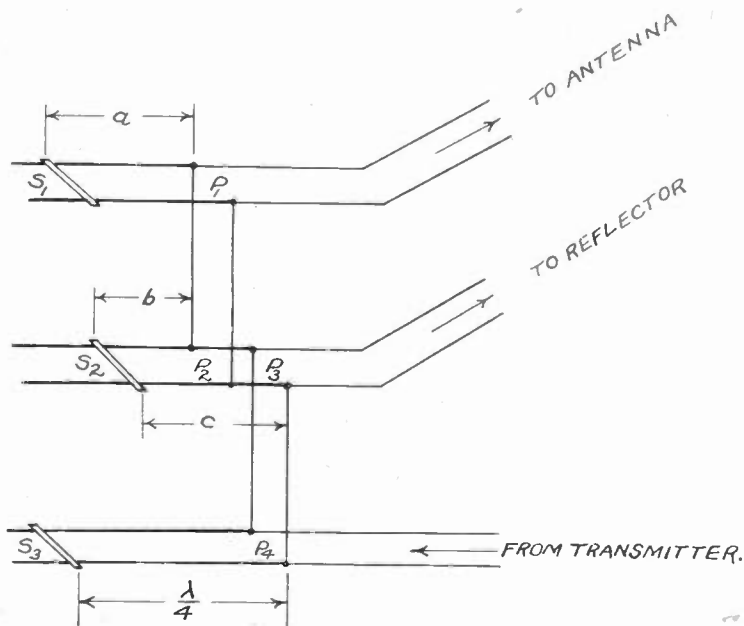

Fig. 31

(d) Directive Characteristics

Polar diagrams of relative power distribution in one plane show little in regard to the relative merits of antenna systems and are often very misleading. We should know the amount of power flowing in all directions throughout space. If we could place our antenna system at the center of a large sphere and make a survey of the amount of power flowing through each unit area of this sphere, our knowledge would be complete. If, from this data, we were to plot contour lines of equal intensity on a small sphere we should obtain an excellent picture of what takes place. Finding the sphere unhandy for use, we could cut it in half at the equator and project each hemisphere with its contour

lines and its coordinate lines of latitude and longitude on a plane sheet of paper. Such a diagram is, of course, distorted in area but presents a good picture of the distribution of radiation. Figs. 32 and 33 are examples of such diagrams and show the characteristics for one and two bays respectively of the Model B antenna. It will be seen from

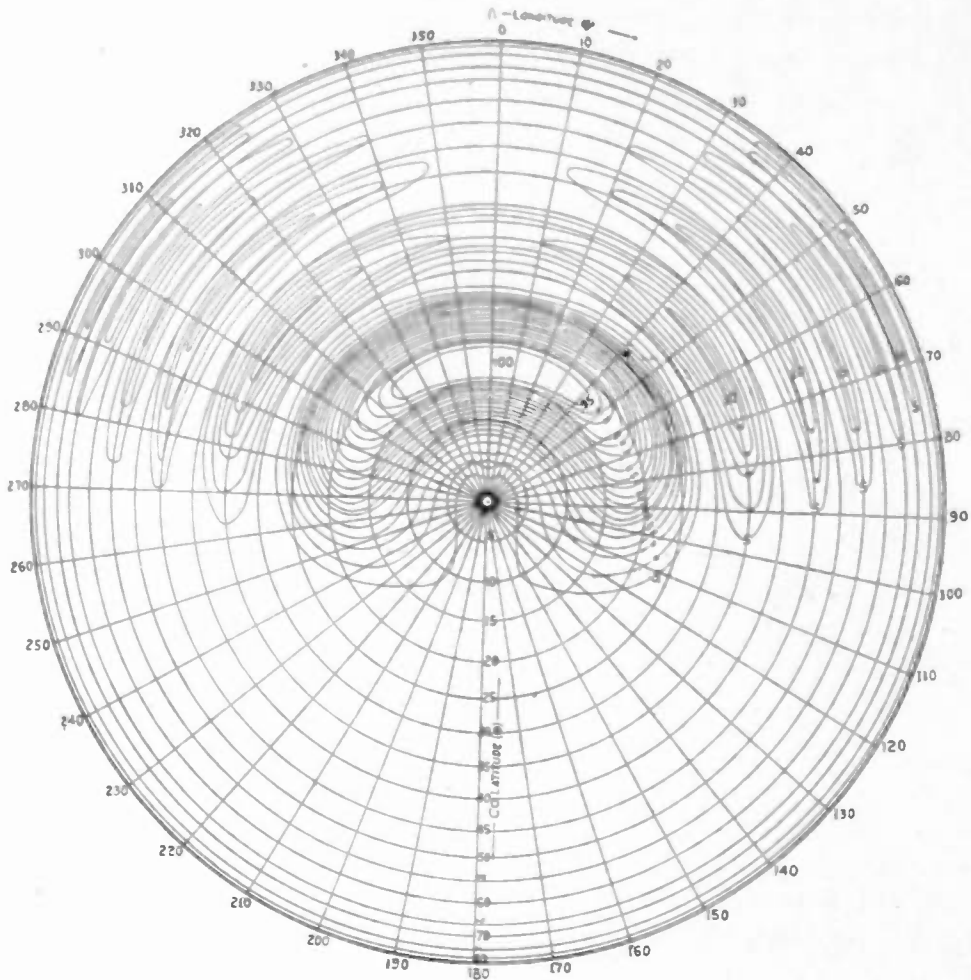

Fig. 32—This map is a projection of front half of imaginary sphere with one-bay vertical harmonic wire projector in the center.

Fig. 33 that the beam from two bays of the Model B antenna is remarkably like that of a search light.

(e) *Method of Calculating Directive Characteristics*

Consider two similar parallel wires spaced in any manner and let S be the line connecting the centers of these wires. (Fig. 34). The field intensity at any point in space is the instantaneous sum of the two components due to the wires. Let the wire pair be at the center of an

imaginary sphere whose radius is so great that lines from any point P on the surface of the sphere to any points on the radiating wires may be considered parallel. We can then neglect the effect of differences in distance upon the amplitudes and need only consider the phase. Let us take the line midway between the wires as our polar axis and measure

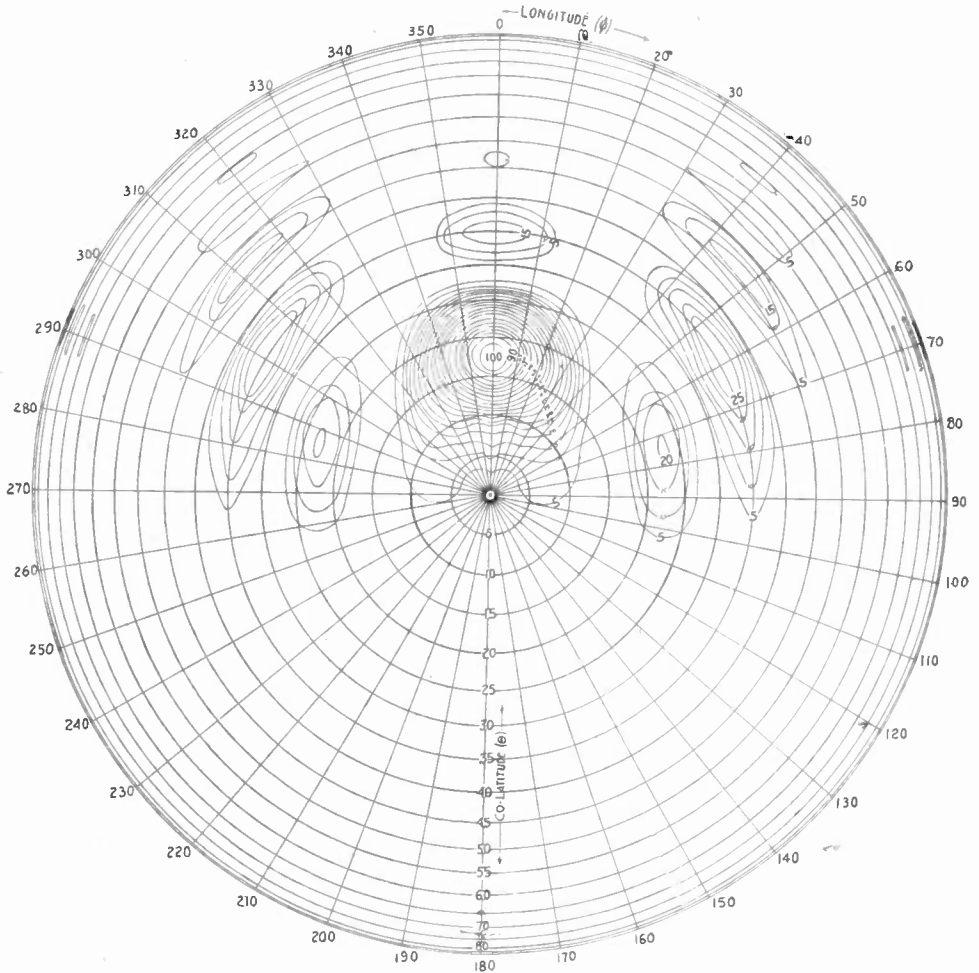

Fig. 33—This map is a projection of front half of imaginary sphere with two-bay vertical harmonic wire projector in the center.

positions of the point P in terms of the colatitude angle θ and the longitude angle ϕ using the intersection of the plane of the wires with the surface of the sphere as the zero meridian.

At a great distance we can consider the field components from the wires as originating at their centers. Now the difference in the distances of travel of the two components is the projection Δd of the line S upon the radius vector r to P . The difference in time of travel, Δt

must then be: $\Delta t = \Delta d/c$ where c is the velocity of light. The corresponding phase angle is then:

$$\gamma = 2\pi f \frac{\Delta d}{c} = 2\pi \frac{\Delta d}{\lambda} \quad (36)$$

where λ is the wavelength, and the wave from b leads the wave from a by this phase angle, provided the currents are in phase in the two wires. Suppose the current in b lags the current in a by the phase angle \mathcal{E} . The total phase angle between the two field components is then:

$$\psi = \gamma - \mathcal{E} \quad (37)$$

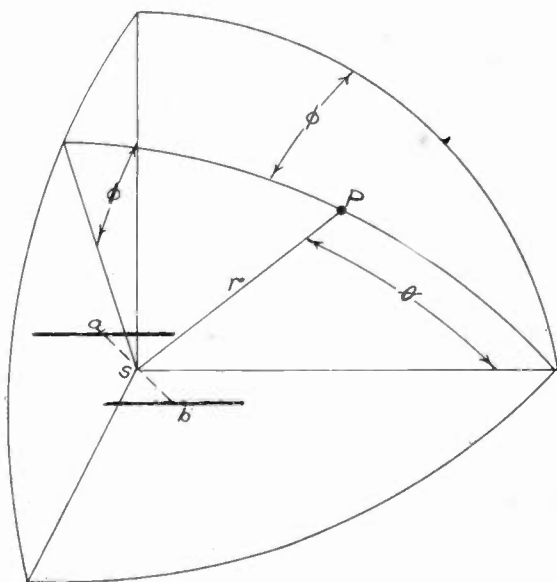

Fig. 34

Let $e_a = E_1 \sin \omega t$ be the field at P due to wire a . Then that due to wire b is $e_b = E_1 \sin (\omega t + \psi)$. Then the total field e_2 due to both is:

$$e_2 = e_a + e_b = 2E_1 \sin \left(\omega t + \frac{\psi}{2} \right) \cos \frac{\psi}{2} \quad (38)$$

We have already stated that the power P per unit area flowing through the surface of the sphere is $(c/4\pi)e^2$. We are interested in the time average of P which we shall designate as \bar{P} and, to save words, shall simply call it "power." Since the time average of $\sin^2(\omega t + \psi)$ is one-half regardless of the phase angle ψ ,

$$\bar{P} = \frac{c}{8\pi} E^2 \quad (39)$$

Hence for the pair:

$$\bar{P}_2 = \frac{c}{8\pi} 4E_1^2 \cos^2 \frac{\psi_1}{2} \quad (40)$$

$$= 4\bar{P}_1 \cos^2 \frac{\psi_1}{2} = 2\bar{P}_1(1 + \cos \psi_1) \quad (41)$$

where \bar{P}_1 is the power for one wire alone in space.

We can consider this pair as a unit and combine it with a second identical pair, spaced from the first in any desired manner, by the same procedure just outlined. If ψ_2 is the total phase angle between the field components, as determined by the spacing between centers of the pairs and the phase relations of the currents in the wires, the power \bar{P}_4 for the four is:

$$\bar{P}_4 = 4\bar{P}_2 \cos^2 \frac{2\psi}{2} = 16\bar{P}_1 \cos^2 \frac{\psi_1}{2} \cos^2 \frac{\psi_2}{2} \quad (42)$$

We can again combine this unit of four wires with a second similar unit spaced in any desired manner. If ψ_3 is the phase angle between the field components due to each of these sets of four wires, we obtain for the total power due to the complete system of eight wires:

$$\bar{P}_8 = 4\bar{P}_4 \cos^2 \frac{\psi_3}{2} = 64\bar{P}_1 \cos^2 \frac{\psi_1}{2} \cos^2 \frac{\psi_2}{2} \cos^2 \frac{\psi_3}{2} \quad (43)$$

We have shown in the discussion of single wires that the power for one wire is:

$$\bar{P} = \frac{I^2}{r^2 c} \frac{\sin^2 \left(\frac{n\pi}{2} \cos \theta \right)}{\sin \theta} \quad (44)$$

when the length is an even multiple of a half wave and

$$\bar{P} = \frac{I^2}{r^2 c} \frac{\cos^2 \left(\frac{n\pi}{2} \cos \theta \right)}{\sin \theta} \quad (45)$$

when the length is an odd multiple of a half wave.

In order to determine the power in any direction (θ, ϕ) it is now only necessary to determine the phase angles in terms of the coördinates (θ, ϕ) for substitution in the above formulas. We shall first consider the pair eight waves long forming the antenna proper. It is apparent from the geometry of the arrangement shown in Fig. 29 that

the length of the spacing line S is, $S = \lambda/2 \sin 35 \text{ degrees} = 0.872\lambda$. The line S makes an angle of $(90 - 17.5)$ degrees or 1.265 radians with the polar axis. Therefore, in the plane of the wires, where $\phi = 0$ the projection Δd of the line S on the radius vector r is:

$$\Delta d = S \cos (1.265 - \theta) = 0.872 \cos (1.265 - \theta) \quad (46)$$

but for the general case of any direction (θ, ϕ) the projection is:

$$\begin{aligned} \Delta d &= 0.872 [\cos 1.265 \cos \theta + \sin 1.265 \sin \theta \cos \phi] \lambda \\ &= 0.872 [0.954 \cos \theta + 0.3005 \sin \theta \cos \phi] \lambda. \end{aligned} \quad (47)$$

Hence the phase angle γ due to the spacing becomes:

$$\gamma = 2\pi \frac{\Delta d}{\lambda} = 2\pi \cdot 0.872 [0.954 \cos \theta + 0.3005 \sin \theta \cos \phi] \quad (48)$$

and, since the currents in the two wires are in phase opposition, the total phase angle is:

$$\psi = \pi - 2\pi \cdot 0.872 [0.954 \cos \theta + 0.3005 \sin \theta \cos \phi]. \quad (49)$$

The spacing of the reflector pair from the antenna pair is one-half S and along the same line as S , and the two pairs are fed in quarter-phase relation. Therefore, the total phase angle is one-half that for a single pair or:

$$\psi_2 = \frac{\psi_1}{2}.$$

For the case of two sections of Model B antenna spaced apart by a distance x the projection of the spacing line x on the radius vector is:

$$\Delta d = x \sin \theta \sin \phi \quad (50)$$

and since the two sections are fed in phase, the phase angle is:

$$\psi_3 = 2\pi \frac{x}{\lambda} \sin \theta \sin \phi. \quad (51)$$

The complete expression for the power flow in any direction from a two-section vertical model system having a spacing x between sections is:

$$\begin{aligned} \bar{P}_8 &= \frac{I^2 \sin^2 (8\pi \cos \theta)}{r^2 c \sin \theta} \cos^2 \left[\frac{\pi}{2} - 0.831\pi \cos \theta - 0.262\pi \sin \theta \cos \phi \right] \\ &\cdot \cos^2 \left[\frac{\pi}{4} - 0.4155\pi \cos \theta - 0.131\pi \sin \theta \cos \phi \right] \\ &\cdot \cos^2 \left[\pi \frac{x}{\lambda} \sin \theta \sin \phi \right]. \end{aligned} \quad (52)$$

According to the definition which has been given the directivity is

$$D = \frac{\bar{P}_{\max}}{\frac{1}{4\pi} \cdot W} \tag{53}$$

where W is the total power radiated. Since all the power radiated must flow through the surface of the imaginary sphere which we have been considering, the total power W must be the surface integral of P over the sphere. Hence,

$$\begin{aligned} W &= \iint_S \bar{P} dS \\ &= \int_0^{2\pi} \int_0^\pi \bar{P} r^2 \sin \theta d\theta d\phi \end{aligned} \tag{54}$$

since the element of surface dS on the sphere is $dS = r^2 \sin \theta d\theta d\phi$.

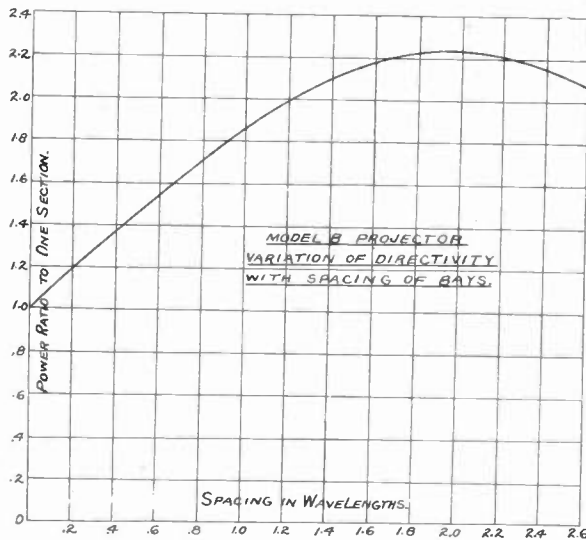

Fig. 35

Due to the extreme complexity of the expression for P (52) this integral cannot be evaluated in terms of elementary functions. Being a double integral mechanical integration involves the plotting of a number of curves. To determine the best spacing for the broadsiding of two sections, it is necessary to repeat the process of evaluation for several values of X . If, by performing one integration, the expression is reduced to a single integral, the labor is greatly reduced, it being necessary to plot only one curve for each condition. This operation has been done with the aid of Bessel's functions.

It can be proved that two sections of any type of radiating system will give an improvement of 2 to 1 in directivity over a single section if they are spaced apart a very great distance. The improvement ratio is an oscillating function of the spacing. It rises from 1 for zero spacing to a value somewhat greater than 2 at some particular spacing, depending upon the characteristics of the single section. As the spacing is fur-

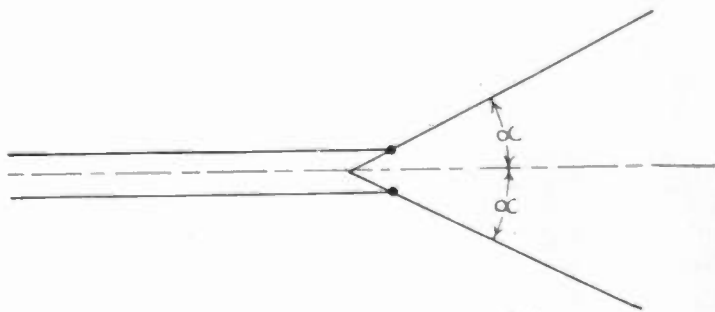

Fig. 36

ther increased the ratio oscillates about a value of 2. For the Model B antenna the first maximum is obtained with a spacing of two wavelengths. Fig. 35 shows the way in which the power varies with the spacing.

The theoretical directivity for one section alone was computed as 26.3 and for a two-section system with 2λ spacing as 57.2. The corresponding ratios to a half-wave dipole are 16 and 35.0.

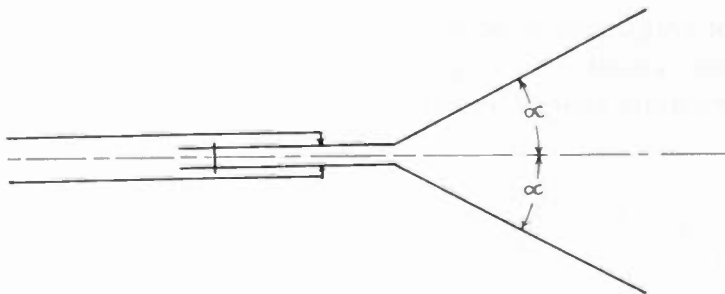

Fig. 37

THE MODEL D ANTENNA

(a) *Description of System*

The fundamental radiating unit of the Model D antenna is a wire, having a length several times the wavelength used and which is partially folded upon itself from the center as shown in Fig. 36. The energy is fed from a transmission line in a manner similar to that in common use with half-wave dipoles.

For convenience in making adjustments, the modified arrangement shown in Fig. 37 is actually used. The correct angle (2α) between the wires depends upon their length in terms of wavelength.

Fig. 38 is a schematic diagram of a complete section of this system

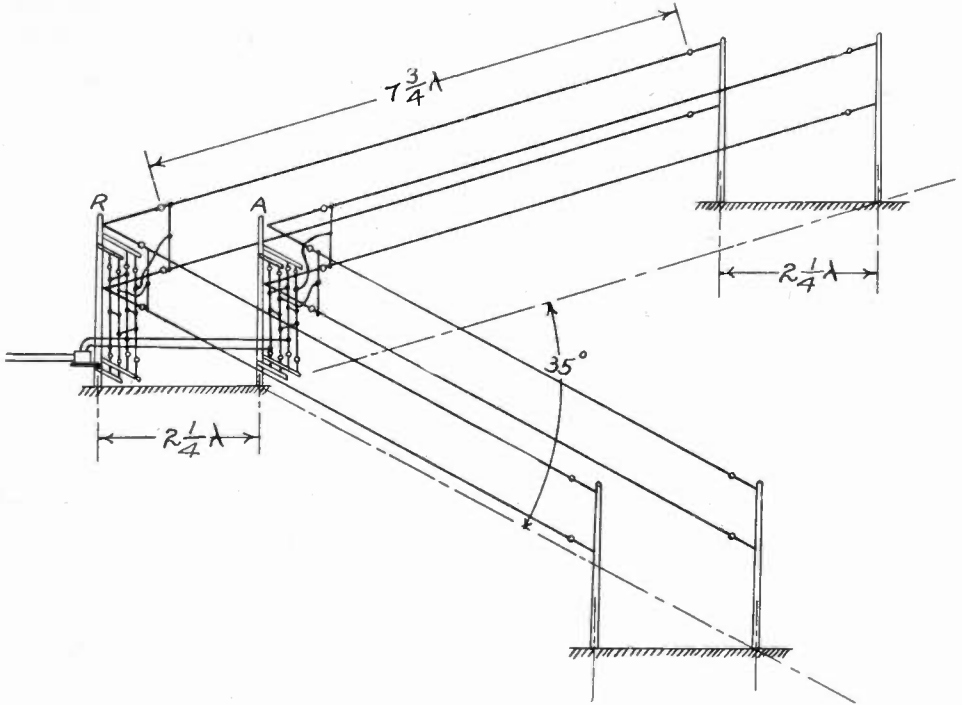

Fig. 38

as used for transmission with wavelengths in the vicinity of 17 meters. One section consists of two pairs of *V* units, *A* and *R*. Each pair consists of two units spaced one above the other at a distance of approxi-

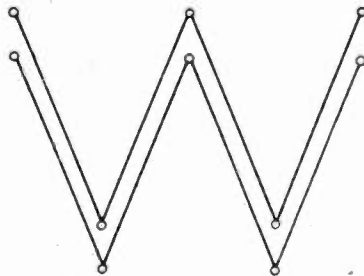
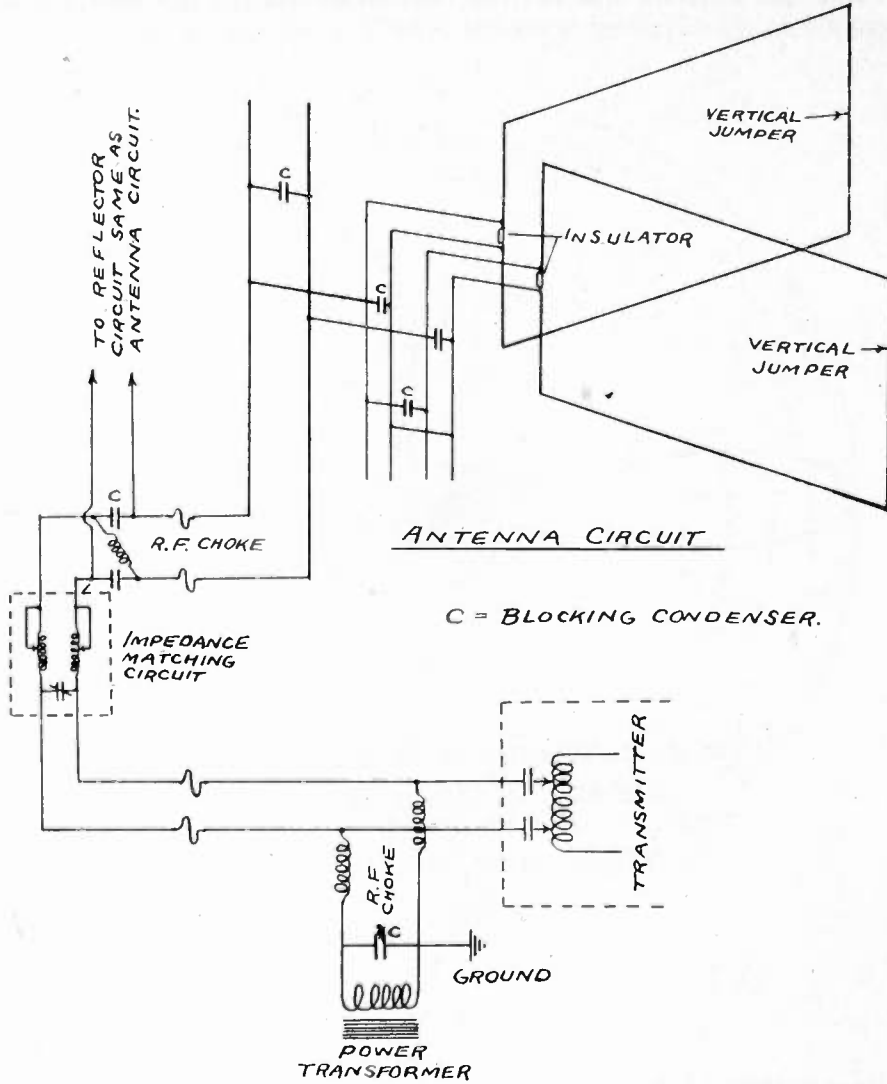

Fig. 39

mately one-half wavelength. The units are fed in phase. The two pairs, *A* and *R*, are separated by a distance of $2 \frac{1}{4}$ wavelengths along the center line, and pair *A* is fed in quarter-phase relation, either leading or lagging, with respect to *R*, depending upon whether transmission is to

be in the direction *A-R* or the direction *R-A*. With the connections as shown in the sketch transmission is in the direction *R-A*. To reverse the direction it is necessary only to make a transposition in the wires of the transmission line between *A* and *R*.



SCHMATIC DIAGRAM SLEET MELTING CIRCUIT FOR MODEL "D" PROJECTOR

Fig. 40

In Fig. 39 is shown a schematic plan view of a two section system which takes the shape of a *W*. It is seen that a single section requires six supporting structures and each additional section four additional supports.

This antenna is readily adapted for sleet melting. An arrangement whereby sleet can be melted from both the antenna and its transmission line at one time and without interruption to service is shown in Fig. 40. Radiation from the vertical jumper is negligible due to the fact that the current flow is from both ends toward the center of each jumper.

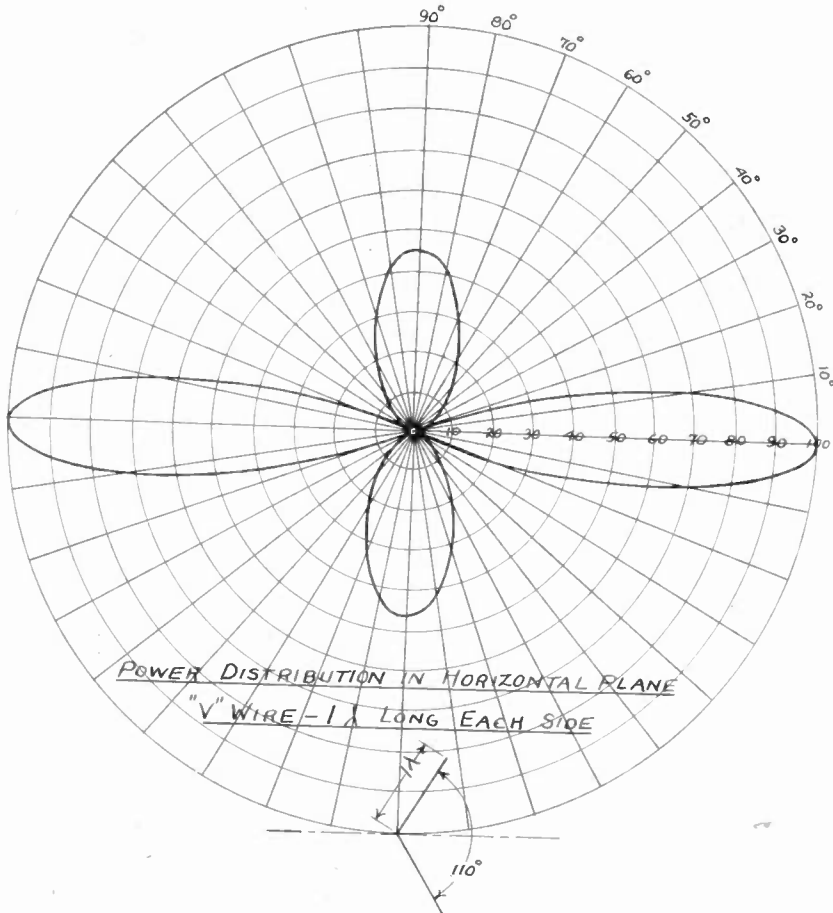

Fig. 41

(b) *Explanation of Action*

If a wire, as shown in Fig. 36, has the proper relation between length (in wavelengths) and included angle and is fed in such a manner that the ends are at opposite instantaneous potential, an excellent bidirectional radiating system is obtained. Maximum radiation takes place along the line bisecting the angle. If such a V is connected to a transmission line in the manner already shown in Fig. 37, the correct potential relations will result.

Fig. 41 is a polar diagram showing the power distribution for a V

wire, having sides equal to one wave, in the plane of the wires. Fig. 42 is a similar diagram in a plane at right angles to the plane of the wires, which bisects the angle between them. For the sake of simplicity we shall henceforth call these two planes the horizontal plane and the vertical plane respectively. Figs. 43 and 44 are polar diagrams showing distributions of power for a V wire whose sides are each eight waves long.

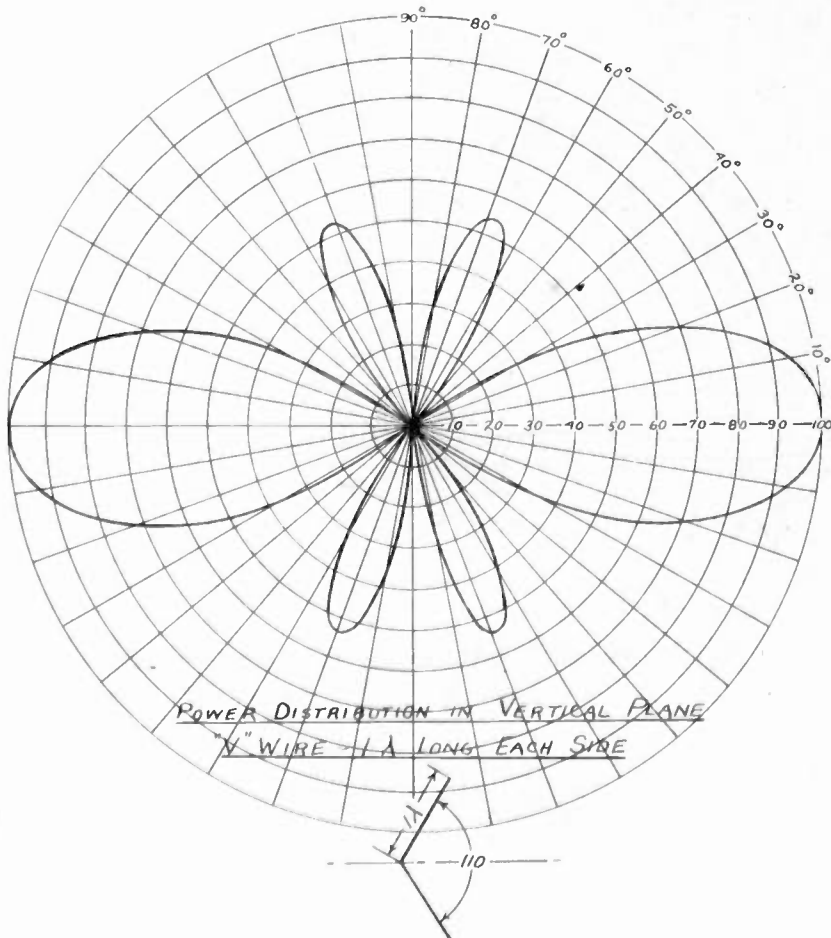

Fig. 42

The power distribution from a V wire can be considered as the effect resulting from the superposition of the radiated field waves from each side of the V. In Fig. 17 were shown a number of polar diagrams of relative power distribution for linear radiators of various lengths. In all cases the direction angle is shown with respect to the wire itself as the axis of reference. If we form a V from two such wires, making the included angle equal to twice the direction angle of the largest lobe, the two component field waves will add in phase along the center line and

maximum radiation will take place in the two directions along this line. In other directions in the horizontal plane the two components more or less cancel each other by wave interference. In directions at high angles to the horizon we have further reduction in intensities due to the non-parallel directions of the component field vectors. Fig. 45 shows in a qualitative way the manner in which the diagrams for the two wires forming the sides of the V combine to form the resultant pattern.

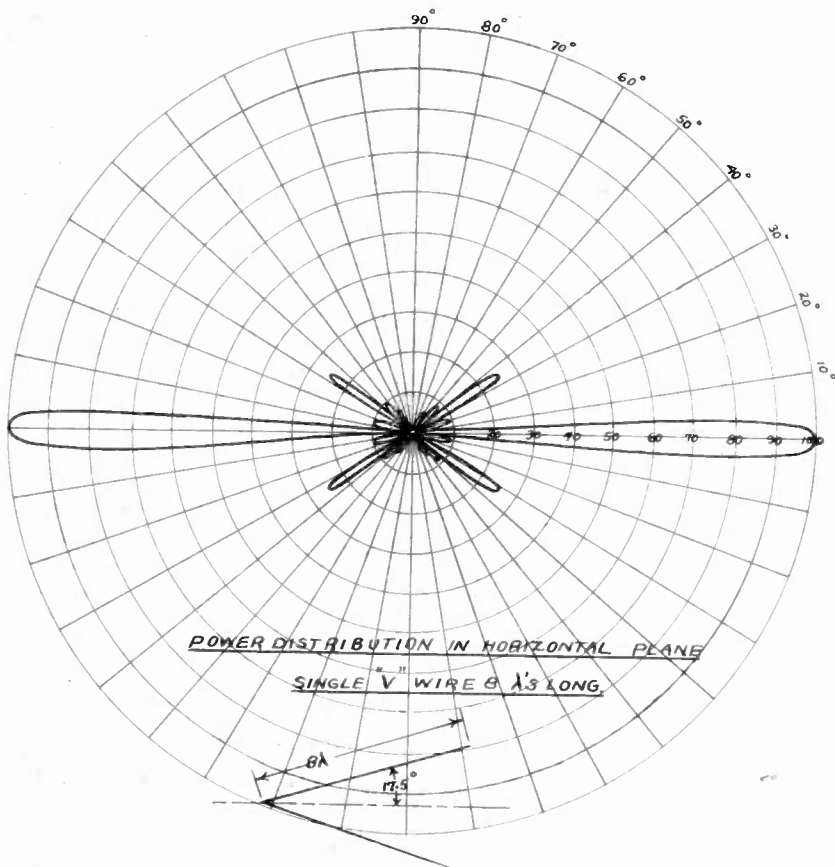

Fig. 43

Fig. 46 is a contour map of the power distribution from a V unit of sides equal to eight wavelengths. This shows only half the directive characteristic. The other half is identical with that shown.

Although the radiation at high angles is too low to show on the contour map, it is distributed over a large portion of the area of the sphere and therefore represents an appreciable portion of the total power. By placing a second V unit above or below the first at a distance of a half wavelength or more, and feeding it cophasially, the high angle radiation is reduced. As previously explained, a unidirec-

tional characteristic is obtained by using two radiator systems in the usual space and phase quadrature relation.

Fig. 47 is a contour map showing the power distribution on an imaginary sphere enclosing a complete antenna section. The antenna is considered as being in space far removed from ground. In the actual case the effect of ground must be considered.

The effect of ground upon a horizontally polarized wave is such as

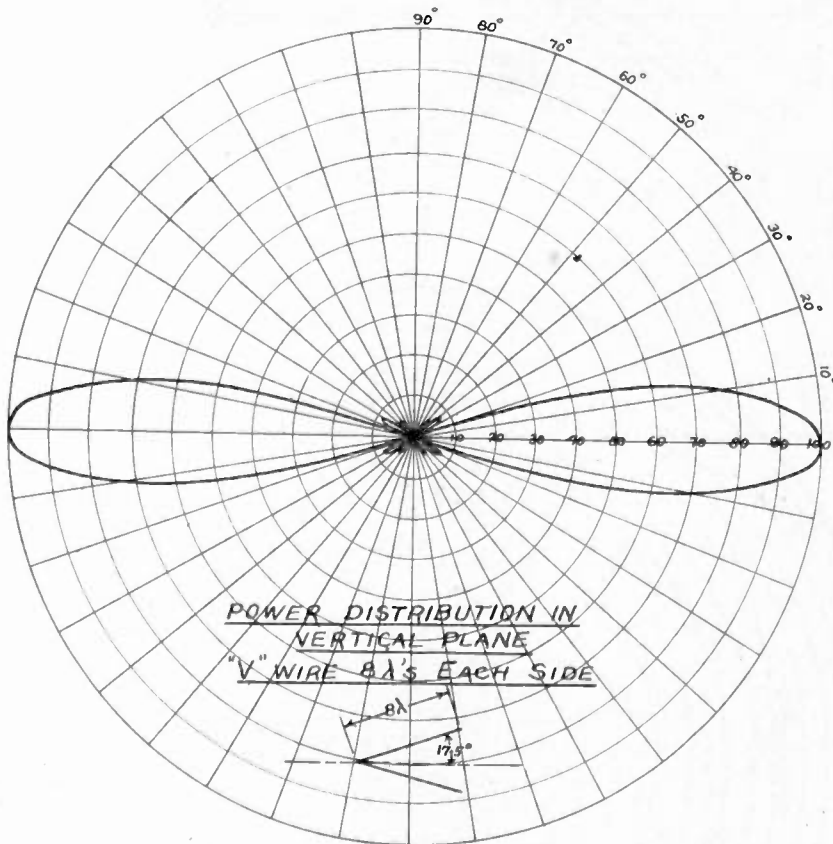

Fig. 44

to cancel radiation at zero angle to the horizon. Fig. 48 is a polar diagram showing the power distribution in the vertical plane when the antenna is located over a perfectly conducting ground and over sandy ground such as at Rocky Point. It is seen that there is little difference in the result in the two cases. The contour map, Fig. 49, shows the power distribution for a one-section antenna located over perfect ground. A comparison of this figure with Fig. 47 shows the effect of ground. Figs. 50 and 51 are contour maps, taking into account the effect of ground for two and three section systems respectively.

(c) *Theory*

1. The Folded Wire

Before considering the theory of the folded wire radiating system

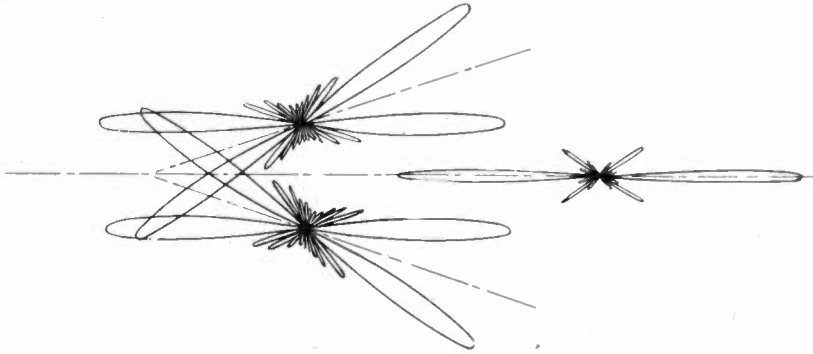

Fig. 45

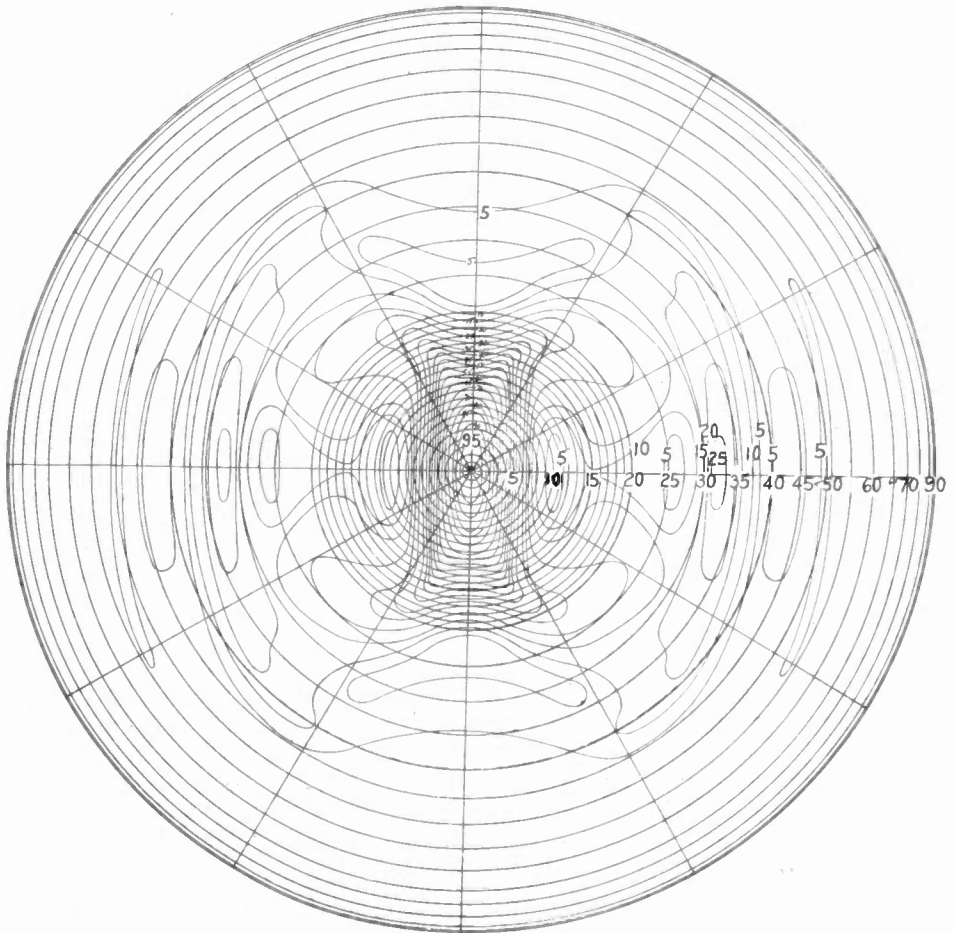

Fig. 46—This map is the projection of a sphere having at its center a single V wire eight wavelengths long. Reverse side of sphere identical with frontside.

we shall discuss certain principles in regard to radiated fields. We have not yet stressed the fact that electric and magnetic field intensities are vector quantities.

At a great distance from a linear radiator the direction of the electric field is at right angles to the radius vector and lies along the meridional line of an imaginary sphere having as its polar axis the axis of the

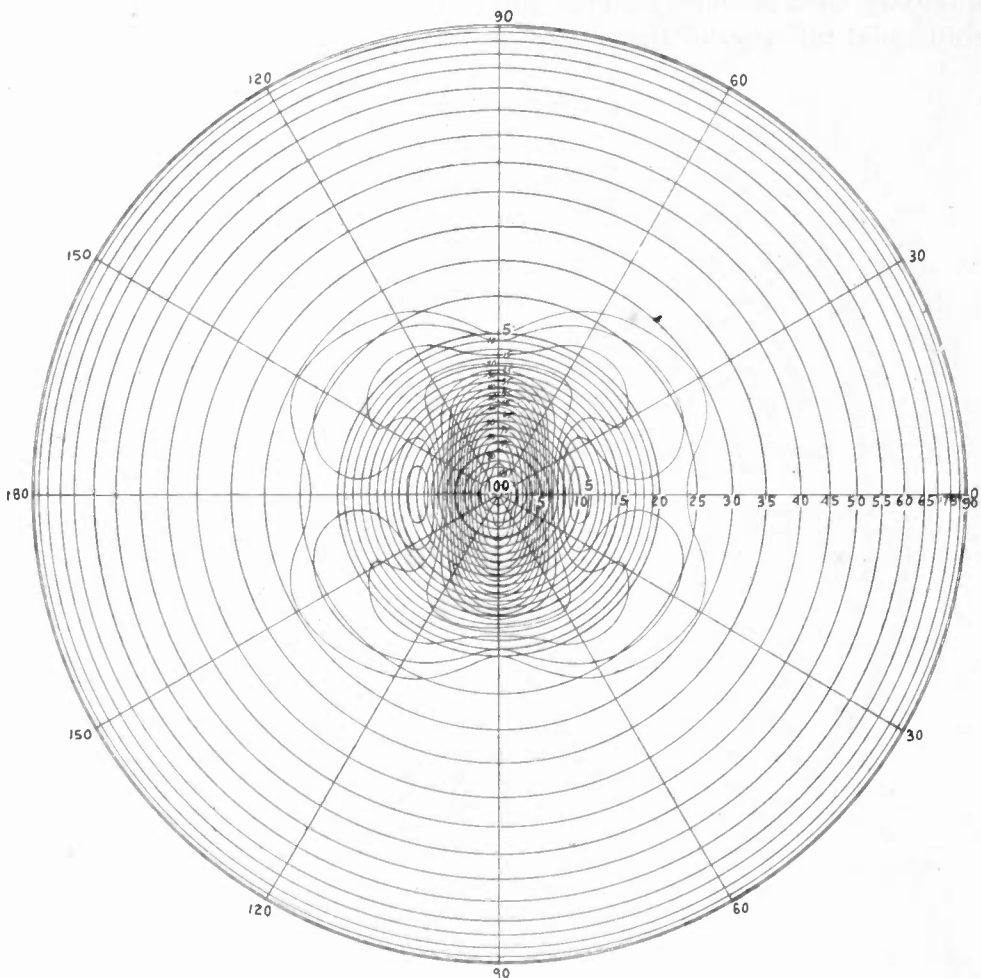

Fig. 47—This map is the projection of a hemisphere having at its center a one bay Model D projector. Projector in space, no ground effect considered.

radiator. The direction of the magnetic field is at right angles to that of the electric field and lies along the latitudinal line.

At a great distance from two parallel wires the instantaneous electric intensity vector components are parallel and the resultant instantaneous field is the arithmetical sum of the components. Though the currents in the two radiators may be in phase there is, in general, a phase difference between the component field waves at the point of

reference due to the difference in time taken to travel the unequal distances to a distant point. Although we may, in this case, obtain the effective value of the resultant field by vectorial addition of the components it should be clearly understood that we are not adding true vectors but are simply making use of the principle that sine waves may be added vectorially. The distinction between a true vector quantity such as electric field intensity and the representation of a sinusoidal function of time, such as a current, by a vector is essential

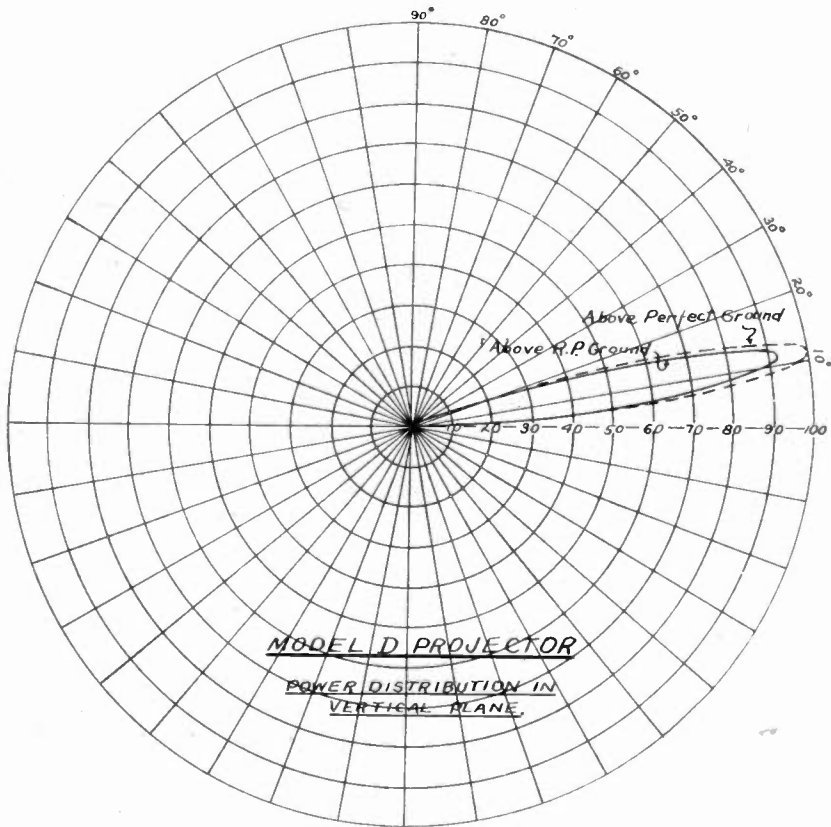

Fig. 48

to a clear understanding of the discussion to follow. The use of vectors to represent sine waves is avoided throughout this discussion in order to reduce the possibility of confusion to a minimum.

In the case where two radiators are not parallel the vector field components are in general not parallel and the resultant field is the instantaneous vector sum. In general the components differ in amplitude, phase, and direction and the terminus of the resultant vector describes an ellipse during the period of each cycle. This condition is called elliptical polarization. Circular and plane polarization then be-

come special cases of the more general elliptical polarization. Fig. 52 is a vector diagram for two sinusoidal vectors having an amplitude ratio of 2:1, differing in phase by an angle of 45 degrees, and in direction by an angle of 60 degrees. Fig. 53 shows the variation of the power for this case.

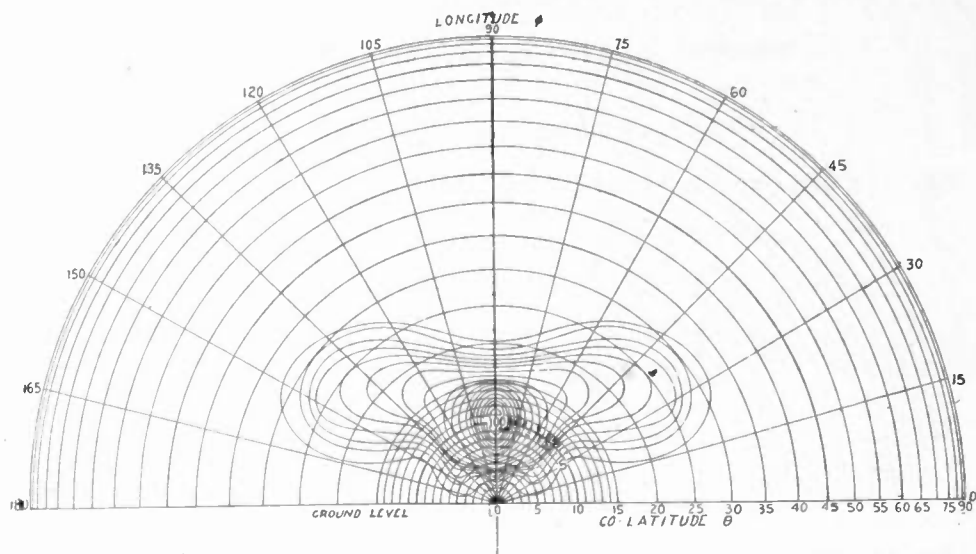

Fig. 49—This map is the projection of the upper front quadrant of an imaginary sphere having at its center a one-bay Model D projector. Projector above perfect ground.

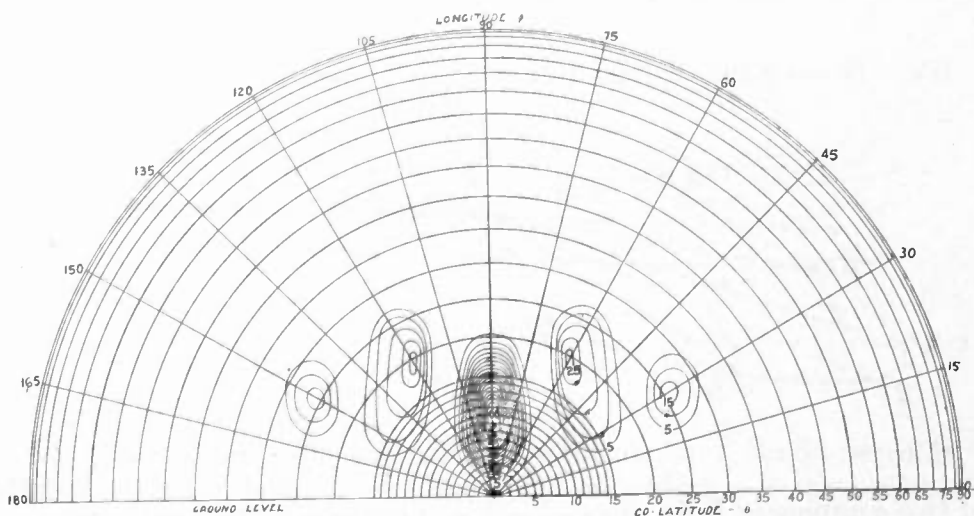

Fig. 50—This map is the projection of an imaginary sphere having at its center a two-bay Model D projector above a perfect ground.

We shall need expressions for the resultant field and the average power for the general case of elliptical polarization. We shall from now on designate a vector electric intensity by e and the magnitude of e

by e , the vector amplitude by E and the magnitude of the amplitude by E . It follows that:

$$e = E \sin (\omega t + \beta).$$

Assume that we have an electric intensity e which is the resultant

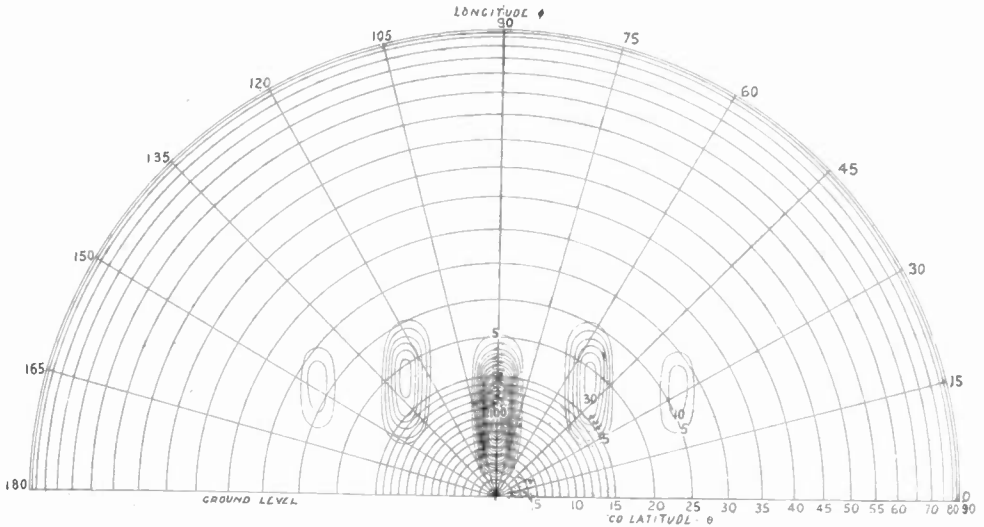

Fig. 51—This map is the projection of an imaginary sphere having at its center a three-bay Model D projector above a perfect ground.

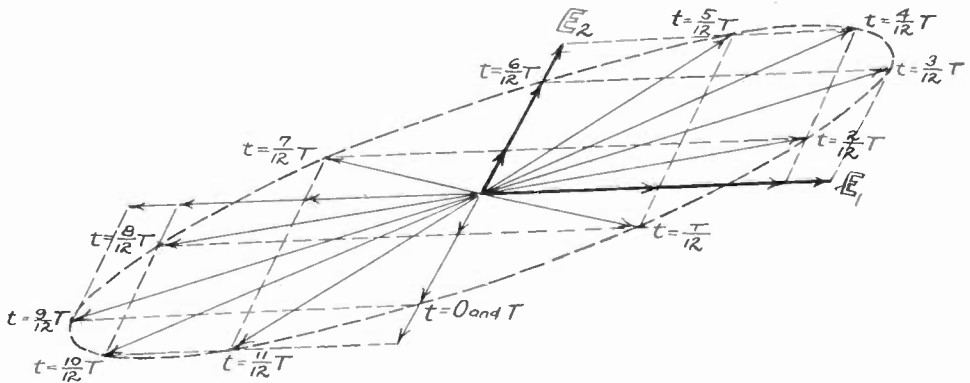

Fig. 52

of two component intensities e_a and e_b . Let these components differ in direction by the angle γ and in phase by the angle ψ . Then:

$$e_a = E_a \sin \omega t \text{ and } e_b = E_b \sin [\omega t + \psi] \tag{55}$$

and,

$$e = e_a + e_b = E_a \sin \omega t + E_b \sin [\omega t + \psi]. \tag{56}$$

For the magnitude of the resultant intensity we obtain, by solving the vector triangle:

$$e = \sqrt{e_a^2 + e_b^2 + 2e_a e_b \cos \gamma}$$

$$= \sqrt{E_a^2 \sin^2 \omega t + E_b^2 \sin^2 (\omega t + \psi) + 2E_a E_b \sin \omega t \sin (\omega t + \psi) \cos \gamma} \quad (57)$$

The power per unit area (Poynting's vector) becomes:

$$P = \frac{c}{4\pi} e^2 = \frac{c}{4\pi} [E_a^2 \sin^2 \omega t + E_b^2 \sin^2 (\omega t + \psi) + 2E_a E_b \sin \omega t \sin (\omega t + \psi) \cos \gamma] \quad (58)$$

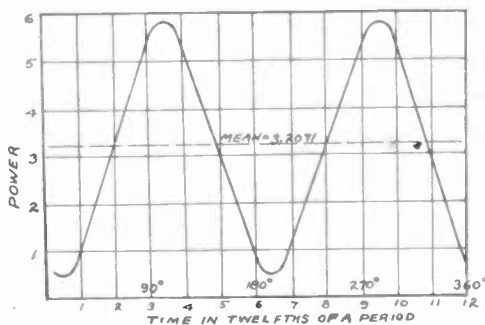

Fig. 53

and the time average of the power per unit area becomes:

$$\bar{P} = \frac{1}{2\pi} \int_0^{2\pi} P d(\omega t) = \frac{c}{8\pi} (E_a^2 + E_b^2 + 2E_a E_b \cos \gamma \cos \psi). \quad (59)$$

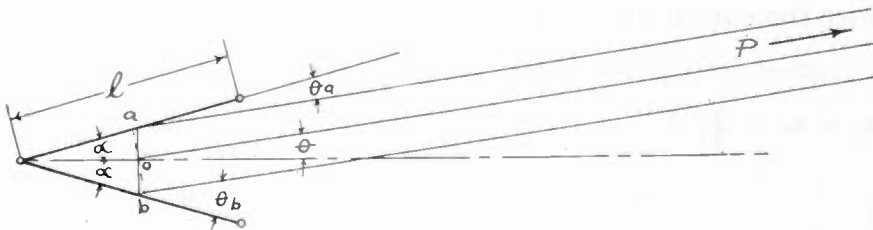

Fig. 54

We shall now discuss the field distribution for a single partially folded wire in the plane of the wires. For convenience let us call this the horizontal plane.

At a point P in this plane, whose distance is so great, compared with the dimensions of the radiating V , that all lines from points of the V to P can be considered parallel, the directions of the electric components are parallel and the resultant field is, at any instant, the arithmetical sum of the components. The phase of the total field from

either wire is the same as the phase of the field from a small element at the center of the wire. Therefore, we may consider the resultant field at P to be due to the fields e_a and e_b from each wire originating at the center points a and b . In Fig. 54 let us take as reference time the time at which a wave from O arrives at P . The wave from a will take Δt seconds longer and the wave from b Δt seconds less than a wave from O where $\Delta t = \Delta d/c$. From the geometry of the figure:

$$\Delta d = \frac{l}{2} \sin \alpha \sin \theta \quad (60)$$

where l is the length of the wire.

To save space we shall consider only the case where the sides of the V are an even number of half waves long.

From (10) we obtain for the two field components, after substituting $t + \Delta t$ and $t - \Delta t$ to take care of the differences in the time of travel to P :

$$e_a = \frac{2I \sin \left(\frac{n\pi}{2} \cos \theta_a \right)}{cr \sin \theta_a} \sin \omega(t - \Delta t) = E_a \sin \omega(t - \Delta t) \quad (61)$$

$$e_b = \frac{2I \sin \left(\frac{n\pi}{2} \cos \theta_b \right)}{cr_0 \sin \theta_b} \sin \omega(t + \Delta t) = E_b \sin \omega(t + \Delta t) \quad (62)$$

in which $\theta_a = \theta - \alpha$, $\theta_b = \theta + \alpha$, and $\Delta t = l/2c \sin \alpha \cos \theta$.

Since the currents in a and b are in opposite phase

$$e = e_a - e_b = \sqrt{E_a^2 + E_b^2 - 2E_a E_b \cos \left(2\pi \frac{l}{\lambda} \sin \alpha \sin \theta \right)} \sin(\omega t + \beta) \quad (63)$$

and the time average of the power per unit area becomes:

$$\bar{P} = \frac{c}{8\pi} \left[E_a^2 + E_b^2 - 2E_a E_b \cos \left(2\pi \frac{l}{\lambda} \sin \alpha \sin \theta \right) \right] \quad (64)$$

from which the relative values of the power distribution in the horizontal plane may be computed.

Throughout the remainder of this discussion we shall use the word "power" to indicate the time average of the power per unit area and designate this by \bar{P} .

In the plane at right angles to the plane of the wires and including the bisector, which, for convenience, is designated as the vertical plane, the distances to each wire are equal and the time difference of travel zero. However, in this plane, in proceeding from the horizontal to the vertical direction the angle between the directions of the component vectors changes from zero to $(\pi - 2\alpha)$. The two electric field vectors are equal and lie along the meridian lines of two concentric spheres, one having as its polar axis the axis of the wire a and the other the axis of wire b as shown in Fig. 55. If θ is the direction angle to the point P with reference to the bisector and θ_a and θ_b the angles to the wire axes, then

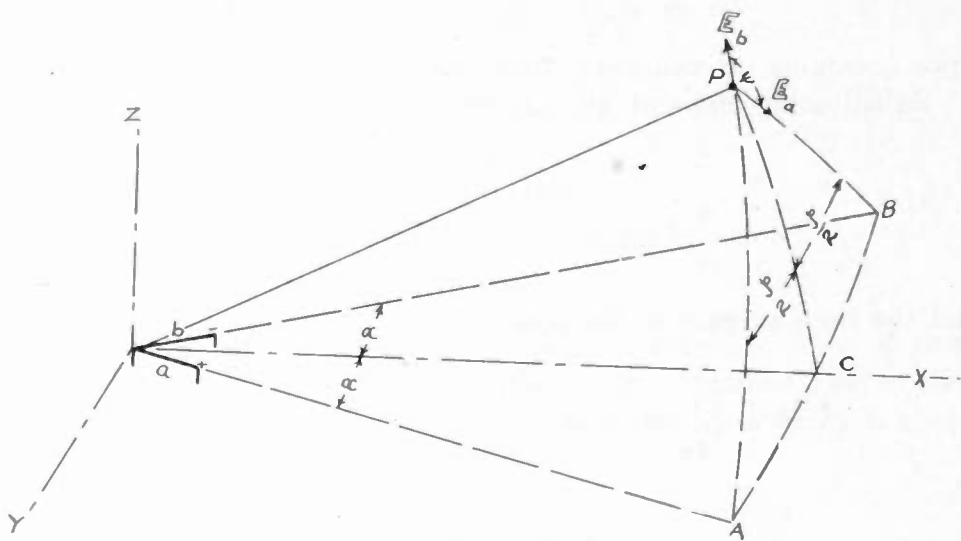

Fig. 55

$\theta_a = \theta_b$. θ_a and ζ are obtained by solving the right spherical triangle $A C P$, resulting in the relations

$$\cos \theta_a = \cos \theta \cos \alpha \quad (65)$$

$$\sin \frac{p}{2} = \frac{\sin \alpha}{\sin \theta_a} = \frac{\sin \alpha}{\sqrt{1 - \cos^2 \theta \cos^2 \alpha}} \quad (66)$$

The resultant intensity must be the vector sum of the components:

$$e = e_a + e_b$$

but,

$$e_a = e_b$$

therefore,

$$e = 2e_a \cos \frac{\gamma}{2} \quad (67)$$

where γ is the angle between the directions. However, since the wires are at opposite polarity, the angle

$$\gamma = \pi - \zeta \quad (68)$$

where ζ is the angle between the two meridians.

Hence,

$$\begin{aligned} e &= 2e_a \sin \frac{\zeta}{2} \\ &= \frac{4I}{cr} \sin \omega t \frac{\sin \left(\frac{n\pi}{2} \cos \frac{\theta_a}{2} \right)}{\sin \theta_a} \sin \frac{\zeta}{2} \end{aligned} \quad (69)$$

upon obtaining the value of e_a from (10).

Substituting (65) and (66) into (69) we obtain:

$$e = \frac{4}{cr} I \sin \omega t \frac{\sin \left(\frac{n\pi}{2} \cos \alpha \cos \theta \right) \sin \alpha}{1 - \cos^2 \theta \cos^2 \alpha} \quad (70)$$

and the time average of the power is

$$\bar{P} = \left| \frac{c}{4\pi} e^2 \right|_{\text{ave}} = \frac{2I^2 \sin^2 \left(\frac{n\pi}{2} \cos \alpha \cdot \cos \theta \right)}{\pi cr [1 - \cos^2 \theta \cos^2 \alpha]^2} \quad (71)$$

or,

$$\bar{P} \propto \frac{\sin^2 \left(\frac{n\pi}{2} \cos \alpha \cdot \cos \theta \right)}{[1 - \cos^2 \theta \cos^2 \alpha]^2} \quad (72)$$

and from this proportionality can be calculated the relative power distribution in the vertical plane. The power distribution for V wires having sides one wave and eight waves long respectively have already been shown in Figs. 42 and 44.

In planes other than the two already considered, the field vector components differ in amplitude, direction and phase. We have already shown how this results in elliptical polarization and derived the formula for the power. In order to make use of the formula we must first determine the phase angle and the direction angle between the two vector components.

The phase angle between the wave from a and the wave from b is: $\psi = \omega \Delta t = \omega \Delta d / c$ where Δd is the projection of the line s , connecting the centers of the wires, upon the radius vector r . In spherical coordinates, (see Fig. 56.)

$$\Delta d = s \sin \theta \cos \phi \tag{73}$$

but,

$$s = l \sin \alpha$$

therefore,

$$\psi = 2\pi \frac{l}{\lambda} \sin \alpha \sin \theta \cos \phi. \tag{74}$$

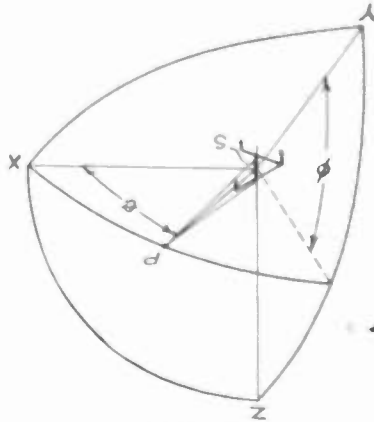

Fig. 56

The vector field components lie along the meridian lines of two superimposed spheres having as their polar axes continuations of the wires as shown in Fig. 57. The angle γ between the vectors is $\pi - \zeta$

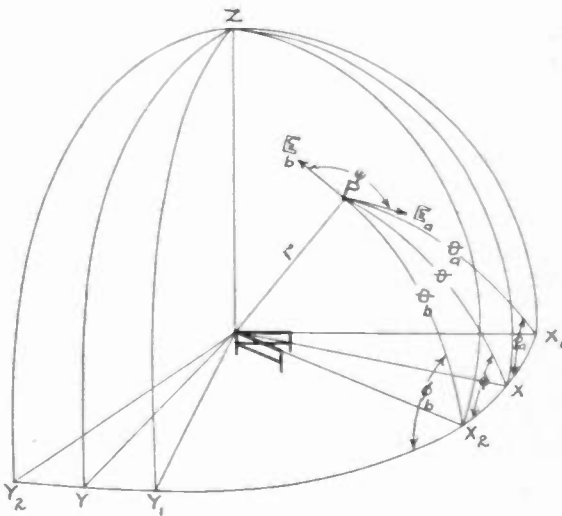

Fig. 57

where ζ is the angle between the meridians. To determine ζ in terms of the coördinates (θ, ϕ) it is necessary to solve the oblique spherical triangle X_1PX_2 . We also need θ_a and θ_b in terms of θ and ϕ in order to determine the amplitudes of e_a and e_b .

By spherical trigonometry:

$$\cos \theta_a = \cos \theta \cos \alpha + \sin \theta \sin \alpha \cos \phi \quad (75)$$

$$\cos \theta_b = \cos \theta \cos \alpha - \sin \theta \sin \alpha \cos \phi \quad (76)$$

and,

$$\cos \frac{\zeta}{2} = \sqrt{\frac{\sin \left(\frac{\theta_a}{2} + \frac{\theta_b}{2} - \alpha \right) \sin \left(\frac{\theta_a}{2} + \frac{\theta_b}{2} + \alpha \right)}{\sin \theta_a \sin \theta_b}} \quad (77)$$

Upon the substitution of $\pi - \zeta$ for γ in (64) we obtain:

$$\bar{P} = \frac{c}{8\pi} (E_a^2 + E_b^2 - 2E_a E_b \cos \zeta \cos \psi). \quad (78)$$

Having obtained θ_a and θ_b from (75) and (76) we can obtain E_a and E_b from (10), ψ from (74), and ζ from (77) which, upon substitution in (78), give us the power radiated in any direction (θ, ϕ) . The contour map resulting from such calculations has been shown in Fig. 46.

2. The Complete Antenna Section

If we space two like linear radiators in any manner whatsoever, as long as their axes remain parallel, the field intensity at any point in space is $2e_1 \cos \psi/2$ where ψ is the phase angle determined in the proper manner and e_1 the intensity due to one radiator alone. If \bar{P}_1 is the power due to one alone, the power due to both is $4\bar{P}_1 \cos^2 \psi/2$. We can combine any number of pairs of groups according to this law. In the system under discussion we have units resulting in elliptical polarization and we wish to investigate the laws for arrays of such units.

The intensity in an elliptically polarized wave can always be resolved into two harmonic components, one acting along the major axis and one along the minor. A similar case in mechanics is the motion of a pendulum when describing an elliptic orbit. Suppose we have two identical radiating systems in which flow equal currents and which are spaced in any manner whatever as long as the corresponding elements in the two systems remain parallel. Assume that at a point P at a great distance from the two systems we find the phase angle to be ψ , after taking proper account of time of travel and relative phase of currents. Let e_a be the intensity due to either system alone. Let its major and minor components be e_a' and e_a'' , respectively, and E_a' and E_a'' the amplitudes of these components. The total field amplitude E' along the major axis is then:

$$E_a' = 2E_a' \cos \frac{\psi}{2} \quad (79)$$

and the total field amplitude E'' along the minor axis is:

$$E'' = 2E_a'' \cos \frac{\psi}{2} \quad (80)$$

The power due to the intensity along the major axis is:

$$\bar{P}' = \frac{c}{8\pi} 4E'^2 \cos^2 \frac{\psi}{2} \quad (81)$$

and for the minor axis:

$$\bar{P}'' = \frac{c}{8\pi} 4E''^2 \cos^2 \frac{\psi}{2} \quad (82)$$

and the total power is:

$$\bar{P} = \bar{P}' + \bar{P}'' = \frac{c}{8\pi} 4(E_a'^2 + E_a''^2) \cos^2 \frac{\psi}{2} \quad (83)$$

but the power due to either system alone is

$$\bar{P}_a = \frac{c}{8\pi} (E_a'^2 + E_a''^2) = \frac{c}{8\pi} E_a^2 \quad (84)$$

Therefore, by substitution the total power is

$$\bar{P} = 4\bar{P}_a \cos^2 \frac{\psi}{2} \quad (85)$$

which is the same as if the two systems were radiating plane polarized waves. Therefore we can treat arrays of units radiating elliptically polarized waves in the same manner as arrays of simple oscillators.

If we place two identical radiating systems one above the other with a spacing s the phase angle between the two component field waves will be zero for directions in the horizontal plane ($\phi = 0$). At a point in any particular direction (θ, ϕ) in space the phase angle ψ between the components must be: $\psi = 2\pi\Delta d/\lambda$ where Δd is the projection of the vertical line s on the radius vector to the point P . In terms of the spherical coordinates θ, ϕ ,

$$\Delta d = S \sin \theta \sin \phi \quad (86)$$

If \bar{P}_1 is the power for one system alone then the power for the combination is:

$$\bar{P}_2 = 4\bar{P}_1 \cos^2 \left(\frac{\pi S}{\lambda} \sin \theta \sin \phi \right) \quad (87)$$

from (85).

To obtain a unidirectional system we place a second pair (*b*) of *V* wires behind the first pair (*a*) a distance *q* equal to an odd number of quarter waves and feed system (*b*) leading (*a*) in phase by an angle $2\pi q/\lambda$. At a point *P* in any direction θ, ϕ , in space the difference in time of travel of the waves from *a* and *b* is $\Delta d/c$ where Δd is the projection of the horizontal line *q* upon the radius vector to *P*. Hence $\Delta d = q \cos \theta$ and the corresponding phase angle is $2\pi q/\lambda \cos \theta$. The total phase angle ψ is the difference between the phase angle due to the currents and the phase angle due to difference in time of travel. Hence

$$\psi = 2\pi \frac{q}{\lambda} (1 - \cos \theta) = \frac{4\pi q}{\lambda} \sin^2 \frac{\theta}{2} \quad (88)$$

Upon substituting this value of the phase angle in (85) we obtain:

$$\bar{P}_{ab} = 4\bar{P}_a \cos^2 \left(2\pi \frac{q}{\lambda} \sin^2 \frac{\theta}{2} \right) \quad (89)$$

which becomes, after replacing \bar{P}_a with its value in terms of \bar{P}_1 from (85):

$$\bar{P}_{ab} = 16\bar{P}_1 \cos^2 \left(\frac{\pi S}{\lambda} \sin \theta \sin \phi \right) \cos^2 \left(2\pi \frac{q}{\lambda} \sin^2 \frac{\theta}{2} \right) \quad (90)$$

Knowing the value of \bar{P}_1 for the single *V* this equation enables us to determine the distribution through space for the complete antenna section. The resulting contour map has been shown in Fig. 47.

So far we have considered the antenna system in space only, neglecting any effects due to ground. In most treatments of radiating systems the ground is assumed a perfect conductor in which case it acts as a perfect mirror. In most cases this assumption is not justified. For short wavelengths the ground acts much more like a perfect dielectric than a perfect conductor. At Rocky Point the soil is sand of extremely small conductivity and having a dielectric constant of approximately 9. In this case the conductivity may be neglected in determining the reflection.

It can be shown from electromagnetic theory that the coefficient of reflection for a wave polarized at right angles to the plane of incidence (horizontal polarization) is, for a pure dielectric, given by the formula:

$$K_h = \frac{\cos \delta - \sqrt{\epsilon - \sin^2 \delta}}{\cos \delta + \sqrt{\epsilon - \sin^2 \delta}} \quad (91)$$

where ϵ is the dielectric constant and δ the angle of incidence. $\delta = 90$ degrees $-\theta$ where θ is the angle to the horizontal.

When a wave is polarized in the plane of incidence the coefficient of reflection is:

$$K_i = \frac{\epsilon \cos \delta - \sqrt{\epsilon - \sin^2 \delta}}{\epsilon \cos \delta + \sqrt{\epsilon - \sin^2 \delta}} \quad (92)$$

In the vertical plane including the line of maximum radiation, the wave from the system under discussion is horizontally polarized. At a point P at a great distance the field is the sum of the direct and reflected waves where proper account of the phase angle due to the greater distance of travel of the reflected wave is taken into account. From the geometry of Fig. 58 it is apparent that the reflected wave may

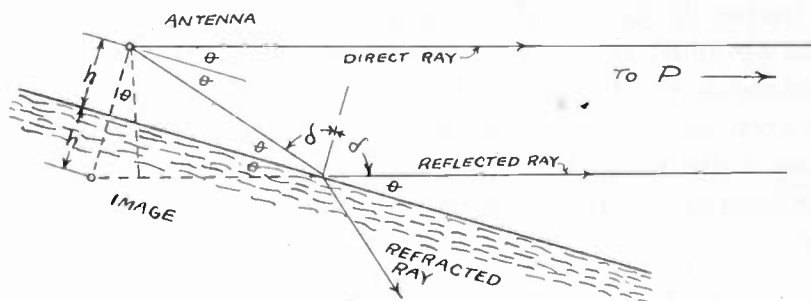

Fig. 58

be considered as originating at an image in which is flowing a current $K_h I$ where I is the current in the antenna. The phase angle between the direct and reflected waves is then:

$$\psi = 4\pi \frac{h}{\lambda} \sin \theta. \quad (93)$$

Adding the two waves we obtain for the power \bar{P}_g when reflection from ground is taken into consideration:

$$\bar{P}_g = \bar{P}_s \left[1 + K_h^2 + 2K_h \cos \left(4\pi \frac{h}{\lambda} \sin \theta \right) \right] \quad (94)$$

where \bar{P}_s is the power neglecting ground.

For the case of a perfect conducting ground the field at P is the sum of the fields due to the antenna and its negative image. The distributions of radiation in the vertical plane both for Rocky Point ground and a perfectly conducting ground have already been shown in Fig. 48. It is seen from this figure that, for this particular antenna system, the assumption of a perfect ground results in approximately the same distribution as that obtained for a dielectric. If the waves had been vertically polarized, the results would have been entirely different.

In vertical planes other than that which we have termed *the vertical plane*, the waves from this antenna are elliptically polarized. The treatment of the reflected wave from dielectric ground in such a case is extremely laborious since the components parallel and normal to the plane of incidence must be considered separately. For this reason together with the fact that in this case there is no great error, the contour map in Fig. 49 was made assuming perfectly conducting ground. An exact mathematical treatment would probably be little nearer the truth since, under actual conditions, there are many factors which are not exactly known.

By placing two complete sections side by side along a line at right angles to the direction of the beam, the concentration of radiated power in the desired direction is approximately doubled. The distribution of power is obtained by adding together the fields due to each section while taking proper account of the phase angle. If X is the length of the line between the apexes of the two sections, the phase angle is $2\pi X/\lambda$ times the projection of this line upon the radius vector in the direction under consideration. In our system of spherical coordinates, the phase angle is:

$$\psi = 2\pi \frac{x}{\lambda} \sin \theta \cos \phi \quad (95)$$

and, from (85), we obtain for the power from the two-section system:

$$\bar{P}_2 = 4\bar{P}_1 \cos^2 \left(\pi \frac{x}{\lambda} \sin \theta \cos \phi \right) \quad (96)$$

where \bar{P}_1 is the power for one section alone.

To obtain the power for a four-section system we can combine two double-section systems. Then:

$$\bar{P}_4 = 16\bar{P}_1 \cos^2 \left(\frac{\pi x}{\lambda} \sin \theta \cos \phi \right) \cos^2 \left(2\pi \frac{x}{\lambda} \sin \theta \cos \phi \right). \quad (97)$$

For a three-section system the formula for power distribution is:

$$\bar{P}_3 = \bar{P}_1 \left[1 + 2 \cos \left(2\pi \frac{x}{\lambda} \sin \theta \cos \phi \right) \right]^2. \quad (98)$$

Contour maps showing the distribution of power for one-, two-, and three-section systems at a mean height of one wavelength above perfect conducting ground has been shown in Figs. 49, 50, and 51.

Figs. 59 and 60 show the power distribution in a plane inclined at 10.5 degrees to the horizontal, the vertical angle of maximum radiation.

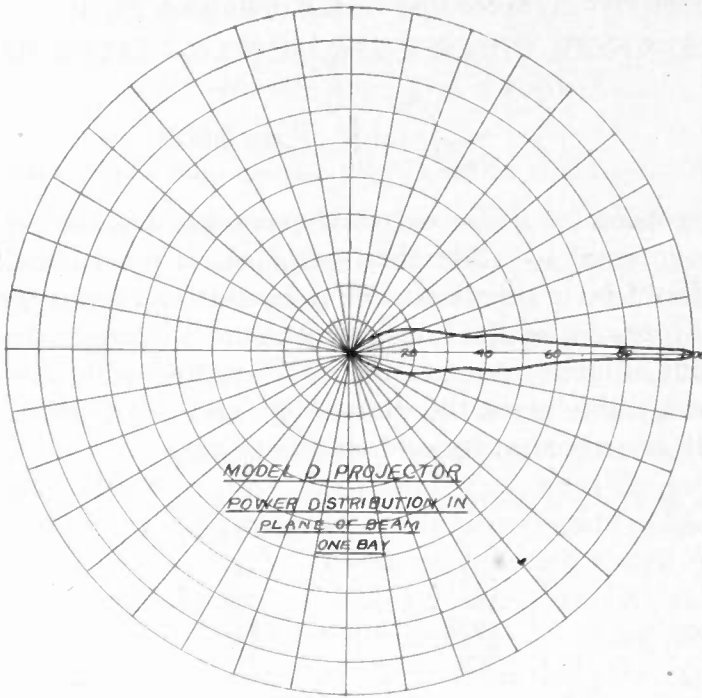

Fig. 59

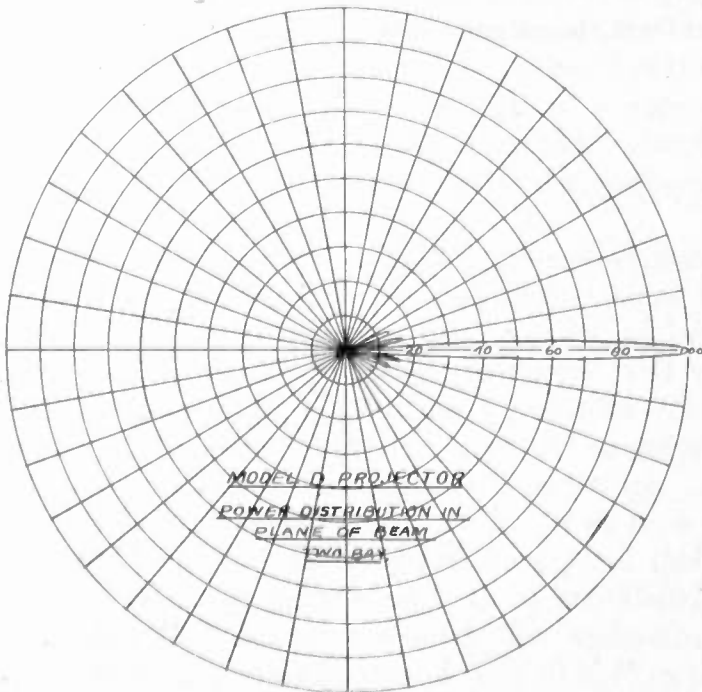

Fig. 60

The directivity is, according to the definition given:

$$D = \frac{\bar{P}_{\max}}{\frac{1}{4\pi} \int_0^{2\pi} \int_0^{\pi} \bar{P}_r \sin \theta d\theta d\phi} \quad (99)$$

The expression for \bar{P} is so extremely complex that the evaluation of the surface integral by other than graphical or mechanical processes would no doubt be impractical. The computations necessary to determine the curves for evaluating by means of a planimeter involve a large amount of labor even when carried out with slide-rule accuracy. The following table gives the directivity, and power ratio to a half-wave dipole as arrived at by such calculations:

<i>Number of Sections</i>	<i>Directivity</i>	<i>Power Ratio to Dipole</i>	<i>Decibels Gain Over Dipole</i>
One	64	39	15.9
Two	128	78	18.9
Three	192	117	20.7
Four	256	156	21.9

Such theoretical calculations cannot completely determine the effectiveness of antenna systems because they do not take into account the phenomena of propagation between transmitter and receiver. It has been found by experiment that the actual results obtained are as would be expected from the calculations.



THE SPOKESMAN FOR THE RADIO ENGINEER*

By

S. C. HOOPER

(Director, Naval Communications, Navy Department, Washington, D. C.)

THE GREAT human desire is for uplift to equality—equality in worship, political rights, home life, comforts, travel, news, entertainment, and health. Thousands of years were spent in the efforts of humanity for political and religious equality, and during the past century has come the living wage, and the possibility for all to enjoy their own homes. The present age is one in which individuals are striving for a semblance of equal luxury and entertainment, and in the accomplishment of this, the engineer becomes the great leader, for it is the engineer who conceives of improvements, and makes inventions which bring about electrical, mechanical, sound, and other devices cheap enough for even the poor to make use of electric lights, good literature, current newspapers, telephones, moving pictures, automobiles. By means of such inventions even the poor can hear the finest music, addresses, and sermons of interest, and witness, through the moving picture, the scenes of the world. This is the day in which the engineer makes his great contribution to assist the public in the struggle for equal happiness.

It is only a very small number of individuals from the world's total who contribute anything in conception and fulfillment of the advancement of science, invention, and their application to improve human comfort and happiness. Foremost among these today stand the radio engineers. It is, therefore, a great honor to be of the membership of this society.

The first application of the radio art for practical purposes was only thirty-five years ago. The entire art has developed since that time. Probably half the history of radio has been written during these few years, and the names of the inventors, engineers, and executives, mostly in their prime now, are listed in our YEAR BOOK. They include many famous figures in the world today and their names will occupy forever prominent places in scientific and business history.

We are blessed with the confidence which grows from successful achievement, while still with active years ahead, and this great advantage will spur us on to solve what may be considered the more difficult problems with which we are faced. The leaders in this field, have, as a rule, made a greater success of their lives than they hoped

* Decimal classification: R000. Original manuscript received by the Institute, April 16, 1931. Presented before Sixth Annual Convention of the Institute, June 4, 1931, Chicago, Illinois.

to make, and during the remaining years we should, in the spirit of fraternalism of this great organization, be friendly and kindly to one another. We should "live and let live" and be friends at peace with one another.

What is the purpose of the Institute PROCEEDINGS? It is to tell about radio—radio communications—for what is radio but radio communications? It is not sound pictures in themselves, not wire communications except as used in connecting to radio, it is radio communications.

This term includes mobile, point-to-point traffic, broadcasting, special services, and the amateur. These services comprise radiotelegraph, radiotelephone, radiotelevision, and radio transmission of power. The uses of radio are many; there is no all-seeing guide to pilot these uses into the fields of greatest relative value to the nation; the path is more dependent on individual imagination, energy, and competition. Sometimes comparatively unimportant applications are given undue importance in the limited spectrum, due to the energy with which presented, while others much more important lag behind for lack of adequate support, and later have difficulty in obtaining suitable frequency channels. The licensing authority then has trouble in readjusting licenses, court action follows and financial losses result. The public is uneducated in these matters and the lack of a proper agency to undertake this education as to the relative importance of the various services, and to disseminate the arguments for and against competition is a serious matter, and often delays some important adaptation of a new type of service. Some group allied with radio should undertake this work. Perhaps the Institute can assist in this.

In the United States our broadcasting is, I believe, equal or better than in other countries. That is because all of the public is interested and because it is not owned by the government. We need have no fears for the future of our broadcast system because the public will be heard. True, some engineers feel that the limit of power on certain channels should be raised but that will all eventually adjust itself. Also, we know there is often too much advertising permitted on each program. Those who pay to broadcast their wares will eventually realize that too much advertising on a program turns the listener against them. A good program and just a word or two to let the audience know to whom he is indebted will make the sale. The Institute might help this situation by an educational campaign.

Probably radio vision and radio transmission of power are too far in the future so far as mature development is concerned to demand at the present more than those channels necessary for experimental work

along those lines. When, if ever, these projects become practical facts, the public will demand the necessary revision of channels, such as was made when broadcasting first became popular.

Radio communications have made wonderful strides since 1915, but we must be very careful and look to the future. All nations must carefully protect the channels assigned to mobile services, for ships and aircraft have no other means of communicating, for the experimenter, and for national defense, and must have the necessary channels with a safe margin. The discipline of the air in mobile bands is below that of other services.

Radio point-to-point communications have brought about opportunities for better and more direct communication between the peoples of all nations, and the competition with wire communications has resulted in improved service and cheaper rates. Only good can result from such improvement, and with international broadcast, and greater flow of news, the understanding between the peoples of all the world will be greater, and the likelihood for wars will decrease. Competition between nations for ownership of the radio systems is not conducive to good feeling, and best results will follow if each nation, either through public or private ownership, controls its terminals on its sovereign soil, and operates with other nations through traffic agreements.

Too much competition, or "cutthroat competition" for public utilities, is fatal to the communication companies, and, in the end the public pays the bill. In the United States there appears to be danger to our best interests in having too much competition. On the other hand, to set aside the natural law of competition is removal of the guarantee of public protection, and research may suffer. Some middle ground is desirable for the best results. And, if the radio engineer is to be protected, he should give study to this question, and see to it that the Government finds the right answer.

The same applies to production of radio sets. The present depression in radio manufacturing has resulted, to a large extent, from overproduction. Do we see any signs of any guiding hand to reduce this production along any sensible well-thought-out lines? And is this a matter in which the radio engineer should have a voice?

On these subjects the public is uninformed and confused; nor is it particularly interested. They lack the much needed source of reliable information. Who will this be—a financier, a radio company, a wire company, or an engineer? There are organizations representing the manufacture of radio equipment, organizations on patent matters, on legal matters, on standards and phraseology, but there is no one standard bearer to speak to and for the public as to what is best for the lat-

ter's interests and those of the nation in radio, and to represent the public before the government. On reflection, this seems a most amazing lack, that we engineers have felt ourselves responsible for radio since its inception yet we have no standard bearer. The result? Engineers are in need, greed is ruling, and the interests with the best legal talent most often obtain the desired channels. This is, in a way, an indictment of the radio engineer.

Among radio engineers there is a coöperation resulting from close daily associations through the medium of the ether, bringing us all into close relationship and understanding. This close association disregards race and nationality and is bound to have a definite influence towards good will and peace. This we should bear in mind as we grow older and become less interested in the purely technical.

As engineers you have done a marvelous work in discovery, and in development of apparatus and systems, but in the application of our work in best form to serve the people, we find our success varied according to our forms of government, and to the nature of the lands we inhabit. It would seem as though there were a gap between the engineer and the executive power of a nation which prevents the engineer from realizing his dreams in the best form. The gap is so wide in some countries that it almost stifles the engineer, and in others, makes the application of his ideas so difficult that his reward is small and the people themselves fail to receive the full rightful advantage.

Engineers as a rule have vision and are practical men. They evolve an idea for something worth while and then invent the apparatus, but why does their original idea for the proper application of the system have so much difficulty in realization? I have come to the conclusion that it is because the engineer lacks a certain broadening to be attained from study of law and political matters. This situation arises from the fact that there is no university wherein a broad course in communications includes outlines of law and business. So, even though he invents his apparatus, the engineer lacks the practical knowledge and confidence to impress upon proper authority the correct method of application.

Consider the example of the United States. Had we had radio engineers eight years ago, properly trained in law, political sciences, and in the adaptation of radio to communications, the present situation would have been foreseen and we would have known how to organize and present, to the government and companies, completed solutions of the problems that would have been accepted. The radio statutes and orders governing radio stations would have been so eminently satisfactory that the companies today would not place themselves so much in the hands of legal departments. Some government officials, know-

ing about radio, and a few engineers undertook to guide the art into certain channels, and on the whole, their ideas were good and they were honest. But, others entered the picture without full knowledge, and in their efforts to make money, challenged the intelligence and honesty of purpose of those who understood the situation.

The result is not at all as we would wish it to be. For lack of this training, radio today is a compromise between engineers, department store managers, politicians, theater owners, and lawyers.

Had the engineers proceeded properly in the beginning they would have first reached accord among themselves as to what the set-up should be, they would have next elected a suitable spokesman, and have organized the necessary propaganda to assist putting their ideas across, and then the problem of getting Congress and the executive branch to provide the needed laws and regulations would have been very easy.

What can be done to remedy the situation in the future? The answer is, first, influence our universities to give the engineer a broader training, second, provide one spokesman for the radio engineer, third, provide an organization which will instruct the spokesman in the policies of the radio engineer

This is not a difficult problem. We have the very organization and power right here in this organization, if we care to use it. Might we not take a leaf from the book of the American Bar Association. That organization, as an organization, represents the legal talent of the United States. It has committees appointed to consider all manner of pertinent subjects of interest to the Association. These committees make their studies and publish them to the members, and the organization ballots on important questions. Then the president of the association is provided with the result of the ballot and is in position to express the desire of the lawyers of the United States. The following up of this is not a difficult task. The strength of the organization is such that it has a tremendous influence for the benefit of the legal fraternity and for the good of the nation.

Now, I say to the radio engineers that if you wish to continue as at present, merely along the lines of least resistance, the fortunes of fame and wealth resulting from your achievements, and the great wealth of your imaginative genius, in which the public has a tremendous interest at stake, will pass to manufacturers, wholesalers, jobbers, politicians, and lawyers; you will only be the slaves. But, if you wish to have the applications of this great radio art made as you know they should be made in the interests of the public, and reap adequate benefits for your own purposes and in order that you may extend your stud-

ies of research, you should stir yourselves now before it is finally too late, discuss the question, elect your spokesman, and the radio world will be yours.

Nothing can be accomplished without free and frank discussion, and representative opinion expressed through some sort of ballot, and even then your leader must go further than speech making to put across your ideas. For example:

What should be the division of the radio spectrum?

What should be the organization of channels for broadcasting?

What should be the limit on the power of transmitters?

What should be the amount of advertising permitted and its form?

What should be the policy of the government in the question of ownership and operation of radio?

Should radio and wire systems be united?

Should the Institute of Radio Engineers make suggestions as to the qualifications of radio commissioners?

Should there be a tax on radio sets?

Is the government efficient in its radio systems?

Should there be some form of radio patent pool?

Should there be some form of coöperative regulation of production?

Should the Institute PROCEEDINGS include papers on different views on such questions, and ballot to determine the crystallization of opinion pro and con?

The Institute to date contains a wonderful historic record, and it makes valuable contributions in standardization and nomenclature work, but it requires someone to breathe the spark of life into its organization to make it a vital factor in the life of each nation. Such might be effected by devoting one-third of its pages to discussion of live issues, balloting on these issues, and selecting a spokesman to present its desires before the public and their administrators.

There is one matter which I feel certain that this Institute could carry on, a worthy task, in bringing before the American public the names of members who have done noteworthy work in advance of science and its application, and that is to sponsor a bill before the Congress of the United States to secure recognition of our leaders. Foreign nations have not been backward in bestowing decorations, medals, and cash prizes in such matters. Likewise, the American Congress has made numerous awards for those who have advanced aviation, the medical profession, and heroes of the battlefield, yet, except for the efforts of individual companies, little recognition has been made of the individuals who have pioneered in the great art of radio. It would seem that recognition in the way of bestowal of decorations and cash prizes would be an inspiration to the coming generation, as well as a due recognition of some of our members.

THE CONDUCTION OF HIGH-FREQUENCY OSCILLATORY ENERGY*

By

H. O. ROOSENSTEIN

(Telefunken Gesellschaft Laboratories, Berlin, Germany)

Summary—Starting from telegraph equations, the action of high-frequency electric lines is treated theoretically and experimentally. Their efficiency is calculated and the relation to the magnitude of the load resistance is determined. For measuring damping and surge impedance of these lines, methods are given that are applicable up to the highest frequencies. This has been confirmed by test. The phenomena that occur on lines whose feeding or loading shows dissymmetry with respect to ground, are analyzed and a method is given for removing dissymmetry systematically in practical installations.

INTRODUCTION

THE problems to be taken up in this paper fall into two groups consisting respectively of symmetrical lines and dissymmetrical lines. A line may be regarded as symmetrical if the lead and return conductors have the same current and voltage distribution but in opposite phase. Unless otherwise stated in the following, the slight energy losses due to radiation are included in the resistance of the line. Furthermore the action of the lines has only been studied for sinusoidal alternating currents.

PART ONE

A. GENERAL THEORETICAL FUNDAMENTALS OF SYMMETRICAL LINES

1. Fundamental equations

As is well known, the telegraph equations in their form for sinusoidal alternating currents can be stated as follows:

$$\begin{aligned}\bar{V}_a &= \bar{V}_e e^{\theta} + \bar{V}_r e^{-\theta} \\ \bar{W}\bar{J}_a &= \bar{V}_e e^{\theta} - \bar{V}_r e^{-\theta}.\end{aligned}\tag{1}$$

In these formulas¹ (see Fig. 1)

\bar{V}_a is the potential difference between the two conductors at the starting point *A* of the line section considered,

\bar{J}_a is the current amplitude at this point

* Decimal classification: R116×621.319.2. Original manuscript received by the Institute, September 16, 1930. Translation received by the Institute, January 19, 1931. Published in *Jahrbuch der drahtlosen Telegraphie*, 36, No. 3, 81-85; September, 1930.

¹ For more detailed explanations, see F. Breisig, *Theoretische Telegraphie*, ed. 2, 1924, published by Vieweg und Sohn, Braunschweig.

\bar{V}_e is the potential difference of the incident waves at the end E of the line

\bar{V}_r is the potential difference of the reflected wave at the end of the line E

\bar{J}_e and \bar{J}_r are the respective currents associated with these two waves
 $g = ja + b = j\alpha l + \beta l$ where α is the phase measure and β is the damping, referred to the unit length of line

\bar{W} is the surge impedance. Instead of the usual symbol \bar{Z} we use here the symbol \bar{W} so that we can use \bar{Z} for normal impedances.

$$j = \sqrt{-1}$$

l is the length of the line AE .

The following calculations are restricted to lines with low losses, in which case the formula:

$$\bar{W} = \sqrt{(R + j\omega L):(G + j\omega K)}$$

can be approximated by

$$W = \sqrt{L/K}, \text{ where } W \text{ is always ohmic.}$$

In the above formula

R is the line resistance (both conductors together) per unit of length.

G is the leakage per unit of length

L is the self-induction per unit of length

K is the capacity per unit of length.

We introduce next the reflection factor:

$$\bar{P} = (\bar{Z} - W):(\bar{Z} + W) = \bar{V}_r/\bar{V}_e. \tag{1a}$$

\bar{Z} in this equation is the impedance by which the line is considered closed at the free end.

2. Current and Potential Along Symmetrical Lines

High-frequency lines must be viewed from another angle than that for the usual telephone lines. Losses of only a few per cent are permis-

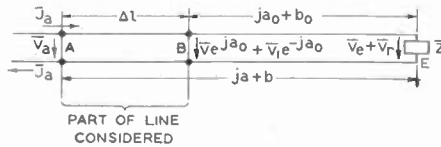

Fig. 1

sible in them, while in telephone lines there is considerable damping, and only a small fraction of the transmitted energy reaches the receiver. Consequently the theoretical problems are different in the two kinds of lines.

In the following we shall determine the potential and current distribution in a line section that is so short that the current is practically unaffected by the power lost on it. This does not mean however that the line of which this section is a part, is without loss, but rather that the losses for the short section under consideration can be disregarded in comparison with the power transmitted by the incident and reflected waves. As will be shown later, the length of this section can, under certain conditions, be several wavelengths long, the losses being very low on a good line.

In accordance with this supposition we can assume that the logarithmic spirals which, as is known, represent the geometric locus of end points of the potential and current vectors for the line section under consideration, can be replaced by circles.¹ In this simplified case the equations become:

$$\begin{aligned}\bar{V}_a &= \bar{V}e^{ja} + \bar{V}_1e^{-ja} \\ \bar{W}\bar{J}_a &= \bar{V}e^{ja} - \bar{V}_1e^{-ja}.\end{aligned}\quad (2)$$

As a result of the above assumption, the magnitudes $\bar{V}_a = \bar{V}e^b$ and $\bar{V}_1 = \bar{V}e^{-b}$ in this formula can be considered constant for the section of line under consideration. If \bar{V} and \bar{V}_1 are given, it is easy to calculate or construct the magnitudes \bar{V}_a and \bar{J}_a for any given measured angle (see Fig. 2).

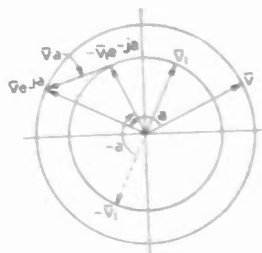

Fig. 2—Construction of the potential vector when the potentials \bar{V} and \bar{V}_1 of the incident and reflected wave at the free end of the line are given.

3. The Wave Ratio

It is evident from Fig. 2 that there are values of a for which the vectors $\bar{V}e^{ja}$ and \bar{V}_1e^{-ja} are of the same or opposite phase. The places on the line at which the potentials of the transmitted and reflected waves are of the same phase, are potential loops. Here, therefore, the voltage V_b is given simply by the sum of the absolute values of \bar{V} and \bar{V}_1 . In the same way we find for the voltage at the voltage nodes $V_k = V - V_1$.

¹ See Breisig, *loc. cit.*

Definition—We call the ratio

$$Q = \frac{V_k}{V_b} = (V - V_1):(V + V_1) \tag{3}$$

the wave ratio. It immediately becomes evident that $Q = I_k/I_b$ if I_b and I_k are the absolute values of the current amplitudes at the current loop and current node respectively.

For the case in which the section of line under consideration is closed by an ohmic resistance r , we also have the relation

$$\partial = r/W \quad \text{or} \quad W/r \tag{4}$$

according to whether $r < W$ or $W < r$. By substitution of (1a):

$$\frac{V_1}{V} = \left| \frac{r - W}{r + W} \right|$$

in (3), this formula may be proved easily.

The wave ratio is easy to measure if it is not very small. When it is known, important conclusions can be drawn as to the power transmitted by the line and its efficiency.

4. Node Width

If the wave ratio is very small, that is, if the line shows sharply pronounced nodes and loops, its determination is difficult because with very high frequencies it is not easy to measure the ratio of two potentials of different order of magnitude.

This difficulty is easily overcome however, by measuring the node width instead of the wave ratio.

Definition—The node width is defined as the distance between two points on both sides of a potential (or current) node in which the potential (or current) is $\sqrt{2}$ times the potential (or current) in the node.

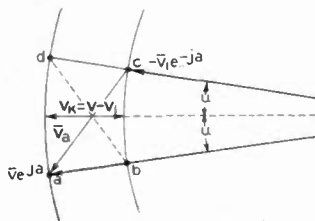

Fig. 3—Determination of the node width.

The manner in which the wave ratio can be found from the node width can best be explained by means of Fig. 3, which shows a section from Fig. 2 for the case of a very small wave ratio. As can be seen in the figure, the node potential is $V_k = V - V_1$.

According to the above definition we must find the place on the line at which the potential is $(V - V_1)\sqrt{2}$. The positions of the vectors $\bar{V}e^{ja}$ and $-\bar{V}_1e^{-ja}$ are shown for a point on the line whose phase angle a differs from the phase angle of the node by a small amount u . The potential at this point of the line is given by the diagonals of the quadrilateral a, b, c, d . It is clear that $\sqrt{2}$ times the value of the node potential is reached for the u_k values of u for which the quadrilateral approximates a square. In this case,

$$ad + bc = 2ab$$

or,

$$2u_k \frac{V + V_1}{2} = V - V_1.$$

$2u_k$ is the node width k expressed in angular measure. In order to find its linear magnitude, $2u_k$ must be multiplied by $\lambda/2\pi$.

The result is

$$k = \frac{V - V_1}{V + V_1} \frac{\lambda}{\pi} = \frac{\lambda Q}{\pi} \quad (4a)$$

Making use of the following, it is easy to find the node width for lines with low losses that are closed by a reactance. With such a termination the reflection is without loss. Thus:

$$V_r = V_e \quad \text{or} \quad V_1 = Ve^{-2b}.$$

If we take $b \ll 1$, we can approximate:

$$V_1 = V(1 - 2b).$$

If this expression for V_1 is used in (4a), we find:

$$k = b \frac{\lambda}{\pi} \quad (5)$$

This formula states that the node width being proportional to b , is therefore proportional to the distance from the end of the line. This relation will be useful later in determining from the node width, the damping of a line short-circuited at one end.

B. CONDUCTION AND LOSSES ON LINES

1. Power Transmitted

The power passing any point of the line can be determined by means of Fig. 4. In this figure the potential vectors $\bar{V}e^{ja}$ and \bar{V}_1e^{-ja} , as

well as the current vectors $\bar{V}/W e^{ja}$ and $-\bar{V}_1/W e^{-ja}$ are drawn for the point in question. The power transmitted is:

$$N = \frac{V^2}{W} - \frac{V_1^2}{W} - \frac{VV_1}{W} \cos \phi + \frac{VV_1}{W} \cos \phi$$

$$N = \frac{V^2}{W} - \frac{V_1^2}{W}$$
(5a)

and is therefore equal to the difference between the power of the incident and the reflected wave. (This should be self-evident. We never-

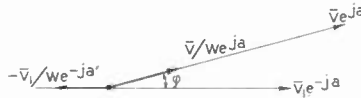

Fig. 4—The transmitted power is equal to the difference in the power of the incident and reflected waves.

theless gave the proof since in a similar case—where the wave is resolved into a standing and a progressing component—the power *cannot be found by simple addition of the powers of the two components.*)

2. Relation of Transmitted Power to the Wave Ratio and to the Node Width

If $V + V_1 = V_b$ represents the potential in the potential loop the expression 5a for the transmitted power can be written as follows:

$$N = (V + V_1)^2 \frac{V - V_1}{(V + V_1)W} = V_b^2 \frac{Q}{W}$$
(6)

In a similar manner, if I_b is the current in the current loop, we find the power:

$$N = I_b^2 Q W$$
(7)

For the case in which the node width is small as compared with the quarter wavelength, we can write using (4a):

$$N = \pi I_b^2 W \frac{k}{\lambda}$$
(8)

or,

$$N = \pi V_b^2 \frac{k}{\lambda W}$$
(9)

Therefore, it can be stated that for a given condition of the line (heating of the copper at the current loops and of the insulators at the potential loops) the transmitted power is proportional to the wave ratio or to the node width.

3. Line Losses and Line Efficiency

In transmission line engineering it is highly important to know the efficiency of a given line.

In order to be able to answer this question we calculate the ohmic losses due to current I_a in a line element dl with resistance Rdl and then integrate these losses over the entire length of line. (The entire line is considered. Part BE in Fig. 1 has zero length in this case.)

Formula 1 holds for I_a . We select the coördinate system so that vector \bar{V}_e lies in the positive real axis, and write:

$$\bar{V}_e = V_e \quad \text{and} \quad \bar{V}_r = V_r e^{j\phi}.$$

Here ϕ is the phase angle between \bar{V}_e and \bar{V}_r . The power lost in line element dl is $I_a^2 Rdl$ or, according to Janet²

$$(\bar{J}_a \bar{J}_{a1} Rdl)_{re}.$$

Here \bar{J}_{a1} is the conjugated value of \bar{J}_a while the index "re" means that the real part of the expression is to be taken. We find:

$$\begin{aligned} W^2 dN_a &= Rdl (V_e e^{ja+b} - V_r e^{-ja-b+j\phi}) \cdot (V_e e^{-ja+b} - V_r e^{ja-b-j\phi})_{re} \\ &= Rdl V_e^2 e^{2b} + V_r^2 e^{-2b} - 2V_e V_r \cos(2a - \phi) \end{aligned}$$

where dN_a is the power that must be used to replace the loss in line element dl at a phase angle a from the free end of the line. For the entire line loss N_a we get

$$\begin{aligned} \frac{W^2 N_a}{R} &= \int_0^l (V_e^2 e^{2\beta l} + V_r^2 e^{-2\beta l} - 2V_e V_r \cos(2\alpha l - \phi)) dl \\ \frac{W^2 N_a}{R} &= V_e^2 \frac{e^{2\beta l} - 1}{2\beta} - V_r^2 \frac{e^{-2\beta l} - 1}{2\beta} - \frac{V_e V_r \sin(2\alpha l - \phi)}{\alpha} \end{aligned}$$

We assume that the line shows slight losses, that is $\beta l \ll 1$.

Then:

$$\frac{W^2 N_a}{R} = (V_e^2 + V_r^2)l - \frac{V_e V_r \sin(2\alpha l - \phi)}{\alpha} \tag{10}$$

From this it follows that the second member of the equation may be neglected as compared with the first, if

$$V_e \alpha l \gg V_r \sin(2\alpha l - \phi).$$

² Janet, *Ecl. El.* 13, 529, 1897.

For transmission lines, in actual use $V_e \gg V_r$ and also $\alpha l \gg 1$. We may therefore write:

$$N_a \approx (V_e^2 + V_r^2) \frac{2\beta l}{W}$$

since, with slight damping, we know that

$$\beta = \frac{R}{2W} - \frac{R}{2} \sqrt{\frac{K}{L}}$$

The actual power reaching the end of the line, according to (5a), is:

$$N_w = (V_e^2 - V_r^2) : W$$

The ratio

$$S = \frac{N_a}{N_w} = \frac{2\beta l(V_e^2 + V_r^2)}{V_e^2 - V_r^2}$$

or,

$$S = \beta l \left(\frac{V_e - V_r}{V_e + V_r} + \frac{V_e + V_r}{V_e - V_r} \right) = \left(Q_0 + \frac{1}{Q_0} \right) \beta l \quad (11)$$

which is to be regarded as a measure of the percentage losses, if these losses are small. In this expression Q_0 is the wave ratio of the last half wave of the line ($l=0$). In a similar way we can derive an expression for the efficiency of the line, but it is much more complicated.

Equation (11) expresses the losses in a very simple manner. Q_0 can always be found in a simple manner, since, according to definition, this magnitude is equal to the ratio between the potential in the loop and the potential in the node of the line. In addition β is also generally known or can be found easily by calculation or measurement. This will be discussed later.

It is easy to see (by substituting in (11) the value for Q given by (4)) that in the case of the purely traveling wave, for which the load resistance r is equal to W , the relative losses reach a minimum value $2\beta l$. This does not require explanation. In this case the amplitudes of potential and current are both damped along the line by βl per cent and consequently the damping of their product is $2\beta l$ per cent.

With (11):

$$S = \left(Q_0 + \frac{1}{Q_0} \right) \beta l$$

it is easy to calculate the amount by which the losses increase if the load does not match the line. For example, in the case in which the

load resistance r is half the wave resistance ($Q_0 = r/W = \frac{1}{2}$) the losses are 1.25 times greater than the possible minimum. This is however only a slight increase. With still poorer matching the losses increase rapidly. They become twice as large if $W = 3.73r$. The relation of the losses to improper matching is shown in Fig. 5.

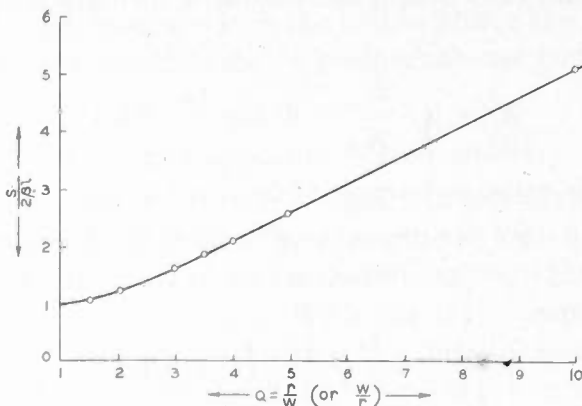

Fig. 5—Relation of losses to matching of load.

It was assumed in the above calculation that the largest part of the losses are due to copper. This is actually the case in all properly constructed lines, as we shall see later.

PART TWO

Data on Lines for Which Use is Found in Practice

The characteristics of a line are determined by their damping and their surge impedance. These two factors will be calculated whenever commonly known expressions are not already available.

Methods will be given for determining the damping and surge impedance for the highest frequencies encountered in practice. The results so obtained will be compared with the theoretical values. In these calculations it is always presupposed that the height of the conductors is low as compared with λ .

A. CHARACTERISTIC OR SURGE IMPEDANCES

1. Theoretical Formulas for Surge Impedances of Different Lines

a. The surge impedance of concentric pipe lines

For the capacity per unit length of two concentric cylinders with radii r_a and r_i , we have the well-known formula:

$$K = \frac{1}{2c^2 \log \frac{r_a}{r_i}} \text{ C.G.S. units} \quad (12)$$

where c is the velocity of light. We also know that for any type of line:

$$c^2KL = 1 \quad (13)$$

if, as is always assumed here, ϵ and μ of the medium surrounding the conductor are equal to unity.

From (12) and (13) we get the following formula for the surge impedance:³

$$W = \sqrt{\frac{L}{K}} = 60 \log \frac{r_a}{r_i} \text{ ohms} \quad (14)$$

b. The antiphase surge impedance of two-wire lines

The loop capacity per unit of length (that is, the capacity between the two wires) of two-wire lines according to a well-known approximate formula is:

$$K = \frac{1}{4c^2 \log \frac{d}{\rho}} \text{ C. G. S. units.} \quad (15)$$

This, with (13), gives us for the antiphase wave resistance, that is, for the wave resistance when the two wires oscillate with a phase difference of 180 degrees

$$W = 120 \log \frac{d}{\rho} \text{ ohms.} \quad (16)$$

In this approximate formula the wire spacing d is assumed to be large as compared with the wire radius ρ .

c. The in-phase surge impedance of two-wire lines

The formula given above for the out-of-phase surge impedance is the normally valid expression when one conductor is used as a return. But in the case of dissymmetry of lines, that will be considered later, it is of value to know the surge impedance when the two conductors are connected in parallel and the ground is used as a return conductor for the oscillations.

The simultaneous capacity of the two wires connected in parallel as compared with the ground¹ is:

$$K' = \frac{1}{c^2 \log \frac{4h^2}{(d \cdot \rho)}} \text{ C. G. S. units.} \quad (17)$$

³ See, for example, B. M. Abraham and A. Föppl, *Theorie der Elektrizität*, I, 298, published by B. G. Teubner, Leipzig, 1923.

¹ F. Breisig, *loc. cit.*, p. 66.

In the manner stated above, we obtain for the surge impedance, which in this case we call the in-phase surge impedance, the following expression:

$$W' = 30 \log \frac{4h^2}{d\rho} \text{ ohms.} \quad (18)$$

This is valid for the case in which the height above the ground is such that $h \gg d \gg \rho$ and the earth is such a good conductor that the waves do not penetrate into it.

2. Surge Impedance Measurements

Many causes, the presence of insulators, the earth, neighboring conductors, etc., may alter the characteristics of high-frequency lines. Consequently it is important to be able to measure the surge impedance under practical conditions. With low frequencies this measurement is generally made by measuring the initial impedance with regard to magnitude and phase with the far end of the line short-circuited and with the far end of the line open. The geometric mean of the two complex magnitudes gives, as simple calculation will show, the desired value of the surge impedance of the line. With high frequency of the order of magnitude of $2 \cdot 10^7$ cycles (20 mc) this measurement is not

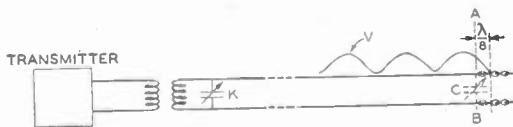

Fig. 6—Measuring the surge impedance at very high frequency.

practicable and the author therefore developed another method that will be described in greater detail. If it is desired to measure the surge impedance of the Lecher system shown in Fig. 6, for example, the procedure would be as follows:

The system is insulated at the free end and is excited by coupling to the transmitter. The capacity K is so adjusted that the line is in resonance. The line is then shortened by $\lambda/8$ and insulated at the end. The system extending to AB is again brought to resonance by a new condenser C at the free end. If C_0 is the resonance value of condenser C , then we have for the surge impedance the equation:

$$W = \frac{1}{\omega C_0} .$$

Proof

From the telegraph equations for approximately no-loss lines—to which these measurements refer, we find from (2) that the impedance

at the input of a line which is opened at the far end is given by the formula:

$$\bar{Z}_a = \frac{\bar{V}_a}{\bar{J}_a} = -jW \cot a.$$

The detuning of the Lecher wires by shortening by $\lambda/8$ ($a = \pi/4$) can therefore be compensated for by a new condenser C_0 connected at the end of the line, whose capacity satisfies the equation

$$\frac{-j}{\omega C_0} = -jW \cot \frac{\pi}{4}$$

or,

$$\frac{1}{\omega C_0} = W.$$

Making the Measurement

The following test was made with a wavelength of 26.7 m. The capacity of the free end of the Lecher system, which was $26.7/8 = 3.34$ m long, was replaced by a variable plate condenser. This condenser had been rebuilt so that its capacity could be calculated. It was found experimentally that a plate spacing of 6.0 mm was necessary in order that the capacity of the condenser would offset the detuning caused by the shortening of the system. The capacity was calculated and found to be

$$C_0 = 25 \text{ cm.}$$

(Sufficiently reliable instruments for measuring this very small capacity were not available.) From this the surge impedance was found to be

$$W = 527 \Omega.$$

The agreement with the theoretical value, given by the expression

$$W = 120 \log \frac{d}{\rho} = 120 \log \frac{100}{1.5} = 500 \Omega$$

(where d is the distance and ρ the radius of the wires,) was as close as could have been expected for the experiment.

B. DAMPING

1. Theoretical Formulas

a. Calculation of the damping of two-wire lines

We assume that the lines do not radiate appreciably. The extent to which this assumption agrees with actual conditions will be tested later.

For a line that shows a very slight leakage—and this is always the case with high-frequency lines—the amount of damping is given by the well-known approximation formula:

$$\beta = \frac{R}{2W} = \frac{R}{2} \sqrt{\frac{K}{L}}$$

For the surge impedance, we can write:

$$W = 120 \log d/\rho \Omega.$$

The resistance R , at the line frequency in question, still remains to be determined. An exact theoretical knowledge is not necessary for our purpose. We assume, therefore, that the current distribution on the cylindrical surface of the one wire is not affected to any great extent by the magnetic field of the other wire. It is also assumed that the frequency is so high that the depth of penetration of the waves into the wire satisfies the simple formula:⁴

$$\alpha = \frac{1}{\sqrt{(2\pi \cdot \mu \cdot \sigma \cdot \omega)}}$$

The depth of penetration in this case is the depth at which the current density is only one e -th of the current density at the wire surface, while σ is the conductivity in electromagnetic units. It can be shown that the effective resistance of such a conductor can be calculated in a simple manner by assuming that the total current flowing through the conductor is uniformly distributed in a surface layer of thickness α .⁴ The formula for copper is:

$$R = \frac{1}{\rho_{mm}} \sqrt{1:(1.83 \cdot \lambda_m)} \quad \Omega/m.$$

The values of R for some of the wavelengths considered in our problem, are given in the following table.

TABLE I

Wave-length m	Wire diameter in millimeters							
	0.5	1.0	1.5	2.0	3.0	4.0	6.0	10.0
10	0.94	0.46	0.31	0.23	0.15	0.11	0.08	0.046
15	0.78	0.39	0.25	0.19	0.125	0.095	0.063	0.038
20	0.66	0.32	0.21	0.16	0.11	0.08	0.053	0.035
25	0.60	0.30	0.20	0.15	0.10	0.075	0.05	0.032
30	0.55	0.28	0.19	0.14	0.09	0.07	0.048	0.028

The numbers in the table give the resistance in Ω/m wire length.

⁴ See Armagnat and Brillouin, *Les mesures en haute fréquence*, Chiron, Paris.

⁴ See Armagnat and Brillouin, *loc. cit.*

When using the table for two-wire lines, one must remember that the value for R is twice that given in the table.

Example

The two-wire line on which the measurements mentioned in the following were made, had wires spaced 16.5 cm. The wires were 2 mm thick. Hence

$$W = 120 \log \frac{16.5}{0.1} = 610 \Omega$$

and, by using the above table for the operating wave of 14.84 m, we find the damping

$$\beta = \frac{0.19}{610} = 0.031 \text{ per cent/m.}$$

b. The efficiency of two-wire lines and lines consisting of concentric tubes

When a wave with a current strength I progresses along a line having a surge impedance W , the power transmitted by the wave is

$$P_w = W \cdot I^2.$$

If we disregard the irregularity of the current distribution in the first conductor caused by the magnetic field from the second conductor, the conductivity at high frequencies is proportional to the circumference of the conductor. If we designate the circumference of the first conductor by U_1 and the circumference of the second conductor by U_2 , the losses per unit of length are proportional to

$$P_v = I^2 \left(\frac{1}{U_1} + \frac{1}{U_2} \right) \times \text{constant}$$

for, in order to avoid radiation, equal currents I must flow in the outward and return conductors. The following ratio is, therefore, a measure of the losses in the conductor system:

$$Q' = \frac{P_v}{P_w} = \frac{U_1 + U_2}{W U_1 U_2} \cdot \text{constant.}$$

Using (14) for concentric pipe systems we get:

$$Q'_{\text{conc}} = \frac{r_a + r_i}{120\pi r_a \cdot r_i \cdot \log \frac{r_a}{r_i}} \times \text{constant}$$

while for parallel wire lines we get

$$Q'_{\text{par}} = \frac{1}{120\pi \cdot \rho \cdot \log \frac{d}{\rho}} \times \text{constant.}$$

Thus the ratio of relative losses of the two kinds of lines is:

$$\frac{Q'_{\text{conc}}}{Q'_{\text{par}}} = \frac{(r_a + r_i)\rho \log \frac{d}{\rho}}{r_a r_i \log \frac{r_a}{r_i}}$$

As an example we shall compare a pipe line ($r_a = 5.2$ and $r_i = 1.7$ cm) with a two-wire line ($d = 15$ and $\rho = 0.3$ cm). For the ratio we find

$$\frac{Q'_{\text{conc}}}{Q'_{\text{par}}} = 0.82.$$

In this case the line of concentric tubes shows smaller losses.

2. Measurement of Damping

The damping of Lecher lines has been measured many times and in various ways. Wuckel⁵, Kartschagin⁶ and Arkadiew⁷ have tried to produce purely progressing waves on wires in order to be able to measure directly the damping of the waves in terms of percentage losses of the amplitude per unit length. Rössler⁸ employed a resonance method in which the current was measured as a function of the length of the system. In the following a method worked out by the author will be used. In this method nothing need be changed in the line itself and the damping is obtained not as the difference between two measured values, but directly from the measurement. The principle underlying these measurements has already been mentioned in Part One, Section A, Division 4, and it was shown that for the damping we have:

$$b = \pi k / \lambda.$$

In order to measure the damping one must determine the voltage distribution in the vicinity of a potential node, and so find the node width from the voltage curve. We must also know the wavelength of the transmitter that is used. A suitable instrument was constructed for the voltage measurement.

⁵ *Ann. d. Phys.*, **73**, 427, 1924.

⁶ *Ann. d. Phys.*, **67**, 325, 1922.

⁷ *Ann. d. Phys.*, **54**, 105, 1919.

⁸ *Elec. Nach. Tech.*, **4**, 281, 1927.

Theory of the Damping Measurements

Voltage measurements with alternating current, considered theoretically, have a definite meaning only in special cases because, as is known, the line integral of the electric field strength in magnetic alternating fields has a magnitude different from O and thus a definite voltage cannot be defined. In Lecher systems on the other hand⁹ we can define a plane voltage in planes perpendicular to the Lecher line. Since the telegraph equations have been derived using this potential, we must measure it in order to determine the node width.

At some distance from the wires, this potential drops rapidly to a value that we shall designate as zero for the plane in question. In order

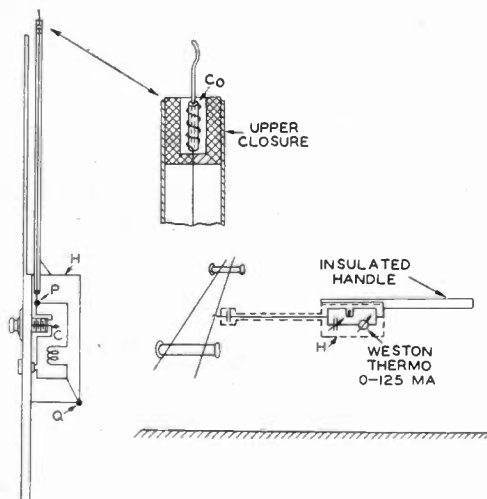

Fig. 7—Instrument for measuring the potential on high-frequency lines. An extremely small capacity C_0 is connected in series with the instrument; this practically avoids affecting the line being measured.

to measure the potential of the line in relation to this part of the field, we compare it with the potential of an auxiliary body H in this part of the field. (See Fig. 7) For this purpose one terminal of a small condenser C_0 is connected with the point of the line whose potential is to be measured. The other terminal is connected with the body H by a wire whose capacity is negligible. If the space-capacity of H is large as compared with the capacity C_0 , the current strength $I = V\omega C_0$ is a measure of the unknown potential V . (One might also have measured the potential between the two wires. This method was used in a similar manner by L. Binder¹⁰ for measurement of the shape of the wave front

⁹ F. Ollendorf, "Grundlagen der Hochfrequenztechnik," p. 446, published by Julius Springer, Berlin, 1926.

¹⁰ *Elek. Tech. Zeit.*, 20-22, 1915.

of traveling waves.) The low current strength I is transformed up to a measurable value by a tuned circuit that will be described later. In the earlier work the capacity C_0 consisted of two insulated wires bound together. One of these wires was very short and was bare at the free end that was placed on the line. The other wire was about 70 cm long and was led to the measuring apparatus which was tuned to the wave to increase the sensitivity and prevent interference from harmonics. But it was found that the latter wire had too much capacity. Even when it had a thickness of only 0.07 mm, the instrument showed a deflection when it was held 50 cm from the line. This trouble was overcome by completely shielding the instrument.

The instrument shown in Fig. 7, the use of which is illustrated in Figs. 13-15, was developed in this way.

As can be seen in the figure, the instrument consists of a Faraday cage with a pipe-like extension. The indicating instrument proper is a Weston thermogalvanometer with 150-ma scale deflection. This galvanometer measures the current in an oscillating circuit one of whose terminals is connected with the housing H . The other terminal is carried through the tube which is almost a meter long to the tiny condenser C_0 . The capacity of this condenser is about 0.3 cm. A very small hook is provided at the end for making contact with the line to be measured. In practice it is preferable to tune the circuit to a higher wave than the operating wave, so that it acts like a capacity for the operating wave between points P and Q . In the opposite case the circuit would act like an inductance and under certain conditions this inductance might balance, in whole or in part, the capacitive reactance of condenser C_0 and the instrument would act more or less like a voltmeter having too low an internal resistance. In general, the method of operation was such that the condenser in the oscillatory circuit was not made smaller than absolutely necessary for the requisite sensitivity. The capacity of the instrument was then so small that it could be applied even in the potential loops without affecting the oscillation on the line to too great an extent.

In this arrangement therefore, the upper opening of the tube with the projecting hook was the only place sensitive to potential. When this was covered with a lid connected to the shielding the instrument could be placed in all positions near and in contact with the line without causing appreciable deflections. In its final form the instrument showed the same sensitivity, within a few per cent, in all positions in the plane perpendicular to the wires; even when it was held at an angle to the wires the deflection hardly changed. Touching the shielding with the hand caused only a very small increase in the sensitivity, as was to be expected.

Precautions to be Taken During the Measurements

Of the many measurements that were made, we shall describe only one in detail in which all precautions were taken that had been found to be necessary in actual practice. These necessary precautions can be summarized as follows:

- (1) One must check whether the current distribution is symmetrical.
- (2) It must be ascertained that there will be no error in the measurement if the shape of the oscillation is not a pure harmonic.

In regard to the requirement mentioned under (1), it has been found necessary to apply artificial means to make the line symmetrical. As will be discussed later, there is a certain dissymmetry due to the fact that there is superposed on the normal wave a second wave for which the current and potential in the two wires have the same phase, while in the normal oscillation these magnitudes are in opposite phase in the

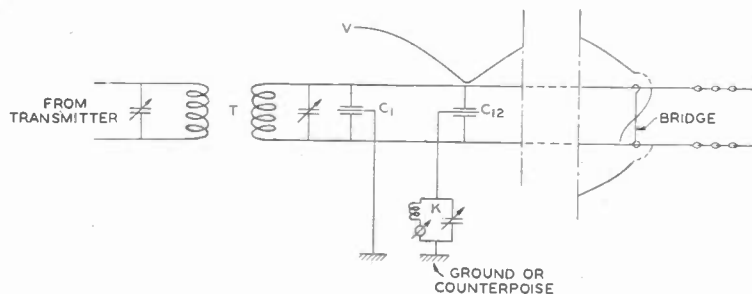

Fig. 8—Schematic view of the Lecher lines shown in Figs. 10, 13, 14, and 15. The triple plate condenser C_{12} is used for approximate adjustment to symmetry.

two wires at a given place in the line. Due to this new wave, which we shall call an "equiphase" wave in contradistinction to the antiphase wave, there is formed a potential loop at the nongrounded end of the line no matter whether or not the arrangement shown in Fig. 8 is short-circuited. Since with a short circuit at the end there is a potential node for the antiphase wave the potential nodes of the antiphase wave approximately coincide with the potential loops of the equiphase wave all along the line. The method used in overcoming this depends on the fact that the equiphase potential must be zero over the entire line if the potential in the potential loop of the equiphase wave is made zero at the beginning of the line.

It is therefore a case of making the resistance to ground as low as possible for the equiphase wave in a potential node of the antiphase wave. Fig. 8 shows that this is done by means of the triple-plate condenser C_{12} whose middle plate is grounded through the circuit K . Due to condenser C_{12} the two lines are connected with the ground

through an equal capacity while the oscillatory circuit K , whose impedance can be changed over wide limits, can be so tuned that it acts like an inductance that balances the capacity reactance of C_{12} for the given frequency. For the equiphase wave there is therefore almost a perfect short circuit from the line to ground. For the antiphase wave on the other hand, the middle plate of the condenser would be assumed to have zero potential even if it were not grounded. Therefore, by means of this so-called "absorption" circuit K only the equiphase wave is drawn off to ground, while the antiphase wave is not affected.

As regards the requirements mentioned under (2), the correct results of the measurements may be influenced by the three following points:

(a) If the transmitter is modulated, the wave consists of several partial waves whose nodes lie at different places on the line. The measuring instrument indicates the square root of the sum of the squares of the individual potentials and consequently measures an enlarged node width, and even multiple nodes if the differences in the wavelengths is sufficient. Assuming purely sinusoidal potential distribution with infinitely sharp nodes for the individual waves, the apparent node width may be calculated from:

$$k = 2hl: \sqrt{3} \quad (19)$$

Here h is the ratio of the modulation frequency to the transmitter frequency, and l is the length of line. This assumes that the transmitter is completely modulated. For a 30-m wave and a modulation frequency of 1400 cycles, there is an apparent node width of 7 mm, at the beginning of a no-loss line 45 m long according to (19). By comparing this value with the results of measurements that will be mentioned later and which give a node width of 9.5 cm for approximately similar conditions, it is seen that a modulation of the transmitter may cause incorrect results, especially if it contains higher harmonics of any strength, which is nearly always the case with modulated transmitters. This is also true for methods of measuring damping other than those used by the author.

There is frequently a particularly dangerous type of auto-modulation in short-wave transmitters. It is due to the fact that the transmitter modulates itself at a frequency that is often inaudible. This modulation frequency usually has many harmonics. The entire phenomenon manifests itself in the transmitter emitting a series of secondary frequencies in addition to its fundamental frequency. This phenomenon even occurs with separately excited transmitters. If such a transmitter is used for the measurements described here, it results in vari-

ous current distributions, being superimposed on the line. Since the nodes of these distributions lie at different places, the node width appears increased. Due to this fault great difficulties were encountered in making the first measurements. The measurement of the node width gave a different result every day until finally it was found by checking with a heterodyne receiver, that the transmitter wave consisted of 6 waves close together. This was not apparent on the wavemeter. After this experience the heterodyne test was always made.

(b) The transmitter frequency is not constant. The effects are the same as under (a).

(c) The transmitter frequency has harmonics. These harmonics may at times easily reach the Lecher system even if there is no intentional coupling. Because these frequencies are far from the transmitter frequency, they are not indicated by the tuned instrument previously described.

Making the Measurements

In all tests we used a crystal-controlled transmitter with water-cooled tubes in the output stage. Obviously only a fraction of the energy that could be supplied was needed. As soon as the transmitter was in operation the purity of the wave was tested with a heterodyne receiver. Because it was absolutely necessary to protect this receiver from too strong influence of the high frequency, it was placed near the transmitter in a completely shielded chamber. As the transmitter was one of the oldest types, a check of the wave was essential. As a rule this was done once before and once after the measurement. After cutting in the transmitter, the primary side of transformer *T* (Fig. 8) was tuned by the balanced secondary circuit. This tuning was generally accomplished by means of a glow lamp. The Lecher system was then tuned by varying the secondary condenser.

As shown in Figs. 13, 14, and 15, the Lecher line was laid on horizontal grooved insulators. The spacing between the wires could then be chosen as desired, in accordance with the groove spacing. The average height was 1.5 m above the ground and the line was closed at the free end by a wire bridge *B* (Figs. 8 and 10). Since it had been intended from the first to determine the losses individually, the insulator losses were eliminated by placing all the insulators in the potential nodes. In order to be able to adjust the nodes to the insulators, the bridge *B* was placed approximately 30 cm from the free end of the line. After applying the potential to the Lecher system, the bridge was then slid along until the potential nodes coincided as accurately as possible with the insulators where it was fastened. The symmetry of the Lecher

system was then tested. As will be explained later, the customary lack of symmetry is observed in the lines only at the nodes. In spite of this, one must observe whether the potential and current are the same on both wires at other parts of the line. The instrument shown in Fig. 9 served for the current measurement. It consisted of a partially tuned circuit that could be brought a given distance from the line by the dimensions of the insulators. (See Fig. 9.) The sensitivity could be adjusted by the variable condenser. Once adjusted, the sensitivity was constant for a given wavelength. The reactive effect on the line was slight. Owing to its comparatively large dimensions (20 cm) this apparatus did not permit the measuring of the current at a fixed point of the line. A measurement of the width of a current node could therefore not be made although the theoretical justification for it was just as great as for the measurement of the width of the potential node.

After a test was made to see whether there was any pronounced lack of symmetry, the node potential was measured at the 7th node from

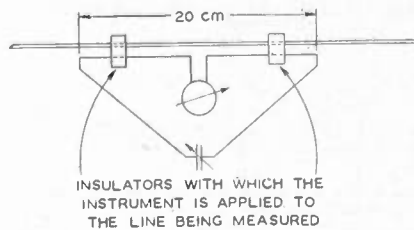

Fig. 9—Instrument for measuring the current strength in high-frequency lines.

the end on both wires. In general the two measured potentials will be different, and one will also be able to observe that the nodes do not lie at the same points on the two wires. We call this phenomenon "node displacement." To obviate this dissymmetry, one proceeds as follows: An observer determines the arithmetical mean of the node potential on both wires. A second observer then changes the condenser in the absorption circuit until a condition is reached at which the node potentials on the two wires are found by the first observer to be the same size and conformable with the arithmetical mean. (For further details, see Part Three, Section A, Division 3a) Then a test is made to see whether the node displacement has disappeared, which must be the case according to the theory of unbalanced lines, which we shall discuss later, and which was always actually observed. The last test measurement is to see whether there is actually a potential node in the center of the bridge at the end of the line. Since the node width is proportional to the damping of the line section between the node and the free end, this last node with current tuning is exquisitely sharp, and for this reason can be determined very accurately.

In the tests that were made it was always astonishing to observe how accurately the node agreed with the center of the bridge. This last control test is illustrated in Fig. 15, which shows how the potential instrument is simply hooked on the center of the bridge where it should show no deflection, although the deflection at the ends of the bridge amounts to more than half the scale.

When the line has been tested thus far, the measurement nodes can be marked on the wire, using a file, at distances of 2.5 cm for example. Then the potential instrument is applied again, and the potential measured at each mark and plotted graphically. Occasionally a check is made to see whether the curves actually have the theoretical shape. This check is very simple. One only needs to plot the squares of the distances from the node as abscissas and the squared potential values as ordinates. The resultant curve must be a straight line, because the relation existing between these two squares is a linear one. This relation is the Pythagorean theorem for the right-angle triangle a, b, c in Fig. 3. Fig. 12 shows the agreement between theory and measured averages.

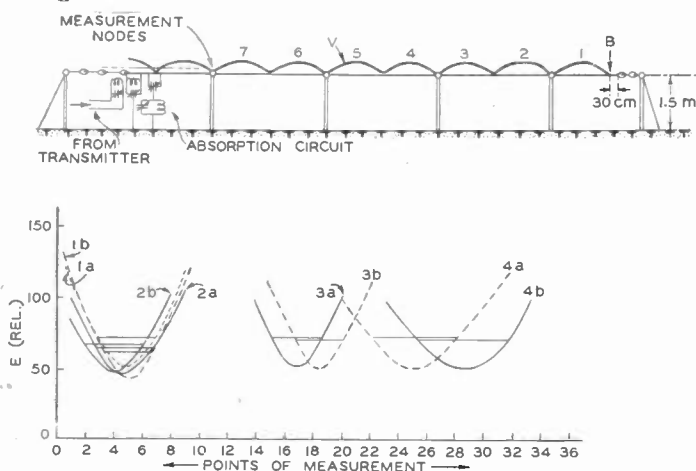

Fig. 10—Damping measurements. Transmitter $\lambda = 14.84$ m, unmodulated, without side bands. Weather dry. Wire: 2 mm Cu, 16.5 cm apart. Lines symmetrical. Absorption circuit detuned to $\lambda = 14.84$ m against $\lambda = 17.84$. Curve 1—line oxidized (exposed to weather for about 2 months). Curve 2—line clean, no insulators in V loops. Curve 3—insulators in V loops, insulators dry, line clean. Curve 4—insulators in V loops, insulators moist, line clean. Measurements spaced 2.5 cm.

V in center of bridge

B = 0

a—north wire

b—south wire

Length of wire to measured nodes 51.94 m

Of the many measurements, we need only explain in more detail the series shown in Fig. 10. This figure represents the potential curve in the vicinity of the node under different conditions. This series of curves was obtained in the following manner.

In the copper line shown in Figs. 10, 14, and 15, which was coated with a rather heavy oxide layer as a result of the action of the weather for two months, the potential curve was measured on the wires designated as north and south wires (Fig. 10, curve 1a and 1b). These curves are shown separately in Fig. 11. The node width was also evaluated by construction. The result is a damping of 2.0 per cent.

After this measurement the line was carefully cleaned with emery paper. Curves 2a and 2b were then obtained. The damping remained constant at 2 per cent in spite of the fact that a decrease might have been expected in view of the removal of the oxide layer.

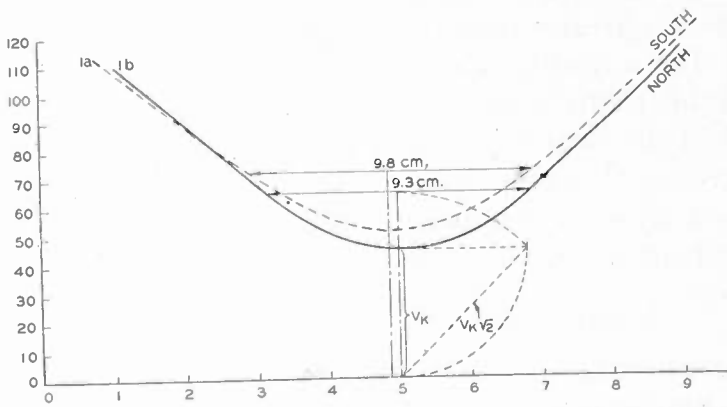

Fig. 11—Evaluating a damping measurement. Line oxidized.

North wire node width	9.3 cm
South wire node width	9.8 cm
Average node width	9.55 cm
Damping $9.55\pi/14.84 =$	2.0 per cent

Groove insulators were then placed in the potential loops on the line giving curves 3a and 3b. A slight decrease in the damping was observed ($b = 1.9$ per cent) which must have been due to an error in measuring. The displacement of the node, as shown by the diagram, is a measure of the capacity of the insulators.

Water was then poured over the insulators in the potential loops. Under these conditions curves 4a and 4b were obtained, which by their displacement as compared with 3a and 3b indicate greatly increased insulator capacity, while at the same time the damping increased appreciably ($b = 3.3$ per cent).

According to the above results, which have often been confirmed, *moist insulators represent an important source of losses in the lines*, which should be avoided whenever possible. From what has been stated above we see that the damping of 2.0 per cent shown for the line, is caused by ohmic losses in the copper, by induction losses in the ground, and by radiation.

Determination of the Maximum Radiation Damping

The damping of the measured line per meter length of line is:

$$\beta = \frac{0.02}{51.94} = 0.039 \text{ per cent/m}$$

since the length of line was 51.94 m.

In B, 1, *a*, the damping due to the copper losses was calculated as 0.031 per cent. We know that the losses due to irregular current displacement and other causes such as ground losses, must be greater than this. It may therefore be concluded that the difference of 0.08 per cent is greater than the damping suffered by the line due to radiation. The measurement was repeated several times but always with the same result. Since the damping was almost proportional to the length of the measured section of line, which, for example, would be impossible with strong radiation from the free end, the radiation damping in general must be much smaller than the damping due to the ordinary copper losses in the line.

Measuring the Damping on Tubular Lines

The same measuring instruments can be used for this purpose. The method is simpler however in that one does not have to use artificial

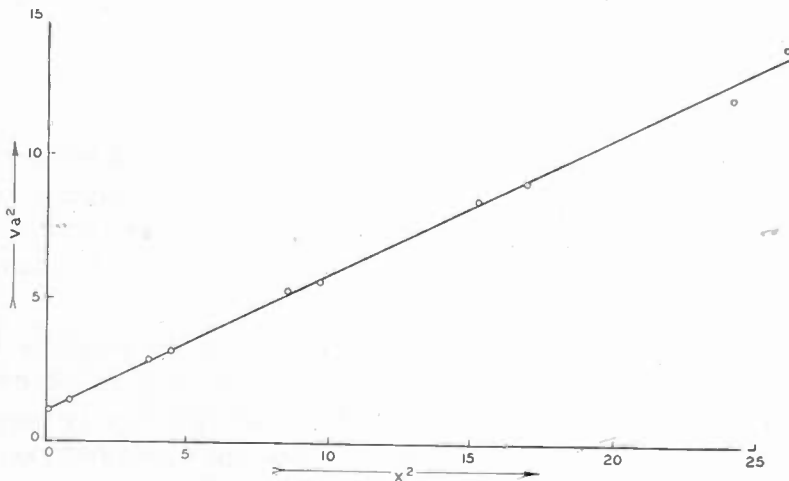

Fig. 12—Observation points and the line $(V_a^2) = 0.49(x^2) + 1.1$.

means for securing symmetry. In a tubular line the current in the inside of the outer tube is necessarily equal to the negative current on the inner tube. There can be dissymmetry only if a current flows on the outer side of the outside tube. But this current involves the presence of potentials on the outside tube. Since the formation of these poten-

tials is avoided by grounding at several points whose spacing is irrational in relation to the wavelength, the cause of their formation and hence dissymmetry is removed indirectly. This can also be proved mathematically.

The measurement of damping on tubular lines is made as follows. Holes are drilled in the outer tube at intervals of several centimeters and at a place where, according to calculation, there should be a potential node. The potential measuring instrument is provided with a point instead of a hook, which makes it possible to establish contact with the inner tube through the hole. The measurement is then made in a manner similar to that with the wire lines.

PART THREE

A. DISSYMMETRY IN TWO-WIRE LINES

1. General Fundamental Equations

It was mentioned in Part Two that in a two-wire line which is not fed in a particularly symmetrical manner, the currents and potentials in the two conductors are generally different. This phenomenon is attributable to the fact that a two-wire line can oscillate simultaneously in an antiphase wave and in an in-phase or "equiphase" wave. The antiphase wave is the normal method of oscillation, whereas for the in-phase wave the two lines oscillate with equal amplitude and phases, and the ground serves as a return conductor.

In order to be able to set up a simple mathematical theory, we assume that the electric length is equally large for equiphase and opposite phase waves. This assumption is practically always correct because for the two waves the propagation velocity closely approximates the velocity of light.

For the antiphase wave we again use the symbols $\bar{V} = \bar{V}_e e^b$ and $\bar{V}_1 = \bar{V}_r e^{-b}$ (see Part One, Section A, Division 2) and for the in-phase wave we use the similar designations $\bar{V}' = \bar{V}'_e e^b$ and $\bar{V}'_1 = \bar{V}'_r e^{-b}$ (the section of line under consideration to be so short that e^b and e^{-b} can be regarded as constant). The line has a different surge impedance for the in-phase wave than it has for the antiphase wave. We shall designate this surge impedance by W' . We calculated (18) Part Two, A, c the value of W' for two-wire lines.

The potential on the conductor, designated by p is therefore simply found from the sum of the potential of the in-phase wave;

$$\bar{V}' \cdot e^{ja} + \bar{V}'_1 \cdot e^{-ja}$$

and half that of the antiphase wave

$$\frac{\bar{V} \cdot e^{ja}}{2} + \frac{\bar{V}_1 \cdot e^{-ja}}{2}$$



Fig. 13—Arrangements for coupling the measured line to the transmitter and for producing symmetry of the oscillation on the measured line.

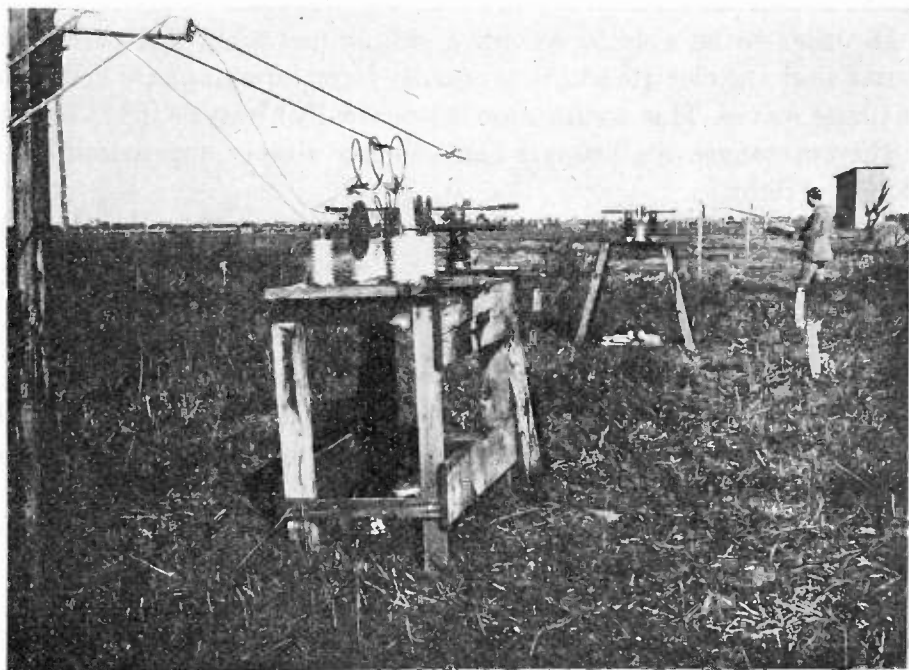

Fig. 14

or, expressed in equations:

$$\bar{V}_p = \left(\bar{V}' + \frac{\bar{V}}{2} \right) \cdot e^{ja} + \left(\bar{V}'_1 + \frac{\bar{V}_1}{2} \right) \cdot e^{-ja}. \quad (20)$$

On the other conductor q the potential of the out-of-phase wave has the opposite sign and in the same manner we find:

$$\bar{V}_q = \left(\bar{V}' - \frac{\bar{V}}{2} \right) \cdot e^{ja} + \left(\bar{V}'_1 - \frac{\bar{V}_1}{2} \right) \cdot e^{-ja}. \quad (21)$$

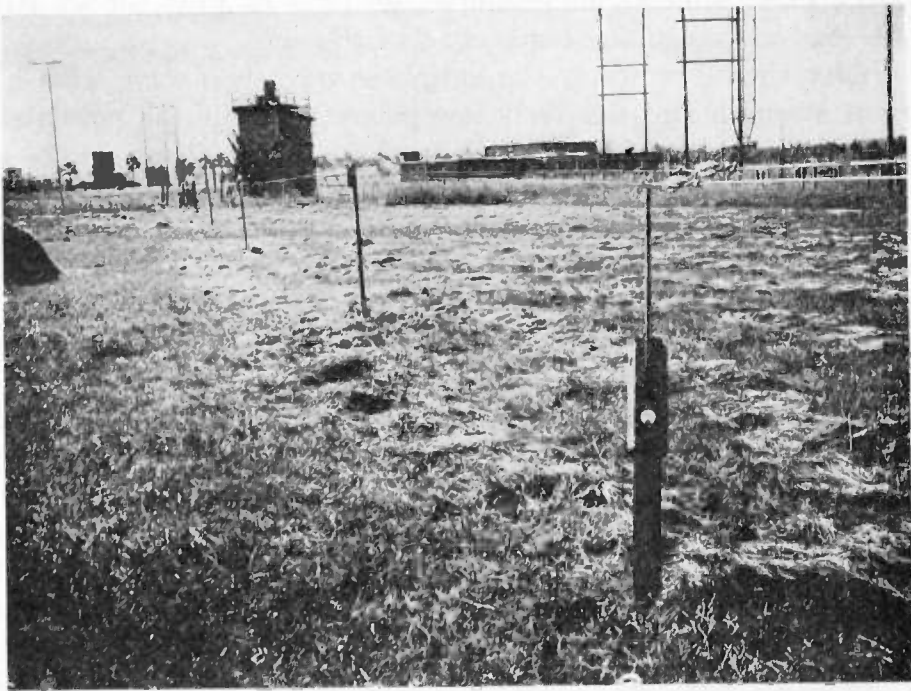

Fig. 15—The potential must be zero in the center of the bridge at the free end of the line being measured.

Taking into consideration the fact that the in-phase current is equally divided, half on each conductor, we get, in like manner, the current amplitudes:

$$\bar{J}_p = \left(\frac{\bar{V}'}{2W'} + \frac{\bar{V}}{W} \right) \cdot e^{ja} - \left(\frac{\bar{V}'_1}{2W'} + \frac{\bar{V}_1}{W} \right) \cdot e^{-ja} \quad (22)$$

$$\bar{J}_q = \left(\frac{\bar{V}'}{2W'} - \frac{V}{W} \right) \cdot e^{ja} - \left(\frac{\bar{V}'_1}{2W'} - \frac{V_1}{W} \right) \cdot e^{-ja}. \quad (23)$$

Even with the simplifications that have been made, the equations are hard to interpret because of the large number of variables in them; moreover, for a knowledge of the current and potential on the two wires, the two surge impedances W and W' and the vectors \bar{V} , \bar{V}' , \bar{V}_1 , and \bar{V}_1' are necessary. This alone would require ten relations between real magnitudes. It is obvious, therefore, that a tabulation summary of the line dissymmetry cannot be given. Instead, we shall try to explain the main symptoms of dissymmetry by the use of some examples.

2. Dissymmetry of Lines when $W' \gg W$

This case is found, for example, on lines of wide copper strips whose lead and return lines are very close together.

Under these conditions the antiphase wave is a wave with high current strength and relatively low potential, while the potential is high and the current is low in the in-phase wave. Therefore, we can imagine the case in which, with a great difference between W' and W , the potential on the line is practically caused only by the in-phase wave, while the current strength is due to the antiphase wave. Consequently potential and current wave forms are almost independent of each other. This may cause phenomena that do not appear with symmetrical lines. It is possible for example, for the potential and current nodes to occur at the same points. In other cases the potential wave may be a pure traveling wave while the current wave may show nodes and loops, etc.

The case in which $W' \ll W$, does not occur, for, even with so great a distance between lead and return conductor that the direct partial capacity between the two conductors can be disregarded, there is always, for the antiphase wave, the series capacity that consists of the two capacities of the conductors to ground. In this limiting case the capacity for equiphase is four times as large as the capacity for antiphase waves and, since the product c^2KL has the value 1 for all cylindrical systems,¹¹ the self induction of the line for antiphase is therefore four times as large as the self induction of the line for equiphase waves. In this case we would have, therefore:

$$4\sqrt{\frac{L'}{K'}} = 4W' = W = \sqrt{\frac{K}{L}}$$

In general, therefore,

$$4W' > W.$$

¹¹ See M. Abraham and Föppl, *Theorie der Elektrizität*, published by B. G. Teubner, Leipzig, I, p. 294.

3. Dissymmetry in Lines in Which W' and W Have the Same Order of Magnitude

By far the greater majority of lines belong to this class. We divide them into lines with slight dissymmetry and lines with great dissymmetry.

a. Lines with slight dissymmetry

Slight dissymmetry in a line is noticed practically only when the waves show strongly pronounced nodes, because the small amplitude of the in-phase wave causing the dissymmetry appears only at places where the amplitude of the in-phase wave is vanishingly small.

It is proper to investigate the results of dissymmetry in the vicinity of a node, and for this reason we give in Fig. 16 a diagram of the poten-

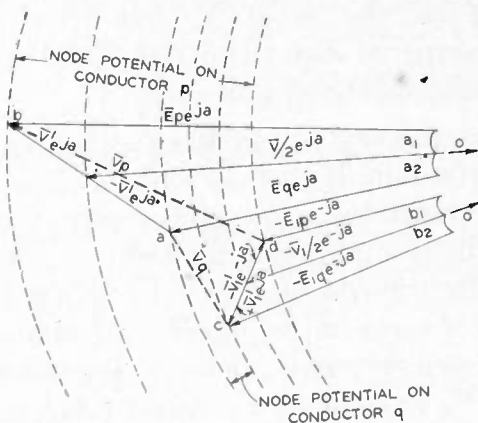

Fig. 16—Vectorial diagram for the vicinity of a potential node of an unsymmetrical oscillating line.

tial vectors of the same type that we gave in Fig. 3 for symmetrical lines. As in Fig. 3, the reflected waves in this case are also shown with a negative sign, so that the sum of the incident and reflected waves in the diagram can be expressed as a difference, resulting in a more constructively lucid diagram. The potential \bar{V}_p at the beginning of the conductor p , according to (20), is as follows:

$$\bar{V}_p = \left(\bar{V}' + \frac{\bar{V}}{2} \right) \cdot e^{ja} + \left(\bar{V}'_1 + \frac{\bar{V}_1}{2} \right) \cdot e^{-ja}$$

or simplified:

$$\bar{V}_p = \bar{E}_p \cdot e^{ja} + \bar{E}_{1p} \cdot e^{-ja}$$

In the diagram we find the vectorial addition of the vectors

$$\frac{\bar{V}}{2} \cdot e^{ja} \text{ and } \bar{V}' \cdot e^{ja} \text{ is } \bar{E}_p \cdot e^{ja}$$

and also the addition of the vectors

$$-\frac{\bar{V}_1}{2} \cdot e^{-ja} \quad \text{and} \quad -\bar{V}_1' \cdot e^{-ja} \quad \text{gives} \quad -\bar{E}_{1p} \cdot e^{-ja}.$$

We then find \bar{V}_p by subtraction

$$\bar{V}_p = \bar{E}_p \cdot e^{ja} - (-\bar{E}_{1p} \cdot e^{-ja}).$$

In a similar manner we find, by simple construction, the vector $-\bar{V}_q$ for the potential on the other conductor. The vectors \bar{V} and \bar{V}_1 are assumed in the diagram to have approximately the same magnitude, which means that the reflection of the wave at the end of the line and the propagation of the wave along the line are approximately without losses. Other than that the vectors \bar{V}' and \bar{V}_1' of the in-phase wave shall be small as compared with the potentials of the antiphase wave, they have been assumed entirely arbitrarily.

We assume that the angles a in the diagram have been made by counter-clockwise rotation. If now the reference point for this diagram is shifted along the transmission line, all vectors in the diagram containing the factor e^{ja} will be rotated counterclockwise, and all other vectors clockwise. The entire triangle oab therefore rotates counter-clockwise, while the triangle ocd turns in the opposite direction at the same rate. In consequence the two vectors \bar{V}_p and $-\bar{V}_q$ become smaller. Primarily the node potential \bar{V}_q on conductor q , whose magnitude is given in the diagram reaches a minimum. The minimum for \bar{V}_p is reached somewhat later: the potential nodes on the two lines are therefore displaced in relation to each other.

Quantitatively, it can be stated that the potential node on conductor p is displaced by the angle $\frac{1}{2}(a_1 - b_1)$ while this displacement on line q is $-\frac{1}{2}(a_2 - b_2)$. However, since with slight dissymmetry the angles a_1 and a_2 as well as angles b_1 and b_2 become equal to one another, we get the following theorem:

(1) In lines with slight dissymmetry there appear node displacements which are equal and opposite on the two conductors, as contrasted with the symmetrical line.

Two more characteristics may be mentioned:

(2) It is evident from the diagram that the node potentials on the two lines are different, and hence, in the case of slight dissymmetry one can therefore say further that, as compared with the symmetrical line, the node potential on one conductor increases approximately the same amount that it decreases on the other conductor.

As defined in Part One, Section A, 4, the node width is equal to the

distance between the two points at which the potential becomes equal to $\sqrt{2}$ times the node potential. For the node width expressed in angular units we found:

$$u_k = (V - V_1):(V + V_1)$$

for which we can write:

$$u_k = V_k/V_b$$

where V_k and V_b are the node and loop potentials.

Because the loop potentials on the two conductors with slight dissymmetry can be considered as equal to each other, the node widths are proportional to the node potentials and in view of this the same law derived for the node potentials holds good for the node widths.

(3) In lines with slight dissymmetry there appear changes in the node widths, as compared with the symmetrical line, and it can be stated that as compared with the node width on the symmetrical line, the node width on one conductor increases approximately as much as it is reduced on the other conductor.

A theorem that should be evident from (22) and (23) finally is as follows:

(4) The current wave has properties similar to the potential wave. The displacements and widths of current and potential nodes are, however, not generally the same quantitatively.

b. Lines with great dissymmetry

While it was possible to give a general idea of the effects of dissymmetry for the cases thus far considered, this cannot be done to the same extent for lines with great dissymmetry because of the great scope of the subject. A general law can be established which is valid for every kind of dissymmetry and which says: every current phenomenon on a line free from losses must show a spatial periodicity with the length of period λ . Dissymmetry is, therefore, never a local phenomenon, but always extends over the entire length of line. From (20) and (21) it follows directly that points on the line spaced by an angle that is a multiple of 2π must always show the same currents and potentials. (See (20) to (23).)

In general it can be said that lines with great dissymmetry will show to a greater extent the same phenomena that we found for lines with slight dissymmetry. In slightly unsymmetrical lines we established the fact that the phenomena due to dissymmetry were not present to the same extent quantitatively as regards distribution of current and potential (theorem (3) of the above section). With great dissymmetry this might be carried so far that hardly any relation ap-

appears to exist between the current distribution and the potential distribution. It is easy to see how this could occur by imagining that the amplitudes of the vectors \bar{V}' and \bar{V}_1' in Fig. 16 are increased by a multiple. Then the approximation laws that were set up in the previous section for node potential and width and node displacement lose their validity.

The current-potential distributions then possible have so many forms that we are not able to treat them even somewhat systematically. We shall therefore select one characteristic case from the many phenomena and analyze it.

Example

In a line, for which (20) to (23) are valid, let q be grounded at the beginning and at the end. Let the conductor p be grounded at the end through an impedance \bar{Z} . If the length of the line is not a whole number of half waves, then both for $a=0$, and $a=2\pi l/\lambda$. There is $\bar{V}_q=0$ so (21) results in:

$$\bar{V}' = \bar{V}/2 \quad \text{and} \quad \bar{V}_1' = \bar{V}_1/2$$

and (20) to (23) become:

$$\bar{V}_p = \bar{V}e^{ja} + \bar{V}_1e^{-ja} \quad (24)$$

$$\bar{V}_q = 0 \quad (25)$$

$$\bar{J}_p = \bar{V} \left(\frac{1}{4W'} + \frac{1}{W} \right) e^{ja} - \bar{V}_1 \left(\frac{1}{4W'} + \frac{1}{W} \right) e^{-ja} \quad (26)$$

$$\bar{J}_q = \bar{V} \left(\frac{1}{4W'} - \frac{1}{W} \right) e^{ja} - \bar{V}_1 \left(\frac{1}{4W'} - \frac{1}{W} \right) e^{-ja}. \quad (27)$$

The magnitudes of the potentials \bar{V} and \bar{V}_1 are specified in each separate case by the magnitudes of the terminating impedance \bar{Z} of conductor p , and the potential applied at the beginning of this conductor.

Conclusions

From (24) to (27) it follows:

- (1) On conductor p the current and potential distribution is the same as on a normal single-conductor line with a surge impedance:

$$\frac{4W'W}{4W' + W}$$

- (2) On conductor q , the potential is zero over the entire length. But the current strength is only zero when $4W' = W$, that is, when the spacing between the two conductors is very large (see Part Three, Sec-

tion A, 2.) As long as this is not the case, there appears on this conductor having no potential, a perfectly normal current distribution, which may show all intermediate forms between a standing and a traveling wave depending upon the values of \bar{V} and \bar{V}_1 .

4. Experimental Confirmation of the Theory

We have observed many cases of great and slight dissymmetry in practice. With great dissymmetry the cause is generally due directly to the connection. For example, in the beginning of the tests with directive antennas, it happened that the feed line of a directive antenna showed a difference over its entire length of about 50 per cent. between current and potential on the two wires. This disturbance continued along the connected antenna where it certainly could have had

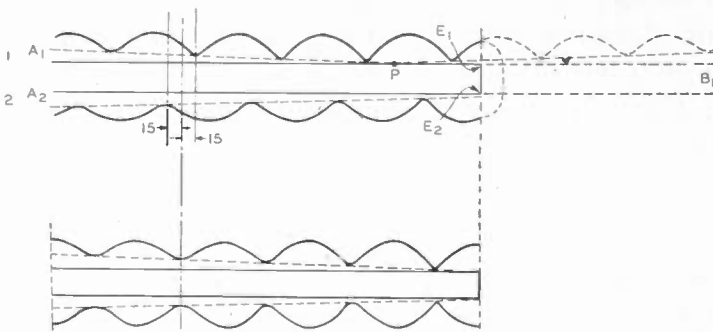

Fig. 17—Comparison of current distribution on symmetrical and unsymmetrical lines. The two lines are short-circuited at the end and have the same losses.

Top: Unsymmetrical line with losses.

Bottom: Symmetrical line with losses.

no favorable effect on the radiation diagram. An investigation led to the discovery that in order to carry off static antenna charges, one of the two wires in the two-wire line had been grounded directly at the transmitter. After removing this ground the disturbance disappeared.

Another disturbance that was traced to dissymmetry of an electric line in the Nauen radio station, was the great interference with telephony as soon as a short-wave transmitter modulated with 500 cycles was operated. Here also, by careful removal of the dissymmetry by means of a triple-plate condenser (see Fig. 8), the disturbance could be reduced to such an extent that telephony was no longer interfered with.

As has already been mentioned in Part Two, Section B, 2, slight dissymmetries appeared in the damping measurements that were described. In these measurements the case was somewhat more complicated than in the cases of slight dissymmetry discussed by us, because

the damping of the line had a marked effect on the shape of the current curve for the line. The current distribution that was found is shown in Fig. 17. The line was the same one on which the above discussed damping measurements had been made, short-circuited at the end and supplied at the input through a transformer (Figs. 13 to 15). Because of the parasitic capacity coupling in the transformer there resulted an in-phase oscillation which gave the node displacements on the line being measured as shown in Fig. 17. For comparison there has been drawn in the same figure the current distribution that would be found on a symmetrical line with losses. It is striking that the node width changes continuously along the line. The cause of this variable unsymmetrical node width is easily perceived if one imagines the circles in Fig. 16 to be replaced by spirals in order to show the line losses in this diagram. It is further shown by means of a broken line, representing the continuation of the current distribution over the length of the line that the current distribution on conductor 2 from E_2 to A_2 is identical with the current distribution that would result on 1 from E_1 to B_1 if the line were continued from E instead of ending it at E by a short-circuit bridge.

5. Removing the Line Dissymmetry

We have mentioned some practical examples of line dissymmetry and have briefly mentioned the ways in which the disturbances were overcome. But these simple methods cannot be used in complicated cases.

The following self-evident facts must then be kept in mind:

(1) A load dissymmetrical with respect to ground makes it impossible to get a symmetrical current distribution and a symmetrical potential distribution on the line at the same time.

(2) A source of energy dissymmetrical with respect to ground has the same effect.

(3) Therefore, in order to remove dissymmetry it is necessary, and sufficient, to balance the beginning and the end of the line; it is impossible to overcome dissymmetry which exists at the end of the line by overcompensation at the beginning. The best way to overcome the dissymmetry is to disconnect the load from the line, or better still to replace it by an exactly equal but symmetrical impedance. Then the beginning of the line is made symmetrical in relation to the ground—by a triple-plate condenser if it is a case of capacity dissymmetry. As an indicator of symmetry we may make use of the fact that no current can be induced in a tuned wire rectangle placed in the plane of symmetry of the Lecher system. If current is induced it indicates that the

currents in the two conductors are not equal or that their phases the not exactly 180 degrees out of phase.

When the symmetry of the source of energy has been established as described above, the load is again connected to the line and so regulated—by a triple-plate condenser in the case of capacity dissymmetry—that symmetry is obtained again.

The author wishes to thank Dr. H. Barkhausen for the active interest he has taken and for the many suggestions that have greatly aided the work.

The above investigations are a part of the researches of Telefunken Company in the field of short waves, and were made in the laboratory of that concern. The writer is greatly indebted to Dr. O. Böhm, Dr. W. Moser, and Dr. R. Bechmann for many suggestions.



DISCUSSION ON "HIGH AUDIO POWER FROM RELATIVELY SMALL TUBES"

LOY E. BARTON*

R. A. Heising¹: This paper commends itself to a large part of the radio engineering field. It is of special importance to engineers concerned with the development of transmitters. The paper should be read by everyone who contemplates developing apparatus in which power efficiency of the radio equipment is important.

Push-pull amplifiers have been used in communication circuits for many years. They have usually been employed for reduction in distortion, or for providing a balanced circuit arrangement. Barton's paper emphasizes a long neglected use which results in increased output power, and decreased dissipated power simultaneously. This is accomplished by using a separate tube to amplify each half of the audio wave.

This circuit instantly commends itself to those interested in audio-frequency power at high power levels. The operation of loud speakers will probably occur to us as its widest field of application, but a very important field also exists in connection with radio transmitters. It is the latter application that I wish to discuss.

In transmitters employing plate circuit modulation of the power tubes, the over-all power efficiency is brought to a relatively low value by the power consumed in the modulators. By embodying push-pull modulator tubes, with a bias which is very close to the cut-off point, the power consumed in the modulators is almost eliminated during quiescent periods, while during talking periods the efficiency of the modulators is more than doubled. The improvement in efficiency in the modulators, therefore, has the very important effect of raising the plate circuit efficiency of the transmitter to a value double that of the next best system.

The importance of this is only appreciated by those who have tried developing transmitters to occupy small space. The improved efficiency in the modulating arrangement allows of using fewer tubes to give complete modulation. It cuts down the amount of heat liberated within the set. It allows of a considerable reduction in size of the power equipment. Modulator tubes are not subjected to as hard working conditions when operated at normal voltages, and have longer life. It is possible to operate the modulator tubes at voltages somewhat higher than normal without shortening the life.

At the same time, other important advantages result. The second harmonic, which is the largest frequency produced by distortion in most tube circuits, is largely reduced by the balanced arrangement, while the third and other odd harmonics which tend to add up are so much below the normal value of second harmonic that much improved quality is secured from tubes delivering large amounts of speech frequency energy. It is not difficult to construct this amplifier so that any distorting frequencies produced are 20 db below the fundamental. This is attested to by Barton's curves.

As a concrete example of increased audio power, and small distortion, I might mention the performance of the radio-telephone transmitter on the Levia-

* Proc. I. R. E., 19, 1131-1150; July, 1931. Delivered before Sixth Annual Convention, July, 5, 1931, Chicago, Illinois.

¹ Bell Telephone Laboratories, New York City.

than. In this set two 212-D tubes (customarily rated as 250 watts capacity on 1500 volts) are used to modulate one 215-A tube (customarily rated at 1 kw at 3000 volts). All are operated at 2000 volts, at which the 215-A tube readily delivers 600 to 700 watts. In this case, complete modulation is secured without forcing the modulator tubes, and the distortion products when modulating 85 per cent are of the order of 25 db down from the fundamental.

The modulator tubes, though operating on a voltage one-third higher than normal, are not overworked in the least. Actually, a study of plate potential-space current relations existing over the audio cycle show that they are working less hard at all instants than when employed in a class A amplifier circuit at 1500 volts.

It is not to be inferred that the type of amplifier circuit under discussion may be arbitrarily substituted for other amplifiers or modulator arrangements in any transmitter. The amplifier possesses requirements of its own that react upon other parts of the equipment. These have been discussed by Barton probably for the first time.

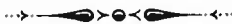

BOOK REVIEW

Aircraft Radio, by Myron F. Eddy. Published by the Ronald Press Company, New York. 284 pages, 64 figures, price \$4.50.

This is an elementary book prepared for the "average student who has learned the elementary principles of electricity in the public schools." It contains a brief history of aircraft radio, a discussion of elementary electricity and elementary radio, and a more detailed discussion of radio aids to air navigation and the methods of equipping aircraft with radio. The Navy radio compass system, the British rotating radio beacon system, the radio range beacon, both aural and visual types, marker beacons and the deviometer are described and circuit diagrams given. There is also a discussion of bonding and shielding and of antenna installations. The book is in general more descriptive than theoretical. Several questionable statements were observed among which was one that the "strength of the field set-up varies inversely as the square of the distance from the antenna."

*S. S. KIRBY

* Bureau of Standards, Washington, D. C.



BOOKLETS, CATALOGS, AND PAMPHLETS RECEIVED

Copies of the publications listed on this page may be obtained gratis by addressing a request to the manufacturer or publisher.

Two catalog sheets have recently been issued by the Daven Company, 158-160 Summit St., Newark, N. J. One of these, entitled "Davohms" lists a line of wire wound resistors covered with baked enamel having dissipation as high as 100 watts. The resistors described in "The Super-Davohm" are noninductive wire wound units normally provided with a tolerance of 1 per cent. Resistors may be obtained from values as low as 0.1 ohm to 15 megohms.

A 32-page brochure on "Laboratory Experiments in Physics" (Series C, Experiment 51) is a comprehensive treatise on various forms of moving coil galvanometers. A number of experiments intended to illustrate the numerous uses of galvanometers are given. The booklet is published by the Central Scientific Company, Chicago, Ill.

The B-L Electric Manufacturing Company of St. Louis has recently published descriptive material on dry metallic rectifiers. "B-L Rectifiers" is the title of a 4-page folder describing dry metallic full wave rectifier units for manufacturers' use. Rectifier power packs for operating clocks, low voltage motors, magnets, relays and the like are described in a folder entitled "Rectopacs" while another sheet, "B-L Filterpacs" describes similar units intended for use with PBX boards, and intercommunicating or apartment house telephone systems.

A number of telephone and telegraph transmitters as well as miscellaneous auxiliary equipment for transmitters is described in folders recently issued by the Radio Engineering Laboratories, Long Island City, N. Y.

Bulletin 19 issued by the Ward Leonard Company of Mount Vernon, N. Y., describes a series of resistors intended for high power continuous or intermittent duty. The resistors are available in values from 0.4 ohm to 10 ohms.

The Supreme Instruments Corporation of Greenwood, Miss. announces a new kit and test set for service men known as the AAA1 diagnometer. The outfit is intended to be used as a set analyzer, a tube tester, a shielded oscillator, an ohm-meter, or a condenser tester.

Type 233 output pentode, manufactured by the CeCo Manufacturing Company, of Providence, R. I., is described in Bulletin 13A. The tube operates with a filament current of 0.26 ampere at 2 volts, and with plate voltage of 135 volts, an output of 0.65 watt may be obtained.



RADIO ABSTRACTS AND REFERENCES

THIS IS prepared monthly by the Bureau of Standards,* and is intended to cover the more important papers of interest to the professional radio engineer which have recently appeared in periodicals, books, etc. The number at the left of each reference classifies the reference by subject, in accordance with the "Classification of Radio Subjects: An Extension of the Dewey Decimal System," Bureau of Standards Circular No. 385, which appeared in full on pp. 1433-56 of the August, 1930, issue of the PROCEEDINGS of the Institute of Radio Engineers.

The articles listed are not obtainable from the Government or the Institute of Radio Engineers, except when publications thereof. The various periodicals can be secured from their publishers and can be consulted at large public libraries.

R100. RADIO PRINCIPLES

- R111 The propagation of electric waves. *Elec. Eng.*, 50, 652-653; August, 1931.
Progress made during the past year in the study of the propagation of electric waves is reported upon briefly by the American Institute of Electrical Engineers, Electrolysis Committee.
- R111.2 Bechmann, R. Zur Abraham'schen Darstellung des Strahlungsfeldes eines stabförmigen Leiters (On Abraham's representation of the radiation field of a rod-shaped conductor). *Zeit. für Hochfrequenz.*, 38, 30-32; July, 1931.
It is shown that the results obtained by Abraham are identical with those obtained by the author by applying the Lorentz theory.
- R113 J. P. Schafer and W. M. Goodall. Radio transmission studies of the upper atmosphere. *PROC. I. R. E.*, 19, 1434-1445; August, 1931.
A number of measurements which show time variations in the virtual height of the ionized regions of the upper atmosphere are given. Most of these measurements were made simultaneously on two frequencies, 1604 kc and 3088 kc.
- R113.7 H. Fassbender, F. Eisner, and G. Kurlbaum. Investigation of the attenuation of electromagnetic waves and the distances reached by radio stations in the wave band from 200 to 2000 meters. *PROC. I. R. E.*, 19, 1446-1470; August, 1931.
The paper gives the results of a large number of field strength measurements in which the relative radiation characteristics of the transmitting and receiving stations remain constant even on changing their distance. The results of the work make possible the numerical calculation of the range of radio waves over land in the wave band between 200 and 2000 meters. They should be more reliable than the rule-of-thumb methods hitherto used.
- R114 J. R. Carson. The statistical energy-frequency spectrum of random disturbances. *Bell Sys. Tech. Jour.*, 10, 374-381; July, 1931.
A mathematical discussion of the statistical characteristics of random disturbances in terms of their "energy-frequency spectra" with applications to such typical disturbances as telegraph signals and static.
- R120 Bechmann, R. On the calculation of radiation resistance of antennas and antenna combinations. *PROC. I. R. E.*, 19, 1471-1480; August, 1931.
It is shown that there are two methods for calculating the radiation of antennas and antenna systems. One depends on the integration of the Poynting vector over a surface enclosing the system, the other is based on a consideration of the electromagnetic phenomena on the conductor itself. The identity of the two methods is demonstrated.

* This list compiled by Mr. W. H. Orton and Miss E. M. Zandonini.

- R125 L. Högelsberger. Zur Berechnung des Leistungsgewinnes bei Verwendung von Richtantennen (The calculation of power-gain by the use of directional antennas). *Zeit. für Hochfrequenz.*, 38, 307-308; July, 1931.
Calculated gain factors for antenna arrays are tabulated. The effects of ground are not considered.
- R125 E. Bruce. Developments in short-wave directive antennas. *Proc. I. R. E.*, 19, 1406-1433; August, 1931.
Part 1 discusses the relative importance of the factors which limit the intelligibility of short wave radio communication and the possibility of counteracting these limitations. Part 2 describes an economical antenna system which maintains a desirable degree of directivity throughout a broad continuous range of frequencies.
- R131 J. Miura. Graphical representation of the three constants of a triode. *Proc. I. R. E.*, 19, 1488-1491; August, 1931.
It is shown that the three constants of a triode; i.e., amplification factor, internal resistance, and transconductance, can be represented by one point in an equilateral triangle logarithmically scaled, and the author gives, as an example, a graph in which are plotted the constants of twenty-four kinds of typical tubes now used in practice.
- R139 L. Hartshorn. The variation of the resistances and interelectrode capacities of thermionic valves with frequency. *Experimental Wireless and the Wireless Engineer*, 8, 413-421; August, 1931.
The order of magnitude and the nature of resistance and interelectrode capacity changes in a vacuum-tube with varying frequency are considered and the errors arising from the usual assumptions are estimated.
- R140 H. König. Drei Bemerkungen zur Theorie des Vierpols. (Three notes on the theory of the four-pole circuit network). *Zeit. für Hochfrequenz.*, 38, 304-306; July, 1931.
The author discusses three phases of the theory of four-pole networks.
- R140 E. Selach. Zur Theorie der Vierpolverbindungen. (On the theory of four-pole circuit networks). *Zeit. für Hochfrequenz.*, 38, 297-303; July, 1931.
A number of special cases are considered in order to show that the formulas of Strecker and Feldtkeller hold generally for four-pole networks.
- R140 R. M. Foster. Mutual impedance of grounded wires lying on the surface of the earth. *Bell Sys. Tech. Jour.*, 10, 408-419; July, 1931.
A formula for the mutual impedance between two insulated wires of negligible diameter lying on the surface of the earth and grounded at their end-points. The formula holds for frequencies which are not too high to allow all displacement currents to be neglected.
- R140 J. Riordan. Transients in grounded wires lying on the earth's surface. *Bell Sys. Tech. Jour.*, 10, 420-431; July, 1931.
Voltages during transient conditions in a grounded wire lying on the earth's surface due to a current in a second grounded wire also on the earth's surface are formulated for types of transient currents ordinarily obtained in a-c and d-c circuits.
- R140 W. H. Wise. Effect of ground permeability on ground return circuits. *Bell Sys. Tech. Jour.*, 10, 472-484; July, 1931.
The formulas for the self and mutual impedances of ground return circuits are derived without restricting ground permeability. Curves are given to show the effect of a ground permeability 1.7 on the mutual impedance between two parallel ground return circuits with the wires lying on the ground.
- R145.3 W. G. Hayman. Approximate formulae for the inductance of solenoids and astatic coils. *Experimental Wireless and the Wireless Engineer*, 8, 422-425; August, 1931.
A single formula for the calculation of the inductance of a solenoid is given. The formula is easily memorized and gives results of sufficient accuracy for practical purposes.

- R148 W. F. Lanterman. Relations between modulation and antenna current. *Electronics*, 3, 59; August, 1931.
A method and table for determining percentage of modulation from percentage increase in antenna current is given.
- R148 W. Jackson. Modulation and the heterodyne. *Experimental Wireless and the Wireless Engineer*, 8, 425-426; August, 1931.
A simple and informative treatment of modulation and heterodyne phenomena is given.
- R149
×R430 F. M. Colebrook. The apparent demodulation of a weak station by a stronger one. *Experimental Wireless and the Wireless Engineer*, 8, 409-412; August, 1931.
An analysis which amplifies that given this subject by Butterworth in the November, 1929, issue of *Experimental Wireless and the Wireless Engineer*.
- R191 R. R. Batcher. Applications of piezo-electric crystals to receivers. *Electronics*, 3, 57-58; August, 1931.
The piezo-crystal bridge circuit as used in the Stenode is analyzed. A simple relation between the factors which govern the response of the bridge as a whole is developed.
- R200. RADIO MEASUREMENTS AND STANDARDIZATION
- R201 A. Janmann. Hochfrequenz-Messgeräte (High-frequency measuring apparatus). *Elek. Zeit.*, 52, 985-991; July, 1931:
A description of methods and commercially available apparatus for making high-frequency measurements of voltage, impedance, amplification, and damping is given.
- R210 A. A. Roetken. Measuring the frequencies of radio signals. *Bell Laboratories Record*, 9, 585-588; August, 1931.
A brief description of frequency measuring equipment having a range of 5 to 30 mc and an accuracy of better than 3 parts in 10⁴. The unknown frequency value appears as a number in a bank of switchboard lights.
- R211.1 F. T. McNamara. A thermionic type frequency meter for use up to 15 kc. *PROC. I. R. E.*, 19, 1384-1390; August, 1931.
A new type of frequency meter is described which is adapted to the measurement of low and intermediate frequencies. The instrument absorbs a negligible amount of power from the circuit being tested, has a linear calibration curve and a sensitivity of about eight microamperes for one per cent change in frequency.
- R214 H. Straubel. Schwingungsform und Temperaturkoeffizient von Quarzoszillatoren (Modes of vibration and temperature coefficient of quartz oscillators). *Zeit. für Hochfrequenz.*, 38, 14-27; July, 1931.
An experimental study of piezo-electric oscillators was made with a view of improving their utility as frequency standards.
- R214 H. Straubel. Piezoelektrische Oszillatoren (Piezo-electric oscillators). *Phys. Zeit.*, 32, 586-587; August, 1931.
A brief report of the results of experiments with piezo-electric oscillators.
- R241 I. J. Saxl. Measuring ionization currents and high resistances. *Electronics*, 3, 62-63; August, 1931.
Description of equipment originally designed for measuring X-ray dosage but applicable also to measuring insulation resistances up to 12×10^{13} ohms.
- R250
×R120 A. H. Taylor and H. F. Hastings. The determination of power in the antenna at high frequencies. *PROC. I. R. E.*, 19, 1370-1383; August, 1931.
Following a brief review of general methods of measuring radio-frequency power in the antenna, a series of tests on a particular transmitter operating from 4000 to 6000 kc is described.

- R261 A. Clausing. Die Messende Bestimmung der Empfangsgüte von Rundfunkempfängern (Broadcast receiving set measurements). *Elek. Zeit.*, 52, 999-1001; July, 1931.

Methods of measuring the sensitivity, selectivity, and fidelity of broadcast receivers are discussed.

- R281 A. B. Lewis, E. L. Hall, and F. R. Caldwell. Some electrical properties of foreign and domestic micas and the effect of elevated temperatures on micas. *Bureau of Standards Journal of Research*, 7, 403-418; August, 1931. *Bureau of Standards*, Research Paper No. 347.

A number of samples of mica, fairly representative of the major sources of the world's supply of mica, have been tested for dielectric constant, power factor, dielectric strength, and ability to withstand elevated temperatures. The results of these tests are given.

R300. RADIO APPARATUS AND EQUIPMENT

- R335 J. M. Glessner. Performance of output pentodes. *Proc. I. R. E.*,
 ×R262 19, 1391-1405; August, 1931.

The comparison of power output, distortion, power sensitivity, and a-c/d-c power economy of a group of experimental pentodes is made with corresponding triodes. The apparatus and method of measuring are described.

- R339 H. Alfven. Versuche mit einer Verstärkerröhre nach dem Quer-
 ×R132 feldprinzip (Experiments with an amplifying vacuum tube that uses a transverse field for control). *Zeit. für Hochfrequenz.*, 38, 27-29; July, 1931.

A vacuum tube in which a concentrated cathode stream is made to pass through a transverse electric field from one electrode to another is described and the amplifying characteristics of such a tube are given.

- R339 W. F. Westendorp. A method of determining the impedance of hot-
 cathode discharge tubes. *Rev. Sci. Instr.*, 2, 437-446; August, 1931.

By means of a superposed alternating current, the negative resistance of hot cathode, neon, and mercury, direct-current arcs was measured and at the same time the reactance for the ripple current in the arc was determined. This reactance is explained on the basis of a time lag in the concentration of metastable atoms.

- R355.7 A. Forstmann. Über die Bemessung verzerrungsfreier Grossleis-
 ×R132 tungs-Endstufen (The calculation of distortionless power amplifiers). *Elek. Zeit.*, 52, 957-961; July, 1931, 1033-1035; August, 1931.

The conditions for minimum distortion in the final power amplifying stage are analyzed.

- R381 W. Hoesch. Wirkungsweise, Bau, and Verwendung von Elektrolyt-
 kondensatoren (Operation, construction, and application of electro-
 lytic condensers). *Elek. Zeit.*, 52, 928-932; July, 1931.

The principles of operation of the electrolytic condenser are discussed, from both the chemical and electrical point of view. Applications of this type of condenser, and service test methods are mentioned.

- R385.5 C. A. Hartmann. Ein neues elektrodynamisches Bandmikrophon
 (A new electrodynamic microphone). *Zeit. für Hochfrequenz.*, 38,
 289-297; July, 1931.

A new type of electrodynamic microphone having exceptional tone-fidelity and ruggedness is described.

R400. RADIO COMMUNICATION SYSTEMS

- R423.3 Single wave length system. *Electrician*, 107, 85-86; July, 1931.
The successful use of the same frequency for receiving and transmitting is accomplished by the radio installation on the SS Olympic. Details of the installation are given.
- R423.5 H. H. Beverage, H. O. Peterson, and C. W. Hansell. Application of frequencies above 30,000 kilocycles to communication problems. *Proc. I. R. E.*, 19, 1313-1333; August, 1931.
The authors briefly describe the results of a number of experiments with frequencies above 30,000 kc covering a period of several years and include some qualitative data covering propagation beyond the optical, or direct vision range.
- R430
×R521 W. Brintzinger, P. v. Handel and H. Viehman. Erschütterungsstörungen bei ortsbeweglichen Empfängern (Shock disturbances in portable receiving sets). *Zeit. für Hochfrequenz.*, 38, 1-14; July, 1931.
A series of tests with various types of short-wave radio receivers indicate that interference due to shock and vibration of set and antenna may be appreciably reduced.

R500. APPLICATIONS OF RADIO

- R520 H. Fassbender. Jahresbericht der Abteilung für Elektrotechnik und Funkwesen der Deutschen Versuchsanstalt für Luftfahrt, E. V. Berlin-Adlershof (A brief report of the activities of the D. V. L. during 1930-1931). *Elek. Zeit.*, 52, 1026-1029; August, 1931.
There is also a brief abstract of each technical paper released by D. V. L. during the same period.
- R526 C. F. Green. Airplane flight aided by electricity. *Elec. Eng.*, 50, 654-657; August, 1931.
A brief summary and description of aircraft navigational aids afforded by electrical and radio devices.
- R526.1 F. G. Kear and G. H. Wintermute. A simultaneous radio-telephone and visual range-beacon for the airways. *Bureau of Standards Journal of Research*, 7, 261-287; August, 1931; *Bureau of Standards Research Paper No. 341*.
Increased use of the airways radio services by transport operators has resulted in a demand for continuous range-beacon service. At the same time the weather broadcast information has increased in importance and the interruptions to the beacon service have become more frequent. To eliminate difficulties arising from this conflict a transmitting system has been developed which provides simultaneous transmission of visual range-beacon and radiotelephone signals.
- R550
×621.385.91 G. Schwaiger. Das Österreichische Rundspruch-Sendernetz (Austria's radiobroadcasting network). *Elek. und Maschinenbau*, 49, 580-583; July, 1931.
A complete description is given of the present broadcasting facilities in Austria.
- R550
×621.385.91 H. F. Mayer. Die Übertragung von Rundfunkprogrammen auf Kabelleitungen (The transmission of radio broadcast programs over wire lines). *Telegraphen und Fernsprech Technik*, 20, 199-205; July, 1931.
The program-distributing network of Germany and Austria is described and the transmission properties of various lines of the network are discussed.
- R550
×621.385.91 L. Fenyö and H. Hoffman. Messung und Betriebsüberwachung von Rundfunkfernleitungsnetzen (Testing and maintenance of program distributing networks). *Telegraphen und Fernsprech Technik*, 20, 205-219; July, 1931.
Testing methods and the solution of maintenance problems in connection with the German distribution network for radio programs.

- R550 G. D. Gillett. Some developments in common frequency broadcasting. *Proc. I. R. E.*, 19, 1347-1369; August, 1931.

This paper describes the results of the simultaneous operation of radio stations WHO and WOC broadcasting the same program on a common frequency, using independent crystal-controlled oscillators. These stations had previously been compelled to share time on 1000 kc and each is now able to render full time service.

- R526.3 H. Diamond and F. W. Dunmore. Airplanes land blind-guided by radio. *Scientific American*, 145, 20-23; July, 1931.

A radio beacon and receiving system is described for use at airports to permit the blind landing of aircraft under conditions of no visibility.

- R590 E. B. Patterson. Automatic color organ. *Proc. I. R. E.*, 19, 1334-1346; August, 1931.

The automatic color organ, a by-product of radio, produces colors by means of music and synchronizes colors with music. Acoustic power on the order of microwatts controls lighting power of hundreds to millions of watts, which is varied in accordance with rapid fluctuations of the input.

R800. NONRADIO SUBJECTS

- 534 H. Fletcher. Some physical characteristics of speech and music. *Bell Sys. Tech. Jour.*, 10, 349-373; July, 1931.

Kinematic and statistical descriptions of the physical aspects of speech and music are given.

- 535.3 W. S. Huxford. Effect of electric fields on the emission of photo-electrons from oxide cathodes. *Phys. Rev.*, 38, 379-395; August, 1931.

A study of the photo-electric emission obtained at room temperature from the equipotential oxide cathodes commonly employed in radio receiving tubes.

- 537.7 H. Roder. A simple method of harmonic analysis for use in radio engineering practice. *Proc. I. R. E.*, 19, 1481-1487; August, 1931.

A simple method of harmonic analysis is applied for a-c waves with certain properties. Curves having such properties often occur in audio- and radio-frequency applications in the form of so-called "characteristics."

- 538.11 G. Dietsch. Magnetostraktion ferromagnetischer Stoffe (Magnetostriction properties of ferromagnetic materials). *Zeit. für Tech. Physik*, 12, 380-389; No. 8, 1931.

A supersensitive method is described for investigating magnetostriction in ferromagnetic materials over a range of low saturation values.

- 621.319.2 W. Waterman. Solving network problems by graphs. *Electronics*, 3, 60-61; August, 1931.

A decibel chart for solving transmission problems is reproduced and its use explained.

- 621.374.7 A. M. Curtis and I. E. Cole. A rapid-record oscillograph. *Electronics*, 3, 70-71; August, 1931.

An improved oscillograph is described. The instrument has a high sensitivity over the frequency range of 200-6000 c.p.s. and the finished record appears developed and fixed within one minute after exposure.

- 621.385 G. Crisson. Negative impedances and the twin 21-type repeater. *Bell Sys. Tech. Jour.*, 10, 485-513; July, 1931.

The properties of negative resistances and impedances, and some devices by which they may be produced, are described.

- 621.385.96 J. P. Livadary. Effects of optical slits in light-valve sound recording. *Electronics*, 3, 54-56; August, 1931.

Definite conclusions are reached as to the advantages and disadvantages of the principal types of recording systems.

CONTRIBUTORS TO THIS ISSUE

Austin, L. W.: See PROCEEDINGS for September, 1931.

Carter, Philip S.: Born July 22, 1896 at Glastonbury, Connecticut. Received A.B. in M.E. degree, Stanford University, 1918. Signal Corps, U. S. Army, 1918; test and radio engineering department, General Electric Company, 1919-1920; engineering department, Radio Corporation of America, 1920 to date. Associate member, Institute of Radio Engineers, 1929.

Hansell, Clarence Weston: See PROCEEDINGS for August, 1931.

Hooper, S. C.: Graduated U.S. Naval Academy, 1905. Associated with radio work in the Navy since its inception. Instructor, physics, chemistry and electricity, U. S. Naval Academy, 1910-1912; fleet radio officer, 1912-1913; 1923-1925; head of radio division, Navy Department, ten years; technical advisor, Washington Arms Conference, 1921; Washington Radiotelegraph Convention, 1927; delegate, Hague Conference, 1929; technical advisor, Federal Radio Commission, 1927-1928; director of naval communications, 1928 to date. Associate member, Institute of Radio Engineers, 1913; Member, 1915; Fellow, 1917.

Karplus, Eduard: Born September 7, 1899 at Moedling, Austria. Received Diplom Ingenieur, Institute of Technology, Vienna, 1923. Development of portable transmitting and receiving apparatus, research and developing of ultra short-wave communication, C. Lorenz Aktien Gesellschaft, Berlin, 1923-1930; engineering department, General Radio Company, 1930 to date. Associate member, Institute of Radio Engineers, 1930.

Lindenblad, Nils Erik: Born October, 1895 at Norrkoping, Sweden. Studied mechanical engineering, Norrkoping Polytechnicum, 1911-1915. Lecturer, Swedish Signal Corps, 1915-1916. Studied electrical engineering, Royal Institute of Technology, Stockholm, 1916-1919; assistant chief, Svenska Gasaccumulator Electrical Laboratory, 1917-1919; consulting engineer to Lundberg, 1919. Immigrated to United States, 1919. Drafting department, radio engineering department, General Electric Company, 1920; engineering staff, R.C.A. Communications, Inc., 1920 to date. Nonmember, Institute of Radio Engineers.

Potter, Ralph Kimball: Born October 1, 1894 at Elgin, Illinois. Received B.S. degree, Whitman College, 1917. Artillery Corps, U. S. Army, 1917-1919. Received E.E. degree, Columbia University, 1923. Department of development and research, American Telephone and Telegraph Company, 1923 to date. Associate member, Institute of Radio Engineers, 1925; Member, 1926.

Roosenstein, H. O.: Born August 8, 1902 at Amsterdam, Holland. Received M.E. degree, Technical High School, Delft, 1924. Radio corps, Dutch Army, 1925; engineer, Dutch Government Wireless Laboratory, 1926-1928. Received Dr. Ing. degree, Dresden Technical High School, 1930. Engineer, Telefunken Laboratory, 1928. Nonmember, Institute of Radio Engineers.

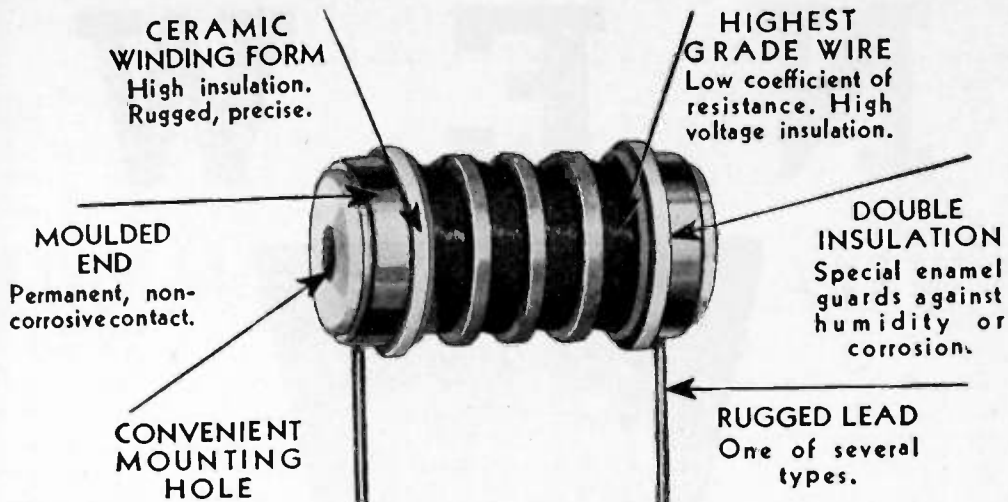

PRECISION RESISTORS

Extra Strength **Improved Insulation**
Closer Accuracy

Wire Wound units to meet all needs of modern electrical equipment—this was the aim of our engineers in developing the resistor here shown.

The task involved elimination of certain marked weaknesses common to ordinary units. *Contact resistance, loose connections, noise*—these had to be conquered. *Breakdowns and shorted turns*, so costly in electrical operations, had to be done away with.

The data above tells a story of marked success. Features found in no other wire wound resistors have been proved of the highest importance by repeated tests under abnormal conditions.

I.R.C. Wire Wound Resistors are made in a complete range. Normal tolerances—1 per cent. Can be obtained in closer tolerances— $\frac{1}{2}$ or $\frac{1}{4}$ of 1 per cent. Folder quoting prices and ranges mailed on request.

INTERNATIONAL RESISTANCE CO.
 PHILADELPHIA TORONTO



PRECISION

WIRE-WOUND

RESISTORS



WW4

ALSO *Metallized* RESISTORS

When writing to advertisers mention of the PROCEEDINGS will be mutually helpful.

NEW



PENTODE TRANSFORMERS

Three AmerTran Output Transformers for use with the new 247-type pentode power tube have won the enthusiastic approval of set builders. These pentode transformers are designed and built with the same skill and fine quality materials and workmanship that has made Amer-Tran Products the Standard of Excellence since 1922.

- Type 6150—Output from two type 247 pentode tubes to 500 ohms (center tapped primary)
- Type 6152—Output from two type 247 pentode tubes to 4000 ohms (center tapped primary)
- Type 6200—Output from two type 247 pentode tubes to 15 ohms (center tapped primary)

DO YOU KNOW

that your set can provide perfect reproduction of music if Amer-Tran audio Transformers are installed?
that radio results are improved if burnt-

out transformers are replaced by Amer-TRAN in your commercial set?
that an AmerTran audio transformer is available to satisfy every amplifier need?

American Transformer Company

Factory and
Main Office—
178 Emmet St.
Newark, N.J.



New York Office
Room 1963
Hudson Terminal
50 Church Street

P.R.I. 10-31

American Transformer Company
178 Emmet Street, Newark, N.J.

Gentlemen: Send me bulletin with complete information of AmerTran Output Transformers.

Name

Street

City and State

When writing to advertisers mention of the PROCEEDINGS will be mutually helpful.

WHAT IS THE VALUE OF
HUMAN CONTACT?



THE *cost* of telephoning is as little as it can be made. Its *value* can be infinite.

If it is worth your while to save time, to be in touch with people at a distance, to do business quickly, to keep in touch with friends and family — if such things have a value, the telephone holds limitless possibilities for you.

It is the means of extending your personality. Unlike commodities, telephone calls cannot be made wholesale. Each one is a personal service. Each goes when and where you wish. At your request you have five thousand or five million dollars' worth of property at your command, two or three people or perhaps a hundred attending the wires along which your voice travels. It is the work of the Bell System to do this well and cheaply.

Its hundreds of thousands of trained workers must keep every part of its 4000 million dollars' worth of equipment ready for instant use.

Here is a business run on the smallest margin of profit consistent with service, security and expansion. Its operation and maintenance have the benefit of the continual research of the 5000 members of Bell Laboratories, the general and technical staff work of the American Telephone and Telegraph Company, and the production economies effected by Western Electric.

Every resource of the Bell System is devoted to making your service clear, quick and inexpensive. As new telephones are added, as improvements are made, you get constantly greater satisfaction and value.

★ AMERICAN TELEPHONE AND TELEGRAPH COMPANY ★



When writing to advertisers mention of the PROCEEDINGS will be mutually helpful.

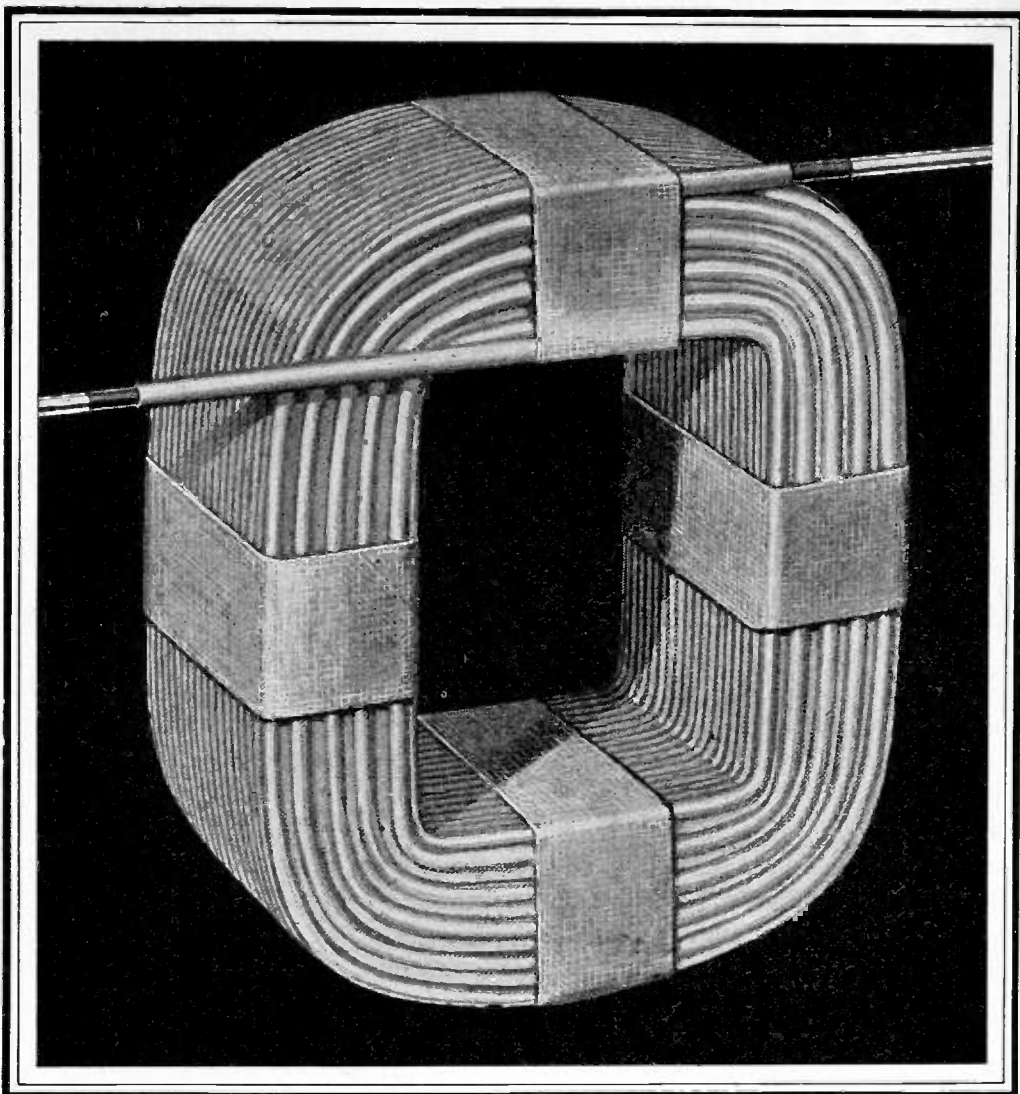

COMMERCIAL RADIO AUTOMOTIVE COILS

High grade magnet wire, made by General Cable; modern manufacturing methods; skilled operators; correct engineering and design . . . such advantages make General Cable Coils more dependable! There is a General Cable Coil of the right size and type for any application you may have.

GENERAL CABLE CORPORATION

420 LEXINGTON AVENUE, NEW YORK • OFFICES IN PRINCIPAL CITIES



When writing to advertisers mention of the PROCEEDINGS will be mutually helpful.

Better!

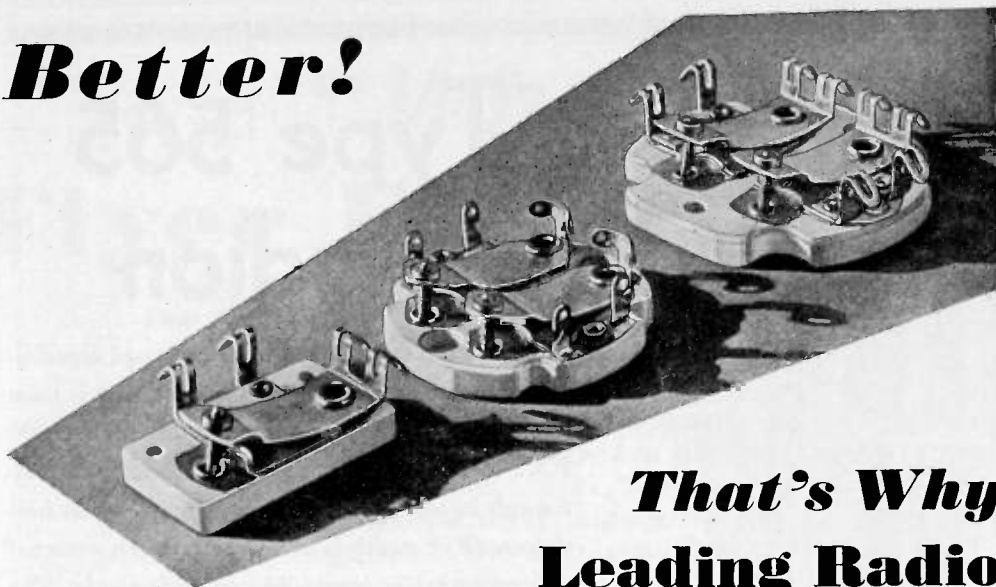

That's Why Leading Radio Manufacturers Use Them

THE Hammarlund Intermediate Tuning Condenser has *proved* its superiority where real *quality* is essential. Because it is *better*, our plant is working day and night to supply the demand from super-heterodyne manufacturers.

And the reasons are these:—

Constant capacity and power factor under all conditions of temperature and humidity. Not affected by vibration.

Specially conditioned Isolantite base will not absorb moisture. Selected mica of much higher quality than many manufacturers consider good enough. Practically straight-line capacity curve, affording minute adjustment. Cut thread adjusting screws, with tapered self-aligning heads. Solder-dipped heat dissipating terminals. All material and processes strictly controlled. Individually inspected for capacity, power and 300 V A.C. breakdown.

Three capacity ranges—10 to 70 mmf.—70 to 140 mmf.—140 to 220 mmf. Singles and duals for 2" and 2½" shields.

You know that a super-heterodyne receiver is only as good as its intermediate circuits. Why not tune with Hammarlunds and be sure. Mail coupon for sample.

For Better Radio
Hammarlund
PRECISION
PRODUCTS

HAMMARLUND MANUFACTURING CO.
424-438 W. 33rd St., New York

Please send us samples of your new Intermediate Frequency Transformer Tuning Condensers and quotations.

Name

Address

PE-10

When writing to advertisers mention of the PROCEEDINGS will be mutually helpful.

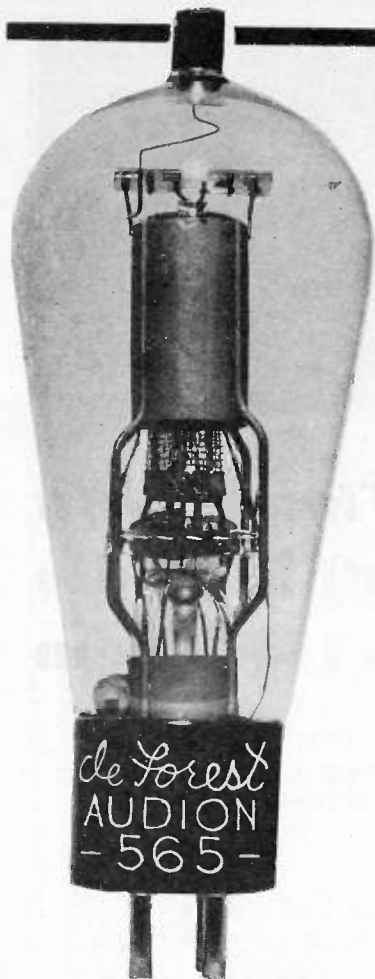

Type 565 Audion

Here is a screen-grid amplifier designed especially for use at radio frequencies. This tube is most appreciated at frequencies greater than 3,000 K.C. It may be employed as an oscillator, although its main function is R.F. amplifier at fundamental or multiple frequencies when external neutralization is impossible or undesirable. The Type 565 is ideal as a buffer stage and as a crystal control amplifier.

The shielding incorporated in the design of this tube reduces effective inter-electrode capacity to such degree that external neutralization is unnecessary.

Clean-cut design, marked by exceptional mechanical and electrical strength, characterizes this DeForest version of a popular type tube.

CHARACTERISTICS

Power Output (normal) . . .	7.5 watts
Filament Voltage	7.5 volts
Filament Current	2.0 amperes
Plate Voltage	500 volts
Screen Voltage (nominal)	125 volts
Average Mutual Conductance	750 M.Mhos.
Average Plate Resistance	200,000 ohms
Average Amplification Factor	150
Interchangeable with UX-865	

Remember, There's an Audion for Every Radio Need

From transmitting to receiving circuits, high-power to low-power ratings, two-element rectifier to three-, four- and five-element tubes, radio to industrial purposes, there is a DeForest Audion available for your needs. The DeForest Audions represent a complete line of tubes.

After all There's No Substitute for 25 Years' Experience

DE FOREST RADIO COMPANY, Passaic, N. J.

Export Department 304 E. 45th Street, NEW YORK CITY

de Forest
(AUDIONS)

RECEIVING
AND
TRANSMITTING **TUBES**

When writing to advertisers mention of the PROCEEDINGS will be mutually helpful.

not "Why Flyer Electrics?"

— instead, "Why not?"

THEY so thoroughly prove themselves the *right* Radio-Phonograph Motor for every job. Specially designed, balanced in efficiency. The Blue Flyer and the Green Flyer for all A. C. Radio-Phonograph work. Self-starting, amply powerful, furnishing dependably uniform speed. For all voltages and frequencies. Also the Green Flyer for direct current, either 110 or 220 volts.

The Green Flyer soon may be had in any of the following specifications:

- 1—78 R.P.M. Governor Speed Controlled or Constant Speed.
- 2—33 $\frac{1}{3}$ R.P.M. Governor Speed Controlled or Constant Speed.
- 3—33 $\frac{1}{3}$ and 78 R.P.M. within the same motor with either Governor or Constant Speed.

No condenser required on Constant Speed.

The **GENERAL INDUSTRIES CO.**

3146 Taylor Street, Elyria, Ohio

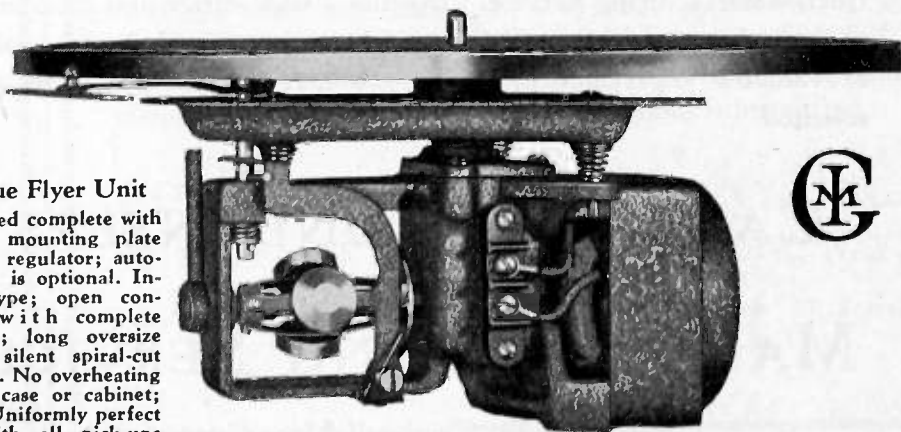

The Blue Flyer Unit

Furnished complete with turntable, mounting plate and speed regulator; automatic stop is optional. Induction type; open construction with complete ventilation; long oversize bearings; silent spiral-cut fiber gears. No overheating in closed case or cabinet; no hum. Uniformly perfect service with all pick-ups and records.

*Responsibly
Guaranteed*

Ontario Hydro-Electric
Power Commission
Approval No. 2685

*In ordering
samples give
voltage and
frequency.*

When writing to advertisers mention of the PROCEEDINGS will be mutually helpful.

IN A TRANSMITTER, GOOD DESIGN IS IMPORTANT— WHAT ABOUT COMPONENTS?

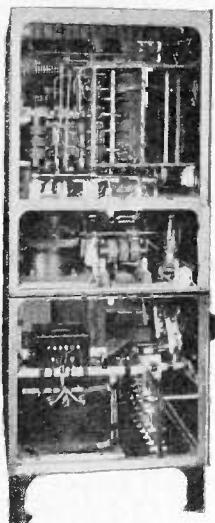

Fine though your transmitter design may be, what gain if, through an unfortunate choice, some components fail to deliver?

For a decade and more, CARDWELL condensers have been a rock upon which engineers have built when selecting variable condensers and this long record of reliable performance has securely established the superiority of the product.

From midget balancing condensers to condensers for high powered transmitters every CARDWELL condenser is built to the same high standard of quality—your guarantee of reliability in service.



It will be worth your while to investigate the CARDWELL Contract-Manufacturing Service. Covering a wide range and in infinite variety, the apparatus manufactured by us has afforded us a wealth of valuable experience by which *you* may benefit. Proposals are solicited.

CARDWELL CONDENSERS AND MANUFACTURING SERVICE

The Allen D. Cardwell Mfg. Corpn.
93 Prospect Street, Brooklyn, N.Y.

“THE STANDARD OF COMPARISON”

When writing to advertisers mention of the PROCEEDINGS will be mutually helpful.

YOUR NEW PROBLEM . . .

and ITS SOLUTION!

WITH home recording promising to be an outstanding feature of next year's radio receivers, the problem of HUM is more serious than ever.

Even a slight hum not noticeable in radio reproduction will, when recorded and augmented through reproduction, make itself heard with sufficient volume to prove disagreeable. In this modern day of radio, hum is not to be tolerated in radio or phonograph reproduction.

For more than twenty years, Pacent engineers have concerned themselves exclusively with problems relating to sound amplification. That's why Pacent amplifiers are the best in the field today.

A standard two stage Pacent Amplifier, Cat. No. 2245M (without input transformer) employing one 227 and two 245's in push-pull has a hum level of 23 DB below its maximum output rating. This same amplifier will provide 4.3 watts undistorted power output and has a voltage gain at 1000 cycles of 31 DB with 3.8 volts input. These figures are not theoretical calculations. They are the result of actual measurements made with a stock amplifier.

A Pacent Amplifier, the 170 Recordovox and the 107 Hi-Output Phonovox make a remarkable combination for recording and reproducing. With this apparatus, it is possible to assure professional results.

The Recordovox and Phonovox are available in special manufacturers' types. Write for additional information.

PACENT ELECTRIC COMPANY, INC.
91 SEVENTH AVE., NEW YORK, N. Y.

Pioneers in Radio and Electric Reproduction for over 20 Years.
Licensee for Canada: White Radio, Ltd., Hamilton, Ont.

PACENT

When writing to advertisers mention of the PROCEEDINGS will be mutually helpful.

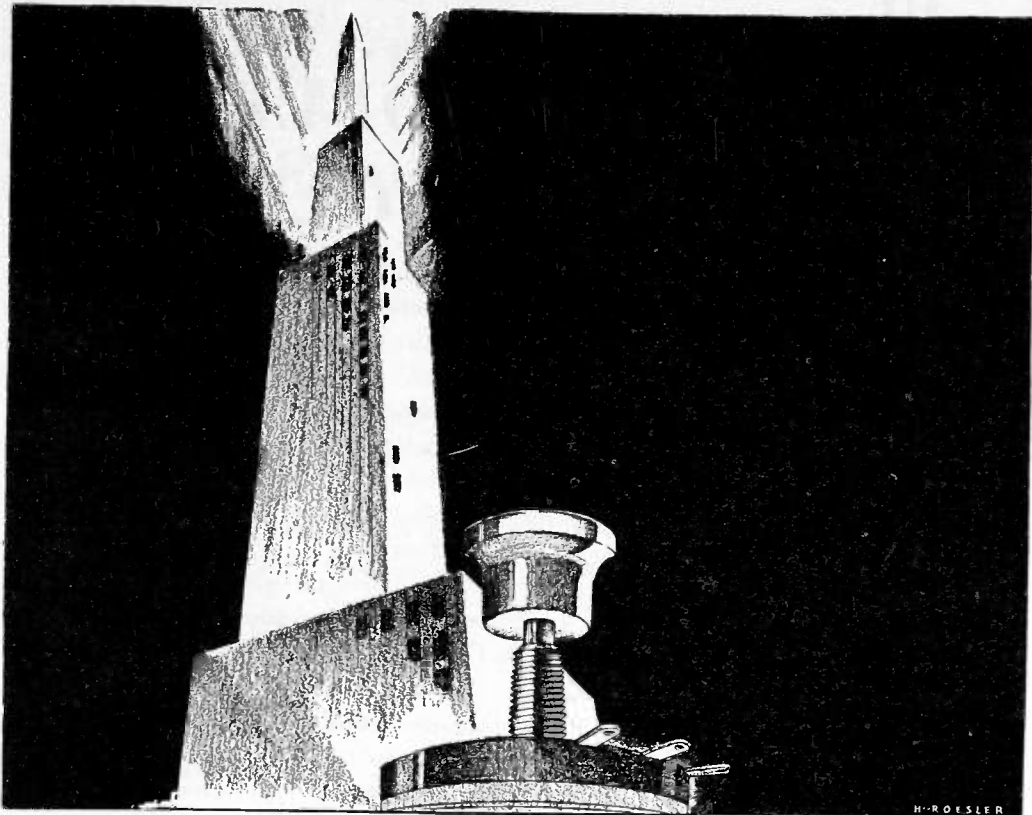

MONUMENTS TO SKILL!

The twenty million volume controls produced by CENTRALAB form a towering monument to skill. Here are twenty million reasons for CENTRALAB'S spectacular rise to fame above the house tops of competitive mediocrity.

Lone experimenters and manufacturers everywhere are offering and producing smoother and more satisfactory reception with CENTRALAB Volume Controls.

The New CENTRALAB

Volume Control with Off and On Switch

More convenient than when mounted separately.
Saves space, saves assembly cost, saves in first cost.
Engineers: send your volume control specifications for sample.

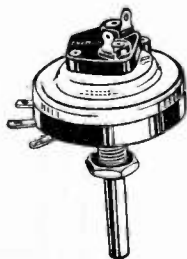

Centralab

Volume Controls

CENTRAL RADIO LABORATORIES—MILWAUKEE, WIS.

When writing to advertisers mention of the PROCEEDINGS will be mutually helpful.

The Institute of Radio Engineers

Incorporated

33 West 39th Street, New York, N. Y.

APPLICATION FOR ASSOCIATE MEMBERSHIP

(Application forms for other grades of membership are obtainable from the Institute)

To the Board of Direction
Gentlemen:

I hereby make application for Associate membership in the Institute.
I certify that the statements made in the record of my training and professional experience are correct, and agree if elected, that I will be governed by the constitution of the Institute as long as I continue a member. I furthermore agree to promote the objects of the Institute so far as shall be in my power, and if my membership shall be discontinued will return my membership badge.

Yours respectfully,

.....
(Sign with pen)

.....
(Address for mail)

.....
(Date)

.....
(City and State)

References:

(Signature of references not required here)

Mr. Mr.

Address Address

Mr. Mr.

Address Address

Mr.

Address

The following extracts from the Constitution govern applications for admission to the Institute in the Associate grade:

ARTICLE II—MEMBERSHIP

Sec. 1: The membership of the Institute shall consist of: * * * (d) Associates, who shall be entitled to all the rights and privileges of the Institute except the right to hold the office of President, Vice-president and Editor. * * *

Sec. 5: An Associate shall be not less than twenty-one years of age and shall be: (a) A radio engineer by profession; (b) A teacher of radio subjects; (c) A person who is interested in and connected with the study or application of radio science or the radio arts.

ARTICLE III—ADMISSION

Sec. 2: * * * Applicants shall give references to members of the Institute as follows: * * * for the grade of Associate, to five Fellows, Members, or Associates; * * * Each application for admission * * * shall embody a concise statement, with dates, of the candidate's training and experience.

The requirements of the foregoing paragraph may be waived in whole or in part where the application is for Associate grade. An applicant who is so situated as not to be personally known to the required number of members may supply the names of non-members who are personally familiar with his radio interest.

DUBILIER CAPACITORS

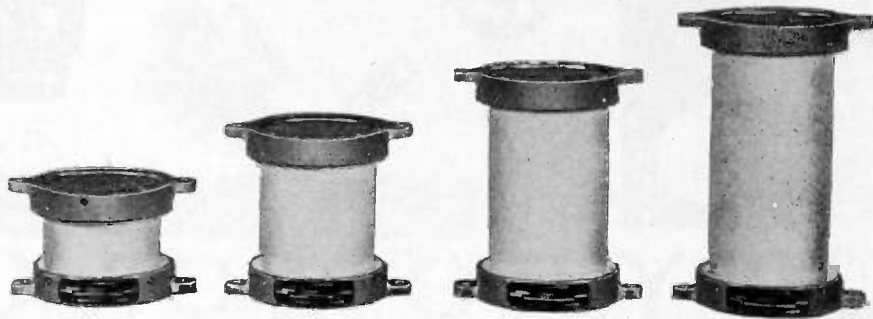

The popular "Type 50" series casings of mica dielectric capacitors have been developed for transmitting circuits requiring a uniformity of design, ease of mounting, etc. A wide range of capacitors is available suitable for practically any voltage, current and frequency requirement.

DUBILIER ANNOUNCES

*The publication of a new and complete
Catalogue of Transmitting Type Capacitors*

A copy is being sent to each member of the I.R.E. Bulletin 1000, because of its wealth of engineering and practical design information, should be in the reference files of every engineer.

Dubilier
CONDENSER
CORPORATION

**4377 Bronx Blvd.
New York, N. Y.**

When writing to advertisers mention of the PROCEEDINGS will be mutually helpful.



EASY TO WORK > AND PERMANENT INSULATING PARTS

FORMICA provides a large number of grades, and variants, in laminated phenolic material adapted to specific requirements. Some of these are especially easy to work, adapting them to manufacturing processes; others stress insulating as against all other considerations.

You can get the grade and type of material best suited to your requirements in full sheets, in cut pieces or in fabricated parts ready for assembly.

Send your blue prints for quotations

THE FORMICA INSULATION COMPANY
4626 Spring Grove Avenue, Cincinnati, O.

FORMICA
Made from Anhydrous Bakelite Resins
SHEETS TUBES RODS

When writing to advertisers mention of the PROCEEDINGS will be mutually helpful.

Piezo Electric Crystals

New Price List Effective Immediately

We are extremely pleased to announce **NEW REDUCED PRICES** for **HIGH GRADE CRYSTALS** for **POWER** use. Due to our **NEW** and **MORE EFFICIENT METHOD** of preparing these crystals, we are allowing you to share in the **LOWER COSTS** of producing these crystals.

We are proud of the confidence our customers have shown toward us, we extend to them our sincere thanks for their patronage thus making this reduction possible.

New prices for grinding **POWER** crystals in the various frequency bands, together with the old prices are as follows:

FREQUENCY RANGE	NEW LIST
100 to 1500 Kc	\$40.00
1501 to 3000 Kc	\$45.00
3001 to 4000 Kc	\$50.00
4001 to 6000 Kc	\$60.00

The above prices include holder of our Standard design, and the crystals will be ground to within .03% of your specified frequency. If crystal is wanted unmounted deduct \$5.00 from the above prices. Delivery two days after receipt of your order. In ordering please specify type tube, plate voltage and operating temperature.

Special Prices Will Be Quoted in Quantities of Ten or More

POWER CRYSTALS FOR AMATEUR USE

The prices below are for grinding a crystal to a frequency selected by us unmounted, (if wanted mounted in our Standard Holder add \$5.00 to the prices below) said crystal to be ground for **POWER** use and we will state the frequency accurate to better than a tenth of one per-cent. **IMMEDIATE SHIPMENT CAN BE MADE.**

1715 to 2000 Kc band.....	\$12.00 each
3500 to 4000 Kc band.....	\$15.00 each

LOW FREQUENCY STANDARD CRYSTALS

We have stock available to grind crystals as low as 13 Kilo-cycles. Prices quoted upon receipt of your specifications.

CONSTANT TEMPERATURE HEATER UNITS

We can supply a high grade heater unit which maintains a constant temperature **BETTER** than a tenth of one degree centigrade. These units have provision for two of our Standard Holders, (one used as a spare) and operate from the 110 V 60 cycle supply mains, entirely automatic and of excellent design. Price and description sent upon request.

Scientific Radio Service

"THE CRYSTAL SPECIALISTS"

P. O. Box 86

Mount Rainier, Maryland

When writing to advertisers mention of the PROCEEDINGS will be mutually helpful.

ACRACON

Electrolytic Condensers

***Preferred by the
Radio Industry***

... because

***they have proved
their dependability***

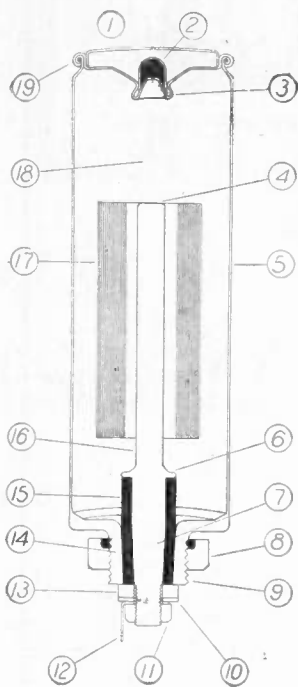

Acracon is the only electrolytic condenser offering all these features in electrical design and mechanical construction:

1. Metal cover for protection and appearance.
2. Live, rubber nipple.
3. Nipple spun into aluminum shell. Absolutely leak-proof.
4. Anode spiral cold welded into anode, giving rigid construction.
5. One piece extruded aluminum container.
6. Retaining flange for rubber gasket.
7. Tapered anode stem for snug fit.
8. Large cadmium plated steel mounting nut, concave to insure tight connection.
9. $\frac{3}{4}$ "-16 thread neck for mounting.
10. Metal washer.
11. Anode nut.
12. Anode soldering tab.
13. Large size insulating washer.
14. Tapered hole to take tapered anode.
15. Special live, rubber insulating gasket free from impurities.
16. Heavy, rigid, anode stem of high purity aluminum.
17. High purity anode, spiral, so wound as to eliminate the necessity of insulating liner between anode and container.
18. Special, high, critical voltage electrolyte, well over anode to insure long life.
19. Leak-proof rolled seam as used in canning industry.

Follow the leaders of the industry. Specify Acracon Electrolytic Condensers. Also Bypass, Wax Impregnated, Oil Impregnated, Power and Transmitting types. Write today, enclosing specifications.

The Acracon unit is now available in capacities up to 16 microfarads at either 440 or 475 volt peak in the single anode type.

Acracon Features are Protected by Patents Pending

Condenser Corporation of America

259 Cornelison Ave., Jersey City, N.J.

Factory Representatives In:

Chicago Cincinnati St. Louis San Francisco Los Angeles Toronto
And Other Principal Cities

When writing to advertisers mention of the PROCEEDINGS will be mutually helpful.

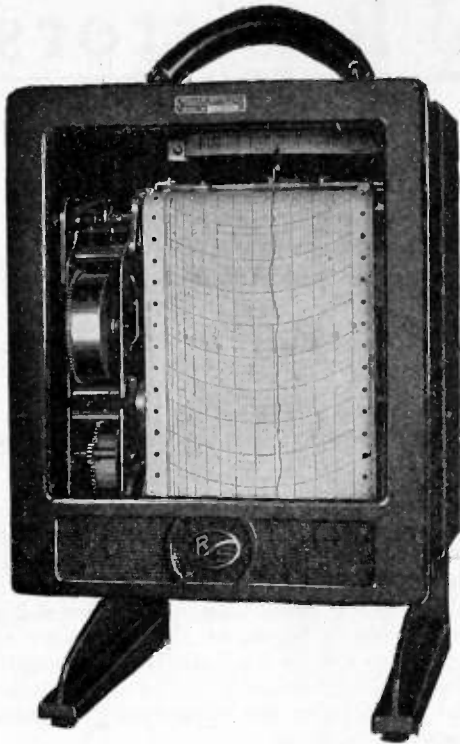

ROLLER-SMITH *Graphics* Need No "Coddling"



The powerful clock runs evenly—without coaxing.

The mechanisms, sturdy efficient and sensitive, are not easily damaged by abuse or overload.

The 5" chart moves along smoothly without jerking or buckling.

The chart rolls are as easy to install as a new film in a Kodak.

The ink flows freely irrespective of temperature, humidity or how long the instrument has been idle.

The ink well is so easy to fill that a child could do it.

The case is made of light but strong aluminum which does not easily crack or break.

And when servicing is required everything is not only accessible but get-at-able—there is a world of difference.

ROLLER-SMITH GRAPHICS are made for direct and alternating current; switchboard, wall and portable models and as ammeters, voltmeters, single and polyphase wattmeters and power factor meters. Either clock or synchronous motor drive is available. Send for Bulletin K-830 for further details or, better still, get in touch with the R-S office nearest you. There is one in every important City in the U.S.A. and Canada.

Forty years' instrument experience is back of

ROLLER-SMITH COMPANY Electrical Measuring and Protective Apparatus

Main Office:
2134 Woolworth Bldg.
NEW YORK



Works:
Bethlehem,
Pennsylvania

Offices in principal cities of U. S. A. and Canada.

When writing to advertisers mention of the PROCEEDINGS will be mutually helpful.

Continental Resistors

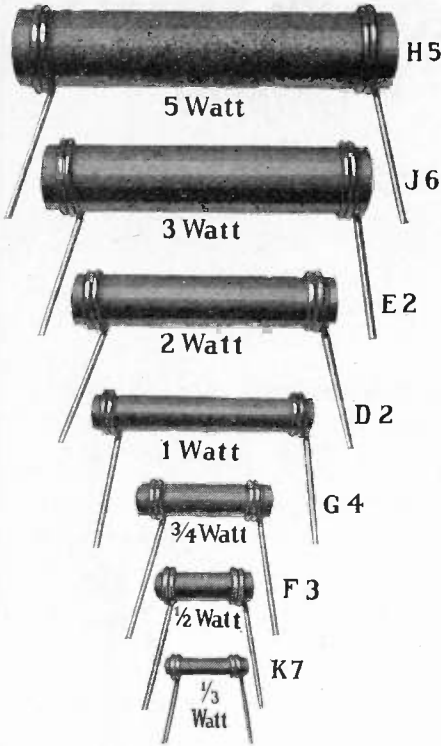

RESISTOR CHARACTERISTICS:

NOISELESS
RESISTANCE CONSTANT
SMALL TEMPERATURE
COEFFICIENT
RUGGED
FIRMLY SOLDERED TERMINALS
DEPENDABLE
COLOR CODED

UNITS SHOWN HALF SIZE

CONTINENTAL SUPPRESSORS

For Radio-Equipped Cars

Stop ignition noise in the automobile radio set when used with suitable by-pass condensers. The distributed capacity is extremely small. The resistors are enclosed in a tough ceramic tube of high crushing and tensile strength, of low coefficient of expansion and of high dielectric strength. They are hermetically sealed in the tube and this renders the suppressors moisture proof.

Suppressors shown full size

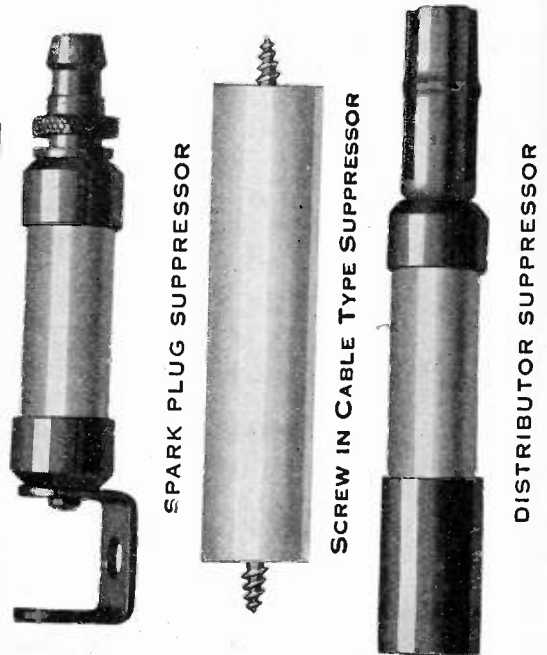

**Curtis
Electro
Chemical
Condenser**

*Essential
Characteristics*

Full capacity at all voltages

Uniform capacity at all frequencies

Low freezing point

Low internal resistance

Low leakage

Made in shape and size to suit the customer, in round, square or rectangular, metal or cardboard containers. Working voltage from 6 Volts to 450 Volts.

For Further Particulars Write to
Curtis Continental Corp.
13900 Lorain Ave.,
Cleveland, O.

Write for Information and Prices
**CONTINENTAL CARBON
INC.**

13900 Lorain Ave.
WEST PARK, CLEVELAND, O.

When writing to advertisers mention of the PROCEEDINGS will be mutually helpful.

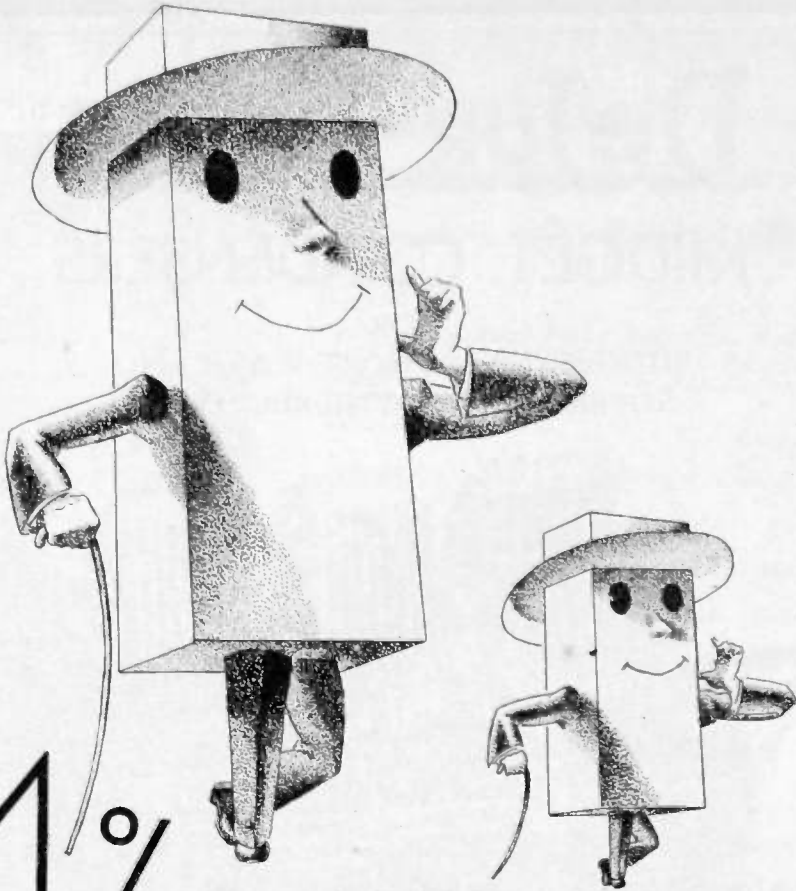

4% POWER FACTOR

THE extraordinary high efficiency of the Elkon non-aqueous electrolytic condenser is well demonstrated by the very low power factor on which it operates. In recent tests it averaged 4%—against 15 and 20, 30 and more percentage power factor of other condensers. It has the highest filtering capacity, low leakage, long life, requires no metal can, and because it is dry* it can be mounted at any convenient angle. Furthermore Elkon has practically the same characteristics as paper condensers—but is *lower in cost and much less bulky*...and here's news—all of the above characteristics apply to our new Bi-pass condensers. 73 leading set manufacturers have standardized on Elkon. A request today will bring you your sample tomorrow. Complete information will be sent to all members of your technical staff. Just send their names.

*—water of crystallization, of course—but no free water.

ELKON — E — CONDENSERS

ELKON DIVISION OF
P. R. MALLORY & CO., Inc., Indianapolis, Ind.

Sales Offices: New York • Cleveland • Detroit • Chicago • Los Angeles

COST LESS TO BUY AND LESS TO INSTALL

When writing to advertisers mention of the PROCEEDINGS will be mutually helpful.

DeJur-Amsco

MIDGET CONDENSERS

FOR
MIDGET T.R.F., SHORT WAVE AND
SUPER-HETERODYNE RECEIVERS

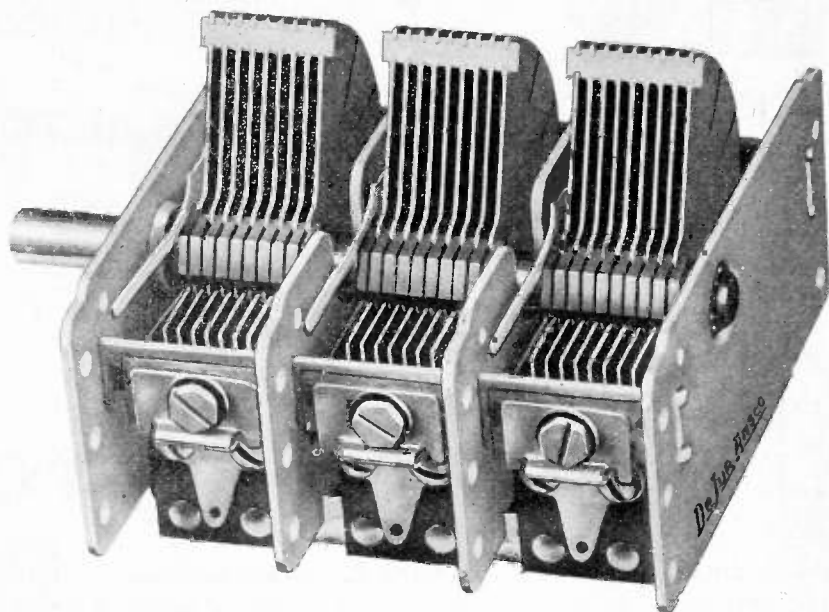

NEW LOWER PRICES

The following features of the DeJur-Amsco Midget Condenser make it the outstanding tuning unit on today's market. And—with these new features, the DeJur-Amsco Midget is priced to meet present day conditions.

- | | |
|--|---|
| New Curve for Uniform Kilocycle Separation | Larger Ratio of Maximum to Minimum Capacity |
| Smaller Size for More Compactness | Special Oscillator Tuning Section for Super-Het Receivers |
| Sturdy Construction for Longer Life | 2-3-4 Gang Units |

MANUFACTURERS

Write for Circular giving full Particulars and Prices

DeJur-Amsco CORPORATION

95 MORTON ST., NEW YORK CITY

When writing to advertisers mention of the PROCEEDINGS will be mutually helpful.

Back of Textolite Laminated . .

Years of Research

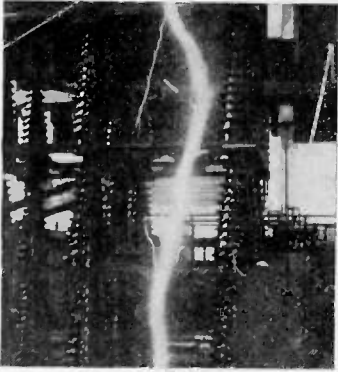

Years of insulation research are behind the G-E insulators that protect this G-E experimental "lightning generator" from a 15-foot bolt, 5,000,000-volt artificial lightning discharge

and Manufacturing Practice

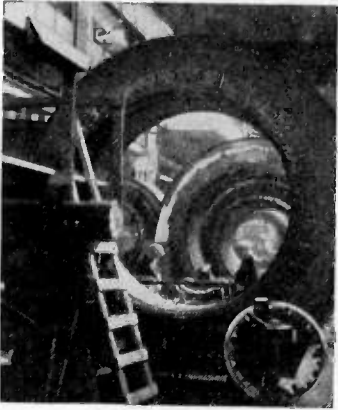

Uniform durable insulation is vital to the satisfactory performance of the stationary armature for this G-E 30,000-kw. synchronous condenser

are behind Textolite Laminated

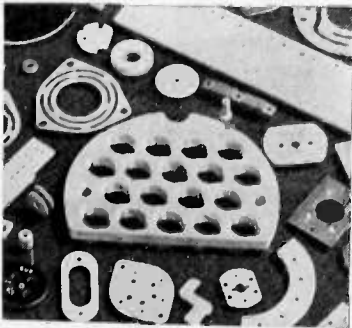

Proved service also characterizes these representative parts made from Textolite laminated

more than 40 YEARS Experience with All Types of Insulations

For more than forty years, insulation has been a basic consideration of G-E engineering.

Generators—motors—high-tension cable—vacuum tubes—the reputation of these and every other G-E product would not be maintained without high quality insulation. For this reason, G-E engineers and research men have steadily worked and progressed toward ultimate excellence in insulation.

The long experience and extensive facilities of General Electric are back of Textolite laminated. It is especially appropriate for insulation needs in radio and electronic applications. Ask the G-E office in your vicinity about Textolite laminated, or inquire of the eastern or western fabricators.

General Fabricating Co. Electrical Insulation Corp.
37 East 18th St. 308 W. Washington St.
New York City Chicago, Ill.



831-5D

GENERAL ELECTRIC

When writing to advertisers mention of the PROCEEDINGS will be mutually helpful.

The Newest '30 Series D.C. TUBES...

with ARCTURUS improved features

These tubes are built to the same rigid specifications that make *blue* tubes the decided preference of critical engineers and progressive jobbers and dealers.

● *Types 136, 137 and 138* are of the heater-cathode construction. This is the construction developed by Arcturus in pioneering the first standard base a. c. tube. Rugged construction that resists shocks and jolts—low current consumption—longer life make these tubes the best yet for automobile sets. They have the usual quick action of all Arcturus tubes.

● *Types 130, 131, 132, 133* The low drain of these tubes meet the exact needs of battery sets, and their sturdy construction assures efficient portable set performance.

Arcturus *Blue* Tubes are the standard tube equipment of more manufacturers than any other tube. Most of this year's sets will be equipped with *blue* tubes.

If you have not already done so, write now for your copy of specifications of Arcturus *Blue* Tubes and for complete data on the new d. c. series. ARCTURUS RADIO TUBE Co., Newark, N. J.



*The
BLUE
Radio
Tube!*



ARCTURUS

"The TUBE with the LIFE-LIKE TONE"

When writing to advertisers mention of the PROCEEDINGS will be mutually helpful.

TO PERFECT THE FILTER CIRCUIT



Single hole mounting

One-piece anode

Vent-metal enclosed

Dull Nickel Can

1931 witnesses the definite triumph of the SPRAGUE INVERTED TYPE ELECTROLYTIC CONDENSER which is now specified by most of the leading radio manufacturers, producing the largest volume of radio receivers absorbed by the American public.

No other device can compare with the SPRAGUE CONDENSER for efficiency, economy and performance in the perfecting of the Filter Circuit. Produced with absolute uniformity, Sprague condensers are specified by those who seek maximum efficiency.

Write for illustrated booklet, diagrams, etc.
Department Number 3

SPRAGUE SPECIALTIES COMPANY
North Adams, Mass.

Small Space

High Capacity

High Voltage

Self-Healing

SPRAGUE
Electrolytic CONDENSERS

When writing to advertisers mention of the PROCEEDINGS will be mutually helpful.



Cornell

TRADE MARK REG.

NEW DUAL "CUB" CONDENSER

REDUCES
ASSEMBLY
OPERATIONS

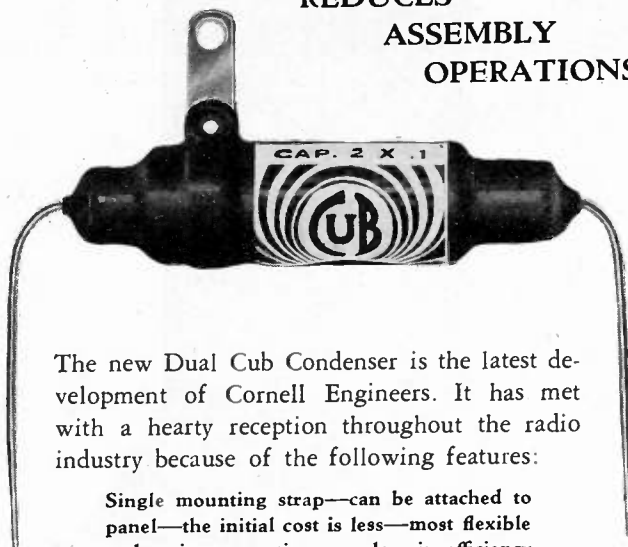

The new Dual Cub Condenser is the latest development of Cornell Engineers. It has met with a hearty reception throughout the radio industry because of the following features:

Single mounting strap—can be attached to panel—the initial cost is less—most flexible and easiest mounting—no loss in efficiency—reduces costs by cutting assembly operations—high insulation resistance—extraordinary dielectric strength.

The new Dual Cub Condenser is totally enclosed and hermetically sealed against exaggerated temperature and humidity. Light weight and compact. Capacities .00025 to .5 Mfd.

*Write for samples and let us know your requirements.
We shall be glad to send you full particulars.*

CORNELL ELECTRIC MFG. CO., Inc.

Manufacturers of
CORNELL "CUB" CONDENSERS
Filter and By-Pass Condensers, Interference Filters and
All Types of Paper Dielectric Condensers
LONG ISLAND CITY, NEW YORK

When writing to advertisers mention of the PROCEEDINGS will be mutually helpful.

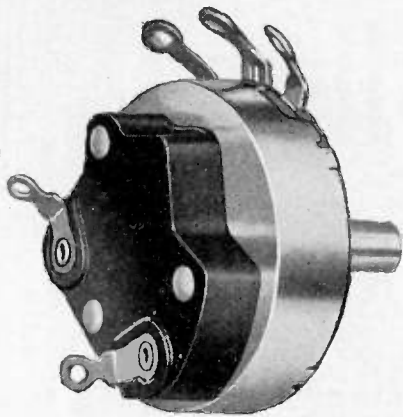

At left: No. 70 Series, with "Underwriters' Laboratories Inspected" Switch. Rated 1.5 Amps. 250 Volts. 3 Amps. 125 Volts.

At right: No. 70 Series, without switch.



Both illustrations actual size

Surprising value and quality in the new "Seventy" Series Volume and Tone Controls

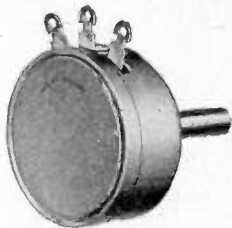

No. 20 Series Single Control.

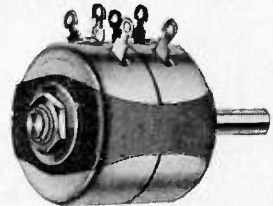

No. 20 Series Tandem Unit.

OUR new "70" Series Composition Element Volume and Tone Controls recently announced, offer surprising value and utmost quality in a low-priced unit. Though low in price, due to design economies and improved manufacturing methods, our "70" Series is of remarkably high quality with no skimping of materials or workmanship.

This new Series Control has a unique movable contact making a full wiping contact with the hard, smooth composition element at a relatively high unit pressure. In spite of this, frictional component is extremely low and tests of 100,000 complete cycles of operation fail to reveal any signs of fatigue.

Upon receipt of specifications from interested engineers, we will send without charge, samples possessing characteristics exactly suited to your circuit conditions.

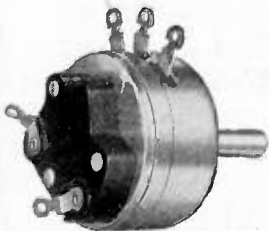

No. 20 Series with "Underwriters' Laboratories Inspected" Switch. Rated 1.5 Amps. 250 Volts, 3 Amps. 125 Volts.

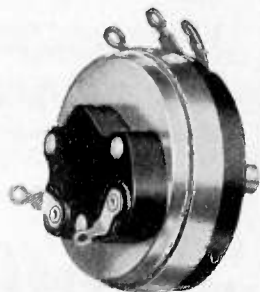

No. 40 Series with "Underwriters' Laboratories Inspected" Switch. Rated 1.5 Amps. 250 Volts, 3 Amps. 125 Volts.

CHICAGO TELEPHONE SUPPLY CO.

HERBERT H. FROST, Inc., Sales Division

GENERAL OFFICES AND PLANT

ELKHART, INDIANA

When writing to advertisers mention of the PROCEEDINGS will be mutually helpful.

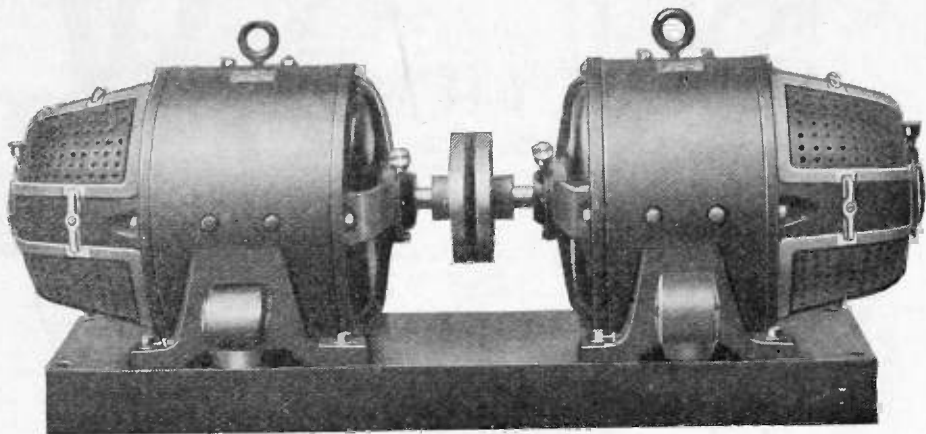

MODERN MOTOR GENERATOR APPLICATION

Is Based on Three Fundamentals

QUALITY - PRICE - DELIVERY

There are as many interpretations of these three fundamentals as there are manufacturers.

This is the Esco interpretation—

The entering of an order is the establishment of an obligation on our part to deliver to our customer a machine of the highest quality of performance, workmanship and material. The cost of manufacture must be low enough to warrant a price both acceptable to our customer and fair to ourselves. The delivery of the machine must be as prompt as practical without endangering the quality.

We warrant our ability to fulfill the above obligation with the triple bond of—

Long and Varied Experience. ESCO has devoted the last twenty years to the sole purpose of developing special electrical machinery. The scope of this field has been tremendous.

Modern and Diversified Equipment. To carry out successfully the above program has necessitated the building up of efficient and extensive equipment.

Practical Engineering Talent. Our staff of senior engineers has spent an average of 25 years in the electrical specialty line and believes in applying theory in a practical manner.

**ELECTRIC  SPECIALTY
COMPANY**

300 South St.

Stamford, Conn.

MANUFACTURERS OF

Motor Generators—High Voltage for radio transmission, Low Voltage for battery charging. ¶Dynamotors, Rotary Converters for radio receivers and power amplifiers. ¶Airplane generators and dynamotors. ¶Special motors for talkies and television. ¶Portable and semi-portable gasoline electric sets for light and power.

When writing to advertisers mention of the PROCEEDINGS will be mutually helpful.

▼

THE MODERN HIGH CAPACITY CONDENSER

AEROVOX HI-FARAD DRY ELECTROLYTIC CONDENSER

DEPENDABLE!



**500 VOLTS
PEAK**

●

THE DRY characteristic and other advanced features of Aero-vox Hi-Farad DRY Electrolytic Condensers make them the modern condensers in every respect. They are compact, light in weight, low in cost per microfarad per voltage rating, low in leakage, safe, surge proof, self-healing, provide long life, stable operation, and high filtering efficiency. Hi-Farad condensers can be mounted at any angle or position and can be handled in practically the same manner as wax paper condensers.

● ●

AN AEROVOX CONDENSER AND RESISTOR FOR EVERY USE

The Aerovox line includes the most complete line of condensers and resistors in the radio and electrical industries. No matter what your requirements are for fixed and tapped condensers or resistors, you are sure to find Aerovox units suited to your needs. In addition, we are equipped to supply special types and sizes of condensers and resistors to meet individual requirements.

**Be Sure to See Us at the Rochester I. R. E. Fall Meeting
We'll Have a Feature of Interest to Show You!**

Write for our 1931 catalog. Also ask to receive the Aerovox Research Worker, a monthly periodical which will be helpful and interesting to you.

AEROVOX WIRELESS CORP.
70 Washington Street, Brooklyn, N. Y.

When writing to advertisers mention of the PROCEEDINGS will be mutually helpful.

It's a product of Isolantite
in the HIGH GAIN
"TRANSITOR"

THE manufacturers of the well known Transitor unit assure their customers that the use of Isolantite products in this device is a guarantee of satisfactory electrical performance. They point out the need for insulation of the highest order of technical excellence to give and preserve in the Transitor transformer unit its maximum electrical efficiency.

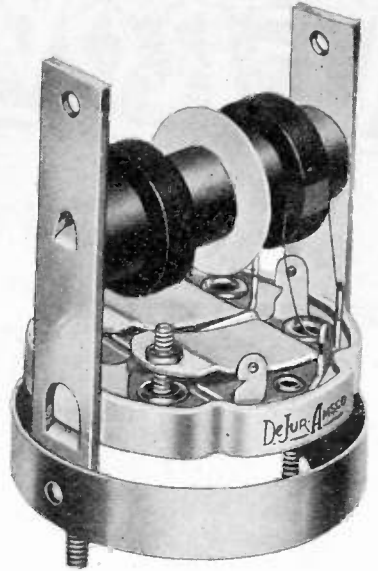

Why DeJur-Amsco and other leading Radio Manufacturers have selected Isolantite ceramics

- 1—Isolantite ceramics are rigid and permanent.
- 2—They offer a plane surface, unaltered by mechanical loads encountered in assembly, upon which to mount condensers and parts in the I.F. circuit of the superheterodyne.
- 3—The power factor remains constant with large variations in temperature and humidity.
- 4—Sealed against penetration by moisture, Isolantite panels retain their high volume resistance under the changing climatic conditions encountered in service.
- 5—Isolantite products provide high, fixed surface resistance owing to their moisture repellant exterior.

Isolantite Inc.

Belleville

New Jersey

When writing to advertisers mention of the PROCEEDINGS will be mutually helpful.

Radio and Scientific Literature

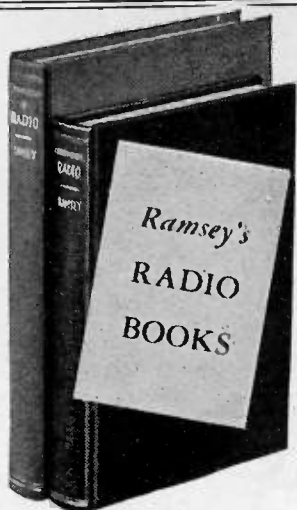

By R. R. RAMSEY, Professor of
Physics, Indiana University, Mem-
ber Inst. Rad. Eng.

Experimental Radio

(255 pages, 168 figures, 128 experiments)
A laboratory manual of radio experiments

The Fundamentals of Radio

(372 pages, 6" x 9", 402 figures)
An excellent text-book of radio written so that a
minimum of mathematics is required for its com-
prehension.

Price postpaid

Fundamentals \$3.50. Experimental \$2.75

RAMSEY PUBLISHING CO.
BLOOMINGTON, INDIANA

Publishers

This Radio and Scientific Literature page is run to help you acquaint the 7,000 and more PROCEEDINGS readers with your radio and technical books.

For detailed information about this page—rates, etc., address:—

Advertising Department

**INSTITUTE OF RADIO
ENGINEERS**

33 West 39th St.
NEW YORK CITY, N. Y.

HAVE YOU A 1931 YEAR BOOK?

If you haven't yet ordered your copy of the 1931 YEAR BOOK of the Institute of Radio Engineers, we suggest that you send us your order and your check for \$1.50 as soon as possible.

All subscribers to the monthly PROCEEDINGS I.R.E. will certainly want to have this 1931 YEAR BOOK on hand, for this publication lists both alphabetically and geographically all members of the Institute of Radio Engineers with their business and residence addresses. The YEAR BOOK also contains an index and a cross index for all papers published in the PROCEEDINGS since 1909 and a Standardization Report which gives current and accurate information on standard radio terms, symbols, and definitions—standard means of measuring broadcast receivers, and other standardization material.

The 1931 YEAR BOOK will be a valuable reference book for you during the current year, and in 1932. When you send us your order be sure to make your check payable to:

INSTITUTE OF RADIO ENGINEERS

33 West 39th Street
NEW YORK CITY, N.Y.

When writing to advertisers mention of the PROCEEDINGS will be mutually helpful.

Radio Tube Engineering Department

Please Note



STUPAKOFF LABORATORIES, Inc.

6619 Hamilton Ave., Pittsburgh (6), Pa.

Cable address, Stupakoff, Pittsburgh

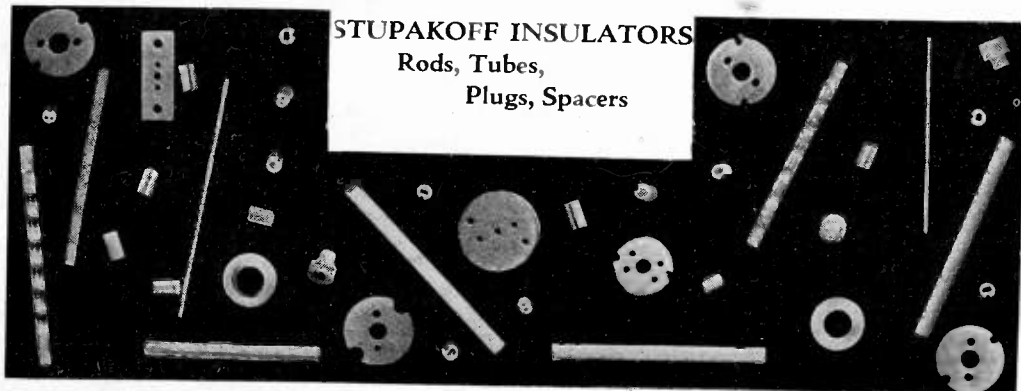

When writing to advertisers mention of the PROCEEDINGS will be mutually helpful.

CHANGE IN MAILING ADDRESS OR BUSINESS TITLE

Members of the Institute are asked to use this form for notifying the Institute office of a change in their mailing address or any change in the listing of their company affiliation or title for the Year Book membership list.

The Secretary,
THE INSTITUTE OF RADIO ENGINEERS,
33 West 39th Street,
New York, N.Y.

Dear Sir:

Effective please note change in my address
(date)
for mail as follows:

FROM

.....
(Name)

.....
(Street Address)

.....
(City and State)

TO NEW ADDRESS

.....
(Street Address)

.....
(City and State)

Also for the membership list for next year's Year Book note change in my business address (or title) as follows, this ^{is} _{is not} my mailing address:

.....
(Title)

.....
(Company Name)

.....
(Address: Street, City and State)

PLEASE FILL IN, DETACH, AND POST TO THE
INSTITUTE PROMPTLY

Back Numbers of the Proceedings, Indexes, and Year Books Available

MEMBERS of the Institute will find that back issues of the Proceedings are becoming increasingly valuable, and scarce. For the benefit of those desiring to complete their file of back numbers there is printed below a list of all complete volumes (bound and unbound) and miscellaneous copies on hand for sale by the Institute.

The contents of each issue can be found in the 1909-1930 Index and in the 1931 Year Book.

BOUND VOLUMES:

Vol. 10 (1922), \$8.75 per volume to members
Vol. 18 (1930), \$9.50 to members

UNBOUND VOLUMES:

Vols. 5, 6, 8, 9, 10, 11, 12, 13, 14, 16, 17, and 18 (1917-1918-1920-1921-1922-1923-1924-1925-1926-1928-1929-1930), \$6.75 per volume (1917-1926) and \$7.50 per volume (1927-1930) to members

MISCELLANEOUS COPIES:

Vol. 1 (1913) July and December
Vol. 2 (1914) June and December
Vol. 3 (1915) December
Vol. 4 (1916) June and August
Vol. 7 (1919) February, April, August, and December
Vol. 15 (1927) January, April, May, June, July, August, October, November, and December
Vol. 19 (1931) January, February, March, April, May, June, July, August, September

These single copies are priced at \$1.13 each to members to the January, 1927, issue. Subsequent to that number the price is \$0.75 each. Prior to January, 1927, the Proceedings was published bimonthly, beginning with the February issue and ending with the December issue. Since January, 1927, it has been published monthly.

MEMBERS will also find that our index and Year Book supplies are becoming limited. The following are now available:

INDEX

The Proceedings Index for the years 1909-1930 inclusive is available to members at \$1.00 per copy. This index is extensively cross indexed.

YEAR BOOK

The 1931 Year Book is available to members at \$1.00 per copy. This Year Book includes the 1931 Report of the Committee on Standardization,—an "up to the minute" report on the most recent standardization information available.

Make remittances payable to the Institute of Radio Engineers and send orders to:

THE INSTITUTE OF RADIO ENGINEERS

33 West 39th Street
NEW YORK CITY, N. Y.

THE CHOICE OF LEADING RADIO MANUFACTURERS

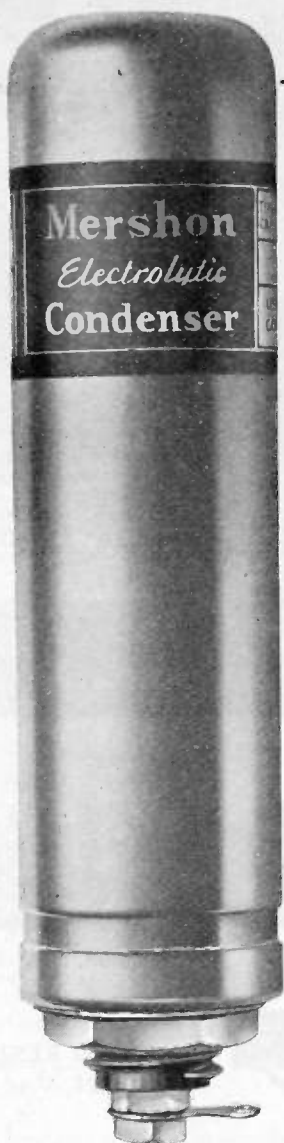

IN selecting a filter condenser, this one significant fact should sweep all other considerations from your mind:

THE MAJORITY OF AMERICA'S FINEST RADIO RECEIVERS ARE BUILT WITH MERSHON ELECTROLYTIC CONDENSERS. OVER 4,000,000 MERSHONS ARE IN USE—MILLIONS MORE THAN ANY OTHER MAKE OF CONDENSER.

Mershons are the original puncture-proof electrolytic condenser, with many exclusive features—the only condenser that has stood the acid-test of ten years' actual service in radio. Their ability to function perfectly and noiselessly for the life of the set is a demonstrated fact, not a claim. That is why Mershons are the universal choice of exacting engineers.

Magnavox Company Ltd.

Executive and Sales Offices: 155 E. Ohio St.,
Chicago, Ill.

Factories: Fort Wayne, Ind.

<i>Subsidiaries</i>	<i>Subsidiaries</i>
The Magnavox Company	Magnavox (Great Britain) Ltd.
Electro Formation, Inc.	Magnavox (Australia) Ltd.

M E R S H O N

ELECTROLYTIC CONDENSERS

Available in a wide range of capacities to satisfy the requirements of every make of radio. Send for engineering data.

When writing to advertisers mention of the PROCEEDINGS will be mutually helpful.

SPECIAL ITEMS FOR RADIO MANUFACTURERS

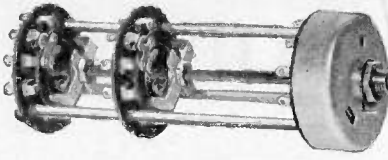

No. 7280A
3 gang, 4 positions
single circuit

Readily adaptable to
other specifications

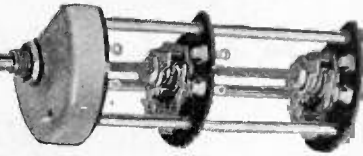

No. 7260A
3 gang, 2 positions
2 circuits

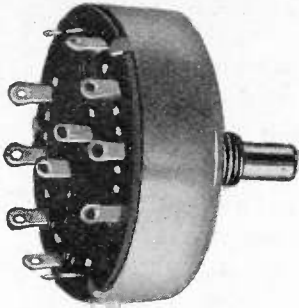

No. 7150A
5 positions, 2 circuits

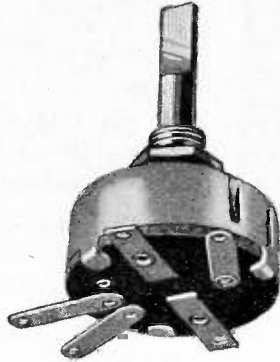

No. 7120A
Combined Acoustic and muting
switch 2 or 3 positions

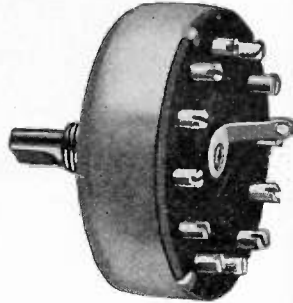

No. 7220A
12 positions, single circuit

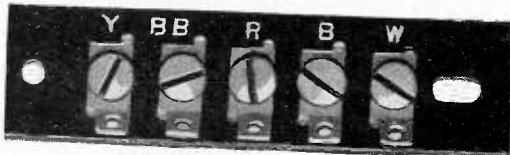

Terminal Strip
5 Lugs No. 6880A, 4 lugs No. 6990A



Terminal Strip
4 Clips, No. 6830A

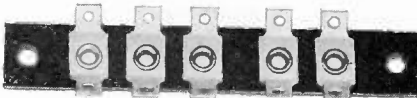

Terminal Strip
5 Lugs, No. 6950A

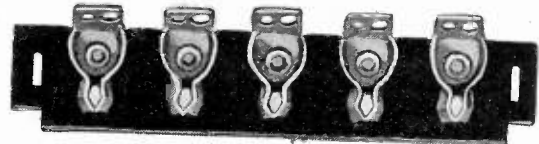

Terminal Strip
5 Clips, No. A6310AA, 4 Clips No. A6320AA

NON-INDUCTIVE
1 Watt Dissipation

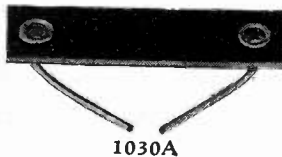

1030A

FIXED RESISTORS
ALL VALUES

After many months of development we announce the perfection of a new process whereby we can give you *closer limits* and *absolutely permanent values* at a large saving. Perfectly noiseless.

SORENG - MANEGOLD CO.

771 Mather Street, CHICAGO, ILL.

1646 W. Adams St.
Los Angeles, Cal.

701 Stephenson Bldg.
Detroit, Mich.

245-5th Ave.
New York City

When writing to advertisers mention of the PROCEEDINGS will be mutually helpful.

PROFESSIONAL ENGINEERING DIRECTORY

For Consultants in Radio and Allied Engineering Fields

ELECTRICAL TESTING LABORATORIES

Tests of Inductances.
Condensers. Transform-
ers etc. Life and charac-
teristics of Radio Tubes

80th. Street and East End Ave.
• • NEW YORK, N.Y. • •

For EXPORT of Material Manufactured
by:

American Transformer Co.
Allen D. Cardwell Mfg. Co.
Corning Glass Works
Dubilier Condenser Corp.
P. R. Mallory
Radio Engineering Labs.
Universal Microphone Co., Ltd.
Ward Leonard Electric Co.
Weston Elec. Inst. Co.

Apply to

AD. AURIEMA, INCORPORATED
116 Broad St.
New York City, N.Y.

JENKINS & ADAIR, INC.

Engineers

Designers and manufacturers of appara-
tus essential to broadcasting, sound re-
cording and sound measurement work.

3333 Belmont Ave., Chicago, U.S.A.
Cable Address: *Jenkadair*
Telephones: *Keystone 2130*

Amy, Aceves & King, Inc.

Consulting Engineers

DESIGN—TEST—DEVELOPMENT

Transmitters, Receivers, Sound Reproduc-
ing and Photoelectric Apparatus

Research Laboratories

11 West 42nd Street, New York
Longacre 5-6622

The J. G. White Engineering Corporation

Engineers—Constructors

*Builders of New York Radio
Central*

43 Exchange Place New York

BEN J. CHROMY

Attorney at Law

Patents and Patent Causes

National Press Bldg.

WASHINGTON, D.C.

"Radio Patent Service"

Weekly

ALLEN B. DU MONT

Consulting Engineer

Television Transmission and Reception
Vacuum Tube Manufacture, Development
and Application

Phone Office and Laboratory
Montclair 9 Bradford Way
2-2176 Upper Montclair, N.J.

I.R.E. MEMBERS

Who are consulting engineers or patent
attorneys will find it well worth their
while to let the rest of the Institute
know of their services through this Pro-
fessional Engineering Directory.

The following minimum rates are offered
to members of the I.R.E. *only*:

Single Insertion.....\$ 8.00
Three Consecutive Insertions..... 12.00
One full year..... 40.00

When writing to advertisers mention of the PROCEEDINGS will be mutually helpful.

Alphabetical Index to Advertisements

A

- Aerovox Wireless Corp.....XXXIX
- American Tel. & Tel. Co.....XV
- American Transformer Co.....XIV
- Arcturus Radio Tube Co.....XXXIV

C

- Cardwell, Allen D., Mfg. Corp....XX
- Central Radio Laboratories.....XXII
- Chicago Transformer Corp.....
.....Inside Back Cover
- Condenser Corp. of America..XXVIII
- Continental Carbon Inc.....XXX
- Cornell Electric Mfg. Co.....XXXVI

D

- DeForest Radio Co.....XVIII
- DeJur-Amsco Corp.....XXXII
- Dubilier Condenser Corp.....XXV

E

- Electric Specialty Co.....XXXVIII
- Employment Page.....XLIX

F

- Formica Insulation Co.....XXVI
- Frost, H. H., Inc.....XXXVII

G

- General Cable Corp.....XVI
- General Electric Co.....XXXIII
- General Industries Co.....XIX
- General Radio Co..Outside Back Cover

H

- Hammarlund Mfg. Co.....XVII

I

- International Resistance Co.....XIII
- I.R.E....XXIII, XXIV, XLIII, XLIV
- Isolantite Inc.....XL

M

- Magnavox Co. Ltd.....XLV
- Mallory, P. R., & Co., Inc.....XXXI

P

- Pacent Electric Co., Inc.....XXI
- Professional Eng. Directory....XLVII

R

- Radio & Scientific Literature....XLI
- RCA Victor Co., Inc.....LII
- Roller-Smith Co.....XXIX

S

- Scientific Radio Service.....XXVII
- Scovill Mfg. Co.....L
- Soreng-Manegold Co.....XLVI
- Sprague Specialties Co.....XXXV
- Stupakoff Labs., Inc.....XLII

W

- Weston Elec. Inst. Corp.....LI

When writing to advertisers mention of the PROCEEDINGS will be mutually helpful.

EMPLOYMENT PAGE

Advertisements on this page are available to members of the Institute of Radio Engineers and to manufacturing concerns who wish to secure trained men for positions. All material for publication on this page is subject to editing from the Institute office and must be sent in by the 15th of the month previous to the month of publication. (September 15th for October PROCEEDINGS IRE etc.) Employment blanks and rates will be supplied by the Institute office. Address requests for such forms to the Institute of Radio Engineers, 33 West 39th Street, New York City, N.Y.

MANUFACTURERS and others seeking radio engineers are invited to address replies to these advertisements at the Box Number indicated, care the Institute of Radio Engineers. All replies will be forwarded direct to the advertiser.

COLLEGE GRADUATE, B.S. in E.E. in 1931, desires position in radio work, preferably along lines of research. Has had eight years amateur operating experience. Single. Age 23. Box 82.

BROADCAST OPERATOR AND SERVICE-MAN desires position in broadcast station where initiative and hard work will lead to advancement. High School graduate and graduate of reputable radio school. Experience includes experimental work with broadcast and short wave receivers, servicing of broadcast receivers and broadcast station operation. Single. Will travel. Age 22. Box 87.

ENGINEERS ASSISTANT desires position in radio laboratory. Pratt Institute electrical engineering graduate, 1928. One year laboratory experience in all phases of radio receiver design and development including power supply, hum, audio systems, radio systems and general measurements. Age 25. Single. Box 88.

MANUFACTURING FOREMAN with experience in servicing broadcast receivers as well as several years as foreman desires position as manufacturing foreman or mechanical designer, preferably of radio equipment. Has had one and one-half years broadcast experience in Germany. Received diploma from German agricultural college in 1922. Married. Age 30. Box 89.

YOUNG MAN having two years service experience, one and one-half years manager of branch radio store, one and one-half years technical work including design and installation of public address systems and with experience in design and construction of production test equipment desires position. Prefers general laboratory work with large manufacturer, preferably engaged in television or sound on film research and design, but will consider any type of factory employment. Has experience as broadcast operator. Eight semesters electrical engineering at evening school. Married. Will relocate if necessary. Age 24. Box 90.

When writing to advertisers mention of the PROCEEDINGS will be mutually helpful.



ince the founding of the radio industry

SINCE the founding of the radio industry, the Scovill Manufacturing Company has been depended on by numerous radio manufacturers for quality metal parts in quantity lots—from machine screws to condensers.

Scovill's service to the industry begins in its long experience in converting new inventions and developments into the practical terms of production — making working models, however simple or complicated, work.

Then, Scovill is unmatched — in the radio parts manufacturing field—in facilities for large-scale, high-quality production. Why not let us relate to you numerous examples in which Scovill's speed and efficiency in supplying metal parts has enabled the radio manufacturer to simplify his plants, reduce his costs, and improve the standard of his sets? We will welcome the opportunity to study your problems. Just write us, marking your letter for the attention of the General Superintendent.

Scovill

Scovill Manufacturing Company, Waterbury, Connecticut

*Boston Providence New York Philadelphia Atlanta
Syracuse Detroit Akron Chicago Cincinnati San Francisco
Los Angeles In Europe: The Hague, Holland*

When writing to advertisers mention of the PROCEEDINGS will be mutually helpful.

ANNOUNCING *THE NEW*

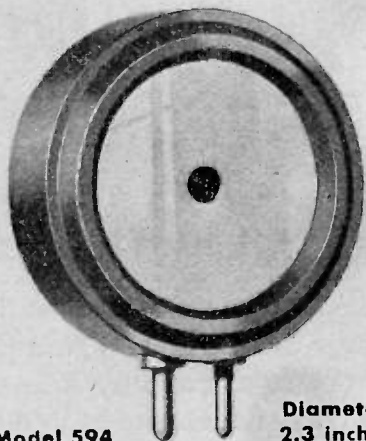

Model 594

Diameter
2.3 inches

WESTON PHOTRONIC CELL

Outstanding Features

Highly sensitive
High current output
(approx. 5 milliamperes in direct sunlight)
No drifting
No chemical change
No physical change
Unlimited life—as far as known
No deterioration on shelf

No dark current
No batteries
No polarizing voltage
No exciting voltage
No readjustments of the circuit
Non-microphonic
Withstands direct sunlight

No liquid
No glass bulb
No gas
No vacuum
Not easily damaged
Nothing to replace
Low cost

[P H O T O - E L E C T R I C]

Dry type—amazing in performance—utterly simple in design—the new Weston Photronic Cell is radically different—a marked advance in light sensitive cells.

It is revolutionizing in operation. It establishes a new standard of performance. Almost limitless in application. And its cost is low.

WESTON

Circular YY, containing details, on request.

ELECTRICAL INSTRUMENT CORP.

589 FRELINGHUYSEN AVENUE
NEWARK . . . NEW JERSEY

When writing to advertisers mention of the PROCEEDINGS will be mutually helpful.

The New Beat Frequency Oscillator Type TMV-28 announced by RCA Victor

THE TMV-28 Beat Frequency Oscillator is introduced after many years of research and development work on precision oscillators. It provides a source of audio frequency with sufficient power to modulate Signal Generators and to measure Transformers without the use of additional amplifiers.

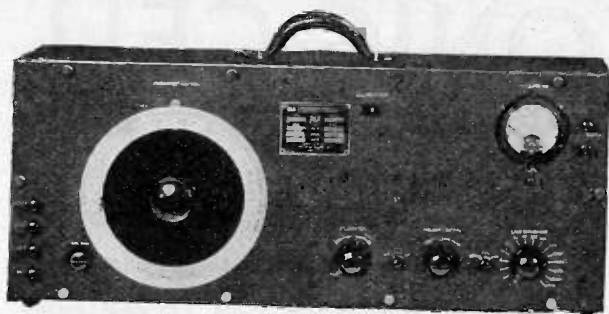

Calibration accurate to 1%.

Reed Indicator for adjusting calibration.

Push-Pull Detector and Amplifier.

Aluminum Case. Finish Black Crackle Lacquer.

Specifications

Frequency Range, 30 to 10,000 cycles.

Output, 0.75 watts.

Output Impedance Adjustment, 2 to 24,000 ohms.

Harmonic Content, less than 5% above 100 cycles.

Output characteristic varies less than 4%.

Battery Requirements

A. 6 V., 4.25 A.

B. 270 V., .085 A.

C. Eight 7.5 V. Blocks.

Radiotron Requirements

Four UX 201-A.

Two UX 112-A.

Two UX 245.

Note:— The TMV-28 Oscillator is especially suitable for modulating our TMV-18 Signal Generator.



Write for Bulletin "A", covering RCA Victor Laboratory and Test Instruments

RCA Victor Company, Inc. · Camden, N. J.

Engineering Products Division

A Radio Corporation of America Subsidiary

"RADIO HEADQUARTERS"

When writing to advertisers mention of the PROCEEDINGS will be mutually helpful.

From Transformer Headquarters



Here are Facilities for Exceptional Service
Any Transformer • Any Quantity • Any Delivery

Cores

The C. T. C. range of core sizes makes it easy to fill any special transformer order from our stock of standard laminations. The C. T. C. tool room makes dies for any special core. Immediate production on any transformer order is thereby assured.

Coils

Prompt service is a simple matter because the C. T. C. coil winding department is fully equipped with the latest high speed coil winding machinery. Any arrangement of taps, turns, shielding or insulation is handled without delay. Let us quote on your next order.

Mountings

Exceptional flexibility is a big feature of C. T. C. design. A wide assortment of mountings used interchangeably on C. T. C. cores provides transformers that meet special needs at standard prices. Every C. T. C. transformer part is made in our own plant for quick service.

Engineering Service

Engineering experience is necessary to obtain highest economy and efficiency in transformer design. Our transformer specialists are at your service. Submit your transformer problems to them. C. T. C. design, suited to your needs, will be submitted.

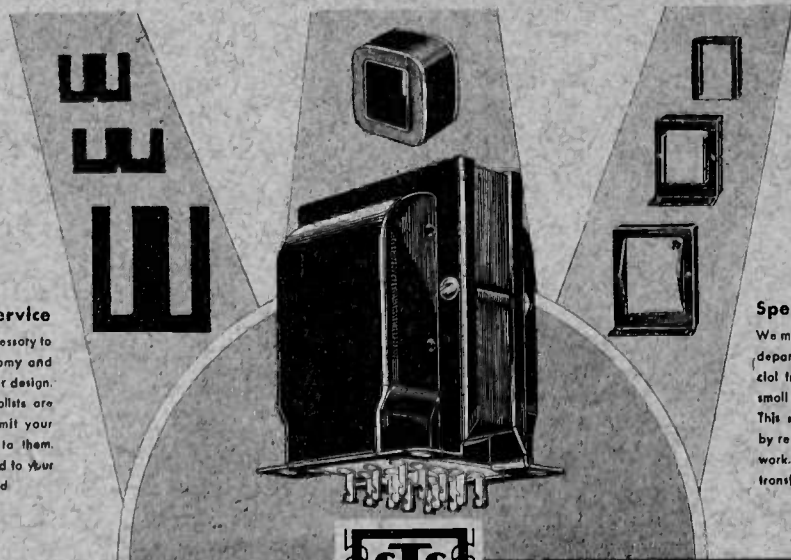

Special Transformers

We maintain a special assembly department to manufacture special transformers on orders too small for quantity production. This service is used extensively by research laboratories in their work. Do you need a special transformer? Let us quote you.



CHICAGO TRANSFORMERS

CHICAGO TRANSFORMER CORP., 2622 WASHINGTON BLVD., CHICAGO, U. S. A.

When writing to advertisers mention of the PROCEEDINGS will be mutually helpful.

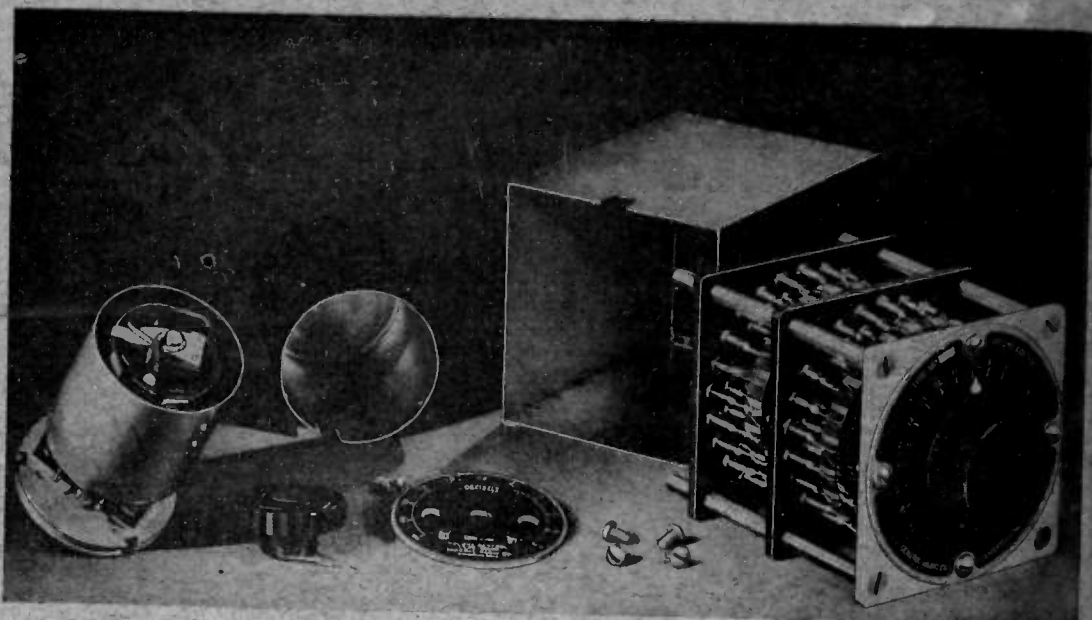

Left: TYPE 652 Volume Control. Right: TYPE 552 Volume Control.

A NEW VOLUME CONTROL

A VOLUME control for mixer use on broadcasting and sound-recording networks must be built to very rigorous specifications as regards both electrical and mechanical performance. It must be free from noise and provide a reasonably close impedance match with associated equipment for a wide attenuation range. It must also be compact, rugged, and protected from the ravages of dirt.

These points were carefully worked into the design of the new TYPE 652 Volume Controls shown at the left of the accompanying photograph. A ladder-type network requiring only one sliding contact is used. This helps keep out whip noises and permits a linear 0-45 db attenuation range with a rapid but gradual increase to infinity. Bearings and shaft are designed for a maximum of resistance to wear, and the whole assembly is shielded from dust by a close-fitting metal cover.

Models having practically constant terminal impedances of 50, 200, or 500 ohms are available. Price \$12.50, each.

WRITE FOR LITERATURE

GENERAL RADIO COMPANY

Offices :: Laboratories :: Factory

Cambridge A, Massachusetts