

VOLUME 19

MARCH, 1931

NUMBER 3

PROCEEDINGS
of
The Institute of Radio
Engineers



1931 CONVENTION
Chicago, Illinois
June 4, 5 and 6

Form for Change of Mailing Address or Business Title on Page XLIII

Institute of Radio Engineers

Forthcoming Meetings

CINCINNATI SECTION

March 17, 1931

April 14, 1931

NEW YORK MEETING

Communication with Quasi Optical Waves

By Eduard Karplus

April 1, 1931

SAN FRANCISCO SECTION

March 18, 1931

TORONTO SECTION

March 25, 1931

PROCEEDINGS OF

The Institute of Radio Engineers

Volume 19

March, 1931

Number 3

Board of Editors

ALFRED N. GOLDSMITH, *Chairman*
 STUART BALLANTINE
 RALPH BATCHER
 G. W. PICKARD
 L. E. WHITTEMORE
 W. WILSON

CONTENTS

	PAGE
PART I	
Frontispiece, E. F. W. Alexanderson, President of the Institute, 1921.....	322
Institute News and Radio Notes.....	323
Meetings of the Board of Direction.....	323
Radio Signal Transmissions of Standard Frequency.....	323
Committee Meetings.....	325
Institute Meetings.....	326
PART II	
<i>Technical Papers</i>	
A Radio Method of Synchronizing Recording Apparatus.....	335
T. PARKINSON AND T. R. GILLILAND	
European Aviation Radio.....	341
GERALD C. GROSS	
Discussion.....	351
L. M. HULL	
Note on the Fifteen-Month Period in Solar Activity, Terrestrial Magnetism, and Radio Reception.....	353
G. W. PICKARD	
Ten Years of Broadcasting.....	356
C. W. HORN	
Measurement of Power and Efficiency in Radio Transmitting Apparatus.....	377
G. PESSON AND T. GORIO	
A New Method of Testing for Distortion in Audio-Frequency Amplifiers.....	401
H. J. REICH	
A Rapid Method for Estimating the Signal-to-Noise Ratio of a High Gain Receiver.....	416
F. B. LLEWELLYN	
Oscillation in Tuned Radio-Frequency Amplifiers.....	421
B. J. THOMPSON	
Some Considerations on the Design of Radio-Frequency Signal Generators.....	438
J. R. BIRD	
Measurement of Resistances and Impedances at High Frequencies.....	452
J. W. LABUS	
Calculation of Electric and Magnetic Field Intensities of Oscillating Straight Conductors.....	461
R. BECHMANN	
Resonant Impedances and Effective Series Resistance of Short-Wave Parallel Resonant Circuits.....	467
H. INUMA	
Some Details Relative to Propagation of Very Short Waves.....	479
R. JOUAUST	
Grid Circuit Power Rectification.....	489
J. R. NELSON	
Book Review, "Theory of Electrical Artificial Lines and Filters," by A. C. Bartlett.....	501
K. S. VAN DYKE	
Booklets, Catalogs, and Pamphlets Received.....	502
Monthly List of References to Current Radio Literature.....	503
Contributors to this Issue.....	508

Copyright, 1931, by the Institute of Radio Engineers

Institute of Radio Engineers

Forthcoming Meetings

CINCINNATI SECTION

March 17, 1931

April 14, 1931

NEW YORK MEETING

Communication with Quasi Optical Waves

By Eduard Karplus

April 1, 1931

SAN FRANCISCO SECTION

March 18, 1931

TORONTO SECTION

March 25, 1931

PROCEEDINGS OF

The Institute of Radio Engineers

Volume 19

March, 1931

Number 3

Board of Editors

ALFRED N. GOLDSMITH, *Chairman*
 STUART BALLANTINE
 RALPH BATCHER
 G. W. PICKARD
 L. E. WHITTEMORE
 W. WILSON

CONTENTS

	PAGE
PART I	
Frontispiece, E. F. W. Alexanderson, President of the Institute, 1921.....	322
Institute News and Radio Notes.....	323
Meetings of the Board of Direction.....	323
Radio Signal Transmissions of Standard Frequency.....	323
Committee Meetings.....	325
Institute Meetings.....	326
PART II	
<i>Technical Papers</i>	
A Radio Method of Synchronizing Recording Apparatus.....	335
..... T. PARKINSON AND T. R. GILLILAND	
European Aviation Radio.....	341
..... GERALD C. GROSS	
Discussion.....	351
..... L. M. HULL	
Note on the Fifteen-Month Period in Solar Activity, Terrestrial Magnetism, and Radio Reception.....	353
..... G. W. PICKARD	
Ten Years of Broadcasting.....	356
..... C. W. HORN	
Measurement of Power and Efficiency in Radio Transmitting Apparatus.....	377
..... G. PESSON AND T. GORIO	
A New Method of Testing for Distortion in Audio-Frequency Amplifiers.....	401
..... H. J. REICH	
A Rapid Method for Estimating the Signal-to-Noise Ratio of a High Gain Receiver.....	416
..... F. B. LLEWELLYN	
Oscillation in Tuned Radio-Frequency Amplifiers.....	421
..... B. J. THOMPSON	
Some Considerations on the Design of Radio-Frequency Signal Generators.....	438
..... J. R. BIRD	
Measurement of Resistances and Impedances at High Frequencies.....	452
..... J. W. LABUS	
Calculation of Electric and Magnetic Field Intensities of Oscillating Straight Conductors.....	461
..... R. BECHMANN	
Resonant Impedances and Effective Series Resistance of Short-Wave Parallel Resonant Circuits.....	467
..... H. INUMA	
Some Details Relative to Propagation of Very Short Waves.....	479
..... R. JOUAUST	
Grid Circuit Power Rectification.....	489
..... J. R. NELSON	
Book Review, "Theory of Electrical Artificial Lines and Filters," by A. C. Bartlett.....	501
..... K. S. VAN DYKE	
Booklets, Catalogs, and Pamphlets Received.....	502
Monthly List of References to Current Radio Literature.....	503
Contributors to this Issue.....	508

Copyright, 1931, by the Institute of Radio Engineers

The Institute of Radio Engineers

GENERAL INFORMATION

The PROCEEDINGS of the Institute is published monthly and contains papers and discussions thereon submitted for publication or for presentation before meetings of the Institute or its Sections. Payment of the annual dues by a member entitles him to one copy of each number of the PROCEEDINGS issued during the period of his membership.

Subscription rates to the PROCEEDINGS for the current year are received from nonmembers at the rate of \$1.00 per copy or \$10.00 per year. To foreign countries the rates are \$1.10 per copy or \$11.00 per year.

Back issues are available in unbound form for the years 1918, 1920, 1921, 1922, 1923, and 1926 at \$9.00 per volume (six issues) or \$1.50 per single issue. For the years 1913, 1914, 1915, 1916, 1917, 1919, 1923, 1924, and 1925 miscellaneous copies (incomplete unbound volumes) can be purchased for \$1.50 each; for 1927, 1928, and 1929 at \$1.00 each. The Secretary of the Institute should be addressed for a list of these.

Discount of twenty-five per cent is allowed on all unbound volumes or copies to members of the Institute, libraries, booksellers, and subscription agencies.

Bound volumes are available as follows: for the years 1922 and 1926 to members of the Institute, libraries, booksellers, and subscription agencies at \$8.75 per volume in blue buckram binding and \$10.25 in morocco leather binding; to all others the prices are \$11.00 and \$12.50, respectively. For the year 1929 the bound volume prices are: to members of the Institute, libraries, booksellers, and subscription agencies, \$9.50 in blue buckram binding; to all others, \$12.00. Foreign postage on all bound volumes is one dollar, and on single copies is ten cents.

The 1930 Year Book, containing general information, the Constitution and By-Laws, catalog of membership, etc., is available to members at \$1.00; to nonmembers, \$1.50.

Contributors to the PROCEEDINGS are referred to the following page for suggestions as to approved methods of preparing manuscripts for publication in the PROCEEDINGS.

Advertising rates for the PROCEEDINGS will be supplied by the Institute's Advertising Department, Room 802, 33 West 39th Street, New York, N.Y.

Changes of address to affect a particular issue must be received at the Institute office not later than the 15th of the month preceding date of issue. That is, a change in mailing address to be effective with the October issue of the PROCEEDINGS must be received by not later than September 15th. Members of the Institute are requested to advise the Secretary of any change in their business connection or title irrespective of change in their mailing address, for the purpose of keeping the Year Book membership catalog up to date.

The right to reprint portions or abstracts of the papers, discussions, or editorial notes in the PROCEEDINGS is granted on the express condition that specific reference shall be made to the source of such material. Diagrams and photographs published in the PROCEEDINGS may not be reproduced without making special arrangements with the Institute through the Secretary.

It is understood that the statements and opinions given in the PROCEEDINGS are views of the individual members to whom they are credited, and are not binding on the membership of the Institute as a whole.

All correspondence should be addressed to the Institute of Radio Engineers, 33 West 39th Street, New York, N.Y., U.S.A.

Entered as second class matter at the Post Office at Menasha, Wisconsin.

Acceptance for mailing at special rate of postage provided for in the Act of February 28, 1925, embodied in paragraph 4, Section 412, P. L. and R. Authorized October 26, 1927.

Published monthly by

THE INSTITUTE OF RADIO ENGINEERS, INC.

Publication office, 450-454 Ahnaip Street, Menasha, Wis.

BUSINESS, EDITORIAL, AND ADVERTISING OFFICES,

Harold P. Westman, *Secretary*

33 West 39th St., New York, N.Y.

SUGGESTIONS FOR CONTRIBUTORS TO THE "PROCEEDINGS"

Preparation of Paper

Form—Manuscripts may be submitted by member and nonmember contributors from any country. To be acceptable for publication, manuscripts should be in English, in final form for publication, and accompanied by a summary of from 100 to 300 words. Papers should be typed double space with consecutive numbering of pages. Footnote references should be consecutively numbered and should appear at the foot of their respective pages. Each reference should contain author's name, title of article, name of journal, volume, page, month, and year. Generally, the sequence of presentation should be as follows: statement of problem; review of the subject in which the scope, object, and conclusions of previous investigations in the same field are covered; main body describing the apparatus, experiments, theoretical work, and results used in reaching the conclusions and their relation to present theory and practice; bibliography. The above pertains to the usual type of paper. To whatever type a contribution may belong, a close conformity to the spirit of these suggestions is recommended.

Illustrations—Use only jet black ink on white paper or tracing cloth. Cross-section paper used for graphs should not have more than four lines per inch. If finer ruled paper is used, the major division lines should be drawn in with black ink, omitting the finer divisions. In the latter case, only blue-lined paper can be accepted. Photographs must be very distinct, and must be printed on glossy white paper. Blueprinted illustrations of any kind cannot be used. All lettering should be 3/16 in. high for an 8 x 10 in. figure. Legends for figures should be tabulated on a separate sheet, not lettered on the illustrations.

Mathematics—Fractions should be indicated by a slanting line. Use standard symbols. Decimals not preceded by whole numbers should be preceded by zero, as 0.016. Equations may be written in ink with subscript numbers, radicals, etc., in the desired proportion.

Abbreviations—Write a.c. and d.c. (a-c and d-c as adjectives), kc, μf , $\mu\mu f$, e.m.f., mh, μh henries, abscissas, antennas. Refer to figures as Fig. 1, Figs. 3 and 4, and to equations as (5). Number equations on the right in parentheses.

Summary—The summary should contain a statement of major conclusions reached, since summaries in many cases constitute the only source of information used in compiling scientific reference indexes. Abstracts printed in other journals, especially foreign, in most cases consist of summaries from published papers. The summary should explain as adequately as possible the major conclusions to a nonspecialist in the subject. The summary should contain from 100 to 300 words, depending on the length of the paper.

Publication of Paper

Disposition—All manuscripts should be addressed to the Institute of Radio Engineers, 33 West 39th Street, New York City. They will be examined by the Committee on Meetings and Papers and by the Editor. Authors are advised as promptly as possible of the action taken, usually within one month.

Proofs—Galley proof is sent to the author. Only necessary corrections in typography should be made. *No new material is to be added.* Corrected proofs should be returned *promptly* to the Institute of Radio Engineers, 33 West 39th Street, New York City.

Reprints—With the galley proof a reprint order form is sent to the author. Orders for reprints must be forwarded promptly as type is not held after publication.

INSTITUTE SECTIONS

<i>Chairmen</i>	<i>Secretaries</i>
	ATLANTA
H. F. Dobbs	Philip C. Bangs, 23 Kensington Rd., Avondale Estates, Ga.
	BOSTON
George W. Pierce	Melville Eastham, 30 State St., Cambridge, Mass.
	BUFFALO-NIAGARA
S. W. Brown	E. C. Waud, 235 Huntington Ave., Buffalo, N. Y.
	CHICAGO
Byron B. Minnium	J. Barton Hoag, Ryerson Laboratory, University of Chicago, Chicago, Ill.
	CINCINNATI
D. D. Israel	Ralph P. Glover, Crosley Radio Corp., Cincinnati, Ohio.
	CLEVELAND
G. B. Hammon	P. A. Marsal, National Carbon Co., Inc., P.O. Box No. 400, Cleveland, Ohio.
	CONNECTICUT VALLEY
R. S. Kruse	George Grammer, 52 S. Beacon St., Hartford, Conn.
	DETROIT
Lewis N. Holland	Samuel Firestone, Room 615, 2000 Second Ave., Detroit, Mich.
	LOS ANGELES
T. E. Nikirk	L. Elden Smith, 340 N. Painter Ave., Whittier, Calif.
	NEW ORLEANS
Pendleton E. Lehde	Anton A. Schiele, 1812 Masonic Temple, New Orleans, La.
	PHILADELPHIA
W. R. G. Baker	G. C. Blackwood, 243 E. Upsal St., Mt. Airy, Philadelphia, Pa.
	PITTSBURGH
L. A. Terven	C. F. Donbar, 233 South Starr Ave., Bellevue, Pa.
	ROCHESTER
Harry E. Gordon	Howard A. Brown, Rochester G. & E. Co., 89 East Ave., Rochester, N. Y.
	SAN FRANCISCO
Walter D. Kellogg	Paul R. Fenner Custom House, San Francisco, Calif.,
	SEATTLE
Abner R. Willson	L. C. Austin, Woolley and Co., Inc., 1113 Third Ave., Seattle, Wash.
	TORONTO
J. M. Leslie	R. A. Hackbusch, Stromberg Carlson Tel. Mfg. Co., 211 Geary Ave., Toronto, Ont., Canada.
	WASHINGTON
L. P. Wheeler	Herbert G. Dorsey, U. S. Coast and Geodetic Survey, Washington, D. C.

GEOGRAPHICAL LOCATION OF MEMBERS ELECTED FEBRUARY 4, 1931

Transferred to the Member grade

Colorado	Denver, 1421 Champa St.	Giese, R. C.
Maryland	Chevy Chase, 6804 Meadow Lane	White, E. L.
New York	New York City, 711 Fifth Ave., National Broadcasting Co.	Guy, R. F.

Elected to the Member grade

California	San Jose, Box. No. 531	Booker, E. R.
New Jersey	Rutherford, W. Pierrepont Ave.	Schwerin, P.
New York	New York City, 67 Broad St.	Capen, W. H.

Elected to the Associate grade

Arizona	Jerome, Box. No. 1228	Morrison, R. H.
California	Glendale, 139 S. Carr Dr.	Kennedy, F. M.
	Long Beach, 725 E. Hill St.	Brown, J. H.
	Long Beach, 4019 American Ave.	Sorenson, L. H.
	Los Angeles, 1412 W. 10th Pl.	Karl, O. G.
	Los Angeles, 2907 Rosanna St.	Mahon, J. L.
	Oakland, 1575 Alice St.	Brodie, A. H.
	Oakland, 5926 E. 16th St.	Simmons, C. S.
	Palo Alto, 851 Homer Ave.	Browning, S. D.
	Palo Alto, 260 Portola Ave.	Frey, R. C.
	San Diego, VP-9B, Fleet Air Base	Signer, R. M.
	San Francisco, 251 Ashbury Ave.	Neville, J. J.
	San Pedro, c/o Postmaster, Box. No. 10, U.S.S. Saratoga	Griffith, M. H.
Connecticut	Middletown, Wesleyan Station	Zottu, P. D.
	New Haven, 82 Wall St.	Fish, G. R.
	New Haven, 68 Whalley Ave.	Keller, E. B.
	New Haven, 35 Argonne St.	Maier, O. C.
	New Haven, 10 Moulton St.	McNamara, F. F.
	New Haven, 394 Whalley Ave.	Mulkey, D. L.
	New Haven, Yale University	Nuesse, L. W.
	New Haven, 255 Whitney Ave.	Pitta, A. B.
	West Haven, 151 Leete St.	McCafferty, W. J.
Delaware	Wilmington, 1218 Oak St.	Griscom, E. C.
Dist. of Columbia	Washington, 1112 Connecticut Ave., N.W., c/o RCA	Clement, J. T.
	Washington, 1835 Phelps Pl., N. W.	Howitt, N.
	Washington, Munitions Bldg., Rm. No. 3441	Penny, N. L.
Florida	Avon Park, Box No. 742	Smith, C. R.
	Jacksonville, 147 Drysdale St.	Diggett, H.
Georgia	Atlanta, 986 Todd Rd., N. E.	Wymore-Shiel, I. J. (Mrs.)
Illinois	Chicago, 7655 Coles Ave.	Cole, W. K.
	Chicago, 456 Belmont Ave.	Dutton, G. H.
	Chicago, 692 Irving Park Blvd.	Janacek, R. K.
	Chicago, 692 Irving Park Blvd.	Peckosh, A. J.
	Chicago, 17 S. Jefferson St.	Pride, W. H.
	Chicago, Merchandise Mart, c/o National Broadcasting Co.	Schreyer, T. E.
	Chicago, 1804 W. Congress St., Rm. No. 1024	Schried, E. A.
	Glenview, P. O. Box No. 375	Little, DeM. H.
	Wilmette, 411 Linden Ave.	Cornish, W. C.
Indiana	Indianapolis, 1402 N. Alabama St., Apt. 108	Carroll, F. M.
	Lafayette, Purdue University	Gillette, E. C., Jr.
Kansas	Wichita, 423 S. Estelle St.	Newman, W. C.
Maine	Bangor, 249 Pine St.	Spates, J. L.
Maryland	Baltimore, 943 Homestead St.	Bassford, S. W.
	Baltimore, 2745 Baker St.	Ridenour, I. L.
Massachusetts	Cambridge, 30 State St., General Radio Co.	Dawes, H. H.
	Cambridge, 34 1/2 Shepard St.	Mimno, H. R.
	Cambridge, 171 Elm St.	Olken, H.
	Dorchester, 19 Vesta Rd.	Friedman, I. J.
	Everett, 635 Broadway	Zwicker, H. H.
	Haverhill, 42 Grove St.	Kockakian, L.
	Salem, 46 Leach St.	Chagnon, M. L.
	Springfield, 33 Cortland St.	Hewinson, E. G.
	Springfield, c/o Amer. Bosch Magneto Corp.	Venurini, A.
	West Springfield, 992 Memorial Ave.	Hallein, J. J., Jr.
Michigan	Detroit, 3458 Wager Ave.	Evans, R. C.
	Detroit, 14467 Mayfield Ave.	Sellers, J. D.
	Williamston, Box No. 249	Love, B. E.
Nebraska	David City	Thomas, J. C.
New Jersey	Audubon, 111 Chestnut St.	Hubbard, B. L.
	Audubon, 27 W. Kings Highway	Sees, J. F.

Geographical Location of Members Elected February 4, 1931

New Jersey (cont.)	Audubon, 107 W. Chestnut St., Apt. 14	Steers, W. F.
	Bayonne, 43 Broadway	Richards, P.
	Bloomfield, 55 Monroe Pl.	Hussey, L. W.
	Camden, c/o RCA-Victor Co.	Brisbin, M. M.
	Camden, c/o RCA-Victor Co., Eng. Dept.	Brown, F. L.
	Camden, c/o RCA-Victor Co.	Colpitts, A. B.
	Camden, c/o RCA-Victor Co.	Cowles, E. E.
	Camden, c/o RCA-Victor Co.	Davis, C. E.
	Camden, 326 Penn St.	Gertsch, E. P.
	Camden, c/o RCA-Victor Co.	Grahn, C. E.
	Camden, c/o RCA-Victor Co.	Grubbs, Harry C.
	Camden, 100 S. 32nd St.	Hampton, J. C.
	Camden, c/o RCA-Victor Co.	Helgeson, F. N.
	Camden, c/o RCA-Victor Co.	Holden, H. C.
	Camden, c/o RCA-Victor Co.	Jacob, F. N.
	Camden, c/o RCA-Victor Co.	Karcher, E. M.
	Camden, 3755 King Ave.	Kerrigan, J.
	Camden, c/o RCA-Victor Co.	Krauss, G. H.
	Camden, c/o RCA-Victor Co.	Lindhurst, R. W.
	Camden, c/o RCA-Victor Co.	Little, M. B.
	Camden, c/o RCA-Victor Co.	McGaughney, P. C.
	Camden, c/o RCA-Victor Co.	Mohler, J. L.
	Camden, 308 Penn St.	Onuska, A.
	Camden, c/o RCA-Victor Co.	Reihman, E. F.
	Camden, c/o RCA-Victor Co., Bldg. 7, Rm. No. 407	Schrader, H. J.
	Camden, c/o RCA-Victor Co.	Shumaker, E. E.
	Camden, c/o RCA-Victor Co.	Tilden, M. W.
	Chatham, Brooklake Rd.	Kuthe, H. K.
	Collingswood, 118 E. Palmer Ave.	Bedford, A. V.
	Collingswood, 639 Lakeview Dr.	Berglund, E. B.
	Collingswood, 639 Lakeview Dr.	Cervený, J. P.
	Collingswood, 422 Woodlawn Ave.	Daley, R. E. J.
	Collingswood, 224 Burrwood Ave.	Wistrup, C. A.
	East Orange, 463 Springdale Ave.	Brooke, E. F.
	East Orange, 111 N. Walnut St.	Crawford, J. W.
	East Orange, 63 Linden Ave.	Marcy, R. J.
	East Orange, 182 N. Arlington Ave.	Rockwood, G. H., Jr.
	Haddonfield, 212 Euclid Ave.	Albright, R. B.
	Haddonfield, 102 Jess Ave.	Scheldorf, R. D.
	Jersey City, 17 Gifford Ave.	Yeck, F. A.
	Lodi, 171 Westminster Pl.	DuBois, H. H.
	Long Branch, 194-7th Ave.	Harris, H.
	Merchantville, 1936 Browning Rd.	Griffing, R. A.
	Merchantville, 606 W. Maple Ave., Apt. J-1	Hurley, H. C.
	Merchantville, 29 Fithian Ave.	Nekervis, E. T.
	Merchantville, 4618 Lafayette Ave.	Smith, J. C.
	Montclair, 45 Gates Ave.	Norton, F. R.
	Moorestown, 23 Valleyview Terrace	Stevenson, W. B.
	North Arlington, 102 Stevens Pl.	Pitzer, H. F.
	Oaklyn, 1115 White Horse Pike	Geyh, C. P.
	Oaklyn, 112 E. Bettleground Ave.	Larson, I. J.
	Red Bank, Box No. 97	Strohl, W. M.
	Roselle, 485 W. 3rd Ave.	Peterson, J. N.
	West Collingswood, 142 Richley Ave.	Nelson, P. H.
	West Englewood, 514 W. Englewood Ave.	Pettus, W. K.
	Woodcliffe, 588-36th St.	Barth, B. B.
	Woodlynne, 204 Evergreen Ave.	Wardell, J. W.
New York	Astoria, L. I., 28-49-36th St.	Champness, T. J.
	Astoria, L. I., 2506 Elm St.	Miller, H. B.
	Bronx, 1050 Lowell St.	Bruck, H.
	Bronx, 3451 Giles Pl.	Katz, D.
	Bronx, 922 Summit Ave., c/o Jones	Van Pelt, J.
	Bronx, 1755 Jarvis Ave.	Sefton, E. F.
	Brooklyn, 415 Kosciusko St.	Belkin, F.
	Brooklyn, 449 Chestnut St.	Dreadner, H. D.
	Brooklyn, 381 Troutman St.	Gaydos, G. J.
	Brooklyn, 185 Marine Ave.	Kroupa, H. F.
	Brooklyn, 1549 E. 36th St.	O'Shea, C. G.
	Brooklyn, 857-58th St.	Petersen, J. C.
	Buffalo, 97 Mayer Ave.	Lovell, M. G.
	Garden City, L. I., P. O. Box No. 382	Brown, N. D.
	Jackson Heights, L. I., 7517-41st Ave.	Campbell, M. E.
	Jamaica, L. I., 177-49-106 Rd.	McCutcheon J. F.
	Long Island City, 45-44-42nd St.	Wood, E. F.
	Midland Beach, S. I., 148-5th St.	Bov, J. M.
	New York City, 11 Cornelia St.	Clothier, S. L.
	New York City, 463 West St., Bell Tel. Labs.	Cowles, L. G.
	New York City, 463 West St., Bell Tel. Labs.	Davis, E. J.
	New York City, 215 E. 117th St.	Garofalo, F.
	New York City, 34 Hillside Ave., Apt. 2-X	Goldner, J. H.

Geographical Location of Members Elected February 4, 1931

New York (cont.)	New York City, 2661 Decatur Ave.	Grunwald, W. J.
	New York City, U. S. Sub-Treas. Bldg., Radio Dept.	Hallenstein, N. A.
	New York City, 306 W. 112th St.	Hoffman, R. W.
	New York City, 9 W. 76th St.	John, P.
	New York City, 1308 Hoe Ave.	Kaplan, A.
	New York City, 180 Varick St., Bell Tel. Labs.	Knapp, K. G.
	New York City, 463 West St., Bell Tel. Labs.	Lindner, H. G.
	New York City, 621 W. 188th St.	Magri, F.
	New York City, 68 W. 176th St.	McKeon, J. J., Jr.
	New York City, 463 West St., Bell Tel. Labs.	Peterson, G.
	New York City, 1760 Andrews Ave.	Revits, S. H.
	New York City, 1751 Fillmore St.	Seger, L.
	New York City, 463 West St., Rm. No. 1320	Smith, K. D.
	New York City, c/o Postmaster, U.S.S. Houston	Smith-Hutton, H. H.
	New York City, 347 W. 121st St.	Stines, C. H.
	New York City, Hotel Caledonia, W. 26th St.	Stone, F. J.
	New York City, 463 West St., Bell Tel. Labs.	Thompson, R. R.
	New York City, 308 E. 108th St.	Verdigi, J. R.
	New York City, 180 Varick St., Bell Tel. Labs.	Woodward, J. D.
	New York City, 463 West St., Bell Tel. Labs.	Wrathall, L. R.
	New York City, 463 West St., Bell Tel. Labs.	Yeutter, C. S.
	New York City, 75 Varick St., RCA Inst.	Zahn, P. E.
	Ozone Park, L. I., 109-42 Lefferts Blvd.	Necker, E. J.
	Richmond Hill, L. I., 121-06-109 Ave.	Gordon, M. J.
	Riverhead, L. I., Box No. 1041	Callahan, E. P.
	Riverhead, L. I., RCA Communications, Inc.	Lindow, I. L.
	Riverhead, L. I., RCA Communications, Inc.	Opperman, K.
	Sayville, L. I., P. O. Box No. 189	Moser, W. E.
	Schenectady, 134 Plymouth Ave.	Crosby, H. M.
	Schenectady, 210 Bradley St.	Frost, E.
	Scotia, 342 Mohawk Ave.	Jensen, R. C.
	Solvay, 800 Cogswell Ave.	Clute, F. H.
	Solvay, 800 Cogswell Ave.	Clute, L. T.
	South Richmond Hill, 132-48-114th St.	Kahn, A.
	Springfield Gardens, 169-01-144th St.	Graf, W.
	Sunnyside, L. I., 45-53-40th St.	Forrest, G. E.
	Syracuse, 810 Seeley Rd.	Woodworth, S.
	Tonawanda, Spaulding Fibre Co.	Moersfelder, H. I.
	Wading River	Dow, O. E.
Ohio	Canton, 1124-12th St., N. W.	Leist, L. G.
	Toledo, 1729 Alvin St.	Barris, H. A.
Oregon	Milwaukee, Rt. 11, Box No. 516	Cupper, H. L.
Pennsylvania	Christiana	Weaver, W. H.
	Easton, 910 Bushkill St.	Gano, A. S.
	Emporium, 414 W. 4th St.	Askman, H. E.
	Emporium, 520 Vine St.	Wilson, M. D.
	Harrisburg, Municipal Airport	Bauer, W.
	Philadelphia, 119 S. 58th St.	Allen, G. D.
	Philadelphia, 1950 E. Clarence St.	Brener, J.
	Philadelphia, Walnut Park Plaza Apts.	Fiedler, G. J.
	Philadelphia, 5214 Chestnut St.	Kies, L. R.
	Philadelphia, 5632 Chester Ave.	Ward, J. M.
	Philadelphia, 2228 N. Hope St.	Watson, F. L.
	Oil City, 315 W. 7th St.	Roess, H. L.
	Roslyn, Belmont Ave.	Heins, J. J., Jr.
Tennessee	Nashville, 1901 1/2-11th Ave., N.	Parman, A. R.
Virginia	Norfolk, 521 W. 28th St.	Grether, J. L.
	Richmond, 3410 Carolina Ave.	Harrison, W. B., Jr.
Washington	Seattle, 4751-12th Ave., N. E.	Estes, F. B.
	Seattle, 331 Belvue N.	Gunston, A. D.
	Spokane, 1512 W. 12th Ave.	Sokoloff, A. H.
West Virginia	Huntington, 1811 Kite Ave.	Pfau, J. A.
	Mukwonago	Hunter, A. B.
Canada	Hamilton, Ont., 224 Grosvenor Ave., S.	Copeland, W. H.
	Montreal, Que., 4912 Sherbrooke St., W.	Annis, R.
	Toronto, 2477 Queen St., E., Apt. 8	Lowman, C.
	Toronto, 52 Mulock St.	Anderson, A. J.
	Toronto, 6, 21 Albermarle Ave.	Baldwin, C. O.
	Toronto, 6, 131 Bastedo Ave.	Dyer, F. W.
	Toronto, 177 Kingston Rd.	Hope, H. E.
	Toronto, 34 Bartlett Ave.	Hunt, B. D.
China	Peiping, Tsinghua University	Chiang, P. C.
	Peiping, Tsinghua University	Young, C. W.
England	Bradford, Yorks., 13, St. Margaret's Pl.	Firth, R.
	Bradford, Yorks., 116, Salt St.	Lawrence, E.
	Chelmsford, Essex, Marconi Wireless Tel. Co.	Stockton, S. A.
	Croydon, Surrey, 29 Marden Rd.	Woods, L. J.
	Haslingden, Rossendale, 171 Manchester Rd.	Coulton, A.
	Lancaster, 2BK Marton St.	Wilkinson, H. J.
	Llandudno, "Sandy Croft," Howard Pl.	Jones, H. C.
	Liverpool, Caryl St., Royal Southern Hospital	Newton, J. F.

Geographical Location of Members Elected February 4, 1931

England (cont.)	London, G. P. O., Eng.-in-Chief's Off., Radio Section	Bewick, W.	
	London, N. 19, 6, Gresley Rd. Highgate	Harris, E.	
	London, EC 1, Alder House, P. O. Eng. Dept., Radio Sect.	Howard, J. L.	
	London, S. E. 1, 8, Tenison St.	Keeling, C. H.	
	London, E.C. 1, Alder House, P. O. Eng. Dept., Radio Sect.	Morris, A.	
	Newbury, Black Boys Hotel	Brown, H. J.	
	Rugby, Warwickshire, P. O. Radio Section	Lemmey, C. W.	
	Sheffield, Yorks., 32 Gatefield Rd.	Hayward, W. R.	
	Stanford-le-Hope, Essex, "Singlewell," Rookery Estate	Bevis, G. J.	
	Tetney, Lincolnshire, Wireless Beam Station	Simmons, J. L.	
France	Paris, 21 Rue Dautencourt	Gavoret, G. C.	
Hawaii	Honolulu, 741-8th Ave.	Green, P. W.	
Japan	Osaka, Senri-Hososhō JOBK	Hashida, K.	
	Osaka, Sumitomo Cable Works	Kajii, K.	
	Kawasaki, Res. Lab., Tokyo Elec. Co.	Hagio, N.	
	Kawasaki, Tokyo Elec. Co.	Sumi, M.	
	Sapporo, c/o Sapporo Broadcasting Station	Kohno, S.	
	Sapporo, Sapporo Hosokyoku Tsukisshappo Hosojo	Takeo, S.	
	Tokyo, c/o Broadcasting Corp. of Japan, Shiseikaikan	Kumon, A.	
	Auckland, Devonport, 39 Clarence St.	Harlow, F. E.	
	New Zealand	Lund, Villa Bjorka	Nilsson, G. A.
	Sweden		
Elected to the Junior grade			
Dist. of Columbia	Washington, 2909 Brandywine St., N. W.	Patterson, G. W.	
Massachusetts	Cambridge, 24 Whittier St.	Berglund, C. W.	
New York	Brooklyn, 305 Ave. C., W.	Palmer, E. H., Jr.	
	Eagle Mills	Lavender, R. W.	
Pennsylvania	Chester, 819 McDowell Ave.	Morris, G. L.	
	Philadelphia, 1953 N. 13th St.	Shipp, R. E.	
	Pittsburgh, 5420 Kincaid St.	Douglass, E. J.	
Canada	Montreal, Que., 4912 Sherbrooke St., W.	McNeill, G. T.	
	Toronto, 6, 312 Strathmore Blvd.	Dynes, C. W.	



APPLICATIONS FOR MEMBERSHIP

Applications for transfer or election to the various grades of membership have been received from the persons listed below, and have been approved by the Committee on Admissions. Members objecting to transfer or election of any of these applicants should communicate with the Secretary on or before March 31, 1931. These applicants will be considered by the Board of Direction at its April 1st Meeting.

For Transfer to the Member grade		
New York	New York, c/o WRNY, 27 West 57th St.	Mc Laughlin, J. L.A.
For Election to the Member grade		
New Jersey	Mountain Lakes	Wilson, James R.
New York	New York, 60 Hudson St., Rm. 1724	Nelson, Crescent F.
Australia	Sydney, Amalgamated Wireless (A/sia) Ltd.	Hooke, L. A.
For Election to the Associate grade		
Arkansas	Dermott, Box 672	Fortune, W. F.
	Fayetteville, A. L. T. House	Albright, H. D.
	Texarkana, 404 State Line	Mims, M. P.
California	Alameda, 3216 Fernside Blvd.	Jackson, C. M.
	Los Angeles, 812 E. 28th St.	Boring, H. M.
	Los Angeles, 711 W. 2nd St.	Harris, Leland D.
	Palo Alto, c/o Mackay Radio & Tel. Co.	Wardlow, H. V.
	Pasadena, c/o Y.M.C.A.	Lindsay, W. F.
	San Francisco, c/o Radio KUP, 36 Annie St.	Paschal, W. P.
	San Francisco, 531 Call Building	Tobin, L. C.
Connecticut	Burnside, 48 Livingston Rd.	Gray, J. B.
Dist. of Columbia	Washington, National Press Bldg.	Lebowitz, S.
Florida	St. Petersburg, 725-15th St., No.	Lynn, W. L.
Idaho	Moscow, 904 Deakin St.	Kiebert, M. P.
Illinois	Chicago, 1907 Oakdale Ave.	Dillard, G. B.
	Chicago, 1804 W. Congress St.	Rice, Robert E.
	Chicago, 1647 Edgewater Ave.	Schuster, A. M.
	Chicago, c/o Automatic Electric, Inc.	Wu, S. W.
	Downers Grove, Great Lakes Broadcasting Co.	Mc Donnell, W. J.
Indiana	Angola, Box No. 164	Cooke, B. D.
	Fort Wayne, c/o Magnovox	Dempster, B.
Iowa	De Witt, 415-5th St.	Martin, Ray L.
	Iowa City, 225 Iowa Ave.	Potter, J. L.
Kansas	Sabetha, 53 Main St.	Baker, Fred L., Jr.
Maryland	Aberdeen, Broadway	Brown, W. C.
	Silver Spring, 8801 Georgia Ave.	Koehne, I. C.
Massachusetts	Brookline, 195 Davis Ave.	Sampson, G. L.
	Cambridge, 8 Maple Ave.	Horn, Tyree R.
	Cohasset	Gagnabin William B.
	Newton, 67 Dalby St.	Sivigny, A. J.
	Springfield, 78 College St.	Cushing, T. F.
	Springfield, 51 Eureka St.	Ferguson, J. C.
Michigan	Ann Arbor, 1033 Packard St.	Nelson, W. H.
	Detroit, 19132 Greeley	Bradley, F. W.
Montana	Anaconda, 620 East Park Ave.	Antonich, P. L.
Nebraska	Rovenna, 323 Grand Ave.	Mc Connell, R. H.
New Jersey	Audubon, 227 Virginia Ave.	Creighton, R. R.
	Camden, R.C.A.-Victor Co., Eng. Dept.	Hughes, M. S.
	Camden, R.C.A.-Victor Co.	Lecchi, P. A.
	Merchantville, 123 S. Lexington Ave.	Erlein, Harold M.
	Newark, 74 S. 10th St.	Cartwright, R. V.
	Newark, 482 So. 19th St.	Macintosh, W.
	Rahway, R.F.D. #2, Box 107 D.	Hubbard, C. W.
New York	Brooklyn, 6805 Baycliff Terrace	Buzalski, T. J.
	Brooklyn, 38 Slocum Place	Mc Cormick, H. L.
	Brooklyn, 679 Franklin Ave.	Mullen, J. F.
	Flushing, L. I., Flushing Hospital	Feliciano, F. A.
	Ithaca, 306 College Ave.	Nardone, August
	Jackson Heights, L. I., 37-20-81 St.	Swift, W. C. G.
	New York City, 711 Fifth Ave., Control Rm.	Grey, Charles C.
	New York City, 180 Varick St., Rm. 825	Jones, R. J.
	New York City, c/o Surprenant & Co., 350 Madison Ave.	Stanford, K. J.
	New York City, 27 East 30th St.	Terry, C. B.
	New York City, 463 West St.	Veazie, E. A.
	New York City, 127 West 96th St.	Wilson, D. B.
	Nyack, Grand View, 9 W. Highway	Stansbury, M. L.
	Richmond Hill, L. I., 9430-113th St.	Berry, F. L.
	Riverhead, 57 Moriches Road	Winans, Paul

Applications for Membership

New York (cont.)	Schenectady, 1405 Grand Blvd.	Smith, H. A.
	Utica, 316 Cooper St.	Mallett, R. W.
	Waverly, 430 Cayuta Ave.	Sosnoski, W. J.
	West New Brighton, S. I., 191 Franklin St.	Langhammer, C. F.
Ohio	Blue Ash, Hunt Rd. & Conklin Ave.	Chapman, R. T.
	Cincinnati, 4133 Kirby Road	Robins, Daniel C.
	Cuyahoga Falls, 1539 Front St.	Makinson, G. E.
	Mt. Gilead, 30 W. Center St.	Bush, Paul W.
	East Pittsburgh, Westinghouse Elec. & Mfg.	Plotts, Ellery L.
	Emporium, Warner House	Klinestiver, G. H.
	Philadelphia, 8419 Anderson St.	DaCosta, R. C.
	Philadelphia, 2303 W. Thompson St.	Guinan, John J.
	Philadelphia, H. H. Eby Mfg. Co.	Lodge, E. G.
	Philadelphia, H. H. Eby Mfg. Co.	White, C. D.
Rhode Island	Pittsburgh, 109 N. Graham St.	Templeman, David
	West Fairview, 508 Third St.	Ottey, Raymond B.
	Wilkinsburg, Penn Lincoln Hotel	Stoddard, Ralph N.
Tennessee	Providence, 92 Early St.	Slocum, Walter E.
Texas	Jackson, 319 W. King St.	Dike, E. R.
	Beaumont, 1645 Avenue G	Murphree, H. L.
Virginia	Fort Worth, Airways Radio Station	Carpenter, C. I.
	Forth Worth, 4725 Birchman	Stinson, R. C.
	Quantico, Marine Corps Radio School, M.B.	Lockard, M. R.
Washington	Quantico, 87th Co., Signal Bn.	Williams, Gerald R.
	Everett, 2015 State St.	Eckstrom, H. E.
Canada	Seattle, 1304 E. 62nd St.	Gleason, R. J.
	Seattle, 4042-51st Ave., S.W.	Lischke, Carl C.
	Haileybury, Ont.	Thorpe, E. O.
	Hamilton, Ont., 7 Maine St.	Alston, L.
	Toronto, Ont., 1792 Bloor St., W.	Choate, H. R.
	Toronto, Ont., 136 Chester Ave.	Gunn, Donald
	Toronto, Ont., 597 Bathurst St.	Hamilton, H. E. S.
	Toronto, Ont., 296 Garden Ave.	Ure, William C., Jr.
	Toronto, Ont., 48 Hiltz Ave.	Williams, H. S.
	Vancouver, Northern Electric Co.	Walker, E. N.
Central America	Nicaragua, Managua, All American Cables	Smith, T. R.
	Egypt	Alexandria, Ras-el-Tin, 4 Magawry St.
China	Hangchow, University of Chekiang	Woung, S. S.
	Birkenhead, Cheshire, 260 Conway St.	Thornton, J.
England	Bradford, Yorkshire, 74 Merley St.	Ault, Harold B.
	Crosshills Keighley, 1 Newby St.	Smith, Harold
	Gt. Bookham, Surrey, "Byways" Sole Farm Rd.	Hesse, C. M.
	High Heaton, Newcastle-on-Tyne, 7 Horsley Rd.	Rush, James
	Hornsey, London, N. S., 23 Ravenstone Rd.	Clark, R. G.
	Leicester, 5 Poplar Ave.	Charles, E. E.
	Moorgate, London, E. C. 2, I & I. C., Ltd	Bruce, J. R.
	Rotherhithe, London, S E 16, 12 Henwood Rd.	Baxter, H. W.
	Southampton, 96 Bernard St.	Corney, W. D.
	Genova, Via A. G. Barril 1/26 A.	Buttolo, Romeo L.
Italy	Ishikawaken, Kanazawa City, Kanazawa Broadcasting Sta-	
Japan	tion JOJK	Nagamura, S.
New Zealand	Macandrew Bay, "Woodford"	Budd, L. W.
	Wellington, 183 Willis St.	Blackwell, W. J.
	Wellington, Box 605	McCutcheon, W. A.
Scotland	Edinburgh, 7, Mertoun Place	Miller, John C.
For Election to the Junior grade		
California	Los Angeles, 3501 Floral Dr.	Katzman, Louis
Dist. of Columbia	San Francisco, 16 Avila St	Letsinger, Paul R.
	Washington, 2151 California St., N W.	Dunne, William
Oklahoma	Tulsa, 2622 E. Archer	Roach, Harry J.
Oregon	Milwaukee, R. 10, Box 178	Perkins, O. D.
Utah	Salt Lake City, 632 Wilson Ave.	Peterson, H. C.
Australia	Melbourne, Vic., 55 Antree Rd.	Archer, E. Lee



OFFICERS AND BOARD OF DIRECTION, 1931

(Terms expire January 1, 1932, except as otherwise noted)

President

RAY H. MANSON

Vice President

C. P. EDWARDS

Treasurer

MELVILLE EASTHAM

Secretary

HAROLD P. WESTMAN

Editor

ALFRED N. GOLDSMITH

Managers

Arthur Batcheller
J. H. Dellinger

Lloyd Espenschied
Harry Houck

C. M. Jansky, Jr.

Serving until January 1, 1933

J. V. L. Hogan

R. H. Marriott

Serving until January 1, 1934

L. M. Hull

A. F. Van Dyck

Junior Past Presidents

A. HOYT TAYLOR
LEE DE FOREST

Board of Editors

ALFRED N. GOLDSMITH, *Chairman*

STUART BALLANTINE
RALPH BATCHER

G. W. PICKARD
L. E. WHITTEMORE

W. WILSON



E. F. W. ALEXANDERSON
President of the Institute, 1921

Ernst Fredrik Werner Alexanderson, ninth president of the Institute, was born at Upsala, Sweden, on January 25, 1878.

After graduating from the Royal Technical Institute at Stockholm, Sweden, Dr. Alexanderson did some post-graduate work at the Royal Technical Institute at Charlottenburg. In 1902 he joined the Drafting Department of the General Electric Company, entering the Engineering Department as a designing engineer of alternating-current machines in 1904. In 1910 he became consulting engineer, a position he still holds with the General Electric Company. In 1920 he was appointed chief engineer of the Radio Corporation of America later becoming consulting engineer to that organization.

In addition to many developments and inventions in the rotating machinery field, Dr. Alexanderson has been responsible for the design of the Alexanderson high-frequency alternator, a system of cascading radio-frequency amplifier stages, a magnetic amplifier for radiotelephony and many other radio developments.

He has published numerous papers in the PROCEEDINGS of the Institute of Radio Engineers and the Journal of the American Institute of Electrical Engineers, and is a Fellow of the American Institute of Electrical Engineers.

He was the recipient of the Medal of Honor of the Institute of Radio Engineers in 1919. He became an Associate member of the Institute in 1913, a Member later in the same year, and a Fellow in 1915.

INSTITUTE NEWS AND RADIO NOTES

Meetings of the Board of Direction

A special meeting of the Board of Direction was held at the office of the Institute at 2 P.M. on Wednesday, January 21. This meeting was devoted entirely to a review of the proposed new constitution of the Institute and was attended by R. H. Manson, president; J. V. L. Hogan, L. M. Hull, R. H. Marriott, chairman of the Committee on Constitution and Laws, and Harold P. Westman, secretary.

The regular monthly meeting of the Board of Direction was held on Wednesday, February 4, at 3 P.M., the following being in attendance: R. H. Manson, president; Melville Eastham, treasurer; Alfred N. Goldsmith, Arthur Batcheller, L. M. Hull, R. H. Marriott, and H. P. Westman, secretary.

As a result of the ballots cast for the office of manager, the Board declared elected for three-year terms, starting January 1, 1931, L. M. Hull and A. F. Van Dyck. In addition, J. H. Dellinger, Lloyd Espenschied, and Harry Houck were appointed managers for 1931.

E. R. Booker, W. H. Capen, and Paul Schwerin were elected to the grade of Member, and R. C. Giese, R. F. Guy, and E. L. White were transferred to the grade of Member. Two hundred and forty-six applicants for the Associate grade and fourteen applicants for the Junior grade of membership were declared elected.

The personnel of the standing committees for 1931 was determined upon. The Committee on Meetings and Papers will hereafter be known as the Committee on Papers inasmuch as its scope no longer includes the preparing of programs for Institute meetings.

A Section Membership Manual which was prepared by the Committee on Membership under the chairmanship of I. S. Coggeshall was approved. This manual, which will be forwarded to all sections, covers the problems of the Institute as regards the obtaining of new members.

Radio Transmissions of Standard Frequency, March to June, 1931

The Bureau of Standards announces a new and improved service of radio standard frequency transmissions. This service may be used by broadcast and other stations in adjusting their transmitters to exact frequency, and by the public in calibrating frequency standards and transmitting and receiving apparatus. The signals are transmitted from the Bureau's station WWV, Washington, D.C. They can be heard and utilized by stations equipped for continuous-wave reception at

distances up to about 1000 miles from Washington, and some of them at all points in the United States. This improved service is a step in the Bureau's program to provide eventually standard frequencies available at all times and at every place in the country.

Besides the usual monthly transmissions of specific frequencies, the Bureau will add another type of transmission which will be much more accurate than any previous transmissions by the Bureau. This transmission will be by continuous-wave radio telegraphy on a frequency of 5000 kc, and will consist primarily of a series of very long dashes. The first five minutes of this transmission will consist of the general call (CQ de WWV) and announcement of the frequency. The frequency and the call letters of the station (WWV) will be given every ten minutes thereafter.

Besides this service, the Bureau will also continue the transmissions once a month on scheduled specific frequencies. These are also by continuous-wave radiotelegraphy. A complete frequency trans-

5000-Kilocycle Transmissions 1:30 to 3:30 and 8:00 to 10:00 P.M., Eastern Standard Time.				
March	April	May	June	
3	7	5	2	
10	14	12	9	
24	28	26	16	
31			30	

Monthly Transmissions, Eastern Standard Time				
Time	March 20	April 20	May 20	June 22
10:00 P.M.	550	1600	4000	550
10:12	600	1800	4400	600
10:24	700	2000	4800	700
10:36	800	2400	5200	800
10:48	1000	2800	5800	1000
11:00	1200	3200	6400	1200
11:12	1400	3600	7000	1400
11:24	1500	4000	7600	1500

mission includes a "general call," "standard frequency signal," and "announcements." The general call is given at the beginning of each 12-minute period and continues for about 2 minutes. This includes a statement of the frequency. The standard frequency signal is a series of very long dashes with the call letters (WWV) intervening; this signal continues for about 4 minutes. The announcements follow, and contain a statement of the frequency being transmitted and of the next frequency to be transmitted. There is then a 4-minute interval while the transmitting set is adjusted for the next frequency.

Information on how to receive and utilize the signals is given in Bureau of Standards Letter Circular No. 280, which may be obtained by applying to the Bureau of Standards, Washington, D.C. Even though only a few frequencies are received (or even only a single one),

persons can obtain as complete a frequency meter calibration as desired by the method of generator harmonics.

The 5000-kilocycle transmissions are from a transmitter of 150 watts power, which may be increased to 1 kilowatt early in the year; they occur every Tuesday except in those weeks in which the monthly transmissions are given. The monthly transmissions are from a transmitter of 1/2 to 1 kilowatt power; they are given on the 20th of every month (with one exception).

The frequencies in the 5000-kilocycle transmission are piezo controlled, and are accurate to a few parts in a million. The frequencies in the monthly transmissions are manually controlled, and are accurate to a few parts in a hundred thousand.

In November, 1930, field intensity measurements were made of the 5000-kilocycle transmissions from WWV on 150 watts between Washington and Chicago. The daytime field intensity up to a distance of about 400 miles from Washington was about 100 microvolts per meter, with fading in the ratio 3 to 1. From this distance to Chicago the field intensity gradually decreased to about 10 microvolts per meter peak values with fading the same as above. The evening transmissions had a field intensity of about 200 microvolts per meter with fading similar to that in the daytime. Around 8 P.M. the received intensity was sometimes too low to measure. This happened at distances of from 75 to 150 miles from Washington.

The Bureau of Standards would like to have detailed information on the reception of the 5000-kilocycles transmissions, and will appreciate receiving reports from any observers on their reception of these transmissions. Phenomena of particular interest are approximate field intensity, and fading (whether slow or rapid, and approximate time between peaks of signal intensity). The Bureau would also like to receive comments on whether or not the transmissions are satisfactory for purposes of frequency measurement or control. Reports on the reception of the transmissions should be addressed to Bureau of Standards, Washington, D. C.

Committee Meetings

COMMITTEE ON ADMISSIONS

A meeting of the Committee on Admissions was held at the office of the Institute on February 4 at 10 A.M. R.A. Heising, vice chairman; A. V. Loughren, R. H. Marriott, E. R. Shute, and J. S. Smith were in attendance. An application for transfer to the grade of Fellow was tabled pending additional data. Of two applications for transfer to Member, one was approved and three of five applications for admission to Member were approved.

STANDARDIZATION

TECHNICAL COMMITTEE ON RADIO RECEIVERS-I.R.E.
SUBCOMMITTEE ON AIRCRAFT RECEIVERS

A meeting of the Subcommittee on Aircraft Receivers operating under the Technical Committee on Radio Receivers of the I.R.E. was held at 10 A.M. on February 5 and was attended by Virgil M. Graham, chairman; S. E. Anderson, E. J. T. Moore, and R. M. Wilmotte.

TECHNICAL COMMITTEE ON RADIO RECEIVERS-I. R. E.
SUBCOMMITTEE ON HIGH-FREQUENCY RECEIVERS

A meeting of the Subcommittee on High-Frequency Receivers of the Technical Committee on Radio Receivers of the Institute was held on January 13 and attended by C. M. Burrill, chairman; H. M. Lewis, H. O. Peterson, F. A. Polkinghorn, S. E. Spittle (representing Paul Watson); and B. Dudley, secretary.

Another meeting of this same subcommittee was held at 10 A.M. on February 5. Those present were C. M. Burrill, chairman; C. A. Gunther (nonmember), H. O. Peterson, F. A. Polkinghorn, S. E. Spittle, V. K. Whitman (representing H. M. Lewis), and B. Dudley, secretary.

TECHNICAL COMMITTEE ON RADIO RECEIVERS-A.S.A.

The Technical Committee on Radio Receivers operating under the Sectional Committee on Radio of the American Standards Association held a meeting at 10 A.M. on January 16. This meeting was attended by Virgil M. Graham, chairman; E. T. Dickey, J. W. Fulmer (representing H. B. Smith), Leslie Woods (representing W. M. Grimditch), and B. Dudley, secretary.

Institute Meetings

CHICAGO SECTION

A meeting of the Chicago Section was held on January 29 in the Engineering Building of the Western Society of Engineers, Byron B. Minnium, chairman, presiding.

A paper on "The Theory and Practice of Photo-Electric Cells" was presented by A. J. McMaster. The speaker gave an interesting and clearly presented outline of the various photo-electric phenomena. Photo-voltaic, selenium, and photo-electric cells were treated. The properties of these were first presented and their connection with thermionic work functions pointed out. The manufacturing methods and properties of caesium-oxide cells having greater than normal red response characteristics and the effect of the frequency of light pulsations followed. Their applications and some details of the General Elec-

tric color machine were given. The general discussion which followed was entered into by Messrs. Bohrlard, Dodge, Durham, Hoag, Krantz, and Minnium.

The meeting was attended by ninety members and guests.

CINCINNATI SECTION

The fifteenth meeting of the Cincinnati Section was held on January 13 at the Cincinnati Chamber of Commerce, Dorman D. Israel, chairman, presiding.

"The Audio-Frequency Transformer; Its General Theory, Design and Use in Communication Circuits" was the subject of the paper presented by J. P. Barton of the General Motors Radio Corporation of Dayton, Ohio.

The general circuit and theory of the audio-frequency transformer was developed and permissible simplifications in practical cases were pointed out. Applying the simplified theory, the stages in the actual design of a commercial high quality audio-frequency transformer was traced. The process was illustrated with curves, practical working limits being pointed out. It was stated that the results of actual measurements on transformers designed by this procedure check the method to within a few per cent.

The paper was discussed by Messrs. Blair, Kilgour, and Osterbrock of the fifty-seven members and guests in attendance.

The personnel of the standing Committees on Meetings and Papers, Membership, and Publicity was appointed.

CONNECTICUT VALLEY SECTION

The January 29 meeting of the Connecticut Valley Section was held at the Hotel Garde, Hartford, R. S. Kruse, chairman, presiding.

A paper on "Pentode Development" was presented by B. V. K. French, assistant engineer of the United American Bosch Corporation at Springfield, Mass.

The paper covered briefly the history of the pentode and discussed its output characteristics in some detail, particularly with reference to audio-frequency work. The paper was illustrated with slides showing the characteristics of some experimental pentodes as well as those of some tubes now available to the public. A demonstration of the pentode in comparison with triodes was given, the test set consisting of a phonograph turntable, a single stage of voltage amplification using a 227-type tube, and an output stage arranged to use either a pair of 245 tubes in push-pull or a pentode of about the same power output rating. The input to the output stage was fed through an attenuator calibrated

in db so that a comparison of the sensitivity of the two amplifiers could be made.

R. S. Briggs of the Champion Radio Company explained briefly some of the constructional difficulties of the pentode and demonstrated an experimental midget receiver using one of the tubes.

Several of the thirty-seven members and guests in attendance participated in the discussion.

DETROIT SECTION

The January 16 meeting of the Detroit Section was held in the Detroit News Auditorium. Due to the absence of both the chairman and vice-chairman, A. B. Buchanan presided.

The speaker of the evening, D. H. Vance of the Radio Engineering Department of the General Electric Company, presented a paper on "Facsimile Transmission and Reception."

A general résumé of past work of the General Electric Company commencing with Dr. Alexanderson's early laboratory experiments and covering the WGY and WEAJ transmissions of 1926 and 1927, the South Schenectady-Marshall (Calif.) circuit, the work at Rocky Point in 1928, and the Oakland Schenectady circuit of 1929 and 1930 was given.

The author then considered the problems involved in the conversion of the variations in density of the pictures to be transmitted into corresponding electrical impulses, the transmission of these impulses over control lines, the problems of maintaining good fidelity and the elimination of undesirable effects due to line noises and distortion, the control of the transmitting equipment by these impulses, their reception, conversion into impulses suitable for controlling the recording equipment, and the recording problems.

The paper was discussed by a number of the sixty members and guests in attendance.

LOS ANGELES SECTION

A meeting of the Los Angeles Section was held on January 19 at the Rosslyn Hotel, chairman T. E. Nikirk, presiding.

A paper on the "Radio Monitoring Work of the U. S. Department of Commerce" was presented by G. L. Jensen of the Bureau of Standards. This was followed by a second paper by E. Underwood of the Don Lee Broadcasting System who discussed "The Short-Wave Standard Frequency Station of the Don Lee Broadcasting System." These papers were discussed by Messrs. Alverson, Hardy, Kennedy, Ludlum, Lubcke, and Nikirk.

Forty-six members and guests attended the meeting.

NEW YORK MEETING

The regular February New York meeting of the Institute was held on the 4th in the Engineering Societies Building, 33 West 39th Street, New York City.

The speaker of the evening was Malcolm P. Hanson who was formerly chief radio engineer of the Byrd Antarctic Expedition and who at present is with the Naval Research Laboratory at Anacostia, D. C. His paper on "Radio in the Antarctic" covered some experiences in the Antarctic showing extensive applications of radio communication as employed on the Byrd Expedition. Various types of radio equipment such as were used at the base station, on board ship and aeroplanes, and on the dog sleds were illustrated. The physical conditions under which the equipment had to function were shown and the radio conditions encountered together with the scientific radio measurements obtained on the expedition were discussed. The paper was illustrated by over one hundred and fifty slides of scenes encountered in the Antarctic.

Four hundred and fifty members and guests were in attendance.

PHILADELPHIA SECTION

A meeting of the Philadelphia Section was held on January 21 at The Engineers Club, D. O. Wheland, vice chairman, presiding.

A paper by A. H. French, manager of aeronautic sales, Industrial Department, General Electric Company, on the "Application of Electrical Apparatus to Aircraft" was read by E. H. Alexander of the Sales Department of the General Electric Company due to the fact that Mr. French was called away at the last moment and could not attend the meeting.

The paper dealt with the complete electrical equipment of aircraft, covering navigational instruments, indicating instruments, and radio.

Following the reading of the paper, C. A. Brokaw gave an illustrated talk on instruments used in aircraft, and L. Linden covered radio transmitters and receivers employed in aeronautical work. These two talks were by members of the RCA-Victor Company staff at Camden and showed pictures of the equipment described in the paper by Mr. French and in addition permitted the demonstration after the meeting of some sample equipment.

The general discussion of these papers were entered into by a number of the sixty members and guests in attendance.

PITTSBURGH SECTION

A meeting of the Pittsburgh Section was held at the Fort Pitt Hotel on January 27, vice chairman J. G. Allen, presiding.

A paper by C. A. Boddie of Wilkinsburg, Pa., on "Some Problems of Carrier Current Communication" was presented. The author introduced the subject by going over some of the work covered in material already published, and in his opening discussion quoted frequently from such works. A lengthy series of slides were then shown while the author explained the problems and their associated equations. His discussion covered such matters as insulation, reflection, peak voltage, capacity, resistance, etc. of carrier current lines, and a model showing the field surrounding a suspended conductor was shown and explained. A comparison between the fields surrounding antennas and suspended conductors was made so that use may be made of the parabolic model in examining the field of the antenna.

At the close of the presentation of the paper, an extensive and interesting discussion, which was participated in by most of the forty members and guests in attendance, ensued.

ROCHESTER SECTION

A regular meeting of the Rochester Section was held on January 8 at the Sagamore Hotel, H. J. Klumb, presiding.

E. M. Gilbert, president of W. S. Barstow Company, presented a paper on "Modern Power Plant Design "

Mr. Gilbert presented a very interesting illustrated talk upon the design problem confronting the engineers who are called upon to produce power plants which will compete in the electrical industry with existing plants or proposed plants. He illustrated his points with reference to the new Gilbert Station at Holland, N. J. This station operates on a steam pressure of 1200 lbs. This pressure was resorted to as the most economical and efficient that could compete with other stations when coal was \$5.50 per ton at the location of the Gilbert Station.

There is a trend toward placing all of the important units on one floor level and eliminating all partitions. In this manner one operator can control the entire plant from a single station as well as have a general view of each machine as he starts or stops it. This includes the boilers which use powdered fuel.

Two hundred and four members and guests attended the meeting.

ROCHESTER SECTION FOR PRESIDENT MANSON

On the evening of January 19, the Executive Committee of the Rochester Section gave a surprise dinner at the Normandie Inn, Sodus, N. Y., in honor of the election of R. H. Manson as President of the Institute for 1931.

The entire dining room was occupied by the party and Harry Gordon, chairman of the Rochester Section, acted as toastmaster.

Several excellent speeches were made and all those in attendance considered the event highly successful.

SAN FRANCISCO SECTION

The January 21 meeting of the San Francisco Section was held at the Pig'n Whistle Restaurant, Walter D. Kellogg, chairman, presiding.

P. T. Farnsworth, director, Television Laboratories, presented a paper on "Some Recent Developments in Television." A brief résumé of the mathematics and problems encountered in the transmission of television over a narrow band of frequencies without the use of synchronous disks was given.

A discussion followed the presentation of the paper, after which those present adjourned to the Television Laboratories and saw a practical application of the theory discussed at the meeting. A moving picture of Lee de Forest transmitted over a five- to seven-kilocycle band was shown.

Fifty-one members and guests attended the dinner which preceded the meeting and seventy-one were in attendance at the meeting.

SEATTLE SECTION

A meeting of the Seattle Section was held at Guggenheim Hall, University of Washington on January 29, Abner R. Willson, presiding.

A paper by T. M. Libby on "Radio Interference and its Suppression" covered in complete detail the suppression of different forms of interference varying in nature from telegraph lines to oil burners. The introduction to the paper was an analysis of the harmonic components of the more common kinds of interference.

A second paper by J. R. Tolmie on the "Mathematical Analysis of Interference Gradients" was presented. It covered the mathematical analysis of interference gradients from direct-current systems, such as telegraph circuits. The harmonic components of interfering currents were detailed.

During the discussion of these papers which was entered into by Messrs. Begg, Eastman, Lovejoy, Parrett, Tolmie, Voris, and Williams the matter of the signal level provided by the local broadcast stations with respect to local interference was considered.

The attendance totaled one hundred members and guests.

TORONTO SECTION

A meeting of the Toronto Section was held on December 17 at the University of Toronto, J. M. Leslie, chairman, presiding.

"An Electrical Method of Determining Atmospheric Dampness and Humidity" was the subject of the paper by E. S. Burton of the Univer-

sity of Toronto. Arnold Pitt, an assistant to Professor Burton, aided in the demonstration of this new electrical device by means of which infinitesimal quantities of moisture may be quickly determined. The instrument, it is anticipated, will be especially valuable in measuring the amount of moisture in wheat and grain. It is equally valuable in determining the electrical conductivity or insulating value of substances, measuring water crystallization in salts, and detecting impurities in materials.

The paper was discussed by F. K. Dalton, C. A. Lowry, and Professor Roseborough of the forty-four members and guests in attendance.

WASHINGTON SECTION

The December meeting of the Washington Section was held on the 11th at the Continental Hotel, L. P. Wheeler, chairman, presiding.

L. V. Berkner, assistant radio engineer of the U. S. Bureau of Standards, presented a paper on "Some Studies of Radio Wave Propagation Made on the Byrd Antarctic Expedition."

The author was located at Duneden during the Byrd Expedition and conducted continuous tests on reception from various stations at various frequencies. In the broadcast band observations were made principally on KFOX, KNX, WENR, and KHJ with some observations on WLW, WGY, and KGO. High-frequency studies of the transmissions from W2XAF, W2XK, KDKA, W6XN, W8XK, G5SW, GBX, and PCS were made. Measurements were also made on transmission from Little America.

Many stereopticon slides showed charts on great circle projections of the paths taken by the waves and how the paths shift from one way around to the other, following darkness. Other slides gave curves of quantitative measurements of signal strength.

The paper was discussed by Drs. Dellinger, Jolliffe, and Wheeler, and Messrs. Burgess, Davis, Hanson, and McBride.

Sixty-five members and guests attended the meeting, twenty-eight of whom were present at the dinner which preceded it.

The January 8 meeting of the Washington Section was held at the Continental Hotel, John B. Brady, presiding.

A paper on "Paralleling the Alaskan Cable with Radio" was presented by Major General George S. Gibbs, Chief Signal Officer, U. S. Army, with detailed discussions by Captain W. V. Parker and Lieutenant W. T. Guest, both of the Signal Corps.

The paper was discussed by a number of the forty-eight members and guests in attendance.

By-laws for the Section constitution were adopted.

PART II
TECHNICAL PAPERS

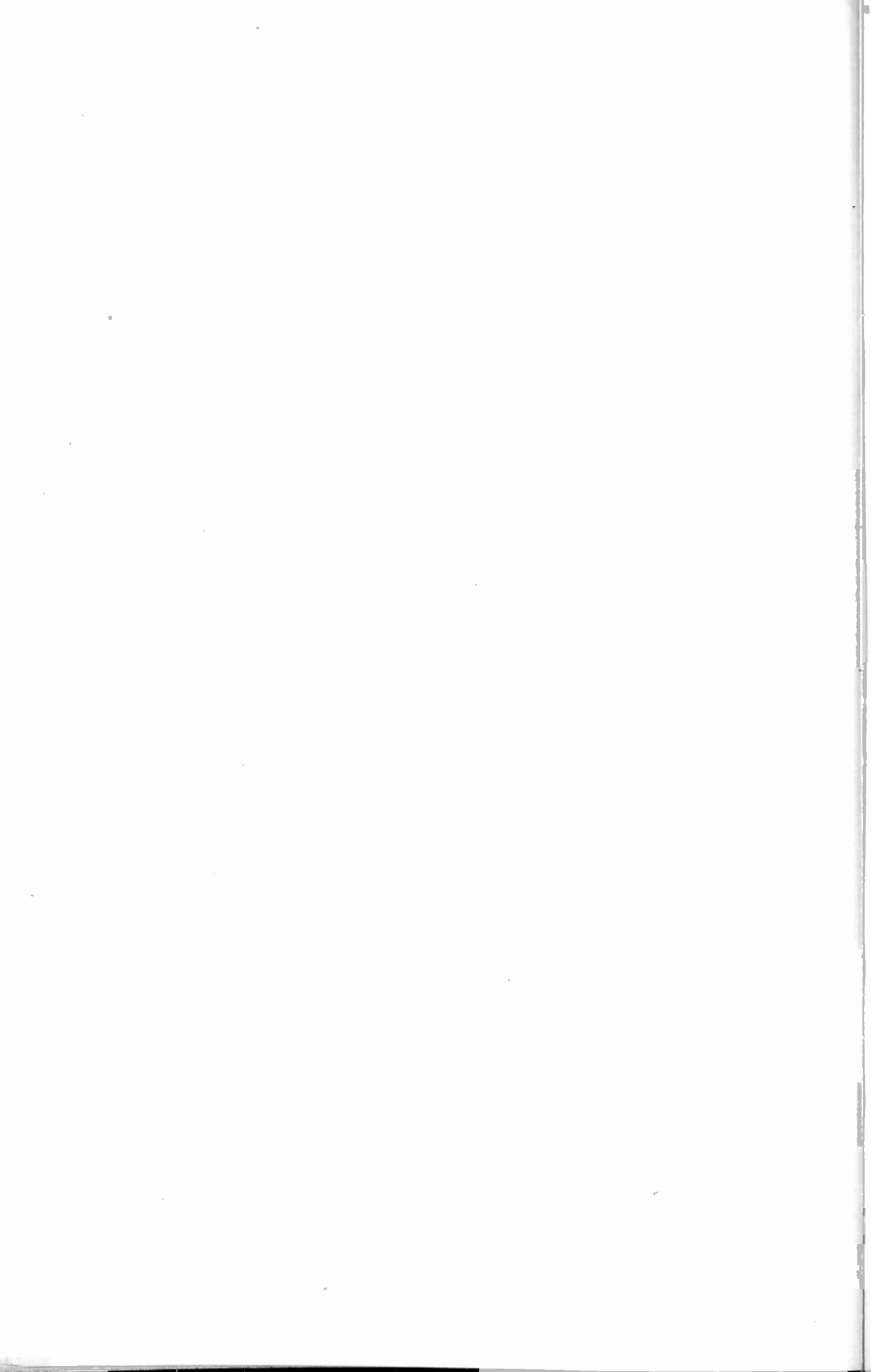

A RADIO METHOD FOR SYNCHRONIZING RECORDING APPARATUS*

BY

T. PARKINSON† AND T. R. GILLILAND‡

(†Formerly Bureau of Standards, Washington, D. C.; at present, University of Michigan, Ann Arbor, Michigan; ‡Bureau of Standards, Washington, D. C.)

Summary—A method is described for running two radio fading recorders at the same speed when it is necessary to have one of the recorders portable so that it can be moved to various distances from the other. In the work reported each of the recorder drums was propelled by a synchronous motor of the type used for clocks. Since wire connections were not practicable the portable recorder was controlled by a radio transmitter placed at the fixed station. The same 60-cycle source of power used to drive the synchronous motor at the fixed station was used to modulate the transmitter, the signal of which was received at the portable station and amplified sufficiently to drive the synchronous motor there. With the transmitter working on low power it was possible to drive the recorders at the same speed when separated by a distance of 16 km. A method is described for marking the two records simultaneously so that they can be superposed.

THE need of synchronizing duplicate recording mechanisms when widely separated in space and when placed in situations which prohibit wire connecting circuits, resulted in the development by the Bureau of Standards of a simple radio method which may be of interest in other lines of research. When it became desirable to compare graphic fading records of the same radio transmission as measured at two points of varying separation, it was found that no recorders were available which could be depended upon to run independently, and at the same time insure equal speeds of the recording tapes. Where wire connections were permissible, synchronous motors driven by a common power supply were satisfactory, but for the projects in hand it was necessary to have one receiving station complete in itself on a laboratory car, which could be moved to any desired distance. Experiments with spring-driven apparatus and with governor-controlled electric motors showed that only at accidental intervals was there sufficient agreement in their speeds to produce pairs of records which could be superposed for comparison. Even slight discrepancies in speed were serious since the changes studied were often very rapid, sometimes having periods as short as five seconds.

Because synchronous motors of the type used for clocks had given very satisfactory results when supplied by wire from the same source

* Decimal classification: 365.3. Original manuscript received by the Institute, November 21, 1930. Publication approved by the Director of the Bureau of Standards of the U. S. Department of Commerce.

of alternating current, it was thought possible to arrive at the same result by radio. Initial experiments verified this belief, and the system hereinafter described was developed and found satisfactory.

The general method consists of the transmission from a transmitter of the half-wave, self-rectifying type with 60-cycle plate supply, and the reception and amplification of this transmission in such a manner that the output is sufficient to drive the 6-watt synchronous clock motor, which in turn propels the recorder drum through a system of gears. The same 60-cycle supply which is stepped up in voltage to sup-

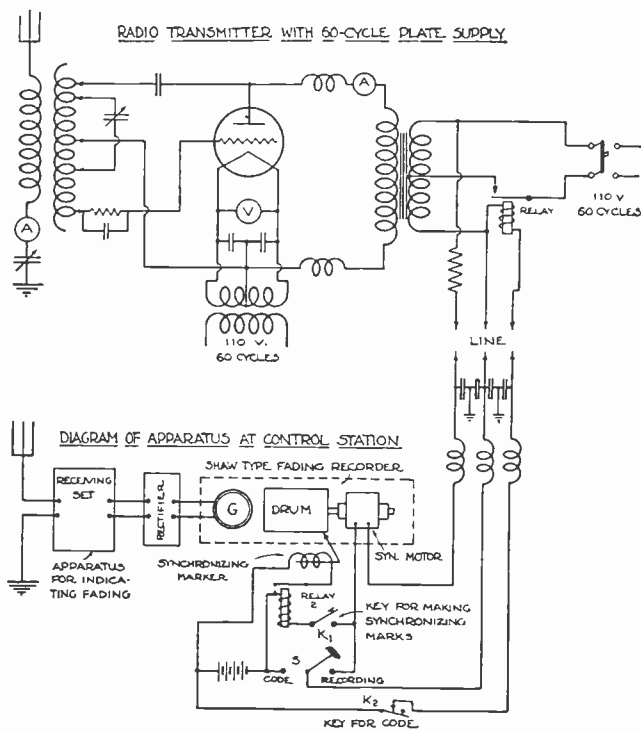

Fig. 1.—Schematic diagram of apparatus at control station.

ply the plate of the transmitting tube is also used to operate directly a second synchronous motor and recorder near the transmitter, suitable reactors and condensers being used in the connecting lines to prevent these conductors from introducing a strong field at the point where receiving measurements are to be made.

Figs. 1 and 2 show the connections used at the control station and at the portable station, respectively.

In order that the records might be superposed for comparison, it was necessary that some method be devised for marking them simultaneously. This was accomplished by attaching a small relay, *B*, (Fig. 2) to the iron yoke of the synchronous motor at the portable station in

such a manner that the relay is held open as long as alternating current flows in the motor circuit. When the flow is stopped the relay closes the battery circuit, causing a magnetically-operated pencil to

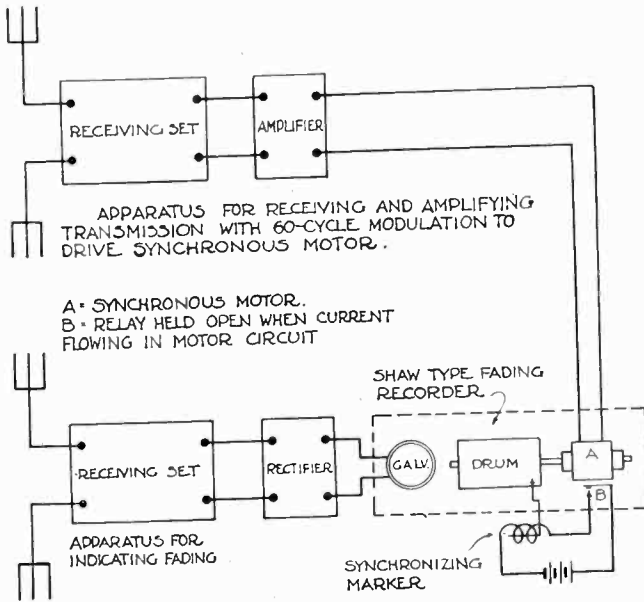

Fig. 2.—Schematic diagram of apparatus at portable station.

make a mark on the record. With the circuits as shown in Fig. 1 the closing of key K_1 with switch S in the recording position, causes relay 1 to open the alternating-current supply, thus stopping the transmitter and the motor at the control station. The closing of K_1 also oper-

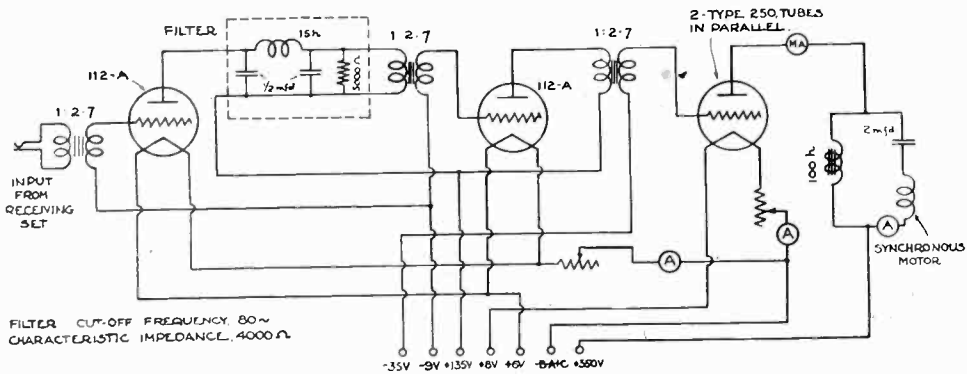

Fig. 3.—Circuit diagram of amplifier used for driving synchronous clock motor.

ates relay 2, thus causing the marker to make a mark on the record. But the stopping of the transmitter also stops the motor at the portable station and causes a mark to be made upon the record there. Thus the closing of K_1 stops the recorders at both stations and causes marks

to be made simultaneously on both records. Both recorders will start out together when K_1 is opened.

It is possible to use the same transmitter to communicate by telegraph with the portable station merely by throwing switch S to the left position and operating K_2 .

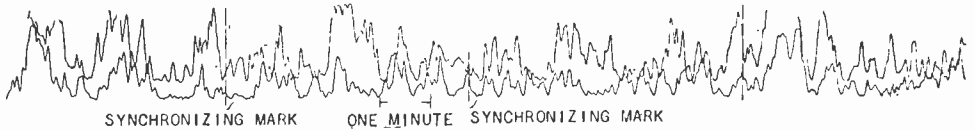

Fig. 4.—A pair of radio fading records made simultaneously on transmission from WJZ, Boundbrook, New Jersey. Record shown with solid line made at field station near Kensington, Maryland. Dotted record made in laboratory car at 0.7 km distance from field station.

Fig. 3 is a diagram of the amplifier used for driving the synchronous motor at the portable station. Best results were obtained when the condenser in the output circuit was of the size which tuned the series circuit including the condenser and motor to 60 cycles. For the motor

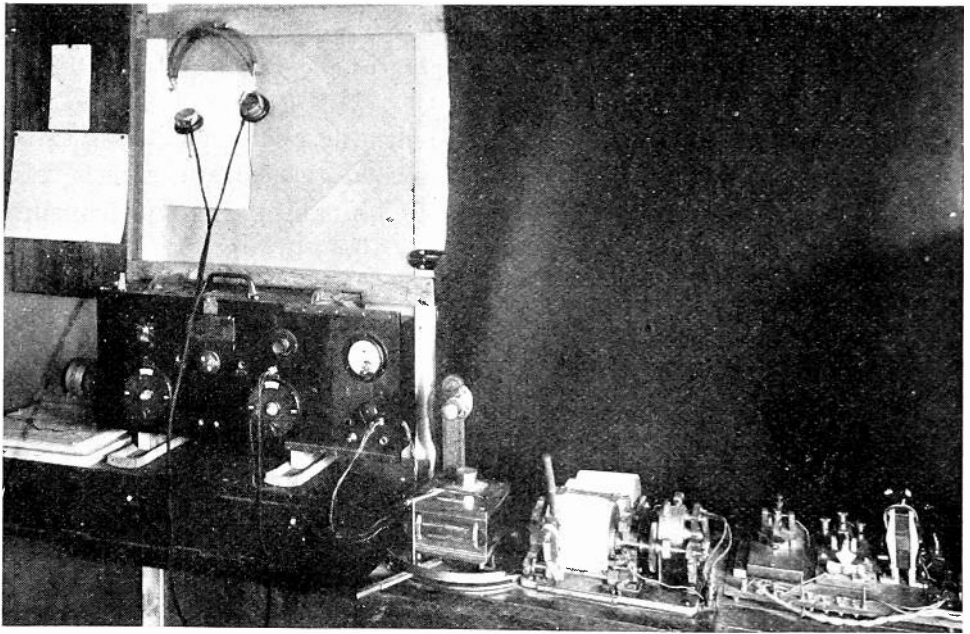

Fig. 5.—Photograph of apparatus at control station. Receiving set on the left with galvanometer and recorder in center. Control switches and keys at right. Synchronizing marker can be seen at right edge of recorder drum.

used, a 2- μ f condenser gave best results. Although it was possible to drive the motor by using only one type 250 tube in the output circuit, more stable operation resulted when two tubes were used in parallel. In testing out the amplifier it was found, by means of an oscillograph,

that the motor would operate better as the wave-shape of the current approached pure sinusoidal form. In order to eliminate higher harmonics a low-pass filter with a cut-off at 80 cycles was placed between the first and second stages.

A single 250-watt tube was used in the Hartley transmitter circuit arrangement shown in Fig. 1. The frequency used was near 1700 kc, and was adjusted so that it would not interfere with the near-by receiving measurements. No trouble was experienced in controlling the portable recorder at a distance of 16 km when the transmitter was operating with small output. If necessary, it should be possible to work at much greater distance.

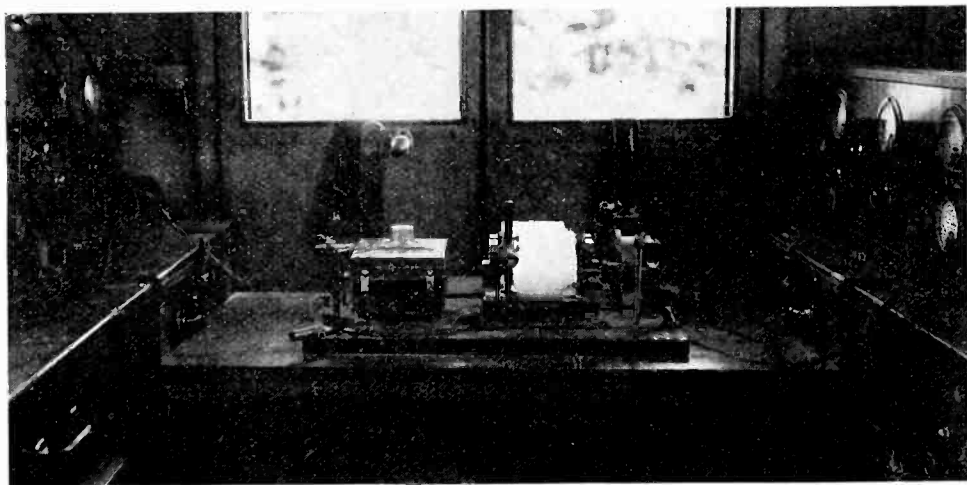

Fig. 6.—Photograph of apparatus at portable station in laboratory car. Receiving set for fading measurements at left. Galvanometer with recorder in center. Set for receiving 60-cycle transmission at right below. 60-cycle amplifier at right above.

Fig. 4 shows a pair of typical records which have been superposed. The record shown with the solid line was made at the control station, while the dotted record was made at the portable station in the laboratory car at a distance of 0.7 km. Both are records of transmission from WJZ, Boundbrook, New Jersey. (760 kc), and were made at 9:00 P.M., E. S. T., December 13, 1929, near Kensington, Maryland. The tape speed used was 4.75 cm per minute.

Although in the arrangement described one of the recording stations was placed near the transmitter and power lines, it would be possible to make it similar to the portable outfit and place it in any desired position. Any number of recorders of the type described might easily be controlled by the same transmitter.

Fig. 5 is a photograph of apparatus at the control station, while Fig. 6 shows apparatus of the portable station set up in the laboratory car.

The writers wish to acknowledge the valuable assistance given by W. H. Doherty and G. L. Davies in the design and construction of the apparatus.



EUROPEAN AVIATION RADIO*

BY

GERALD C. GROSS

(Federal Radio Commission, Washington, D. C.)

Summary—The author summarizes observations made on an inspection trip over the major European airways. Aviation radio in Europe differs from aviation radio in the United States in the prevalent use of intermediate frequencies exclusively.

European aviation radio may be divided into three major classifications as follows:

- (1) Communications from ground to plane and plane to ground.
- (2) Point-to-point communications in connection with the traffic dispatching of aircraft.
- (3) Meteorological communications relating to safe flying conditions.

The type of equipment used for receiving and transmitting on ground and on aircraft, together with the frequencies and power used, is described.

The present system of direction finding is given in detail. The use of high frequencies for aviation radio in Europe is still in a highly experimental stage.

AT THE close of the first meeting of the International Technical Consulting Committee on Radio Communications at The Hague, the author made an inspection trip of the principal airports of Europe to secure information concerning current operating practices in European aviation radio. The tour, starting at The Hague, was entirely by airplane, and included successive stops at Amsterdam, Hannover, Berlin, Cologne, Paris, and London.

Aviation radio in Europe differs from aviation radio in the United States in that the entire system of ground-to-plane and plane-to-plane communication in Europe is based on the use of intermediate frequencies in the frequency band centered around 333.3 kilocycles; in the United States, high frequencies are almost exclusively used.

Radio communications in connection with aircraft fall naturally into three major headings, as follows:

- (1) Communications from ground to plane and plane to ground.
- (2) Point-to-point communications in connection with the traffic dispatching of aircraft.
- (3) Meteorological communications relating to safe flying conditions.

Under the first heading given above, namely, communications from ground to plane and plane to ground, the two frequencies universally

* Decimal classification: R520. Original manuscript received by the Institute, January 13, 1930. Revised manuscript received by the Institute, July 16, 1930.

used for communications to and from aircraft are 322.6 kilocycles (930 meters) and 333.3 kilocycles (900 meters). In addition to these two frequencies, the frequency 344.8 kilocycles (870 meters) is also used for direction finding from the ground, in order that a plane flying over a certain sector may be given its exact position by the ground station.

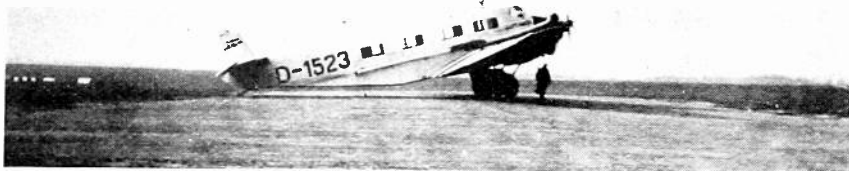

Fig. 1—Junkers all-metal monoplane.

Practically all transmissions from aircraft in flight are carried on by radiotelephony, with the exception of the German planes carrying radio operators who use radiotelegraphy.

The equipment used for transmitting on aircraft consists of an intermediate-frequency transmitter with a maximum power ranging from 50 to 120 watts, and feeding into a trailing-wire antenna.



Fig. 2—Loading baggage at Cologne Field.

For receiving, the sets used are in general of a simple type relatively low sensitivity receiver, using one or two stages of radio-frequency amplification, a detector permitting the use of regeneration, and usually one stage of audio-frequency amplification. The microphones used in the transmitting sets and the audio-frequency stages in the receiving sets are designed to cut off practically all frequencies

above 3000 cycles in order to reduce the interference from engine noises. This results in an artificial sound of the voice, but with a little practice in listening, it is not hard to secure intelligibility.

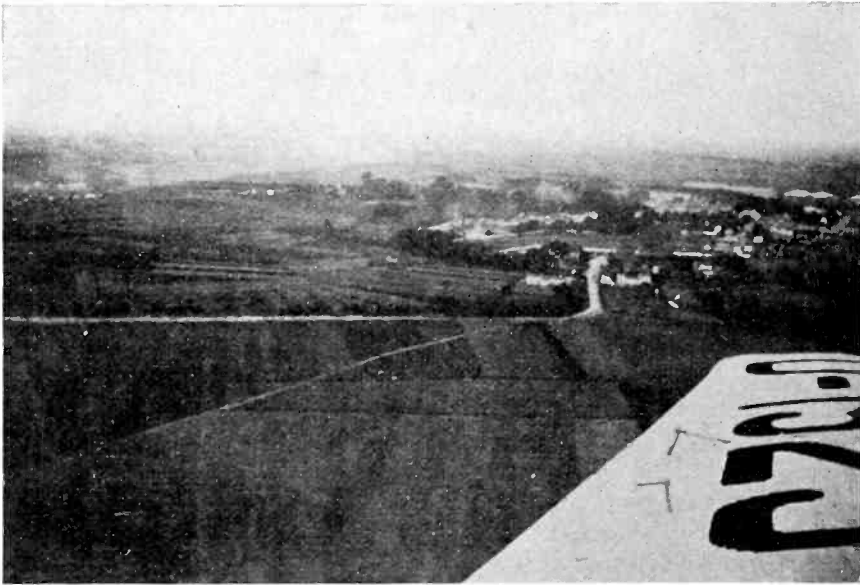

Fig. 3—Just before landing at Le Bourget.

The direct communication with aircraft has been perfected to a highly efficient degree at all the major airports of Europe, considering the scarcity of frequencies and the congestion and interference that must inevitably result when several aircraft are in the air at one time



Fig. 4—Junkers all-metal trimotored monoplane.

in the same locality. All communications from aircraft stations are rigidly limited to messages essential to the proper functioning of the plane in flight; for instance, an airplane leaving Croydon airport for a flight across the English Channel to Le Bourget field in Paris, must

send a checking-out signal to the Croydon operator as soon as the aircraft has had time to gain sufficient altitude to permit the operator to unreel his trailing-wire antenna. This message is sent in abbreviated form, by voice, somewhat as follows:

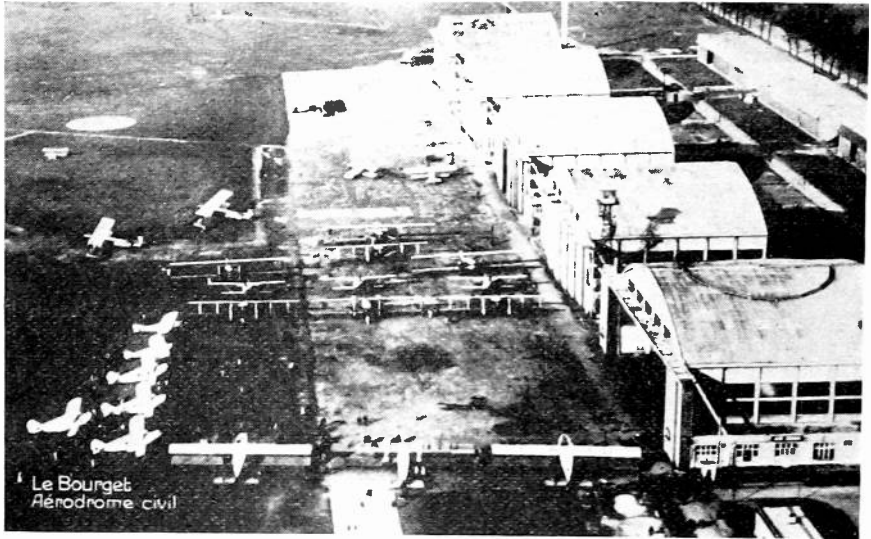

Fig. 5—Le Bourget civil aërodrôme.

“Plane XYZ leaving Croydon for Le Bourget.”

After the ground station has acknowledged this communication, the plane does not transmit again until it reaches the English Channel, when it will simply announce that it is leaving the English coast to



Fig. 6—Bleriot air union liner.

cross the channel. As soon as the channel crossing has been effected the report is once more sent, and contact is established with Le Bourget, and the final communication is the one just before the landing at the port of destination.

By thus limiting superfluous transmissions, it is possible to carry on a great many communications on a single frequency.

The direction-finding service furnished to aircraft is similar to that furnished ships along the coasts of the United States by United States



Fig. 7—Le Bourget field, Paris.

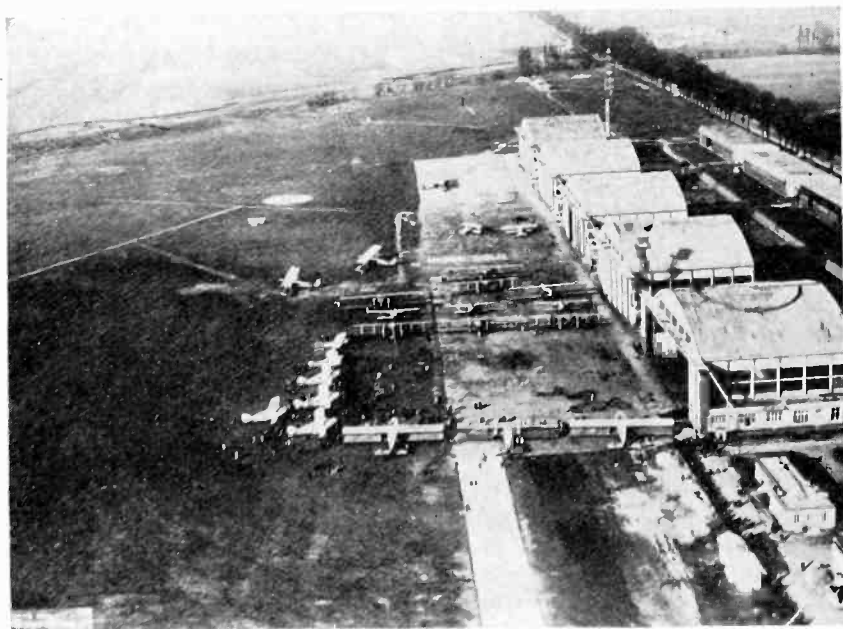

Fig. 8—Le Bourget field, Paris.

Naval stations. The aircraft desiring such report informs the ground station of this fact, either on its regular frequency or on the special

direction-finding frequency, 344.8 kilocycles (870 meters). After having established contact with the ground station, it transmits for a period of a few minutes, during which time the station called and at least two other ground stations, situated in different directions from the plane,

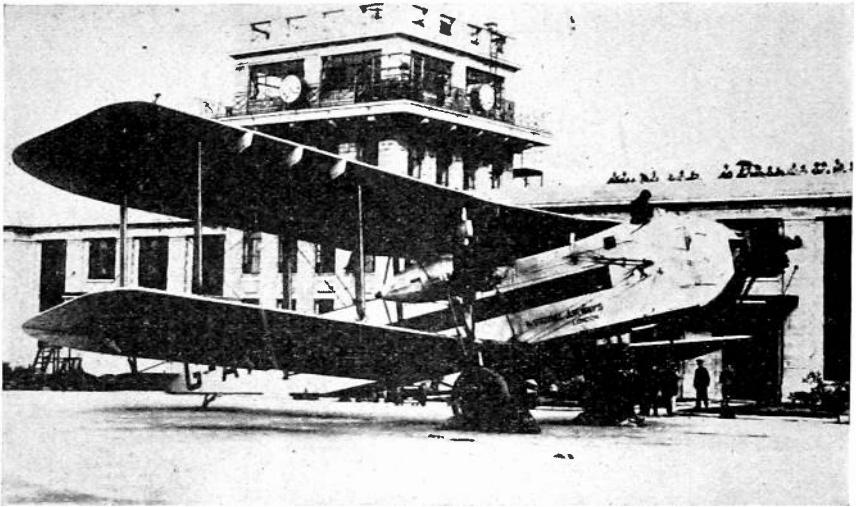

Fig. 9—Imperial airways silver wing air liner.

take bearings on the plane by means of the minimum signal method. Stations in Germany use the large directly rotating loop antennas for this purpose, while those in Holland, France, and England use the Bellini-Tosi system, consisting of two large fixed loops crossed at an angle

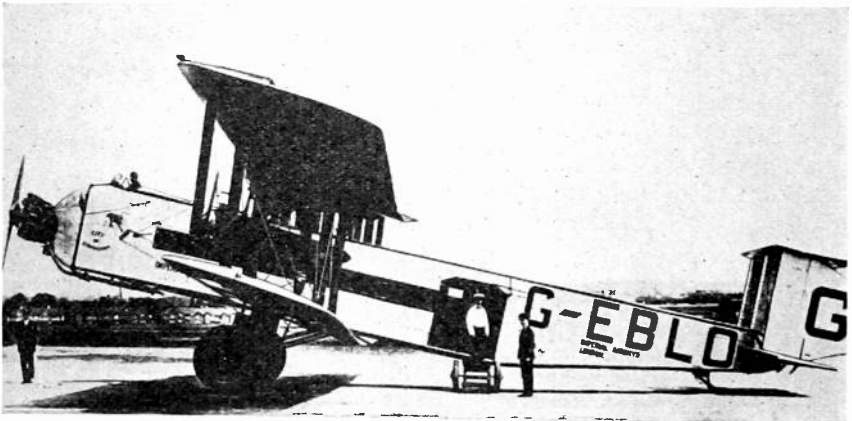

Fig. 10—Imperial airways biplane.

of 90 degrees and connected to a goniometer, which performs the same function as actually rotating the large loops themselves.

The European nations have adopted the following system of control stations in direction finding operations over various air routes:

For England: Croydon is the control station with stations at Pulham and Lympe operating for cross bearings.

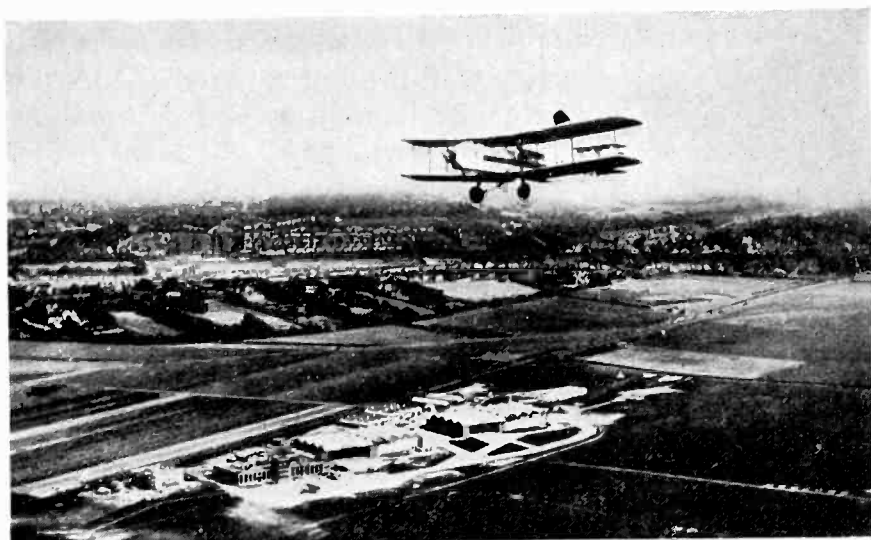

Fig. 11—"Argosy" over Croydon aërodrome.

For France: Le Bourget acts as the control station with Lympe and Valenciennes operating as cross-bearing stations.



Fig. 12—Imperial airways passenger saloon, silver wing service de luxe.

For the German-Belgian route: Brussels acts as the control station, with Valenciennes and Croydon acting as the cross-bearing stations.

For the Netherlands-German route: Rotterdam acts as the control station, with Pulham and Brussels furnishing the cross bearings.

The position given is generally accurate to within one or two kilometers and requires no more than two or three minutes to secure.

Under the second heading above, namely, point-to-point communication between airport stations, the frequencies 217.4 kilocycles (1380 meters) and 247.9 kilocycles (1210 meters) are used. Constant communication is obtainable between the various airports and messages

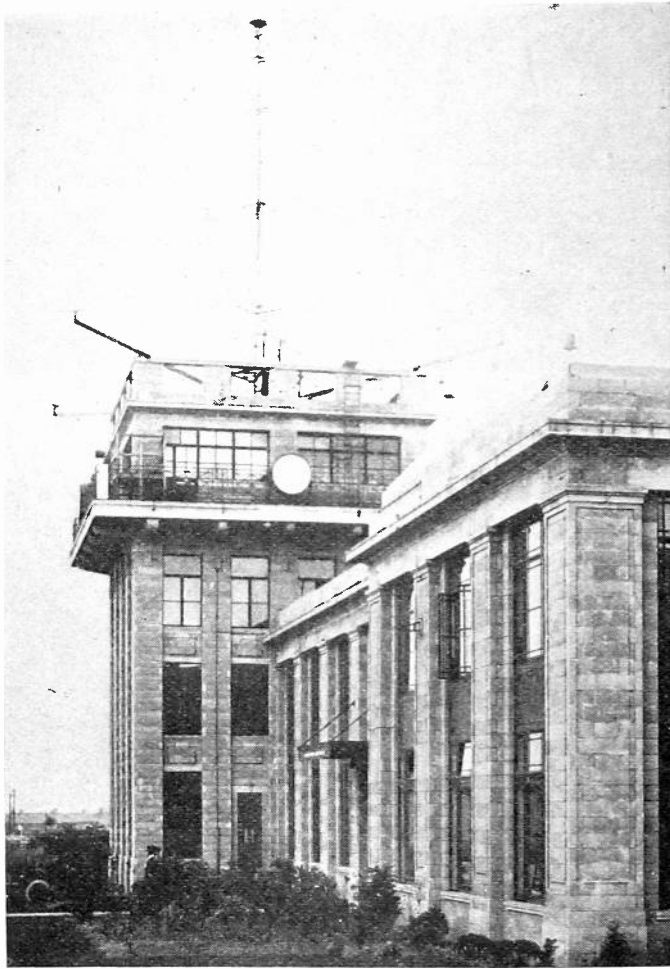

Fig. 13—Control tower, Croydon aërodrome.

relating to the arrivals and departures of aircraft are exchanged. The transmitting sets consist usually of the master-oscillator type, without crystal control, with a power ranging from 1 to 5 kilowatts; communication up to 700 miles can be effected.

Under the third classification given above, namely, meteorological communications, this service is conducted among the European stations on the frequencies 238.1 kilocycles (1260 meters), 232.9 kilo-

cycles (1288 meters), and 150 kilocycles (2000 meters). Each station in the network transmits its synoptic meteorological messages at regu-



Fig. 14—The London terminal aërodrôme.

lar intervals on the prearranged time schedule. These messages are sent broadcast and are picked up by the other stations and assembled

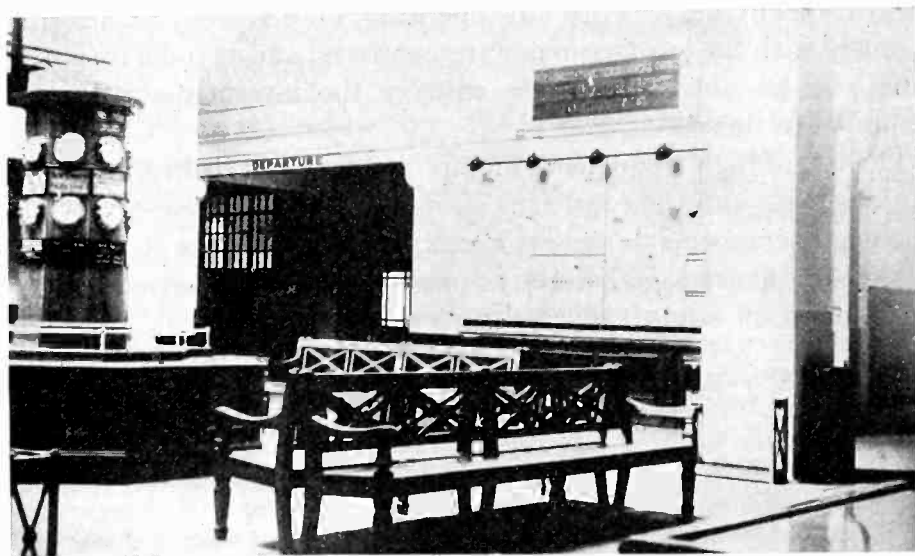

Fig. 15—Croydon waiting room.

in proper form at the various airports for the information of pilots arriving and departing. No acknowledgements are made of these receptions by the stations receiving these broadcasts, and it is therefore in-

cumbent upon each station to transmit only during the times assigned to it by schedule, in order to permit interference free reception to all the other stations.

The organization of control stations for direction finding and the arrangements for meteorological schedules bring up many problems which have to do with international relations, and for this reason unofficial aeronautical conferences are held twice each year, once in the spring before the summer passenger services begin operations, and once in the fall before the winter schedule goes into effect, in order to bring up pending questions for discussion and solution. These conferences, called "Conférence Aéronautique Internationale," are attended by unofficial government delegates, but, although no formal conventions are signed, the regulations have a moral binding force. The following nations are the principal ones forming these conferences: Great Britain, France, Belgium, Holland, Germany, Czechoslovakia, Saar Territory, and Switzerland.

Occasional informal conferences affecting the mutual interests are also held between Germany, Holland, Denmark, Norway, and Sweden.

Although the use of high frequencies has not extended to regular schedule operation on aircraft or ground stations, considerable experimental work is being done in this field, particularly in connection with the point-to-point and meteorological services. A number of meteorological transmitting sets are now operating on high frequencies simultaneously with the low-frequency transmitters, and at some future date it may be possible to displace entirely the intermediate-frequency equipment in this service.

The use of high frequencies on aircraft, however, is in a much more nebulous state and the consensus of opinion among European aviation radio engineers seems to be that much progress will have to be made in the high-frequency field before the present intermediate-frequency apparatus used on aircraft will be superseded.



DISCUSSION

L. M. Hull¹: In connection with Mr. Gross' succinct outline of the radio systems now in use on the European commercial airlines, certain comparisons from both engineering and economic angles, with current American practice, are worth mentioning. Commercial aircraft radio in Europe, under complete government control and support from the beginning, has been confined during the past ten years to progressive organization and refinement of methods fully known at the beginning of the decade, without major additions thereto. American practice in the same field, supported and sponsored by private agencies with non-regulatory participation by the government, has grown up with considerable haste during the past three years along radically different lines. The European transport companies have paid the penalty of the pioneer in that the groundwork of their safety communications systems was laid before practical operating knowledge was available on methods which are extensively used in this country. An extensive plan of coöperation between the air ministries of various countries was worked out in such detail that radical alterations in technique became a matter of international agreement, and are therefore extremely slow in practice. Only one or two continental countries maintain such an extensive system of domestic air transport that new communication methods can be tried out on a practical scale without seriously interfering with international traffic. And their work is subject to inherent limitations which are fortunately never brought to the attention of the American transport operator. For example, high-frequency radiophone service (3000 to 6000 kc) between airplane and ground, which is now a commonplace feature of American airline operation, does not fit into the European scheme of things except on an experimental basis, because 6000-kc waves are too apt to cross several international boundaries, particularly at night.

In Europe, two-way communication is an essential element, not only of the aircraft dispatch operations but also of the position finding service now in vogue. Thus the radio ground stations are all owned and operated by the same governmental departments that operate the position finding stations. Close coördination with the aircraft operating organizations results from the fact that they are, indirectly, government-owned. In this country, the government's contribution in direct radio service is confined to one-way radio broadcasting—the broadcasting of guiding signals along the airways from "radio beacons" and radiophone weather reports. The maintenance of two-way communication facilities is left to the privately owned companies who fly the airways. The desirability of general government subsidies for airlines is of course a major problem in economics. But it is believed that under existing conditions of private ownership of American air transport lines, the most rational and indeed the only practical balance between government control and private control of radio communications is now being maintained. Private operators have full liberty, under reasonable restrictions as to frequency allocations, to try any innovations which they deem proper in the interests of safety, while the government "radio lighthouse" service is always available for general public use. Rapid and efficient extension of this service to all the principal airways of the country is the most effective means of encouraging the use of radio by all who fly, without resorting to compulsory measures which in the very nature of things must define limits and thus by implication hamper inventive development. Such an extension will

¹ Radio Frequency Laboratories, Boonton, N. J.

also go far toward removing the outstanding disadvantage accompanying the separation of navigational radio from privately-owned two-way radio that now characterizes American practice. This disadvantage is the comparative scarcity of radio facilities for the private flier who does not follow established airways. In England the private flier who is sufficiently progressive and affluent to equip his plane with a two-way radio outfit is assured of an assumption of responsibility for his safety by any government station within range. In this country such an individual has no public ground stations to which he can appeal for help, and under existing conditions can obtain guidance over only a few sections of the country. Thus it is probably true that the American system of aviation radio, under existing conditions, is less useful to the individual flying his own airplane than the European system under complete government ownership.



NOTE ON THE FIFTEEN-MONTH PERIOD IN SOLAR ACTIVITY, TERRESTRIAL MAGNETISM, AND RADIO RECEPTION*

BY

GREENLEAF W. PICKARD

(R.C.A. Victor Co. of Massachusetts, Boston, Mass.)

Summary—A marked 15-month period has been found in sun spots, terrestrial magnetism, and radio reception. Early in 1929 this cycle abruptly changed phase by about 60 deg., 210 deg., and 160 deg., respectively, for these elements, resulting in changed relations between solar activity and the two geophysical measures.

IT HAS long been known that solar activity shows a number of well marked cycles, with periods ranging from the major one of 11 years down to even such short intervals as days, which are reflected to a greater or less extent in disturbances of terrestrial magnetism.

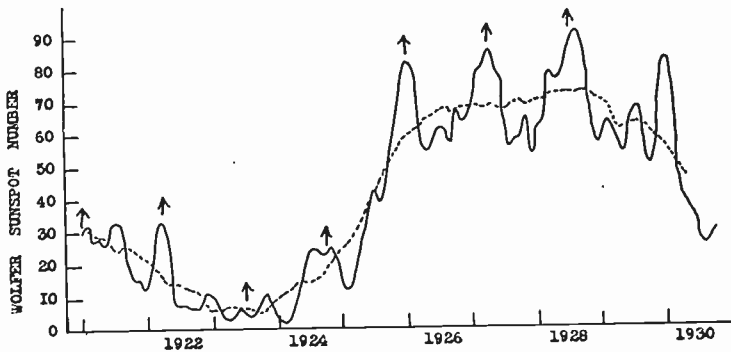

Fig. 1.

More recently I have shown that certain of these solar periods are also found in radio reception¹. Abbot, in an analysis of the Smithsonian measures of solar constant, which then included 6 1/2 years of data, found several short periods, including one of 15 2/3 months.² Alter and other meteorologists have also called attention to a 15-month period as a ninth harmonic of the 11-year cycle, and of significance in world precipitation.

Fig. 1 is a graph of sun spot numbers for the period 1921–1930, which includes the last maximum and minimum of this solar index. The full line curve is made from monthly averages of sun spot numbers, smoothed by a 3-month mean, while the dotted curve is a moving 15-

* Decimal classification: R113.2. Original manuscript received by the Institute, November 22, 1930.

¹ Proc. I. R. E., 15, No's. 2, 9, and 12, 1927.

² C. G. Abbot, "A Group of Solar Changes," *Smithsonian Miscellaneous Collections*, 50, No. 2; April, 1927.

month average which serves as a base line. Aided by the seven arrows placed at exact 15-month intervals, the cycle can be seen at a glance.

Nor is this cycle peculiar to the last sun spot period. In Fig. 2 is shown a mean of the sun spot maxima of 1860, 1870, 1884, 1894, 1907, 1917, and 1928 aligned with respect to the month of highest spot number, which falls on "0" of the figure. As before, the full line curve is a moving 3-month mean of sun spot numbers, while the dotted line represents a further smoothing by a 15-month average. Again, the 15-month cycle shows clearly, as does also a double-frequency component of $7\frac{1}{2}$ month period.

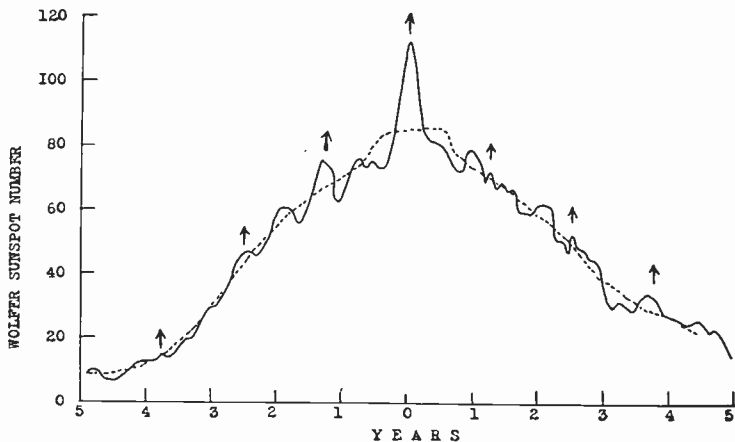

Fig. 2.

For the first three years' recording of night field from WBBM, the monthly values swung rather closely inversely to sun spot numbers, but early in 1929 they parted company, and for the past eighteen months have shown a direct, rather than the former inverse, correlation, with respect to the 15-month cycle. A similar change has taken place in the relation between sun spots and terrestrial magnetism, and also, I think, with Mr. Brown's Pasadena measurements of night field from KPO of San Francisco. In Fig. 3 there is plotted in full line smoothed monthly means of sun spots, WBBM, Pasadena reception and magnetic character of day as given by Cheltenham Observatory. To these curves I have fitted in dotted line sine curves of an exact 15-month period, but with amplitudes proportional to the values in full line. Early in 1929 the dotted and full line curves part company, and can only be made to fit thereafter by a considerable phase shift, amounting to about 60 deg. for sun spots, 160 deg. for WBBM, 80 deg. for Pasadena reception, and 210 deg. for magnetism. As a result of this phase change, WBBM, Pasadena, and sun spots are now, with re-

spect to the 15-month cycle, nearly in phase, with magnetism nearly 180 deg. out of phase.

It must be clearly understood that this phase shift with its resulting changed relation between sun spots, magnetism, and reception applies only to the 15-month period. There is no reason to believe that any change has taken place in the relation of sun spots and magnetism over

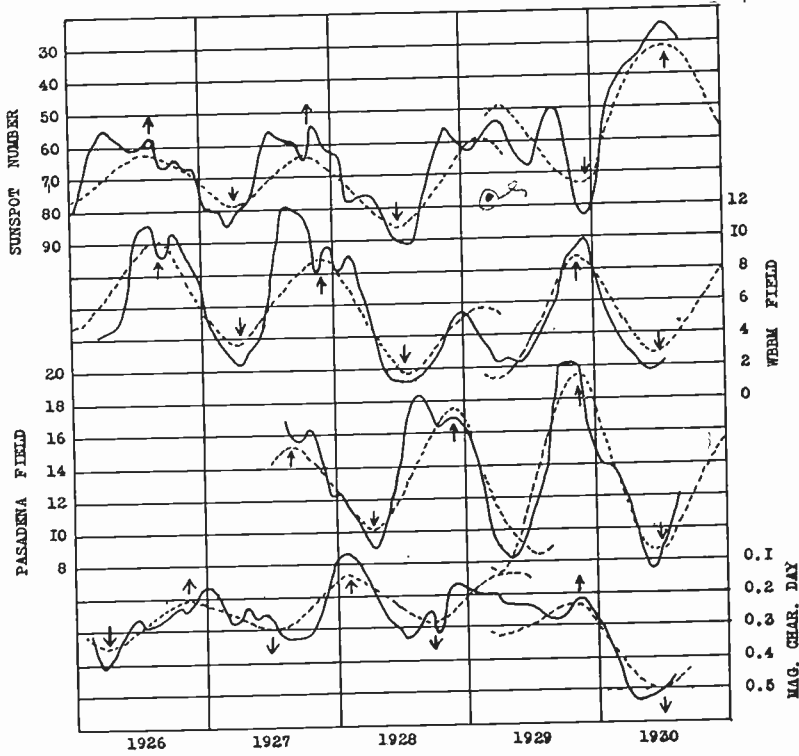

Fig. 3.

the 11-year period, and I know that no change has occurred in the direct day-to-day relation of magnetic storms and depressions in night radio reception. Although it would be difficult to summarize briefly the reasons for this belief, I feel that the present 1929-1930 15-month period in radio reception will continue without phase change for several years to come, and will therefore be useful in the prediction of reception levels.



TEN YEARS OF BROADCASTING*

By

C. W. HORN

(General Engineer, National Broadcasting Co., New York City)

Summary—The salient points in the development of broadcasting during the last decade are reviewed. It is shown that further improvement may be expected with the more extensive introduction of higher powered transmitters.

A DECADE of broadcast development has passed filled with pell mell endeavor and high achievement, but yet we find that nothing is so permanent as change. Aviation has changed ideas of transportation, mechanization of industry is lifting from man the burden of labor, nations have met to limit their ability to make war, and communication spans the world with the speed of light.

In all history there has been no period of engineering progress to compare with the past ten years, and in that decade, I believe, there has been no achievement to rank with the birth and development of that tremendous public service of radiotelephony which we term broadcasting.

Consider the fact that today we may converse with almost every country on the globe; that in a moment's time the human voice may carry its message to every portion of the world; that the same voice that is heard in New York is also heard in Australia, though seasons of the year may be reversed and 10,000 miles separate transmitter and receiver. This is true progress and achievement.

It is unlikely that the pioneers of electrical engineering had any thought as to the possibilities contained in radio during their early experiments. Some visions might have been theirs but I venture the belief that their imaginations were restricted by the immediate problems confronting them. In the early days of radio only a Jules Verne could have foreseen national and international broadcasting with its vast ramifications.

Broadcasting is an outgrowth of radiotelephony. We all know of the men who pioneered in radiotelephony. We are fortunate in having as the President of the Institute of Radio Engineers at this time, a man who did a great deal of valuable work in this field—I refer to Dr. Lee de Forest.

We may consider that broadcasting is radiotelephony applied to serve the public. To define broadcasting is difficult. Yet if we assume

* Decimal classification: R550xR090. Original manuscript received by the Institute, October 1, 1930. Presented before October 1, 1930, New York Meeting. of The Institute of Radio Engineers.

that broadcasting must be a prearranged, scheduled service on a daily basis (as we know it to be today) then it is clear how it differs from experimental radiotelephone work and transmissions of a desultory nature.

All honor is due to those men and their organizations who played their parts in the start of this service, but if we consider broadcasting as defined above, then it began in 1920, when the Westinghouse Electric and Manufacturing Company placed in operation KDKA. As is well known the first program transmitted from this pioneer Pittsburgh station was a news event, the Harding-Cox election returns of Novem-

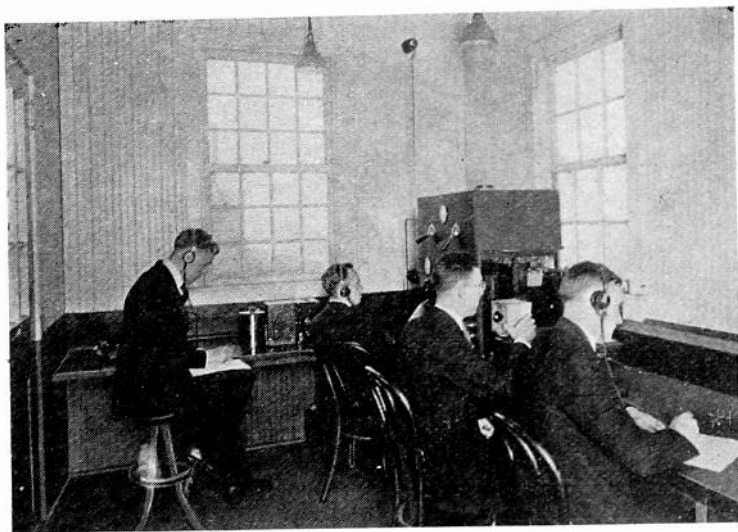

Fig. 1—Original KDKA transmitter, East Pittsburgh, Pennsylvania.

ber 2, 1920. That station was organized on a permanent basis, and has not missed a day's broadcast in ten years. We therefore, may consider 1920 as the birth date of broadcasting.

The World War, which brought with it a demand upon the part of the combatant governments for improved radio apparatus, made it possible for the electrical industry to offer broadcasting to the public in 1920. Previously much of the manufacturing had been in the hands of small companies, handicapped by lack of public support. With government commissions placed in the hands of the large electrical manufacturers, the art immediately had the benefit of their vast capital research facilities and capable engineering staffs. The result was that improvements and developments were made that placed some of the equipment on an efficient plane. Particularly is this true of developments made in the vacuum tube. During that time the research staffs of several large companies were hard at work perfecting various forms

of tubes, with the result that in 1920, that great achievement was applicable to broadcasting. Improvements and developments prior to 1920 had also been made in transmitters and even in receiving circuits, although these were primarily adapted to radiotelegraphic work.

Patent conditions were, however, difficult. These were variously held and again it required the War period to make clear to all interested parties that they must join in order to keep the situation from reaching an impasse. It was due to the ability of the manufacturers to agree on a patent policy that made it possible for this new industry to develop as rapidly as it has.

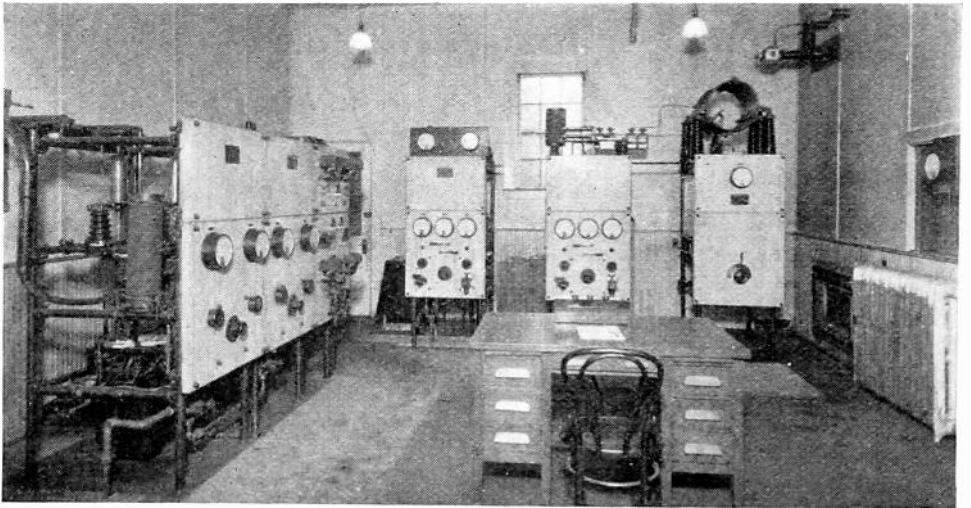

Fig. 2—Early 10-kw transmitter at KDKA.

Previous to the start of KDKA it had been the belief that the greatest field of radiotelephony lay in private communication. It was a newspaper advertisement which changed the course of thought. Westinghouse experimenting had led to the establishment of a station at the home of one of its engineers. There radiotelephone experimenting was carried on, in a cursory manner, between various contacts established throughout the Eastern section of the country.

One of the Pittsburgh department stores installed a radio department, which was stocked with equipment commonly used by amateurs. Finding a market for its wares and knowing of the Westinghouse transmissions, the store advertised the fact that these parts were for sale and that by their use, Pittsburgh radio programs could be heard. H. P. Davis, a vice president of the Westinghouse Company, read this advertisement and it may be said that then and there the vision of broadcasting was conceived.

His thought was that the then existing ideas concerning the private communication field were wrong and that the real field of endeavor lay in widespread communication, so that all who desired to do so might hear. The next step was KDKA.

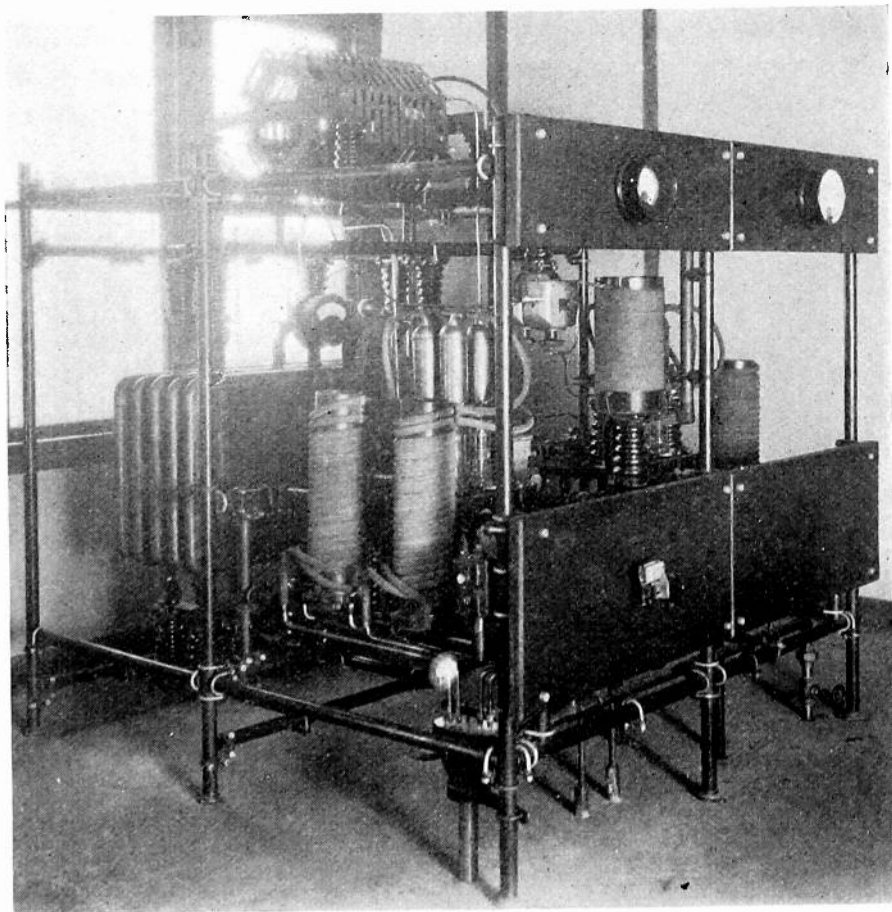

Fig. 3—Early high power (50-kw) transmitter at KDKA.

The pioneer station's first transmitter was rated at 500 watts. Therefore, it is apparent that here was no haphazard beginning but a major development as a half-kilowatt station in 1920 was a solid foundation. Today 200-kilowatt stations have been erected and there is no doubt that the future will see transmitters of even greater power.

Other stations were started soon after the fact was made apparent by public acceptance of the idea that broadcasting was a new factor in civilization. The General Electric Company, which has made many major contributions to radio engineering placed WGY in operation at Schenectady. Stations WBZ in Boston, WJZ in New York, KYW

in Chicago, and others went on the air until at the close of 1922, there might have been a dozen or even more stations operating regularly. Then the deluge.

Having started broadcasting, the first stations found themselves much in the position of the actor without an audience. Rather, the

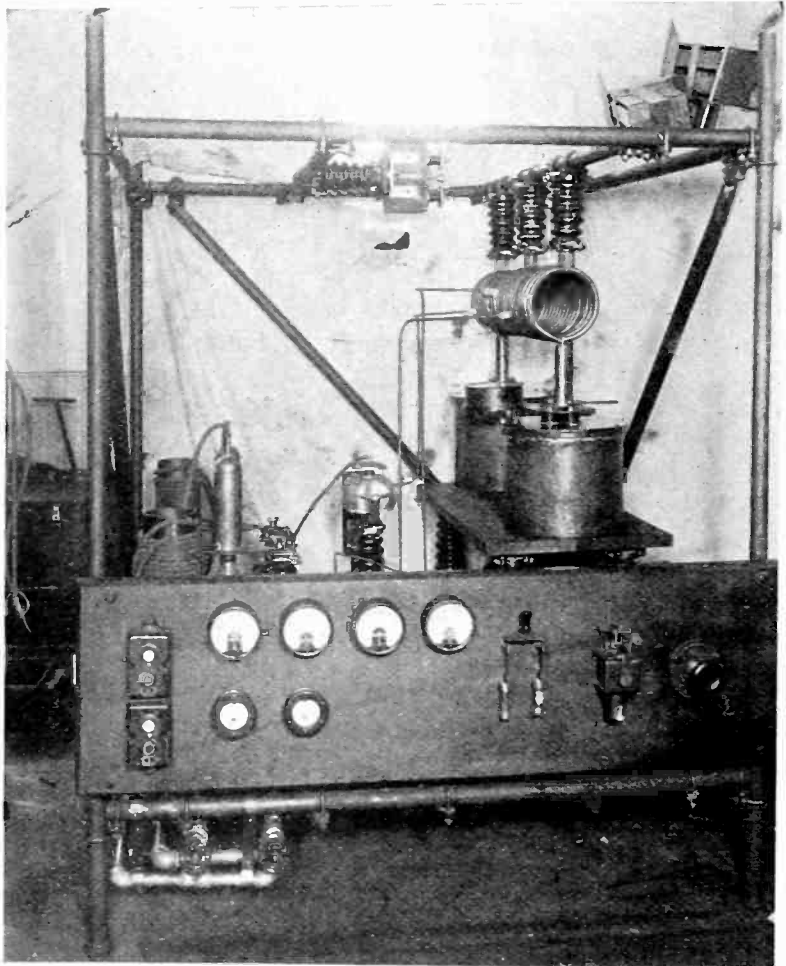

Fig. 4—A pioneer high power short-wave transmitter. Westinghouse Electric and Manufacturing Company, East Pittsburgh.

audience was theoretically available, but could not enter the theater. A commercial receiver was the necessity of the hour.

The Westinghouse Company, therefore, offered the world the first commercial broadcast receivers, these being the Aeriola, Jr., and Aeriola, Sr. The first was a crystal detector set of usual design, while the second was a single circuit, regenerative receiver using the WD-11 tube, a 1.1-volt quarter-ampere tube, with an oxide-coated filament,

utilizing dry cells for its filament supply. B batteries, of course, supplied the plate current. The mutual conductance of the WD-11 was 350 to 400.

The first receivers and tubes on the market filled existing requirements. Selectivity was not required because there were few stations on the air and sensitivity was therefore the prime factor. The tubes were of necessity of high economy in current supply, since dry cells were the accepted source of power.

As broadcast conditions changed, receiving equipment and tubes were developed to meet the requirements of the public. We remember the UV-199, a General Electric contribution to the art, a thoriated-tungsten-filament tube operating on three volts at 65 milliamperes, which was admirably adapted to conditions that presented themselves at the time it was offered to the public.

The next major step in vacuum tube development was due to the demand for greater amplification and loud-speaker application. This was in 1924. A tube in the 5-volt class with rectangular plate and grid structure and an oxide-coated filament was developed and became the forerunner of the low internal impedance type. The filament required one-half ampere and the mutual conductance was approximately 1700; four times that of the WD-11. Later the filament was reduced to one-fourth ampere without lowering the quality of the tube.

The major steps of tube development after 1924 were mostly all toward a-c operation. As early as 1921 considerable work was being done on a-c tubes of the indirect heated type and practical tubes were used in experimental sets in 1922 with good results, very little hum being noticed. Many designs were tried, such as different types of cathodes, insulators, and heaters.

In 1926 the demand for a-c tubes became very urgent, resulting in the development of the UX-226 tube. The UY-227, an outgrowth of previous indirect heated tube developments, was used as a detector.

For an all-electric a-c receiver the B and C supply must be provided for. Therefore, in the course of time came the UX-280 and UX-281 rectifier tubes. The first was a double wave rectifier for low voltage supply, while the second was a single wave rectifier for higher voltage requirements. These tubes were the first successful oxide-coated-filament rectifiers for heavy current demands placed on the market. Emission from the plates on the reverse half cycle had been practically eliminated by the use of the carbonized plate resulting in a long life tube.

Concurrently output tubes were developed. Tube development of today has reached a high state of efficiency.

From the original single circuit regenerative receivers of the 1921 period up to today's radio superheterodyne receiver, the screen-grid tubes, power control, extreme sensitivity and selectivity, is a long step.

The early single circuit regenerative receivers were not on the market long before the public demanded something better. As the number of transmitting stations increased, and interference began to make itself

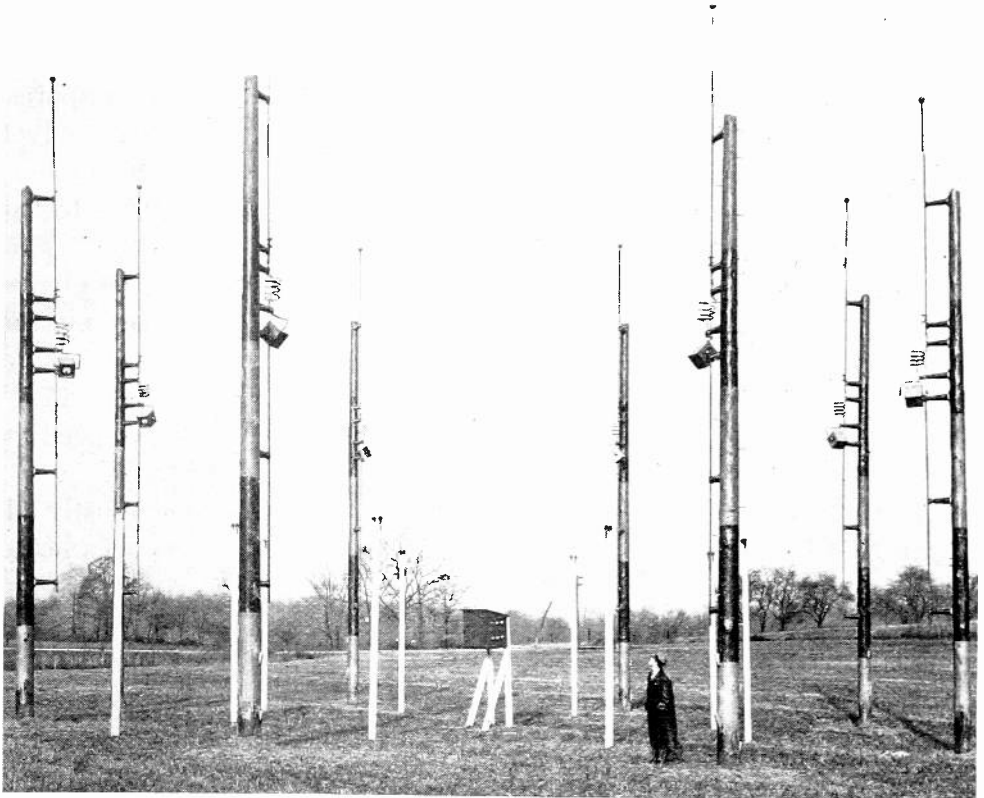

Fig. 5—Experimental short-wave transmitting antenna. Westinghouse Electric and Manufacturing Company, Saxonburg, Pennsylvania.

felt, it was necessary that greater selectivity be provided, and at the same time the sensitivity of receivers either be maintained or, if possible, increased. This brought about the multistage type of receiving set, which is so very common today. Right here I want to point out and emphasize the trend in development which made itself manifest due to the peculiar conditions under which broadcasting has developed itself. The transmitting stations began as comparatively low powered affairs. During the early period the art was far enough advanced to permit the manufacture and sale of rather small tubes, such as receiving

tubes, but no really high power transmitting tubes had as yet been developed. The situation was as follows:

On the one hand we had low powered transmitters. If a listener desired to hear signals from such a station, it was necessary for him to have a comparatively sensitive receiving set, especially if he lived at any distance. As the transmitters could furnish but a feeble wave it was natural that the receiving set manufacturers should find themselves compelled constantly to increase the sensitivity of their receiving equipment. The result of such a situation was that the listener had to use tremendous amplification in order to be able to hear even a fair quality signal, with the result that he amplified static, both natural and man-made, and also greatly increased distortion. In my opinion, broadcasting started off on the wrong foot, if I may use that expression. Because stations of such low power as 500 watts were heard on occasion at distances of hundreds and even thousands of miles, the general belief was that higher powers were not necessary. A decided movement against higher powers on the part of transmitters made itself felt, so that the governing bodies in Washington hesitated in granting licenses for the use of greater power. This retarded the general development to some extent.

What actually should have taken place, and would have been the most natural line of development had circumstances been otherwise, was to begin with low sensitivity on the part of receivers. This would have stimulated intense development work on the part of transmitter engineers in order to provide higher power. Then with later improvements in receiving sets more attention could have been paid to selectivity and quality, rather than sensitivity, which would have resulted in the general acceptance of higher field strength for suitable reproduction. During this period of development, receivers had to be operated on signals of low intensity and rated in microvolts per meter instead of millivolts per meter as we know now is necessary for reliable high quality reception.

Nature being generous with its supply of static, and the human being insisting on the use of electrical devices to increase his comforts, there exists a high noise level which, at the present state of the art, can only be overcome by using higher field strengths. In some localities, such as the metropolitan sections of the country, signals of ten millivolts per meter are required to bring in a program that is only fairly free from interference. Twenty millivolts per meter would be better in some sections.

Now let us turn to transmitter and transmitting station developments. As stated before, the first few stations began with compara-

tively low power. A 250-watt tube was considered quite a development in 1920. A great deal of information on the behavior of tubes was obtained from the 250-watt type. This in fact, gave us a great deal of experience on which further developments were made. It was demonstrated very early in the game that higher power tubes would be required. One of the difficulties experienced was the dissipation of the heat which was generated in the tube. This led to the metal-jacketed water-cooled tube. The first water-cooled tube was rather crude, and had a glass water jacket. Obviously this tube could only be operated

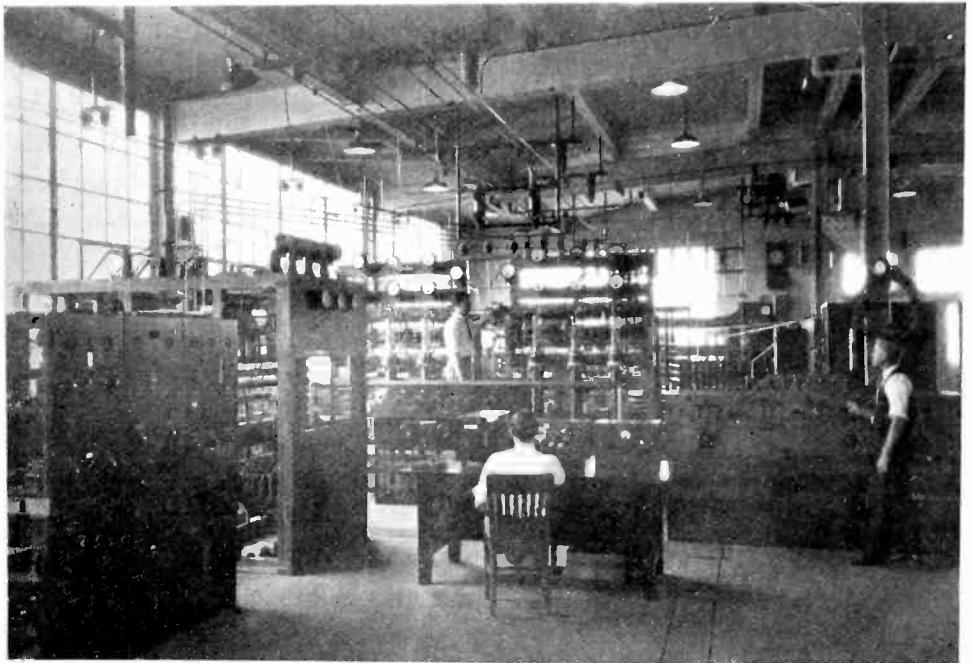

Fig. 6—General Electric Company 100-kw development transmitter, Schenectady, N.Y.

with comparatively low voltages. The discovery was then made that copper could be sealed to glass, and we then entered into the period when copper-jacketed water-cooled tubes grew to practical use. It was not very long before powers in the order of 10 kw and more were being handled by a single tube, so that in the Spring of 1924, there were several experimental stations which were capable of handling powers above 25 kilowatts.

Practically all of the credit for transmitter tube development in this country must be given to the great laboratories such as the General Electric Company, Westinghouse Electric and Manufacturing Company, and the Bell Telephone Laboratories. Research and advance development work on this type of material is inherently a laboratory

proposition. Only with the tremendous resources of these great laboratories was it possible to improve and develop these devices. Great credit must be given to Dr. Langmuir of the General Electric Company's Research Department for his fine research work with filaments and other tube structures.

If I were to begin to give credit to the many men who made possible the devices we use today in this activity, this paper would take several days to read. I, therefore, find it necessary to refrain from giving too much space for this purpose. I wish, however, to state that

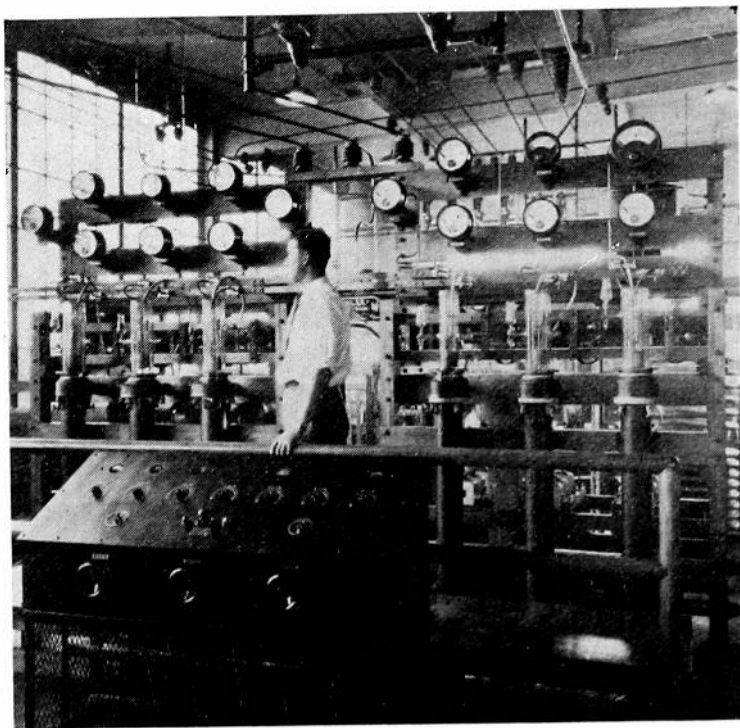

Fig. 7—General Electric Company 100-kw development transmitter, Schenectady, N.Y. Close-up view of power amplifier.

most of these men are Fellows of our Institute, and have presented many papers giving the results of some of their work in detail.

After it was found possible to operate tubes at 10- and 20-kw capacity, very active work was begun to develop still higher powers. We all know that today there are tubes which can handle in excess of 100-kw output, and experiments have been made with transmitting stations operating with 200 kw and more in the antenna. This work will constantly go on so that in the very near future we shall come to recognize the 500-kw transmitting station as being a normal proposition.

The development of transmitters did not depend upon tubes alone. It was necessary to create improved designs in circuits, capacitors, and materials in the construction of the various parts. Also with the advent of a great many broadcast stations, with consequent crowding, it became imperative that some attention be paid to the stabilization of frequencies. This led to a great deal of research work in connection with quartz crystals, sometimes called piezo crystals.

With the use of increased power, it was found that certain materials which formerly had been thought as excellent insulation were not

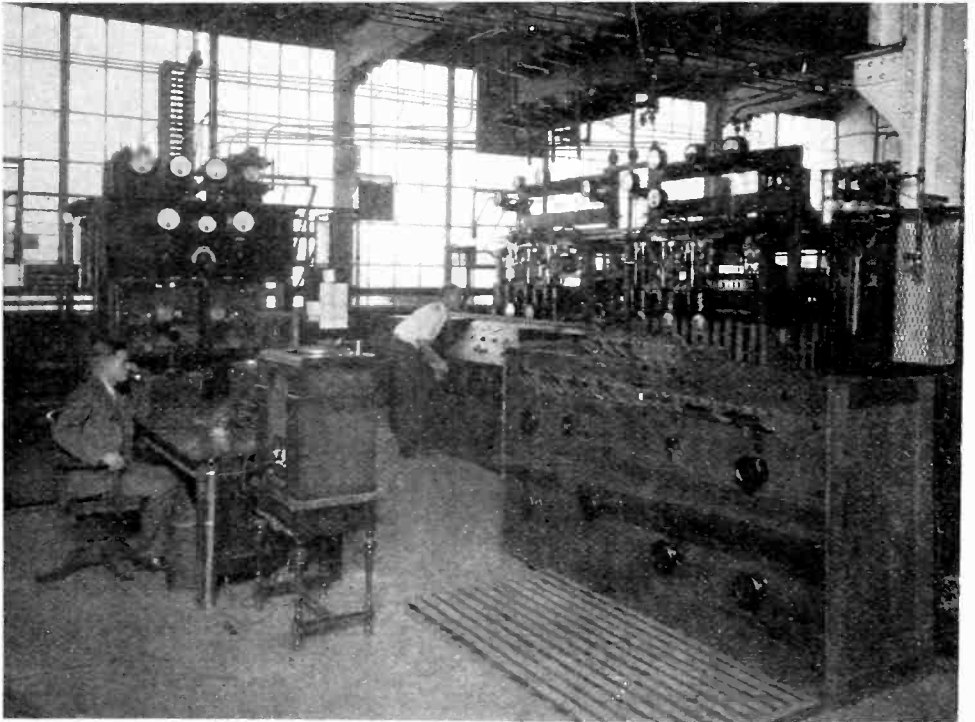

Fig. 8—General Electric Company 200-kw experimental transmitter.

exactly suitable. Ordinary glass at one time was thought quite sufficient but because of high losses and resultant heating, special materials had to be developed.

This is an illustration that whenever one radical change is made, there is a great deal of associated apparatus which must be taken care of and also improved to meet the new conditions.

The first transmitters were what were known as self-excited oscillators. In other words, the frequency on which they operated was determined by the capacity and inductance of the circuit to which the tube was directly connected. Any changes in constants was accompanied by a change in frequency. During the past few years practically all

the transmitters constructed made use of what is known as master oscillator circuits. This means that the frequency was generated on rather low power, and with more or less precision equipment, and then this power was amplified by successive stages to the quantity required. Since we have been able to operate piezo crystals on radio frequencies, this form of frequency control has become popular and rather general. It was found that temperature changes had quite an influence upon the operating characteristics of the crystals, so that now all modern sets are equipped with crystal-control devices operated in heaters or thermostatic chambers maintained at a constant temperature. This permits an accuracy to within a few cycles of the assigned frequency in the broadcast band. The development of accurate frequency control also stimulated work in connection with frequency standards and the devices for the measurement, within very close limits, of radio frequencies. We are reaching a point in accuracies that will require more precise methods in reading star time than exist at present. This is another illustration of how one branch of science aids and stimulates the development work along other lines.

The various pictures illustrate different degrees of improvement in transmitter design, beginning with the first KDKA transmitter at East Pittsburgh, Pa. The last picture is the latest type of 50-kw high quality broadcast transmitter as furnished by the RCA.

NETWORK BROADCASTING

Let us briefly review the history of the service that broadcast stations rendered during the past decade. In the very early days, a great deal of mechanical reproduction supplied the programs for the stations. The public was quite satisfied to be able to hear something at a distance, and even though they could hear the same record on their own phonograph, it gave them a thrill when received over the radio. In addition to this some talent appeared, in most cases at no cost to the station. In fact it became the vogue to offer a certain amount of publicity in return for appearances of artists. Obviously his type of program would become monotonous in time, and broadcast popularity would suffer. It became necessary to engage musicians and vocal talent of a high grade which of course greatly increased the cost of operating the stations, which in those days had no income or revenue. They were operated merely for the purpose of obtaining prestige and for whatever advertising value the owner of a station could get out of it. There was quite a little discussion in the years 1922, 1923, and 1924 as to who paid for broadcasting. The owners of stations literally "had a bear by the tail" and could not very well let go. They appre-

ciated they had a wonderful medium, and that some way must be found to make it possible to continue and to improve the service. At about this time, or early in 1923, the American Telephone and Telegraph Company experimentally connected several stations together by telephone lines and supplied a program. By October, 1923, football broadcasts were being transmitted through their main station WEAJ, and also furnished to Schenectady, Providence, and Washington. Other stations were added from time to time. The Telephone Company inaugurated what we now call commercial or sponsored programs. In doing this they thus secured financial assistance from large business

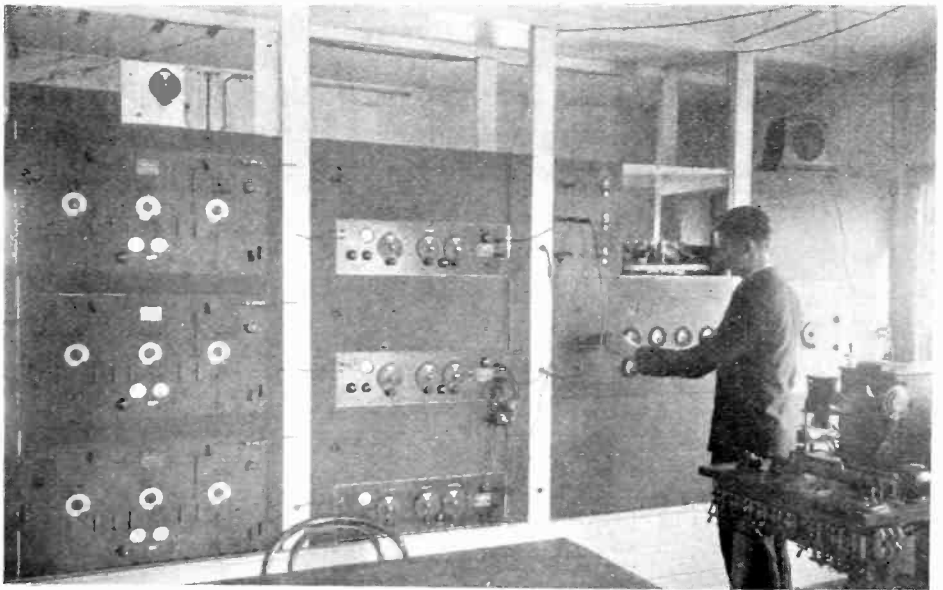

Fig. 9—General Electric Company short-wave receivers, Sacandaga, N.Y.

concerns who found it profitable to utilize this new advertising medium for creating good will. A spirit of competition developed between these various commercial companies which has resulted in a very great improvement in the standard of broadcasting making use of the very finest talent available. By means of telephone line connections to many different cities and parts of the country, the best talent is presented to people who would not have had the opportunity of enjoying these high grade performances otherwise. In fact, the networks which started with but a few stations have increased in size until today almost every owner of a receiving set can hear not only excellent programs but also participate in all great events of national interest. They hear the greatest speakers and authorities on different subjects discuss problems of vital interest to the public. They hear the Presi-

dent of the United States report to the people, and they even determine their attitude on political matters by listening to the political leaders prior to election. When such national heroes as Colonel Lindbergh, and Admiral Richard E. Byrd return from a conquest, the public participates in the reception to these great men by being in "attendance" through this medium of radio. Everybody in the United States knows and recognizes the voice of President Hoover, whereas formerly, the President was simply known as the man who presided at the White House.

The network systems have grown and it is gratifying to note that the broadcast companies are motivated by the highest impulses to

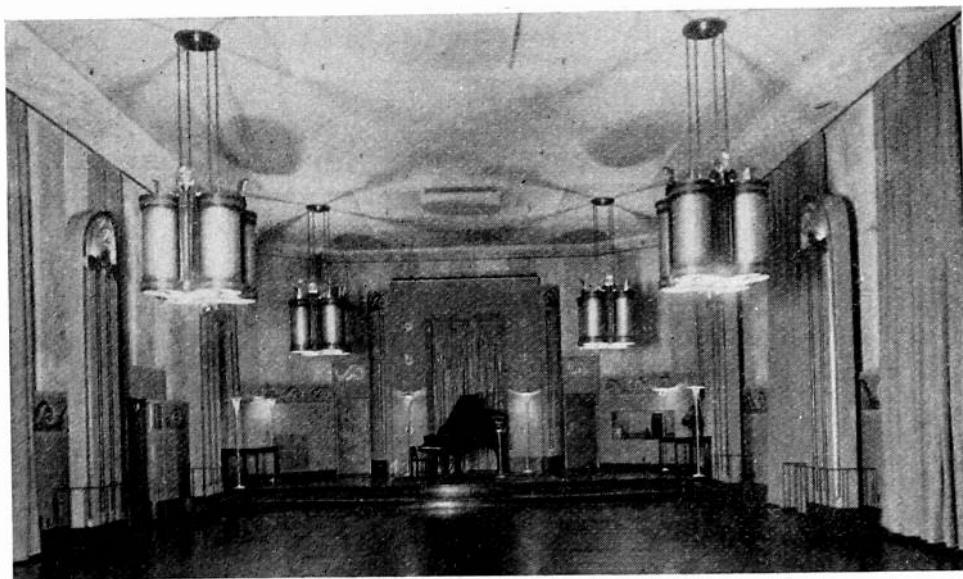

Fig. 10—View of studio "H" National Broadcasting Company, 711 Fifth Ave., New York City.

increase and better the service to the listener. They do this by extending their networks, increasing the value and interest of their programs, and by being constantly on the lookout for material and talent. The broadcast companies are organized on a truly fundamental and correct principle. Their existence and success depends entirely upon good will, and that good will can only be obtained by pleasing the listener. Therefore, the final judge is the listener himself, and his reaction to the programs that are furnished determines the verdict.

Furthermore, because of competition, the listener is in a position to tune his receiver to the program and station that he finds gives him the best service. It therefore, brings home to the broadcast management the basic fact that only by rendering efficient and excellent service can he hope to maintain his position.

Let us discuss briefly the growth of the networks. This growth is based entirely upon the fact that the public demands this service. By service, I mean the transmission of all important events and sports news, as well as entertainment, farm and market reports, etc. This is made possible of course, through the sponsorship of commercial programs by companies desiring to advertise. The commercial portion of broadcasting supports the sustaining and noncommercial features, much in the same manner that advertising in magazines makes it possible to provide the reader with articles and stories of interest to him. Without such financial support there could be no networks, and there would be no structure and organization in existence that could be utilized on a moment's notice in the event of national emergencies or for the purpose of transmitting to listeners the high spots in national events. The public is, therefore, assured of a radio feature service which, in my opinion, is responsible for the great growth of radio in this country.

The first network consisted of but a few stations. Today the circuits of the broadcast companies extend to all the principal cities in the country. Extension of these high quality telephone lines is a brilliant achievement on the part of telephone engineering. To pick up a program at some point, and to transmit it several thousand miles without any appreciable loss in quality is truly remarkable, and is the result of fine engineering work. I am glad to know that many of the men responsible for this development are members of our Institute.

Perhaps I can best describe the scope of network broadcasting by giving some facts and figures which I have available, and which concern the National Broadcasting Company. This company maintains elaborate studios in New York, Chicago, Washington, and San Francisco. In New York alone there are eleven studios. The National Broadcasting Company furnishes broadcast service from 6:45 A.M. until 1 A.M. This is done practically every day in the year, and over two networks. In addition to these programs, there are others that originate in other studios and which serve certain portions of the country. It requires a staff of almost 1100 people, exclusive of talent or musicians, to perform this work. Hour after hour, day after day, and month after month, throughout the entire year, programs must be originated, rehearsed, produced, and transmitted over the lines, and with what success, the reader may decide. Duplications must be avoided in order to keep the programs from becoming monotonous.

The radio industry today, as far as the broadcast stations are concerned, is still in a partially disorganized state. There are many stations on the air, the existence of some of which is not really justi-

fied. Congress endeavored to create some sort of standard of service to the public by requiring that stations must prove that they are operating in "public interest, convenience, and necessity." The public having become accustomed to listening to some excellent programs and high grade service has set a rather high standard as to what it wants. Those stations which in some measure, fulfill that standard, may be expected to survive. Stations not working in the interest of the public must fail. Because of the increase in cost of production, and the high price of talent, the average individual station has a difficult situation confront-

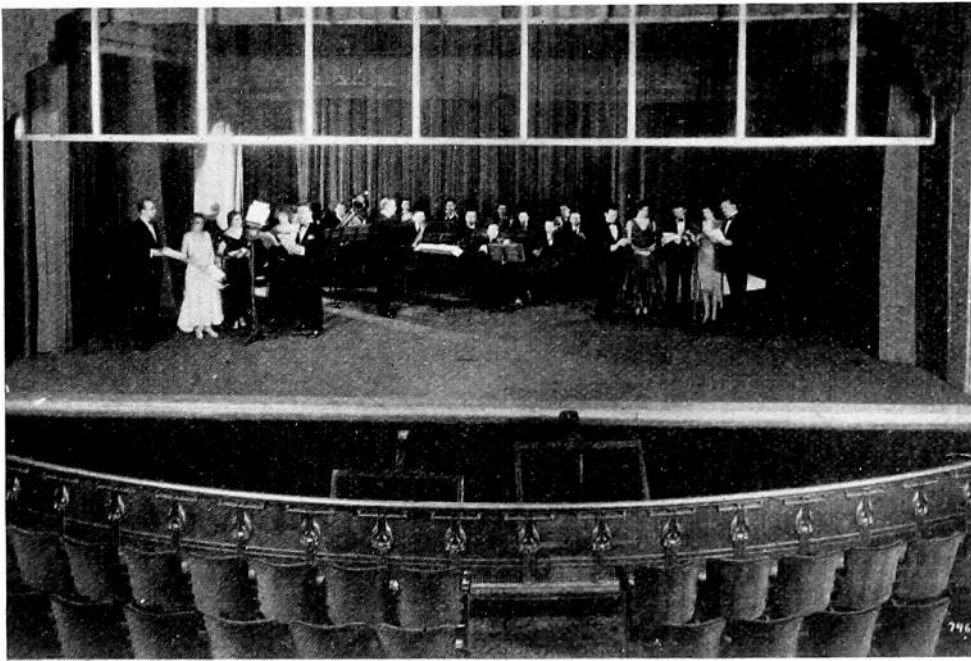

Fig. 11—Stage studio—National Broadcasting Company's Times Square Studio N. Y., showing glass curtain.

ing it. That is one reason why network broadcasting is so outstandingly the leader in furnishing excellent talent. Newspapers make use of the same principle on which network broadcasting is conducted. Articles and works of gifted and prominent writers and authorities are syndicated so that many newspapers may take advantage of this high class service at a reasonable cost. Obviously, it is impossible for every individual newspaper to maintain a great staff of outstanding writers. No more so can the individual station. However, we must be careful that we do not overlook the value of the local programs. Only the very best that are available locally should be used, and the rest should be nationally known talent. Therefore, the future of program work through the broadcast station will mean a happy bal-

ance between the nationally known and nationally syndicated entertainment, and the best that the particular locality in which the station is located has to offer. Again, as in the case of the newspaper you can obtain both the local news as well as that which is of interest to the public in general. I have no fears in regards to our future development for we are working to fulfill the demands of the public itself. Any time that we may deviate from the general public interest, we may be sure that we shall be quickly advised of the fact by the public's reaction.



Fig. 12—Control room, Times Square Studio, New York.

Therefore, the future for radio broadcasting and its associated activities looks very bright because as is stated above, it is based upon sound, fundamental, economic principles.

The tremendous growth of broadcasting can best be illustrated by looking at the figures compiled by reliable authorities. In 1920 there was no such apparatus known as the broadcast receiving sets; we now have more than twelve million in use. This means that every other home in the United States possesses a radio receiving set. Another basis for comparison is that it is estimated there are slightly more than thirteen million residence telephones in existence in the United States

which is a trifle more than the number of broadcast receivers. From an industry that was zero ten years ago, we have reached a point where we rank high among the great industries of the country with an estimated business of approximately eight hundred million dollars per year. Radio has given employment to many thousands of people directly, and many more thousands indirectly.

The radio industry has created many by-products, of which perhaps the best known is that which is called the "talking movies." There



Fig. 13—N. B. C. field truck.

are many others such as public address systems, the transoceanic telephone, and even apparatus used in medical science, as is illustrated by the fact that the General Electric Company has been experimenting with electric equipment which will produce artificial fevers for curing certain diseases. This equipment, some medical authorities contend, will be of great benefit to humanity.

Let us take for granted what we have achieved to date. Let us consider for a moment what the future trend may be. During the past year a great advance was made in short-wave transmissions which has

resulted in the frequent interchange of programs between America and foreign countries. This was very forcibly demonstrated last Christmas Day when especially prepared programs originating in England, Holland, and Germany were received in this country, and rebroadcast over the national networks. Since then we have heard King George of England address the Naval Conference in London and we have listened to many prominent personages who attended that Conference. Hardly a week goes by without two or three foreign programs being broadcast in this country, and conversely the foreign radio listeners hear many important events as they take place in America. This activity will advance rapidly until within a couple of years we will think it rather "commonplace" to listen to events which transpire at almost any point on the globe.

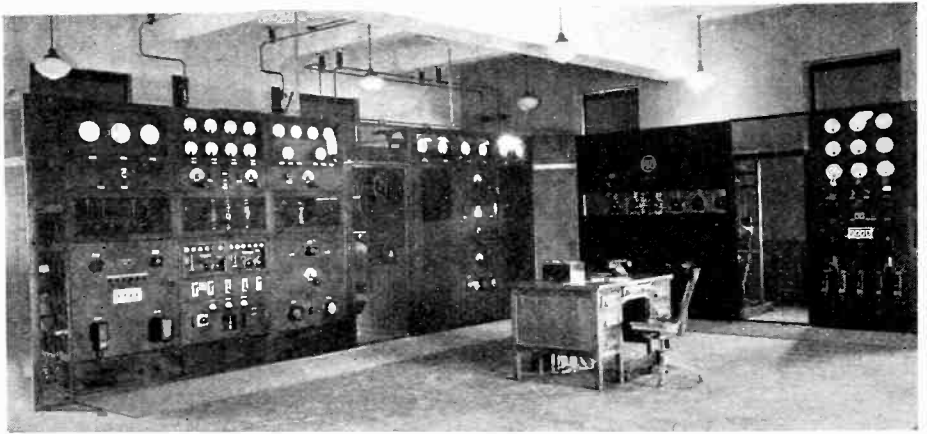

Fig. 14—Typical R.C.A. 50-kw transmitter.

In looking ahead we must consider the difficulties we are experiencing today. We find that almost one-half of the listeners are located at points usually considered as outside of the "service area" of the nearest station. This means that approximately one-half of our listeners are not receiving the signal strength that they should receive. As there are already too many stations in existence, and a great deal of confusion and chaos exists because of this fact, there is but one answer to the problem, and that is that the existing stations which are rendering the service which the public desires should be enabled to increase their range in order to accommodate as many of these listeners as possible. This means a general increase in power of all stations. We must recognize the fact that we cannot continue to serve listeners with the energy rated in "fly power" but that we must continue to develop equipment for the production of higher levels of signal in order that the listener who is located some distance from the station shall enjoy the

same degree of quality and reliability as the more fortunate listener who happens to be located near the high powered stations. Rural listeners are indeed entitled to the best that radio can bring them, and this means high power transmission.

Therefore, every encouragement should be given to those who are tackling the problem of higher power. We must lift the industry from the rather haphazard service that is now possible, to one that will give absolute and dependable results. We must realize that a station

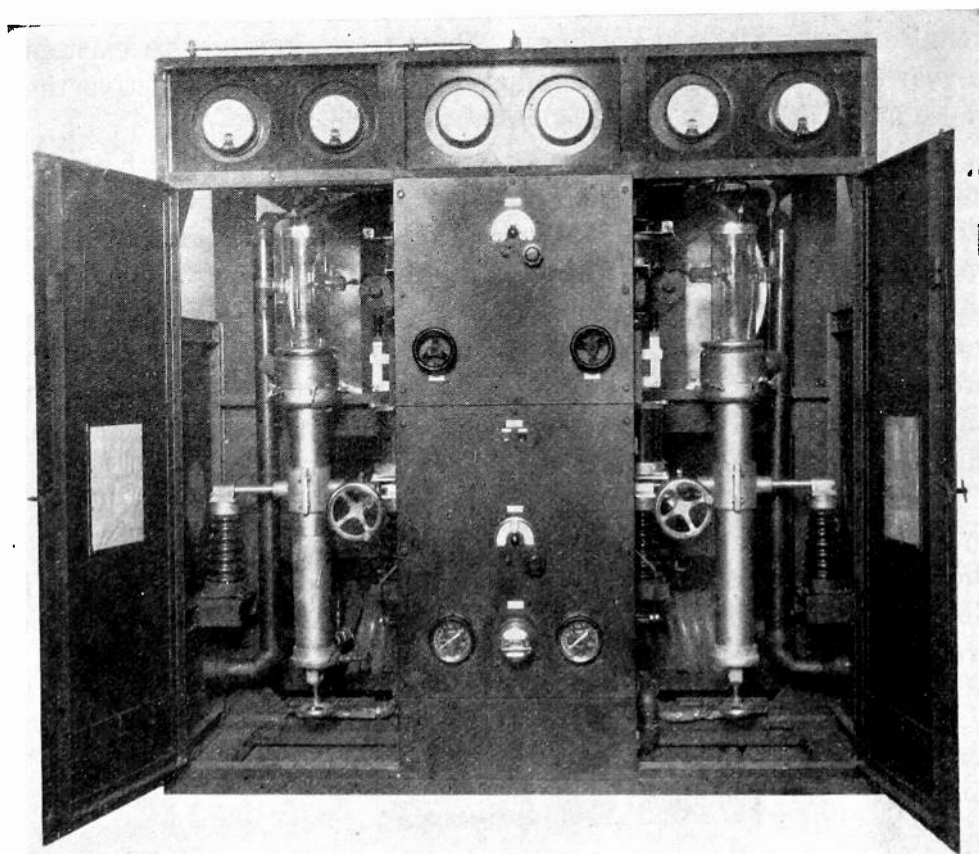

Fig. 15—50-kw amplifier of R.C.A. broadcast transmitter.

utilizing energy equal to that consumed by two or three flatirons serves no really useful purpose to the majority of listeners. We must overcome the belief existing at present, that even 50,000 watts is high power, and train our minds to think correctly in hundreds of kilowatts.

A great responsibility falls upon the receiver design engineers, for the only excuse thus far against increase in power has been that interference would result, and that such high power would cause what has been referred to as "blanketing." We all know that it is a matter of receiver selectivity, rather than the power of the transmitter which is

at fault, for a transmitter which is properly designed and operated emits but one frequency plus the side bands required for modulation. We have great hopes as to rapid development in overcoming this receiver problem because of the general introduction of the superheterodyne type of receiver. We know that by utilizing this circuit we can produce an extremely sharp and selective receiver which thus takes away the last argument against high power. With a definite demand for increase in selectivity, there will undoubtedly be other advances made in circuit design so that next year should produce some very definite results along these lines. The average receiver in existence a year from now will have tuning considerably more selective than those in use at present, and also improved fidelity.

We have completed one decade of very intensive work with gratifying results. What the next ten years will bring cannot be foretold but we may rest assured that it required half of the last decade to gain speed and that we are now proceeding forward at such a rapid pace that the momentum is sure to carry us on to a point from which we can look back to the present day and again confirm the thought that there are no limits in scientific development. It is my belief that almost anything the mind can picture or even dream of, the energy and determination of man can accomplish.

Gentlemen, the only permanent factor in our lives is change, and by change I mean progress. What wires and conductors have been to the electrical industry in the past, radio will be in the future, and particularly in its especially appropriate sphere of mass communication or broadcasting.



MEASUREMENT OF POWER AND EFFICIENCY OF RADIO TRANSMITTING APPARATUS*

BY

G. PESSION¹ AND T. GORIO²

(¹Captain Royal Italian Navy, Rome, Italy; ²Chief of Radiotelegraph Laboratory,
Royal Experimental Institute of Communications, Rome, Italy.)

Summary—This paper reports the various methods and results of the measurement of power and efficiency in radio transmitting apparatus.

High-frequency power measurements are classified as wattmeter, ammeter, calorimeter and indirect methods. The high-frequency wattmeter method and the methods based on the current and resistance measurements are briefly discussed. The direct and indirect calorimeter methods are upheld by the authors on account of their advantages, which are enumerated.

The experimental results employing calorimeter methods for direct and indirect power measurement are quantitatively reported and the degree of precision obtainable in practical applications is shown.

CLASSIFICATION OF HIGH-FREQUENCY GENERATORS

IN ORDER to examine various methods of power measurement continuous wave generation methods must be classified. One convenient classification of present day systems is to consider those transmitters which generate a frequency which is independent of circuit constants, and their operating conditions. In this class of transmitters can be included the alternator transmitters and those vacuum tube transmitters whose frequency is controlled by a piezo-electric crystal, or by a simple master oscillator, constructed with all the technical precision necessary to realize the required stability of frequency in the driving circuit, independent of the controlled circuit's regulation. This class will be designated as frequency stabilized transmitters.

Other transmitters in which a circuit or a system of circuits oscillate at a frequency which is a function of its constants (C , L , R) will be designated as unstabilized transmitters. In this class the generated frequency is subjected to variations depending on the circuit's regulation and coupling.

1. Stabilized transmitters can be classified as follows:

(a)—Transmitters which generate directly the required power and frequency (radio-frequency alternators of the Alexanderson and La-tour types; piezo-oscillators).

* Decimal classification: R250. Original manuscript received by the Institute, September 10, 1930.

(b)—Transmitters directly generating the required power at a frequency lower than the required one making it necessary to use suitable frequency multipliers (Goldschmidt and Telefunken alternator transmitters).

(c)—Transmitters which generate directly the frequency but which require a successive amplification of the power (medium- and low-frequency vacuum tube transmitters with master-oscillator or piezo-electric stabilization).

(d)—Transmitters which require the amplification of power as well as the multiplication of frequency (modern ultrashort wave sets and stabilized frequency vacuum tube transmitters).

2. The nonstabilized transmitters include:

(a)—The arc converters of the Poulsen type.

(b)—Self-excited vacuum tube transmitters.

DEFINITIONS CONCERNING THE POWER OF RADIO TRANSMITTERS

In speaking of the power of a radio transmitter, we must always specify at which point of the chain the measurement of the power has been made.

The "International Technical Consulting Committee on Radio," in its first meeting of September, 1929, at the Hague,¹ recognizing the inconvenience caused by referring the power of transmitters at different points of the chain, suggested that the power of a radio transmitter means the power in the antenna.

Therefore, we think it useful to specify some of the technical points relating to high-frequency power measurements. Referring to the general scheme of a radio transmitter represented by Fig. 1, we shall consider the set in continuous emission (the key permanently operated in the case of a simple radiotelegraphic station, or with absence of modulation in the case of a radiotelephone transmitter).

Indicating by I, II, N the various stages of the transmitter, let $w_1, w_2, \dots w_n$ be the absorbed powers and $W_1, W_2, \dots W_n$, the output power in the same stages.

Generally we ought to consider also important auxiliary machinery *viz*, blowers, water and oil pumps, regulating gears, etc., (represented in Fig. 1 by the rectangle *A*), which we suppose to absorb a power w_A and besides signaling items (relays, automatic transmitters, etc.,) or modulating gears (represented by the rectangle *B*) which absorb a power w_B .

In a vacuum tube generator it is always necessary to specify if

¹ PROC. I.R.E., 18, 768; May, 1930.

the filament heating power is included in the auxiliary services *A*, or in the power absorbed by each stage.

Some of the powers indicated with the small letter *w* can be zero, as in the case of intermediate circuits formed by oscillating or filter circuits.

For instance, in the case of the 1(b) class generators, the power *w* (mechanical power in the alternator shaft, or electric power absorbed for the excitation) will represent nearly all of the input power of the machine, while the powers $w_2 \cdots w_n$ will be relatively small, namely, the power necessary to create the excitation field in the frequency multipliers.

On the contrary, in the case of the generator class 1(d), the power w_1 will be the smallest in comparison with the progressively growing

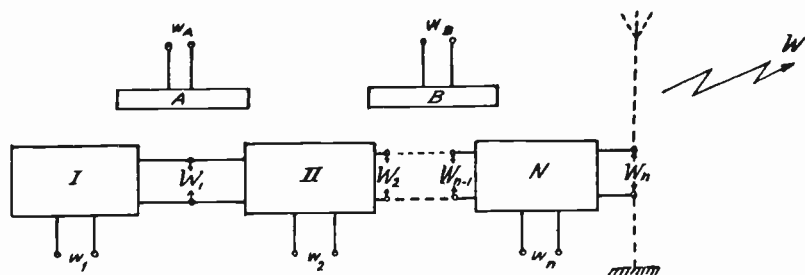

Fig. 1

absorbed powers of the following stages, which reach a maximum in the last power amplifying stage.

According to the agreement of the Hague Conference in the determination of the efficiency of a radio station the high-frequency power W_n in the last stage has a preëminent importance over the other output powers W_1, W_2, \cdots etc. of the previous stages. We shall call this power the antenna absorbed power, and as the antenna (marked with dotted lines in Fig. 1) is the last item of the transformation chain, the power absorbed by it can be considered the true useful power of the set.

When the high-frequency power is conveyed to the antenna by a feeder, the power W_n will be that measured at the line terminals towards the antenna, and in this case the line may be considered either as part of the *N* stage or as a separate stage.

The radiated power W_i in some cases could be calculated² employing the well-known formula:

$$W_i = 1600 \left(\frac{h_e}{\lambda} \right)^2 I^2$$

² See also, A. A. Pistolokors. "The radiation resistance of beam antennas," Proc. I. R. E., 17, 562; March, 1929.

(W_i = watts; h_e = effective height of the antenna in meters; I = antenna current in amperes). It could also be considered in relation with the power W_n , when determining the antenna efficiency, or the efficiency of the chain of transformation immediately preceding the radiator, which in general must be considered independent of the chain of generator transformations. Obviously, then we can define the total power supplied to the transmitter as that given by the sum of various absorbed powers, plus the power absorbed for auxiliary services and for keying or modulation, viz:

$$w_T = w_1 + w_2 + \dots + w_n + w_A + w_B$$

while the simple amount of all the powers absorbed by the various circuits of the transmitter, viz,

$$w_t = w_1 + w_2 + \dots + w_n$$

could be defined as the power supplied to the transmitter proper. From the above definition, we can deduce the total transmitter efficiency by the ratio:

$$\eta_T = \frac{100W_n}{w_1 + w_2 + \dots + w_n + w_A + w_B}$$

and the *normal efficiency* by the ratio

$$\eta_t = \frac{100W_n}{w_1 + w_2 + \dots + w_n}$$

We believe it possible to apply the above considerations when it is necessary to examine the value of the output power of an intermediate stage, in which case the input power must be referred to all preceding stages as far as K . Thence the normal efficiency of all the chain of circuits preceding and including stage K , can be obtained by

$$\eta_k = \frac{100W_k}{w_1 + w_2 + \dots + w_k}$$

and the total efficiency of the same chain by adding at the denominator an aliquote part of w_A and w_B for the auxiliary services referring to the same and preceding stages.

In some particular cases it might be necessary to calculate the normal efficiency of an intermediate stage K , as to say:

$$\eta_k' = \frac{100W_k}{W_{k-1} + w_k}$$

from which the total stage K efficiency can be obtained by adding an aliquote part for the accessory power spent in auxiliary services of this stage.

The measurement of the above mentioned partial efficiencies involves too many conventional specifications, so that we shall not examine it in this study.

If we designate the manipulation coefficients the ratios between the mean power supplied during the manipulation and the power absorbed during the emission of a continuous signal as $a_1, a_2, \dots a_n$, it is obvious by assuming that the useful instantaneous powers are equivalent in the two cases, a comparison of the performance during the manipulation among several systems can be obtained from the previous formulas by putting in place of the absorbed powers $w_1, w_2, \dots w_n, w_A, w_B$ the same powers multiplied by the corresponding manipulation coefficients.

In the case of radiophonic modulation the result would be more complex as it would depend upon the kind of sounds applied to the microphone.

METHODS OF HIGH-FREQUENCY POWER MEASUREMENT

The experimental determination of the above powers and efficiencies requires the measurement of mechanical powers and that of direct and alternating-current electrical powers. In such measurements the common industrial methods (brakes, wattmeters, etc.,) can be utilized.

However, the same procedure cannot be easily adopted for the determination of the high-frequency power w_n impressed on the antenna, the measurement of which needs some particular cautions.

The principal object of our study is that of reviewing the methods which can be used in high-frequency power measurements, and to examine the boundaries within which these methods can be employed as well as their order of precision. The above mentioned methods can be classified as follows:

- (a) Wattmeter methods.
- (b) Ammeter methods, which involve the measurement of resistance.
- (c) Calorimeter methods.
- (d) Indirect methods, based on the measurement of the absorbed power and on the separation and measurement of the various losses.

Wattmeter methods

The wattmeters to be used must give very exact indications at high frequencies; moreover it is an essential condition that they do not in-

produce any variation in the equilibrium of the currents, or absorb any appreciable quantity of power.

Chireix³ suggested the employment of a thermal wattmeter and studied all the methods of its application in high-frequency measurements.

The principle upon which the thermal wattmeter is based is well known. Two expansible wires AB , AC , (Fig. 2) (which can also be the heating wires of two thermocouples) give passage respectively to the difference $(i_1 - i_2)$ and to the sum $(i_1 + i_2)$ of the currents i_1 and i_2 , which are respectively proportional to the current or voltage to be measured.

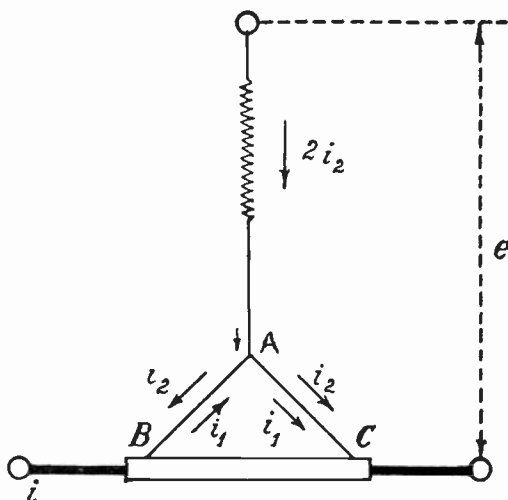

Fig. 2

The circuit is arranged to obtain the subtraction of the thermal effects (wires extension or thermocouple electromotive force), so that the instrument deviation will be proportional to the difference $(i_1 + i_2)^2 - (i_1 - i_2)^2$, compared to the product $i_1 \times i_2$, and thence to the instantaneous power.

In the case of the alternating current the deviation is proportional to the expression:

$$\frac{1}{T} \int_0^T i_1 i_2 dt = I_1 I_2 \cos \phi$$

where ϕ is the phase angle, so that the deviation is proportional to the power to be measured.

Chireix, with the aim of reducing the instrument absorbed power, substituted a reactance for the voltmeter resistance, and used a cur-

³ H. Chireix, "Nouvelles méthodes permettant de mesurer exactement la résistance d'une antenne ou d'un circuit quelconque h.f.-wattmètre h.f.," *Radio-électricité*, No. 57, April 10, 1924.

rent transformer with a secondary having a very high resistance-to-inductance ratio. Referring to Fig. 3 the inductance l and the resistor ρ regulate the phases of the two currents i_1 and i_2 maintaining between them the same phase angle as exists between the current and the voltage.

It is easy to show by a simple calculation that the correction depends very slightly upon frequency. It is stated that these wattmeter methods are of value in power measurements over a large range of frequency and for power factors varying from $\cos \phi = 1$ to $\cos \phi = 0.2$.

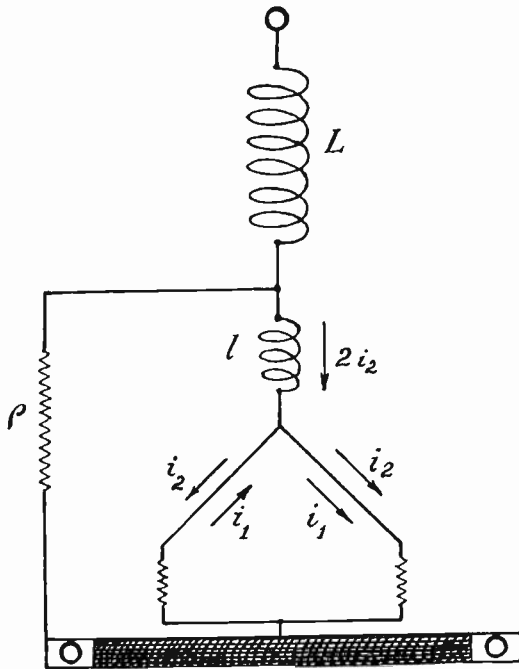

Fig. 3.

A high-frequency wattmeter based on the same principle has been studied by Prof. Bruckman and constructed by Kipp and Zonen of Delft, Holland.

The instrument utilizes two thermoconverters connected in parallel in the voltmeter circuit, and at the same time in series with the current. The millivoltmeter has a resistance of 10 ohms and a sensitivity of 3 mv for the full scale of 150 divisions.

The instrument has a range of 30, 150, and 300 volts at 1.5 amperes. The ammeter circuit resistance is 1.5 ohms and the instrument can be furnished with adequate shunts rated for 6, 15, and 30 amperes.

In practice, neither the above mentioned wattmeters, nor the electrostatic wattmeters have entered into common use for radio-fre-

quency measurements, except in the case of small power generators, at low radio frequencies.

The method based on the employment of an oscillograph⁴ can also be classified among the wattmeter methods.

If we apply the potential difference existing between the output terminal to a couple of electrodes in a cathode-ray oscillograph, and the potential difference taken across a condenser put in series with the source at the other pair of electrodes, the value of the power W is given by the formula:

$$W = KfCS$$

where K is a constant which can be experimentally determined, f is the frequency, and S the area of the image drawn by the light on the oscillograph screen.

We have experimented with this method in the case of telephonic frequencies.⁵ Its application to high-frequency measurements is, in general, very complex, requiring adequate laboratory means.

Ammeter methods

This method, which is based on the measurement of the current, of the effective high-frequency resistance, and on the application of the formula $W = I^2R$, is the one more frequently used in practice.

The method currently used for the measurement of the high frequency resistance is the so called "resistance variation method," which, being based on the measurement of very small currents, requires the employment of very sensitive instruments, whose resistance at the frequency employed must be accurately determined. It is not easy to avoid the influence of external fields on the measurement of the antenna resistance.

When the resistance possesses a certain degree of capacity and inductance, the measurement is affected by considerable errors.

The principal objection which is ordinarily made to the ammeter method is that the values of the high-frequency resistance which are obtained by means of weak currents are not always equivalent to those presented by the same circuits when a current of higher value flows in it. In effect we can admit that, in many cases, high intensity currents produce greater losses in the circuit and thence the effective resistance is higher compared with those obtained by weak current measurement.

⁴ A. Hund, *Hochfrequenzmesstechnik*, Page 220, Par. 167.

⁵ Consiglio Nazionale delle ricerche. Dati e memorie sulle Radiocomunicazioni 1929, page 200.

Chireix⁶ suggests a method which he considers to be exempt from the greater part of above mentioned inconsistencies. A vacuum tube driver is directly coupled to the circuit to be measured. The antenna inductance S is then adjusted to a value somewhat higher than that at resonance.

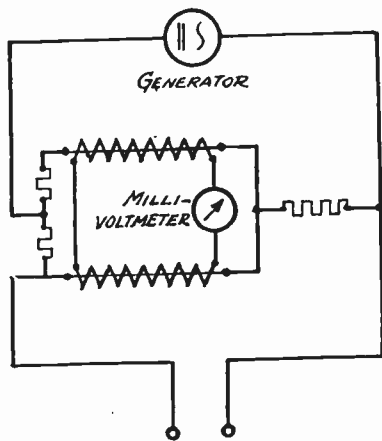

TO UTILISATION
CIRCUIT
Fig. 4

By displacing then the point P , (Fig. 5), along the small inductance L , until a minimum indication is obtained at the voltmeter V , it is possible to obtain the unknown resistance value by a simple determination of the ratio V/I .

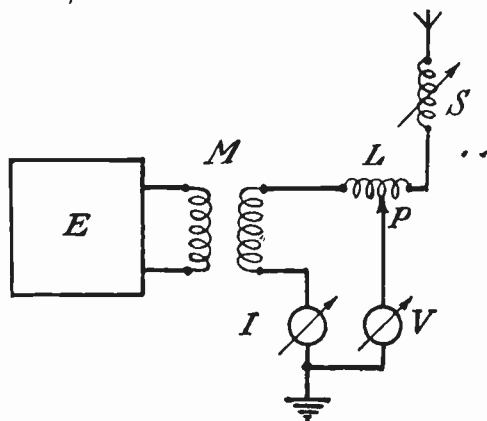

Fig. 5

In the Philips Radio, Eindhoven, laboratory a 200-kw generator was employed to test the cooled anode triodes. The power is dissipated in an artificial antenna having a resistance formed by a great number of carbon rods.⁷

⁶ loc. cit.

⁷ Balth Van der Pol and K. Posthumus, "Un poste d'émission de 200-kw pour essais de triodes," *L'Onde Electrique*, page 324, 1925.

The value of this resistance has been determined first by measuring it in conjunction with the load with a low-frequency current. In this case it was found that, owing to the negative temperature coefficient, the resistance diminishes as the load increases. From very accurate measurements with the resistances cold when employing the normal testing frequency ($\lambda = 2800$ m) a ratio was found of the high-frequency resistance to the direct-current resistance of only 1.06, as a consequence of the low skin effect in carbon. The same ratio was assumed for the high temperature resistance.

The losses in the air condenser and in the self-inductance coil of the artificial antenna were not considered in the calculation of efficiency.

Calorimeter Methods

If we substitute for the ordinary antenna an artificial antenna formed by a self-inductance L , a capacity C , and a resistance R of convenient values, we are able to measure the high-frequency power by

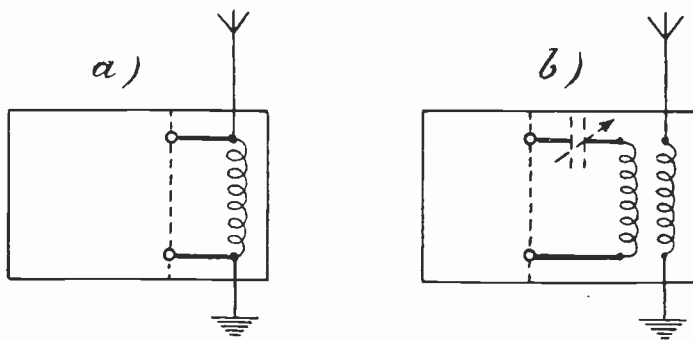

Fig. 6

employing some type of calorimeter. When L and C are accurately constructed as to present negligible losses, we can assume that all the output power is dissipated in heat in the resistance R .

This system can be used during the official tests of a new station, in which case an artificial antenna having exactly the same constants of the normal service antenna should be employed.

In the measurement of the output power of a special set coupled to a fixed antenna, it is possible to substitute for the latter, an oscillatory circuit whose constants and coupling to the set are advantageously adjusted. In order to insure that power dissipated in both are the same, care should be taken that the frequencies, the absorbed power and the oscillatory current in each stage remain exactly the same as in the ordinary service.

Two distinct cases must be considered in the adjustment of the oscillatory circuit of Fig. 6:

- (a) The antenna is directly coupled to the generator (arc converter, or some type of tube transmitter);
- (b) The antenna is coupled to the generator by means of a radio-frequency transformer.

In case (a) the artificial antenna will consist of a resonating circuit and a variable resistance.

After having tuned the circuit to the frequency generated by the set, the resistance must be adjusted until a current equivalent to the normal antenna current is obtained in the artificial antenna.

The application of this method to medium and high power transmitters of the (a) type is not very practical, owing to the difficulty of

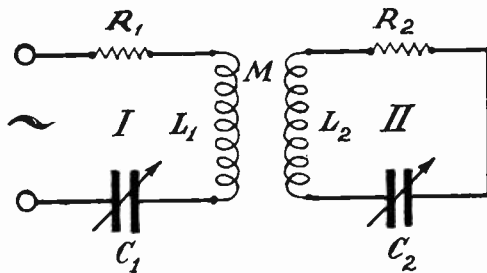

$$X_1 = \omega L_1 - \frac{1}{\omega C_1} \quad X_2 = \omega L_2 - \frac{1}{\omega C_2}$$

$$Z_1 = \sqrt{R_1^2 + X_1^2} \quad Z_2 = \sqrt{R_2^2 + X_2^2}$$

Fig. 7

obtaining a resistor susceptible of a very fine regulation and capable of dissipating considerable power.

In case (b), let I represent the primary circuit (in which the condenser C may be absent) and II the antenna circuit of Fig. 7. Owing to the theory of coupled circuits, the apparent primary reactance and resistance are given by:

$$X_1' = X_1 - \frac{\omega^2 M^2 X_2}{Z_2^2}$$

$$R_1' = R_1 + \frac{\omega^2 M^2 R_2}{Z_2^2}$$

If we substitute for the antenna a resonant circuit whose resistance R_2' is different from R_2 , the values of X_1' and R_1' and thence the primary current as well as the general conditions, will remain unchanged when the secondary reactance and the mutual inductance are adjusted to the two new values X_2' and M_1' such as to have:

$$X_1 - \frac{\omega^2 M^2}{Z_2^2} X_2 = X_1 - \frac{\omega^2 M'^2}{Z_2'^2} X_2'$$

$$R_1 + \frac{\omega^2 M^2}{Z_2^2} R_2 = R_1 + \frac{\omega^2 M'^2 R_2'}{Z_2'^2},$$

from which:

$$X_2' = \left(\frac{M'}{M}\right)^2 X_2 \quad (1)$$

$$R_2' = \left(\frac{M'}{M}\right)^2 R_2. \quad (2)$$

If we admit, as it is the case in ordinary service, that the transmitter is adjusted at the maximum of the antenna current I_2 , with the conditions (1) and (2) verified, the artificial antenna will absorb the same power as the actual antenna.

Hence, in case that such a maximum is verified for $\omega M \geq \sqrt{R_1 R_2}$ the power (expressed by $W_2 = E^2/4R_1$) is independent of the resistance R_2 of the secondary circuit and, precisely, it is equal to one-half the total output power in the two circuits.

When it is not possible to realize the above mentioned condition, that is when $\omega M < \sqrt{R_1 R_2}$, the secondary power, which is expressed by

$$W_2 = \frac{E^2 \omega^2 M^2}{(R_1 R_2 + \omega^2 M^2)^2} R_2 \quad (3)$$

remains, evidently, the same (for 2) when R_2' and M' are respectively substituted for R_2 and M .

By calling M_{\max} and M_{\min} the boundaries between which M varies, the expressions (1) and (2) can be satisfied with all the values of R_2' for which:

$$\frac{R_2' - R_2}{R_2} < \frac{M_{\max}^2 - M^2}{M^2}$$

or

$$\frac{R_2 - R_2'}{R_2} < \frac{M^2 - M_{\min}^2}{M^2}.$$

This result is very important as it shows that in maintaining the service conditions unchanged it is necessary to introduce in the equivalent artificial circuit only an approximate value of the real antenna resistance R_2 .

There is, then, the possibility of adopting for the artificial antenna a fixed resistance easily obtainable for high power dissipation so that

the calorimeter measurement of high-frequency power can be done without the uncertainties that almost always accompany the method when based on the antenna resistance measurement.

As a consequence of the above considerations we shall now examine some methods of power measurement based on the determination of the heating and lighting power dissipated in the artificial circuit resistance.

We have conducted some measurements of efficiency in low power vacuum tube transmitters simply by placing the resistance coil of the oscillatory circuit (a straight filament lamp) in a thermic insulated space; and obtained a diagram of the increase in temperature as a function of time, due to the high-frequency power dissipated in the resistor.

For the determination of the unknown power we operated with a direct current, and starting from the same initial temperature, we reproduced the same increasing temperature law. With this procedure it is possible to determine the unknown power by the number of watts dissipated in the resistor.

In practice it is sufficient to trace two curves between which that corresponding to the high frequency is comprised; then the unknown power can be obtained by interpolation between the ordinates.

A method based on the same principle was applied by Groszkowski⁸ for the determination of the power dissipated in the vacuum tube triode of a generator. A thermometer was simply placed near the triode, and a precision varying from one to two per cent was obtained. We believe that a greater precision is obtainable by operating in a closed space and with the procedure that we have suggested.

The heat developed in the resistor can be measured by an absolute system if an ice or water calorimeter is employed.

Putting the dissipating resistor in a double-walled tank having a water-circulation system, and measuring the terminal temperatures of the water, viz., the entrance temperature t_0 and the outlet temperature t_1 ; then calling P the volume, or water-carrying capacity, in litres per minute, the dissipated power W in kilowatts will be given by the expression:

$$W = 4.18 \frac{P}{60} (t_1 - t_0).$$

This method is available for long- and short-wave high power measurements, when a carbon rod resistor of appropriate value, or a regu-

⁸ J. Groszkowski, "Détermination du rendement d'un générateur à lampes par la méthode thermométrique," *L'Onde Électrique*, p. 82, 1925.

lating liquid resistor is employed, and the calorimeter water carrying capacity is well proportioned to the operating power.

The above method has been employed by us in the measurement of the efficiency of Radio Roma Trastevere 5-kw transmitter, to which we shall refer later.

Photometric Methods

When the heat developed in the resistor is accompanied by the production of luminous energy, it can be indirectly measured by means of a photometer.

The photometer calibration can be executed by measuring the power with a voltmeter and an ammeter when a direct current flows in the resistance.

When operating at high frequency it is necessary, for a correct application of the method, that no other power dissipation take place, except that in the resistor. It is preferable to employ high vacuum lamps with very long straight filaments as resistors in order to avoid errors due to leakage currents by spurious capacitances and other imperfect condensers.

The method is very useful for quick measurements, and it gives a sufficient precision, if we assume with Voit⁹ that the quantity of light emitted by the filament is proportional to the cube of the supplied power, in which case the error in the determination of W is the third part of the photometric measurement error.

Method of the Thermoelectric Pyrometer

We have also experimented with the measurement of the heat developed in the resistance lamp by employing a surface thermocouple pyrometer similar to that used by Crossley and Page.¹⁰

The thermocouple, formed by a flat strip, is connected to the millivoltmeter by means of two flexible conductors and it is maintained in a straight line by a heavier metal strip and insulated from it by hard rubber end pieces. The thermocouple element is applied against the glass wall of the lamp and gives a measure of its average temperature, which can be considered as proportional to the filament developed heat.

Indirect Methods

If it is possible to determine power losses with one of the above methods in the various transmitter stages, the efficiency can be ob-

⁹ L. Lombardi, *L'Elettrotecnica*, vol. II, par 117.

¹⁰ A. Crossley and R. M. Page, "A new method for determining the efficiency of vacuum-tube circuits," *Proc. I. R. E.*, 16, 1375; October, 1928.

tained as the ratio between the supplied power less the losses and the same power.

For instance, in the case of a Poulsen arc transmitter, owing to the fact that the arc burns in a water-cooled chamber, there is the possibility of measuring with a calorimeter the heat energy lost in the arc, which represents in this type of transmitter almost all of the losses, since the losses in the field coils may be considered negligible.

The indirect method also can be utilized in the case of cooled anode vacuum tube transmitters, in which the power dissipated in the triodes can be determined by measuring the volume and temperatures of the water stream at the entrance and at the issue of each tube.

In this case it is necessary to take in account the intermediate circuit losses, which can be measured with the ammeter method. The

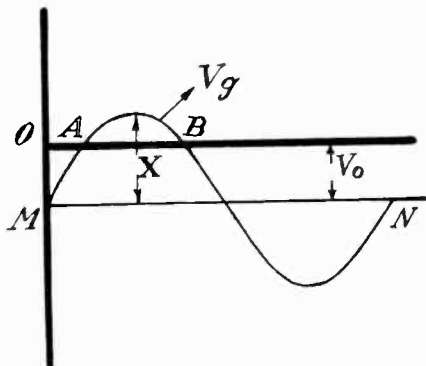

Fig. 8

losses in the master oscillator (when used) can be calculated by subtracting from the input power the power p furnished by the master oscillator to the grid circuit of the high power tube,

The power p can be obtained approximately graphically after the following elements of the cooled anode power tube have been measured.

- V_{eff} the total effective grid voltage
- V_0 the d-c grid voltage
- I_g the grid current.

Thence, the maximum value X of the grid voltage alternating component can be deduced by the formula:

$$V_{eff}^2 = V_0^2 + \frac{X^2}{2}$$

by which we can determine the value of X . Knowing X we are able to plot the diagram of Fig. 8, from which the fraction of a period AB during which the grid voltage has a positive value can be calculated.

For the calculation of the grid power it would be necessary to trace, with the aid of the triode static characteristic, the curve of the grid current, but as the power in question is very small compared with the total operating power, we can admit with sufficient approximation, that such a current is constant, and equal to $I_g(\overline{MN}/\overline{AB})$ in the interval AB , and equal to zero in the remaining fraction of the period.

We shall have then, evidently:

$$p = \frac{1}{T} I_g \frac{\overline{MN}}{\overline{AB}} \int_A^B V_g dt.$$

As an illustration of the above method, the efficiency measurements which we have executed upon the *Radio San Paolo* (IDO) arc converter, and upon a cooled anode transmitter of the *Roma-Torrenova* Italo radio station are reported.

In the case of the air-cooled vacuum tube generators, Crossley and Page¹¹ have suggested a thermoelectric pyrometer method for determining the triode losses.

The thermocouple element being applied to the glass walls of the tube, a run is made with the tube in the nonoscillating state and the plate temperature is registered for different values of plate power dissipation. The circuit is then placed in the oscillating state and the plate temperature is again obtained by use of the thermoelectric pyrometer. The plate input in watts is registered for the oscillating condition and from this value is subtracted the dissipation in watts represented by the pyrometer reading. The remaining number represents the watts which have been converted into radio-frequency power.

The authors have found that in various repeated measurements they obtained values differing from each other by less than 10 per cent.

A paper condenser of 1 μ f capacitance is shunted across the millivoltmeter for the purpose of by-passing any radio-frequency currents that may be picked up by the thermocouple and leads.

Practical Applications

Experimental results utilizing the above calorimeter methods are as follows:

As a matter of control we have traced the curves of the Fig. 9 which show how the temperature increases as a function of the time in a case where the dissipated heat was produced by a d-c 110-volt lamp contained in a celotex chamber.

The lamp was supplied respectively with 37.2 watts (w_1), 41.28

¹¹ Crossley and Page, loc. cit.

watts (w_2), and 45.56 watts (w_3), taking 18.5 deg. C as the initial temperature in each experiment.

The values w_2' are obtained by interpolation between the values w_1 and w_3 by means of the ordinates in the curves.

We could observe that the interpolated power w_2' corresponding to the first few minutes of the series are affected by the greatest errors, as a consequence of the greater weight presented by the errors of the thermometer readings on the differences of temperature. By taking

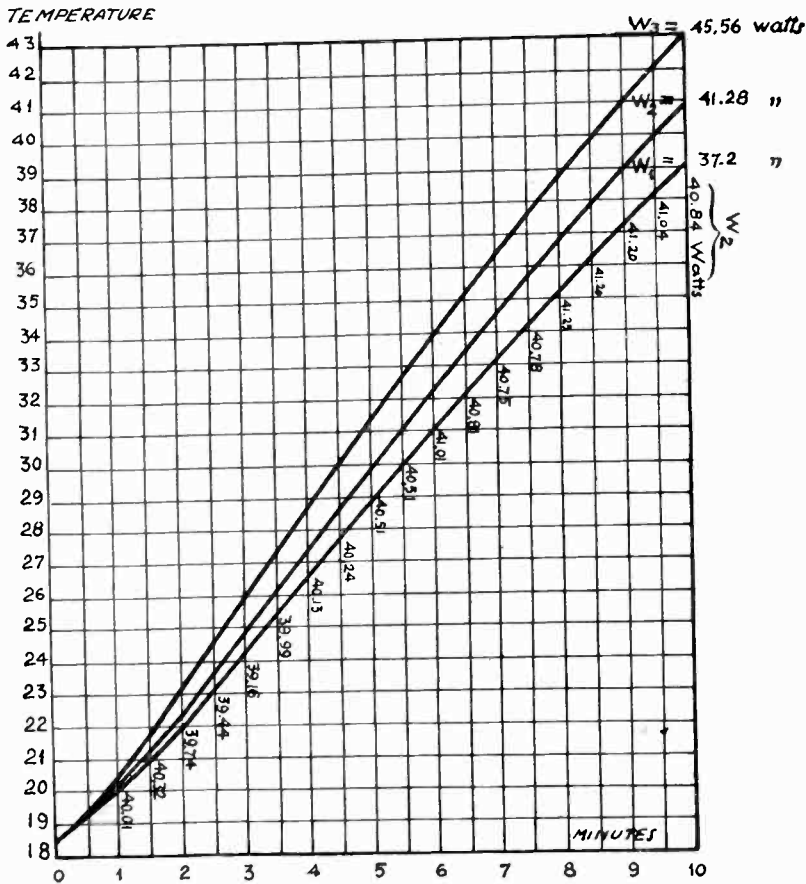

Fig. 9

in consideration only the portions of curves beginning after the fifth minute, it can be found that the shift of w_2 from the mean of w_2' is, in the case in question, equal to 0.83 per cent and not greater than 1 per cent. Thus the method can assure a sufficient precision.

When the method is applied to high-frequency measurements a lesser regularity of the curve w_2 and consequently a precision not greater than 1 or 2 per cent is to be expected, because of the difficulty in keeping the dissipated power constant during the high-frequency measurement.

The method is not suitable in high power measurements, owing to the difficulty of obtaining large thermostatic spaces and placing the thermometers in them conveniently, considering that the temperatures vary with different laws in the various regions within the chamber.

Efficiency measurement of a short-wave stabilized set (55 meters) employing a Philips T.B. 04/10 vacuum tube.

(A) The artificial antenna was a graphite resistor of 10.8 ohms and a variable condenser. The transmitter was so adjusted as to give the same absorbed anode power (298 volts, 48 ma, 14.3 watts) and the

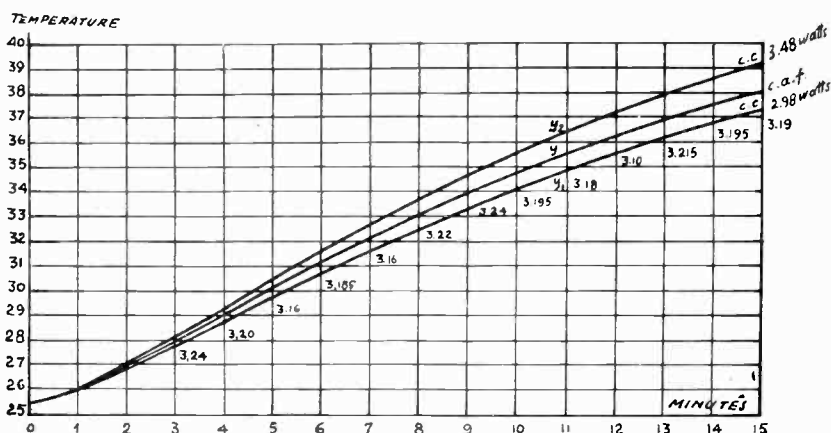

Fig. 10

same currents in the intermediate circuit and in the artificial antenna (respectively of 0.48 and 0.58 ampere) as in normal antenna conditions.

The curves of the increasing temperatures y_1 , y , y_2 reported in Fig. 10 were traced respectively by employing a 2.98-watt direct current, the artificial antenna high-frequency current, and a 3.48-watt direct current. From the above mentioned curves we obtained the value 3.2 watts of high-frequency power dissipated in the resistor.

The efficiency, referred to the anode circuit absorbed power, therefore, is:

$$100 \frac{3.2}{14.3} = 22.4 \text{ per cent.}$$

The total efficiency, considering also the filament absorbed power (20 watts) is reduced to 9.4 per cent.

(B) Anode absorbed power 10.5 watts.

1. Filament absorbed power, 20 watts.

2. Intermediate circuit current 0.29 amperes.
3. Antenna current 0.52 amperes.
4. High-frequency power, computed by the curves of increasing temperature, 2.26 watts.

Efficiency (referred to the anode power supply) 21.5 per cent.

Total efficiency 7.4 per cent.

We shall see later that quite a similar result was obtained by executing simultaneously the measurement with the indirect method, employing a thermoelectric pyrometer.

Calorimeter Measurements

An example of this method as applied to the power and efficiency measurements of the experimental 5-kw station of Roma-Trastevere is given.

We utilized as a calorimeter a 25-kw arc chamber put in a celotex thermoinsulated chamber. The arc chamber had been conveniently prepared by removing all the arc accessories and closing all the holes with wood plugs covered in their interior with asbestos and with celotex on the outside. A 9-ohm resistor made up of 28 arc carbons in series was put in the interior of the chamber. Its value corresponded very nearly to the antenna resistance value and it was able to dissipate nearly 3.5 kw.

Checks made with a direct current whose power was measured with a Siemens precision wattmeter showed that the error in measurement due to leakages inside the calorimeter were less than 2 per cent.

(C) For the artificial antenna two 10,000-cm Dubilier condensers put in series with the above mentioned resistor and the antenna tuning coil, were so adjusted as to put the circuit in resonance with the set frequency (101.7 kc-2950 m).

During the calorimetric measurement, which required almost half an hour, the transmitter adjustment was as follows:

Grid voltage of the power tubes.....	415.	v
Filaments of the power tubes.....	Voltage	83.5 v
	Current	33.7 amperes
	Power	2.8 kw
Anode Supply.....	Voltage	9300. v
	Current	0.54 amperes
	Power	5.02 kw
Intermediate Circuit Current.....	7.	amperes
Antenna Current.....	16.	amperes

The calorimeter water volume was 0.025 liters per second and the water temperatures respectively at the issue and entrance were 31 deg. C and 12.4 deg. C.

The dissipated power was

$$4.18 \times (31 - 12.4) \times 0.025 = 1.945 \text{ kw.}$$

The efficiency referred to the anode supply:

$$\frac{100 \times 1.945}{5} = 39 \text{ per cent.}$$

The total efficiency

$$\frac{100 \times 1.945}{5 + 2.8} = 25 \text{ per cent.}$$

(D) In another test the same method was employed with the following regulating conditions:

Frequency—101.7 kc (2950 m)

Grid Voltage.....	935.	v
Filaments.....	Voltage	85. v
	Current	32.2 amperes
	Power	2.74 kw
Anode supply.....	Voltage	9200. v
	Current	0.53 amperes
	Power	4.87 kw
Intermediate circuit current.....	7.5	amperes
Antenna current.....	15.	amperes

The results of the calorimetric measurement were:

Water volume, liters/sec. 0.0254

Temperature at the issue 30.5 deg. C

Temperature at the entrance 12 deg. C

Dissipated power $4.18 \times (30.5 - 12) \times 0.0254 = 1.97 \text{ kw.}$

Efficiency referred to the anode supply 40.5 per cent

Total efficiency..... 26 per cent

Photometric Method

In this application a Weber photometer with a total-reflection double prism of the Brodhun Lummer type was employed.¹² The standard lantern was replaced with a punctiform glowing lamp, the absorption of which was controlled during the measurements.

The adjustable distance between the lacteous glass screen lighted by a standard lamp and the lamp is determined by a running index in

¹² E. Gerard, *Mesures Électriques*, Chapter III.

a scale graduated from 6 to 33 cm. If we call d the scale reading when the photometer is adjusted for equal lighting and I the standard lamp intensity, the lighting intensity due to the examined source is I/d^2 .

In order to make the measurement easy the photometer is supplied with monochromatic filters (red and green coloured glasses), as the eye cannot easily distinguish lighting equality when the emitted spectrums of the two sources are not exactly alike.

(E) The photometric method was applied to determining the efficiency of a heterodyne generator connected to a resonating circuit containing a resistance which was a straight filament lamp.

Frequency.....	157.1 kc (1910 m)
Anode supply.....	465. v
	93.5 ma
	24.8 w
Filament.....	7.8 v
	1.25 amperes
	9.7 w

Photometric Measurement

<i>Light</i>	<i>d</i>
Red	7.5 cm
White	7.5 cm
Green	7.5 cm

The same lighting intensity was obtained by operating the lamp with a direct current of 7.4 volts at 815 ma totaling 6.03 watts.

The efficiency referred to the anode power supply was:

$$\eta = 100 \frac{6.03}{24.2} = 24.4 \text{ per cent.}$$

and the total efficiency:

$$\eta = 100 \frac{6.03}{34.5} = 17.5 \text{ per cent.}$$

(F) Tests were made to compare the photometric method with the increasing temperature method, utilizing as a generator the short-wave set (6660 and 4280 kc, respectively 45 m and 70 m) of the Rome Post Office (San Silvestro) station.

The set operated into an oscillatory circuit, containing as a resistance a 50-c.p., 100-volt glow lamp of the commercial type, which could be enclosed in a wooden chamber whose interior was covered with celotex.

After having plotted the increasing temperature curve, by employing an oscillatory current, we then measured the dissipated power in

the lamp by the photometric method. Then, by lighting the same lamp with a direct current of the same power, we found that the increasing temperature diagram corresponded practically with the one previously traced. The measurement was performed with the frequencies of 6660 and 4280 kc. (See Fig. 11.)

This experiment shows that the photometric method can give the same precision as the thermometric method. The results are very satisfactory and, moreover, the measurement can be made very rapidly.

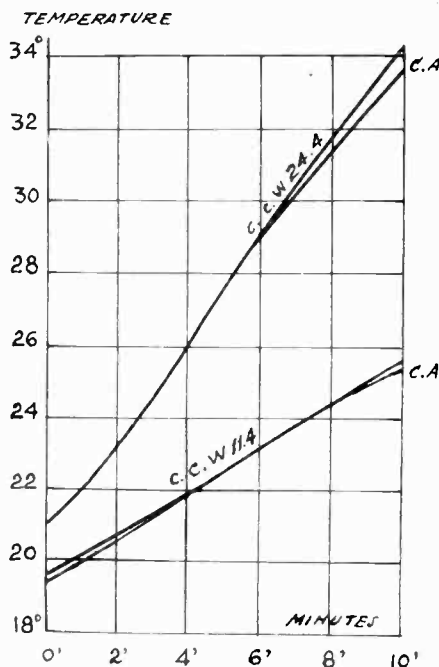

Fig. 11

Owing to its simplicity, the photometric method of measurement can be applied very easily to the measurement of considerable power by utilizing a lamp of adequate size or several lamps in parallel. Lamps of 1-, 2-, or 3-kw rating are now commercially available. In case several lamps are used, it is preferable to photometer them separately.

(G) We employed this method in the measurement of the efficiency of the Rome-San Paolo arc converter (frequency 27.9 kc; wave 10,750 m) and of the Rome-Torrenova 20-kw vacuum tube transmitter. The measurement was performed in 30 minutes. The d-c arc supply current was 135 amperes at 567 volts; the absorbed power 76.5 kw and the antenna current 94.5 amp.

The refrigerating water temperatures resulted 12.5 deg. C at the entrance and 36.7 deg. C at the outlet; the water volume being 29.200 liters per minute.

The power dissipated in the refrigerating water was therefore:

$$4.18 \times \frac{29.2}{60} \times (36.7 - 12.5) = 49.2 \text{ kw}$$

and the efficiency:

$$\eta = 100 \frac{(76.5 - 49.2)}{76.5} = 35.7 \text{ per cent.}$$

The antenna resistance, which was measured with the added resistance method, was 2.55 ohms. The power given by the product of RI^2 would therefore be 22.7 kw, so that we obtained by this measurement an efficiency of 29.7 per cent.¹³ Due to the above mentioned reasons this value is in error being somewhat too small while the preceding one is slightly in excess, for the reason that we neglected the field coil and the other circuit losses.

(H) Tests were than made of the Rome-Torrenova 20-kw transmitter with two different regulating conditions corresponding to the 3rd and 4th tap of the power transformer primary.

The following table indicates the conditions and measurement results. The power furnished by the master oscillator to the power tube grid circuit was calculated by the method previously described.

The thermoelectric pyrometer method employed in the indirect power measurement of air-cooled vacuum tube transmitters.

Simultaneously, as a check, during the B measurement we determined the power dissipated in the triode by using both the thermoelectric pyrometer and the method described by Crossley and Page. An efficiency value of 19 per cent was obtained, while employing the increasing temperature method the efficiency was indicated at 21.5 per cent.

In consequence of other measurements performed with the same method we convinced ourselves that this method presents some difficulties in regard to the thermocouple calibration, so that it cannot give a greater accuracy than that of 10 per cent as indicated by the authors.

When quick and very precise measurements are requested, the direct photometric method is undoubtedly the better one to employ.

¹³ This value is in correspondence with that obtained by Jullien and Calvel in the measurement of the Eiffel Tower arc efficiency, *Annale des Postes et Telegraphes*, January, 1922.

TABLE I
MEASUREMENT OF EFFICIENCY OF THE ROME-TORRENOVA 20-KW SET ($\lambda = m$ 6500) OCT. 20, 1929.

Tap	Total effective grid voltage V	D-C grid voltage V	Grid current A	Drive tube plate current A	Pilot tube voltage V	Pilot tube plate power kw	Power tube plate current A	Power tube plate voltage V	Plate power of the power tube kw	Intermediate circuit h-f current A	Intermediate circuit resistance Ω	Intermediate circuit dissipated power kw	Antenna current A
	(1)	(2)	(3)	(4)	(5)	(6)	(7)	(8)	(9)	(10)	(11)	(12)	(13)
III	300	31.5	0.1	0.06	8050	0.48	1.55	8050	12.48	12	3.06	0.44	60
IV	300	31.5	0.1	0.06	9200	0.55	2 -	9200	18.4	18	3.06	0.99	75

TABLE I (Cont.)
MEASUREMENT OF EFFICIENCY OF THE ROME-TORRENOVA 20-KW SET ($\lambda = m$ 6500) OCT. 20, 1929.

Tap	Volume for anode refrigeration l/1'	Water temperature (anode issue) $^{\circ}$ C	Water temperature (anode entrance) $^{\circ}$ C	Plate heat dissipated power kw	Volume for grid refrigeration l/1'	Water temperature (grid issue) $^{\circ}$ C	Water temperature (grid entrance) $^{\circ}$ C	Grid heat dissipation power kw	Supplied power from 1st to 2nd stage kw	Useful power in the power tube (9) + (22) - (12) - (17) - (21) kw	Anode supplied power in the two stages (6) + (9) kw	Efficiency 100 ⁽²³⁾ / ₍₂₄₎ %
	(14)	(15)	(16)	(17)	(18)	(19)	(20)	(21)	(22)	(23)	(24)	(25)
III	12	26	18	6.7	3	20	18.7	0.27	0.024	5.09	12.96	39.3
IV	12	28	18.5	7.95	3	20	18.7	0.27	0.024	9.11	18.95	48.2



A NEW METHOD OF TESTING FOR DISTORTION IN AUDIO-FREQUENCY AMPLIFIERS*

By

HERBERT J. REICH

(Department of Electrical Engineering, University of Illinois, Urbana, Illinois)

Summary—A periodic voltage wave consisting of a series of straight lines is distorted into a series of curves when it passes through an amplifier which gives nonuniform amplification. As such distortion can very readily be detected visually with an oscillograph, it affords a means of testing for uniformity of amplification.

Mathematical analysis shows that a "saw-tooth" voltage wave is distorted into a series of exponential curves in passing through a resistance-capacity-coupled amplifier, the distortion being considerable at low audio frequencies if the coupling capacity or the grid-leak resistance is too small. The analysis proves that a falling off in amplification of less than 1/2 per cent at low audio frequencies can be detected with ease. In other types of amplifiers the distortion is not necessarily exponential, but curvature of the output wave is in general a sign of nonuniform amplification or phase shift. The method is applicable to the testing of any type of coupling circuit. The apparatus required for this method of testing is very readily constructed and is of general laboratory usefulness.

IN THE course of the development of a cathode-ray oscillograph using a linear time scale¹ it was necessary to use a resistance-capacity-coupled amplifier for amplifying a saw-tooth wave of the form shown in Fig. 1a. It was found that under certain conditions this wave was distorted into a series of exponential curves, as shown in Fig. 1b. Analysis of the input circuit of a stage of the amplifier showed this

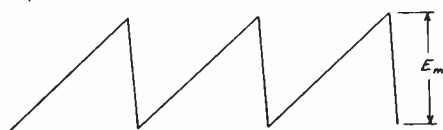

Fig. 1a.—Input saw-tooth wave.



Fig. 1b.—Output saw-tooth wave.

distortion to be caused by the combined action of the coupling capacity and the grid-leak resistance. The ease with which even a slight amount of such distortion may be detected visually by means of an oscillograph at once suggested the possibility of using it in testing for uniformity of amplification at low audio frequencies. It is the purpose of this paper to show that the distortion is an indication that the amplification drops off at low frequencies, and that this distortion may therefore be used

* Decimal classification: R263. Original manuscript received by the Institute, May 21, 1930. Revised manuscript received by the Institute, October 9, 1930.

¹ Bedell and Reich, "The oscilloscope, a stabilized cathode-ray oscillograph with linear time-axis," *Jour. A. I. E. E.*, 275, June, 1927.

in obtaining a quick indication of decreased amplification at low audio frequencies.

This method is of principal value at frequencies below 1000 cycles, and hence the input admittance of the tube at frequencies which will be considered is so low that no noticeable error will be introduced into the discussion by neglecting it. The amplification of the tube itself may safely be considered as constant for these frequencies. It may for simplicity be taken as unity or 100 per cent and the discussion limited to the attenuation caused by the input circuit.

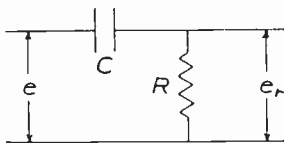

Fig. 2.—Simplified circuit of resistance-capacity-coupled amplifier.

Fig. 2 shows the simplified diagram of the input circuit. The differential equation for this circuit is

$$\frac{Q}{C} + R \frac{dQ}{dt} = e(t) \quad (1)$$

where,

$e(t)$ is the impressed voltage, and

Q the charge on the condenser at any instant.

The general solution of this equation for any periodic impressed voltage of period p gives for the output voltage $e_r(t)$ across the resistance R :

$$e_r(t) = \left[e(t) + \frac{1}{RC} \int_0^{t'} e(s) \epsilon^{(s-t')/RC} ds + \frac{\epsilon^{-t'/RC}}{RC(1 - \epsilon^{-p/RC})} \int_0^p e(s) \epsilon^{(s-p)/RC} ds \right] + A \epsilon^{-t/RC}. \quad (2)$$

The terms within the brackets are periodic with periodicity p , and therefore we define $t' = t - np$, n being the number of complete cycles which have taken place since the application of the impressed voltage at the time $t = 0$. The last term, in which A is an arbitrary constant, represents the starting transient, and must be evaluated for t , the actual value of time elapsed since the application of the voltage.

For a sinusoidal impressed voltage, $e = E_m \sin \omega t$, applied at the time $t = 0$, the solution reduces to

$$e_r(t) = \frac{E_m R}{Z} \sin(\omega t + \alpha) - \frac{E_m R}{Z} (\sin \alpha) \epsilon^{-t/RC} \quad (3)$$

where,

$$Z^2 = X^2 + R^2 = \frac{1}{\omega^2 C^2} + R^2$$

and,

$$\alpha = \tan^{-1} \frac{X}{R}.$$

The second term in (3) represents the starting transient and may be neglected in the discussion of steady conditions. The equation may therefore be simplified to

$$e_r(t) = E_m \frac{R}{Z} \sin(\omega t + \alpha). \quad (4)$$

Since both Z and α increase with a decrease of frequency, the attenuation and shift in phase are greater for low frequencies than for high. We thus have two causes of distortion in this circuit: change in attenuation and change in phase shift with change in frequency. The phase distortion is not ordinarily of great importance since with usual values of R and C the phase shift is negligible even for frequencies below 60 cycles. Unequal attenuation, or, considering the tube, unequal amplification of different frequencies, is usually undesirable. The test for this kind of distortion ordinarily consists in measuring the amplification of the amplifier for a number of frequencies distributed throughout the desired frequency range of the amplifier and plotting a curve from the data so obtained. This gives an accurate test, but takes considerable time and requires accurate instruments. When a precise quantitative test is not essential a quicker and simpler method should be of value.

If the applied voltage is not sinusoidal, but periodically increases at a uniform rate to a maximum value E_m in the period p , dropping instantaneously to zero at the end of the cycle, then the right side of (1) becomes

$$e(t) = kt' = \frac{E_m t'}{p} = E_m f_1 t' \quad (5)$$

in which f_1 is the fundamental frequency or reciprocal of the period, and as before,

$$p = \text{the period} \\ t' = t - np.$$

For such an applied voltage the general solution, (2), simplifies to

$$e_r(t) = E_m f_1 \left[RC - \frac{p \epsilon^{-t'/RC}}{1 - \epsilon^{-p/RC}} \right] + E_m f_1 \left[\frac{p}{1 - \epsilon^{-p/RC}} - RC \right] \epsilon^{-t/RC}. \quad (6)$$

The terms in the first brackets in this equation are periodic with periodicity p , and those within the second give the starting transient. Under steady conditions the transient is zero and

$$e_r(t) = E_m f_1 \left[RC - \frac{\epsilon^{-t'/RC}}{f_1(1 - \epsilon^{-1/f_1 RC})} \right]. \quad (7)$$

In Fig. 3a equation (7) has been plotted for a frequency of 50 cycles and a value of RC of 0.01 ohmfarads. In addition to being distorted into an exponential curve, the output is seen to be displaced downward with respect to the axis of zero voltage. That this is to be expected becomes evident from a purely physical analysis of the action of the circuit. At the beginning of the first cycle the condenser is uncharged and the resultant e.m.f. in the circuit is just that which is impressed. The condenser, therefore, charges throughout the first cycle. Since the impressed voltage drops instantaneously to zero at the end of the cycle there is no time for this charge to leak off before the commencement of the second cycle, and the value of the charge at every instant of the second cycle will be greater than at the corresponding instant in the first cycle. The average charge of the cycle will increase with each successive cycle until the potential across the condenser exceeds the applied voltage during such a part of the cycle that as much charge leaks off in this part as flows on during the remainder. The output voltage is lower than the impressed voltage by the amount of the potential across the condenser, and it is therefore evident that the output wave will be displaced with respect to the input. The charge, and hence the displacement, varies with the applied frequency and with R and C , approaching E_m as a limit as RC approaches zero.

Since we are interested mainly in the shape of the curve, it will be best to plot the difference between the voltage at any instant and that at the beginning of the cycle and thus neglect the displacement. From (7) we obtain

$$e_r(t) - e_r(np) = \frac{E_m}{1 - \epsilon^{-1/f_1 RC}} [1 - \epsilon^{-t'/RC}]. \quad (8)$$

An examination of this equation shows that at the end of each cycle, when $t' = p = 1/f_1$, the value of the output voltage has increased over that at the beginning by an amount E_m , which means that the output amplitude must always equal the input amplitude. This is not strictly

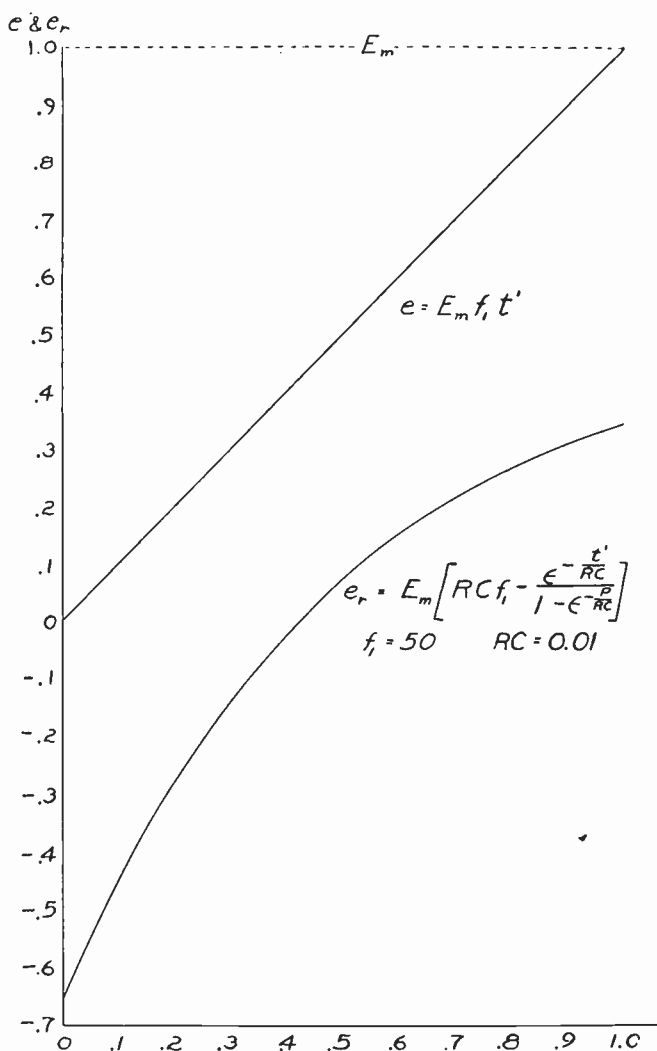

Fig. 3a.—Theoretical input and output saw-tooth waves; $f_1 = 50$ cycles, $RC = 0.01$ ohmfarads, $E_m = 1$.

true physically, especially for very low values of R or C , since as R or C becomes small other small resistances and capacities in the circuit which have been neglected become of importance. The effect of these is to reduce the output amplitude.

In Fig. 3b equation (8) has been plotted for a number of values of f_1RC which were used in the experimental work.

SUMMARY OF MATHEMATICAL ANALYSIS

It has been shown: (a) That if the saw-tooth wave, $e(t) = E_m f_1 t'$, is applied to the input circuit of a resistance-capacity-coupled amplifier it will be distorted into an exponential wave of the form given by (7). By Fourier analysis or by a rigorous discussion of the method used in obtaining the general solution given by (2), it may further be shown: (b) that this distortion is caused by unequal phase shifts and non-

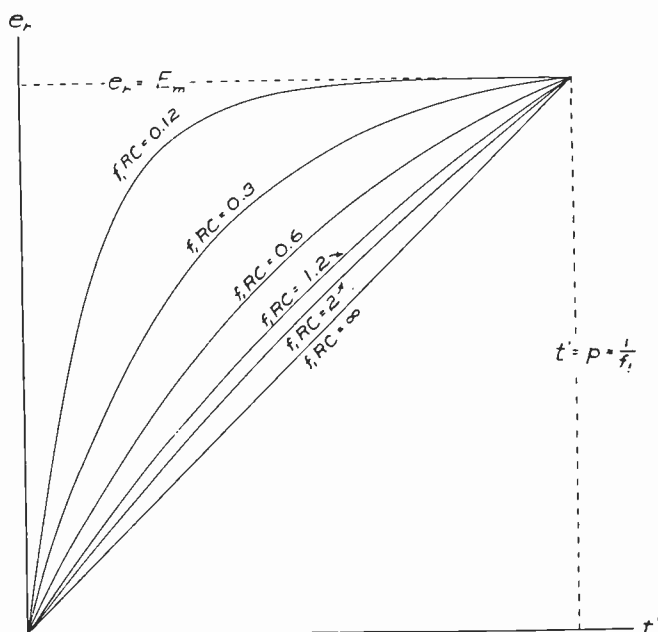

Fig. 3b.—Theoretical shape of output waves corresponding to periodic linear input voltage, $e = E_m f_1 t'$.

uniform amplification of the various harmonics contained in the impressed wave; (c) that the phase shift of any harmonic is the same as would be obtained for a sine wave of the same frequency as the harmonic if it alone were applied to the input; (d) that the relative amplification of the various harmonics is the same as would be obtained for sine waves of these same frequencies independently applied to the circuit.

It is evident, therefore, that instead of applying a series of frequencies to such an amplifier and measuring the amplification for each frequency, it is possible to test for uniformity of amplification at low audio frequencies by applying a periodic saw-tooth wave of the form $e(t) = E_m f_1 t'$, where f_1 , the fundamental frequency of the wave, is equal to

the lowest frequency which it is desired to amplify, and examining the output wave oscillographically. Distortion into an exponential wave is mainly a sign of insufficient amplification of the lower frequencies since phase displacement is negligible for values of R and C commonly used. It may readily be shown by Fourier analysis that the amplitude of any harmonic contained in the applied wave is inversely proportional to the order of the harmonic, and hence this test indicates principally whether or not the fundamental frequency of the applied wave is being amplified as much as the higher frequencies. When it is necessary to test for distortion at higher frequencies, an applied wave of greater fundamental frequency should be used. At the upper end of the audio-frequency range other types of distortion are likely to become important, and this test will indicate only the kind of distortion which has been discussed. Since with usual values of R and C this type of distortion is not likely to occur at frequencies above 1000 cycles, this method is of principal value at frequencies below this.

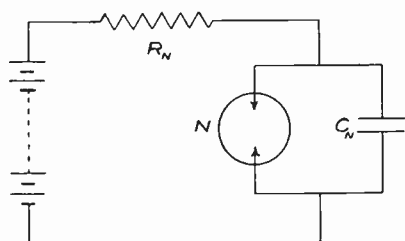

Fig. 4.—Simple neon tube oscillator circuit.

It is of interest to determine with what accuracy distortion can be detected by this method. It is seen by (3) that the amplification of a sine wave of frequency $f = \omega/2\pi$ is:

$$U = \frac{E_m \frac{R}{Z}}{E_m} = \frac{R}{Z} \quad (9)$$

This may be put into the form:

$$U = \sqrt{\frac{(2\pi fRC)^2}{1 + (2\pi fRC)^2}} \quad (10)$$

For large values of fRC , U approaches unity, and there is no distortion (neglecting other factors which may influence amplification at high frequencies). Fig. 3b shows, and it has been verified experimentally, that distortion of a saw-tooth wave may readily be detected for values of f_1RC less than or equal to 2. Substituting this value in (10), we find that the corresponding circuit amplification (neglecting the tube) is 0.9965. This means that a reduction of amplification of less than $\frac{1}{2}$ per

cent for a frequency equal to the fundamental frequency of the impressed saw-tooth wave may be detected.

EXPERIMENTAL PROCEDURE

The most satisfactory source of a saw-tooth voltage for this work is the neon tube oscillator.^{2,3} The simplest form of this device is shown in Fig. 4. It consists of a neon tube N , in parallel with a capacity C_n , connected through a high resistance R_n to a source of voltage higher

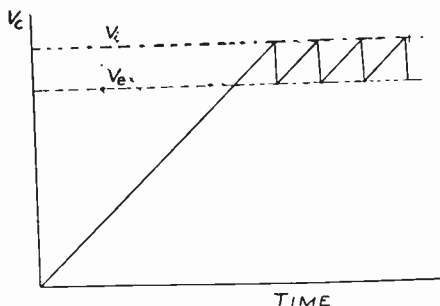

Fig. 5.—Voltage wave obtained with simple neon tube oscillator.

than the ignition potential of the tube. The action of the oscillator is as follows: As soon as the circuit is closed the condenser starts to charge. It continues to charge until the potential across its terminals equals the ignition potential of the neon tube, when the tube commences to glow. The resistance of a neon tube during discharge is very low, and hence the condenser is discharged very quickly to a point at

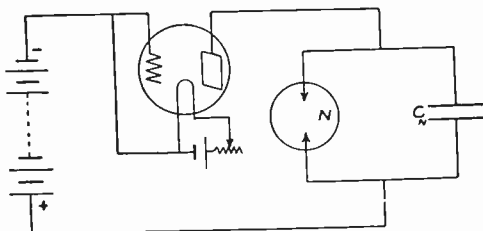

Fig. 6.—Improved neon tube oscillator circuit.

which the potential across its terminals equals the extinction potential of the tube, which is usually about ten or fifteen volts lower than the ignition potential. The tube then becomes nonconducting and the condenser again begins to charge. The potential across the condenser goes through a cycle consisting of a slow rise and a rapid drop, the frequency being inversely proportional to the resistance and the capacity, and also depending upon the applied voltage and the constants of the tube.

² Pearson and Anson, *Proc. Phys. Soc. (London)*, 34, 175 and 204, 1922.

³ Taylor and Clarkson, *Proc. Phys. Soc. (London)*, 36, 269, 1924.

As the rate of charging and discharging, and hence the terminal voltage of the condenser follows an exponential law, the voltage wave will consist of a series of exponential curves, as in Fig. 5.

If the resistance R_n , of Fig. 4, is replaced by a thermionic vacuum tube as shown in Fig. 6, and the applied voltage is made sufficiently high so that this tube is operated above voltage saturation, then the condenser charging current will be constant despite the relatively small variations of plate voltage throughout the cycle. The rate of charging will be constant, and hence the condenser potential will build up at a uniform rate. Discharge will still follow the exponential law. The resulting curve will be that shown in Fig. 7. The frequency may be varied either by changing the capacity of the condenser or by varying the filament current of the triode. Satisfactory saw-tooth waves of fre-

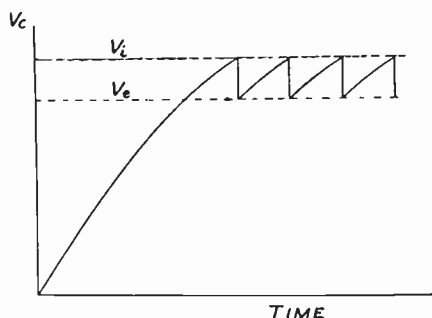

Fig. 7.—Voltage wave obtained with improved neon tube oscillator.

quencies varying from one in several minutes to six or seven thousand per second may be produced by this oscillator. The portion of the cycle taken up by the discharge of the condenser varies with the frequency and the constants of the neon tube and the circuit, but is seldom more than 10 per cent of the cycle, and can by proper adjustment be made less than 1 per cent.⁴

Fig. 8 shows the wiring diagram of the complete circuit used in this work. The apparatus to the left of the dotted line A-A' is the neon tube oscillator and its coupling tube. This portion of the apparatus is of frequent value in the laboratory, and was therefore built up in a unit. The 171 amplifier tube, V_1 , in addition to amplifying the output of the neon tube oscillator, makes possible the variation of amplitude of the saw-tooth wave by means of the potentiometer R_1 , and also insulates the neon tube and condenser from the amplifier which is being tested. The apparatus to the right of A-A' is the stage of resistance-capacity-coupled amplification which is being tested. If the input circuit of this stage were connected directly across the oscillator condenser without the intervening coupling tube, the condenser C , in series with the grid

⁴ See footnotes 2 and 3.

leak R , would be shunted across the neon tube condenser C_n , and would change the frequency. If the amplifier tube V_2 drew grid current the frequency would also be changed, and the saw-tooth wave would be distorted because the charging current of the oscillator condenser would no longer be constant. The coupling stage prevents these difficulties. The 171 tube was chosen because it can stand the relatively high grid swing without producing noticeable distortion due to curvature of the characteristic. (An oxide-filament 171-A tube was tried in place of the 171, but seemed to draw appreciable grid current, and therefore distorted the wave.)

A total B voltage of approximately 300 volts is necessary. Batteries preferably should be used, but a well-filtered full-wave eliminator will

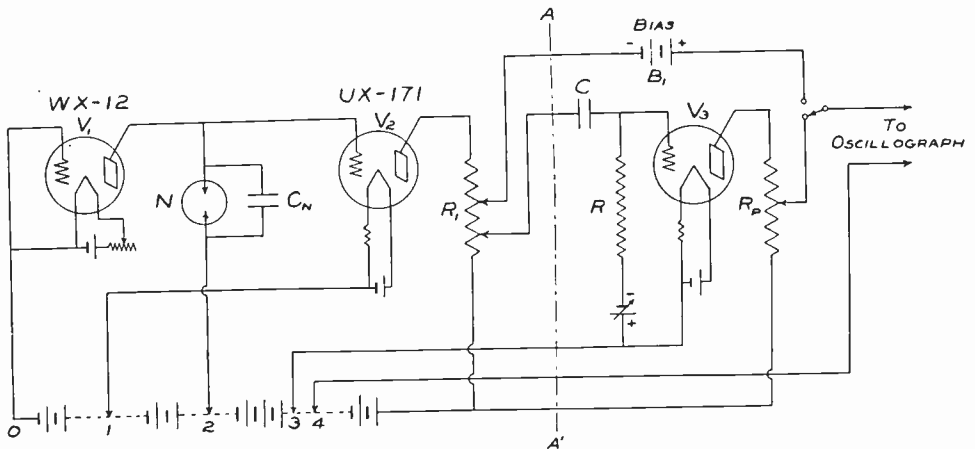

Fig. 8.—Complete wiring diagram for amplifier-testing set-up.

serve the purpose. The grid of the coupling tube is very sensitive to disturbances and if any appreciable ripple exists in the plate voltage supply the output of the oscillator will be distorted. The voltage 0-2 must be at least equal to the sum of the ignition potential of the neon tube plus the saturation plate voltage of V_1 . The latter is operated with very low values of filament current, and so the saturation value of the plate voltage is correspondingly low. About 175 volts is usually ample for 0-2. After 2 has been set, the voltage tap 1 is adjusted so as to apply the proper bias to the grid of V_2 . The proper setting is best determined by observing the output oscillographically. If the negative bias is too low, V_2 will draw grid current and will distort the wave or even prevent the neon tube circuit from oscillating; if it is too high, the output amplitude will be small and the wave will be distorted. It is obvious that the voltage 1-2 should be smaller than the average neon tube potential by an amount equal to the normal grid bias of V_2 . The position of tap 3 is ordinarily of little importance, since the coupling condenser and

the grid leak and biasing battery maintain the grid of V_3 at the correct potential. If it is desired, however, to short-circuit the coupling condenser and study the characteristics of a resistance-battery-coupled amplifier, tap 3 must be adjusted to give the correct grid bias to V_3 . Tap 4 varies the bias applied to the input of the oscillograph and is therefore used for centering the image on the screen. The oscillator condenser C_n should be as large as the desired frequency will permit in order to minimize the picking up of stray fields by the grid of the coupling tube. With proper adjustment of the coupling tube it is possible to obtain an undistorted wave over almost the entire range of frequencies produced by the oscillator.

The *stabilized oscilloscope*⁵ was used for both visual and photographic study of the input and output voltages. Its advantages for this type of work are that it is compact and easy to operate and that it responds equally well to all frequencies in the audible range. This instrument employs a Western Electric cathode-ray tube, and embodies apparatus for obtaining a linear time axis, so that the true wave-form is shown by the tube. In order to lock the timing oscillator into synchronism with the observed wave, a stage of amplification similar to the coupling stage V_2 was connected in parallel to V_3 , the output being applied to the oscilloscope by means of special terminals provided for that purpose on the instrument.

The lower slider of the potentiometer R_1 was adjusted so that the proper input was applied to the amplifier stage V_3 which was being tested. R_p was then set so that the amplifier output applied to the oscillograph had the correct amplitude, and the other slider of R_1 was adjusted so that for high frequencies the same amplitude of input wave was obtained on the oscillograph when the switch S was thrown. The biasing battery B_1 and the bias tap 4 of the main battery were adjusted to balance out the direct-current drops in the resistances R_1 and R_p . The telephone key-switch S made possible rapid change from input to output, so that a very accurate comparison could be obtained on the oscillograph. When the switch was snapped back and forth rapidly, persistence of vision made possible simultaneous examination of the two waves. Photographic records were made by holding bromide paper against the end of the oscillograph tube for exposures ranging from five to ten seconds.

In studying the distortion of sinusoidal voltages the neon tube oscillator was replaced by an audio-frequency vacuum tube oscillator. Standard multistage resistance-capacity-coupled amplifiers and a transformer-coupled amplifier were studied in the same manner as the single stage shown in Fig. 8 by connecting them to the coupling tube.

⁵ See footnote 1.

OSCILLOGRAMS

The oscillograms of Fig. 9 show the variation of amplification and phase shift with frequency and with coupling capacity. The three oscillograms in each horizontal row are for the same frequency and show the effect of change of coupling capacity; the four in each column are for the same coupling capacity and show the effect of change in frequency. In order to exaggerate the distortion sufficiently to make it visible in these oscillograms a grid leak of only 5000 ohms resistance

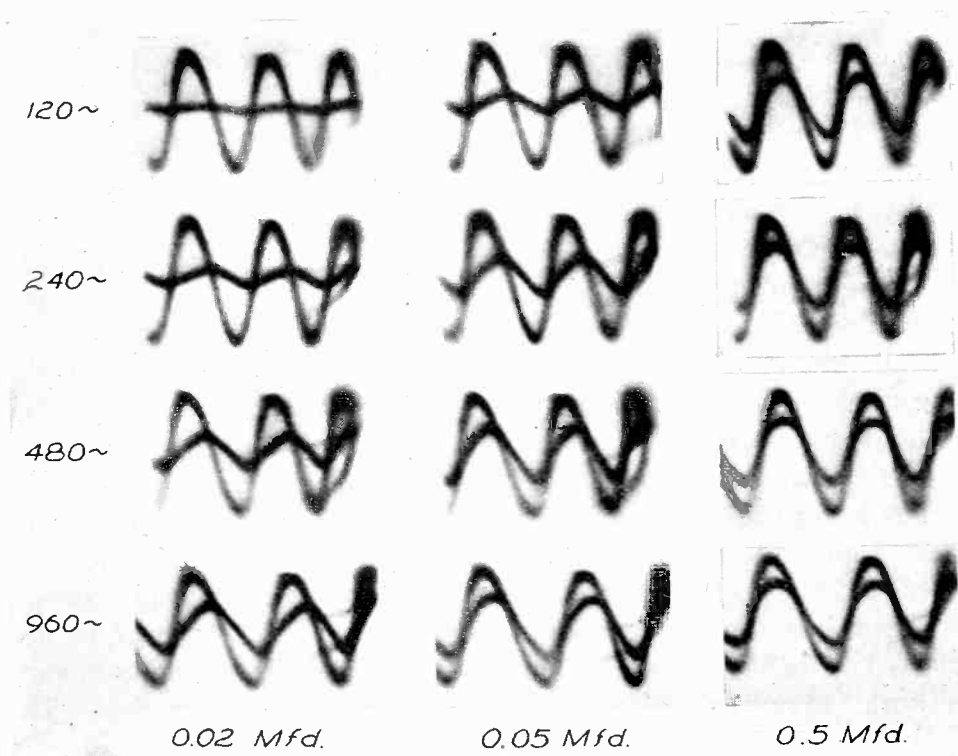

Fig. 9.—Oscillograms showing variation of amplification and phase shift of sine waves with frequency and with coupling-capacity; $R=5000$ ohms.

was used. The phase shifts and relative amplifications obtained agree within the accuracy of measurement with theoretical values. Since the oscillograms were obtained by holding the sensitized paper in direct contact with the cathode-ray tube, the direction of phase shift is reversed. (The output waves have the smaller amplitude.)

Fig. 10 shows the saw-tooth input and output voltages at 60 cycles for values of coupling capacity of $0.02 \mu\text{f}$, $0.05 \mu\text{f}$, and $0.5 \mu\text{f}$, with $1/4$ -megohm grid leak. The oscillograms in Fig. 11 are typical input and output waves at 30 cycles with $0.02\text{-}\mu\text{f}$ coupling capacity and $1/4$ -megohm grid leak. The relative amplitudes of input and output in Fig.

11 have no significance, since they were adjusted independently to convenient values.

The oscillograms obtained in applying the saw-tooth wave test to a stage of good transformer-coupled amplification appear in Fig. 12. The effect of overloading the tube is clearly visible in (a). (b) gives to

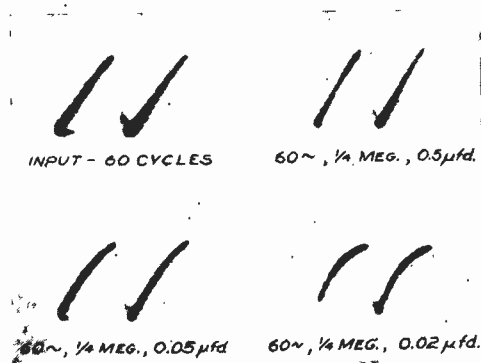

Fig. 10.—Oscillograms of input and output saw-tooth waves at 60 cycles; $R = 1/4$ megohm.

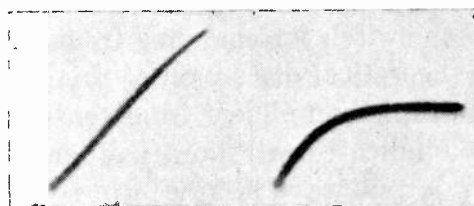

Fig. 11.—Oscillograms of input and output saw-tooth waves at 30 cycles; $R = 1/4$ megohm, $c = 0.02 \mu f$.

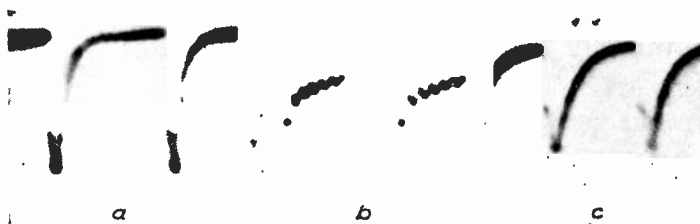

Fig. 12.—Oscillograms of output waves for transformer-coupled amplifier.

a larger voltage scale and smaller time scale the flat portion of (a), making visible transient oscillations above the point of overloading. (c) is taken under normal operating conditions for a 60-cycle input wave. The marked bending of the output wave is to be expected, since the amplification of low frequencies is not so good as with a resistance-coupled amplifier.

An interesting effect was observed in connection with the oscillograph. In order to prevent a permanent oscillograph deflection by the direct-current drops in the plate resistors an attempt was made to couple the oscillograph to the circuit through a condenser. As a grid leak is used across the input of the oscillograph this resulted in a circuit of the same form as the resistance-capacity-coupled amplifier and gave the same kind of distortion. Removal of the grid leak across the oscillograph plates failed to solve the difficulty, and it was found that the conductance between the plates caused by the electron stream acted in the same manner as the grid leak. Direct coupling with proper bias completely eliminated this effect.

CONCLUSIONS

The oscillograms of Figs. 10, 11, and 12 demonstrate the ease with which distortion may be detected by this method. Bending of the output wave is plainly visible for values of f_1RC as high as 2, for which the fundamental frequency is amplified by a factor of 0.9965 as compared to unity for an infinite frequency or for perfectly uniform amplification. Even greater accuracy is possible with visual oscillographic observation, using a key switch for changing from input to output. Although part of the theoretical discussion of this paper applies only to capacity-resistance-coupled amplifiers, an extension of the Fourier analysis which has been indicated will show that bending of a linear input wave into a curved output wave of any form is an indication of non-uniform amplification (or nonuniform phase shift). The method is therefore of value in testing any type of amplifier. The apparatus needed for this work is easily constructed and may be used for other purposes. Once it is at hand, an amplifier may be quickly and readily tested qualitatively for uniformity of amplification at low audio frequencies.

Oscillograms verify the theoretical curves of Fig. 3 and indicate that in order for a resistance-capacity-coupled amplifier to be suitable for undistorted amplification of saw-tooth and similar nonsinusoidal voltage waves of low frequency the coupling capacity and grid leak should be sufficiently large so that the product f_1RC , in which f_1 is the lowest frequency to be amplified, is not less than 6. Because of other types of distortion, however, this value may be unsatisfactory at high audio frequencies.

Because of the conductance between the control plates of a cathode-ray oscillograph tube, series capacity should not be used in coupling the oscillograph to the circuit under observation if high accuracy is desired. When it is necessary to use capacity coupling to isolate the os-

cillograph, care must be taken to insure that the condenser is sufficiently large to prevent distortion at low frequencies. If G represents the conductance between the control plates of the oscillograph tube, then f_1C/G should be not less than 6. The saw-tooth wave test may be used to advantage here by connecting the oscillograph directly to the output of the coupling tube V_2 .

A tuned grid-rectification detector uses essentially the same circuit as a resistance-capacity-coupled amplifier, and is subject to the same type of distortion for low modulation frequencies. The saw-tooth wave method has been used to advantage by Riichi Okada, a graduate student of this department, in comparing detectors using grid and plate rectification.⁶

The accuracy of the method which has been outlined arises partially from the ease with which distortion from a straight line can be detected by eye. An alternative method would be to apply to the amplifier any type of wave containing a large number of harmonics and to analyze the input and output oscillograms by means of a harmonic analyzer. The amplification characteristic could then be obtained from the ratios of output to input for the various harmonics.

In conclusion I wish to acknowledge my indebtedness to Prof. W. A. Hurwitz of the Department of Mathematics at Cornell University for a rigorous solution of the differential equation of the circuit for non-sinusoidal periodic impressed voltages.

⁶ Riichi Okada, "Oscillographic comparison of the characteristics of anode and grid rectification," Thesis submitted for the degree of Master of Science in Electrical Engineering, University of Illinois, 1930.



A RAPID METHOD OF ESTIMATING THE SIGNAL-TO-NOISE RATIO OF A HIGH GAIN RECEIVER*

BY

F. B. LLEWELLYN

(Bell Telephone Laboratories, New York City)

Summary—It is shown that a figure of merit for the signal-to-noise ratio in a receiving system is obtained directly by noting how much the total noise output increases when the input circuit is tuned through resonance, in the absence of signal. The effect of mismatching the antenna and input circuit impedances is discussed, and it is concluded that although a small improvement may be obtained in certain ideal cases by making the circuit impedance much higher than the antenna impedance, other considerations indicate that the matched impedance condition gives the best results in practice.

IN A recent issue¹ of the PROCEEDINGS of the Institute of Radio Engineers, the writer discussed some of the causes of noise in high gain radio receiving circuits and attached vacuum tubes. Still later,² Stuart Ballantine discussed certain aspects of this noise and described a complete and ingenious method for measuring the merit of a receiving system with regard to its signal-to-noise ratio.

In the Bell Telephone Laboratories we have approached the problem of classifying the signal-to-noise properties of receiving systems somewhat differently from Mr. Ballantine. The basis of our method of attack lies in the realization that there is a limit beyond which the noise in a receiving system may not be reduced and that the best signal-to-noise ratio possible for a fixed value of signal field strength bears a very definite relation to this limit of noise. For an illustration of this limiting relation the accompanying figure shows a receiving system in operating condition with antenna and input circuit attached to the grid of the first tube. The band width of the system is fixed by considerations other than noise and is as narrow as is consistent with the quality of reception desired. The input circuit causes a thermal noise voltage to be impressed on the grid of the first tube. Then, if the remainder of the circuits of the system contribute so little noise to the final output that the whole noise disappears when the input circuit is either detuned or short-circuited, it is evident that no further improvement in signal-to-noise ratio is possible with any radio set having the given input circuit,

* Decimal classification: R261.5. Original manuscript received by the Institute, November 3, 1930. Presented before Boston Section of the Institute, October 24, 1930.

¹ F. B. Llewellyn, "A study of noise in vacuum tubes and attached circuits," PROC. I.R.E., 18, 243-266; February, 1930.

² S. Ballantine, "Fluctuation noise in radio receivers," PROC. I.R.E., 18, 1377-1388; August, 1930.

and that an increase in the gain of the receiver will only cause the noise to increase in the same proportion as the signal.

An observation or measurement of the amount by which the total noise output is changed when the input circuit is tuned through resonance, furnishes a measure of the closeness to which the ideal "limit of noiselessness" (where practically all of the noise is furnished by the thermal agitation of electricity in the input circuit) has been approached.

Any noise originating at points in the circuit subsequent to the grid of the first tube, as for instance from thermal agitation in the plate circuit of the first tube, represents an addition to the noise without a corresponding increase in signal and consequently acts to decrease the signal-to-noise ratio. It is thus clear that if the gain secured in the first tube is sufficient to raise the noise voltage on its grid to a level far above that of the noise originating on its plate, or elsewhere in the circuit, then the signal-to-noise ratio of a set is fixed by the signal-to-noise ratio obtained in the input circuit alone for any given signal field strength.

The limit to be attained in signal-to-noise ratio in a radio receiving set by design of the set is therefore the ratio of the signal to the thermal noise of the input circuit.

If the signal-to-noise ratio of the input circuit alone were the same for all forms of input circuit, then the signal-to-noise capabilities of any set could be directly compared with any other set by comparing the relative increase in the noise in the two sets caused by tuning their respective input circuits through resonance. The signal-to-noise ratio of each set would be proportional to a fraction, the numerator of which gives the noise output of the set when the input circuit is tuned to resonance, and the denominator of which gives the noise output when the input circuit is detuned. Indeed this proceeding actually is allowable for practical purposes since the variations which are introduced by other elements of the amplifier are, in general, very much larger than those which can come from different forms of input circuit. The small effect on the measured ratio which can be caused by different forms of input circuit may be accounted for by the following considerations:

The source of noise in the input circuit of the type of set under discussion is the thermal agitation of electricity in the conductors which form the circuit. The effective mean-square noise voltage produced on the grid of the first tube is proportional to the resistive component of the impedance occurring between the grid and filament, when the input circuit and antenna³ are connected and properly tuned. The source of

³ In this discussion it is assumed that radiation resistance behaves like circuit resistance at the atmospheric temperature in regard to thermal noise, and when "static" is absent. This point is being checked.

the signal may be assumed to be a generator in series with the radiation resistance of the antenna. If the signal suffers attenuation in the network of the input circuit before becoming effective at the grid-filament terminals of the first tube, the signal-to-noise ratio is reduced below an otherwise possible value. These more involved cases are more rarely encountered in practice than the simple circuit where the antenna is directly coupled into a tuned input circuit.

The action of a simple input circuit depends upon the relative impedances of the circuit network and the antenna to which it is coupled. For example, if R_1 represents the radiation resistance of the antenna and R_2 the antiresonant resistance of the portion of a tuned circuit



Fig. 1

across which the antenna is tapped, as shown in the figure, then the signal-to-noise ratio across the grid of the first tube, and in the narrow frequency range passed by the whole receiver, may be expressed by⁴

$$\left| \frac{V}{N} \right|^2 \propto \frac{R_2}{R_1 + R_2}$$

where V is the mean signal voltage and N is the mean noise voltage.

This equation shows several interesting things. First, it is seen that the signal-to-noise ratio improves as R_2 is made larger and larger. In Fig. 1 this corresponds to moving the antenna tap nearer and nearer to the top of the antiresonant circuit. Such a proceeding cannot, however, be carried too far because of the following considerations: Imagine the tap to include the whole antiresonant circuit so that R_2 is as large as it is possible to make it. Under these conditions the impedance of the input circuit, as viewed from the grid of the first tube, is somewhat less than R_1 , the radiation resistance of the antenna, which can seldom be greater than two or three thousand ohms. In order to bring the noise from such a low resistance to a higher level than the noise

⁴ The signal voltage, V , is equal to $ER_2/(R_1+R_2)$ where E is the effective signal e.m.f. in the antenna. But E is proportional to the effective height which in turn is proportional to the square root of R_1 . The noise voltage is proportional to the square root of the resistance of R_1 and R_2 in parallel. In this argument antenna losses are neglected and absence of reactance is assumed to be assured by tuning.

originating in its plate circuits, the amplification of the first tube would have to be enormous; much higher than it is practically possible to produce. The favorable signal-to-noise ratio obtained in the input circuit accordingly would be spoiled by noise added in the plate circuit of the first tube.

Second, under the usual operating conditions the input circuit is adjusted so that the impedance of the input circuit matches the antenna impedance. When this state of things exists, R_1 and R_2 are equal, and the signal-to-noise ratio in the input circuit has been decreased some 3 db below the greatest possible ratio which was discussed above. Nevertheless, as viewed from the grid of the first tube, the input circuit offers a reasonably high value of resistance, since the tap for the antenna is now moved down nearer the lower end of the coil, and it has been found that the noise produced is sufficient to exceed the noise from the plate circuit of the first tube even when a practically attainable degree of amplification in the first stage is employed.

Any further reduction in R_2 by moving the tap still further down on the coil results in a reduction in signal and an increase in noise, since the resistance as viewed from the grid of the tube continues to increase as the tap is moved toward the bottom of the coil.

It would appear, as a result of these considerations, that the optimum signal condition, which is that obtained when the impedances are matched, is also the most practical condition under which to operate when signal-to-noise relations also are taken into account. The signal-to-noise energy ratio on the grid of the first tube under conditions of matched impedances is exactly one-half of the best signal-to-noise ratio obtainable under any conditions so that the ratio is independent of the exact form of input circuit and antenna employed, so long as the antenna resistance is mainly radiation resistance.

In the foregoing discussion, the antenna and the antiresonant circuit were assumed to be separately tuned. This assumption was made only for purposes of exposition, and the same conclusions hold when a detuned antenna is coupled into the antiresonant circuit which is then adjusted so as to tune the system as a whole. This is evident when it is remembered that the antenna resistance and reactance may be reduced to an equivalent impedance acting in series with the coil of the antiresonant circuit.

In the field, where optimum coupling is employed, so as to give the greatest signal voltage, signal-to-noise ratios are measured with the antenna disconnected in order to eliminate interfering signals and noises. The thermal noise of the circuit network forming the input is thus measured by tuning through resonance and noting the change in

noise output. Then the effect of the antenna is taken into account by reducing the result 3 db. In case there is too little gain in the receiver to measure or observe noise in the absence of a signal carrier, a local oscillator of the carrier frequency may be used to introduce an e. m. f. on the grid of the detector tube and thus beat in enough noise so that the effect of tuning the input circuit may be noted in the usual manner.

To recapitulate:

The signal-to-thermal noise ratio in the input circuit is the limit which can be reached in signal-to-noise ratio.

How near an actual set approaches this limit may be measured by observing the change in the total noise when the input circuit tuning is varied through resonance.

The signal-to-thermal noise ratio with an input circuit which is so coupled to the antenna and tuned as to give a maximum signal, is 3 db below the theoretical maximum obtainable.



OSCILLATION IN TUNED RADIO-FREQUENCY AMPLIFIERS*

BY

B. J. THOMPSON

(General Electric Company, Schenectady, New York)

Summary—The wide use of screen-grid tubes renders an understanding of the conditions for stability of tuned radio-frequency amplifiers important. In this paper the relation between the feed-back capacity and the other circuit and tube parameters at the threshold of instability is computed for one, two, three, and four stages. The form of the relation is found to be

$$C_0 = \frac{Ag^2}{\omega g_m},$$

where g is the conductance of the load circuit and plate resistance in parallel, assuming that all circuits are similar. The values of A are 2.0, 1.0, 0.764, and 0.667, respectively, for one, two, three, and four stages. It is found that the circuits are tuned so that the phase angle of each is approximately 45 deg. lagging, still including the plate resistance of the tube in the tuned circuit.

An experimental verification of the conditions for stability of a one-stage amplifier is described. The experimental value checks the theoretical value within the accuracy of the measurements.

INTRODUCTION

THE advent of the screen-grid tube has aroused interest in the conditions for stability in tuned radio-frequency amplifiers. The merit of the tube lies in its ability to give high amplification per stage in stable circuits without neutralization. It is important, therefore, that the conditions for stable amplification be understood in the design of both the tubes and the circuits.

In the ideal screen-grid tube,¹ the normal source of the feed-back which sets up the oscillations, the plate to grid capacity, is eliminated. In practical tubes this is not possible, of course, and the best that may be hoped is that the feed-back capacity is reduced to such a low value that oscillation will not occur. The problem here discussed is the determination of the relation between this feed-back capacity and the other tube and circuit parameters for the threshold conditions.

In the past four years, several writers have presented analyses of this problem. The present writer's justification for adding to this literature is his belief that these analyses are inadequate.

* Decimal classification: R132. Original manuscript received by the Institute, August 16, 1930.

¹ A. W. Hull and N. H. Williams, "Characteristics of shielded grid pliotrons," *Phys. Rev.*, 27, 432; April, 1926.

Beatty² has presented an interesting analysis of the amplification of a one-stage tuned-grid tuned-plate circuit. The method is largely graphical, but correct conclusions are drawn. The analysis, however, is strictly limited to one stage. Hull³ and, more lately, Nelson⁴ have analyzed the conditions for stability in terms of the maximum amplification per stage, ignoring the all-important effect of feed-back on amplification. Thomas⁵ and Beatty² have shown that the amplification

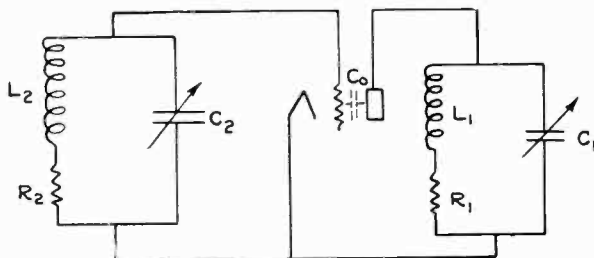

Fig. 1

may reach infinity at the threshold of instability. Nelson⁴ extended his analysis to two stages by a point-by-point method, and from these results set up a general expression for n stages. Even ignoring the fundamental error mentioned above, the latter expression is erroneous. The present writer in collaboration with another⁶ has presented the conditions for stability of a one-stage amplifier, but the derivation was not given.

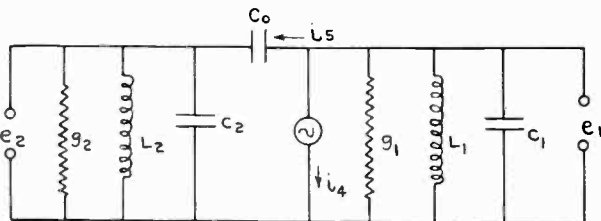

Fig. 2

FIRST CASE

The Single-Stage Amplifier

The simplest case is that of the single-stage tuned-grid tuned-plate circuit in which all of the feed-back takes place through the grid-

² R. T. Beatty, "The stability of the tuned-grid tuned-plate h.f. amplifier," *Exp. Wireless and Wireless Eng.*, 5, No. 52, p. 3; January, 1928.

³ A. W. Hull, "Measurements of high-frequency amplification with shielded-grid plotrons," *Phys. Rev.*, 27, 439; April, 1926.

⁴ J. R. Nelson, "Circuit analysis applied to the screen-grid tube," *Proc. I. R. E.*, 17, 320; February, 1929.

⁵ H. A. Thomas, "Retro-action in amplifiers," *Exp. Wireless and Wireless Eng.*, 5, No. 56, p. 245; May, 1928.

⁶ A. C. Rockwood and B. J. Thompson, "Application of the four-electrode receiving tube," a paper delivered before the Radio Club of America, Feb. 8, 1928, published, *Radio Eng.*, 8, July and August, 1928.

plate capacitance. For this and other reasons the analysis of this case will be made first.

Fig. 1 shows such a circuit, which may be represented as shown in Fig. 2.⁷ For ease in handling, g_1 and g_2 are treated as conductances having the values

$$g_1 = \frac{R_1}{\omega^2 L_1^2} + \frac{1}{r_p} \quad (1)$$

and

$$g_2 = \frac{R_2}{\omega^2 L_2^2} \quad (2)$$

where r_p is the internal resistance of the tube.

If e_2 is any voltage of the frequency $\omega/2\pi$ assumed to exist in the grid circuit, the power P_a consumed in this circuit to maintain the voltage is given by

$$P_a = e_2^2 g_2. \quad (3)$$

The condition for sustained self-oscillations is that

$$P_b = P_a \quad (4)$$

where P_b is the power fed back from the plate circuit to the grid circuit through the capacity C_0 .

If

$$e_1 = a + jb \quad (5)$$

and

$$i_5 = c + jd \quad (6)$$

then

$$P_b = ac + bd. \quad (7)$$

Now, it is apparent that

$$e_1 = - \frac{e_2 g_m}{g_1 + j\omega C_1 - j \frac{1}{\omega L_1}} \quad (8)$$

$$= - \frac{e_2 g_m}{g_1 \left(1 + j \frac{\omega C_1 - \frac{1}{\omega L_1}}{g_1} \right)} \quad (9)$$

$$= - \frac{e_2 g_m}{g_1 (1 + jt_1)} \quad (10)$$

⁷ For an explanation of the equivalence of these circuits see Appendix A.

where g_m is the mutual conductance of the tube and t_1 is the tangent of the phase angle between the current and voltage in the combined plate circuit. This neglects the loading effects of the input circuit on the output, which are truly negligible in screen-grid circuits. Rationalizing (10) gives

$$e_1 = -\frac{e_2 g_m (1 - jt_1)}{g_1 (1 + t_1^2)} \quad (11)$$

and separating the reals and imaginaries

$$e_1 = -\frac{e_2 g_m}{g_1 (1 + t_1^2)} + j \frac{e_2 g_m t_1}{g_1 (1 + t_1^2)} \quad (12)$$

$$= a + jb. \quad (5)$$

Now

$$i_5 = (e_1 - e_2)j\omega C_0 \quad (13)$$

which from (12) becomes

$$i_5 = -\frac{e_2 g_m t_1 \omega C_0}{g_1 (1 + t_1^2)} - j \left[\frac{e_2 g_m \omega C_0}{g_1 (1 + t_1^2)} + e_2 \omega C_0 \right] \quad (14)$$

$$= c + jd. \quad (6)$$

From (7)

$$P_b = \frac{e_2^2 g_m^2 \omega C_0 t_1}{g_1^2 (1 + t_1^2)^2} - \frac{e_2^2 g_m^2 \omega C_0 t_1}{g_1^2 (1 + t_1^2)^2} - \frac{e_2^2 g_m t_1 \omega C_0}{g_1 (1 + t_1^2)} \quad (15)$$

$$= -\frac{e_2^2 g_m t_1 \omega C_0}{g_1 (1 + t_1^2)}. \quad (16)$$

It follows from (3), (4), and (16) that

$$e_2^2 g_2 = -\frac{e_2^2 g_m t_1 \omega C_0}{g_1 (1 + t_1^2)} \quad (17)$$

or

$$C_0 = -\frac{g_1 g_2 (1 + t_1^2)}{g_m t_1 \omega}. \quad (18)$$

The above expression gives the minimum value of C_0 which will cause sustained oscillations for any value of t_1 . It remains only to determine the value of t_1 corresponding to the minimum value of C_0 .

By taking the derivative of C_0 which respect to t_1 , (18) becomes

$$\frac{dC_0}{dt_1} = \frac{g_1 g_2 (1 + t_1^2)}{g_m \omega t_1^2} - \frac{2g_1 g_2}{g_m \omega} \quad (19)$$

Equating (19) to zero,

$$\frac{2g_1g_2}{g_m\omega} = \frac{g_1g_2(1 + t_1^2)}{g_m\omega t_1^2} \quad (20)$$

or

$$\frac{1 + t_1^2}{t_1^2} = 2. \quad (21)$$

Hence

$$t_1 = \pm 1. \quad (22)$$

Substituting for t_1 in (18) shows that for $t_1 = +1$, C_0 must be negative,

hence

$$t_1 = -1 \quad (23)$$

is the condition for minimum C_0 .

From (18) and (23)

$$C_0 = \frac{2g_1g_2}{\omega g_m} \quad (24)$$

which is the minimum value of C_0 to cause sustained oscillations with two tuned circuits.

It is of interest to determine the phase angle t_2 of the grid circuit. Since the circuit is self-oscillatory

$$e_2g_2(1 + jt_2) = i_5 \quad (25)$$

$$= -\frac{e_2g_mt_1\omega C_0}{g_1(1 + t_1^2)} - j\left[\frac{e_2g_m\omega C_0}{g_1(1 + t_1^2)} + e_2\omega C_0\right]. \quad (26)$$

By substituting in the values of t_1 and C_0 from (23) and (24), (26) becomes

$$1 + jt_2 = 1 - j\left[1 + \frac{2g_1}{g_m}\right] \quad (27)$$

or

$$t_2 = -1 - \frac{2g_1}{g_m}. \quad (28)$$

Hence, the conclusion is reached that the limiting condition for stability of a single-stage tuned amplifier is that the feed-back capacity from plate to grid shall be less than $2g_1g_2/\omega g_m$, and that oscillations will occur most readily when the output circuit is tuned so that the current lags the voltage by 45 deg. and the input circuit is tuned so that there is a very slightly greater lag.

SECOND CASE

The Two-Stage Amplifier

The analysis for two stages, or three tuned circuits, is less simple than that of the first case, and, to the writer's knowledge, no strictly mathematical analysis of it has previously been published.

Fig. 3 shows the extension of Fig. 2 to fit the second case. It will be understood that the impedances Z_1 , Z_2 , and Z_3 represent the same type of circuits as shown in Fig. 2, and that

$$\frac{1}{Z_1} = g_1(1 + jt_1) \quad (29)$$

$$\frac{1}{Z_2} = g_2(1 + jt_2) \quad (30)$$

$$\frac{1}{Z_3} = g_3(1 + jt_3). \quad (31)$$

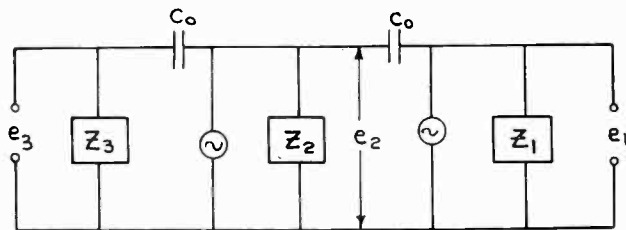

Fig. 3

By proceeding in a manner similar to that used by Beatty⁸ for the single stage and differing only in the method of inducing the voltage in Z_2 , it can be shown that⁹

$$e_1 = e_3 \frac{g_m^2 - \omega^2 C_0^2 - j2g_m \omega C_0}{g_1 g_2 (1 + jt_1)(1 + jt_2) + \omega^2 C_0^2 + jg_m \omega C_0}. \quad (32)$$

As Beatty points out, the second two terms in the numerator and the second term in the denominator are negligible, so that (32) becomes

$$e_1 = \frac{e_3 g_m^2}{g_1 g_2 (1 + jt_1)(1 + jt_2) + jg_m \omega C_0}. \quad (33)$$

Now, from (10)

$$e_1 = \frac{e_2 g_m}{g_1 (1 + jt_1)}.$$

⁸ See footnote 2.

⁹ For this derivation see Appendix B.

Hence, from (10) and (33)

$$e_2 = - \frac{e_3 g_m g_1 (1 + jt_1)}{g_1 g_2 (1 + jt_1)(1 + jt_2) + jg_m \omega C_0} \quad (34)$$

$$= - \frac{e_3 g_m}{g_2 (1 + jt_2) + j \frac{g_m \omega C_0}{g_1 (1 + jt_1)}} \quad (35)$$

If no feed-back exists, it is obvious that

$$e_2 = - \frac{e_3 g_m}{g_2 (1 + jt_2)} \quad (36)$$

which may be written

$$e_2 = - \frac{e_3 g_m}{y_2} \quad (37)$$

where y_2 is the admittance of the second circuit Z_2 . Hence, the second term in the denominator of (35) may be regarded as an additional admittance in parallel with y_2 due to the feed-back. It may then be said that

$$y_2' = g_2 (1 + jt_2) + j \frac{g_m \omega C_0}{g_1 (1 + jt_1)} \quad (38)$$

where y_2' is the apparent admittance of the second tuned circuit, including all feed-back effects from the first circuit. If y_2' is substituted for y_2 , the first circuit may be neglected as regards effects further ahead in the amplifier.

From (38) it may be written that

$$y_2' = g_2 + jg_2 t_2 + j \frac{g_m \omega C_0 (1 - jt_1)}{g_1 (1 + t_1^2)} \quad (39)$$

$$= g_2 + \frac{g_m \omega C_0 t_1}{g_1 (1 + t_1^2)} + j \left[g_2 t_2 + \frac{g_m \omega C_0}{g_1 (1 + t_1^2)} \right] \quad (40)$$

$$= \left[g_2 + \frac{g_m \omega C_0 t_1}{g_1 (1 + t_1^2)} \right] [1 + jt_2'] \quad (41)$$

$$= g_2' (1 + jt_2') \quad (42)$$

and

$$g_2' = g_2 + \frac{g_m \omega C_0 t_1}{g_1 (1 + t_1^2)} \quad (43)$$

where t_2' is the tangent of the phase angle of the apparent admittance y_2' , and g_2' is the apparent conductance.

Since it was shown that

$$C_0 = \frac{2g_1g_2}{\omega g_m} \quad (24)$$

for the threshold conditions, this may be rewritten to fit this case as

$$C_0 = \frac{2g_3g_2'}{\omega g_m} \quad (44)$$

By substituting for g_2' from (43), (44) becomes

$$C_0 = \frac{2g_3 \left[g_2 + \frac{g_m \omega C_0 t_1}{g_1(1+t_1^2)} \right]}{\omega g_m} \quad (45)$$

$$= \frac{2g_3g_2g_1(1+t_1^2) + g_m \omega C_0 t_1 2g_3}{\omega g_m g_1(1+t_1^2)} \quad (46)$$

$$= \frac{2g_3g_2g_1(1+t_1^2)}{\omega g_m g_1(1+t_1^2) - 2g_3g_m \omega t_1} \quad (47)$$

It now remains to determine the value of t_1 corresponding to the minimum value of C_0 . From (47)

$$\frac{\omega g_m}{2g_3g_2g_1} \frac{dC_0}{dt_1} = \frac{2t_1}{g_1 + g_1t_1^2 - 2g_3t_1} - \frac{(1+t_1^2)(2g_1t_1 - 2g_3)}{(g_1 + g_1t_1^2 - 2g_3t_1)^2} \quad (48)$$

$$= - \frac{2g_3t_1^2 + 2g_3}{(g_1 + g_1t_1^2 - 2g_3t_1)^2} \quad (49)$$

Equating (49) to zero,

$$- 2g_3t_1^2 + 2g_3 = 0 \quad (50)$$

from which it follows that

$$t_1^2 = 1 \quad (51)$$

and

$$t_1 = \pm 1. \quad (52)$$

Substituting the two possible values of t_1 in (47) shows that C_0 is minimum when

$$t_1 = -1. \quad (53)$$

By the substitution of this value of t_1 (47) becomes

$$C_0 = \frac{2g_3g_2g_1}{\omega g_m(g_1 + g_3)} \quad (54)$$

or

$$C_0 = \frac{2g_3g_2}{\omega g_m \left(1 + \frac{g_3}{g_1}\right)} \quad (55)$$

which is the minimum value of feed-back capacity which will place a two-stage amplifier on the threshold of instability. If it be assumed that $g_1 = g_2 = g_3 = g$, then

$$C_0 = \frac{g^2}{\omega g_m} \quad (56)$$

THIRD CASE

The Three-Stage Amplifier

The same method which was applied to the case of three tuned circuits will give a solution for the case of four tuned circuits. From (43) it may be written that

$$g_3' = g_3 + \frac{g_m \omega C_0 t_2'}{g_2'(1 + t_2'^2)} \quad (57)$$

where g_3' is the apparent conductance of the third circuit and g_2' and t_2' are as given before. Hence, from (43)

$$g_3' = g_3 + \frac{g_m \omega C_0 t_2'}{\left[g_2 + \frac{g_m \omega C_0 t_1}{g_1(1 + t_1^2)} \right] (1 + t_2'^2)} \quad (58)$$

Now

$$C_0 = \frac{2g_4g_3'}{\omega g_m} \quad (59)$$

$$= \frac{2g_4 \left[g_3 + \frac{g_m \omega C_0 t_2'}{\left[g_2 + \frac{g_m \omega C_0 t_1}{g_1(1 + t_1^2)} \right] (1 + t_2'^2)} \right]}{\omega g_m} \quad (60)$$

From (45) and (53) it is apparent that

$$t_2' = -1 \quad (61)$$

from which (60) becomes

$$C_0 = \frac{2g_4 \left[g_3 - \frac{g_m \omega C_0}{2 \left[g_2 + \frac{g_m \omega C_0 t_1}{g_1(1 + t_1^2)} \right]} \right]}{\omega g_m} \quad (62)$$

From (40) and (41)

$$t_2' = \frac{g_2 t_2 + \frac{g_m \omega C_0}{g_1(1+t_1^2)}}{g_2 + \frac{g_m \omega C_0 t_1}{g_1(1+t_1^2)}} \quad (63)$$

or, from (61) and (63),

$$-g_2 - \frac{g_m \omega C_0 t_1}{g_1(1+t_1^2)} = g_2 t_2 + \frac{g_m \omega C_0}{g_1(1+t_1^2)}. \quad (64)$$

By collecting the terms this becomes

$$g_2 g_1 (t_2 + t_2 t_1^2 + 1 + t_1^2) + g_m \omega C_0 (t_1 + 1) = 0. \quad (65)$$

Since C_0 is a function of g_3 and g_4 and, of course, g_2 and g_1 are not, it follows that both quantities in (65) must be zero for the sum to be zero in all cases. Then

$$t_1 + 1 = 0 \quad (66)$$

or

$$t_1 = -1 \quad (67)$$

and

$$2t_2 + 2 = 0 \quad (68)$$

or

$$t_2 = -1. \quad (69)$$

By substituting (67) in (62), it becomes

$$C_0 = \frac{2g_4 \left[g_3 - \frac{g_m \omega C_0}{2 \left(g_2 - \frac{g_m \omega C_0}{2g_1} \right)} \right]}{\omega g_m} \quad (70)$$

which becomes

$$\omega g_m C_0 = 2g_4 g_3 - \frac{2g_1 g_4 g_m \omega C_0}{2g_1 g_2 - g_m \omega C_0} \quad (71)$$

or

$$\omega^2 g_m^2 C_0^2 - 2\omega g_m C_0 (g_1 g_2 + g_4 g_3 + g_1 g_4) + 4g_1 g_2 g_3 g_4 = 0 \quad (72)$$

from which

$$\omega g_m C_0 = [(g_1 g_2 + g_4 g_3 + g_1 g_4)^2 - 4g_1 g_2 g_3 g_4]^{1/2} + g_1 g_2 + g_3 g_4 + g_1 g_4 \quad (73)$$

or

$$C_0 = \frac{[(g_1g_2 + g_4g_3 + g_1g_4)^2 - 4g_1g_2g_3g_4]^{1/2} + g_1g_2 + g_3g_4 + g_1g_4}{\omega g_m} \quad (74)$$

By assuming that

$$g_1 = g_2 = g_3 = g_4 = g \quad (75)$$

(74) becomes

$$C_0 = \frac{(\sqrt{5} + 3)g^2}{\omega g_m} \quad (76)$$

or

$$C_0 = \frac{0.764g^2}{\omega g_m} \quad (77)$$

or

$$= \frac{5.236g^2}{\omega g_m} \quad (78)$$

It is obvious that the first value is the proper root, which is the minimum value of feed-back capacity which will place a three-stage amplifier on the threshold of instability.

FOURTH CASE

The Four-Stage Amplifier

The case of five tuned circuits may be solved in the same manner as above. From (43)

$$g_4' = g_4 + \frac{g_m \omega C_0 t_3'}{g_3(1 + t_3'^2)} \quad (79)$$

$$= g_4 + \frac{g_m \omega C_0 t_3'}{\left[g_3 + \frac{g_m \omega C_0 t_2'}{\left[g_2 + \frac{g_m \omega C_0 t_1}{g_1(1 + t_1^2)} \right] (1 + t_2'^2)} \right] (1 + t_3'^2)} \quad (80)$$

Now

$$t_3' = t_2' = t_1 = -1 \quad (81)$$

for minimum C_0 , so that

$$g_4' = g_4 - \frac{g_m \omega C_0}{\left[2g_3 - \frac{g_m \omega C_0}{\left[g_2 - \frac{g_m \omega C_0}{2g_1} \right]} \right]} \quad (82)$$

Since

$$C_0 = \frac{2g_5g_4'}{\omega g_m} \quad (83)$$

$$\omega g_m C_0 = 2g_5g_4 - \frac{2g_5g_m\omega C_0}{\left[2g_3 - \frac{g_m\omega C_0}{\left[g_2 - \frac{g_m\omega C_0}{2g_1} \right]} \right]} \quad (84)$$

By assuming

$$g_5 = g_4 = g_3 = g_2 = g_1 = g \quad (85)$$

it can be shown that

$$C_0 = \frac{2g^2}{3\omega g_m} \quad (86)$$

which is the minimum value of feed-back capacity which will place a four-stage amplifier on the threshold of instability.

In all of the foregoing analyses for more than two tuned circuits, it is assumed that the amplifier does not go into oscillation in parts; that is, that the power losses are not supplied in any circuit at a lower feed-back capacity than that required to do so for the input circuit of the amplifier. Whether or not this will happen, and the value of feed-back capacity to cause it, may be determined by solving the amplifier circuit first as merely a two-circuit case, using the values of g_1 and g_2 , then as a three-circuit case, and then by steps until all circuits have been added, advancing from the output end. The lowest value of C_0 obtained is, of course, the value which will place the amplifier on the threshold of instability. If it be assumed that all circuits are similar this process is not necessary and the analysis, as presented, is complete.

EXPERIMENTAL VERIFICATION

It was desired to make an experimental verification of the minimum feed-back capacity to cause oscillations as determined in Case I, since the analysis for all other cases rests on this.

A very carefully shielded and filtered one-stage amplifier was made up. To go with this, a number of pairs of coils were wound, the coils of each pair being as similar as possible. These coils could be plugged into the amplifier as desired.

Using any given tube in the amplifier and any pair of coils, the values of voltages on the tube to cause oscillation at any frequency were determined. The frequency of the oscillations was determined with a

wavemeter. The impedance of the tuned circuits at this frequency was determined by the dynatron method,¹⁰ the same tube being used as the dynatron as was used as the amplifier in exactly the same circuit, with the exception of the readjustment of voltages. The mutual conductance and plate resistance of the tube were then determined at the same voltages as had been found to cause oscillations. Experimental tubes similar to the present RCA-232 were used in making this verification.

From the values of g_m , r_p , f , and Z_p the value of C_0 from (24) was computed for each tube. Then the value of C_0 was measured on two different test sets which were considered accurate. The results are presented in the accompanying table. It will be seen that the agreement

TABLE I

Tube No.	Coil No.	$f \times 10^{-5}$	$\omega \times 10^{-5}$	$Z_p \times 10^{-5}$	$g_m \times 10^5$	$r_p \times 10^{-5}$	$C_0 \times 10^{12}$ (Computed)	$C_0 \times 10^{12}$ Set No. 1	(Measured) Set No. 2
1	10	0.825	5.18	0.1950	600	0.480	0.0237	0.022	0.025
2	10	0.884	5.55	0.1946	650	0.480	0.0207	0.018	0.022
3	10	1.366	8.59	0.1722	450	0.800	0.0211	0.020	0.023
4	10	1.125	7.07	0.1855	640	0.720	0.0191	0.017	0.022
5	10	1.076	6.76	0.1870	410	1.000	0.0244	0.020	0.023
6	10	1.237	7.78	0.1807	440	0.930	0.0214	0.020	0.023
7	24	0.987	6.20	0.2145	450	0.900	0.0193	0.021	0.023
8	10	1.088	6.84	0.1866	440	0.840	0.0232	0.020	0.022
9	10	0.955	6.00	0.1925	600	0.300	0.0245	0.020	0.024
10	10	1.030	6.47	0.1892	510	0.400	0.0249	0.021	0.023
Average							0.0222	0.0199	0.0230

between the computed values and either group of measured values is as good as, or better than the agreement between the two groups of measured values. Considering the number of measurements required to determine C_0 from the formula, this may be considered a perfectly satisfactory verification.

OTHER SOURCES OF REGENERATION

In all of the foregoing analysis it has been assumed that all of the feed-back occurs through the plate to grid capacity of the vacuum tube. This is not strictly true, of course. However, in a carefully constructed amplifier, the effects of external feed-back are usually practically negligible. In any case, the measurement of the amount of external coupling between output and input is so difficult as to render any quantitative treatment of its effects useless. If an amplifier be designed conservatively on the basis of the equations given and shielded and filtered carefully, oscillation will not occur.

¹⁰ This method has great advantages for such measurements, both in convenience and accuracy. Since this was written a description of the method has been published. Hajime Inuma, "A method of measuring the radio-frequency resistance of an oscillatory circuit," Proc. I. R. E., 18, 537; March, 1930.

CONCLUSION

The values of feed-back capacity to place a tuned amplifier on the threshold of instability have been computed for one, two, three, and four stages. The form of the equation is found to be

$$C_0 = \frac{Ag^2}{\omega g_m}$$

when it is assumed that all circuits are similar. The values of A are shown in Table II.

TABLE II

Number of Stages	Value of A
1	2
2	1
3	0.764
4	0.667

ACKNOWLEDGMENT

The writer wishes to acknowledge the excellent work of Paul D. Zottu and J. R. Moore in making the experimental verification.

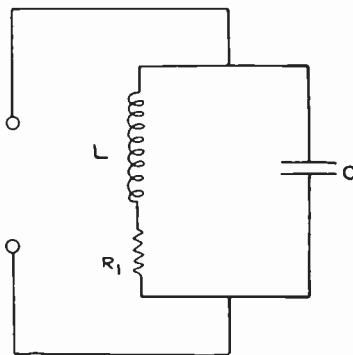

Fig. 4.

APPENDIX A

It is well known that a tuned circuit as represented in Fig. 4 is equivalent to the circuit as represented in Fig. 5 where

$$R_2 = \frac{L}{CR_1} \quad (87)$$

provided that R_1 is very small with respect to L . It is, however, felt that the treatment of the vacuum tube is original.

The customary expression for the output voltage e_p in terms of the input voltage e_o is as follows:

$$e_p = - \frac{\mu e_g \dot{Z}}{\dot{i}_p + \dot{Z}} \quad (88)$$

where \dot{Z} is the load impedance. Now

$$\mu = g_m r_p. \quad (89)$$

Substituting in this value of μ and dividing both numerator and denominator by $\dot{i}_p \dot{Z}$ result in

$$e_p = - \frac{g_m e_g}{\frac{1}{\dot{Z}} + \frac{1}{\dot{i}_p}} \quad (90)$$

or

$$e_p = - \frac{g_m e_g}{\dot{y} + \dot{g}_p} \quad (91)$$

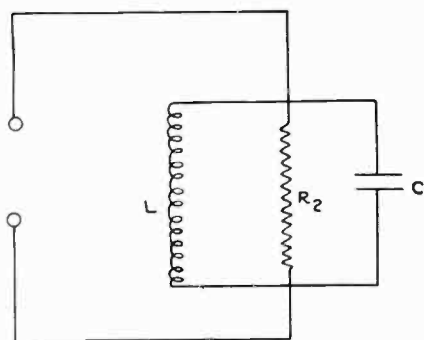

Fig. 5

where g_p is the internal plate conductance.

Since

$$\dot{y} = g + jb \quad (92)$$

(91) becomes

$$e_p = - \frac{g_m e_g}{(g + g_p) + jb} \quad (93)$$

The physical interpretation of (93) results in the interesting conception that a vacuum tube may be considered a constant-current generator, generating a current equal to $-e_g g_m$, and having a resistance equal to r_p shunted across its output terminals. The load is, of course, placed in parallel with this internal resistance. This conception is particularly useful in handling parallel load circuits, and in picturing the effects of variation in internal and load resistances in screen-grid tubes.

APPENDIX B

The derivation of (32) is here given to render this paper as complete as possible. The equivalent circuit is shown in Fig. 6. From Kirchoff's Laws

$$i_1 + i_2 + i_3 + i_4 + i_5 = 0 \quad (94)$$

or

$$e_1 \left(g_1 + j\omega C_1 - j\frac{1}{\omega L_1} \right) + e_2 g_m + (e_1 - e_2)j\omega C_0 = 0 \quad (95)$$

which may be rewritten

$$e_1 \left[g_1 + j\omega(C_1 + C_0) - j\frac{1}{\omega L_1} \right] + e_2(g_m - j\omega C_0) = 0 \quad (96)$$

or

$$e_1 g_1(1 + jt_1) + e_2(g_m - j\omega C_0) = 0 \quad (97)$$

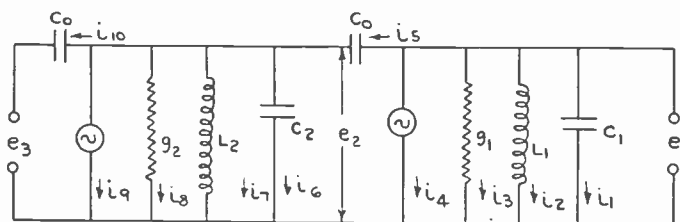

Fig. 6

Likewise

$$i_6 + i_7 + i_8 + i_9 + i_{10} - i_5 = 0 \quad (98)$$

or

$$e_2 \left(g_2 + j\omega C_2 - j\frac{1}{\omega L_2} \right) + e_3 g_m + (e_2 - e_3)j\omega C_0 - (e_1 - e_2)j\omega C_0 = 0 \quad (99)$$

which may be rewritten

$$e_2 \left[g_2 + j\omega(C_2 + C_0) - j\frac{1}{\omega L_2} \right] + e_3(g_m - j\omega C_0) - e_1 j\omega C_0 = 0 \quad (100)$$

or

$$e_2 g_2(1 + jt_2) + e_3(g_m - j\omega C_0) - e_1 j\omega C_0 = 0. \quad (101)$$

From (101)

$$e_2 = \frac{e_3(j\omega C_0 - g_m) + e_1 j\omega C_0}{g_2(1 + jt_2)} \quad (102)$$

and substituting this value of e_2 in (97) results in

$$e_1 g_1 (1 + jt_1) + (g_m - j\omega C_0) \frac{e_3 (j\omega C_0 - g_m) + e_1 j\omega C_0}{g_2 (1 + jt_2)} = 0 \quad (103)$$

Expanding this gives

$$g_1 (1 + jt_1) + \frac{e_3 (\omega^2 C_0^2 - g_m^2 + j2g_m \omega C_0) + e_1 (\omega^2 C_0^2 + jg_m \omega C_0)}{g_2 (1 + jt_2)} = 0 \quad (104)$$

and separating the terms

$$e_1 \left[g_1 (1 + jt_1) + \frac{\omega^2 C_0^2 + jg_m \omega C_0}{g_2 (1 + jt_2)} \right] - e_3 \left[\frac{g_m^2 - \omega^2 C_0^2 - j2g_m \omega C_0}{g_2 (1 + jt_2)} \right] = 0 \quad (105)$$

hence

$$e_1 = e_3 \frac{g_m^2 - \omega^2 C_0^2 - j2g_m \omega C_0}{g_1 g_2 (1 + jt_1) (1 + jt_2) + \omega^2 C_0^2 + jg_m \omega C_0} \quad (106)$$



THE DESIGN OF RADIO-FREQUENCY SIGNAL GENERATORS*

By

J. R. BIRD

(Formerly of the Crosley Radio Corporation; at present, Massachusetts Institute of Technology, Cambridge, Mass.)

Summary—Certain factors involved in designing signal generators free from stray voltage errors are considered. The importance of accounting for all circuit details, particularly of wiring elements, is stressed. The impedances of certain connections, particularly of the output connections from generator to measured receiver, are shown to be important. Shielding is considered in some detail.

INTRODUCTION

THE following discussion of radio-frequency signal generators is offered as a result of an attempt to build up a consistent picture of the important factors involved in designing such apparatus. While satisfactory treatment has been given to most phases of the subject, information seems generally lacking on the mechanical and electrical details of circuit design which determine the degree of accuracy with which apparatus of this sort translates a circuit diagram into operation. The conclusions to be outlined seem sufficiently comprehensive for our present accuracy requirements, and are capable of extension to the less important effects which will require attention when apparatus of greater precision can be used. It is realized that other general methods of treatment are effective and that there is room for considerable difference of opinion as to the relative importance of the effects involved, with the hope that further discussion will be forthcoming. The material naturally divides itself into two parts:

- (a) The general layout of receiver and signal generator to allow use of an accurately known r-f voltage assumed available at an attenuator, i.e., the stray voltage problem;
- (b) The design of generation, measurement, and attenuation circuits to supply such voltages.

The present discussion concerns part (a) only.

In sensitivity measurement work, we are faced usually with the problem of eliminating several extraneous signal sources of approximately the same frequency as the desired signal, and arising either by devious paths from the same source as the latter, or from external sources. With even the worst shielded of present day receivers, it is highly unlikely that interference of objectionable magnitude can enter

* Decimal classification: R355.9. Original manuscript received by the Institute, November 13, 1931.

by any path except the normal input terminals, or rather that such post-input pick-up can present a problem comparable to stray voltage sources in the antenna-ground circuit. Practically, it is necessary to consider only those sources of extraneous e.m.f. which produce at the input terminals voltages comparable in magnitude to the known e.m.f. from the standard source.

I. THE ANTENNA-GROUND CIRCUIT

The most important sources of extraneous voltages in the antenna-ground circuit are indicated in Fig. 1, where the attenuator output voltage e_a is shown, together with the voltages e_c , e_l , and e_b , representing

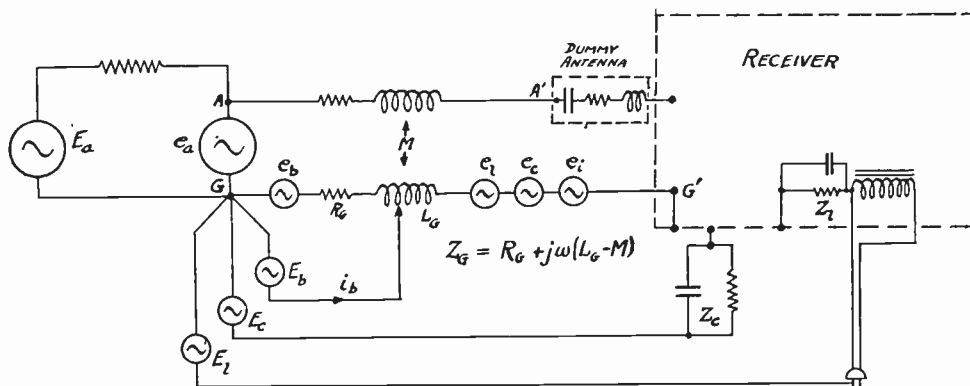

Fig. 1

stray e.m.f.'s arising from the oscillator or other high level apparatus associated with the attenuator, and the voltage e_i , generalizing magnetic pick-up in the antenna circuit. Although the voltages e_a , e_c , e_l , and e_b arise from the same oscillator, they are practically independent of each other and may be thought of as entirely separate e.m.f.'s. The attenuator output is shown localized between the points A and G, and the other voltages are referred, for convenience, to the point G. The significance of the various voltages is given as follows:

- e_a —A known r-f voltage produced by an attenuator, and localized between points A and G, on the generator.
- E_l —Stray voltage produced between the a-c line cord of the receiver, if a-c operated, and point G, either because of direct connection or inductive action between generator and the a-c supply lines, or because of voltages from other sources on the a-c line.
- e_l —Resulting voltage in the antenna-ground circuit.
- e_i —General e.m.f. representing magnetic pick-up in the antenna-ground lead loop, from stray fields of the generator or of other sources.

E_c —A general e.m.f. representing a number of stray voltages arising between point G and the generator case, (assuming some sort of metal cover), its external connections and apparatus, and affecting the receiver on account of the impedance Z_c between receiver chassis, batteries, speakers, etc., and the apparatus mentioned.

e_c —Resulting voltage in the antenna-ground circuit.

e_b —The drop produced by the current i_b , which is a generalization of filter by-pass currents which may be returned through some part of the impedance Z_G of the ground lead.

The e.m.f.'s e_l and e_c , it is evident, arise on account of the impedance of the ground lead to the receiver. The e.m.f. developed in the antenna ground circuit is determined by the voltages E_l , E_c and the relative impedances of Z_c , Z_l and the ground lead. The values of Z_c can be made low by body conductance and capacity effects of the operator. However, the most troublesome stray voltages are those represented by e_l , for a-c receivers, because of the relatively high capacity between power transformer primary and chassis.

Since the impedances Z_l and Z_c are comparatively high, the extraneous voltage developed is practically proportional to the impedance Z_G , defined, for this discussion, as the inverse ratio of the current along the ground lead, to the resulting voltage between A' and G' .

$$Z_G = R_G + j\omega(L_G - M).$$

Measures should be taken to reduce the lead impedance, which is mainly inductive, either as a primary remedy for pick-up of the types under discussion or as a precautionary measure when the voltages E_c and E_l have been reduced as far as possible. Successful methods of reducing the equivalent impedance require placing the antenna and ground leads in close proximity, to make use of the mutual inductance between leads to counteract the self-inductive drop along the ground lead. Possibilities for reducing inductance with paired leads are rather limited, but a concentric construction using the outer tube as the ground lead offers considerable advantages. For ideal cases of exact concentricity, uniform current distribution and so forth the equivalent inductance, $(L_G - M)$, of Z_G is zero, since all flux produced by current in the tube links with the core conductor. A practical antenna-ground lead construction, found quite useful, consists of braided copper sleeving, for the ground lead, enclosing a small No. 20 wire for the antenna.

Although the equivalent inductance of Z_G , for various reasons, is not zero, it is of the order of three per cent of that resulting from interchanging tube and core, or of that obtained with paired conductors normally insulated. For example, the measured reactance of Z_G , per inch,

for paired No. 20 wires, (wire diameter 0.032 in., spacing 0.078 in.) at 1000 kc is approximately 0.050 ohm. A measurement on the construction using a Beldenbraided tube over No. 20 insulated wire, (0.078 in. over insulation) yielded Z_G per inch = 0.0013 ohm. An added advantage of close coupled leads is the reduction of induced voltages e_i from stray magnetic fields around the leads, or in the possibility of trouble from this source if such fields are thought to be eliminated. In cases where the added capacity of such concentric leads becomes too large, the dummy antenna should be located at the receiver end of the leads, where, from other considerations, it probably belongs. The lead capacity then appears only across the attenuator output impedance.

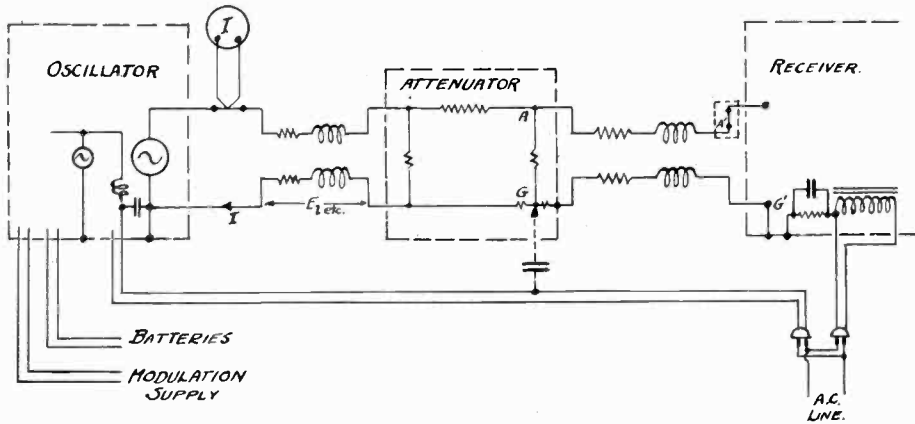

Fig. 2.

It will be noticed in the following that voltages of the e_i sort drop out of the picture, and attention is concentrated most on e_a , e_b , and e_c . This results naturally from experience with carefully arranged input leads. Under this condition, even in working with the most sensitive receivers at broadcast frequencies, there appears little necessity for shielded measurement booths and similar precautions, (except in the case of loop receivers). The problem usually resolves into relations between the signal generator components, affecting the magnitude of voltages of the types E_a , E_b , and E_c . Reactance drops along connections within the signal generator, along circuit elements usually neglected in forming circuit diagrams, are again of great importance. This is true for strays both from the generator itself and from outside sources.

II. GENERATOR LAYOUT

The production of accurately known small voltages at e_a , accompanied by as little as possible of the undesired effects represented by e_b , e_c , e_l , e_i , depends closely on the mechanical arrangement of the units which make up a signal generator design. A diagram, such as Fig. 2,

showing the essential general features of a generator layout, will be helpful in analyzing design requirements.

A simple outfit which will operate to produce r-f voltages for receiver measurement may take the general form of Fig. 2, and will comprise a radio-frequency oscillator of some sort, with perhaps an amplifier succeeding it, and supplying current through a measuring instrument to the input of an attenuator. The latter, shown as a resistance network, would be expected to produce, for a given input, voltages calculable from d-c resistance perhaps, or certainly from measured r-f values of the network constants. The oscillator naturally would be shielded and the necessary external leads by-passed to the oscillator shield, which connects to the low side of the output circuit. For the moment we may assume the shielding and internal filtering perfect. For mechanical and electrical reasons, the oscillator apparatus would necessarily be spaced some small distance from the point G . Twelve inches is a reasonable lower limit on the effective length of leads between oscillator and attenuator. The lead impedance, even at the lowest value attainable with the concentric construction, will be so large that the drop along the ground lead to the oscillator will produce trouble of the e_c and e_l types mentioned before.

Examples		
Construction	L_∞ Per Inch One Lead	Inductive Drop ($I = 10$ ma at 1500 kc) Microvolts
Paired No. 20 wires 12 in. long, $D/d = 2.44$	$8. \times 10^{-3} \mu\text{h}$	9000
Paired wires 12 in. long, $D/d = 1$	$3.6 \times 10^{-3} \mu\text{h}$	4000
Braid over No. 20 wire 12 in. long, $a_2/a_1 = 2.44$	$2.1 \times 10^{-4} \mu\text{h}$	230

The lowest values of lead drop attainable may be of the order of a millivolt. To eliminate the effects of this voltage, the first step results in a capacity shield, grounded to G and surrounding but insulated from the oscillator, its purpose being primarily to reduce the effective capacity between receiver chassis and oscillator, or, to reduce E_c to zero. A necessary second step is the addition of another section or two of low-pass filter in each of the leads emerging from the oscillator, the filter

shunt elements being returned to G . Assuming these filters effective, the external apparatus of the generator is disposed so that effects of the e_c and e_t type are eliminated.

The System Reference Point

Generalizing, we can say that the object of signal generation design should be to make the point G , at the low end of the attenuator output, and originally, in Fig. 1, chosen merely as one of several logical reference points, a ground point for the entire system to which the attenuator output voltage is referred, and to which, as far as possible, the potentials of the external generator apparatus are brought.

There are definite reasons for designing the apparatus this way. If similar apparatus were designed for work at much lower frequencies, the ordinary reasoning would assume the oscillator case at the same potential as G , and because of the lower values of ground connection impedances, the assumption would be correct; but at the broadcast frequencies, conductor impedances ordinarily neglected become finite, and considerable, when work at two highly different power levels is attempted. From the standpoint of either input or output circuit alone the impedance between various points on a single massive conductor, or of short leads, say two inches long, between a set of terminals is usually negligible. But when such impedances are common to circuits in which the normal power levels differ by 80 db an entirely different situation prevails at radio frequencies. Some good is done by reducing point-to-point impedances in the ground circuits, but the ultimate solution lies in so disposing the circuits that impedances which remain are not mutual to circuits operating at widely different power levels.

It is now proposed to offer reasons why the object of shielding and lead filtering should be to bring to exactly the potential of G , to be called ground potential henceforward, all external parts of the generator and all connections to other apparatus. Really all that is necessary is an analysis of a circuit diagram showing representative self and mutual impedances in their approximate true magnitude. Failing in this, recourse may be had to equivalent generalizations.

The attenuator output voltage will be produced between definite points or terminals on the attenuator. To accomplish the purpose of the measurement set-up, the antenna and ground terminals of the receiver must have corresponding potentials. Since the self-impedance of the receiver input leads can be made negligible in comparison with the receiver input impedance, the potentials of A and A' , G and G' will differ appreciably only when currents larger than the normal input current to the receiver are allowed to flow through all or part of the lead imped-

ances. Some ways in which such currents arise have been outlined above, and the remedy indicated in methods which bring generator case and external leads nearly to the potential of G . These methods, as far as the leads are concerned, will involve the use of low-pass choke and condenser filters. In grounding the shunt sections of these filters, care must be taken that the shunted currents do not flow through any small impedance common to the antenna ground circuit. This means that the filter returns must be brought to some point to the left of G in Fig. 2. On the other hand, the impedance drop in the low side attenuator connections and input lead, which carry relatively large currents, tends to defeat the purpose of the filtering, if the filter shunts are returned to points too far from G on that side.

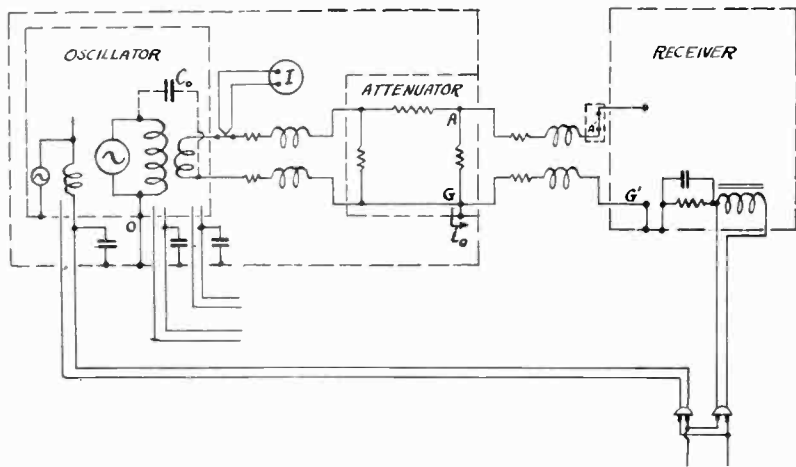

Fig. 3

The limits of the process would have all filter returns made exactly to G , the dimensions of this terminal being so small that it might be considered an equipotential surface. In designing generators to work with broadcast receivers of the highest present day sensitivities a practical limit is easily reached when the final by-pass condensers in the filter ladders connect either to a high conductivity external case which in turn is solidly grounded by very short leads (less than two inches) to the resistance terminal which is G , or have individual short leads to G . In the former instance, the filter currents produce along the case and in the short lead to G , a drop which may be of the order of ten microvolts, a value certainly not objectionable for E_c of Fig. 1. The second arrangement tends toward the ideal case of exact single point grounding, and is inherently better, so that the way is clear if more stringent requirements demand that the case be more nearly at ground potential and more free from stray filter currents. In practically every arrangement,

the ground lead to the receiver must be brought out independently, from G , and insulated from the generator case.

The arrangement of Fig. 2 has been chosen to illustrate the principal source of interference voltages from the generator, i.e., the drop along the return lead between oscillator and attenuator. Obviously a transformer may be used to advantage in coupling the attenuator input to the oscillator, since then independent ground connections, free of large currents, can be made between G and the oscillator ground. Fig. 3 illustrates this. Currents in the connection between G and O will be of secondary magnitude, arising as shown from the by-passed filter currents, and from the stray capacity C_0 , so that considerable latitude is allowed in disposing by-pass shunt connections. The metal external shield may be used as outlined above for this connection. The capacity C_0 can be particularly troublesome. Although it is very small, the voltages acting run high into the volt order, and the resulting component of i_0 may flow through impedances common to the antenna circuit. A static shield around the coupling coil, connected to O , is effective in reducing C_0 , and can be simply arranged. The errors produced of course depend on the arrangement of the conductors shown connecting to G . However, transformer coupling at this point, with the third conductor between ground points, is inherently far superior to direct connection.

Shielding Arrangements

Having provided an external shield around attenuator and shielded oscillator, it might be argued that the oscillator shield can well be dispensed with. Such an arrangement can be made to work satisfactorily at low oscillator power levels, by careful design of the oscillator apparatus. In particular the oscillator apparatus must all be insulated from the external shield so that the latter carries only shielding currents. But the original purpose of the oscillator shield was to prevent the induction by stray fields of voltages in the attenuator circuits and in those sections of the a-c line leads, etc., beyond the filter shunts. To accomplish this, the most logical way is to confine the powerful static and magnetic fields from the oscillator to a particular locality inside the generator, and to restrict the size of this region by including in it only essential r-f components. Even for the purpose of the oscillator shield a single metal box cannot be entirely satisfactory. To realize the condition of perfect oscillator shielding assumed above, i.e., all electric and magnetic fields confined to the shield interior, it is essential that some form of multiple shielding be employed. In an assembly of tube, coils, and condensers inside a metal box, capacities of the order of ten to fifty

$\mu\mu\text{f}$ may be expected between the shield and parts at high r-f potentials. This capacity, particularly at the high frequencies, will cause considerable currents to return through the shield, which, naturally, produces external fields. The double shield in some form is the means adopted to confine stray fields within the outer.

Fig. 4 represents several possible shielding arrangements, proceeding from the worst toward an ideal design. The general unworkability of (a) leads to (b), and certain difficulties with the latter, mentioned above, are cured in (d). Arrangement (c) might be considered in place of (d), from the cost standpoint. Finally (e) represents an arrange-

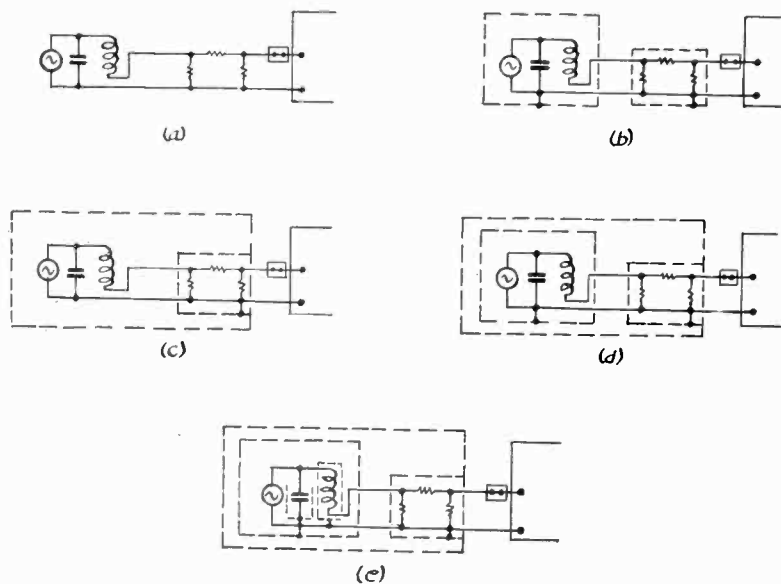

Fig. 4

ment whereby stray fields can be practically eliminated outside the oscillator and attenuator shields, and of course beyond the general shield.

The last three arrangements have in common the external metallic case connected to G . For a high standard of performance, with high safety factors, the multiple shielded designs will certainly have greater possibilities, and where careful internal shielding is applied only to those parts essentially at high power levels, costs, for a given performance, can usually be made less than with brute force over-all shielding.

III. METHODS OF ELIMINATING STRAY VOLTAGES

It may be said that the great majority of errors in radio-frequency attenuator work result from stray inductance effects, self and mutual, rather than from capacity or resistance effects. The reason lies inher-

ently in the choice of low impedance levels for the attenuator circuits, or in other words, the use of relatively high currents and low impedances to produce the required maximum output voltages. Two factors combine to prevent a shift to higher impedance attenuator circuits, where a better balance between inductive and capacitive errors could be attained. These are:

- (1) Limitations opposed to the use of lower range thermocouples;
- (2) The output impedance of the attenuator network must not exceed limits depending on the antenna circuit of the receiver under test.

The more difficult problem of eliminating stray inductance errors by shielding and by mechanical arrangement of conductors must be undertaken. The following remarks emphasize the effectiveness of proper arrangement of circuit elements, as against elaborate shielding precautions.

Stray Magnetic Fields

Consideration is here given to eliminating mutual inductances between high and low level circuits, as regards both the direct production of the strays e_i in the output circuit, and also contribution to E_1 , E_c , etc., from this cause. Mention of high and low level circuits is made to emphasize the fact that certain circuits, because either of the high currents carried, or of their extremely low normal voltages, warrant special consideration. Concentration of effort on such circuits produces results economically. This involves:

- (a) Reducing the self and mutual inductances of these circuits when they are not necessarily inductive, the method being non-inductive wiring arrangement.
- (b) Effective shielding or astatic construction for inductive elements, with general shielding covers to care for remaining stray fields.

The consistent application of (a) above, to the smallest details of the wiring, is vital to good attenuator design. Elsewhere, it is a factor requiring concentric lead construction for the receiver antenna circuit, and the attenuator input circuit. Some care must be given to battery, a-c line, and other circuits emerging from the generator, so that line filters may not be rendered useless.

Oscillator and amplifier tuning coils and chokes are inductors requiring special attention. Probably the best solution is one of the astatic winding methods, the D coil, toroid, or figure-eight for instance, which have inherently very little field at reasonable distances from the coil, particularly in certain directions. Where shielding is used, high

conductance enclosing loops, effective because of the induced currents, are standard at the broadcast frequencies. Using proportions adopted from the work of receiver designers, shields may be expected to reduce stray fields from the coil to the same order of magnitude as those from circuit wiring, or perhaps to two per cent of the fields from the unshielded coil. With coil fields thus reduced, a shield for the entire oscillator may be made using much less weight of metal than would be required otherwise.

The effectiveness of metallic shielding from the magnetic standpoint depends on the conductance offered to the induced currents. The fields behave like liquids in finding ways through small openings, so that it is useless to employ heavy metallic shielding without adequate provision for sealing the joints along which the shield must be opened, and for eliminating other gaps. It will usually be found that stray fields are produced outside the shielding only when two openings are provided, (or two parts of a large opening) between which the internal m.m.f. causes the flux to pass. In some cases where a single heavy shield, well joined, would be considered adequate, it might be found simpler to construct double shields of light material with less care in making joints, so staggering the openings that fields beyond the outer are eliminated. Considered from the standpoint of eliminating fields beyond the main generator shield, the above is another point in favor of an internal shield around the oscillator apparatus.

Stray Electrostatic Fields

The definition of point G as the ground point for the system simplifies the consideration of capacity errors in attenuator operation. One form of such trouble has been illustrated in the stray capacity between coupling coil and plate circuit, Fig. 3. The remedy has been indicated; a metallic screen placed between the parts involved and connected to G . The method is general and its application much simpler than that of magnetic shielding for two reasons:

- (a) The reactances of the stray capacities, even in attenuators where circuits at widely different power levels are placed close together, are so high in comparison to impedances to ground that serious trouble is unlikely. This, of course, results from using low impedance attenuators.
- (b) Capacities which exist may be effectively eliminated by inserting metallic shields or screens, not necessarily of high conductance or close joining.

In general, an outfit sufficiently shielded to eliminate magnetic cou-

pling errors can very easily be made satisfactory from the electrostatic standpoint by connecting the shields to the proper ground points.

Conductive Coupling; Wiring Impedances

Sufficient has been said to indicate that in attenuator work, attention must be devoted to the exact details of circuit wiring, remembering that many conductor impedances ordinarily neglected in drawing circuit diagrams must be considered if a true picture of the signal generator is desired.

A point having considerable to do with the effectiveness of oscillator shielding is the use of the shield as a return path for various cur-

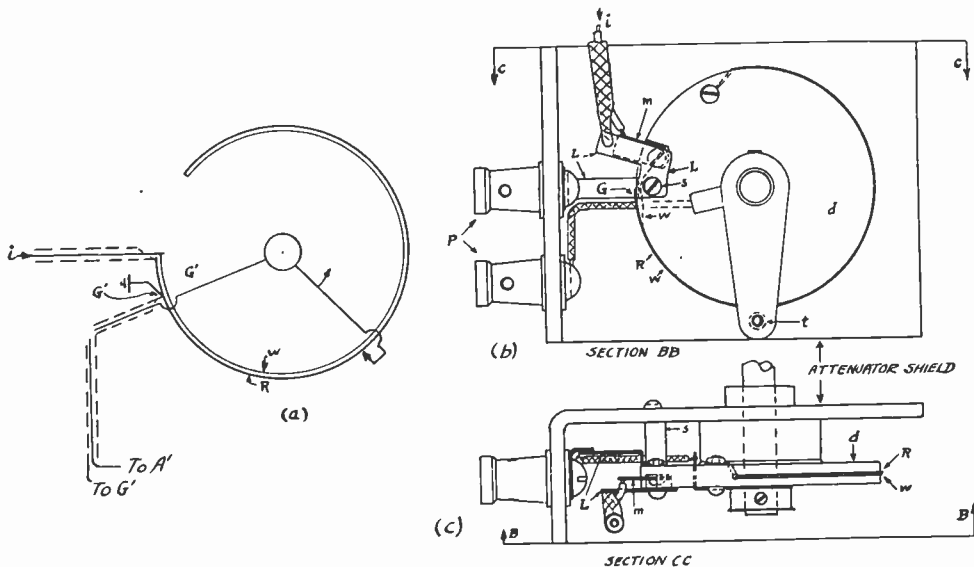

Fig. 5

rents in the tuned circuits. A common practice is to mount a variable condenser on a metallic panel which is used to connect the condenser rotor to the circuit. Large currents may flow through the shield as a result, defeating its purpose as a shield. The effects of the capacity to the shielding, where the stray capacities become large, may also be classed as results of using the external shield for other than its shielding purpose. In many cases it will be found convenient to adopt an internal ground for the oscillator apparatus. To this terminal the oscillatory circuit can be grounded, and the output return connected. A lead to the shield will then carry only stray shielding currents so that shield and oscillator ground point are practically at equal potentials. To this terminal also by-pass shunts for the filtered outgoing leads can be returned.

Perhaps the most likely region for stray coupling troubles of the conductive sort to enter is the low side of the attenuator circuit and the

associated antenna and ground leads within the attenuator. The solution here is the rigid application of the single ground point principle. Difficulties arise when mechanical considerations must be reconciled with the exact circuit requirements, and the best resulting design is the best compromise between these factors. In Fig. 5 are sketches of a potentiometer used in a continuously variable attenuator. In (a) the arrangement is shown schematically, while (b) and (c) are views of the resulting design. The current (i) flowing along the resistance wire (R) provides the desired resistance drop. The reactive drop along (R) is neutralized to a great extent by the reverse current in the small copper wire (W) placed as close as possible to (R) on the circumference of the disk (d), and kept also very close to the double lug (L) which terminates (R) on the ground end. The contact (t) is of a rolling type, to minimize wear on the wire (R), of No. 32 B and S gauge Advance. The point (G) is at the terminus of (R) on the lug (L), although negligible potential difference would exist across the width of the lug. The output terminals, for convenience in use, have been made binding posts (P), placed close together and to the lug (L) so that the nonconcentric portion of the output leads may be short. Point G is connected to the shielding by the stud (S), which is on the opposite side of (G) from the output connection, so that not even a part of the lug (L) is common to the output circuit and the stray currents in (S). The known current (i) enters and leaves by the concentric leads connecting to one end of (L) and to the lug (m) terminating the wire (w). It will be recognized that this arrangement is not by any means exactly represented by the schematic Fig. 5 (a) because of the considerable size of the terminals used. However, the design proved satisfactory. Because, in part, of the difficulty of designing continuously variable elements which combine mechanical permanence and suitability for r-f operation, the fixed step attenuator with variable input current is more widely used.

The subject of lead impedances and of circuit arrangements to eliminate their effects is important in securing effective line filters. Radio-frequency filters will be required on many leads emerging from a signal generator, and are usually necessary in the a-c lines to receivers under test to eliminate broadcast and noise pick-up. The filter will probably take the form of a brute force low-pass choke and condenser ladder, with perhaps some attempt at a proper termination.

On circuits where shunting action to audio frequencies is not a factor, the most economical filter will use by-pass condensers of 0.1 to 0.5 μf in the shunt sections. The theoretical attenuation per stage of such a filter with large choke impedance is given quite closely by $a = \omega^2 LC$. For example: A section with $L = 1$ mh and $C = 0.5$ μf , at 1500

kc, figures to give a voltage attenuation of 45,000 per stage. Considerable care must be taken in arranging the wiring to secure anything like the calculated attenuation. In the first place, the shunt sections must be returned to some point whose potential with respect to the system ground is small compared to the calculated filter output voltage. This postulates arrangement of the circuit with the single ground point idea in mind. Exact results are not desired in practice, and only qualitative information can be given here. Inductance in the condenser itself may be so large as to be the controlling factor in its impedance. The leads of the shunt condenser, unless very short, will have inductive reactances larger than the condenser reactance. Mutual impedance, introduced between adjacent shunt sections either by running parallel leads or by using a common ground lead, easily defeats the filter action. Much depends on arranging the parts so that short shunt leads are possible, since even if single point grounding is adopted, mutual inductance between leads of any length, running to the same terminal will become objectionable. By taking precautions as mentioned, closer approximations to calculated attenuations in such filter networks can be attained.

CONCLUSION

In conclusion it should be said that the primary purpose of this paper is to emphasize the necessity for considering all the circuit details involved in work with r-f attenuators. Taking everything into account, and assigning relative importances based on experiment, a sufficiently exact picture of any signal generator situation can be built up.



MEASUREMENT OF RESISTANCE AND IMPEDANCES AT HIGH FREQUENCIES*

By

J. W. LABUS

(General Electric Company, Schenectady, N. Y.)

Summary—It is well known that the resistance of a conductor increases with frequency. At very high frequencies the usual method of measurement fail, especially if the unknown resistance is more than about one hundred ohms.

In the following it is shown that the absolute value of the unknown impedance, when put across the end of a transmission line, is a simple function of the ratio of the currents, measured at the beginning and the end of a transmission line.

This method has been tested out at a wavelength of 21.8 meters, measuring the resistance of a number of grid leaks and of a decade box. The a-c resistance was considerably higher than the labeled d-c value. At the same time, the shunted capacity across the resistors has been measured and values have been obtained, which agree with expectations.

In general, this method lends itself to measurement of impedances of any kind; but it only gives the absolute value of the unknown impedance. However, by means of a known capacity or resistance, connected in series or in parallel with the impedance to be determined, the phase of the latter and, therefore, its real and imaginary components are found.

At frequencies corresponding to wavelengths longer than 100 meters the line becomes rather long. In this case another method, as described in the second part of this paper, can be applied. The procedure of the measurement is quite similar to that of the first method; however, the line is replaced by a lumped circuit, consisting of a coil and two condensers.

While the second method works very accurately at frequencies at which the inductance and capacity of the leads can be neglected, the method, using the transmission line is preferable at wavelengths less than about 150 meters.

PART I

THE ordinary methods for measuring a-c resistances or impedances fail, if the frequency becomes very high. If for instance the substitution method is used, the standard resistance (constantan wire in vacuum) must have a very small inductance and capacity. This however, determines the upper limits for which these resistors can be built. Such resistors cannot exceed much more than about 100 ohms.

In this paper a method is described which enables us to measure resistances and impedances at short-wave frequencies, irrespective of the magnitude of the unknown impedance. In the following, we shall also use the term impedance for resistors, because, at these frequencies the inductance or capacity of the latter must usually be taken into account.

* Decimal classification: R241. Original manuscript received by the Institute, November 25, 1930.

It will be shown that if we connect the unknown impedance across one end of a transmission line (Fig. 1) which is energized at the other end, and measure the currents at both ends of the line, the absolute value of the impedance is given by

$$|Z_x| = Z(I_1/I_2) \tag{1}$$

I_1 and I_2 being the r.m.s. values of the currents and Z the surge impedance of the line which, at these frequencies can be assumed to be a pure ohmic resistance.

In order to prove the relation in (1), we start from the differential equation of a transmission line, at the one end of which a sinusoidal voltage is impressed, while the other end is loaded.

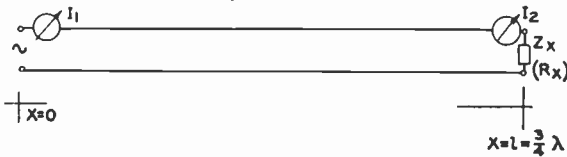

Fig. 1—Schematic diagram of impedance measurement apparatus for frequencies above 3000 kc.

$$\frac{\partial^2 E}{\partial X^2} = n^2 E$$

$$\frac{\partial^2 I}{\partial X^2} = n^2 I$$

E and I represent time vectors, whose amplitudes and phases depend on the distance x , the latter being measured from the ammeter A_1 .

The general solution is given by

$$E = A\epsilon^{nx} + B\epsilon^{-nx}$$

$$I = -1/Z(A\epsilon^{nx} - B\epsilon^{-nx}). \tag{2}$$

The constants A and B are determined by the boundary conditions mentioned above:

At $x = 0$: $I = I_1$

At $x = l$: $E = I_2 Z_x$.

Substituting these conditions in (2) we get for the current at any point x of the line:

$$I = \frac{Z \cosh n(l - x) + Z_x \sinh n(l - x)}{Z \cosh nl + Z_x \sinh nl}. \tag{3}$$

n is the so-called propagation constant, defined by

$$n = \sqrt{(R + j\omega L)(G + j\omega C)} = \alpha + j\beta$$

wherein L , C , R , and G are the characteristics of the line per unit length. The real part (α) represents the attenuation constant (determines the amplitude at x) while β is the wavelength constant (gives the time phase of the current or voltage vector). On account of the high frequency, the surge impedance $Z = \sqrt{(R + j\omega L)/(G + j\omega C)}$ can be written approximately $Z = \sqrt{L/C}$, because R and G become negligibly small beside ωL and ωC .

For $x=1$ equation (3) becomes

$$I_1/I_2 = \cosh nl + Z_x/Z \sinh nl.$$

Usually, the attenuation constant (α) is very small. In the case of the line, used in the experiment, the numerical value of α was 0.0003 for 1 meter. Therefore, α can be neglected in the expression for n . Hence we get from the last equation:

$$I_1/I_2 = \cos \beta l + jZ_x/Z \sin \beta l. \quad (4)$$

Now let us choose the length l of the line such, that

$$\beta l = \omega \sqrt{LC} l = (2k + 1) \pi/2$$

or since $c = \sqrt{1/LC}$ is the velocity of propagation along an unattenuated line:

$$\beta l = \frac{2\pi}{cT} l = \frac{2\pi}{\lambda} l = (2k + 1) \frac{\pi}{2}.$$

Hence the length of the line

$$l = (2k + 1) \frac{\lambda}{4}$$

equals an odd number of quarter wavelengths. Therefore $\sin \beta l = 1$, $\cos \beta l = 0$ and we get

$$\frac{I_1}{I_2} = j \frac{Z_x}{Z}$$

I_1 and I_2 are vectors which have a certain phase displacement, depending on the nature of the unknown impedance Z_x . The readings we take at the ammeters give the r.m.s. values and therefore we have to equate the amplitudes of the expressions on both sides of the above equation. Thus we finally get

$$|Z_x| = Z(I_1/I_2)_{\text{r.m.s.}} \quad (5)$$

In this way the absolute value of the unknown impedance is obtained. If it is not a pure ohmic resistance, we can find its phase by shunting

Z_x with a known capacity or connecting the latter in series with Z_x and repeating the measurement.

Let for instance Z_x be a grid leak resistor having a certain natural capacity C_x in parallel with R_x :

Then:

$$|Z_x| = \frac{R_x}{\sqrt{1 + (\omega C_x R_x)^2}}$$

R_x being the a-c resistance.

Calling a_1 the current ratio I_1/I_2 , measured when the grid leak alone is connected across the end of the line and a_2 when it is shunted by a known capacity C_0 , we get for the a-c resistance R_x and the natural capacity C_x

$$R_x = \frac{2qZ}{\sqrt{2q^2(1/a_1^2 + 1/a_2^2) - q^4 - (1/a_1^2 - 1/a_2^2)^2}} \quad (6)$$

$$C_x = \frac{1/a_2^2 - 1/a_1^2 - q^2}{2qZ}$$

wherein q denotes: $\omega Z C_0$.

Likewise, the phase of the unknown impedance can be determined by inserting a known capacity C_0 in series with Z_x . Then we have to substitute for Z_x in (5)

$$|Z_x + 1/j\omega C_0| = |u + jv + 1/j\omega C_0| = \sqrt{u^2 + (v - 1/\omega C_0)^2} \quad (7)$$

and measuring the current ratio, when $C_0 = \infty$ and $C_0 =$ the selected value, we can readily calculate the real and imaginary parts of Z_x .

Obviously the resistance of the ammeter at the beginning of the line ($x=0$) does not affect the result. However, the resistance (r_2) of the ammeter at the other end of the line ($x=1$) adds to Z_x and therefore (5) had to be written more correctly:

$$|Z_x + r_2| = Z(I_1/I_2)_{r.m.s.}$$

Measurement

In order to check the method described heretofore, an experiment has been carried on, using a transmission line of copper wire No. 12, B and S 152 mm and about 21 meters long. The height above ground was about 2 meters. The surge impedance Z of a transmission line consisting of two parallel cylinders (diameter d) which are spaced by a distance s , is given by:

$$Z = 277 \log_{10} \left[\frac{s}{d} \left(1 + \sqrt{1 - \left(\frac{s}{d} \right)^2} \right) \right]$$

In the case referred to, the surge impedance was found to be 600 ohms.

At the first and last pole of the line, shelves were mounted (Fig. 3) to hold the apparatus, located at the beginning and the end of the line, and therefore the connections between the line and the connected circuits could be made very short. The oscillator and the ammeters were on the ground. The maximum range of the thermocouples was 50 milliamperes.

First, the frequency had to be determined, for which the line was $3/4\lambda$ (an odd number of quarter wavelengths). For this purpose the

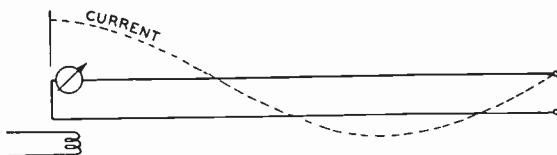

Fig. 2—Distribution of current along an open transmission line.

line was left open at its far end and short-circuited across the ammeter at the beginning, at which point a coil, fed by the oscillator, was coupled very loosely to the line (Fig. 2). However, when the line was loaded later by the unknown impedance, it became evident that the energy transferred by this coupling was too small to be measured. Therefore, a coupling coil (L_1 in Fig. 3) was inserted into the line in series with a condenser C_1 by means of which the inductance of this coil could be tuned out. In this way it became possible to induce a suf-

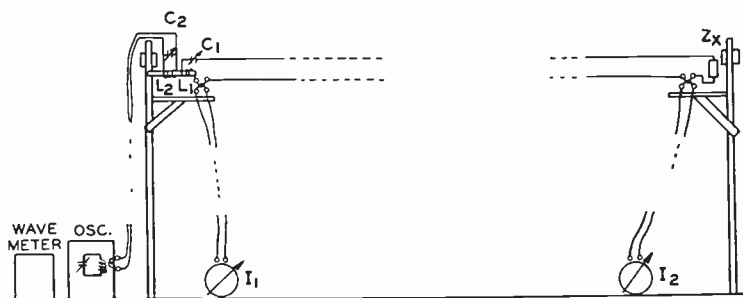

Fig. 3—Complete diagram of impedance measurement apparatus.

ficiently high voltage into the transmission line without changing its electric length. However, the coupling must be loose enough so as to prevent a noticeable reaction of the line on the oscillator circuit. The condenser C_2 across the primary side served to boost up the input energy, because it raised the impedance of the plate circuit of the oscillator to its optimum value. With this arrangement an extremely sharp tuning could be obtained. The wavelength for which the open line was $3/4\lambda$ long, corresponding to a loop of current at the beginning of the line, was determined by changing first the oscillator frequency,

until I_1 read a maximum; then C_1 was adjusted, until I_1 reached another maximum. It was found that $\lambda = 21.8$ meters.

The following table shows the result of the experiment. The measured resistances were grid leaks about $1\frac{1}{8}$ in. long, with soldered terminals. It may be noticed that for the low resistances (below 1000 ohms) the value, determined from (1) (capacity disregarded) does not differ very much from the value, obtained from (6). At high resistances, however, these values no longer coincide, because the reactance of the capacity across the resistor becomes small compared with R_x . In this case R_x must be calculated from (6). Finally the resistance of a decade box has been measured in the same way. Obviously, the value ωC_x stands for the total reactance ($\omega C_x - 1/\omega L_x$) of the resistor, partly compensating the reactance of the capacity C_x .

TABLE I

Unknown resistance (Labeled value in ohms)	I_1 milliamperes	I_2 milliamperes	I_1/I_2	$Z(I_1/I_2)$	Average	Capacity C in $\mu\mu\text{f}$	R_x	C_x	
							Calculated	from (6)	
500 carbon	43.5	38.5	1.13	678	675	0			
	36.3	32.5	1.12	672		0			
	31.4	28.0	1.122	674		0			
500 carbon	31.25	27.0	1.158	695	690	0	695	2.2	
	38.5	33.7	1.140	685		21			
	21.5	32.4	0.665						
	15.3	22.2	0.688						
1000 carbon	37.1	21.0	1.766	1060	1080	0			
	43.2	23.6	1.83	1096		0			
	40.6	22.5	1.80	1080		0			
	24.7	34.7	0.712			21			
	18.0	25.1	0.718						
1800 carbon	36.5	13.5	2.70	1620	1629	0	2660	5.55	
	44.4	16.25	2.73	1638		0			
	18.6	25.6	0.726			21			
	25.2	35.8	0.704						
600 decade box	24.4	21.2	1.15	690	685	21	918	11.3	
	33.5	29.6	1.13	680					21
	19.4	34.6	0.56						
	17.5	31.6	0.554						
	11.2	31.5	0.356						
	13.0	35.8	0.364						

PART II

At frequencies, corresponding to 100 meters and above, the transmission line will become rather long. Therefore, in the following, another method which enables us to measure impedances by means of a lumped circuit is described. It can be shown that if the transmission line is replaced by an artificial line, a similar relation holds as given in (5) of Part I of this paper.

The circuit used in the present paper (see Fig. 4) is nothing else than one element of an artificial line. The unknown impedance is connected

across the terminals bd . At ac the circuit is coupled to an oscillator and the currents I_1 and I_2 (r.m.s. values) are measured by means of thermocouple meters, the resistances of the meters being r_1 and r_2 . If the circuit is tuned such that

$$\omega^2 L(C + C_0) = 1,$$

($\omega = 2\pi f$, f = frequency of oscillator, C_0 = capacity of coil L) then the relation holds:

$$|Z_x + r_2| = \frac{1}{\omega C} (I_1/I_2) \text{r.m.s.} \quad (8)$$

This relation can be readily proved. Referring to Fig. 4, we assume that the resistance r of the coil L is negligibly small beside its reactance ωL and the leakage resistance ρ of the condensers C is very large as compared with their reactance $1/\omega C$. A very good accuracy can be attained, if the ratios $r/\omega L$ and $(1/\omega C)/\rho$ do not exceed about 0.01. Later it will be shown that this condition can be easily fulfilled.

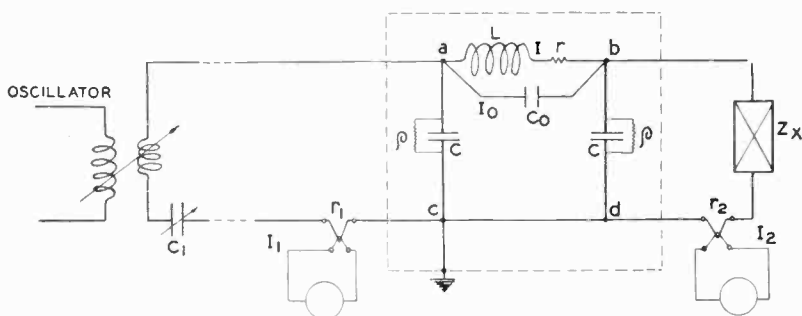

Fig. 4—Diagram of impedance measurement apparatus for frequencies below 3000 kc as described in Part II.

Applying Kirchoff's law, we get for the vectors of the currents and voltages:

$$I + I_0 = I_2 + j\omega C(r_2 + Z_x)I_2$$

$$I_1 = I + I_0 + j\omega C(E - r_1 I_1)$$

$$E = (r_2 + Z_x)I_2 + j\omega L I + r_1 I_1$$

$$j\omega L I = I_0 / j\omega C_0.$$

Solving for the current ratio we get

$$\frac{I_1}{I_2} = 1 - \frac{\omega^2 LC}{1 - \omega^2 LC_0} + j\omega C(r_2 + Z_x) \left(2 - \frac{\omega^2 LC}{1 - \omega^2 LC_0} \right). \quad (9)$$

Now let us choose L and C such that

$$\omega^2 L(C + C_0) = 1. \quad (10)$$

Hence,

$$I_1/I_2 = j\omega C(r_2 + Z_x)$$

or, since we measure the r.m.s. values of the currents:

$$(I_1/I_2)_{\text{r.m.s.}} = \omega C |r_2 + Z_x| \quad (11)$$

whence (8) can be obtained.

It may be noticed that the resistance r_1 of the meter at the input does not enter the final result.

Measurement

This method enables us to measure the absolute values of impedances. In order to determine the phase (or real and imaginary part) of the unknown impedance (Z_x) we have to proceed as indicated in Part I: After measuring the current ratio with Z_x across bd , we shunt Z_x by a known capacity C_0 or connect the latter in series with Z_x , measuring again the current ratio. Thus from (8) two equations are obtained, whence the amplitude and phase of Z_x can be determined (see (6) and (7) in Part I).

The condition expressed in (10) can be fulfilled, by choosing arbitrarily the magnitude of either L or C . However, for practical reasons, the capacity C more or less depends on the nature of the unknown impedance and the range of the ammeters. If, for instance, we were to measure a resistance of about 16 ohms, using a 2 and 10 milliammeter, whereby the resistance of the latter is $r_2=38$ ohms, the capacity C should be chosen such that the meters show about the same deflections. Thus, from (11):

$$I_1/I_2 = 2/10 = \omega C(38 + 16),$$

it follows that ωC should not differ very much from $\omega C = 0.0037$.

The exact values of C and L as given by (8) are adjusted by tuning the circuit. Referring to Fig. (4), ac is short-circuited and the condenser C_1 is tuned until the meter (I_1) reads a maximum. In this way the reactance of the coupling coil of the oscillator is tuned out. Then (b) is connected with (c) by a short wire and the left-hand condenser (C) is adjusted until I_1 reads a minimum. Thus the resonance conditions required by (8) is fulfilled. By short-circuiting (a) and (d) and energizing the circuit at b (instead of a), the right-hand condenser can be tuned in the same way. On account of the body capacities of the unknown impedance (Z_x) and the meter (I_2), both should be connected across bd while tuning is performed. It also has been found necessary to place all parts of the circuit on a grounded copper sheet. Furthermore the coil L should be placed in a metal box, so as to prevent pick-up.

In order to investigate the operation of this method, a number of measurements have been made, at 380 to 1135 kilocycles (780 to 260 meters), upon a phantom antenna resistor of about 15.5 ohms (d-c value). The data of the coil L were: diameter 7.6 cm, length 5 cm, 23 turns of No. 14 B and S copper wire; inductance $35 \mu H$. Equation (11) requires accurate knowledge of C and r_2 . As neither of them were known accurately enough, they had to be determined. For this purpose the terminals b and d (Fig. 4) were short-circuited across the meter. The current ratio thus obtained at the frequency 385 kc was $I_1/I_2=0.485$. Therefore, according to (5):

$$I_1/I_2 = 0.485 = \omega C(r_2).$$

Then a standard resistor of 25 ohms (constantan wire in an evacuated tube) was inserted at Z_x and a current ratio of 0.806 was measured. Thus

$$I_1/I_2 = 0.806 = (r_2 + 25)\omega C.$$

From both equations we get

$$r_2 = 31.9 \text{ ohms and } \omega C = 0.0128 \text{ (Corresponding to } C = 5300 \mu\mu\text{f.)}$$

The labeled value of the resistance of the thermocouple heater was $r_2=37.8$ ohms. Instead of a standard resistance, a standard condenser can be used as well. This calibration was performed at different frequencies within the range mentioned above and each time the same value for r_2 was obtained.

With the antenna resistor inserted, r_2+R_x was found to be 56.8 ohms which would give an unexpectedly high value of R_x , indicating a reactive component of Z_x . Therefore, a condenser was connected in series with the antenna resistor and for several values of the capacity of this condenser, the total impedance between points b and d was measured. This impedance consisted of the resistance (R_x) and inductance (L_x), the antenna resistor, the inserted capacity (C_i) and the resistance r_2 of the thermocouple:

$$r_2 + Z_x = r_2 + R_x + j(\omega L_x - 1/\omega C_i).$$

From these measurements L_x and R_x were obtained:

$$L_x = 8.5 \text{ microhenries and } R_x = 15.6 \text{ ohms.}$$

The latter measurements were carried on at the frequency of 1135 kc (260 meters). Therefore, at this frequency range, the investigated antenna resistor showed no appreciable increase of resistance over the d-c resistance.

CALCULATION OF ELECTRIC AND MAGNETIC FIELD STRENGTHS OF ANY OSCILLATING STRAIGHT CONDUCTORS*

By

R. BECHMANN

(Telefunken-Gesellschaft, Berlin, Germany)

THERE ARE two methods for the calculation of the electric and magnetic field strengths in any straight oscillators such as antennas and antenna systems. One method depends on the fact that the fields produced by the individual elements in the arrangement, are superposed according to their amplitudes and phases. The fields of the elements thus are produced by Hertzian dipoles. The other method depends on the formation of Hertzian vectors for the given arrangement, and the derivation of the components of the electric and magnetic fields in the usual manner.

The electric field of a Hertzian dipole can be divided into three parts, designated as the near-by field, the transition field, and the remote field. The magnetic field of a Hertzian dipole is divided in two parts, a near-by field, and a remote field. On using the first method, the component fields, corresponding to the magnetic and electric field, can be represented as the sum of integrals that are determined by the arrangement of the elements on the given conductors, that is, by the current distribution along the conductor. In general, this integration cannot be completed.

Using the second method, as shown in the following, we start out in a general way to give complete expressions for the electric and magnetic fields of any oscillating straight conductors. We shall now form the Hertzian vectors for such arrangements. For this also we obtain a complete representation.

Let us consider the linear conductor of length l that lies in the z -axis of the coordinate system. Let the ends be under the influence of any capacity and self-induction.¹ It is assumed that the system is tuned to the exciting frequency. The distribution of the current Y or the electric moment y along the conductor is given by the expression:

$$\psi(z_0)$$

which will always signify a sine function in the following, corresponding

* Decimal classification: R120. Original manuscript received by the Institute, May 29, 1930. Translation received by the Institute, September 29, 1930. Communication from Telefunken-Gesellschaft.

¹ Balth. van der Pol, Jr., *Proc. Phys. Soc. (London)*, **13**, 217, 1917.

to the solution of the oscillation equation for the conductor. For y we get the law $y_x=0$, $y_y=0$; $y_z=\psi(z_0) \cdot e^{-i\nu t}=P \cos(kz_0-\beta)e^{-i\nu t}$. Here, $k=2\pi/\lambda=\nu/c$; λ is the wavelength, ν is the frequency of the exciting oscillation, c is the velocity of light, $i=\sqrt{-1}$, P is the amplitude and β a constant determined by the load at the ends. Let the limits of the conductor be z_{01} , and $z_{02}=z_{01}+l$. From the electric moment y we obtain the electric current Y along the conductor by the relation

$$\frac{\partial y}{\partial t} = Y. \quad (1)$$

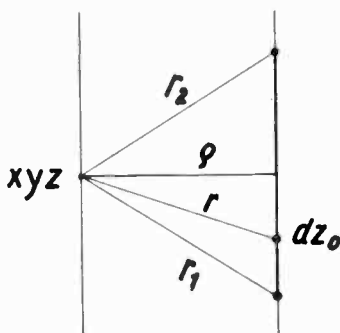

Fig. 1

The electric field strengths E and the magnetic field strengths H are derived as follows from the Hertzian vector Z :

$$\begin{aligned} E &= \text{curl curl } Z \\ H &= \frac{1}{c} \text{curl } \frac{\partial Z}{\partial t} \end{aligned} \quad (2)$$

Z is thus given by

$$Z = \int \frac{dz_0}{r} \bar{y} \quad (3)$$

dz_0 is an element of the conductor; $r = \sqrt{x^2 + y^2 + (z - z_0)^2} = \sqrt{\rho^2 + (z - z_0)^2}$ indicates the distance of this element $(0, 0, z_0)$ from the origin (x, y, z) . The line above y indicates that y is retarded, that is, instead of time t we must use the retarded time $t - r/c$. According to the assumption for the distribution of the electric moment along the oscillating conductor we get:

$$\begin{aligned} Z_x &= 0 \quad Z_y = 0 \\ Z_z &= P \int_{z_{01}}^{z_{02}} \frac{dz_0}{r} \cos(kz_0 - \beta) e^{-i\nu(t-r/c)} = \bar{\Pi} \cdot e^{-i\nu t} \end{aligned} \quad (4)$$

therefore,

$$\Pi = P \int_{z_{01}}^{z_{02}} \frac{dz_0}{r} \cos(kz_0 - \beta) e^{ikr}. \tag{4a}$$

This integral can be worked out. For (4a) we can write

$$\Pi = P \left\{ \frac{e^{-i\beta}}{2} \int_{z_{01}}^{z_{02}} \frac{e^{ik(r+z_0)}}{r} dz_0 + \frac{e^{i\beta}}{2} \int_{z_{01}}^{z_{02}} \frac{e^{ik(r-z_0)}}{r} dz_0 \right\}. \tag{5}$$

The integrals in (5) can be worked out easily. We shall not give the intermediate calculation here, but the result is

$$\int_{z_{01}}^{z_{02}} \frac{e^{ik(r+z_0)}}{r} dz_0 = e^{ikz} \int_{u_1'}^{u_2'} \frac{e^{iku}}{u} du = e^{ikz} \{ Ei(iku_2) - Ei(iku_1) \} \tag{6}$$

$$\int_{z_{01}}^{z_{02}} \frac{e^{ik(r-z_0)}}{r} dz_0 = -e^{-ikz} \int_{u_1'}^{u_2'} \frac{e^{iku}}{u} du = -e^{-ikz} \{ Ei(iku_2') - Ei(iku_1') \}$$

with the values

$$u_1 = \sqrt{\rho^2 + (z - z_{01})^2} - (z - z_{01});$$

$$u_1' = \sqrt{\rho^2 + (z - z_{01})^2} + (z - z_{01}); \tag{6a}$$

$$u_2 = \sqrt{\rho^2 + (z - z_{02})^2} - (z - z_{02});$$

$$u_2' = \sqrt{\rho^2 + (z - z_{02})^2} + (z - z_{02}).$$

The function $Ei(ix)$ appearing in (6) is the integral logarithm with purely imaginary argument. For this we get:

$$Ei(ix) = Ci(x) + iSi(x) \tag{7}$$

in which $Ci(x)$ and $Si(x)$ represent the cosine integrāl and the sine integrāl.

By using (6) we get for the z components of the Hertzian vector Π for (4a)

$$\Pi = \frac{P}{2} [e^{i(kz-\beta)} \{ Ei(iku_2) - Ei(iku_1) \} - e^{-i(kz-\beta)} \{ Ei(iku_2') - Ei(iku_1') \}] \tag{8}$$

with the values

$$u_2 = \sqrt{\rho^2 + (z - z_{02})^2} - (z - z_{02}) = r_2 - (z - z_{02})$$

$$u_1 = \sqrt{\rho^2 + (z - z_{01})^2} - (z - z_{01}) = r_1 - (z - z_{01}) \tag{9}$$

$$u_2' = \sqrt{\rho^2 + (z - z_{02})^2} + (z - z_{02}) = r_2 + (z - z_{02})$$

$$u_1' = \sqrt{\rho^2 + (z - z_{01})^2} + (z - z_{01}) = r_1 + (z - z_{01}).$$

For the system of parallel conductors, the resultant Hertzian vector is represented by a sum of expressions of the form in (8), in which the values r_1 and r_2 in (9) must be correspondingly selected.

Now we form the components of the electric and magnetic field strengths. This can be calculated from Π according to (2). We use as a basis the following cylindrical coordinates ρ, ϕ, z . By making the vectorial operations, we obtain for the components of the electric field, E_ρ, E_ϕ, E_z , if $\mathbf{E} = \mathbf{E} \cdot e^{-i\nu t}$:

$$E_z = P \left[k \frac{e^{ikr_2}}{r_2} \sin(kz_{02} - \beta) - k \frac{e^{ikr_1}}{r_1} \sin(kz_{01} - \beta) - \frac{\partial}{\partial z} \left(\frac{e^{ikr_2}}{r_2} \right) \cos(kz_{02} - \beta) + \frac{\partial}{\partial z} \left(\frac{e^{ikr_1}}{r_1} \right) \cos(kz_{01} - \beta) \right] \quad (10)$$

$$E_\rho = P \left[-k \frac{e^{ikr_2}}{r_2} \frac{z - z_{02}}{\rho} \sin(kz_{02} - \beta) + k \frac{e^{ikr_1}}{r_1} \frac{z - z_{01}}{\rho} \sin(kz_{01} - \beta) + \frac{1}{\rho} \frac{\partial}{\partial z} \left(\frac{e^{ikr_2}}{r_2} (z - z_{02}) \right) \cos(kz_{02} - \beta) - \frac{1}{\rho} \frac{\partial}{\partial z} \left(\frac{e^{ikr_1}}{r_1} (z - z_{01}) \right) \cos(kz_{01} - \beta) \right]$$

$$E_\phi = 0.$$

For the components of the magnetic field H_ρ, H_ϕ, H_z for $\mathbf{H} = \mathbf{H} e^{-i\nu t}$ we get

$$H_z = 0 \quad H_\rho = 0$$

$$H_\phi = P \left[+ k \frac{e^{ikr_2}}{\rho} \sin(kz_{02} - \beta) - k \frac{e^{ikr_1}}{\rho} \sin(kz_{01} - \beta) - \frac{1}{\rho} \frac{\partial}{\partial z} (e^{ikr_2}) \cos(kz_{02} - \beta) + \frac{1}{\rho} \frac{\partial}{\partial z} (e^{ikr_1}) \cos(kz_{01} - \beta) \right] \quad (10a)$$

From (10) and (10a) we see that the expression for E and H can be represented formally as differences for the limits z_{01} and z_{02} of the conductor, that is, by the expressions

$$E_z = - \left\{ \frac{e^{ikr}}{r} \frac{d}{dz_0} \psi(z_0) \right\}_{z_{01}}^{z_{02}} + \left\{ \frac{\partial}{\partial z} \left(\frac{e^{ikr}}{r} \right) \psi(z_0) \right\}_{z_{01}}^{z_{02}} \quad (11)$$

$$E_\phi = 0$$

$$E_\rho = \frac{e^{ikr}}{r} \frac{z - z_0}{\rho} \frac{d}{dz_0} \psi(z_0) \Big|_{z_{01}}^{z_{02}} + \frac{1}{\rho} \frac{\partial}{\partial z} \left(\frac{e^{ikr}(z - z_0)}{r} \right) \psi(z_0) \Big|_{z_{01}}^{z_{02}}$$

or,

$$H_z = 0, \quad H_\rho = 0 \tag{11a}$$

$$H_\phi = - \left\{ \frac{e^{ikr}}{\rho} \frac{d}{dz_0} \psi(z_0) \right\}_{z_{01}}^{z_{02}} + \frac{1}{\rho} \frac{\partial}{\partial z} (e^{ikr} \psi(z_0)) \Big|_{z_{01}}^{z_{02}} \Big\}.$$

Therefore in (11) or (11a), for any member we must form the difference of the expressions that are obtained for $z_0 = z_{02}$ and $z_0 = z_{01}$. In expressions (11) and (11a) the distribution function $\psi(z_0)$ is introduced in a general way. The expressions are valid for any distribution in so far as they satisfy the earlier assumptions, and are represented by a sine function.

Let us consider the special case of the conductor length l , that is a multiple of the half wavelength of the exciting oscillation. Therefore for this $l = n\lambda/2$, $n = 1, 2, 3$, etc. This is tuned to the exciting oscillation by its length. There is no load at the ends. The limits of the conductor are then $z_{01} = 0$ and $z_{02} = l$. The distribution of the current, or the moment, is given by $\psi(z_0) = P \sin k_n z_0$, in which $k_n = n\pi/l$. At the ends of the conductor the distribution is 0. Accordingly, the second member disappears in (11) and (11a). From (11) we get for the electric field

$$E_z = - Pk_n \left[\frac{e^{ikr_2}}{r_2} \cos n\pi - \frac{e^{ikr_1}}{r_1} \right] \tag{12}$$

$$E_\rho = Pk_n \left[\frac{e^{ikr_2}}{r_2} \frac{z-l}{\rho} \cos n\pi - \frac{e^{ikr_1}}{r_1} \frac{z}{\rho} \right]$$

$$E_\phi = 0$$

and for the magnetic field, (11a) gives us

$$H_z = 0 \quad H_\rho = 0$$

$$H_\phi = - Pk_n \left[\frac{e^{ikr_2}}{\rho} \cos n\pi - \frac{e^{ikr_1}}{\rho} \right]. \tag{12a}$$

The expression for the z component of the electric field in (12) was previously derived by A. Pistolokors,² while the more general expression for the z component of the electric field in (11) was given by the author.³ In both cases the derivation is carried out by transformation by partial integration of the integral for the field component parallel to the conductor. In a similar way the field components can be given for other coordinate systems. In the derivation of the above field expression, the

² A. Pistolokors, Proc. I.R.E., 17, 562; March, 1929.

³ R. Bechmann, Ann. d. Phys., 4, 829, 1930.

electric moment of the conductor is used as a basis. We obtain the expressions for the field components based on currents from the expressions based on the moment, in which $P = iA/\nu$ according to (1), where A is the current amplitude.

The expressions that have been derived here make possible simple calculation of the radiation conditions near the conductor. This is of practical importance in the calculation of radiation characteristics and radiation resistances of any linear antenna arrangements.



RESONANT IMPEDANCE AND EFFECTIVE SERIES RESISTANCE OF HIGH-FREQUENCY PARALLEL RESONANT CIRCUITS*

BY

HAJIME IINUMA

(Electrotechnical Laboratory, Ministry of Communications, Tokyo, Japan)

Summary—The writer has already published in a previous issue of the PROCEEDINGS a new method of measuring resonant impedance and radio-frequency resistance as applied to broadcast frequencies. In the present paper he gives, as another example of its application, some results obtained from the measurement in a band of high frequencies extending from 6300 to 26,300 kilocycles. It is ascertained that the additional dielectric loss, which is introduced into the resonant circuit by using a screen-grid tube as a dynatron, exercises only a slight influence on the measurement. The constants of the resonant circuit alone may be derived from those of the circuit combined with the tube, which can be measured directly. The correctness of the result is verified by the aid of a known value of the additional series resistance. Finally some remarks on short-wave amplification are given as a result of measurements.

INTRODUCTION

DESPITE the fact that the remarkable development of high-frequency apparatus has been made by leaps and bounds in recent years, it is surprising to find how little has been known of the reliable value of resonant impedance or effective series resistance of parallel resonant circuits employed therein, whereas exact knowledge of that is of vital importance for closer studies of their performance. The writer believes that lack of data in this line is due to nothing but some considerable difficulties encountered in applying most of the usual methods of radio-frequency resistance measurement to high-frequency circuits, on account of very high frequencies to be dealt with. In a previous issue of the PROCEEDINGS,¹ the writer suggested however that such difficulties might, to a large extent, be overcome by employing a dynatron. It is the object of the present paper to describe some results obtained by this means from the measurement with high-frequency resonant circuits whose frequencies of resonance are as high as from 6300 to 26,300 kc.

FURTHER DESCRIPTIONS OF THE APPARATUS AND PROCEDURE OF MEASUREMENT

The principle underlying the present apparatus and procedure of measurement is substantially the same as that in the preliminary ex-

* Decimal classification: R241. Original manuscript received by the Institute, July 16, 1930.

¹ H. Iinuma, "A method of measuring the radio-frequency resistance of an oscillatory circuit," PROC. I. R. E., 18, 537; March, 1930.

periment carried out at broadcast frequencies, the report of which has been already published in some detail in the previous paper. Therefore, descriptions to be given here will be confined to some further precautions worthy of note as well as some suitable modification therein. The circuit arrangement for the measurement is as shown in Fig. 1.

As seen from the result of measurements which will be given later, the numerical value of the negative resistance, $|R_i|$, of a screen-grid tube used as a dynatron is, in the present case, required to be as low as from 50,000 to 10,000 ohms. It cannot, however, be expected that all the screen-grid tubes of various types are capable of providing such

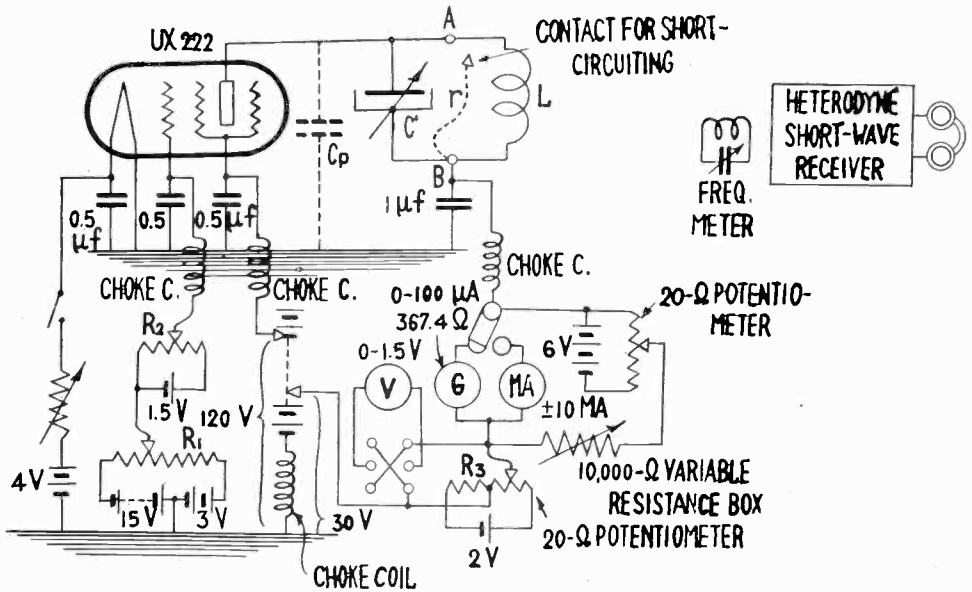

Fig. 1

low values. When adjusted to give the dynatron characteristics, the screen of tubes of such a type is generally subjected to a serious loss, which increases as $|R_i|$ decreases, and consequently the loss due to the screen of tubes limits the lowest available values of $|R_i|$. In this connection, among several types tested the UX-222 tube has been found to be the only type fit for the present use. Even if a tube of the UX-222 type be used, the value of $|R_i|$ as low as 10,000 ohms cannot be reached without the sacrifice of a serious power loss amounting to nearly one watt at the screen, and a further lowering of $|R_i|$ in its value would no longer be expected for the safe operation of the tube. (See Fig. 2, showing the characteristics of a UX-222 used.)

It may be said of all the tubes of the screen-grid type that the higher the potential applied to the screen, the potentials of other elements being kept constant, the lower is the value of $|R_i|$. And yet, it should

always be borne in mind that, in order to meet the demand for a low value of $|R_i|$ at the cost of a minimum amount of loss at the screen, the plate potential is required to be adjusted at a certain optimum value which seems to be almost independent of the potentials of the other elements and, in the author's experiment with a UX-222 tube, it has been found that it takes a value something like 24 to 30 volts.

In experiments with a screen-grid tube having the plate lead drawn out through its base as in the UX-222 type, the use of base and socket might cause some appreciable amount of additional loss due to the introduction of the dielectrics into the resonant circuit under test; the

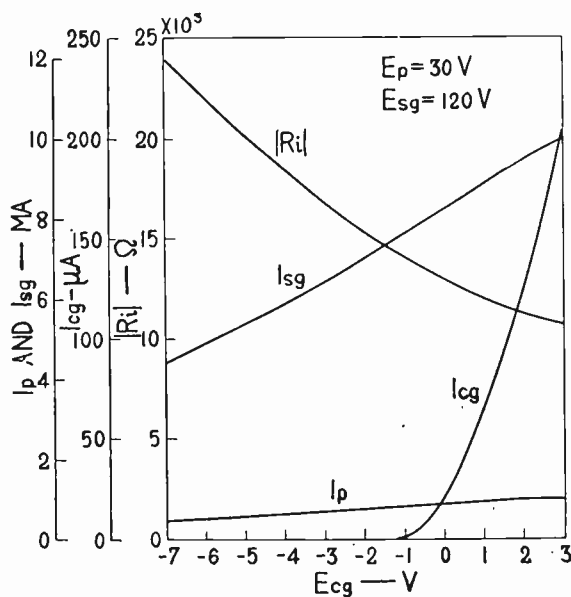

Fig. 2

loss might bring forth difficulty in the determination of the circuit constants free from the influence of the tube, which is, in general, desired. For this reason, the base has been taken away from the tube used, thus confining the loss to what unavoidably comes into play through the glass seal. This brings a further advantage of saving the length of the lead wire to the plate and consequently reducing the unfavorable stray inductance associated therewith.

When the control-grid potential is gradually raised up to such a critical value that the tube oscillates as a dynatron, a sudden jump generally takes place in the d-c plate current, as in the case of usual triode oscillators. For most of the present cases where the tube has been subjected to distinct dynatron characteristics, this change has scarcely been less than 30 to 40 microamperes and has given to a 100-microampere direct-current galvanometer of direct reading type so

marked a deflection that there was no need of other apparatus such as a heterodyne receiver for the mere purpose of detecting the generation of oscillation. In consequence of the considerable numerical reduction of the negative resistance, increments of the plate voltage as small as ± 0.5 volt have for the most case sufficed for its determination, which have been read with a 1.5-volt direct-current voltmeter. The measurement of frequency has been accomplished by means of an absorption type frequency meter coupled to a heterodyne receiver.

In experiments with a short-wave apparatus, there may be formed some unexpected local resonant circuits which would exercise serious influence upon its performance. All possible means have been employed to prevent the present apparatus from the adverse effect, for

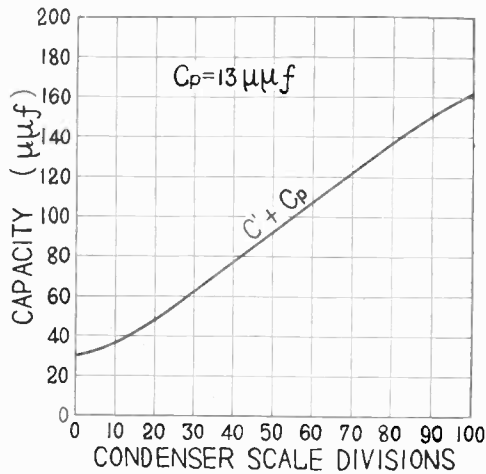

Fig. 3

instance, by inserting appropriately designed low-pass filter units to the circuit at important places (see Fig. 1), by using thick copper strips for lead conductors, and by shortening lead wires considerably with an orderly arrangement of all the parts of the apparatus on a sheet of copper.

RESULT OF MEASUREMENTS

The experiment has been carried out with parallel resonant circuits on hand for receiving purposes. A variable air condenser of the usual rotary type consisting of seven semicircular brass plates and bakelite insulation, is combined with one of three coils having 3 turns (No. 1), 4 turns (No. 2), and 6 turns (No. 3), respectively. Each coil is wound with B. S. No. 14 tinned copper wire to form a single-layer solenoid having a diameter of 80 mm, four thin bakelite pieces ensuring a distance of 4 mm apart between turns as well as satisfactory rigidity of the coil. No shielding has intentionally been provided, except the one on the side of the variable condenser facing the experimenter.

After the condenser and the tube were set, their combined capacity was measured as function of scale divisions of the condenser at the terminals of the coil holder (coil removed) by the ordinary substitution method at 500 kc. Denoting the capacity of the variable condenser including the small capacity of its lead to the coil by C' and that of the tube (measured to be $13 \mu\mu\text{f}$) including the small capacity of its lead to the resonant circuit under test by C_p , the sum of C' and C_p is the combined capacity under consideration. The results are as shown in Fig. 3. When the coil is connected across the condenser, the coil capacity

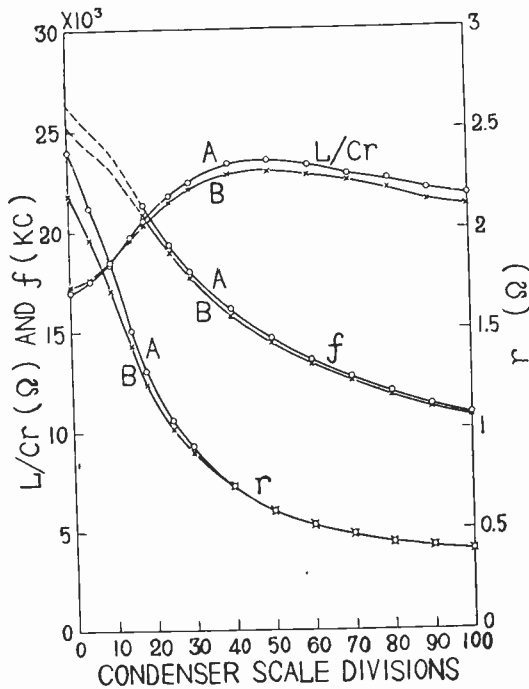

Fig. 4

has to be added to the above in order to obtain the total effective capacity which is responsible for the oscillation generated. Denoting the total capacity by C and the effective coil capacity by C_c ,

$$C = C' + C_p + C_c.$$

The effective capacity C_0 of the resonant circuit which is isolated from the tube, may then be derived from the expression,

$$C_0 = C - C_p.$$

Moreover, let the effective series resistances of the resonant circuit with and without the tube be denoted by r and r_0 , respectively, the corresponding resonant frequencies by f and f_0 , and the effective inductance by L .

One of the curves of family *A* given in Fig. 4, represents the values of L/Cr , the resonant impedance of the resonant circuit formed with coil No. 1 and connected with the tube, which has been found directly by determining the critical value of the negative resistance $|Ri|$ when the system begins to oscillate, as described in the previous paper. The corresponding measured values of the frequency f are also shown. In order to compute the values of r from the above two quantities, the value of either L or C should first be found. L in this case has, however, too small a value for us to determine by an ordinary simple method,

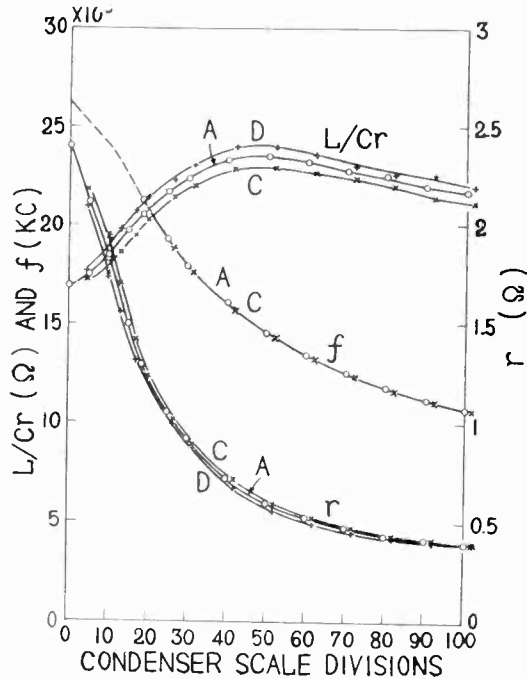

Fig. 5

and the accurate value of C is not so readily obtainable due to lack of the suitable means of determining C_c . For this reason, the author gives in the figure only the approximate value of r calculated by neglecting C_c , that is, by using the values of $C' + Cp$ (see Fig. 3) for C .

The values of L/Cr and r as obtained above may be affected to some extent by the loss involved in the tube, as has already been referred to. An attempt has been made to find out to what extent those values are affected. Immediately after L/Cr and f were measured at each condenser setting, a glass seal of another UX-222 has been inserted in shunt across the resonant circuit, all other parts of the tube such as base, bulb, electrodes, etc., being removed, and then the similar process of measurement has been repeated at the same setting. The results are as shown in the curves of family *B* in the same figure. Curve

B for the frequency is shifted slightly to the left from the original, owing perhaps to the small amount of capacity newly introduced by the glass seal. This capacity has been estimated from the shifting at $2.6\mu\mu f$ as an average. If the curves of family B in Fig. 4 are shifted so that every point on the curves moves horizontally to the right by such an amount of scale divisions so as to get an increase of $2.6\mu\mu f$ in capacity, the curves of family C in Fig. 5 are obtained, where the curve for f coincides with that of family A . Curves of C for L/C_0r_0 and r represent those values when the loss in the additional glass seal only is considered, and

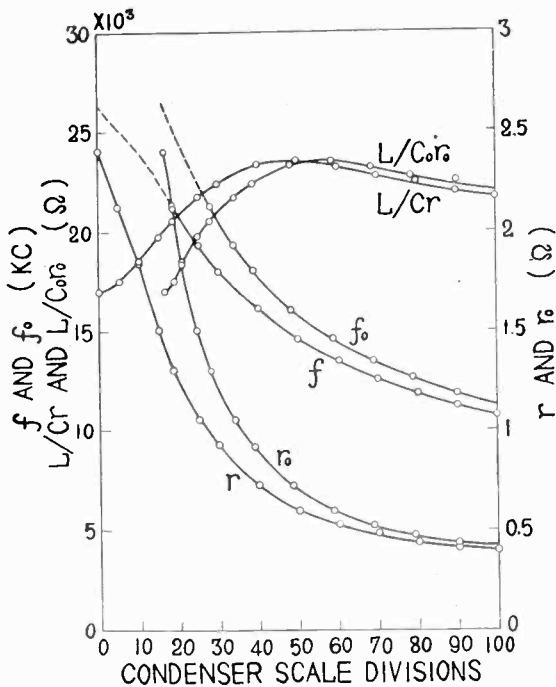

Fig. 6

the effect of its capacity is placed out of consideration. If curves of C for L/Cr and r are then transformed on the opposite side of their own curves of family A as shown by the curves of family D in such a way that the vertical distance from A to C , and that from A to D , are equal at every point on A , these newly derived curve D 's represent those of the resonant circuit which is accompanied by the tube free from loss, that is, by an ideal condenser of $13\mu\mu f$ in place of the tube. It is noticed from this experiment that the effect of the loss under consideration hardly exceeds 4 per cent and, therefore, it properly may be assumed that the tube without its base is, as a practical approximation, considered free from loss.

To derive the curves for L/C_0r_0 and r_0 , the constants of the resonant circuit isolated from the tube, the following procedure may be applied

to the curves of family A, Fig. 4. The values of the resonant impedance or effective series resistance of the resonant circuit including the tube will not seriously be affected, if the capacity of the tube is substituted

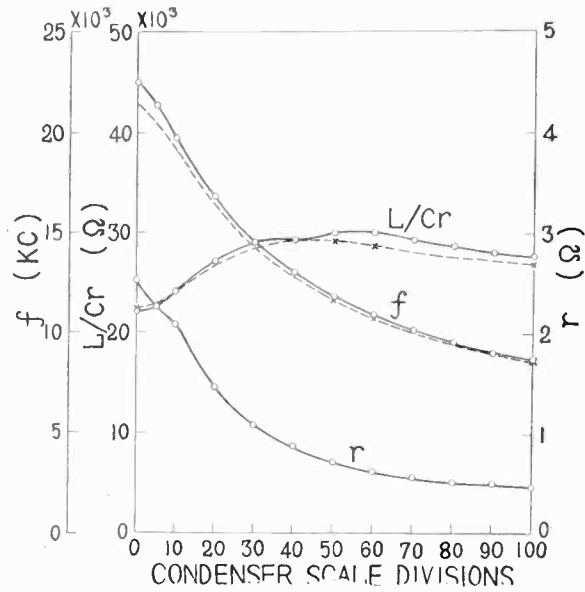

Fig. 7

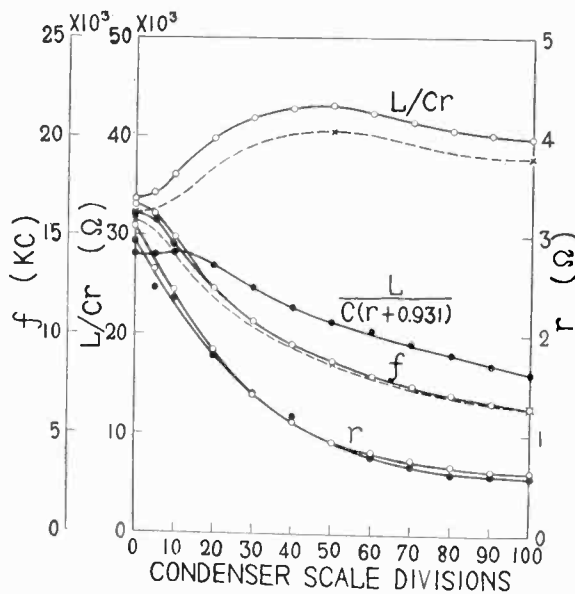

Fig. 8

by rotating the condenser, so as just to recover the tube capacity C_p . The curves of L/C_0r_0 , r_0 , and f_0 may thus be derived from the curves of family A. Those are shown in Fig. 6, in which the curves of family A in Fig. 4 are also reproduced for comparison. As is clear from Fig. 6

the method fails to give the values of L/C_0r_0 and r_0 for scale divisions below a certain limit which corresponds to Cp inherent in the tube employed. This may be only the disadvantage of the present method of measurement.

The results directly obtained with coils No. 2 and 3 are as shown in Figs. 7 and 8, respectively, which correspond to those given in Fig. 4 for coil No. 1, and they are plotted here again by points marked by a cross or a circle according as the additional glass seal has been connected across the resonant circuit or not. It will be seen that the effect of the seal loss is no more than 7.5 per cent and may be neglected in

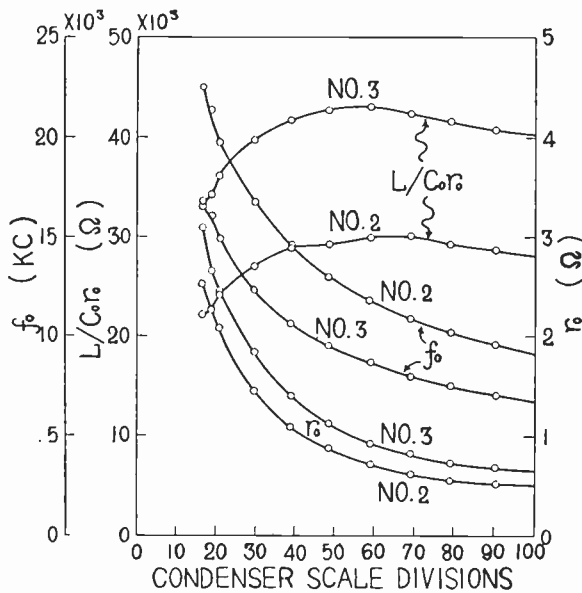

Fig. 9

this case as is also permissible in practice. The corresponding curves for L/C_0r_0 , r_0 , and f_0 are as shown in Fig. 9.

The author was able to carry out the whole experiment under the condition of extremely good stability, and to reproduce all the measured values of a series of tests within 5 per cent in the measurement repeated again after long interval of time. It is also necessary to know whether the results are correct or not. The following experiment may be of service to some extent for this purpose.

A small piece about 12 mm long of B.S. No. 40 manganin wire has been inserted in series with the resonant circuit at the high potential side of coil No. 3 and then the resonant impedance as well as the resonant frequency has been measured by the same process as before. They are plotted with black circles in Fig. 8. The values of the resonant impedance are considerably diminished on account of the increase

in the series resistance, whereas no appreciable alteration is noticed in the frequency as expected. The manganin wire used is so thin and has so high a resistivity that its resistance may not be appreciably affected by the frequency even at short waves. Hence the value of effective series resistance, which has been derived from that of resonant impedance measured as above, minus 0.931 ohm, the direct-current resistance of the manganin piece, should be equal to the measured value of resistance of the original circuit without the piece. Fig. 8 shows that this is true within the deviation as small as 10 per cent.

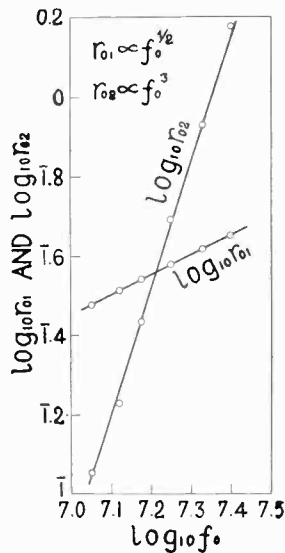

Fig. 10

Some remarks relating to high-frequency amplification may be made as a result of the measurements referred to above.

The effective series resistance of a parallel resonant circuit, r_0 , is due, in general, to two kinds of losses, one involved in metallic parts and the other in dielectrics. The component due to the latter, r_{02} , seems to take the following relation, based on a fact that the power factor of most dielectrics is slightly affected by the frequency,

$$r_{02} \propto C_o^{-3/2} \text{ or } f_0^3$$

where L is assumed to be constant. On the contrary, the component due to the former kind of loss, r_{01} , does not take such a simple form. It is evident however, that the term proportional to f_0^3 will have the most overwhelming influence upon it. Roughly assuming that r_{01} and r_{02} are proportional simply to f_0^1 and f_0^3 respectively, r_0 as a function of f_0 may be divided into components as shown in Fig. 10 by cut and try method. It may, therefore, be said that the rapid rise in the r_0 curve at higher frequencies is chiefly caused by r_{02} .

In Fig. 11, the values of L/Cr obtained with the three coils are plotted against condenser scale divisions with frequency as the parameter. It is therefore certain from the figure that the more the number of turns of coil or the less the condenser scale divisions, the higher the value of L/Cr at a given frequency. It can therefore be concluded that high-frequency amplifiers ought be operated with as small a capacity as possible in the resonant circuits; otherwise the amplification will be lowered, and that, since the dielectric loss, in such a case, decidedly limits the value of L/Cr , an improvement in amplification at high fre-

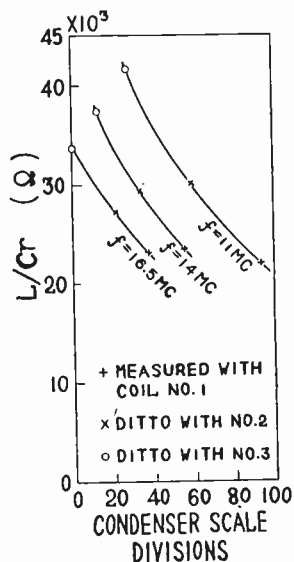

Fig. 11

quencies depends in rather greater measure upon the proper choice of materials as well as geometrical shapes of dielectric parts than upon the design of coils.

CONCLUSIONS

As mentioned above, the present method of measurement has given satisfactory results in the range of frequency used. There is no doubt that the method is also applicable to ultra high frequencies, above 30 megacycles, provided that a lower numerical value of the negative resistance is available. For such an application, it is suggested that two or more tubes be put in parallel operation in order to get a numerical decrease in the negative resistance while there will be some undesirable increase in tube capacity. In this respect the writer has the opinion that such a low numerical value of negative resistance might be obtained without any risk of increasing the tube capacity, only if a material of large emissivity, as oxide in the case of oxide-coated filament

is applied to the surface of the plate. This would provide on the other hand the solution to the problem of reducing the undesirable tube capacity to which the only defect of the present method is due as already described.

Although the method has primarily been developed for the purpose of measuring the resonant impedance, it also enables us to determine accurately the effective series resistance as a resistance variation method, if a resonant impedance normally measured is compared with that obtained in the presence of a suitable additional series resistance introduced into the circuit at a suitable place. The additional resistance should be of such careful design, that its insertion gives no rise to other effects than the introduction of certain known amount of radio-frequency resistance.

Another practical application of the method is for the measurement of the amplification of high-frequency amplifiers, which has scarcely been attained successfully by other methods using the measurement of radio-frequency currents or voltages. In this case the voltage amplification may be computed from the measured value of the resonant impedance with the aid of tube constants. In case screen-grid tubes, employed therein as interstage tubes, are capable of providing required low numerical values of the negative resistance, these tubes associated with the properly modified direct-current circuits, can readily be utilized to measure the resonant impedance under the same condition of the resonant circuits as they are.

The idea of employing the dynatron for the radio-frequency resistance measurement was also published by H. Pauli.² The writer's³ experiment was, however, carried out independently of it and his first report on it was published in Japan, in 1929, and its English translation in March, 1930. The second report of his work on the subject appeared in Japan in January, 1930.

In conclusion the writer wishes to acknowledge his indebtedness to S. Kawazoe who kindly gave him valuable suggestions throughout the experiment.

² H. Pauli, *Z. f. Tech. Physik.*, December, 1929.

³ H. Iinuma, *Jour. I. E. E. (Japan)*, June, 1929; *Jour. I. E. E. (Japan)*, January, 1930; *Proc. I. R. E.*, 18, 573; March, 1930.



SOME DETAILS RELATING TO THE PROPAGATION OF VERY SHORT WAVES*

By

R. JOUAUST

Summary—The laws governing propagation of very short waves are the same as those governing the propagation of luminous vibrations. However, because of the difference in frequencies, the absorption, due in large measure to diffusion by particles suspended in air, is less for very short waves than for light, which explains the very great distance traveled by these waves.

Communications have been carried on by very short waves between points not in direct line of vision. The phenomena of atmospheric refraction may explain this result, and the hypothesis seems to be justified by certain observations.

IN conformity with the decisions of the International Technical Consulting Committee on Radio, we designate as very short waves those whose frequency is greater than 30,000 kilocycles per second.

Since November, 1917, when Gutton and Touly¹ were successful in utilizing the properties of triodes for the production of sustained waves some meters in length, with which they were able to repeat all the classical experiments of Hertz, many plans were proposed in France and abroad for the practical application of these oscillations. Up to the present it seems to be admitted that they do not have the long range² that can be reached with lower frequencies. This result was verified in France in 1923 under the following conditions:

In 1921 at a time when the part played by the upper atmosphere in the propagation of radio waves was hardly suspected, Colonel Chaulard brought forth a hypothesis according to which he believed that in the upper atmosphere there should be an ionized layer capable of reflecting waves, returning them at a great distance from their point of emission, and consequently, short-wave emission should not be received at a certain distance from the transmitter, and should be detected again at a greater distance, which is an established fact now. Tests were undertaken with a transmitter set up at Fort d'Issy near Paris, using a wavelength of 45 meters and an antenna oscillating in a harmonic, in order to increase the amount of energy radiated toward the upper atmosphere. The results that were obtained confirmed the

* Decimal classification: R111. Original manuscript received by the Institute, July 3, 1930. Translation received by the Institute, November 7, 1930.

¹ Gutton and Touly, *Comptes Rendus de l'Académie des Sciences*, 168, 271, 1919.

² Recent tests have shown that in certain directions just as great distances can be reached with very short waves as with short waves. This is a point that should be explained.

hypothesis. For distances between 200 and 700 kilometers, the reception intensity increased with the distance, and there was a zone of silence near the station. Tests repeated with 9-meter waves gave absolutely negative results. These short ranges of very short waves are explained by the fact that at no point of the Kennelly-Heaviside layer does the electronic density gradient reach a value sufficient for refraction to bend the waves and turn them toward the earth.

If this is the case, these very high frequency oscillations should act like light vibrations and their use can only supplement that of visual transmission. At any rate it is easy to see that the use of electric oscillations offers certain advantages over luminous vibrations.

A luminous source of a tenth candle power is still visible at 1 kilometer.³ At the top of a 70-meter tower, the curvature of the earth limits visibility to about 30 kilometers. If the law of the variation of the brightness as a function of the distance were exact, to be visible at this distance the luminous source should have an intensity of 90 candle power, it being assumed that the consumption of the best modern electric lamps corresponds to 45 watts. In the following we shall see that with powers of this order of magnitude, it is possible to get much longer ranges. The reason is as follows. In the short-wave radio station the efficiency is close to unity. Seventy to eighty per cent of the energy supplying the station is changed to high-frequency energy. In luminous sources, on the other hand, a very small part (of the order of 1 per cent) of the power supplied is transformed into visible radiations. We see in this the first advantage of very short waves over luminous vibrations.

There is another more important point.

The law of the variation of the brightness as a function of the distance is not applicable in air over great distances, because of the diffusion of light by air molecules and particles in suspension. The result is an absorption of light and the illumination produced at a distance d by a source of luminous intensity I instead of being expressed by the simple relation I/d^2 is given by a formula of the type I/d^2e^{-td} . This law was established some time ago by the professor of hydrography, Bouguer.⁴ In a very pure atmosphere without any particles in suspension, the gaseous molecules alone take part in diffusion, the coefficient t having a very low value, but this is only an exceptional case. Air always contains particles in suspension, especially water molecules, and the distances are much less than those we calculated above.

Lord Rayleigh showed that the diffusion was inversely proportional

³ Walsh, *Photometry*.

⁴ Bouguer, *Traité sur la graduation de la lumière*.

to a certain power of the wavelength. This power is 4 when it is a case of only gaseous molecules, and 2 or even 1 when it is a case of particles with larger dimensions. However, the absorption due to diffusion should be less as the frequency of the oscillations is lower. This makes it possible to have communication by infra-red radiations in fog and over distances at which luminous radiations would be completely invisible.

For very short waves the absorption due to diffusion should be practically zero.

In optics the distances are increased by concentrating the total luminous energy emitted by a source, into a narrow beam by means of mirrors. In order to secure this result it is necessary that the mirrors have dimensions larger than those of the emitted waves. This is a condition which is easily met in the case of luminous vibrations, but cannot be met with long radiotelegraph waves. It is not a problem at very short waves.

Finally, obstacles stop luminous vibrations. We know that the phenomenon of diffraction permits luminous waves to pass certain of these obstacles. But their dimensions not being great as compared with the wavelength of the source that it used, it can be said that practically all obstacles stop light. It is hoped on the other hand that very short waves whose length is 6000 times larger, on the average, than that of luminous waves, will be able to pass around certain objects in their path by diffraction. The substitution of very short waves for luminous vibrations therefore offers certain advantages that did not escape General Ferrière. In 1921, with his coworkers Mesny, David, and Beauvais, he started research on the application of very short waves to certain purposes in connection with national defense and navigation.

It is not within the scope of this article to describe the apparatus used and the results obtained. It is only necessary to refer to various publications on this subject.⁵

We merely wish to point out certain characteristics in propagation that appeared during the various tests undertaken in the course of the work, and which we deem worthy of special attention.

First, let us state that diffraction was shown plainly. With a small portable station operating with a wavelength of 2 meters and having a dipole antenna consisting of a wire 1 meter long, the current in the antenna being 0.08 ampere, telephony was possible in open country at a distance of 2 kilometers. In forest regions it was possible to communicate at 500 meters. Another phenomenon, disconcerting at first, was observed during the tests.

⁵ Mesny, *Les Ondes Courtes* (Presse Universitaires); *L'Onde Electrique*, p. 28, January 1924; p.99, February 1924, Jouaust: *L'Onde Electrique*, p. 1, January 1930.

The transmitter with a wavelength of 3.50 meters was placed at the top of the Eiffel tower. Reception was possible by means of a set carried by one of the operators. In 1923 the investigators, spread over a hilly region about 60 kilometers from Paris, found that the reception was very strong at the edge of a crest, diminished, and then disappeared as the distance from the edge of the plateau increased, and then reappeared very intensely at the next crest. There was always visibility between transmitter and receiver. It may be explained as follows (Fig. 1): When the operator was at AB , he received only direct radiation EA . At CD , in addition to the direct radiation EC , he also received reflected radiation ERC .

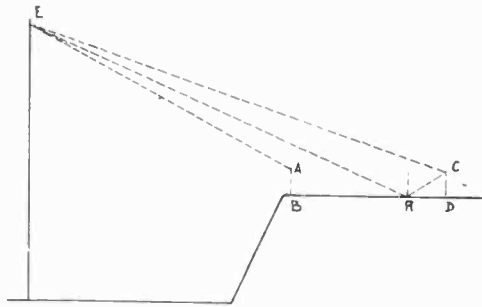

Fig. 1

As the figure is not drawn to scale, it is impossible to consider the magnitudes of the different geometric elements that are involved. But if they are calculated by introducing real numerical magnitudes, we find that angle ERB is less than a degree. Ray ER , therefore, is a grazing ray. The reflecting power of the electric field is given by the formula:

$$\rho = \frac{\tan(i - r)}{\tan(i + r)}$$

Therefore, it is very close to unity, if i is the angle of incidence and r the angle of refraction.

On the other hand, the calculation shows that under the experimental conditions the difference between the direct ray EC and the reflected ray ERC is negligible as compared with the wavelength used. Under these conditions the electric field at E is the difference between two equal fields and is zero.

In particular, if we consider point C at ground level, a well-known optical formula shows us that the resultant field E_r is given as a function of the direct field E_d by the relation:

$$E_r = E_d \frac{\sin 2i}{\sin(i + r) \cos(i - r)}$$

If the reflecting medium can be considered as a pure dielectric, which was the case because of the high frequency of the waves that were used and the character of the terrain, we see that for a grazing ray E_r is cancelled.

In this connection we wish to point out an acoustic analogy. It was found⁶ in tests made to find the depth of the sea by acoustics, that in the open sea a sound producer immersed behind a vessel could not be heard by a hydrophone placed at the front (Fig. 2). The reason is as follows. There was interference between the direct sound ray AB and the ray reflected at the surface of the sea ARB . On the other hand, when the vessel reaches the continental shelf, the receiver B picks up the sound vibrations from A reflected at the bottom of the sea. It should be noted

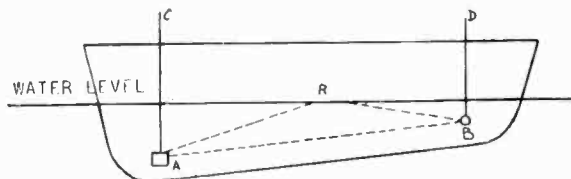

Fig. 2

that the zones of silence that we have just mentioned for very short waves require special conditions, a soil that can be considered a perfect dielectric and incident rays almost horizontal.

These conditions, especially the one regarding the soil, are rarely fulfilled. The soil always conducts more or less. It acts as if it had a complex specific inductive power of the form:

$$k - j \frac{4\pi\sigma}{\omega}$$

ω being 2π times the frequency and σ the conductivity.

Under these conditions the resultant field component is no longer zero for the grazing ray. And particularly if the imaginary term in front of the real term is large, that is, if the ground can be considered a perfect conductor, the reflected electric field is added to the incident field and the resultant field is twice the incident field.

For the frequencies under consideration, the surface of the sea cannot be considered a perfect conductor, but it is nearly enough so to assume that the surface of the sea will not show the zones of silence mentioned above. Tests have verified this. A receiving set on a vessel was able to receive until at the horizon, from a transmitter with a wave length of 3 meters placed 80 meters above the ground on a cliff near the port of Brest. As the sea is in a perpetual state of agitation, its surface will cause diffusion rather than reflection of the waves.

⁶ Harvey C. Hayes, *Jour. Franklin Institute*, 197, 550, 1924.

The interference between the direct ray and the reflected ray also may explain a phenomenon recently observed by the French National Meteorological Office. This office makes altitude readings in the medium regions of the atmosphere by balloons carrying recorders,⁷ and thought to provide the balloons with radio apparatus that would send certain signals during the ascension. The first tests, made with 30-meter waves, gave very encouraging results. To make the apparatus lighter, the use of 4-meter waves was tried. It was then found, by following the balloon with a theodolite, that when the angle of elevation of the balloon in relation to the receiving set (angle of line of sight of balloon reception with the horizontal) became less than about twenty degrees, the transmission weakened very rapidly. If, for a decidedly

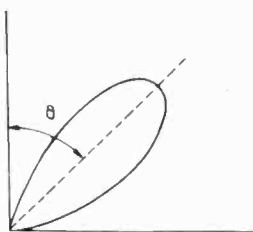

Fig. 3

dielectric soil, we draw the value of the induced electromotive force⁸ in a vertical antenna as a function of the angle of incidence, we get a curve identical to that in Fig. 3. We see plainly on this curve that when the angle of incidence increases beyond a certain value, the electromotive force in the antenna decreases very rapidly.

We now shall take up the part played by atmospheric refraction, but we believe that first we should describe the circumstances under which its influence is shown.

After the preliminary experiments showing the possibility of very short-wave telephone communication between France and Corsica, General Ferriè and Mr. Milon (Inspector General of Telegraphs) had a series of systematic tests made by David and Beauvais in the summer of 1929.

For a long time there had been visual communication between France and Corsica by means of apparatus on two mountains with altitudes of more than 1000 meters. This communication could not be continued regularly, as the ray of light traveling very close to the surface of the sea was frequently absorbed by fog. It was thought to establish radio stations at the same locations as the visual stations,

⁷ Idrac and Bureau, *Comptes Rendus de l'Académie des Sciences*, 184, 691, 1927; Bureau, *ibid.*, 188, 1565, 1929.

⁸ Bouthillon, *Jour. l'Ecole Polytechnique*, 25, ser. 2, p. 151.

which were at places far from good roads, but this would make it difficult to connect them with telephone offices.

In France, the station was installed on a peak near Nice, at Fort de la Revère, with an altitude of 700 meters, and in Corsica, the Col de Teghine was used, with an altitude of 530 meters. The distance between the two stations was 205 kilometers and with the stations at these altitudes the curvature of the earth should limit the ranges to 175 kilometers. The straight line joining the two stations passed more than a hundred meters below the surface of the sea.

For transmission a full wavelength antenna was employed. Five-meter waves were used.

With a power of 36 watts it was possible to obtain very good radio-telephonic communication. We see that this power is of the order of magnitude that, as stated above, would be given by luminous signals at distances of 30 kilometers, and this justifies what we stated on this subject in connection with one of the advantages of the substitution of very short waves for light. The fact that the actual range exceeded the geographic distance, was attributed to diffraction without noting any special facts during these tests. During hot days, there was very strong transmission during the night; it decreased beginning at fourteen o'clock, passed through a minimum at about eighteen o'clock, and regained its original value at about twenty o'clock. This weakening was shown only on sunny days and never when cloudy.

During the weak period it was necessary to maintain good communication by increasing the power to 150 watts, or by substituting for the single-wire antenna a reflector made up of an array of antennas. The diurnal phenomena could be explained only by an effect of the lower atmosphere on the wave propagation. Atmospheric refraction, depending on the state of the atmospheric layers nearest the ground, therefore, should be very important in the propagation of short waves.

The rôle of atmospheric refraction is very important in the visibility of luminous signals at great distances. It has been the subject of many studies.

Of just what does atmospheric refraction consist? Because of the curvature of the earth, the straight line joining two distant points is not always the same distance from the ground. Therefore, it passes through layers of air whose temperature, pressure, and humidity are variables, the magnitudes being a function of the amplitude.

These variations change the index of refraction of the gas, and consequently the speed of light. Therefore a ray of light cannot follow the straight line considered above, since, because of the Fermat principle, the trajectory of light waves should correspond to the minimum

distance. As a rough approximation we can consider air as made up of strata with different indexes, the index increasing as the altitude decreases.

Let us consider (Fig. 4) a ray of light SX coming from an elevated point S and which would not strike the surface of the earth unless there

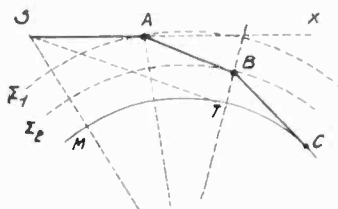

Fig. 4

were refraction. When at Σ_1 this ray meets the first surface of atmospheric discontinuity Σ_2 , it is refracted along AB , approaching the perpendicular.

At point B it meets the second stratum Σ_2 , undergoes new refraction and finally strikes the earth at C , a point beyond the point of contact T of the tangent drawn from S to the terrestrial great circle continued in the plane of the figure. The apparent range of the light signal therefore is SC and is greater than the arc representing the geographic distance. In reality, the variation of the index is continuous, and the problem that we have just treated geometrically by applying Descartes' law becomes a law of differential calculus.

The solution of this problem, which would permit the determination of the trajectory of light, would give a rather complicated equation for this curve. But this curve can be roughly compared to a circle, and we reach the following conclusions:

Because of refraction, the light ray from A (Fig. 5) at height H to a point at height h beyond the geographic horizon, is a circle of radius



Fig. 5

mR , R being the radius of the earth and m a factor depending on the atmosphere at the time of observation. This circle is tangent to the surface of the earth at C . To an observer at A , the horizon appears to be at C while it should be at T , the point of contact of the tangent to the earth from A . This is called the "depression of the horizon." This depression is perceptible even to sailors 5 or 6 meters above the sea on the bridge of a vessel, and as it influences their astronomical readings,

it has been made the subject of many studies⁹ that have shown the effect of atmospheric conditions on this depression. Thus, lieutenant Koss showed that the coefficient was clearly influenced by atmospheric humidity. This result was to have been foreseen *à priori*, for we know that the amount of water vapor acts extensively on the specific inductive power and on the index of refraction of air.

We can even calculate this effect by applying the mixture rule to the specific inductive power. However, it is refraction phenomenon that makes objects visible beyond the geographic horizon.¹⁰ The actual distance due to refraction, the distance between two points *A* and *B*, is given by the formula¹¹:

$$L = \sqrt{RH \frac{2m}{m-1}} + \sqrt{Rh \frac{2m}{m-1}}$$

The distance is greater as *m* becomes smaller. If *m* is infinity, the distance is equal to the geographic horizon, while if it is negative, the real horizon is nearer. This distance sometimes may be considerable if we refer to the fact pointed out by Alexander Russel, that alpine climbers were able to see vessels in the English Channel 600 kilometers away, from the top of the Finsteraarhorn.

This is evidently an exceptional case. But refraction always intervenes, and one of its special effects is to modify the range of beacons.

This effect of refraction has been taken up by the departments in charge of improving these apparatus. For example, the French Department of Roads and Bridges has studied the question by observing over a period of eleven years, three times a night, the height above sea level at which Kreach beacon is no longer perceptible to an observer descending along the cliff at the top of the Raz, 55 kilometers away. The value of factor *m* can be deduced from this. Some negative *m* values have been found, but in general the values are positive. The average over a year was 10.5. The observations have shown a seasonal effect very plainly. For example, the average *m* value was 15 in January, but dropped to 7 in August. In order to explain the results obtained in the France-Corsica communications, *m* must be given a value of nearly 5. Such low values have rarely been found in the tests by the Department of Roads and Bridges, but it should be noted that these latter tests were made on the Atlantic Ocean where climatic conditions are very different from those on the Mediterranean.

⁹ Assier de Pompignan, *Annales d'Hydrographie*, 1901.

¹⁰ Refraction is frequently confused with mirage. Mirage is only a special case of refraction consisting of a double image of the objects, one true and the other reversed as if there were reflection in water.

¹¹ Ribière, *Phares et Signaux Maritimes*; Doin, Paris, p. 36.

The effect of certain factors should not be the same for the relative index of refraction of light rays as for the relative index of very short waves.

Certain investigators¹² have already proved that the specific inductive power of air saturated with water vapor does not follow the law of mixtures, with radiotelegraph waves.

Finally, the effect of diffraction might be added to that of refraction.

This seems to justify the rôle we attributed to refraction. The effect of sunny days, found during the France-Corsica tests, has also been shown to exist in long-distance visibility studies.

Over a period of many years Torel,¹³ at the edge of Lake Lemman, made many observations on the effect of refraction on the visibility of objects on the side of the lake opposite the observer. He found that the range decreased every time the water in the lake became heated to a temperature above that of the air. Objects that should be visible geographically, ceased to appear. The factor m became negative.

This is what must have happened during the France-Corsica communication tests. Due to the effect of the sun in the morning, the air heated more rapidly than water, which has a high heat capacity. In the afternoon, on the other hand, as the sun sank to the horizon the air cooled more rapidly than the water, causing a reduction in the factor $2m/(m-1)$, as in Torel's observations. The wave range decreased. We see why this phenomenon does not take place in cloudy weather.

CONCLUSION

It seems probable that very short waves are propagated like luminous vibrations. But this propagation is accompanied by certain characteristics that can be predicted by the laws of optics. These must not be overlooked in planning to use these waves, as their effect may be considerable.

¹² Delcellier, Guinchant, and Hirsch, *L'Onde Electrique*, p. 189, 1926.

¹³ *Astronomie*, p. 493, November, 1929.



GRID CIRCUIT POWER RECTIFICATION*

By

JAMES R. NELSON

(Raytheon Production Corporation, Newton, Mass.)

Summary—Grid circuit power rectification is investigated by studying the ideal rectifier and applying the results obtained to the case of a tube rectifier. Characteristic curves are used in this study to obtain the optimum conditions for rectification and the order of the output voltage obtainable. Conditions for minimum loading of the circuit preceding the detector are discussed. Audio-frequency discriminations is also studied as a function of grid circuit impedances and experimentally determined curves showing the magnitude of the frequency distortion are also given.

LINEAR power rectification is being quite widely used at present. A grid bias detector is used to obtain this linear rectification and the results obtained are good provided that the circuit is correctly designed. The possibilities of using grid circuit detecting for linear rectification have not been investigated very extensively. Grid circuit power rectification has certain limitations but very good results, both as to linearity of rectified voltage with respect to input voltage and overload characteristics, may be obtained using this method of rectification as will be shown later.

The theory of grid circuit rectification for small signals of the order of hundredths of a volt has been studied quite extensively both theoretically and experimentally. The theory of small signal detection becomes very difficult to apply when the input voltage is increased so that it will be abandoned here and the subject of grid circuit power rectification will be studied by means of certain measured characteristic curves taken in both the grid and plate circuits. The basis of the method used here is old in the art being nothing more than finding voltage, current, or power values by means of load lines plotted on tube characteristic diagrams. This method has been successfully used in the study of grid bias rectification.

IDEAL CIRCUIT THEORY

The theory of an ideal detector will be studied first. The application of the theory to the tube detector will be quite evident. Assume some device has a linear relation between current and voltage as shown in Fig. 1 by the line ACB , where the starting voltage has been shifted to the left of zero voltage. This shifting was done so that the ideal curve considered would correspond closer to the $ig-eg$ curve of a tube.

* Decimal classification: R134. Original manuscript received by the Institute, November 11, 1930.

The direct current is given by the expression $I = KE$ when the voltage is to the right of point A and E is the difference in potential between the point considered and A and the current is zero when the voltage is to the left of point A . If a sine wave of E volts is inserted in series with this device and the direct voltage E_0 is varied the relation between the direct voltage and current will be represented by a line FDC , say for one unit of alternating voltage. Similarly the relations for other values of input voltage may be found. Certain points on this diagram may be calculated quite readily. For example, assume that the direct bias is to the left of point A an amount equal to the peak value of one unit of alternating voltage. As soon as the bias is decreased some current will start

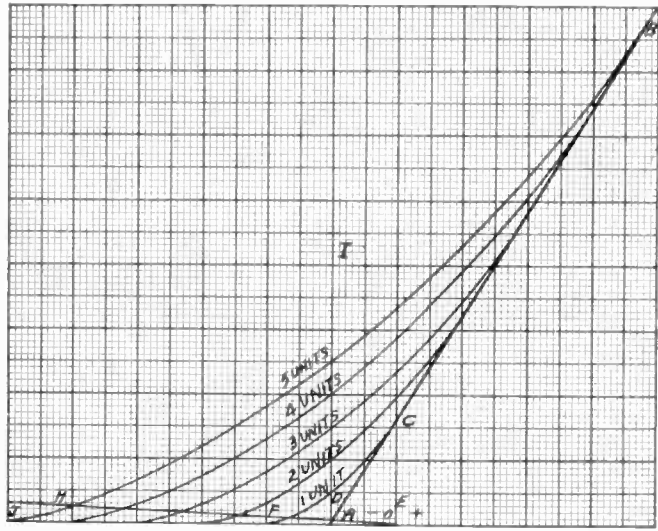

Fig. 1.—Theoretical direct-current relations of a linear rectifier for various input voltages.

to flow over part of the cycle. The direct voltage at which the start of the current may be measured depends upon the sensitivity of the meter but will be to the left of point A some value less than the peak value of a.c. Hence, the limiting value of point E will be the voltage OA plus the peak value of a.c. When the direct voltage has the value OA current will flow during half the cycle. It can be shown easily that the average value of this current is

$$I_0 = \frac{E_0}{\pi r} \quad (1)$$

where, r is the resistance of the device found by the relation between I_0 and E_0 for zero carrier voltage.

The above current is the value of direct current that would be given

by a direct change of voltage E divided by π so that the value of AD may be determined for any voltage. When the direct voltage has a value to the right of point A equal to the peak value of one unit E , there will be no rectified current so that for all voltages to the right of point C the relation between E and I will follow the line ACB obtained for zero alternating voltage. The corresponding current and voltage may be calculated similarly for different values of carrier voltages. The rectified current curve and its resistance may be calculated exactly as the bias is varied by the following formulas.¹

$$I_0 = \frac{EK}{\pi}(\sin \alpha - \alpha \cos \alpha) \quad (2)$$

$$\frac{1}{r} = \frac{K\alpha}{\pi} \quad (3)$$

where α is one-half the angle during which current flows. K is determined from relation $I = KE$.

Assume a series of such lines calculated for various carrier voltages. If a resistance R is inserted and tied in at some point, say zero, the direct potential will vary according to the carrier voltage. The value of potential for any given carrier voltage will be given by the intersection of the carrier voltage curve and the line OH having a slope equal to $1/R$. Several points should be noted here. One is that the relation between the direct current and direct voltage for various carrier voltages is not a straight line and because of this fact equal increments of carrier voltages do not cause exactly equal increments of change in the direct voltage when the device is operated in series with the resistor R unless R is infinite. The second is that as R is increased the internal resistance r is also increased so that when R becomes infinite r internal also becomes infinite. The third point is that if the original curve ACB starts from zero and if the resistor R is tied into zero also, the internal resistance r at the intersections of the various curves with the load line $1/R$ will be constant regardless of the value of external resistance R used. This may be seen from (2) and (3) for if the load line intersects the curve for one unit of carrier at some value I_0 it will intersect the curve for N units at a current NI_0 for the same angle α which according to (3) will give a constant internal resistance r .

One other relation is of interest and this is the point of intersection of the line OIH and the curve for any given carrier voltage. This may be calculated approximately quite easily. The average value of current is given by the point H for a voltage $5E$. Call this current I . Cur-

¹ E. Peterson and F. B. Llewellyn, "The operation of modulators from a physical viewpoint," Proc. I. R. E., 18, January, 1930.

rent will be drawn only over part of the positive cycle. If we assume the part that draws current is a sine wave the peak value of the current will be πI . The voltage for zero signal to give a peak value of πI may be found quite readily from the curve for zero signal. Call this voltage E_0 . The intersection of OII and JB will then have the approximate value OA plus $5E$ minus E_0 . It is also to be noted that we can reduce the part of the cycle drawing current by increasing the resistance R . This is quite an important point in the operation of the actual tube as will be shown later.

A rectified voltage curve may be found from Fig. 1 by plotting the relation between the peak value of E and the rectified voltage V which value is given by the difference in voltage between the intersections of the load line and the line for zero carrier and that for some voltage E , say, JB . It is quite easily seen from this procedure that the relation V and E is approximately linear for large values of R and becomes exactly linear when R is made infinite.

If the external resistor R is not by-passed for the carrier the rectified voltage V for any given peak voltage E will be given by

$$V = \frac{ER}{r + R} \quad (4)$$

where r represents the internal resistance between the grid and cathode.

If the sensitivity S is defined as dV/dE its value will be

$$S = \frac{R}{r + R} \quad (5)$$

It is easily seen that the limiting value of (3) becomes one-half as R is increased. If the resistor R is by-passed for the carrier voltage it may be proved quite easily that the sensitivity is

$$S = \frac{R}{r} \quad (6)$$

The limiting value of (6) becomes one as R is increased, thus by-passing doubles the sensitivity in the limiting cases.

THE INPUT VOLTAGE

The operation of the detector will be studied for the conventional modulated voltage given by

$$e = E \sin pt (1 + B \cos qt) \quad (7)$$

where,

p is 2π times the carrier frequency
 q is 2π times the audio frequency
 B is the percentage modulation

AUDIO-FREQUENCY VOLTAGE CALCULATIONS

The audio-frequency variation of the carrier voltage may be taken as $B \cos qt$. If B is unity the peak value carrier is varied from 0 to $2E$. For example, if a two-unit carrier is impressed in series with the ideal detector as shown in Fig. 1, the grid potential will vary between the intersections of the lines for a zero and a 4-unit carrier with the load line OH when the carrier is modulated 100 per cent provided that the impedance of the condenser by-passing R is high for the modulating frequency. Similarly the variation for any other percentage modulation is easily found. The actual voltage for any carrier and any percentage modulation may be calculated quite readily from the rectification diagram.

The relation between the audio-frequency current and voltage will no longer be given by a straight line such as OH when the impedance of the condenser C is comparable to that of the R , but will be given in the general case by a distorted ellipse. The resistor R , however, determines the operating voltage for any carrier regardless of the a-c impedance. The modulated carrier may then be replaced by an internal audio-frequency generator, $B \cos qt$ which has its operating point at the intersection of the load line and the curve for the particular carrier voltage. The instantaneous relation between the current and voltage will be given by a distorted ellipse having its center about the operating point. This case will be further discussed in the audio-frequency discrimination considerations given later.

In the discussion that follows it will be assumed that the impedance of the by-pass condenser C is high compared to that of the resistor considering audio frequency only.

ACTUAL CIRCUIT THEORY

Fig. 2 shows the I_g - E_g measured characteristic curves of an ER-227 using various carrier voltages. The plate voltage was varied so that its value was the same as when the B voltage was 180 volts fed through an 18,000-ohm resistor. The actual characteristic curves roughly approximate the curves calculated for the linear relation given in Fig. 1. The main difference is the curvature at the foot of the I_g - E_g curve for zero signals which causes the resistance of this curve to vary between infinity and about 4500 ohms, instead of remaining constant.

A one-megohm load line is drawn in from the point of zero poten-

tial, in this case the cathode. The method of operation is quite evident. For example, assume a carrier voltage of four volts. If the carrier is modulated 100 per cent its peak value from (7) will vary between zero and $2E$ or 8 volts. The variation will be proportional to the percentage of modulation so that when B is fifty per cent the peak value of the input voltage will vary between one-half and three halves of E or between 2 and 6 volts. Thus if the external impedance is one megohm the audio-frequency variation of the grid potential may be found from the curves of Fig. 2 for various carrier voltages and percentages of modulation.

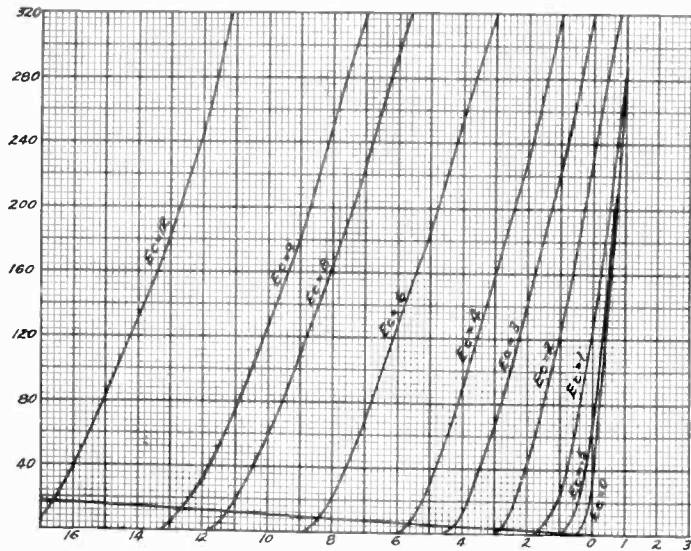

Fig. 2.—Experimentally determined $ig-eg$ curves for various input voltages using ER 227 tube.

The rectification curve for a one-megohm grid resistor is shown plotted in curve A, Fig. 4. This curve is nearly linear which gives approximately distortionless rectification. Theoretically, the grid rectification curve multiplied by the voltage factor of the tube, that is, $\mu R_{ext}/R_{ext} + r_p$ should give the rectified voltage in the plate circuit. Under the usual conditions, however, this does not hold for very large input voltages due to plate rectification. Plate rectification results in an increase of plate current while grid circuit rectification as used here results in a decrease of plate current; thus plate rectification causes a reduction of output. A detailed discussion of plate rectification is, however, beyond the scope of this article.

Fig. 3 shows the I_p-E_p curves of the same tube plotted for various a-c input voltages. A one-megohm resistor by-passed for the carrier voltage was used in the grid circuit. A 9000-ohm load line is shown

plotted in B, Fig. 4. This curve is very nearly linear up to 2.5 volts input beyond which it bends over due to plate rectification.

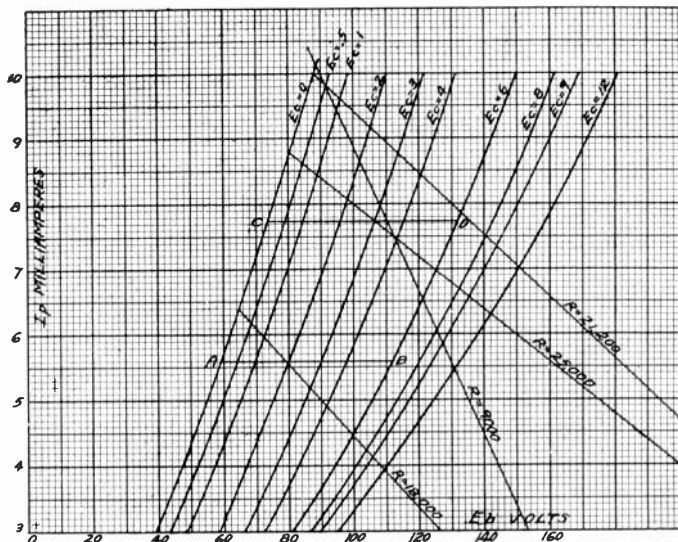

Fig. 3.— E_p curves ER-227 tube for various input voltages using a one-megohm grid resistor by-passed for the carrier voltage.

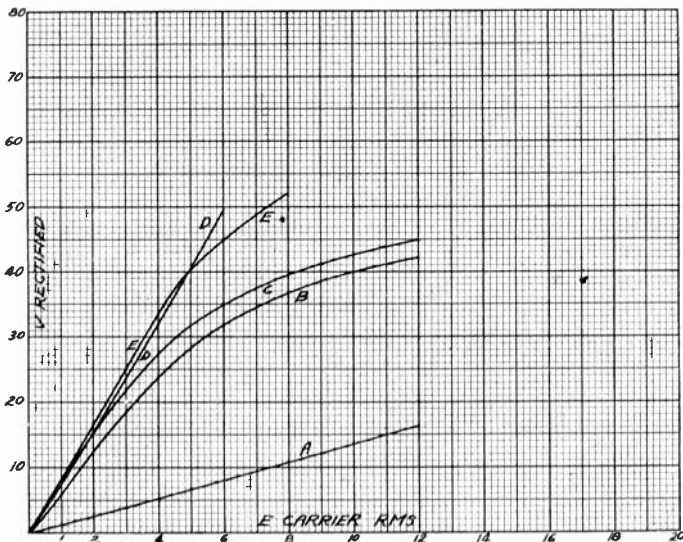

Fig. 4.—Rectification curves for ER-227 tube with r_g -equal to one megohm.

- A—Rectified voltage in grid circuit.
- B—Rectified voltage in plate circuit E_b -180 volts, R_p -9000 ohms.
- C—Rectified voltage in plate circuit E_b -180 volts, R_p -18,000 ohms.
- D—Theoretical rectified voltage in plate circuit for E_b -180 volts, R_p -18,000 ohms.
- E—Rectified voltage in plate circuit E_b -300 volts, R_p -25,000 ohms.

The linear output is limited for the above condition. An increase of external plate resistance does not increase the linear output as may

be seen from curve *C*, Fig. 5 which is for the case of using an 18,000-ohm resistor in series with a 180-volt supply. Curve *D*, Fig. 5, shows the theoretical rectification curve obtained by multiplying *A* by the voltage factor of the tube. The curves coincide up to about 2.5 volts.

An increase of plate voltage results in considerable more output voltage. Curve *E*, Fig. 5, shows the rectified output voltage using a 25,000-ohm resistor in series with a 300-volt supply. This curve is practically parallel to the calculated curve *E* up to about 5 volts input voltage. The plate resistor has been used for two purposes. With no signal, the tube has a slight negative bias which becomes more negative

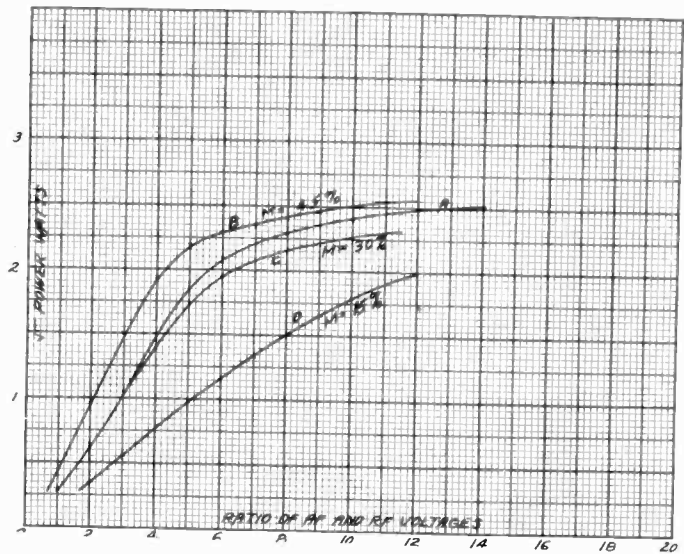

Fig. 5.—Power output curves of receiver for ratios of audio-frequency and radio-frequency voltages.

A— $\sqrt{P_o}$ vs audio-frequency voltage introduced in the external detector plate circuit.

B, C, D— $\sqrt{P_o}$ for grid circuit detector r_g -1 megohm, e_g -100 μ f, E_b -180 volts, R_p -18,000 ohms.

when a signal is applied. Thus the zero signal conditions determine the voltage that may be safely applied to the plate. The plate resistor thus reduces the effective plate voltage for no signal and acts also as an audio coupling impedance. It would be desirable to use a resistor bypassed for the audio frequency in series with the plate supply even if transformer coupling were used. For example, about 9 volts would be the maximum practical value of plate voltage to use with a transformer which would give 10.35 ma plate current. A three-volt carrier would have the intersection of the three-volt curve and 90 volts as its operating point. If the impedance of the transformer were high the maximum possible change in audio-frequency voltage would be given by

AB, Fig. 3 or 112-0-90 or 22 volts on one side and 90-59 or 31.0 volts on the other which would, of course, result in bad distortion. If a 25,000-ohm resistor were used in series with a 300-volt supply and by-passed the operating point would be the intersection of the 25,000-ohm load line and the three-volt curve or 106.3 volts. The maximum possible peak change in voltage would be given by the line *CD*. (Fig. 4.) The peak voltage would be 25.5 volts on one side and 32.5 volts on the other which is some improvement over the previous case. The use of a series resistor which is by-passed and a higher supply voltage thus results in a higher output voltage for a given percentage of distortion when transformer coupling is used.

Better results could be obtained by a reduction of the series resistor. For example, if a 21,200-ohm resistor were used in series with 300 volts the operating point for zero signal would be 88 volts and 10 ma and the power is 0.88 watt which would be about as high a value as practical to use. With a three-volt carrier the operating point would be 113 volts and 8.8 ma. The peak voltages would be 32.7 on one side and 27.7 on the other. Thus something less than a three-volt carrier should be used. About 30 volts peak output voltage for 100 per cent modulation would be the practical limit considering distortion. This detector even with 100 per cent modulation and a 3/1 coupling transformer would not give quite enough output voltage to work a push-pull, 245 stage requiring 100 volts.

Detectors working directly into a push-pull 245 stage are in general not very satisfactory as regards overload characteristics. Grid circuit power detection would not give as much output voltage as it is possible to obtain using bias detection. The logical method of using this method of detection for present day output tube requirements is in connection with an intermediate audio stage transformer coupled to the push-pull stage. The following experimental work was done with a receiver having an intermediate audio stage. The detector was resistance coupled to the intermediate stage because it delivers sufficient output voltage to overload the first audio stage without a coupling transformer under the conditions used.

Curve *A*, Fig. 5, shows the square root of the power output plotted vs. audio-frequency voltage introduced in the external circuit of the detector of the receiver mentioned above. The detector was then connected for grid-circuit detection with R_g 1 megohm, C_g 100 $\mu\mu\text{f}$, R_p 18,000 ohms and E_b 180 volts. The coupling condenser to the first audio-frequency stage was 0.006 μf and the grid resistor was two megohms. The power output curves of the detector for 45, 30, and 15 per cent modulation are shown by the other curves in Fig. 5. These curves

show that output is very nearly linear up to practically the theoretical undistorted power of the two 245 tubes in push-pull even for 15 per cent modulation.

Fig. 6 shows the same curves for R_p 25,000 ohms and E_b 300 volts for 30, 15, and 7.5 per cent modulation. These curves show quite conclusively that for the conditions given here the detector will deliver enough voltage to overload the audio system even at 7.5 per cent modulation.

GRID RESISTOR AND CONDENSER CONSIDERATION

An examination of the I_g-E_g curves shows that the grid resistance becomes quite low. Grid current will flow during part of the radio-frequency cycle and as was shown previously the part of the cycle during

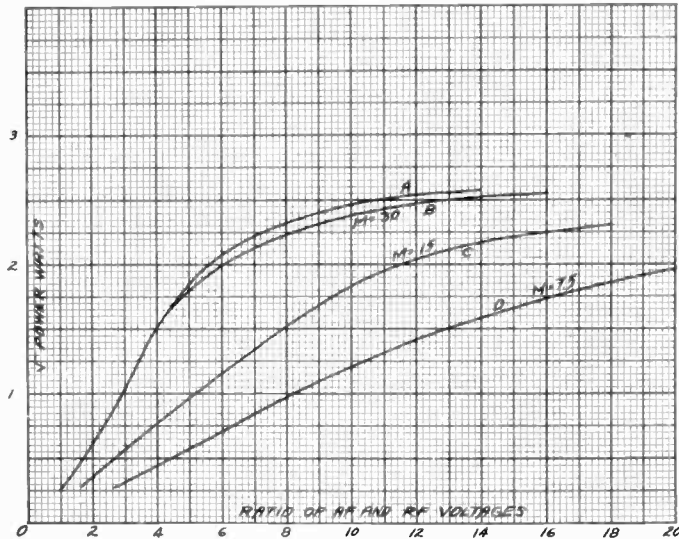

Fig. 6.—Power output curves of receiver for ratios of audio-frequency and radio-frequency voltages.

A— $\sqrt{P_o}$ vs audio-frequency voltage introduced in the external detector plate circuit.

B, C, D,— $\sqrt{P_o}$ for grid circuit detection, r_g -1 megohm, c_g -100 $\mu\mu\text{f}$, E_b -300 volts, R_p -25,000 ohms.

which grid current flows may be made small by using a grid resistor having a high value of resistance. It is desirable to make the part of the cycle drawing grid current as small as possible because the effective grid to cathode resistance which is in series with the grid leak and condenser shunts the tuned input circuit. The smaller the part of the cycle drawing grid current the higher the input resistance will be.

The smaller the grid condenser the less will be the effect of shunting the grid-cathode capacity by the low input resistance during part of the cycle. This may readily be seen from the fact that the impedance

of the grid leak and condenser is practically that of the grid condenser so that the grid condenser is in series with the low input resistance which will detune the stage preceding the detector. On the other hand, however, the smaller the grid condenser the less will be the fraction of the secondary voltage impressed on the grid. This consideration should not be so important in present day receivers as it was previously. A 250- $\mu\mu\text{f}$ condenser has been used extensively in the past but this is much larger than necessary. The size of this condenser should be chosen from audio-frequency discrimination considerations as will be discussed below.

The audio frequency for purposes of analysis may be considered to be generated by an internal generator in series with the internal resistance rg . The grid bias will be fixed for any given carrier voltage. Considering audio frequency only then the effect is only to fix the bias by drawing some grid current and the bias potential is that given by the load line and the ig - eg curve for that carrier voltage. The internal resistance will vary throughout the cycle and its values may be found from the intersections of the load line and the corresponding curves. The variation of internal resistance over the cycle would of course cause distortion and the external resistance should be chosen so as to make this effect small which can be done by making the ratio of external to internal resistance as high as possible. This may easily be seen as the internal voltage $R/(rg+R) Eb \cos qt$ where E is the peak value of the internal generator.

The audio voltage impressed upon the grid will be the ratio of the external impedance to the total impedance times the generated voltage. In actual operation, there will be frequency discrimination because one of the elements of the external impedance, the grid condenser in parallel with the input capacity, varies with frequency. It may easily be shown that the ratio of the external to total impedance is

$$\frac{R_1}{\sqrt{(R_1 + rg)^2 + (\omega C_1 R_1 rg)^2}}$$

For a low audio frequency the second term of the denominator will be small compared to the first. The ratio of any high-frequency voltage to the low-frequency voltage may be expressed as follows:

$$\sqrt{1 + \frac{(\omega C_1 R_1 N)^2}{(1 + N)^2}}$$

where,

$$N = \frac{r_g}{R_1}$$

An examination of this equation shows that the effect of frequency discrimination may be negligible by using either a small grid condenser or a low value of external grid resistance, or by making the ratio of the internal to the external resistance as small as possible which is tied up with the size of external grid resistor used. There is a certain minimum size of grid condenser which it is advisable to use. The grid resistor because of other considerations should be of the order of at least one megohm. It is practical, however, to obtain good results as regards frequency discrimination and still have the value of circuit elements satisfactory for other considerations as shown below by some experimental results.

Curve *A* of Fig. 7 shows the audio-frequency current in the output of the receiver using bias detection. This and the following curves

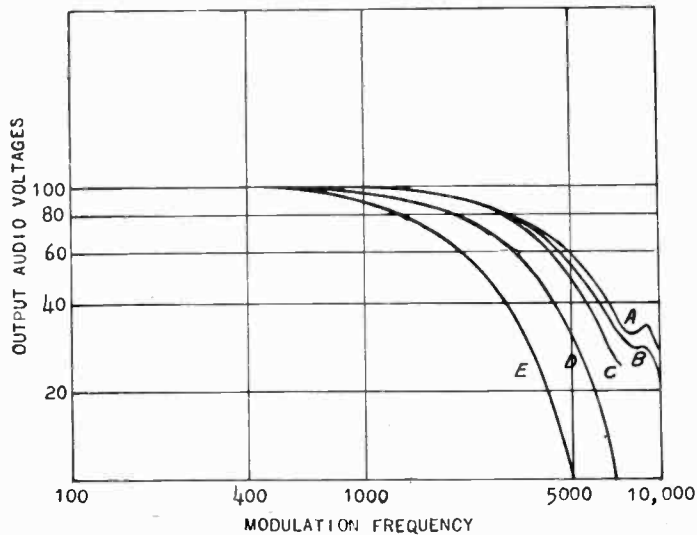

Fig. 7.—Fidelity characteristics of receiver.

- A—Bias rectification, r_p -250,000 ohms, C_p -150 μmf .
- B—Grid circuit rectification, r_g -1 megohm, C_g -50 μmf .
- C—Grid circuit rectification, r_g -2 megohms, C_g -50 μmf .
- D—Grid circuit rectification, r_g -1 megohm, C_g -250 μmf .
- E—Grid circuit rectification, r_g -2 megohms, C_g -250 μmf , r_p -20,000 ohms, and E_b -180 volts for B, C, D, and E.

were taken by impressing a 30 per cent modulated carrier voltage on the input of the stage preceding the detector. The carrier was then modulated with various audio frequencies higher than 400 cycles as lower frequencies were of no interest in this investigation. Curves *B* and *C* show the same curves obtained when a 50- μmf condenser is used with a one- and a two-megohm leak, respectively. Curves *D* and *E* show the same resistors with 250 μmf . From these curves it is seen that the frequency discrimination effect may be made small by using a large enough value of grid resistance to obtain linear rectification provided that a small grid condenser is used.

BOOK REVIEW

The Theory of Electrical Artificial Lines and Filters, A. C. Bartlett. 155 pp.; 160 figs. John Wiley and Sons, Inc., New York. Printed in Great Britain, 1930. Price \$3.50.

The author provides an excellent general introduction to the theory of such networks. The book is a textbook on the combination of complex impedances and the development of this field by means of artificial line theory rather than an exhaustive treatise. In the treatment of filters, for example, there is no mention of the character of the effects of dissipation in modifying the properties of the ideal, purely reactive structures.

The treatment is steady-state throughout, though this appears not to be specifically mentioned. In addition to the algebra of complex quantities, hyperbolic functions and determinants are used. The elements of the theory of continued fractions and simple continuants are developed and used in the treatment of ladder-type networks. A later chapter deals with the homographic transformation (elsewhere variously called *linear fractional*, *general linear*, and *bilinear* transformation), and the rôle of this transformation particularly in accounting for the frequent occurrence of circle diagrams in circuit theory.

After a simple treatment of T - and π -section artificial lines, the general repeated network is considered. The notion of reciprocal impedances and networks is developed for its value in the transformation of networks. There is a brief chapter on equivalent networks related to artificial lines, following Cauer, which emphasizes the aid which hyperbolic functions offer in visualizing the properties of artificial lines. The general theory of the multistage vacuum tube amplifier is developed, based on Butterworth's constant current generator rather than on the constant voltage generator more usual in vacuum tube circuit theory.

At the end of each chapter a number of examples are suggested, some of which are worked out for the reader. The examples are exercises in mathematics and paper theory and, like most of the text, leave the consideration of practical possibilities in the application of artificial line theory to other treatises.

KARL S. VAN DYKE*

* Wesleyan University, Middletown, Conn.



BOOKLETS, CATALOGUES, AND PAMPHLETS RECEIVED

Copies of the publications listed on this page may be obtained gratis by addressing a request to the manufacturer or publisher.

Details of the Compton quadrant electrometer made by the Rubicon Co., of 29 North Sixth St., Philadelphia, are given in Bulletin No. 330. The Compton electrometer is a refinement of the well-known quadrant electrometer originally invented by Lord Kelvin.

Bulletin No. 16 of Jenkins and Adair, Inc., 3333 Belmont Ave., Chicago, describes their Type D plate supply rectifier. This unit, which is designed for standard nineteen-inch relay racks, delivers a maximum output of 200 milliamperes at 350 volts, and two to three milliamperes at 135 volts. Two mercury vapor rectifiers are used.

Model 30 short tester and preheater manufactured by the Supreme Instruments Corp. of Greenwood, Mississippi, is described in a two-page mimeograph announcement of this new product. After the tubes come to the proper temperature, short circuits in the tube are indicated by the illumination of a number of miniature flashlight lamps.

Type PD direct-current volt-ohmmeters manufactured by the Roller Smith Co., of 233 Broadway, New York, are described in Supplement No. 3 to Bulletin No. 100.

The Polymet Manufacturing Corporation, 829-839 East 134th Street, New York, has recently published a sixteen-page catalog of products of interest to service men and manufacturers. Dimensional drawings of resistors, condensers, transformers, and other products listed in the catalog are given.

Loose leaf catalog No. 17 has been recently published by the H. H. Eby Manufacturing Company of 22nd St., and Lehigh Ave., Philadelphia. It describes various binding posts, binding post assemblies, volume controls, vacuum tube sockets, and resistors for manufacturing purposes.



REFERENCES TO CURRENT RADIO LITERATURE

THIS IS a monthly list of references prepared by the Bureau of Standards and is intended to cover the more important papers of interest to the professional radio engineer which have recently appeared in periodicals, books, etc. The number at the left of each reference classifies the reference by subject, in accordance with the "Classification of Radio Subjects: An Extension of the Dewey Decimal System," Bureau of Standards Circular, No. 385, which appeared in full on pp. 1433-56 of the August, 1930, issue of the Proceedings of the Institute of Radio Engineers. The classification numbers are in some instances different from those used in the earlier version of this system used in the issues of the Proceedings of the Institute of Radio Engineers before the October, 1930, issue.

The articles listed are not obtainable from the Government or the Institute of Radio Engineers, except when publications thereof. The various periodicals can be secured from their publishers and can be consulted at large public libraries.

R000. RADIO

- R000 Rickard, C. E. Address delivered Nov. 5, 1930, before the Wireless Section of the Institution of Electrical Engineers, London. *Jour. I.E.E.* (London), 69, 11-24; December, 1930.

The author reviews developments in radio communication that have taken place during 1930.

- R000
×R450 Buttner, H. H. The rôle of radio in growth of international communication. *Proc. I.R.E.*, 19, 51-58; January, 1931.

The author portrays the development of communication in its international aspects, emphasizing the rôle which radio plays in that development.

R100. RADIO PRINCIPLES

- R100 Colebrook, F. M. The physical reality of side-bands. *Experimental Wireless & W. Engr.* (London), 8, 4-10; January, 1931.

The reception and rectification of a modulated continuous wave is considered theoretically and experimentally with special reference to the variation of the modulated frequency output with the tuning of the receiving circuit. The physical reality of the side frequencies is demonstrated, and their effect on the shape of the tuning curve is shown. A brief discussion is also given of the side-band cut-off effect, i.e., the variation of amplitude of the modulation frequency output with modulation frequency.

- R113.6 Taylor, A. H. Note on skip distance effects on superfrequencies. *Proc. I.R.E.*, 19, 103-105; January, 1931.

A report of measurements on skip distances in the frequency band between 30,000 and 40,000 kc is followed by a brief discussion of results.

- R113.61 Gilliland, T. R. Kennelly-Heaviside layer height observations for 4045 and 8650 kc. Research Paper No. 246. *Bureau of Standards Jour. of Research*, 5, 1057-61; November, 1930. *Proc. I.R.E.*, 19, 114-119; January, 1931.

Abstracted in January, 1931, issue of *PROCEEDINGS*, the Institute Radio Engineers.

- R113.61 deMars, P. A., Gilliland, T. R., Kenrick, G. W. Kennelly-Heaviside layer studies. *Proc. I.R.E.*, 19, 106-113; January, 1931.

Oscillographic observations of pulse transmissions on 1410 kc and a number of higher frequencies, made at the Bureau of Standards and Tufts College in collaboration with workers at the Naval Research Laboratory and the Department of Terrestrial Magnetism, are discussed.

- R114 Bäumler, M. Gleichzeitige Luft und Kabelstörungen. (Simultaneous static interference in the air and in cables.) *Elek. Nach. Technik*, 7, 325-30; August, 1930. *PROC. I.R.E.*, 19, 138-44; January, 1931.
Abstracted in November, 1930, issue of *PROCEEDINGS* of the Institute Radio Engineers.
- R125.1 Walmsley, T. Beam arrays and transmission lines. *Experimental Wireless & W. Engr.* (London), 8, 25-27; January, 1931. Abstract of paper read before Wireless Section, Institution of Electrical Engineers, December 3, 1930.
After illustrating various short-wave antenna arrays that have been used, the author presents a new and improved type of array, and discusses the principles underlying the theory involved.
- R130 Becker, J. A. The rôle of barium in vacuum tubes. *Bell Laboratory Record*, 9, 54-58; October, 1930.
An explanation of the effect that barium has on the activity of a vacuum tube filament and the resulting increase of efficiency.
- R132 Bainbridge-Bell, L. Interaction in amplifiers with special reference to common impedance in filament circuits. *Experimental Wireless & W. Engr.* (London), 8, 18-20; January, 1931.
Attention is drawn to a generally unsuspected cause of retroaction, which is common impedance in the filament battery circuits. Methods of prevention are discussed.
- R132 Thomas, H. A. Effect of output load upon frequency distortion in resistance amplifiers. *Experimental Wireless & W. Engr.* (London), 8, 11-17; January, 1931.
A theoretical and experimental analysis of the resistance-capacity coupled amplifier leads to the conclusions, that frequency distortion is inherent, and that there is no advantage in using a larger number of low factor stages in cascade.
- R134
×R170 Aiken, C. B. The detection of two modulated waves which differ slightly in carrier frequency. *PROC. I.R.E.*, 19, 120-137; January, 1931. *Bell Sys. Tech. Jour.*, 10, 1-19; January, 1931.
The present paper contains an analysis of the detection of two waves modulated with the same, or with different, audio frequencies and differing in carrier frequency by several cycles or more. Both parabolic and straight line detectors are treated and there are derived the expressions for all of the important audio frequencies present in the output of these detectors when such waves are impressed. There are discussed the types of interference which result when one station is considerably weaker than the other and simple attenuation formulas are employed in estimating the character and extent of the interference areas around the two transmitters. Beyond the use of such formulas no attention is given to phenomena which may occur in the space medium such as fading, diurnal variations in field intensity, etc.
- R139
×R335 Kilgour, C. E. Graphical analysis of output tube performance. *PROC. I.R.E.*, 19, 42-50; January, 1931.
After outlining the graphical method for the analysis of power tube output as applied to the case of a simple resistive load the method is extended to the case of a plate load presenting a value of resistance that is different for direct current than for alternating current. It is shown that in this case the various load lines cannot be drawn through a common operating point because the effective plate voltage shifts when rectification occurs. The method is applied to an experimental pentode and it is shown that in this case the condition for no rectification does not imply the absence of odd or even harmonics.
- R140
×621.314.3 Turner, H. M. Transient currents in transformers. *Jour. Franklin Institute*, 211, 1-36; January, 1931.
A presentation of the fundamental principles underlying the phenomena of transient currents in transformers, is given: The elements affecting the transient current are considered individually, starting with simple inductive circuits and leading up to the more involved case of the transformer in the transient state. Also, a description of the "transient visualizer" is given. This is a synchronous switch for controlling circuit conditions in connection with oscillographic studies of periodic and transient electric phenomena.

- R141 Sowerby, A. L. M. The design of tuned circuits to fulfill predetermined conditions. *Experimental Wireless & W. Engr.* (London), 8, 23-24; January, 1931.

This method of design prescribes a definite sharpness of tuning and a definite stage gain, and then proceeds to calculate the resistance and inductance, which will be required in the circuit.

- R144 Frenkel, J. On the electrical resistance of contacts between solid conductors. *Phys. Rev.*, 36, 1604-18; December 1, 1930.

A contact between two solid bodies is visualized as a small gap between them. This gap is considered as a potential hill over which the electrons, according to the wave mechanical theory can pass even with insufficient kinetic energy. The general expression of the resulting current intensity is obtained and discussed for the case of two identical or different bodies in connection with the resistance of granular structures (thin metal films) and the rectifying action of certain contacts.

R200. RADIO MEASUREMENTS AND STANDARDIZATION

- R213 Hall, E. L. Accurate method of measuring transmitter wave frequencies at 5,000 and 20,000 kilocycles per second. Research Paper No. 220. *Bureau of Standards Jour. of Research*, 5, 647-52; September, 1930. *Proc. I.R.E.*, 19, 35-41; January, 1931.

Abstracted in December, 1930, issue of PROCEEDINGS of the Institute Radio Engineers.

- R220 Griffiths, W. H. F. A simple capacity test set. *Experimental Wireless & W. Engr.* (London), 8, 21-22; January, 1931.

A compact portable test set is described. It is essentially a four-capacity arm bridge with buzzer, battery, and standard condensers all contained in an 8-inch cubical box and has a range of 0.00005 μ f to 1.0 μ f on a single-scale rotary dial.

- R220 Schlesinger, K. Eine einfache Anordnung zum Messen kleiner Kapazitäten. (A simple apparatus for measuring small capacities). *Zeits. fur Tech. Physik*, 11, 537-38; December, 1930.

The measurement of capacities as low as 1/10 cm, with less than 5 per cent error is possible with the shielded capacity bridge described.

- R265.2 Barclay, W. A. Loud speaker impedance. *Wireless Wld. & Radio Rev.*, 27, 627-30; December 3; 662-666; December 10, 1930.

A four-variable alignment chart is given for determining the impedance of a loud speaker, considering the latter as a resistance and inductance in series. The construction of alignment charts is also briefly discussed.

R300. RADIO APPARATUS AND EQUIPMENT

- R361 Robinson, J. The Stenode radiostat. *Radio News*, 12, 682-87; February, 1931.

This paper was delivered before the Radio Club of America by Dr. Robinson and presents his version of the principles underlying the theory and operation of the Stenode.

- R380 ×
621.313.7 Feldtkeller, R. and Kirshbaum, H. Zur Theorie der Tonfrequenzmessgeräte mit Trockengleichrichtern. (On the theory of dry rectifier instruments for a-c measurements at audio frequencies.) *Telegraphen und Fernsprechtechnik*, 19, 333-40; November, 1930.

A mathematical analysis of the problem is carried out and the results are applied to a-c instruments containing oxide rectifiers.

- R390
×R262.1 Lindsay, M. H. A. A standard test set for vacuum tubes. *Bell Laboratory Record*, 9, 85-89; October, 1930.

The description of an apparatus used to calibrate and check vacuum tubes, where it is important that their characteristics are definite and constant.

- R390 Dunn, H. K. A new analyzer of speech and music. *Bell Laboratory Record*, 9, 118-123; November, 1930.
 ×R265.2

A description is given of an apparatus for measuring, at definite successive time intervals, the average and peak values of amplitude over various frequency bands.

R500. APPLICATIONS OF RADIO

- R520 Miner, J. D. Power equipment for aircraft radio transmitters. *Proc. I.R.E.*, 19, 59-77; January, 1931.
 ×R356
 ×R522

This paper covers all of the systems of power equipment now used or contemplated for supplying power to aircraft radio transmitters. The various types of power equipment are described and the advantages and disadvantages of each type are discussed. The types of power equipment discussed are (1) the wind-driven generator, (2) the dynamotor, (3) the main engine-driven generator, (4) the auxiliary engine generator set, (5) the combination wind-driven generator and dynamotor, and (6) the constant speed main engine-driven alternator.

- R520 Martin, D. K. Radio telephone equipment for airplanes. *Bell Laboratory Record*, 9, 59-64; October, 1930.

A description is given of a complete radio-telephone equipment for an airplane which permits two-way telephone communication in the 1500-6000-kc frequency band, and reception of weather information and range signals in the 250-500-kc band, as well as interphone communication between points within the airplane itself. Results of tests are given.

- R521.1 Anderson, S. E. Aircraft radio receivers. *Bell Laboratory Record*, 9, 71-76; October, 1930.

A description is given of two recently developed receiving sets, both for aircraft installation. One has a frequency range of 250-500 kc while the second, a similar set, covers the 1500-6000-kc band.

- R522.1 Bair, R. S. New radio transmitters for airways applications. *Bell Laboratory Record*, 9, 65-70; October, 1930.

A description is given of two recently developed crystal-controlled transmitters that operate in the frequency band of 1500-6000 kc. One type is designed for use on board aircraft while the other is for ground station work.

- R550 Gillett, G. D. Common frequency broadcasting development. *Bell Laboratory Record*, 9, 183-87; November, 1930.

A brief nontechnical report of the problems that were solved in bringing about the synchronization of radio stations, WHO, Des Moines, and WOC, Davenport, Iowa.

- R583 Weinhart, H. W. Glow discharge lamps for television. *Bell Laboratory Record*, 9, 80-85; October, 1930.
 ×535.38

A description of glow discharge tubes for television purposes, and their development since 1927, is given.

- R592 Cauchy, W. K. Test truck for aircraft radio. *Bell Laboratory Record*, 9, 77-79; October, 1930.

A description of the radio equipped autotruck used by the Bell Laboratories in connection with aircraft radio research.

R600. RADIO STATIONS

- R612.1 Hanson, O. B. and Morris, R. M. The design and construction of broadcast studios. *Proc. I.R.E.*, 19, 17-34; January, 1931.
 ×534

The science of sound, for years one of the most neglected of subjects related to physics, has during the past decade been the subject of much interesting research. A certain amount of impetus has been added to this work by the phenomenal growth of radio broadcasting owing to the necessity of providing studios suitable from an acoustic standpoint. This paper indicates certain facts relative to the science of acoustics and sound control and shows how they are applied in the construction of present day studios for radio broadcasting. Examples are given as well as methods of overcoming difficulties in practical application of principles.

R800. NONRADIO SUBJECTS

- 537.7 Cramp, W. Note on the use of the cyclogram for the determination of wave-form. *Jour. I.E.E.* (London), 69, 81-82; December, 1930.
The author suggests an accurate and comparatively simple method for the determination of wave-form.
- 537.7 Wheatcroft, E. L. E. The calculation of harmonics in rectified currents. *Jour. I.E.E.* (London), 69, 100-108; December, 1930.
×R140 After discussing the characteristics of rectifiers and of smoothing circuits, the author proceeds with a mathematical analysis of the problem in which he presents first, the classical method of solution, and then a new and less laborious method, involving the solution of certain equations by successive approximation.
- 538 Haworth, F. E. A magnetization curve tracer. *Bell Laboratory Record*, 9, 167-70; November, 1930. *Bell Sys. Tech. Jour.*, 10, 20-32; January, 1931.
An ingenious device is described which automatically traces out the magnetization curve and the hysteresis loop of any magnetic specimen and does it quickly and accurately.
- 621.313.7 Armstrong, R. W. Polyphase rectification special connections. *Proc. I.R.E.*, 19, 78-162; January, 1931.
Characteristics of various rectifier circuits and factors governing their selection are given. It is pointed out that in general, the double 3-phase circuit is most desirable from the standpoint of transformer and tube capacity requirements for mercury pool type tubes, and the 6-phase single Y for hot cathode mercury vapor tubes or high vacuum tubes, but that other factors may make other circuits more desirable, for particular cases. Data are given for 3-, 4-, 6-, and 12-phase rectifiers using T-connected transformers, so that fewer transformers are required.
- 621.374.6 Zickner, G. and Pfestorp, G. Thermowattmetrische Verlustmessungen an grossen Kapazitäten. (Measurement of the losses in large condensers by means of a thermowattmeter.) *Elektrotechnische Zeitschrift*, 52, (No. 49), 1681-84; December 4, 1930.
×R264.1 After discussing the principles underlying the theory of the thermowattmeter, the method of its application to the measurement of the losses in large condensers is given.
- 621.388 Ives, H. E. A multichannel television apparatus. *Jour. Opt. Soc. of America*, 21, 8-19; January, 1931. *Bell Sys. Tech. Jour.*, 10, 33-45; January, 1931.
×R583 Television images of extreme fineness of grain may be achieved by (1) extension of the frequency band used or (2) by the use of several relatively narrow frequency bands. After considering the relative merits of both methods, the author describes experimental apparatus based on the second method.
- 621.388 Ives, H. E. Television in color from motion picture film. *Jour. Opt. Soc. of America*, 21, 2-7; January, 1931.
×R583 A description of the apparatus for achieving television in colors by a beam scanning method is given. A single scanning disk is used at each end as for monochrome work and colored motion picture film is used at the transmitting end.



CONTRIBUTORS TO THIS ISSUE

Bechmann, Rudolf: Born July 22, 1902, at Nürnberg, Germany. Studied theoretical physics, University of Muenchen. Received Ph.D. degree, 1927. Assistant to Professor Meissner, Telefunken Company for Wireless Telegraphy, 1927 to date. Nonmember, Institute of Radio Engineers.

Bird, J. R.: Born November 11, 1908 at Cincinnati, Ohio. St. Xavier College, Cincinnati, 1925-1926; University of Cincinnati, cooperative E. E. course, 1926-1929. Inspection and engineering departments, Crosley Radio Corporation, 1928 to September, 1930. Student, Massachusetts Institute of Technology September, 1930 to date. Associate member, Institute of Radio Engineers, 1930.

Gilliland, T. R.: See Proceedings for January, 1931.

Gorio, Tullio: Born July 3, 1885 at Rome, Italy. Licensed industrial engineer at Polytechnic School in Turin, 1908. During World War, in charge of Wireless Aircraft Service in Lower Adriatic, 1916-1918. Higher grade technical inspector, Italian General Post Office. Chief of laboratory of radiotelegraphic researches, Royal Experimental Institute of Communications in Rome. Assistant to G. Pession in the Telegraphic and Telephonic Superior School of Italy. Member, Superior Committee for Vigilance in Italian Broadcasting. Nonmember, Institute of Radio Engineers.

Gross, Gerald C.: Born 1903 in Brooklyn, N. Y. Received B. S. degree, Haverford College, Haverford, Pennsylvania. Research work with airplane radio and radio beacon; in charge of standard frequency transmissions and testing work. French interpreter to International Radio Telegraph Conference of Washington, 1927. French technical interpreter at the First International Aeronautical Conference, 1928. Transferred to the Federal Radio Commission as radio engineer, high- and low-frequency band, from Bureau of Standards. Technical advisor, European Radio Conference at Prague, Czechoslovakia, 1929. Member, American Delegation to first meeting of the International Technical Consulting Committee on Radio Communications at The Hague, Holland. At present time with the Federal Radio Commission in Washington. Associate member, Institute of Radio Engineers, 1927; Member, 1930.

Horn, C. W.: Born July 9, 1894 in New York City. Radio operator on board ship, summer 1910. Later studied electrical engineering, and was associated with the United Fruit Company. Connected with development of radio direction finding equipment and erected first shore stations during the war. After the war was superintendent of radio operations, Westinghouse Electric and Manufacturing Company. At present time general engineer, National Broadcasting Company. Associate member, Institute of Radio Engineers, 1914; Member, 1928; Fellow, 1930.

Inuma, Hajime: Born March 3, 1907, at Haranomachi, Fukushima Prefecture, Japan. Graduate Osaka Higher Technical School, 1928. Radio engineer, Electrotechnical Laboratory, Ministry of Communications, Japan, 1928 to date. Associate member, Institute of Radio Engineers, 1928.

Jouaust, Raymond: Born 1875, in Rennes. Licentiate* in sciences, graduate engineer of the Ecole Supérieure d'Electricité, entered the Laboratoire Central d'Electricité in Paris as Chef de Travaux, and became Sous-Directeur in 1926. Consulting engineer for the Laboratoire National de Radioélectricité in Paris. Nonmember, Institute of Radio Engineers.

Labus, J. W.: Born June 29, 1901 at Vienna, Austria. Received M. S. and Ph. D. degrees, Technical University of Prague, 1924. Assistant to Professor Siegel, University of Prague, 1924-1928. Engineering department, General Electric Co., 1929-30. Nonmember, Institute of Radio Engineers.

Llewellyn, Frederick Britton: Born September 16, 1897, at New Orleans, La. Received M. E. degree, Stevens Institute of Technology, 1922; Ph. D. degree, Columbia University, 1928; assistant to Dr. F. K. Vreeland, 1922-1923. Member technical staff, Western Electric Co., 1923-1925; Bell Telephone Laboratories, 1925 to date. Associate member, Institute of Radio Engineers, 1923.

Nelson, J. R.: Born October 27, 1899, at Murray, Utah. Power inspector' Western Electric Co., 1922-1923; received B. S. degree in E. E., University of Southern California, 1925. Engineering Record Office, Bureau of Power and Light, Los Angeles, 1925; radio test, Radio Development Laboratory and Tube Research Laboratory, 1925-1927. Received M. S. degree in E. E., Union College, 1927. Engineering department, E. T. Cunningham, Inc., July, 1927 to September, 1928. Research Laboratory, National Carbon Co., September, 1928 to March, 1930. Raytheon Production Corporation, March, 1930 to date. Associate member, Institute of Radio Engineers, 1927; Member, 1929.

Parkinson, Taintor: Born October 22, 1886, at Falmouth, Mass. Received A. B. degree, Dartmouth College, 1909; Pd. M. degree, New York University, 1911. Public school work in New England, 1909-1919. Engaged in research in radio wave phenomena at U. S. Bureau of Standards, 1924-1930. Graduate work, University of Michigan, 1930 to date. Associate member, Institute of Radio Engineers, 1926.

Pession, Giuseppe: Born May 30, 1881. Educated at Royal Naval Academy; appointed mishipman in 1902; director of La Spezia Radiotelegraphic School and teacher of radiotelegraphy at Rome Military Institute of Radiotelegraphy; since 1920 professor of radiotelegraphy and naval magnetism at Naples Royal Superior Polytechnical School; member of several commissions dealing with development and reorganization of the radiotelegraphic services both in Italy and abroad; erection of Rome-S. Paolo station and other radio installations; chief of radio services in Italian Navy Department and commander of Rome radio stations, 1917-1924; awarded professor's degree in electrical and radio sciences, Polytechnical school of Naples and Rome, 1924; chief of Italian Postal and Telegraph Administration, 1925 to date. Author of scientific books and active correspondent to scientific magazines. Member of Specialist Body of the Italian Navy; vice president of radio section, Consiglio Nazionale delle Ricerche. Captain, Royal Italian Navy. Fellow, Institute of Radio Engineers, 1929.

Pickard, Greenleaf Whittier: Born February 14, 1877, at Portland, Maine. Educated at Westbrook Seminary, Westbrook, Maine, Lawrence Scientific School

*This is a degree between Bachelor and Doctor.

of Harvard University, and Massachusetts Institute of Technology. Experimental radio work with Blue Hill Observatory, 1898-1899. Research engineer for and director of the Wireless Specialty Apparatus Company of Boston, 1907-1930. RCA-Victor of Massachusetts, 1930 to date. Received Medal of Honor, 1926. Member, Institute of Radio Engineers, 1912; Fellow, 1915.

Reich, Herbert J.: Born October 25, 1900, at New Dorp, N. Y. Received M. E. degree, Correll University, 1924. Instructor, machine design and physics, Cornell University, September, 1924 to June, 1925; instructor in physics, Cornell University, September, 1925 to June, 1929. Assistant professor of electrical engineering, University of Illinois, September, 1929 to date. Member, American Physical Society and several others. Associate member, Institute of Radio Engineers, 1926.

Thompson, B. J.: Born August 14, 1903, at Roanoke, La. Received B. S. degree in E. E., University of Washington, 1925. Research Laboratory, General Electric Company, 1926-1930. Vacuum Tube Engineering Department, General Electric Company, 1930 to date. Associate member, Institute of Radio Engineers, 1929.



MOULDED-END CONTACTS IMPROVED WINDING FORMS HIGH GRADE *and* LARGER WIRE

THESSE and other features give I. R. C. units a vast superiority over ordinary wire wound resistors.

The winding forms are of non-hygroscopic ceramic, having high insulation qualities, mechanical strength and low coefficient of expansion.

Moulded end contacts, exclusive with I. R. C. Resistors, insure positive connection at the terminals. *No contact resistance, no loose connections, no noise.*

Alloy wire, of highest grade and largest size consistent with resistance value, used exclusively. Special insulation process eliminates breakdowns and shorted turns.

I. R. C. Wire Wound Resistors meet all needs of modern electrical equipment. Folder quoting prices and ranges mailed on request.

INTERNATIONAL RESISTANCE
COMPANY

2006 Chestnut Street, Philadelphia



WW1

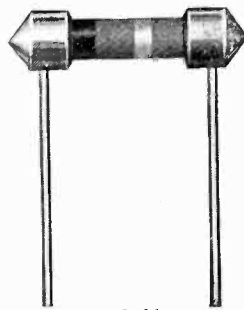

MF4½

IRC

PRECISION *wire wound* RESISTORS

made by the makers of

Metallized

RESISTORS

When writing to advertisers mention of the PROCEEDINGS will be mutually helpful.

Smooth, Noiseless

The new Frost-Radio No. 20 Series Wire-Wound Volume Controls are the result of eleven years of manufacturing experience and research, and represent the very highest development we have yet seen in *smooth, noiseless action*.

The variable contactor used in our No. 20 Series makes two separate and distinct line contacts with the resistance element. Each of these is $3/32''$ in length, or a total line contact of $3/16''$. The contactor is made in the form of a shoe with two runners, each $3/32''$ in width. As the runners are in vertical alignment with each other both can make contact with the same turn of wire simultaneously. However, when this condition exists and the arm is moved slightly, one runner, due to the pitch of the winding, contacts with the next turn of wire *one-half turn ahead* of the other runner. This cuts down the resistance steps to one-half the resistance of one turn of wire, giving the same result as though the winding strip contained twice as many turns of wire. Every fraction of an inch that can be added to the effective length of the resistance element improves both the quality and the durability of the control, as it then becomes possible to *employ more turns and larger wire*. To obtain the *maximum number of turns* of wire on our strips we utilize the smallest possible spacing between turns that will give the required resistance value. For example, on a strip wound with $.002''$ wire, there is but one ten-thousandth of an inch between turns. Such a strip has 466 turns of wire per linear inch of wound strip. With the conventional type of contactor, variations in the height of the adjacent turns of wire no greater

than five ten-thousandths of an inch higher or lower than adjoining turns will produce serious noise. The contacting runners of the No. 20 Series Controls are *pulled* along their raceways with an action similar to drawing a sled. This action is reversible, so that the runners are never pushed. As the spring tension is

applied midway between the two runners, equalization of pressure is automatically effected by the compression type helical spring. By contacting on the *inside* of the strip these runners have an area in contact with the wire many times greater than when contacting on the edge of the strip in the conventional manner. This reduces the contact pressure per square inch of area to a mere fraction of what has been past practice, and at the same time gives a contact pressure several times greater than that employed in old style rheostats. Danger of cutting and scoring between the contactor and wires is reduced to a negligible quantity, and a *lower contact resistance than has ever before been possible in commercial units of this class is obtained*.

Dirt, fragments of metal, or other foreign bodies on the raceway of one runner cannot prevent other runner from making positive contact with the element less than one-half a turn of wire away from the point where the contact is impaired, insuring against a high resistance or broken contact with the resistance element. Thousands of tests have proved that this type of contactor is noiseless even when the winding is fouled with dirt, dust, etc., sufficient to render any of the conventional types of volume controls noisy and unusable. *Fatigue tests show that our No. 20 Series Controls can be depended upon for 1,000,000 complete rotating operations without trouble of any kind developing.*

Our No. 20 Series Controls are completely enclosed in dust-proof cases. Extreme care is taken to keep foreign substances from getting into the resistance chamber during manufacture.

The high resin-content bakelite strip used in Frost-Radio No. 20 Series is made especially for our own use. This, plus our lubricating system which entirely surrounds the strip and all insulations with a neutral oil film, positively insures against loose wires or changes in dimensions of the insulated parts. Shaft material is needle bar steel ground to plus or minus $.0005''$, rotating in a reamed brass journal. A. C. switches may be mounted on either single controls or tandem units. These switches occupy less than half the usual

number of degrees of movement, giving an increased length of effective resistance element. Separation of driving arms in tandem units reduces capacitance to a negligible quantity, while our driving coupler used in these units provides universal joint action and thus eliminates binding and rough running.



No. 20 Series Single Control



No. 20 Series Single Control with A. C. Switch



No. 20 Series Tandem Unit with A. C. Switch

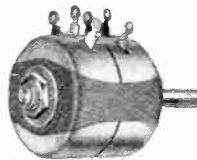

No. 20 Series Tandem Unit

FROST-RADIO

When writing to advertisers mention of the PROCEEDINGS will be mutually helpful.

Action!

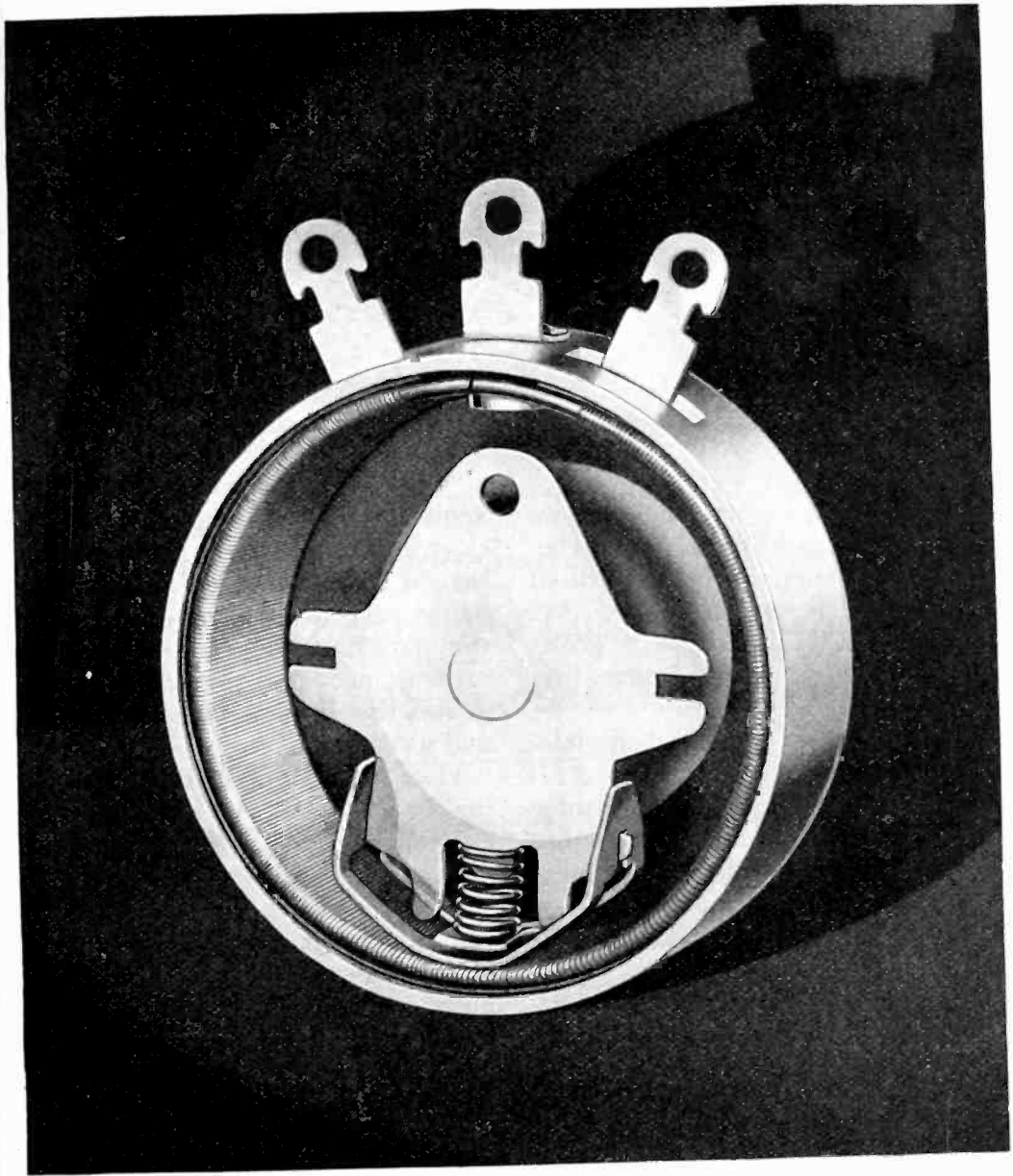

Practical experimenting with this new type of unit, illustrated in detail above, began early in 1930 and tests have been carried on continuously for more than twelve months in order to thoroughly prove in the principles involved in its design and construction.

We invite engineers to send us specifications, upon receipt of which we will gladly send samples for experimental and test purposes

CHICAGO TELEPHONE SUPPLY CO.

HERBERT H. FROST, Inc.
SALES DIVISION

General Offices **ELKHART, INDIANA** and Plant

When writing to advertisers mention of the PROCEEDINGS will be mutually helpful.

FOR VALUE RECEIVED



A GREAT MANY PEOPLE will tell you that the biggest single service that five cents can buy today is a local telephone call. Without question, it is big value . . . and value that steadily grows as new telephones come into your neighborhood.

There are times when telephone service is priceless . . . when the ability to call instantly a doctor, a policeman, or the fire department could not be measured in terms of money.

But it is not alone the emergencies that give the telephone its value. There are the commonplaces of every-day conversation . . . in the home, the shop, the office . . . whenever you wish two-way communication with any one, almost anywhere.

The telephone has become such

an every-day, matter-of-fact convenience—like running water and electricity—that it is natural to take it for granted. It is well to pause occasionally and consider the nation-wide organization of men, money, and materials that makes this vital service possible, and at such low cost.

Here is a system of the public, for the public . . . run on the barest margin of profit consistent with service, security, and expansion. A service that grows as the community grows . . . placing within the reach of an increasing number the means to talk back and forth with people in the next block, the next county, a distant state, a foreign country, or on a ship at sea!

No other money that you spend can bring you more actual value.

★ AMERICAN TELEPHONE AND TELEGRAPH COMPANY ★



When writing to advertisers mention of the PROCEEDINGS will be mutually helpful.

ROLLER-SMITH
Control Panels

Roller-Smith Instruments
Air and Oil Circuit Breakers
Relays

Slate of highest quality or Ebony Asbestos
or Stretcher-Levelled Sheet Steel

Highest Grade Switchboard Wire
High Conductivity Copper Busbars
Best Bus Supports Obtainable

Transformers, Disconnects, Watthour Meters
Special Relays, Instrument Switches,
Knife Switches and Fittings are all of the
first grade as made by leaders in these lines

40 YEARS EXPERIENCE

Send your control panel specifications to Roller-Smith

ROLLER-SMITH COMPANY
Electrical Measuring and Protective Apparatus

Main Office:
2134 Woolworth Bldg.
NEW YORK



Works:
Bethlehem,
Pennsylvania

Offices in principal cities in U. S. A. and Canada

When writing to advertisers mention of the PROCEEDINGS will be mutually helpful.

AMERTRAN SOUND SYSTEM PANELS

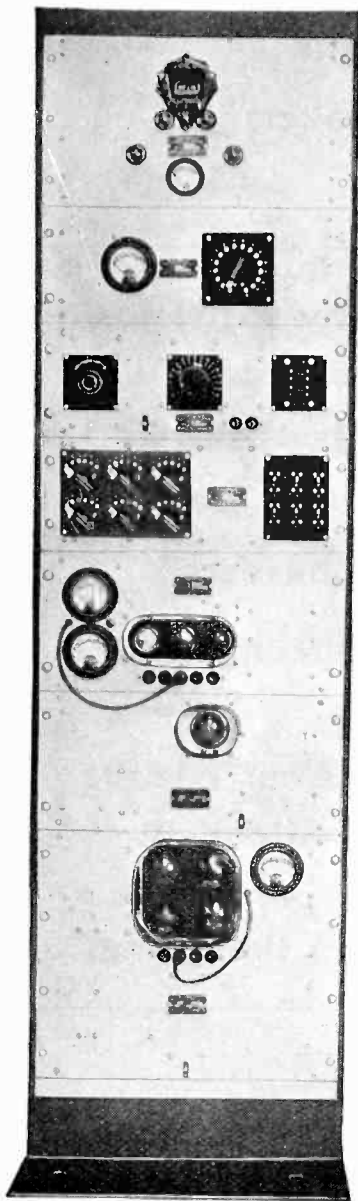

Suggested Panel Layout No. 2
(For Undistorted Outputs of 12.5 Watts)

Long recognized as typifying the "Standard of Excellence" in audio products, the Amertran line now includes a wide assortment of standard panels designed to fill every requirement for complete sound systems.

Amertran panels are so constructed that they may be assembled on racks in various combinations for every purpose. They are the best that engineering genius can produce with the finest of materials and workmanship.

Before placing these Sound Systems on the market, months of research were spent in perfecting them, and thousands of panels were built for special applications—tested for true fidelity and satisfactory service, both in the laboratory and in actual installations.

Bulletin 1200 gives complete information and illustrations of Standard Amertran Panels. Write for it on your business stationery, and send specifications of your particular problem. Our engineering staff is at your service.

AMERICAN TRANSFORMER COMPANY
179 Emmet Street, Newark, N. J.

Representatives in following cities

Atlanta · Boston · Chicago · Knoxville · Minneapolis
Montreal · Philadelphia · San Francisco · St. Louis



AMERTRAN

When writing to advertisers mention of the PROCEEDINGS will be mutually helpful.

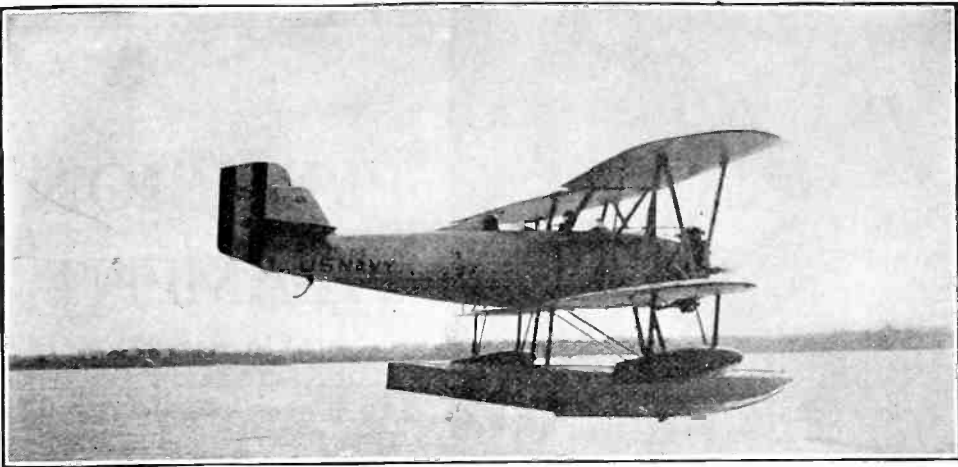

Rigid Performance Requirements

*are constantly being met by
"CARDWELL condensed" equipment.*

In Commercial Service, in Broadcasting and Amateur Stations large and small, on the Airways, with the Army and Navy, CARDWELL variable condensers are daily vindicating the judgment of designers who expected much of CARDWELL condensers and find their faith justified by fine, consistent performance.

As with condensers, so with CARDWELL built-to-order apparatus. Manufactured with scrupulous exactness, CARDWELL-built instruments meet every requirement of a discriminating clientele.

Concerning Condensers,

THE  **NEW**
MID **WAY**
FEATHERWEIGHT
CONDENSER

Recently announced by Cardwell is compact, small, light (weighing from 4 to 7 ounces). It is admirably adapted for use in aircraft receivers and for transmitters using up to 75 watt tubes, for portable sets and for neutralizing capacitors in intermediate stages of vacuum tube transmitters. The CARDWELL line comprises many other types of condensers, large and small, for transmitting and receiving. Send for literature.

**CARDWELL CONDENSERS
AND
MANUFACTURING-SERVICE**

The ALLEN D. CARDWELL MFG. CORP'N
93 Prospect Street, Brooklyn, N.Y.

“ THE STANDARD OF COMPARISON ”

When writing to advertisers mention of the PROCEEDINGS will be mutually helpful.

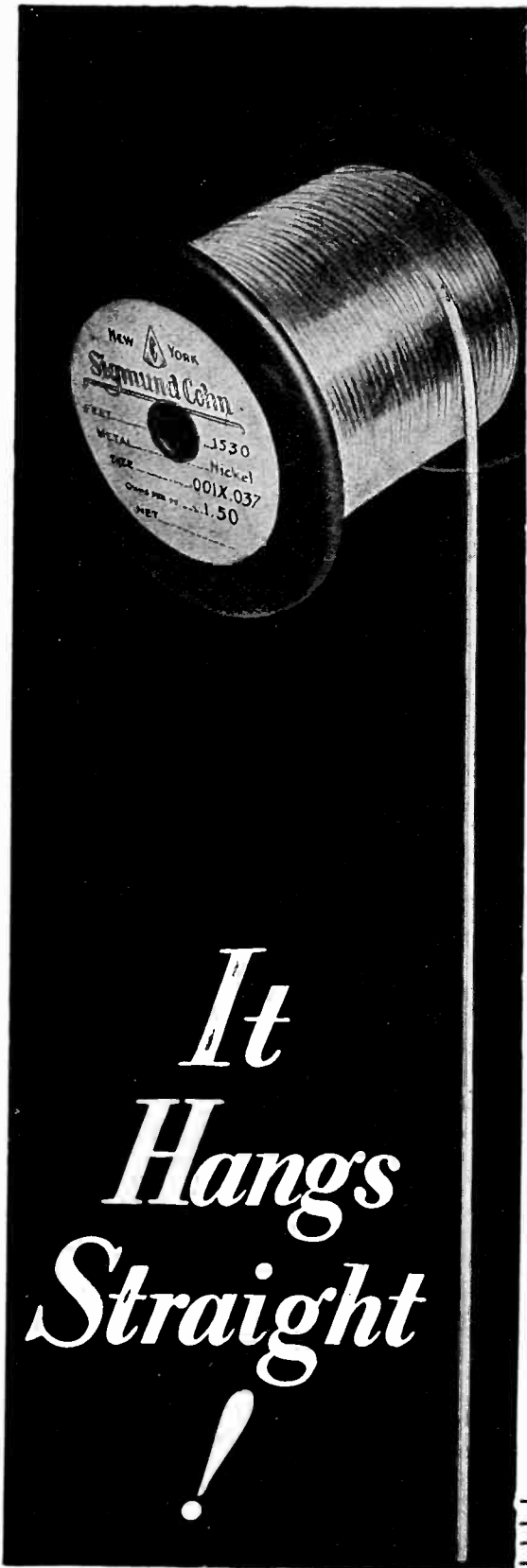

*It
Hangs
Straight
!*

PRECISION FILAMENT

(Uncoated)

for
Radio
Vacuum
Tubes

Scientifically controlled—
chemically, physically
and electrically



A PRODUCT OF
SIGMUND COHN
44 Gold Street
New York

When writing to advertisers mention of the PROCEEDINGS will be mutually helpful.

Licensed under
Loftin-White and
R. C. A. patents

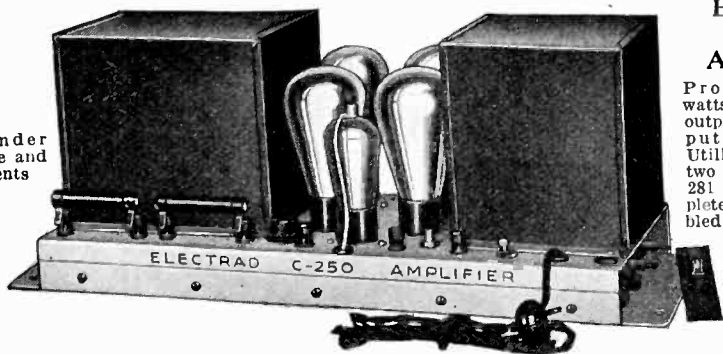

Electrad C-250 Amplifier

Provides 10.35
watts undistorted
output with in-
put volts .3.
Utilizes one 224,
two 250 and two
281 tubes. Com-
pletely assem-
bled only, \$135.00.

Three New

ELECTRAD Amplifiers

(High Quality at Low Cost)

*Using the Perfected Loftin-White
Direct-Coupled System*

EVERY modern power-amplifying re-
quirement is met by these three new
Electrad developments.

Using the perfected Loftin-White Direct-
Coupled System, the highest quality of out-
put is attained, at low initial and maintenance
cost.

The simplicity of these amplifiers makes for
compactness and the use of fewer parts—
hence low service costs.

They are readily adaptable to all usual re-
quirements of sound amplification from mi-
crophones, phonograph pick-ups, radio tuners
—in fact, wherever high amplification with
fine tone quality is required.

Electrad designed and built, these amplifiers
have back of them Electrad's world-wide
reputation for high standards of components
and workmanship. Let our Engineering De-
partment co-operate with you in adapting
these amplifiers to your special needs.

*Mail Coupon for complete new
ELECTRAD Catalog, 36 pages
of Helpful Radio Information.*

175 Varick St., New York, N. Y.

ELECTRAD

INC.

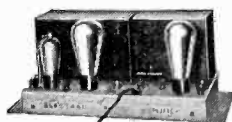

Electrad A-250 Amplifier

Provides 4.6 watts undistorted
output. Utilizes one 224, one
250 and one 281 tube. Com-
pletely assembled only, \$87.50.

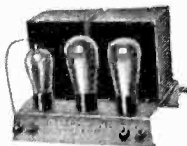

Electrad A-245 Amplifier

Provides 1.6 watts undistorted
output with one 224, one 245
and one 280 tube. Com-
pletely assembled \$40.00, or
in kit form \$35.00.

ELECTRAD, INC., Dept. P-3,
175 Varick St., New York, N. Y.

Please send copy of complete new
ELECTRAD CATALOG. Enclosed
10c (stamps or coin) for mailing
cost.

Name

Address

City..... State.....

When writing to advertisers mention of the PROCEEDINGS will be mutually helpful.

ESCO Motor-Generators

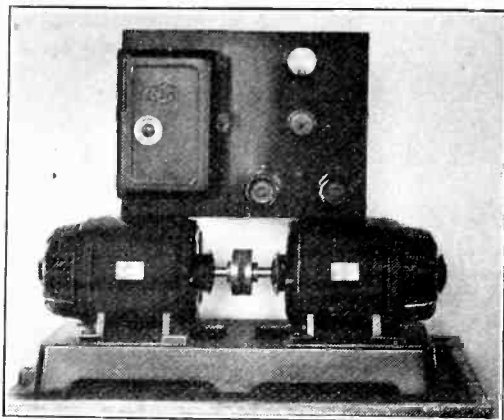

“Fit” the application

“Fit” the power supply

Motors—Generators—Dynamotors—Rotary Converters

Designed · Developed · Manufactured

Quick Delivery · Low Priced

“ESCO” is a company where “Special” does not mean “soak ‘em” or “Let ‘em wait.” Because for twenty years “ESCO” has specialized in the “Special.” “Special” voltages, frequency, speed, and mechanical design is the objective of our equipment and organization.

OUR EXPERIENCE IS BROAD. Below is a list of some of the special applications of our motors and generators, manufactured during this last December.

Telegraph
Airplane dynamotors
Wind driven generators
Portable gasoline units
Radio beacons
Radio transmitters
Television
Talkies
Radio receivers
Automobile radio
Valve control
Water tight doors
Pianos
Electric indicators

Speed reducers
Ventilators
Teletchro resetters
Automatic chucks
Recording instruments
Elevator door control
Elevators
Flexible shafts
Riveters
Gasoline pumps
Bottle washers
Phase shifters
Frequency changers
Hair dryers

Arc lamps
Anti-corrosion
Oil burners
Automatic whistle
Ore-vibrators
Organ generators
Hoists
Freight trucks
Temperature control
Polishers
Stock quotations
Sun lamps
Bookkeeping unit
Forced draft

Knitting mills
Printing press
Electro plating
Remote control
Movie cameras
Aerial cameras
Cloth cutting
Coin counters
Pneumatic Valves
Valve grinders
Theater dimmers
Cup vending
Refrigerator
Automatic stoker
Weaving

Why not profit by our long experience? Up to date equipment and practical engineering talent. They are all at your disposal. Write us for bulletins or information.

ELECTRIC  **SPECIALTY**
COMPANY

300 South St.

Stamford, Conn.

Manufacturers of motors, generators, dynamotors and rotary converters.

When writing to advertisers mention of the PROCEEDINGS will be mutually helpful.

Rich coil experience
Rich wire experience
Unite for your Benefit

Under General Cable, the wire and cable making experience of many manufacturers is united to form a fund of wire knowledge that is unique. Every improved process or material known to any of the organizations affiliated in General Cable is used by all. To this fundamental advantage in the making of wire is added the combined experience of Dudlo, Rome and others in the production of coils.

Beginning with the copper bar, and ending with the final test, inspection and packing of the

finished coils, every step represents highly developed present-day technique. There it does not rest. For leadership can not rest, and continue to be leadership. Therefore, in well-equipped laboratories every physical, chemical and electrical factor that applies to coils is subject to further scientific search for improvement or economy.

Coils purchased from General Cable carry with them the assurance that you have the best that science, skill and extensive manufacturing facilities can produce.

GENERAL CABLE CORPORATION

420 LEXINGTON AVENUE, NEW YORK • OFFICES IN PRINCIPAL CITIES



When writing to advertisers mention of the PROCEEDINGS will be mutually helpful.

Individually Tested



ISOLANTITE now offers a new series of antenna insulators for the suspension of structures of the heavier types. These insulators are designed not only to support greater loads but to provide a longer insulating path between fittings to give greater protection against electrical leakage and flash-

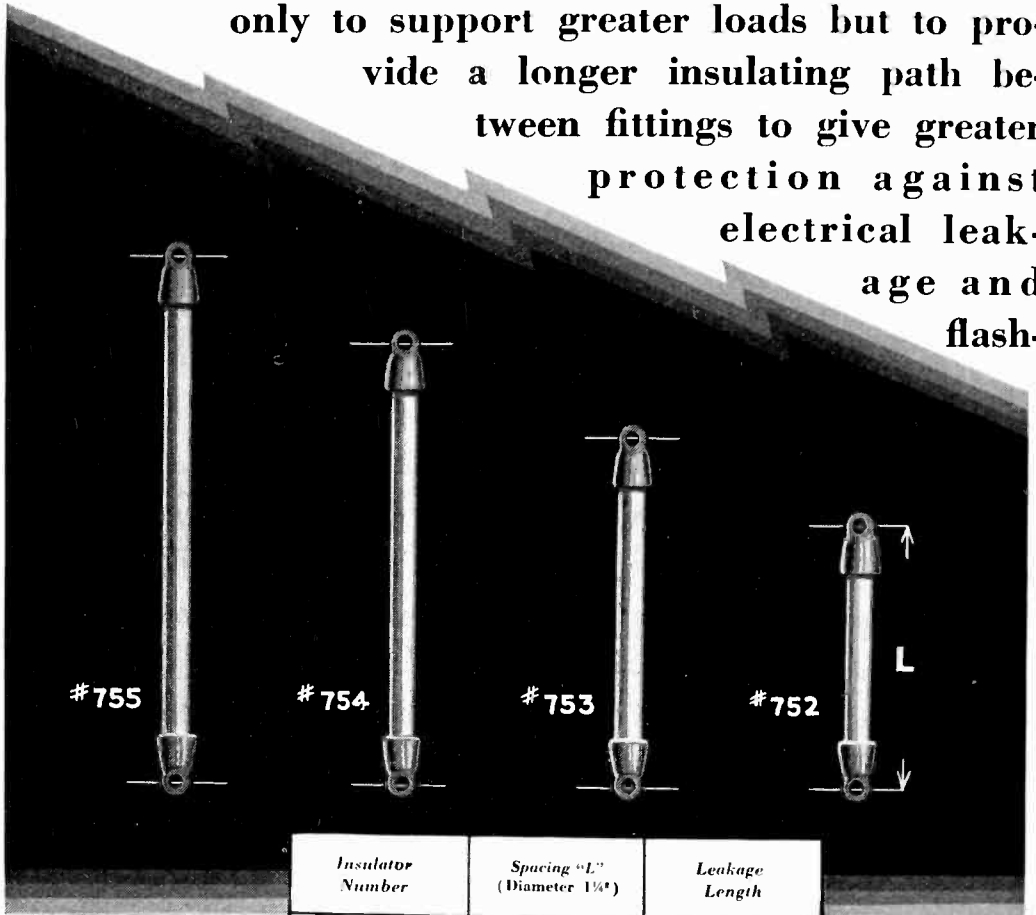

<i>Insulator Number</i>	<i>Spacing "L" (Diameter 1/4")</i>	<i>Leakage Length</i>
No. 752	12 inches	8 inches
No. 753	16 inches	12 inches
No. 754	20 inches	16 inches
No. 755	24 inches	20 inches

Ultimate Strength 6,000 Pounds.

Isolantite Company

SALES OFFICES -----

551 FIFTH AVE., NEW YORK CITY

When writing to advertisers mention of the PROCEEDINGS will be mutually helpful.

Antenna Insulators



over in the high voltage network. The insulators listed herewith *are given individual load tests* before shipment, a feature of added interest to those demanding the utmost in mechanical reliability. Full technical details and quotations will be made available to all radio engineers upon request.

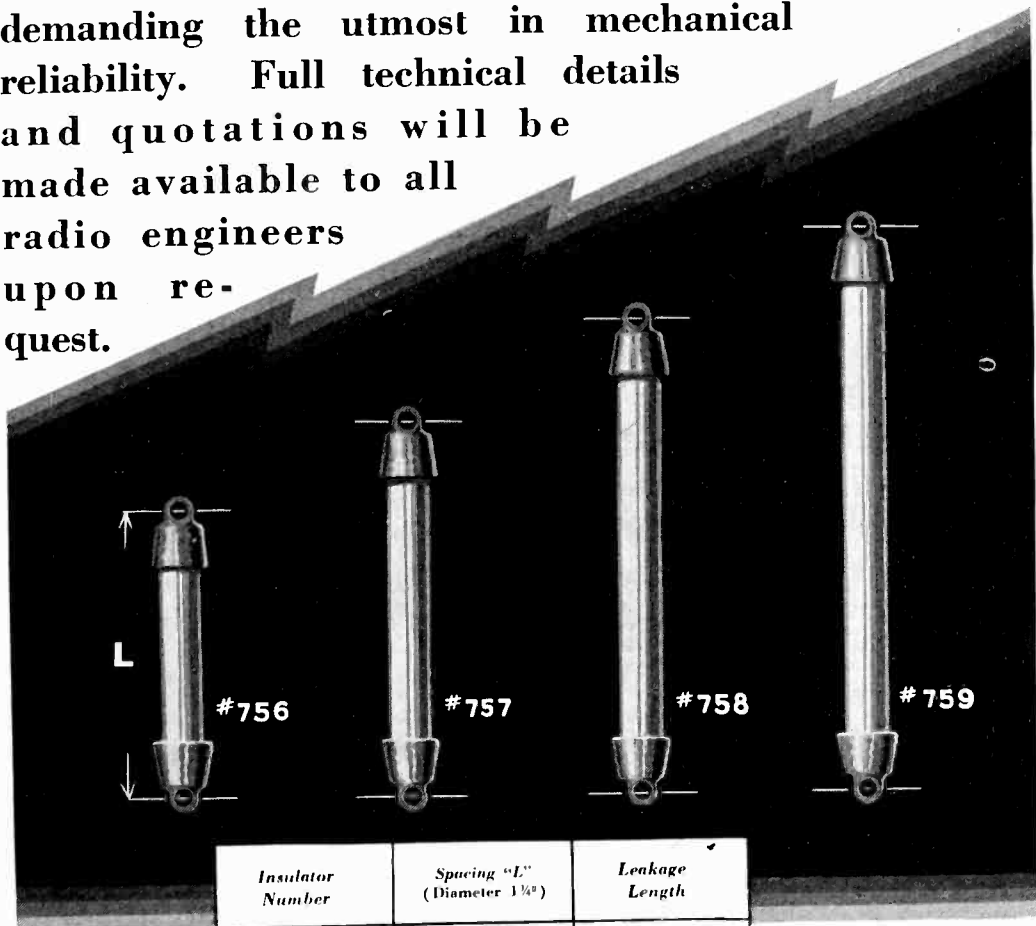

Insulator Number	Spacing "L" (Diameter 1 1/4")	Leakage Length
No. 756	13 inches	8 inches
No. 757	17 inches	12 inches
No. 758	21 inches	16 inches
No. 759	25 inches	20 inches

Ultimate Strength 9,000 Pounds

of America, Inc.

-----FACTORY
BELLEVILLE, N. J.

When writing to advertisers mention of the PROCEEDINGS will be mutually helpful.

What's the

BIG Idea

for 1931?

THE BIG idea for radio manufacturers in 1931 is to provide additional useful sales features, so that sales will be easier.

Competition is keener than ever. Therefore the more talking points your receiver has, the easier it will sell.

AMPERITE Line Voltage Control solves one of radio's biggest problems. It makes a set operate in every locality as you intend it to operate. It makes your precise laboratory specifications *mean something* to the user in improved performance. *That's the BIG idea.*

AMPERITE reduces free service and lowers set upkeep costs. It smooths out volume and insures uniform quality. It saves tubes and protects power equipment.

It gives your dealers something BIG and NEW to tell their customers about and close more sales of your sets.

AMPERITE *automatically* regulates line voltage variations *up or down*, between 100 and 140 volts, to exact requirements.



It is easily included in chassis design without increasing chassis cost. Or it can be installed in five minutes in any electric radio not originally equipped for it.

Mail COUPON for
full information
and AMPERITE Set Chart

AMPERITE
Self-Adjusting
LINE VOLTAGE CONTROL

AMPERITE Corporation
Dept. PE-3 561 BROADWAY, NEW YORK

Please send Amperite Tube Chart, installation instructions and technical data to

Name

Address

.....

When writing to advertisers mention of the PROCEEDINGS will be mutually helpful.

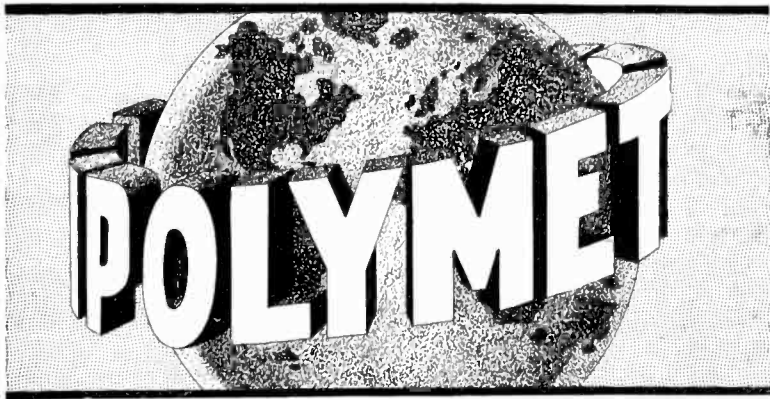

Insured Profit if it's of Polymet Quality

Radio manufacturers throughout the world are learning more and more of the profit resulting from the use of Polymet radio parts.

Manufacturers, dealers, and users profit by the use of Polymet quality products. The manufacturer builds a profitable and satisfied trade, the dealer's sales are more easily made and the user gets more service and value for his money.

Polymet Quality Products include:

PAPER, ELECTROLYTIC and MICA CONDENSERS . . . RESISTANCES
. . . COILS . . . MAGNET WIRE . . . VOLUME CONTROLS . . .
TRANSFORMERS and SOUND EQUIPMENT PARTS.



P O L Y M E T

Manufacturing Corporation
829 East 134th Street, New York City

Canadian Representative

WHITE RADIO, Ltd.

41 West Avenue

North Hamilton, Canada

Representative for the British Isles

A. H. HUNT, Ltd.

Tunstal Road, Croydon, Surrey, England

When writing to advertisers mention of the PROCEEDINGS will be mutually helpful.



COMPARE

AND THEN

DECIDE ON

ACRACON

THE inverted electrolytic construction principle featured in the Acracon Electrolytic Condenser was pioneered by the Condenser Corporation of America. Although the design of our unit has been copied by other manufacturers, comparison of the Acracon Condenser and any other make will quickly prove Acracon's superiority in both construction and electrical efficiency.

Consider these advantages. No moulded threads to strip in production. Better contact area with chassis, through both nut and the container itself. No loss of electrolyte, regardless of the amount of pressure on the nut. Contact made below chassis, eliminating wiring above the chassis.

Acracon Electrolytic Condensers are now available in capacities of 8 mfd. or 16 mfd., 440 volts peak, in the same containers. The 8 mfd., unit can also be supplied formed for 475 volts peak. Write today enclosing your specifications.

**All Acracon Features Are Protected by Patents Pending*

Condenser Corporation of America

259-271 Cornelison Ave.

Jersey City, N. J.

Chicago
Cincinnati

Factory Representatives in:

St. Louis
San Francisco

Los Angeles
Toronto

and other Principal Cities

When writing to advertisers mention of the PROCEEDINGS will be mutually helpful.

Evolution!



THE public little realizes the intensive and continuous activities carried on by the RCA Radiotron Company in developing and manufacturing RCA Radiotrons. A few of the hundreds of experiments devoted to the design and improvement of tubes are indicated by the accompanying illustration of the standard UY-227. Any individual RCA Radiotron might have been used to equal purpose.

Each tube in the group has been the subject of an experiment or a combination of experiments with a view toward meeting requirements of design; such as . . . maximum operating performance . . . hum- and noise-free operation . . . quicker heating . . . rugged, non-microphonic construction.

Constant improvement enables the RCA Radiotron Company to maintain its forward position in the general progress of the radio industry.

RCA RADIOTRON COMPANY, INC.
HARRISON, NEW JERSEY
A Radio Corporation of America Subsidiary

RCA RADIOTRONS

« « THE HEART OF YOUR RADIO » »

When writing to advertisers mention of the PROCEEDINGS will be mutually helpful.



EVERY RESOURCE

*for Quality
and Uniformity!*

THE FORMICA organization is well equipped to give the electrical and radio industries prompt service on high quality insulating material.

It has the largest equipment for producing and fabricating materials of this kind in the country. It has a well equipped and competently manned laboratory for the control of production and the development of new and better formulas.

For 18 years it has specialized on just one product. During most of that time it has served some of the leading American technical organizations.

THE FORMICA INSULATION COMPANY
4638 Spring Grove Avenue, Cincinnati, Ohio

FORMICA
Made from Anhydrous Bakelite Resins
SHEETS TUBES RODS

When writing to advertisers mention of the PROCEEDINGS will be mutually helpful.

XXX

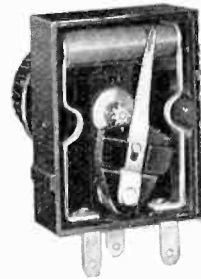
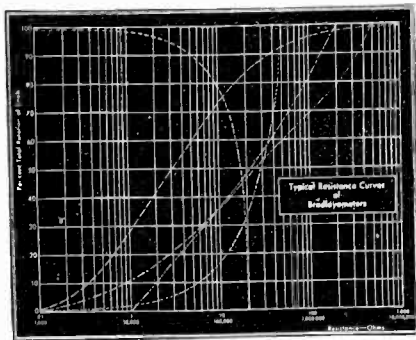
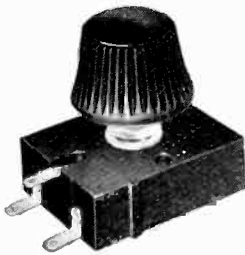

Only the Bradleyometer can achieve these results!

THE Bradleyometer is a distinctly new type of potentiometer, unusual in design and marvelous in performance. Approximately fifty solid resistance discs are interleaved between thin metal discs. A contact arm moves from one end of the resistance column to the other.

The resistance value of each disc is separately controlled and the total number of discs can be arranged in accordance with any resistance-rotation curve desired. No other type of resistor offers such flexibility in the variation of resistance so essential in modern electronic tube circuits.



Type AA
Double
Bradleyometer



Type AAA
Triple
Bradleyometer

One or more Bradleyometers can be arranged to operate with one knob. Each Bradleyometer has its own resistance characteristic as shown in the diagram above. In this manner, mixer controls, T-pad and H-pad attenuators and other complex controls can be provided.

The extraordinary performance of the new Bradleyometer, its silent operation, and its unlimited adaptability can be appreciated only by installing a Bradleyometer in a test circuit. Samples will be gladly furnished to set manufacturers.

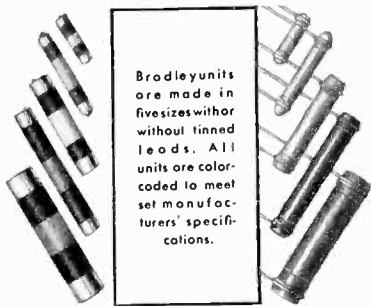

Bradleyunits are made in five sizes without tinned leads. All units are color-coded to meet set manufacturers' specifications.

BRADLEYUNIT RESISTORS FOR ALL APPLICATIONS

Bradleyunits are solid molded resistors unaffected by temperature, moisture or age. Their accurate calibration, great mechanical strength and permanence make them ideal for providing correct C-bias, plate voltage, screen grid voltage and for use as gridleaks and as fixed resistors in resistance coupled circuits.

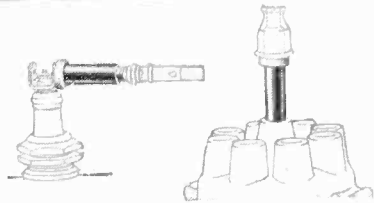

BRADLEY SUPPRESSORS FOR RADIO-EQUIPPED CARS

These special solid molded resistors are now used by prominent car manufacturers to provide individual resistors for each spark plug and for the common cable to the distributor on radio-equipped cars. They increase the resistance of the high tension ignition system and minimize the disturbing oscillations in the ignition circuit which interfere with the radio receiver in the car. When used with suitable by-pass condensers in other parts of the circuit, shielded ignition cables are unnecessary. They do not affect the operation of the motor.

For complete information on Allen-Bradley Resistors address

ALLEN-BRADLEY CO.
116 W. Greenfield Ave. Milwaukee, Wis.



ALLEN-BRADLEY RESISTORS

Produced by the makers of Allen-Bradley Control Apparatus

When writing to advertisers mention of the PROCEEDINGS will be mutually helpful.



Simplifying 1931 circuits . . . THE NEW VARIABLE-MU TUBE

THE constant quest for improved, yet simplified circuits never ends for radio engineers.

Now, for 1931 receivers, Arcturus presents the new Variable-Mu Tube, Type 551. This tube contributes vital advances of great interest to set engineers . . . vastly improving operating efficiency of any receiver and making possible definite economies and simplification of the circuit arrangement.

The Arcturus Type 551 Tube renders unnecessary the use of double pre-selectors, dual volume controls, and eliminates the necessity of a "local-long distance" switch.

This new Variable-Mu tube permits distortionless operation with signal input voltages approximately 25 times greater than with present-day tubes and extends the range of automatic and manual volume controls by this factor. It divides maximum cross-talk by five hundred. And it effects a marked reduction in receiver "hiss."

This is accomplished by a new principle in construction whereby the current-voltage characteristic is specially shaped so as to reduce the higher-order parameters responsible for distortion and cross-talk.

A special technical bulletin on the Arcturus Type 551 Variable-Mu Tube will be sent to manufacturers, engineers, and all others interested in this new development.

ARCTURUS RADIO TUBE CO., Newark, N. J.

551

*Licensed under patent applications of
Boonton Research Corporation*

ARCTURUS

RADIO TUBES

"The TUBE with the LIFE-LIKE TONE"

© A. R. T. Co., 1931



When writing to advertisers mention of the PROCEEDINGS will be mutually helpful.

The Institute of Radio Engineers

Incorporated

33 West 39th Street, New York, N. Y.

APPLICATION FOR ASSOCIATE MEMBERSHIP

(Application forms for other grades of membership are obtainable from the Institute)

To the Board of Direction
Gentlemen:

I hereby make application for Associate membership in the Institute.
I certify that the statements made in the record of my training and professional experience are correct, and agree if elected, that I will be governed by the constitution of the Institute as long as I continue a member. I furthermore agree to promote the objects of the Institute so far as shall be in my power, and if my membership shall be discontinued will return my membership badge.

Yours respectfully,

.....
(Sign with pen)

.....
(Address for mail)

.....
(Date)

.....
(City and State)

References:

(Signature of references not required here)

Mr. Mr.

Address Address

Mr. Mr.

Address Address

Mr.

Address

The following extracts from the Constitution govern applications for admission to the Institute in the Associate grade:

ARTICLE II—MEMBERSHIP

Sec. 1: The membership of the Institute shall consist of: * * * (d) Associates, who shall be entitled to all the rights and privileges of the Institute except the right to hold the office of President, Vice-president and Editor. * * *

Sec. 5: An Associate shall be not less than twenty-one years of age and shall be: (a) A radio engineer by profession; (b) A teacher of radio subjects; (c) A person who is interested in and connected with the study or application of radio science or the radio arts.

ARTICLE III—ADMISSION

Sec. 2: * * * Applicants shall give references to members of the Institute as follows: * * * for the grade of Associate, to five Fellows, Members, or Associates; * * * Each application for admission * * * shall embody a concise statement, with dates, of the candidate's training and experience.

The requirements of the foregoing paragraph may be waived in whole or in part where the application is for Associate grade. An applicant who is so situated as not to be personally known to the required number of members may supply the names of non-members who are personally familiar with his radio interest.

What a Whale of a Difference a Few Cents Make

to paraphrase this popular slogan, CENTRALAB Volume Controls do cost more.

But it is hardly possible to build for less a control that embodies the exacting specifications, the painstaking care, the fine engineering skill that make CENTRALAB CONTROLS a necessary part of millions of modern radios.

When dealers predicate the purchase of a line with a definite demand that it be CENTRALAB equipped, it is safe to assume that "such popularity must be deserved". More than twenty million

Centralab CRL Volume Controls

have been built—a real tribute to *quality*—a splendid testimonial to the desire of the radio set manufacturer to give their public the best.

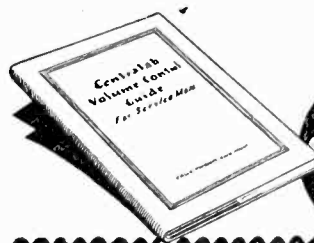
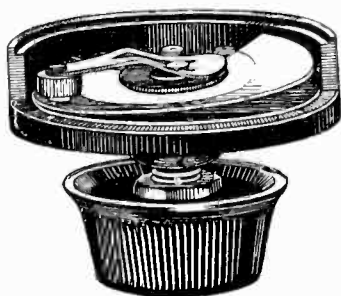

CENTRAL RADIO LABORATORIES
942 Keefe Ave., Milwaukee, Wis.
Enclosed find 25c for which send me new
VOLUME CONTROL GUIDE.

Name

Address

City State

I.R.E.

When writing to advertisers mention of the PROCEEDINGS will be mutually helpful.

STUPAKOFF MAGNESIA INSULATORS

*An Actual Size
Photograph*

**Write for samples
Stupakoff Laboratories, Inc.
6619 Hamilton Ave.
Pittsburgh, (6) Pa.
Cable Address, Stupakoff, Pittsburgh**

When writing to advertisers mention of the PROCEEDINGS will be mutually helpful.

Model I-C-D

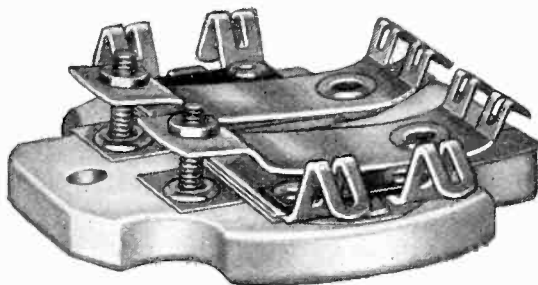

Approximately
actual size

A New Hammarlund Condenser for Tuning Intermediate-Frequency Transformers

HAMMARLUND quality *clear through* in a rugged tuning condenser for use where only the best is good enough.

Strong Isolantite base designed for mounting inside of the intermediate transformer shield. Adjustment screws for precise tuning of both transformer circuits.

Self-aligning, phosphor bronze, adjustable spring plates, and the highest grade mica insulation. Plates firmly anchored by double rivets with shock-absorbing guard. Condenser will not change in resistance or capacity under any condition of humidity, temperature or vibration. Slotted gripper solder-dipped terminals.

Efficiency of design proved in actual service. Materials the best obtainable. Thoroughly tested for break down.

Three ranges obtainable in single (code I C S) or dual (code I C D) models. 10 to 70 mmf.—70 to 140 mmf.—140 to 220 mmf.

Mail coupon for sample and quotations

H For Better Radio
Hammarlund
PRECISION
PRODUCTS

HAMMARLUND MFG. CO., New York
424-438 W. 33rd St., New York

Please send us sample of your new Intermediate
Frequency Transformer Tuning Condenser
and quotations.

Name

Address

FE-3

When writing to advertisers mention of the PROCEEDINGS will be mutually helpful.

Piezo Electric Crystals

"The Standard of Comparison"



When in the market for Accurately Ground Piezo Electric Crystals suitable for POWER USE, write us stating your requirements and our *seven years* of experience in this specialized field will be at your disposal.

Our prices for grinding these crystals are not the cheapest, but we believe our product to be *second to none* considering output and accuracy of frequency.



"A Trial Will Convince You"



Scientific Radio Service

"The Crystal Specialists"

P.O. Box 86

Mount Rainier, Maryland

When writing to advertisers mention of the PROCEEDINGS will be mutually helpful.

VARIATOR

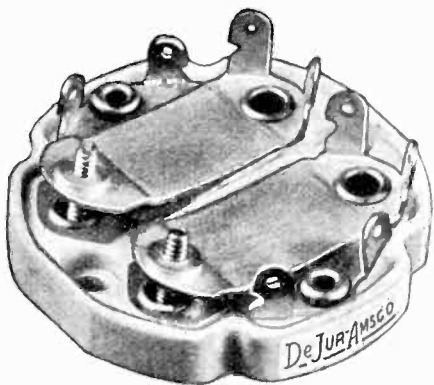

**ADJUSTABILITY and
PERMANENCE
Effectively Combined for
STABLE CIRCUIT
OPERATION**

Advances in radio receiver and oscillator circuits have necessitated the development of semi-variable condensers of an order of excellence far exceeding the elementary devices of the early ganged tuning condenser era.

The DeJur-Amsco Varitor is designed to fulfill the following requirements of the semi-variable

or "fixed variable" capacitor in modern radio frequency and super-het circuits:

1. Adequate variation in capacity.
2. Adequate total capacity.
3. Permanence of adjustment, preferably secured by locking.
4. Rapid but micrometric adjustment.
5. High electrical efficiency.
6. Adaptability to production specifications and methods.
7. Absolute guarantee against mechanical or electrical fault requiring replacement.

Write for circular giving complete specifications.

MULTIPLE VARIABLE CONDENSERS FOR STANDARD AND MIDGET RECEIVERS

Each size made in one capacity. Available in 2, 3, 4 and 5 gang units.

Write for engineering data and working drawings. Send us your specifications and let us quote.

Samples on request.

**We Also Make Special Condensers
for Automobile Radios and
Portable Receivers**

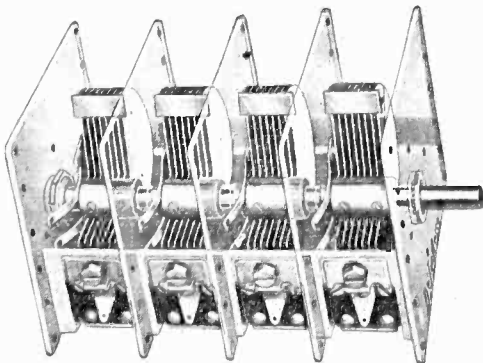

DeJUR-AMSCO CORPORATION

Varitors—Variable Condensers—Power Rheostats
95 MORTON ST., NEW YORK CITY

When writing to advertisers mention of the PROCEEDINGS will be mutually helpful.

Self-Re-cycling
TIME DELAY RELAY

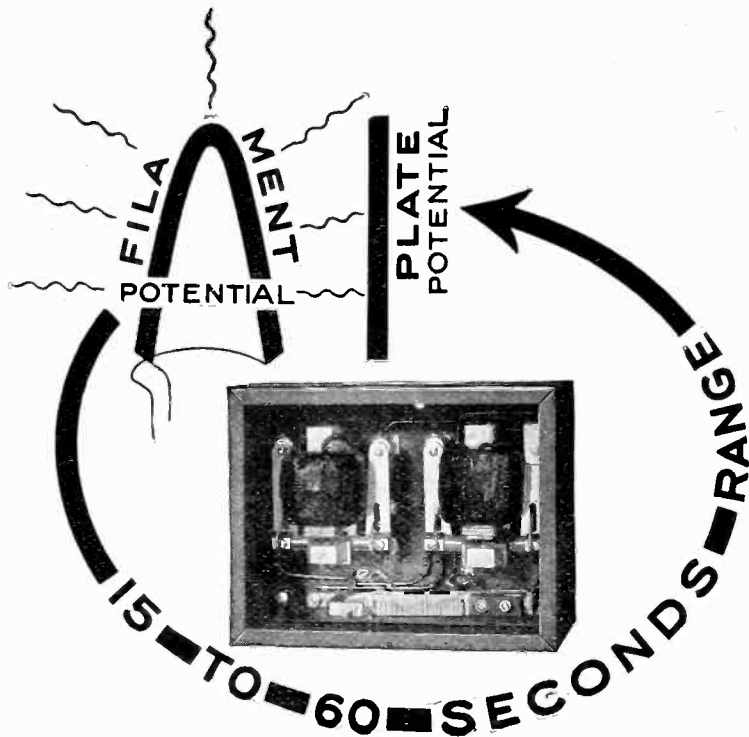

- SET** the time delay
for example at 30 seconds
- CLOSE** the circuit
starting the cycle of operations
- OPEN** the circuit
before the 30 seconds has elapsed
stopping the cycle of operations
- RESTART** and the original setting
of 30 seconds has not been shortened

*Send for information on this
and other Ward Leonard relays.*

WARD LEONARD ELECTRIC CO.
MOUNT VERNON, N. Y.

When writing to advertisers mention of the PROCEEDINGS will be mutually helpful.

*Simplicity in design of
1931 Radio Receivers
is aided by this new...*
SPRAGUE
*Inverted Type
Electrolytic*
CONDENSERS



SPRAGUE ELECTROLYTIC CONDENSERS were the dominant choice of radio engineers in 1930. They were specified for more radio sets, used by most manufacturers. The great improvement represented by the new Sprague Inverted Type Electrolytics is sure to be reflected in an increasing use in 1931. Let our engineering department co-operate with you in the design of filter circuits. Write for illustrated folder and complete catalog of Sprague Electrolytic and Paper Condensers.

Department 13-H
SPRAGUE SPECIALTIES COMPANY
North Adams, Mass.

SPRAGUE
Electrolytic **CONDENSERS**

When writing to advertisers mention of the PROCEEDINGS will be mutually helpful.

AEROVOX

BUILT BETTER
CONDENSERS AND RESISTORS

The Aerovox Hi-Farad Dry Electrolytic Condenser

Low Cost
Self-Healing
High Capacity
500 Volts Peak

DRY!



Universal mounting ring permits mounting of condensers in any position, upright or inverted.

Free!

This Book Giving the Latest and Most Complete Information on All Electrolytic Condensers Sent Free on Request.

Aerovox Wireless Corporation
80 Washington Street
Brooklyn, N. Y.

Please send me, without charge or obligation, a copy of your book, "The Hi-Farad DRY Electrolytic Condenser."

Name

Address

City State



AEROVOX WIRELESS CORP.

80 Washington Street, Brooklyn, N. Y.



PRODUCTS THAT ENDURE



When writing to advertisers mention of the PROCEEDINGS will be mutually helpful.

CHANGE IN MAILING ADDRESS OR BUSINESS TITLE

Members of the Institute are asked to use this form for notifying the Institute office of a change in their mailing address or any change in the listing of their company affiliation or title for the Year Book membership list.

The Secretary,
THE INSTITUTE OF RADIO ENGINEERS,
33 West 39th Street,
New York, N.Y.

Dear Sir:

Effective please note change in my address
(date)
for mail as follows:

FROM

.....
(Name)

.....
(Street Address)

.....
(City and State)

TO NEW ADDRESS

.....
(Street Address)

.....
(City and State)

Also for the membership list for next year's Year Book note change in my business address (or title) as follows, this ^{is} ~~is not~~ my mailing address:

.....
(Title)

.....
(Company Name)

.....
(Address: Street, City and State)

PLEASE FILL IN, DETACH, AND POST TO THE
INSTITUTE PROMPTLY

Back Numbers of the Proceedings, Indexes, and Year Books Available

MEMBERS of the Institute will find that back issues of the Proceedings are becoming increasingly valuable, and scarce. For the benefit of those desiring to complete their file of back numbers there is printed below a list of all complete volumes (bound and unbound) and miscellaneous copies on hand for sale by the Institute.

The contents of each issue can be found in the 1914-1926 Index and in the 1929 Year Book (for the years 1927-28).

BOUND VOLUMES:

Vols. 10 and 14 (1922-1926), \$8.75 per volume to members
Vols. 17 and 18 (1929-1930), \$9.50 to members

UNBOUND VOLUMES:

Vols. 6, 8, 9, 10, 11, 14, and 16 (1918-1920-1921-1922-1923-1926-1928), \$6.75 per volume (year) to members

MISCELLANEOUS COPIES:

Vol. 1 (1913) July and December
Vol. 2 (1914) June
Vol. 3 (1915) December
Vol. 4 (1916) June and August
Vol. 5 (1917) April, June, August, October and December
Vol. 7 (1919) February, April and December
Vol. 12 (1924) August, October and December
Vol. 13 (1925) April, June, August, October and December
Vol. 15 (1927) April, May, June, July, August, October, November and December
Vol. 17 (1929) January, February, March, April, May, June, July, August, September, November and December.
Vol. 18 (1930) April, May, June, July, August, September, October, November and December.

These single copies are priced at \$1.13 each to members to the January 1927 issue. Subsequent to that number the price is \$0.75 each. Prior to January 1927 the Proceedings was published bimonthly, beginning with the February issue and ending with December. Since January 1927 it has been published monthly.

MEMBERS will also find that our index and Year Book supplies are becoming limited. The following are now available:

FOURTEEN YEAR INDEX

The Proceedings Index for the years 1909-1926 inclusive is available to members at \$1.00 per copy. This index is extensively cross indexed.

YEAR BOOK

The 1931 Year Book is available to members at \$1.00 per copy. This Year Book includes the 1930 Standardization Report,—an "up to the minute" report on the most recent standardization information available.

Make remittances payable to the Institute of Radio Engineers and send orders to:

THE INSTITUTE OF RADIO ENGINEERS

33 West 39th Street
NEW YORK CITY, N. Y.

YOUR NEW PROBLEM . . . *and* ITS SOLUTION!

WITH home recording promising to be an outstanding feature of next year's radio receivers, the problem of HUM is more serious than ever.

Even a slight hum not noticeable in radio reproduction will, when recorded and augmented through reproduction, make itself heard with sufficient volume to prove disagreeable. In this modern day of radio, hum is not to be tolerated in radio or phonograph reproduction.

For more than twenty years, Pacent engineers have concerned themselves exclusively with problems relating to sound amplification. That's why Pacent amplifiers are the best in the field today.

A standard two stage Pacent Amplifier, Cat. No. 2245M (without input transformer) employing one 227 and two 245's in push-pull has a hum level of 23 DB below its maximum output rating. This same amplifier will provide 4.3 watts undistorted power output and has a voltage gain at 1000 cycles of 31 DB with 3.8 volts input. These figures are not theoretical calculations. They are the result of actual measurements made with a stock amplifier.

A Pacent Amplifier, the 170 Recordovox and the 107 Hi-Output Phonovox make a remarkable combination for recording and reproducing. With this apparatus, it is possible to assure professional results.

The Recordovox and Phonovox are available in special manufacturers' types. Write for additional information.

PACENT ELECTRIC COMPANY, INC.
91 SEVENTH AVE., NEW YORK, N. Y.

Pioneers in Radio and Electric Reproduction for over 20 Years.
Licensee for Canada: White Radio, Ltd., Hamilton, Ont.

PACENT

When writing to advertisers mention of the PROCEEDINGS will be mutually helpful.

Shakeproof

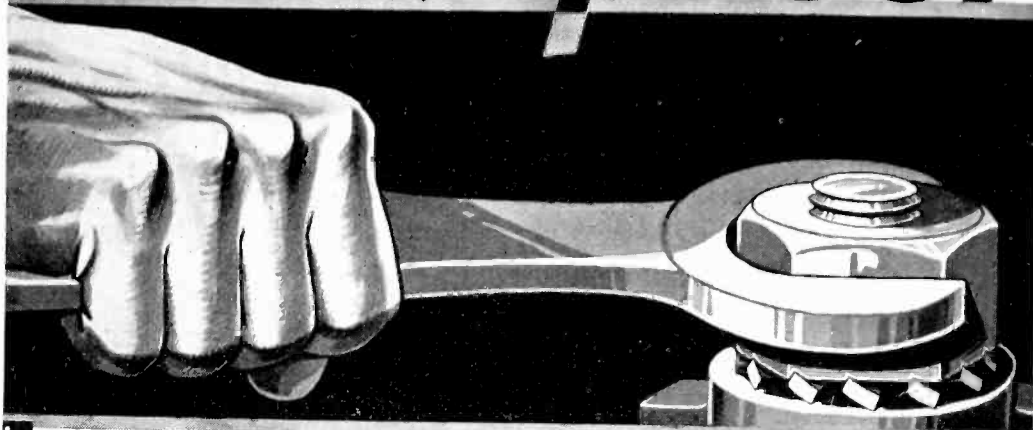

Locks Tight with Only One Half Turn!

WHEN speed on the production line counts—Shakeproof always wins. After the nut comes against the washer, it only takes one half turn to lock it home. This means many minutes of precious time saved and thousands of dollars for hundreds of manufacturers.

What's more, Shakeproof never lets go—because the twisted steel teeth bite into both the nut and work surfaces and only applied pressure can release their hold. Their positive locking method is Vibration's greatest enemy and adds years of perfect performance to any product.

Test Shakeproof Now! See for yourself how it solves your locking problems. Free samples of any type or size desired will be gladly furnished on request. Write for a supply today!



Type 12. Internal For S. A. E. and Standard Machine Screws



Type 11. External For Standard Bolts and Nuts



Type 15. Countersunk For all Countersunk Screws



Type 20 Locking Terminals For Radio and Electrical Work

U. S. Patents
1,419,564
1,604,122
1,697,954
1,782,387
Other patents pending.
Foreign patents.

SHAKEPROOF Lock Washer Company



{Division of Illinois Tool Works}
2529 N. Keeler Avenue, Chicago, Ill.

"It's the Twisted Teeth that LOCK"

When writing to advertisers mention of the PROCEEDINGS will be mutually helpful.

Service Manuals Should Specify these up-to-date methods . . .



1—"Test All Circuits With an Analyzer"

Too often design engineers are criticized for poor set performance that is really due to faulty adjustment by servicemen. Minor troubles, that could be easily remedied by proper servicing, are the cause of friction between engineering and sales organizations.

The Jewell Analyzer provides the most modern and thorough-going method for radio receiver servicing. Assure this modern service for your set. Specify the Jewell Analyzer in your service manuals and include analyzer test data.



2—"Make Adjustments With an Oscillator"

Inaccurate adjustments of radio frequency circuits by servicemen often make worthless the most advanced receiver design. Service adjustments on radio frequency circuits can be made more accurately and in less time with a radio service oscillator.

The Jewell Pattern 560 Radio Service Oscillator meets the requirements of radio service work. It has two frequency ranges, 550-1500 K.C. and 125-185 K.C., for servicing both tuned radio frequency and super-heterodyne receivers.

Protect the performance of your receivers by specifying in your service manuals that radio frequency circuit adjustments be made with the Jewell Radio Service Manual.

The Jewell organization cooperates with radio engineers in preparing service manuals. Information and illustrations will be furnished concerning radio servicing methods, the use of analyzers, test oscillators and tube checkers. This service is available without obligation. Write today.

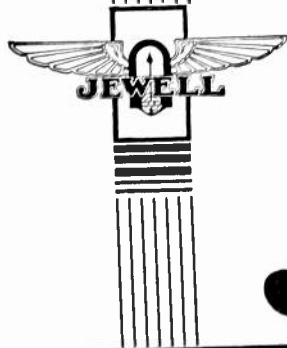

Jewell Electrical Instrument Co.

1642-D Walnut St., Chicago, Ill.

31 YEARS MAKING GOOD INSTRUMENTS
JEWELL

When writing to advertisers mention of the PROCEEDINGS will be mutually helpful.

W
P
D
L

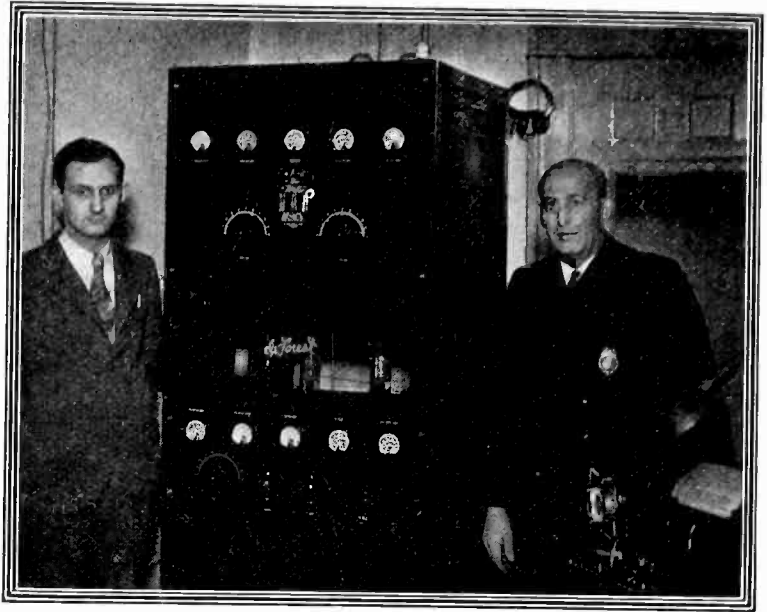

of Lansing

PROGRESSIVE Lansing believes in adequate police protection. Station WPDL, the nucleus of its DeForest police radio alarm system, has an unfailing service range of 8 miles, fully covering the municipality. The standard DeForest 50-watt single-panel transmitter and speech amplifier, 100% modulated, feeds a doublet antenna suspended from City Hall tower. The 511 and 545 Transmitting Audion filaments

operate at full temperature throughout daily schedule.

States Chief Seymour:

"With our transmitter now on the air 16 hours each day, and looking ahead to a 24-hour schedule, we must insist on the best in apparatus and tubes. Our filaments operate at full temperature hour after hour. That we have chosen DeForest equipment and tubes expresses best our opinion of their intrinsic worth."

After All, There's No Substitute for 25 Years' Experience!

WRITE for catalog on DeForest transmitting tubes for every conceivable purpose. Also do not hesitate to place special transmitting and receiving problems before our Engineering Department.

DE FOREST RADIO COMPANY, PASSAIC, N. J.
Export Department, 304 E. 45th Street, New York City, N. Y., U. S. A.

de Forest
(AUDIONS)

RECEIVING
AND
TRANSMITTING **TUBES**

When writing to advertisers mention of the PROCEEDINGS will be mutually helpful.

Efficient Short Wave Receivers

Must Use Correctly Proportioned Coils and Condensers

(REL) Units Solve the Problem

REL plug-in coils are adaptable to all circuits. These can be wound with extremely heavy enamel covered wire offering rigidity and permanent calibration. A one piece bakelite moulded properly proportioned coil form is employed. Positive electrical contact is always secured by means of the heavy duty plug-in base.

REL variable condensers are designed especially for short wave receiver uses. Plates are well spaced and the entire condenser is designed so that there is minimum material in the dielectric field. The main tank condenser can be supplied in various capacities. This unit can be varied and calibrated as desired. The vernier narrow band tuning portion of the condenser offers extremely wide spread of stations. Its maximum capacity can also be adjusted.

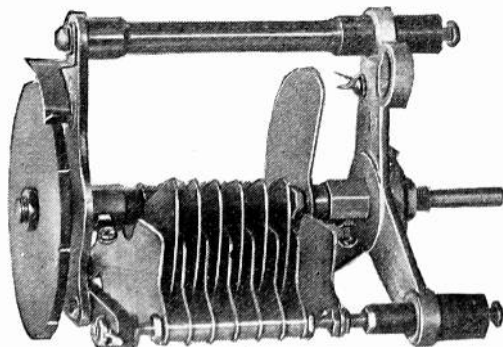
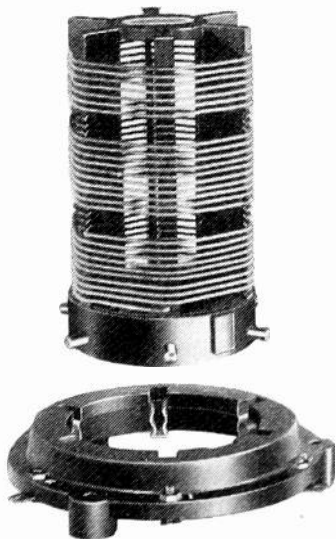

Illustrates the REL Cat.—187E combined tank and vernier condenser—can be used to obtain full spread coverage of any desired narrow frequency band.

Illustrates the REL one-piece bakelite plug-in coil and base—space wound—heavy enamel covered wire—positive base contact.

Manufacturers, engineers, designers and operators of commercial and point to point radio stations write to our Engineering Department. Full information will be gladly forwarded upon request.



MANUFACTURES A COMPLETE LINE OF
APPARATUS FOR SHORT WAVE TRANS-
MISSION AND RECEPTION

Radio Engineering Laboratories, Inc.

100 Wilbur Ave.

Long Island City, N. Y., U.S.A.

When writing to advertisers mention of the PROCEEDINGS will be mutually helpful.

The Green Flyer Motor unit. Like the larger Blue Flyer, self-starting, with automatic stop equipment optional. Spiral-cut fiber gears, long oversize bearings, open construction and complete ventilation. Made to operate on all voltages and frequencies. For D.C., either 110 or 220 volts. Like the Blue Flyer, furnished complete with mounting plate, turn-table and speed regulator, as shown. *Responsibly Guaranteed.*

In ordering samples, please give voltage and frequency.

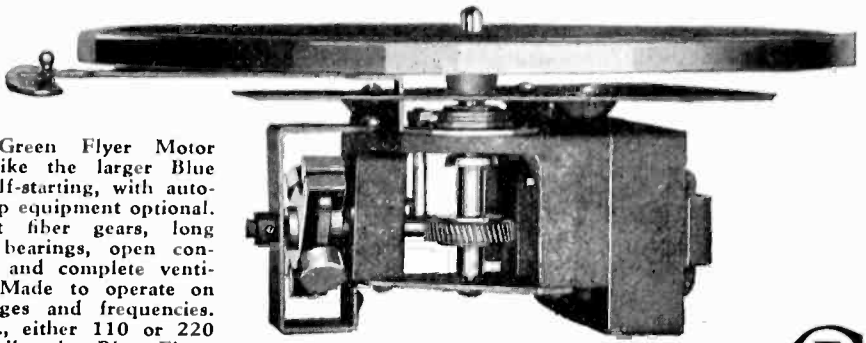

Service . .
Handling the
job to perfection . .
Flyer
Electrics

MOTORS built to dependably insure the full enjoyment of the radio-phonograph's highest achievements. Year in and year out. The popular Flyer Electrics.

They have abundant reasons for most satisfactorily so doing. Always they have been known for balanced efficiency. Always for simplicity of design. Always for dependability. Always they have consistently met every requirement . . . kept right on proving their superiority.

Only Flyer Electrics have their advantages. Made by a concern with a quarter century of experience in specialized electrical manufacturing coupled with 15 years of leadership in large scale production of quality phonograph motors.

Specially designed for radio-phonographs. Used by leading builders of quality combinations.

Ontario Hydro-
Electric Power
Commission
Approval No.
2685

The GENERAL INDUSTRIES CO.

3146 Taylor Street, Elyria, Ohio

When writing to advertisers mention of the PROCEEDINGS will be mutually helpful.

ANNOUNCING...

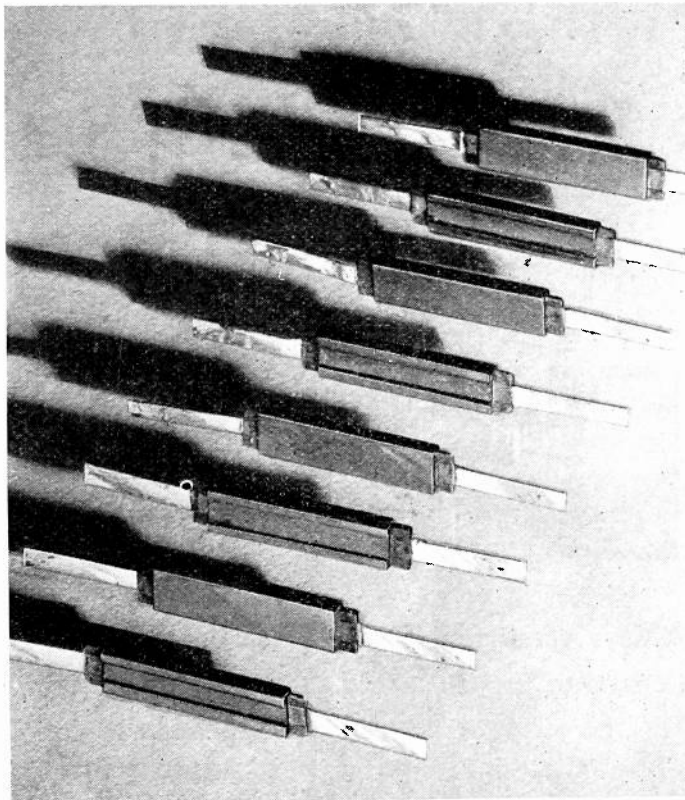

Dubilier Type 702 Toothpick Condensers

Haven't you long been looking for mica condensers, precision built but at quantity prices, and which possess the following ideal features,—

- (1) A design better than molded condensers.
- (2) A development which would insure constancy of capacity during the life of a set.
- (3) A very negligible change in capacity over a large temperature range.
- (4) Capacitors of any value between 1 and 2500 micro-microfarads, to meet your requirements.
- (5) And, in DUBILIER standard capacity tolerances of either 1, 5, or 10%.
- (6) Available to RCA Licensees—A preferred design for uses in super-heterodyne or other receivers.

If so, then write us for samples and prices, based upon your requirements and production quantities.

Dubilier
CONDENSER
CORPORATION

4377 Bronx Blvd.
New York, N. Y.

When writing to advertisers mention of the PROCEEDINGS will be mutually helpful.

FOR MOLYBDENUM WIRE

at its best

**FANSTEEL
THE BEST
SOURCE
OF
SUPPLY**

Whether you make flat or round grids, in fact whatever fabricating process you use, the necessary properties are provided in Fansteel Molybdenum Wire.

Always you'll find Fansteel Molybdenum of exceptional purity and exact as to dimension specifications. It is the result of 12 years' specialization in this field, most of the time in close cooperative development work with vacuum tube producers.

As a final check, we make practical working tests in our laboratory with samples from each lot of metal before it is shipped.

Standard sizes of wire, rod and sheet are stocked for prompt delivery. Tell us your problem or requirements and we will send you free samples for testing.

FANSTEEL PRODUCTS COMPANY, Inc.
NORTH CHICAGO, ILLINOIS

TANTALUM · TUNGSTEN · MOLYBDENUM · RARE METAL ALLOYS

When writing to advertisers mention of the PROCEEDINGS will be mutually helpful.

Continental Resistors

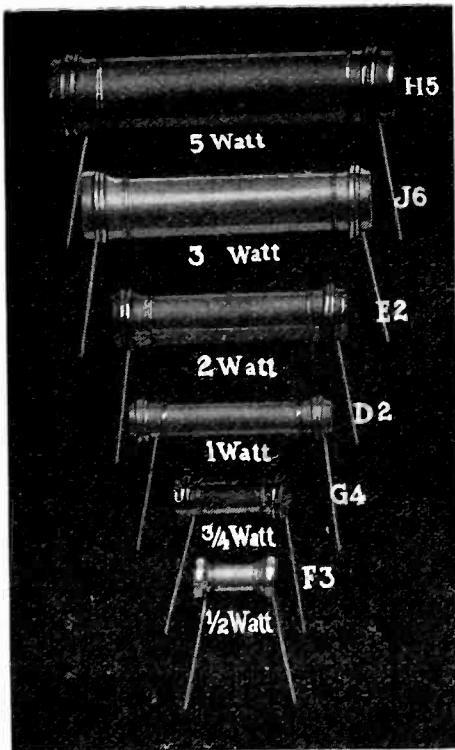

RESISTOR CHARACTERISTICS:

NOISELESS
RESISTANCE CONSTANT
SMALL TEMPERATURE
COEFFICIENT
RUGGED
FIRMLY SOLDERED TERMINALS
DEPENDABLE
COLOR CODED

UNITS SHOWN HALF SIZE

CONTINENTAL SUPPRESSORS

For Radio-Equipped Cars

Stop ignition noise in the automobile radio set when used with suitable by-pass condensers.

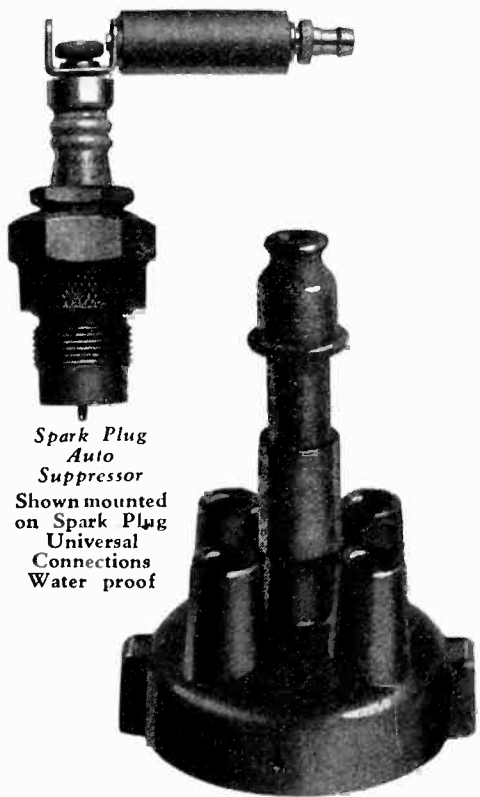

Spark Plug
Auto
Suppressor
Shown mounted
on Spark Plug
Universal
Connections
Water proof

Distributor Auto Suppressor
Shown mounted on distributor cap. Fully insulated, no metal parts exposed, rigid mounting.



Curtis Electro Chemical Condenser

Essential Characteristics

- Full capacity at all voltages
- Uniform capacity at all frequencies
- Low freezing point
- Low internal resistance
- Low leakage
- No nipples, new breather principle
- One hole mounting terminal at bottom

For Further Particulars Write to
Curtis Continental Corp.
13900 Lorain Ave.,
Cleveland, O.

Write for Information and Prices
CONTINENTAL CARBON, INC.
WEST PARK, CLEVELAND, O.

When writing to advertisers mention of the PROCEEDINGS will be mutually helpful.

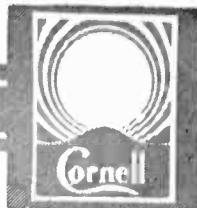
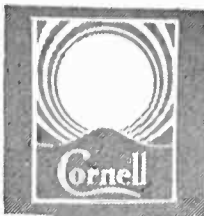

HAVE STOOD THE TEST OF TIME AND SERVICE



The "Cub" Condenser is no longer an experiment. Millions of them are now in service and millions more constantly join their ranks.

They have stood the test of time and service and have made a place for themselves in the radio industry.

"Cub" Condensers are now approved and specified by leading radio engineers throughout the country.

Write for Sample

*High Insulation Resistance
Extraordinary Dielectric Strength
Capacities .00025 to .5 Mfd.*

Cornell

FILTER CONDENSERS
BY-PASS CONDENSERS
RADIO INTERFERENCE FILTERS
POWER FACTOR CORRECTION BANKS
UNIFORMLY HIGH INSULATION RESISTANCE
PAPER DIELECTRIC CONDENSERS (All Types)

*Write for Sample "Cub" Condenser and Catalog of
Complete Line of Cornell Products.*

Cornell Electric Mfg. Co., Inc.
LONG ISLAND CITY, NEW YORK

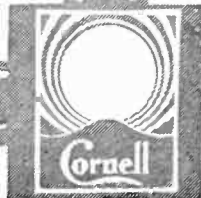
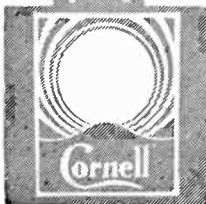

When writing to advertisers mention of the PROCEEDINGS will be mutually helpful.

PROFESSIONAL ENGINEERING DIRECTORY

For Consultants in Radio and Allied Engineering Fields

THE MAGNAVOX COMPANY

155 East Ohio Street, Chicago, Ill.

*PIONEERS AND SPECIALISTS
IN THE ART OF
SOUND REPRODUCTION.
DYNAMIC SPEAKERS SINCE
1911.*

ELECTRICAL TESTING LABORATORIES

Tests of Inductances.
Condensers. Transform-
ers etc. Life and charac-
teristics of Radio Tubes

80th. Street and East End Ave.
• • NEW YORK, N.Y. • •

Radio, Television and Sound Picture
Patents bought and sold. Applications,
searches and reports for Inventors and
Manufacturers.

Over twenty five years practical ex-
perience as an Engineer and Manufac-
turer in Radio and kindred fields.

H. R. VAN DEVENTER
Consulting Engineer and Patent Attorney
342 Madison Ave., New York City

The J. G. White Engineering Corporation

Engineers—Constructors

*Builders of New York Radio
Central*

43 Exchange Place New York

Radio Engineers



Your card on this professional card page will give
you a direct introduction to over 8,000 technical
men, executives, and others with important radio
interests.



Per Issue—\$10.00

When writing to advertisers mention of the PROCEEDINGS will be mutually helpful.

Alphabetical Index to Advertisements

A

Aerovox Wireless Corp.....XLII
Allen-Bradley Co.....XXXI
American Tel. & Tel. Co.....XVI
American Transformer Co.....XVIII
Amperite Corp.....XXVI
Arcturus Radio Tube Co.....XXXII

C

Cardwell, Allen D., Mfg. Corp...XIX
Central Radio Laboratories...XXXV
Cohn, Sigmund.....XX
Condenser Corp. of America..XXVIII
Continental Carbon, Inc.....LIII
Cornell Electric Mfg. Co.....LIV

D

DeForest Radio Co.....XLVIII
DeJur-Amsco Corp.....XXXIX
Dubilier Condenser Corp.....LI, LX

E

Electrad, Inc.....XXI
Electric Specialty Co.....XXII
Elkon, Inc.....LVIII
Engineers Available.....LVII

F

Fansteel Products Co., Inc.....LII
Formica Insulation Co.....XXX
Frost, H. H., Inc.....XIV, XV

G

General Cable Corp.....XXIII
General Industries Co.....L
General Radio Co..Outside Back Cover

H

Hammarlund Mfg. Co.....XXXVII

I

International Resistance Co.....XIII
I.R.E.....XXXIII, XXXIV,
XLIII, XLIV
Isolantite Co. of Amer...XXIV, XXV

J

Jewell Electrical Instr. Co.....XLVII

P

Pacent Electric Co., Inc.....XLV
Polymet Manufacturing Corp..XXVII
Potter Co.....Inside Back Cover
Professional Engineering Directory
.....LV

R

Radio Engineering Labs.....XLIX
RCA Radiotron Co., Inc.....XXIX
RCA Victor Co.....LIX
Roller-Smith Co.....XVII

S

Scientific Radio Service.....XXXVIII
Shakeproof Lock Washer Co...XLVI
Sprague Specialties Co.....XLI
Stupakoff Labs., Inc.....XXXVI

W

Ward Leonard Electric Co.....XL

When writing to advertisers mention of the PROCEEDINGS will be mutually helpful.

ENGINEERS AVAILABLE

Advertisements on this page are available only to members of the Institute of Radio Engineers. For rates and further information address the Secretary, The Institute of Radio Engineers, 33 West 39th Street, New York, N.Y.

Manufacturers and others seeking radio engineers are invited to address replies to these advertisements at the Box number indicated, care the Institute of Radio Engineers. All replies will be forwarded direct to the advertiser.

INSTRUCTOR IN PHYSICS AND RADIO COMMUNICATION, is interested in securing position with broadcast station in any capacity, or with radio manufacturer offering opportunity to do radio research. Has had experience in construction and design of broadcast stations, as well as in station management. College graduate, 1925. Age, 27. Box 50.

YOUNG MAN, since 1925 in engineering departments of several radio manufacturing concerns, is interested in obtaining position doing design and general development work on radio receiving equipment. Specialized in design of radio frequency amplifiers. Has had high school education and one year of business college. Age, 27. Box 51.

SERVICE MAN, for four years and commercial radio operator in land and ship stations since March 1930, is interested in changing position. Willing to do anything. Service experience includes one year as owner of radio and battery service station, and two years service work for radio manufacturers. Age, 24. Box 52.

SERVICE MAN, having high school education and university extension course in radio, desires position as field service man to work on public address systems or radio receivers. Four years experience on servicing radio and talking picture equipment and half year on cost work. Age, 22. Box 45.

PRODUCTION MAN, familiar with practical methods and cost reduction is interested in position where past experience will be best appreciated. Instrument maker up to 1913. Since 1913 has specialized in radio experimental model making and manufacturing. Since 1925 has had responsible position in charge of model shops or factory production. Graduate of School of Technology, Budapest in 1905. Reference by reputable concerns. Age, 41. Box 47.

COLLEGE STUDENT, is interested in obtaining position in any radio work, preferably with broadcast station or with communication department of airways system. Holds commercial radio operator's license and has had several years experience in servicing broadcast receivers as well as two years experience in broadcast station. B.S. in E.E. 1931. Available after June 15, 1931. Age, 22. Box 53.

The ELKON Non-Aqueous

Hi-Volt Condenser.

OUTSTANDING CHARACTERISTICS

1 High Working Voltage: 450 volts—withstands without injury transient peaks in excess of 575 volts.

2 Absolutely Dry: A condenser from which all water is eliminated.

3 Low Leakage: Normal rated leakage 0.1 mil per mfd. (After perating short period the leakage is 0.025 mils per mfd.)

4 Impervious to Low Temperatures: Operates efficiently from minus 40° F to 150° F.

5 Long Life: To reduce replacements and interrupt service periods to a minimum.

6 Self Healing: Transient peaks in excess of 575 volts do not injure the Elkon condenser.

7 Compactness: Smallest cubical volume per microfarad of any condenser on the market.

8 Maximum Filtering: Due to low power factor, the Elkon condenser has the greatest filtering action of any electrolytic condenser on the market.

9 Stability in Operation: To guard against mechanical and electrical variation that would affect action of circuit.

10 Low cost per microfarad per voltage rating: A large safety factor in volt rating for the same cost as lower voltage condensers.

450
Working
Volts Any
Combination
of Capacities.
Wide Variety
of Can Sizes.

**Greatest Filtering
Capacity of Any Electrolytic Condenser**

Samples built to your specifications will be sent to all recognized manufacturers.

Send for booklet giving complete technical data and general description.

ELKON DIVISION

P. R. MALLORY & CO., Incorporated
Indianapolis, Indiana

SMALL!
Typical can size
16 Mfd. Condenser
4 1/4" x 2" x 1 1/2"



Booklet with complete data upon request.

THE
ELKON
NON-AQUEOUS
Hi-Volt Condenser

Standard Can Sizes and Their Microfarad Capacities

Vertical Cans			Horizontal Cans		
MFD Cap'ty of Sections	Total Capa'ty MFDs	Can Size	MFD Cap'ty of Sections	Total Capa'ty MFDs	Can Size
1	1	2 3/4 x 1 x 1/2	5	5	4 1/4 x 1 1/2 x 3/4
2	2	2 3/4 x 1 3/8 x 3/4	6	6	4 1/4 x 1 1/2 x 3/4
2-2	4	2 3/4 x 1 3/8 x 1 1/2	8	8	4 1/4 x 2 x 3/4
2-2-2	6	2 3/4 x 1 3/8 x 2	8-8	16	4 1/4 x 2 x 1 1/2
2-2-2-2	8	2 3/4 x 1 3/8 x 2 3/4	8-8-8	24	4 1/4 x 2 1/4 x 1 3/4
4	4	4 1/4 x 1 x 1	8-8-8-8	32	4 1/4 x 3 x 2
4-4	8	4 1/4 x 2 x 1	2-4-8	14	4 1/4 x 2 x 1 1/2
4-4-4	12	4 1/4 x 1 3/4 x 1 3/4	2-8-8	18	4 1/4 x 2 x 1 3/4
4-4-4-4	16	4 1/4 x 2 1/2 x 1 3/4	2-8-16	26	4 1/4 x 2 1/4 x 1 3/4
ROUND CANS					
				4	1 3/8 dia x 2 3/4
				8	1 3/8 dia x 4 1/4
				8-8	2 1/2 dia x 4 1/4
				8-8-8	3 dia x 4 1/4
				8-8-8-8	3 dia x 4 1/4

— A CONDENSER FOR ALL POWER PACK ASSEMBLIES —

When writing to advertisers mention of the PROCEEDINGS will be mutually helpful.



New laboratory and test instruments



Visual Oscillograph

for circuit analysis and rapid aligning of intermediate frequency amplifiers, transformers, etc.

Instruments also available for accurate and rapid measurement of R. F. inductances and capacitors over wide range of values.

Operation by projection of resonance curve on screen.

Now available to radio and tube manufacturers, laboratories, colleges, etc., for precision and rapid measurements in the laboratory and production line.

HARMONIC ANALYZER
MICROPHONIC TEST SET
HUM TEST SET
MUTUAL CONDUCTANCE METER
GM & RP METER
TUBE CAPACIMETER
RADIO FREQUENCY FILTERS
MASTER SIGNAL GENERATOR
LABORATORY SIGNAL GENERATOR
R. F. ATTENUATORS
BEAT FREQUENCY OSCILLATOR
PRECISION CAPACITY METER
R.F. SIGNAL SYSTEMS FOR PRODUCTION TEST
MAGNETIC PICKUP TEST EQUIPMENT

Information and prices on request

ENGINEERING PRODUCTS DIVISION

RCA VICTOR CO., INC., CAMDEN, N. J.

Chicago—100 West Monroe St.

San Francisco—235 Montgomery St.

A Radio Corporation of America Subsidiary

When writing to advertisers mention of the PROCEEDINGS will be mutually helpful.



DUBILIER CONDENSER CORPORATION

4377 Bronx Blvd.
New York City

Announcing

Dubilier Electrolytic Condensers

In meeting the demand of the radio industry for inexpensive capacity, Dubilier engineers have developed the Dubilier Hi-Mike Condenser—a refined semi-dry high-voltage electrolytic condenser with these outstanding characteristics:

1. Aluminum can $4\frac{1}{2}$ by $1\frac{3}{8}$ inches, interchangeable with other standard electrolytic units.
2. Available in upright and inverted types.
3. Standard capacity of 8 mfd., with highest percentage of effective capacity.
4. Working voltage conservatively rated at 400, peak of 430, or more than ample for —80 type rectifier circuits.
5. Fully self-healing, reforming faster than any other electrolytic condenser.
6. Lower leakage at high voltages than any other electrolytic condenser.
7. Life expectancy in excess of requirements of usual radio assembly.
8. Compact, clean, non-spillable, efficient, inexpensive, self-healing, reliable.

Thus the Dubilier organization brings two years of research and engineering development on electrolytic condensers to a practical conclusion. The results are available to you in meeting your condenser requirements. May we present complete details and samples?

When writing to advertisers mention of the PROCEEDINGS will be mutually helpful.

Check These Features

» of Potter
Electrolytic Condensers

✓ Absolutely Dry

✓ 500 Working Volts

Electrolytic Capacity Units



Two reasons that enable Potter Electrolytic Condensers to step far ahead of the ordinary electrolytic unit.

The Potter Electrolytic capacity unit may be had with a working potential of 500 or 350 volts with a very low leakage current under ordinary circuit voltages. It may be used in circuits with higher voltages than the usual 500 peak potential type.

The dry gum electrolyte is completely sealed in. No vents are necessary. It never freezes, spills, evaporates, or changes in any way as to affect the operation of the unit. Potter Electrolytic Filter Capacity Units may be mounted in any position or may be combined in the same block with paper by-pass and filter units.

Potter Electrolytic Capacity Units and Potter Condenser Blocks combining paper and electrolytic units may be quickly supplied to meet any voltage, capacity, or size requirements.



By-pass condenser for midget receivers 1-7/8 inches long.

48 Hour Condenser Service

When you need a special condenser unit, make use of this quick Potter service. Potter can build any condenser unit to your exact specifications in less than 48 hours. The complete winding, impregnating, and case-making facilities of the Potter plant eliminate delay and assure the quickest possible delivery of your unit.

The Potter Company
1944 Sheridan Rd., North Chicago, Ill.

Potter Condensers



Type 457-A Modulation Meter—\$125.00

Modulation Measurements

The Type 457-A Modulation Meter is an effective means of locating modulation faults in modern broadcast transmitters. It measures percentage modulation on both the positive and negative peaks, thereby showing up "asymmetrical distortion" and shifts of the carrier amplitude during modulation. Information it supplies enables the engineer to secure the maximum modulation from his transmitter and to maintain that optimum adjustment.

The modulation meter operates on a very small amount of power taken from the transmitter output circuit by a pickup inductor. It is entirely self-contained except for the 110-volt, 60 cps.-supply which supplies power to heat the filaments of the two tubes.

For further details, address Department R3.

GENERAL RADIO COMPANY
CAMBRIDGE A, MASSACHUSETTS