

VOLUME 19

FEBRUARY, 1931

NUMBER 2

PROCEEDINGS
of
The Institute of Radio
Engineers



Form for Change of Mailing Address or Business Title on Page XLIII

Institute of Radio Engineers

Forthcoming Meetings

CINCINNATI SECTION

February 17, 1931

March 17, 1931

LOS ANGELES SECTION

February 16, 1931

NEW YORK MEETING

March 4, 1931

SAN FRANCISCO SECTION

February 18, 1931

PROCEEDINGS OF

The Institute of Radio Engineers

Volume 19

February, 1931

Number 2

Board of Editors

ALFRED N. GOLDSMITH, <i>Chairman</i>	
STUART BALLANTINE	G. W. PICKARD
RALPH BATCHER	L. E. WHITTEMORE
J. W. HORTON	W. WILSON

CONTENTS

PART I	Page
Frontispiece, E. Leon Chaffee, Vice President of the Institute, 1922	158
Institute News and Radio Notes	159
Meetings of the Board of Direction	159
Radio Transmissions of Standard Frequency, February to June, 1931	159
Committee Work	161
Institute Meetings	162
Address of the Retiring President, Dr. Lee de Forest	169
PART II	
<i>Technical Papers</i>	
On the Simultaneous Operation of Different Broadcast Stations on the Same Channel P. P. ECKERSLEY	175
Some Methods of Measuring the Frequency of Short Waves H. MÖGEL	195
Monitoring the Operation of Short-Wave Transmitters H. MÖGEL	214
The Use of the Copper-Oxide Rectifier for Instrument Purposes J. SAHAGEN	233
Wide Range Scales for Fading Records by Electrical Means G. D. ROBINSON	247
Note on High-Frequency Transmission During the Summer of 1930 G. W. KENRICK, A. H. TAYLOR, AND L. C. YOUNG	252
Condenser Loud-Speakers with Flexible Electrodes P. E. EDELMAN	256
Experimental Method of Studying Transient Phenomena H. M. TURNER	268
Overseas Radio Extensions of Wire Telephone Networks LLOYD ESPENSCHIED AND WILLIAM WILSON	282
Propagation of Sinusoidal Currents in Linearly Tapered Loaded Transmission Lines J. W. ARNOLD AND P. F. BECHBERGER	304
Booklets, Catalogs, and Pamphlets Received	311
Monthly List of References to Current Radio Literature	312
Contributors to this Issue	318

The Institute of Radio Engineers

GENERAL INFORMATION

The PROCEEDINGS of the Institute is published monthly and contains papers and discussions thereon submitted for publication or for presentation before meetings of the Institute or its Sections. Payment of the annual dues by a member entitles him to one copy of each number of the PROCEEDINGS issued during the period of his membership.

Subscription rates to the PROCEEDINGS for the current year are received from nonmembers at the rate of \$1.00 per copy or \$10.00 per year. To foreign countries the rates are \$1.10 per copy or \$11.00 per year.

Back issues are available in unbound form for the years 1918, 1920, 1921, 1922, 1923, and 1926 at \$9.00 per volume (six issues) or \$1.50 per single issue. For the years 1913, 1914, 1915, 1916, 1917, 1919, 1923, 1924, and 1925 miscellaneous copies (incomplete unbound volumes) can be purchased for \$1.50 each; for 1927, 1928, and 1929 at \$1.00 each. The Secretary of the Institute should be addressed for a list of these.

Discount of twenty-five per cent is allowed on all unbound volumes or copies to members of the Institute, libraries, booksellers, and subscription agencies.

Bound volumes are available as follows: for the years 1922 and 1926 to members of the Institute, libraries, booksellers, and subscription agencies at \$8.75 per volume in blue buckram binding and \$10.25 in morocco leather binding; to all others the prices are \$11.00 and \$12.50, respectively. For the year 1929 the bound volume prices are: to members of the Institute, libraries, booksellers, and subscription agencies, \$9.50 in blue buckram binding; to all others, \$12.00. Foreign postage on all bound volumes is one dollar, and on single copies is ten cents.

The 1930 Year Book, containing general information, the Constitution and By-Laws, catalog of membership, etc., is available to members at \$1.00; to nonmembers, \$1.50.

Contributors to the PROCEEDINGS are referred to the following page for suggestions as to approved methods of preparing manuscripts for publication in the PROCEEDINGS.

Advertising rates for the PROCEEDINGS will be supplied by the Institute's Advertising Department, Room 802, 33 West 39th Street, New York, N.Y.

Changes of address to affect a particular issue must be received at the Institute office not later than the 15th of the month preceding date of issue. That is, a change in mailing address to be effective with the October issue of the PROCEEDINGS must be received by not later than September 15th. Members of the Institute are requested to advise the Secretary of any change in their business connection or title irrespective of change in their mailing address, for the purpose of keeping the Year Book membership catalog up to date.

The right to reprint portions or abstracts of the papers, discussions, or editorial notes in the PROCEEDINGS is granted on the express condition that specific reference shall be made to the source of such material. Diagrams and photographs published in the PROCEEDINGS may not be reproduced without making special arrangements with the Institute through the Secretary.

It is understood that the statements and opinions given in the PROCEEDINGS are views of the individual members to whom they are credited, and are not binding on the membership of the Institute as a whole.

All correspondence should be addressed to the Institute of Radio Engineers, 33 West 39th Street, New York, N.Y., U.S.A.

Entered as second class matter at the Post Office at Menasha, Wisconsin.

Acceptance for mailing at special rate of postage provided for in the Act of February 28, 1925, embodied in paragraph 4, Section 412, P. L. and R. Authorized October 26, 1927.

Published monthly by

THE INSTITUTE OF RADIO ENGINEERS, INC.

Publication office, 450-454 Ahnaip Street, Menasha, Wis.

BUSINESS, EDITORIAL, AND ADVERTISING OFFICES,

Harold P. Westman, *Secretary*

33 West 39th St., New York, N.Y.

SUGGESTIONS FOR CONTRIBUTORS TO THE "PROCEEDINGS"

Preparation of Paper

Form—Manuscripts may be submitted by member and nonmember contributors from any country. To be acceptable for publication, manuscripts should be in English, in final form for publication, and accompanied by a summary of from 100 to 300 words. Papers should be typed double space with consecutive numbering of pages. Footnote references should be consecutively numbered and should appear at the foot of their respective pages. Each reference should contain author's name, title of article, name of journal, volume, page, month, and year. Generally, the sequence of presentation should be as follows: statement of problem; review of the subject in which the scope, object, and conclusions of previous investigations in the same field are covered; main body describing the apparatus, experiments, theoretical work, and results used in reaching the conclusions and their relation to present theory and practice; bibliography. The above pertains to the usual type of paper. To whatever type a contribution may belong, a close conformity to the spirit of these suggestions is recommended.

Illustrations—Use only jet black ink on white paper or tracing cloth. Cross-section paper used for graphs should not have more than four lines per inch. If finer ruled paper is used, the major division lines should be drawn in with black ink, omitting the finer divisions. In the latter case, only blue-lined paper can be accepted. Photographs must be very distinct, and must be printed on glossy white paper. Blueprinted illustrations of any kind cannot be used. All lettering should be 3/16 in. high for an 8 x 10 in. figure. Legends for figures should be tabulated on a separate sheet, not lettered on the illustrations.

Mathematics—Fractions should be indicated by a slanting line. Use standard symbols. Decimals not preceded by whole numbers should be preceded by zero, as 0.016. Equations may be written in ink with subscript numbers, radicals, etc., in the desired proportion.

Abbreviations—Write a.c. and d.c. (a-c and d-c as adjectives), kc, μf , $\mu\mu f$, e.m.f., mh, μh henries, abscissas, antennas. Refer to figures as Fig. 1, Figs. 3 and 4, and to equations as (5). Number equations on the right in parentheses.

Summary—The summary should contain a statement of major conclusions reached, since summaries in many cases constitute the only source of information used in compiling scientific reference indexes. Abstracts printed in other journals, especially foreign, in most cases consist of summaries from published papers. The summary should explain as adequately as possible the major conclusions to a nonspecialist in the subject. The summary should contain from 100 to 300 words, depending on the length of the paper.

Publication of Paper

Disposition—All manuscripts should be addressed to the Institute of Radio Engineers, 33 West 39th Street, New York City. They will be examined by the Committee on Meetings and Papers and by the Editor. Authors are advised as promptly as possible of the action taken, usually within one month.

Proofs—Galley proof is sent to the author. Only necessary corrections in typography should be made. *No new material is to be added.* Corrected proofs should be returned *promptly* to the Institute of Radio Engineers, 33 West 39th Street, New York City.

Reprints—With the galley proof a reprint order form is sent to the author. Orders for reprints must be forwarded promptly as type is not held after publication.

INSTITUTE SECTIONS

<i>Chairmen</i>	<i>Secretaries</i>
	ATLANTA
H. F. Dobbs	Philip C. Bangs, 23 Kensington Rd., Avondale Estates, Ga.
	BOSTON
George W. Pierce	Melville Eastham, 30 State St., Cambridge, Mass.
	BUFFALO-NIAGARA
A. B. Chamberlain	E. C. Waud, 235 Huntington Ave., Buffalo, N. Y.
	CHICAGO
Byron B. Minnium	J. Barton Hoag, Ryerson Laboratory, University of Chicago, Chicago, Ill.
	CINCINNATI
D. D. Israel	Ralph P. Glover, Crosley Radio Corp., Cincinnati, Ohio.
	CLEVELAND
G. B. Hammon	P. A. Marsal, National Carbon Co., Inc., P.O. Box No. 400, Cleveland, Ohio
	CONNECTICUT VALLEY
R. S. Kruse	George Grammer, 52 S. Beacon St., Hartford, Conn.
	DETROIT
Lewis N. Holland	Samuel Firestone, Room 615, 2000 Second Ave., Detroit, Mich.
	LOS ANGELES
T. E. Nikirk	L. Elden Smith, 340 N. Painter Ave., Whittier, Calif.
	NEW ORLEANS
Pendleton E. Lehde	Anton A. Schiele, 1812 Masonic Temple, New Orleans, La.
	PHILADELPHIA
W. R. G. Baker	G. C. Blackwood, 243 E. Upsal St., Mt. Airy, Philadelphia, Pa.
	PITTSBURGH
L. A. Terven	C. F. Donbar, 233 South Starr Ave., Bellevue, Pa.
	ROCHESTER
Harry E. Gordon	Howard A. Brown, Rochester G. & E. Co., 89 East Ave., Rochester, N. Y.
	SAN FRANCISCO
Walter D. Kellogg	Paul R. Fenner Custom House, San Francisco, Calif.,
	SEATTLE
Abner R. Willson	L. C. Austin, Woolley and Co., Inc., 1113 Third Ave., Seattle, Wash.
	TORONTO
J. M. Leslie	R. A. Hackbusch, Stromberg Carlson Tel. Mfg. Co., 211 Geary Ave., Toronto, Ont., Canada
	WASHINGTON
L. P. Wheeler	Herbert G. Dorsey, U. S. Coast and Geodetic Survey. Washington, D. C.

GEOGRAPHICAL LOCATION OF MEMBERS ELECTED JANUARY 7, 1931

	Transferred to the Fellow grade	
New York	Larchmont, 3 Bay Ave.	Farrand, C. L.
	Transferred to the Member grade	
California	Palo Alto, 233 Mariposa Dr.	Shermund, R. C.
Ohio	Cincinnati, Crosley Radio Corp., Sound Dept.	Rockwell, R. J.
Wisconsin	South Milwaukee, 2401 S. Chicago Ave.	Wareing, H. F.
	Elected to the Member grade	
Indiana	Lafayette, 1815 Thompson St.	Stafford, J. W.
China	Hongkong, Radio Dept., P. W. D.	Gee, W. C.
	Elected to the Associate grade	
California	Arcadia, 920 S. Baldwin Ave.	Strachan, G. H.
	Azusa, R. R., Foothill Blvd.	Wright, Delmar
	Baldwin Park, 680 N. Bresee St., Rte 1.	Martin, O. F.
	Los Angeles, 1000 S. Broadway.	Hughes, E. N.
	Los Angeles, 1812 W. 38th St.	Montague, J. W.
	Los Angeles, 2437 Granville Ave.	Piersall, Bruce
	Los Angeles, 921 W. Sixth St.	Weatherford, R. V.
	Richmond, 1609 Penn Ave.	Watson, H. M.
	San Francisco, 150 Edinburgh St.	Barton, C. G.
	West Hollywood, 500 Huntley Dr.	Kruger, Leon
Colorado	Pueblo, 113 Broadway.	Coday, W. A., Jr.
Connecticut	New Haven, 10 Hillhouse Ave.	Heitman, C. E., Jr.
Dist. of Columbia	Washington, 1714 Pennsylvania Ave., N. W.	Asistores, E. M.
	Washington, c/o Bur. of Navigation, Navy Dept.	Groseclose, S. K.
	Washington, 1112 Connecticut Ave.	Havens, B. H.
	Washington, 4509 Illinois Ave., N. W.	Reymer, S. E.
	Washington, 1650 Harvard St., N. W.	Straughn, J. B.
Florida	Miami Beach, P.O. Box No. 102.	Dutton, Laurence E.
Georgia	Savannah, E. Bay St., Radiomarine Corp. of Am.	McCarty, S. L.
Illinois	Chicago, 6028 Kimbark Ave.	Kohler, E., Jr.
	Park Ridge, 914 W. Crescent Ave.	Van Nice, J. H.
Kansas	Arkansas City, c/o Kansas Gas & Elec. Co.	Sigler, F. M.
Kentucky	Middlesboro, P.O. Box No. 518.	Sharpe, M. O.
Louisiana	New Orleans, 6025 Coliseum St.	Courtenay, J. A.
Massachusetts	Boston 71 Joy St.	Baldwin, Frank
	Cambridge, 30 State St., c/o General Radio Co.	Karplus, Edward
	Stoneham, 63 Elm St.	O'Shea, C. J.
Michigan	Ann Arbor, 410 State St.	Hessel, John
	Ann Arbor, Univ. of Michigan, Physics Dept.	Misiek, William
	Charlotte, 443 S. Pleasant St.	Gay, P. S.
	Detroit, 1983 Hazelwood Ave.	Fox, David
	Detroit, 2019 Taylor Ave.	Reimer, Allen
	Detroit, Cass Technical High School.	Stormzand, H. A.
	Holland, R. 5, W. 32nd St.	Bloemendal, G. W.
Minnesota	Anoka, 303 Benton St.	Collier, G. X.
	St. Paul, 2164 Jefferson Ave.	Clark, D. L.
Missouri	Kansas City, 430 W. 13th St.	Craig, J. O.
	Kansas City, 312 W. 45th St.	Hayes, C. D.
	St. Louis, 3224 Lafayette Ave.	Mace, R. D.
Nevada	Reno, Jay Peters, Inc., c/o Radio Station KOH.	Kees, A. A.
New Hampshire	Claremont, 63 Mulberry St.	Lewis, E. E.
New Jersey	Audubon, 546 White Horse Pike.	Manwiller, W. G.
	Audubon, 736 White Horse Pike.	Rosenberg, A. L., Jr.
	Boonton, 212 William St.	Merrill, H. M.
	Brooklawn, 130 New Jersey Rd.	Uhlig, Erich
	Camden, RCA-Victor Co., Inc.	Barton, F. C.
	Camden, 1309 Haddon Ave.	Bond, P. R.
	Camden, RCA-Victor Co., c/o Eng. Prod. Div.	Enis, T. W.
	Camden, 2757 Constitution Rd.	Fitzsimons, Frank
	Camden, 2587 Baird Blvd.	McClung, C. A.
	Camden, 326 Penn St.	McKechnie, J. S.
	Camden, 624 Penn St.	Scott, F.
	Camden, Hotel Plaza, Room No. 404.	Swalm, G. W.
	Collingswood, 133 E. Palmer Ave.	Morlock, W. J.
	East Orange, 339 Main St.	Davenport, R. W.
	East Orange, 644 S. Clinton St.	Toth, Emerick
	Gloucester, 231 Greenwood Ave.	Epstein, D. W.
	Haddonfield, 212 Euclid Ave.	Aceto, Louie
	Haddonfield, 505 Avondale Ave.	Briekner, L. S.
	Haddonfield, 760 Mt. Vernon Ave.	Collins, F. J.

Geographical Location of Members Elected January 7, 1931

New Jersey(cont.)	Haddonfield, 505 Avondale Ave.....	McLamore, J. T.	
	Haddonfield, Kingsway Apts., Apt. 1-6.....	Osgood, H. F.	
	Haddonfield, 920 Mt. Vernon Ave.....	Stacy, J. D.	
	Haddonfield, 832 Princeton Ave.....	Stangert, J. C.	
	Haddon Heights, 304 Crest Ave.....	Watt, W. H.	
	Jersey City, 103 Jewett Ave.....	Lindauer, J. H.	
	Merchantville, 6359 Grant Ave.....	Billings, H. P.	
	Merchantville, 606 W. Maple Ave., Apt. E-1.....	Brooks, N. M.	
	Moorestown, Pleasant Valley Ave.....	Mapelsden, J. H.	
	Oaklyn, 3 Harding Ave.....	Schlichting, E. N.	
	Palmyra, 309 Melrose Ave.....	Austin, J. W.	
	Palmyra, 1203 Morgan Ave.....	Woodard, R. A.	
	Riverton, 301 Bank Ave.....	Conron, W. H.	
	Roseland, 15 Godfrey Ave.....	Tiffany, J. M.	
	Somers Point, 237 Sunny Ave.....	Shaw, H. R.	
	Ventnor, 19 S. Hillside Ave.....	Crawe, L. S.	
	Westmont, 17 Oriental Ave.....	Clark, E. L.	
	New York	Astoria, 2236—28th St.....	Gerlach, G. G.
		Ballston Lake, Box 145.....	Williamson R. H.
		Brooklyn, 127 Winthrop St.....	French, J. B.
		Kenmore, 244 Victoria Blvd.....	Fichtel, F. C.
		New York City, 711 Fifth Ave., Room No. 1545.....	Ashby, A. L.
		New York City, 140 West St., c/o N. Y. Tel. Co.....	Eldridge, H. W.
New York City, 755 West End Ave.....		Green, William	
New York City, 215 W. 23rd St.....		Johnston, T. F.	
New York City, 75 Varick St., c/o Radiomarine Corp. of Amer.....		Kotsum, J. H.	
New York City, 1803 Washington Ave.....		Robinson, J. M.	
New York City, 180 Varick St., c/o Bell Tel. Labs.....		Slade, Benjamin	
New York City, 2478 Elm Pl.....		Slater, F. L.	
New York City, 286 Ft. Washington Ave.....		Spitalny, Max	
New York City, 501 Fifth Ave., Corning Glass Works.....		Taubert, W. H.	
New York City, 1355 Morris Ave.....		Waterman, William	
Sayville, L. I., Mackay Radio Station.....		Eldredge, E. E.	
Schenectady, Gen. Elec. Co., Bldg. 37, Rm. No. 419.....		Rose, G. M., Jr.	
Schenectady, 4 Columbia St.....		Brown, G. M.	
Southampton, L. I., Mackay Radio & Tel. Co.....		Hayes, J. D.	
Utica, 906 Jefferson Ave.....		Edick, V. F.	
Ohio		Woodhaven, L. I., 8075-88 Rd.....	Harned, A. M.
		Cincinnati, 604 Straight St.....	Stewart, A. W.
		Columbus, 137 Goodale St.....	Roberts, Theldon
	Dayton, 340 W. First St.....	Apuli, J. A.	
	Dayton, 340 W. First St.....	Beer, R. M.	
	Dayton, 340 W. First St.....	Chipman, S. E.	
	Delaware, Perkins Observatory.....	Stetson, H. T.	
Pennsylvania	Elyria, P.O. Box No. 366.....	van der Woude, Fritz	
	Roseville, Potter Ave.....	Sagle, R. E.	
	East Lansdowne, 131 Beverly Rd.....	Wright, A. B.	
	East Pittsburgh, Westinghouse Elec. & Mfg. Co., Radio Operations Div.....	Smith, H. M.	
	Emporium.....	Hayward, J. B.	
	Lansdowne, 661 Rose St.....	Gildemeyer, F. H.	
	Philadelphia, 1613 N. 59th St.....	Brewster, Grant	
	Philadelphia, 5006 Rorer St.....	Cohen, Fred	
	Philadelphia, 5441 Montgomery Ave.....	Dutkin, Murray	
	Philadelphia, 3849 N. 18th St.....	Filderman, Joseph	
	Philadelphia, 6144 Wayne Ave.....	Geist, H. J.	
	Philadelphia, 314 W. Delphine St.....	Hills, J. M.	
	Philadelphia, 1642 N. 59th St.....	Hallister, K. R.	
	Philadelphia, 1405 Locust St., Gen. Elec. Co.....	Littlejohn, Sam	
	Philadelphia, 200 S. 33rd St.....	Mellwain, Knox	
	Philadelphia, 2024 E. Madison St.....	Miller, J. J.	
	Philadelphia, 6212 Chestnut St.....	Persons, E. N.	
Philadelphia, 325 E. Albanus St.....	Suckle, B. W.		
Philadelphia, 1405 Locust St., Gen. Elec. Co.....	Whitcotton, N. L.		
Philadelphia, 3510 Malta St.....	Youngblood, I. J.		
Shillington, 200 W. Lancaster Ave.....	Hornberger, J. E.		
South Carolina	Darlington, 133 S. Main St.....	Hope, R. S.	
	Johnson City, 1303 N. Roan St.....	Shamhart, P. B.	
Tennessee	Houston, 3901 Polk Ave.....	Wolf, R. C.	
	Waco, 1316 N. 11th St.....	DeJarnette, W. Y.	
Texas	Buenos Aires, San Fernando, Necochea 1396.....	del Pozo, Luis	
	Callawadda, Victoria, "Bryn Avon".....	Hutchings, A. T. E.	
Australia	Kogarah, New South Wales, 11 Ocean Ave.....	Bailey, E. G.	
	Montreal, Que., 2230 Old Orchard Ave.....	Desaulniers, R. R.	
Canada	Montreal, Que., The Loz Lodge.....	Downs, W. P.	
	Ottawa, Ont., 7 Fairburn Ave.....	Hayman, E. D.	
	Toronto, Ont., 64 High Park Ave.....	Plummer, C. A.	
England	Chelmsford, Marconi's Wireless Tel. Co., Ltd.....	Lea, Norman	
	Churston Ferrers, S. Devon, Broadsands House.....	Wortley-Talbot, J. R.	
	Leeds, 56, Accommodation Rd.....	Wood, Eric	

Geographical Location of Members Elected January 7, 1931

England (cont.)	London, E. C. 1, Alden House, Radio Section, Eng. in •Chief's Office.....	Beer, H. G.
	London, S. W. 12, Balham, 13a Cambray Rd.....	Miller, R. F. E.
	London, E 7, Forest Gate, 308, Katherine Rd.....	Bennington, T. W.
	London, N 4, Harringay, 50 Roseberry Gardens.....	Charman, F. J. H.
	Porth, Cornwall, St. Columb Minor, Porth House.....	Powditch, H. J.
	Stockport, 540 Hempshaw Lane.....	Jones, Ernest
	Wallasey, Cheshire, 34, Oarside Dr.....	Cleator, P. E.
	Warlingham, Surrey, Doone Cottage.....	Jordan, J. R.
India	Lahore, 81, The Mall.....	Silver, B. J.
Italy	Rome, 6-Piazza Belle Arti.....	Ruspoli, Don Edmondo
Japan	Kohnan-Kotogakko, nr. Kobe, c/o Dept. of Physics.....	Nishida, S.
	Kohnan-Kotogakko, nr. Kobe, c/o Dept. of Physics.....	Shoda, M.
New Zealand	Otahuhu, Auckland, No. 1 Seddon Terrace.....	Anderson, A. D.
	Wanganui, 11 Victoria Ave.....	Robinson, R. R.
Portugal	Lisbon, Rua das Amoreiras, 50 r/c E.....	Borges, F. B.
South Wales	Cardigan, Penpark, "Glen-Moor".....	Thomas, Griff
West Indies	Barbados, Bank Hall Rd., "Verona".....	Archer, T. A.

Elected to the Junior grade

Dist. of Columbia	Washington, 1538—17th St., N. W.....	Rector, E. W.
Illinois	Chicago, 2053 Howe St.....	Stadler, Robert
Missouri	St. Louis, 5831 DeGiverville Ave.....	Lauman, L. F., Jr.
Nebraska	Scottsbluff.....	Kluge, M. E.
New York	New York City, 1697 Broadway, WMCA.....	Marx, Frank
Ohio	Cincinnati, 118 Hereford Court.....	Foster, J. D.
	Cincinnati, 254 Melish Ave.....	Marshall, C. J.
	Cleveland, 3682 E. 61st St.....	Gorecki, J. M.
Virginia	Danville, Danville Military Institute.....	Boland, J. N.
Canada	Toronto 3, Ont., 20 Virtue St.....	Amos, W. G.



APPLICATIONS FOR MEMBERSHIP

Applications for transfer or election to the various grades of membership have been received from the persons listed below, and have been approved by the Committee on Admissions. Members objecting to transfer or election of any of these applicants should communicate with the Secretary on or before February 28, 1931. These applicants will be considered by the Board of Direction at its March 4th meeting.

For Transfer to the Member grade

New Jersey	Red Bank, Box 97.....	Mutch, W. W.
New York	Rochester, 63 Sonora Parkway.....	Long, John J., Jr.
	West New Brighton, S. I., 102 Bard Ave.....	Dinsdale, A.
South Africa	Durban, Studio Town Hall, African Broadcasting Co....	Cumming, Noel Douglas

For Election to the Member grade

New York	New York, 75 Varick St.....	Manley, Lee L.
	New York, 463 West St.....	Strieby, Maurice E.
Washington	Seattle, 3910 Densmore Ave.....	Wiltse, George V.
England	Somerset, Portishead, Redcliffe Bay, Hillcrest Rd.....	Wilson, Frank
Poland	Warsaw, Grazyzny 7.....	Groszkowski, J.

For Election to the Associate grade

California	Hollywood, 1006 N. Spaulding Ave.....	Holden, Dale S.
	Los Angeles, 4583 Ellenwood Drive.....	Currie, Burton A.
	Pasadena, 935 Palm Terrace.....	Moore, Robert M.
	San Francisco, 311 California St., Dollar SS Co.....	Bender, John A.
	San Pedro, Box 10, U.S.S. Saratoga.....	Brown, L. D.
	Wilmington, 111 East "N" St.....	Blank, S. A.
Connecticut	Elmwood, 221 South St.....	Batthey, E. L.
Dist. of Columbia	Washington, 316 Todd Pl., N. E.....	Bertonis, Peter W.
	Washington, Navy Dept.....	Dugan, Paul F.
	Washington, 6701-6th St., N. W.....	Holt, Laurence J.
	Washington, 4509 Illinois Ave., N. W.....	Reymer, Stephen E.
Georgia	Hapeville, P. O. Box #1.....	Shuman, Geo. W., Jr.
Illinois	Chicago, 9705 Cottage Grove Ave.....	Arnold, R. M.
	Chicago, 4209 N. Albany Ave.....	Cerman, Herman A.
	Chicago, 3802 Ellis Ave.....	Chan, G. S.
	Chicago, 400 W. Madison, The Chicago Daily News.....	Hathaway, Kenneth A.
	Chicago, 3350 N. Halsted St.....	Kester, Arthur S.
	Chicago, 5901 Race Ave.....	Sherk, Lynn E.
	Chicago, 100 West Monroe St.....	Willet, G. Rush
	Elgin, 121 Vine St.....	Meyers, Carl J.
	Elmhurst, 206 E. Grantley Ave.....	Kennedy, Edward J.
	Peoria, 1008 Eiler Ave.....	Janssen, John F.
Indiana	Evansville, 10 S. E. 7th St., Smith Radio Corp.....	Rowland, Stirman
	Valparaiso, 822 E. Institute St.....	Miller, Emmert C.
Kansas	Iola, 219 South Buckeye.....	Major, A. R.
Kentucky	Owensboro, 411 W. 13th St.....	Bain, George W.
	Owensboro, 106 W. Eight St.....	Waugh, George T.
Louisiana	New Orleans, 321 St., Charles St., Tropical Radio.....	Williams, L. P.
Maine	Bangor, 16 N. Park St.....	Webb, Harold S.
Maryland	Annapolis, Postgraduate School, U.S.N.A.....	Cogswell, W. P.
	Annapolis, Postgraduate School, Naval Academy.....	Levasseur, J. T.
	Baltimore, 121 S. Gay St.....	Petersen, F. T.
Massachusetts	Arlington, 41 Milton St.....	Benham, Harold J.
	Boston, 536 Statler Bldg., R. C. A. Photophone, Inc.....	Cox, Wallace
	Cambridge, Harvard University, Cruft Laboratory.....	Foley, Joseph H.
	Cambridge, Harvard University, Cruft Laboratory.....	Ragan, Thomas C.
	Franklin, Pleasant St.....	Miller, O. F., Jr.
	Hyde Park, 19 Summer St.....	Rosignol, Thomas
	Newton Centre, 142 Jackson St.....	Gorman, Walter R.
	Salem, 18 New Derby St.....	LeBlanc, William A.
	Springfield, 35 Long Hill St.....	Letellier, Roy T. L.
	Taunton, 49 Broadway.....	Tracy, John B., Jr.
Michigan	Detroit, c/o Superintendent of Lighthouses.....	Richie, S. M.
	Detroit, 1984 Taylor.....	Stanfield, Lionel J.
	Detroit, 3490 Lincoln Ave.....	Truesdale, James R.
	Detroit, 5736 Field Ave.....	Wendler, Edward A.
	Manistee, 605 Maple St.....	Halliday, L. R.
	Mt. Clemens, 105 Grand Ave.....	Sonnenberg, John H.
Mississippi	Biloxi, 210½ Keller Ave.....	Manuel, John G.
Missouri	Kansas City, 4235 Holmes St.....	Dodds, Leonard F.
Montana	Butte, Radio Station KGIR.....	Craney, E. B.

Applications for Membership

New Jersey	Audubon, 510 Cuthbert Rd.	Currier, Stuart E.	
	Camden, 1062 Everett St.	Kerniect, Leon S.	
	Camden, 222 North Second St.	Mac Millan, William T.	
	Camden, R.C.A.-Victor Co., Engineering Dept.	Norton, William B.	
	Camden, R.C.A.-Victor Co., Building 6	Williams, A. F.	
	Collingswood, 100 Haddon Ave.	Baldwin, Charles F.	
	Collingswood, 403 Comly Ave.	Knight, Robert W.	
	Delanco, 209 Vine St.	Thaidigsman, J. H.	
	Glen Ridge, 16 Midland Ave.	Menut, George H.	
	Gloucester, 623 Hunter St.	Landgraf, Harry S.	
	Haddonfield, 604 Avondale Ave.	Mickel, Harry F.	
	Haddon Heights, 414 Ninth Ave.	Flaherty, Mark	
	Harrison, R.C.A.-Radiotron Co., Inc. Dev. Lab.	Orth, R. T.	
	Merchantville, 606 West Maple Ave., Apt. E-2.	Taylor, D. A.	
	Merchantville, 4723 Lafayette Ave.	West, Kenneth A.	
	Newark, 705 Ridge St.	Duvall, F. B.	
	Oaklyn, 165 Kendall Blvd.	Neal, George F.	
	Red Bank, Box 97.	Ring, Douglas H.	
	Stratford, Princeton Ave.	Gardiner, A. N.	
	New York	Westville, 325 Highland Ave.	Chew, Stephen A.
Brooklyn, 208 Barbey St.		Nixon, George M.	
Brooklyn, 365 E. 16th St. Sir Henry Hotel.		Petersen, Carl O.	
Brooklyn, 3921 Seventh Ave.		Prigge, John, Jr.	
Buffalo, No. 404 Hickory St.		Silvermans, Sidney	
Harrison, RCA Radiotron Corp., Dev. Lab.		Kauzmann, A. P.	
Jamaica, L. I., Central Queens, Y.M.C.A.		Read, Oswald W.	
New York, 790 Riverside Drive, Apt. 1K.		Core, Christopher W.	
New York, 490 E. 189th St.		Duggan, Jack	
New York, International Comm. Labs., 67 Broad St.		Garceau, E. L.	
New York, Bell Tel. Labs., 463 West St.		Jameson, Malcolm	
New York, Bell Tel. Labs., 180 Varick St.		Levin, Samuel A.	
New York, Bell Tel. Labs., 463 West St.		Moore, George E.	
New York, 210 Sixth Ave.		Tinus, William C.	
New York, Columbia Broadcasting Co. 485 Madison.		Vanderhoeven, R. M. P.	
New York, 17 Battery Pl. c/o J. H. Winchester.		Walker G.	
New York, 304 West 34th St.		Wright, W. S.	
Richmond Hill, L. I., 8427-105 St.		Jacobs, Frank	
Ohio		Rochester, 33 Erion Crescent.	Bullis, Ormond F.
		Rochester, 287 Genesee Park Blvd.	Gardner, Kenneth J.
	Rochester, 413 Lexington Ave.	Marsh, Albert H.	
	Schenectady, 947 Maple Ave.	Becker, Stewart	
	Syracuse, 253 Roosevelt Ave.	Mullin, LeRoy A.	
	Utica, 1119 Taylor Ave.	Allen, Raymond H.	
	Cincinnati, 2953 Coleraine Ave.	Chamberlain, Paul	
	Cincinnati, 2131 Kindie Ave.	Ginandt, George, Jr.	
	Cincinnati, 3302 Coleraine Ave.	Macy, Fred E.	
	Dayton, 2212 Wayne Ave.	Byrd, Nevin C.	
Oklahoma	Norman, 227 East Main St.	Bettis, Lloyd D.	
	Oregon	Medford, 721 Alder St.	Walker, Verl G.
Portland, 5350-70 Ave.		Tonn, Alfonso H.	
Pennsylvania	East Pittsburgh, Westinghouse Elec. & Mg. Co.	Swedlund, L. E.	
	Lima, Delaware Co.	Wolf, Donald G.	
	Philadelphia, 3453 N. Sydenham St.	Goodwin, Winfield	
	Philadelphia, 3048 "D" St.	Ingham, James, Jr.	
	Philadelphia, 3800 Archer St.	Kurdziel, John F.	
	Philadelphia, 6483 Malvern Ave.	Packard, Charles A.	
	Philadelphia, 645 N. 39th St.	Rose, William A.	
	Philadelphia, 210 N. 33rd St.	Ruelius, Louis Franz	
	Philadelphia, 2019 N. Broad.	Stelzer, Alphonse C.	
	Pittsburgh, 327 Craft Ave.	Palmer, Harris C.	
Rhode Island	Wayne, R.F.D. No. 1.	Skerrett, W. H. W.	
	Providence, 92 Keene St.	Kraus, Charles N.	
Texas	Providence, 242 Rugby St.	Perron, Raymond T.	
	Brownsville, P.O. Box 318.	Crosas, Ernesto G.	
Utah	Dallas, 2214 Pine St.	Hulse, Daniel O.	
	Salt Lake City, c/o Radio Station (Airway).	Waterman, Edward C.	
Virginia	Alexandria, 815 Prince St.	Bailey, W. B.	
	Norfolk, 222 Brewer St. Radiomarine Corp. of America.	Cain, O. J.	
Washington	Quantico, 87th Co., Signal Bn.	Macy, Spencer A.	
	Quantico, 87th Co., Singal Bn.	Stachura, Edward J.	
	Edmonds,	Leyda, G. D.	
	Raymond, Box 992.	Wills, James E.	
	Seattle, 1423-32nd Ave.	Frazier, R. K.	
	Seattle, 5280-45th S. W.	Neelands, F. J.	
Wisconsin	Seattle, 617-28th Ave., No.	Pinkman, Herbert N.	
	Seattle, 3937 Whitman Ave.	Wilbon, Roy	
Argentina	Snohomish, 509 Pearl St.	Kester, C. O.	
	Milwaukee, 1905 No. Prospect Ave.	Halinton, Harry	
Australia	Buenos Aires, Defensa 143, Cia Internacional de Radio.	Toombs, R.	
	Victoria, Melbourne, 346 St. Kilda Rd.	Gronow, W. R.	
Belgium	Antwerp, 48, rue Quellins.	Weilert, Bertil	

APPLICATIONS FOR MEMBERSHIP

Applications for transfer or election to the various grades of membership have been received from the persons listed below, and have been approved by the Committee on Admissions. Members objecting to transfer or election of any of these applicants should communicate with the Secretary on or before February 28, 1931. These applicants will be considered by the Board of Direction at its March 4th meeting.

For Transfer to the Member grade

New Jersey	Red Bank, Box 97.....	Mutch, W. W.
New York	Rochester, 63 Sonora Parkway.....	Long, John J., Jr.
	West New Brighton, S. I., 102 Bard Ave.....	Dinsdale, A.
South Africa	Durban, Studio Town Hall, African Broadcasting Co.....	Cumming, Noel Douglas

For Election to the Member grade

New York	New York, 75 Varick St.....	Manley, Lee L.
	New York, 463 West St.....	Strieby, Maurice E.
Washington	Seattle, 3910 Densmore Ave.....	Wiltse, George V.
England	Somerset, Portishead, Redcliffe Bay, Hillcrest Rd.....	Wilson, Frank
Poland	Warsaw, Grazyzny 7.....	Groszkowski, J.

For Election to the Associate grade

California	Hollywood, 1006 N. Spaulding Ave.....	Holden, Dale S.
	Los Angeles, 4583 Ellenwood Drive.....	Currie, Burton A.
	Pasadena, 935 Palm Terrace.....	Moore, Robert M.
	San Francisco, 311 California St., Dollar SS Co.....	Bender, John A.
	San Pedro, Box 10, U.S.S. Saratoga.....	Brown, L. D.
	Wilmington, 111 East "N" St.....	Blank, S. A.
Connecticut	Elmwood, 221 South St.....	Battey, E. L.
Dist. of Columbia	Washington, 316 Todd Pl., N. E.....	Bertonis, Peter W.
	Washington, Navy Dept.....	Dugan, Paul F.
	Washington, 6701-6th St., N. W.....	Holt, Laurence J.
	Washington, 4509 Illinois Ave., N. W.....	Reymer, Stephen E.
Georgia	Hapeville, P. O. Box #1.....	Shuman, Geo. W., Jr.
Illinois	Chicago, 9705 Cottage Grove Ave.....	Arnold, R. M.
	Chicago, 4209 N. Albany Ave.....	Cerman, Herman A.
	Chicago, 3802 Ellis Ave.....	Chan, G. S.
	Chicago, 400 W. Madison, The Chicago Daily News.....	Hathaway, Kenneth A.
	Chicago, 3350 N. Halsted St.....	Kester, Arthur S.
	Chicago, 5901 Race Ave.....	Sherk, Lynn E.
	Chicago, 100 West Monroe St.....	Willett, G. Rush
	Elgin, 121 Vine St.....	Meyers, Carl J.
	Elmhurst, 206 E. Grantley Ave.....	Kennedy, Edward J.
	Peoria, 1008 Eiler Ave.....	Janssen, John F.
Indiana	Evansville, 10 S. E. 7th St., Smith Radio Corp.....	Rowland, Stirman
	Valparaiso, 822 E. Institute St.....	Miller, Emmert C.
Kansas	Iola, 219 South Buckeye.....	Major, A. R.
Kentucky	Owensboro, 411 W. 13th St.....	Bain, George W.
	Owensboro, 106 W. Eight St.....	Waugh, George T.
Louisiana	New Orleans, 321 St. Charles St., Tropical Radio.....	Williams, L. P.
Maine	Bangor, 16 N. Park St.....	Webb, Harold S.
Maryland	Annapolis, Postgraduate School, U.S.N.A.....	Cogswell, W. P.
	Annapolis, Postgraduate School, Naval Academy.....	Levasseur, J. T.
	Baltimore, 121 S. Gay St.....	Petersen, F. T.
Massachusetts	Arlington, 41 Milton St.....	Benham, Harold J.
	Boston, 536 Statler Bldg., R. C. A. Photophone, Inc.....	Cox, Wallace
	Cambridge, Harvard University, Cruft Laboratory.....	Foley, Joseph H.
	Cambridge, Harvard University, Cruft Laboratory.....	Ragan, Thomas C.
	Franklin, Pleasant St.....	Miller, O. F., Jr.
	Hyde Park, 19 Summer St.....	Rosignol, Thomas
	Newton Centre, 142 Jackson St.....	Gorman, Walter R.
	Salem, 18 New Derby St.....	LeBlanc, William A.
	Springfield, 35 Long Hill St.....	Letellier, Roy T. L.
	Taunton, 49 Broadway.....	Tracy, John B., Jr.
Michigan	Detroit, c/o Superintendent of Lighthouses.....	Richie, S. M.
	Detroit, 1984 Taylor.....	Stanfield, Lionel J.
	Detroit, 3490 Lincoln Ave.....	Truesdale, James R.
	Detroit, 5736 Field Ave.....	Wendler, Edward A.
	Manistee, 605 Maple St.....	Halliday, L. R.
	Mt. Clemens, 105 Grand Ave.....	Sonnenberg, John H.
Mississippi	Biloxi, 210½ Keller Ave.....	Manuel, John G.
Missouri	Kansas City, 4235 Holmes St.....	Dodds, Leonard F.
Montana	Butte, Radio Station KGIR.....	Craney, E. B.

Applications for Membership

New Jersey	Audubon, 510 Cuthbert Rd.	Currier, Stuart E.
	Camden, 1062 Everett St.	Kerniect, Leon S.
	Camden, 222 North Second St.	Mac Millan, William T.
	Camden, R.C.A.-Victor Co., Engineering Dept.	Norton, William B.
	Camden, R.C.A.-Victor Co., Building 6	Williams, A. F.
	Collingswood, 100 Haddon Ave.	Baldwin, Charles F.
	Collingswood, 403 Comly Ave.	Knight, Robert W.
	Delanco, 209 Vine St.	Thaidigsman, J. H.
	Glen Ridge, 16 Midland Ave.	Menut, George H.
	Gloucester, 623 Hunter St.	Landgraf, Harry S.
	Haddonfield, 604 Avondale Ave.	Mickel, Harry F.
	Haddon Heights, 414 Ninth Ave.	Flaherty, Mark
	Harrison, R.C.A.-Radiotron Co., Inc. Dev. Lab.	Orth, R. T.
	Merchantville, 606 West Maple Ave., Apt. E-2	Taylor, D. A.
	Merchantville, 4723 Lafayette Ave.	West, Kenneth A.
	Newark, 705 Ridge St.	Duvall, F. B.
	Oaklyn, 165 Kendall Blvd.	Neal, George F.
	Red Bank, Box 97.	Ring, Douglas H.
	Stratford, Princeton Ave.	Gardiner, A. N.
	Westville, 325 Highland Ave.	Chew, Stephen A.
New York	Brooklyn, 208 Barbey St.	Nixon, George M.
	Brooklyn, 365 E. 16th St. Sir Henry Hotel.	Petersen, Carl O.
	Brooklyn, 3921 Seventh Ave.	Prigge, John, Jr.
	Buffalo, No. 404 Hickory St.	Silvermans, Sidney
	Harrison, RCA Radiotron Corp., Dev. Lab.	Kauzmann, A. P.
	Jamaica, L. I., Central Queens, Y.M.C.A.	Read, Oswald W.
	New York, 790 Riverside Drive, Apt. 1K.	Core, Christopher W.
	New York, 490 E. 189th St.	Duggan, Jack
	New York, International Comm. Labs., 67 Broad St.	Garceau, E. L.
	New York, Bell Tel. Labs., 463 West St.	Jameson, Malcolm
	New York, Bell Tel. Labs., 180 Varick St.	Levin, Samuel A.
	New York, Bell Tel. Labs., 463 West St.	Moore, George E.
	New York, 210 Sixth Ave.	Tinus, William C.
	New York, Columbia Broadcasting Co. 485 Madison.	Vanderhoeven, R. M. P.
	New York, 17 Battery Pl. c/o J. H. Winchester.	Walker G.
	New York, 304 West 34th St.	Wright, W. S.
	Richmond Hill, L. I., 8427-105 St.	Jacobs, Frank
	Rochester, 33 Erion Crescent.	Bullis, Ormond F.
	Rochester, 287 Genesee Park Blvd.	Gardner, Kenneth J.
	Rochester, 413 Lexington Ave.	Marsh, Albert H.
Schenectady, 947 Maple Ave.	Becker, Stewart	
Syracuse, 253 Roosevelt Ave.	Mullin, LeRoy A.	
Utica, 1119 Taylor Ave.	Allen, Raymond H.	
Ohio	Cincinnati, 2953 Coleraine Ave.	Chamberlain, Paul
	Cincinnati, 2131 Kindle Ave.	Ginandt, George, Jr.
	Cincinnati, 3302 Coleraine Ave.	Macy, Fred E.
	Dayton, 2212 Wayne Ave.	Byrd, Nevin C.
Oklahoma	Norman, 227 East Main St.	Bettis, Lloyd D.
	Oregon	Medford, 721 Alder St.
Portland, 5350-70 Ave.		Tonn, Alfonso H.
Pennsylvania	East Pittsburgh, Westinghouse Elec. & Mg. Co.	Swedlund, L. E.
	Lima, Delaware Co.	Wolf, Donald G.
	Philadelphia, 3453 N. Sydenham St.	Goodwin, Winfield
	Philadelphia, 3048 "D" St.	Ingham, James, Jr.
	Philadelphia, 3800 Archer St.	Kurdziel, John F.
	Philadelphia, 6483 Malvern Ave.	Packard, Charles A.
	Philadelphia, 645 N. 39th St.	Rose, William A.
	Philadelphia, 210 N. 33rd St.	Ruelius, Louis Franz
	Philadelphia, 2019 N. Broad.	Stelzer, Alphonse C.
	Pittsburgh, 327 Craft Ave.	Palmer, Harris C.
	Wayne, R.F.D. No. 1.	Skerrett, W. H. W.
	Rhode Island	Providence, 92 Keene St.
Providence, 242 Rugby St.		Perron, Raymond T.
Texas	Brownsville, P.O. Box 318.	Crosas, Ernesto G.
	Dallas, 2214 Pine St.	Hulse, Daniel O.
Utah	Salt Lake City, c/o Radio Station (Airway).	Waterman, Edward C.
Virginia	Alexandria, 815 Prince St.	Bailey, W. B.
	Norfolk, 222 Brewer St. Radiomarine Corp. of America.	Cain, O. J.
Washington	Quantico, 87th Co., Signal Bn.	Macy, Spencer A.
	Quantico, 87th Co., Singal Bn.	Stachura, Edward J.
	Edmonds.	Leyda, G. D.
	Raymond, Box 992.	Wills, James E.
	Seattle, 1423-32nd Ave.	Frazier, R. K.
	Seattle, 5280-45th S. W.	Neelands, F. J.
	Seattle, 617-28th Ave., No.	Pinkman, Herbert N.
Seattle, 3937 Whitman Ave.	Wilbon, Roy	
Wisconsin	Snohomish, 509 Pearl St.	Kester, C. O.
	Milwaukee, 1905 No. Prospect Ave.	Halinton, Harry
Argentina	Buenos Aires, Defensa 143, Cia Internacional de Radio.	Toombs, R.
Australia	Victoria, Melbourne, 346 St. Kilda Rd.	Gronow, W. R.
Belgium	Antwerp, 48, rue Quellins.	Wellert, Bertil

Applications for Membership

Brazil	Sao Paulo, Praca Ramos de Azevedo 16, Western Electric Company of Brazil	Barzee, G. W.	
Canada	Kitchener, Ont., 28 Gordon Ave.	Tremain, Earnest L.	
	London, Ont., 336 Oakland Ave.	Kimble, Earle B.	
	Montreal, Que., 4912 Sherbrooke, W.	Robertson, W. G.	
	Montreal, Que., c/o Canadian Marconi Company, Mount Royal Factory,	Jaederholm, H. W.	
	Parkhill, Ont.	Penhale, A.	
	Toronto, Ont., 505-90 Carlton St.	Jacobs, G. Ansley	
	Winnipeg, Man., 65 Rorie St., c/o Northern Electric Co., Ltd.	Grimes, H. B.	
	Winnipeg, Man., Northern Electric Co., Ltd.	Miller, S. S.	
	Shanghai, 24 Hankow Rd., c/o N.Z. Kov, The Shun Pao	King, P. K.	
	Copenhagen, Classensgade 19 A	Bransland, G.	
England	Ascot, Berks., New Road, Linda Cottage	Taylor, A. S.	
	Bolton, Lancashire, 37 Stanley Rd.	Sheffield, Charles W.	
	Chelmsford, 3 Tudor Ave.	Gifford, K. H. B.	
	Chelmsford, 28 Van Diemens Road	Varley, W. C. E.	
	Farnborough, Hants., 30 Manor Road	Kirkinan, R. A.	
	Harefield, Middlesex, Pinner Rd. "Lynton"	Dockree, G. E.	
	Leigh-on-Sea, Essex, 42 Leigham Court Drive	Woodward, L. A.	
	London, W.C.1, BM/ZNOC	Conway, M. J.	
	London, W.7, 141 Clitherow Ave.	Hoar, Harold G.	
	London, Blackheath, 169 Old Dover Road	McLelland-Brown, G. F.	
	Purley, Surrey, 22 Station Approach	Forbes, F. D.	
	Seedley, Manchester, 12 Scales St.	Percival, W. R.	
	Sheffield, Essex, Priests Lane, "Elnido"	Young, A. M.	
	Wealdstone, Middlesex, Station Rd. No. 7 Flat	Loos, G. F.	
	Westerham, Kent, Tatsfield, B.B.C.	Partridge, J. A.	
	Federated Malay States	Lumpur, Kuala, Petaling Hill, Wireless Station	Oakes, W. G.
	France	Paris, 207 Bd. Raspail, Paris 6	Asche, R. E.
Paris, 66 Boulevard de la gare		Hummel, J. E.	
India	Paris, 1 Rue Octave, Fevillet	Klappenbach, W.	
	Saint-Cloud Seto, 52 Avenue Bernard Palissy	Higonnet, R. A.	
	Bangalore, Indian Institute of Science	Mohammed, A.	
Japan	Ahmedabad 1, Advance Mills Ltd.	Shroff, T. R.	
	Kawasaki, c/o The Tokyo Electric Co.	Kamio, K.	
	Kinutamura, nr. Tokyo, Japanese Broadcasting Co.	Mukai, T.	
	Kinutamura, nr. Tokyo, Japanese Broadcasting Co.	Suzuka, M.	
	Kinutamura, nr. Tokyo, Japanese Broadcasting Co.	Suzuka, T.	
	Kinutamura, nr. Tokyo, Nihon-Hosokyokai, Gijutsuken-kyujo	Takamura, S.	
	Kinutamura, nr. Tokyo, Japanese Broadcasting Co.	Yokoyama, H.	
New Zealand	Siba, Tokyo, c/o Teisin-Kanri-Renshujo-Musen	Takase, J. Yosiaki	
	Tokyo, Waseda University, Elec. Eng. Department	Iwakata, H.	
	Ashburton, 74 Wills St.	Buchanan, D. W.	
	Christchurch, 204 Salisbury St.	Hurrell, L. W.	
Peru	Masterton, 35 Queen St.	Ansell, W. D.	
	Lima, c/o All American Cables	Pedersen, A. A.	
Port. E. Africa	Talara, S/S Incalite, c/o Inter. Petroleum Co.	Hampton, S. G. A.	
South Africa	Lourenco Marques, Post Office	Gordinho, T. J.	
	Johannesburg, Transvaal, 23 York St.	Levington, Abie	

For Election to the Junior grade

Indiana	Oakland City, 414 W. Columbia St.	Harper, Everett L.
Iowa	Ames, 2644 Lincoln Way	Andersen, Donald E.
Kansas	Manhattan, 731 Humboldt St.	Allen, John H.
Massachusetts	Boston, M.I.T. Dormitories	Jacobson, J.
Minnesota	Moorhead, Concordia College	Distad, M.
Nebraska	Lincoln, c/o Nebraska Wesleyan University	Jensen, R. R.
New York	Brooklyn, 456-7th St.	Simmons, R. A., Jr.
	New Rochelle, 261 Sickles Ave.	Wilson, R. F.
	New York, 230 W. 107th St.	Garner, Melvin E.
	New York, Bell Tel. Labs., 463 West St.	Kobliha, F. E.
	New York, 1127 Sheridan Ave.	Samuelson, C. D.
Pennsylvania	New York, 251 W. 102nd St.	von Doenhoff, A. E.
	Rochester, 341 Farmington Rd.	Anderson, Roy S.
	Duquesne, 312 Viola Ave.	Murcek, S. J.
	Philadelphia, 801 S. St. Bernard St.	Ludwig, C. S., Jr.



OFFICERS AND BOARD OF DIRECTION, 1931

(Terms expire January 1, 1932, except as otherwise noted)

President

RAY H. MANSON

Vice-President

C. P. EDWARDS

Treasurer

MELVILLE EASTHAM

Secretary

HAROLD P. WESTMAN

Editor

ALFRED N. GOLDSMITH

Managers

(Serving until February 1, 1931)

J. H. DELLINGER

L. M. HULL

A. F. VAN DYCK

R. A. HEISING

RAY H. MANSON

(Serving until January 1, 1932)

C. M. JANSKY, JR.

ARTHUR BATCHELLER

(Serving until January 1, 1933)

J. V. L. HOGAN

R. H. MARRIOTT

Junior Past Presidents

A. HOYT TAYLOR

LEE DE FOREST

Board of Editors

ALFRED N. GOLDSMITH, *Chairman*

STUART BALLANTINE

G. W. PICKARD

RALPH BATCHER

L. E. WHITEMORE

J. W. HORTON

W. WILSON







E. LEON CHAFFEE
Vice President of the Institute, 1922

Emory Leon Chaffee was born in Somerville, Massachusetts, on April 15, 1885. After attending the four-year course in electrical engineering at the Massachusetts Institute of Technology he received his S.B. degree in 1907. He then attended the Graduate School of Arts and Sciences at Harvard University studying physics and obtaining an M.A. in 1908 and a Ph.D. in 1911. His doctor's thesis covered a new method of producing continuous oscillations by means of what is now known as the Chaffee gap. This method was successfully used for radiotelephone transmission over a distance of thirty-five to fifty miles in 1910 and 1911.

Dr. Chaffee became an instructor in the Department of Physics at Harvard University in 1913, instructing in electrical engineering during 1914. He became assistant professor of physics in 1917, associate professor of physics in 1923, and professor of physics in 1926. He has specialized in the field of test measurements, radio communication, and vacuum tubes. He has taught many courses at Radcliffe College since 1913 and is in charge of the Physics Department of that school.

His research work in the field of electric oscillations and vacuum tubes has resulted in the publication of many papers in the PROCEEDINGS and other periodicals. For six or seven years he has continued research on the eye in which the potentials produced by the nerves in the retina when stimulated by light were recorded by an amplifier system. In collaboration with Miss Charlotte Perry he has just completed an accurate direct determination of the physical constant e/m (ratio of the charge to the mass of an electron).

He has carried on a consulting practice and has given expert testimony in patent suits.

Dr. Chaffee is a Fellow of the American Academy of Arts and Sciences and of the American Physical Society, a Member of the American Association for the Advancement of Science, the Optical Society, Executive Committee of the International Scientific Radio Union, and Chairman of the Committee on Radio Physics of the International Union. He became a Member of the Institute in 1917 transferring to the grade of Fellow in 1921. He is a member of the Committee on Standardization and the Technical Committee on Vacuum Tubes.

INSTITUTE NEWS AND RADIO NOTES

Meetings of the Board of Direction

A special meeting of the Board of Direction of the Institute was held at the office of the Institute on December 17, 1930, the following being in attendance: Alfred N. Goldsmith, acting chairman; Arthur Batcheller, R. A. Heising, C. M. Jansky, Jr., R. H. Marriott, A. F. Van Dyck, and Harold P. Westman, secretary.

The meeting was devoted entirely to a discussion of a number of basic questions brought out by the Committee on Constitution and Laws in its proposed revision of the constitution.

At the January 7, 1931, meeting of the Board of Direction, the following were in attendance: Alfred N. Goldsmith, acting chairman; R. H. Manson, president elect; C. P. Edwards, vice president elect; Melville Eastham, treasurer; J. H. Dellinger, J. V. L. Hogan, L. M. Hull, C. M. Jansky, Jr., R. H. Marriott, A. F. Van Dyck, and Harold P. Westman, secretary.

The report of the Committee on Tellers covering the votes cast for the offices of president and vice president was accepted and R. H. Manson declared elected president for 1931 and C. P. Edwards declared elected vice president for 1931.

Radio Transmissions of Standard Frequency, February to June, 1931

The Bureau of Standards announces a new and improved service of radio standard frequency transmissions. This service may be used by broadcast and other stations in adjusting their transmitters to exact frequency, and by the public in calibrating frequency standards and transmitting and receiving apparatus. The signals are transmitted from the Bureau's station WWV, Washington, D.C. They can be heard and utilized by stations equipped for continuous-wave reception at distances up to about 1000 miles from Washington, and some of them at all points in the United States. This improved service is a step in the Bureau's program to provide eventually standard frequencies available at all times and at every place in the country.

Besides the usual monthly transmissions of specific frequencies, the Bureau will add another type of transmission which will be much more accurate than any previous transmissions by the Bureau. This transmission will be by continuous-wave radio telegraphy on a frequency of 5000 kc, and will consist primarily of a series of very long dashes. The first five minutes of this transmission will consist of the general call (CQ de WWV) and announcement of the frequency. The frequency

and the call letters of the station (WWV) will be given every ten minutes thereafter.

Besides this service, the Bureau will also continue the transmissions once a month on scheduled specific frequencies. These are also by continuous-wave radio telegraphy. A complete frequency transmission includes a "general call," "standard frequency signal," and "announcements." The general call is given at the beginning of each 12-minute period and continues for about 2 minutes. This includes a statement of the frequency. The standard frequency signal is a series of very long dashes with the call letters (WWV) intervening; this signal continues for about 4 minutes. The announcements follow, and contain a statement of the frequency being transmitted and of the next frequency to be transmitted. There is then a 4-minute interval while the transmitting set is adjusted for the next frequency.

Information on how to receive and utilize the signals is given in Bureau of Standards Letter Circular No. 280, which may be obtained by applying to the Bureau of Standards, Washington, D.C. Even though only a few frequencies are received (or even only a single one), persons can obtain as complete a frequency meter calibration as desired by the method of generator harmonics.

The 5000-kilocycle transmissions are from a transmitter of 150 watts power, which may be increased to 1 kilowatt early in the year; they occur every Tuesday except in those weeks in which the monthly transmissions are given. The monthly transmissions are from a transmitter of 1/2 to 1 kilowatt power; they are given on the 20th of every month (with one exception).

5000-Kilocycle Transmissions 1:30 to 3:30, and 8:00 to 10:00, P.M., Eastern Standard Time.					
Feb.	March	April	May	June	
3	3	7	5	2	
10	10	14	12	9	
24	24	28	26	16	
	31			30	

Monthly Transmissions, Eastern Standard Time					
Time	Feb. 20	March 20	April 20	May 20	June 22
10:00 P.M.	4000	550	1600	4000	550
10:12	4400	600	1800	4400	600
10:24	4800	700	2000	4800	700
10:36	5200	800	2400	5200	800
10:48	5800	1000	2800	5800	1000
11:00	6400	1200	3200	6400	1200
11:12	7000	1400	3600	7000	1400
11:24	7600	1500	4000	7600	1500

The frequencies in the 5000-kilocycle transmission are piezo controlled, and are accurate to a few parts in a million. The frequencies in the monthly transmissions are manually controlled, and are accurate to a few parts in a hundred thousand.

In November, 1930, field intensity measurements were made of the 5000-kilocycle transmissions from (WWV) on 150 watts between Washington and Chicago. The daytime field intensity up to a distance of about 400 miles from Washington was about 100 microvolts per meter, with fading in the ratio 3 to 1. From this distance to Chicago the field intensity gradually decreased to about 10 microvolts per meter peak values with fading the same as above. The evening transmissions had a field intensity of about 200 microvolts per meter with fading similar to that in the daytime. Around 8 p.m. the received intensity was sometimes too low to measure. This happened at distances of from 75 to 150 miles from Washington.

The Bureau of Standards would like to have detailed information on the reception of the 5000-kilocycle transmission, and will appreciate receiving reports from any observers on their reception of these transmissions. Phenomena of particular interest are approximate field intensity, and fading (whether slow or rapid, and approximate time between peaks of signal intensity). The Bureau would also like to receive comments on whether or not the transmissions are satisfactory for purposes of frequency measurement or control. Reports on the reception of the transmissions should be addressed to Bureau of Standards, Washington, D.C.

Committee Work

COMMITTEE ON ADMISSIONS

A meeting of the Committee on Admissions was held at the office of the Institute at 9:30 A.M. on January 7th, the following being in attendance: R. A. Heising, chairman; C. N. Anderson, C. M. Jansky, Jr., George Lewis, E. R. Shute, and J. S. Smith.

Four of the six applications for transfer to the grade of Member were approved and five transfers were granted of the nine applications for admission to the grade of Member that were considered.

COMMITTEE ON TELLERS

A meeting of the Committee on Tellers was held at 10 A.M. on January 6th at the office of the Institute and was attended by W. G. H. Finch and Harold P. Westman, the entire committee.

STANDARDIZATION

TECHNICAL COMMITTEE ON RADIO RECEIVERS-IRE

A meeting of the Technical Committee on Radio Receivers was held at 10 A.M. on January 8th the following being in attendance: E. T.

Dickey, chairman; C. M. Burrill, Harry Diamond, Virgil M. Graham, F. X. Rettenmeyer, and B. Dudley, secretary.

SUBCOMMITTEE ON HIGH-FREQUENCY RECEIVERS

The Subcommittee on High-Frequency Receivers operating under the Technical Committee on Radio Receivers, I.R.E., met at 10 A.M. on December 18th at the office of the Institute, the following being in attendance: C. M. Burrill, chairman; H. L. Peterson (representing H. H. Beverage), F. A. Polkinghorn, Paul Watson, and B. Dudley, secretary.

TECHNICAL COMMITTEE ON RADIO RECEIVERS-ASA

Virgil M. Graham, chairman; E. T. Dickey, J. W. Fullmer (representing H. B. Smith), W. H. Murphy, Leslie Woods (representing W. M. Grimditch), and B. Dudley, secretary, attended a meeting of the Technical Committee on Radio Receivers operating under the Sectional Committee on Radio of the American Standards Association which was held at 9 A.M. on December 12th.

Institute Meetings

BUFFALO-NIAGARA SECTION

A meeting of the Buffalo-Niagara Section was held on the 23rd of December at Edmund Hayes Hall of the University of Buffalo, A. B. Chamberlain, presiding.

A. R. Barfield of the Rudolph Wurlitzer Manufacturing Company of North Tonawanda, N. Y., presented a paper on "Electric and Magnetic Design of Dynamic Loud-Speakers." A projector was used to present schematic diagrams, formulas, and experimental characteristic curves. The paper was discussed by Messrs. Hector and Huntsinger of the twenty-six members and guests in attendance.

The new Section constitution prepared by the Committee on Sections and approved by the Board of Direction was adopted unanimously.

CINCINNATI SECTION

The November 18, 1930, meeting of the Cincinnati Section was held at the Engineers' Club in Dayton, Ohio and presided over by Homer J. Loftis, vice chairman.

At the meeting which was preceded by an inspection trip through the General Motors Radio Corporation plant at Dayton, H. J. Nichols, chief engineer of the General Motors Radio Corporation, presented a paper on "Some Aspects of Development."

The speaker discussed at some length the various states or phases through which an invention passes. These were arbitrarily divided into the following periods:

1. Make the invention work somehow.
2. Make the invention work well.
3. Objective to make the invention work well and cheaply.
4. Objective to obtain ultimate or extraordinary development in a particular direction.

The usefulness of such a classification of the state of development was demonstrated in estimating the future possibilities of a device. The radio receiver and transmitter were analyzed in these respects.

The parts played in development by research, experimenting, analysis, synthesis, "cut-and-try," intuition, and guesswork were mentioned. All are valuable and modern development practice is a combination of them.

The meeting was attended by eighty-two members and guests.

The December meeting of the Cincinnati Section was held at the Cincinnati Chamber of Commerce on the 16th, R. H. Langley, chairman, presiding.

The annual election of Section officers was held at this meeting and the following declared elected: chairman, D. D. Israel; vice chairman, Homer J. Loftis; secretary-treasurer, Ralph P. Glover.

Mr. Glover, acting secretary-treasurer, reported that the membership of the Section had grown from sixty-two to one hundred and thirty-two members during the past twelve months. •

The paper of the evening was presented by Dr. Palmer H. Craig, consulting physicist. This paper "A System for Suppressing Hum by a New Filter Arrangement" covered the mathematical design and gave an example demonstrating the superiority of the results obtained by the new system compared with standard systems. The examples referred particularly to systems for use on radio receivers in connection with the 280-type rectifier tube. The system is based on the superposition of two currents, one of which has been given a phase-shift of approximately 180 degrees by means of a wave-filter. The use of the wave-filter principle permits this phase-shift to be obtained with circuit elements of reasonable dimensions and cost. A saving in cost over the now prevalent "brute-force" filter can be obtained, according to the speaker, with somewhat superior results.

The paper was discussed by Messrs. Austin, Barton, Israel, and Kilgour of the forty-four members in attendance.

CLEVELAND SECTION

The December 19th meeting of the Cleveland Section was held at the Case School of Applied Science, D. Shregardus, chairman, presiding.

At the annual election of the officers of the Section the following were named: For chairman, Professor G. B. Hammon; vice chairman G. B. Schneeberger; secretary-treasurer, P. A. Marsal.

A paper on the "Loftin-White Amplifier" was presented by Messrs. Burtch and Spencer of the Sterling Manufacturing Company and Mr. Kelley of the Loftin-White Laboratories.

The paper summarized the difficulties encountered in the production of a mantel type receiver embodying the Loftin and White amplifier. It was discussed by a number of the fifty-nine members and guests in attendance.

CONNECTICUT VALLEY SECTION

A meeting of the Connecticut Valley Section was held at the Garde Hotel, Hartford, on December 11, 1930.

Election of officers was held with the following results: chairman, R. S. Kruse; vice chairman, E. A. Laport; secretary-treasurer, George Grammer.

The paper of the evening was presented by E. A. Laport, section engineer, Installation Department, Westinghouse Electric and Manufacturing Company and covered the "Installation of a 50-kw Broadcast Station at Rome, Italy."

The difficulties encountered in transporting and setting up overseas a radio station of such magnitude were discussed together with the practical engineering problems involved. The paper was illustrated by projections of photographs taken by the author at various phases of the installation. Some interesting sidelights on European broadcasting, especially in Italy, were given and the discussion that followed the paper was participated in by many of the thirty-seven members and guests in attendance.

DETROIT SECTION

The November 21st meeting of the Detroit Section was held in the Detroit News Auditorium, L. N. Holland, presiding.

A paper by W. H. Nelson of the General Electric Company on "Super Power Broadcasting" was presented.

This paper covered operation of the experimental broadcast transmitter of the General Electric Company at Schenectady operating under the call letters of W2XAG. This was the first station to use 200 kilowatts of power in operation in the broadcast band.

Many difficulties attendant on such high power were discussed. Prevention of parasitic oscillations by means of a new nondissipative method and dynatron excitation controlled by a compensating network were covered.

Twelve phanotrons which are air-cooled hot-cathode mercury-vapor rectifier tubes supply 600 kilowatts of rectified power at 18,000 volts for the Class B power output stage which utilized six 100-kilowatt water-cooled triodes.

The paper was discussed by Messrs. Chase, Firestone, Holland and others of the one hundred and twenty-five members and guests at the meeting.

The new constitution approved by the Board of Direction of the Institute for adoption by sections was adopted and by-laws to be appended thereto were approved.

L. N. Holland, chairman, presided at the December 19th meeting of the Detroit Section held in the Detroit News Auditorium.

A paper on the "Manufacture of Oxide Cathode Tubes in Theory and Practice" was presented by John Hessel, research associate, Department of Engineering Research, University of Michigan.

The paper was a description of the processes of manufacture involved in producing modern radio receiving tubes and a discussion of the theories involved in these processes. The speaker traced the course of the various tube parts from the raw materials department through the many treatments and inspections and described the method of coating filaments and cathodes, the assembly, the exhaust, and aging processes and discussed the final test. The latter section of the paper was devoted to a discussion of the development of oxide coatings following their discovery by Wehnelt, and to a critical comparison of the theories of emission proposed by Becker, Lowry, and Rieman, and Murgoci.

The discussion which followed was entered into by a number of the sixty-five members and guests in attendance.

The first series of questions from the "Question Box" were answered by some of the members present and a home-recording type of radio receiver was on display at the meeting.

LOS ANGELES SECTION

The December 15th meeting of the Los Angeles Section was held at the Rosslyn Hotel in Los Angeles, T. C. Bowles, chairman, presiding.

A paper on "The new 50-kilowatt Western Electric Broadcast Equipment" was presented by E. H. Schreiber of the Southern California Telephone Company.

Following the presentation of this paper, Bernard H. Linden, Supervisor of Radio for the 6th District described the Department of Commerce Standard Frequency Station now being installed at San Pedro California.

At the annual election of officers the following were elected for 1931: chairman, T. E. Nikirk; vice-chairman, K. G. Ormiston; and secretary-treasurer, L. Elden Smith.

The meeting was attended by fifty-eight members and guests.

NEW YORK MEETING

At the January 7th meeting of the Institute a paper on "Radio Tracking of Meteorological Balloons" was presented by Major William R. Blair and Harold M. Lewis of the Signal Corps, Fort Monmouth, and Hazeltine Service Laboratories, respectively.

It was illustrated by slides and included a demonstration of the direction finding equipment employed and is summarized as follows:

There is a need for upper air meteorological observation at night as well as in the daytime, in cloudy and in foggy weather as well as in clear. This need has given rise to a number of interesting methods of obtaining these data, among them radio tracking of meteorological balloons. A free balloon moves in the air current prevailing at the level it occupies. A small rubber balloon, six inches or less in diameter, when inflated with hydrogen to a given excess lift will rise at a given ascensional rate to great heights. Successive determinations of the position of one of these pilot balloons provides ready means for computing the mean direction and speed of the wind in the layer of air through which the balloon has risen during the interval between determinations of position. On clear days these balloons have been followed by visual methods to heights of 20 miles.

This paper deals with a radio method of determining successive balloon positions. A light transmitter, weighing about a pound, is carried up by the balloon at a known ascensional rate. Loop receivers are employed in ranging for this transmitter. The whole project involves the determination of air temperature aloft as well as air movement but the work on it so far has been limited to the development of equipment needed for the observation of wind, direction, and speed. Positions are usually determined at minute intervals. Tables and equipment employed in the reduction of data are made to fit this interval.

The attendance at the meeting totaled two hundred.

PITTSBURGH SECTION

A meeting of the Pittsburgh Section was held at Utility Hall in Pittsburgh on December 30, 1930. The presiding officer was vice chairman J. G. Allen. A paper on "Manual and Automatic Volume Controls for Broadcast Receivers" was presented by C. Williamson of the Physics Department of the Carnegie Institute of Technology.

Mr. Williamson in his paper discussed the advantages and disadvantages of a number of manual volume controls among them being filament and heater temperature control, grid bias control, antenna and ground shunt control, loud-speaker shunt control, audio transformer, variable resistor, and potentiometer secondary shunt control, radio-frequency screen-grid voltage control, and a capacity bridge volume control which operates on the a-c signal input to the receiver. A demonstration of automatic volume control as incorporated in two standard broadcast receivers was given and the circuit arrangements and operation of each explained. An extensive discussion of distortion, side modulation, and cross-talk illustrated by blackboard diagrams was given.

The discussion of the paper which ensued was entered into by many of the thirty-five members and guests in attendance.

It was with regret that the resignation of the chairman of the Pittsburgh Section was accepted from A. J. Buzzard due to his inability in finding the necessary time to continue this work. L. A. Terven was chosen to fill the unexpired term of Mr. Buzzard by the Executive Committee.

ROCHESTER SECTION

The December 11th meeting of the Rochester Section was held at the Sagamore Hotel in Rochester, R. T. Soule, presiding.

A paper by Alvin L. Powell, Manager, Eastern Division, Nela Park Engineering Department, General Electric Company on "Illumination" was presented. Mr. Powell declared the levels of illumination, meaning the amount of light being supplied through different units, have been gradually going up and will continue to rise. Standards of artificial lighting are still far below the levels of daylight. Glare is sometimes mistaken for lighting.

Lighting requirements of homes are not so exacting as in public buildings but that it is almost impossible for human beings to live entirely under colored lights was pointed out as the reason for not employing too much color in home lighting. It is better to use slight variations in tints, employing tints for decorative purposes and bringing out numerous objects in novel and interesting relief through intelligent direction of lights.

Gaseous tubes are coming much into use in commercial and advertising lighting with the neon tubes supplying the colors. Architects are giving more attention to the requirements of the interiors to be served and fixtures are being made to harmonize with architectural designs.

The extension of the light spectrum to make use of the new ultra-violet in the offices, schools, gymnasiums, greenhouses, etc., was pre-

dicted. The paper was illustrated with colored slides showing modern use of lighting in hotels, homes, apartments, office buildings, merchandise display, advertising signs, industrial plants, streets, golf courses, night baseball, and other sport events.

The attendance at the meeting totaled one hundred and six.

SAN FRANCISCO SECTION

A meeting of the San Francisco Section was held on December 17th at the Pig'n Whistle Restaurant, Walter D. Kellogg, chairman, presiding.

A paper on "Some Notes on the Practical Aspects of Vacuum Tube Design" was presented by Charles V. Litton of the Federal Telegraph Company. Mr. Litton classified the various types of glass envelopes and seals which were employed for them. In concluding he described an instrument for determining the best type of oxide-coated filament. The general discussion which followed the presentation of the paper was participated in by many of the sixty-nine members and guests in attendance, a large number of whom inspected some samples of seals used in present day tubes and also parts of a 20-kilowatt tube.

SEATTLE SECTION

At the December 19th meeting of the Seattle Section held at the University of Washington, Austin V. Eastman, presiding, the annual election of officers was held with the following results: chairman, Abner R. Willson; vice chairman, Nick H. Foster; secretary-treasurer, L. C. Austin.

A paper on the "Short-Wave Experimental Station WGY" was presented by P. A. Jacobson who described the experimental apparatus and control methods used at South Schenectady. The paper was illustrated by lantern slide diagrams and photographs of apparatus and the grounds about the station.

Thirty-nine members and guests were in attendance.

•

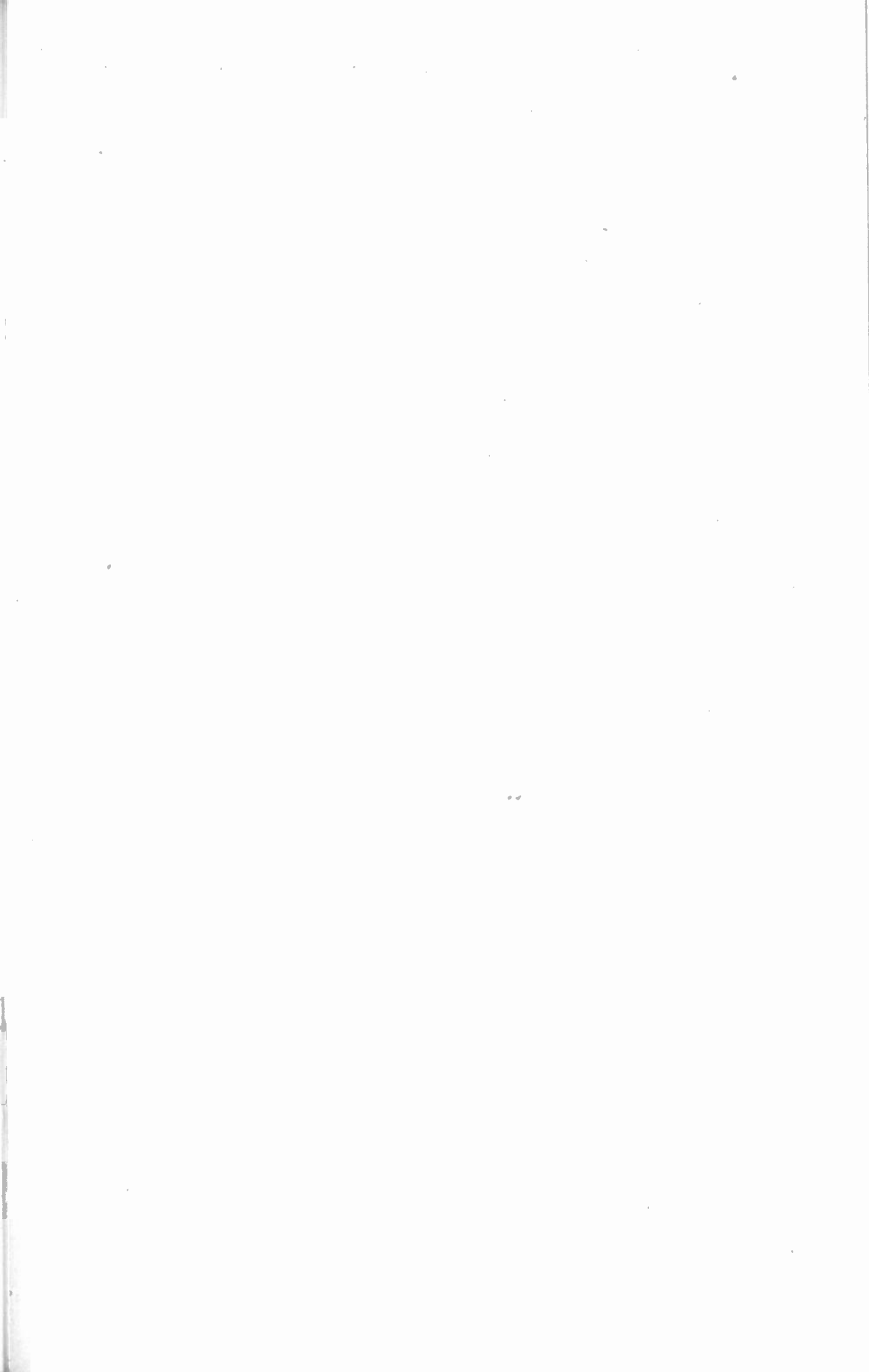



ADDRESS OF THE RETIRING PRESIDENT

DR. LEE DE FOREST

MEMBERS of the Institute of Radio Engineers: In turning over to my esteemed successor the office of President of the Institute, I wish to take this opportunity to express to all my fellow officials, members of the Board of Direction, and to the numerous Committee members who have labored so devotedly and wisely in the interests of this fine organization, my most sincere and appreciative thanks.

From my close personal associations with many and from the insight into the tireless activities of others in our behalf during the past year, I am better qualified than heretofore to appreciate what is the measure of indebtedness which the entire membership of the Institute owes to these gentlemen who are guiding its development and its destinies.

Knowing this as I do, it is with utmost confidence for the future that I turn over the office of President to Mr. Ray H. Manson.

I can assure you, Sir, that you will find your course in this high office made pleasant sailing, abetted as you will be, as I have been, by the extremely efficient labors of our capable Secretary, Mr. Westman, his trained corps of assistants, and the numerous devoted Committeemen on whom you must chiefly rely for information and guidance.

To you, Sir, and to all of whom you may continue in office and positioned responsibility, I bespeak my sincere best wishes for success and pledge my fullest cooperation while I remain a member of the Board.

Notwithstanding the general great depression through which the country has passed, it is gratifying to be able to announce an increase in membership of the Institute during the past year of 840. The progress of the Institute from almost every point of view during the year now ending should be highly gratifying to its members.

During the past year the radio industry in America has passed through perilous times. Most of the members of the Institute, being directly dependent for their livelihood on the prosperity of the radio industry, have likewise suffered in consequence.

Observers on the tall towers which support the fabric of radio's world antenna report glimmers of light, heralding the dawning of a brighter day.

We fervently hope that this is not "false dawn."

Always a fervent optimist, the rôle of a Jeremiah, prophet of gloom, is not at all to my liking. Yet I have conscientiously felt impelled in my several addresses as President of the Institute to sound a serious

note of warning against a real and genuine evil, a cancerous growth which is relentlessly eating at the vitals of radio's usefulness and prosperity. Nor should I fail now in my duty, as I see it, to call your thoughtful attention once more to this situation, solely to the end that some useful remedy or corrective measures may be developed and speedily applied.

In sad contrast with the situation of radio manufacturers and dealers, the year has admittedly been an unusually prosperous one for the broadcast stations and their owners. I am convinced that this state of affairs is an unhealthy one, is an alarming symptom for the future. The radio listening public is becoming more critical of program quality, more lukewarm to what is being offered them. Fewer "fans" put their complaints in writing than formerly, but the insistent ballyhoo of sales talk which now viciously interrupts seventy per cent of entertainment programs even on the costly chain networks has already materially reduced the sum total of listening hours. Meanwhile radio advertising from the *local* stations has become so uncontrolled that one must wonder at the patience of the suffering public who listens to these at all.

Yet the broadcasters are greedily selling more and more time for impudent and undisguised "sales talk"; little realizing, or caring, that they, like parasites, are consuming the very vitals of the organism on which they depend for their livelihood.

This situation can go on, becoming worse and still worse, until so few radio listeners remain that the advertisers find their money thus spent unprofitably. But long before that final stage of dissolution is reached, the usefulness of the radio to the public will have practically terminated.

It is worse than futile, therefore, to sit idly by until this situation has corrected itself. As an economical proposition, those who depend on the manufacture and sales of radio receiving equipment (and this includes most of our members) must regard the present broadcast situation as perilously menacing. It is encouraging to note that I am not alone in my forebodings. Chief Federal Radio Commissioner, Ira E. Robinson, in a recent memorandum to his associates, has predicted a rebellion of the American public against the "overdose of advertising on the radio," adding, "the excesses of the broadcaster in his search for commercial returns will assuredly bring about the revolution predicted"—in my address before the Institute Convention at Toronto.

I believe that it is actually this resultant decline of the public's interest in radio programs, which is largely responsible for the astonishing falling off in radio sales, and particularly of radio tubes. Hard times is

of course a powerful reason; but with radio provender what it is today it requires no Spartan stoicism to forego the luxury of listening!

"Every home has its radio," at least in metropolitan districts; but these sets are not turned on continuously as they once were, not by a considerable percentage of time.

Unless these broadcast conditions are very soon materially improved, and unless the public be given the opportunity to listen to four or five hours each day of fine entertainment free from sales talk, I cannot see any way of restoring its former prosperity to the radio industry. This is putting the matter wholly on a commercial basis, without mentioning the moral obligation of the broadcasters to give the public the very best in entertainment and cultural values which it is in their power to bestow.

It is my earnest hope that the twenty-odd fifty-kilowatt stations, recently authorized by Washington will, if properly distributed throughout the nation, enable most listeners to tune them in. It is also my hope that when thus tuned in listeners will obtain therefrom programs of such high merit that they will no longer be dependent on the local advertising stations for radio entertainment and cultural education.

It was consistently my thought when I first began radio broadcasting that all broadcast stations and programs would be financed and maintained, largely if not entirely, *by the manufacturing companies or association of companies interested in radio sales*, those interests which obviously would directly or indirectly *benefit* by supplying the listening public with continuous entertainment by the highest quality programs, entirely free of advertising except the barest announcement as to the organization sponsoring the programs.

And so long as it seems hopeless to expect our Congress to authorize any censorship of radio programs, or to levy for the support of fine programs a tax on receiving instruments, or even on the relatively few manufacturers of radio tubes, even if such contemplated measures were wise (and I am by no means sure that they would be wise) I am forced to regard the above outlined plan of associated radio manufacturers collectively sponsoring several hours each day of high-class programs freed of all advertising, as the surest and most practical means for remedying a situation which, unless cured, will most certainly spell disaster to the radio industry, and continue to rob the radio public of the benefits to which it was once accustomed, and which are so unquestionably its right.

With this parting thought and admonition, I wish you, Mr. Manson, our new President and the Institute of Radio Engineers, a fervent "Godspeed" and a Prosperous New Year.

LEE DE FOREST

PART II
TECHNICAL PAPERS

ON THE SIMULTANEOUS OPERATION OF DIFFERENT BROADCAST STATIONS ON THE SAME CHANNEL*

BY

P. P. ECKERSLEY

(High-Frequency Engineering Co. Ltd., North Acton, W,3, England).

Summary—This paper gives a detailed account of experiments in the operation of several radio broadcast stations on a common frequency, conducted in England. The theory involved in synchronous transmission is set forth as well as accounts of tests. Three different methods of common frequency operation were tried. The results are discussed at length giving the relative advantages and disadvantages of each.

GENERAL

IT IS obvious to anyone who studies the art of broadcasting that the public could be more fully satisfied if given a wider choice between different radio programs. The theater, the concert, and the cinema, for example, offer a comparatively wide choice to the discriminating; reading matter is bewilderingly diverse; broadcasting largely dictates its own criteria rather than allows the public to indicate its preferences. Broadcasting does not suffer in popularity in this respect because it possesses intrinsic novelty. However, its well-wishers see that a lack of variety of choice is its most serious limitation. The perfect broadcast system would diffuse the world's important events simultaneously leaving the listener to choose his program according to his judgment. It is possible to argue that the limitations which forbid this ideal automatically impose another of a better kind, since dictatorship is preferable in cultural matters, but the conscientious technician would rather assume intelligence on the part of those who use his discoveries than satisfy himself with a *status quo*. Thus, technicians in all parts of the world have brought their minds to bear upon methods to give a greater range of choice of alternative programs in service conditions. They are, however, inevitably barred from practical achievement by the restricted number of available station channels. In the large towns of America there is a wide choice between different programs, but no true service, as the author has defined it, in the more remote rural districts; in Europe, there is a wide diffusion of service area conditions for one program but little true choice between different programs in service conditions. In Great Britain and Northern Ireland the author is responsible for a scheme which gives a very large proportion of the population a choice between at least two programs *in true service conditions*.

* Decimal classification: R550×R612.1. Original manuscript received by the Institute, October 17, 1930.

It is only natural, in these circumstances, that technicians in different parts of the world have sought to utilize a single channel for use by more than one station.

The author claims no originality in being one of many to seek this solution to a fundamental problem, but believes, in view of certain misconceptions casually encountered, that it may be of interest to record relevant theories and practical observations with which he has been in contact during the last six or seven years.

HISTORICAL

In 1924 the author proposed that a plan for the repartition of wavelengths in Europe (the so-called "Plan de Genève") should be based upon the use of so-called "international common waves" where a single wavelength was to be shared by several stations in different countries. Every successive plan has been based upon this original conception. It is important, however, to state that the scheme, while successful, and even necessary, as a temporary expedient, has fundamental disadvantages which demand, in time, its discontinuance.

It is believed that for some considerable time the "common wave" scheme (where stations transmitting *different* programs attempt to share the one channel) has been used in America to fit in stations surplus to the number of available channels.

In the winter of 1924-1925 the author arranged for certain experiments to be conducted to explore the fields of two 100-watt British stations sharing a single channel. Pressure of other work compelled a cessation of the experiments after encouraging preliminaries, but experiments of a more fundamental nature were restarted in 1928. Nevertheless, from 1926 to 1928 four British stations (100 watts power) were roughly synchronized on the same wavelength. As a result of the experiments of 1928 the year 1929 saw a practical realization of a single wavelength working scheme. Thus, ten stations in Great Britain at present share a single channel and yet give first-class service to a large number of persons.

Experiments were undertaken in Germany and in Sweden along the lines similar to those pursued by the British Broadcasting Corporation and in consequence today several European stations share a single channel. The author is unacquainted with American practice but believes two stations have been accurately synchronized for some time.

THE THEORY OF SINGLE WAVELENGTH WORKING

Consider conditions when two stations are transmitting on nearly identical frequency. If both are unmodulated, the carrier waves of the

stations will produce, in any receiver capable of appreciating the combination of their radiations, a "beat note" equal in pitch to the difference of frequency of the carrier waves of the two stations. This beat note will, however, be inaudible in any given receiver under the following conditions:

(1). If the beat-note frequency is of so small or so great a value as to be inaudible to the listener. To satisfy this condition in practice the beat note must be less than 30 to 10 cycles per second or greater than from 10,000 to 15,000 cycles per second depending upon the type of reproducer in use. In this paper we are not concerned with the latter condition since it does not represent the case of "single wavelength operation." Thus the beat-note interference can be eliminated if a high degree of synchronization exists between the emitted waves of the stations sharing the same wavelength.

(2). If one of the stations is so overwhelmingly strong compared to any other that the beat note produced by malsynchronization is inaudible. It is interesting to observe, however, that measurements reveal that there must be a preponderance of the field of one station over the field of another represented by a ratio of 300 to 1 or even more. (say, 50 db)

The author has shown in previous papers¹ that the average field of a given station remains sensibly constant (at night) between distances of a few hundred to more than a thousand miles from the station. The value of the field is approximately 0.1 millivolt per kilowatt radiated. Thus the field of a "local" station must be greater than 30 to 50 millivolts to overcome distant heterodyne interference from a 2-kilowatt station and hundreds of millivolts if the distant station is relatively powerful.

From the above it will be seen that in practice the only solution to the problem of heterodyne elimination is by a synchronization of an accuracy sufficient to hold the frequency of two radiations at a constancy which must not be departed from by more than 10 to 15 cycles maximum. With a wavelength of 300 meters this demands an accuracy of roughly 1 part in 100,000.

EFFECT OF MODULATION ON THE INTERFERENCE PATTERN

But the problem is by no means completely stated if it is assumed that the stations are unmodulated and that the elimination of carrier-wave heterodyne constitutes the sole problem.

The following is an exposé of a theory to indicate the interference pattern produced by exactly synchronized but modulated stations.

¹ Notably, "The calculation of the service area of broadcast stations," *Proc. I.R.E.*, 18, 1160-1193; July, 1930.

This theory was first set out by the author and A. B. Howe² in a paper read before the Institution of Electrical Engineers in 1929.

If two broadcast stations emit carrier waves of identical frequency, we presume that an interference pattern will be set up in areas where the field strength of both is appreciable. Taking a simple case, we shall consider two stations to be of equal power, and to be exactly synchronized.

Let us first consider that there is no modulation of the carrier waves, and that the stations are emitting radiation of a single frequency. The interference pattern at points taken along a straight line drawn between the stations will take the form of stationary waves, with maxima and minima each a distance apart equal to half the wavelength of the carrier wave. At points nearly equidistant from both stations the minima

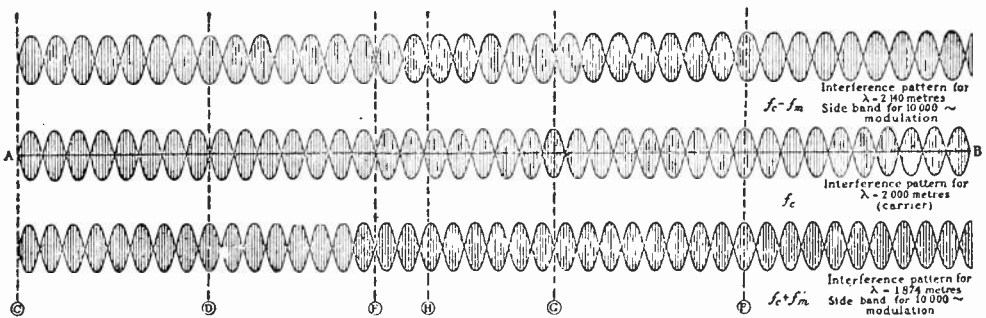

Fig. 1—Interference pattern produced by two broadcast stations using the same wavelength of 2000 meters and having the same modulation of 10,000 cycles per second.

of the stationary waves will be practically zero, and the maxima practically double the field strength of one station working alone.

Now consider that the stations are modulated by the same "low" frequency. A carrier wave of frequency f_c , modulated by a "low" frequency f_m , can be represented as the simultaneous existence in the ether of frequencies f_c , $(f_c + f_m)$ and $(f_c - f_m)$. We call the frequencies $(f_c + f_m)$ and $(f_c - f_m)$ "side bands." Interpreting this in terms of wavelengths, the radiation of a carrier wave of frequency f_c modulated by a low frequency f_m can be represented as the radiation of three wavelengths $\lambda = c/f_c$, $\lambda_1 = c/(f_c + f_m)$, $\lambda_2 = c/(f_c - f_m)$, where $\lambda =$ carrier wavelength, $c =$ a constant, and λ_1 and $\lambda_2 =$ wavelengths of the side bands.

Modulation of the carrier waves of each station thus produces additional waves of length λ_1 and λ_2 (λ_1 being a shorter and λ_2 a longer wavelength than λ). The interference patterns caused by λ_1 and λ_2 will be dissimilar, and the maxima and minima will each be $1/2 \lambda_1$ and

² P. P. Eckersley and A. B. Howe, "The operation of several broadcasting stations on the same wavelength," *Jour. I.E.E.*, 67, No. 390, pp. 772-789; June, 1929.

$1/2\lambda_2$ apart. But since $\lambda_1 \neq \lambda_2 \neq \lambda$, the points of maximum or minimum for one side band, for the other side band, and for the carrier, will not, in general, be coincident. To make this point very clear, let us refer to Fig. 1, which, to render the diagram manageable, has been drawn for a frequency of carrier wave of 150 kilocycles per second (2000-meter wavelength), modulated by the "low" frequency of 10,000 cycles per second. The diagram is conventionalized to the extent of assuming the strength of the two stations to remain the same along the line AB of length 20 wavelengths. The sine curves of Fig. 1 are the envelopes of the stationary waves. They give a representation of the field strengths of the resultant carrier, and of the two resultant side bands produced, at any point AB , by the addition of the radiations from the two sources. By moving from place to place in the interference pattern we find different states of energy. The results are shown in Table I.

TABLE I

Point	Condition	Result to a receiver installed at the given points
C and E	Zero energy	No reception
D	Strong side bands. No carrier	Carrierless telephony, and distortion for ordinary reception
F	Double carrier and double side bands	No distortion
G	Strong carrier and no side bands	No modulation
H	Elimination of one side band; relative strengthening of other	Distortion with most types of detector

It is important to note that the distortion referred to in the above table is that of the wave-form of the single low frequency with which we have supposed our transmitters to be modulated. In addition, frequency distortion, or distortion of the low-frequency response characteristic of the combined transmitters, will occur. In fact, at no point in the interference pattern will this form of distortion be entirely absent unless the two transmitters are approximately equidistant from the receiver. This point will be appreciated if it is realized that the interference bands shown for the side bands in Fig. 1 refer to one particular modulation frequency only. For other modulation frequencies the nodes and loops of the side band interference patterns will be formed in different localities.

Thus, points F and G , in Fig. 1, for example, at which conditions for the carrier are the same but for the side bands are different, can be taken as representing conditions which will occur at one locality for different modulation frequencies. That is to say, even at a point where the carriers from the two transmitters are received in phase, and no distortion of wave-form can occur, there will be distortion of the fre-

quency response characteristic, since as we swing through the gamut of audible frequencies the respective side bands received from the two stations will alternately be in and out of phase. The same plainly occurs for all the other conditions referred to in the table.

The frequency distortion is, however, of such a nature that in some cases, so long as the carriers are received approximately in phase, it will not be noticed in an ordinary receiver. In the "eliminated-carrier" case, however, frequency distortion may be more serious, the high modulation frequencies alone being strongly reproduced; hence the introduction of a local carrier would not suffice to produce good quality reception.

There are other and intermediate states of distortion, notably the disturbance of the phase relationships between resultant carrier and resultant side bands, but the above is typical and sufficient to point what follows. Thus we see that, where the field strengths of both sta-

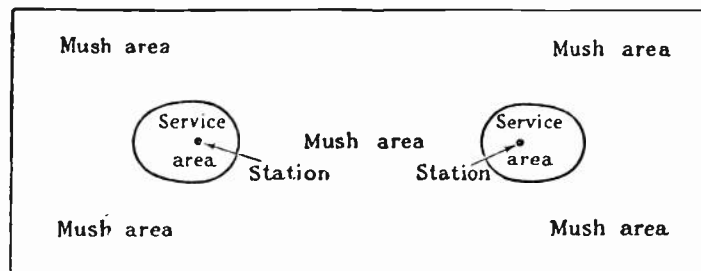

Fig. 2—Showing small service area and large "mush" area (where quality of transmission is bad) around two stations sharing the same wavelength.

tions are practically equal, good reception is fortuitous and distortion highly probable. In general we may say that this distortion will take the form of overmodulation (where the carrier suffers diminution), frequency distortion (where portions of the side band spectrum are blotted out), elimination of carrier (where intelligible reception could only be obtained by the introduction of a homodyne at correct phase), and distortion due to the disturbing of the relative magnitudes and phase relationships of two side bands. Distortion will not be greatly influenced by the relative phases of the low-frequency modulation component at each station; a change of modulation phase at one station relative to the other merely shifts the side band interference pattern of Fig. 1 horizontally right or left, and changes the type of frequency distortion at any given point. The typical states indicated in the table will still occur, though in the case of modulation with a single frequency side band, elimination will occur at a different point.

So far we have investigated the condition where both transmissions are sensibly equal. But considers a point close to one station (so close

that the field strength of that station is enormously greater than that at the other sharing the wave). At such points we should expect no distortion, the interference from the distant station being too feeble to produce an appreciable interference pattern. As we move away from the close proximity of one station towards the other, the distortion produced by the interference pattern becomes more and more appreciable until a point is reached at which the interfering station produces noticeable distortion, and we may say that we can no longer expect good service from the nearer station. There must be, practically speaking, a definable boundary inside which reception is good, while outside it is bad. Around each of the stations there will be an area in which the distortion will not be noticeable, service area, but there will also be a large area between and round the stations which we decide to call a "mush" area where service conditions cannot be said to exist. (See Fig. 2.)

EXPERIMENTAL VERIFICATION OF THEORY

Empirical Relevant Quantities

The above theory was promulgated in advance of any *quantitative* experiments. Many qualitative tests indicated that the theory was acceptable as a basis for further experimentation. It was the object of full-scale experiments to determine the empirical quantitative relationships involved and find out more particularly the extent of mush and service areas in practice.

To this end it was decided to select two typical existing broadcast stations, synchronize these as perfectly as possible, and then to explore the resulting field with a conventional receiver as well as a field measuring device. Two typical broadcast stations, 40 miles apart, were chosen for the experiment. In order to hold these exactly in synchronism the master drive of each was the alternating disturbance set up in receivers, local to each station, from a remote continuous wave station. Thus two broadcast stations, *A* and *B*, were each equipped with a wireless receiver to pick up transmissions from continuous wave station *C*. The master drive station radiated waves of frequency f . This was received at each broadcast station *A* and *B* and the frequency f was there doubled and used as the master drive of the station. Thus the broadcast stations, were synchronized on a frequency $2f$. As the master drive station was no farther away from either of the broadcast stations than 40 miles direct-ray reception of the master drive station was possible and there was therefore a unique single frequency of drive and a constant phase difference between the drives of each broadcast station. Precautions were taken to maintain the frequency of the master drive station as constant as possible. The frequency of radiation of the master drive

station was about 250 kilocycles per second making each of the radiated waves of frequency $2 \times 250 = 500$ kilocycles per second.

In order to check whether the expected perfect synchronization between the two broadcast stations actually occurred in practice, a touring automobile explored the field produced by the broadcast stations in areas where the field of each was of the same order of magnitude. The detector feed current of the conventional receiver (installed in the touring automobile) was measured and was found to remain practically constant at any given point. This indicated that the interference pattern set up by the synchronized broadcast stations was, in fact, stationary. Further, moving from place to place showed that there were definite nodes and antinodes of field and that, so long as observations were taken where the field was not distorted (by, for instance, the proximity of telephone wires), quite definite distances, equal to the wavelength used for the experiments, separated these nodes and antinodes. In fact the basic theory was vindicated and the interference pattern between the two unmodulated stations appeared to be perfectly stationary.³

This point having been proved, and the conditions of the experiment having been definitely fixed, the radiations from each broadcast station were similarly and simultaneously modulated; that is to say the *same* program was radiated by each station. It was then found that, in places where the fields of each station were comparable, the faithfulness of reproduction, as observed on a typical receiver, was seriously marred. Points could be found in which the music and speech could be restored to fair quality by the introduction of receiver homodyne; other points gave apparently normal reception. There were furthermore places in which there was an obvious frequency distortion; in fact all the conditions postulated by theory were observed in practice. The experiment proved that, in areas where the fields were nearly equal, good quality reception was purely fortuitous and seldom encountered.

LIMITS OF SERVICE AREA EXPERIMENTALLY DETERMINED

The important point, however, was to determine the practical limits of true service area of either station. To this end the exploring receiver was brought nearer and nearer to one station until, this station becoming, relatively to the other, overwhelmingly strong, a boundary was found within which no apparent variation of quality was manifest on switching on and off the more distant station. The ratio of field between near-by and distant broadcast stations was then measured so that an empirical ratio of local to distant field was determined which defined

³ An interesting suggestion has been made, namely, that the field nodes and antinodes set up by two synchronized stations should be accurately measured and a check reading on the velocity of light derived therefrom!

the borders of the service area of the local or nearer station. It was found that, *when the stations were perfectly synchronized, then, service area conditions could be said to exist at any point, provided the field of one station at that point was more than 5 times the field strength of the other station at that point and provided each station radiated the same program.* This discovery has, naturally, a fundamental practical importance. The empirical law could not probably have been determined by theory.

Now let us consider methods by which stations may be synchronized and show that some malsynchronization is inevitable. The reason for this apparent divergence from a straightforward method of attack is that practical conditions modify the above empirical law but still allow a practical condition for working. It is obvious that, owing to the congestion in the ether, no government would licence a master-drive station for the purpose of synchronizing broadcast stations. It would appear at first sight that stations might be perfectly synchronized by taking their master drive from a common low-frequency source simultaneously diffused through an existing wire network. To this end one would postulate a constant tone source sent via land wire to all stations of a group and multiplied at each radio station the same number of times, eventually to form the "high-frequency" drives of each (widely separated) station. But this does not produce perfect synchronization because any one wire circuit will give an ever varying phase shift relative to another wire circuit. This phase shift is magnified in the frequency multipliers. As the phase shift is different in every circuit of the postulated network the effect is the same as if the stations were imperfectly synchronized. Analogously two flywheels, coupled together by an India-rubber shaft, might be said to run at the same frequency of revolution in a given (long) time, but at any instant they would be moving, relatively to one another, at a different angular velocity and give, momentarily, the effect of imperfect synchronization.

EXPERIMENT TO DETERMINE PRACTICAL SERVICE AREA CONDITIONS

The two stations *A* and *B* of the previously described experiment were, therefore, driven from a common tone source exactly as indicated above, and it was found that the interference pattern was no longer stationary, proving that the differential phase shift on the lines gave the effect of malsynchronization.

One must, therefore, in making a practical study, consider the case in which the stations have a slight frequency difference, but a difference of course, which can never be, for reasons stated previously, more than 10 to 30 "effective" cycles per second. A little consideration will

show that any malsynchronization produces further a distortion, additional to those met with under conditions of perfect synchronization.

It is supposed that we have a carrier wave frequency of f_c for a broadcast station *A*, and $(f_c + \Delta f)$ for station *B*. Suppose each station to be modulated by frequency f_m then, at a point where the field strength of both stations is appreciable, there will be side bands of frequency $(f_c + f_m)$, $(f_c - f_m)$, $(f_c + \Delta f + f_m)$ and $(f_c + \Delta f - f_m)$. We thus postulate the presence of frequencies $(\Delta f + f_m)$ and $(\Delta f - f_m)$ which are audible after rectification and which are additional beat tones to those present when there is perfect synchronization between the stations. In fact, we can say, that, in addition to the distortion which will be present when there is perfect synchronization, there will be a further distortion when the radiations from the stations are different in frequency by an amount of frequency Δf . This is due to the addition of a frequency Δf to every modulation frequency.

It was, therefore, important to determine, by experiment, whether the extent of the service area was changed to any appreciable degree by slight malsynchronization. To this end each of the stations *A* and *B* of the experiment described above was driven by a similar but separate master oscillator of an accuracy of frequency constancy sufficient to give no greater variation between the two stations than 10 cycles per second. In this case it was found that *service area conditions of one station could be said to be bounded by a field contour which was everywhere ten times greater than the interfering field from the other station provided each station radiated the same program*. This ratio is therefore twice that found when the stations were perfectly synchronized.

Thus, in sum, the experiments proved, that, with perfectly synchronized stations, the theoretical considerations set out above gave a fair picture of what happened in practice. It was furthermore proved, that, if there was a slight degree of malsynchronization, the field strength contour bounding the service area of one station had to have a doubly great value than if both stations were perfectly synchronized.

Less critical experiments set out to determine what quantitative differences there might be if two stations, perfectly synchronized, or synchronized within the necessary degree of accuracy specified above, simultaneously radiated *different* programs. The above described experiments applied, of course, only when the same program was radiated by each station. Data were obtained which showed that in this case, with either perfect synchronization or slight malsynchronization, the service area of each station was far more restricted and that it required the field of one station to be greater than the interfering station by over 300 times (50 db) if service area conditions were to be manifest.

CONDITIONS FOR SUCCESSFUL SINGLE WAVELENGTH WORKING

This experiment gave us a most important fact because it showed that, except in special cases, it is quite impossible to expect to set up any successful single wavelength system (wherein the stations are reasonably close together) if *different programs are radiated by stations sharing the same wavelength.*

It is repeated, for the sake of emphasis, that no single wavelength system can ever be practically successful unless all the stations sharing a wavelength radiate the same program. Nevertheless there are exceptions to this rule.

It is possible to radiate different programs from different stations sharing the same wavelength during daytime and/or when the stations are several thousands of miles apart. This is obvious because in the daytime the indirect ray is of far less intensity than at night and so one station may well give 300 times the field strength of a distant station at the boundaries of a reasonably extended service area. When the stations are more than 3000 or 4000 miles apart the indirect ray is too weak to have any appreciable effect, even at night, and particularly along the east and west line when the time difference factor is manifest. In practice, stations are not likely to be this distance apart if they are usefully synchronized one with another to prevent heterodyne and daytime working is of little practical importance when dealing with the problem of a national broadcast system. Thus italicizing and repeating the above, *single wavelength operation must rely upon the radiation of the same program by all the stations sharing the same wavelength if the system is to be successful.*

PRACTICAL RANGE OF STATIONS SHARING THE SAME WAVELENGTH

So far we have stated a theory which has been verified in practice. It is of practical necessity to engineers to understand the full quantitative implications to decide whether the method is of practical value or not. From previous theories and practical verification undertaken by the author and the staff of the British Broadcasting Corporation, it is possible to make a sufficiently accurate computation of the extent of the service areas of stations sharing the same wavelength. The reader is referred to previous papers wherein a theory has been set out which gives a method for estimating the field strength of any station (using any wavelength normally used for broadcast stations) provided we know the type of ground over which the waves must pass and the power and the design of aerial used by the stations. Obviously, as we are able to calculate the field of any two given stations, we are thus able, using the results given above, to find the boundaries of their service areas

when they share the same wavelength. It is impossible to generalize because there are so many variables. But for the sake of a typical example we might assume equal power stations and a ground conductivity of 10^{-13} c.g.s. units. This will give the order of quantity of service area in a typical case and will indicate the practicality of the method in general terms.

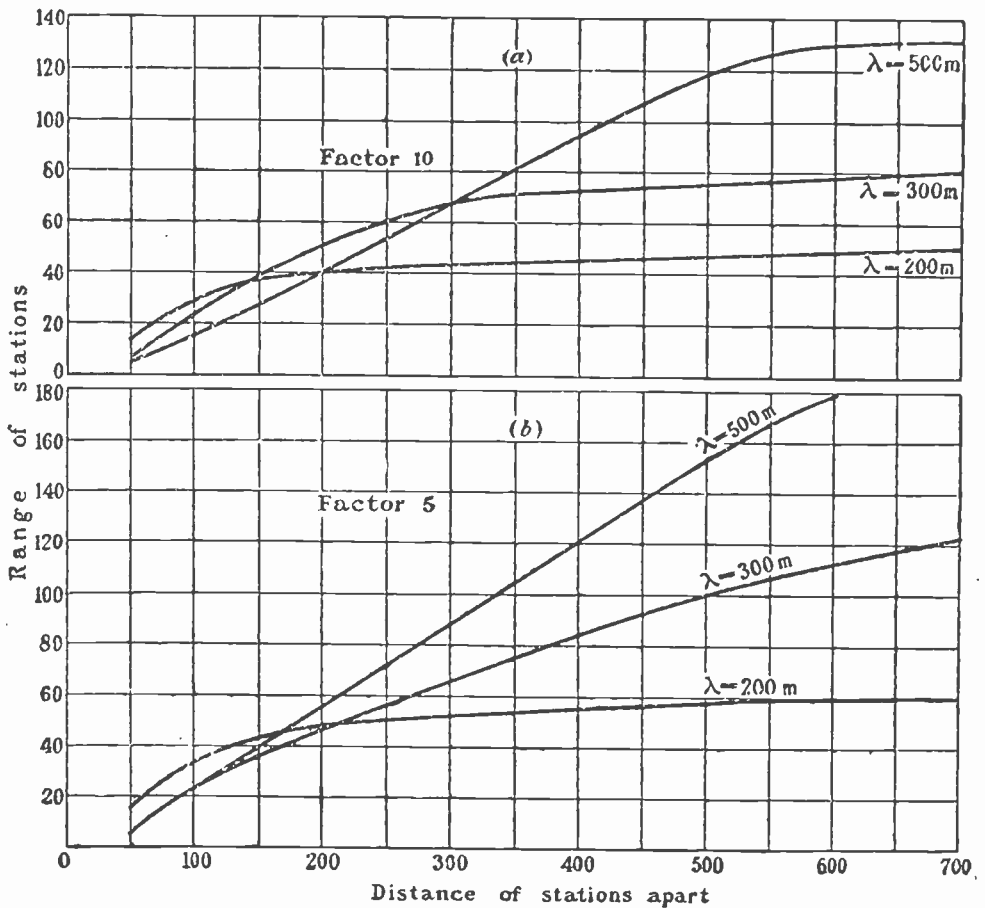

Fig. 3—Range of two equal power stations sharing same wavelength, at different distances apart and different factors.

The curves of Fig. 3 have been worked out for the above mentioned conditions, Fig. 3(a) is for partial malsynchronization, Fig. 3(b) for perfect synchronization. Every engineer attempting to find out expected service area in particular cases will need to work out that case; the variables are too numerous to enable one to give information applicable to every case. This paper attempts, however, to give all the necessary data for calculation.

CONDITIONS WHEN A NUMBER OF STATIONS GREATER THAN
(SAY) 5 SHARE THE SAME WAVELENGTH

The above calculations, which are designed to indicate the order of quantities involved, assume that only two stations share the same wavelength. One must consider the case in which relatively large numbers of stations share the same wavelength.

It is a question of calculating the combined field created by a scattered group of stations in the environs of a particular station of that group. Thus if we wish to calculate the range of station *A*, sharing a wavelength with station, *B, C, D, E, F*, it is necessary to know the approximate field of stations *B, C, D, E, F*, near the location of station *A*. As the stations cannot be perfectly synchronized and as the path of the waves passes probably over different types of country, and as the stations may be of different power, it is obvious that the method, in calculating a particular case, must be painstakingly detailed. It is nevertheless possible to form an estimate of the several fields of stations *B, C, D*, etc., at a point; the question to decide is how these values will combine on the average. There will be casual subtractions and additions of field due to malsynchronization. What is the mean field in such a case? It is obviously a question of probabilities and the well-known theorem, due to Lord Rayleigh, tells us that, in a case of this kind, the average value of the field over a long time will be the square root of the sum of the fields of each station. Thus the average field E_n at a point due to stations *A, B, C, D, E, F*, imperfectly synchronized and producing fields at that point Ea, Eb, Ec, Ed, Ee, Ef , is proportional, if N is large, to $\sqrt{Ea + Eb + Ec + Ed + Ee + Ef}$. It is worth noting in passing, that this result is independent in wide limits of the geographical separations of stations if these are so large that the direct ray is negligible compared to the indirect.

METHODS OF SYNCHRONIZATION

We have proved, so far, that with certain limitations, it is possible to share a single channel between several stations. In order that the method may be practically successful we have seen that each station of a group sharing the same wavelength, must, if day and night working is presupposed, and if the stations are reasonably close together, radiate the same program. We have furthermore seen that if these conditions are complied with, stations sharing a wavelength may have a range of from 3 to 10 miles depending upon conditions. We have seen, lastly, that provided the method is to be successful, the stations must be so accurately synchronized, that the frequency of their radiated waves

does not vary more than 10 to 30 cycles per second from a mean.

It is thus pertinent to consider the most practical method of maintaining such synchronization between stations widely separated in geographical distance. We have already seen that it is impractical to rely upon a master drive provided by the ether radiations from a central wireless station. There remains the choice between individual drives of great accuracy, and a central common drive connected to each station by means of land wires.

CHOICE BETWEEN THE TUNING FORK, THE CRYSTAL AND THE TUNED CIRCUIT

Turning first to the question of individual drives we have the choice between the valve maintained tuning fork, the quartz crystal, and the tuned circuit. The valve maintained tuning fork, provided it is enclosed so that its temperature remains reasonably constant, gives as far as can be judged, a variation from a steady value of not more than ± 10 to 15 cycles during long periods of working. The crystal oscillator, if properly installed and if maintained at a constant temperature, gives it is believed, a comparable accuracy. The author is unaware whether the tuning fork or the crystal gives the greater constancy; it would seem, however, that provided both give a frequency constancy suitable to the needs of the case, the crystal presents a certain practical superiority inasmuch as it requires less subsidiary apparatus and therefore has a smaller first cost. The greatest difficulty with the crystal is to prepare several having exactly the same performance.

The author, having tried many methods, believes that the best way of deriving "high" frequencies from a tuning fork vibrating at "low" frequencies, is to use successive stages of valve circuits each of which gives an output exactly double the frequency of the input. No other arrangement appears so inherently stable as the "doubler." Thus, if a tuning fork gives a frequency of vibration of 1000 per second, the most efficient method of achieving a high frequency is to double, redouble, and re-redouble, etc., the original frequency. In a practical case it requires 10 stages to convert a frequency of 1000 into a frequency of about a million. As it is easier to use the so-called "push-pull" connection this involves 20 valves. No such quantitatively clumsy apparatus is required when the crystal forms the drive circuit. The question whether to use crystal or tuning fork can only be resolved when it is proved that the crystal will give an accuracy under ordinary maintenance conditions of 10 to 15 cycles maximum variation in a million and that several identical crystals can be prepared in the first place. The author has not practical experience on this point but when setting up a

single wavelength working system in Great Britain, chose the tuning fork method because it appeared at that time (1928-1929) to give greater potentialities of reliability and accuracy than any purchasable crystal circuit. Later researches by Marconi's Wireless Telegraph Company show that we might expect sufficient accuracy from an ordinary tuned oscillating circuit provided certain precautions are taken. This method is, of course, more practical than either crystal or tuning fork.

COMMON TONE SOURCE SUPPLIED OVER A WIRE NETWORK

Apart from the above general method of the individual drive we have to consider the possibility of using a common tuning fork or low-frequency master oscillator the output from which is distributed, via land lines, to all the broadcast stations of a single wavelength working group and where each station is equipped with some form of frequency multiplier. The disadvantage of this method when compared with the individual crystal drive, is that each station must be equipped with a relatively complicated and expensive frequency doubler. The advantage of the method is obviously that the amount of malsynchronization will never exceed, even in its apparent value, that necessary to ensure successful single wavelength working. The method would be peculiarly applicable if short waves were used by the broadcast stations. Furthermore, since a land line is probably necessary for the distribution of the same program from some one station of the group or central point, and hence a "control line" for operators' communication is sometimes also considered a necessary adjunct to the program circuit, the low-frequency tone can be superimposed over the communication circuit without much complication or difficulty. The superimposition of the master tone drive over existing and necessary wire circuits makes the method more practical than it might at first sight be considered, inasmuch as it does not involve the extra expense of an additional line which otherwise constitutes a heavy continuing expense. On the other hand, if there is a common source of program and if this program is distributed by land line, the necessity for communication by additional telephone line is not obvious. The author believes that on balance the individual drive is most to be recommended as it scores on first cost and maintenance and appears to give a satisfactory performance under ordinary conditions of service. The individual tuning fork drive may be proved in the future to be unnecessarily expensive. The extra land line must be, in the majority of cases, an unnecessary expense. The tuning fork still appears to give the only truly reliable form of drive.

EXISTING SYSTEMS

The author is naturally most informed as to conditions in Europe and particularly in Great Britain and a description of the conditions of British broadcasting may be of interest.

The first plan of allocation of wavelengths to the then existing European stations relied upon the allocation of certain so-called common waves to be shared among stations in different nations. Thus in 1925 international common waves were shared by the less important broadcast stations in Britain, France, Norway, Germany, etc. It was thus possible to set up a national system of broadcasting with a certain number of regional stations using exclusive waves and allocate common waves to the surplus low powered relay stations.

It is obvious to-day that the international common wave offended against every principle of single wavelength working. It was thus impossible to maintain the desired degree of synchronization between different stations in different countries; the programs radiated by stations sharing this international common wave were necessarily different and the distance of separation was always insufficient to prevent interference. When the first international plan was agreed to by European broadcast organizations, Britain found herself with 21 stations and only 10 exclusive channels. The surplus stations worked on international common waves and for the reasons indicated above it was soon proved that this compromise gave no real service to the local listener. Small powered relay stations were in certain cases "jammed" at places two hundred yards from the transmitting aerials!

As the results of encouraging experiments on single wavelength working as detailed above, it was thought desirable to try to use one of the national exclusive waves as a national common wave. Thus at the end of 1928, 11 British stations were equipped with the necessary synchronization gear and shared an exclusive British national common wave. No two stations were closer together than 50 miles and the maximum distance between any two stations was of the order of 500 miles. The wavelength used was 281.5 meters, (a frequency of 1140 kilocycles per second). The stations chosen to share this wavelength were all of relative low power and were designed in any case only to serve large towns and cities. They were not, in fact, regional stations. As theory indicated, it was soon found that their service areas were greatly increased when they radiated the same program and were synchronized on the same channel rather than when they shared a wavelength with (a far more distant) continental station. In fact, towns and cities from 100,000 to 500,000 inhabitants were brought into perfect service area conditions by the application of the single wavelength

working method, whereas when the international common wave was used interference was manifest generally up to within a quarter of a mile from the stations and at night their true service area was negligible.

A single channel was sufficient with the total expenditure of about 3 kilowatts aerial power in ten stations to bring 10 per cent of the population of the British Isles service conditions of one program.

METHOD OF SYNCHRONIZATION FOR BRITISH STATIONS

The stations referred to above are each separately driven from a vacuum tube operated tuning fork. The valve maintained fork was designed by G. M. Wright of Marconi's Wireless Telegraph Company Ltd., and was used by him in a system of short-wave facsimile photography. The fork is maintained at an even temperature. To this end it is enclosed in a "lagged" box containing a thermostatically controlled

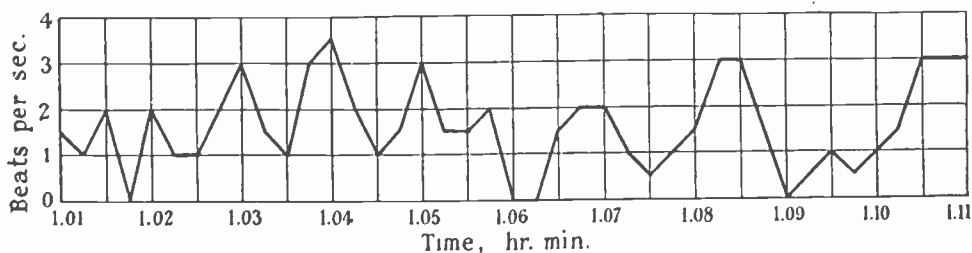

Fig. 4—Continuous variation of frequency of tuning fork drive. Beats observed between the carrier waves of Bournemouth and Bradford transmitters at 1 A.M. on January 16, 1929. Observations taken every 15 seconds.

heater. A stirrer fan keeps the contained air in circulation. The fork is made of mild steel as it is preferable to have a vibrator of low damping but poor temperature coefficient than one having a better temperature coefficient but a greater damping. The temperature control involves the switching on and off of a carbon filament electric lamp inside the lagged box the switching being controlled by the expansion and contraction of liquid which in turn makes and breaks a mercury contact. Sparking at the mercury contact is avoided by using a thermionic valve to work the relay. The performance of the device can be gauged by referring to Fig. 4 where the divergences of two similar forks are compared. The discontinuities may be due to the stirrer fan making momentary variations of magnetic state in the fork maintaining circuits. Later experiments showed that something of this kind was going on, and via the doubler, was causing an amplitude modulation which could be heard in the service area of the station as a dull rumble. A slight redesign of the stirrer fan removed the objectionable modulations.

THE DOUBLER

The doubler circuit is very simple and is shown in essence in Fig. 5. The principle relies upon obtaining a distortion in the input stage and picking out the strong double frequency component by tuned circuits in the output stage.

PRACTICAL METHODS OF MAINTAINING SYNCHRONIZATION OF STATIONS WITH INDIVIDUAL DRIVES

While it is true that the individual drives maintain a quite amazing accuracy it is necessary about once a week to check the synchronization of the stations comprising the single wavelength group and prevent any otherwise unobserved creep of some station away from a recognized standard.

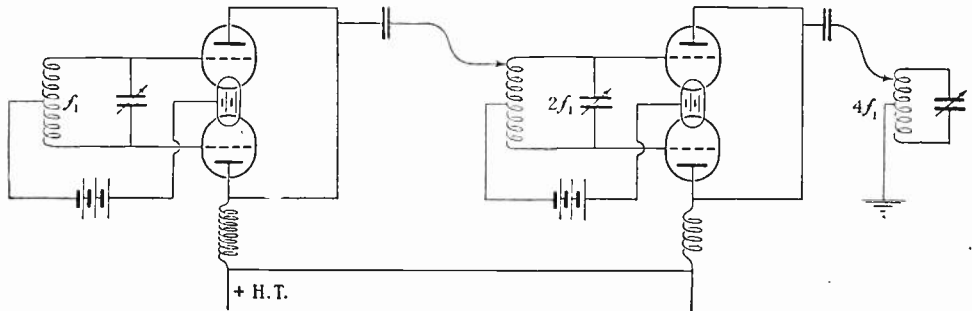

Fig. 5—Theoretical diagram of frequency doubling apparatus.

One station of the group is thus chosen as "master." Its wavelength is checked from time to time by national and international substandard wavemeters. Thus once a week the master station continues to transmit an unmodulated carrier after the program has finished. The other stations of the group receive the radiations (via their transmitting aerials) on a sensitive receiver. The high-frequency input from the master station can thus be compared in frequency by the zero beat method with the output of the doubler. A small change of plate voltage on the tube in the fork-drive circuits is sufficient to give a fine control over the frequency of the local fork and quickly bring the beats between the station drive and the master station to zero. The operator picks up any audible beat by phones but the final adjustment to zero beat is visual. Thus the sensitive receiver is fitted with a detector feed current meter and when the beats come nearly to zero the needle of the meter moves up and down and ultimately can be set nearly, but never quite, steady. The curve of Fig. 3 was obtained by counting beats on a detector feed meter.

OTHER SYSTEMS

Single wavelength working has also been applied in Germany and the practical observations made in Britain have been verified. The only difference between the British and the German systems is that the latter relies upon a central low-frequency tone source the output from which is distributed by land lines to the various single wavelength working stations. The author understands that single wavelength working has been successfully achieved in Sweden, but is unaware of the methods of synchronization. Lastly the author has heard of two stations in America which have for some long while past been sharing a single channel and have been accurately synchronized, but he is unaware of the results obtained and whether it is agreed that the theory set out above accords with American observation.

CONCLUSION

The introduction to this paper pointed out that the greatest difficulty confronting the technician in charge of national broadcast systems is the lack of a sufficiency of ether channels for giving both service and variety. With approximately 100 channels and with the extremely unsuitable wavelengths allocated internationally to broadcasting, it is impossible to satisfy ideals.

It has been explained that single wavelength working does allow a certain extension of service area but that severe limitations are imposed and that it cannot be expected that stations sharing a wavelength will give the same extent of service area as those which work on exclusive channels. Obviously the chief function of single wavelength working is to extend service area conditions to dense agglomerations of the population. A 200-watt station costing no more than £1000 is sufficient to give service area conditions to 500,000 people. Economically speaking the relay station, so-called, has great importance. If there were no lack of ether channels 1000 small stations would give better listening conditions than 10 high powered stations, but the lack of ether channels bars the extension of the relay station system, and so engineers have looked for service more to super high power regional stations than to small relay stations. Single wavelength working, however, enables service area conditions to be extended to almost any quantity of persons provided those persons live in densely populated areas. Single wavelength working, in fact, is suitable for giving service area conditions in densely populated areas provided the same program can be radiated from the stations covering such areas. The method, however, gives no service conditions to country districts. It is here that the high powered station is useful, and, by combining high powered regional stations with low powered single wavelength working stations, service area can be extended to almost an indefinite amount. Furthermore the field

need not be anything like so strong in rural districts as in towns, because in the latter case there is apt to be severe local interference. Thus the regional station, in spite of the unsuitable wavelengths at present allocated to broadcasting, can have an extended rural service area and 1 millivolt per meter may be enough to give service conditions in country districts. It requires, however, as much as 50 millivolts per meter in urban districts. The latter conditions can be fulfilled with an economy of ether channels if single wavelength working is used. It is again impossible to lay down hard and fast rules; circumstances must illustrate the case, but ideally the designer of a national system of broadcasting must find the use of single wavelength working properly applied a great help in extending the service area of a given program. It is, in fact, a useful supplement to regional broadcasting.

It has been suggested, notably in America, that single wavelength working may do more than this. It is obvious, from what has gone before, that fading is minimized if two stations share a single wavelength and bombard a given receiver remote from each. When, owing to fortuitous circumstances, one station fades to zero, however, the other station, most likely, will give some appreciable value of field strength. Thus by simply observing the detector feed meter in a given receiver it appears as if two stations sharing a single wavelength would minimize fading. The author is the first to agree that this is so and that fading considered as the ratio of field from moment to moment is certainly diminished if two stations are synchronized accurately upon one wavelength. From the theoretical and practical considerations discussed above, however, it is obvious that single wavelength working is only useful when the field of one station is predominately strong, a condition never realized when it is attempted to use the indirect rays of two equal powered stations for service. The author has long held that broadcast systems can never be considered to be successful if a greater number of listeners depend for their service upon reception of the indirect ray. Listeners are presumably interested in the program and wish to hear it clearly. Fading militates against this policy but if we minimize fading merely to introduce continuous bad quality we have gained nothing.

It is worth while, therefore, to point out that synchronized operation should be considered only as a practical means of extending service area of one program per channel in densely populated districts, not as a means of extending indirect ray service over large territories. Between the exclusive longwave regional station and relay stations sharing a common wave we may extend service area conditions almost indefinitely and with a great economy of wavelengths. Nevertheless, variety of programs is denied us. Wireless broadcasting must admit its failure in this respect.

SOME METHODS OF MEASURING THE FREQUENCY OF SHORT WAVES*

BY

HANS MÖGEL

(Transradio A. G., Berlin, Germany)

Summary—Four methods are given for practical frequency measurements on short waves (10–50 meters 30,000–6000 kc) with an absolute accuracy of ± 0.01 per cent to ± 0.001 per cent and a relative accuracy of ± 0.0001 per cent. Harmonic overtones are used in each method. The frequency standards are exclusively the luminous quartz resonators developed by Giebe and Scheibe, which are exceedingly useful and at the present time represent secondary standards constant to 1/100,000 so that continuous supervision with special calibration apparatus and chronograph is unnecessary. The indirect methods use fixed or variable fundamental frequency, while the direct methods use resonators whose response is indicated visually or acoustically. The methods were developed by Transradio A. G., Berlin, and are used by the transmitting and receiving stations in Nauen and Gellow-Beclitz.

THE rapid development and expansion in the use of short waves, especially in commercial oversea communication and in the army and navy, make it essential to find more accurate methods of measuring and maintaining assigned frequencies. Some years ago an accuracy of ± 0.1 per cent, obtained with standard wavemeters, was satisfactory. For a measuring range of 10–50 meters, a set of four coils or auxiliary condensers was needed. In these technical wavemeters which operate according to the direct absorption method the indication being by meter or, (in the range of weak signals) by an audion, the limit of absolute accuracy was 0.1 per cent, while the accuracy of the reading was about ten times greater.

According to proposals of the Radio Corporation of America, the essentials of which were approved by the Hague Radio Conference, the transmitting frequencies with undamped oscillations, that is, without modulation by sound, telephone, picture, or television, should be separated about 0.13 per cent. According to the findings of the Hague Conference the tolerance in the region from 50 to 13 meters (6000–23,000 kc/sec) for fixed stations is now set at 0.05 per cent and later is to be 0.01 per cent. This makes it necessary to keep the transmitting frequency constant to about ± 0.01 per cent and demands absolute measurement accuracy of at least the same order. For commercial purposes it is desirable to have a constancy that is ten times as great, i. e., 0.001

* Decimal classification: R214. Original manuscript received by the Institute, May 28, 1930. Translation received by the Institute, October 25, 1930

per cent, if this can be accomplished without undue complication of method or apparatus.

Harmonic overtones are used for almost all measuring methods, because standards for lower frequencies are easier to produce and more reliably controlled than those for high frequencies, and because the law of harmony of the overtones holds exactly. In addition, if necessary, the entire region from 10 to 50 meters, more than two octaves, can be calibrated with one standard, while with direct measuring methods, n times as many standards are needed ($n = f_2/f_1 =$ the ratio between fundamental and overtones) if the same calibration points are kept. The Radio Corporation of America, the Bureau of Standards, the American Navy, and others used quartz oscillators in thermostats as secondary standards. Marconi uses tuning fork oscillators. The frequency of these quartz oscillators is constantly measured and checked by special calibrating apparatus, measuring time with a chronograph.

In Germany, quartz resonators are used almost exclusively as secondary standards because they are somewhat simpler as to manipulation and attention required, with the same constancy and accuracy. Possibly the resonator is superior to the oscillator because of the smaller electrode capacity. Giebe and Scheibe at the Physikalisch-Technische Reichsanstalt have developed the so-called "luminous quartz" with which an oscillation can be measured accurately to a millionth.

According to a communication by Giebe and Scheibe¹ the resonators have shown very good results in an international comparison of standards in which some quartz oscillators with and without thermostats and some "luminous quartzes" were sent to the standards organizations of various countries for measurement.

It must be noted that these "luminous quartzes" were of the earliest type and were not specially selected. Since that time, medium-frequency standard quartzes have been developed, which are supported rigidly at a vibration node. These resonators can be excited up to the tenth harmonic.

In the duplex receiving station of the Transradio A. G. für drahtlosen Uebersee Verkehr in Geltow, some methods of measuring the frequency of short waves to an absolute accuracy of 0.01 to 0.001 per cent have been developed, based on the use of "luminous quartz" resonators as secondary standards. Since these differ in many respects from the usual methods, we shall describe them briefly in the following, and give the results that have been obtained with them.

¹ Giebe and Scheibe, "Internationale Vergleichen," etc., *Jahrb. drahtl. Tel.* 33, No. 5, p. 176; May, 1929.

I. METHOD OF MEASUREMENT WITH A STANDARD CIRCUIT AND MIRROR GALVANOMETER USING VARIABLE FUNDAMENTAL FREQUENCY

As the Transradio installation in Geltow includes a Giebe and Alberti standard wavemeter² we first applied a method in which we could use the standard circuit calibrated by the Reichsanstalt. This circuit consisted of a rather large number of precision condensers (fixed and variable) and standard coils, by means of which a wavelength from 600 to 30,000 meters could be covered. Because of the comparatively high temperature coefficients, the absolute accuracy and constancy of

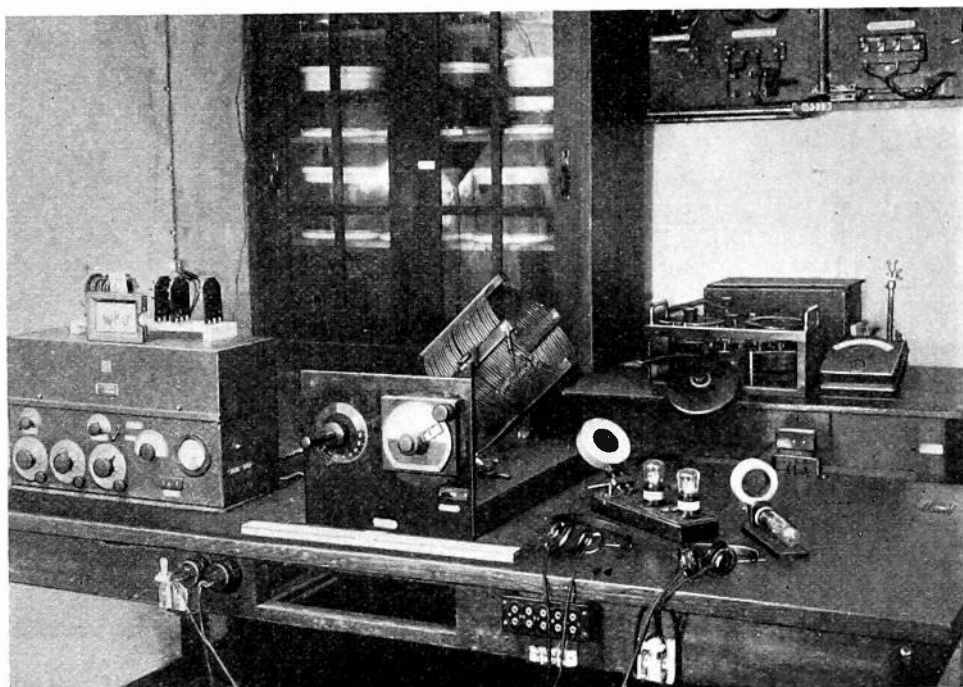

Fig. 2—Part of the first measuring apparatus in Geltow. Short-wave receiver, 160-kc test generator, and quartz standards.

the wavemeter was only about 0.03 per cent unless corrected by comparison with standards or used in a thermostat. The medium fundamental oscillation selected was a frequency of 160 kc (1900 meters) as the harmonic overtones could be separated easily at a wavelength of about 10 meters (approximately the 190th overtone). The range of the standard circuit suitable for this medium fundamental oscillation on changing the variable condenser from 10 deg. to 170 deg., included about 1900 meters ± 1.5 per cent so that the accuracy of reading the standard circuit whose variable condenser had a vernier and fine adjustment, is about 2 one-hundred-thousandths of the frequency. The

² E. Giebe and E. Alberti, *Z. S. f. tech. Phys.* 6, 92–103, 135–145, 1925.

fixed condenser has a capacity of about $5000\mu\mu\text{f}$ and the variable condensers about $200\mu\mu\text{f}$. In order to produce the fundamental oscillation which is variable within ± 2 per cent, a small test generator of about 5 watts (Figs. 1 to 3) is used in which the biasing of the tube and the external resistances are so chosen that about 200 overtones can be determined easily with a standard short-wave receiver. The resonance indicator is a very loosely coupled coil of few turns with detector and mirror galvanometer. Special emphasis was placed on good electric and mechanical damping of this galvanometer in order to make it quick

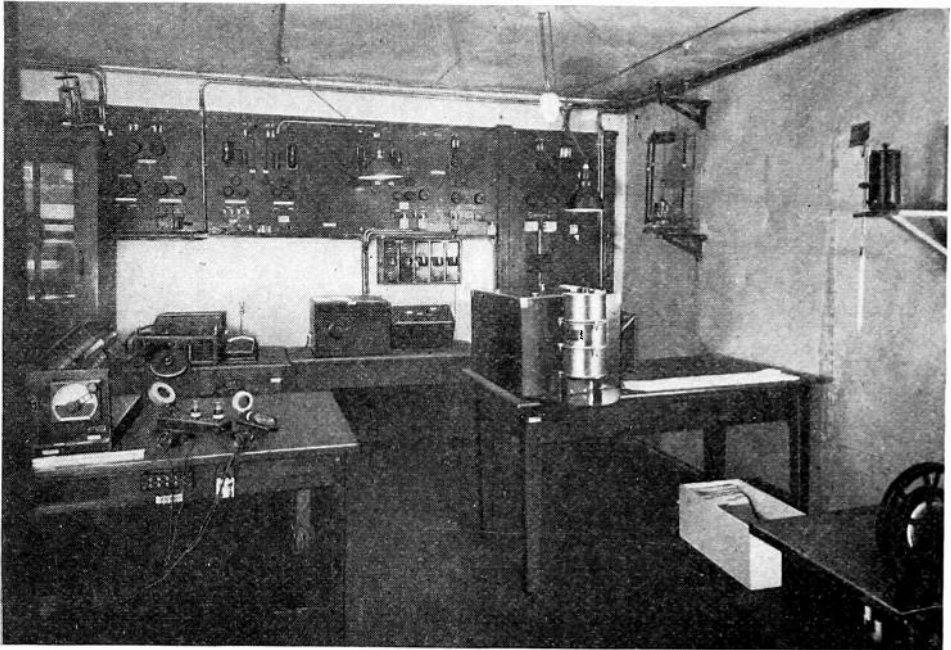

Fig. 3—Continuation of Fig. 2. Left: 160-ke test generator with quartz standards. Right: standard test circuit with mirror galvanometer and reading lamp. Center at rear: rough measuring apparatus.

reading. The oscillation circuit coil of the generator and the coupling coil of the indicator circuit are perpendicular to each other and each at an angle of 45 deg. with the measuring coil of the standard circuit in order to prevent the generator from exerting a direct effect on the galvanometer. Fig. 1 shows the essential wiring diagram of this first measuring device. Figs. 2 and 3 are photographs of the test room in Geltow and Fig. 4 the "luminous quartz" resonators that are used. The transmitting frequency to be measured is tuned in on the short-wave receiver (5) whose reradiation due to the use of a self-oscillating detector or to a separate heterodyne oscillator, is reduced by one or two preceding stages of screen-grid tubes. This permits almost every station being worked to be measured without disturbing the operation of any

communication channel, even when there are a large number of them in use.

Next a harmonic of the long-wave generator (1) coupled with the short-wave set, is caused to heat with the frequency being measured, and is adjusted to zero beat. The fundamental oscillator is measured with the standard circuit (2) and checked by means of the "luminous quartz" resonators (4). The calibration curve of the standard circuit (whose scale is large enough for the desired accuracy of reading) is verified by two or three "luminous quartzes" whose frequencies are uniformly distributed over it. On a change in temperature or capacity, the curve shifts exactly parallel a few hundred-thousandths, and consequently it is in general satisfactory to check with these quartz frequencies which lie near the value of the overtone being used.

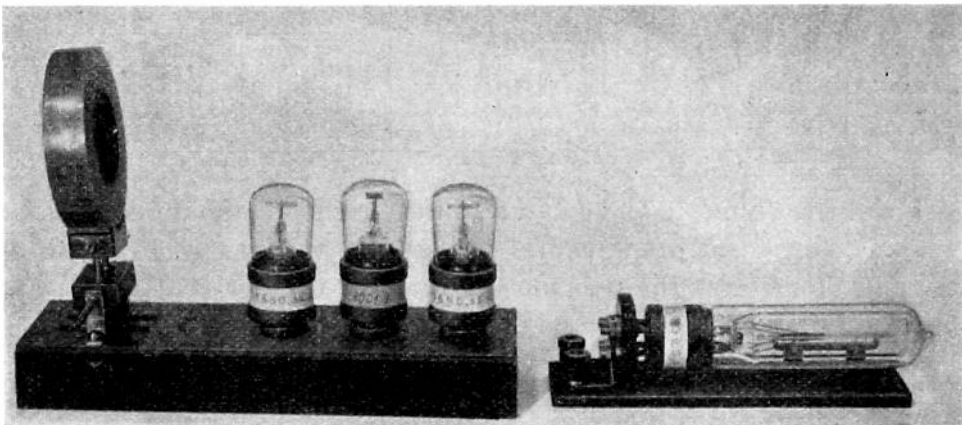

Fig. 4—Old (left) and improved (right) luminous quartz resonators.

At the same time as a result of the sharpness of response of the "luminous quartz" any effect on the calibration curve due to the coupling between standard and indicator circuit (8) with different detector sensitivity is eliminated. This also renders negligible any direct influencing of the indicator circuit by the generator.

The value of the fundamental oscillation obtained from the calibration curve (after correction) is now multiplied by the ratio number n , in order to obtain the desired harmonic which is equal to the frequency being measured. The value n is obtained either by measuring two adjacent overtones or by a rough measurement to about 1 per cent by the direct method. The rough measurement, made with the short-wave generator (7) and simple wavemeter (6) (Fig. 1) is accomplished by bringing the second harmonic to zero beat in order to reduce the spreading of the beat zero by "pulling in." Correspondingly, the wavemeter

is calibrated to twice the frequency. In order that the adjustment to zero beat may be made as exactly as possible, especial emphasis is placed on good sensitivity of the amplifier for low frequencies.

Table I gives for some frequencies between 14 and 40 meters, pairs of adjacent fundamental oscillations with their ratio numbers based on a medium fundamental oscillation of 150 kc (200 meters.) Here f (kc/s) is the frequency to be measured (equal to the harmonic overtone of the generator); f_1, f_2 are a pair of adjacent fundamental oscillations (index 2 for higher frequency); n_1, n_2 are the corresponding ratio numbers.

TABLE I

Frequency being measured (overtone)		Ratio coefficients		Adjacent fundamental oscillations		Difference in fundamental oscillations	
f (kc/s)	λ m	n_2	n_1	f_2 (kc/s)	f_1 (kc/s)	Δ (cycles)	Δ per cent
21420	14	142	143	150,845	149,790	1055	0.705
20000	15	133	134	150,376	149,253	1123	0.75
15000	20	99	100	151,515	150,000	1515	1.01
10000	30	66	67	151,515	149,253	2262	1.51
7500	40	49	50	153,061	150,000	3061	2.04

From the values in the columns on the right for the differences between two adjacent fundamental oscillations, we see that in the worst case (at 14 meters) the overtones are about 0.7 per cent apart, and therefore they can be separated easily.

As $f = c/\lambda = f_1 n_1 = f_2 n_2$ and $n_1 = n_2 + 1$, we get:

$$n_2 = n_1 - 1 = \frac{f_1}{f_2 - f_1}.$$

(On account of the difference term in the denominator the accuracy of the determination of n is n -times less than that of f_1 or f_2 , and hence in most cases in which the order of magnitude of the frequency is unknown, it is recommended that a rough measurement be first made. With longer waves, the application of the difference method is practically impossible if there is only one overtone within the measuring range of the long-wave circuit.

This method of using variable harmonics in each measurement is not so cumbersome as it appears at first glance. It has been found very practical after considerable experience with it in the duplex receiving installation of the Transradio A. G. in Geltow. The time required for a measurement varies between 2 and 10 minutes according to external conditions. With strongly modulated long-distance transmitters whose amplitude is weak and subjected to fluctuations, the measurement is

somewhat more difficult and generally takes about 10 minutes because of the difficulty in adjusting to the exact zero beat. The measuring room as shown in Figs. 2 and 3 contains also a tape recorder, so that in measuring interference from transmitters that operate at high speed, the call letters can be determined.

In Geltow, comparative measurements have been made simultaneously with the Radio Corporation in New York as frequently as possible, and show rather good agreement. Most of the differences are not half as much as the absolute accuracy of ± 0.01 per cent given by us. Table II contains some results obtained during the year 1929. It should be stated that the Transradio receiving office in Geltow makes measurements regularly (except for disturbances on its own lines) on almost all the short-wave transmitters from 14 to 50 meters in the world. The results are tabulated weekly, (about 1500 measurements per month).

TABLE II
COMPARISON OF FREQUENCY MEASUREMENTS ON SHORT-WAVE TRANSMITTERS*

Date 1929	Transmitter		Measured value (kc/s)		Difference	
	Call letters	Location	RCA	Transradio	kc, s	per cent
Feb.	WKM	New York	18870.0	18869.6	-0.4	-0.0021
Feb.	DGX	Nauen	20069.0	20069.6	+0.6	+0.0030
Mar.	DHA	Nauen	10478.0	10477.8	-0.2	-0.0022
May	DGX	Nauen	20046.3	20047.0	+0.7	+0.0035
May	DFA	Nauen	19615.4	19615.4	± 0	+0.
May	PPX	Rio	20569.8	20570.6	+0.8	+0.0039
May	WEL	New York	9018.3	9018.4	+0.1	+0.0011
Sept.	DFA	Nauen	19238.3	19238.0	-0.3	-0.0016
Sept.	DFA	Nauen	19238.3	19238.0	-0.3	-0.0016
Sept.	DFA	Nauen	19235.7	19236.0	+0.3	+0.0016
Sept.	DFA	Nauen	19235.6	19236.0	-0.4	-0.0021

* Made by the Radio Corporation of America in Riverhead and the Transradio A.G. in Geltow

II. MEASURING METHOD USING STANDARD GENERATOR WITH VARIABLE FUNDAMENTAL FREQUENCY

The method described above had to be changed in order to measure the short-wave transmitters in the Nauen radio station, as the standard circuit and the mirror galvanometer were too strongly affected by the long-wave transmitters (DFW and DFY) in operation there. At the same time, the previous Geltow method, which had been developed around already existing apparatus, was improved and simplified.

1. Standards

"Luminous quartz" resonators (of an improved construction) serve the same purpose as before. In the previous construction the "luminous quartzes," oscillating longitudinally with a natural oscillation of about 160 kc/s, were loosely held in a metal holder as shown in Fig. 5. As the grip was not positive, their constancy was somewhat reduced,

The Physikalisch-Technische Reichsanstalt, therefore, generally cannot guarantee these quartzes to more than ± 0.01 per cent, as the breadth of luminous response and the illuminating potential may vary from sample to sample. Recently however Giebe and Scheibe have obtained very much better results with low- and medium-frequency quartz resonators. According to a personal communication from Prof. Giebe and Dr. Scheibe, the temperature coefficient of these new longitudinally excited quartz rods is about 2 to 4×10^{-6} per degree C. Their constancy, determined over a period of two years was about 1×10^{-5} . Therefore, it was not necessary to obtain a special calibrating apparatus with chronograph for constant checking of the standards as must



Fig. 5—Old type of luminous quartz resonator for 150 kc in metal holder.

be done with oscillators. It is enough to have these secondary standards tested once a year by the government standards department (by the Bureau of Standards in America, or by the Physikalisch-Technische Reichsanstalt in Germany). It is recommended that several resonators be secured, as their intercomparison makes it possible to test their constancy quickly and with accuracy.

These new "luminous quartzes" are supported at nodal points by silk threads practically eliminating the effect of the mounting on the

constancy and damping. Since quartz rods with a fundamental oscillation of 150 kc are only about 20 mm long, they cannot easily be mounted in this manner. Resonator rods four times as long are therefore chosen and are excited longitudinally in the fourth harmonic. This design proves to be very good. The rod lights up satisfactorily with fourth harmonic excitation, and the breadth of luminous response with

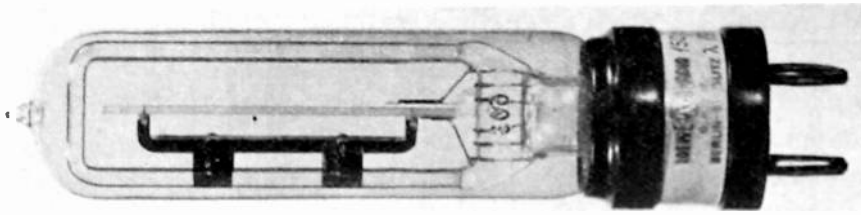

Fig. 6—Luminous quartz resonator of the latest type, for 150 kc.

loose coupling is about 1 to 2 one-hundred-thousandths. A photograph of the new quartz resonator is shown in Fig. 6, while Fig. 7 shows a diagram of the quartz with electrodes and coupling coil. It is to be noted, also, that the adjustment of the generator to the quartz resonant frequency is possible not only visually by adjusting to maximum brightness, but also acoustically with the aid of a low-frequency ampli-

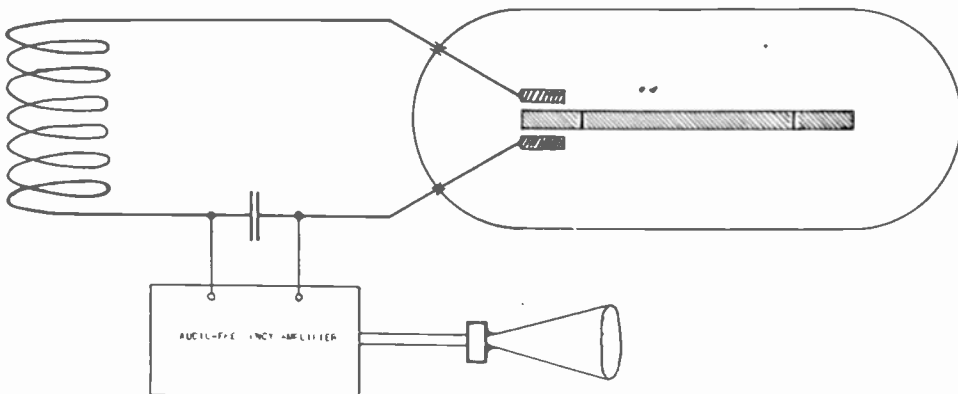

Fig. 7—Diagram of a luminous resonator excited in the 4th harmonic, with coupling coil and amplifier for acoustic determination of resonance.

fier by tuning to the lowest pitch. During the illumination, which is only 0.001 to 0.002 per cent wide with a loose coupling, the glow discharge lights up most intensely at the exact resonance point. A constant loose coupling of the quartz reduces to a minimum the effect of the electrodes or coupling capacities (probably to less than 1 one-hundred-thousandth). The voltage necessary for lighting the quartz is

about 10 volts so that a small coil whose natural oscillation frequency lies far from that of the quartz resonance, is used in a loose coupling for

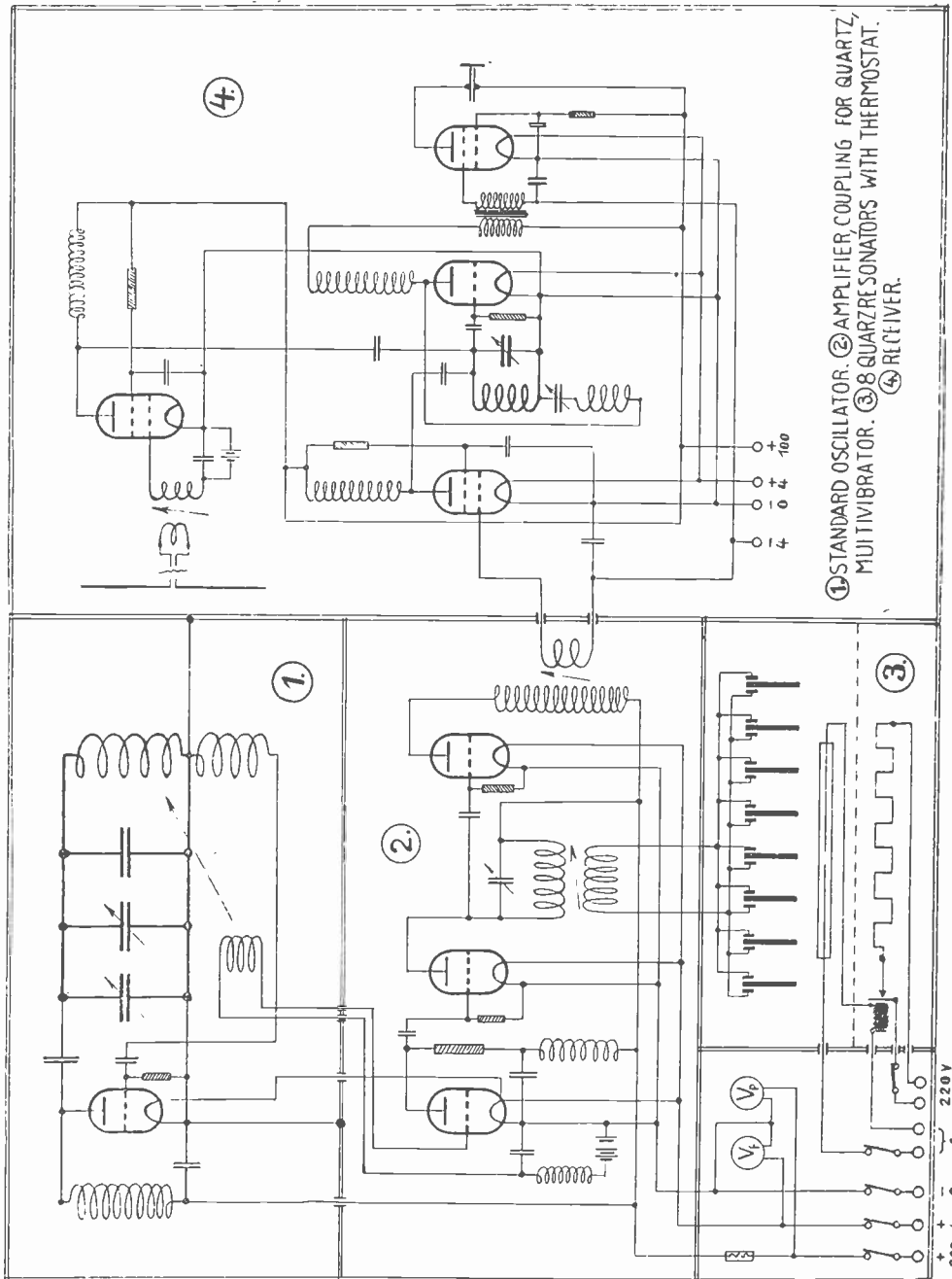

Fig. 8—Essentials of the wiring diagram for the frequency-measuring apparatus at Nauen, which has an accuracy of ± 0.001 per cent.

adjusting to resonance. Because of the stable construction of this quartz resonator arrangement and its other good properties, the absolute accuracy of these quartzes (assuming selected material and proper

cutting) can be certified to 1 one-hundred-thousandth by the Physikalisch-Technische Reichsanstalt.

2. *Method of Measurement*

The procedure has been greatly improved and simplified, and the variable fundamental frequency feature is retained. The long-wave generator (1) (Fig. 1), the standard circuit (2) with its indicator circuit (3) and luminous quartzes (4) have been replaced by a single piece of equipment, the standard generator (1) to (4) in Fig. 8, which shows a general wiring diagram of the new arrangement. The range of the standard generator was first made 150 kc (2000 meters) ± 1 per cent for a short-wave test region of 10–45 meters. This latter can be extended up to the broadcast band (i.e., from 45 to 300 meters) by adding a second test heterodyne.

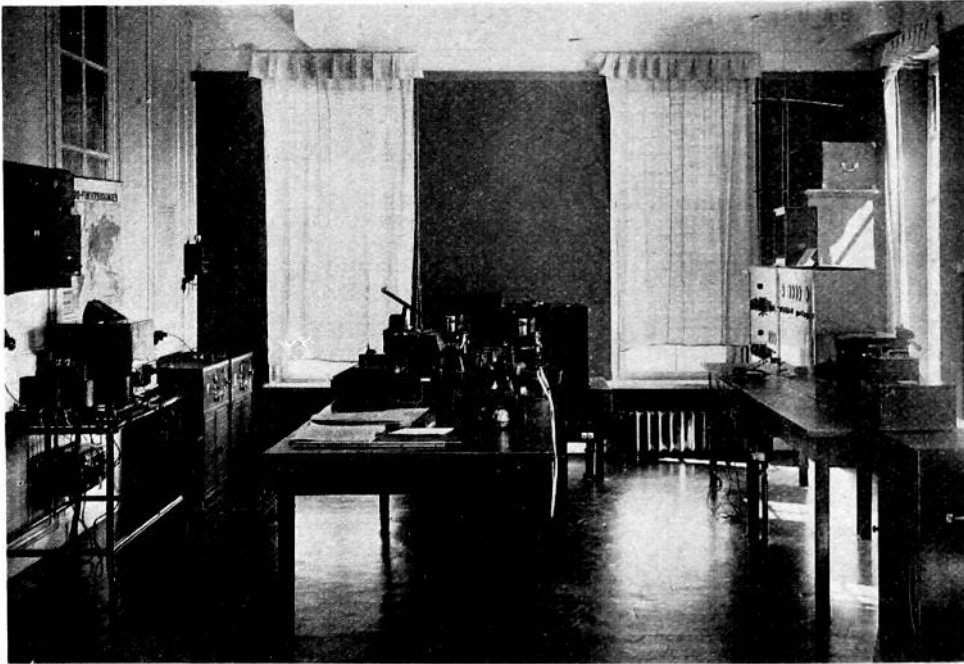

Fig. 9—Central monitoring and test room at Nauen.

The oscillation circuit of the generator in addition to a rigidly constructed coil has a fixed standard condenser of about 8000 $\mu\mu\text{f}$ capacity and 2 precision variable condensers of 200 $\mu\mu\text{f}$ and 40 $\mu\mu\text{f}$ with fine adjustment and are read with a vernier. These condensers were made according to the designs of the Physikalisch-Technische Reichsanstalt. The accuracy of reading with the larger condenser is 0.001 per cent of the frequency, and 0.0002 per cent with the smaller. Readings are taken conveniently with a magnifying glass and artificial illumination of the

scale. The range of the standard generator, that is, $150 \text{ kc/s} \pm 1$ per cent, is covered by 8–9 approximately uniformly spaced luminous quartz resonators of the improved type mentioned above (fourth harmonic) shown by (3) in Fig. 8, so that the frequency separation of these secondary standards is about 0.2 per cent or about 300 c/s. In order to ensure that the couplings of the standard generator to the luminous quartz and to the oscillating detector shall be without reac-

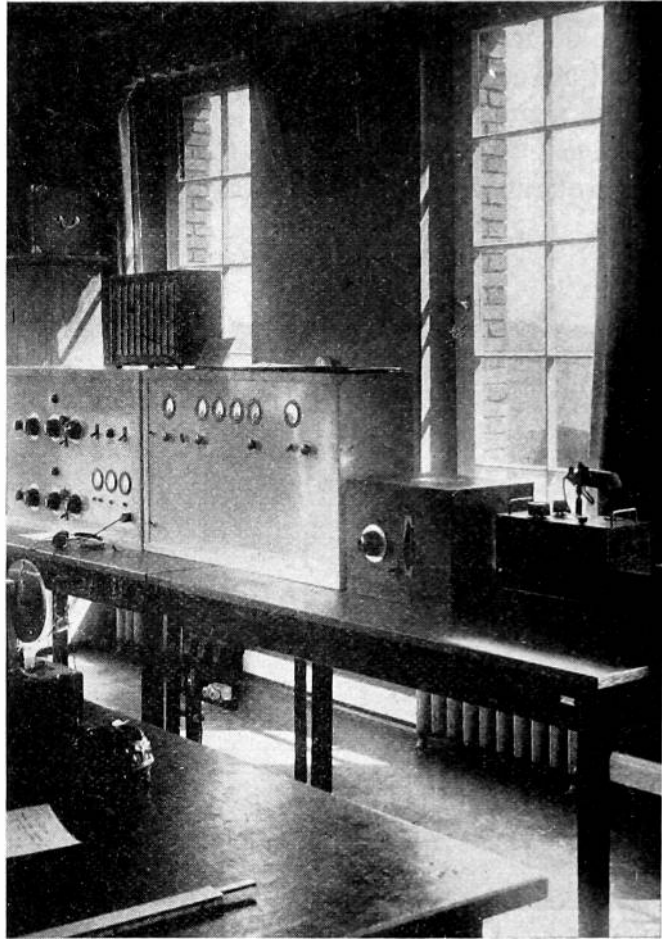

Fig. 10—Partial view of the Nauen monitoring room.

Left: Test and monitoring receiver (10–50 meters).

Center: Rectifier for single- and two-phase current.

Right: Rough measuring apparatus (to ± 0.05 per cent).

tion to one or two parts in a million over the great variation range necessary, special amplifier and multiplication stages (2) are provided. The first amplifier tube operates wholly in the region of negative grid potentials and obtains its energy free from reaction through a coupling

coil from the standard generator which is placed in a well-shielded box. The coupling coil has a ball joint and is so adjusted that it lies in the field of the standard generator, but perpendicular to the magnetic flux of the coil fields of the two long-wave machine senders. In spite of the small distance between them (about 50 meters) their influence is so slight that it practically can be disregarded.

The luminous quartzes are placed in a special heat-insulated box (3) the temperature of which is kept at $30 \text{ deg. C} \pm 0.2$ per cent by a thermostat (contact thermometer). The quartzes are visible from the outside through a well-shielded slot and can easily and conveniently be ad-

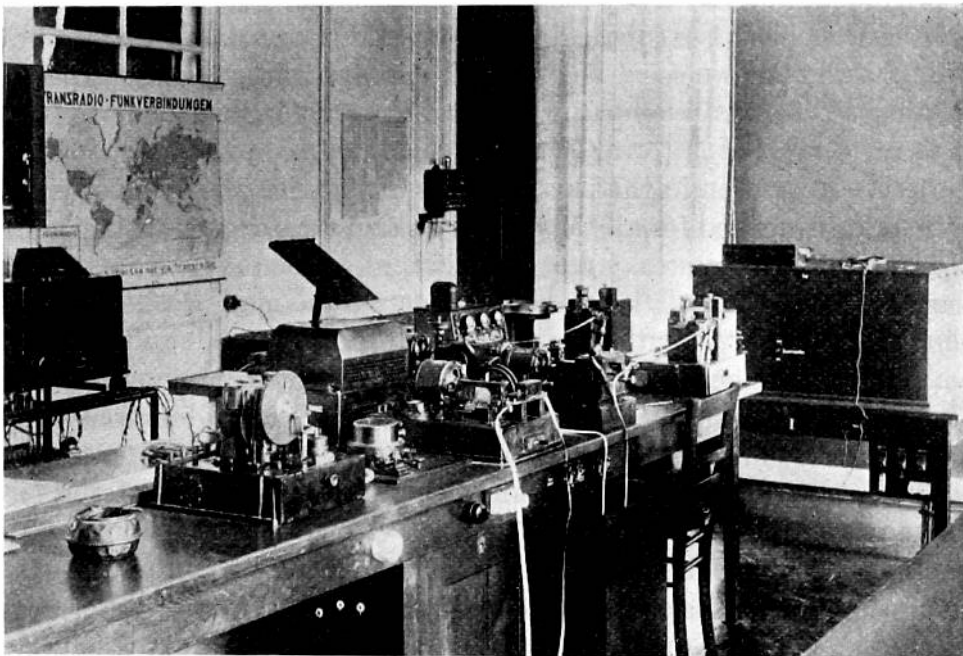

Fig. 11—Partial view of the Nauen monitoring room.

Center: Monitoring undulators, signal transmitter, perforator, etc.
Right: Standard generator (1) to (4) Fig. 8).

justed to resonance from the outside, even in bright daylight and with low intensity of luminosity and narrow breadth of luminous response. The adjustment can be made at the same time by the acoustic method (see Fig. 7). The standard generator, the amplifier and multivibrator stages and quartz resonators are located in separate boxes in the same cabinet.

The oscillating detector of the receiver (4) in Fig. 8 is preceded by two screen-grid tubes in parallel that are used independently of each other to provide reaction-free variable coupling to the antenna

and to the harmonics. The receiver is so rigidly constructed that there is a change in note only with rather violent vibrations.

In addition, the receiver at the Nauen radio station has been so accurately shielded and screened, and the energy acting on the receiver has been so positively controlled, that not only can the carrier waves of the 12 short-wave transmitters now in Nauen be measured quickly and reliably from the central station, but the band widths and any secondary waves can be detected and measured. Fig. 9 shows a picture of the central control room in Nauen. In the other center at the rear there is the standard driver that is connected with the receiver (visible at the right) by a conductor in order to transmit the overtones. In the front at the right is placed the rough measuring device. In the front center there is a control board with undulators, keys, perforators, etc. On the left we see a Siemens oscillograph with its accessories by means of which, through rectifiers in each transmitting room, there is positive central monitoring of the keying, modulation, and distortion. Details can be seen in the partial views in Figs. 10 and 11. Only one attendant is needed for all these controls and measurements.

In making a frequency measurement, as in the previous method, a harmonic overtone of the standard generator is made to beat in the short-wave receiver, with the frequency to be measured, and adjusted to zero beat. The harmonic is always between two luminous quartz resonators whose frequency is known exactly to 1 one-hundred-thousandth. The functional relation of the frequency to the condenser position is linear to 1 to 2 one-hundred-thousandths because of the low value of the ratio of the variable condenser capacity to the fixed condenser capacity, and hence the ratio of the coil self-inductance to the total capacity (L/C), is also linear. If f_2 is the frequency of the higher-frequency standard quartz and f_1 is that of the resonator with a lower frequency value, and if α_1 and α_2 are the condenser positions in question and α the condenser position for the overtone adjusted to zero beat, we get for the desired frequency f , the value

$$f = f_2 - \beta(f_2 - f_1)$$

where

$$\beta = \frac{\alpha - \alpha_2}{\alpha_1 - \alpha_2}$$

In order to get a measuring accuracy of 1 to 2 one-hundred-thousandths, it is only necessary that the standard transmitter remain constant during the measurement, and this can be checked rapidly by making several relative measurements. In order to be able to take into considera-

tion the deviation of the frequency curve from a straight line in still more accurate relative measurements by including a correction factor, great importance was laid on a stable type of generator. In addition, the standard generator has a second variable condenser ($40 \mu\text{mf}$) whose range just covers 2 of the luminous quartz frequencies and permits a reading accuracy of 1 to 2 millionths. Separate stationary batteries (with one in reserve) of sufficient size are used as the source of current for receiver and standard generator, thus ensuring a satisfactory constancy of operation. Because of the extraordinarily easy and convenient adjustment of the generator to the luminous quartz resonators and likewise to the zero beat with the frequency to be measured, the overtone measurement requires only one-fifth of the time required for the measurement by the old method with the standard circuit with detector and mirror galvanometer.

Although we were able to damp the mirror galvanometer so that mounted even without a solid support, the rest position was reached in a few seconds even during vibrations, the relative accuracy of measurement at the maximum position was not the same as the accuracy of adjustment. Only by "bracketing" the maximum value and by making several relative measurements, could the relative accuracy be made equal to the accuracy of adjustment, which could be tested easily by measurements on several adjacent overtones. If in addition, a calculating machine is used in order to evaluate the overtone measurement, an exact measurement with an absolute accuracy of ± 0.001 per cent requires only 2 to 5 minutes with skillful operation of the apparatus. This rapid measurement is highly desirable for modern high speed duplex communication on short waves with the frequent interferences of frequency due to other transmitters, which necessitates rapid manipulation.

III. METHOD OF MEASURING WITH A STANDARD GENERATOR USING A FIXED FUNDAMENTAL FREQUENCY

There is a third method of measurement, in which only one standard is employed, and which has been used recently in the Geltow duplex receiving set. The other methods worked with variable fundamental frequency, while the new method uses a fixed standard fundamental frequency produced by an auxiliary generator. A wiring diagram showing the arrangement in this method, is given in Fig. 12. The auxiliary generator (1) is kept to the standard fundamental frequency by the latest type of luminous quartz resonator (2). A thermostat keeps the temperature of the quartz constant at the value calibrated by the Reichsanstalt. The temperature regulation is accomplished by a con-

tact thermometer with a tube relay in the circuit. The harmonics of the fundamental frequency are carried through multiplication stages

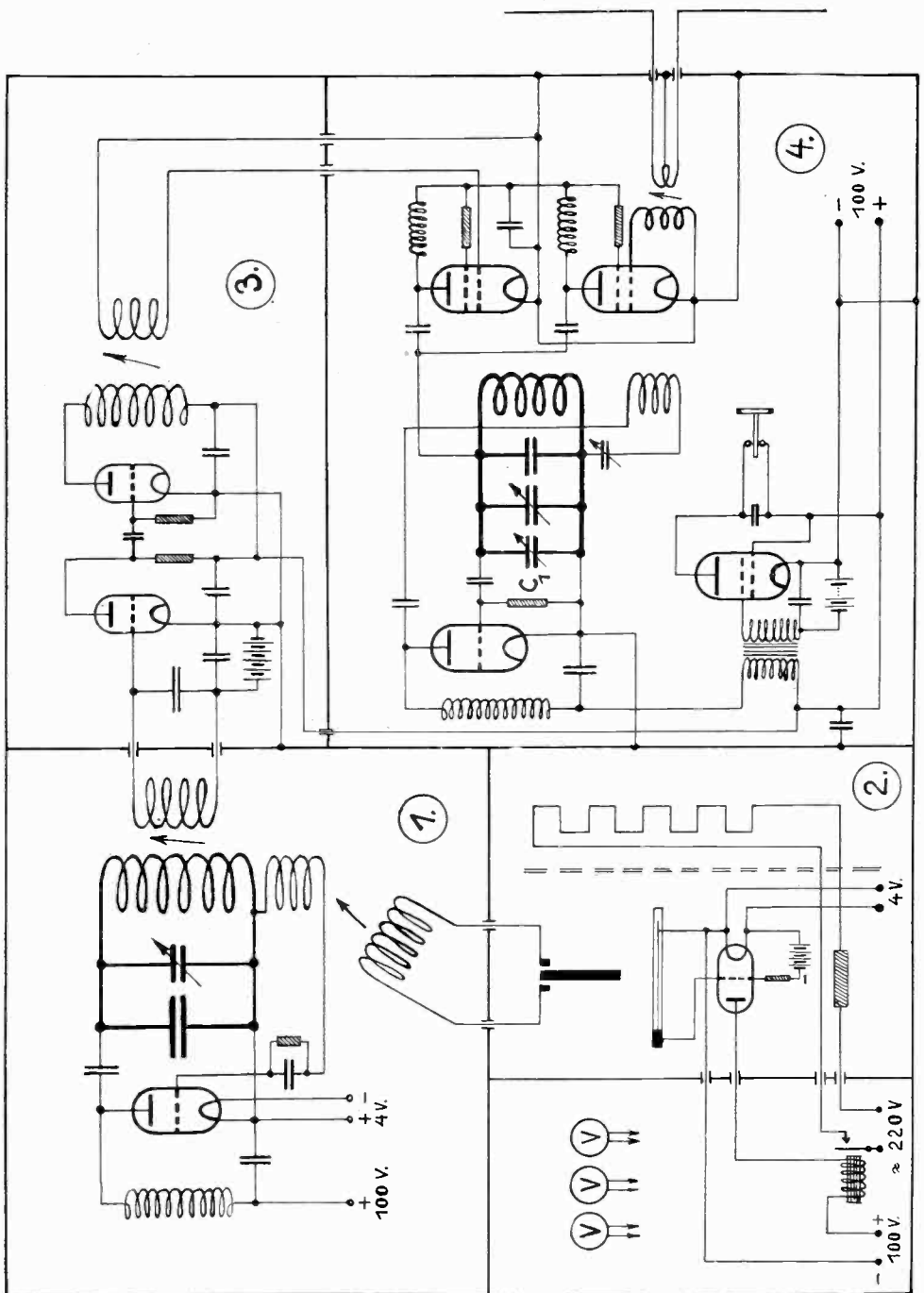

Fig. 12—Diagram of the third method of measuring frequency (Geltow) with fixed fundamental frequency and interpolation of the measured frequency between two adjacent harmonics.

(3) to a reaction-free oscillating detector receiver (4). Two screen-grid stages are connected in parallel before the audion proper, one being used for reaction-free transmission of the overtone, and the other to

couple to the antenna. The couplings of the harmonics as well as of the remote received signal can be varied from maximum to zero as in method II, so that in the oscillating audion the remote received signal and the harmonic can be made to beat in turn without reaction and independent of each other. The oscillation circuit of the audion has a standard variable condenser of very small capacity (about $4 \mu\mu\text{f}$) in addition to a small fixed condenser and an ordinary tuning condenser. This distribution of the capacities is chosen so that the range of the small precision variable condenser bridges 1 to 2 adjacent overtones of the standard generator for the wavelength range of each coil. The measurement is then done in a simple manner by "bracketing" the frequency to be measured between the adjacent overtones and interpolating linearly between these points on the condenser scale whose calibration is known absolutely to 1 one-hundred-thousandth. The ratio of the capacity of the standard condenser to that of the other condensers is so small that the linear interpolation causes only a very small error that lies within the order of magnitude of the accuracy of the reading. As the frequency of the oscillating audion is measured by this method, the oscillating audion should be capable of adjustment as accurately as possible to zero beat with the frequency that is to be measured. The batteries for the entire arrangement are constantly checked so that the frequencies of the standard generator and oscillating audion remain constant to a few millionths during the measurement. We have been so successful in getting good receiver stability, that even on making a measurement at 14 meters (21,400 kc) there is no noticeable tone distortion due to vibrations. This measuring device is very small and can be placed, with the rough measuring device, on a relatively small table. Methods similar to the above, but using quartz oscillators, were used by Bogardus and Manning³ for frequency measurements in the broadcast range. The authors likewise interpolate the frequency being measured, between two adjacent overtones, but they use an ordinary wavemeter that first must be tuned to the harmonics and the frequency being measured, by means of an auxiliary generator using visual and acoustic methods. The much simpler and more refined method of using the oscillation circuit of the audion for making the interpolation directly is therefore new, obvious as it may be.

In addition it should be mentioned that the frequency being measured can be found not only by interpolation, but also by adding a constantly variable medium frequency in the well-known manner. The calibrated auxiliary generator is then checked by several luminous quartz resonators. It is essential here to tune in the harmonic through

³ See bibliography.

an intermediate, slightly damped circuit so that no disturbing interference will be obtained. If the distance between the overtones is made sufficiently large, the tuning circuit can be calibrated in harmonics, so that the rough measurement previously required is not needed. In order to determine the frequency in question therefore, the frequency of the medium-frequency auxiliary transmitter is added to or subtracted from the frequency of an harmonic adjacent to the frequency being measured (found from tabulated calibration), depending on whether the former is less or greater than the latter. The manipulations in these methods are very simple and rapid.

IV. USE OF LUMINOUS QUARTZ RESONATORS FOR DIRECT FREQUENCY MONITORING AT THE TRANSMITTER

Another frequency monitoring method that has been tested at the transmitter itself, involves placing luminous quartzes, in one of the first transmitter stages.* Several resonators close together in frequency can be installed and then we have a monitoring device that works exactly like a reed frequency meter at low frequencies.

When using a resonator for the frequency checking, the simultaneous use of the acoustic resonance indicator method is highly recommended. For example, the chief operator at the central office can check the frequency of each transmitter acoustically and can ascertain immediately if a transmitter is off frequency.

Bibliography

1. E. Giebe and A. Schiebe, "Internationale Vergleichenungen" etc. *Jahrb. drahtl. Tel.*, 33, No. 5, p. 176; May, 1929.
2. E. Giebe and E. Alberti, *Z.S.f. techn. Phys.*, 6, 92-103 and 135-145, 1925.
3. Henry L. Bogardus and Charles T. Manning, "The routine measurement of the operating frequencies of broadcast stations," *Proc. I.R.E.* 17, July, 1929.
4. J. H. Dellinger, "The status of frequency standardization," *Proc. I.R.E.*, 16, 579; May, 1928.
5. Robert H. Worrall and Raymond B. Owens, "The navy's primary frequency standard," *Proc. I.R.E.*, 16, 778; June, 1928.
6. L. P. Wheeler and W. E. Bower, "A new type of standard frequency piezo-electric oscillator," *Proc. I.R.E.*, 16, 1035; August, 1928.
7. J. R. Harrison, "Piezo-electric oscillator circuits with four-electrode tubes," *Proc. I.R.E.*, 16, 1455; November, 1928.
8. Earle M. Terry, "The dependence of the frequency of quartz piezo-electric oscillators upon circuit constants," *Proc. I.R.E.*, 16, 1486; November, 1930.
9. R. C. Hitchcock, "A direct reading radio-frequency meter," *Proc. I.R.E.*, 17, 24; January, 1929.
10. J. Warren Wright, "The piezo-electric crystal oscillator," *Proc. I.R.E.*, 17, 127; January, 1929.
11. L. M. Hull and J. K. Clapp, "A convenient method for referring secondary frequency standards," *Proc. I.R.E.*, 17, 252; February, 1929.

* As the procedure followed in monitoring a transmitter by the use of these resonators is detailed by the author in the paper of the author "Monitoring the Operation of Short-Wave Transmitters," this issue, page 214, it does not seem necessary to repeat it here.—Ed.

12. E. L. Hall, "A system for frequency measurements based on a single frequency," *Proc. I.R.E.*, 17, 272; February, 1929.
13. G. Pession and T. Gorio, "Measurement of the frequencies of distant radio transmitting stations," *Proc. I.R.E.*, 17, 734; April, 1929.
14. Seikichi Jimbo, "Measurement of frequency," *Proc. I.R.E.*, 17, 2011; November, 1929.
15. J. R. Harrison, "Push-pull piezo-electric oscillator circuits," *Proc. I.R.E.*, 18, 95; January, 1930.
16. P. von Handel, K. Krüger, and H. Plendl, "Quartz control for frequency stabilization in short-wave circuits," *Proc. I.R.E.*, 18, 307; February, 1930.
17. H. Mögel, "Exakte Frequenzmessung kurzer Wellen," *Telefunkenzeitung*, No. 52, p. 54 and No. 53, p. 44, September, 1929.
18. H. Mögel, "Einige Methoden zur Frequenzmessung von kurzen Wellen," *E.N.T.*, 7, No. 4, p. 135, 1930.

MONITORING THE OPERATION OF SHORT-WAVE TRANSMITTERS*

BY

HANS MÖGEL

(Transradio, Berlin, Germany)

Summary—A discussion is given of all the methods of monitoring the variations in the radiated high-frequency energy which occur in the operation of short-wave transmitters which have been used in the five years' experience of the great Nauen radio station of the "Transradio A.G." Berlin, for overseas wireless communication. The monitoring apparatus is in part located at each transmitter or transmitter group and in part centrally located. Experience has shown that the monitoring of the keying, the modulation (wave-form and degree of modulation), the frequency of the carrier waves, side bands, and any adjacent waves which may possibly be present at a large short-wave transmission station where the separate short-wave transmitters are located in separate buildings within a radius of 1 to 2 km, is most advantageously effected by being centralized, whereby only one or two attendants are needed.

I. GENERAL

THE continuous monitoring of the radiated high-frequency energy is important in the operation of a large short-wave transmitting station. The demands made by operation on the monitoring equipment have greatly increased in recent times, due to the increased transmitting speed in telegraphing, the use of facsimile transmission, and multiplex telegraphy, and furthermore because of the high demands made by overseas telephony and especially by the great increase in the number of short-wave stations. The monitoring of the energy radiated is concerned chiefly with the following matters:

- (a) Testing the keying, i.e., the make and break and the amplitude constancy of the signal in telegraphy and facsimile transmission.
- (b) Monitoring and measurement of the degree of modulation by tone, telephony, facsimile, etc.
- (c) Measuring and testing the wave-form of the modulation (with tone) for simplex and multiplex telegraphy.
- (d) Measuring the frequency of the carrier wave with an accuracy of 0.001 per cent.
- (e) Measuring the width of the channel.
- (f) Determining and measuring adjacent waves.
- (g) Monitoring the antenna characteristics for directional antennas.

* Decimal classification: R614. Original manuscript received by the Institute, June 7, 1930. Translation received by the Institute, September 26, 1930.

The systems dealt with in this paper have general significance, although in the main the specific systems described are those tried out at the Nauen station. They are in accordance with present practice and have proved successful. At present there are at Nauen, besides the two long-wave transmitters, 12 short-wave sets for overseas service. Some of the transmitters are in the main building, others are in special short-wave houses located around the main building and about 500 meters from it. The monitoring of all the short-wave transmitters is handled centrally of late, by one attendant in the main building. In constructing the frequency measuring apparatus there was some difficulty at first, due to the effect of the strong long-wave fields but this has been sufficiently overcome for all practical purposes.

II. MONITORING INSTALLATIONS FOR KEYING AND MODULATION

In telegraphy, keying is taken to mean the whole amplitude variation from one signal to the next, i.e., it includes the breaks (periods of no current). The make and break in the groups of oscillations is of special interest here. Poor signaling is hardly ever caused by trouble in the mechanical (automatic) sender or in the line relays (chattering, etc.); in modern multistage transmitters the trouble must be looked for in one of the keyed stages. Sometimes there is a minor fault in the keying line, which may have a most unfavorable effect on transmission. Thus, for example, the receiving station of the "Transradio" company at Geltow has noted that many overseas transmitters have faulty keying which has continued for months and in some cases for years, so that they have become characteristic of the particular transmitter.

1. *Oscillograms showing poor keying*

In order to show what kinds of signal distortion occur most frequently we shall first show some oscillograms made at Geltow for distant short-wave transmitters. One must be very careful in interpreting oscillograms made at the receiving end, because, as is well known, double and multiple signals and nearby echoes can cause effects similar to those due to a faulty transmission; also, overloading of the last detector or in a low-frequency stage in the receiver can cause apparent signal distortion.

Fig. 1 shows rounded and distorted signals of a transmitter in Central America. Here the impression is obtained as if the signal came from a long-wave transmitter which was keyed at high speed. However, the sending speed in Fig. 1 is less than 20 words per minute. At higher speed the signals would completely run into each other and no longer be legible.

The signals shown in Fig. 2 are of a somewhat different and yet similar character. Here also, they are rounded and broken up at the end of the signal, even torn apart in the case of the dash. One of the



Fig. 1—Rounded and blurred signals of a Central American transmitter of about 16-meter wavelength. 1000-cycle timing wave at bottom.

Japanese transmitters has now been operating for more than a year with this poor keying.



Fig. 2—Rounded and chopped signals of a Japanese transmitter ($\lambda=15$ m). 1000-cycle timing wave at bottom.

Fig. 3 shows so-called "distortion signal pulses" or overhanging signals which appear at times in the signals from a South American transmitter, and which can be laid to poor neutralization in the last stages.

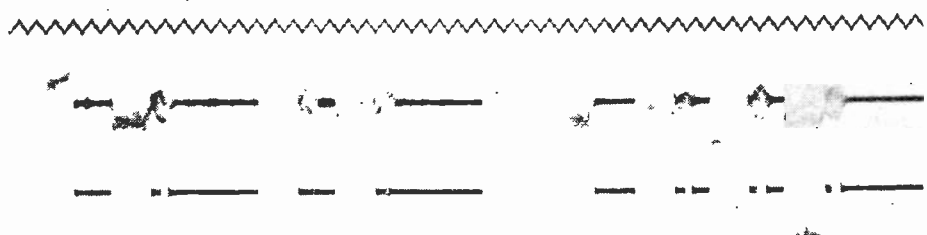

Fig. 3—Poor keying of a South American transmitter. Center: without receiver limitation. Bottom: with receiver limitation. 50-cycle timing wave at top.

In the middle line there is shown the approximately true reception (moderate amplitude) recorded when the oscillograph element is inserted immediately after the monitor unit of the large Telefunken re-

ceiver,¹ while the lower line shows the amplitude, (limited above and below) which is obtained when the record is made at a point following the tone control unit. We see that those distortion signal pulses "S," the amplitudes of which are about one-third of the signal amplitudes, are more or less completely suppressed by the tone control unit. Where the maximum amplitude of these pulses is less than one-fourth of the signal amplitude, we see that the tone control apparatus absolutely suppresses them. It should be noted that the limits of the amplitude above and below in records such as shown in the lower line can be changed almost at will in the large Telefunken receiver mentioned above. For example, the lower limit in Fig. 3 could be so set that the distortion signal pulses shown in the lower line would disappear even when their amplitude is as great as one-third of the signal amplitude. However, one would then in addition have to operate with automatic



Fig. 4—Relay chatter in connection with poor neutralization of the end stages of a Chinese transmitter. 1000-cycle timing wave at bottom.

amplifying regulation in the high- and intermediate-frequency stages, in order that the main signals should not disappear in the tone control unit when a certain amount of fading occurs.

Similar distortion signal pulses produced by other causes are shown in Fig. 4, which is an oscillogram of signals from a Chinese transmitter. Here we have to deal with chattering in the relays, combined with insufficient blocking of the tube being keyed and poor neutralization. As the keying occurs mostly with no load in the negative grid return circuit of the control tube, the chatter signals normally are rectangular and of the same amplitude as the true main signal. However, under the conditions mentioned above the distortion signal pulses of the Chinese transmitter, shown in Fig. 4, are pointed; full amplitude is not reached because of the comparatively large time constant. The mechanical (automatic) sender at the time was running without load,

¹ W. Runge, "Ein Kurzwellenempfänger für transoceanischen Schreibbetrieb," *Telefunkenzeitung*, No. 52, p. 43, September, 1929.

because of which automatic alternations were transmitted. These oscillograms can only be regarded as indicating the complexity of signal distortions, and the deception which may be caused thereby at the receiving end.

2. *Monitoring with an undulator*

It used to be considered that it was possible to get along by using only a so-called undulator recorder in connection with a rectifier for keying monitoring. These recorders, of which there are many types, consist of a coil system which moves in a strong magnetic field, and which



Fig. 5—A Morse tape recorded by a Siemens and Halske coil undulator.

actuates a recording stylus. A tape record from such an apparatus is shown in Fig. 5. Such a recording apparatus with a small rectifier which rectifies the high-frequency directly is placed close to each short-wave transmitter, so that the man attending the transmitter is at all

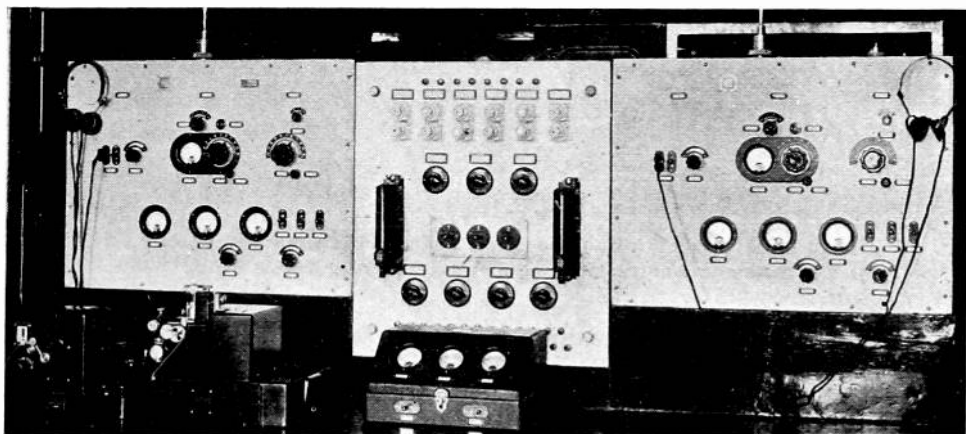

Fig. 6—Telefunken transmitter monitoring apparatus with oscillograph-rectifier, oscillating detector for the third harmonic, amplifier, and rectifier for single and double current and recording equipment for direct monitoring in the immediate vicinity of the transmitter.

times in a position to observe the signals sent out. Fig. 6 shows two sets of Telefunken monitoring apparatus with undulator recorder and accessories for one transmitting group. The apparatus has other control possibilities which are further discussed below.

However, such signal monitoring with an undulator can only be used if operated by skilled hands. When distortion occurs, the control must function very quickly making it exceedingly difficult for the attendant to deliver a good tape when the keying is bad. As is well known, the recorded signal can be controlled within a wide range

above or below, according to the amplitude available and according to the sensitiveness of the coil system, an advantage which is utilized in many ways in tape recording reception as indicated above. For control at the transmitter itself, however, the possibility of thus limiting the amplitude is a decided disadvantage. In order to follow the whole signal the needle must swing absolutely free at each end of its excursion; at the lower end there is also the distortion caused by the quadratic action of the rectifier. Let us assume for example, that the radiated signals end with a distortion signal pulse, as is the case in Figs. 3, 4, and particularly 7; the amplitude of the pulse being 20 per cent of the amplitude of the main signal. Now if the control attendant records these distorted signals completely at the bottom, (which he does not do in most cases), the distortion signal appears, because of the quadratic action in the lower part of the characteristic line, with only 5 to 10 per cent of the amplitude of the main signal according to the current in the rectifier tube; consequently, it is only just visible on the narrow record tape. If, in addition, the sensitive recording system is not accurately set, the needle in striking the stop lightly, will rebound and under certain circumstances produce a record similar in appearance to that due to a pulse. Thus the control attendant is apt to pay no special attention to it because he has accustomed himself to ascribe such slight irregularities to rebounds of the needle.

Now one might perhaps object that these overhanging signals of only one-fifth the maximum amplitude of the main signal are of no importance at the receiving end because, there one can set the lower limit of the recording apparatus at will. Unfortunately however, just the opposite is true; even with good receiving conditions it is well known one must limit the recorder on the upper side to about 80 per cent of the maximum receiving amplitude in order that the signal shall not disappear with 1:5 fading. For heavy fading of 1:10 such as is often present even when large directional antennas are used, one must accordingly set a limit at 10 times the value of the minimum amplitude. The pulses will be then always fully recorded with heavy signals, so that the Morse signals are no longer legible. These points are illustrated in Fig. 7. Line *A* shows the true main signal with the overhanging signal at a transmitting rate of 20 words a minute. Line *D* shows the same signals transmitted at 4 times the rate (80 words per minute). Lines *B* and *E* show the corresponding control tapes for the sending end, and *C* and *F* for the receiving end, the latter being adjusted for an upper limit of only five times the minimum. In the control record at the transmitter the pulses are only visible as small bends in the zero line; at the receiving end, on the other hand, the Morse signals are legible only if

the fading is small (without automatic amplification regulation) because only then do the pulses become small as compared to the limited signal amplitudes.

Hence an undulator requires great care when used for monitoring purposes at the transmitter and only to a very limited degree can one compare it with an oscillograph apparatus.

3. *Monitoring with an oscillograph*

The Siemens loop mirror oscillograph combined with a power rectifier has proved to be excellent in all cases. As shown in Fig. 8, some

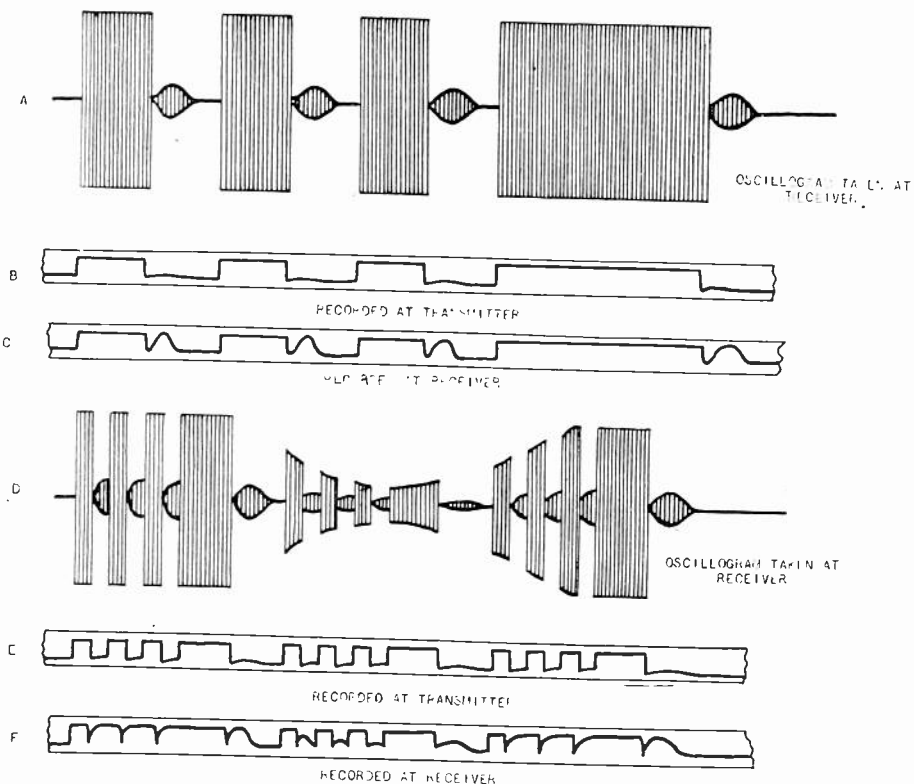

Fig. 7—Graphic representation of keying distorted by “overhanging signals” as shown by undulator monitor records at the transmitting and receiving ends.

energy is drawn from the antenna circuit of the transmitter through a small coupling coil and carried to a rectifier by a lead-covered cable. The necessary selectivity is amply assured by an intermediate circuit, and the amplitude can be regulated by two variable couplings. By means of a variable grid bias the working point is placed in the lower bend of the characteristic curve; in order to set the working point and the amplitude, an ammeter is placed in the plate circuit of the tube. Grid, filament, and plate voltages are taken from a “power pack.” All wires are shielded against high frequency. The whole apparatus, which

is extraordinarily simple, is built into a copper cabinet with several partitions. The oscillograph is connected directly in the plate circuit at the grounded point so that it is in no way endangered. In order to record the phenomena as exactly as possible, loops with a natural period of 10,000 cycles are used. Recently the new 20,000-cycle Siemens loops, which will take care of any monitoring necessary in operation, have been available. For a 30-mm deflection, the 10,000 cycle loop requires 60 ma, and the 20,000-cycle loop about 300 ma. This comparatively high current is easily obtained within the range of the negative grid voltage of the normal characteristic of modern

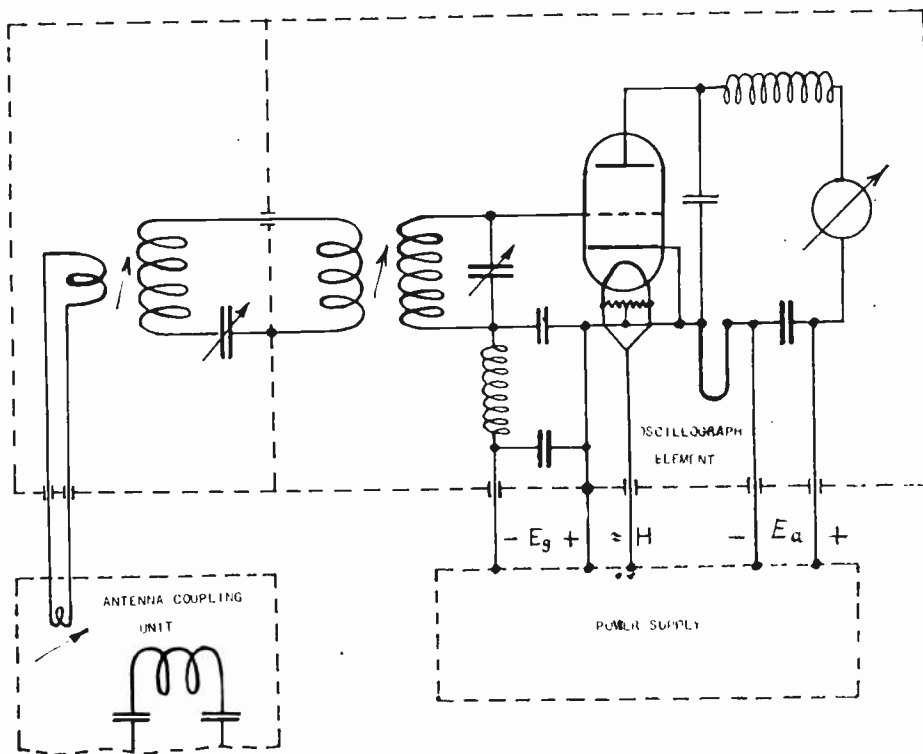

Fig. 8—Transmitting monitor rectifier for accurate oscillographic monitoring (central) of keying and modulation (wave-form and degree of modulation).

power amplifying tubes. The 20,000-cycle loop, moreover, has a considerably larger mirror so that even when running the oscillograph at high speed, good light is obtained for photographing as well as for observation. The Siemens oscillograph with high-frequency loops in most cases is preferred to the Braun tube for these monitoring uses, primarily because with the Braun tube the rapid development of the time axis causes difficulty. Recently, however, Braun tubes of great brilliance and strong actinic rays have been brought out, so that the question of using them for monitoring is being brought up again.

The transmission monitoring with an oscillograph can be conveniently arranged centrally as shown in Fig. 9, and can be operated by one man. In each transmitting house, or for each transmitting group, such a rectifier is set up which can be connected with each transmitter

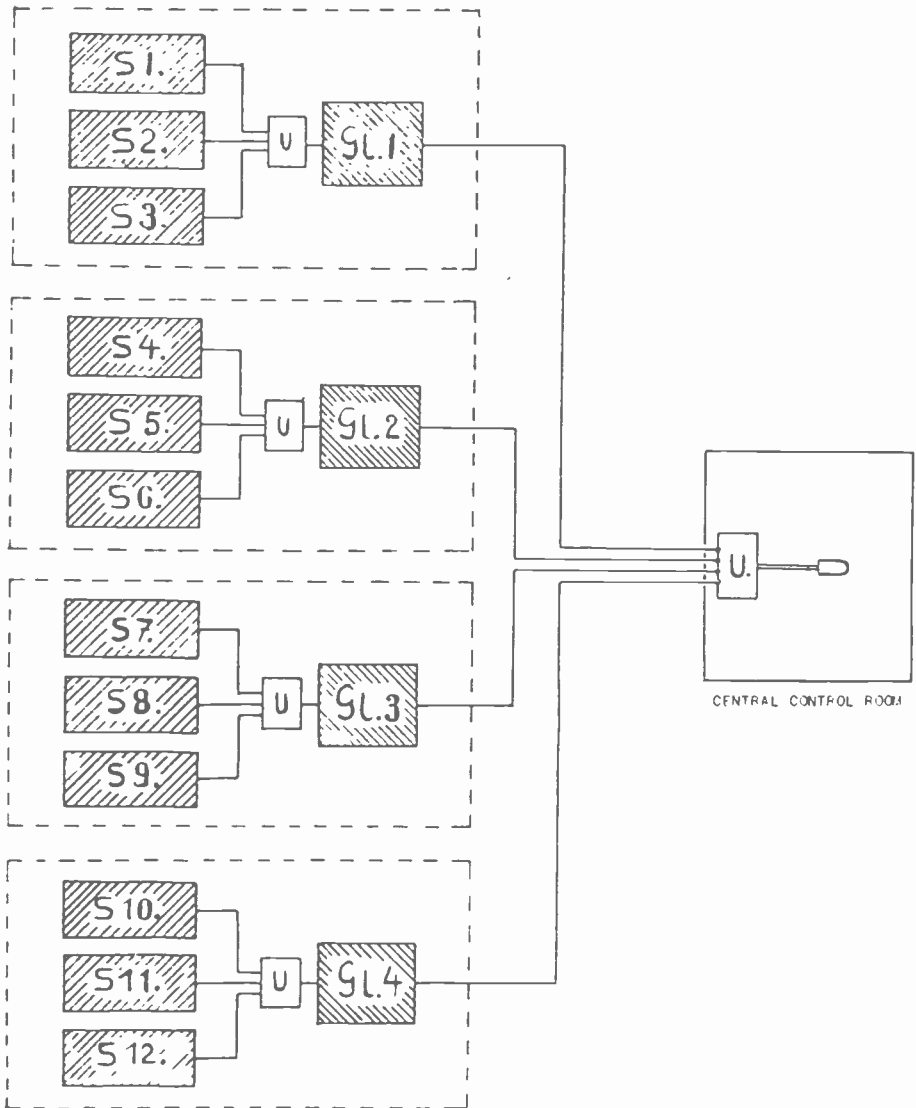

Fig. 9—Schematic arrangement of a central oscillograph monitoring system for 12 short-wavelength transmitters.

as desired, by means of a switch. Such a rectifier is also incorporated in the Telefunken transmission monitoring apparatus. Each rectifier is connected by a lead-covered cable to the oscillograph which is set up centrally, so that the man in charge of monitoring only has to request the transmission from the attendant by telephone, and within two

minutes he gets the oscillographic picture of the signal. As the oscillograph loops have only the very low resistance of $1/2$ to 1 ohm, the distortion due to the capacity of the lines is unimportant. At the Nauen station the longest line from the control house to a transmitting house has a capacity of 100,000 μmf . The apparent resistance at 10,000 cycles is then only about 130 ohms, so that the amplitude distortion, as compared with the lower frequencies, is of the order of 1 per cent. In the same manner, of course, an oscillograph can be set up in each transmission house, or at each transmission group, and thus several transmitters can be monitored at once. However, as trouble rarely occurs at several transmitters at the same time, one oscillograph set up centrally is usually sufficient. The present loop oscillographs developed by Siemens and Halske are not sufficiently convenient for this purely monitoring use. For other purposes also there is a need for a small compact loop oscillograph which could be easily handled by men not so highly

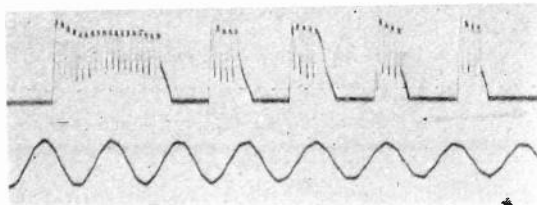

Fig. 10—Monitor record of a short-wave transmitter at Nauen with slightly distorted signaling. 50-cycle timing wave at bottom.

trained. I have in mind the small American loop oscillograph, the "Osiso" which is also frequently used in schools. A similar construction would be welcomed in Germany.

With the aid of the rectifier arrangement just described, not only can the keying of each transmitter be most accurately observed, but also the wave-form of the modulation and the degree of modulation can be very accurately determined and monitored. For example, one sees the oscillogram in Fig. 10, which was made by a short-wave transmitter at Nauen operating with a wavelength of about 15 meters, that the keying is somewhat faulty. Furthermore, by comparison with the 50-cycle time curve it is seen that the transmitter is approximately 60 per cent modulated at about 500 cycles. Also the wave-form can be determined from such a picture; for example, in Fig. 10 the wave is not sine shaped. After a little practice the wave-form can even be determined visually as the figure, which is crossed by the light rays, appears heavier and brighter at points where it changes comparatively slowly, than it does at the points where the change takes place very rapidly. In Fig. 10 the hair lines between the upper and lower limits

of modulation, which are hardly visible, were somewhat retouched in order to make them visible.

Fig. 11 shows a control picture made at Nauen at the high rate of 240 words per minute; here, with a modulation frequency of about 1000 cycles, only 5 modulation periods occur in one dot. The keying is exact; the normal working point for the modulation voltage lies in the upper part of the telephone characteristic, so that the high frequency is only cut off for a short time.

The wave-form of the modulation which is used in telegraphy so that reception does not cut out at once for slight changes either in the transmitting frequency or the heterodyning frequency of the receiver, has particular significance because with a rectangular wave-shape the

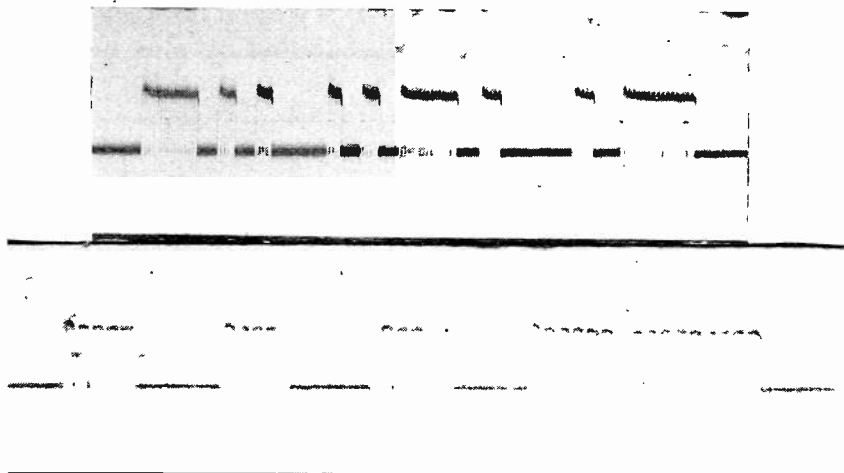

Fig. 11—100 per cent modulation of a short-wave transmitter at Nauen with good keying at a speed of 240 words per minute; above for slow, and below for fast, operation of the oscillograph drum.

side bands of the radiated frequency increase considerably with very rapid changes within the modulation period. This is not at all a rare occurrence. For example, at the overseas receiving station at Geltow, we can detect such disturbances far beyond the frequency channel of the carrier wave almost every day, by audible clicks at the make or break, or in each period of modulation.

Furthermore, the oscillograph loop provides a definite means of demonstrating the transient phenomena which are in part the cause of the great band width. If the duration of the transient is of the order of the natural period of the measuring loop or slightly less, the light point will shoot over the zero line or over the other limit and return to the former point of rest in $1/10,000$ or $1/20,000$ of a second, according to the loop used as can be seen, for example, in the oscillogram in Fig.

12; one can note here the hair lines below the zero line. Under such conditions, it is of course necessary that the holder be filled with castor oil and that the loops be in good condition.

Fig. 13 shows another modulation record of a transmitter at Nauen. Because of unfavorable coupling of the last stage, several distortion frequencies appear here at an unstable point in the telephone characteristic, which can be easily recognized in the picture and which in part produce adjacent waves.

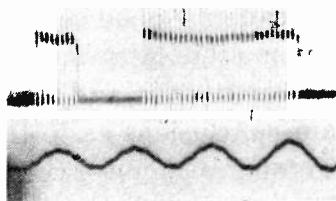

Fig. 12—Rectangular wave-form of the modulation of a short-wave transmitter at Nauen, showing the light point of the oscillograph overshooting the zero line. 50-cycle timing wave at bottom.

By using the 20,000-cycle loop the maximum and average modulation of the transmitter by speech transmission, can be read off directly; too little or too much modulation can be detected very quickly. In general the use of modulation measuring instruments is tedious, also measurements of the modulation voltage impressed on the transmitter are not always clear, as the telephone characteristic can usually be dis-



Fig. 13—Undesired modulation of a short-wave transmitter by distortion frequencies of about 500, 100, and 10 cycles. 50-cycle timing wave at bottom.

placed within wide limits, so that recalculations and repeated photographing of curves is necessary. It should also be mentioned that with this kind of monitoring the distortion by the quadratic part of the rectifier characteristic plays only a very minor part, as almost the entire characteristic in the range of the negative grid voltage is used, of which the quadratic part amounts to only a small percentage. In any case it pays to accept these slight distortions, when one realizes how simple is the arrangement and care of the apparatus.

It should be remarked here that an accurate monitoring of the keying and modulation of the short-wave transmitter at Nauen, at the

duplex-receiving station at Getlow about 30 km away, is not possible, because of the nearly always present phenomenon of near-by echos, which are due to "throwback" strong waves from the first two or three reflection zones from the Kennelly-Heaviside layer. This was discussed in greater detail in a supplement to an earlier paper on double and multiple signals with short waves.²

At this point mention should be made also of the fact that there are other methods of monitoring, keying, and modulation, some of which are very simple. Here we shall only mention the aperiodic circuit, the so-called tone tester, which can give good service in connection with a telephone or a small galvanometer. A trained ear can easily detect irregularities in keying by the sputtering and clicking. With tone modulation we can draw certain conclusions as to the wave-form from the tone quality. One can also roughly monitor the modulation by comparing the loudness of the direct-current clicks caused by opening and closing the telephone circuit, with the loudness of the modulation. Hence a tone tester, inherited from the tone arc period, should not be lacking in any short-wave transmitting station.

III. MEASURING THE FREQUENCY OF CARRIER WAVES SIDE BANDS, AND ADJACENT WAVES

The exact maintenance and measurement of transmission frequencies are just as important for smooth operation in a congested frequency region as exact monitoring of keying and modulation. Nothing interferes more with the operation of a receiving station or its operating central office than when a connecting station is blanketed by foreign disturbances. It often takes a long time before the transmitting stations in question have changed their waves and approximately reached the frequencies assigned. In order to be able in the meantime, to use the channel interfered with, it is often advisable that the transmitter interfered with be slightly shifted in frequency. To carry this out quickly it is necessary to have a good organization in the various stations, and means of measuring, in the shortest possible time, the frequency of the transmitter and of the transmitter interfered with. It is also necessary to have apparatus on the transmitter so that the radiation can be quickly and surely altered in frequency.

1. Regarding frequency measurement with short waves in general

In the present state of the art it is possible to reach an absolute accuracy of measurement of from ± 0.01 per cent to 0.001 per cent, i.e., 2000 to 200 cycles with 15-meter waves, and to do this with compara-

² E. Qüack and H. Mögel, "Doppel und Mehrfachzeichen bei Kurzwellen," *Elek. Nach.-Technik*, 6, No. 2, p. 45-79, 1929.

tively simple and practical means. In Germany quartz resonators developed by Giebe and Scheibe at the "Physikalisch-Technische Reichsanstalt" are used almost exclusively as secondary standards, whereas in other countries quartz or tuning fork oscillators are used. The latter must be constantly checked with special calibrating apparatus including a chronograph, whereas the "luminous quartz" resonators of modern construction need only be checked once a year by the state bureau of standards (in Germany, by the Physikalisch Technische Reichsanstalt). Some of the methods used by the Transradio A.G. at the large Nauen station and at the receiving station at Geltow are partially described in previous papers.^{3,4} A bibliography on various other methods was appended to the article by the author in the PROCEEDINGS of the I.R.E.⁵

In all these methods the principle of the harmonic oscillations is used for making measurements. This system has been found very suitable for use with short waves, i.e., with very high frequencies, as one can start with standards of average frequencies (100-200 kc/s). Furthermore, only a few standards are necessary because one can work with rather large harmonic ratios ($n = 50-200$).

2. Frequency monitoring at the transmitter

A measuring system, using a method previously described,³ with a variable standard base frequency is installed in the central control room at the large radio station at Nauen. Interference from our own transmitters has been eliminated as far as possible by employing very great selectivity with double shielding of the oscillating detector receiver, so that exact adjustment of the frequency of the oscillating detector to the frequency of the transmitter to be measured is not in general difficult; however, with strong tone modulation it is recommended that the modulation be temporarily reduced in order to attain greater accuracy of measurement. Remote comparative measurements made with other operating companies have shown an agreement within 1000 cycles, whereas comparative measurements, made in our own organization, between Nauen and Geltow, showed differences of at most 400 cycles.

Another method of monitoring frequency which has been tried out at the transmitter itself, is the use of "luminous quartzes" in one of the first transmitting stages. In the modern Telefunken short-wave trans-

³ H. Mögel, "Exakte Frequenzmessung kurzer Wellen," *Telefunkenzeitung*, No. 52, p. 54 and No. 53, p. 44.

⁴ H. Mögel, "Einige Methoden zur Frequenzmessung von kurzen Wellen," *E.N.T.*, 4, No. 7, April, 1930.

⁵ H. Mögel, "Some methods of measuring the frequency of short waves," *Proc. I.R.E.*, this issue, page 212.

mitters the base frequencies for a range of 10 to 50 meters are between 100 and 200 meters so that the resonators are comparatively easy to make. Generally one resonator for the assigned frequency is sufficient. If there is an arrangement in the control stage of the transmitter for constantly changing the frequency over a small range, then the mechanic attending the transmitter is in a position to maintain or control the assigned frequency by means of the resonator. It is advisable to provide protection against high voltage, so that the quartz will not be overloaded. Temperature regulation of the luminous quartz by a sim-



Fig. 14—A longitudinally excited luminous quartz resonator for a wavelength of about 124 meters.

ple thermostat is recommended for high accuracy; at present this type of quartz will give an absolute accuracy of ± 0.005 per cent. A crystal for a 124-meter wavelength (2420 kc) is shown in Fig. 14. The construction of these crystal resonators has recently been altered because of their comparatively high temperature coefficient of several hundred thousandths, and because very good results in respect to temperature coefficients are possible with small fixed quartz rods, which can be operated at harmonic frequencies as high as the 10th harmonic of their fundamental.

3. *Maintaining a constant transmitting frequency*

Quartz oscillators are almost exclusively used today for regulating the modern multistage transmitters. For very small loading of the quartz the frequency of the regulating stage is chiefly dependent on the temperature of the quartz and on the air gap between the quartz and its holder. Thus, when the temperature is kept constant by a thermostat, the only means of regulation is to vary the air gap. This means of regulation, by which a frequency under light load (1 watt) can be changed with stability, has a range of ± 1 to 2 "promille" depending on the activity of the crystal; thus it is large enough to make a slight shift in frequency possible when there are disturbances from other transmitters. One can of course, also use fixed quartz holders and switch to another quartz to change the frequency. Of course in that case, several quartzes with fixed holders and of neighboring frequencies are necessary. Recently the Telefunken company made successful experiments with the aim of replacing the regulating quartz by a very slightly damped circuit which is provided with an automatic temperature correction, so that the temperature coefficient is extraordinarily small and perhaps smaller than that of the quartz; this circuit may also be applied for the usual purpose, as a substitute for the quartz or tuning fork oscillator.

4. *Width of band and adjacent waves*

The determination and measurement of the width of the band and of adjacent waves is also one of the most important tasks necessary in order to carry on operations without trouble. Naturally the monitoring of this can be carried out most simply at the receiving end, at a place distant from the transmitter. By doing this, however, much time is usually lost so that a means of monitoring at the transmitter is greatly to be desired. At Nauen it has been possible to carry this out by using the central measuring and observation receiver. By good shielding of the apparatus and of the battery lines, the energy of the transmitter which affects the receiver can be so definitely confined that the limits of the band of a modulated transmitter can be determined and measured in the same way as at the receiving end. Deceptions rarely occur, as within the band width of the transmitter, a changing beat note is audible when turning the tuning condenser. If a transmitter has an improper width of band, according to the determinations made with the receiver, tests can be made at once with an oscillograph to determine whether the cause is due to the too rectangular waveform of the modulation.

Any adjacent waves which may be present also can be detected easily by the central oscillating detector. As these distortion frequencies

are usually caused by contact or modulation pulses, their determination within a distance of from 10 to 20 meters about the transmitter is very difficult owing to direct blanketing if an ordinary oscillating detector is used. The selectivity is so low that one can hear the contact and modulation pulses over a wide tuning range even where narrow side bands exist and when no adjacent waves are present. With the Telefunken transmission monitoring apparatus set up at each transmitter (see Fig. 6) it has been possible to effect an accurate monitoring of the side bands and of the adjacent waves by utilizing the third harmonic of the oscil-

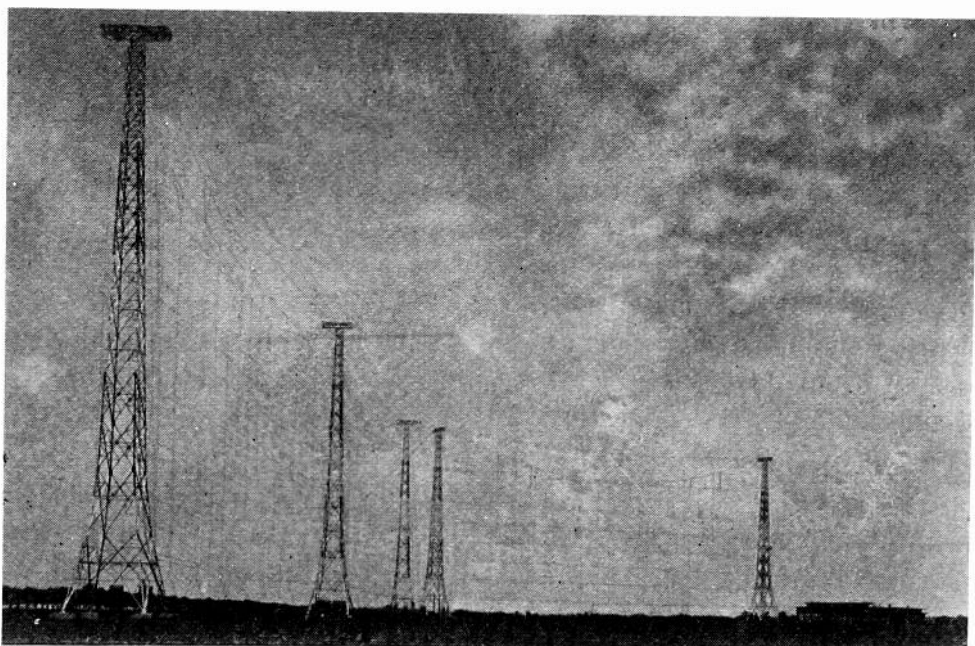

Fig. 15—Three directional antennas at Nauen for daytime transmission to North and South America.

lating detector, whereby the beat notes are audible only when that harmonic beats with the transmitting frequency.

Parasitic oscillations generally arise when instability occurs at definite points in the telephone characteristic; with gas-filled tubes these phenomena may appear in the range of small negative grid potentials; also, at positive grid voltages dynatron action can cause self-oscillations of any wave-form. The distortion frequencies generally lie between 1 and 200 kilocycles, so that adjacent waves in this range lie symmetrically on each side of the main wave. In recent years such symmetrical adjacent waves have been detected at many transmitters of various types; for undamped transmission only pulses were observed; on tone modulated transmission, irregular sputter pulses were

perceptible in each period of modulation. Thus on telephoning, sputter noises can only be heard with modulation (speech, etc.). Undamped adjacent waves have not been observed to date.

IV. MONITORING OF THE RADIATION CHARACTERISTIC OF A DIRECTIONAL ANTENNA

At the present time large directional systems for concentrating energy in a given direction are used in the important commercial short-

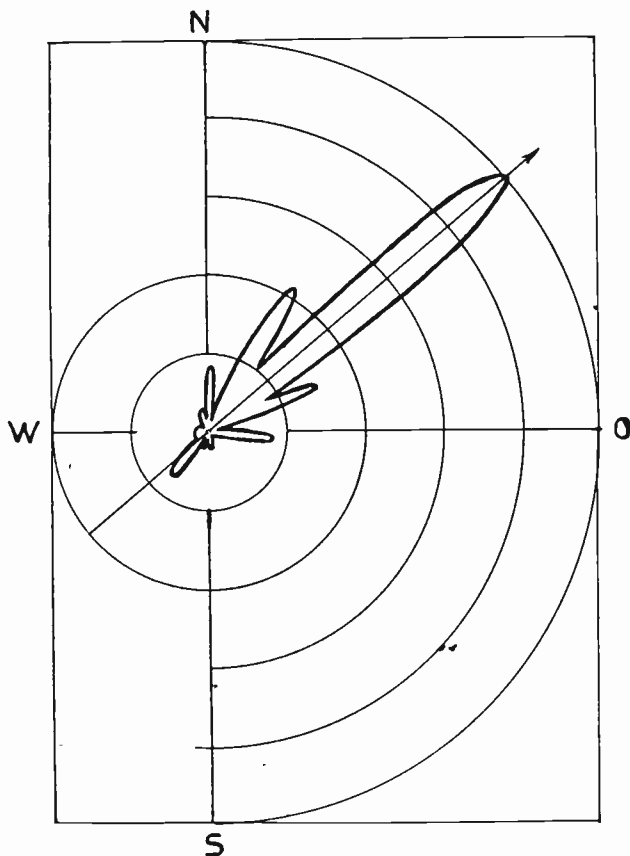

Fig. 16—Horizontal radiation characteristic for a small directional system for transmission to Japan, at the large radio station in Nauen, which was made from an airplane by the D.V.L.

wave channels, so that it is advisable to check the antenna characteristic from time to time, especially as short circuits, etc., may occur because of the large dimensions of such antenna structures. Fig. 15 shows three of the directional antennas built by the Telefunken company at Nauen. They are directed toward North and South America. In such stations, trouble can also occur in the antenna transformers or in the transmission lines. In any case, continuous control of the energy concentration, at least in the horizontal plane, increases the certainty of

operation. The characteristic curves are taken with ordinary field intensity measuring instruments at a height of about 3 meters above the ground and at a small fixed distance. For this work it is most convenient to use a push-pull tube system with compensation of the grid current, the grid voltage, or the plate current. At greater distances (about 5 km on the ground) it is more suitable to use a rectifier with low-frequency amplification in connection with a tube voltmeter. Detailed measurements of the radiation field of a directional antenna made from an airplane by the radio and electrical division of the German Aircraft Testing Bureau (D.V.L.) at the instigation of the Central Government Postal Bureau (R.P.Z.) and with the aid of the Telefunken company and also the Transradio company, showed that the horizontal characteristic curves at considerable altitudes have approximately the same relative shape as those near the ground. This is, of course, assuming that no disturbing structures (steel towers, fences, etc.) lie in the field of radiation; moreover the amplitude at the ground is many times smaller. In every case, a greater stray radiation field of the system can easily be shown at from 2 to 6 meters above the ground. The many fine methods of taking measurements from an airplane, which function with the greatest measurement speed imaginable and which furthermore make it possible to get the vertical diagram, will only be used for special scientific investigations because of the great expense.

Fig. 16 shows a horizontal characteristic curve for a small directional antenna for transmission to Japan, made by the D.V.L. It was taken from an airplane on a circular flight with a radius of about 3 km.



THE USE OF THE COPPER-OXIDE RECTIFIER FOR INSTRUMENT PURPOSES*

BY

JOSEPH SAHAGEN

(Standardizing Laboratory, General Electric Co., West Lynn Works, West Lynn, Mass.)

Summary—Mention is made of the need for high sensitivity a-c measuring instruments and the development of the copper-oxide rectifier as a ready means of obtaining high sensitivity without sacrificing other desirable characteristics. Possibilities and limitations of half-wave rectification are discussed. An analysis is made of the copper-oxide full-wave instrument rectifier. Characteristics of this rectifier and of rectifier instruments under varying conditions of current, temperature, frequency, and wave-form are discussed. A study is made of the interrelation of range and sensitivity in determining temperature coefficients of rectifier voltmeters. Methods of compensation are developed for offsetting errors due to temperature or frequency. The chief limiting factors in the use or manufacture of rectifier instruments are set forth.

THE usual forms of a-c measuring instruments such as the thermal, iron vane, and dynamometer types are limited in their use by the comparatively large power consumption which is characteristic of such instruments. In the d-c instrument field there are many types of rugged instruments with full-scale currents of one-tenth to two-tenths milliamperes. Until the advent of rectifier instruments, such a sensitivity was admitted an impossibility in the a-c field. Exceptions are electrostatic voltmeters and thermionic instruments, both of which have very definite limitations.

It was early seen that if alternating currents could be adequately and conveniently rectified, d-c instruments might be used to measure alternating currents too minute for detection in the usual manner. Various suggestions were made and experimental rectifier instruments were built from time to time. The early work naturally centered about crystal rectifiers of the type used in the early days of radio reception. These rectifiers possessed all the vagaries and idiosyncrasies of those first crystal radio sets.

The oxide rectifier, with a constancy much greater than the early crystal rectifiers, was at once recognized as a unit of unique characteristics which would be of service in a-c measurements in the communication and radio fields.

The simplest way to use any rectifier in an indicating instrument circuit is to insert a single rectifier unit in series with a d-c instrument,

* Decimal classification: 621.313.7. Original manuscript received by the Institute, November 15, 1930.

as in Fig. 1(a). The arrow in front of the rectifier gives the direction of normal current flow through the rectifying unit.

The indications of such a combination will be an arithmetical average of the half-wave that is passed by the rectifier. This is a decided disadvantage for most measurement purposes as the most desired a-c

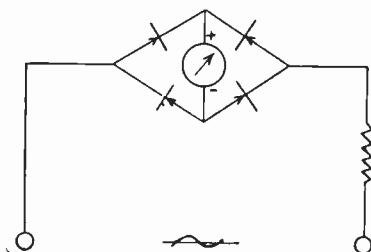
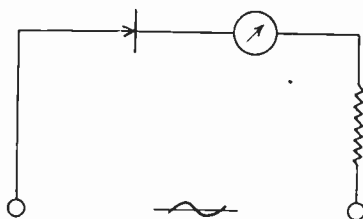

Fig. 1(a)—Schematic diagram of half-wave rectification.

Fig. 1(b)—Schematic diagram of full-wave rectification.

measurement is the “effective” value of the wave rather than the “average”. Such an arrangement has other very obvious disadvantages. Beside the inefficiency of half-wave rectification, there may be serious

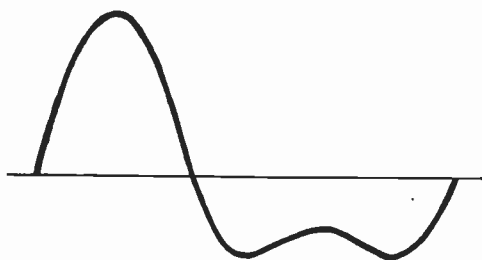

Fig. 2(a)—Wave-form with even harmonics.

errors introduced when even harmonics are present in the complex wave. An example of such a wave-form with even harmonics is given in Fig. 2(a). Another disadvantage is the possible mechanical resonance of the usual d'Arsonval instrument pointer. A non-resonant type of pointer is of necessity heavier than the standard type. One such design is shown in Fig. 2(b).

To overcome these difficulties by using both half-waves of the alternating current, the classical combination of four rectifiers is used in a

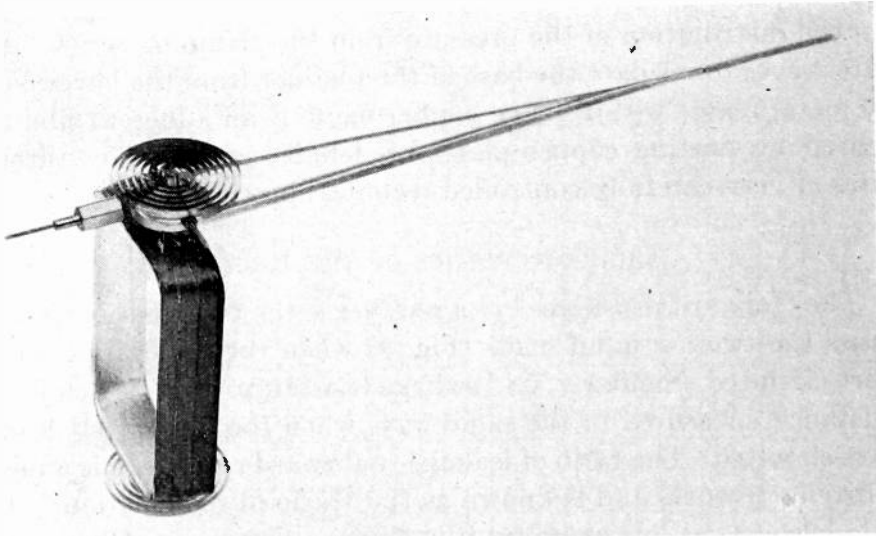

Fig. 2(b)—Nonresonant pointer.

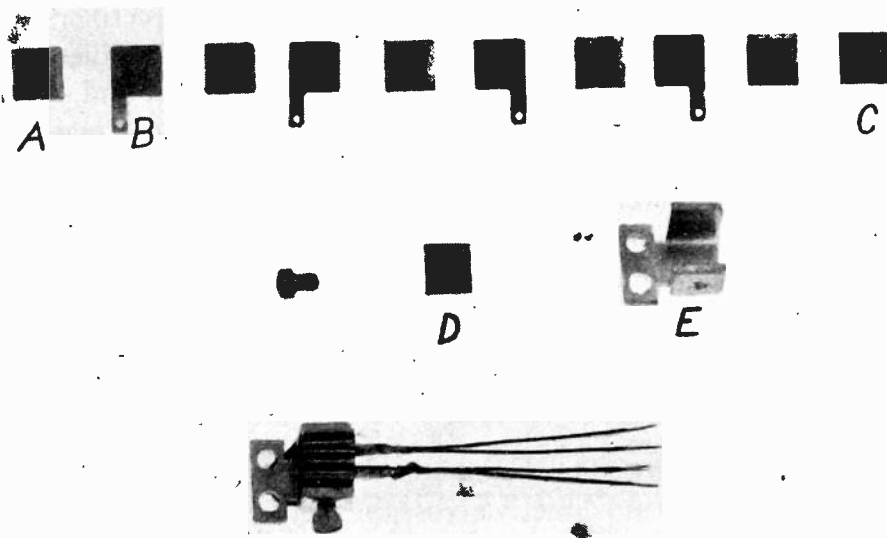

Fig. 3—The copper-oxide full-wave instrument rectifier.

- A—Lead plate.
- B—Oxidized copper plate.
- C—Phosphor-bronze plate.
- D—Insulating fibre.
- E—Holder.

bridge circuit arrangement. The schematic diagram is shown in Fig. 1(b). This arrangement of four rectifier units is the one used in practically all instrument work.

Fig. 3 shows the present rectifier both assembled and disassembled. The lead plates are used merely to secure a good contact on the copper-oxide films, and the phosphor-bronze plate on the end is used to secure an even distribution of the pressure from the clamping screw. A fiber plate serves to insulate the base of the rectifier from the lower edges of the metal plates within. The copper-oxide is an adherent film and is secured by putting copper plates of definite composition through a series of very carefully controlled technical processes.

CHARACTERISTICS OF THE RECTIFIER

The "forward resistance" of a rectifier is the resistance as measured across the two a-c input leads (Fig. 3) when the d-c output leads are short-circuited. Similarly, its "leakage resistance" may be defined as its resistance, measured in the same way, when the d-c output leads are open-circuited. The ratio of leakage to forward resistance is a measure of its effectiveness and is known as the "ratio of rectification." If this ratio becomes as low as unity, it is obvious that no rectification takes place and the plates act as pure resistances. The average ratio of rectification of copper-oxide plates made for measurement purposes is in the vicinity of 50 or 60. If this ratio is below 25 the rectifier is considered unusable for measurement purposes. Both the effectiveness and life of a rectifier depend in a large degree upon the extent and duration of overloads to which it is subjected. An overload sustained over a long period of time will gradually decrease the ratio of rectification to unity, or breakdown. A maximum rating of 65 milliamperes per square centimeter has been assigned to the instrument rectifier and this figure seems to be a reasonably conservative one. Instantaneous overloads of several thousand per cent seem to have no effect, and an overload of 400 per cent for ten minutes fails to produce any signs of breakdown. However, in practice the current density is far below this value of 65 milliamperes.

The practice followed in the manufacture of rectifier instruments is to connect the armature directly across the rectifier output and to place any necessary series resistance in the input side, thus reducing the voltage on the rectifier proper to the lowest practicable value.

The forward resistance of a rectifier is found to vary in a nonlinear manner with changes in current. As the current through the rectifier is increased from zero to four or five milliamperes per square centimeter, the rectifier resistance decreases, first, very rapidly, then more slowly, from infinity to about 800 or 1000 ohms for a 3/16-in. rectifier. As the current is further increased to 50 or 60 milliamperes per square centimeter, the resistance falls more and more slowly to about 500 or

600 ohms. Should the temperature increase, the forward resistance will decrease approximately one per cent per degree Centigrade rise in temperature. Fig. 4 shows the nonlinear current resistance characteristics

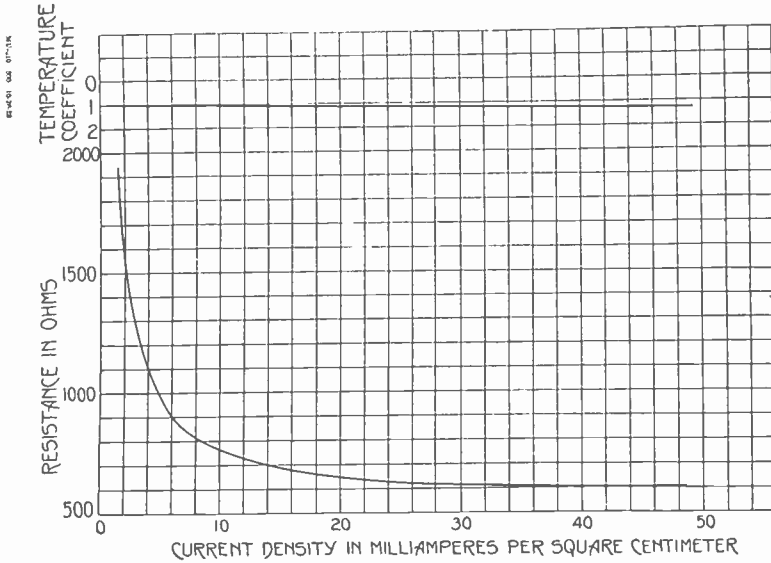

Fig. 4—Forward resistance—current density characteristics at 25 deg. C and temperature coefficient of forward resistance.

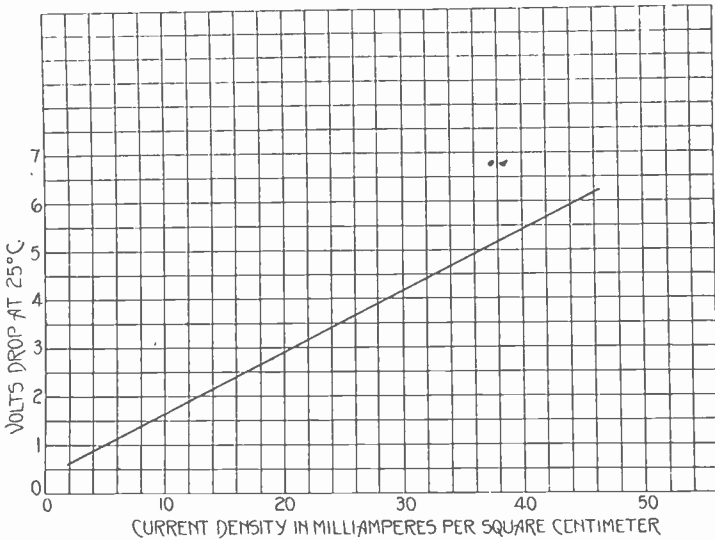

Fig. 5—Forward voltage—current density characteristics.

and the temperature coefficient of forward resistance for an average rectifier. Fig. 5 gives the corresponding voltage drop as a function of current density.

Figs. 6 and 7 give similar characteristics for the "leakage resistance." It is seen that the leakage resistance rises sharply at very low

voltages and reaches a maximum around two or three volts, after which it drops slightly. The temperature coefficient is also negative, but two or three times the value of the forward resistance coefficient. As the

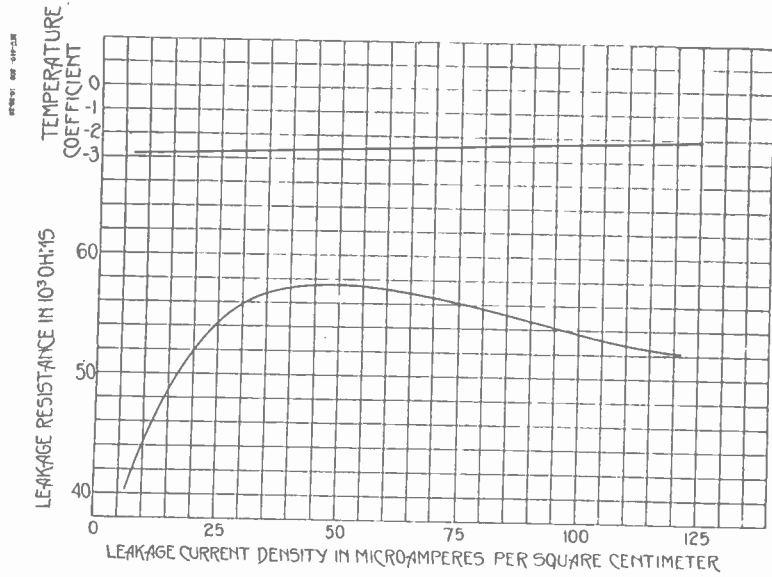

Fig. 6—Leakage resistance—current density characteristics at 25 deg. C and temperature coefficient of leakage resistance.

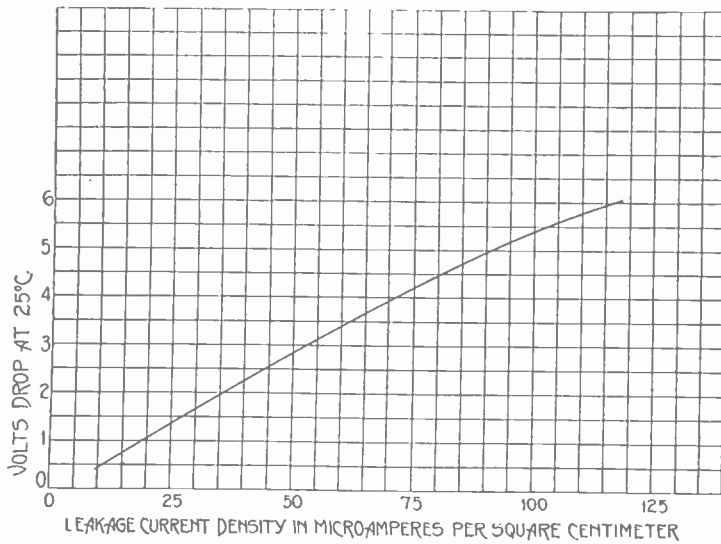

Fig. 7—Leakage voltage—current density characteristics.

temperature of the rectifier is increased, its leakage resistance decreases at least twice as rapidly as the decrease in forward resistance. The combination of these two unequal changes thus introduces a third variable, namely, a variation in the ratio of rectification with changing

temperature. The interrelation of these variables and the importance of striking a proper balance among them will be discussed in greater detail in connection with instrument characteristics.

Rectifiers are often put into instruments which will be used on direct currents of unknown polarity as well as upon a-c circuits. To obtain the same "output" (rectified) current with a d-c voltage of either positive or negative polarity requires unusually close selection of plates and assembly care in building the complete rectifier unit. Such results are accomplished, however, on a commercial basis.

CHARACTERISTICS OF RECTIFIER INSTRUMENTS

As previously pointed out, an a-c voltmeter or milliammeter of the rectifier type indicates "average" values of an alternating current; it

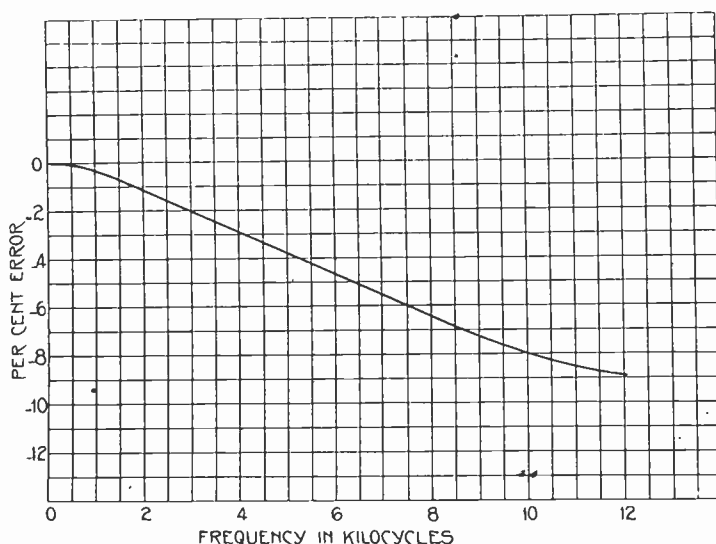

Fig. 8—Frequency characteristics of low range rectifier voltmeters.

does not indicate root-mean-square values. For a sine wave, the r.m.s. values are 1.11 times the average values. This offers no particular difficulty if the instruments are used on sine waves, as the calibration is made on such waves and the scales are marked in r.m.s. values. But if the instruments are used on distorted wave-forms, the readings will still be 1.11 times the average values. The error introduced thereby depends entirely upon the amplitude and phase angle of the harmonics, and to a lesser extent upon their frequencies. If the wave-form is known, a correction factor can be easily computed and applied. The simplest case is that of a direct current. A rectifier instrument calibrated in r.m.s. sine wave values should show an error of +11.1 per cent when used on direct currents. Such is found to be the case when the mean of d-c reversals is taken.

The rectifier as used for instrument purposes has a capacitance of about $0.009 \mu\text{f}$ at 1000 cycles. Although this capacitance does not cause trouble in the power-frequency range, the errors become rather serious in the higher audio frequencies. Fig. 8 shows the error that may be expected in a low voltage instrument with variations in frequency. Such errors can be compensated, at least for any desired limited band of frequencies, by shunting a portion of the series resistance with small capacitance of suitable value. This scheme is shown schematically in Fig. 9.

Fig. 10 gives curves from which one may predict what excellence of performance, under ambient temperature changes, can be expected of a given rectifier voltmeter. The temperature coefficient of such a voltmeter is a complex function of the instrument range and of its sensitiv-

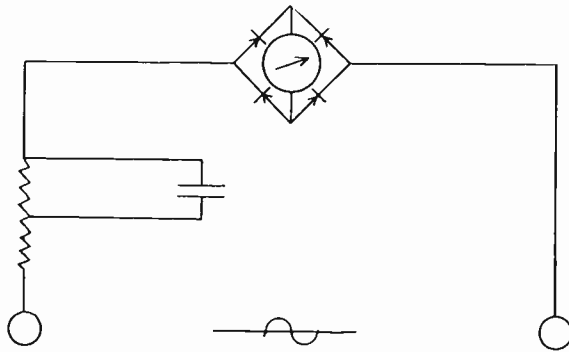

Fig. 9—Diagram of frequency compensation.

ity. Each of the curves in Fig. 10 represents the behavior of a voltmeter of different full-scale rating. The ranges plotted vary from 1.5 to 300 volts. An examination of the curves shows that:

- (1) At low sensitivities all voltmeters have a positive temperature coefficient;
- (2) As the sensitivity of any voltmeter is increased its temperature coefficient decreases and approaches zero;
- (3) When the temperature coefficient for a given range of instrument reaches zero it does not remain there but increases in a negative direction as the sensitivity is further increased.

The positive temperature coefficient at low sensitivities can be explained by referring to Fig. 4. At low "ohms-per-volt" sensitivities the resistance of the rectifier is an appreciable part of the total instrument resistance and as the ambient temperature rises, the rectifier resistance and consequently the total instrument resistance decreases, thus causing the instrument to read high. An instrument of increased sensitivity

uses more resistance in series with the rectifier, making the percentage of rectifier to total resistance smaller. This means that changes in rectifier resistance have a decreased effect upon the instrument as a whole. As the curves indicate, there is an optimum value of sensitivity for each full-scale voltage rating. To explain the action of the curves in dropping below zero beyond this optimum, it is necessary to discuss further the rectification ratio.

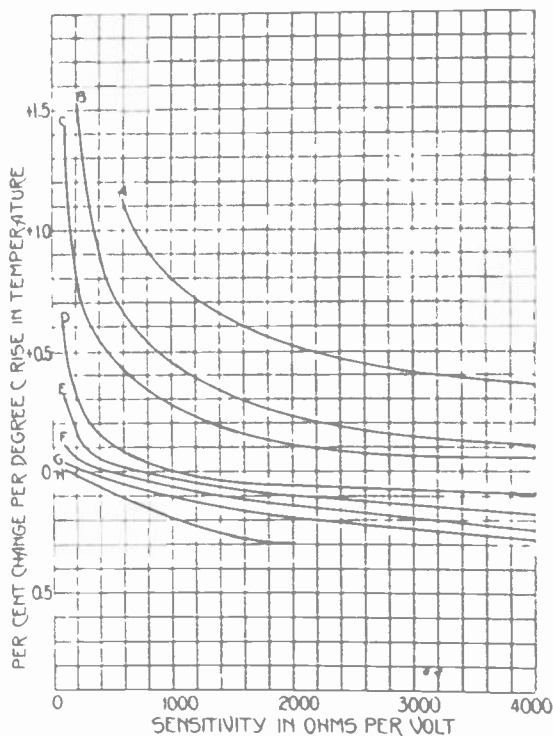

Fig. 10—Temperature coefficients of rectifier voltmeters as a function of voltage range and sensitivity.

Curve	Instrument Rating
A	1.5 volts
B	3.0 "
C	5.0 "
D	15 "
E	30 "
F	75 "
G	150 "
H	300 "

It has been shown (Figs. 4 to 7) that the temperature coefficient of leakage resistance is about two or three times as great as that of forward resistance. This means that with increasing temperatures the leakage resistance will decrease much faster than the forward resistance, the net result being a decrease in the ratio of rectification. As this

ratio is a measure of the effectiveness of the rectifier, it is apparent that an increase in ambient temperature decreases the efficiency of the rectifier. If the sensitivity of a particular voltmeter is so high that the effect of decreased rectifier forward resistance is negligible, then the decrease in rectifier effectiveness will give the instrument a negative temperature coefficient.

As a specific example, in a 300-volt instrument of 1000 ohms-per-volt sensitivity the rectifier resistance will be so small a portion of the total 300,000 ohms that a change in the rectifier of a few hundred ohms will be a truly negligible factor in this total. Assume, for the sake of simplicity, that the ratio of rectification is 49:1. It is seen that if a

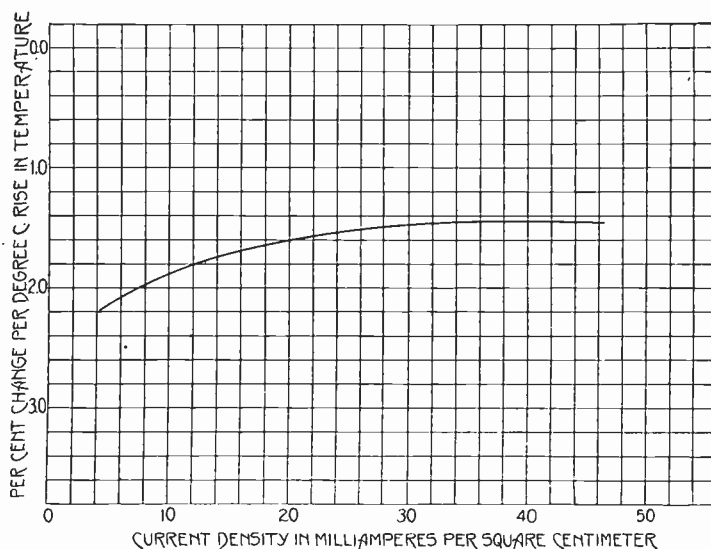

Fig. 11—Temperature coefficient of rectification ratio.

10 deg. C. rise in temperature reduces this ratio to 48:1, thus decreasing the rectifier effectiveness from 98 to 96 per cent, the instrument indications will be lower by 2 per cent, which means that the instrument will have a negative temperature coefficient of about 0.2 per cent per degree Centigrade. On the other hand, in a 1.5-volt instrument of the same sensitivity, the rectifier resistance would be a major portion of the total instrument resistance and a decrease of a few hundred ohms would cause such a serious positive temperature coefficient that a small decrease in rectifier efficiency would have but a slight effect. Fig. 11 shows the temperature coefficient of the rectification ratio as a function of current density in the forward direction.

The factors already discussed are the more important ones in determining the curve forms of Fig. 10, but these alone may fall short of a complete quantitative analysis. In some cases the temperature coeffi-

cient of resistance of the copper armature may have an appreciable effect. Also, in the case of very low voltage instruments, an increase in temperature will decrease the total resistance, causing a decrease in the ohms-per-volt sensitivity of the instrument. This change in sensitivity or current rating will introduce a new set of values for forward and leakage resistance and a new rectification ratio. The temperature coefficients themselves are not constant but vary slightly with temperature. These statements are made largely in the way of precaution against attempts to predict too exactly the behavior of any particular instruments.

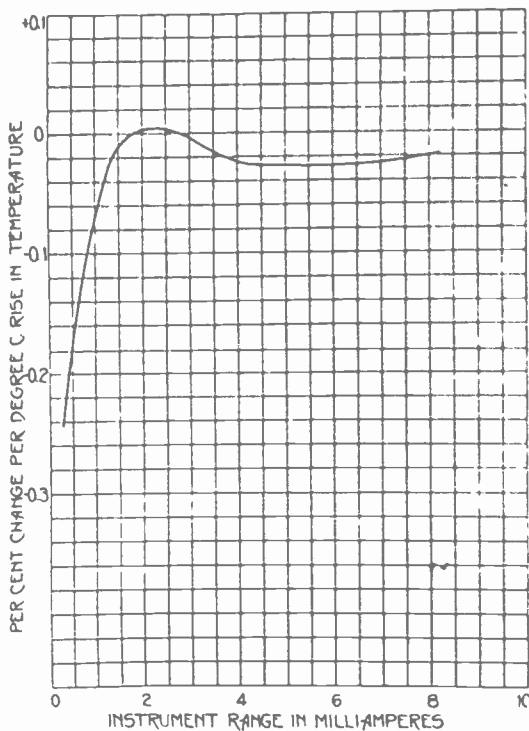

Fig. 12—Temperature coefficients of rectifier milliammeters as a function of the instrument range.

When instruments are required for which the curves of Fig. 10 predict an excessive temperature coefficient, simple compensating schemes can be resorted to. In the case of negative coefficients, it is possible to shunt the armature and a proper amount of zero temperature coefficient resistance placed in series with it by a resistor having a comparatively large positive temperature coefficient, such as copper or nickel wire of high purity. In the case of very low range voltmeters, where the positive coefficient is excessively high, there are two distinct possible methods for compensation. One is accomplished by using a series resistance which has a high positive temperature coefficient, such as

nickel, iron, or copper. These methods of temperature compensation are shown in Fig. 13. The other method is to use a rectifier which has forward and leakage resistances substantially lower than those of Figs. 4 and 6. Such rectifier instruments are self-compensating at much lower ranges and sensitivities than the curves of Fig. 10 indicate. Rectifiers of this kind are made but require much more care in manufacture. If such rectifiers are used in high range voltmeters, the negative temperature coefficients of the combination will reach too great a value.

Fig. 12 shows what may be expected in the way of temperature coefficients in a-c milliammeters of the rectifier type. For ranges of one

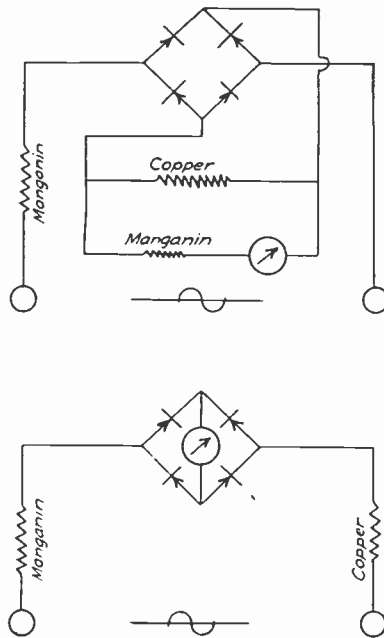

Fig. 13—Compensating schemes for temperature errors.

milliamperes and above, the coefficient is 0.1 per cent or less, a reasonably good figure for general rectifier instrument work. As milliammeters the rectifier instruments are found to be, on the whole, very satisfactory.

Rectifier instruments are found to have a truly uniform scale when the resistance of the rectifier unit forms a negligible part of the total instrument resistance. As the rectifier becomes a more appreciable factor in the instrument resistance, the lower end of the scale becomes somewhat cramped or narrowed. This is due to the increased resistance of the rectifier unit at very low currents. For example, in the case of a 5-volt instrument of 1000 ohms-per-volt sensitivity, the current through the rectifier at full-scale deflection is one milliamperes. At this

current its resistance is in the vicinity of 1000 ohms. But on one volt, when the current through the rectifier is only about a fifth of a milliamperere, its resistance is roughly 2000 ohms. This means that the total

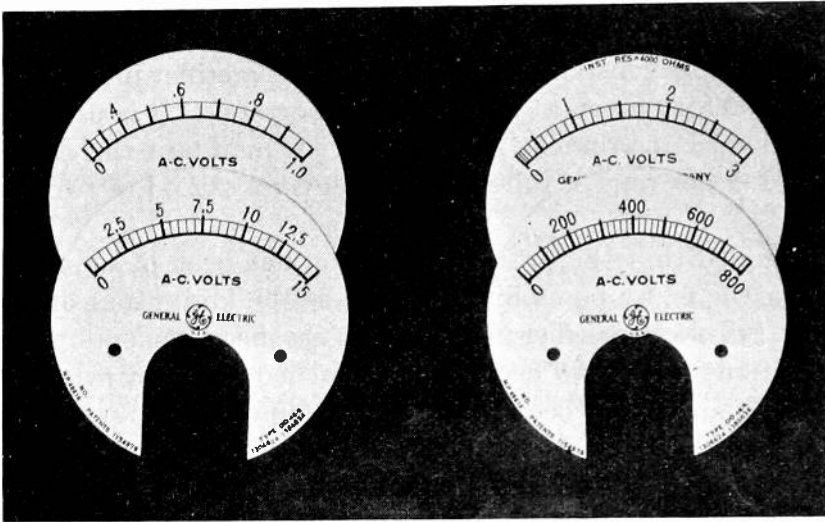

Fig. 14—Typical rectifier voltmeter scales.

instrument resistance has increased from 5000 to 6000 ohms. The impressed potential of one volt will, therefore, cause a smaller deflection than would otherwise have been the case. In voltmeters with ranges above 15 volts and with reasonably high sensitivities, the nonlinearity

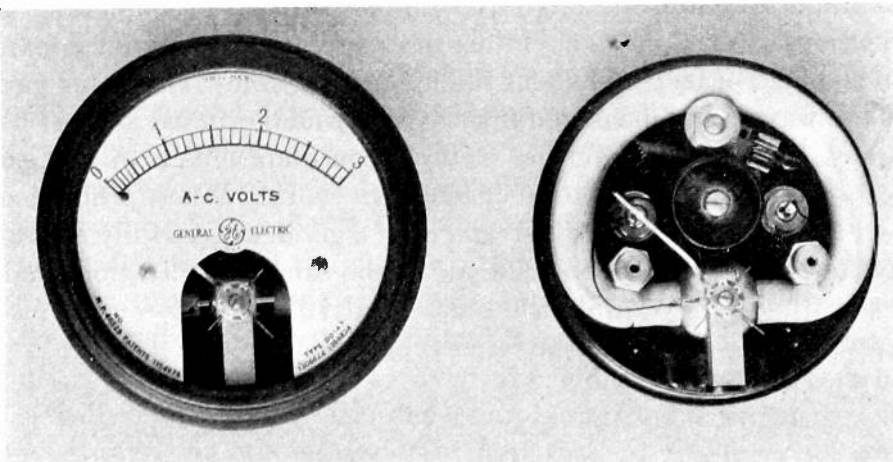

Fig. 15—Type DO-14x a-c miniature voltmeter.

of the scale is negligible. As either the range or sensitivity is decreased the nonlinearity becomes more marked until at ranges of two or three volts it is found that about a quarter of the scale measures a third of

full-scale voltage. This lack of scale uniformity is much less than in conventional a-c instruments. Fig. 14 shows a few scales for voltmeters of different ranges and sensitivities. Fig. 15 is a picture of a completed miniature rectifier voltmeter (left) and the same instrument with scale and cover removed (right).

The life and constancy characteristics of rectifier instruments are quite satisfactory for most measurement purposes. It is usual for the combination of instrument and rectifier to maintain the calibration within 1 1/2 per cent of full-scale value over a period of two or three years.

It is hoped that the present discussion has been of some value in indicating the many possibilities as well as the limitations of the copper-oxide full-wave rectifier in the field of a-c measurements. Some few considerations that have been lightly touched upon, or even ignored, have been omitted not because they are unimportant but because the argument has been deemed self-evident. A case in point is the sturdy character of the copper-oxide rectifier, a consideration of utmost importance from a practical standpoint. The methods of compensation which have been outlined to take care of the inherent errors of the rectifier have been found by experience to be entirely practicable. Properly compensated rectifier instruments can be built so that an accuracy of about one per cent can be maintained under any reasonable conditions, barring, of course, the effect of distorted wave-forms. This approximate range in accuracy and the restriction as to wave-form are the most important limiting factors in the use of such instruments. The former merely excludes the rectifier in its present stage of development from the field of instruments of the highest accuracy; the latter means that the wave to be measured must be sinusoidal or must at least have a known form factor. Neither of these considerations is of any great weight in the ordinary run of instrument work. When properly designed and built, a rectifier instrument of a given class is fully as usable as any other type of a-c instrument in the same classification, and in addition there are possible the high sensitivities and low power consumption not available in the other types.



WIDE RANGE SCALES FOR FADING RECORDS BY ELECTRICAL MEANS*

BY

G. D. ROBINSON

(U. S. Naval Academy, Annapolis, Md.)

Summary—The electrical means discussed in the following paper are two in number. Relatively small modifications of the response characteristics of the recording system may be obtained by the use of a combination of plate detection and grid detection in which the latter becomes active only for strong signals. Great modifications of the response characteristics are produced by circuit arrangements of the type used for "automatic volume control." Curves are given showing typical results. These show the possibility of obtaining greatly increased scale ranges and also of obtaining scales in which the recorder response is roughly proportional to the logarithm of the strength of the carrier wave. The response to side bands is stated to be small.

STARTING in January, 1925, a series of fading records were made automatically using a Westinghouse type R recording voltmeter (without multiplier) as the recording instrument. The object of this series of measurements was to study fading phenomena in the broadcast band. The recording meter was operated by one stage of d-c amplification from the output of a detector stage consisting of two high- μ tubes (push-pull on the r-f side) using plate detection. Preceding this detector stage was a superheterodyne type of receiver using a combination of resistance coupling and tuned transformer coupling, the latter being utilized only for input and output. The response of the second detector of this superheterodyne system has the usual curved characteristic. The recorder, which is a Kelvin balance type of instrument with all coils connected in series, has a similarly curved characteristic. Since the recorder was originally intended to be used as a suppressed zero instrument, enough current was supplied, from a source independent of the strength of the signal, to bring the pen to an arbitrary zero line without the aid of any incoming signal. The above arrangements give an over-all response characteristic which is decidedly curved, the scale deflection being proportional to something between the second and fourth powers of the received signal voltage. Such a response necessarily means a very limited range of values which may be recorded without changing the equipment in some manner.

* Decimal classification: R365.3. Original manuscript received by the Institute, June 12, 1930. Presented before U.R.S.I., Washington, D. C., April 25, 1930.

The problem originally appeared to be the discovery of some means for straightening the response curve. Such a means, to fit the equipment in hand, appeared to require more response to weak signals and less to strong ones. The first could be provided by additional amplification, which was already available, so that the problem boiled down to reducing the response to strong signals without correspondingly reducing the response to weak signals.

The literature known to the author supplied only one means for accomplishing the desired result. This was the semimechanical scheme of mechanically operating the contacts to an attenuating network by the same mechanism that made the record, the adjustment being such as to return the final output to a selected constant value automatically. As this equipment was not available, simpler means were sought. The first arrangement which was effectively used to alter the shape of the response curve utilized a grid leak of about 0.1 megohm in combination with the usual grid condenser. As long as the grid remained negative this combination had no effect on the detection which was then purely plate detection. As soon as the signal voltage applied to the detector grids became great enough to run them positive during part of the cycle this combination started to function in opposition to the plate detection. The result, while never a straight line, was thought to be a decided improvement over the simple uncorrected curve. Incidentally, this combination appreciably reduced the action of crashing static upon the recorder. Later, response to side bands was found to be reduced by omitting the grid condenser. This interferes but little with the action of the detector in the special case using two detector tubes with the r-f grid voltage 180 deg. apart on the two grids.

More recently, while attempting to compare day and night fading of the 870-ke transmission from a broadcast station about 600 miles (1000 km) away, it became desirable to extend greatly the range of the scale of the recorder. This meant that the over-all response curve for the equipment must be caused to curve in the direction opposite to that in which it tends to go. It appeared to be desirable to provide for variations of carrier of from 60 to 100 db. Also, a logarithmic response curve appeared to be desirable although not actually essential.

Based upon the knowledge that the so-called "automatic volume control" operates effectively but not with perfect regulation, and the further evident condition that the regulation of the volume control circuit could easily be made poorer, a circuit was installed using a separate pair of detector tubes to provide control bias for the amplifier grids. This was immediately found to be effective.

Practical experience with the particular equipment in hand has shown that certain adjustments utilizing both the volume control circuit and the combination of plate and grid detection closely approach a logarithmic scale over a considerable portion of the total range.

Fig. 1 shows several response curves for this recorder with various adjustments of the receiving circuit. The zero level of signal is arbitrary as usual, but in fact corresponds to about 200 microvolts in a large antenna. Curve 1 shows the simple response characteristic, when neither of the above corrections are applied. Curve 5 shows the effect of adding to the above a "volume control circuit" using a separate

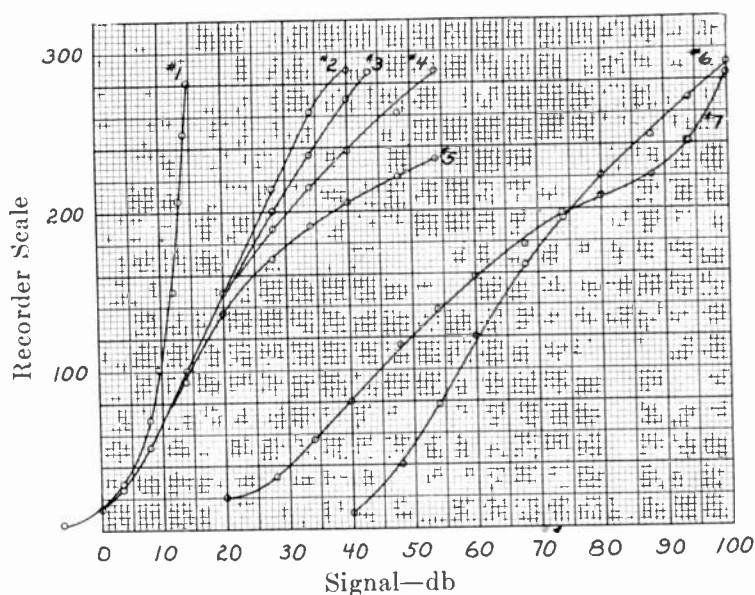

Fig. 1

detector but no grid leak. Curves 4, 3, and 2, respectively, show the result of applying the grid leak correction to the separate detector which operates the "volume control." The grid-leak resistances used in these cases were 1, 3, and 13 megohms, respectively. Curves 6 and 7 were taken with a different arrangement of the "volume control circuit" in which the same two tubes were used both for operation of the d-c amplifier and for providing grid bias for the amplifier tubes. The difference between curves 6 and 7 is due principally to more amplification with curve 7 and to some change in the regulation of the "volume control circuit." The upshoot at the end of curve 7 is typical of a condition thought to be due to coupling through or around the portion of the amplifier upon which the "volume control" operates. If this is the cause, shielding, the use of screen-grid tubes, or the use of

more stages to obtain the same amplification should remove this upshoot.

It appears that a recorder which operates as this one does cannot be free from some effect due to modulation of the carrier. Experience shows that this effect is small. This is probably accounted for in part by the fact that even in those stations whose modulation closely approaches a maximum of 100 per cent, this close approach is maintained during only a small portion of the total time.

Fig. 2 shows the essential parts of the recorder circuit as used when recording curves 6 and 7. All filaments except those of the UX-250 tubes were connected directly in parallel and fed through one rheostat from a 500-ampere-hour battery. Slight adjustments about twice in twenty-four hours serve to keep conditions sufficiently constant in most cases.

R_1 and R_2 are 50,000-ohm resistors. The two resistors R_6 each of 100,000 ohms serve to couple the second detector and balancing or bridge tubes to the two UX-250 tubes which actually operate the re-

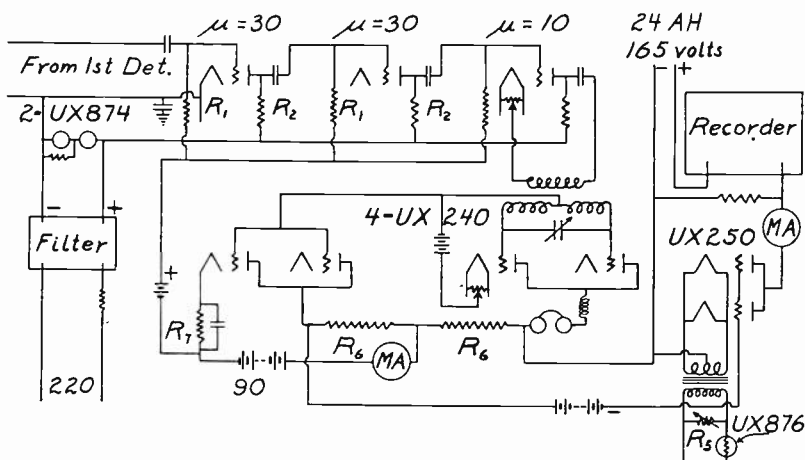

Fig. 2

corder. This is a direct coupling which provides one stage of d-c amplification. The *current* amplification provided by this stage is about 330, a 300-microampere change in detector current serving to provide the 0.1-ampere change required to operate the recorder over its full scale. R_7 is the resistor which provides the volume control bias for the amplifier tubes. Its by-pass condenser is a large one, such as 2 microfarads, which by-passes audio frequencies as well as radio. A typical value of R_7 in this particular equipment is 35,000 ohms.

The extra pair of UX-240 tubes to the left of the pair used for second detector form one arm of a bridge circuit. Variations in plate

supply voltage or grid bias voltage which would cause drift of the zero point of the recorder in a simple circuit are approximately balanced out by this bridge. It is necessary to pick these tubes to match approximately the characteristics of the pair of second detector tubes. A grid leak for the second detector, when used, must be connected adjacent to the center tap on the detector grid coil and not in the grid circuit to the balancing tubes.



NOTE ON HIGH-FREQUENCY TRANSMISSION DURING THE SUMMER OF 1930*

BY

G. W. KENRICK,^{††} A. H. TAYLOR[§], and L. C. YOUNG[§]

([†]Tufts College, Mass., [‡]Consulting Engineer, Bureau of Standards, Washington, D. C.,
[§]Naval Research Laboratory, Bellevue, Anacostia, D.C.)

Summary—The results of observations of echo signals at Cheltenham, Md., on 20 and 25 megacycles during the summer of 1930 are presented. A notable absence of strong echoes during this period is noted and marked abnormalities in their time of occurrence (as compared with previously reported results) are found. A comparison with field strength observations on GBU, (18.62 mc) is included and a discussion of possible causes of the abnormalities is given. The close correlation between the intensity of echoes and the intensity of the reception at Bellevue of the high-frequency signals from Rocky Point is also emphasized.

IT IS the purpose of this note to describe a series of observations undertaken during the summer of 1930 at the Naval Research Laboratory. The object of the work was to extend the echo signal results reported in an earlier publication¹ to higher frequencies and to include consistent observations over 24-hour intervals. It was hoped that these observations would serve to clarify further the characteristics and times of occurrence of the phenomena.

A set-up similar to that employed in the previous observations and utilizing four Beverage wires in north, south, east, and west directions was employed at the U.S. Magnetic Observatory at Cheltenham, Md., where the observations to be described were carried out. A receiver of the double detection type was available with considerably more gain than formerly employed. The set-up enabled echoes of 5 per cent or 10 per cent of the amplitude of the highly attenuated ground wave received from Bellevue to be readily observed. It was hoped that this would permit an extension of the observations to fainter echoes and higher frequencies than had been studied. It was therefore with considerable surprise that the writers noted a marked decrease in the number of observable echoes, as well as certain other peculiarities in the time of their occurrence notably at variance with conditions obtaining at the time of the observations previously reported, and this supplementary note hence seemed appropriate.¹ The negative character of the results obtained is considered particularly significant in view of the generally disturbed conditions during the

* Decimal classification: R113.6. Original manuscript received by the Institute, October 3, 1930.

¹ A. H. Taylor and L. C. Young, "Studies of echo signals," Proc. I. R. E., 17, 1491-1507; September, 1929.

TABLE I

Date	E. S. T. Time	Frequency	Beverage wires employed	Echoes	Path difference in sec. retarded after ground wave	Magnetic character of the day (Cheltenham)	GBU (18.62 mc) Reception at Holmdel, N. J.
7-8-30	14:00	20.0 mc	NSE and W	None	—	0	N
7-8-30	16:00	20.0 mc	All	Faint and erratic	0.02 sec.	0	N
7-9-30	14:30	20.0 mc and 26.8 mc	NSE and W	None	—	0	M
7-9-30	17:00	" " "	"	"	—	0	M
7-9-30	18:30	" " "	"	"	—	1	M
7-10-30	18:30	20 mc	SE and W	Faint	0.007 sec.	2	M
7-11-30	14:30	24 mc	NSE and W ₁	None	—	2	M
7-11-30	16:50	20 and 24 mc	"	"	—	2	M
7-11-30	17:00	"	"	"	—	0	M
7-11-30	18:45	24 mc	"	"	—	0	M
7-14-30	18:30	20 and 24 mc	"	"	—	0	M
7-15-30	16:50	20 and 24 mc	NSEW	None	—	0	M
7-15-30	16:55	"	"	None	—	0	M
7-16-30	16:20	20 mc	NSE and W	None	—	1	M
7-16-30	18:00	20 and 24.6 mc	"	None	—	1	M
7-16-30	20:00	"	"	None	—	1	M
7-16-30	23:00	"	"	"	—	1	M
7-16-30	23:30	"	"	"	—	0	M
7-23-30	13:15	"	"	"	—	0	M
7-23-30	18:30	"	"	"	—	0	M
7-23-30	20:30	20 and 24.6 mc	"	"	—	0	M
7-23-30	23:00	"	"	"	0.006 sec.	0	M
7-24-30	9:50	20 mc	Echoes on SEW ant. none observed N antenna	Clearer echoes observed during tests	—	1	M
7-24-30	10:50 *	"	NSE and W	None	—	1	M
7-24-30	11:20	"	"	None	—	1	M
7-24-30	11:35	24.6 mc	"	None	—	1	M
7-24-30	12:55	20 mc	"	"	—	0	M
7-28-30	14:15	20 mc	"	"	—	0	M
7-28-30	15:00	20 mc	"	"	—	0	M
7-29-30	8:30	20 and 25 mc	"	"	—	0	M
7-29-30	9:30	"	"	"	—	0	M
7-29-30	11:00	20 mc	"	"	—	0	M
7-30-30	11:15	20 and 25 mc	"	"	—	0	M
7-30-30	13:40	20 mc	"	"	—	0	M
7-30-30	14:30	20 and 25 mc	"	"	—	0	M
7-30-30	16:30	"	"	"	—	0	M
7-31-30	8:45	20 mc	"	"	—	0	M
7-31-30	9:30	20 and 25 mc	"	"	—	0	M
7-31-30	10:50	20 mc	"	"	—	0	M
7-31-30	12:15	20 and 25 mc	"	"	—	0	M
7-31-30	14:00	20 mc	"	"	—	0	M

* N=Normal (average field above 5.0 microvolts/meter), 9:00 to 17:00 E. S. T.
M=Moderately disturbed (average field 5 to 0.5 microvolts per meter) 9:00 to 17:00 E. S. T.
S=Severely disturbed (average field less than 0.5 microvolts per meter) 9:00 to 17:00 E. S. T.

period of the observations which extended for several weeks as noted in Table I. A comparison of the observed results with magnetic activity and the results of field intensity observations on a channel of approximately the same frequency (data furnished by the courtesy of the Bell Telephone Laboratories) are included therein.

It will be noted that no echoes were observed during magnetically disturbed periods and that even during quiet periods afternoon echoes such as those previously recorded were but infrequently noted and, when observed were of faint amplitude. It is believed significant that signals from the Rocky Point group of stations operating on frequencies near those under observation were also notably absent during the summer months. Since these stations are within the skip distance, the signals supposedly arrive by echo paths similar to those under

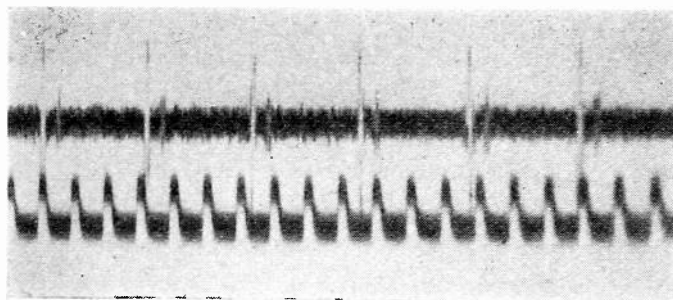

FIG. 1—Echo as received at 9:50 A.M. on July 24, 1930, on south wire. (One-hundred-cycle fork for timing wave).

observation. The strength of the reception of signals from these stations has been found to follow closely the intensity of the echoes and their absence hence serves to confirm the negative character of the results observable during the summer. Another point of interest are the morning echoes observed on July 24th at 9:50 A.M. It will be recalled that in the previously reported observations no morning echoes were found on 20 megacycles while in this case only morning echoes were noticed on this frequency. These echoes are shown in Fig. 1 where their small but distinct character will be noted.²

The results tabulated in Table I indicate only the results of oscillograms taken during periods of the observations. The data thus obtainable were supplemented by frequent visual monitoring with negative results which led to more extended periods of observations as noted and to the discovery of the unexpected morning echoes.

During August and early September the observations on 20 and 25

² Due to tube saturation, the ratio of echo to signal is exaggerated. The actual echo is probably about 10 per cent of the signal amplitude.

megacycles were made by T. R. Gilliland of the Bureau of Standards staff at the Bureau's experimental station at Kensington, Md., and no echoes were observed until September 17th. On that date he obtained marked echoes during the afternoon and early evening hours. This return of the echoes had been anticipated by a marked strengthening of the Rocky Point signals and a general improvement of high-frequency reception at Bellevue a few days prior to this time.

Observations have not yet extended over a sufficient period to establish whether the phenomena observed are typical summer conditions on these frequencies or are associated with the disturbed magnetic conditions existing during the period of the observations at Cheltenham. *A priori* reasoning based on electron density considerations would lead one to predict excellent high-frequency transmission during the summer, with its correspondingly high solar constant, but the results observed in these tests do not confirm this prediction. On the contrary the results of these tests (and generally of range tests conducted during the same period at the Naval Research Laboratory on 20-megacycles and higher frequencies) indicate much greater attenuation than obtained during the winter months. The explanation of these phenomena may perhaps involve considerations of turbulence, layer movements, and the relative density of several layers as well as electron density considerations in a single layer. Apparently considerably increased periods of observation of these phenomena and also of layer heights and transmission conditions on the lower frequencies will be necessary before anything approaching a general theory can be evolved. With this in view, observations are being continued and the cooperation of other observers is invited.



CONDENSER LOUD-SPEAKER WITH FLEXIBLE ELECTRODES*

BY

P. E. EDELMAN

(Electrical Engineer, Chicago, Illinois)

Summary—Condenser loud speakers employing flexible electrodes are described together with their uses as the input to an amplifier or for reproducing from the output of an amplifier unit. One electrode diaphragm utilizes an impregnated cloth carrying a conductive coating. The cooperating electrode is also flexible and air-permeable. Textile threads at spaced distances are used to maintain the separation between the operating electrodes and to reduce backlash rattle noises.

The improvement in response, fidelity, and efficiency, as well as durability, are set forth, accompanied by examples of suitable operating circuits. It is pointed out that such condenser speakers operate most favorably with an amplifier arranged to compensate for their characteristics.

THE condenser loud speaker illustrated in Fig. 1 comprises, essentially, two flexible electrode diaphragms, supported closely adjacent to each other with a definitely regulated air gap of variable dimensions between.¹ One of the diaphragms is made air-permeable and takes the form of a metal cloth carrying flexible soft metal strips. The other diaphragm is flexible cloth to which a very thin metal foil surface is flexibly fastened. To obtain a definite range of air gap spacing between the two electrodes, a series of spaced threads is interposed between the two members. These threads are flexible and serve to counteract "backlash" effect, previously a serious fault in condenser reproducers operated at large volume of response.

STRUCTURE

The front diaphragm is made of empire cloth carrying a metal coating on the front side. The back side of this flexible cloth or diaphragm is dusted with mica or talcum particles to prevent adhesion to the rear electrode during operation. Cambrie or silk fabric prepared with oxidized linseed oil, or an insulation material including asphaltum, has been found suitable in thicknesses ranging from 0.0022 to 0.0055 inch. Overlapped mica sheets 0.001 inch thick, cemented to cloth, may also be used. The conductive coating consists of very thin aluminum foil and is held to the cloth by means of cerowax or gold size

* Decimal Classification: R365.2. Original manuscript received by the Institute, July 10, 1930. Revised manuscript received by the Institute, October 3, 1930.

¹ U. S. Patents, No. 1,767,657, June 24, 1930; No. 1,759,811, May 20, 1930; No. 1,759,810, May 20, 1930; No. 1,767,656, June 24, 1930; No. 1,759,809, May 20, 1930; No. 1,776,112, September 16, 1930.

japan varnish. This affords a flexible laminated diaphragm of light weight and good insulation qualities with an approximate dielectric constant of 3. It has an operating life known to exceed four years and a breakdown strength more than twice the normal operating e.m.f. This electrode diaphragm structure is stretched on a supporting frame as shown in Fig. 1. The supporting frame is maintained under tension by springs placed at its expansible corners so that diaphragm wrinkles are avoided.

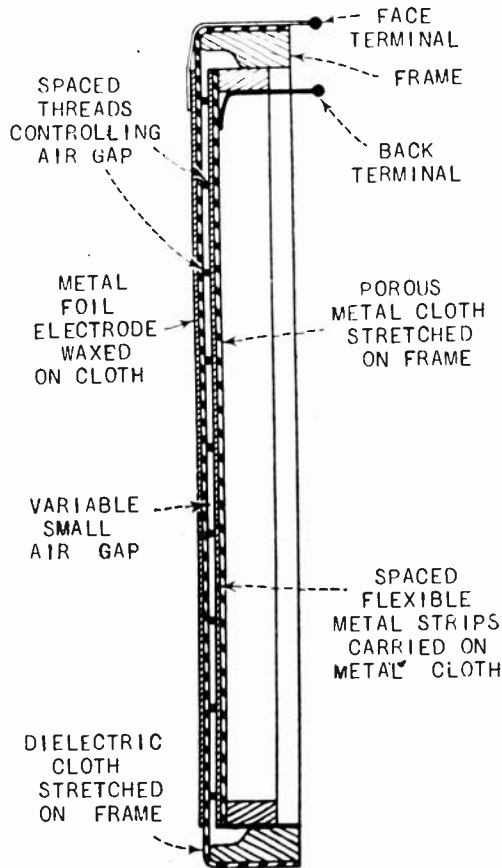

Fig. 1—Acoustic condenser structure.

The rear diaphragm is supported either from the same frame or an adjustable auxiliary frame. It is a porous air-permeable laminated structure, comprising a metallized fabric or tinsel metal cloth carrying spaced groups of soft metal ribbons on its top side. An extra fabric sheet is used to support the flexible electrode for manufacturing convenience. The soft metal ribbons are fastened to the tinsel cloth by a flexible metal cement. This affords a porous electrode having approximately 25 per cent of its area open to air flow. The thickness of this metal cloth may vary from 0.003 to 0.01 inch. The metal ribbons are

composed of an alloy of lead and tin of thickness within the limits 0.001 to 0.009 inch, and 1/4 to 1/2 inch wide. These strips are securely and flexibly fastened to the metal cloth. Sometimes crossed layers of such strips are used. The relative areas on the back electrode member covered by such soft metal strips range from one-third to two-thirds of the total area.

The metal cloth is farther away from the impermeable electrode than are the flexible strips, but the metal cloth itself affords a multiplicity of air pores, permitting efficient response.

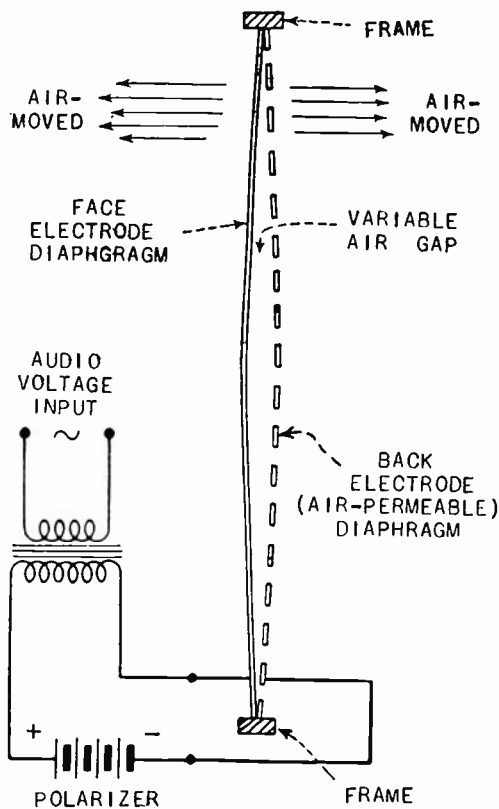

Fig. 2—Operating principle.

Terminal contacts are brought out from each electrode by means of insulated flexible metal ribbons reinforced with a tinned copper strip.

The question of the initial tension at which these members are stretched has received attention. It is preferable to have one member stretched at greater tension than the other, but it is not advisable to maintain a greater tension than that which will keep the members free from wrinkles and from such tightness as is likely to cause frame resonance effects. Each member is substantially dead to sounds *per se*.

AIR GAP SPACING

The operation of this type of speaker requires a source of audio-frequency potentials superimposed on a direct polarizing potential. The polarizing potential must exceed the highest peak voltage of the audio-frequency voltages applied to the electrodes. This polarizing voltage draws the two electrodes together except as limited by the thread spacers. The threads are best used in spaced groups, linearly or crossed, and in thickness of the order of 0.001 to 0.003 inch, with corresponding spacing of the order of 1/4 to 3/4 inch. The thinner the threads, the closer may be the spacing. A diagram to illustrate the operation is shown in Fig. 2. The function of the thread is shown in the enlarged section of Fig. 3. Upon returning towards each other after an initial transient stress, the flexible members would tend to strike

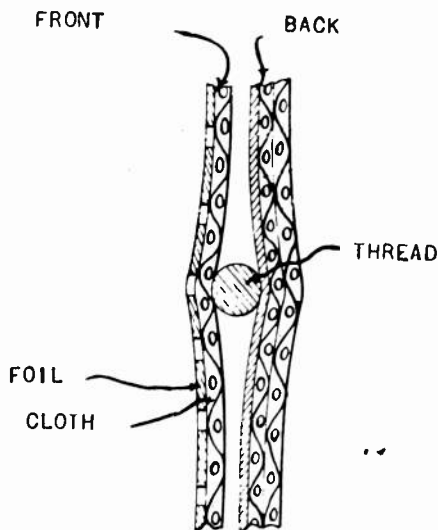

Fig. 3—Function of thread.

together, but are first caused to compress against the thread members and roll slightly thereabout. This tends to break the transient vacuum and allows free return of the stressed members. The result is that the overload characteristics are greatly improved. It will be noted, too, that the threads serve as an insulating element so that the closest points of contact against the threads correspond to the weakest force and least retentivity of the electrostatic path. This effectively serves to prevent "sticking" of the electrodes or lag in return travel of the operating members. If any such sticking were permitted, the two vibrating members would tend momentarily to operate as a single laminated diaphragm. The phase relation required, which is secured by this structure, is that, for a particular instant, air should be pushed out simultaneously by both front and back members.

This explains the reason for the observed operation in all except the smallest sized condenser speakers (such as are less than 500 square inches in area), that no auxiliary baffles are required for satisfactory bass reproduction. On small units, such as have a working area of only the order of 70 to 200 square inches, a box baffle is usually employed. This baffle may be the cabinet space enclosure usually provided in a radio set equipped with a built-in cone speaker. A suitable baffle arrangement for a cabinet enclosure is shown in Fig. 4. Ordinarily the speakers are arranged in artistic frames, pictures, plates, signs, prints, or tapestries, or merely hung near a wall. They are suitable for use with midget size radio sets. An unobvious location on a wall is both pleasing and effective. In the reverse use as a microphone, the

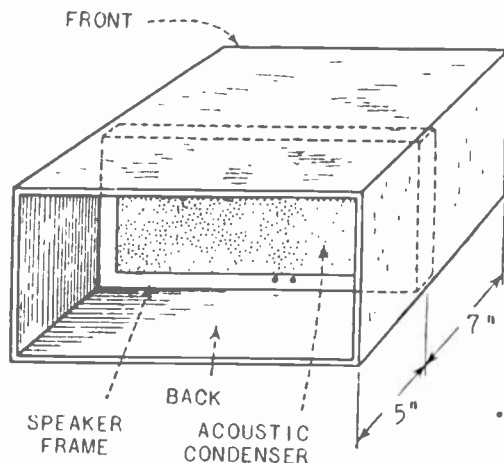

Fig. 4—Box baffle arrangement.

artistically concealed acoustic condensers have proved utility, both indoors and outdoors. For outdoor service in either pick-up or reproducing function, they are usually weatherproofed. Cerowax has been found suitable for sealing in the casing and relatively little of the sound energy is lost by transmission through the extra waterproofing diaphragms used.

The speaker is suitable as a reproducer when operated from an amplifier employing either single or push-pull triodes. It may also be advantageously operated from a pentode output, with hum suitably removed. The quality of the amplifier must, however, be as high as can be attained. A unit of the order of area of 150 square inches gives pleasing response on the output of push-pull 45-type tubes when fed through a suitable output transformer. If desired, as many as ten such speaker units can be parallel operated from the same amplifier output because the acoustic condenser is essentially a voltage actuated device. The shape of the condenser speaker is not important and may be either rectangular, or of curved contour.

From the simplicity of the structure used, it follows that this construction permits economy in costs. Aside from the lower cost of the condenser unit compared to the equivalent electromagnetic type speaker, a considerable saving in the cost of the amplifier unit and its power supply is possible when it is designed to fit with the acoustic condenser. Then, too, there is a reduced weight and consequent shipping cost in the case of the condenser reproducer. The suitability of the condenser reproducer for operation on a radio amplifier output is particularly evident in the case of a remote controlled radio installation, because several such condenser speakers are conveniently operated from a single amplifier unit.

At the present time the operating sensitivity, compared to the best type of commercial electrodynamic speaker operated from the same amplifier tubes, is from 65 per cent up to 150 per cent. The higher percentage of response is attained by the use of larger sized or multiple grouped units, and the lowest relative percentage is obtained with a small unit, using a proper coupling transformer in each instance. The volume of response obtainable is thus comparable to the best previously obtained with other types of speakers, and exceeds by more than 400 per cent that previously obtained by some forms of condenser speakers employing rigid perforated electrode elements. Voice reproduction of this speaker is particularly clear and true pitched.

The necessity for "in-phase" excitation for simultaneous movement of all areas of the diaphragms is evident in order to avoid interferences or different rates of travel of the sound energies over different portions of each diaphragm.

The frequency response range of this condenser loud-speaker is free from noticeable resonance peaks and valleys. It is important, however, to have a proper amplifier output or coupling device to operate the condenser speaker. The same unit which operates poorly when connected to the plate circuit of an amplifier tube, such as is intended to operate a dynamic type coupling transformer, operates very satisfactorily when a suitable transformer coupling is substituted for the step-down transformer previously used. Reversing the amplifier output terminals with respect to the polarizer often improves the quality. With some amplifiers, defects in the amplifier, not noticed when a dynamic reproducer is coupled thereto, become very evident when the electrostatic reproducer is connected to it. This occurs because the latter responds to overtones and high frequencies which are missed entirely by dynamic reproducers previously considered to be of good commercial quality.

The weakened bass response of condenser speakers has been found to be due to lack of proper coupling or amplifier constants to get the

energy represented in the lower frequencies through the speaker. One may be assured by observation that the condenser speaker is fully capable of going down as low as desired in the scale, provided only that means are arranged to get the operating energy at such low frequency through the speaker. Much has already been accomplished by selection of transformer constants with the primary to secondary ratio stepped up as much as 1 to 3-1/2, accompanied by the use of electrostatic shielding between the windings in the transformer structure. By providing generous capacity leakage in the coupling transformer, it has been possible to accentuate the bass input to the speaker with improved results. In other attempts, a filter circuit has been utilized to improve the relative ratios of low- to high-frequency input to the condenser speaker and a range down to 50 cycles has been attained. More improvement in this direction awaits the commercial advent of amplifiers designed to fit condenser reproducers rather than dynamic type reproducers; that is to say, the introduction of commercially satisfactory high impedance output tube amplifiers such as the output pentode.

Due to the relatively high impedance values, an exact impedance matching to amplifiers has not been attained with condenser speakers. Considering the small amount of the total audio-frequency energy utilized by the condenser speaker, its performance is remarkable. Given a suitable high impedance output amplifier, it may be predicted that this condenser loud-speaker can outperform the best known type of dynamic reproducer. The impedance of the condenser speaker cannot be considered merely as its static capacity reactance component. The mechanical load, imposed by the air moved, as well as the changing air gap distances during operation, defeat attempts to obtain any but static impedance values by known methods. It may be presumed that some scientific method will be developed to obtain the dynamic impedance values.

As the working area of a speaker of this type is progressively increased on the same amplifier output, an optimum area for maximum response is soon reached, after which further increase of working area results in a weakened total sound response. If the impedance values were independent of the air load, an amplifier could be loaded with additional working area of the condenser reproducer to attain an exact impedance match. It seems best to regard the condenser reproducer as analogous to a small water pipe operated from a controllable head of water, and to increase the head to the extent possible to get a greater flow through the pipe. Probably the limit in this direction has already been reached.

Acoustic condensers are capable of plane wave front propagation of reproduced sounds without a pronounced dead spot in the polar response pattern. The air for a particular instant is pushed out simultaneously from both the face and the back of the acoustic condenser, there being approximately 75 per cent as much air moved from the back as from the face. There is an improved response in the edge-wise direction away from the speaker. This is a favorable characteristic resembling the natural sound emission by a living speaker and probably accounts for a large measure of the improvement obtained with the condenser reproducer on the reproduction of human speech. Unlike the case of cone-speaker reproduction, the listener, upon hearing a condenser reproducer of this kind, appears to hear the sounds at about the same intensity whether the listener is located close to or remote from the speaker. The wave front propagation appears to set out straight for as much as 30 feet before diverging perceptibly at any but a small angle. This permits utilization of sound focus art in covering a large audience without waste of sound energy up to the ceiling or to side walls having poor acoustical properties capable of causing echo effects. The observed effect in a living room of a home is that the reproduced sounds appear to have a nondirectional source in the room itself.

Substantially all of the area of the diaphragms is effective in moving air. This characteristic has been utilized in very large sized acoustic condensers and in groups thereof, ranging in the order of value of 600 square feet for large audience coverings. Such large speakers have also been built at the factory of the Potter Company at North Chicago, Illinois, wherein the front electrode is utilized as a screen for motion picture projection, affording a sound picture screen, combined with the reproducer.

OPERATING CIRCUITS

A number of interesting operating circuits have been developed to actuate condenser speakers and microphones. The essential features of all such circuits are that a source of direct potential shall be maintained on the speaker electrodes while a suitable source of audio-frequency energy is applied thereto simultaneously at lower peak voltage values than the polarizing voltage. A typical operating circuit is shown in Fig. 5. The output coupling transformer should be designed with minimum capacity coupling between the primary and secondary. A generous sized core for the transformer is also desirable. In Fig. 6 there is shown an effective circuit for a large group of speakers of this type. The d-c polarizing source enters at two corners of a Wheatstone mesh circuit, while the audio-frequency potentials are applied at the

other two corners of the mesh. Groups of acoustic condensers can be used in any multiple of four for this circuit, such as 4, 8, 12, 16, or 20. A -50 push-pull amplifier output is suitable to feed 8 to 20 units of 500 square inches working area each. Usually the face of one speaker is connected to the back of the next, to complete a series of four for the group. Part of the adjacent speaker frames may be advantageously situated at an angle with respect to the others to disperse the audience coverage to fit peculiar acoustic conditions. Multiple series grouped and spaced speakers of this kind are fed from a looped wire circuit, operating ten speakers of 20x30 inches size, from a -50 type push-pull amplifier for each 2000 persons covered. For a small living room, satisfactory response can be had with a single speaker of 150 square inches area. It is permissible and safe to utilize a single wire loop to feed multiple grouped speakers, with ground return. For double looped circuits, a wide spacing of the two wires is desirable to avoid capacity

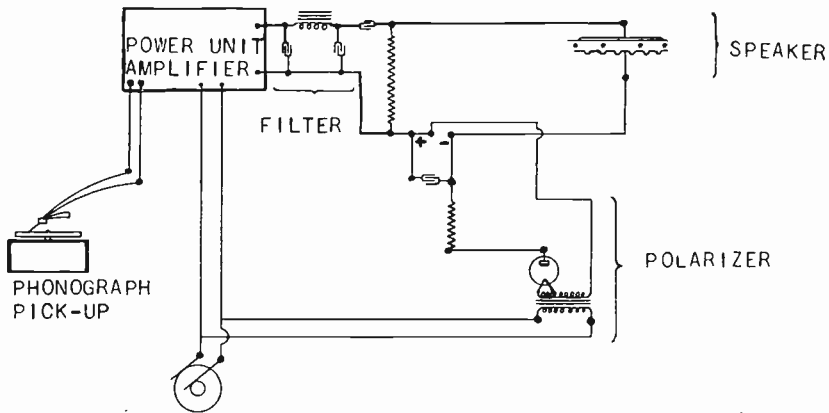

Fig. 5—Operating circuit.

losses between the wires of the circuit. For long circuits or where conduit must be used, it is preferred to transmit the voice energy at low voltages and step same up by a suitable unit at the speaker end of the line. This unit comprises a transformer and a polarizer.

POLARIZER

The polarizer does not always necessitate a separate unit but may be combined with the regular power supply of the amplifier or taken directly therefrom. This condenser speaker, because of its structure, requires only nominal and not high polarizing voltage. A typical polarizer unit is shown in Fig. 7. The polarizing voltage need not be obtained from a hum-filtered source. A 201-A tube connected as a rectifier with proper circuit affords all the polarization necessary. Resistances are included in such a circuit to limit the current drain

through the rectifier and after the acoustic condenser is once charged, allowing for slow leakages through the high resistance dielectric material employed, negligible current is drawn from the rectifier in service. In many 250-tube amplifiers, or in direct coupled resistance amplifiers, or in the case of a pentode output tube, the power pack used for the amplifier may be employed to obtain all the polarizing voltage required, in series or parallel with the output transformer, through limiting resistance.

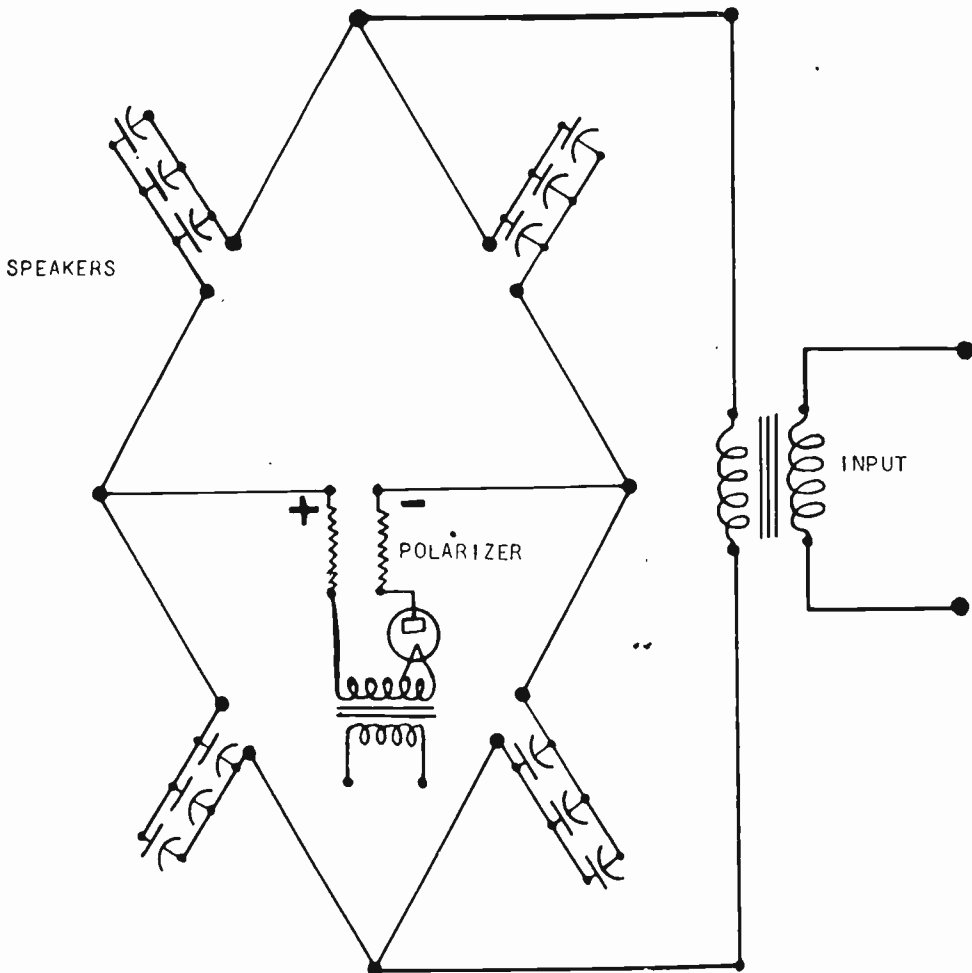

Fig. 6—Bridge circuit.

A polarizing voltage must be used just as a magnetic field is essential in the case of a dynamic speaker. The polarizing voltage serves to keep the acoustic condenser plates charged so that the audio-frequency energy impressed thereon can move the plates without doubling the frequency of response. No benefit is found from excessive polarizing voltage, but too low a polarizing e.m.f. results in somewhat lessened volume of response. Deficiency in polarizing voltage evidences

itself as a mushy distortion. A polarizing voltage ranging between 500 and 600 volts per speaker reproducer is found to be suitable. Such voltage combined with the audio-frequency voltage is well within the safe operating limit of the dielectric strength of the material used.

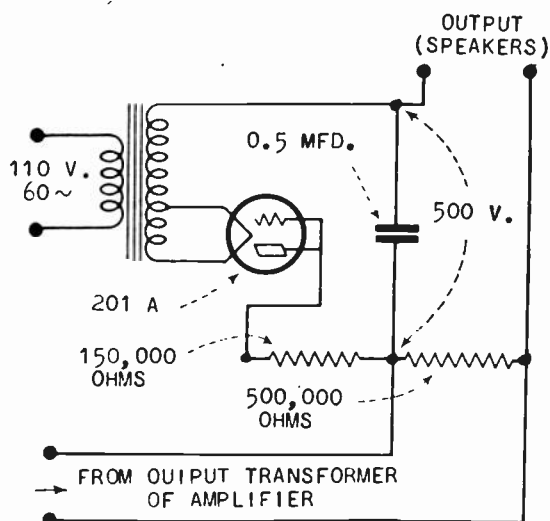

Fig. 7—Polarizer circuit.

There is a large factor of safety so that normal operation never breaks through the dielectric. Provision is made so that, if there is an imperfection in the dielectric, the fault is self-correcting. Usually a small

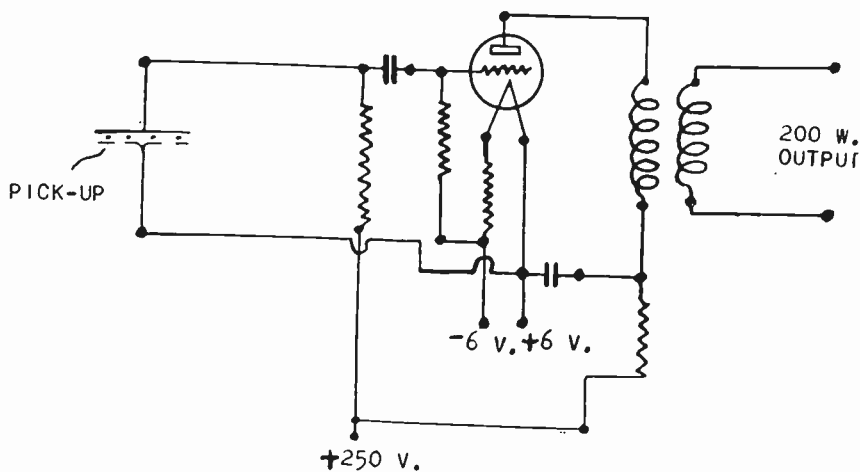

Fig. 8—Pick-up circuit.

area of the thin metal foil in burning away upon rupture of the dielectric permanently cures the said defect. In the case of the wax-fastened foil speakers, the wax melts and fills in the puncture.

A conventional microphone pick-up circuit is shown in Fig. 8. For this service a silk dielectric cloth 0.002 inch thick is preferred for

use in the front diaphragm. A high megohm resistance feeds polarizing voltage to the acoustic condenser pick-up from the plate voltage supply. Sound waves vary the capacity of the pick-up condenser and cause the charging current thereto to change. Such varying current through the resistance sets up a voltage drop across it which changes according to the sound waves received. This varying voltage actuates the grid of the amplifier. Two stages of amplification are sometimes employed instead of a single stage.

The conclusion is advanced that the departures in structure discussed have brought the flexible condenser speaker to a stage where it can compete with the best other known types of reproducers, that in some respects it has distinctive advantages in quality of reproduction, and that further advances may be attained along this line by the development of amplifiers with vacuum tubes designed to fit the characteristics of the condenser speaker.



AN EXPERIMENTAL METHOD OF STUDYING TRANSIENT PHENOMENA*

BY

H. M. TURNER

(Yale University, New Haven, Conn.)

Summary—The following is a description of an experimental method of studying transient phenomena which, by repeating the phenomena synchronously, enables one to observe it on the screen of an oscillograph as long as desired.

THE object of this paper is to describe an experimental method of studying transient electrical phenomena, developed at Yale University. It is effective in stimulating the student by enabling him to obtain a new kind of laboratory experience on which he can build with confidence. It appeals to the engineer as being useful in research because of its precise control and flexibility. This method is in no sense a substitute for the analytical and mathematical treatment but follows and supplements it and gives it a definite physical significance. However, it can be used where the amount of work involved in computation would be prohibitive and in those cases where it is impossible to formulate the problem, due to lack of exact knowledge of the relation existing among the variables, in order to obtain a rigorous mathematical solution.

In the usual case of transient phenomena, which are not recurrent, it is impossible to view the curves on the screen of an oscillograph because the trace produced by a single sweep of the light spot across the screen is insufficient to make an impression on the eye and furthermore there would be no time for a detailed study of the curves. As a consequence, it was necessary in all cases to make photographic records which were, in general, unsatisfactory due to the fact that the amplitude could not be accurately predetermined nor could the closing point on the electromotive force wave be easily and precisely controlled, nor could the curves be properly placed on the film.

The method being described is based upon the use of the transient visualizer,¹ in conjunction with an oscillograph which not only makes it possible to view the transient curves for as long a period as desired but also to obtain instructive coordinated oscillograms that would otherwise be impossible.

* Decimal classification: R140. Original manuscript received by the Institute, November, 10, 1930. Revised manuscript received by the Institute, December 23, 1930.

¹ H. M. Turner, "The transient visualizer," *Jour. A.I.E.E.*, June, 1924.

DESCRIPTION OF THE TRANSIENT VISUALIZER

The transient visualizer is a synchronous switch for repeating the transient periodically with respect to the oscillating or rotating oscillograph mirror and also for controlling circuit conditions. It consists essentially of a four-pole, self-starting, synchronous motor connected through helical gears to an insulated drum into which contact segments have been set. Segments 1 to 5 are electrically connected as are 6, 7, and 8 but the two groups are insulated from each other. The lengths and relative angular positions of the various segments, shown in a development of the drum in Fig. 1, are designed to give maximum flexibility.

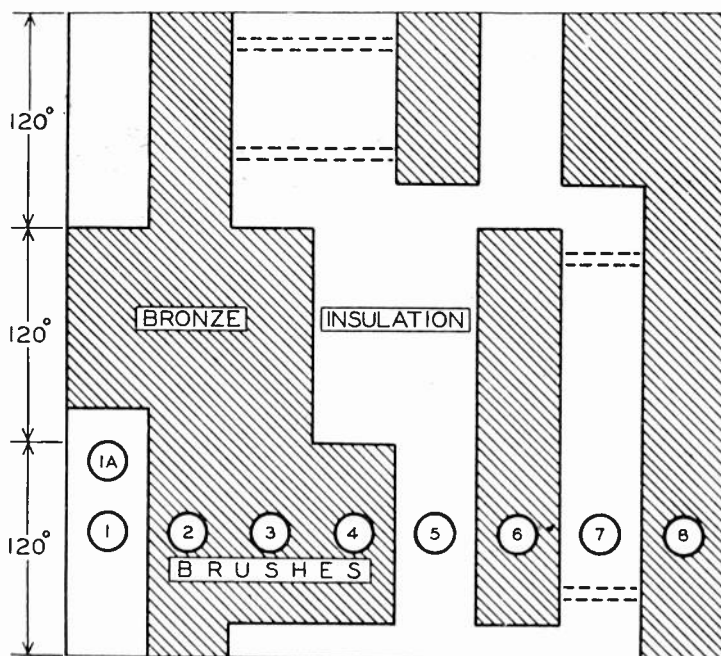

Fig. 1—A development of transient visualizer drum.

Brushes 1 to 8, which make contact with their respective segments, are mounted on a common arm which may be rotated to any desired position and then locked so the curves may be properly placed on the screen and started at a predetermined point of the electromotive force wave. Attached to the brush arm, through gears, is a pointer which moves over a scale, (see Fig. 5), graduated in electrical degrees for determining, or starting at, desired points of the electromotive force wave. Brush 1a, which also makes contact with segment 1, is mounted on a disk at the left of the contactor and may be rotated independently of the main brush arm or locked so as to move with it. The object of this auxiliary brush is to produce the equivalent of an increase in length

of any one of the following segments: 1, 3, 4, or 5 which is accomplished by connecting it in parallel with brush 1, 3, 4, or 5 so as to extend the time the circuit is closed or to open it at some desired point.

A photograph of the transient visualizer is shown in Fig. 2. The shaft at right angles to the apparatus was originally used for driving the photographic drum through helical gears but it has been replaced by another design as illustrated in Fig. 5.

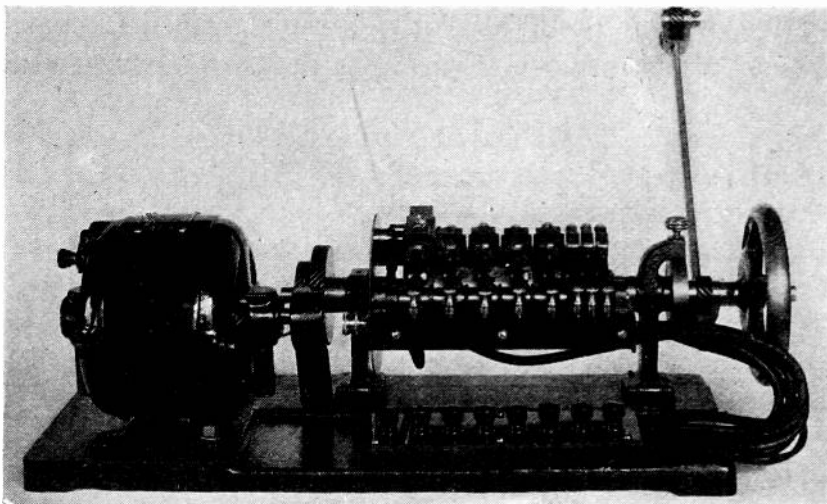

Fig. 2—The transient visualizer.

VIEWING TRANSIENT CURVES ON SCREEN

For viewing transient curves on the screen there need be no mechanical connection between the visualizer and the oscillograph as illustrated in Fig. 3, where it is used with a projection equipment in the study of coupled oscillatory circuits. As shown in Fig. 4, the primary condenser is charged from a storage battery by completing the circuit through the transient visualizer by means of brushes 2 and 5 after which the circuit is opened and then the condenser is discharged through the primary winding using brushes 2 and 3. The two curves shown in Fig. 3 refer only to the discharge period; the upper is the primary current and the lower that of the secondary. Fig. 3 is not a true photograph because with sufficient illumination to take a picture of the apparatus the curves would not show on the screen, however, it does represent accurately what one would see if present in the dark room. The results are actually uncanny. At the slightest change in resistance, inductance, capacity, or coupling the curves become living creatures and fairly dance as they assume new shapes and positions instantly. The change in frequency, phase relation, amplitude, and the

group frequency of the wave-train are immediately evident. What would take hours to calculate mathematically may be obtained in a few minutes by this method. It is particularly effective for demonstration lectures and group discussions.

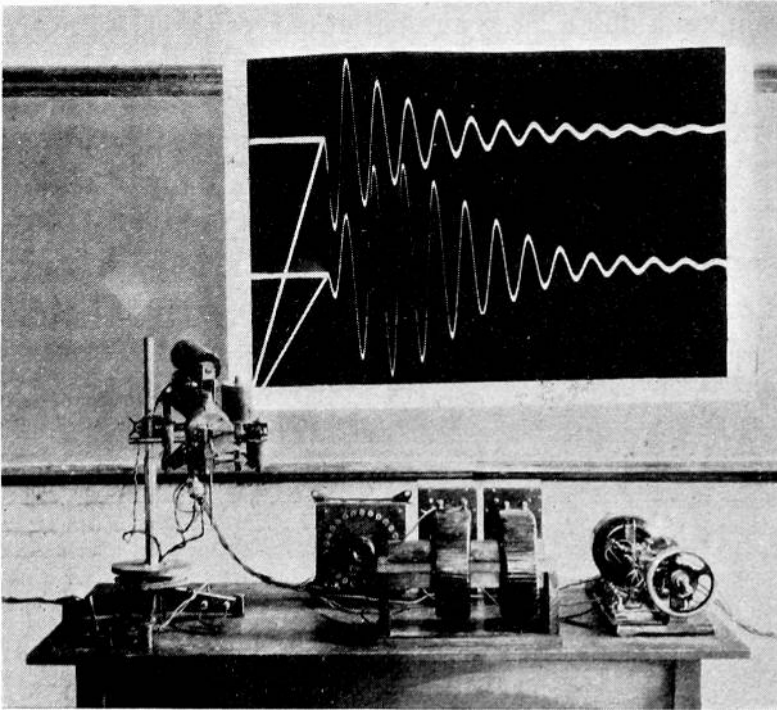

Fig. 3—The transient visualizer with projection oscillograph.

COÖRDINATED OSCILLOGRAMS

In order to realize the full possibilities of the transient visualizer in obtaining coördinated photographic records of transient and periodic

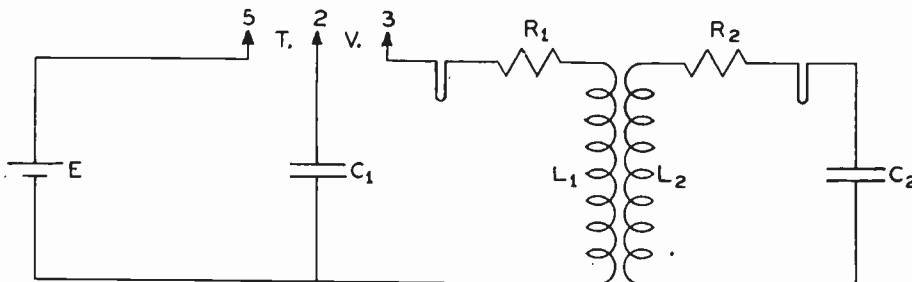

Fig. 4—Diagram of connections for coupled circuits.

phenomena the film drum should be driven at the same speed. A convenient arrangement is shown in Fig. 5 the drive being by means of a sprocket and steel chain free from lost motion. This is extremely im-

portant in making a progressive study where, for the convenience of comparison, it is desired to take a series of curves of related phenomena on the same film, one after the other, all starting from the same point. Since the film drum and the transient visualizer, when run at the same speed, maintain the same mechanical phase relation it is possible to superpose upon a film a large number of curves taken successively for

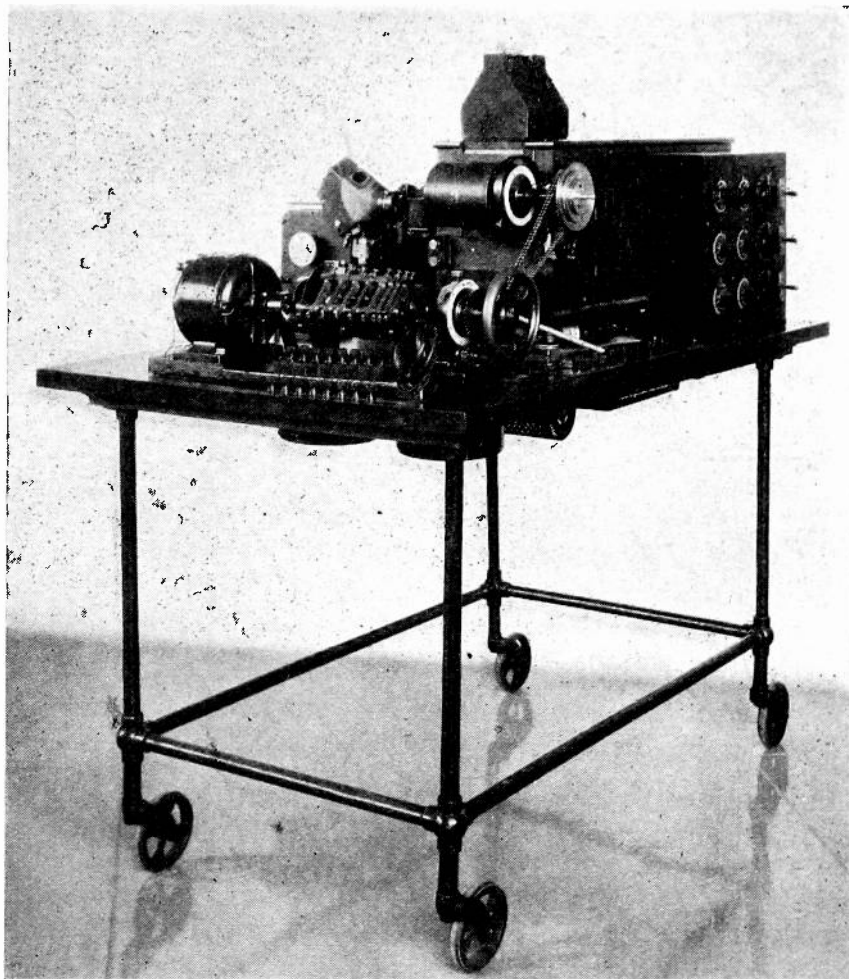

Fig. 5—Equipment arranged for obtaining coördinated oscillograms.

different circuit conditions thus showing progressive changes. This is illustrated in Fig. 7, which shows the discharge of a condenser through a resistance and inductance as shown in Fig. 6, where without any confusion whatever eight separate exposures were made, the capacity being different in each case. The gradual transition from the nonoscillatory state through the critical, to the oscillatory state is readily apparent. Preliminary adjustment of the amplitude is made by viewing the curves on the screen before taking the oscillogram.

A PHYSICAL INTERPRETATION OF COUPLED CIRCUITS

A thought provoking experiment is a study of the change produced in the frequency of an oscillatory circuit due to coupling, the connections being the same as in Fig. 4. Mathematically one obtains two component frequencies, but suppose one looks at this problem from another point of view, viz., that of a frequency which varies throughout the

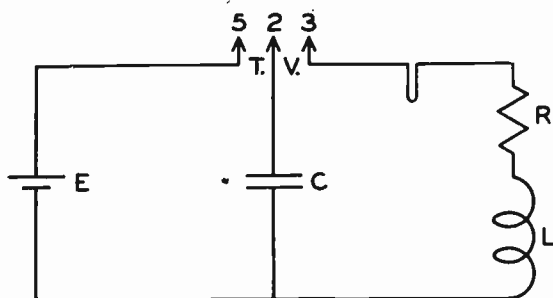

Fig. 6—Connections for discharge of condenser through resistance and inductance.

wave-train. The frequency of a simple oscillatory circuit, having negligible resistance, is determined entirely by its inductance and capacity. However, when the secondary is coupled to it the apparent inductance, as viewed from the primary condenser, is no longer constant but varies due to the magnetizing and demagnetizing action of the secondary cur-

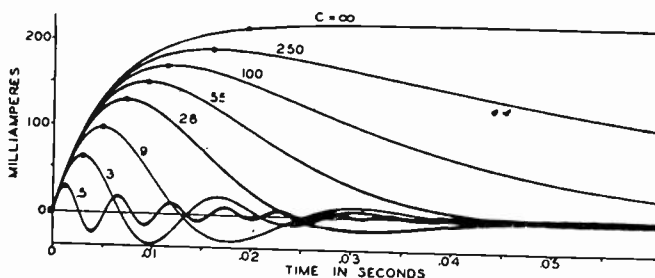

Fig. 7—Oscillogram showing the effect of varying the capacity through wide limits.

$R = 252$ ohms.
 $L = 1\frac{1}{2}$ henries.

rent. It is sometimes larger and sometimes smaller than that of the primary alone and it appears reasonable to consider that the frequency would vary accordingly. This variation would not only take place from cycle to cycle but from instant to instant.

However, as a first approximation, consider the half-period frequency as determined by the time interval between two successive zero points of the current curve. In Fig. 8 it will be observed that it varies along the time axis. Referring to the upper pair of curves one is the primary current with the secondary open which is used as a standard of

comparison; and the other the primary current when coupled to an identical secondary. During the first half-cycle of the primary current the secondary current is small in comparison, (see lower curve), and the demagnetizing effect small so one would expect the frequency to be only slightly higher than that of the reference curve due to the small reaction of the secondary which is confirmed experimentally. The general effect is that the primary frequency increases for the first four or five half-cycles after which it decreases.

If the secondary by some means or other, had a small amount of energy introduced into it and was then left free it would oscillate at its own natural frequency which is, in the illustration, the same as that of

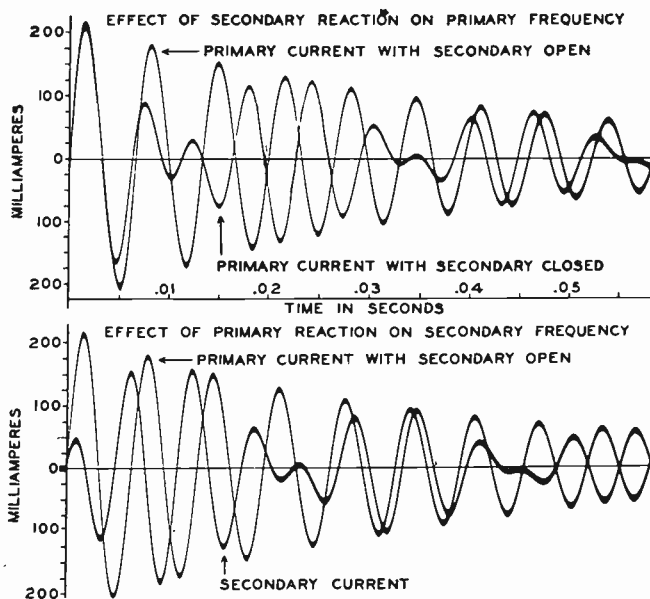

Fig. 8—Oscillogram showing the reaction of one circuit on another.

the primary. In the case under consideration this energy is supplied by the primary but the secondary is not free to oscillate at its natural frequency due to the demagnetizing action of the primary current, which is large thus greatly decreasing the apparent inductance of the secondary and thereby appreciably increasing the frequency. The lower curve in Fig. 8 shows that at first it is twice that of the natural frequency due to the large reaction of the primary, and then decreases for several cycles before increasing again.

Since a free circuit oscillates at its natural frequency along a normal curve, any reaction due to magnetic coupling will cause a point-to-point departure from the normal curve thus either accelerating or retarding the approach to the end of the half-cycle which may be thought of as producing an instantaneous change in the frequency. However,

for a complete understanding of the action a point-to-point analysis based on the rate of change of current in the circuit would be required which space does not permit.

The object of this discussion is not to replace the exact mathematical analysis but to emphasize the physical aspects of the phenomenon and to stimulate a more thorough study of it.

LOCATING A POINT ON THE ELECTROMOTIVE FORCE WAVE

In oscillographic investigations it is often desirable to be able to locate definite points on the electromotive force wave, especially when taking oscillograms. This is important in the study of transient and periodic phenomena. It is quite simply accomplished.

To locate the zero point of the wave proceed as follows: With the transient visualizer running, an oscillograph element, with a suitable series resistance, is connected to the source of alternating voltage through, say, brushes 2 and 3. Observe, on the screen of the oscillograph of Fig. 5, a heavy ground line up to the point where the circuit is closed, a lighter ground line from this point on, and the voltage wave. Rotate the main brush arm until this change in ground line density comes at the zero, or other desired point, on the voltage wave which is observed on the screen. Lock the brush arm in position.

The fact that one sees a ground line extending across the screen, a break in the ground line which moves as the brushes are rotated and the permanent voltage wave is due to the persistence of vision. The speed of the synchronous motor, on 60 cycles, is 1800 r.p.m. so the transient visualizer, due to a three-to-one reduction, runs at 600 r.p.m. thus making a revolution in 0.1 second which corresponds to six cycles of the power. The synchronous motor that drives the oscillating oscillograph mirror runs at 1800 r.p.m. so the light spot will sweep across the screen three times for one revolution of the transient visualizer. Now the circuit is closed by the transient visualizer for approximately 0.6 of a revolution or for 3.6 cycles showing the starting point and the permanent voltage wave and is open for 0.4 which provides the ground line and fortunately, due to the persistence of vision, one sees all three at the same time. The heavy portion of the ground line is due to the light spot retracing this portion of the path more times than it does the remainder of the ground line.

In the case of the projection oscillograph, Fig. 3, one will see a ground up to the point of closing and the permanent voltage curve from this point on. This is due to the fact that the light beam sweeps across the screen once for each revolution of the transient visualizer drum.

When the brush arm is once correctly set it can be left indefinitely

without further attention. However, should it be necessary to stop the transient visualizer, say to remove the film, the next time it is started the motor may pull in so the circuit is closed at the point for which it was adjusted or 180 degrees out of phase. In the latter case this may be easily corrected by restarting the motor once or twice until the phase is correct as observed on the screen.

Starting oscillograms at the zero point of the wave greatly improves the appearance as will be illustrated by the reproductions which follow. Where it is desired to start at some other point use is made of the scale, graduated in electrical degrees, already referred to.

LOCATING THE STARTING POINT ON THE FILM

After having located the desired point on the electromotive waves at which the circuit is to be closed the transient visualizer drum is stopped and then rotated slowly by hand to the point where the brushes close the circuit. This can be done by eye directly, or more precisely by means of an ammeter or oscillograph element in series with the circuit. Release the set screw that holds the upper sprocket to the film drum shaft, Fig. 5, rotate the drum to the desired starting point on the film as indicated by the graduated scale, and then lock the sprocket to the shaft.

CONSTANT CYCLE LENGTH

When making oscillograms at power frequencies it is of great advantage in comparing different curves to have a definite cycle length. This is made possible by the synchronous film drive. The curves need not be taken on the same day, or on the same machine, or even at the frequency although, in general, this would be desirable. Any variation in the frequency of the power source will change the film speed proportionally so that the length of a cycle measured along the time axis will be exactly the same. Of course, if a change in the cycle length is desired it may be brought about by changing the gear ratio between the driving motor and the transient visualizer or between the transient visualizer and the film drum.

The value of this feature is illustrated in Fig. 9. The upper curves show the permanent exciting current for 144 turns and for 84 turns in the primary with a constant impressed voltage. The lower curves show the primary voltage as a reference together with the secondary and tertiary voltages in test windings of ten turns each, for the two values of magnetic saturation. The number of turns in secondary and tertiary test windings is small in order to prevent magnetic reaction due to the current taken by the elements. The circuit diagram is given in Fig. 10. These oscillograms were taken two years apart. The vertical lines con-

nect points of interest in the two oscillograms. Since the magnetic shunt has two air gaps its reluctance will be practically constant and the voltage induced in the tertiary winding will vary approximately as the rate of change of the current. The secondary having a complete iron

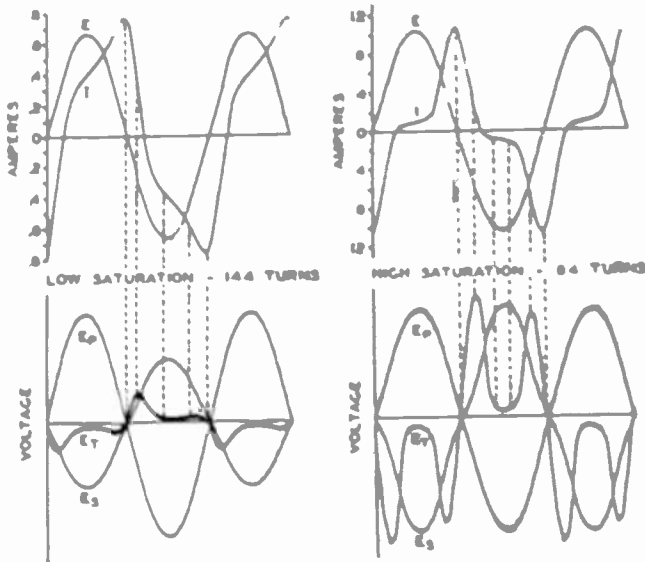

Fig. 9—Oscillogram showing the effect of magnetic saturation on exciting current and induced voltages

path when operating at high flux densities becomes saturated, its voltage is not proportional to the rate of change of current but must be determined by the rate of change of flux which is quite different. Note

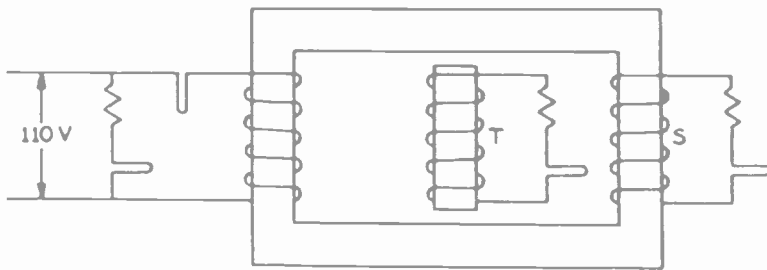

Fig. 10—Circuit diagram of magnetic shunt transformer.

that when the tertiary voltage is a maximum there is a depression in the secondary curve and vice versa. The constant cycle length aids materially in making a direct comparison between the voltages and exciting current and starting at zero improves the appearance of the oscillograms.

OSCILLOGRAMS ON SUCCESSIVE PORTIONS OF FILM

For many purposes, when studying transient or periodic phenomena oscillographically, the desired information often may be obtained on a very short length of film, particularly when one is interested only in amplitudes. With a film shield, having a window of suitable dimensions for a particular objective, part of the film will be unexposed and may be used for other curves. This not only economizes on film but what is often more important enables one to bring together a large number of curves for comparison and study.

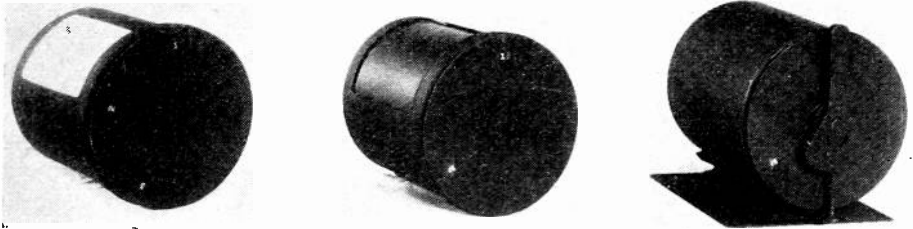

Fig. 11—Film shield.

A design which has been found extremely convenient is shown in Fig. 11. At the left is the shield, in the middle it is in position over the drum and at the right is shown the entire unit in position in the holder. The film drum is driven by an arm, not shown, which engages with the pin that, in the right-hand photograph, is shown pointing down towards the base. This pin passes through the body of another arm, which is directly opposite, and screws into the shaft of the film drum thus

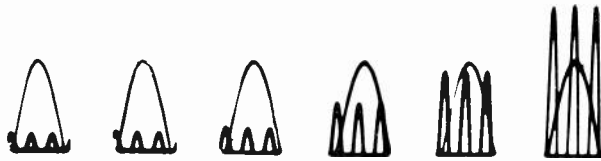

Fig. 12—Oscillogram showing use of film shield.

locking these two units together. A projecting pin attached to the latter arm engages with holes in the disk, Fig. 11, which is attached to the hub of the shield so the window of the shield can be moved to successive positions of the film merely by shifting this pin from one hole to another without the necessity of removing the holder to a dark room. The control is extremely simple and satisfactory.

In Fig. 12 are shown six oscillograms on successive portions of a single film. This is a study of the relative amplitudes of the fundamental and triple frequency voltages in the secondary of a balanced three-phase, Y-connected system as a function of the saturation. The

primary line voltage was 193, 110-volt fundamental per coil, for all six oscillograms but the number of primary turns for the different cases correspond to the following normal impressed voltages: 200, 160, 140, 120, 100, and 80, respectively. There is no need for more than a half-cycle of the fundamental as it is used merely as a frequency reference to determine the order of the particular harmonic which is not filtered out. It will be noted that the curves are separated by a half-cycle which permits the addition of a scale without crowding. Similar curves of harmonics up to the nineteenth have been obtained. The appearance is far superior to what it would have been had these curves been taken at random, that is, without control over the starting point.

RETRACING TO INCREASE LINE DENSITY

In taking oscillograms where the light is poor, or of high-frequency current where the light spot is moving too fast to make a good curve with a single exposure, it is possible to retrace it as many times as necessary to obtain the required density, provided there is not too much stray light in the oscillograph cabinet to fog the film. Satisfactory pictures have been obtained where the light spot, even when stationary, could not be seen on the screen by making a long exposure, say, four or five hundred times. Under ordinary conditions the usual practice would be to expose the film anywhere from fifty to two hundred times. While usually a much smaller number of exposures will give the required density, however, no harm is done by the larger number and it eliminates the necessity of special care and gives a perfect tracking, evident in Fig. 14, which has been exposed many times.

RETRACING OF ELECTRON TUBE OSCILLATOR CURVES

It is a perfectly simple matter to retrace curves that bear an integral relation to the frequency of the power source, for example, since the photographic drum makes ten revolutions per second there would be just six cycles per revolution in the case of sixty-cycle power and it will repeat perfectly. Had the frequency been slightly different from that of the power source, say, sixty-one there would have been more than six cycles per revolution and the light spot would follow a different path each revolution. Likewise this would be true for an oscillator whose frequency bears no integral relation to that of the film drive. However, if the oscillations could be started each revolution, at the same point on the film and in the same phase, the problem would be solved. But how is it possible to start the oscillations, allow time for them to build up to normal, expose the film, stop the oscillations, and be ready to start again in one-tenth second, the time of one revolution. This appears impossible but really is extremely simple.

It is accomplished by using the circuit arrangement shown in Fig. 13. Consider first the electron tube oscillator at the left which is coupled to an amplifier in the middle, with an oscillograph element in its plate circuit. With the transient visualizer running the control circuit is closed through brushes 2 and 5, charging the condenser by

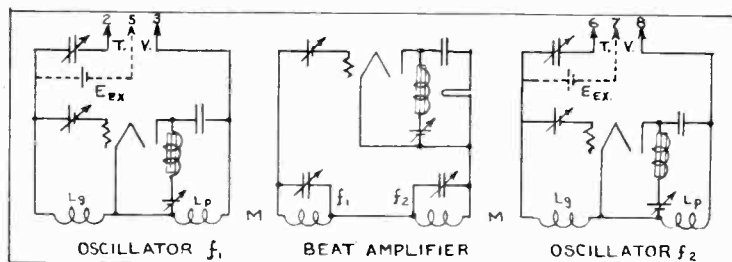

Fig. 13—Control circuit making possible the retracing of curves of any frequency.

means of the exciting battery after which it is disconnected as the brush leaves segment 5. The condenser is next connected to the oscillator circuit. If the condenser charge is too small, appreciable time is required for the oscillations to build up, and if too large, time is required to build down to normal. However, by varying the battery potential it

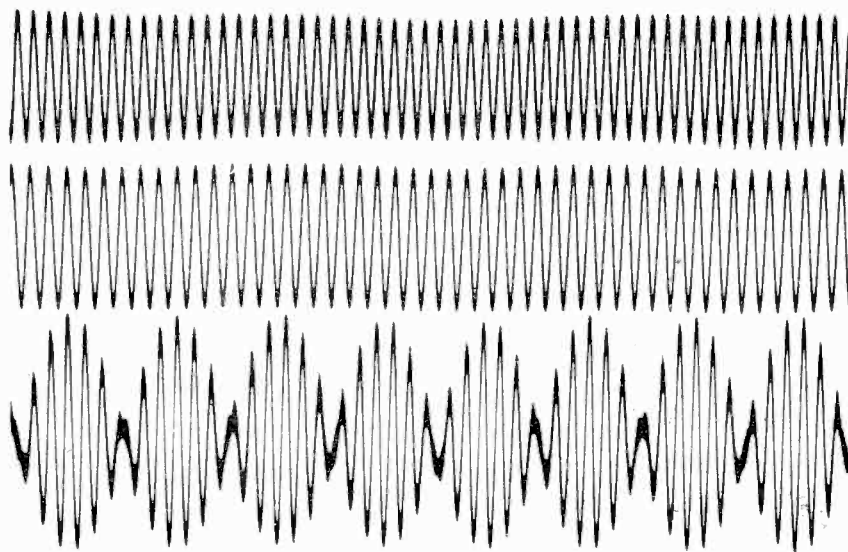

Fig. 14—Oscillogram showing perfect retrace.

can be made to start at normal value instantly. During the time the oscillator is functioning the film is exposed after which the oscillations are stopped when brush 3 opens the circuit. This series of events is repeated each revolution of the film drum, starting from exactly the same point of the film.

After taking the upper curve of Fig. 14, which shows perfect re-tracing even though it was exposed many times, the middle curve was obtained in a similar manner from oscillator f_2 .

This same idea is applicable to beat phenomena, where neither of the frequencies are multiples of the power frequency, by using brushes 2, 3, and 5 to control oscillator f_1 and 6, 7, and 8 to control oscillator f_2 . The results are shown by the lower curve of Fig. 14.

These curves were all taken with the same oscillograph element in their correct phase relation and to the same scale.

The applications discussed in this paper are merely illustrative of the many uses to which the transient visualizer is adapted.



OVERSEAS RADIO EXTENSIONS TO WIRE TELEPHONE NETWORKS*

BY

LLOYD ESPENSCHIED¹ AND WILLIAM WILSON²

(¹American Telephone and Telegraph Co., ²Bell Telephone Laboratories, New York City)

INTRODUCTION

THE progress which long-distance electric communication is making in tying the world together is perhaps nowhere more interestingly illustrated than in the developments which are now taking place in the interconnection of widely separated wire telephone networks by means of overseas radiotelephone links. It was only a few years ago, in 1927, that telephone service was first extended across the barrier of the North Atlantic and a beginning made in the interconnection of the great telephone networks of North America and of Europe. Rapid progress has been made since then in the further development of the North Atlantic facilities and in the extension of radiotelephone links from these wire telephone networks outward in other directions, until today such links span a large portion of the globe.

Since it is the nature of telephony that the circuits are employed personally by the telephone users it is necessary that these interconnecting links be of a high standard of transmission effectiveness and be free from interference. Also it is important that they be reliable in operation and continuously available during the operating periods, for the usefulness of telephone service is in part dependent upon its being immediately available on call. Although these requirements are not yet being fully met, the circuits already in operation are very effective and are proving to be valuable additions to the world's communication facilities.

The progress which is being made and the problems which are arising in the establishment of these systems and in the coordination of them into a world-wide telephone network appeal to the imagination and challenge the best efforts of communication engineers. Especially is this development of interest to radio engineers since in this pioneering stage the interconnecting links are being forged by radio. Work is also going forward in the development of new types of submarine telephone cables for this purpose and undoubtedly such

* Decimal classification: R450. Original manuscript received by the Institute, August 9, 1930. Presented before Fifth Annual Convention of the Institute, August 19, 1930.

cables will in time play a large part in fortifying the more important of the world routes. The radio part of the picture is, however, quite enough in itself and this paper is, therefore, largely confined to this phase of the subject.

There is given first, a sketch of the wire telephone networks and the interconnecting links as they exist today, second, a picture of the transmission results which are being obtained in the operation of some of these overseas links, and finally, a discussion of the more important phenomena and problems involved in the radio transmitting medium.

THE EXISTING WORLD TELEPHONE PICTURE

A simplified picture of the present telephone development of the world is given in the map of Fig. 1. Only the principal areas of telephone development are indicated, by the shaded portion, and only the more important routes of the wire networks have been sketched in. The figures give the approximate number of telephone subscribers in each continental area.

It is, of course, these networks which give direct access to millions of people in offices and homes and permit of the personal contact which characterizes telephone communication. It is natural, therefore, that they should be the foundation of the world-wide system which is growing up. The larger of these networks already spread over national boundaries so that the engineering problem is primarily one of interconnecting the networks, generally comprising groups of countries, rather than that of directly interconnecting by radio all of the component countries. The points within each network at which the interconnections are made may be expected to be determined largely by considerations of traffic and of operating efficiency. The differences of time and of languages between these widely separated areas, and of course, the expense of providing reliable interconnections over these distances, are factors which will naturally limit the volume of use to be made of these connections. That they are destined to fulfill a very real need is already proven, however, by the services which are now being given.

DEVELOPMENT OF INTERCONNECTING LINKS

The present status of the development of these transoceanic radio-telephone links is illustrated in Fig. 2. There are shown the circuits which are in operation and also the projects which have been reported as under consideration or under construction. These telephone paths will be observed to correspond in general with the routes followed by

the ocean telegraph and radiotelegraph services, in fact with the trade routes of the world, along which community of interest has been built up. Thus a certain orderly arrangement of the services is being realized naturally.

In general, there may be said to be five major groupings:

1. The North American-European connections. These are, of course, of outstanding importance because of the economic and social interest which exists between the two continents and because they connect with the large telephone wire networks on both sides of the Atlantic. North America and Europe combined account for about 32 million telephones out of a world total of about 35 million. The present situation on the North Atlantic route is discussed later on.
2. North America-South America.
3. South America-Europe.
4. Europe to Africa, Asia, and Oceania. The connections to Africa and to Oceania represent the interest which some of the European nations have in associated commonwealths and in colonies.
5. North America to Pacific points and the Far East. These are in the construction and project stage.

Most of these services are being given on a part time basis although that across the North Atlantic has been found to require 24-hour service and that between North and South America is for the full business day. Some of the circuits from Europe to South America and to the East Indies are not yet connected fully into the wire telephone network. The circuits which are in operation between South America and Europe instead of connecting into the European network by means of a single station are shared on a part time basis by several stations located in different countries in Europe, as is indicated by the forked lines in the figure.

One advantage of the use of radio for these services, particularly in this pioneering stage during which traffic over many of the routes is likely to be small, is the ability to share the use of a transmitting channel as between a number of receiving points where wire lines are not available. A representative case of this kind would be that of an important central station linked with a continental wire network from which it is desired to establish connections with a number of smaller outlying points. This possibility is not as simple as it may appear, however, because there enter the problems of directive antennas, of shifting frequencies if widely different distances are involved, and of



the ocean telegraph and radiotelegraph services, in fact with the trade routes of the world, along which community of interest has been built up. Thus a certain orderly arrangement of the services is being realized naturally.

In general, there may be said to be five major groupings:

1. The North American-European connections. These are, of course, of outstanding importance because of the economic and social interest which exists between the two continents and because they connect with the large telephone wire networks on both sides of the Atlantic. North America and Europe combined account for about 32 million telephones out of a world total of about 35 million. The present situation on the North Atlantic route is discussed later on.
2. North America-South America.
3. South America-Europe.
4. Europe to Africa, Asia, and Oceania. The connections to Africa and to Oceania represent the interest which some of the European nations have in associated commonwealths and in colonies.
5. North America to Pacific points and the Far East. These are in the construction and project stage.

Most of these services are being given on a part time basis although that across the North Atlantic has been found to require 24-hour service and that between North and South America is for the full business day. Some of the circuits from Europe to South America and to the East Indies are not yet connected fully into the wire telephone network. The circuits which are in operation between South America and Europe instead of connecting into the European network by means of a single station are shared on a part time basis by several stations located in different countries in Europe, as is indicated by the forked lines in the figure.

One advantage of the use of radio for these services, particularly in this pioneering stage during which traffic over many of the routes is likely to be small, is the ability to share the use of a transmitting channel as between a number of receiving points where wire lines are not available. A representative case of this kind would be that of an important central station linked with a continental wire network from which it is desired to establish connections with a number of smaller outlying points. This possibility is not as simple as it may appear, however, because there enter the problems of directive antennas, of shifting frequencies if widely different distances are involved, and of

not permitting the return transmission to be materially weaker than the outgoing transmission which means the use of relatively powerful stations at the outlying points. In general, these short-wave stations represent rather large investments and in working out interconnecting arrangements of this kind it is important to fit together the schedules at the various stations so as to minimize lost circuit time and to avoid leaving stations in idleness.

NORTH ATLANTIC FACILITIES

Of the four circuits which now exist across the North Atlantic, as indicated in Fig. 2, one is the long-wave circuit, with which the service was originally started, and three are short-wave circuits. The dashed line, shown in the figure, between New York and London indicates an additional long-wave circuit which is planned. There is also indicated in the figure the ship-to-shore telephone service on the North Atlantic which connects with the land line network on either side.

The transatlantic long-wave system has already been the subject of technical papers* and need not be described in detail. It operates on a single side-band carrier suppression system in a frequency band centering at 60 kc. The single side-band system is used to minimize the frequency space occupied. The single band is used alternately for transmission in the two directions by means of voice actuated switching devices at the New York and London terminals. For the purpose of minimizing the principal limitation of long waves, that of "static," the receiving stations are located as far north as is reasonably possible and use is made of directive receiving antennas.

The three short-wave circuits which have been provided on the North Atlantic route add materially to the traffic capacity but are erratic in their behavior and their usefulness is dependent, in a large measure, upon being operated in combination with the more stable long-wave circuit. All three short-wave circuits are affected similarly by the adverse conditions accompanying magnetic storms, whereas long-wave transmission is not materially affected by these conditions except at night.† The second long-wave circuit is planned to provide a more balanced combination of facilities as well as to add to the total circuit capacity across the Atlantic. In this connection, it should be noted also that a new type of submarine telephone cable is under development and is planned to be laid across the North Atlantic when

* See attached bibliography.

† Bibliography 6, 14, 15.

completed. While this cable will provide only one two-way circuit, it is expected to be free from atmospheric disturbances and to fortify greatly the telephone service between North America and Europe.

The ship-shore telephone service which is being given on the North Atlantic includes a land station connection with the land line network in both the United States and in England and through these land stations service is given to most of North America and Western Europe. Four of the larger transatlantic vessels are equipped. The service may be expected to include in time additional shore stations and many other vessels. It is an example of a class of service for which radio alone is available, that of extending telephone service to moving craft at sea or in the air.

SHORT-WAVE TECHNIQUE

With the exception of the long-wave circuit across the North Atlantic, all of the links indicated in Fig. 2 are of the short-wave type. As to these different short-wave stations throughout the world, there is, of course, considerable difference between them in the requirements which are being met and the performance obtained. However, the same fundamental principles are being followed in all of the countries and the short-wave telephone technique may be said to be rather remarkably alike throughout the world. Transmission is on the ordinary double side-band basis since the necessity for narrowing the band is not of great importance in the present state of the art and the difficulty of single side-band operated at high frequencies is very much greater. In general, the transmitters are of the vacuum tube type employing master oscillators which are stepped up in frequency and in power for the final transmission; directive antennas are employed for both transmitting and receiving, and in the receiving apparatus use is made of the double detection principle with its advantages in giving stable operation with high amplification and high selectivity.

In the case of the radiotelephone stations which connect with the United States, the short-wave technique is further characterized by the use of transmitting sets which are provided with a piezo-crystal oscillator with temperature control for stabilizing the transmitting frequency, and the use of interchangeable coils which permit the frequency of the transmitter to be changed in keeping with the requirements for the different times of the day and year. The carrier output of 15 kw corresponds to a peak output of about 60 kw. The final power stage of such a set is shown in Fig. 3. The units marked 1, 2, and 3 are the water jackets for three of the six double-ended, 10-kw tubes, the other three being on the other side of the mounting. The circuit is of the push-pull type.

The radio receivers employed in the United States are built so as to have low intrinsic noise and sufficient gain to enable very small field strengths, of the order of $1 \mu\text{v}$ per m, to be detected and raised to the required telephone speech level. They are equipped with auto-

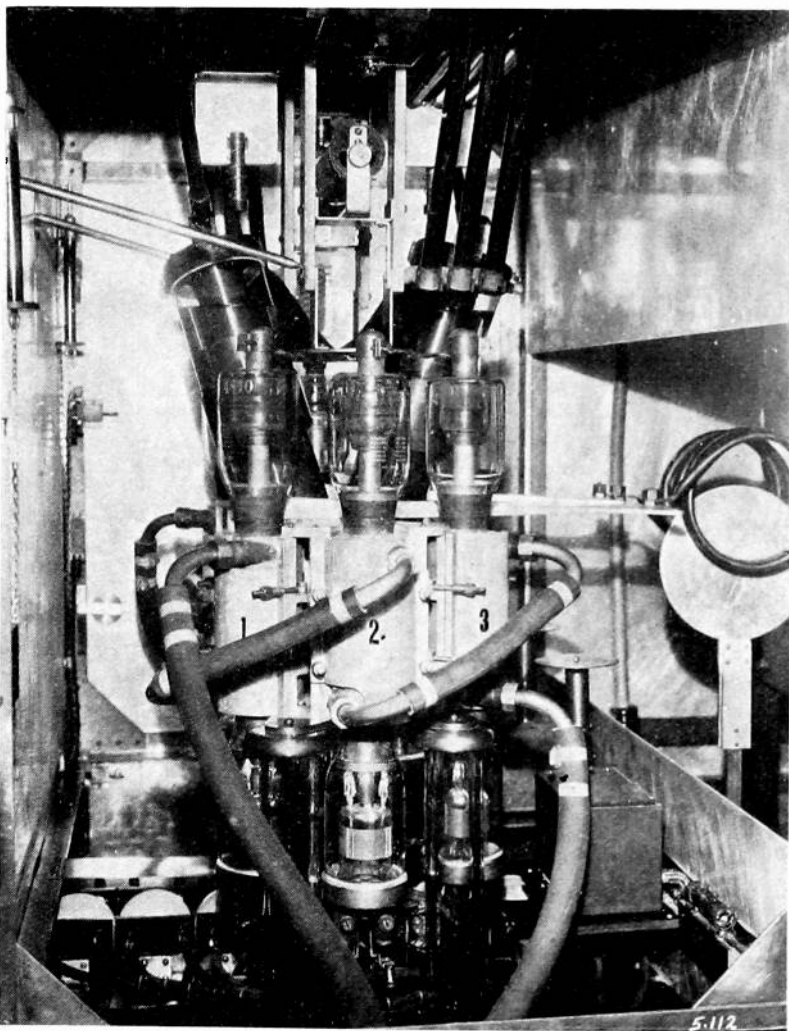

Fig. 3—Short-wave radiotelephone transmitting center of the American Telephone and Telegraph Company, Lawrenceville, N. J. Six 10-kw tubes used in one of the output stages of a transmitting set. Coupling coils on right, monitoring amplifier boxes at lower right.

matic gain control which minimizes the fading variations in speech volume. One of the radio receivers employed at the Netcong, N. J., receiving station is illustrated in Fig. 4. The antenna leads are brought in beneath the floor in the concentric pipes which are seen to rise at the right and connect with the input of the set on the upper left-hand panel. The first two vertical bays are the radio set proper, including

the automatic gain control. The third bay, on the right, includes the volume indicator and control and the line connecting equipment.

In general, three wavelengths are used, one around 19,000 kc (16 meters), one around 14,000 kc (21 meters) and one around 9,000 kc (33 meters), and each transmitter and receiver is arranged so that it can be connected at any time with a directive antenna designed for

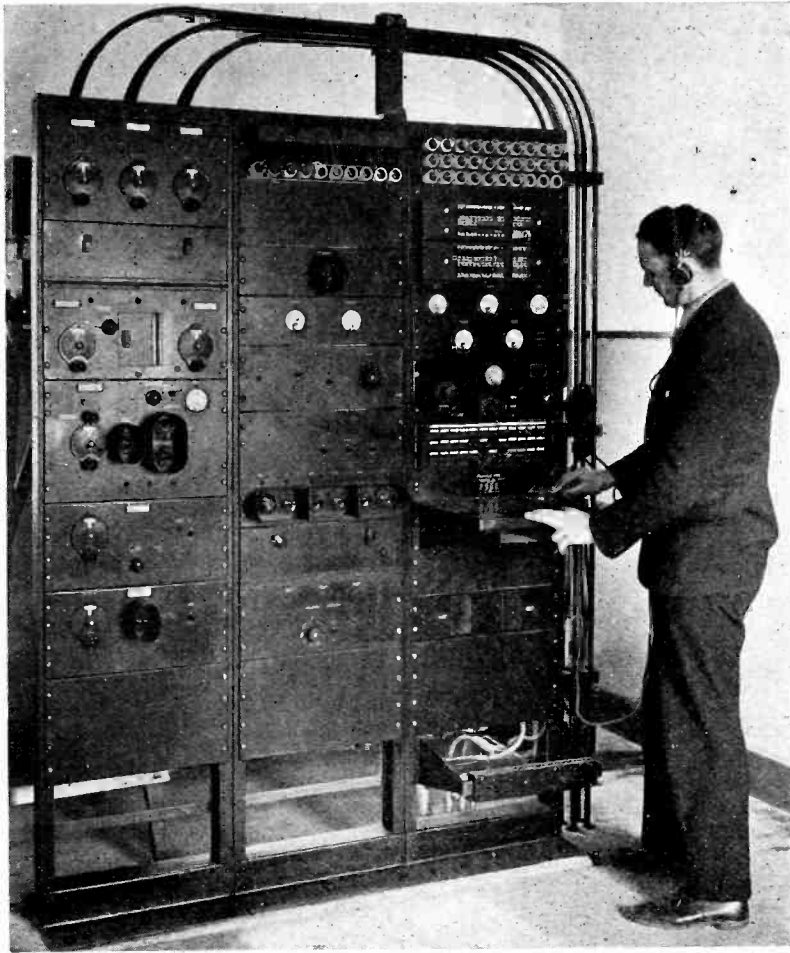

Fig. 4—Short-wave radiotelephone receiving center of the American Telephone and Telegraph Company, Netcong, N. J. Radio receiver for South American circuit. Antenna concentric pipe transmission lines enter set overhead.

each of these frequency ranges. The transmitter antenna ins gaare about 17 db over a one-half wave antenna. These short-wave radiotelephone facilities which connect the American telephone network with Europe and South America have already been the subject of technical papers* and need not be described in further detail. An air

* See bibliography.

view of the Lawrenceville, N. J., transmitting station is given in Fig. 5. The longer of the two lines of towers supports the antennas for the three short-wave circuits to England, and the shorter line of towers the antennas for the single circuit to the Argentine. Some idea of the magnitude of the plants employed for these short-wave circuits may be had from this photograph. The longer line of antennas is approximately one mile long, consisting of twenty-one 185-ft. towers. Substantial fireproof buildings are provided for the transmitting sets and auxiliary equipment. Probably every operating agency which has

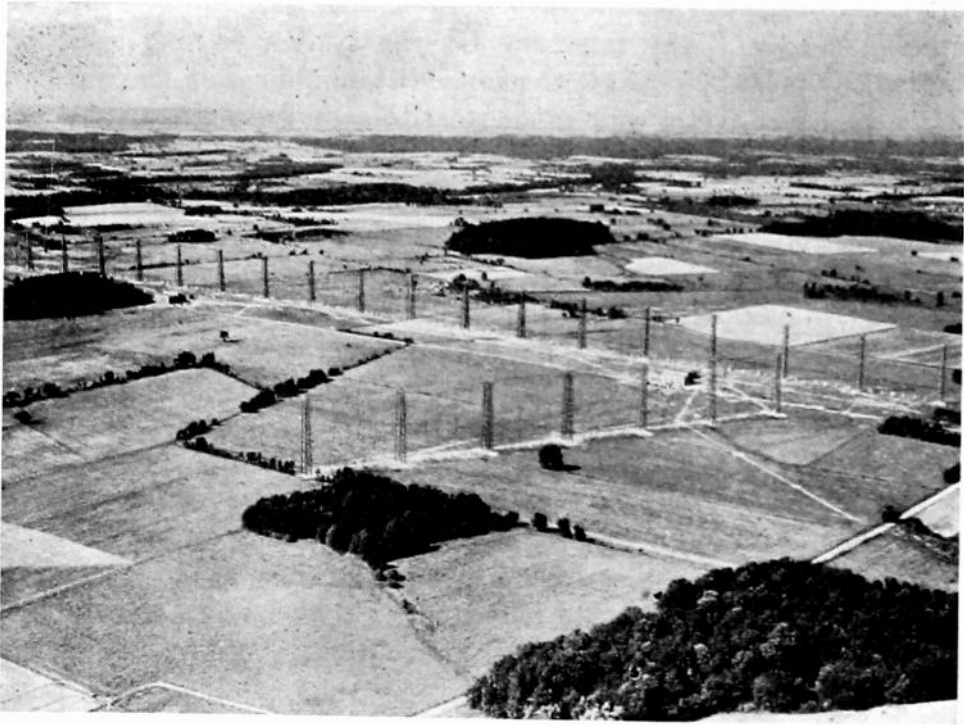

Fig. 5—Lawrenceville transmitting station. Aerial view—South American antenna in the foreground; European antenna in the background. Two buildings each containing two transmitters are shown.

had experience with short-wave operation realizes that the cost of such radio facilities is proportional to the standard of service and to the degree of reliability and exactitude of operation which is undertaken in the terminal stations.

JOINING OF A RADIOTELEPHONE LINK WITH WIRE NETWORK

The manner of joining the transoceanic radio links with the wire network to meet the requirements of through two-way transmission is an interesting and important development in itself. In general this technique is an outgrowth of wire telephone practice and is so new as

not yet to have been fully applied to all of the radiotelephone links in existence.

The problem is that of how to form the two oppositely directed speech channels which comprise the radiotelephone link itself into the usual two-way telephone circuit suitable for use as a regular telephone toll line and for termination before long-distance traffic operators at each end.

The transmission equivalent of the radio paths may be continually changing over a considerable range due to fading. It is undesirable that noise or speech on the incoming channel be reradiated on the outgoing channel. Any tendency for the system to sing must be avoided. It must be possible to change the amplification looking into the transmitters over a wide range so as to get a fully modulated output from them, irrespective of the length of the connected lines or the volumes of the talkers' voices. Furthermore, in some cases, as where the same radio-frequency band is used for transmission in the two directions, the radio transmitter tends to interfere with the receiver at the same end.

A solution of these conflicting requirements necessitates that only one of the radio paths be connected to the wire network at a time. This fundamental principle at one stroke wipes out singing, reradiation or echoes, and permits independent adjustments of amplification in the two radio paths. To apply it, it becomes necessary to employ voice-current-operated switching devices which connect alternately the sending or receiving radio channel to the wire line as the subscriber talks or listens, automatically following the conversation and serving the needs of the subscriber without his volition.

Various mechanisms for carrying out this function have been devised. Some employ mechanical relays for switching while others use vacuum tubes, but in principle they are much alike. The broader ideas involved are illustrated in Fig. 6. When the circuit is quiescent, i.e., neither subscriber speaking, the receiving radio channel is connected and the transmitter disconnected. Speech coming from the wire line connects the transmitter and disconnects the receiver. The positive switching action is, therefore, dependent upon the impulses of speech from the land line. This arrangement is preferred to the reverse one of depending upon impulses of speech received over the radio channel. This is because the system must operate on speech only and not noise, and the speech-to-noise-ratio is usually higher and more dependable on the wire line than on the incoming radio channel.

This single function of switching-over in response to the subscriber's voice is the principal and basic function of such devices.

There are, however, many auxiliary features incorporated to guard against false operation by noise currents and speech current echoes which greatly increase the ability of the arrangement to operate satisfactorily under conditions of severe noise or weak speech. These have been described elsewhere* more completely than would be appropriate in this discussion.

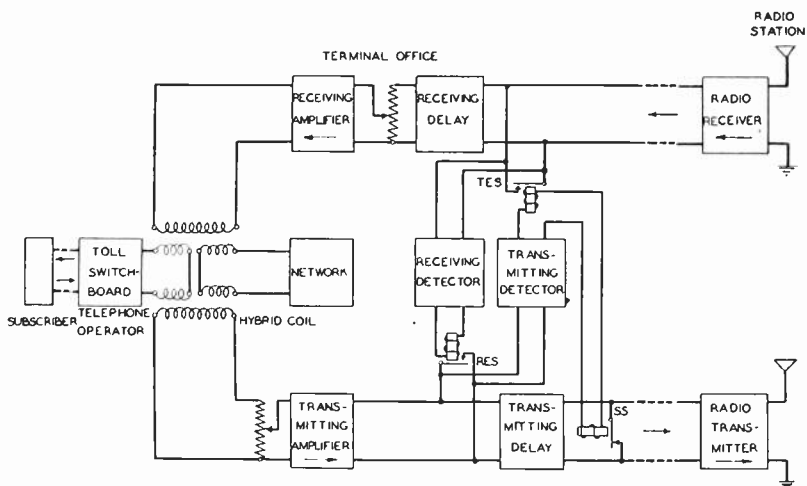

Fig. 6—Circuit diagram illustrating operation of voice-operated switching device. Note: Voice currents coming from the line, rectified in the transmitting detector, clear the transmitting path by removing short circuit at *SS* and short-circuiting receiving path at *TES*. Switch at *RES* is operated by received radio speech or noise to prevent echoes in the wire lines from reaching transmitting detector.

Viewed from the radio standpoint these voice-operated devices are of great importance since they permit radio links to be used as trunks in wire networks without their having to meet the requirements which wire line trunks must meet. At the present stage of development it would be practically impossible to provide radio circuits meeting wire line standards.

TRANSMISSION RESULTS

We now come to a consideration of these transoceanic links which is perhaps the most important one from the standpoint of the service given and of the engineering development required. It is that of the general transmission effectiveness and of the continuity of service which is given. So far as the radiotelephone circuits operating out of the United States are concerned, this phase of the subject is pretty well summarized by the charts given in Fig. 7. These show from top to bottom the continuity of *two-way transmission* which has been obtained over the past year, (1) on the long-wave transatlantic circuit,

* See bibliography 7.

(2) on one of the short-wave transatlantic circuits, and (3) on the short-wave circuit which operates with Buenos Aires. The last named circuit has been in operation only since the spring of this year.

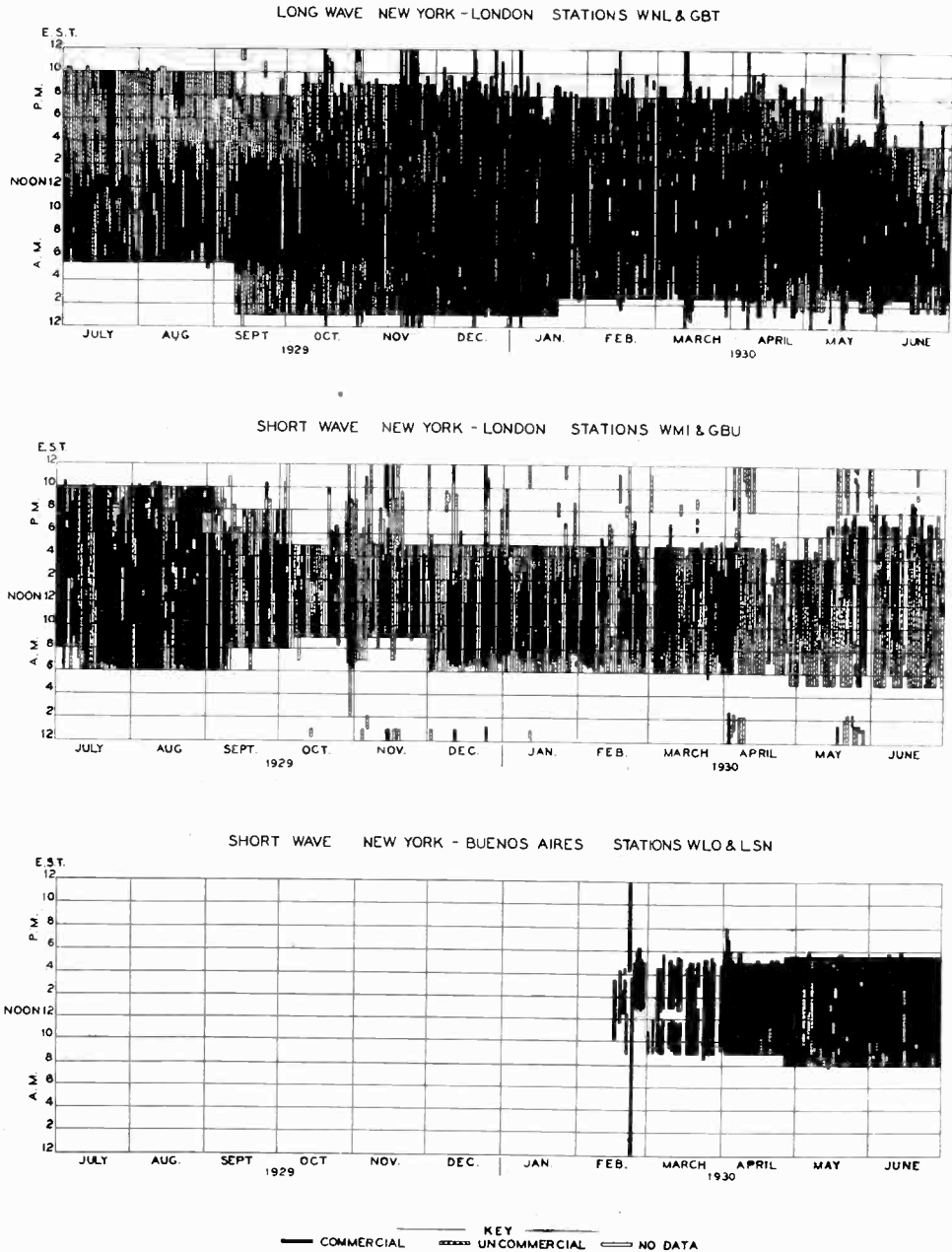

Fig. 7—Chart showing transmission results on long waves—transatlantic: short waves—transatlantic: short waves—South America.

The black areas show in each case the hours of the day during which the circuit was commercially usable. The white gaps indicate periods

during which no operation was attempted and for which there are no data. The dotted-in lines show the periods during which the circuit was found to be commercially unusable, i.e., the lost time periods.

The following points are to be noted:

1. The long-wave circuit, shown at the top, is poorest during the summer months. This is because of atmospheric disturbances due to lightning. Throughout the year shown, the long-wave circuit was available for service about 80 per cent of the time.
2. The North Atlantic short-wave circuit, center figure, was fairly good last summer but suffered much lost time during the spring months of 1930. The poor behavior during the spring is apparently due to unusually high solar activity. Such related phenomena as aurora disturbances in the earth's magnetic field, and earth currents have been affected similarly. For the year shown this short-wave circuit was commercially available about 64 per cent of the operating time. Similar experience was had on the other two transatlantic short-wave telephone circuits, one of which was operated over a longer period of the day than that shown.
3. The combination of the North Atlantic of the long-wave and short-wave circuits gives a much improved result as compared with either one alone. As is indicated in the diagrams, last summer when the long wave circuits suffered from "static", the short-wave transmission was fairly good; conversely, this last winter and spring when the short-wave transmission suffered severely from magnetic storm effects, the long-wave circuit was the mainstay of the service.
4. The short-wave transmission between New York and Buenos Aires, as depicted by the bottom chart of Fig. 3, will be seen to be more reliable than short-wave transmission across the North Atlantic. The single short-wave circuit between New York and Buenos Aires has, since the initiation of this service last spring been commercially usable about 97 per cent of the operating time.

The difference in short-wave transmission east and west across the North Atlantic and that across the tropical zone, shown in Fig. 7, is quite in keeping with the general experience of other operating agencies and is already a well recognized fact in short-wave transmission. There is obviously a radical difference in the character of the transmission paths involved which requires further survey and analysis.

TYPICAL MAGNETIC STORM EFFECT

It will be noted from the second diagram of Fig. 7 that the interruption of short-wave transmission across the North Atlantic sometimes continues for several days at a time. These periods have been found to correspond to disturbances in the magnetic state of the earth and to be accompanied by the appearance of relatively large differences of electric potential along the earth's surface. Measurements which have been carried out on the strength of electric field received across the Atlantic during such periods and simultaneous records which have been made of earth potentials shed some light on what happens during these periods.

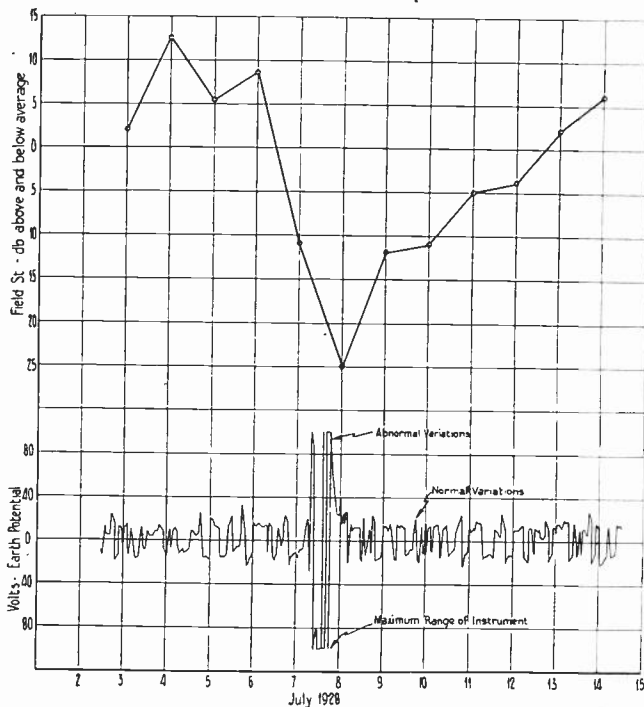

Fig. 8—Magnetic storm effects, showing drop in field strength and appearance of earth potentials.

There is shown in Fig. 8 observations which were made during a major effect of this kind which occurred in July, 1928. Short-wave transmission conditions appeared to have been normal both before and after the occurrence of this effect. The measurements were made at New Southgate, England, upon station WND, one of the radio transmitters at Deal, N. J., used before the present transmitting plant at Lawrenceville was built. The measurements were made on 18,340 kc during the normal hours of daylight operation. The upper curve of the figure shows the variation in received field strength averaged over

the daylight hours for each of the several days shown. Below the field strength curve there is plotted a record which was made during this same period of the earth potentials in the vicinity of New York. This is a smoothed transcript of a record taken on a continuously operated recorder connected in a grounded wire circuit which extended from New York westward to Reading, Pa., about 100 miles distant.

It will be observed that the time of minimum field strength coincided approximately with the time of maximum earth potential (the small wiggles of earth potential are to be neglected since they are due to disturbances set up by man-made electrical systems). The drop in the strength of the received field will be observed to be large, of the order 35 db. The effect upon transmission lasted several days, the recovery appearing to have been slower than the initial effect.

A high degree of coincidence has been found to exist between these adverse effects in short-wave transmission on the one hand, and on the other hand the appearance of earth currents and abnormalities in the earth's magnetic field. This is a subject which cannot be adequately treated in the present paper and it is hoped that a report upon it can be made to the Institute during the forthcoming winter. As is explained below radio transmission is believed to be largely dependent on the state of ionization of the earth's atmosphere. Earth potentials are probably also affected by variation in this ionic state. Therefore we have in such a recorder a useful check on the transmitting medium when transmission difficulties are encountered. Such earth potential observations may prove to be useful in exploring these conditions more generally throughout the world.

In Fig. 8 each point of the radio data was obtained by averaging the field strength of the carrier throughout a 24-hour period. Fig. 9 on the other hand, presents in a more detailed manner, the way in which the field strength varied throughout each of seven days, between June 24 and July 1, 1930, on transmission from England to the U. S. A. Within this period, there was a magnetic storm. No data were obtained on June 29. The original curves were obtained with an automatic recorder, receiving from station GBU of the British General Post Office during regular operation. In redrafting for publication, the rapid variations which are characteristic of fading have been eliminated and only the slow drifts are shown. It will be seen that the effect of the storm became evident on June 26, the average signal being 15 to 20 db lower than the preceding day. This condition continued on the 27th and 28th, on the 30th the signal averaged a little higher, and on July 1 a recovery had set in. The incompleteness of the record on three days is caused by the transmitting station shifting

to a different frequency in an attempt to improve conditions. As to commercial transmission results over this channel during this period; the first two days were fair, the third day poor, the 27th, the 28th, 29th, and 30th very poor, and July 1 still rather poor.

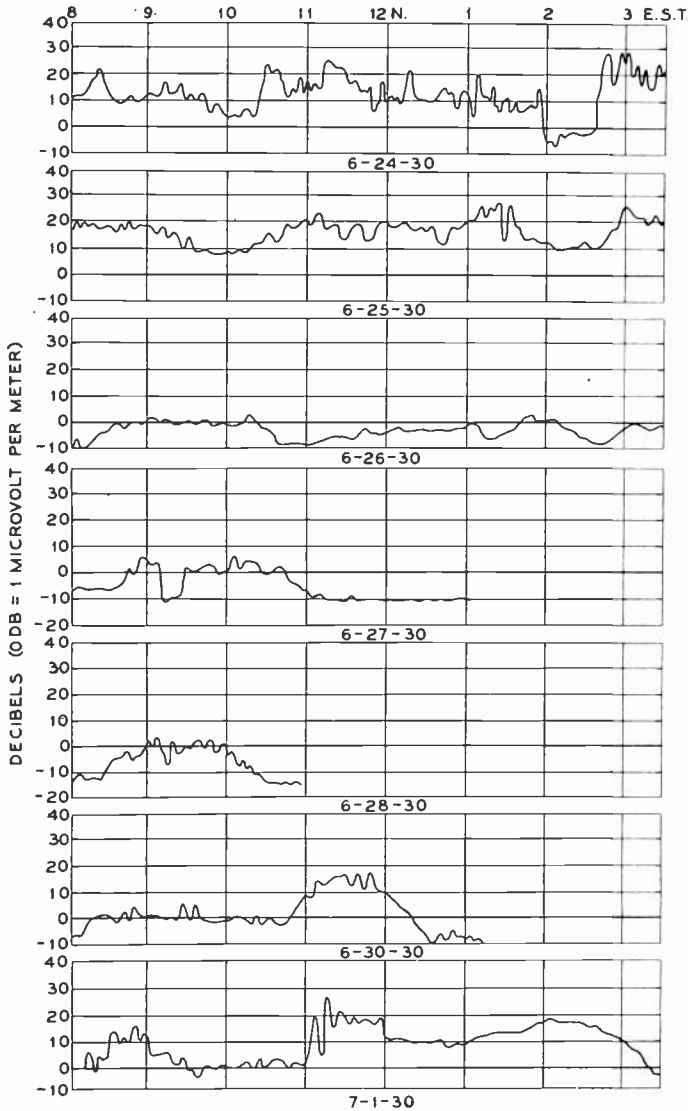

Fig. 9—Magnetic storm effect, oscillograms of received carrier.

THE PROBLEM OF THE TRANSMITTING MEDIUM

These adverse effects in short-wave transmission are ascribed to the nature of the medium through which the propagation of the waves takes place. The short-wave signals which reach a distant point are carried by waves which have traveled in the upper regions of the atmosphere, where a condition of ionization exists which causes the waves

to move in a curved path and, finally, to arrive again at the earth's surface. The ionization in the upper part of the atmosphere varies with atmospheric conditions and hence its action on the waves which are passing through it varies from day to night, from season to season, in a more or less regular manner, on which are superposed fortuitous variations due to other conditions. The conditions in the upper atmosphere may be such that two or more waves arrive at a distant point from the same source after having traversed different paths. If the length of one of the paths is changing, the resulting signal from the two waves will pass through a series of maxima and minima in time, which process is known as fading. This complicated path condition is present at practically all times, since it is only on very rare occasions that short-wave signals do not fade in and out. Furthermore there appear to be different kinds of fading corresponding to different transmission paths. For example, the fading on the North Atlantic short-wave circuits is of a deep slow variety as compared with the faster and more choppy type of fading experienced on the north and south circuit between New York and Buenos Aires.

To some extent this fading can be overcome by means of automatic gain control in the radio receiver which causes a steady signal to be delivered to the listener. However, this does not correct for the distortion which may be produced by interference between two transmission components. This distortion may result from a selective fading of the various frequencies in the voice band and an oscillogram showing this condition is given in Fig. 10 which is taken from a paper by R. K. Potter.* These are records of transmission across the North Atlantic of the voice band occupied by 10 suitably spaced tones of equal amplitude at the transmitting end. There is shown in the vertical columns a succession of snapshots which are separated by intervals of about one-twelfth of a second. By following these columns down, the progressive change which occurs in the distortion of the voice band may readily be seen. The worst distortion occurs at times when the carrier itself is blotted out. Tests have indicated that the use of single side band is of value in minimizing this type of distortion. Experiments have been in progress for some time looking to the evaluation of gain to be expected along these lines from the introduction of a single side-band system and toward the development of single side-band equipment for use at these frequencies.

Another method which might be employed to reduce this type of distortion is to pick up the signal on a number of antennas spaced more than about 10 wavelengths apart, since it is found that at points

* See bibliography 19.

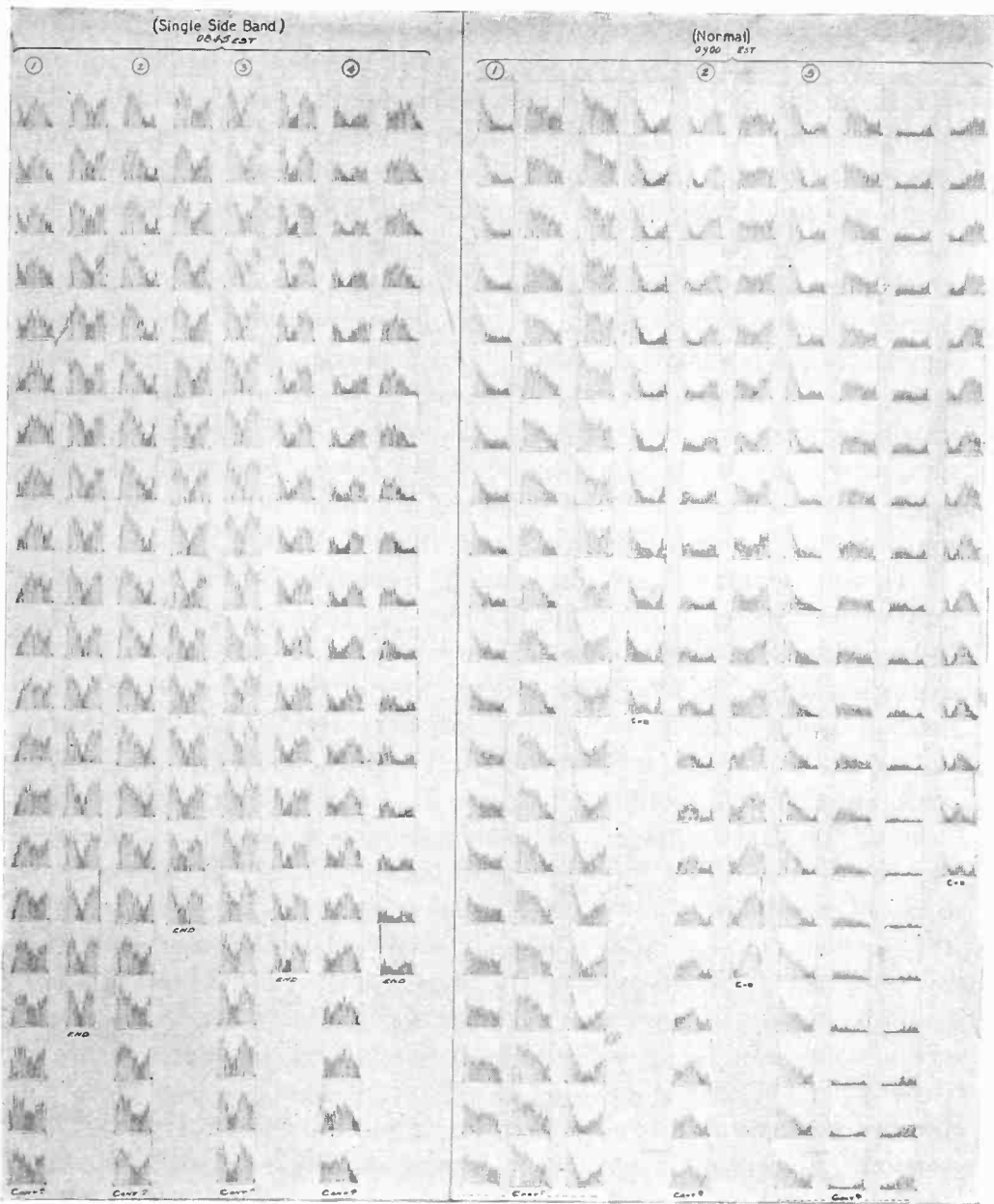

Fig. 10—Distortion of voice band in short-wave transmission.

this far distant from each other, while the general average signal values are the same, the instantaneous values of the signals are apparently random within the fading limits. By an automatic arrangement for selecting the best signal from, let us say, three antennas arranged in this manner, voice distortion can be diminished.

During periods of magnetic storms, however, the signals are so very much reduced in intensity at times that they cannot be heard above the noise level. There appears to be nothing in the present art which will fully cope with this situation. Of course, some of the time which is now lost during these periods may be expected to be regained by further transmission improvements. As was indicated earlier in the paper, it is an interesting but rather discomfoting fact that these particularly severe conditions are due to some peculiarity in the condition of ionization as indicated by the magnetic and earth current disturbances referred to above and by the fact that aurora displays are likely to be pronounced at these times. Furthermore, it appears that the transmission is most adversely affected during these times along paths which pass near the aurora zones surrounding the magnetic poles. This is indicated by the marked effect which these storms had on the North Atlantic circuits while showing only a slight effect on the South American circuit.

The advantages to be gained by the use of directive antenna systems were touched on a little earlier in this paper. So far, most of the gain has been obtained by sharpening the transmission in the horizontal plane. This can only be done advantageously up to a certain point, corresponding to an antenna spread of from six to ten wavelengths—at any rate for transatlantic signals—and representing a gain when a reflector is used of about 15 db. A further gain of 3 to 5 db can be obtained by sharpening in the vertical plane; and while a still greater gain can at times be obtained in this manner, the procedure has so far appeared not worth its possibilities of trouble. This is due to the fact that with varying conditions in the upper atmosphere the waves as they reach the receiving station apparently approach from different vertical angles and care must be taken not to build an antenna with such a sharp vertical characteristic that the received waves will fall on the antenna at such an angle that its calculated gain cannot be realized. We have, in fact, constructed several antennas sharp in the vertical plane, which have given as much as 16 to 20 db gain over a one-half wave vertical antenna on local test but which have given for a signal from a distant point all variations of gain from this same value down to a loss of 2 db.

PLANNING THE INTERNATIONAL USE OF FREQUENCIES

The problems of the transmitting medium discussed above are those which have been under study in connection with telephone transmission across the North Atlantic and between North and South America. Doubtless further observation and the exploration of other portions of the earth's surface will disclose a much more complete picture than it is now possible to present. It is important that further data be gathered not alone for the purpose of improving the transmission results obtained but also for use in agreeing internationally upon the most effective use of the frequency spectrum for different services in the interest of the world as a whole.

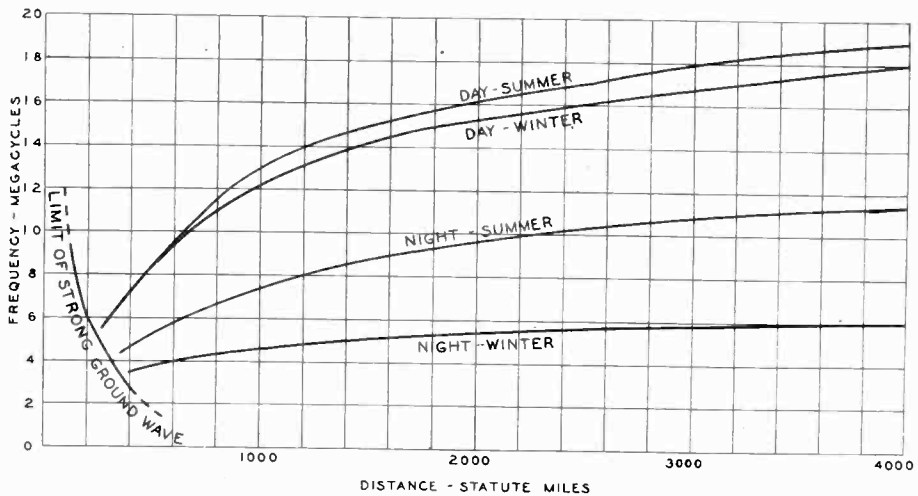

Fig. 11—Frequency-distance characteristic.

Of fundamental importance is the question of the frequencies which are best suited to different distances of transmission. The curves of Fig. 11* give this relationship between frequency and distance in so far as it has been disclosed by measurements carried on between North American and Europe and South America, and also between the American continent and ships plying the Atlantic Ocean. In the construction of these curves use has been made also of data obtained by other agencies such as the Radio Corporation and the United States Navy Department. The curves are reproduced here merely for such use as they may be in connection with this problem of planning and with the hope of stimulating the contribution of corresponding data for other regions of the earth. It should be realized that actually each curve is the center of a considerable band of frequencies and that these bands merge one with another.

* See bibliography 22.

While experience has indicated that during the adverse transmission conditions which accompany a magnetic storm some improvement in transmission can at times be obtained by shifting the frequency. In general, these effects are found to extend over the entire high-frequency range now in general use, and shifting frequency does not dodge them.

In view of the extent to which transoceanic radio links, telegraph as well as telephone, are dependent upon the use of the higher frequencies, and of the importance of communications to the world as a whole, it is highly desirable that they be conserved for these longer distance uses. This has already gained recognition and the 1929 Hague Conference of the C.C.I.R. has recommended it as a principle. The carrying of it out in practice means that, in general, communications over the shorter distances should be carried out on the lower of the high frequencies (and possibly at the extreme high frequencies). It logically calls, also, for making the maximum use of existing wire networks for overland services, in order to free the radio channels for uses for which they are most needed. Finally, there is of course, the need for coördinating the transoceanic links among themselves and minimizing unnecessary duplication.

In the Washington, 1927, Convention the world took a constructive step forward in organizing the use of radio channels by blocking-out the high-frequency spectrum in respect to classes of service, thus: point-to-point, relay broadcast, mobile services. It is of interest to note that there is a further line of distinction which might be availed of for the purpose of reducing interference. As matters now stand, powerful and expensive stations which can well afford to live up to the highest standard of frequency stability, radio receiver selectivity, etc., are intermixed in the frequency spectrum with stations which cannot justify living up to these standards. Wide differences, in the caliber of station in accordance with the different needs is, of course, to be expected. This would appear to call for some grouping of stations in the various frequency bands in accordance with the frequency tolerance which they are prepared to meet. Some indication of the prevalence of interference on these short waves is given by the experience which has been had in operating the transatlantic short-wave telephone circuits during the first six months of 1930. Of some 3,000 operating hours in which the short-wave circuits were commercially useful, 110 hours, or about 3 per cent of the time, were lost due to interference from other stations. The frequencies of the interfering stations were found to differ from their registered frequencies by varying amounts up to hundreds of kilocycles.

The Hague 1929 Conference of the C.C.I.R. recommended that the frequencies of fixed stations operating in the 6,000 to 23,000-kc range be held to 0.05 per cent tolerance and improved to 0.01 per cent as soon as possible. That this is not an unreasonable requirement for large stations is indicated by the following results of measurements made on the four short-wave telephone transmitters at Lawrenceville, N. J., during the periods of regular operation for the first half of 1930. Of 2826 measurements of the frequencies of these transmitters which were made at a measuring bureau 99.75 per cent were within the ± 0.05 per cent deviation, and 89.1 per cent were within the ± 0.01 per cent.

The existence of the problems of the transmitting medium and of the reduction of interference is a reminder of the need which exists for further quantitative studies of radio transmission throughout the world and of radio station performance, in the interest of the more effective use of the radio channels of the world.

Bibliography

1. Ralph Bown, "Some recent measurements of transatlantic radio transmission," *Proc. Nat. Acad. of Sci.*, 9, No. 7, 221-225; July, 1923.
2. H. D. Arnold and Lloyd Espenschied, "Transatlantic radio telephony," *Jour. A.I.E.E.*, August, 1923; *Bell Sys. Tech. Jour.*, October, 1923.
3. H. W. Nichols, "Transoceanic wireless telephony," *Electrical Communication*, 2, No. 1, July, 1923.
4. A. A. Oswald and J. C. Shelleng, "Power amplifiers in transatlantic radio telephony," *Proc. I.R.E.*, 13, 313-363, June, 1925.
5. R. A. Heising, "Production of single side-band for transatlantic radio telephony," *Proc. I.R.E.*, 13, 291-313; June, 1925.
6. Lloyd Espenschied, C. N. Anderson, and Austin Bailey, "Transatlantic radiotelephone transmission," *Bell Sys. Tech. Jour.*, July, 1925. (Also I.R.E.)
7. S. B. Wright and H. C. Silent, "The New York-London telephone circuit," *Bell Sys. Tech. Jour.*, 6, 736-749; October, 1927.
8. Frank B. Jewett, "Transatlantic telephony," *Scientific Monthly*, 25, 170-181; August, 1927.
9. Ralph Bown, "Transatlantic radiotelephony," *Bell Sys. Tech. Jour.*, 6, 248-257; April, 1927.
10. K. W. Waterson, "Transatlantic telephony—service and operating features," *Jour. A.I.E.E.*, 47, 270-273; April, 1928. *Bell Sys. Tech. Jour.*, 7, 187-194; April, 1928.
11. O. B. Blackwell, "Transatlantic telephony—the technical problem," *Jour. A.I.E.E.*, 47, 369-373; May, 1928; *Bell Sys. Tech. Jour.*, 7, pp. 168-186; April, 1928.
12. Frank B. Jewett, "Some research problems in transoceanic telephony," *Proc. Amer. Soc. for Testing Materials*, 28, Part 11, 7-22, 1928.
13. Austin Bailey, S. W. Dean, and W. T. Wintringham, "Receiving system for long-wave transatlantic radiotelephony," *Proc. I.R.E.*, 16, 1645-1705; December, 1928.

14. Clifford N. Anderson, "Transatlantic radio transmission and solar activity," *PROC. I.R.E.*, 16, 297-347; March, 1928.
15. Clifford N. Anderson, "Solar disturbances and transatlantic radio transmission," *PROC. I.R.E.*, 17, 1528-1535; September, 1929.
16. S. W. Dean, "Weather phenomena and directional observations of atmospheres," *PROC. I.R.E.*, 18, 1185-1192; July, 1929.
17. R. A. Heising, J. C. Schelleng, and G. C. Southworth, "Some measurements of short-wave transmission," *PROC. I.R.E.*, 613, 649; October, 1926.
18. J. C. Schelleng, "Some problems in short-wave telephone transmission," *PROC. I.R.E.*, 18, 913; June, 1930.
19. R. K. Potter, "Transmission characteristics of a short-wave telephone circuit," *PROC. I.R.E.*, 18, 581, April, 1930.
20. H. W. Nichols and Lloyd Espenschied, "Radio extension of the telephone system to ships at sea," *PROC. I.R.E.*, 193-243; June, 1923.
21. A. E. Harper, "Directional distribution of static," *PROC. I.R.E.*, 17, 1214-1225; July, 1929.
22. W. Wilson and L. Espenschied, "Radiotelephone service to ships at sea," *Jour. A.I.E.E.*, 49, 542; July, 1930.
23. T. G. Miller, "Transoceanic telephone service—general aspects," *Jour. A.I.E.E.*, 49, 107; February, 1930.
24. Ralph Bown, "Transoceanic telephone service—short-wave transmission," *Jour. A.I.E.E.*, 49, 385; May, 1930.
25. A. A. Oswald, "Transoceanic telephone service—short-wave equipment," *Jour. A.I.E.E.*, 49, 267; April, 1930.
26. F. A. Cowan, "Transoceanic telephone service—short-wave stations," *Jour. A.I.E.E.* (forthcoming)
27. P. Craemer, "Der Weltfernsprechverkehr," *E.T.Z.*, 50, 959-963; July, 1929.
28. P. Craemer, "The geographical implications of the world telephone network," Paper No. 206, *World Engineering*, Congress, Tokio, 1929.
29. E. H. Shaughnessy, "Rugby radio station," *Jour. P.O.E.E.*, 19, 373-382; January, 1927; *El. Rev.* 98, 753-756; May 7, 14, 21, 1926; *Elect.* 96, 468-469; April 23, 1926.
30. A. G. Lee, "Transatlantic telephony," *Jour. Tel. & Tel.*, 13, 92-93; February, 1927; *Jour. P.O.E.E.*, 19, 74-75; April, 1926; *Jour. Tel. & Tel.*, 12, 150-151; April, 1926.
31. R. V. Hansford, "London-New York telephone circuit," *Jour. P.O.E.E.*, 20, 55-64; April, 1927.
32. T. F. Purves, "Ship and shore telephony," *Electrician*, 104, 516-517; April 25, 1930.
33. T. F. Purves, "Ship-shore radiotelephony," *El. Rev. (London)*, 106, 865-866; 929-930; May 9-16, 1930.
34. A. S. Angwin, "Ship-and-shore terminal equipment," *Electrical Communication*, 9, 56-61; July, 1930.
35. T. F. Purves, "Inaugural address," *Jour. I.E.E.*, 68, No. 396, pp. 1-16; December, 1929.

SINUSOIDAL CURRENTS IN LINEARLY TAPERED LOADED TRANSMISSION LINES*

By

JOHN W. ARNOLD AND PAUL F. BECHBERGER

(Western Union Telegraph Company, New York City)

Summary—Working formulas for the calculation of input impedances and attenuation are obtained for a transmission line in which the resistance and inductance per unit length are linear functions of distance, and in which the capacitance and leakage are constant. Generalized functions depending on the initial constants and the rate of taper are introduced, in such a way that the formulas and the functions are analogous to the usual formulas and hyperbolic functions. The latter are secured as special cases of the former. The theory is applicable to the tapered loaded submarine cable. Propagation in such a transmission line, as distinguished from that in the smooth uniform line, is characterized by the fact that the current attenuation is, in general, different from the voltage attenuation.

THE relations among sinusoidal currents and voltages, distance and transmission line constants per unit length in the smooth uniform transmission line are readily derived from the telegraph equation in terms of hyperbolic functions. They are well known and widely used on account of their convenient form.

In many cases where current, voltage, attenuation, and impedance formulas are thus expressed, as, for example, in treatment of the propagation of sinusoidal currents in submarine cables, it is realized that the effective values of the "constants" R , L , G , and C are really functions of frequency and other parameters. In a continuously loaded cable, particularly, the inductance and resistance are functions of current. For the most part, however, such variations from constant values as are of consequence in practice are often handled either with separate calculations for different values of the parameters, or with special devices not departing too widely from the desirable simplicity of the hyperbolic functions.

When the loading per unit length varies considerably from point to point, however, the dependence of R and L upon position exerts more than a second order effect on the manner of propagation. Applicable general expressions have been given by Ravut,¹ Carson,² and Thomas.³

* Decimal classification: 621.319.2. Original manuscript received by the Institute, November 25, 1930.

¹ C. Ravut, "Propagation des courants sinusoidaux sur des lignes quelconques," *Revue Général de l'Élec.*, 7, No. 19, pp. 611-615; May 8, 1920.

² John R. Carson, "Propagation of periodic currents over non-uniform lines," *The Electrician*, 86, No. 10, pp. 272-273; March 4, 1921.

³ François Thomas, "Propagation du courant sur les lignes quelconques," *Revue Général de l'Élec.*, 26, No. 15, pp. 567-569; October 12, 1929.

A special case has been rather completely worked out by Ballantine.⁴ The special case where G and C are constant but R and L are linear functions of distance will be treated here. An attempt will be made to develop expressions, as nearly as may be, analogous to the already familiar hyperbolic functions; moreover, to proceed from the same point of departure and to employ the same processes already familiar to engineers in the theory of the smooth uniform transmission line.

A continuously loaded line possessing the following constants at the distance l from the beginning may be designated as "linearly tapered:"

$$\left. \begin{aligned} L &= L_0 + k_L e \\ R &= R_0 + k_R e \\ G &= \text{constant} \\ C &= \text{constant.} \end{aligned} \right\} \quad (1)$$

The initial inductance and resistance per mile are L_0 and R_0 ; the rates of taper, positive or negative, are k_L and k_R .

For instantaneous values of current and voltage i and e at any point:

$$\left. \begin{aligned} -\frac{\partial i}{\partial l} &= Ge + C\frac{\partial e}{\partial t} \\ -\frac{\partial e}{\partial l} &= Ri + L\frac{\partial i}{\partial t} \end{aligned} \right\} \quad (2)$$

In complex notation, where I and E are sinusoidal, and $\omega = 2\pi f$,

$$-\frac{dI}{dl} = (G + j\omega C)E \quad (3)$$

$$-\frac{dE}{dl} = (R + j\omega L)I. \quad (4)$$

From differentiation of (3) and combination with (4)

$$\frac{d^2 I}{dl^2} = (G + j\omega C)\left(-\frac{dE}{dl}\right) \quad (5)$$

$$= (G + j\omega C)[(R_0 + j\omega L_0) + l(k_R + j\omega k_L)]I. \quad (6)$$

Let $\gamma^2 = (G + j\omega C)(R_0 + j\omega L_0)$ (7)

$$\delta^2 = (G + j\omega C)(k_R + j\omega k_L).$$

Then $\frac{d^2 I}{dl^2} = (\gamma^2 + \delta^2 l)I.$ (8)

⁴ Stuart Ballantine, "Non-uniform lumped electric lines, *Jour. Franklin Institute*, 203, 561-582; April, 1927. Discussion, 15, 849-853; June, 1927.

Further let $\gamma l = \theta$ (9)

$$\frac{\delta^2}{\gamma^3} = \alpha. \quad (10)$$

Then $\frac{d^2 I}{d\theta^2} = (1 + \alpha\theta)I.$ (11)

Solutions of (11) may be obtained in the form of power series C_1 and S_1 .

That is,

$$I = AC_1 + BS_1 \quad (12)$$

and from (3):

$$-(G + j\omega C)E = \frac{dI}{dl} = \gamma \frac{dI}{d\theta} = A\gamma \frac{dC_1}{d\theta} + B\gamma \frac{dS_1}{d\theta}. \quad (13)$$

If Z_0^2 be written for $(R_0 + j\omega L_0)/(G + j\omega C)$, (12) and (13) become:

$$\begin{aligned} C_1 A + S_1 B &= I \\ -Z_0 \frac{dC_1}{d\theta} A - Z_0 \frac{dS_1}{d\theta} B &= E. \end{aligned} \quad (14)$$

The series C_1 and S_1 and their derivatives may be found in the usual manner. Arbitrary constants A and B may be determined from (14) and the boundary conditions

$$E = E_0, \quad I = I_0 \text{ when } \theta = 0. \quad (15)$$

Finally from (14) there are obtained the general equations for current I and voltage E at a distance $l = \theta/\gamma$ from the head of the line characterized by equations (1):

$$I = I_0 C_1 - \frac{E_0}{Z_0} S_1 \quad (16)$$

$$E = E_0 C_2 - I_0 Z_0 S_2 \quad (17)$$

where the four functions of α and θ are defined by the following series:

$$\begin{aligned} C_1(\alpha, \theta) = 1 + & \frac{\theta^2}{2!} + \frac{\theta^3 \alpha}{3!} + \frac{\theta^4}{4!} + \frac{4\theta^5 \alpha}{5!} + \frac{\theta^6(1 + 4\alpha^2)}{6!} + \frac{9\theta^7 \alpha}{7!} \\ & + \frac{\theta^8(1 + 28\alpha^2)}{8!} + \frac{\theta^9(16\alpha + 28\alpha^3)}{9!} + \frac{\theta^{10}(1 + 100\alpha^2)}{10!} + \dots \end{aligned} \quad (18)$$

$$\begin{aligned} S_1(\alpha, \theta) = \theta + & \frac{\theta^3}{3!} + \frac{2\theta^4 \alpha}{4!} + \frac{\theta^5}{5!} + \frac{6\theta^6 \alpha}{6!} + \frac{\theta^7(1 + 10\alpha^2)}{7!} + \frac{12\theta^8 \alpha}{8!} \\ & + \frac{\theta^9(1 + 52\alpha^2)}{9!} + \frac{\theta^{10}(20\alpha + 80\alpha^3)}{10!} + \dots \end{aligned} \quad (19)$$

$$\begin{aligned}
 S_2(\alpha, \theta) = \frac{dC_1(\alpha, \theta)}{d\theta} &= \theta + \frac{\theta^2\alpha}{2!} + \frac{\theta^3}{3!} + \frac{4\theta^4\alpha}{4!} + \frac{\theta^5(1 + 4\alpha^2)}{5!} + \frac{9\theta^6\alpha}{6!} \\
 &+ \frac{\theta^7(1 + 28\alpha^2)}{7!} + \frac{\theta^8(16\alpha + 28\alpha^3)}{8!} + \frac{\theta^9(1 + 100\alpha^2)}{9!} \\
 &+ \frac{\theta^{10}(25\alpha + 280\alpha^3)}{10!} + \dots \tag{20}
 \end{aligned}$$

$$\begin{aligned}
 C_2(\alpha, \theta) = \frac{dS_1(\alpha, \theta)}{d\theta} &= 1 + \frac{\theta^2}{2!} + \frac{2\theta^3\alpha}{3!} + \frac{\theta^4}{4!} + \frac{6\theta^5\alpha}{5!} + \frac{\theta^6(1 + 10\alpha^2)}{6!} + \frac{12\theta^7\alpha}{7!} \\
 &+ \frac{\theta^8(1 + 52\alpha^2)}{8!} + \frac{\theta^9(20\alpha + 80\alpha^3)}{9!} + \frac{\theta^{10}(1 + 160\alpha^2)}{10!} + \dots \tag{21}
 \end{aligned}$$

The series may be extended by use of the following relations between terms:

For C_1 and S_1 :

$$T_n = \frac{\theta^2 T_{n-2} + \alpha \theta^3 T_{n-3}}{n(n-1)} \tag{22}$$

For C_2 and S_2 :

$$T_n = \frac{\theta^2 T_{n-2}}{n(n-1)} + \frac{\alpha \theta^3 T_{n-3}}{n(n-2)} \tag{23}$$

where T_n is the term containing θ^n .

Relations among the modified functions of α and θ and between them and the hyperbolic functions of θ may be summarized as follows:

$$C_1(\alpha, \theta)C_2(\alpha, \theta) - S_1(\alpha, \theta)S_2(\alpha, \theta) = 1 \tag{24}$$

$$\frac{d}{d\theta} S_1(\alpha, \theta) = C_2(\alpha, \theta) \tag{25}$$

$$\frac{d}{d\theta} C_1(\alpha, \theta) = S_2(\alpha, \theta) \tag{26}$$

$$C_1(0, \theta) = C_2(0, \theta) = \cosh \theta \tag{27}$$

$$S_1(0, \theta) = S_2(0, \theta) = \sinh \theta \tag{28}$$

$$C_1(\alpha, 0) = C_2(\alpha, 0) = 1 \tag{29}$$

$$S_1(\alpha, 0) = S_2(\alpha, 0) = 0. \tag{30}$$

WORKING FORMULAS

For the tapered line of length l closed by an impedance Z_a :

$$E = IZ_a = E_0C_2(\alpha, \theta) - I_0Z_0S_2(\alpha, \theta). \tag{31}$$

$$I = I_0 C_1(\alpha, \theta) - \frac{E_0}{Z_0} S_1(\alpha, \theta). \quad (32)$$

Whence

$$Z_a = \frac{E_0 C_2(\alpha, \theta) - I_0 Z_0 S_2(\alpha, \theta)}{I_0 C_1(\alpha, \theta) - \frac{E_0}{Z_0} S_1(\alpha, \theta)} \quad (33)$$

and

$$Z = \frac{E_0}{I_0} = Z_0 \frac{Z_a C_1(\alpha, \theta) + Z_0 S_2(\alpha, \theta)}{Z_0 C_2(\alpha, \theta) + Z_a S_1(\alpha, \theta)} \quad (34)$$

If the terminating impedance is simply the characteristic impedance of the distant end of the tapered portion; that is, $Z_a = Z_t$ where

$$Z_t = \sqrt{\frac{(R_0 + k_R l) + j\omega(L_0 + k_{LL})}{G + j\omega C}} \quad (35)$$

then

$$\frac{Z_a}{Z_0} = \sqrt{1 + \alpha\theta} = k \quad (36)$$

which is a constant for a given initial and terminal R and L , and

$$\frac{Z}{Z_0} = \frac{k C_1(\alpha, \theta) + S_2(\alpha, \theta)}{C_2(\alpha, \theta) + k S_1(\alpha, \theta)} \quad (37)$$

If the distant end is closed, $Z_a = 0$

$$\frac{Z}{Z_0} = \frac{S_2(\alpha, \theta)}{C_2(\alpha, \theta)} \quad (38)$$

If the distant end is open, $Z_a = \infty$

$$\frac{Z}{Z_0} = \frac{C_1(\alpha, \theta)}{S_1(\alpha, \theta)} \quad (39)$$

As a further example the voltage and current attenuation of a tapered line closed by an impedance Z_a may be found.

Let the attenuations be

$$\alpha_v = \frac{1}{l} \log \left| \frac{E_0}{E} \right| \quad \text{and}$$

$$\alpha_c = \frac{1}{l} \log \left| \frac{I_0}{I} \right|.$$

From (24), (31), and (32)

$$\frac{E_0}{E} = C_1(\alpha, \theta) + \frac{Z_0}{Z_a} S_2(\alpha, \theta) \tag{40}$$

$$\frac{I_0}{I} = C_2(\alpha, \theta) + \frac{Z_a}{Z_0} S_1(\alpha, \theta). \tag{41}$$

Again, if Z_a is the characteristic impedance of the distant end of the taper, (36) obtains and

$$\frac{E_0}{E} = C_1(\alpha, \theta) + \frac{S_2(\alpha, \theta)}{k} \tag{42}$$

$$\frac{I_0}{I} = C_2(\alpha, \theta) + k S_1(\alpha, \theta). \tag{43}$$

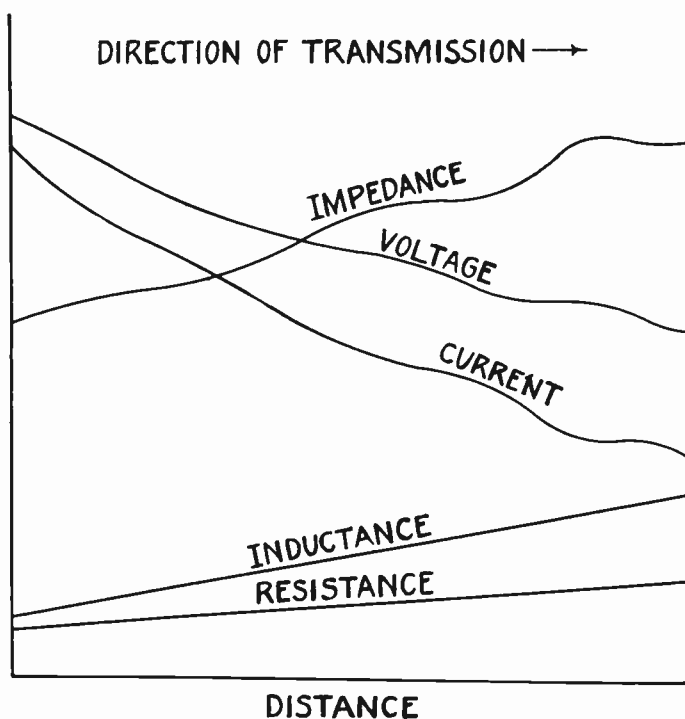

Fig. 1—Variation of Current, voltage, and impedance along a tapered line section.

The close correspondence between the formulas given and the uniform-line formulas, and also the necessity for such differences as do exist, should be apparent.

It can be said that the present treatment simply introduces a slope factor " α " into the usual functions and formulas, and that all formulas

here given reduce to the usual formulas when the slope factor " α ," that is, the amount of taper, is zero.

Fig. 1 illustrates the variation of voltage, current, and local impedance along a line-section in which the tapering of inductance and resistance is upward from the head, and which is terminated in the

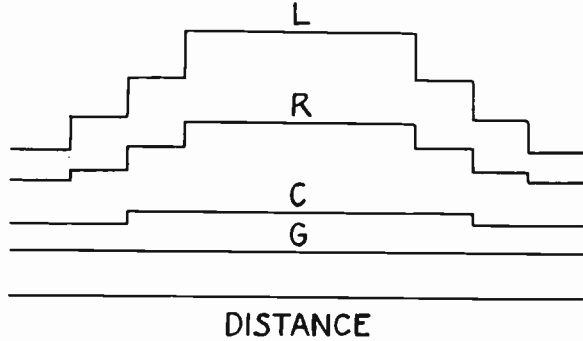

Fig. 2—Line calculable with simple hyperbolic functions.

characteristic impedance of its distant end. The local impedance is taken at the point considered, looking in the direction of transmission. All the ordinates represent absolute values.

To handle curved inductance and resistance characteristics, and also to increase the rate of convergence of the series when necessary, broken lines may be fit approximately to the curved lines representing the variation of inductance and resistance with distance. The modified

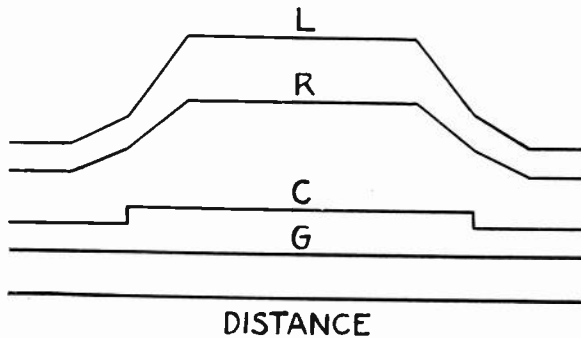

Fig. 3—Line calculable with modified functions in combination with simple hyperbolic functions.

functions suggested here, together with the simple hyperbolic functions, permit of substantially exact determinations of impedances and propagation characteristics of transmission lines possessing arbitrary broken-line inductance-distance and resistance-distance characteristics and possessing capacitances and leakances constant in any segment; separate calculations being made for each segment.

BOOKLETS, CATALOGS, AND PAMPHLETS RECEIVED

Copies of the publications listed on this page may be obtained gratis by addressing a request to the manufacturer or publisher.

A 68-page book on "Laboratory Vitreosil" describes the properties of various types of fused silica and quartz wares and shows some of the numerous forms in which vitreosil may be obtained. A considerable amount of technical and engineering information concerning the properties of vitreosil is given. Copies of this catalog are obtainable from the Thermal Syndicate, Schenectady and Atlantic Avenues, Brooklyn, N.Y.

Bulletin AMP-1 of the Polymet Manufacturing Corporation, 829-839 East 134th St., New York City, describes amplifiers and sound equipment for theaters and public address systems.

The 1931 catalog of the Aerovox Wireless Corporation, 70-82 Washington St., Brooklyn, N.Y., gives the electrical characteristics and dimensions of Aerovox condensers and resistors. The catalog contains description of condensers up to 4 microfarads and rated at 1000 volts d.c. Data on dry electrolytic condensers up to 4000 microfarads capacity are also given. Several useful tables and data are given in the booklet.

Data sheet No. 6 from the Engineering Department of the Jewell Electrical Instrument Co., 1650 Walnut St., Chicago, entitled "Testing Alignment of Tuning Condensers in Radio Receivers" will be of interest to service men who are frequently called upon to repair radio receivers. Data sheet No. 7, "Direct Reading Mutual Conductance Meters" shows a schematic wiring diagram for a grid-plate transconductance meter which may be made up for use where it is desirable to make a number of tests on tubes.

The Supreme Instruments Corporation of Greenwood, Mississippi, announces two new instruments in a recent mimeographed bulletin. One of these, their model 70 oscillator, is a radio-frequency oscillator designed for aligning intermediate-frequency amplifiers of superheterodyne receivers. Intermediate frequencies of 130 kc and 170 kc to 180 kc may be obtained by setting a toggle switch. Model 60 signal driver is a modulated radio frequency and oscillator and attenuator for servicing broadcast receivers. The oscillator operates on direct current. Provision is made for variable tuning of the intermediate-frequency bands over a range of from 125 kc to 185 kc as well as for covering the usual broadcast band from 500 kc to 1500 kc.

A series of step-down transformers which are intended to reduce the supply voltage from 200-240 volts to 100-120 volts are described in a folder recently issued by the Acme Electric and Manufacturing Company, 1440 Hamilton Ave., Cleveland, Ohio.

Microphone mixing panels for combining the output of as many as three microphones or other audio sources are described in bulletin No. 7B issued by the Jenkins and Adair, Inc., Bulletin No. 8B shows their type-C volume indicator panel.

REFERENCES TO CURRENT RADIO LITERATURE

THIS is a monthly list of references prepared by the Bureau of Standards, and is intended to cover the more important papers of interest to the professional radio engineer which have recently appeared in periodicals, books, etc. The number at the left of each reference classifies the reference by subject, in accordance with the "Classification of Radio Subjects: An Extension of the Dewey Decimal System," Bureau of Standards Circular No. 385, which appeared in full on pp. 1433-56 of the August, 1930, issue of the Proceedings of the Institute of Radio Engineers. The classification numbers are in some instances different from those used in the earlier version of this system used in the issues of the Proceedings of the Institute of Radio Engineers before the October, 1930, issue.

The articles listed are not obtainable from the Government or the Institute of Radio Engineers, except when publications thereof. The various periodicals can be secured from their publishers and can be consulted at large public libraries.

R000. RADIO COMMUNICATION

- R007 Basis established by the Federal Radio Commission for the Division of Radio Broadcast facilities within the United States. *PROC. I.R.E.*, 18, 2032-40; December, 1930.
Includes an explanatory statement and revised quota tables prepared by the Engineering Division of the Federal Radio Division.
- R007 Butman, C. Explaining the radio law. *Radio News*, 12, 502-503; December, 1930.
The radio laws of the United States are discussed, and explained with special reference given to those laws which affect broadcasting and broadcast stations. A list of essential "Don'ts for radio stations" is given.
- R007 Butman, C. Observing the Federal Radio Licensing requirements. *Radio News*, 12, 602-603; January, 1931.
An explanation concerning the issuance of all types of radio licenses by the Federal Government is given, after pointing out how the various nations, by international agreement, have set up radio laws and regulations with which to conduct orderly radio communication.
- R050 Classification of radio subjects—An extension of the Dewey decimal system. Bureau of Standards Circular No. 385, issued October 16, 1930. Supersedes Bureau of Standards Circular No. 138. Obtainable for 10 cents per copy from the Superintendent of Documents, Government Printing Office, Washington, D.C.
Was published in full in the *PROC. I. R. E.*, 18, 1433-56; August, 1930; abstracted in November, 1930 issue of the *PROC. I.R.E.*
- R060 Summary of piezo-electric crystal conference held by U. S. Navy Department, December 3-4; 1929. *PROC. I.R.E.*, 18, 2128-35; December, 1930.
Representatives of various Government departments, radio manufacturers, and scientists interested in radio, discussed the following: (1) The crystallography and piezo-electricity of quartz; (2) Methods of cutting and testing quartz; (3) Best laboratory practices and experience relative to the two principal "cuts" used in the art.

R100. RADIO PRINCIPLES

- R111 Schekulin, L. Fortpflanzung einer elektromagnetischen Welle in einem ionisierten magneto-aktiven Medium. (Propagation of an electromagnetic wave in an ionized magneto-active medium). *Zeits. für Hochfrequenz.*, 36, 172-82; November, 1930.
A theoretical treatment of wave propagation is given, for the case of an electromagnetic wave in a homogeneous medium and having any angle of inclination to a prevailing magnetic field.
- R113 Edes, N. H. Some experiences with short-wave wireless telegraphy. *PROC. I.R.E.*, 18, 2011-31; December, 1930.
An analysis is given, of the factors that may be expected to determine the transmission phenomena peculiar to any given short-wave channel. It is shown that the optimum wavelength for satisfactory communication is determined by (a) the great circle distance between stations, (b) the geographical positions of the stations, (c) the time of year, and (d) the time of day. A summary is given of working experiences and results of tests over various "links" of the British Military short-wave system.
- R113.1 Krüger, K. and Plendl, H. Untersuchungen über Schwunderscheinungen bei kurzen Wellen. (Investigation of fading phenomena at short wavelengths). *Zeits. für techn. Physik*, No. 51 (11), pp. 478-82; 1930.
Using wavelengths of 32 and 50 meters several methods of eliminating fading were tried. The results indicate that the use of two transmitting antennas, which are excited alternately by a push-pull transmitter, practically eliminate fading. Comparative results are given.
- R113.5 Austin, L. W., Judson, E. B., Wymore-Shiel, I. J. Solar and magnetic activity and radio transmission. *PROC. I.R.E.*, 18, 1997-2002; December, 1930.
In this paper curves are shown indicating a connection between the annual averages of sun spot numbers and daylight radio signal strength of Nauen, Germany, as received in Washington from 1915 to 1929. The curves of the monthly averages of sun spots and daylight transatlantic signals for the years 1924-29 show little evidence of correlation. On the other hand, the correlation between these monthly average signals and terrestrial magnetic activity seems definite. Reception from Monte Grande (Argentina) shows less definite and on the whole inverse correlation with magnetic activity. This indicates that long waves, like the ultra short, are more influenced by magnetic activity when traveling across the earth's magnetic field than when traveling parallel to it.
- R120 Glas, E. T. On the efficiency-rating of transmitting aeri-als for broadcasting distribution. *Exp. Wireless & W. Engr.*, 7, 665-68; December, 1930.
A proposal for the numerical rating of broadcast antennas relative to the true half-wave antenna is given and the result is discussed for theoretical linear radiators.
- R131 Barclay, W. A. Method of alignment applied to antilogarithmic triode characteristics. *Exp. Wireless & W. Engr.*, 7, 671-75; December, 1930.
As a supplement to his article "The algebraic representation of triode valve characteristics," (*Exp. Wireless & W. Engr.*, April, 1929), the author suggests the alignment method as a quick and accurate way of solving the antilogarithmic formula representing the lumped characteristics of a triode.
- R132 Uehling, E. A. Analysis of uniform r-f amplification. *Electronics*, 1, 414-16; December, 1930.
A theoretical treatment of the problem of maintaining uniform amplification over the entire broadcast range.
- R132 Feldkeller, R. and Strecker, F. Theorie der Niederfrequenz-Verstärkerketten. (The theory of multiple-stage low-frequency amplifiers). *Archiv. für Elektrotechnik*, 44, 425-68; November, 1930.
A comprehensive theoretical treatment of low-frequency amplifiers.

- R133 Ito, Y. Das Gitterdynatron. (The grid dynatron). *Elek. Nach. Tech.*, 7, 419-26; November, 1930.
 A distinction is made between: (a) The grid dynatron in which the secondary emission of the grid and, (b) The anode dynatron, in which the secondary emission of the anode, is utilized for the production of oscillations. It is shown that the grid dynatron acting as a generator will stand heavy loads with no appreciable change of frequency.
- R133 Möller, H. G. Über die Frequenz der Barkhausenschwingungen. (On the frequency of Barkhausen oscillations). *Elek. Nach. Tech.*, 7, 411-19; November, 1930.
 A theoretical treatment of the Barkhausen type of oscillation wherein the author attempts more nearly to approach practical results by eliminating the assumptions that Barkhausen made in his original treatment of the subject.
- R134 Terman, F. E. and Morgan, N. R. Some properties of grid leak power detection. *Proc. I.R.E.*, 18, 2160-75; December, 1930.
 It is shown theoretically that grid leak power detection can be obtained without undue distortion. Theory is developed which indicates necessary conditions, and experimental results are given which verify the theoretically determined point at which distortion becomes excessive. These results indicate that the grid leak power detector is more sensitive than the C-bias power detector, and will ordinarily give at least as much undistorted output when operated at the same plate voltage.
- R134 Hall, C. D. The estimation of the sensitivity of the grid rectifier for large inputs. *Exp. Wireless & W. Engr.*, 7, 668-70; December, 1930.
 The author shows that the time constant of the grid condenser and leak circuit is a factor which cannot be neglected and suggests a method of analysis which gives accurate results.
- R140 Steimel, K. Die Stabilität und die Selbsterregung elektrischer Kreise mit Organen fallender Charakteristik. The stability and self-excitation of electric circuits containing elements with falling characteristics. *Zeits. für Hochfrequenz.*, 36, 161-72; November, 1930.
 A theoretical discussion of oscillating circuits is given, with an attempt to explain some of the apparent contradictions in present theory.
- R144 Palermo, A. J. and Grover, F. W. A study of the high-frequency resistance of single layer coils. *Proc. I.R.E.*, 18, 2041-58; December, 1930.
 Existing formulas for the high-frequency resistance of single layer coils have all been obtained by making simplified assumptions. The errors, due to these assumptions are difficult to estimate and the data available are not conclusive. This paper gives the experimental results of a systematic study of the high-frequency resistance of single layer coils of the forms and sizes usual in radio circuits in the broadcast range of frequency. New formulas are derived by expanding Hickman's low-frequency formulas in asymptotic series, thus making the formulas applicable to high frequencies. An empirical formula for coils of intermediate lengths is also found. These formulas are compared with the experimental results.
- R148 Loest, W. Phasenmodulation. (Phase modulation). *Zeits. für Hochfrequenz.*, 36, 188-90; November, 1930.
 A theoretical treatment of the principle of phase modulation is given wherein it is pointed out that its aspects are similar to those of frequency modulation.
- R148.1 Ballantine, S. and Snow, H. A. Reduction of distortion and cross-talk in radio receiving sets by means of variable-mu tetrodes. *Proc. I.R.E.*, 18, 2102-27; December, 1930.
 The principle of the variable-mu tube (type 550 and 551) is outlined and its application to the problem of distortion and cross-talk is discussed from both the theoretical and experimental viewpoints. Results show that cross-talk is reduced to 1/500th of that obtained with the present type 24 tube at input voltages of 0.1 volt.

R200. RADIO MEASUREMENTS AND STANDARDIZATION

- R214 Clapp, J. K. Temperature control for frequency standards. *Proc. I.R.E.*, 18, 2003-10; December, 1930.

A brief summary of the factors influencing the stability of temperature-control assemblies, in which control is obtained by adding heat and without the use of circulating mechanisms, is given. These factors include the degree of insulation; rate of application and method of distribution of heat; sensitivity, regularity of operation, and position of thermostat; degree of "ripple" attenuation; and the operating temperature. Examples of three types of control units regulating to within approximately ± 0.5 degree, ± 0.1 degree, and ± 0.01 degree C, respectively, at 50 degrees C are given, with heating rates and details of construction. Diagrams and photographs are included.

- R220 Zickner, G. Eine Messbrücke für sehr kleine Kapazitäten. (A bridge for the measurement of very small capacities). *Elek. Nach. Tech.*, 7, 443-47; November, 1930.

After a discussion of the present inadequate methods of measuring small capacities of the order of $1/10 \mu\mu\text{f}$, a new method is presented whereby such capacities may be measured to a satisfactory degree of accuracy.

- R242 Martyn, D. F. On a new method of measurement of minute alternating currents. *Proc. Royal Soc. (Edinburgh)*, 50, 166-74; part II, Series of 1929-30.

A sensitive method of measuring alternating currents of the order of microamperes and of any frequency, is described. The current to be measured is passed through a diode valve and the main heating current of this valve is supplied by an independent oscillator working at the frequency of the current under measurement. The change in the plate current of the valve is noted, this indicating the amplitude of the alternating current being measured.

- R265.2 Oliver, D. A. Loud speaker tests and performance factors. *Exp. Wireless & W. Engr.*, 7, 653-64; December, 1930.

The author recommends uniform practice methods in loud speaker testing.

- R270 von Ardenne, M. Über eine neue Felstärke-Messeinrichtung. (A new apparatus for field intensity measurements). *Elek. Nach. Tech.*, 7, 434-43; November, 1930.

A direct-indicating, portable apparatus is described which has an eight stage r-f amplifier with a gain of 5 to 10,000, a special gain control that has no effect on the frequency, and a vacuum tube voltmeter in the output. The provision for the possible use of recording instruments is included.

R300. RADIO APPARATUS AND EQUIPMENT

- R350 Lampkin, G. F. A dual-frequency audio-source for general laboratory use. *Electronics*, 1, 417; December, 1930.

A small compact dynatron oscillator, designed to supply either 415 cycles or 1061 cycles with sinusoidal wave-form, independent of the nature of the load, is described.

- R361 Robinson, J. The Stenode radiostat. *Radio News*, 12, 590; January, 1931.

The inventor of this new departure in radio receiving sets gives his explanation of how it works.

- R390 Schlesinger, K. Ein Kapazitiver Spannungsteiler mit Lastausgleich und seine Anwendungen. (A capacitive attenuator with load compensator, and its applications). *Zeits. für Hochfrequenz.*, 36, 190-96; November, 1930.

A capacitive attenuator or voltage divider is described, which is independent of frequency within the range of 10^4 to 10^7 cycles, has a possible reduction ratio of 15,000 to 1, and is independent of load conditions. The instrument is adapted for measuring sensitivity of receiving sets, amplification constants, etc.

- R390 Glover, R. P. A review of high-frequency attenuation devices. *Radio Engineering*, 10, 23-26; November, 1930.

An explanation and description of several types of commonly used attenuation devices is given, including the resistance, and the reactance potential divider type, the voltage drop type, and the type employing mutual inductance.

R500. APPLICATIONS OF RADIO

- R520 Richardson, J. S. Aviation communication. *PROC. I.R.E.*, 18, 2143-59; December, 1930.

This paper deals with the different functions of radio in the field of aviation. Requirements encountered in the design of suitable equipment are indicated, and details given of equipment now operating commercially.

- R520
×R356
×R366 Doughman, F. C. Power for aircraft radio. *Electric Journal*, 27, 701-04; December, 1930.

Four types of power units are described and the proper selection for the particular service required, is discussed.

- R521.2 Dorn, W. Die Funkabschirmung an Flugmotoren. (The shielding of aircraft motors). *Electrotechnische Zeitschrift*, 51, No. 47), 1610-1613; November 20, 1930.

The necessity of shielding is shown, and the methods that have been used are mentioned. It is pointed out that the only satisfactory method is the complete shielding of both high and low tension sides of the ignition system. Shielded spark plugs and engine harnesses are described.

- R526.12 Jackson, W. E. and Bailey, S. L. The development of a visual type of radio range transmitter having a universal application to the Airways. *PROC. I.R.E.*, 18, 2059-2101; December, 1930.

This paper deals with the development of a visual type radio range which has universal application to the civil airways of the United States. Following a discussion of the relative merits of the aural and visual systems of course indication the theory of the production of twelve courses by utilizing a three-phase radio-frequency source is presented, followed by a description of the transmitting installation and its performance.

- R550
×R423.5 von Ardenne, M. Vielfachrundfunk auf einer Ultrakurzwelle. (Multiple-program broadcasting on a single ultra high-frequency channel). *Elektrotechnische Zeitschrift*, 51, (No. 47), 1619-20; November 20, 1930.

It is suggested that a single high frequency might be modulated with several radio frequencies from the broadcast spectrum each of the latter being modulated in turn with the voice frequency of a broadcast program. A small high-frequency detector is added to the ordinary broadcast receiving set for reception. Experiments have been carried out and results indicate that the plan has great possibilities.

R800. NONRADIO SUBJECTS

- 535.38 Koechel, W. P. Phototube voltage supervisor. *Electronics*, 1, 417; December, 1930.

An ingenious solution of the problem of supplying correct and uniform voltages to test positions in a tube manufacturing plant, utilizes a phototube to monitor these voltages and to give warning when abnormalities occur.

- 537.65 Cady, W. G. Piezo-electricity terminology. *PROC. I.R.E.*, 18, 2136-42; December, 1930.

Recommendations are made respecting terminology and symbols used in the field of piezo-electric crystals and their applications in radio.

- 621.314.6 Binneweg, A. Practical radio-frequency choke coils. *Radio Engineering*, 10, 34-36; November, 1930.
The engineering requirements are discussed for choke coil construction, to meet the various needs in vacuum tube circuits.
- 621.382.8 Mason, H. Advances in transoceanic cable technique. *Proc. I.R.E.*, 18, 2176-91; December, 1930.
Progress in the construction of transoceanic cables is described from the earliest, to the most recent type, which operates at 1400 letters per minute. Without technical detail the development of cable operating mechanisms and operating procedures is sketched. Trends of growth are given with data covering the fall of file as to hours of the day, direction, and class of business.
- 621.385.971 Forstmann, A. Zur Theorie elektromagnetischer Tonabnehmer. (On the theory of the electromagnetic phonograph pick-up). *Elek. Nach. Tech.*, 7, 426-434; November, 1930.
The vibrating mechanical system of the pick-up is reduced to an equivalent electrical system and considered with other factors in determining optimum dimensions and characteristics.
- 629.13 Born, F. Die Electrotechnik auf dem Internationalen Luftfahrt-kongress im Haag. (The electrotechnical phase of the International Air Transport Congress at the Hague). *Elektrotechnische Zeitschrift*, 51, (No. 47), 1618-19; November 20, 1930.
A brief report of the proceedings of the above mentioned conference.



CONTRIBUTORS TO THIS ISSUE

Arnold, John W.: Born September 13, 1897 at Paulding, Ohio. Received B.A. degree, 1921; M.A. degree, 1923, University of Illinois. Mathematics staff, University of Illinois, 1921-1923. Engineering department, Western Union Telegraph Company, 1923 to date. Associate member, Institute of Radio Engineers, 1929.

Bechberger, Paul F.: Born 1906 at Norwalk, Ohio. Received B.S. in E.E. degree, Ohio State University, 1928. Western Union Telegraph Company, Engineering department, 1928 to date. Nonmember, Institute of Radio Engineers.

Eckersley, P. P.: Born January 6, 1892 at La Puebla, Mexico. Educated at Bedales School and Manchester University. Apprenticed, Mather and Platt and Lancashire Dynamo and Motor Company. Royal Flying Corps, 1915; officer in charge of wireless training Southern Brigade, 1916; brigade wireless officer, France; wireless experimental section, aircraft department, Marconi Company, 1919; head of experimental design department, 1921; chief engineer, British Broadcasting Corporation, 1923; His Master's Voice Gramophone and Marconi Company, 1929-1930. High-Frequency Engineering Co., Ltd., 1930 to date. Member, Institution of Electrical Engineers. Fellow, Institute of Radio Engineers, 1925.

Edelman, Philip E.: Born July 16, 1894. Received B.S. degree in Engineering, 1916, E.E. degree, 1917, University of Minnesota; Fellow, Research Corporation, 1917. Antisubmarine development, Naval Experiment Station, New London, Connecticut, 1918; perfected and received basic patents, automatic chemical control, 1919-1920; developed electrical, chemical, radio, and labor-saving improvements, 1921-1925; perfected devices for radio power supply, electroplating, acoustic condensers, and production processing, 1926-1920. Associate member, Institute of Radio Engineers, 1914.

Espenschied, Lloyd: Born April 27, 1889 at St. Louis, Missouri. E.E. course at Pratt Institute, 1909; amateur experimenter and radio operator on ships, 1905-1909; assistant engineer, Telefunken Wireless Telegraph Company of America, 1909-1910; engineer, department of development and research, American Telephone and Telegraph Company since 1910. In charge of transmission of high frequency in wire carrier and radio systems. Responsible for a number of inventions relative to communication systems, both wire and radio; also in field of railway signal and speed control systems and phonograph systems. He has contributed frequently to the *PROCEEDINGS*; Charter member, 1913; Fellow, Institute of Radio Engineers, 1924.

Kenrick, G. W.: Born May 25, 1901 at Brockton, Massachusetts. Received B.S. degree in physics, Massachusetts Institute of Technology, 1922; M.S. in physics, M.I.T., 1922; Sc. D. in mathematics, M.I.T., 1927. Department of physics, M.I.T., 1920-1922; department of development and research, American Telephone and Telegraph Company, 1922-1923; instructor in electrical engineering, M.I.T., 1923-1927; Moore School of Electrical Engineering, University of Pennsylvania, 1927-1929; assistant professor of electrical engineering. Tufts College, 1929 to date; consulting radio engineer, Bureau of Standards, 1930 to date. Associate member, Institute of Radio Engineers, 1923; Member, 1929.

Mögel, Hans E.: Born May 31, 1900 at Leipzig, Germany. Educated at Dresden High School. Received E.E. degree, 1922; Dr. Eng., 1926, Dresden High School. Assistant to Professor Barkhausen, 1921; research engineer, laboratories of the Huth Company at Berlin, development of transmitters, receivers, and amplifiers, 1922-1926; consulting engineer, Transradio A. G., Berlin, working especially at the receiving station in Geltow, 1926 to date. Member, Institute of Radio Engineers, 1930.

Robinson, Gordon D.: Born May 21, 1892 at Maywood, Illinois. Received M.E. degree in E.E., Cornell University, 1914; M.S. degree in E.E., Massachusetts Institute of Technology and Harvard University jointly, 1915. Continental Can Company working on cam design, Pennsylvania-Paoli railroad electrification; inventory of overhead equipment, Commonwealth Edison Company, Chicago. Instructor, department of electrical engineering, Pennsylvania State College, 1916-1917; instructor-associate professor, department of electrical engineering and physics, United States Naval Academy, 1917 to date. Active charge of Radio Laboratory, United States Naval Academy, 1918 to date. Associate member, A.I.E.E., U.R.S.I., S.P.E.E. Associate member, Institute of Radio Engineers, 1919.

Sahagen, Joseph: Born in 1907 at Cambridge, Massachusetts. Received B.S. degree, Harvard University, 1928. Dean of Evening Division, New England College of Transportation, 1929-1930. West Lynn Standardizing Laboratory, General Electric Company, 1929 to date. Nonmember, Institute of Radio Engineers.

Taylor, A. Hoyt: Born January 1, 1879 at Chicago, Illinois. Received B.S. degree, Northwestern University; Ph.D. degree, University of Göttingen, Germany, 1908. Instructor, Michigan State College, 1900; instructor, University of Wisconsin, 1903; Professor and head of physics department, University of South Dakota, until 1917. Lieutenant, Naval Reserve, 1917; Lieutenant commander, 1918; in charge of aircraft radio laboratory, Washington, D. C., 1919; promoted to Commander, remaining in active service until 1922. Upon organization of the Naval Research Laboratory was made superintendent of its radio division. In 1927 awarded the Morris Liebmann Memorial Prize by the Institute. Member, Institute of Radio Engineers, 1916; Fellow, 1920.

Turner, H. M.: Born July 20, 1882 at Hillsboro, Illinois. Received B.S. degree, University of Illinois, 1910; M.S. degree, 1915; assistant instructor in electrical engineering, 1910-1912; instructor, University of Minnesota, 1912-1918; assistant professor, Yale University, 1918-1926; associate professor, 1926 to date. Associate member, Institute of Radio Engineers, 1914; Member, 1920.

Wilson, William: Born March 29, 1887 at Preston, England. Received B.S. degree, University of Manchester, 1907; M.S. degree, 1908; D.Sc. degree, 1913. Research work on electronic physics, University of Manchester, University of Cambridge, and University of Giessen, Germany, 1907-1912. Lecturer, in physics, University of Toronto, 1912-1914. Research department, Western Electric Company and Bell Telephone Laboratories, 1914 to date. In charge, Western Electric Company manufacture of tubes for the United States government, 1917-1918; in charge, research, development, and manufacture of vacuum tubes, 1918-to date; in charge, radio research and development and design of the transatlantic radiotelephone equipment, 1925 to date. Member, A.I.E.E., U.R.S.I. Member, Institute of Radio Engineers, 1926; Fellow, 1928.

Young, L. C.: Born January 12, 1891 at Danville, Illinois. Amateur experimental work, 1909-1917. Telephone and Telegraph Department, Western Division, Pennsylvania Railroad, 1912-1917. Experimental radio work, 1917-1919. Aircraft radio section, Bureau of Standards, 1919; research work, radio section, Naval Research Laboratory, 1919 to date. Associate member, Institute of Radio Engineers, 1919; Member, 1929.

***Bäumler, M.:** Born August 8, 1874 at Salzmunde, Halle. In higher service of German Post and Telegraph Office, 1896-1914; in charge, development and testing of instruments, Reich's Central Post Office, 1914 to date. Nonmember, Institute of Radio Engineers.

* Paper published in January, 1930 Proceedings.



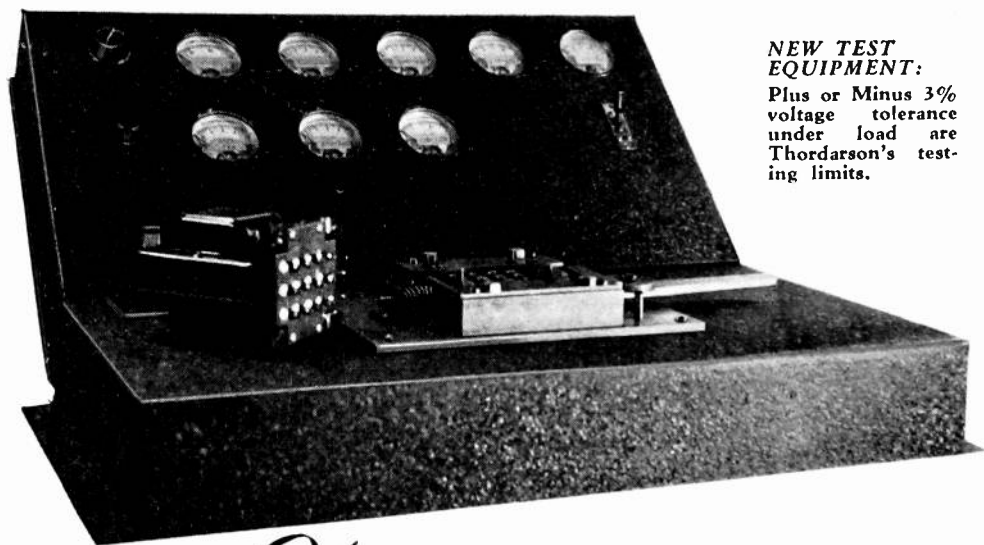

**NEW TEST
EQUIPMENT:**
Plus or Minus 3%
voltage tolerance
under load are
Thordarson's test-
ing limits.

Here's a Thordarson

TRANSFORMER

TEST

**It's Rigid—Exact
Complete**

“OK” means “OK” . . . not just “acceptable” . . . at the Thordarson plant. Precision testing is a rigid requirement. In this process even the slightest deviation in winding, for instance, is quickly detected . . . as you will note by the narrow margin of tolerance we allow . . . and the transformer rejected.

Every step in the engineering of Thordarson Transformers is carried out entirely within the Thordarson organization. Even the Precision Test instrument shown above is a Thordarson product. And our elaborately equipped research laboratory keeps abreast of the trends in radio engineering. In transformer circles it is a recognized leader. May we work with you?

THORDARSON
Transformer Specialists Since 1895

Thordarson Electric Manufacturing Co.
Huron, Kingsbury and Larrabee Streets, Chicago, Ill., U. S. A.

When writing to advertisers mention of the PROCEEDINGS will be mutually helpful.



1931 Radio Receivers Perform Better if Serviced with The Jewell Oscillator



A Necessary Instrument for Adjusting All Receivers

Radio frequency circuits in both Tuned Radio Frequency and Super-heterodyne sets must be adjusted to greater accuracy than is possible by the use of a broadcast wave.

The Jewell Pattern 560 Portable Test Oscillator gives the radio serviceman the only method of making these adjustments accurately.

Simplicity of operation, hair-line accuracy and assured reliability are achieved by constructional and design features found exclusively in the Jewell Pattern 560 Portable Test Oscillator.

Features of the Radio Service Oscillator

Self-Contained Batteries

The self-contained battery operated oscillator is unquestionably the best type of construction, as it can be perfectly shielded. While it is possible to obtain the same degree of shielding in an A.C. operated job, the cost of construction would be higher. The self-contained battery job also has the advantage of not being dependent on any outside source of power.

Leak-Proof Interlock Shielding

Every part of the Jewell Test Oscillator is enclosed by a combination aluminum and copper interlocking shield. An oscillator with less shielding is unsatisfactory.

Broadcast and Intermediate Bands

The Jewell Pattern 560 Portable Test Oscillator covers the broadcast band from 550 to 1500 K. C. and the intermediate frequency band from 125 to 185 K. C. The Jewell Test Oscillator has been designed for testing every Superheterodyne receiver built today, and provides for future design in that it covers the entire band from 125 to 185 K. C.

Specify the Jewell Radio Service Oscillator for your Service Department. Accurate service adjustments will assure test performance from your receivers.

JEWELL ELECTRICAL INSTRUMENT CO.

1642-D Walnut Street, Chicago, Ill.

31 YEARS MAKING GOOD INSTRUMENTS

JEWELL

New '30 Type Tubes

Two tubes are used; one a radio frequency oscillator and a second to audibly modulate the radio frequency current generated by the first tube. Shielded tube compartments are of ample size and provide perfect shielding for the tubes themselves.

Output Meter

The Jewell Test Oscillator may be had with or without the Jewell Pattern 559 Portable Output Meter. The meter is carried in a pocket provided in the oscillator case. In use, it is placed near the receiver output circuit to which it is connected, eliminating long leads and preventing any possible coupling to the oscillator.

Easy to Operate

You do not have to study the instruction book to use the Jewell Test Oscillator. A wiring diagram and calibration chart is carried in the cover where it can never be mislaid.

When writing to advertisers mention of the PROCEEDINGS will be mutually helpful.

Pin Point Precision

in

Stupakoff Pure Magnesia Insulators

Every Stupakoff Insulator can be guaranteed to have precision accuracy to .0005 in. Coupled with superior raw materials, this makes possible increased tube production and lower manufacturing costs by minimizing tube rejects and failures due to improper insulation.

Now two series to choose from—the well known No. 287 and the new 125% stronger B 90, which is specially valuable for extremely small sizes. Write today for sufficient samples to make your own conclusive tests.

STUPAKOFF LABORATORIES, Inc.,
Insulators
6619 Hamilton Ave., Pittsburgh (6), Pa.

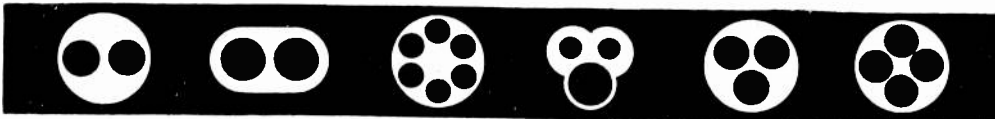
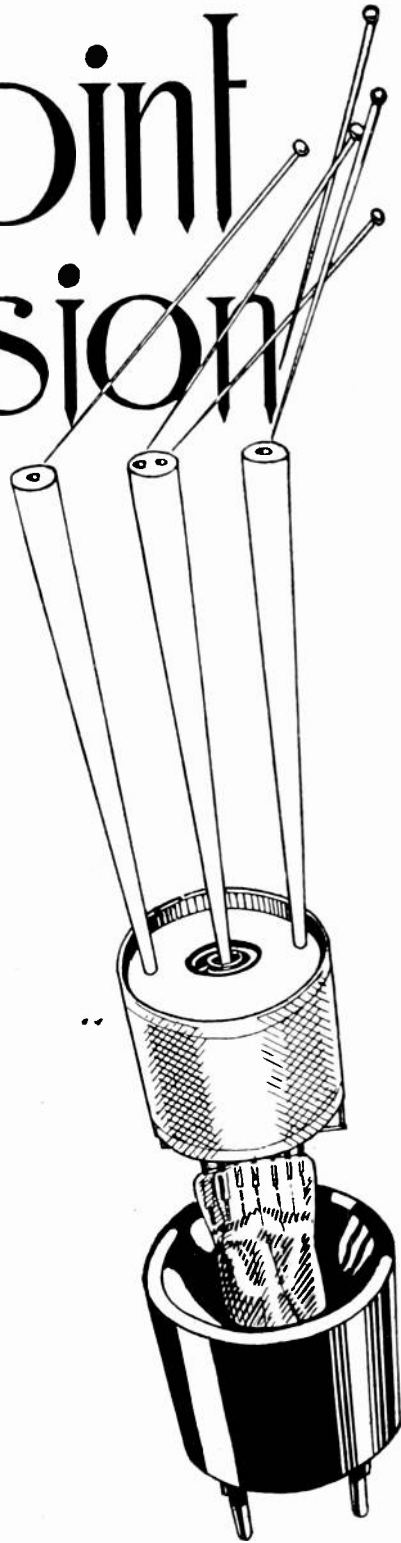

When writing to advertisers mention of the PROCEEDINGS will be mutually helpful.

The ELKON Non-Aqueous



Typical can size
16 Mfd. Condenser
4 1/4" x 2" x 1 1/2"

450 Working Volts
Any Combination of Capacities
Wide Variety of Can Sizes

THE Elkon Non-Aqueous Hi-Volt condenser marks a new milestone in the condenser art.

Although the Elkon condenser was favorably introduced to the commercial field in October 1930, its development extends over a period of seven years.

This new condenser has all of the essential characteristics of a high grade filter.

It has the smallest capacity content per microfarad of any condenser. It has the greatest filtering capacity of any electrolytic condenser—and closely approximates the filtering capacity of a paper condenser. It is self-healing. It operates at 450 volts DC. It is not injured by transient peaks even in excess of 600 volts.

Study the oscillographs and charts on the opposite page. They tell the story. Already a number of leading set and instrument manufacturers have adopted Elkon condensers as standard equipment. Samples built to your specifications will be sent to all recognized manufacturers. Send for booklet which gives complete description and technical data.

Outstanding Characteristics

- 1 **High Working Voltage:** 450 volts—withstanding without injury transient peaks in excess of 600 volts.
- 2 **Absolutely Dry:** A condenser from which all water is eliminated.
- 3 **Low Leakage:** Normal rated leakage 0.1 mil per mfd. (After operating short period the leakage is 0.025 mils per mfd.)
- 4 **Impervious to Low Temperatures:** Operates efficiently from minus 40 F to 150 F.
- 5 **Long Life:** To reduce replacements and interrupted service periods to a minimum.
- 6 **Self Healing:** Transient peaks in excess of 600 volts do not injure the Elkon condenser.
- 7 **Compactness:** Smallest cubical volume per microfarad of any condenser on the market.
- 8 **Maximum Filtering:** Due to low power factor, the Elkon condenser has the greatest filtering action of any electrolytic condenser on the market.
- 9 **Stability in Operation:** To guard against mechanical and electrical variation that would affect action of circuit.
- 10 **Low cost per microfarad per voltage rating:** A large safety factor in volt rating for the same cost as lower voltage condensers.

Standard Can Sizes and Their Microfarad Capacities

Vertical and Horizontal Cans			Vertical and Horizontal Cans			Vertical and Horizontal Cans		
MFD Cap'ty of Sections	Total Capa'ty MFDs	Can Size	MFD Cap'ty of Sections	Total Capa'ty MFDs	Can Size	MFD Cap'ty of Sections	Total Capa'ty MFDs	Can Size
1	1	2 3/4 x 1 x 1/2	5	5	4 1/4 x 1 1/2 x 3/4	20	20	4 1/4 x 2 x 1 1/4
2	2	2 3/4 x 1 3/8 x 3/4	6	6	4 1/4 x 1 1/2 x 3/4	30	30	4 1/4 x 2 x 2
2-2	4	2 3/4 x 1 3/8 x 1 1/2	8	8	4 1/4 x 2 x 3/4	4-8-12	24	4 1/4 x 2 1/2 x 1 3/4
2-2-2	6	2 3/4 x 1 3/8 x 2	8-8	16	4 1/4 x 2 x 1 1/2	ROUND CANS		
2-2-2-2	8	2 3/4 x 1 3/8 x 2 3/4	8-8-8	24	4 1/4 x 2 1/4 x 1 3/4	4	4	1 3/8 dia x 2 3/4
4	4	4 1/4 x 1 x 1	8-8-8-8	32	4 1/4 x 3 x 2	8	8	1 3/8 dia x 4 1/4
4-4	8	4 1/4 x 2 x 1	2-4-8	14	4 1/4 x 2 x 1 1/2	8-8	16	2 1/2 dia x 4 1/4
4-4-4	12	4 1/4 x 1 3/4 x 1 3/4	2-8-8	18	4 1/4 x 2 x 1 3/4	8-8-8	24	3 dia x 4 1/4
4-4-4-4	16	4 1/4 x 2 1/2 x 1 3/4	2-8-16	26	4 1/4 x 2 1/4 x 1 3/4	8-8-8-8	32	3 dia x 4 1/4

When writing to advertisers mention of the PROCEEDINGS will be mutually helpful.

Hi-Volt Condenser

Mill-Amperes per Microfarad

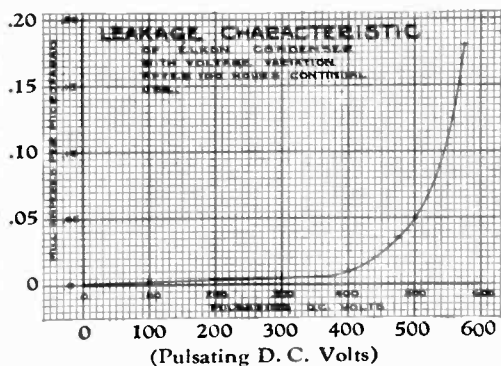

(Above) Leakage Characteristic of Elkon Condenser with Voltage Variation after 100 Hours Continual Use

Mill-Amperes per Microfarad

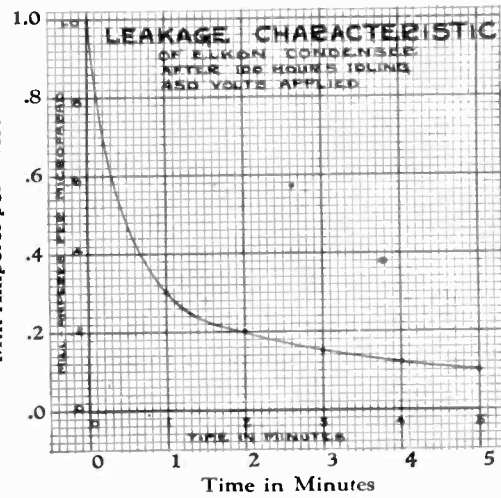

(Above) Leakage Characteristic of Elkon Condenser after 100 Hours Idling 450 Volts Applied

Leakage Mill-Amperes per Microfarad

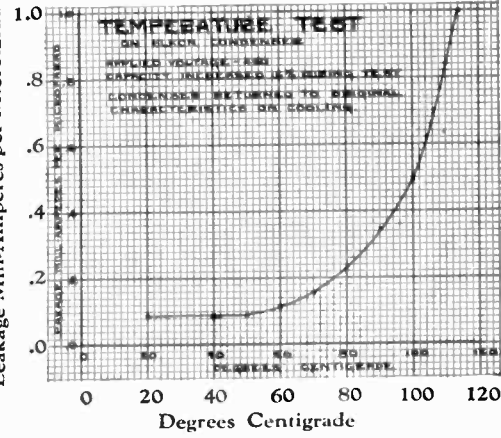

TEMPERATURE TEST on Elkon Condenser
 Applied Voltage 450. Capacity Increased 16% During Test. Condenser Returned to Original Characteristics on Cooling.

(Above and at left) Temperature and leakage characteristics as shown by the accompanying charts, indicate the efficiency of the Elkon Hi-Volt condenser.

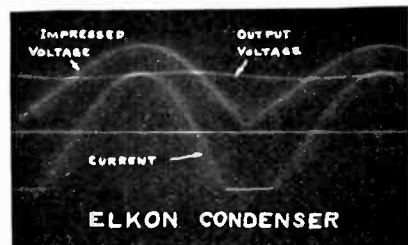

Oscillographs show comparative filtering action of the Elkon, the paper and wet types of condenser. Note the variation between the Elkon and the wet condenser.

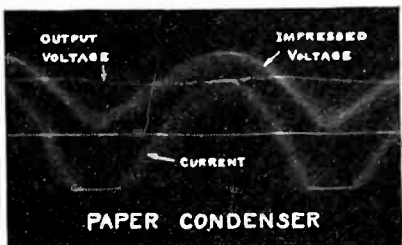

Booklet with complete data upon request.

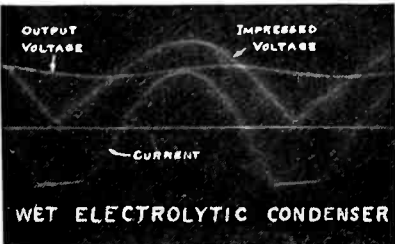

ELKON DIVISION

P. R. MALLORY & CO., Incorporated, - INDIANAPOLIS, IND.

When writing to advertisers mention of the PROCEEDINGS will be mutually helpful.

WHAT IS THE

A · T · & T · ?



ALL that most people see of the telephone company are a telephone and a few feet of wire.

But through that telephone you can talk with any one of millions of people, all linked together by the web of equipment of the Bell System.

All its efforts are turned constantly to one job—to give better telephone service to an ever-increasing number of people, as cheaply as it possibly can.

The American Telephone and Telegraph Company provides the staff work for the Bell System. To it the operation of the telephone service is a public trust. It pays a reasonable dividend to its stockholders . . . and uses all earnings beyond that to improve and extend the service. There are more than five hundred and fifty thousand stockholders,

and no one person owns so much as one per cent of its stock.

The Bell System operates through 24 regional companies, each one attuned to the needs of its particular territory. In addition, the 5000 members of the Bell Laboratories staff do the scientific work which makes it possible to improve and widen the service at least cost to its users. The Western Electric Company, which manufactures for the Bell System, specializes in the economical production of telephone equipment of the highest quality.

All these facilities are directly available throughout the entire Bell System, at any time or place. . . . Because of them, every dollar that you spend for telephone service brings you constantly greater value and convenience.

★ AMERICAN TELEPHONE AND TELEGRAPH COMPANY ★



When writing to advertisers mention of the PROCEEDINGS will be mutually helpful.

FROST- RADIO RELIABILITY



No. 590—590



No. 2880—2880

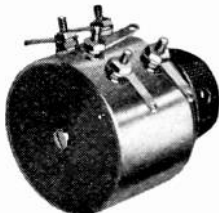

No. 890

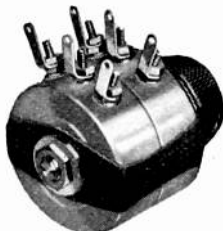

No. 280—280

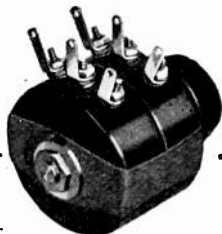

No. 1880—1880

Not an empty phrase, this statement of FROST-RADIO *RELIABILITY*, but a fact which has been demonstrated during the entire life of the radio industry. As a matter of fact, this habit of building reliability into all of its products extends back more than twenty years beyond the birth of radio, for this company have been builders of precision telephonic equipment for nearly a third of a century. That is why, when you specify FROST-RADIO, you obtain not only the finest possible apparatus, but also the very best possible results in the finished product.

If you are not now using these parts in your apparatus, why not become acquainted with them today?

MAY WE SEND YOU A COPY OF OUR COMPLETE CATALOG OF ALL FROST-RADIO PARTS AND ACCESSORIES? TO OBTAIN YOUR COPY JUST FILL OUT AND MAIL COUPON

HERBERT H. FROST, INC.
ELKHART, INDIANA, U. S. A.

HERBERT H. FROST, INC.
Elkhart, Indiana, U. S. A.

I. R. E.—2-31

Please send me a copy of your complete catalog of FROST-RADIO Parts and Accessories, and tell me how your products will improve our own.

Name Address
City State

When writing to advertisers mention of the PROCEEDINGS will be mutually helpful.

Engineers · Designers · Constructors

CARDWELL Announces the

“MIDWAY”

Featherweight Condenser

COMPARE!

STANDARD
Transmitting
Condenser
Weight, 15
ounces
Panel space re-
quired 4" x 4"

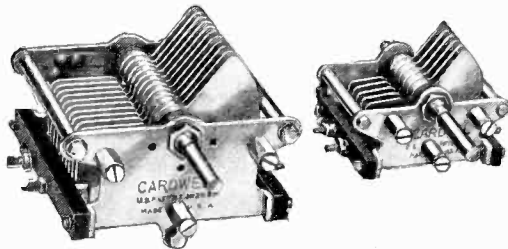

“MIDWAY”
Transmitting
Condenser
Weight 5 ounces
Panel space re-
quired
2¾" x 2½"

LIGHT—COMPACT—STRONG

For Transmitters and Receivers

Although fully adequate for replacing full size transmitting condensers of capacities up to 150 mmfds. in transmitters using up to 75 watt tubes, the “Midway” transmitting condensers are only slightly larger and heavier than many so called “Midget” condensers, at the same time having the same well known solid and substantial construction found in the full size CARDWELL transmitting and receiving condenser.

The “Midway” has many applications—as a neutralizing capacity for intermediate stages of a vacuum tube transmitter, in aircraft transmitters and receivers, for portable sets; in fact, for any purpose where compactness and light weight are desirable.

Extreme lightness of weight is made possible because with a few minor exceptions aluminum is used throughout. The voltage breakdown is materially increased in the transmitting models by reason of the use of highly polished plates with rounded edges.

The following models are available—

For receiving, in seven sizes—26 to 365 mmfds.

For transmitting, in six sizes—22 to 150 mmfds.

Weight from 4 to a maximum of 7 ounces.

Panel space required 2¾" x 2½".

Full particulars will be sent upon request.

CARDWELL CONDENSERS

Receiving and Transmitting

THE ALLEN D. CARDWELL MFG. CORP'N

81 Prospect Street, Brooklyn, N.Y.

Since Broadcasting Began

“THE STANDARD OF COMPARISON”

When writing to advertisers mention of the PROCEEDINGS will be mutually helpful.

PERMANENT ELECTRICAL CONTACTS and LOW CONTACT RESISTANCE are assured through this new Electrad Pressure Anchorage. Open ends permit air circulation throughout tube.



VITMONEL
FERRULE
TYPE

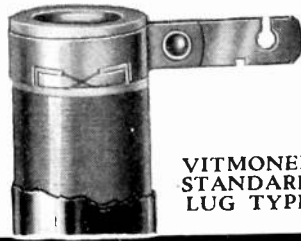

VITMONEL
STANDARD
LUG TYPE

PERMANENT Contacts

*One of the Many Features Which
Prove the Superiority of*

ELECTRAD RESISTORS



represent the thorough attention to detail which characterize all Electrad Products.

Ferrule Type Resistors for insertion in fuse clips offer many features hitherto unavailable. Pressure anchorage lies flat under enamel—no exposed wires. Contact ferrules of Monel metal provide uniform expansion of all parts. Ferrules fit tightly by own spring pressure. Will not work loose under hardest usage. No center bolt. Free air circulation throughout tube assures cooler operation. Standard ferrules 9/16" and 11/16". Can be furnished in all usual resistance values and wattage ratings, for this type resistor. Special sizes to order. Standard lug type made in all usual sizes. Special sizes to order. Write for 4 page illustrated Circular.

*For That "Special Job" Consult
Our Engineering Department ..*

The Electrad line of resistors and voltage controls is complete. There is a unit for all radio purposes, small motor control and for vacuum tube relays, counters and other devices.

Our Engineering Department will gladly cooperate with you in the selection of the proper unit for your purpose—or, if a special design is required, we will develop it from your specifications.

Write us today for technical data on Vitmonel resistors and general line of Electrad Resistors and Voltage Controls. Mail coupon for new 36-page catalog of complete Electrad Line.

ELECTRAD INC.

ELECTRAD, INC., Dept. PE-2,
175 Varick St., New York, N.Y.

Please send me copy of new complete Electrad
Catalog. Enclosed 10 cents (stamps or
coin) for mailing cost.

Name

Address

When writing to advertisers mention of the PROCEEDINGS will be mutually helpful.

DEPENDABLE INSULATION

accurately
FABRICATED

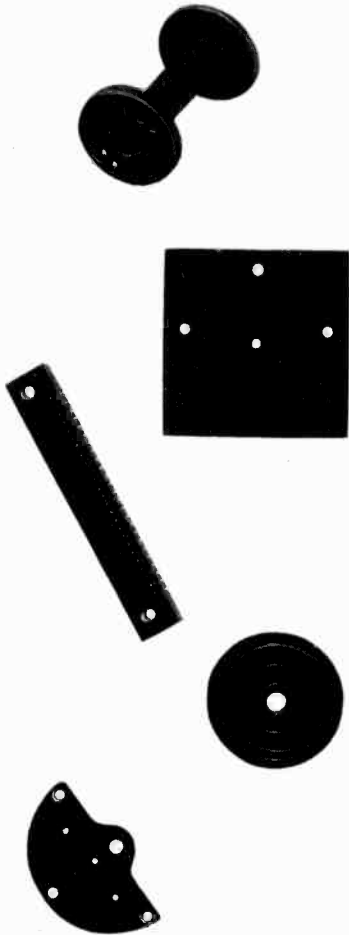

CONCENTRATION for 18 years on the problem of making just one material has produced in Formica a dependable insulation.

A large amount and a wide variety of the best modern machinery for fabricating the material make possible accurate work done quickly in quantity.

For many years Formica has been regularly used by some of the leading American technical organizations.

Send your blue prints for quotations.

THE FORMICA INSULATION
COMPANY

4646 Spring Grove Avenue
Cincinnati, Ohio

FORMICA
Made from Anhydrous Bakelite Resins
SHEETS TUBES RODS

When writing to advertisers mention of the PROCEEDINGS will be mutually helpful.

ACRACON



The Solution to Your Condenser Problems!

NO longer need manufacturers worry over their condenser problems. Not if they follow the example of the many leading manufacturers who rely on Acracon Condensers for quality, dependability, and efficiency.

Begin 1931 right! Specify Acracon for every condenser requirement. Electrolytic. By Pass. Wax Impregnated. Oil Impregnated. Power and Transmitting types.

Write Today Enclosing Your Specifications!

* "Acracon" Features Are Protected by Patents Pending

CONDENSER CORPORATION OF AMERICA
259-271 Cornelson Ave. Jersey City, N. J.

Factory Representatives in:

Chicago
Cincinnati

St. Louis
San Francisco

Los Angeles
Toronto

and other Principal Cities

When writing to advertisers mention of the PROCEEDINGS will be mutually helpful.

PRECISION

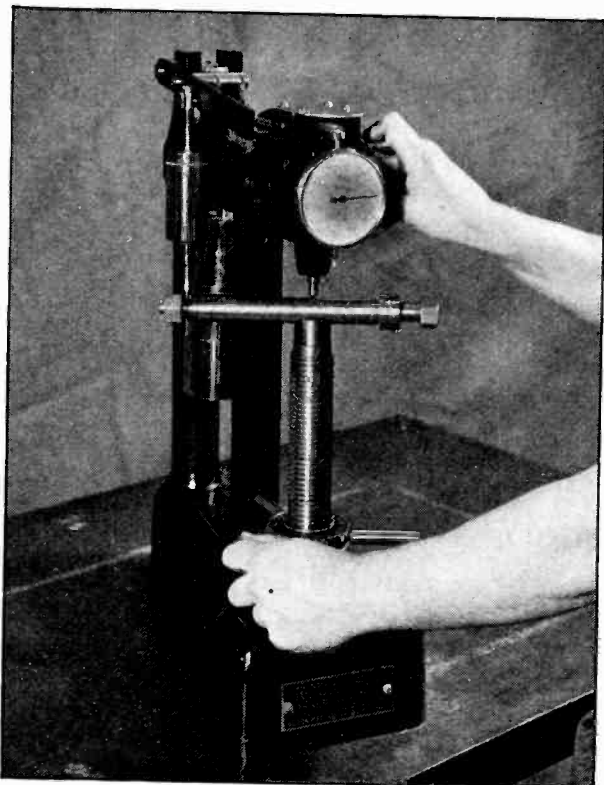

THE MANUFACTURE of RCA Radiotrons necessitates the use of machinery that is accurate, dependable, and infallible. It accepts no substitute for—PRECISION!

This demands the maintenance of an extensive Development Equipment Laboratory, operated by a corps of highly specialized mechanical engineers. Here are designed and built super-accurate machines incorporating the very latest developments resulting from the constant research and experimentation of RCA Radiotron engineers.

This machinery is built with a watch-maker's accuracy, meeting the most rigid specifications and subjected to the severest of tests and inspections.

RCA RADIOTRON COMPANY, INC. ~ HARRISON, N. J.

A RADIO CORPORATION OF AMERICA SUBSIDIARY

RCA RADIOTRONS

« THE HEART OF YOUR RADIO » »

When writing to advertisers mention of the PROCEEDINGS will be mutually helpful.



E. H. RIETZKE, DIRECTOR

BELIEVE IT OR NOT!

(With apologies to Ripley)

You have to know just as much to earn \$75.00 per week in radio as in any other profession. In many respects, because of its exceptionally rapid development, the radio profession demands even more of its members than does the industry whose growth has been more gradual.

A thorough groundwork of the fundamental principles involved is an absolute essential to the ability to keep up with the developments in modern radio practice. How many experienced operators six or eight years ago had their opportunity to get in on the ground floor in radio broadcasting and are still operators at \$35.00 per week because, due to their lack of basic training, they have been unable to advance with their profession? How many broadcast receiver technicians, making good money servicing battery sets five years ago, are losing out now because the expert servicing of the modern light socket receiver is beyond their ability?

Exceptional Opportunities

To compensate for the demands of Radio for exceptional ability in its leaders Radio offers exceptional opportunities to the men who are willing to meet these demands. In a recent visit to New York the writer was greatly impressed by the large percentage of the executives and heads of the engineering departments of large radio organizations who entered the radio profession as operators. The opportunities are as great now as ever.

To the experienced radiomen, ship operators, broadcast station operators,

service technicians, and men in all other branches of radio we offer an advanced home study course in Practical Radio Engineering. This training may be just what you need to pull you out of the rut—it may mean the difference between a routine job and success in Radio.

Our present student list contains hundreds of experienced radiomen in all parts of the world; among these are Chief Operators and Engineers of broadcast stations, Commissioned and Warrant Officers in the U. S. Navy and Coast Guard, Service Managers of large radio organizations, and operators and technicians in all branches of radio. Send in the coupon at once for complete details of this training.

CAPITOL RADIO ENGINEERING
INSTITUTE, INC.

3166 Mt. Pleasant St., N.W., Wash-
ington, D.C.

Please send me, without obligation, your
new issue of "Modern Radio" explain-
ing your advanced course in Practical
Radio Engineering.

Name

Address

Position

When writing to advertisers mention of the PROCEEDINGS will be mutually helpful.

Cornell

Cornell

HAVE STOOD THE TEST OF TIME AND SERVICE



The "Cub" Condenser is no longer an experiment. Millions of them are now in service and millions more constantly join their ranks.

They have stood the test of time and service and have made a place for themselves in the radio industry.

"Cub" Condensers are now approved and specified by leading radio engineers throughout the country.

Write for Sample

*High Insulation Resistance
Extraordinary Dielectric Strength
Capacities .00025 to .5 Mfd.*

Cornell

FILTER CONDENSERS
BY-PASS CONDENSERS
RADIO INTERFERENCE FILTERS
POWER FACTOR CORRECTION BANKS
UNIFORMLY HIGH INSULATION RESISTANCE
PAPER DIELECTRIC CONDENSERS (All Types)

*Write for Sample "Cub" Condenser and Catalog of
Complete Line of Cornell Products.*

Cornell Electric Mfg. Co., Inc.
LONG ISLAND CITY, NEW YORK

Cornell

Cornell

When writing to advertisers mention of the PROCEEDINGS will be mutually helpful.

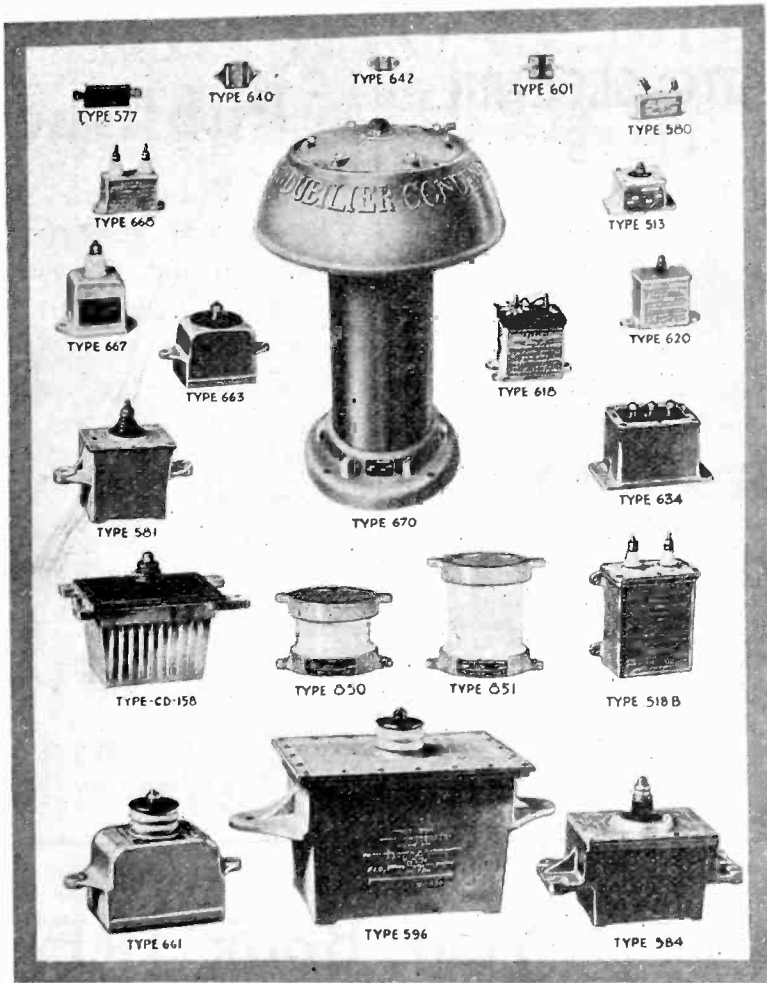

Leadership... Since 1913

A Group of Mica Dielectric Transmitting Condensers

There is a DUBILIER Capacitor available to meet any electrical requirement.

Send us your inquiries for Mica, Paper, or Chemical Dielectric Condensers.

Dubilier
CONDENSER
CORPORATION

4377 Bronx Blvd.
New York, N. Y.

When writing to advertisers mention of the PROCEEDINGS will be mutually helpful.

Radio and Scientific Literature

PHOTO-ELECTRIC CELLS

By DR. NORMAN R. CAMPBELL and DOROTHY RITCHIE, Research Staff, General Electric Co., Wembley, England. Illustrated, \$4.50.

The first thorough presentation of practical application of photo-electric cells in television, sound projection, etc. Also discusses theory and uses. "Particularly timely . . . well worth its addition to one's library."—*Electronics*.

Send for Technical Book List

TELEVISION

By SYDNEY A. MOSELEY and H. J. BARTON CHAPPLE. Illustrated, \$2.50.

Foreword by JOHN L. BAIRD

The development of television, early experiments and its present and probable commercial use, is told as a fascinating story of scientific triumph. Well illustrated, it shows a number of hitherto unpublished photographs and diagrams.

Write for Technical Book List

ISAAC PITMAN & SONS
2 W. 45th St., N. Y.

Publishers

This Radio and Scientific Literature page is run to help you acquaint the 8,000 and more PROCEEDINGS readers with your radio and technical books.

For detailed information about this page—rates, etc., address:—

Advertising Department

INSTITUTE OF RADIO
ENGINEERS

33 West 39th St.
NEW YORK CITY, N. Y.

1931 Year Book IRE

The 1931 YEAR BOOK of the Institute of Radio Engineers will be available in March and we suggest that all *subscribers* to the monthly PROCEEDINGS send in their checks for \$1.50 now so that this YEAR BOOK may be sent to them as soon as it comes from press.

The 1931 YEAR BOOK will contain an alphabetical and geographical listing of the Institute members with their business and residence addresses; an index and cross index for all papers published in the PROCEEDINGS since 1909; and the STANDARDIZATION REPORT. This report will contain accurate, up to the minute information on standard radio terms, symbols, and definitions—standard means of measuring broadcast receivers, and other standardization material.

As we mentioned before—we suggest that *subscribers* order their 1931 YEAR BOOKS now! Make checks payable to:

INSTITUTE OF RADIO ENGINEERS

33 West 39th St., New York City, N. Y.

All Institute members will automatically receive a copy of the 1931 YEAR BOOK with their March PROCEEDINGS IRE.

When writing to advertisers mention of the PROCEEDINGS will be mutually helpful.

INDUCTORS *for* TRANSMISSION

CAT. NO. 127



TYPE S
10 to 50 Meters
3" Dia.



TYPE L
30 to 100 Meters
5" Dia.



TYPE LL
100 to 550 Meters
8" Dia.

*Adaptable to all Circuits
employing up to 2 K.W. Input*

Flatwise Wound—Low Distributed Capacity.
Moulded Glass Separators—Low Losses.
95% Air Dielectric—Mechanically Rugged.
Unaffected by Climatic Conditions.

Employed and endorsed by the foremost
Radio manufacturers throughout the
world. Used in Army and Navy
Short Wave Stations.

Write for Bulletin 27



MANUFACTURES A COMPLETE LINE OF
APPARATUS FOR SHORT WAVE TRANS-
MISSION AND RECEPTION

Radio Engineering Laboratories, Inc.

100 Wilbur Ave.

Long Island City, N. Y., U.S.A.

When writing to advertisers mention of the PROCEEDINGS will be mutually helpful.

YOUR NEW PROBLEM . . . *and* ITS SOLUTION!

WITH home recording promising to be an outstanding feature of next year's radio receivers, the problem of HUM is more serious than ever.

Even a slight hum not noticeable in radio reproduction will, when recorded and augmented through reproduction, make itself heard with sufficient volume to prove disagreeable. In this modern day of radio, hum is not to be tolerated in radio or phonograph reproduction.

For more than twenty years, Pacent engineers have concerned themselves exclusively with problems relating to sound amplification. That's why Pacent amplifiers are the best in the field today.

A standard two stage Pacent Amplifier, Cat. No. 2245M (without input transformer) employing one 227 and two 245's in push-pull has a hum level of 23 DB below its maximum output rating. This same amplifier will provide 4.3 watts undistorted power output and has a voltage gain at 1000 cycles of 31 DB with 3.8 volts input. These figures are not theoretical calculations. They are the result of actual measurements made with a stock amplifier.

A Pacent Amplifier, the 170 Recordovox and the 107 Hi-Output Phonovox make a remarkable combination for recording and reproducing. With this apparatus, it is possible to assure professional results.

The Recordovox and Phonovox are available in special manufacturers' types. Write for additional information.

PACENT ELECTRIC COMPANY, INC.
91 SEVENTH AVE., NEW YORK, N. Y.

Pioneers in Radio and Electric Reproduction for over 20 Years.
Licensee for Canada: White Radio, Ltd., Hamilton, Ont.

PACENT

When writing to advertisers mention of the PROCEEDINGS will be mutually helpful.

DeJUR-AMSCO VARITOR

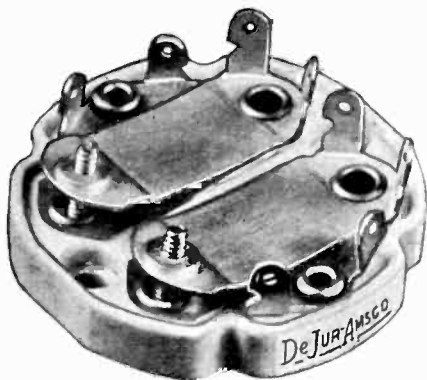

SMALL FIXED VARIABLE CAPACITOR FOR SUPERHETS

Single
Duplex
Variable
Semi-Variable

These units are mounted on an insulating base of Isolantite. The Duplex types are mounted electrically and mechanically independent of each other with mica dielectric between the plates.

The various types have various uses in circuits requiring small variable or semi-variable condensers; as trimmers in gang condensers and for neutralizing purposes in T.R.F. circuits.

Write for Booklet Giving Complete Specifications

MULTIPLE VARIABLE CONDENSERS FOR STANDARD AND MIDGET RECEIVERS

Each size made in one capacity. Available in 2, 3, 4 and 5 gang units.

Write for engineering data and working drawings. Send us your specifications and let us quote.

Samples on request.

We Also Make Special Condensers for Automobile Radios and Portable Receivers

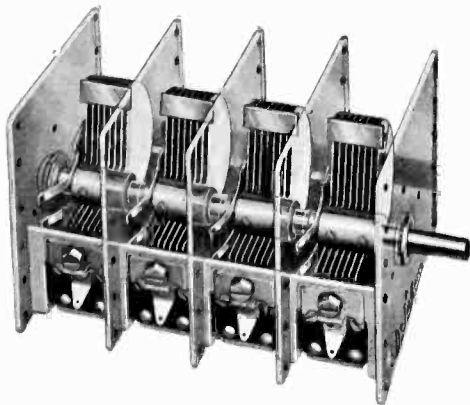

DeJUR-AMSCO CORPORATION

Varitors—Variable Condensers—Power Rheostats
95 MORTON ST., NEW YORK CITY

When writing to advertisers mention of the PROCEEDINGS will be mutually helpful.

The organization
behind a product
is a good index
of its worth ▲ ▲



WESTON ELECTRICAL INSTRUMENT CORPORATION
589 Frelinghuysen Avenue Newark, N. J.

When writing to advertisers mention of the PROCEEDINGS will be mutually helpful.

The Institute of Radio Engineers

Incorporated

33 West 39th Street, New York, N. Y.

APPLICATION FOR ASSOCIATE MEMBERSHIP

(Application forms for other grades of membership are obtainable from the Institute)

To the Board of Direction
Gentlemen:

I hereby make application for Associate membership in the Institute.

I certify that the statements made in the record of my training and professional experience are correct, and agree if elected, that I will be governed by the constitution of the Institute as long as I continue a member. I furthermore agree to promote the objects of the Institute so far as shall be in my power, and if my membership shall be discontinued will return my membership badge.

Yours respectfully,

.....
(Sign with pen)

.....
(Address for mail)

..... (Date) (City and State)

References:

(Signature of references not required here)

Mr. Mr.

Address Address

Mr. Mr.

Address Address

Mr.

Address

The following extracts from the Constitution govern applications for admission to the Institute in the Associate grade:

ARTICLE II—MEMBERSHIP

Sec. 1: The membership of the Institute shall consist of: * * * (d) Associates, who shall be entitled to all the rights and privileges of the Institute except the right to hold the office of President, Vice-president and Editor. * * *

Sec. 5: An Associate shall be not less than twenty-one years of age and shall be: (a) A radio engineer by profession; (b) A teacher of radio subjects; (c) A person who is interested in and connected with the study or application of radio science or the radio arts.

ARTICLE III—ADMISSION

Sec. 2: * * * Applicants shall give references to members of the Institute as follows: * * * for the grade of Associate, to five Fellows, Members, or Associates; * * * Each application for admission * * * shall embody a concise statement, with dates, of the candidate's training and experience.

The requirements of the foregoing paragraph may be waived in whole or in part where the application is for Associate grade. An applicant who is so situated as not to be personally known to the required number of members may supply the names of non-members who are personally familiar with his radio interest.

Modern equipment demands the extreme accuracy of THESE NEW WIRE WOUND RESISTORS

DEFECTIVE resistors cost the electrical industry millions yearly—in faulty contacts, insufficient resistance, breakdowns and shorted turns.

I. R. C. Precision Wire Wound Resistors have been developed to meet the most exacting needs of accuracy and endurance. They possess features of construction and design found in no other resistance units. In the *winding*, in the *wire and its treatment*, and in the *contact*, weaknesses common to ordinary wire wound resistors have been positively eliminated.

Years of specialization on resistors have enabled us to arrive at these superior units. They are supplied in a complete range. Folder quoting prices will be mailed on request.

INTERNATIONAL RESISTANCE
COMPANY

2006 Chestnut Street Philadelphia

Designed for—

- Radio Broadcast Receivers
- Radio Broadcasting Stations
- Sound Recording and Reproducing Equipment and other
- Electrical Apparatus



IRC

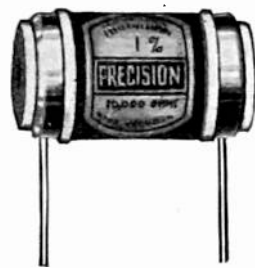

PRECISION wire wound **RESISTORS**

made by the makers of

Metallized

RESISTORS

When writing to advertisers mention of the PROCEEDINGS will be mutually helpful.



Relays for A. C. or D. C.

and for special radio applications

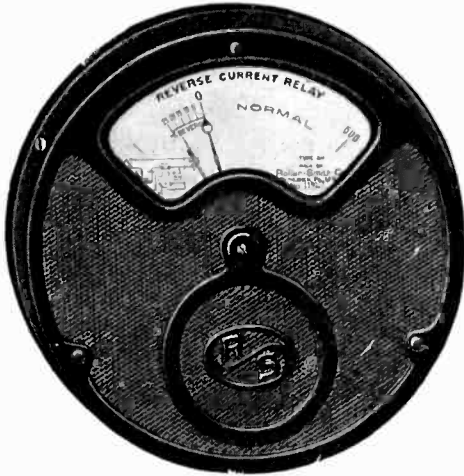

Type SR Relay

TYPE SR

Reverse Current, Overload, Underload, Over Voltage, Under Voltage

Constant and unfailing operation under the most severe conditions. Wide range of adjustment. Round pattern type, $7\frac{1}{2}$ inches diameter.

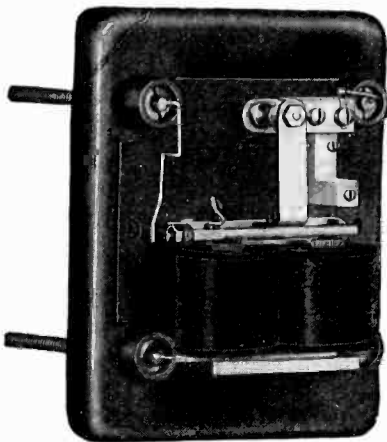

Type FR Relay

TYPE FR

Secondary relays for alarm and many other purposes.

TYPE AB

Overload Relays, instantaneous and time limit.

Here are shown only a few of the many types of R-S relays. ROLLER-SMITH has just issued new Bulletin No. K-550 covering these relays in detail—Send for your copy.

"Forty years' experience is back of Roller-Smith"

ROLLER-SMITH COMPANY
Electrical Measuring and Protective Apparatus

MAIN OFFICE:



2134 Woolworth Bldg., New York

WORKS:

Bethlehem, Pennsylvania

Offices in principal cities in U. S. A. and Canada

When writing to advertisers mention of the PROCEEDINGS will be mutually helpful.

NEW TIME DELAY RELAY

*For use with Mercury Vapor '66 or '72 Type
Rectifier Tubes.*

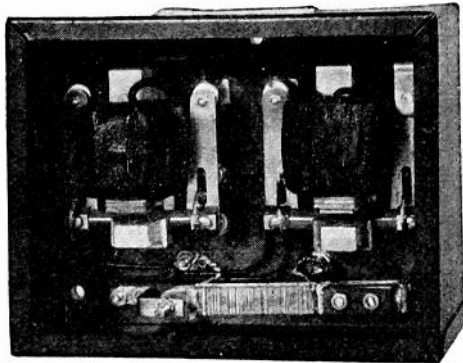

1. A control relay providing protection to the tube by delaying the application of potential to the plate until full brilliancy of the filament is attained.
2. The time between applying filament potential and plate potential can be adjusted between 15 and 60
- seconds and once set this time delay is self recycling.
3. They are arranged for panel mounting, enclosed in a pressed steel metal case with glass cover.
4. Sturdy, compact, economical and quiet in operation.

*Write for further information on this and other
Ward Leonard magnetic relays.*

WARD LEONARD ELECTRIC CO.
Mount Vernon, N. Y.

Resistor specialists for more than 39 years.

When writing to advertisers mention of the PROCEEDINGS will be mutually helpful.

Piezo Electric Crystals and Constant Temperature Equipment

Piezo Electric Crystals:

We are prepared to grind Piezo Electric Crystals for POWER use to your assigned frequency in the 550 to 1500 KC band, *accurate to plus or minus 500 cycles* for \$55.00 fully mounted. Crystals for use in the HIGH FREQUENCY BROADCAST BAND (4000 to 6000 KC) for POWER use, accurate to plus or minus .03% of your assigned frequency, fully mounted, \$75.00. In ordering please specify type of tube used, plate voltage and operating temperature. All crystals guaranteed with respect to output and accuracy of frequency. Deliveries can be made within three days after receipt of order.

Constant Temperature Equipment

In order to maintain the frequency of your crystal controlled transmitter to a high degree of constancy, a high grade temperature control unit is required to keep the temperature of the crystal constant. Our unit is solving the problem of keeping the frequency within the 50 cycle variation limits. Our heater unit maintains the temperature of the crystals constant to **BETTER THAN A TENTH OF ONE DEGREE CENTIGRADE**; is made of the finest materials known for each specific purpose and is absolutely guaranteed. Price \$300.00. Further details sent upon request.

Low Frequency Standards:

We have a limited quantity of material for grinding low frequency standard crystals. We can grind them as low as *15,000 cycles*. These crystals will be ground to your specified frequency accurate to **ONE HUNDREDTH OF ONE PER CENT**. Prices quoted upon receipt of your specifications.

Scientific Radio Service

"The crystal specialists"

P. O. Box 86

Dept. R6

Mount Rainier, Md.

When writing to advertisers mention of the PROCEEDINGS will be mutually helpful.

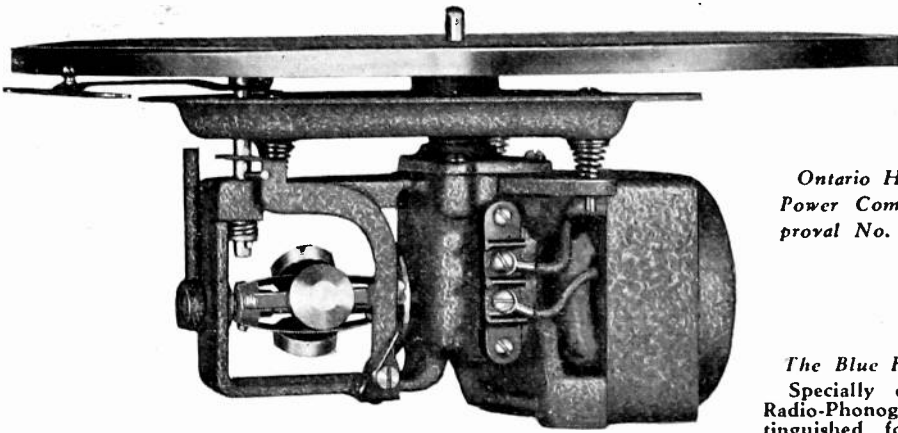

Ontario Hydro-Electric
Power Commission Ap-
proval No. 2685.

The Blue Flyer Motor

Specially designed for Radio-Phonographs. Distinguished for abundant, silent, dependable and accurate power under all conditions. Open construction with complete ventilation, does not overheat in closed case or cabinet. Silent spiral-cut fiber gears, long oversize bearings. Made for all commercial voltages and frequencies—direct or alternating current. Supplied complete with mounting plate, turn-table and speed regulator. Automatic stop equipment is optional.

Responsibly
Guaranteed

Satisfaction
year after year
IS sure . . . with
Flyer
Electrics



THE record of Flyer Electric Motors shows why they are the choice of more and more leading builders of quality Radio-Phonograph combinations. Service with satisfaction year after year. Because specially designed and produced for Radio-Phonographs under unequalled advantages.

Flyer Electrics will exactly fill *your* requirements too. Due to co-ordinated simplicity and efficiency of design. Due to superior precision manufacturing. Due to a quarter century of specialized electrical manufacturing and to leadership for 15 years in large-scale production of quality phonograph motors. Advantages obtained only with these simplest, soundest and most dependable motors. Both the Blue Flyer and the smaller Green Flyer give complete satisfaction . . . self-starting, abundant power, uniform speed and uninterrupted service.

In ordering samples, please give voltage. If for alternating current also give the frequency.

The GENERAL INDUSTRIES CO.

3146 Taylor Street, Elyria, Ohio

When writing to advertisers mention of the PROCEEDINGS will be mutually helpful.

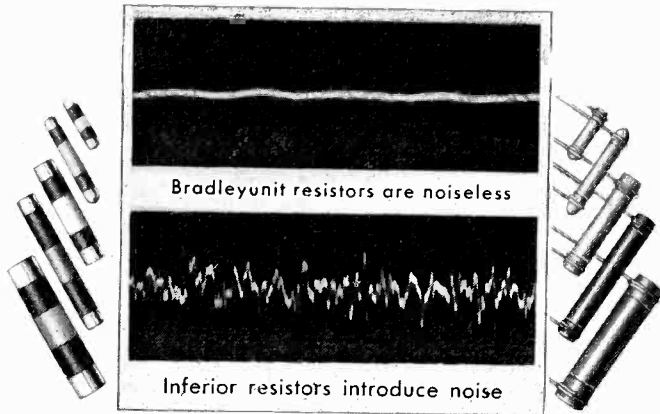

Bradleyunit Resistors are different <<< they're Noiseless >>>

MODERN radio receivers utilize many fixed resistors. If these resistors are of poor quality they introduce unnecessary and disturbing noises in the receiver. Comparative oscillograms of current variation in receiver circuits are shown above. The upper oscillogram portrays the silent operation of a receiver equipped with Bradleyunits. The

lower oscillogram portrays the irritating noises introduced in a receiver circuit by poor resistors.

Bradleyunits are solid-molded resistors that are unaffected by moisture, temperature or age. They are noiseless! Millions of these units are used annually by the leading radio manufacturers.

Bradleyometer the Perfect Potentiometer

A new step potentiometer of approximately 50 steps. Each step is separately controlled and any resistance-rotation curve can be obtained.

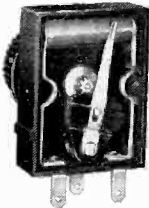

The resistor comprises a series of resistance discs interleaved between thin metal discs. A moving arm makes contact with the resistor.

Two or more Bradleyometers may be assembled in tandem, for volume control, mixer control, T-Pad and H-Pad attenuators and for every type of radio circuit.



Bradley Suppressors for Radio Equipped Cars

Prominent motor car manufacturers are providing their radio-equipped cars with Bradley Suppressors. Individual Bradley Suppressors for each spark plug and for the common distributor lead minimize the disturbing oscillations in the circuit and thus suppress interference in the receiver from ignition systems. When used with by pass condensors in other parts of the ignition circuit, shielded ignition cables are not required. The power of the engine is not affected by Bradley Suppressors.

Allen-Bradley Co.
 116 W. Greenfield Ave.,
 Milwaukee, Wis.

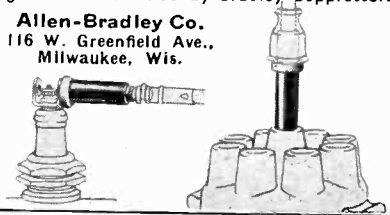

ALLEN-BRADLEY RESISTORS

Produced by the makers of Allen-Bradley Control Apparatus

When writing to advertisers mention of the PROCEEDINGS will be mutually helpful.

★

INTO THE LANGUAGE OF p r o d u c t i o n

WORKING MODELS of a superb new condenser won't put a penny in the manufacturer's pocket. . . . *Every* invention or development in the industry is a mere hopeful speculation until it can be applied to the production line.

The Scovill Manufacturing Company makes a business of translating the designs and specifications of radio manufacturers into the practical language of production—producing in *quantity* the metal parts whose *quality* determines the success of the set.

Scovill is singularly well equipped for this type of work. From the standpoint of experience, Scovill has worked closely with many leading manufacturers since the founding of the industry, both on design and production. In physical equipment—laboratories, facilities for large-scale, high-quality production—Scovill is unmatched in its field. The speed and efficiency with which Scovill can supply metal parts have enabled many radio manufacturers to simplify their plants, reduce costs, and at the same time improve the standards of their sets.

Whether your needs are simple as machine screws, or complex as condensers, Scovill will be glad of an opportunity to study your problems.

SCOVILL MANUFACTURING COMPANY

Waterbury, Connecticut

Boston
Atlanta
Chicago

Providence
Cleveland
Los Angeles

New York
Detroit
San Francisco

Cincinnati
Philadelphia

In Europe—The Hague, Holland



Scovill

When writing to advertisers mention of the PROCEEDINGS will be mutually helpful.

AEROVOX

BUILT BETTER
CONDENSERS AND RESISTORS

The Aerovox Hi-Farad Dry Electrolytic Condenser

Low Cost
Self-Healing
High Capacity
500 Volts Peak

DRY!



Universal mounting ring permits mounting of condensers in any position, upright or inverted.

Free!

This Book Giving the Latest and Most Complete Information on All Electrolytic Condensers Sent Free on Request.

Aerovox Wireless Corporation
80 Washington Street
Brooklyn, N. Y.

Please send me, without charge or obligation, a copy of your book, "The Hi-Farad DRY Electrolytic Condenser."

Name

Address

City State



AEROVOX WIRELESS CORP.



80 Washington Street, Brooklyn, N. Y.

PRODUCTS THAT ENDURE



When writing to advertisers mention of the PROCEEDINGS will be mutually helpful.

CHANGE IN MAILING ADDRESS OR BUSINESS TITLE

Members of the Institute are asked to use this form for notifying the Institute office of a change in their mailing address or any change in the listing of their company affiliation or title for the Year Book membership list.

The Secretary,
THE INSTITUTE OF RADIO ENGINEERS,
33 West 39th Street,
New York, N.Y.

Dear Sir:

Effective please note change in my address
(date)
for mail as follows:

FROM

.....
(Name)

.....
(Street Address)

.....
(City and State)

TO NEW ADDRESS

.....
(Street Address)

.....
(City and State)

Also for the membership list for next year's Year Book note change in my business address (or title) as follows, this ^{is} ~~is not~~ my mailing address:

.....
(Title)

.....
(Company Name)

.....
(Address: Street, City and State)

PLEASE FILL IN, DETACH, AND POST TO THE
INSTITUTE PROMPTLY

Back Numbers of the Proceedings, Indexes, and Year Books Available

MEMBERS of the Institute will find that back issues of the Proceedings are becoming increasingly valuable, and scarce. For the benefit of those desiring to complete their file of back numbers there is printed below a list of all complete volumes (bound and unbound) and miscellaneous copies on hand for sale by the Institute.

The contents of each issue can be found in the 1914-1926 Index and in the 1929 Year Book (for the years 1927-28).

BOUND VOLUMES:

Vols. 10 and 14 (1922-1926), \$8.75 per volume to members
Vols. 17 and 18 (1929-1930), \$9.50 to members

UNBOUND VOLUMES:

Vols. 6, 8, 9, 10, 11, 14, and 16 (1918-1920-1921-1922-1923-1926-1928), \$6.75 per volume (year) to members

MISCELLANEOUS COPIES:

Vol. 1 (1913) July and December
Vol. 2 (1914) June
Vol. 3 (1915) December
Vol. 4 (1916) June and August
Vol. 5 (1917) April, June, August, October and December
Vol. 7 (1919) February, April and December
Vol. 12 (1924) August, October and December
Vol. 13 (1925) April, June, August, October and December
Vol. 15 (1927) April, May, June, July, August, October, November and December
Vol. 17 (1929) January, February, March, April, May, June, July, August, September, November and December.
Vol. 18 (1930) April, May, June, July, August, September, October, November and December.

These single copies are priced at \$1.13 each to members to the January 1927 issue. Subsequent to that number the price is \$0.75 each. Prior to January 1927 the Proceedings was published bimonthly, beginning with the February issue and ending with December. Since January 1927 it has been published monthly.

MEMBERS will also find that our index and Year Book supplies are becoming limited. The following are now available:

FOURTEEN YEAR INDEX

The Proceedings Index for the years 1909-1926 inclusive is available to members at \$1.00 per copy. This index is extensively cross indexed.

YEAR BOOK

The 1930 Year Book is available to members at \$1.00 per copy. This Year Book includes Standardization information pertaining to allied communication arts.

Make remittances payable to the Institute of Radio Engineers and send orders to:

THE INSTITUTE OF RADIO ENGINEERS

33 West 39th Street

NEW YORK CITY, N. Y.

PRACTICALLY ANY SPECIFICATION CAN BE FILLED FROM FANSTEEL STOCK

HOW often, for experimental purposes, have you ordered a small quantity of rare metal wire or sheet in an odd size, only to be told that it would take days or weeks to make this metal to your order—and at “special” prices?

It pays to turn to Fansteel first—always—because there is here maintained a complete stock of Tantalum, Tungsten and Molybdenum wire and sheet in a wide assortment of diameters and sizes—ready for immediate shipment.

If it should so happen that your requirements are *most unusual*, we can draw, roll, or otherwise fabricate your material for you, in a few hours.

Give this service a trial, as well as get quotations covering your regular production requirements.

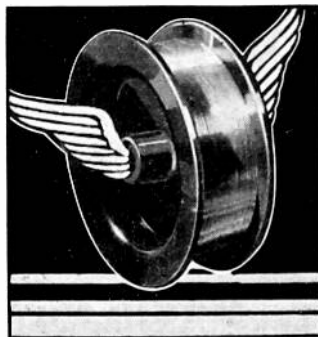

Fansteel is your best source of supply also for pure Molybdenum, Tantalum, hardened Molybdenum alloys, photo-cell metals and salts. Ample stocks for immediate delivery. Information and prices on request.

FANSTEEL PRODUCTS COMPANY, INC.
North Chicago, Illinois

TANTALUM · TUNGSTEN · MOLYBDENUM · CAESIUM · RUBIDIUM AND ALLOYS

When writing to advertisers mention of the PROCEEDINGS will be mutually helpful.



Standard of Excellence

A phrase synonymous with dependability—a phrase that has come to be applied to all Amertran equipment.

During 1931 the same high grade engineering skill and technical experience that has won respect for all Amertran products will continue at the service of radio engineers.

Your attention is called to the following equipment in particular.

Audio Transformers	Choke Coils
Complete Amplifiers	Power Supply Units
Sound Systems	Special Transformers
High Voltage Testing Sets	Electric Spot Welders
Radio Power Transformers	

Bulletins describing all these products are available. Your request for information will receive prompt and courteous reply.

AMERICAN TRANSFORMER COMPANY

179 Emmet Street, Newark, N. J.

Representatives in the following cities

Atlanta	Boston	Chicago	Knoxville	Minneapolis
Montreal	Philadelphia	San Francisco	St. Louis	

AMERTRAN

When writing to advertisers mention of the PROCEEDINGS will be mutually helpful.

V o l u m e c o n t r o l s

This business of tolerances

The production of more than twenty million volume controls for radio reception has given us many interesting facts and has helped to dispel a number of obviously erroneous theories. Even tho it is possible to build a receiver that could split a kilocycle it would be impractical for public use. The tolerances would be too small . . . too exacting.

Mass production of radio makes such precision engineering impractical . . . even laboratory models cannot aspire to such standards.

Given a standard radio of undeviating exactness, unaffected by temperature, humidity, and the stray atmospheric and mechanical inductances that are all about us, it would be possible to build a resistance control definitely suited to that *one and only* receiver.

But to make this one control fit into a million sets is an obviously different matter. Yet CENTRALAB has been successfully meeting the requirements of set manufacturers whose control demands run into millions.

Our knowledge of the tolerances required is backed as we have mentioned before by this unparalleled performance.

If you have a resistance problem our engineering staff is at your service.

Send 25c for volume control guide showing circuits for old and new sets.

Centralab
CENTRAL RADIO  LABORATORIES
36 Keefe Ave. Milwaukee, Wis.

A CENTRALAB VOLUME CONTROL IMPROVES THE RADIO SET

When writing to advertisers mention of the PROCEEDINGS will be mutually helpful.

It's the little details that make the big difference

by George Lewis, Vice-President
Arcturus Radio Tube Company

THERE'S no side-stepping this fact—tubes do make a noticeable difference in the performance of any set . . . After all the months you've spent engineering your new model, in the long run you're virtually staking the sales of the set on the tubes. The ears of the public hear only what passes through the tubes. Why risk sales of a perfectly-engineered set on tubes that will not show the set at its best? The danger is greatest at the dealer's demonstration, where inferior tubes often lose the sale . . . That's why set builders and critical engineers specify Arcturus Blue Tubes, to insure first-class performance. Their *7-second action* helps sell your set and keep it sold. *Extreme durability* and clear, *life-like tone* of Arcturus Tubes mean continual satisfaction to the purchaser of your set . . . It takes so little time and thought to insure perfect performance for your set. Just specify Arcturus Blue Tubes *now* both for factory testing and standard equipment.

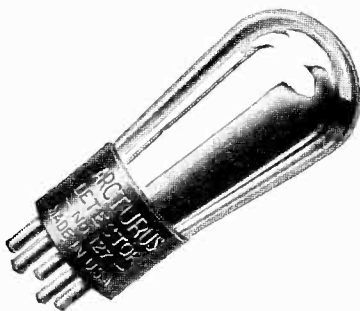

The TUBE with the
LIFE-LIKE TONE

Arcturus Radio Tube Co.
Newark, New Jersey

When writing to advertisers mention of the PROCEEDINGS will be mutually helpful.

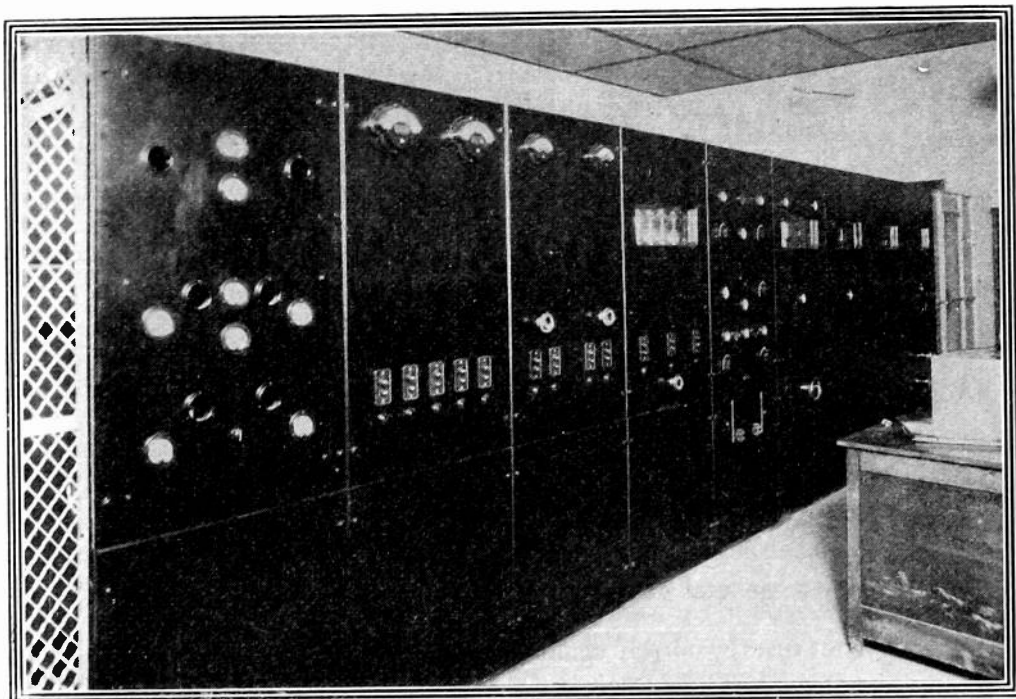

XED—Reynosa—Mexico

OPERATING continuously for 100 hours in handling its initial program, XED received over 25,000 letters from every State, Canada, Alaska, every section of Mexico, and Panama.

Behind the powerful XED signals is a nine-panel transmitter designed and built by W. E. Branch of Fort Worth, Texas. DeForest Transmitting Audions are employed throughout, or to be specific: three 510s, two 560s, three 503As, five 504As, six 572 rectifiers, and four 520Bs in

parallel as Class B amplifier for an output of 10 kilowatts, 100% modulated.

Writes Mr. Branch: "I might state that I am applying to the plates of the tubes in the last stage a full 10,000 volts, and four of the tubes in parallel are pulling three amperes. These tubes are being operated as linear amplifiers, with both plate current and antenna current talking up, and are 100% modulated. I can recommend these tubes as being able to stand a lot of punishment."

After all, There's No Substitute for 25 Years' Experience

DE FOREST RADIO COMPANY, PASSAIC, N. J.
Export Department, 304 E. 45th Street, New York City, N. Y., U. S. A.

de Forest
(AUDIONS)

RECEIVING
AND
TRANSMITTING **TUBES**

When writing to advertisers mention of the PROCEEDINGS will be mutually helpful.

Insure Yourself Against Disappointment . . . NOW!

Every day requests come into the Institute office for back issues of the PROCEEDINGS. We always fill these orders if we have copies of the issues desired—but frequently we do not have the particular copy wanted.

Then someone is disappointed—someone's bookshelf is incomplete and there are general growls and grumbles.

So why not insure yourself against any loss of your present or future copies of the PROCEEDINGS by keeping all of these copies in a

PROCEEDINGS BINDER

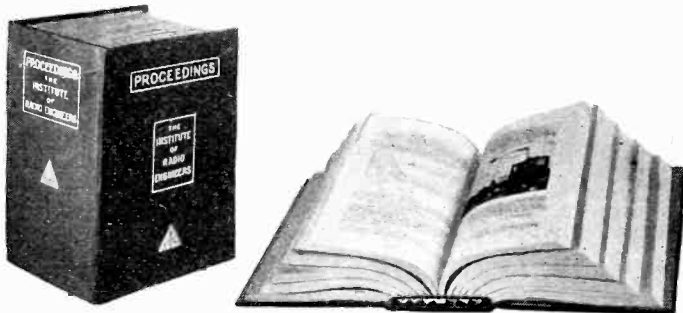

Binder of handsome Spanish Grain Fabrikoid in blue and gold. Can be used as temporary transfer binder or as a permanent cover. Wire fasteners hold each copy in place and permit removal of any issue from binder in a few seconds. All issues lie flat when binder is opened.

BINDER (holds complete 1929 or 1930 copies) \$1.75

(Name stamped on volume for \$.50 additional)

Send orders for binders, accompanied by remittance, to

INSTITUTE OF RADIO ENGINEERS

33 West 39th Street

New York City, New York

When writing to advertisers mention of the PROCEEDINGS will be mutually helpful.

Continental Resistors

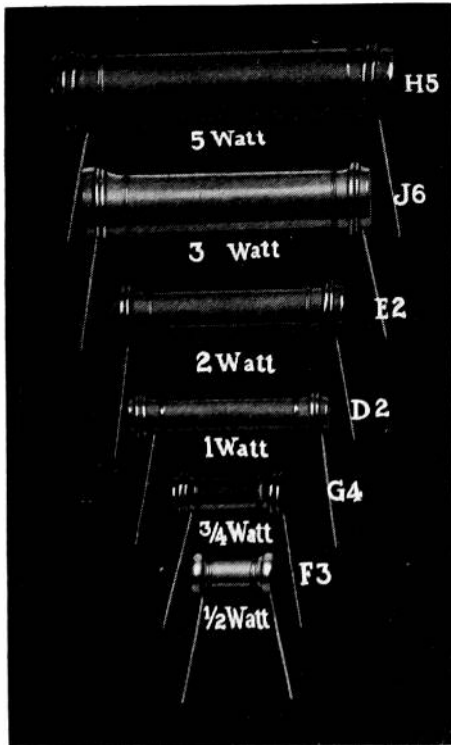

RESISTOR CHARACTERISTICS:

NOISELESS
RESISTANCE CONSTANT
SMALL TEMPERATURE
COEFFICIENT
RUGGED
FIRMLY SOLDERED TERMINALS
DEPENDABLE
COLOR CODED

UNITS SHOWN HALF SIZE

CONTINENTAL SUPPRESSORS

For Radio-Equipped Cars

Stop ignition noise in the automobile radio set when used with suitable by-pass condensers.

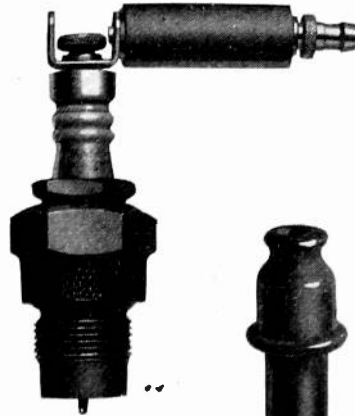

*Spark Plug
Auto
Suppressor*

Shown mounted
on Spark Plug
Universal
Connections
Water proof

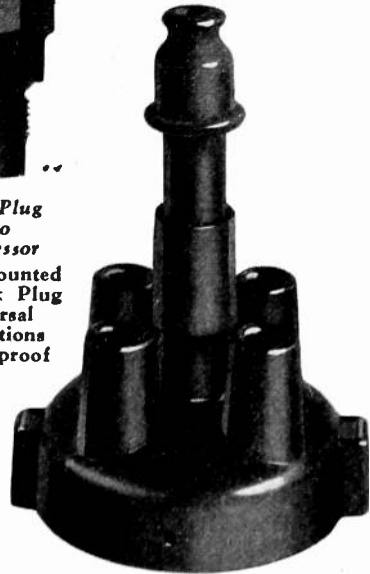

Distributor Auto Suppressor

Shown mounted on distributor cap. Fully insulated, no metal parts exposed, rigid mounting.

Write for Information and Prices
**CONTINENTAL CARBON,
INC.**
WEST PARK, CLEVELAND, O.

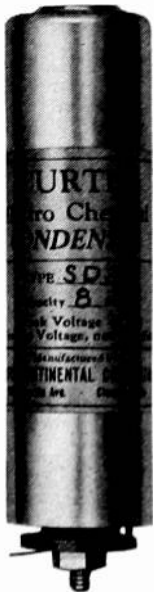

**Curtis
Electro
Chemical
Condenser**

*Essential
Characteristics*

Full capacity at all voltages

Uniform capacity at all frequencies

Low freezing point

Low internal resistance

Low leakage

No nipples, new breather principle

One hole mounting terminal at bottom

For Further Particulars Write to
Curtis Continental Corp.
13900 Lorain Ave.,
Cleveland, O.

When writing to advertisers mention of the PROCEEDINGS will be mutually helpful.

A SAFE GUIDE

in the selection
of insulation for
Radio Transmitting
and Receiving Sets

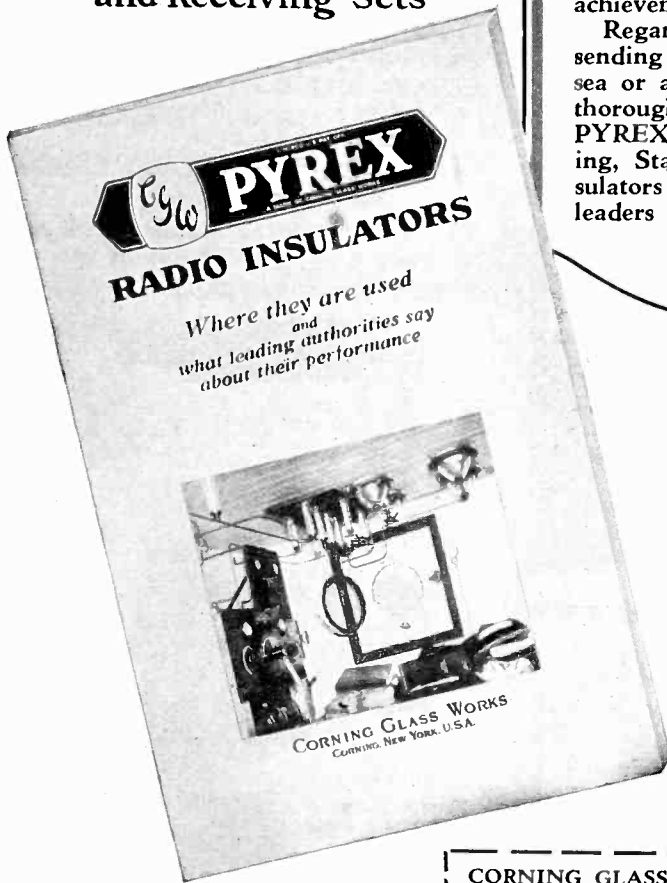

OVER 300 broadcasting stations, leading radio telegraph systems, the United States Army, Navy, Air Mail, Coast Guard and Ice Patrol Services, explorers like Commander Byrd, and exacting amateurs everywhere have utilized PYREX insulators in many spectacular achievements.

Regardless of whether you are sending or receiving—on land, sea or airplane—you should be thoroughly familiar with the PYREX Antenna, Strain, Entering, Stand-off and Bus-bar Insulators that are helping these leaders to make radio history.

The new PYREX Radio Insulator booklet lists all types and sizes with data that you will want for ready reference.

Return the coupon for your copy, and if you want further advice on any insulation problem, our Technical Staff will answer your questions promptly.

CORNING GLASS WORKS, Corning, N. Y.

Send copy of your new bulletin on Radio Insulators

Name

Address

I.R.E. 2-31

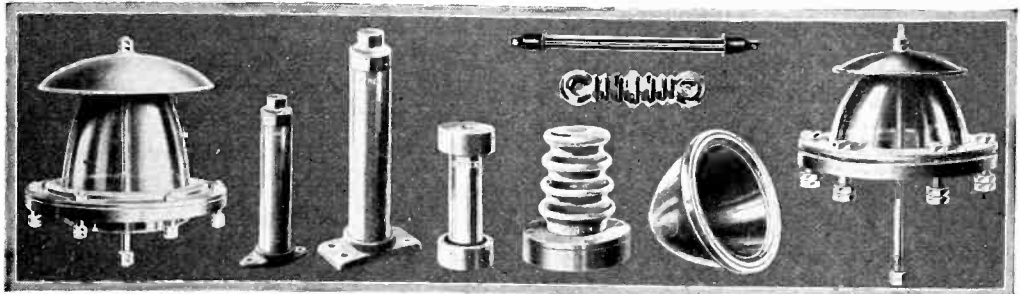

When writing to advertisers mention of the PROCEEDINGS will be mutually helpful.

PROFESSIONAL ENGINEERING DIRECTORY

For Consultants in Radio and Allied Engineering Fields

THE MAGNAVOX COMPANY

155 East Ohio Street, Chicago, Ill.

*PIONEERS AND SPECIALISTS
IN THE ART OF
SOUND REPRODUCTION.
DYNAMIC SPEAKERS SINCE
1911.*

ELECTRICAL TESTING LABORATORIES

Tests of Inductances.
Condensers. Transform-
ers etc. Life and charac-
teristics of Radio Tubes

80th. Street and East End Ave.
• • NEW YORK, N. Y. • •

TEN DOLLARS DOES IT!

You can directly acquaint over 8,000 of the most influential and authoritative radio men of the day with your services each month through this Professional Card Page.

Per insertion\$10.00

The J. G. White Engineering Corporation

Engineers—Constructors

*Builders of New York Radio
Central*

43 Exchange Place New York

Radio Engineers



Your card on this professional card page will give you a direct introduction to over 8,000 technical men, executives, and others with important radio interests.



Per Issue—\$10.00

When writing to advertisers mention of the PROCEEDINGS will be mutually helpful.

Alphabetical Index to Advertisements

A

Aerovox Wireless Corp..... XLII
Allen-Bradley Co..... XL
American Tel. & Tel. Co..... XVIII
American Transformer Co..... XLVI
Arcturus Radio Tube Co..... XLVIII

C

Capitol Radio Eng. Inst., Inc..... XXV
Cardwell, Allen D., Mfg. Corp..... XX
Central Radio Laboratories..... XLVII
Chicago Transformer Corp.....
..... Inside Back Cover
Condenser Corp. of America..... XXIII
Continental Carbon, Inc..... LI
Cornell Electric Mfg. Co..... XXVI
Corning Glass Works..... LII

D

DeForest Radio Co..... XLIX
DeJur-Amsco Corp..... XXXI
Dubilier Condenser Corp..... XXVII

E

Electrad, Inc..... XXI
Electric Specialty Co..... LVII
Engineers Available..... LV

F

Fansteel Products Co., Inc..... XLV
Formica Insulation Co..... XXII
Frost, H. H., Inc..... XIX

G

General Industries Co..... XXXIX
General Radio Co.....
..... Outside Back Cover

I

International Resistance Co.... XXXV
I.R.E..... XXXIII, XXXIV,
XLIII, XLIV, L

J

Jewell Electrical Instrument Co... XIV

M

Mallory, P. R., Co..... XVI, XVII

P

Pacent Electric Co., Inc..... XXX
Professional Engineering Directory
..... LIII

R

Radio & Scientific Literature.. XXVIII
Radio Engineering Labs..... XXIX
RCA Radiotron Co., Inc..... XXIV
Roller-Smith Co..... XXXVI

S

Scientific Radio Service.... XXXVIII
Scovill Mfg. Co..... XLI
Shakeproof Lock Washer Co.... LVI
Sprague Specialties Co..... LVIII
Stupakoff Labs., Inc..... XV

T

Thordarson Elec. Mfg. Co..... XIII

W

Ward Leonard Electric Co.... XXXVII
Weston Elec. Instr. Co..... XXXII

When writing to advertisers mention of the PROCEEDINGS will be mutually helpful.

ENGINEERS AVAILABLE

Advertisements on this page are available only to members of the Institute of Radio Engineers. For rates and further information address the Secretary, The Institute of Radio Engineers, 33 West 39th Street, New York, N.Y.

Manufacturers and others seeking radio engineers are invited to address replies to these advertisements at the Box number indicated, care the Institute of Radio Engineers. All replies will be forwarded direct to the advertiser.

YOUNG ENGINEER, backed by ten years radio experience, and specializing in high frequency communication is interested in securing position as engineer in charge of police radio communication system or other high frequency communication project. Now employed as inspector of radio in charge of several Canadian governmental stations. Available for foreign service, if necessary. Best of references. Age, 30. Box 46.

YOUNG MAN, with two years of college training in communication is interested in change of employment. Desires to do design, development or experimental radio work. Has experience as commercial radio telegraph and broadcast operator. At present is employed doing experimental and development work for communication system of nationally known air transport company. Age, 22. Box 43.

SERVICE MANAGER, for large broadcast receiver manufacturer, with several years experience as radio telegraph and broadcast operator, is interested in doing high frequency experimental work. Thoroughly familiar with problems relating to design and construction of high frequency apparatus. Will travel anywhere. Immediately available. Age, 22. Box 44.

SERVICE MAN, having high school education and university extension course in radio, desires position as field service man to work on public address systems or radio receivers. Four years experience on servicing radio and talking picture equipment and half year on cost work. Age, 22. Box 45.

PRODUCTION MANAGER, familiar with practical methods and cost reduction is interested in position where past experience will be best appreciated. Instrument maker up to 1913. Since 1913 has specialized in radio experimental model making and manufacturing. Since 1925 has had responsible positions in charge of model shops or factory production. Graduate of the School of Technology, Budapest in 1905. Reference by reputable concerns. Age, 41. Box 47.

ENGINEER, ship operating experience, two years radio inspector in governmental departments, two years teaching radio, physics and science, ten years in broadcast transmitter work, three with large development organization. Desires contact on Pacific coast due to health of family. Age, 36. Box 48.

INSPECTION FOREMAN is interested in position as factory inspector with opportunity of working on factory efficiency problems. Has had one year of college education. Was foreman of testing department for large manufacturer of broadcast receivers for three years, and held similar positions with loud speaker manufacturers for past two years. Familiar with mass production and inspection methods. Age, 25. Box 49.

When writing to advertisers mention of the PROCEEDINGS will be mutually helpful.

Spreadproof Tool!



Even under an Air Wrench

ON mass production lines—where speed and efficiency count—Shakeproof Lock Washers have definitely demonstrated their outstanding superiority. Being made in one continuous circle, they are tangleproof and spreadproof too! This means easier and quicker handling and also prevents lost time and delays in backing off a nut because a washer has spread.

In scores of industries today, Shakeproof Lock Washers are saving manufacturers thousands of dollars on their assembly costs. And, at the same time, this positive locking method is making thousands of products perform better and last longer. That's why it will pay you to test Shakeproof on your own production line and see for yourself how they cut down overhead and reduce customer complaints.

Send at once for free samples—we will gladly furnish a supply of any type or size desired—write for yours today!



Type 12. Internal
For
S. A. E. and Standard
Machine Screws



Type 11. External
For Standard Bolts
and Nuts



Type 15. Countersunk
For all Countersunk
Screws



Type 20
Locking Terminals
For Radio
and Electrical Work

U. S. Patents
1,419,564
1,604,122
1,697,954
1,782,387
Other patents
pending.
Foreign patents.

SHAKEPROOF Lock Washer Company

{Division of Illinois Tool Works}
2529 N. Keeler Avenue, Chicago, Ill.



"It's the
Twisted
Teeth that
LOCK"

When writing to advertisers mention of the PROCEEDINGS will be mutually helpful.

ESCO Motor-Generators

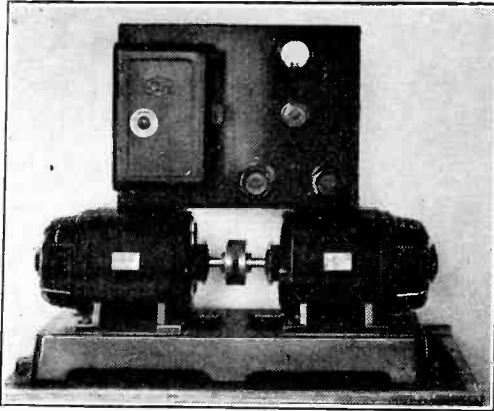

“Fit” the application

“Fit” the power supply

Motors—Generators—Dynamotors—Rotary Converters

Designed · Developed · Manufactured

Quick Delivery · Low Priced

“ESCO” is a company where “Special” does not mean “soak ‘em” or “Let ‘em wait.” Because for twenty years “ESCO” has specialized in the “Special.” “Special” voltages, frequency, speed, and mechanical design is the objective of our equipment and organization.

OUR EXPERIENCE IS BROAD. Below is a list of some of the special applications of our motors and generators, manufactured during this last December.

Telegraph
Airplane dynamotors
Wind driven generators
Portable gasoline units
Radio beacons
Radio transmitters
Television
Talkies
Radio receivers
Automobile radio
Valve control
Water tight doors
Pianos
Electric indicators

Speed reducers
Ventilators
Telechron resetters
Automatic chucks
Recording instruments
Elevator door control
Elevators
Flexible shafts
Riveters
Gasoline pumps
Bottle washers
Phase shifters
Frequency changers
Hair dryers

Arc lamps
Anti-corrosion
Oil burners
Automatic whistle
Ore-vibrators
Organ generators
Hoists
Freight trucks
Temperature control
Polishers
Stock quotations
Sun lamps
Bookkeeping unit
Forced draft

Knitting mills
Printing press
Electro plating
Remote control
Movie cameras
Aerial cameras
Cloth cutting
Coin counters
Pneumatic Valves
Valve grinders
Theater dimmers
Cup vending
Refrigerator
Automatic stoker
Weaving

Why not profit by our long experience? Up to date equipment and practical engineering talent. They are all at your disposal. Write us for bulletins or information.

ELECTRIC  SPECIALTY
COMPANY

300 South St.

Stamford, Conn.

Manufacturers of motors, generators, dynamotors and rotary converters.

When writing to advertisers mention of the PROCEEDINGS will be mutually helpful.



"Here's a New SPRAGUE INVERTED CONDENSER that does the work"

Metal enclosed
vent

One piece
anode

One hole
mounting

Can—dull
nickel finish

Small space—
high capacity

High voltage—
self-healing

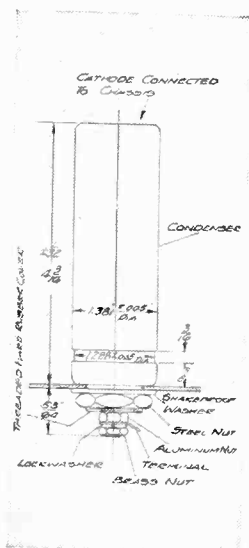

RADIO engineers of 1931 receiving sets will receive with unqualified approval this announcement of a Sprague Electrolytic Condenser that helps materially in their problems to make the new radio receivers as simple as possible, more efficient than ever before—and at the same time conserve time, space and expense.

Only an organization like SPRAGUE, with superb modern manufacturing facilities, highly developed research laboratories, an engineering department devoted to the problems of the set manufacturer, and a highly trained personnel could produce the tremendous improvement represented by this new SPRAGUE INVERTED ELECTROLYTIC CONDENSER in tremendous quantities with unqualified UNIFORMITY.

Send for illustrated booklet, diagrams, etc. Address Dept. 13B

SPRAGUE SPECIALTIES COMPANY
North Adams, Mass.

SPRAGUE

Electrolytic CONDENSERS

When writing to advertisers mention of the PROCEEDINGS will be mutually helpful.

From Transformer Headquarters

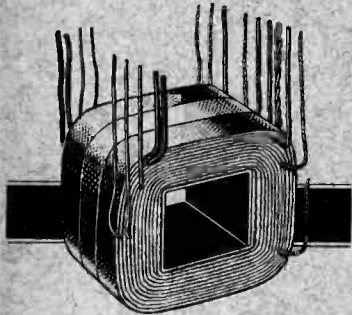

Leads!

Every coil must have leads. How many and where? Well, that varies. Chicago Transformers have no restrictions as to number and arrangement of leads nor as to style and location of terminals.

Here's a typical coil for vacuum tube plate and filament current supply. There are a total of 19 leads, including the three primary taps to accommodate line voltage of 100, 110 and 120 volts.

What is your coil problem? We are prepared to solve it quickly.

Transformers for Largest Outdoor Sound System



The public address system installed at the National Air Races, Chicago, Ill., was the largest outdoor system built up to that time. The gigantic network kept the 650,000 spectators of the races informed as events progressed.

The Operadio Manufacturing Company of St. Charles, Illinois, employed C. T. C. Transformers at hundreds of points when building this system.

Mercury filled hot-carbide rectifier tube power transformers, inter-stage audio transformers, microphone transformers, filter chokes and impedance matching transformers are some of the many types of transformers necessary for such systems.

Chicago Transformers are found in many other of the country's finest sound installations. Quick delivery of special design transformers is a feature of C. T. C. service especially important to manufacturers of sound equipment.

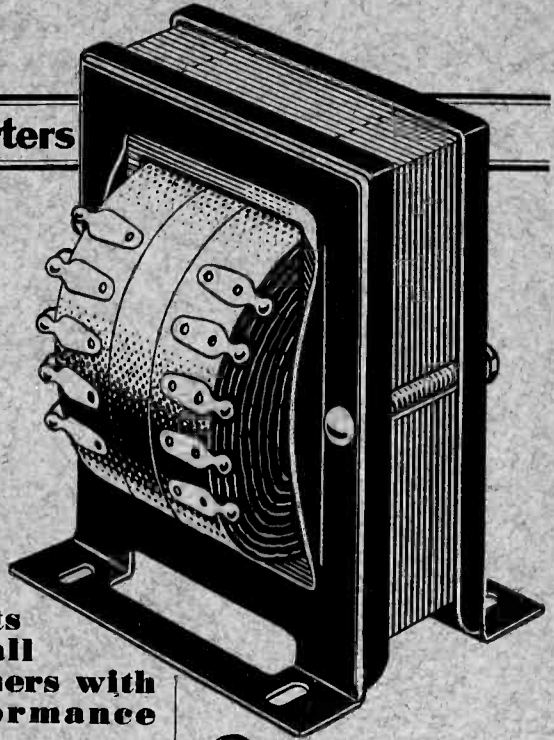

Midget Sets Need Small Transformers with Big Performance

RADIO engineers again have found their design problems completely reversed. Compact receivers, so universally in demand, put new restrictions on the design of chassis parts.

A clumsy, inefficient transformer doesn't fit into the midget chassis picture. Limited space must not be wasted with a bulky, poorly designed transformer. Nor is there room to isolate an inefficient overheating transformer of skimpy design.

Accurate design and skilled manufacturing can produce a transformer that will greatly simplify the chassis design and contribute to the high dollar value necessary in 1931 receivers.

The Chicago Transformer Corporation has designed transformers for many prominent midget receiver manufacturers. The transformer shown is used by the Echophone Radio Mfg. Co., Ltd., one of the pioneer builders of compact radio receivers. It supplies filament and plate power for three '224, one '227, one '245 and one '280 type tubes.

The unusual design enables it to utilize to minimum space, yet to operate quietly and not to overheat under the most continuous use.



Meet Pete Keegan, foreman of the C. T. C. special transformer department.

Says Pete: "My men will build on short notice any transformer you can lay out on a drawing board. A broad statement, I'll admit, but I'll be glad to prove it at any time."

Next time you want a transformer whose design is out of the ordinary, let Pete build it up. He'll stick to your specifications and produce the best possible unit with unbelievable economy.

Core Shape

Cores are not a limiting factor in the design of a C. T. C. Transformer.

Flexibility of design is assured both by an unusual stock of standard laminations, and by stamping facilities that can produce laminations of any new size or shape.

Countless seemingly unsurmountable problems in transformer design have been solved by the C. T. C. organization.

A technique for handling unusual requirements has been developed that assures both economy of cost and excellence of finished product.

Just another reason why C. T. C. has never said, "Can't do it."



CHICAGO TRANSFORMERS

CHICAGO TRANSFORMER CORP., 2622 WASHINGTON BLVD., CHICAGO, U. S. A.

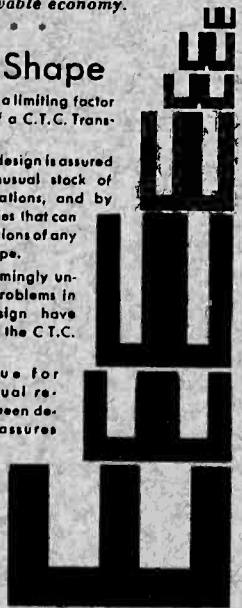

Volume Controls for High-Quality Sound Systems

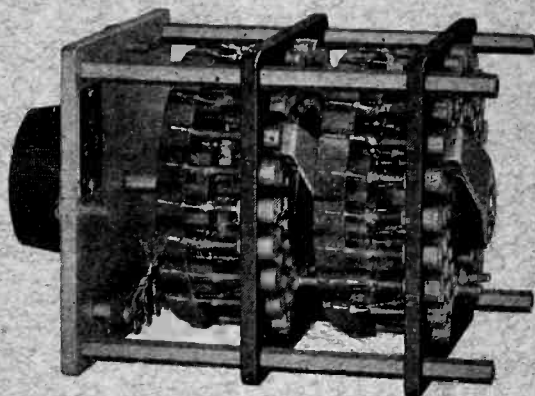

IF you are operating a high-quality voice-frequency transmission system, the TYPE 552 Volume Controls deserve your consideration. Note the following features:

1. Low noise level
2. Attenuation values accurate within narrow limits up to 20 kc.
3. Brass dust cover gives protection against dust and stray fields
4. Panel space 4 inches square required
5. Knob, pointer, and scale plate furnished.

Here are the principal specifications:

<i>Type</i>	<i>Attenuation</i>	<i>Section</i>	<i>Impedance</i>	<i>Price</i>
552-LA	30 db in steps of 1.5 db	L	50 ohms	\$28.00
552-LB	30 db in steps of 1.5 db	L	200 "	28.00
552-LC	30 db in steps of 1.5 db	L	500 "	28.00
552-TB	30 db in steps of 1.5 db	T	200 "	34.00
552-TC	30 db in steps of 1.5 db	T	500 "	34.00
552-HB	30 db in steps of 1.5 db	Balanced-H	200 "	48.00
552-HC	30 db in steps of 1.5 db	Balanced-H	500 "	48.00

See the February Experimenter for an article on picking the right volume control. Extra copies are free.

GENERAL RADIO COMPANY
OFFICES ** LABORATORIES ** FACTORY
CAMBRIDGE A MASSACHUSETTS