

VOLUME 18

JULY, 1930

NUMBER 7

PROCEEDINGS
of
**The Institute of Radio
Engineers**



1930 CONVENTION
Toronto, Ont., Canada
August 18-21

Form for Change of Mailing Address or Business Title on Page XLIX

**TENTATIVE PROGRAM OF FIFTH ANNUAL CONVENTION
INSTITUTE OF RADIO ENGINEERS
TORONTO, ONT., CANADA
AUGUST 18-21, 1930**

August 17th—Sunday

2:00 P.M.—6:00 P.M. Registration at the King Edward Hotel. Badges, trips, luncheon and banquet tickets.

August 18th—Monday

8:00 A.M.—10:00 A.M. Registration at the King Edward Hotel. Badges, trips, luncheon and banquet tickets.

10:00 A.M.—12:30 P.M. Opening session in the Crystal Ballroom of the King Edward Hotel.

Speeches of welcome by Dr. Lee de Forest, President of the Institute, J. M. Leslie, Chairman of the Toronto Section, and A. M. Patience, Chairman of the Convention Committee. The addresses of welcome will be followed by a technical program, the individual papers of which are listed in the complete program which appears in this issue.

12:30 P.M. Photograph of those attending Convention.

1:00 P.M.—1:45 P.M. Buffet luncheon in the King Edward Hotel Ballroom

1:45 P.M. Trip No. 1. Technical Inspection trip to Canadian National Carbon Co., Leaside Transformer Station, and Canada Wire and Cable Co.

2:00 P.M. Trip No. 2. Shopping tour for ladies.

8:00 P.M. Popular lecture by Dr. R. W. Boyle of the National Research Laboratory of Ottawa, at the Physics Building, University of Toronto.

August 19th—Tuesday

9:30 A.M. Technical Session in the King Edward Hotel Ballroom (see complete program).

2:00 P.M. Technical Session in the King Edward Hotel Ballroom (see complete program).

2:00 P.M. Trip No. 3. Technical Inspection trip to Broadcast Station CKGW.

2:00 P.M. Trip No. 4. Sight-seeing Tour.

2:00 P.M. Trip No. 5. Sight-seeing trip for ladies.

6:00 P.M. Committee on Sections meeting at the Engineers Club.

8:00 P.M. Technical Session in the King Edward Hotel Ballroom (see complete program).

August 20th—Wednesday

9:30 A.M. Technical Session in the King Edward Hotel Ballroom (see complete program).

12:00 Noon. Luncheon and Golf at St. Andrews Golf Club.

2:00 P.M. Trip No. 6. Technical Inspection trip through the plants of the Rogers Majestic Co., and the DeForest-Crosley Co.

2:00 P.M. Committee meeting of Engineering Division of the Radio Manufacturers' Association in the King Edward Hotel Blue Room.

3:00 P.M. Trip No. 7. Boat trip for ladies.

7:00 P.M. Annual dinner and dance in the King Edward Hotel Crystal Ballroom.

August 21st—Thursday

9:00 A.M. Trip No. 8 to Niagara Falls, Queenston Power Plant, and Welland Canal.

2:00 P.M. Committee meeting of Engineering Division of the Radio Manufacturers' Association in the King Edward Hotel Blue Room.

PROCEEDINGS OF

The Institute of Radio Engineers

Volume 18

July, 1930

Number 7

Board of Editors

ALFRED N. GOLDSMITH, *Chairman*
 STUART BALLANTINE G. W. PICKARD
 RALPH BATCHER L. E. WHITTEMORE
 J. W. HORTON W. WILSON

CONTENTS

PART I

	Page
Condensed Program of Fifth Annual Convention	Inside front cover
Frontispiece, Michael I. Pupin	1098
Institute News and Radio Notes	1101
Toronto Convention of the Institute	1101
June Meeting of the Board of Direction	1113
Radio Signal Transmissions of Standard Frequency	1114
Committee Work	1114
Institute Meetings	1116
Personal Mention	1118
Inaugural Address of President Lee deForest	1121

PART II

Technical Papers

Ultra-Short waves for Limited Range Communication	W. J. BROWN	1129
A Radio-Frequency Potentiometer	WILLIAM W. MACALPINE	1144
Whistling Tones from the Earth	HEINRICH BARKHAUSEN	1155
The Calculation of the Service Area of Broadcast Stations	P. P. ECKERSLEY	1160
Frequency Modulation	BALTH. VAN DER POL	1194
Effect of Cavity Resonance on the Frequency Response Characteristic of the Condenser Microphone	STUART BALLANTINE	1206
Locating Radio Interference with the Oscillograph	J. K. MCNEELY AND P. J. KONKLE	1216
The Variation of the Resistance of a Radio Condenser with Capacity and Frequency	R. R. RAMSEY	1226
Wireless Telegraphy and the Ionization in the Upper Atmosphere	E. O. HULBURT	1231
Design of a Portable Temperature-Controlled Piezo Oscillator	V. E. HEATON AND W. H. BRATTAIN	1239
Electroelastic and Pyro-Electric Phenomena	W. G. CADY	1247
Discussion on Some Possibilities of Intelligence Transmission when using a Limited Band of Frequencies	F. E. TERMAN	1263
Book Reviews		1266
Booklets, Catalogs, and Pamphlets Received		1268
Monthly List of References to Current Radio Literature		1270
Contributors to This Issue		1275

The Institute of Radio Engineers

GENERAL INFORMATION

The PROCEEDINGS of the Institute is published monthly and contains papers and discussions thereon submitted for publication or for presentation before meetings of the Institute or its Sections. Payment of the annual dues by a member entitles him to one copy of each number of the PROCEEDINGS issued during the period of his membership.

Subscription rates to the PROCEEDINGS for the current year are received from non-members at the rate of \$1.00 per copy or \$10.00 per year. To foreign countries the rates are \$1.10 per copy or \$11.00 per year.

Back issues are available in unbound form for the years 1918, 1920, 1921, 1922, and 1926 at \$9.00 per volume (six issues) or \$1.50 per single issue. For the years 1913, 1914, 1915, 1916, 1917, 1919, 1923, 1924, and 1925 miscellaneous copies (incomplete unbound volumes) can be purchased for \$1.50 each; for 1927, 1928, and 1929 at \$1.00 each. The Secretary of the Institute should be addressed for a list of these.

Discount of twenty-five per cent is allowed on all unbound volumes or copies to members of the Institute, libraries, booksellers, and subscription agencies.

Bound volumes are available as follows: for the years 1922 and 1926 to members of the Institute, libraries, booksellers, and subscription agencies at \$8.75 per volume in blue buckram binding and \$10.25 in morocco leather binding; to all others the prices are \$11.00 and \$12.50, respectively. For the year 1929 the bound volume prices are: to members of the Institute, libraries, booksellers, and subscription agencies, \$9.50 in blue buckram binding; to all others, \$12.00. Foreign postage on all bound volumes is one dollar, and on single copies is ten cents.

The 1930 Year Book, containing general information, the Constitution and By-Laws, catalog of membership, etc., is available to members at \$1.00; to non-members, \$1.50.

Contributors to the PROCEEDINGS are referred to the following page for suggestions as to approved methods of preparing manuscripts for publication in the PROCEEDINGS.

Advertising rates for the PROCEEDINGS will be supplied by the Institute's Advertising Department, Room 802, 33 West 39th Street, New York, N.Y.

Changes of address to affect a particular issue must be received at the Institute office not later than the 15th of the month preceding date of issue. That is, a change in mailing address to be effective with the October issue of the PROCEEDINGS must be received by not later than September 15th. Members of the Institute are requested to advise the Secretary of any change in their business connection or title irrespective of change in their mailing address, for the purpose of keeping the Year Book membership catalog up to date.

The right to reprint portions or abstracts of the papers, discussions, or editorial notes in the PROCEEDINGS is granted on the express condition that specific reference shall be made to the source of such material. Diagrams and photographs published in the PROCEEDINGS may not be reproduced without making special arrangements with the Institute through the Secretary.

It is understood that the statements and opinions given in the PROCEEDINGS are views of the individual members to whom they are credited, and are not binding on the membership of the Institute as a whole.

All correspondence should be addressed to the Institute of Radio Engineers, 33 West 39th Street, New York, N.Y., U.S.A.

Entered as second class matter at the Post Office at Menasha, Wisconsin.

Acceptance for mailing at special rate of postage provided for in the Act of February 28, 1925, embodied in paragraph 4, Section 412, P. L. and R. Authorized October 26, 1927.

Published monthly by

THE INSTITUTE OF RADIO ENGINEERS, INC.

Publication office, 450-454 Ahnaip Street, Menasha, Wis.

BUSINESS, EDITORIAL, AND ADVERTISING OFFICES,

Harold P. Westman, *Secretary*

33 West 39th St., New York, N.Y.

SUGGESTIONS FOR CONTRIBUTORS TO THE "PROCEEDINGS"

Preparation of Paper

Form—Manuscripts may be submitted by member and non-member contributors from any country. To be acceptable for publication, manuscripts should be in English, in final form for publication, and accompanied by a summary of from 100 to 300 words. Papers should be typed double space with consecutive numbering of pages. Footnote references should be consecutively numbered and should appear at the foot of their respective pages. Each reference should contain author's name, title of article, name of journal, volume, page, month, and year. Generally, the sequence of presentation should be as follows: statement of problem; review of the subject in which the scope, object, and conclusions of previous investigations in the same field are covered; main body describing the apparatus, experiments, theoretical work, and results used in reaching the conclusions and their relation to present theory and practice; bibliography. The above pertains to the usual type of paper. To whatever type a contribution may belong, a close conformity to the spirit of these suggestions is recommended.

Illustrations—Use only jet black ink on white paper or tracing cloth. Cross-section paper used for graphs should not have more than four lines per inch. If finer ruled paper is used, the major division lines should be drawn in with black ink, omitting the finer divisions. In the latter case, only blue-lined paper can be accepted. Photographs must be very distinct, and must be printed on glossy white paper. Blueprinted illustrations of any kind cannot be used. All lettering should be 3/16 in. high for an 8 x 10 in. figure. Legends for figures should be tabulated on a separate sheet, not lettered on the illustrations.

Mathematics—Fractions should be indicated by a slanting line. Use standard symbols. Decimals not preceded by whole numbers should be preceded by zero, as 0.016. Equations may be written in ink with subscript numbers, radicals, etc., in the desired proportion.

Abbreviations—Write a.c. and d.c. (a.c. and d.c. as adjectives), kc, μ f, $\mu\mu$ f, e.m.f., mh, μ h henries, abscissas, antennas. Refer to figures as Fig. 1, Figs. 3 and 4, and to equations as (5). Number equations on the right in parentheses.

Summary—The summary should contain a statement of major conclusions reached, since summaries in many cases constitute the only source of information used in compiling scientific reference indexes. Abstracts printed in other journals, especially foreign, in most cases consist of summaries from published papers. The summary should explain as adequately as possible the major conclusions to a non-specialist in the subject. The summary should contain from 100 to 300 words, depending on the length of the paper.

Publication of Paper

Disposition—All manuscripts should be addressed to the Institute of Radio Engineers, 33 West 39th Street, New York City. They will be examined by the Committee on Meetings and Papers and by the Editor. Authors are advised as promptly as possible of the action taken, usually within one month.

Proofs—Galley proof is sent to the author. Only necessary corrections in typography should be made. *No new material is to be added.* Corrected proofs should be returned *promptly* to the Institute of Radio Engineers, 33 West 39th Street, New York City.

Reprints—With the galley proof a reprint order form is sent to the author. Orders for reprints must be forwarded promptly as type is not held after publication.

INSTITUTE SECTIONS

<i>Chairmen</i>	<i>Secretaries</i>
	ATLANTA
H. F. Dobbs <i>Acting Chairman</i>	Philip C. Bangs, 23 Kensington Rd. Avondale Estates, Ga.
	BOSTON
George W. Pierce	Melville Eastham, 30 State St., Cambridge, Mass.
	BUFFALO-NIAGARA
L. Grant Hector	E. C. Waud, 235 Huntington Ave., Buffalo, N. Y.
	CHICAGO
H. E. Kranz	J. H. Miller, Jewell Electrical Inst. Co., 1650 Walnut St., Chicago, Ill.
	CINCINNATI
R. H. Langley	W. W. Boes, Radio Products, Co., 5th and Norwood Sts., Dayton, Ohio
	CLEVELAND
D. Schregardus	C. H. Shipman, 14805 Ardenall Ave., East Cleveland, Ohio
	CONNECTICUT VALLEY
Q. A. Brackett	F. C. Beekley, 96 S. Main St., W. Hartford, Conn.
	DETROIT
A. B. Buchanan	W. R. Hoffman, 615 West Lafayette Blvd., Detroit, Mich.
	LOS ANGELES
T. C. Bowles	Charles S. Breeding, 1187 N. Normandie Ave., Hollywood, Calif.
	NEW ORLEANS
Pendleton E. Lehde	Anton A. Schiele, 1812 Masonic Temple, New Orleans, La.
	PHILADELPHIA
J. C. Van Horn	<i>Acting Secretary</i> E. T. Darlington, 2848 Idaho Road, Camden, N. J.
	PITTSBURGH
A. J. Buzzard	C. F. Donbar, 233 South Starr Ave., Bellevue, Penna.
	ROCHESTER
E. C. Karker	A. R. Barfield, Valley Appliances, Inc., Rochester, N. Y.
	SAN FRANCISCO
Donald K. Lippincott	Paul R. Fenner Custom House, San Francisco, Calif.,
	SEATTLE
Austin V. Eastman	Abner R. Willson, 8055—14th Ave., N. E., Seattle, Wash.
	TORONTO
J. M. Leslie	G. E. Pipe, 90 Chestnut St., Toronto, Canada
	WASHINGTON
C. B. Jolliffe	J. B. Brady, Ouray Bldg., Washington, D. C.

**GEOGRAPHICAL LOCATION OF MEMBERS
ELECTED JUNE 11, 1930**

Transferred to the Member grade

Massachusetts	Springfield, 47 Florence St.	Hutcheson, J. A.
Ohio	Norwood, 3934 Ivahoe Ave.	Blair, R. M.

Elected to the Member grade

Massachusetts	Tufts College	de Mars, Paul A.
New York	Bayside, L. I., Parker Court Apts.	Trautwein, Paul K.
Ohio	Barberton, c/o Ohio Insulator Co.	Snyder, E. B.
	Dayton, Wright Field	Mitchell, Hugh
Washington	Seattle, 4216 West Findlay St.	Robinson, A. K.

Elected to the Associate grade

Arkansas	Little Rock, c/o Radio KLRA	Logan, E. Warren, Jr.
	Little Rock, 1920 Main St.	Simmons, G. A., Jr.
California	Compton, 123 B-West Olive St.	Smith, F. E.
	Hollywood, 1613 Vista del Mar	O'Harra, Paul Cross
	Long Beach, 835 West Third St.	Gray, William
	Los Angeles, Los Angeles Junior College	Kennedy, Douglas
	Los Angeles, 340 S. Cloverdale Ave.	McCullough, F. S.
	Palo Alto, c/o Federal Telegraph Co.	Morrison, G. K.
	Palo Alto, 1145 Middlefield Road	Woodbury, E.
	San Diego, c/o U. S. S. Rigel, U. S. Des. Base	Hamlin, F. E.
	San Rafael, 365 Mission Ave.	Lyman, Harry J.
Connecticut	New Haven, 270 Sherman Ave.	King, Cary J., Jr.
Dist. of Columbia	Washington, 3237 Hiatt Pl. N. W., Apt. 46	Rittenhouse, J. P.
Florida	Hialeah, Box No. 488	Rowan, F. C.
	Hialeah, 1302 Northwest Second Ave.	Sherwood, L. F.
Illinois	Chicago, Room 703, Monadnock Bldg.	Gray, Kline
	Chicago, 7708 South Shore Drive	Harrell, Fred E.
	Chicago, 1300 N. Dearborn St.	Kelsey, Elizabeth L.
	Chicago, 7641 Paxton Ave.	Nichols, D. O.
	Chicago, 11931 Eggleston Ave.	Reed, Clifford J.
	Chicago, 3300 Federal St.	Sear, Arthur W.
	Chicago, 3341 Berteau Ave.	Wiegrefe, E. J.
	Lockport, 1010 Madison St.	Carter, O. M.
	Melrose Park, 165 N. 35th Ave.	Searles, Ansel A.
	Plano, P. O. Box No. 1	Leitch, G. L.
	Rantoul, Chanute Field	Akure, R. O. S.
Indiana	Valparaiso, 60 Jefferson Ave.	Audrain, R. M.
	Valparaiso, 308 Monroe St.	Evans, H. D.
	Valparaiso, 308 Monroe St.	Repass, W. D.
	Valparaiso, 451 Greenwich St.	Steinbrech, J. M.
Kansas	Kansas City, 239 North Thorpe	Thompson, E. J.
Kentucky	Clinton	Weatherford, H. N.
	Grayson	DeHart S. B.
Maryland	Annapolis, P. G. School, U. S. Naval Academy	Layne, F. C.
	Baltimore, 3718 Kate Ave.	Rodgers, J. W.
Massachusetts	Cliftondale, 25 Jackson St.	Tripp, A. B.
	Springfield, 565 Page Blvd.	Gubin, Samuel
	Taunton, 282 Bay St.	Godfrey, J. S.
	Wollaston, 97 Willow St.	Kennard, K. F.
Michigan	Detroit, 1365 Cass Ave., Room 1321	Carter, Rex B.
	Detroit, 2041 McDougall Ave.	Denstaedt, E. C.
	Detroit, 101 Westminister	Lehmann, McKenna
	Detroit, 4471 Lakepointe Ave.	Sheridan, R. J.
	Holland, 88 E. 13th St.	Tysse, Henry L.
Missouri	Wyandotte, 2332-10th St.	Bednarek, W. J.
	St. Louis, 1318 Clara Ave.	Bergtold, A. L.
	St. Louis, 3622 McRee Ave.	Sampson, John C.
	St. Louis, 4004 Maffitt Ave.	Schaffer, D. W.
	St. Louis, 4820 Kossuth Ave.	Welhoelter, Milton
	St. Louis, 3829 Greer Ave.	Wirts, C. C., Jr.
Montana	Butte, 224 S. Main St.	Derr, C. R.
Nebraska	Lincoln, 925 S. 32nd St.	Harvey, H. C.
New Jersey	Bloomfield, 72 Watsessing Ave.	Roush, G. F.
	Boonton, c/o Aircraft Radio Corp.	Parkes, A. W., Jr.
	Camden, 1160 Kenwood Ave.	Cioffari, Bernard
	Collingswood, 13 Odgen Ave.	Shoup, F. F.
	East Orange, 82 N. Arlington Ave.	Curtis, R. C.
	Haddon Heights, 306 White Horse Pike	Gottier, T. L.
	Jersey City, 248 Palisade Ave.	Gross, Ralph
	Long Branch, 688 Broadway	Goodwin, E. A.

Geographical Location of Members Elected June 11, 1930

New Jersey (cont.)	Newark, 159 N. 12th St.	Geiges, Karl S.	
	Oaklyn, 76 Kendall Blvd.	Alexander, J. E.	
	Oaklyn, 1115 White Horse Pike, Cedar Court Apts.	Fowler, L. T.	
	Oceanport, Box No. 18.	Denniston, E. E.	
	Riverton, 301 Bank St.	Holst, P. F. G.	
	Trenton, 45 Barnt Ave.	Donohue, E. F.	
	Upper Montclair, 5 Emerson Pl.	Caughey, W. K.	
	New York	Astoria, L. I., 3043-31st St.	Sollima, Joseph
		Brooklyn, 23 Bay 7th St.	De Meyer, Harold
	New York	Brooklyn, 1627 West 13th St.	Mazzola, J. R.
Brooklyn, 2106 Bedford Ave.		Murray, Allan J.	
Brooklyn, 34 Moore St.		Siegal, Jack	
Brooklyn, 202 S. Oxford		Sullivan, F. T.	
Greenport, 305 Front St.		Boerum, H. S.	
Mamaroneck, Halstead Ave. and 5th St.		Herdman, W. P.	
Monticello, 246 Broadway		Fleischer, A. P.	
New York City, U. S. S. Texas, c/o Postmaster		Hixson, J. P.	
New York City, 862 E. 169th St.		Lebow, Samuel	
New York City, 36 Market St.		Newcombe, Jack	
New York City, 1186 Lexington Ave.		Pattee, J. R.	
New York City, 463 West St.		Wurmser, A. V.	
New York City, U. S. S. Bushnell, c/o Postmaster		Zamba, John	
Riverhead, L. I., c/o R. C. A. Station		White, Nathaniel	
Schenectady, 448 Third St.		Van Alstyne, A. J.	
Scotia, 134 Riverside Ave.		Schaper, A. W.	
North Carolina		Charlotte, Box No. 237	Parker, J. C.
	Tarboro, Box No. 247	Shaw, H. B., Jr.	
North Dakota	Devil's Lake, 604 Fourth St.	Norton, T. S.	
	Cincinnati, 3441 Wilson Ave.	Epstein, Jesse	
Ohio	Cincinnati, Univ. of Cincinnati Dormitory	Jordan, J. F.	
	Cincinnati, 545 Purcell Ave.	Hentz, E. G.	
	Cincinnati, Crosley Radio Corp.	Kidd, Andrew	
	Cincinnati, 1725 Elmore St.	Squires, C. E.	
	Cincinnati, Room 920 Chamber of Commerce Bldg.	Valentine, F. C.	
	Cleveland, 7704 Dearborn Ave.	Roebuck, Neel	
	Cleveland, 9708 Adams Ave.	Stanton, Sol.	
	Cleveland, 2269 Ashland Road	Willard W. C.	
	Columbus, 914 Ellsworth Ave.	Young, D. A.	
	Custer	Talmage, W. L.	
	Dayton, 371 Kenilworth Ave.	Baker, J. R.	
	Dayton, 1310 Kumler Ave.	Goldston, Henry	
	Springfield, R. F. D. No. 3	Bushong, V. L.	
	Springfield, Radio Station WCSO	Kratz, L. M.	
	Youngstown, 223 Kyle St.	Carlson, N. G.	
	Oklahoma	Oklahoma City, 3921 Shields Blvd., R. S.	Cordell, W. G.
		Chester, 322 E. 8th St.	Baylor, H. M.
Pennsylvania	Narberth, Fairview Farms	La Fore, J. A., Jr.	
	Nickleville	Rumberger, Carl S.	
	Philadelphia, 548 Ellet St., Mt. Airy	Brown, R. D., Jr.	
	Philadelphia, 125 Apsley St.	Gilbert, W. E.	
	Philadelphia, 32 N. Fifth St.	Illingsworth, F. H.	
	Philadelphia, 4213 Van Kir, St.	Walker, Harold	
	West Philadelphia, 1730 Martlon Ave.	Jennings, E. C.	
	Armour, Route 2, Box 54	Lightenberg, William	
	Emery	Janssen, R. J.	
	Dallas, 2515 Maple Ave.	Curll, Van C. n	
Texas	Dallas, 218 Alcalde St.	Wilkinson, Lee A.	
	Houston, 1603 Welch St.	Hunt, J. W.	
Vermont	Burlington, 81-85 Main St.	Siegel, Harold S.	
Virginia	Arlington	Dresser, O. C.	
	Culpeper	Jones, H. R.	
Washington	Seattle, R. 13, Box No. 207	McCash, P. V.	
	Tacoma, 4001 East B St.	Beatty, D. L.	
Wisconsin	Milwaukee, 730 Hubbard St.	Schweizer, M. J.	
	Sheboygan, 1221 Ashland Ave.	Troeglen, Karl, Jr.	
Brazil	Rio de Janeiro, Voluntarios de Patria 86	Lima, A. C. de Silva	
Canada	Toronto, Ont., 345 Adelaide St. West	McLean, L. V.	
Channel Islands	Guernsey, 6 Contree Mansell	Adams, A. M.	
England	Bradford, 90 Leeds Old Road	Fennessay, J. R.	
	Cambridge, St. John's College	White, F. W. G.	
	Chelmsford, Essex, 26 Nursery Road	Amey, S. H.	
	Ipswich, Suffolk, 35 Carr St.	Wilby, R. A.	
	Upminster, Essex, 20 Cedar Gds.	Connell, W. H.	
	Wetherby, Yorks, 16 High St.	Wetherill, J. E.	
	France	Paris, 29 Rue de Lisbonne, c/o Co. des Lampes	Kahn, Pierre O.
	Japan	Tokyo, c/o Japan Wireless Telegraph Co., Marunouchi	Shuzui, Saburo
	New Zealand	Christchurch, 20 Fitzgerald St.	Gerity, L. P.

Elected to the Junior grade

California	Monrovia, 529 King St.	Barnard, T. A.
	Santa Barbara, Radio KDB, Faulding Hotel	Campbell, C. W.
Dist. of Columbia	Washington, 2026 F St., N. W.	Bullock, J. W.

Geographical Location of Members Elected June 11, 1930

Illinois	Highland Park, 388 Walker Ave.....	Berg, B. V.
	Peoria, 510 Windom St.....	Clark, Bruce
Indiana	Gary, 366 Hancock St.....	Gustafson, C. L.
	Princeton, 502 S. Seminary St.....	Clark, R. K.
	Rensselaer, 604 Jefferson St.....	Halstead, W. H.
	Tifton, Rural Route No. 1.....	Gaiser, Martin
	Valparaiso, 451 Greenwich St.....	Cone, W. W.
	Valparaiso, Stiles Hall.....	Fleming, Carl
	Valparaiso, 405 Monroe St.....	Phillips, V. G.
	Valparaiso, P. O. Box No. 455.....	Rosenberg, B. L.
Iowa	Ames, Box N, Station A.....	Lewis, J. R.
	Britt, R. F. D. No. 3.....	Mickelson, Silas
	Des Moines, 1753 East Grand Ave.....	Peavey, E. A.
	Mount Vernon, 306 First Ave. So.....	Beranek, L. L.
Michigan	Ludington, c/o P. M. Ry.....	Fenton, K. G.
Nebraska	Clay Center, Box No. 203.....	Omer, G. P., Jr.
New York	Buffalo, 209 Franklin St.....	Munde, E. M.
	Colden.....	Robinson, M.
	New York City, 186 Second Ave.....	Weitzman, Irwin
North Carolina	Pittsboro.....	Roberson, R. E.
Ohio	Dayton, 305 Park St.....	Braden, Paul F.
	Lima, 125 Miller Ave.....	Arnett, T. T.
	Urbana, R. F. D. 7.....	Sulenbinder, W. A.
Pennsylvania	Johnstown, 1123 Franklin St.....	Lohr, L. H.
Virginia	Dunn Loring.....	Harris, R. T.
Wisconsin	Kenosha, 6227 Sheridan Road.....	Hanson, Gordon
Canada	St. Hyacinthe, Que., 219 Cascades.....	Marceau, Jules P.

APPLICATIONS FOR MEMBERSHIP

Applications for election to the various grades of membership have been received from the persons listed below, and have been approved by the Committee on Admissions. Members objecting to the election or transfer of any of these applicants should communicate with the Secretary on or before August 1, 1930.

For Transfer to the Member grade

Massachusetts	Springfield, 103 Federal St.	Andrew, V. J.
New Jersey	Bloomfield, 30 Fulton St.	Schoene, R. L.
	Merchantville, 6529 Rogers Ave.	Patterson, E. B.
New York	New York City, c/o The Aviation Corp., 122 E. 42d St.	Shangraw, C. C.
	Schenectady, Vacuum Tube Eng. Dept., General Electric Co.	Rockwood, A. C.

For Election to the Member grade

Dist. of Columbia	Bellevue, Anacostia, Naval Research Laboratory	Harvey, L. M.
New York	Schenectady, 18 Hampton Ave.	Nixdorff, S. P.
England	London, Radio Section, Engineer-in-Chief's Office, G.P.O.	Mercer, C. P.

For Election to the Associate grade

Arkansas	Blytheville, 109 West Kentucky Ave.	Shide, J. R.
	Little Rock, 600 North Lyler St.	Waller, Paul
California	Bolinas, c/o R. C. A.	Schick, J. R.
	Los Angeles, Park Vista Hotel	Coblentz, O. R.
	Los Angeles, 1647 Shenandoah St.	Grove, H. G.
	Los Angeles, 1448 Dana St.	Miller, G. B.
	Oakland, 1624 East 38th St.	Lar Rieu, E. A.
	Palo Alto, 841 Bryant St.	Keefe, V. C.
	Palo Alto, Federal Telegraph Co.	Walton, R. C.
	San Bruno, P. O. Box 996, 996 Green Ave.	Bishop, C. M.
	San Pedro, U.S.S. California, Box 17	Carlson, C. F.
Colorado	Holyoke, 907 Campbell Ave.	Scheneman, Ernest
Connecticut	West Hartford, 31 South Highland St.	Houldson, C. J.
Dist. of Columbia	Washington, 120 C St., N.E., Apt. 107	Carroll, C. S.
	Washington, National Broadcasting Company	Cooper, D. H.
	Washington, c/o Navy Department	Moran, J. G.
Illinois	Champaign, 705 South Sixth St.	Orner, R. J.
	Chicago, 6242 South Sacramento Ave.	Friedman, Joseph
	Chicago, 520 N. Michigan Ave.	Gruskin, Georg
	Chicago, 7425 Cottage Grove Ave.	Kaynor, H. J.
	Chicago, 4614 North Kostner Ave.	Lehnert, F. H.
	Chicago, 1970 Milwaukee Ave.	Lazae, J. H.
	Chicago, 4015 Melrose St., Apt 3-J	Paelig, T. H.
	Chicago, 3150 West North Ave.	Petersen, W. H.
	Chicago, 208 West Washington St., Room 901	Snowden, P. T.
	Evanston, 2219 Central St.	Christopherson, F.
	Rock Island, 3201-17th Ave.	Stanley, O. T.
Indiana	Indianapolis, 652 E. 52d St.	Albershardt, M.
	South Bend, 207 Pythian Bldg.	Bouchard, I. H.
Iowa	Cedar Rapids, 1200 Fourth Ave.	Fink, Jack
Kentucky	Covington, 427 Russell St.	Bryant, William
Louisiana	New Orleans, 813 Howard Ave.	Hanna, G. E.
Maryland	Baltimore, 7th and Paul Sts.	Mahone, G. A.
	Boys	Hargett, W. D.
Massachusetts	Boston, 66 Bay State Rd.	Mann, H. K.
	Winthrop, 154 Pauline St.	Belcher, C. D.
Michigan	Muskegon, 285 Pine St.	Fonger, C. I.
Minnesota	Minneapolis, 2615 Park Ave.	Cooke, L. S.
	Minneapolis, 1037-12th Ave., S.E.	Gibbs, Earl
New Jersey	Ampere, P.O. Box 16	Adams, Harry
	Bloomfield, 104 Warwick St.	Zimber, R. M.
	Camden, RCA-Victor Co.	Farrow, F. R., Jr.
	Carlstadt, 538 Third St.	Fuelling, P. W.
	Collingswood, 34 Woodlawn Ave.	Hamilton, Sam
	Collingswood, 1002 Belmont Ave.	Strasser, E. J.
	Jersey City, 365 Union St.	Perkins, G. C.
	Newark, 107 Halsey St.	Coleman, C. C.
	Riverton, 301 Bank Ave.	Harding, H. B.
	Verona, 37 Marion Rd.	Heyman, Nicholas
New York	Clinton	Ellinwood C. W.
	Forest Hills, L. I., 336 Burns St.	Leonard, A. A.
	Lockport, 98 West Ave.	Fiedler, L.
	New York City, Bell Telephone Laboratories, 463 West St.	Burton, E. T.
	New York City, 2032 Valentine Ave.	Osherow, S. A.
	New York City, 135 West 183rd St.	Strong, J. M.
	New York City, Amtorg Trading Corp., 261 Fifth Ave.	Yakovlev, A.
	New York City, American Tel. & Tel. Co., 195 Broadway	Yarmack, J. E.
	Ozone Park, L. I., 107-28-93rd St.	Hingle, A. W.
	Richmond Hill, L.I., 8642-106th St.	Beach, E. W.
	Rochester, 236 Oxford St.	Malone, W. J.
	Rochester, 34 Court St., Room 224	Webb, Elmer
	Schenectady, 1102 Baker Ave.	Farrell, J. J.
	St. Albans, L.I., 121-04-195th St.	Baldwin, C. P.

Applications for Membership

North Carolina	Winston-Salem, 224 South Green St.	Lee, D. J.
North Dakota	Langdon	Charrier, G. M.
Ohio	Akron, 580 Blanche St.	Nerhood, H. E.
	Cincinnati, 1045 Linn St.	Boblett, A. J.
	Cincinnati, 2630 Vine St.	Boyle, H. G.
	Cincinnati, Crosley Radio Corp.	Heina, W. M.
	Cincinnati, Crosley Radio Corp.	Kierulff, W. E.
	Cincinnati, Mt. Washington	Vogelsang, G. E.
	Dayton, c/o Radio Products Co., Fifth & Norwood Sts.	Jackson, P. F.
	Granville	Clark, J. V.
Oklahoma	Guthrie, 708 East Oklahoma Ave.	Steele, K. K.
	Oklahoma City, 1123 N. Oklahoma Ave., Apt B	Parish, E. V.
	Tulsa, 1515 South Baltimore St.	Hess, H. R.
	Tulsa, 1907 South Phoenix Ave.	Sampson, W. A.
Oregon	North Bend, c/o Coos Ray Wireless Telegraph Co.	Olin, R. C.
Pennsylvania	Camp Hill, 2135 Market St.	Reinbold, J. W.
	Merion, 766 Beacon Lane	Dohan, W. R.
	Monongahela, R.F.D. 2	McCallister, D. J.
	Oakmont, 140 View St.	Best, V. C.
	Philadelphia, 535 E. Mayland Ave.	Allen, H. B. Jr.
	Philadelphia, Atwater Kent Co.	Petrillo, S. E.
Rhode Island	Woonsocket, 55 Division St.	Massart, R. E.
South Dakota	Mitchell, 621 W. Fifth Ave.	Vert, H. F.
Texas	Brownsville	Mulhollan, Roye
	College Station, Box 256 F.E.	Dillingham, H. C.
	El Paso, c/o Radio Station WDAH	Stewart, A. W.
Virginia	Norfolk, c/o Radiomarine Corp. of Am., 222 Brewer St.	Butt, H. R.
Washington	Seattle, 8003-18th Ave., N. W.	Voris, D. L.
	Spokane, W-1017 Cleveland Ave.	Ruid, L. M.
	Spokane, 1209 E. Liberty Ave.	Schanks, M. J.
Wyoming	Cheyenne, Boeing Air Transport	Leland, W. H.
Australia	Melbourne, Radio Research Board, c/o The University	Martyn, D. F.
	Melbourne, "Rymble," Earl St. Mont Albert	Steane, G. W.
Bolivia	Yacuiba	Ellis, N. B.
Canada	Galt, Ont., 332 Dundas St.	Stauffer, W. J.
	Montreal, Que., 5206 Decarie Blvd.	Andresen, Sigurd
	Montreal, Que., 637 Craig St., West	Harry, Eve
	Montreal, Que., c/o Northern Electric Co., 637 Craig St. W.	Stewart, H. H.
	St. John, N. B. c/o Radio Station CFBO	Shelfoon, A. J.
	Toronto 6, Ont., 677 Broadview Ave.	Haines, D. G.
	Toronto, Ont., 374 Main St.	Hayes, P. R.
	Toronto, Ont., 21 Woodfield Rd.	Maundrell, D. A.
	Toronto, Ont., 299 Waverly Rd.	Penny, H. G. Y.
	Toronto, Ont., 72 Bastedo Ave.	Pollock, Alexander
	Victoria, B. C., 585 Marifield Ave.	Sealey, F. W.
Denmark	Hellerup, Ehlersvej 8	Steffensen, James F.
England	Liverpool, 64 Prince's Rd.	Dolovitz, Ronald
	Liverpool, 69 ^a Muirhead Ave., West Derby	Gardiner, W. J.
	London, N. W. 2, P.O. Radio Research Station, Dollis Hill Lane	Searle, R. F. T.
	Reading, The Firs, 50 Armour Rd., Tilehurst	Herbert, A.
	South Elmsall, Yorks, 191 New Queen St.	Clatworthy, Thomas
	South Elmsall, York, 17 Poplar Terrace	Woodward, Bernard
	Surbiton, Surrey, 17 Arlington Rd.	Lane, C. V.
	Warwickshire, "Croydon" Cremorne Rd., Four Oaks	Roberts, Raymond
France	Paris, Laboratoires Standard, 46 Avenue de Breteuil	Braggio, J. C.
	Paris, Int. Tel. & Tel. Lab., Inc., 46 Ave. de Breteuil	Embrechts, A. C.
Italy	Milan, 24 Via Eustachi	Ramsay, Frank R. F.
Japan	Kumamoto City, c/o Shinizu Hoso-jo (TOGK)	Tokushima, Genji
	Kumamoto City, Kumamoto Broadcasting Station	Yoshitoshi, Tanabe
	Tokyo, c/o Nihon-Hoso-Kyokai, No. 2, 1-Chome Uchiyama-shita-cho	Akamatsu, Kaworu
	Tokyo, Marunouchi, c/o Japan Wireless Telegraph Co., Jiji Bldg.	Amari, S.
	Tokyo, Marunouchi, c/o Japan Wireless Tel. Co., Jiji Bldg.	Endo, K.
	Tokyo, Marunouchi, c/o Japan Wireless Tel. Co., Jiji Bldg.	Kobayashi S.
	Tokyo, Marunouchi, c/o Japan Wireless Tel. Co., Jiji Bldg.	Nagoshi, M.
	Tokyo, Marunouchi, c/o Japan Wireless Tel. Co., Jiji Bldg.	Tamai, I.
New Zealand	Auckland, c/o The District Telegraph Engineer	Clarkson, T. R.
	Wellington, P.O. Box 936	Johnson, E. C.
Mexico	Monterey, P.O. Box 147	Tarnava, C., Jr.
Rep. of Pan.	Panama City, Tropical Radio Tel. Co., Box 1098	Jones, R. C.

For Election to the Junior grade

California	San Francisco, 133 Nevada St.	Rosa, W. P.
Iowa	Des Moines, 716 Oak Park Ave.	Willits, R. L.
	Grundy Center, 524 G. Ave.	Martz, F. W.
New York	Bronx, 4562 White Plains Ave.	Luisi, John
	Maspeth, L.I. 66-14-58th Ave.	Purzner, W. H.
Ohio	Cincinnati, 117 Parker St.	Kittel, Claude
Oklahoma	Oklahoma City, c/o KFXR, 1308 S. Pennsylvania Ave.	Marrinan, Horace J.
Pennsylvania	Philadelphia, 5300 Akron St.	Riley, A. S.
Texas	Houston, 1517 Alamo St.	Robinson, K. H.
Virginia	Farmville, Box 102	Harrison, C. W., Jr.
Washington	Spokane, 632 W 20th Ave.	Sutton, R. B.
Australia	Curramulka	Jellett, B. C.
England	Cambridge, "Falinge", St. Andrew's Rd., Chesterton	Deane, H. A. B.

OFFICERS AND BOARD OF DIRECTION, 1930

(Terms expire January 1, 1931, except as otherwise noted)

President

LEE DE FOREST

Vice-President

A. G. LEE

Treasurer

MELVILLE EASTHAM

Secretary

HAROLD P. WESTMAN

Editor

ALFRED N. GOLDSMITH

Managers

J. H. DELLINGER

L. M. HULL

A. F. VAN DYCK

R. A. HEISING

R. H. MANSON

ARTHUR BATCHELLER

(Serving until Jan. 1, 1932)

C. M. JANSKY, JR.

J. V. L. HOGAN

(Serving until Jan. 1, 1932)

(Serving until Jan. 1, 1933)

R. H. MARRIOTT

(Serving until Jan. 1, 1933)

Junior Past Presidents

ALFRED N. GOLDSMITH

A. HOYT TAYLOR

Board of Editors

ALFRED N. GOLDSMITH, *Chairman*

STUART BALLANTINE

G. W. PICKARD

RALPH BATCHER

L. E. WHITEMORE

J. W. HORTON

W. WILSON





MICHAEL I. PUPIN
PRESIDENT OF THE INSTITUTE, 1917

MICHAEL I. PUPIN
President of the Institute, 1917

Michael I. Pupin was born October 4, 1858 in Idvor, Banat, which is now a part of the Kingdom of the Serbs, Croats, and Slovenes. He is a Serb by race and came to this country in 1874.

He attended Cooper Union at evenings and later entered Columbia College in 1879, graduating in 1883. After attending the University of Cambridge, England, where he studied mathematics, and the University of Berlin, where he studied physics under the late Professor von Helmholtz, he returned to Columbia as an instructor in mathematical physics of the newly established Department of Electrical Engineering. In 1893 he became an adjunct professor and in 1903 a full professor of Electro-Mechanics.

In 1893 and 1894 his researches on electrical resonance and its application to multiplex telegraphy and wireless telegraphy were published. In 1896 he discovered that X-ray photographs could be taken in a fraction of a second by interposing between the object to be photographed and the photographic plate, a fluorescent substance. Previously an X-Ray photograph required an exposure of an hour or more. During the same year he discovered the secondary X-ray radiation. His later investigations resulted in his invention of the insertion of inductance coils at periodically recurring points in long telephone lines, and this invention, together with the vacuum tube, has practically eliminated all limits to the distance over which telephony over wire lines may be practiced.

Professor Pupin has been the recipient of the Elliot Crescent Medal of the Franklin Institute, the Edison Medal of the American Institute of Electrical Engineers, the Medal of Honor of the Institute of Radio Engineers, the Gold Medal of the Institute of Social Sciences, the Hebert Prize of the French Academy, and the George Washington award of the Western Society of Engineers. In addition he has received eighteen honorary doctor's degrees from American and European Universities, together with decorations from a number of foreign governments.

He is a member of many scientific organizations and was president of the New York Academy of Science, the American Institute of Electrical Engineers, the American Association for the Advancement of Science, and the Institute of Radio Engineers. He was Chairman of the Engineering Foundation at the time when activities resulting in the organization of the National Research Council were started.

His autobiography "From Immigrant to Inventor" received the Pulitzer Prize and has gone through fourteen editions. It was translated into several foreign languages.

He became a Fellow of the Institute of Radio Engineers in 1915.



The King Edward Hotel—Convention Headquarters.

INSTITUTE NEWS AND RADIO NOTES

Fifth Annual Convention of the Institute

The Fifth Annual Convention of the Institute of Radio Engineers is to be held in Toronto, Ont., Canada, August 18-21, 1930. An excellent program has been prepared, and in addition to the technical papers which have been arranged, a number of trips to radio organizations in and around Toronto have been scheduled. Special sight-seeing trips have been planned for the ladies who will find much of interest to them. A summary of the program to be presented is given on the inside front cover of this issue, the technical program follows.

MONDAY, AUGUST 18

10:00 A.M.-12:30 P.M. Opening session. Addresses of welcome, Dr. Lee de Forest, President of the Institute; J. M. Leslie, Chairman, Toronto Section; A. M. Patience, Chairman, Convention Committee.

Technical Papers

"Some Developments in Broadcasting Transmitters," by I. J. Kaar, General Electric Company, and C. J. Burnside, Westinghouse Electric and Manufacturing Company.

"Design and Acoustics of Broadcast Studios," by O. B. Hanson, National Broadcasting Company.

"Polyphase Rectification Special Connections," by R. W. Armstrong, Westinghouse Electric and Manufacturing Co.

8:00 P.M. Popular lecture on "Ultra-Sonics," by Dr. R. W. Boyle, National Research Laboratory, Ottawa, Ont., Canada.

TUESDAY, AUGUST 19

9:30 A.M.-1:00 P.M. "RCA Photophone System of Sound Recording and Reproduction for Sound Motion Pictures," by Alfred N. Goldsmith, Radio Corporation of America, and M. C. Batsel, RCA Photophone, Inc.

"Efficiency of Loud Speakers," by A. Ringel, RCA-Victor Co.

"Radio Transmission Phenomena," by G. W. Kenrick, R. A. deMars, Tufts College, and G. W. Pickard, Wireless Specialty Apparatus Co.

"Oscillographic Analysis of Radio-Frequency Current and Voltage," by B. deF. Bayly, University of Toronto.

"Functional and Structural Evolution of the Vacuum Tube," by Keith Henney, McGraw-Hill Publishing

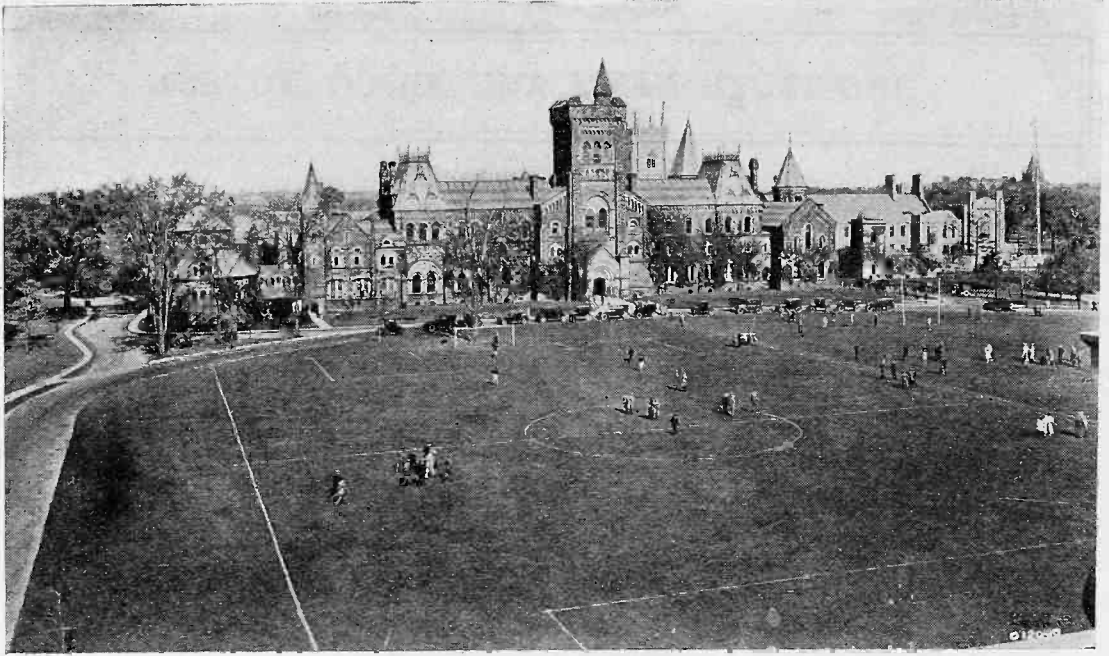

University of Toronto.



Parliament Building.

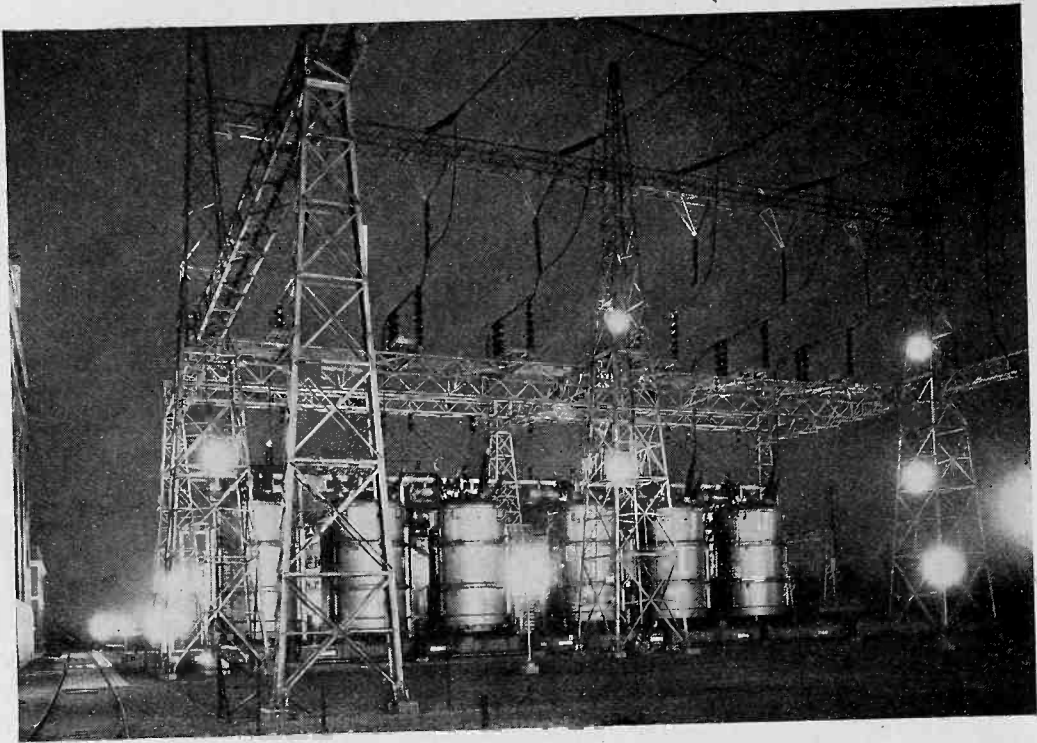

The transformers and switching equipment at the Leaside terminal of the world's longest 220-kv transmission as seen at night Trip No. 1.

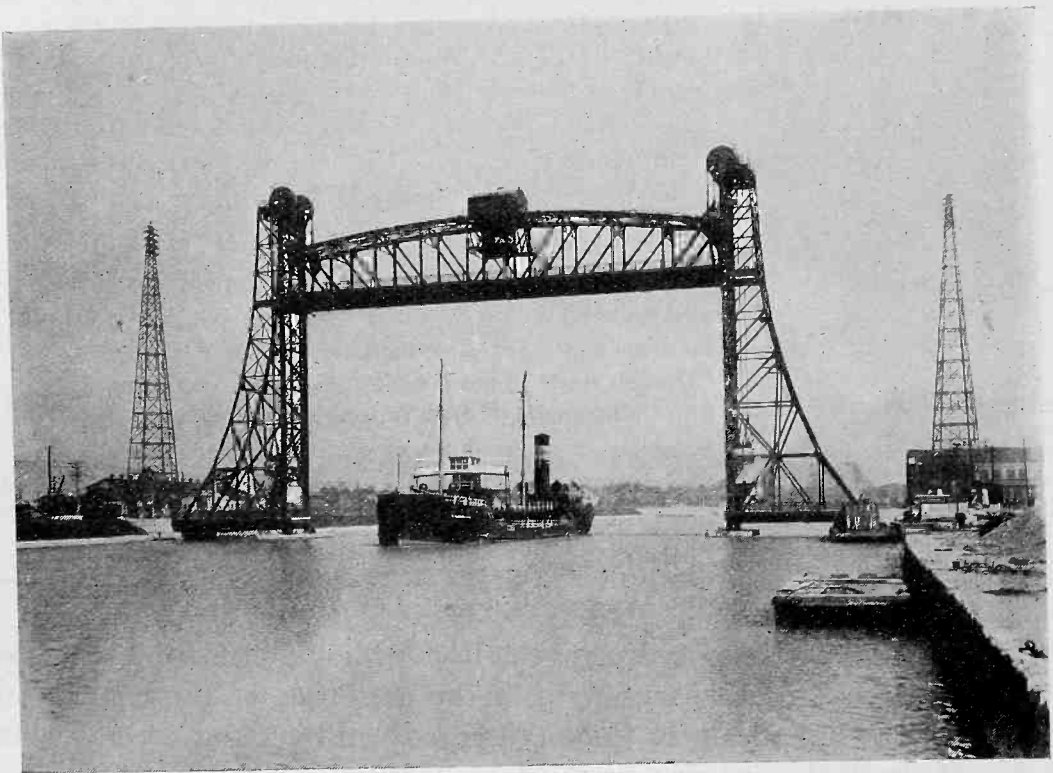

One of the bridges across the Welland Ship Canal in open position. Trip No. 8.

Company. (Electronics.) "The van der Pol Four-Electrode-Tube Relaxation-Oscillation Circuit," by R. M. Page and W. F. Curtis, Naval Research Laboratory.

2:00 P.M.—5:00 P.M.

"Directive Antennas," by G. C. Southworth, American Telephone and Telegraph Co.

"Aviation Communication," by J. S. Richardson, Northern Electric Company.

"A New Frequency-Stabilized Oscillator System," by Ross Gunn, Naval Research Laboratory.

"A Unique Aircraft Transmitter," by M. H. Schrenk, Naval Research Laboratory.

"Aircraft Power Supply," by J. D. Miner, Westinghouse Electric and Manufacturing Company.

"Radio Electric Clock System," by H. C. Roters and H. L. Paulding, Stevens Institute of Technology.

8:00 P.M.

Symposium on International Communication.

"Radio Communication Services of the British Post Office," by Lt. Colonel A. G. Lee, General Post Office.

"Overseas Radio Extensions of Wire Telephone Networks," by Lloyd Espenschied, American Telephone and Telegraph Co., and W. Wilson, Bell Telephone Laboratories.

"The RCA World-Wide Radio Network," by A. A. Isbell, RCA Communications, Inc.

"Advances in Transatlantic Cable Technique," by Hobart Mason, Western Union Telegraph Company.

"Point to Point Communication," by H. H. Higgins, Northern Electric Company.

"The Role of Radio in the Growth of International Communication," by H. H. Buttner, International Telephone and Telegraph Co.

WEDNESDAY, AUGUST 20

9:30 A.M.—1:00 P.M.

"The Practical and Commercial Aspects of Sensitivity and Selectivity of Radio Receivers," by W. D. Loughlin, Radio Frequency Laboratories.

"Design and Theory of Tuned Radio-Frequency Coupling Networks," by W. A. MacDonald and H. A. Wheeler, Hazeltine Service Corporation.

"Variation of Inductance of Coils Due to the Magnetic Shielding Effect of Eddy Currents in their Cores," by K. L. Scott, Western Electric Company.

Radio Manufacturers' Association

The Engineering Division of the Radio Manufacturers' Association has been invited to participate in the activities of the convention. Among the list of papers to be presented will be found several which are of particular interest to the manufacturer. These are to be presented during the technical session given on Wednesday, August 20. In addition, a number of committee meetings of the Engineering

Division are scheduled during the course of the convention. We take this opportunity of cordially inviting members of the Radio Manufacturers' Association to be present.

Exhibition

The entire mezzanine floor of the King Edward Hotel has been reserved for an exhibition of component parts used in radio receivers and transmitters. No complete sets of any nature will be shown at this

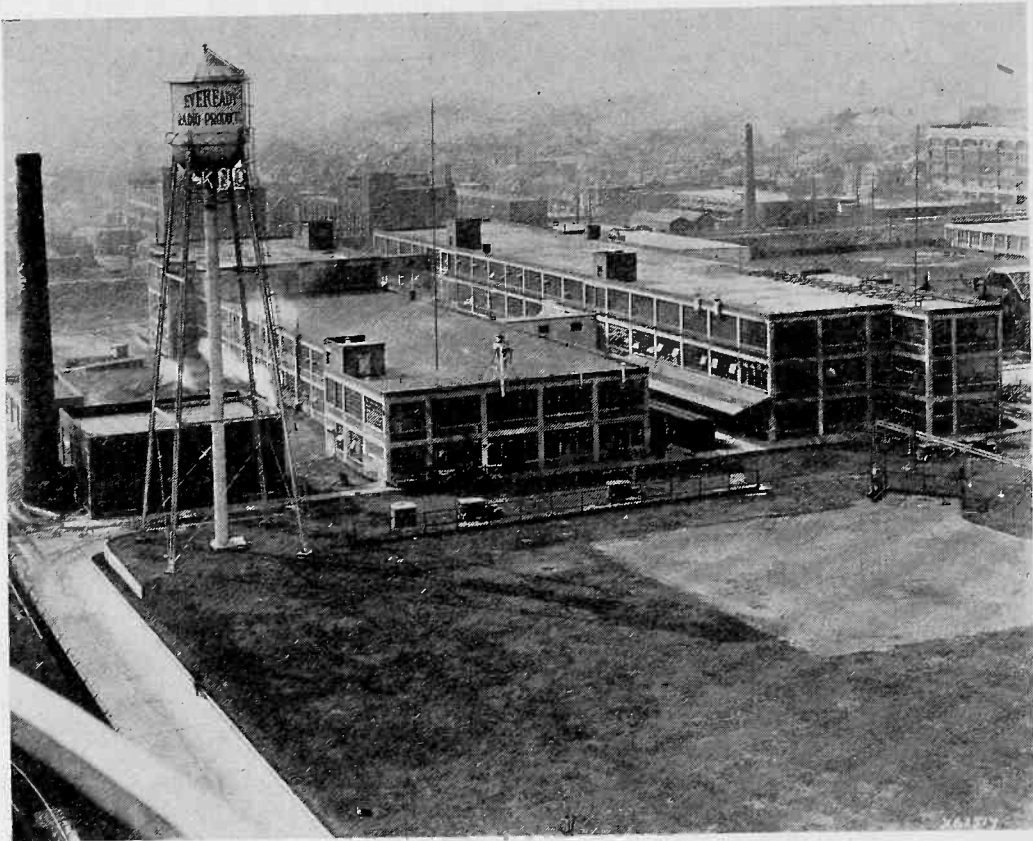

The Canadian National Carbon Company Plant and Station CKNC. Trip No. 1. exhibition which is open to displays of parts only. Competent engineers who are capable of discussing the merits and limitations of the parts exhibited will be in charge and the manufacturer and engineer will thus be enabled to gather a much greater amount of data concerning these products than he would normally be able to obtain by personal visits or mailed literature.

Inspection Trips

A number of interesting inspection trips have been arranged for both the members of the Institute and the ladies in their parties. An outline of these trips follows:

Monday, August 18, Trip No. 1

To Canadian National Carbon Company, manufacturers of Eveready Products and owners of broadcasting station CNKC. After visiting the Eveready plant and CNKC the party will proceed to the Leaside Transformer Station of the Hydro-Electric Power Commission. This is the receiving station for all power transmitted from the Gatineau Generating Station located in Quebec. This power is transmitted over the longest 220-kv transmission line in the world and the capacity of the station is 225,000 kva. It embodies the

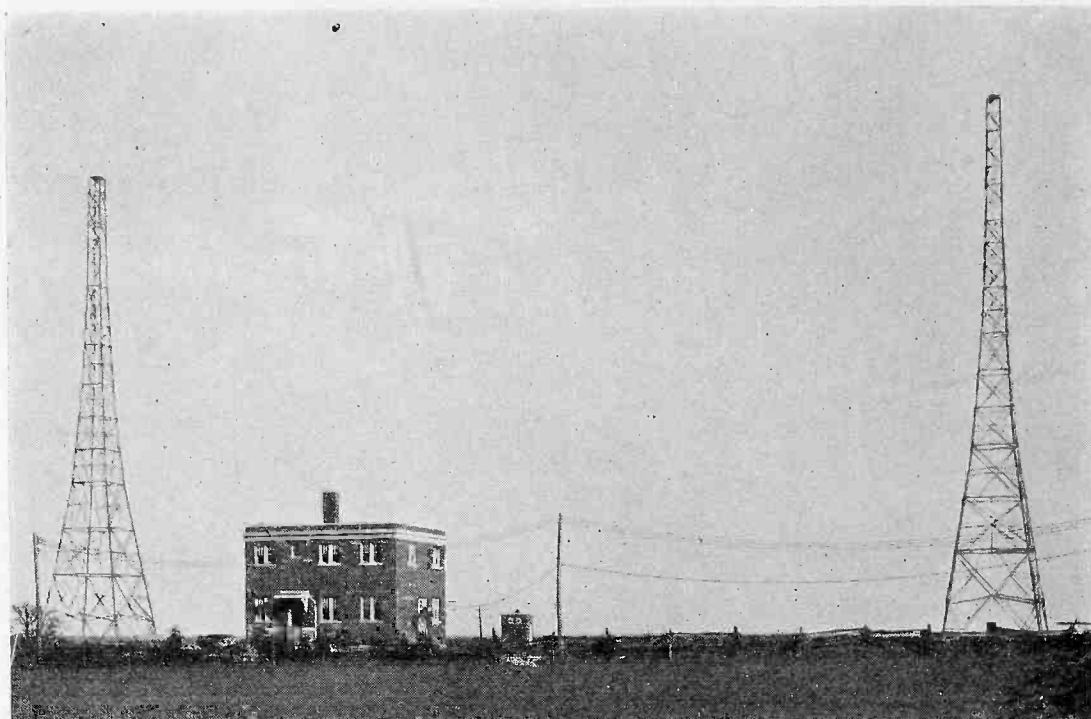

The Transmitting Station of CKGW at Bowmanville which will be seen on Trip No. 3.

latest in high-voltage switching and transformer equipment. From the Leaside Transformer Station the delegates will go to the Canada Wire and Cable Company where the processes in the manufacture and drawing of wire, and the winding of commercial coils will be inspected.

Trip No. 2

At the same time the members of the Institute are on Trip No. 1, Trip No. 2, which is a shopping tour for the ladies only, will be in progress. This tour will take the ladies through Ryrie-birks, Canada's exclusive jewelry store, and then to the T. Eaton Company, the largest department store in the world. Afternoon tea will be served in the Georgian Room of the latter place and the ladies will be the guests of the stores visited.

Tuesday, August 19. Trip No. 3

A special Canadian National Railway train will leave from Union Station and take the visitors to inspect the transmitting equipment of broadcast station CKGW which transmitting equipment is located at Bowmanville. The studios of CKGW are on the mezzanine floor of the King Edward Hotel where the Convention Headquarters are. They also will be open for inspection.



The plant of DeForest-Crosley, Ltd., which will be visited on Trip No. 6.

Trip No. 4

As an alternate, Trip No. 4 may be made. This is a tour of Toronto for sight-seeing purposes.

Trip No. 5

While trips 3 and 4 are in progress, trip No. 5, for the ladies only, will take them upon a sight-seeing tour around Toronto and they will be the guests of the City of Toronto at an afternoon tea given at the Old Mill on the Humber River.

Wednesday, August 20. Trip No. 6

A visit to the Rogers Majestic Company plant where the Rogers and the Majestic receivers are manufactured and to the DeForest-Crosley Company plant at which DeForest-Crosley radio receivers are made will comprise this trip.

Trip No. 7

Trip No. 7 for the ladies will include a boat trip around Toronto Harbor, the Toronto Harbor Commission being the hosts.



Assembling chassis at the Rogers-Majestic Plant. Trip No. 6.

Golf

For those who are interested in golf, arrangements have been made whereby they may devote the time taken by Trip No. 5 and Trip No. 6 to a round of golf on the course of the St. Andrews Golf Club. A luncheon will be served at the club before play starts.

Thursday, August 21. Trip No. 8

The last day of the convention has been set aside for a trip that will prove instructive and entertaining to all. The delegates will

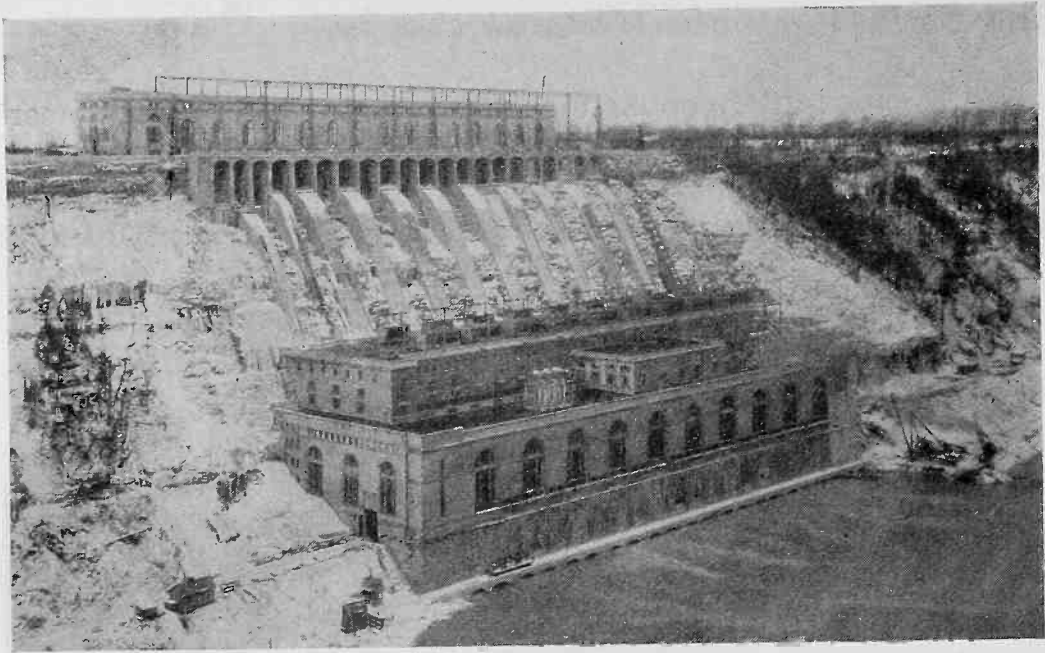

A general view of the Queenston Generating Station located at the end of the Chippawa Power Canal. Seen on Trip No. 8.

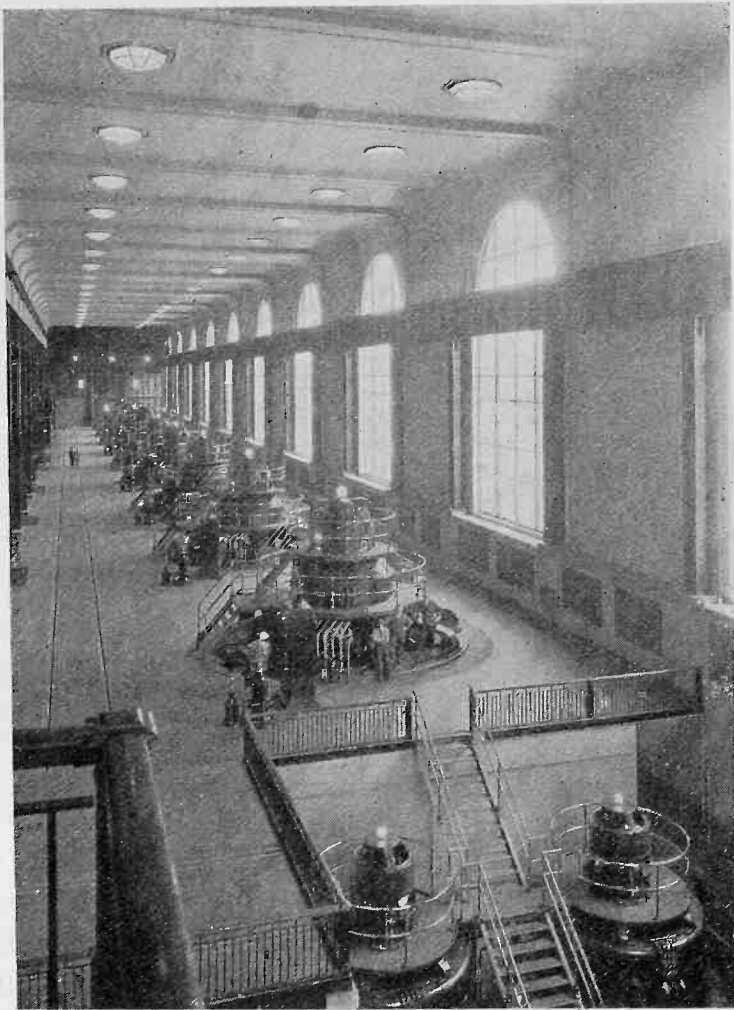

Interior View of the Queenston Generation Station. Trip No. 8.

leave Toronto in the morning for Port Dalhousie, a boat trip of more than two hours across Lake Ontario. From Port Dalhousie, electric trains will carry the delegates across the Niagara Peninsular which is known as the Garden of Canada to Niagara Falls. Luncheon will be

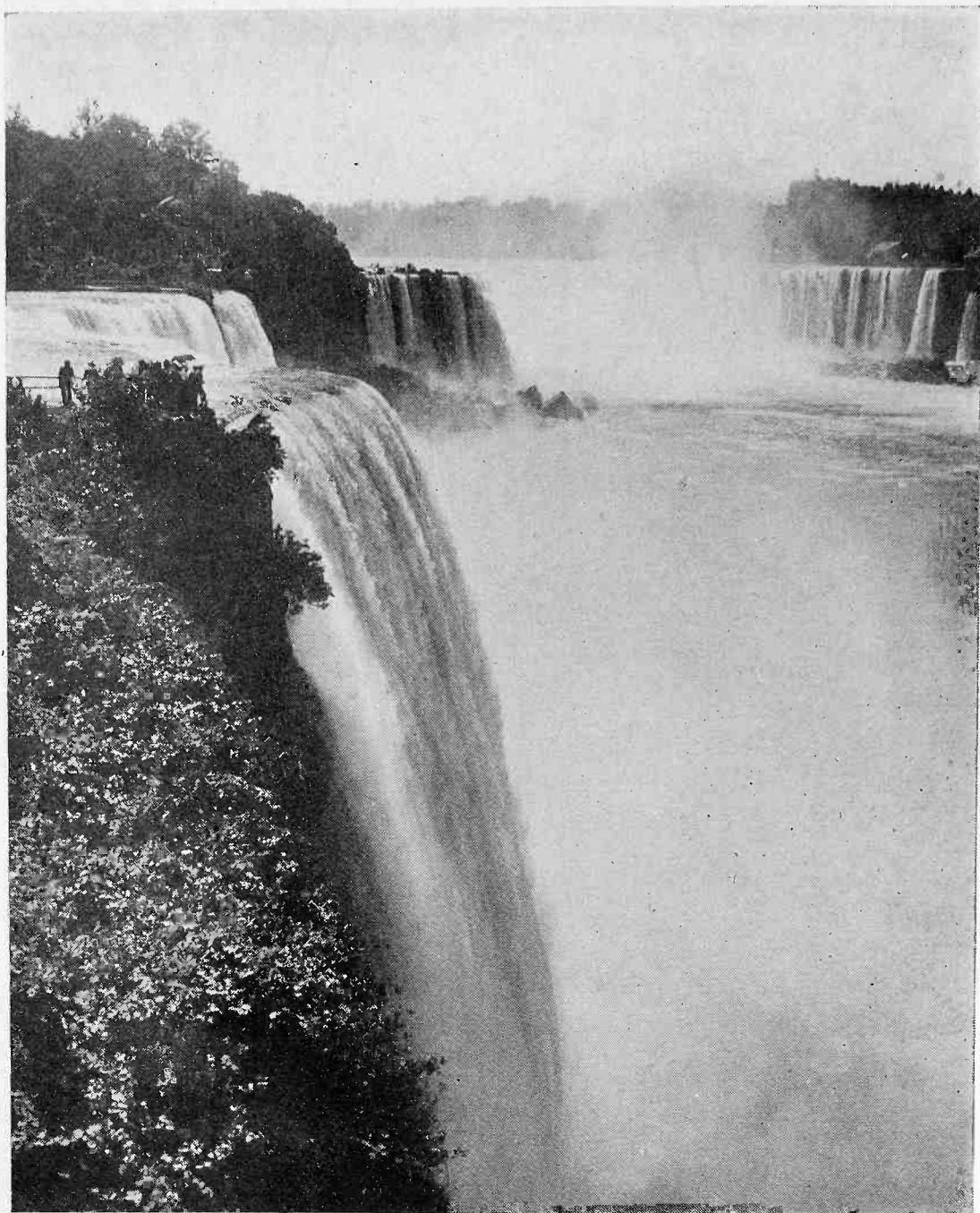

Underwood and Underwood

Niagara Falls.

served at the Tower Inn and plenty of time will be allowed to view the Falls. From the Falls, the members of the party will travel by trolley to the Queenston Power Plant of the Hydro-Electric Commission. This is the largest generating plant in the world, having a ca-

capacity of 500,000 kva. From Queenston, the trolleys will carry the party to the new Welland Ship Canal and the return to Port Dalhousie will be made by boat. After dinner has been served at Port Dalhousie, the return trip across Lake Ontario will be made and Toronto will be reached at about 10:30 P.M.

Banquet

The Annual Banquet will be held August 20, at 7 P.M. in the Crystal Ballroom of the King Edward Hotel. At the banquet the annual awards of the Institute Medal of Honor and the Morris Liebmann Memorial Prize will be made to the recipients for 1930. Dr. Lee

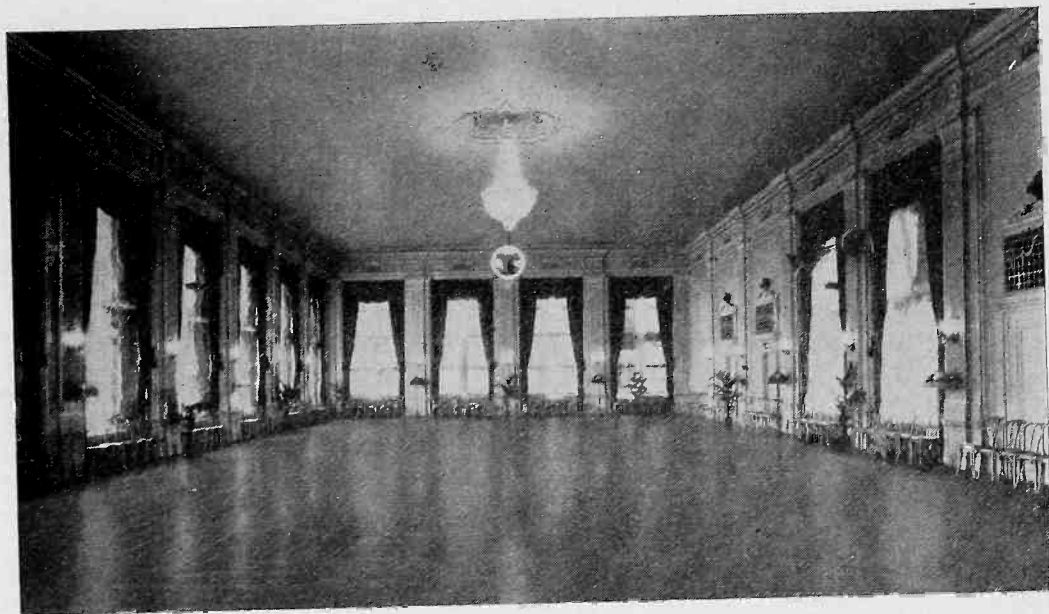

Crystal Ballroom, King Edwards Hotel.

deForest, President of the Institute, will preside as toastmaster and make the awards. An excellent program of entertainment has been provided and a dance will be held after the dinner.

Committee on Sections Meeting

A meeting of the Committee on Sections, at which it is hoped representatives of all sections of the Institute will be present, will be held at the Engineers Club on Tuesday, August 19th at 6 P.M. This meeting will give the many Sections of the Institute an opportunity to be represented at a meeting of the Committee on Sections and will provide a means whereby the Sections may exchange opinions and ideas as to methods of operation. A thorough treatment of the subject of sections and their operation will be in order and Section representatives are requested to come prepared to discuss the many angles of the question.

General Information

For the information of those who have not visited Canada before, we point out that tourists entering Canada are not required to have passports. Automobiles may be brought into Canada for pleasure purposes for a period up to ninety days without duty or bond, and for a period up to six months by fulfilling certain security requirements. No fee whatever should be paid for an automobile entry permit as these are issued without cost.

The tourist may drive his car under his own state license for one month in the province of Ontario. The time limit varies in other provinces, though. In leaving Canada no difficulty will be entailed providing the tourist can present proof of his U. S. citizenship. A birth certificate, if native born, or suitable credentials from responsible persons proving U. S. citizenship will be satisfactory. Naturalized citizens of the United States should be prepared to tender their certificates of naturalization. An alien resident of the United States should be prepared to present proofs of his legal entrance into the United States.

A number of booklets are available for those who desire them and may be obtained from the Director, Natural Resources Intelligence Service, Department of the Interior, Ottawa, Canada. Some of these are entitled as follows: "How to Enter Canada," "Motoring in Canada," "Fishing in Canada," "Hunting in Canada," "Canoeing in Canada," and "Vacations in Canada." In addition, four maps showing main automobile roads between Canada and the United States are available. These are known as the Atlantic, Great Lakes, Middle West, and Pacific sheets and cover those sections of the country. Any and all of this material may be obtained from the address given above. Such other questions you may have regarding Canada may also be directed as above.

A number of excellent hotels are available and details concerning them and rates will be provided with the advance registration cards mailed to all members of the Institute. In addition, garage facilities are readily available.

Canadian National Exposition

As many will undoubtedly desire to attend the convention as part of a vacation in Canada, we bring to your attention that the fifty-second Canadian National Exhibition opens on Friday, August 22, the day following the closing of the convention. This exhibition is one of greatest events of its kind. The exhibition grounds are perman-

ent and cover three hundred and fifty acres and together with the buildings represent an investment of more than twenty million dollars. About two million people attend the exhibition each year.

June Meeting of the Board of Direction

The regular monthly meeting of the Board of Direction of the Institute was held June 11, 1930 in the offices of the Institute. Those present were: Lee DeForest, president; Alfred N. Goldsmith, R. A. Heising, J. V. L. Hogan, L. M. Hull, R. H. Manson, R. H. Marriott, A. F. Van Dyck and H. P. Westman, secretary.

The following were transferred or elected to the higher grades of membership in the Institute. Elected to the Member grade: R. A. deMars, Hugh Mitchell, A. K. Robinson, E. B. Synder and R. K. Trautwein; transferred to the Member grade: R. M. Blair and J. A. Hutcheson.

One hundred and thirty-eight Associate members and forty Junior members were elected.

J. H. Dellinger of the Bureau of Standards was appointed the official representative of the Institute to attend the International Electrotechnical Commission meeting to be held in Stockholm-Copenhagen-Oslo June 27 to July 9, 1930. At this meeting, attempts will be made to arrive at a number of international standards in the radio field.

Proceedings Binders

Because of the enlarged size of the PROCEEDINGS published during 1929, many of our members find that they are unable to fit the twelve issues into the standard binder which has been available in the past.

We are pleased to announce that a larger size of binder is now available which will hold the twelve issues published during 1929.

When ordering the larger size be sure to specify that the large binder is desired. They are available at \$1.75 each and the member's name will be stamped on it for 50 cents additional. The smaller size binder is still available at \$1.50.

Associate Application Form

For the benefit of members who desire to have available each month an application form for Associate membership, there is printed in the PROCEEDINGS a condensed Associate form. In this issue this application will be found on page XXXIII of the advertising section.

Application forms for the Member or Fellow grades may be obtained upon application to the Institute office.

The Committee on Membership asks that members of the Institute bring the aims and activities of the Institute to the attention of desirable and eligible non-members. The condensed form in the advertising section of the PROCEEDINGS each month may be helpful.

Radio Signal Transmissions of Standard Frequency July to December, 1930

The following is a schedule of radio signals of standard frequencies for use by the public in calibrating frequency standards and transmitting and receiving apparatus as transmitted from station WWV of the Bureau of Standards, Washington, D. C.

Further information regarding these schedules and how to utilize the transmissions can be found on pages 10 and 11 of the January, 1930 issue of the PROCEEDINGS, and in the Bureau of Standards Letter Circular No. 171, which may be obtained by applying to the Bureau of Standards, Washington, D. C.

Eastern Standard Time	July 21	Aug. 20	Sept. 22	Oct. 20	Nov. 20	Dec. 22
10:00 P.M.	1600	4000	550	1600	4000	550
10:12	1800	4400	600	1800	4400	600
10:24	2000	4800	700	2000	4800	700
10:36	2400	5200	800	2400	5200	800
10:48	2800	5800	1000	2800	5800	1000
11:00	3200	6400	1200	3200	6400	1200
11:12	3600	7000	1400	3600	7000	1400
11:24	4000	7600	1500	4000	7600	1500

Committee Work

COMMITTEE ON ADMISSIONS

A meeting of the Committee on Admissions was held at the offices of the Institute at 1 P.M. on June 11, the following being present: R. A. Heising, chairman; C. N. Anderson, R. H. Marriott, J. S. Smith, and A. V. Van Dyck.

The committee considered eighteen applications for transfer or admission to higher grades of membership in the Institute.

COMMITTEE ON AWARDS

The Committee on Awards of the Institute held a meeting at 2 P.M. on June 11 at the Institute offices. W. G. Cady, chairman and Alfred N. Goldsmith were present at the meeting while Ralph Bown and A. Hoyt Taylor were consulted by telephone.

The committee's recommendations of recipients for the Institute Medal of Honor and the Morris Liebmann Memorial Prize were

prepared for presentation to the Board of Direction. The decision of the Board of Direction will be announced and the awards made at the banquet held during the Annual Convention of the Institute in Toronto on August 20.

COMMITTEE ON BROADCASTING

At 10 A.M. on June 11, a meeting of the Committee on Broadcasting was attended by L. M. Hull, chairman; R. Guy, J. V. L. Hogan, C. W. Horn, R. H. Marriott, and E. L. Nelson.

COMMITTEE ON CONSTITUTION AND LAWS

R. H. Marriott, chairman, presided at a meeting of the Committee on Constitution and Laws held at 10 A.M. on June 11, the following other members being present: W. G. H. Finch, H. E. Hallborg, and R. A. Heising.

COMMITTEE ON MEMBERSHIP

At 7 P.M. on June 11 a meeting of the Committee on Membership was held with the following in attendance: I. S. Coggeshall, chairman; B. Dudley, H. C. Gawler, C. R. Rowe, A. M. Trogner, and H. P. Westman, secretary.

COMMITTEE ON NEW YORK PROGRAMS

A meeting of the Committee on New York Programs was held at 9:30 A.M. on May 13, R. H. Ranger, chairman, presiding. The other members of the committee present were: Austin Bailey, E. R. Shute, and H. P. Westman, secretary.

COMMITTEE ON SECTIONS

The Committee on Sections held a meeting at 7 P.M. on May 13, Austin Bailey, chairman, L. A. Briggs, D. H. Gage, B. Dudley, assistant secretary, and H. P. Westman, secretary, were present.

STANDARDIZATION

SUBCOMMITTEE ON AIRCRAFT RADIO RECEIVERS OF THE TECHNICAL COMMITTEE ON RADIO RECEIVERS-IRE

A meeting of the above subcommittee was held at 10 A.M. on May 21 at the Institute offices. E. J. T. Moore, acting chairman, S. E. Anderson, W. H. Murphy, H. O. Peterson, and B. Dudley, secretary, were present.

SUBCOMMITTEE ON HIGH-FREQUENCY RECEIVERS OF THE
TECHNICAL COMMITTEE ON RADIO RECEIVERS-IRE

A meeting of the above subcommittee was held at 10 A.M. on May 22, and was attended by C. M. Burrill, chairman; H. H. Beverage, F. A. Polkinghorn, and B. Dudley, secretary.

Institute Meetings

ATLANTA SECTION

At the April 30 meeting of the Atlanta Section held at the Cecil Hotel, P. C. Bangs, secretary, presided. A paper on "How Constant is Constant Frequency" was presented by W. G. Cady of Wesleyan University.

Nineteen members and guests attended the meeting. The paper was discussed by Messrs. Bangs, Davis, Gardberg, and Thornton.

CINCINNATI SECTION

On May 22, a meeting of the Cincinnati Section was held at the Chamber of Commerce, Cincinnati. R. H. Langley, chairman, presided.

An illustrated paper on "Notes on Tuned Radio-Frequency Transformer Design" was presented by W. S. Harmon who covered the elementary principles of tuned radio-frequency transformer design, showing curves indicating the effect of changing dimensions on the inductance-to-resistance ratio.

A second paper on "Effect of Mass of Moving Parts on Loud-Speaker Performance" was delivered by J. D. Seabert who indicated the analogies between the electric and acoustic circuit elements. The variations in magnitude of the acoustic circuit elements with frequency were stressed, and the low acoustic efficiency of the usual type of moving-coil speakers was discussed.

A considerable amount of discussion ensued on these papers, and many of the sixty-one members and guests in attendance participated therein.

CLEVELAND SECTION

D. Schregardus, presided at a meeting of the Cleveland Section held May 2, at the Physics Laboratory of the Case School of Applied Science. A paper describing Broadcast Station WHK and giving its past history was presented by E. L. Gove, construction engineer of that station.

Thirty-seven members and guests attended the meeting.

LOS ANGELES SECTION

The April meeting of the Los Angeles Section was held on the 22nd

of the month at the Engineers Club in Los Angeles, T. C. Bowles, chairman, presiding.

Two papers were presented, the first by Captain H. W. Furniss of the 160th Inft., C. N. G., on "Communications as Applied to the Army in the Field." The second paper on "Operations and Engineering Principles of Field Equipment" was delivered by Lieutenant W. L. Conyons also of the 160 Inft., C. N. G. These papers were discussed by Messrs. Anderson, Breeding, Crawford, Cramer, Nikerk, and others of the fifty-six members and guests who attended the meeting.

A portion of the meeting was devoted to Institute business.

PHILADELPHIA SECTION

On May 6 a meeting of the Philadelphia Section was held at The Franklin Institute, J. C. Van Horn presiding.

A paper on "Methods of Matching Dynamic Speakers to Vacuum Tubes" was presented by C. D. Haigis of the Receiver Division, RCA-Victor Company.

Nominations for officers for the coming year were also prepared. One Hundred and eight members and guests attended the meeting.

PITTSBURGH SECTION

The April meeting of the Pittsburgh Section was held on the 22nd of the month at the Fort Pitt Hotel, Pittsburgh, A. J. Buzzard, presiding.

A paper on "Western Electric Sound Picture Recording" was presented jointly by A. J. Wilson and C. L. Stong. Mr. Wilson outlined the accomplishments of the past in the sound-film field, and then considered probable future developments and discussed their importance. The second portion of the paper by Mr. Stong outlined the process and methods involved in the simultaneous recording of sound and pictures on film. An extensive discussion of the paper ensued and was participated in by Messrs. Baudino, Diamond, Donbar, Hitchcock, McKeel, Mag, Reynolds, Roess, Shuey, Sunnergren, Thomas, Thompson, Watts, and Wycoff.

Thirty-seven members and guests attended the meeting.

SEATTLE SECTION

At the May 2nd meeting of the Seattle Section A. V. Eastman, presided. A paper by Professor Victorian Sivertz on "History, Composition, Extraction, and Use of Rare Gases" was delivered.

A demonstration of the behavior of some of the gases under various pressures and the various colors due to electrical discharges through the gases was given as part of the paper.

Thirty-eight members and guests were in attendance.

WASHINGTON SECTION

A meeting of the Washington Section was held at the Continental Hotel on May 8, C. B. Jolliffe, presiding.

Both of the speakers of the evening, Major William R. Blair of the U. S. Signal Corps, and Dr. A. Hoyt Taylor of the Naval Research Laboratory discussed the problems of "Aircraft Radio between Planes and the Ground."

The vital importance of communication with aircraft was stressed by both speakers and the problems and difficulties involved in the construction of suitable transmitting and receiving equipment for use on the planes were discussed. The practical design of aircraft equipment also received attention.

The papers were commented upon by Messrs. Gross, Mirick, and Walls.

The following officers were elected for next year:

Chairman, L. P. Wheeler

Vice Chairman, John B. Brady

Secretary-Treasurer, Herbert G. Dorsey

Eight-two members and guests attended the meeting.

Personal Mention

H. B. Closson, Jr. has left the Atwater Kent Manufacturing Company to join the Radio Engineering staff of RCA-Victor at Camden.

Roy H. Cole is now chief engineer of the Central Texas Broadcast Company at Waco, Texas, previously being on the engineering staff of WKY at Oklahoma City, Okla.

Carl H. Butman, former secretary of the Federal Radio Commission is now a member of the firm of Butman, Cooke, and Lowe, representatives of broadcast stations in the obtaining of advertising.

Previously Director of Instruction, R. L. Duncan is now president of the RCA Institutes, Inc. of New York City.

Formerly with the General Electric Company at Cincinnati as a radio engineer, L. A. W. East is now a radio engineer for the Canadian Pacific Railroad Company Telegraphs at Montreal, Canada.

F. J. Ewald, Jr. is an engineer for the Edison General Electric Appliance Company of Chicago having previously been in the Research Department of the Kellogg Switchboard and Supply company.

M. K. Gordon, Jr. has left the Brandes Laboratories at Newark, N. J. to join the Research Department of the Bell Telephone Laboratories.

M. J. Grainger, recording engineer for RCA Photophone, was formerly sound engineer for the Fox Case Corporation of New York.

H. E. Gray is now communications engineer for the Universal Air Lines of Chicago previously being chief engineer of WJAY at Cleveland.

V. Ford Greaves, formerly chief engineer for the United Reproducers Corporation is now an assistant chief engineer on the staff of the Federal Radio Commission.

Charles I. Harrison who was previously a radio engineer for the Federal Telegraph Company of Palo Alto, Cal. has joined the engineering staff of the Bell Telephone Laboratories.

Clyde C. Harvey has been made vice president in charge of production of the Colonial Radio Corporation of Rochester, N. Y.

Kenneth L. Huntley has joined the Bell Telephone Laboratories as specifications engineer.

Barton Kreuzer, previously in the Electro-Acoustic Research Department of the Radio Corporation of America is now a research engineer for RCA Photophone in New York City.

Formerly in the Radio Engineering Department of the General Electric Company, G. G. Langdon is now with the American Gas and Electric Company.

E. A. Lederer, previously research engineer for the Westinghouse Lamp Company of Bloomfield, N. J. is now chief engineer for National Union Radio Corporation.

H. B. Lockhart has been made chief engineer of the Eagle Broadcasting Company of Corpus Christi, Texas.

Louis Malter has become research engineer for RCA Photophone, Inc., being previously with the Radio Corporation of America.

Captain C. F. McDowell, U. S. N., is now inspector of radio material in San Francisco having previously been manager of the U. S. Navy Yard at Pearl Harbor, T. H.

Frank H. McIntosh has left Station WOW to join the engineering staff of the Bell Telephone Laboratories.

Edward A. Michelman, previously in the Design Division of RCA Communications has become a specifications engineer for RCA-Victor Company at Camden.

Herman E. Gihring, formerly assistant broadcast engineer with the Radio Corporation of America is now an engineer for the RCA-Victor Company at Camden.

Previously a radio engineer for the National Radio Manufacturing Company of Oklahoma City, Okla., Wayne Miller has become general manager of the Kansas City Radio School of Kansas City, Mo.

James R. Nelson, previously radio engineer for the National Carbon Company is now radio engineer for the Raytheon Products Corporation of Newton, Mass.

Faint, illegible text, likely bleed-through from the reverse side of the page. The text is mirrored and difficult to decipher.

INAUGURAL ADDRESS OF DR. LEE DE FOREST*

PRESIDENT, INSTITUTE OF RADIO ENGINEERS

FOR ONE who has been privileged to have had a part in the erection even from its foundation stones of the great fabric which is the Radio Industry of today—it is no easy matter to express adequately the deep sense of appreciation and of responsibility which my election to this honored office imposes.

Because the memories of my first labors in this field of wireless go back further than those of most of you today, I can realize, perhaps more than many of you, the great magnitude of service which you members of the Institute of Radio Engineers have achieved.

Little, indeed, of today's splendid achievement was envisioned by the small band of pioneers who began with the present century the creation of wireless communication.

At a time when our only source of wave energy was the open spark gap, the only detectors, the coherer and anti-coherer, when 10 miles of sea were considered wide-open spaces, when all antennas were vertical and a wave-meter was unknown, it required more than a prophet to foresee just what radio communication was destined to become.

The way to a definite organization of effort, to an accurate science, as we pioneers traversed it year by year, seemed at the time devious, and long, and frequently discouraging. Yet in retrospection, after a scant three decades, the progress made by that constantly increasing group of radio engineers now seems fairly rational and consistent.

Starting with nothing but a general understanding based on Hertz and Maxwell, the speed with which our first primitive methods and instruments were scrapped and superseded by those of greater refinement, larger power, and higher selectivity, was surely in full keeping with the most advanced practices which the older science of electrical engineering was even then establishing.

Competition among the few in the field during the first decade was fully as intense and exacting as at the present. International pride in wireless achievement began at the very beginning to spur us to radical advances. Added to this was the keen struggle among the two or three American companies for every eager crumb of patronage which a doubtful Navy, and an economical Army Department could be induced to offer.

* Delivered at New York meeting of the Institute, January 8, 1930.

Inventors were few in those days. Invention was easy, the soil exceedingly fertile, and the Patent Office not yet clogged with thousands of pending applications on insignificant or hardly distinguishable details. Consequently the incentive to strike out and pioneer on paths radically new and therefore wondrously attractive was intense. In rapid succession followed the auto-detector, (electrolytic and crystal types), the telephone receiver, the alternating-current transmitter, the two tuned circuits at sender and receiver; the high-frequency spark, the quench spark gap, the Poulson Arc and Tikker, the direction finder, the series-selective circuits of Stone, the heterodyne principle, the audion as detector and telephone amplifier, the Alexanderson high-frequency generator, and the audion oscillator, first regenerative for heterodyne reception, then as transmitter for telegraph and telephone. All of these kaleidoscopic changes and epochal achievements were accomplished in less than 15 years, from 1900 onward.

And, barring the more recent return to the short-wave transmission of the very early days, and crystal control, the above list is, I believe, a truthful catalog of the really significant strides in advance which have made radio engineering what it is today. Everything else, important though it be, and the result of years of careful research and study, may be classified, nevertheless, as an improvement in detail, electrical, mechanical, or chemical, as the case may be.

In truth this young giant, Radio, has attained maturity with astonishing speed. We search in vain for a like development in all the history of man. Radio began to *run* in 1906, ever quickening his stride. Thereafter he received a terrific impetus from the relentless demands of the World War, only to find directly following, instead of a breathing spell, a new incentive, alluringly financial, and aesthetic, in a call which in incredibly few years became nation wide—the *Radio Broadcast*.

Perhaps it is this latter development which, because I envisioned as early as 1907 some of its present-day development and aspects, appeals to me more personally and directly than any other phase of radio.

Beginning my efforts in opera-aria broadcast in 1909, with only prearranged and pathetically meager audiences, I essayed in 1916 with the Columbia Phonograph Company a daily or tri-weekly demonstration of their newest records. I well remember in 1919 when the High Bridge station after the war again began an entertainment service with occasional casual mention of the merits of the new variable condensers and whatnots my company was marketing, frequently overhearing certain disparaging remarks from a rival West Street

radiophone that "*they* had no condensers which they were interested in selling by radio"!

Then and there I learned the lesson that direct advertising by broadcast did not always build good-will. And I have consistently condemned the practice as perverse, pernicious, reflecting on the good name of radio, and distinctly retarding its development.

I did not then foresee the fine excellence of the "sponsored program," or its powerful potentialities in building up the almost incredible demand for receiving apparatus. But the insidious influence of the avaricious advertiser, his stupid insistence on direct, crass, venal advertising has, I regret to observe, become increasingly more and more effective and devastating.

As the so-called "Father of Radio Broadcasting" I wish again to raise my voice in most earnest protest against this revolting state of affairs. The present all too marked tendency of the broadcast chains and of many individual stations to lower their bars to the greed of direct advertising will rapidly work to sap the lifeblood and destroy the greatest usefulness of this magnificent new means of contact which we engineers have so laboriously toiled to upbuild and to perfect. If this stupid venality is not suppressed, if this reptile of etheric advertising is not scotched, we may well resign ourselves to a rapid decadence of a noble institution. Frankly and in all seriousness I attribute a part of the present undeniable slackening in radio sales to the public as actually due to this one cause. The radio public is, I believe, becoming nauseated by the quality of many of the present programs. Short-sighted greed of the broadcasters, station-owners and advertising agencies, is slowly killing the broadcast goose—layer of many golden eggs.

Too long has this perilous situation continued without earnest protest from our organization. We members of this Institute must be jealous of the good name, regardful of a wise supervision of this broadcast institution. We should, I maintain, take active steps (in Washington if need be) to rid ourselves of this stupid, this killing avarice, which is destroying the most splendid and potent means for entertainment, culture, and education which mankind has yet devised.

From this evil the radio manufacturer suffers first—is already severely suffering. But the broadcast agencies will ere long feel the effects of their growing policy in the falling off of large numbers of radio listeners, with resultant loss in advertising receipts. Who of you do not personally know of numerous friends who no longer listen regularly to their radios because of the distasteful advertising which is unceremoniously hurled into their homes?

This situation can be cured. It is of prime importance to us radio engineers that it should be cured. If we anticipate the day of the international broadcast, when American programs are interchanged with those from Europe, you may rest assured that any foreign programs of high-class music will be relished in this country in preference to much of the stuff which American audiences are now compelled to hear.

This factor, the international broadcast, is at hand. The sterling work of radio communication engineers the world over in the fascinating field of short-wave transmission is rapidly bringing it to pass. Perhaps we all too little realize just what this development will eventually mean to the cause of world understanding.

Mutual acquaintanceship between peoples, international amity, eventually an end to war, and finally the blessings of one common tongue.

In this fine affair, it is cause for pride to note that members of the Institute of Radio Engineers have assumed a long lead. And incidental to this work we should expect the foreign membership of the Institute to increase rapidly. This is a feature to which our Membership Committee is to give more careful attention than ever before.

It is to be noted that this year of 1930 will mark the tenth anniversary of the beginning of systematized broadcasting on a regular commercial scale from stations located at San Francisco, Detroit, Newark and Pittsburg, all within a few months of each other.

It has been proposed to commemorate properly this first decade of man's latest and most universal means of contact. If so it may be appropriate and wise that the Institute take steps to advise or direct these decennial plans.

From the earliest beginnings the thrill of adventure has ever characterized work in wireless, more so, I believe, than in any other branch of engineering. And these thrills continue to come to the fortunate radio engineer, each year, each month. For our mistress never ages. Recently outstanding beyond all compare, as a vivid example of the wonder which modern radio has achieved in the progress of communication is the reporting to a breathlessly awaiting world of the recent flight over the South Pole by Commander (now Admiral) Byrd. In that event all the wonder, all the thrilling romance with which radio has endowed and adorned science shines epitomized.

It was not history we were reading. It was not as when, only twenty years ago, Peary came out of the North to file his first dispatches five months after he had reached the Pole. Nor, when for three anxious years following 1910, the outside world did not know whether Scott's

brave party was alive or dead. Not history this, but a gripping present reality of adventure and romance. It is not too much to classify this achievement of Byrd and his associates in radio communication, as the most astounding example in the history of the art of transferring intelligence.

Where it is leading no one can surely tell. Radio of the future can only be guessed at with extreme caution, but we know that it will be forever indispensable to the gatherer of news.

The sum total of what our members, notably those enrolled in the Bureau of Standards and in Naval Radio Research, have contributed during the past two years to the safeguarding of aviation can scarcely be comprehended. Without radio, aviation must inevitably have remained a brave adventure with Chance ever at the controls. Very much yet remains to be done, however, especially in altitude sounding and in "block-signal systems," warning planes of their approach to another, and to mountain sides.

No field of invention calls more imperatively both to the radio and the acoustic engineer than here.

Recently developed in Great Britain, a remarkably practical simplification in small, light-weight facsimile transmission equipment now actually places at the disposal of aircraft this valuable aid to navigation, to give to or from the aviator up-to-the-minute weather charts, or outlines of terrain, either photographic or outlined by pen.

The vacuum-tube amplifier and loud speaker in addition to bringing to millions of homes a form of outside contact which is completely altering the modes of life and mental attitude of our nation, has recently undertaken to revolutionize the theater. This upset of the nation's fourth-sized industry, while the direct outgrowth of radio engineering, has come about in one-third of the time which the broadcast industry required to attain its present state of perfection (or imperfection, as the case may be).

And the above time relation expresses in a rough and general way the comparative *excellence* of the talking picture as compared with the radio today—about one-third as good!

Here, both in studio recording and in theater reproducing methods and apparatus, is witnessed a most deplorable result of engineering indigestion. The profession has bitten off very much more than it could properly masticate in these few years.

But, alas, the resultant belly-ache must be endured by the entire theater-going public! That good old-fashioned English word is alone adequate to express frankly the present situation as regards sound, mechanically or photographically recorded, and loudly reproduced.

As one of the American pioneers in this new development (not yet, surely, may one properly apply the word *Art*) I feel at liberty to talk plainly on this subject.

Recent heroic, and mostly painful, attendance at various leading Broadway successes makes me pause in wonderment that our supposedly blasé Metropolitan audiences will endure, not to mention struggle, to sit in crowded houses to hear that which they hear. Truly, it has been said that the talking picture has taken the noise out of the studio and put it into the theater. Male voices perhaps clearly understandable but all of one timbre, and that wholly unnatural and unpleasing—as if emanating from wooden tonsils and fibre tongues; female voices that lisp, or rasp, and through nasal harshness make all men misogynists; raucous or shrieking “music” which too frequently recalls the olden days of His Master’s Voice—and is almost never either natural or pleasant to hear—these faults seem actually on the increase rather than diminishing.

Admitted that the motion picture producers have in many cases taken over into their own hands the management of microphone and recording apparatus, (although the very best our profession has designed) and liberally botched and boggled the process; and that the film laboratories frequently butcher good negatives into wretched prints. Nevertheless even where the large electrical companies have bodily taken over the film concern from studio to theater the results are all too often deplorably second-rate. In my opinion, despite the tremendously enthusiastic response of the public to sound pictures, what we have done to the better class of motion picture theatre is as yet distinctly retrogressive. Who of you is not actually chagrined and saddened in visiting such theatres, as for example the Rivoli or Rialto, where two years ago one could sit in restful repose listening to masterpieces of music well played by small but symphonic orchestras, or to the soothing diapason of the large organ, to contrast with the present shrieking noises which at best are only a sad burlesque of fine music, painful to endure?

When one makes this comparison, the thought of the thousands of musicians actually put out of employment by this loud-speaking Robot in whose development he perhaps has had a leading, if not criminal, hand, it bids him pause to take counsel with his conscience.

In all seriousness then it behooves us of the radio profession and its by-products to concentrate every human effort upon this urgent and highly baffling task of bringing back real music to the cinema and real voices to the theater screen. Or, if not, let an outrageous and long-suffering public rise in its righteous wrath and curse us.

One word more and I am done. Mythology tells us of a sleeping giant, the Cyclops, having one eye centered in his forehead. Today that giant is yet an infant—Television, with one pink eye. But already he is stirring, is growing, already muttering radio sound, and groping in the dark to find in which way to travel.

Let us begin now to watch closely this wonder, to guide by careful thought, by standardization of line and frequency bands his broadcasting, to the end that in the briefest possible time we may have, in as equally perfected form and available for every home, the visual accompaniment of the radio voices. This advance is so closely at hand that the organization of an Institute Committee on Television may now be in order.

Fellow members of the Institute of Radio Engineers, as one of the founders who has followed through the swift years the still swifter growth of this splendid science—I take justifiable pride in all your amazing achievements.

Conscious of our past triumphs over nature (physical and human), frankly acknowledging the shortcomings still to be made good, let us not pause a moment in our onward stride, but again highly resolve that what radio has thus far accomplished in the cause of a higher civilization is but a brave beginning, the blazing of a trail, an earnest of yet greater things which lie before us for the welfare of mankind.

Faint, illegible text at the top of the page, possibly a header or title.

Second block of faint, illegible text, appearing as several lines of a paragraph.

Third block of faint, illegible text, continuing the paragraph or starting a new one.

Fourth block of faint, illegible text, showing the middle section of the page.

Fifth block of faint, illegible text, appearing towards the bottom of the page.

Sixth block of faint, illegible text, the final section of text on the page.

Final block of faint, illegible text at the very bottom of the page.

PART II
TECHNICAL PAPERS

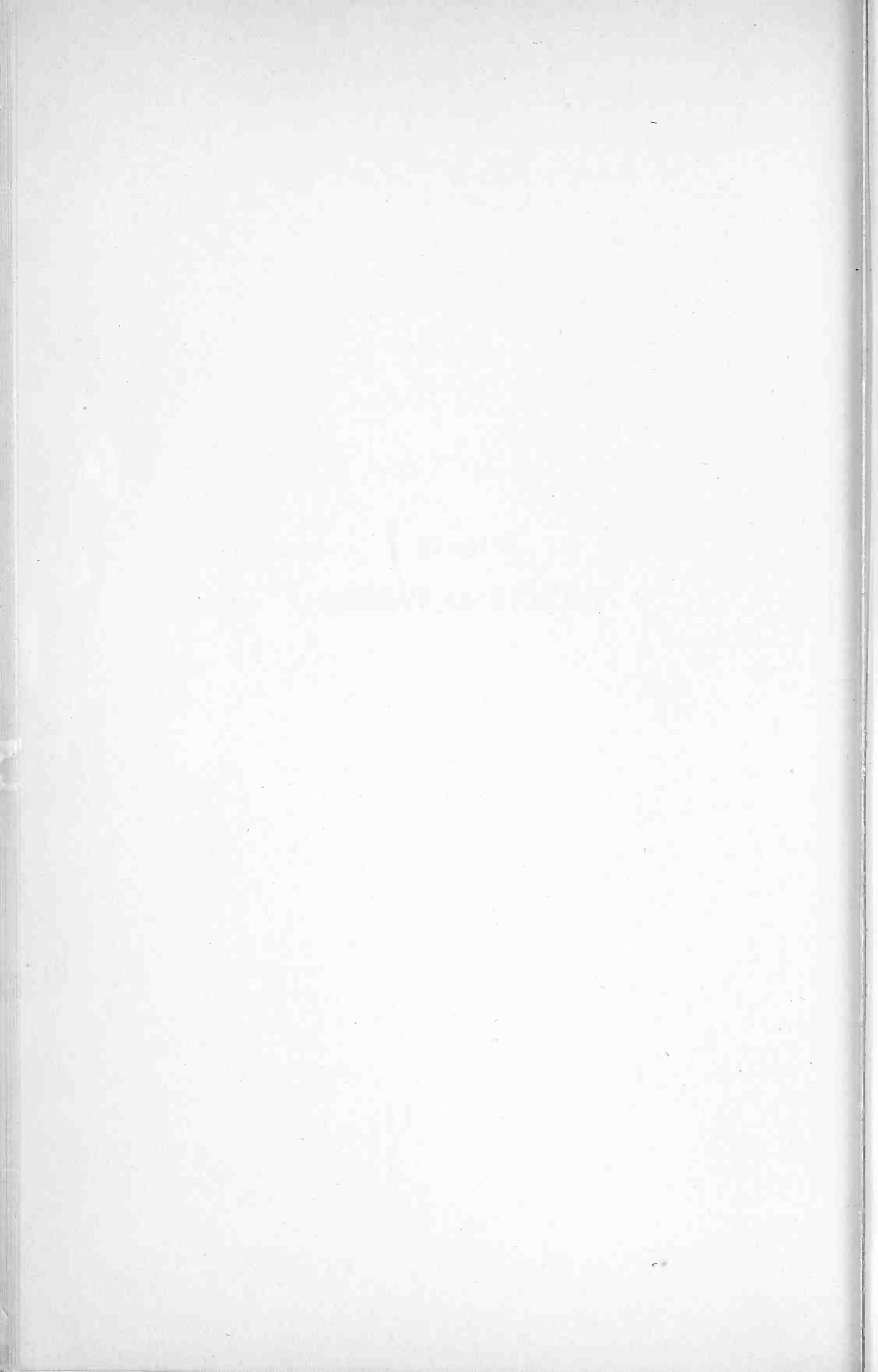

ULTRA-SHORT WAVES FOR LIMITED RANGE COMMUNICATION*

BY

W. J. BROWN

(Uxbridge, Middlesex, England)

Summary—Experiments on short-distance communication using a wavelength of two meters together with details of equipment used are described. A range of over 12 miles was obtained with a super-regenerative receiver. The advantages of a limited-range short-wave system for certain maritime and other purposes are listed.

INTRODUCTION

SOME YEARS ago, while investigating various methods for producing short-wave oscillations it was decided to make a serious investigation into the possibility of using wavelengths of the order of two meters and below for communication purposes.

A fair amount of experimental work had already been carried out on methods of producing short-wave oscillations of limited power,

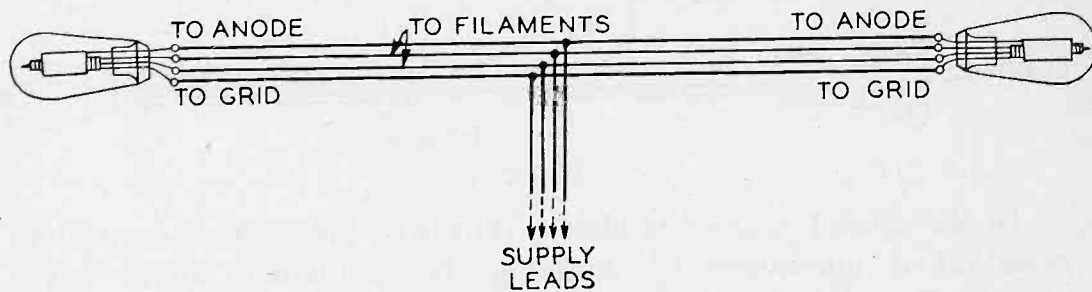

Fig. 1

and this had shown an arrangement, comprising a pair of ordinary 5-watt tubes having their bases removed and their corresponding electrodes connected by straight parallel conductors, to be satisfactory. Two varieties of this kind of oscillator had been tried, as shown in Figs. 1 and 2. In the first of these, the tubes are located at the extremities of a perfectly straight system of conductors, while the leads for supplying energy to the system are connected to the mid-point of the straight-conductor assembly. In operation the straight conductors form, together with the interelectrode capacities of the tube, an oscillatory circuit, and if the conductors are suitably arranged so as to obtain correct phasing of the anode and grid voltages, the tubes will generate oscillations at a wavelength depending upon the length of the system.

* Dewey decimal classification: R 402.

As the arrangement is symmetrical about the mid-point of the conductor system, this point is a potential node on the oscillatory circuit and provided the power supply leads are connected to this point and taken away roughly at right angles to the oscillatory circuits, no radio-frequency currents will flow in the supply leads and there will be no power loss on this account.

Since the length of the oscillatory circuit is a considerable fraction of a wavelength, a fairly high percentage of the radio-frequency energy produced will be radiated into space, and the transmitter thus forms, to a certain extent, its own antenna, though the radiation is improved by coupling to the transmitter circuit a regular half-wave antenna.

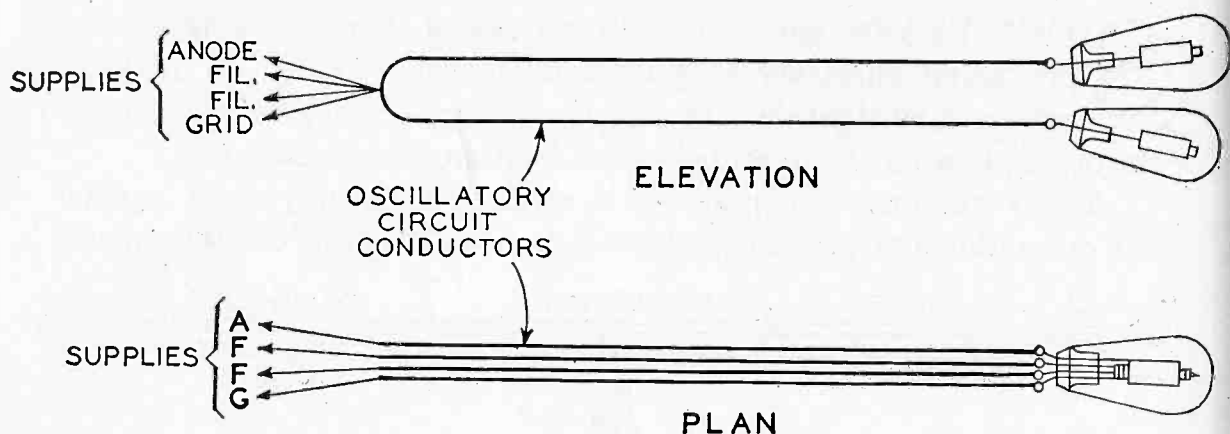

Fig. 2

In the second type of oscillator shown in Fig. 2, high-frequency radiation is minimized by doubling the oscillatory circuit back upon itself so that the currents in the two halves of the circuit produce equal and opposite fields at a distance.

This type of oscillator was used in the earliest communication experiments. The radiating system comprised a half-wave antenna which was broken at its mid-point and connected so as to include a short length of the tube oscillator circuit (see Fig. 3). By adjusting the points at which the two halves of the antenna are tapped on to the oscillatory circuit, the loading imposed on the oscillator by the antenna may be varied at will. The dimensions of a satisfactory arrangement, with reference to Fig. 3, were as follows:

total length of oscillatory circuit ($OA - OB$)	= 50 cm
total length of antenna ($UX - VY$)	= 100 cm
length of common coupling circuit ($XO - OY$)	= 5 cm
distance apart of parallel circuits (XY)	= 1.25 cm
type of tube employed	Marconi LS5
wavelength	2.00 meters

The radiation was estimated by a small hot-wire ammeter located in the antenna circuit at X or Y. Typical results for the arrangement were

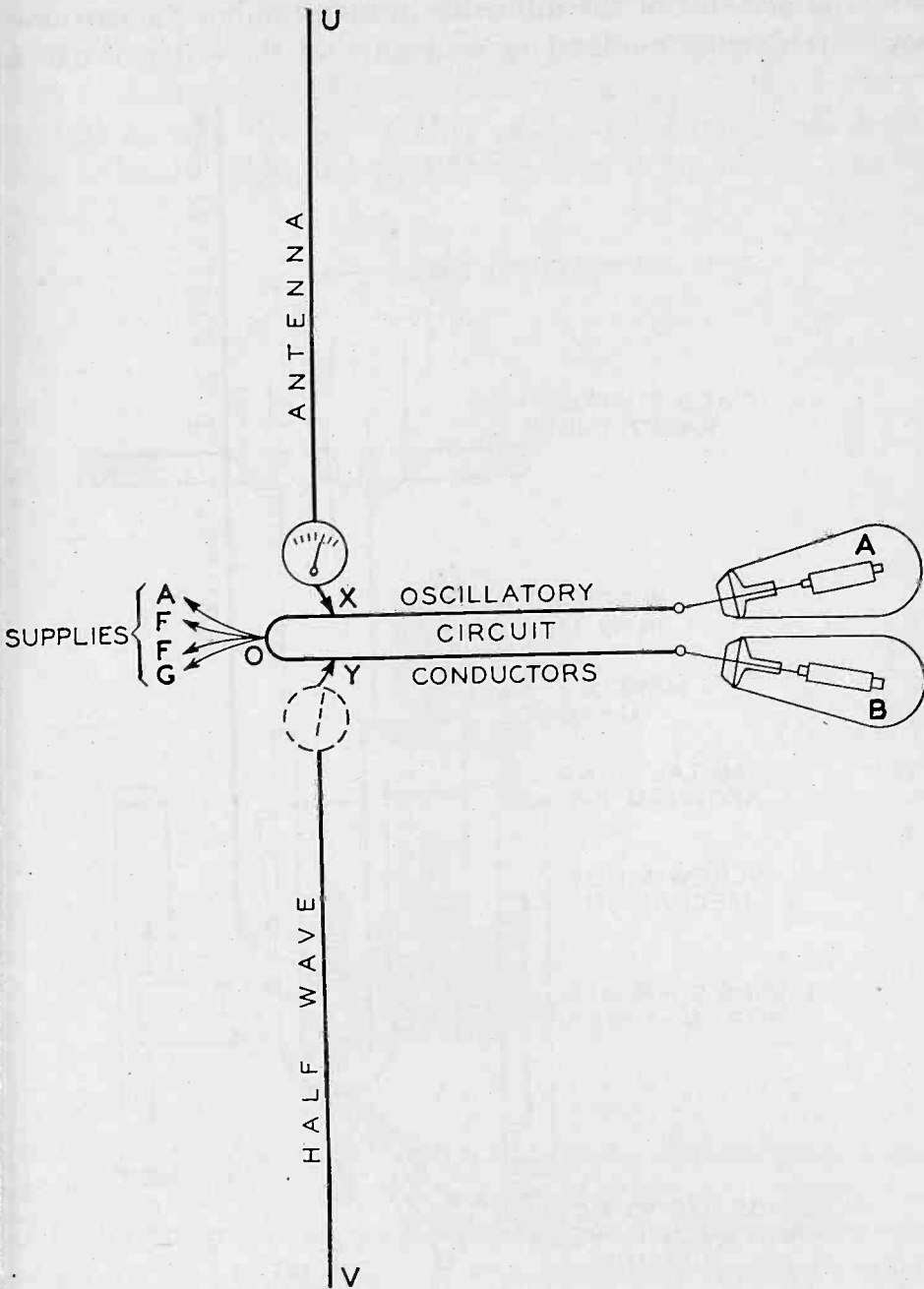

Fig. 3

r.m.s. a-c voltage applied to anodes (500 cycles) = 500 volts
 average value of plate current = 50 milliamperes
 antenna ammeter reading = 0.3 amperes

It should be noted that the antenna ammeter reading is useful for comparative purposes only, and its absolute value is subject to considerable error at such high frequencies.

As the arrangement is symmetrical about the mid-point of the conductor system, this point is a potential node on the oscillatory circuit and provided the power supply leads are connected to this point and taken away roughly at right angles to the oscillatory circuits, no radio-frequency currents will flow in the supply leads and there will be no power loss on this account.

Since the length of the oscillatory circuit is a considerable fraction of a wavelength, a fairly high percentage of the radio-frequency energy produced will be radiated into space, and the transmitter thus forms, to a certain extent, its own antenna, though the radiation is improved by coupling to the transmitter circuit a regular half-wave antenna.

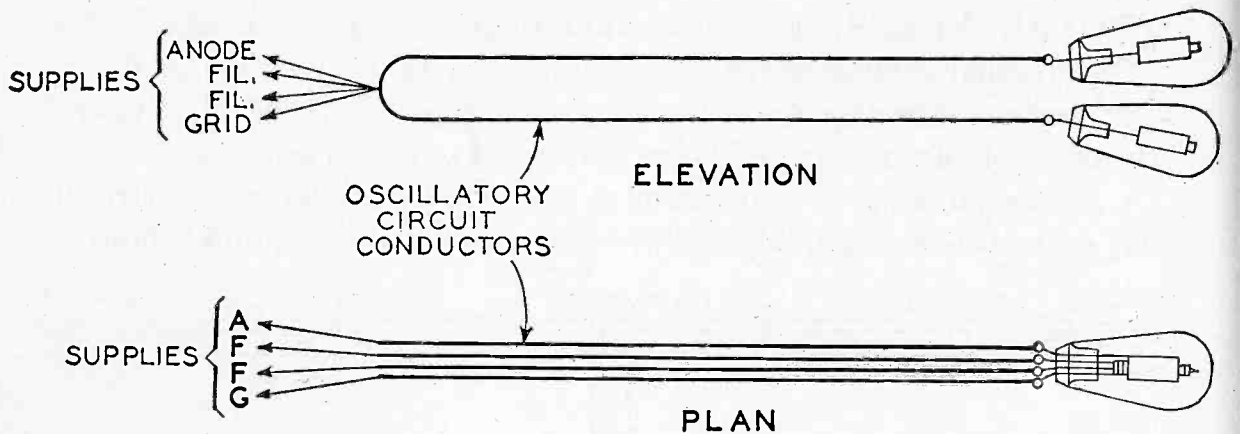

Fig. 2

In the second type of oscillator shown in Fig. 2, high-frequency radiation is minimized by doubling the oscillatory circuit back upon itself so that the currents in the two halves of the circuit produce equal and opposite fields at a distance.

This type of oscillator was used in the earliest communication experiments. The radiating system comprised a half-wave antenna which was broken at its mid-point and connected so as to include a short length of the tube oscillator circuit (see Fig. 3). By adjusting the points at which the two halves of the antenna are tapped on to the oscillatory circuit, the loading imposed on the oscillator by the antenna may be varied at will. The dimensions of a satisfactory arrangement, with reference to Fig. 3, were as follows:

- total length of oscillatory circuit ($OA - OB$) = 50 cm
- total length of antenna ($UX - VY$) = 100 cm
- length of common coupling circuit ($XO - OY$) = 5 cm
- distance apart of parallel circuits (XY) = 1.25 cm
- type of tube employed Marconi LS5
- wavelength 2.00 meters

The radiation was estimated by a small hot-wire ammeter located in the antenna circuit at X or Y. Typical results for the arrangement were

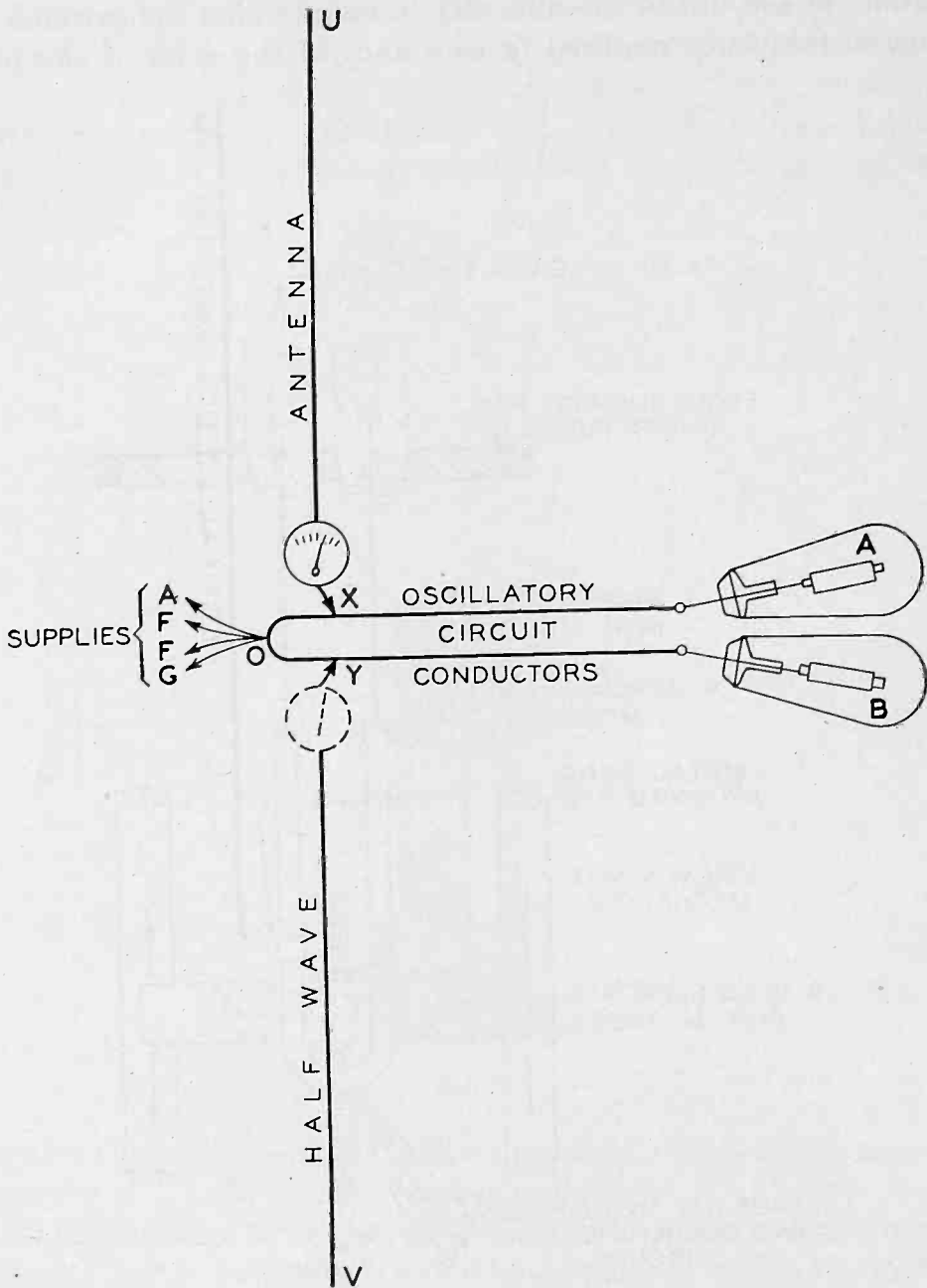

Fig. 3

r.m.s. a-c voltage applied to anodes (500 cycles) = 500 volts
 average value of plate current = 50 milliamperes
 antenna ammeter reading = 0.3 amperes

It should be noted that the antenna ammeter reading is useful for comparative purposes only, and its absolute value is subject to considerable error at such high frequencies.

As the arrangement is symmetrical about the mid-point of the conductor system, this point is a potential node on the oscillatory circuit and provided the power supply leads are connected to this point and taken away roughly at right angles to the oscillatory circuits, no radio-frequency currents will flow in the supply leads and there will be no power loss on this account.

Since the length of the oscillatory circuit is a considerable fraction of a wavelength, a fairly high percentage of the radio-frequency energy produced will be radiated into space, and the transmitter thus forms, to a certain extent, its own antenna, though the radiation is improved by coupling to the transmitter circuit a regular half-wave antenna.

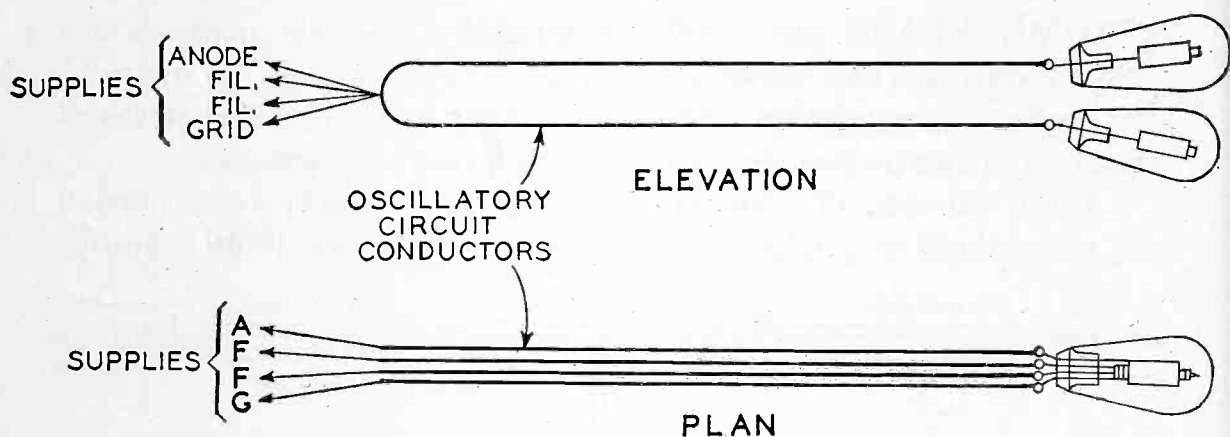

Fig. 2

In the second type of oscillator shown in Fig. 2, high-frequency radiation is minimized by doubling the oscillatory circuit back upon itself so that the currents in the two halves of the circuit produce equal and opposite fields at a distance.

This type of oscillator was used in the earliest communication experiments. The radiating system comprised a half-wave antenna which was broken at its mid-point and connected so as to include a short length of the tube oscillator circuit (see Fig. 3). By adjusting the points at which the two halves of the antenna are tapped on to the oscillatory circuit, the loading imposed on the oscillator by the antenna may be varied at will. The dimensions of a satisfactory arrangement, with reference to Fig. 3, were as follows:

total length of oscillatory circuit ($OA - OB$)	= 50 cm
total length of antenna ($UX - VY$)	= 100 cm
length of common coupling circuit ($XO - OY$)	= 5 cm
distance apart of parallel circuits (XY)	= 1.25 cm
type of tube employed	Marconi LS5
wavelength	2.00 meters

The radiation was estimated by a small hot-wire ammeter located in the antenna circuit at X or Y. Typical results for the arrangement were

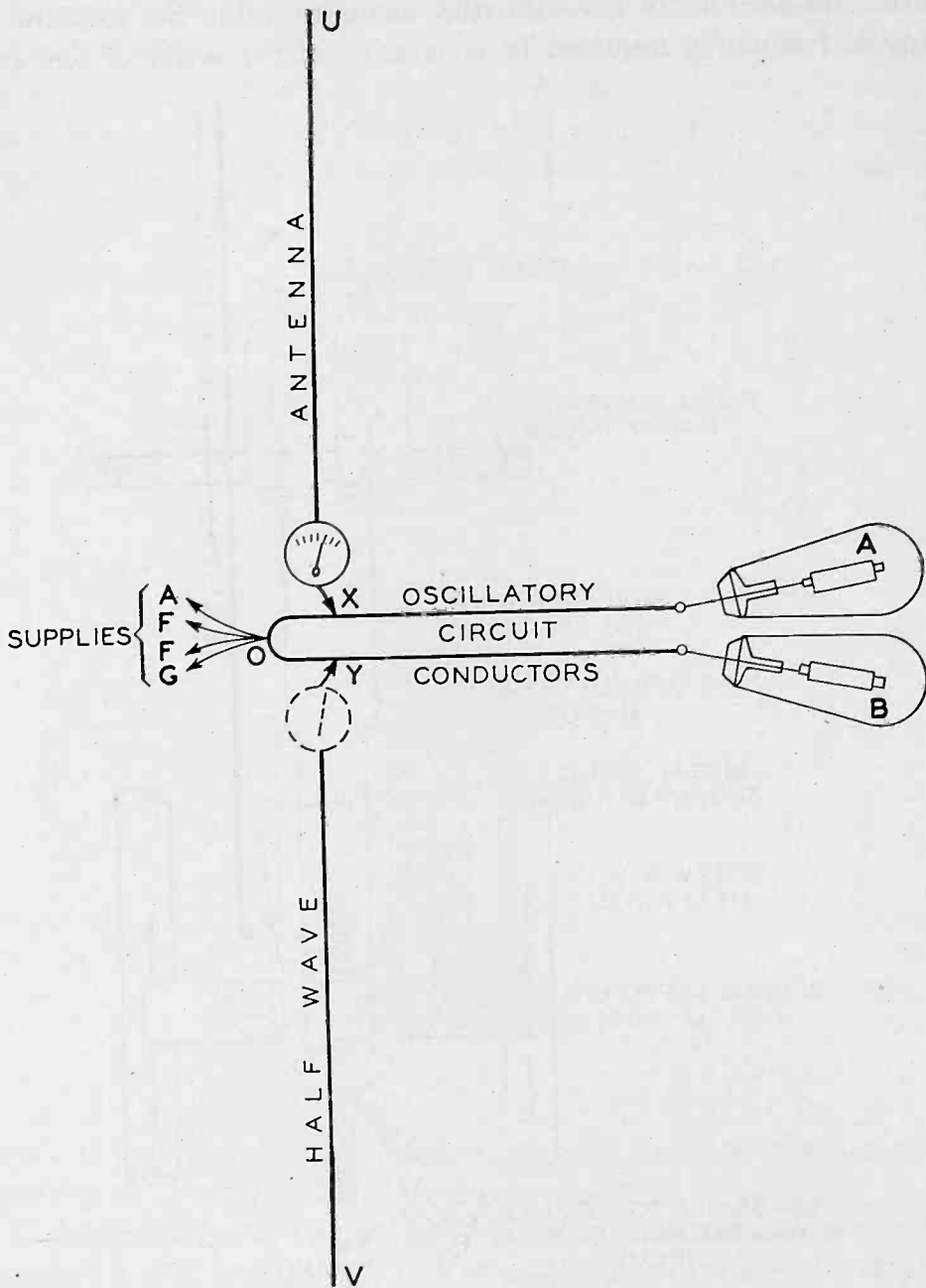

Fig. 3

r.m.s. a-c voltage applied to anodes (500 cycles) = 500 volts
 average value of plate current = 50 milliamperes
 antenna ammeter reading = 0.3 amperes

It should be noted that the antenna ammeter reading is useful for comparative purposes only, and its absolute value is subject to considerable error at such high frequencies.

RECEIVING APPARATUS

The next question was to decide on the most suitable type of receiver. Heterodyne reception appeared at the time to be out of the question on account of the difficulty in maintaining the extreme constancy of frequency required (a constancy of the order of one in ten

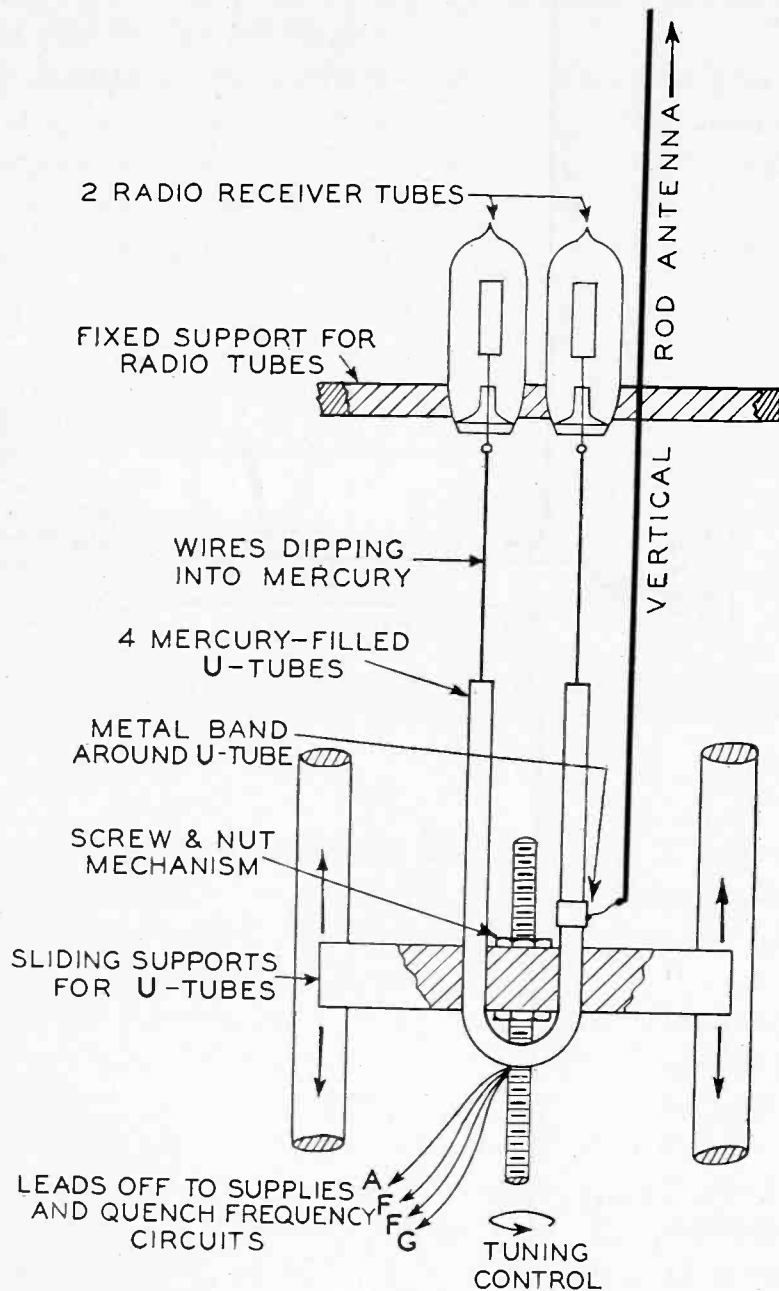

Fig. 4

million), and greater sensitivity was required than could be obtained by using an a-c transmission and a regenerative receiver. The super-heterodyne again was considered too critical in its demands for constancy of frequency. The super-regenerative or periodic-trigger type of receiver appeared to be the most promising since this combines the

qualities of extremely high sensitivity and flatness of tuning. Experience with this type of receiver at wavelengths of the order of 20 to 100 meters had already shown it to retain these properties at short wavelengths, and furthermore, they showed that at such wavelengths this type of receiver lost its objectionable uncontrollability and became in fact unusually easy to manipulate. The quenching frequency may be well above audibility so that the circuit does not have the objectionable high-pitched whistle that occurs with long-wave

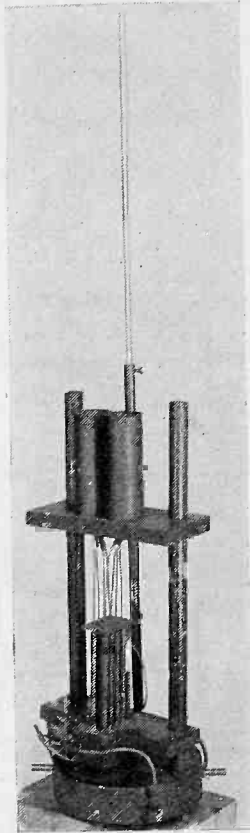

Fig. 5

reception; for the two-meter receiver about to be described, a quench frequency of 300,000 cycles was employed.

The adjustment or control of the short-wave tuning of the receiver presented a new problem; it was considered inadvisable to employ a variable condenser, however small, for this purpose on account of the desirability of keeping the L/C ratio as high as possible. It was finally decided to employ a circuit similar to that used for the transmitter shown in Fig. 3, and to adjust the tuning by varying the length of the straight oscillatory circuits OA , OB . This was carried into effect by mounting the U -shaped oscillatory circuit in a vertical position and making the lower portion of it consist of a system of

ebonite *U*-tubes filled with mercury, while the upper portion comprised a set of straight rods sliding in the *U*-tubes. Tuning was effected by raising or lowering the *U*-tubes, thus shortening or lengthening the circuit. The arrangement is shown diagrammatically in Fig. 4, with a photograph in Fig. 5. The antenna comprised a quarter-wave vertical type attached to a metal band encircling one limb of the *U*-tube connecting the grids of the radio tubes.

The apparatus just described comprises the oscillatory detector unit of the short-wave super-regenerative receiver and its position in

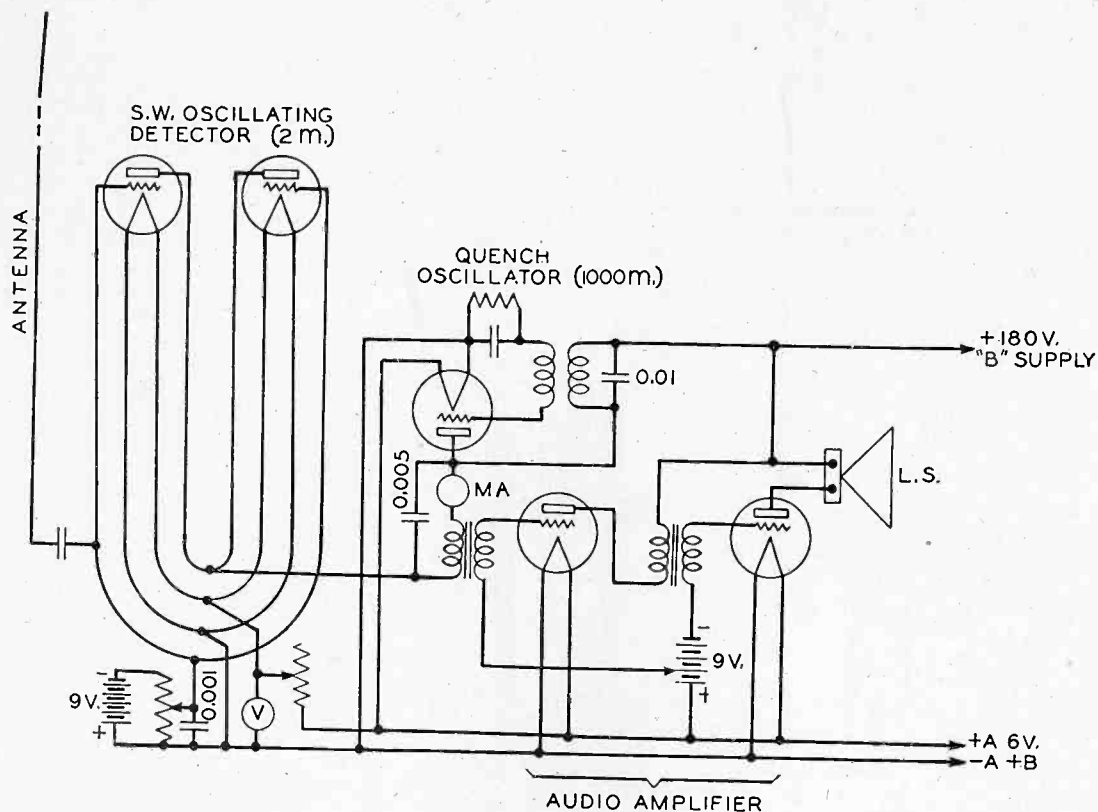

Fig. 6

the circuit is indicated in the receiver diagram, Fig. 6. In the practical layout of the portable receiver employed for the tests, this oscillatory detector unit with its antenna was mounted on the top of a copper-lined wood box measuring roughly 24 in. long by 14 in. wide by 11 in. deep; this box contained the whole of the quenching-oscillator and audio-amplifier circuits as well as the batteries and loud speaker.

The only portions of the receiver which were external to the screening box were the oscillating detector and its antenna, the loud-speaker horn, and the controls. All the controls were mounted at one end of the copper-lined box, including the short-wave tuning control which operated through a bevel gear and a screw-and-nut movement to raise and lower the *U*-tubes.

In the tests about to be described, the transmitter referred to above and shown in Fig. 3 was supplied with alternating current at 500 cycles, and the receiver picked out this audio-modulation frequency.

RANGE TESTS

Preliminary trials indicated that a range of the order of several miles was to be expected, and a series of tests was therefore carried out along the coast of North Wales, to make definite observations of the range. The North Wales coast was chosen for these experiments since it comprises a number of wide bays, across which signals could be transmitted without the intervention of land. Since the possible

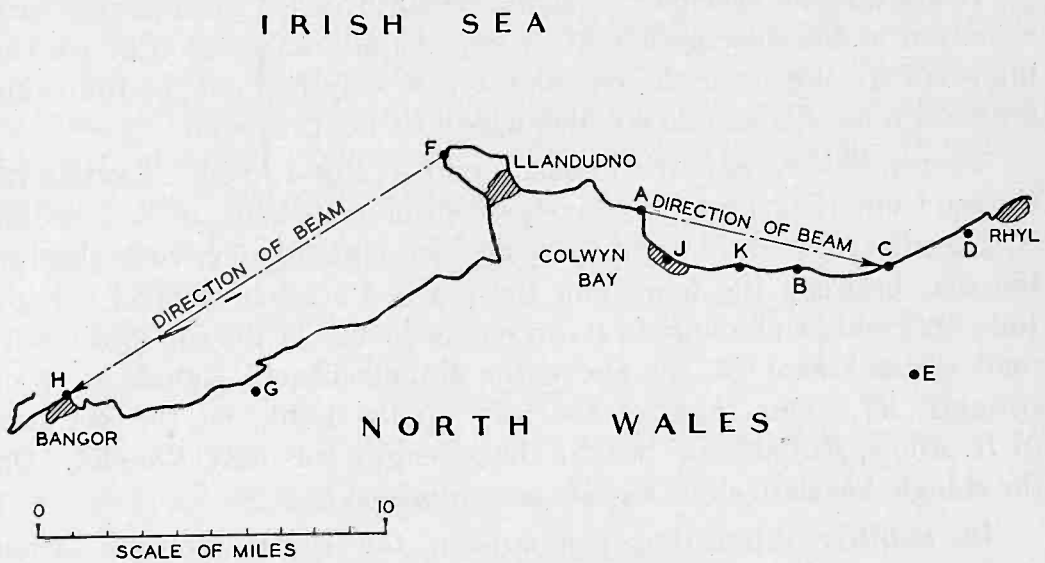

Fig. 7

applications of the system are principally for maritime purposes, the above tests simulated the working conditions which would be encountered in practice.

For the purpose of the tests, the transmitter and antenna complete were mounted on a 7-ft. vertical ash pole and the necessary low-frequency power was supplied through a four-core flexible cable. It should be noted that this cable carried no high-frequency currents and that the transmitter is so small and light that it may be mounted together with its antenna in any convenient position, remote from the power source and from the keying position.

Anode power supply for the transmitter was taken from a generator mounted on an automobile, delivering 500 volts at 400 to 500 cycles, the average plate current being 50 milliamperes corresponding roughly to a power of 20 watts. A supply for the filaments (5 volts, 1 1/2 amperes) was taken from the car starter battery and all control

and keying operations were effected from a small control box mounted on the running board of the car. In operation an antenna ammeter reading of 0.3 was obtained.

The receiver was carried around in a second automobile and the procedure was to erect the transmitter at some convenient point on the coast and to explore the signal strength along the coast with the portable receiver. The results of some of these tests will now be given, and reference may be made to the map in Fig. 7 for the location of the transmitter and receiver during the tests.

EFFECT OF HEIGHT ON SIGNAL STRENGTH

It was quickly verified that signal strength varied considerably with variation in the average height of the line of transmission above the intervening country or the sea, as the case may be, and the following is an example of tests taken which will illustrate this point:

Transmission was carried out at point *A*, Fig. 7, from a position on the sea front 15 ft. above sea level, reception tests being made at point *B*, 4.2 miles distant. At point *B* a railroad embankment runs close to the sea; between the bank and the sea is a stretch of level shingle 100 yards wide and about 15 ft. above sea level. At the top of the railroad embankment (25 ft. above the shingle beach) signals were of strength *R7*. One third of the way up the bank, on the sea side (9 ft. above the shingle beach) the strength was only *R3*—*R4*. On the shingle beach itself no signals were received.

In another interesting comparison, the signal strength when transmitting from point *A*, 15 ft. above sea level, was *R5* at 6 1/2 miles (point *C*) and *R3* at 8 1/2 miles (point *D*), the receiver being in each case at the top of a bridge over the railroad, about 20 ft. above the surrounding country, which itself was not more than 15 to 30 ft. above sea level. On the side of a hill (point *E*), at a distance of 8 miles from the transmitter, and at a point 815 ft. above sea level, the strength was *R7*. In this case there were hills intervening between the transmitter and receiver which prevented a direct view from one to the other; on the other hand the "line of transmission" was well above the intervening country.

The transmitter was next moved to a part of the coast where high cliffs prevail and was installed at the top of the cliff at point *F*, about 400 ft. above sea level. Signals were now of great strength *R9* at points *G* and *H* which were 10 1/2 and 12 1/4 miles distant, respectively, and about 25 ft. above sea level. Unfortunately time did not permit of the ultimate range being determined under these conditions.

REFLECTOR EXPERIMENTS

Tests were made with a portable parabolic reflector to determine the improvement in signal strength and also the degree to which the signal strength could be reduced in the unwanted directions. The reflector comprised 50 aluminum wires 18 gauge, each 1 meter in length, suspended vertically around the circumference of a parabola of focal length 50 cm, the "aperture" or greatest diameter of the parabola being 5 meters (i.e., $2\frac{1}{2}$ wavelengths).

Transmission was carried out from point A, with the reflector directed towards point C. Transmissions were made alternately with and without reflector, and reception tests were made at various points in the immediate locality behind and to the side of the reflector and then at various points along the coast in front of the reflector. In all cases the receiver was purposely rendered insensitive by detuning the antenna, so that the louder of the two signals was of just comfortable strength, otherwise comparison would have been impossible. The results of these tests were as follows:

Receiver location	Deviation from center of beam	Strength with reflector	Strength without reflector
Local	160 deg.	R2	R5-R6
Local	128 deg.	R2	R9
J	80 deg.	R4	R9
K	21 deg.	R5	R2
L	8 deg.	R7	R3
C	0 deg.	R7	R2

The code of signal strength employed above is as follows:

- R1 Signal just audible but unreadable
- R4 Signal just readable
- R7 Signal of comfortable strength

Intermediate values estimated accordingly.

The tests of which the above are typical examples indicated that the range obtainable over sea at a wavelength of only two meters is quite a useful one for certain particular purposes which will be discussed later on. Meanwhile, other tests were made under conditions other than oversea conditions as a matter of general interest.

With the transmitter installed at ground level in an open courtyard near the center of a city, reception was carried out in an automobile in the city streets up to a distance of a mile. At this distance the signal strength varied greatly according to whether the street in which the receiver was located ran along or across the line of transmission, the greater strength being of course obtained in the streets running along the line of transmission. The overhead wires belonging to the street-car system did not have a very serious effect; sometimes

they weakened and sometimes they strengthened the signal. Where the street passed under a street railroad bridge, however, a distinct shadow was cast.

With the transmitter located on the roof of a 50-ft. building near the city center, reception could be obtained almost without interruption for a distance of two miles through the streets.

Tests made in the open country indicated that the range depended very largely on topographical conditions and varied from 4 to 15 or 20 miles. Good reception was obtained when the line joining transmitter and receiver averaged a good height above the intervening country and also when the ground at the receiver end sloped down towards the transmitter. Contrary to a popular belief, however, it was not necessary that the transmitter should be visible from the receiver; the average height of the line of transmission and the slope of the ground appeared to be the determining factors. Reception could be carried out even inside sheet-steel structures where it might be expected to be impossible on account of screening effect.

LIMITED-RANGE FEATURE

In "long-wave" radio communication a portion of the received signal is due to the direct or "ground" ray and a further portion is reflected or refracted down from the Heaviside layer. At short distances we receive chiefly the ground ray, but as the distance increases this becomes rapidly attenuated and we become more and more dependent on the reflected ray for reception.

At shorter wavelengths, between 10 and 20 meters, we do not begin to receive the reflected ray until we have gone some distance beyond the limiting range of the ground ray. The assumed reason for this "skip zone", in which no signals can be received, is that the 20-meter wave is incapable of reflection through such a sharp angle as are the longer wavelengths, so that it may not return to earth until a distance of 1000 miles or so has been covered. As the wavelength is still further reduced, the "skip distance" increases and there is every reason to suppose that below a certain wavelength the reflected ray will never return to the earth at all. A. Hoyt Taylor has collected together a large amount of experimental data and has correlated this with the ray theory in an attempt to estimate the shortest wavelength at which long distance signals can be received.

The minimum wavelength for long distance reception appears to vary from about 25 meters on winter nights to something of the order of 7 meters under abnormal summer conditons. He suggests that possibly very occasional long-distance reception might be obtained

at 5 meters. It would thus appear justifiable to assume that a wavelength of 2 meters will be immune from the possibility of long-distance pick-up under all conditions.

T. L. Eckersley¹ has also discussed the "short-wave limit" and has given an alternative explanation on the "attenuation theory" as distinct from the "ray theory" as A. Hoyt Taylor and others. Eckersley places the short-wave limit at roughly 7 meters in darkness and 8 to 10 meters in daylight under normal conditions.

Assuming the above evidence to be correct, the all-important result follows that the two-meter system will have a *limited range* which can be *determined at will* since it will depend simply upon the ground attenuation, which is constant, at any rate over sea. For instance, if it is desired to signal over a distance of 10 miles, the transmitter power and height can be adjusted to suit this range when it can be safely predicted that the signal is incapable of being picked up outside a radius of say 20 or 30 miles at the same level. Such limitation of range has never been possible before, for however low the transmission power there has always been the possibility of "freak" reception at great distances owing to reflection from the Heaviside layer.

DIRECTIONAL TRANSMISSION

To produce a concentrated "beam" we must have a reflector which is several wavelengths in breadth and possibly in height. If the reflector size is limited, as it must be on a ship or aircraft, we realize that conversely in order to obtain a beam the wavelength must be short in comparison with the possible dimensions of the reflector. The two-meter system requires a reflector but a few yards in length, while still shorter wavelengths and smaller dimensions may perhaps be attained by using the special oscillator construction to be described later. It should be noted that the superficial area of the reflector will decrease as the square of the wavelength.

The "beam" feature in conjunction with the "limited range" feature might be expected to ensure that when sending to a point 10 miles distant the signal cannot be picked up outside a 3 or 4 mile radius in the wrong direction.

RADIO-FREQUENCY MODULATION

By modulating the two-meter wave at a radio- instead of an audio-frequency we have a transmission which can be received under certain conditions by an ordinary super-regenerative receiver. It can

¹ T. L. Eckersley, "Short-wave wireless telegraphy," *Jour. I.E.E.* (London, 660-664; June, 1927.

only be received, however, if the quenching frequency is adjusted so as to give an audible beat note with the modulation frequency. Hence anyone attempting to intercept the transmission has to adjust his receiver to two independent frequencies simultaneously. Apart from the advantage of secrecy, the number of possible channels of communication is enormously increased, since a large number of independent

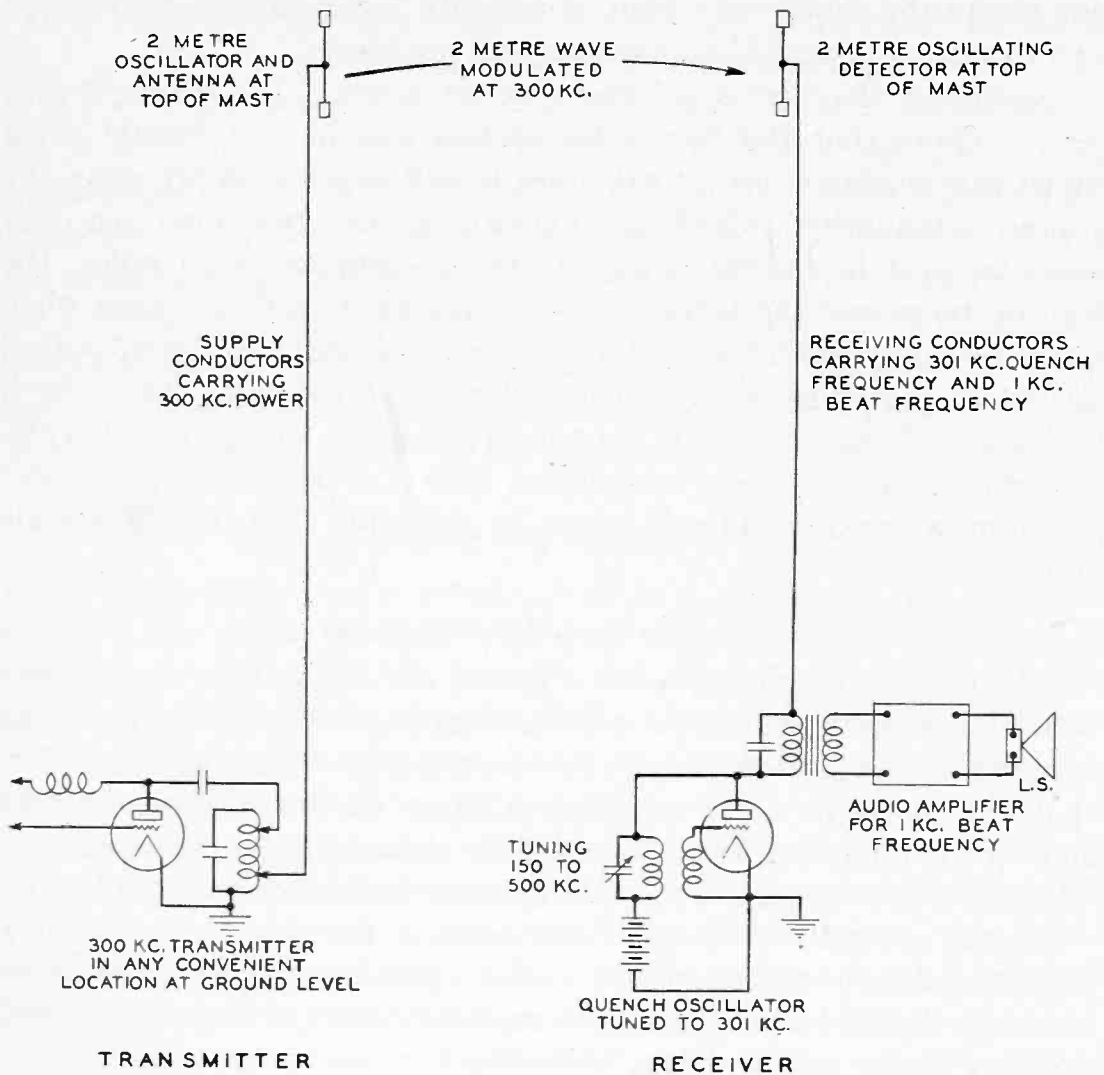

Fig. 8

transmissions may be made at the same short wavelength by using different modulation frequencies, e.g., 150, 175, 200, 225, 250, 275, 300, etc., kc.

The short wavelength may be fixed, or adjustable between narrow limits only, thus leaving the operator free to concentrate his attention on adjusting the long-wave tuning. We should visualise and ordinary 150- to 500-kc transmitter at one end and a 150- to 500-kc receiver at the remote end. The only difference between this and an ordinary long-wave system is that instead of supplying say, 300-kc

power to an ordinary long antenna, this power will be supplied to a small two-meter oscillator and antenna which will preferably be slung at the top of a mast, the same principle being adopted for reception. This is illustrated by Fig. 8.

It is of course realized that there is nothing new in modulating a radio transmitter at a lower radio frequency, but this becomes more practicable the shorter the wave on account of the greater difference between the carrier and modulation frequencies.

COMMERCIAL APPLICATION

The above characteristics immediately suggest a number of commercial and other applications such as the following:

(1) For signalling between neighboring shipping, between ship and shore, or between aircraft and ground in case of fog. Such a fog-signalling system might take the form of a continuous warning emitted by a short-wave transmitter aboard every ship, with a receiver located aboard each ship for detecting the presence of a nearby transmitter other than its own. All transmitters and receivers would operate on a common wavelength, and interference between the two units on board any single ship would be prevented by one of the usual duplex methods, for instance by transmitting and receiving on alternate half-cycles of an a-c supply, which supply is of slightly different frequency for every ship.

By employing a directional loop receiver the bearing of a neighboring ship could be determined. By a slight extension to the scheme it could be arranged that each transmitter is directional and sends out a beam which rotates at a regular speed about a vertical axis. By transmitting suitable signals when the beam is pointing North and South and at each point of the compass any neighboring ship could estimate the bearing without possessing a directional receiver by the usual method of noting which of the compass points are received at maximum and at minimum strength. By arranging that further special signals are transmitted when the beam is pointing dead ahead and dead astern the direction of travel may be indicated to a neighboring ship as well as the bearing of one ship in relation to the other.

Ordinary radio wavelengths cannot conveniently be employed for the above purpose owing to the fear of jamming at comparatively long distance; a system having a limited range would appear to be essential.

(2) For communication over short distances in special cases where absolute secrecy is required the system appears to have advantages possessed by no other system. It is generally recognized that

any wavelength above about 7 to 10 meters may be accidentally picked up at remote quarters of the globe, while the indications are that with wavelengths around two meters this will be impossible.

(3) It has already been suggested that icebergs, etc. might be detected by short-wave radio and it is possible, for instance, that this would be done by projecting a short-wave beam and observing whether any energy were reflected back to the source. A similar method might be employed for estimating the height of aircraft above ground.

(4) The system might have some applications to television transmission in that the shortness of the wave permits of an unusually high modulation frequency.

While the experiments described earlier in this paper are interesting as showing that the range obtainable with quite low powers is of utility for special purposes it is quite clear that it would be useful to be able to increase the range; this can be done in two ways, by increasing the power of the transmitter, and by increasing its height above the ground level. Both methods have been explored in the following ways:

INCREASED TRANSMITTER HEIGHT

For maximum range the transmitter complete with its antenna

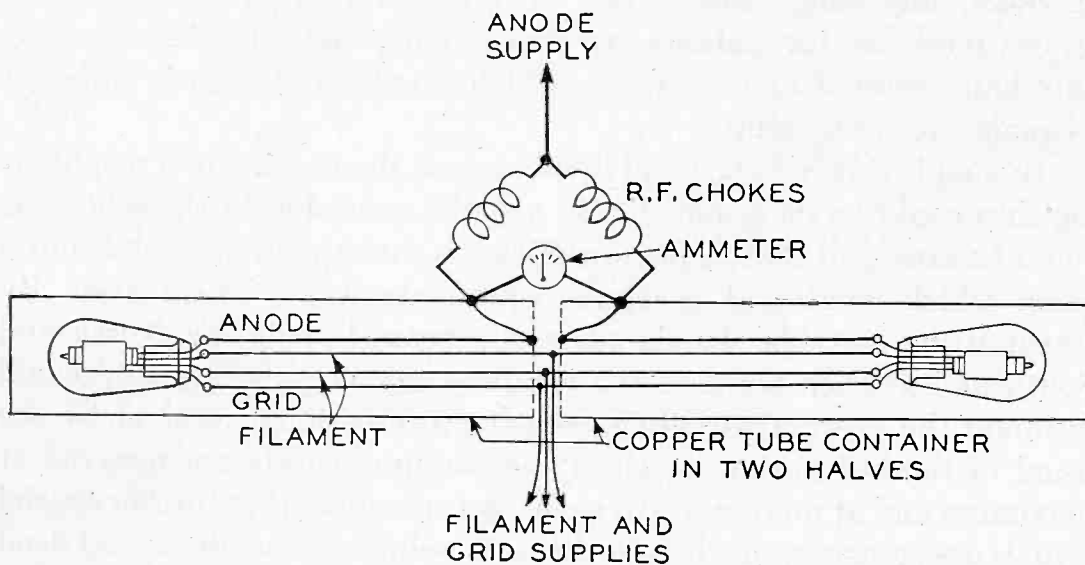

Fig. 9

should be as high as possible above ground level. When used on board ship it should be slung at the mast-head if possible, but if this is done the transmitter must naturally be of very robust design. A simple solution of the problem is to enclose the whole of the transmitter in a copper container which may be of tubular form and which may be so proportioned that the container itself acts as the transmitting antenna. A model was made up on this principle in which an oscillator of the

type shown in Fig. 1 was employed, dimensioned to generate a two-meter wave. Two copper tubes each 4 in. in diameter and a half a meter in length were slipped over the transmitter and arranged so as to have a small adjustable gap between the tubes at the center. Various methods for coupling the tubular antenna to the oscillator inside it were tried out.

The arrangement shown in Fig. 9 was quite satisfactory. An interesting point is that with such a circuit the gap at the center of the tubular antenna must exceed a definite minimum value, otherwise the coupling appears to be insufficient and very little radiation takes place. A gap of millimeter or two will suffice however.

Such an arrangement may be built in very robust form, by providing a central insulating collar having metal tubes rigidly attached to it. The oscillator may be mounted on suitable spring supports within the metal tubes.

INCREASED TRANSMITTER POWER

Any attempt to increase the transmitter power when using ordinary radio tubes involves serious difficulties in leading the high-frequency current through the seals and it also gives rise to excessive dielectric loss in the insulating material of which the seals are composed. These difficulties have, however, been largely overcome by developing a special type of oscillator in which the oscillatory circuits, as well as the tube electrodes, are enclosed in the same evacuated envelope, and with this type of oscillator an output of 100 watts has been obtained at a wavelength of two metres.



A RADIO-FREQUENCY POTENTIOMETER*

BY

WILLIAM W. MACALPINE

(International Communications Laboratories, Inc., New York City)

Summary—A potentiometer has been developed for the measurement of the amplitude and phase of voltages at frequencies up to at least 10^6 cycles per sec. Two slide wires are used which carry currents whose phases are approximately in quadrature. A method of standardizing the instrument is described, that is, of determining the relative phase and ratio of amplitude of the currents carried by the two slide wires. Due principally to distributed inductance, the constants, especially the phase angles, of the best networks of resistances and capacities which may be built up are uncertain at 10^6 cycles. The method of standardizing is to measure a suitable network and then rotate the phases of the currents in the potentiometer, or in the network, by about 90 deg., leaving their ratio and relative phases constant. The voltages of the network are again measured and a simple calculation gives the constants of the potentiometer and of the network. The ratio of the currents in the two slide wires or dials may be determined to within one per cent, and their phases to $1/2$ deg.

1. INTRODUCTION

POTENTIOMETERS have been used for some time for the measurement of the amplitude and phase of alternating currents and voltages. A practical a-c potentiometer was first introduced by Drysdale¹† who used a phase-shifting transformer. The most common type²⁻⁹ has been that in which the current through a slide wire passed through the primary of a mutual inductance. The secondary winding gave the quadrature component and this was varied either by varying the coupling or by a contact on a slide wire across the secondary. Other papers^{10-12,21} describe somewhat different types. A vacuum tube a-c potentiometer has been described by Wentz.¹³ A number of papers^{3,4,9,14-19} describe the uses of the instrument, among which are measurements in telephone, telegraph and cable work, various electrical networks, phase angle of impedances, magnetic properties and analysis, current transformers, and amplifiers. All the above papers referred to commercial and audio frequencies. The present instrument, designed for use at frequencies up to 10^6 cycles per sec. was first reported²⁰ at the December, 1928, meeting of the American Physical Society. Several of the improvements and refinements increasing the precision of the instrument have been made since then.

It has two circular slide wires, called the *R* dial and *C* dial, through

* Dewey decimal classification: R269. Developed at Columbia University for use in connection with research work for the Ph. D. degree.

† Refer to bibliography at end of paper.

which currents flow which are approximately equal in amplitude and approximately 90 deg. out of phase with each other. These are connected together at their mid-points and the two sliders are connected in series with the unknown potential through a selector switch, and a detecting device so that when the null point or balance is obtained the unknown potential is equal and opposite to the sum of the potential drops on the two slide wires between the sliders and mid-points of the respective dials. As an example of the range of the instrument, the voltage drop across the dials in the present experiments was usually 10 to 20 mv each side of the mid-point. Lower or higher ranges may be built with only minor changes in design.

2. DESCRIPTION OF INSTRUMENT

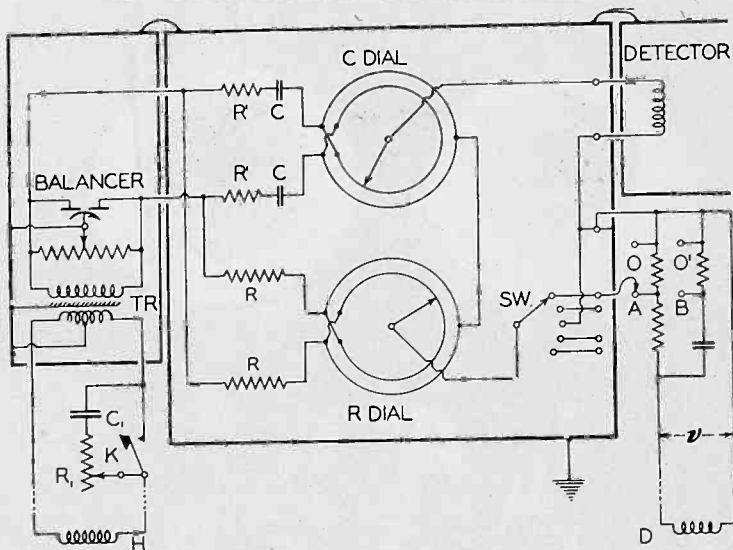

Fig. 1—The potentiometer circuits. Two test circuits shown at lower right corner.

The instrument and associated apparatus are shown in Fig. 1. The two slide wires are fed from the secondary of a shielded input transformer *Tr*. In series with the *R* dial are two resistances *R* of about 250 ohms each and with the *C* dial two condensers *C* each of about 250-ohms reactance at the frequency being used. Phase-correcting resistances *R'* will be discussed below. Each slide wire is stretched around the periphery of a bakelite disk 4 in. in diameter. In order to avoid unequal currents in the two halves of the slide wire a second wire is laid in a groove in the disk just above the slide wire and the mid-tap made on this wire. These two wires are connected in parallel in a bifilar manner to minimize external coupling. The wires are of No. 36 Nichrome and the resistance of the pair is 12 ohms.* A shaft

* Nichrome is somewhat magnetic but its skin effect does not reduce the accuracy of the instrument since it is accounted for in the method of standardization. The results of the standardizing tests show that the skin effect is small at 1000 kc in the sizes of wire used in the apparatus.

in an accurately centered bearing carries a bakelite arm, on the other end of which is a phosphor bronze sliding contact which presses lightly on the slide wire. A dial on the shaft is divided into 200 divisions around the complete circle, from -100 to 0 to $+100$. The resistances R each consist of about 10 in. of Nichrome wire 0.0015 in. diameter, which has 290 ohms per ft., the wire being wound on a strip of mica $3/8$ in. wide.

Fig. 2 shows the two dials and the selector switch. Of the four

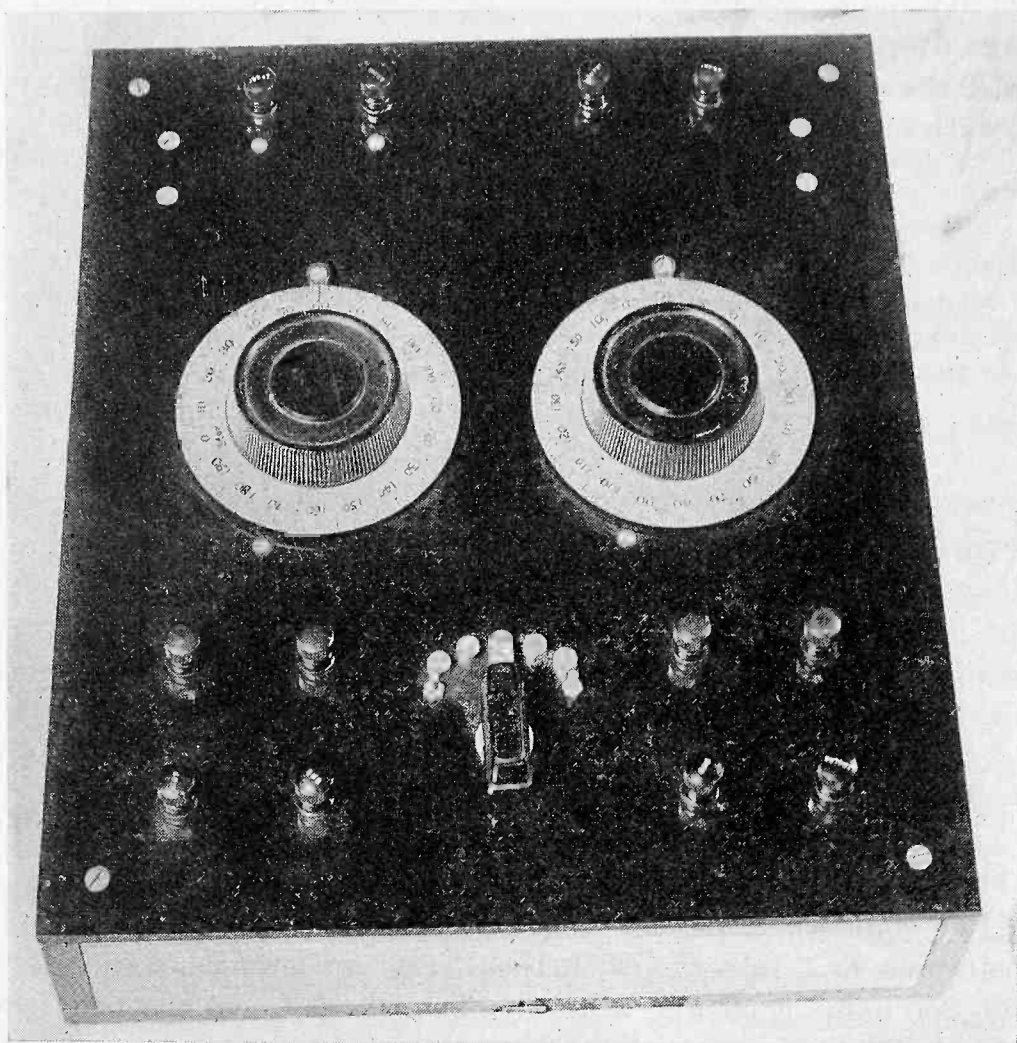

Fig. 2

binding posts at the bottom, three are ground and one output to detector. Above these are four posts connected to the points of the selector switch. The four posts at the top are the inputs to the two slide-wire circuits. General Radio dials are used, with graduations added around the part ordinarily left blank.

In Fig. 3 the box and shield are removed, showing the bakelite disks carrying the slide wires. The two approximately matched condensers and two 250-ohm resistances are at the lower end. All inactive

metal parts are grounded, including the dials. No shields are used between the various parts because of the smallness of all active current-carrying elements and the bifilar connection of slide wires and mid-tap wires. The standardization takes account of any coupling which exists.

The source of supply is a coil H coupled to the oscillator which supplies the system being measured. In some uses of the instrument an amplifier or other intermediate apparatus may be interposed between H and Tr , but it is obviously necessary that the same source must control the frequency and phase of both the potentiometer and the potentials being measured. The input transformer in the present case has a primary of 20 turns with mid-tap, on a 1 in. by 1 in. form. It is shielded inside and outside by copper foil. The secondary is spaced $1/8$ in. from the primary and has 30 turns space wound. At lower frequencies the same transformer may be used, inserting sections of Western Electric iron-dust core to increase its reactance.

A phase-shifting device C_1R_1 is provided, with a switch K to cut it out of circuit. C_1 is a variable condenser of 0.0015 μ f. maximum, and R_1 is usually under 100 ohms. There is also a balancing system mounted on the shielding box of the transformer. This system consists of a non-inductive potentiometer of 100,000 to 500,000 ohms total resistance bridged across the transformer secondary with its slider to the shield; and a special double midget condenser. The latter has a single plate on the rotor which goes to the shield, and two stator plates. Each stator plate goes to its own end of the secondary and they are so arranged that when the rotor is turned its capacity to one stator is increased and that to the other decreased.

The detecting device is a tuned step-up transformer whose primary approximately matches the impedance of the potentiometer circuit. In order to make the signal audible, a very satisfactory system is to modulate the oscillator supplying the voltages being measured, and to use a grid-leak detector. However, any of the schemes used in common practice in bridge measurements may be employed, such as heterodyning or the system just mentioned.

One side of each potential to be measured is grounded and the other side goes to one of the four terminals connected to the points of the selector switch. If neither side of the unknown potential may be grounded, the potential at each side must be measured, the difference being the result desired.

3. OPERATION

It operation it will be seen that when the selector switch is placed on an open point we have a bridge circuit, two arms of which are the

distributed capacities to the shields from the two ends of the input transformer secondary and its leads. The other two arms are the associations of resistances and condensers in the arms of the potentiometer and the slide wires. Ordinarily this bridge will be balanced when the *C* dial is at zero, its mid-point, provided that the two distributed capacity arms are equal. However, when the dial is moved from zero the bridge becomes unbalanced. The purpose of the double midget

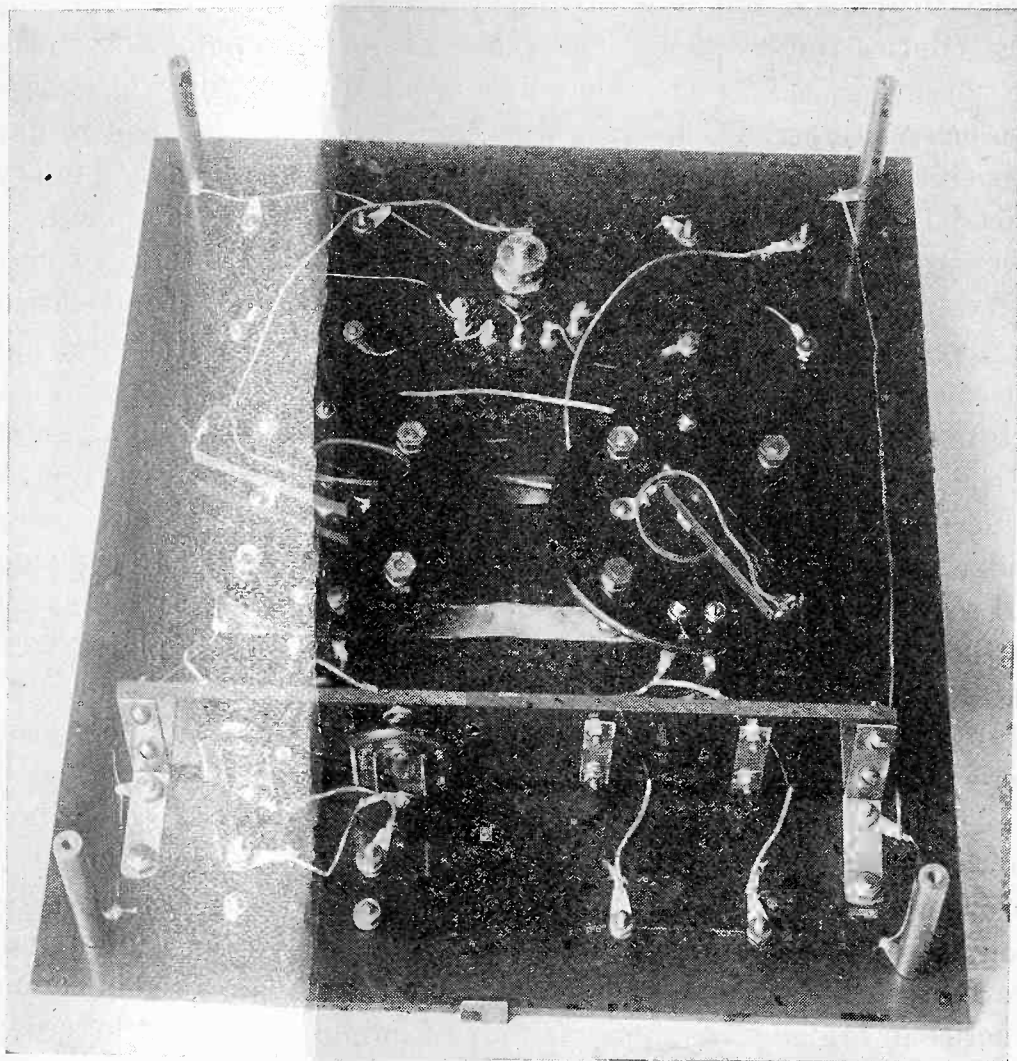

Fig. 3

condenser is to restore balance again. This does not disturb the currents flowing in the arms of the potentiometer since when balanced the current to the detector from the slider of the *C* dial is zero, and the currents in the arms are determined only by the resistances and reactances of their circuits. There may also be small voltages induced in the detector circuit from external sources and from circulating currents in the ground system. When these induced voltages are small the balancer will compensate for them without appreciably disturbing the

currents in the potentiometer arms. The resistance in the balancer need only be adjusted for the zero position of the dials, being left in this adjustment for all other positions.

The method of using the balancer is to obtain the dial settings with the selector switch set on the unknown potential to be measured. The selector switch is then thrown to an open point and the null point is obtained by adjusting the balancing condenser. New settings for the unknown potential are obtained and the balancing process repeated if necessary. When the unknown potential is in a circuit of low resistance the balancer becomes unnecessary, the readings being practically the same whether it is used or not. To test the balancer a potential drop across a resistance of say 10 ohms is measured by the potentiometer. Then a resistance of 100 to 300 ohms is inserted in series with the lead to the potentiometer (from point *A* to switch *Sw*) and the dial settings are again obtained. The same null point is obtained when the balancer is used, showing that the dial settings are the same whether the resistance is low, high, or open. Without the balancer the dial settings sometimes change as much as ten divisions when 100 ohms is introduced in series.

In calibrating the instrument it is necessary to determine the ratio of the amplitude of the currents in the two slide wires, their relative phase, and the constant of one of the dials: millivolts per division. In order to do this a test circuit is required such as, for example, the one shown in Fig. 1. *D* is a pickup coil to supply the circuit, which consists of two voltage dividers. In the present case resistance *DA* is 98 ohms wound with 0.0015 in. diameter Nichrome on a mica strip 2 in. by 1/2 in.; *OA* and *O'B* are pieces of the same wire about 0.6 in. long clamped at each end between washers which have been flattened by rubbing on a file. The condenser *DB* has about 1000-ohms reactance. In order to avoid reactance of leads, the potentials are measured as close to the ends of the resistances as possible, this being analogous to the use of potential and current terminals on ammeter shunts. To determine the drop across *OA* the potential is measured at point *O* by tapping the lead from the potentiometer onto the screw which clamps the wire at this point. The potential is then measured at point *A*, and the difference between the readings at *O* and at *A* represents the potential difference between these points.

4. STANDARDIZATION AT HIGH FREQUENCIES

At lower frequencies where the phase angle of the resistance is negligible the relative phases and amplitudes of the drops across *OA* and *O'B* can be accurately calculated. However at 10^6 cycles con-

distributed capacities to the shields from the two ends of the input transformer secondary and its leads. The other two arms are the associations of resistances and condensers in the arms of the potentiometer and the slide wires. Ordinarily this bridge will be balanced when the *C* dial is at zero, its mid-point, provided that the two distributed capacity arms are equal. However, when the dial is moved from zero the bridge becomes unbalanced. The purpose of the double midget

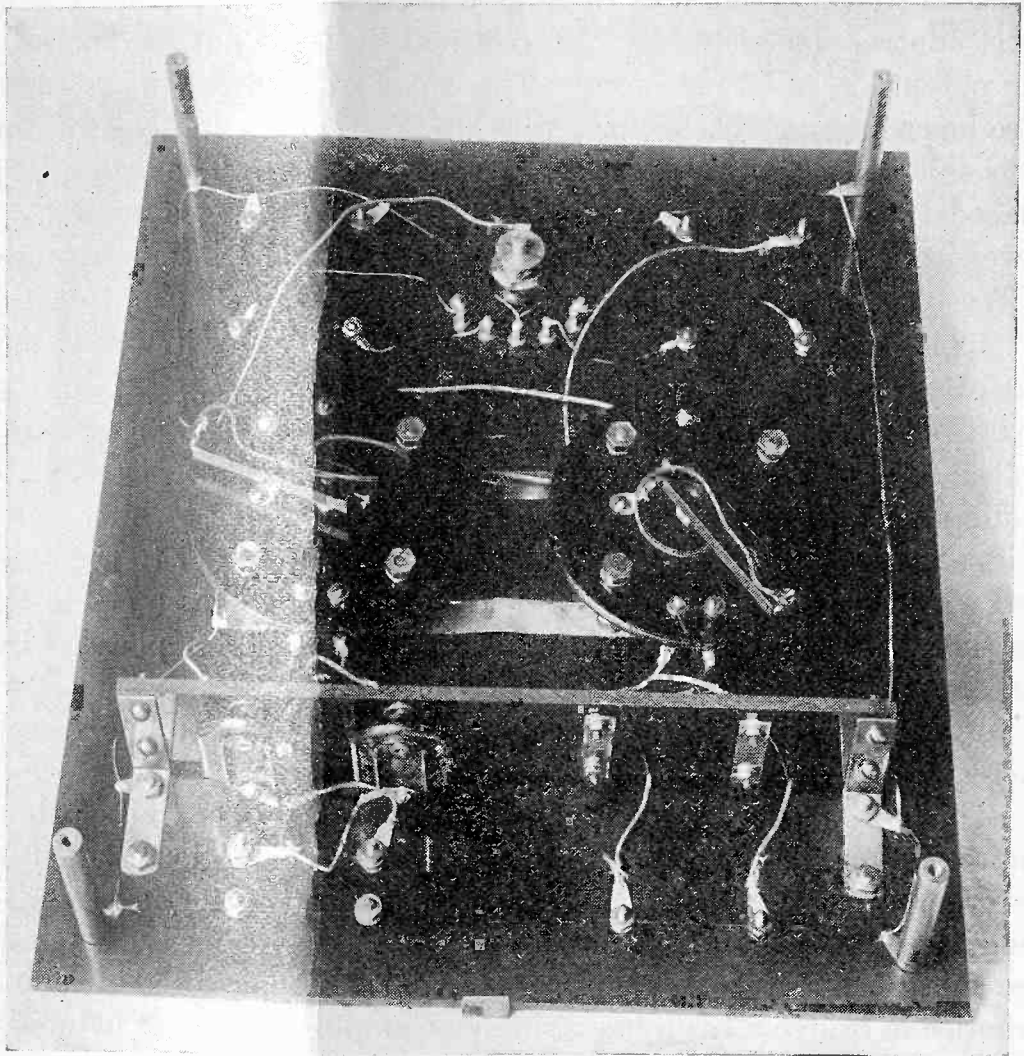

Fig. 3

condenser is to restore balance again. This does not disturb the currents flowing in the arms of the potentiometer since when balanced the current to the detector from the slider of the *C* dial is zero, and the currents in the arms are determined only by the resistances and reactances of their circuits. There may also be small voltages induced in the detector circuit from external sources and from circulating currents in the ground system. When these induced voltages are small the balancer will compensate for them without appreciably disturbing the

currents in the potentiometer arms. The resistance in the balancer need only be adjusted for the zero position of the dials, being left in this adjustment for all other positions.

The method of using the balancer is to obtain the dial settings with the selector switch set on the unknown potential to be measured. The selector switch is then thrown to an open point and the null point is obtained by adjusting the balancing condenser. New settings for the unknown potential are obtained and the balancing process repeated if necessary. When the unknown potential is in a circuit of low resistance the balancer becomes unnecessary, the readings being practically the same whether it is used or not. To test the balancer a potential drop across a resistance of say 10 ohms is measured by the potentiometer. Then a resistance of 100 to 300 ohms is inserted in series with the lead to the potentiometer (from point *A* to switch *Sw*) and the dial settings are again obtained. The same null point is obtained when the balancer is used, showing that the dial settings are the same whether the resistance is low, high, or open. Without the balancer the dial settings sometimes change as much as ten divisions when 100 ohms is introduced in series.

In calibrating the instrument it is necessary to determine the ratio of the amplitude of the currents in the two slide wires, their relative phase, and the constant of one of the dials: millivolts per division. In order to do this a test circuit is required such as, for example, the one shown in Fig. 1. *D* is a pickup coil to supply the circuit, which consists of two voltage dividers. In the present case resistance *DA* is 930 ohms wound with 0.0015 in. diameter Nichrome on a mica strip 2 in. by 1/2 in.; *OA* and *O'B* are pieces of the same wire about 0.6 in. long clamped at each end between washers which have been flattened by rubbing on a file. The condenser *DB* has about 1000-ohms reactance. In order to avoid reactance of leads, the potentials are measured as close to the ends of the resistances as possible, this being analogous to the use of potential and current terminals on ammeter shunts. To determine the drop across *OA* the potential is measured at point *O* by clipping the lead from the potentiometer onto the screw which clamps the wire at this point. The potential is then measured at point *A*, and the difference between the readings at *O* and at *A* represents the potential difference between these points.

4. STANDARDIZATION AT HIGH FREQUENCIES

At lower frequencies where the phase angle of the resistance is negligible the relative phases and amplitudes of the drops across *OA* and *O'B* can be accurately calculated. However at 10^6 cycles con-

siderable error is possible. Since a test circuit whose constants are accurately known at these frequencies is impractical to build, a means is used to standardize the potentiometer and at the same time determine the constants of the test circuit. This is the phase shifter C_1, R_1 . Since the potentiometer is shielded and the only driving force is through the inductive coupling between the windings of the input transformer, rotation of the phase of the current in the primary rotates the phase of the currents in both slide wires by the same amount, leaving their relative phase and amplitude constant.

A vector diagram of the potentiometer currents and measured voltages is shown in Fig. 4. Here the two rectangular axes are R and C , while the currents through the two slide wires are represented by I_R and I_C , where $I_C = mI_R$. The axes of the instrument are then R

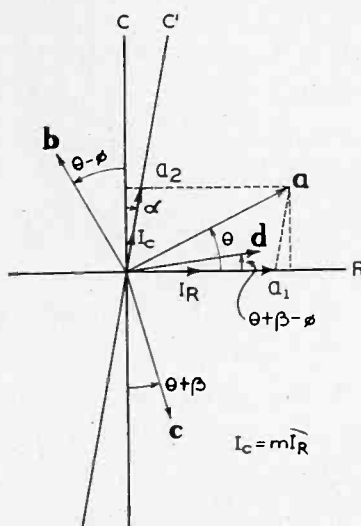

Fig. 4—Vector relations of potentiometer axes and test voltages.

and C' , where C' makes a small angle α with C . Let the drop across resistance OA of Fig. 1 be represented by vector a of Fig. 4. The readings for a are a_1 and a_2 , so the rectangular coordinates are $(a_1 + \alpha ma_2)$ and ma_2 and similarly for b which is the drop across $O'B$ of Fig. 1. Now if the dials are set at $c_1 = a_2$ and $c_2 = -a_1$, and the lead from the potentiometer clipped on point A , a new null point may be obtained by opening K and adjusting C_1 and R_1 .^{*} c will then be roughly 90 deg. behind a , and d will be the same angle behind b . For convenience Fig. 4 represents the test voltage phases as being rotated instead of the poten-

^{*} More accurately, the potential at point A is measured, giving readings a_1' and a_2' . The dials are then set at $c_1' = a_2'$ and $c_2' = -a_1'$, allowing for any zero reading the dials may have (obtained by setting the selector switch on the mid-point, Fig. 1, and adjusting the dials for the null point). A new null point is then obtained by adjusting the phase shifter, and readings of c and d are made.

tiometer axes. Either may be rotated with identical results. We may now set up certain conditions which are satisfied, as follows: ratio of lengths $a/b = c/d$; angles $a - b = c - d$: angles $a - b$, $c - d$, $a - c$ are each near 90 deg.; angle α is small.

Then, as may be seen from the figure:

$$\frac{b \cos (\theta - \phi)}{a \cos \theta} = \frac{mb_2}{a_1 + \alpha ma_2}$$

$$\frac{d \cos (\theta + \beta - \phi)}{c \cos (\theta + \beta)} = \frac{d_1 + \alpha md_2}{mc_2}$$

Since $b/a = d/c$ and ϕ and β are small, we have

$$\left. \begin{aligned} m^2 b_2 c_2 (1 + \phi \beta \sec^2 \theta) + \alpha m (a_1 d_2 + a_2 d_1) + a_1 d_1 + \alpha^2 m^2 a_2 d_2 = 0 \\ \text{Similarly} \\ m^2 a_2 d_2 (1 - \phi \beta \csc^2 \theta) + \alpha m (b_1 c_2 + b_2 c_1) + b_1 c_1 + \alpha^2 m^2 b_2 c_2 = 0 \end{aligned} \right\} \quad (1)$$

Since α is small, the terms in $\alpha^2 m^2$ can be neglected in a first approximation, and similarly the $\phi \beta$ terms. There remain

$$\left. \begin{aligned} m^2 b_2 c_2 + \alpha m (a_1 d_2 + a_2 d_1) + a_1 d_1 = 0 \\ m^2 a_2 d_2 + \alpha m (b_1 c_2 + b_2 c_1) + b_1 c_1 = 0 \end{aligned} \right\} \quad (2)$$

a pair of linear equations in m^2 and αm which are easily solved for α and m .

After solving (2) for α and m , the values found may be used in determining the error due to neglecting the $\alpha^2 m^2$ terms in (1). This is done by adding $\alpha^2 m^2 a_2 d_2$ to $a_1 d_1$ and $\alpha^2 m^2 b_2 c_2$ to $b_1 c_1$, obtaining new terms in place of $a_1 d_1$ and $b_1 c_1$ in (2). The resulting equations are then solved for the correct values of α and m . After the phases of I_R and I_C have been corrected as shown below, α becomes so small that this correction becomes negligible. The errors introduced by the omission of the $\phi \beta$ terms may be determined in the same way. These errors are usually quite negligible especially when θ is not under 20 deg.

Various test circuits may be used in place of the one described. For instance the most reliable for determining the phase of the voltage v of coil D , Fig. 1, is two mica condensers in series because of their small phase angle and also because any inductance in the leads does not rotate the phase. (Three such circuits of various ratios connected in parallel and measured gave vectors whose phases differed by only a small fraction of a degree.) Other circuits would be a resistance DA

and a condenser in place of OA with a similar condenser in place of $O'B$. A General Radio Company bridge may be used in some cases, readings being taken with OA set at 0, 10, and 20 ohms, the difference between the reading at 10 ohms and that at 0 being the voltage drop for $OA = 10$ ohms. In all observations with test circuits, readings should be made with the circuit connected to pickup coil D in one direction and then the connections to D reversed and readings taken again. The leads from coil D to the test circuit may be of twisted magnet wire of a size about No. 22. Where D is a coil of low impedance, it will be found that the same readings are obtained whether these leads are, say, 2 ft. long or 10 ft. long, showing that the leads have no effect on the output voltage of D .

5. EQUIVALENT CIRCUIT

Fig. 5 shows a simplified circuit of the potentiometer and Fig. 6 its vector diagram. E is the voltage across the secondary terminals of the input transformer, $-\alpha_R$ is the phase angle of I_R and $(90 \text{ deg.} - \alpha_C)$ that of I_C with respect to E . L and L' are unavoidable inductances of leads and resistances. Two resistances R' are introduced, one on each



Fig. 5— Simplified circuit of potentiometer.
Fig. 6— Vector diagram of simplified circuit.

side of the C arm for phase correction as shown below. r represents the resistance of the slide wire and its mid-tap wire in parallel.

We have

$$I_R = \frac{E \cos \alpha_R}{(2R + r)}$$

$$I_C = \left(\frac{\omega C'}{2} \right) E \cos \alpha_C$$

where

$$C' = \frac{C}{(1 - \omega^2 CL')}$$

Experiment shows that L' is small enough that we can usually write

$C' = C$. Where α_R and α_C are both small, say less than 10 deg. and their difference even smaller, we may write

$$m = \frac{I_C}{I_R} = \frac{\omega C}{2}(2R+r) \quad (3)$$

The values of m obtained from (1) for a number of observations checked the value calculated by (3) within ± 1 per cent.

The phase angles are

$$\tan \alpha_R = \frac{2\omega L}{(2R+r)}$$

$$\tan \alpha_C = \left(\frac{\omega C'}{2}\right)(2R'+r)$$

As above, since $C = C'$ very nearly, both $\tan \alpha_R$ and $\tan \alpha_C$ are proportional to the frequency. The two small resistances R' can be inserted and adjusted to bring α_C close to α_R and then, both being small, $(\alpha_C - \alpha_R)$ varies as the frequency.* Since the instrument is set up for measurements at a particular frequency and the frequency in any tests may only vary a few per cent at most from this frequency, $(\alpha_C - \alpha_R)$ or α of Fig. 4 may be considered constant.

6. CONCLUSION

Experiment shows that under the conditions as used by the author, the instrument being close to a 50-watt oscillator, m is accurate to better than ± 1 per cent and α to $\pm 1/2$ deg. Where the instrument may be used far away from disturbing oscillators, etc., the precision possibly would be a little higher.

When the potentiometer is used at a lower frequency, such as 50,000 cycles per second, the problem becomes much simpler. For instance, the balancing system may be omitted, or at least the resistance part of it. Distributed inductance becomes negligible so that the constants of the potentiometer and test circuits may be calculated fairly accurately, thus rendering the phase shifter less necessary. At this frequency shielding becomes of much less importance and it is sometimes possible to dispense with much of it.

7. BIBLIOGRAPHY

1. C. V. Drysdale, *Phil. Mag.*, 17, 402, 1909.
2. A. Larsen, *Elekt. Zeits.*, 31, 1039, 1910.

* At lower frequencies, phase correction is obtained by inserting two small inductances in series with the R arm instead of by resistances R' .

3. H. Schering and E. Alberti, *Archiv. f. Elektrot.*, 2, 263, 1914.
4. A. E. Kennelly and E. Velandar, *Jour. Frank. Inst.*, 188, 1, 1919.
5. D. C. Gall, *Electrician*, 90, 360, 1923.
6. W. Geyger, *Archiv. f. Elektrot.*, 13, 80, 1924.
7. W. Geyger, *Elekt. Zeits.*, 45, 1348, 1924.
8. W. Geyger, *Archiv. f. Elektrot.*, 15, 174, 1925.
9. W. Geyger, *Archiv. f. Elektrot.*, 17, 213, 1926.
10. P. O. Pedersen, *Electrician*, 83, 523, 1919.
11. M. Doté, *Jour. I. E. E.* (Japan), 465, 434, 1927.
12. M. Sase and T. Muto, *Jour. I. E. E.* (Japan), 466, 489, 1927.
13. E. C. Wentz, *Jour. A. I. E. E.*, 40, 900, 1921.
14. C. V. Drysdale, *Electrician*, 71, 687, 1913.
15. C. V. Drysdale, *Electrician*, 75, 157, 1915.
16. C. Déguisne, *Archiv. f. Elektrot.*, 5, 303, 1917.
17. C. Déguisne, *Archiv. f. Elektrot.*, 5, 375, 1917.
18. A. E. Kennelly and E. Velandar, *Proc. Amer. Phil. Soc.*, 58, 97, 1919.
19. T. Spooner, *J.O.S.A.*, and *R.S.I.*, 12, 217, 1926.
20. W. W. Macalpine, (Abstract), *Phys. Rev.*, 33, 284, 1929.
21. W. Geyger, *Zeits. f. Hochfreq.*, 34, 223; 1929.



WHISTLING TONES FROM THE EARTH*

BY

HEINRICH BARKHAUSEN

(Director of Division of Weak-Current Engineering, Institute of Technology, Dresden, Germany.)

Introduction

UNDER THE heading "Two phenomena discovered with the aid of the new amplifier," the author described¹ two phenomena, one of which (the so-called Barkhausen effect on magnetizing), has led to many further investigations, while the other (whistling tones from the earth) has aroused but little interest. Before two new possibilities are given for an explanation of this latter phenomenon, let us first summarize that paper.

"During the war, amplifiers were used extensively on both sides of the front in order to listen in on enemy communications. Partly because of faulty insulation and also due to inductive action, stray earth currents spread out from the vicinity of the telephone line. Although these currents are extremely weak, they could be made audible by exceedingly high amplification. Fig. 1 shows the listening-in wiring diagram. The two grounds *A*, *B*, generally some hundreds of meters apart, merely go to the telephone *T* through the amplifier *V*.

"At certain times a very remarkable whistling note is heard in the telephone. At the front it was said that one hears "the grenades fly." So far as it can be expressed in letters, the tone sounded about like "pēou." From the physical viewpoint, it was an oscillation of approximately constant amplitude, but of very rapidly changing frequency, as shown in Fig. 2, beginning with the highest audible tones, passing through the entire scale and becoming inaudible with the lowest tones. Because of the character of the amplifier, the tones were particularly strongly emphasized around a frequency of 1000. The entire process lasted almost a full second. These whistling tones were so strong and frequent on many days that at times listening in was impossible. This phenomenon certainly was related to meteorological influences. It occurred particularly in the forenoon on warm days in May and June, but was entirely different from normal atmospheric disturbances which cause only a crackling or boiling noise in the telephone. The ground electrodes, which sometimes also cause noises, could hardly be the cause of the whistling tones. For a meteorological influence on ground wires, frequently deeply buried, is very improbable. Then also, these same whistling tones also occurred in the sea, with copper electrodes dipping into seawater. And finally, how could such a remarkable periodic process originate at the electrodes?

"It seems much more probable that the amplifier itself produces these characteristic oscillations, possibly as the result of a particularly strong atmospheric disturbance. But the writer has tried in vain to produce whistling tones

* Dewey decimal classification: R114. Communication from the Institute of Weak-Current Engineering, Dresden Technische Hochschule.

¹ *Phys. Zeits.* 20, 401-403, 1919.

on such an amplifier in the laboratory by means of heavy switch surges and direct spark flashovers. Also, in numerous experiments with amplifiers, the author has never found these whistling tones elsewhere.

"At first it seems inexplicable how such characteristically weak alternating currents could form periodically in the earth and in the sea. Possibly further communications from all those who have used such apparatus will contribute to the explanation."

The author would now like to add to the facts described in 1919 the following two explanations as being possible.

Explanation A

In recent years it has been experimentally determined that electromagnetic waves are frequently reflected from a layer, the so-called

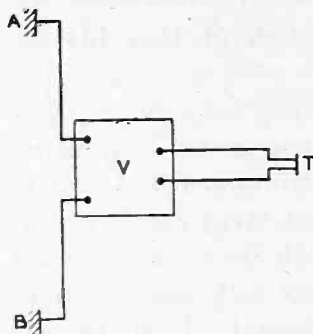

Fig. 1

Heaviside layer, about 100-km high, without considerable attenuation. Therefore, if at a distance a from the receiving station E there is a thunderstorm, S , (Fig. 3), the electromagnetic impulse caused by a stroke of lightning can travel directly along the earth from S to E ; further, it can go from S to E by one reflection from the Heaviside layer, or, by 2, 3, \dots n reflections from the layer and the earth. The path of these different radiations is

$$a, \sqrt{a^2 + (2h)^2}, \quad \sqrt{a^2 + (4h)^2} \dots \sqrt{a^2 + (2nh)^2}$$

If n^2h is small as compared with a , the difference in travel times of radiations 0 and 1 equals approximately $2h \cdot h/a$

"	"	1	"	2	"	"	$2h \cdot 4h/a$
"	"	2	"	3	"	"	$2h \cdot 9h/a$
"	"	$n-1$	"	n	"	"	$2h \cdot n^2h/a$

But, on the other hand, if n^2h is no longer small but large as compared with a , the path difference is merely equal to $2h$. The impulses coming to E by the different paths at first arrive very rapidly one after the other with large a/h , then come slower and slower and finally reach an almost constant interval.

Qualitatively, therefore, one gets the process, corresponding to the observation, of a tone whose frequency decreases very rapidly from a high to lower value.

Qualitatively, from an altitude $h = 100$ km and a propagation velocity $c = 300,000$ km per sec. we can calculate a lowest frequency (corresponding to the path difference of $2h$) $f_{\min} = 1500$ cycles, while the

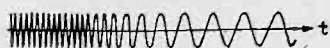

Fig. 2

highest initial frequency depends on the distance a . For $a/h = 10$, therefore for $a = 1000$ km, we would get $f_{\max} = 15,000$ cycles, and highest frequency therefore would be above the limit of audibility. This corresponds perfectly to the observations. But $f_{\min} = 1500$ cycles seems to be somewhat too high. My earlier data, estimated by ear, certainly are not reliable enough to give a perfect answer here. A lower frequency f_{\min} would correspond to a greater altitude of the Heaviside layer or to a lower propagation velocity (which is not improbable for higher altitudes). It is astonishing, from the chance duration of the tone of almost one second, that as a result one would have to reach more than 1000 reflections of the impulse!

Furthermore, we must inquire why all atmospheric disturbances are not reflected a large number of times, thus assuming a tone character. It first should be remarked that according to our experiences there is

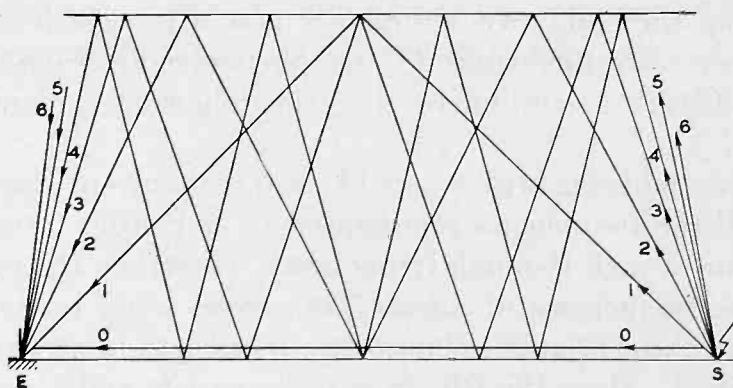

Fig. 3

not always a Heaviside layer of good reflecting qualities. But during the observation of the whistling tones, crackling noises other than whistles were observed simultaneously. Perhaps the explanation of this lies in the fact that the atmospheric disturbances causing only crackling come from the immediate vicinity. If the distance a is considerably smaller than $2h \approx 200$ km, the first impulse, which

travelled only the distance a , will be considerably louder than the following which travelled a distance $2h$ longer. The first strong impulse will then cause a strong crackling that the much softer tone possibly following it, may be covered by it.

There is another question that is harder to answer: Why do the whistling tones appear only with pure low-frequency amplification? I do not know that such whistling tones have ever been observed in high-frequency apparatus, the normal radio receiver. It must be concluded from this that it is not a question of a series of short high-frequency impulses, as assumed by explanation A, or that at least the high-frequency impulse character must be lost due to the multiple reflection.

Explanation B

In an article by Küpfmüller and Mayer,² transmission networks are described which have the property of transmitting higher frequencies more quickly than lower frequencies. The oscillogram,³ (Fig. 4), shows

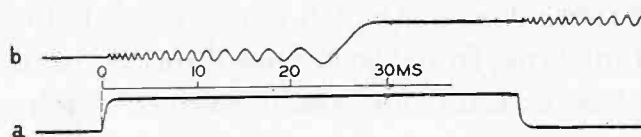

Fig. 4

a direct-current impulse in curve a , which was impressed at the beginning in the transmission network, while curve b , gives the current coming from the end. We see plainly how a process is caused here which is perfectly analogous to the phenomenon described by the author in 1919. According to this, the following explanation B is possible.

A remote lightning stroke acts like a direct-current impulse which contains all the frequencies represented by a Fourier integral, hence low frequencies with the high frequencies. Therefore, the propagation velocity for frequencies of about 5000 cycles must be considerably greater than those of about 500 cycles, in order to cause the whistling tone described. Since the whistling tone persists audibly almost one second, the difference in time of transit must be almost one second.

We still have the question whether the propagation takes place principally as a space wave in the earth or as a space wave in the air, or as a surface wave along the surface of the earth. Space waves in the

² Küpfmüller and Mayer, "Oscillation processes in loaded lines and their reduction," *Wissenschaftlichen Veröffentlichungen aus dem Siemens Konzern*, 5, No. 1, 1926.

³ See Fig. 24, page 75, of paper referred to in footnote 2.

earth actually travel faster if their frequency is higher, but are so strongly attenuated, according to the experiments made by the author during the war with earth telegraphy at 50 and 500 cycles, that propagation to 100 km and more seems improbable. Space waves through the air also probably would have the necessary frequency relation if they would reach the altitude of the Heaviside layer. With the great intensity and length of lightning, a remote effect in the range of audio frequency does not seem impossible to several hundred km. In this case it would be more difficult to explain the long time of transit of almost one second. But long echoes recently observed permit us to conclude that such long times of transit occasionally occur there also.

It would be desirable to know about more observation data on the whistling tone. Unfortunately, as far as earlier observations go, they occur rather rarely, so that one can hardly wait for them. But someone, in a region free from interference, must have a loud speaker on his desk using such a low-frequency amplification that the normal atmospheric disturbances, which are practically always present, will produce a clear cracking and boiling sound. The occasional appearance of whistling tones will then appear clearly from these general disturbances. In the vicinity of cities with electric-light plants or electric railways the disturbances are generally so great that sufficiently high amplification cannot be used (about 100,000 times = 5 tubes with loud-speaker reception). But there are solitary houses, such as radiotelegraph stations, where undisturbed observation can be made without difficulty. Observations should be made particularly on warm days in spring when there is a threat of thunder storms.

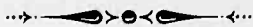

THE CALCULATION OF THE SERVICE AREA OF BROADCAST STATIONS*

By

P. P. ECKERSLEY

(Gramophone Co., Ltd., London, England)

Summary—This paper is a comprehensive study of the practical considerations in the determination of the field strength laid down at any distance by a given radio station at any given location. All factors entering into such calculations are considered and practical means of their determination or estimation set forth.

Methods are provided for the evaluation of field strength due to the space ray which should prove of value in further work on this subject. No attempt at extreme accuracy is made, the keynote of the paper being practicability.

FOREWORD

THIS DISCUSSION is based upon previous publications.¹ Some of the confirmatory experimental results are cited here for the first time, and some new theories are advanced on the estimation of effective conductivity for different types of ground.

The symbols and definitions used in the text are usually specifically referred to therein, but for the sake of completeness they are summarized hereunder:—

$1/4\lambda$ aerial, an aerial having a vertical height $= 1/4\lambda = h$

$1/2\lambda$ aerial, an aerial having a vertical height $= 1/2\lambda = h$

h = physical height of the vertical part of an aerial

λ = wavelength

λ_0 = natural wavelength of an aerial

f = frequency

f_c = frequency of carrier wave

f_m = frequency of low-frequency modulation

I = aerial current, defined as the maximum current in the aerial

W = total aerial power

E = field strength

E_d = field strength of direct ray

E_n = field strength of indirect ray

d = distance from the transmitting aerial before attenuation is noticeable

* Dewey decimal classification: R113.7.

¹ P. P. Eckersley, "The design and distribution of wireless broadcasting stations for a national service," *Jour. I. E. E.* (London), 66, No. 377; May, 1928.

P. P. Eckersley, T. L. Eckersley, H. L. Kirke, "Design of transmitting aerials for broadcasting stations," *Jour. I. E. E.* (London), 67, No. 388; April, 1929.

P. P. Eckersley, "The service area of broadcasting stations," privately printed and published by the British Broadcasting Corporation, London.

x = distance from the transmitting aerial after attenuation is noticeable

h_1 = effective height of aerial derived from the expression $E\lambda d / (377I)$

R_D = dead-loss resistance of an aerial

R_R = radiation resistance of an aerial

R = total resistance of an aerial

η = relative power efficiency = $h_1^2(\lambda^2 R)$

σ = conductivity of the earth

S = reduction factor for numerical distance d_n

d_n = numerical distance = $(\pi x / \lambda) \{ 1 / 2\sigma\lambda c \}$ approx.

c = velocity of light

The analysis is mostly based upon well-known theory, but the results are presented in a form which makes it, one hopes, of practical value to engineers.

A simplification of the Sommerfeld theory is taken as a basis for the calculation of the attenuation of the ground ray; the theoretical analysis of van der Pol, T. L. Eckersley, and Stuart Ballantine is adapted for finding the effect of aerial design upon initial radiation; and the author's assumptions, checked by experimental work done by Professor Appleton and the Bureau of Standards at Washington, are used for an estimation of the field strength of the indirect ray.

DEFINITION OF SERVICE AREA

The progress of broadcast technique shows that the listener is basically interested in what is heard, rather than the technical means by which he is enabled to hear. Thus it is fundamental that the broadcast engineer must try to arrange the distribution of the stations under his control, so that the maximum number of persons can clearly hear the program transmitted from those stations. Once it is admitted that broadcasting primarily exists to distribute programs, then interference, fading, and background noise cannot, obviously, be tolerated as part of the reception. Speaking generally, and assuming that proper methods of reception are available, the degree of background noise is the less for a given listener as the field of the station tuned in by that listener is the greater. Thus we can arbitrarily define service areas of broadcast stations in terms of the expected interruption to be found within an area embraced by a given field contour due to such stations.

The author is informed only as to European conditions and particularly those in northern Europe. A conclusion has been arrived at, based upon northern European conditions, as follows:

That we shall define an "A" service area of a broadcast station as an area in which the field due to that station is greater than 10 mv per meter.

That we shall define a "B" service area of a broadcast station as an area in which the field due to that station is greater than 5 mv per meter and less than 10 mv per meter.

That we shall define a "C" service area of a broadcast station as an area in which the field due to that station is greater than 2.5 mv per meter and less than 5 mv per meter.

"A" service conditions give a reception free from background interference in 99 per cent of the cases met with even in an industrial area. Local thunderstorms, electro-medical apparatus, and tramcars may, on rare occasions, bring in unwanted background.

"B" service conditions give a reception free from background noises typically in country or suburban conditions, but background may be experienced if the receiver is installed near tramway routes, electro-medical installations, etc; static will cause interruption during about 5 per cent of the total time of transmission.

"C" service conditions give reception which suffers slightly from background always, but which is not so pronounced as to make the service unacceptable to listeners in rural and semi-rural districts. Static may cause unpleasant background about 20 per cent of the total time of listening. (Of course, mostly during the summer.)

With a typical aerial, 30 ft. high and consisting of 150 ft. of wire in all, and a good earth, crystal reception is possible up to the boundaries of the "B" service area.

It is likely that the "A" service area constitutes the limit of silent background in southern latitudes where static is usually very much more severe. In certain rare conditions of listening in industrial towns or in tropical attitudes interference may be so bad that a 100-mv-per-meter field is required to give proper conditions of listening.

The above definitions must obviously be taken as generalizations and typically applicable in northern Europe and, by inference, Canada, northern Russia, Australia, New Zealand, southern South America, South Africa, etc.

GENERAL THEORY AND METHOD OF ANALYSIS

A broadcast station can be considered to radiate rays symmetrically in the horizontal plane. It furthermore can be considered to radiate a family of rays in any vertical plane at varying angles to the horizontal.

For the purposes of definition and for a discussion of the service areas of broadcast stations, we may call the ray radiated substantially

parallel to the earth's surface the "ground ray" or "direct ray" and all other rays "space rays" or "indirect rays".

The ground ray suffers attenuation due to the finite conductivity of the earth. The space rays do not suffer attenuation but, obeying the inverse distance law, fly off into space to be bent downward again with some loss of energy when they impinge upon an electrified layer said to exist in the upper atmosphere.

The effect of the waves radiated from a transmitting aerial at a point some distance from that aerial must be made up of a combination of the effects of the ground and space rays. We shall need to attempt to calculate the field of each type of ray to arrive at a final expression of the total field at a given point at a given distance from the transmitter.

Before attempting to estimate either of these quantities we must know the intensity of the initial radiation. This will be determined by the power in the radiating aerial, and its efficiency as a radiator. The method of analysis adopted hereafter will be first, to assume a given initial radiation and find the field intensity of the ground wave at given distances from the transmitter, as a proportion of the initial radiation (i.e., predict attenuation); secondly, to assess the strength of the space ray at different distances from the transmitter for the same initial radiation; and thirdly, to find an expression for the initial radiation as a function of the power in and the design of the transmitting aerial.

ATTENUATION OF THE GROUND WAVE

Following R. H. Barfield² the author has taken the Sommerfeld³ theory as basic to all calculations for the attenuation of the ground ray. In no case where experiments, using the wavelengths used for broadcasting, have been made to verify theory, has this course appeared to be unsound.

One can say that for wavelengths within the broadcast band and for earth conductivities met with in most countries where broadcasting takes place, the field E_x at a point distant x from the transmitter can be determined as E_x proportional to $1/x(S)$, where S is a multiplier of value always less than unity, which takes into account the attenuation due to the effect of the earth's finite conductivity.

S is said to be a function of d_n the numerical distance, which is in turn dependent upon the earth conductivity σ , wavelength λ of the emitted ray, the distance x from the transmitting aerial in the following relation:

² R. H. Barfield, *Jour. I. E. E.* (London), 66, 204; 1928.

³ *Annalen der Physik*, 28, 665; 1909.

$d_n = (\pi x/\lambda) \{1/2\sigma\lambda c\}$ where c is the velocity of light and the earth's effective conductivity.

The relation between S and d_n is given in curve form in Fig. 1. It is thus only required to determine d_n , of which the unknown quantity is σ , the conductivity of the earth. The quantity σ involves not only the actual earth's conductivity, but is influenced also by anything on the earth which tends to absorb energy from the waves.

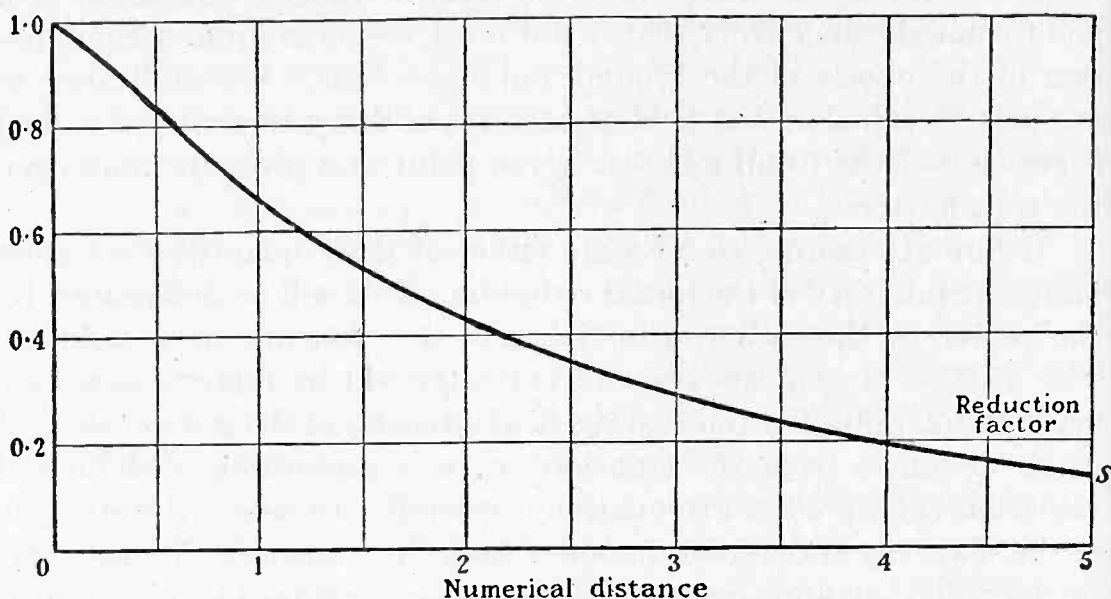

Fig. 1—Sommerfeld's theory.

A complete set of attenuation curves can be worked out from this theory. This has been done and the curves are given in Figs. 2 (a), (b), (c), and (d). These curves must be based on a certain value of initial radiation and a certain value of σ . The former has been determined by assuming a power of 1 kw radiated from a $1/4\lambda$ aerial; the latter has been taken as 10^{-13} c. g. s. units. *We can determine attenuation curves for any value of radiation, any typical form of aerial, and any value of σ using the curves of Fig. 2 as a basis.*

Effect of Different Values of σ .

It has been shown that d_n , the numerical distance, is proportional to $1/\lambda^2\sigma$. Therefore, we shall find the same value of d_n and hence the same reduction factor S and the same attenuation curve, provided the product of $\lambda^2\sigma$ is constant. Consider the curves of Fig. 2 which are drawn for $\sigma = 10^{-13}$. Obviously since attenuation is determined by the product $\lambda^2\sigma$, the attenuation curve for 2000 meters wavelength and for $\sigma = 10^{-13}$ is the same as that for a wavelength of 200 meters and $\sigma = 10^{-11}$. In Fig. 3 we can therefore draw an abacus to give us a conversion table for use with Fig. 2 to find the effect of the varying σ .

It is, in fact, merely a question of changing the labelling of Fig. 2 and finding, for different values of σ , a new value of wavelength, an "effective wavelength" that is, to substitute for those of Fig. 2. Given a wavelength of 300 meters and $\sigma = 10^{-14}$ we find that the equivalent wavelength is 96 meters, and the curve in Fig. 2 labelled 96 meters will give the attenuation of a 300-meter wave with an earth conduc-

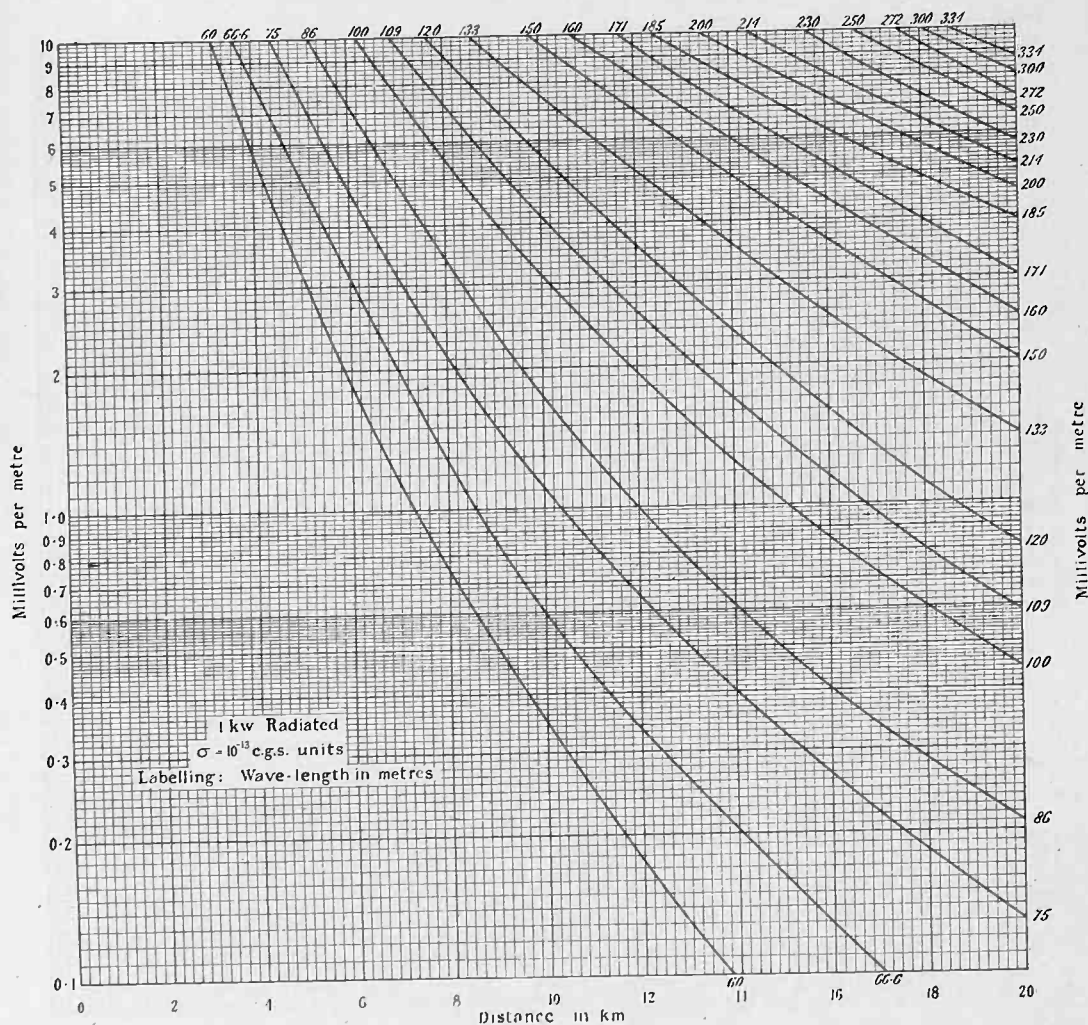

Fig. 2a—Field intensity vs distance (attenuation curves).

tivity of 10^{-14} . If the value of σ was greater than 10^{-13} we follow the lines of Fig. 3 from this greater value to $\sigma = 10^{-13}$ and find a greater equivalent wavelength.

The Value of σ .

So far we have seen that Figs. 2 and 3 enable us to predict attenuation curves for any wavelength within the broadcast band, *provided we know the value of σ .*

Now the effective conductivity of the earth varies from place to place, and it might be imagined that before being able to predict service area we should have actually to plot the attenuation curves experimentally and find therefrom, according to the foregoing analysis, a value of σ for all the territories covered by the broadcast station, and in the end rely only upon experiment to determine the service area.

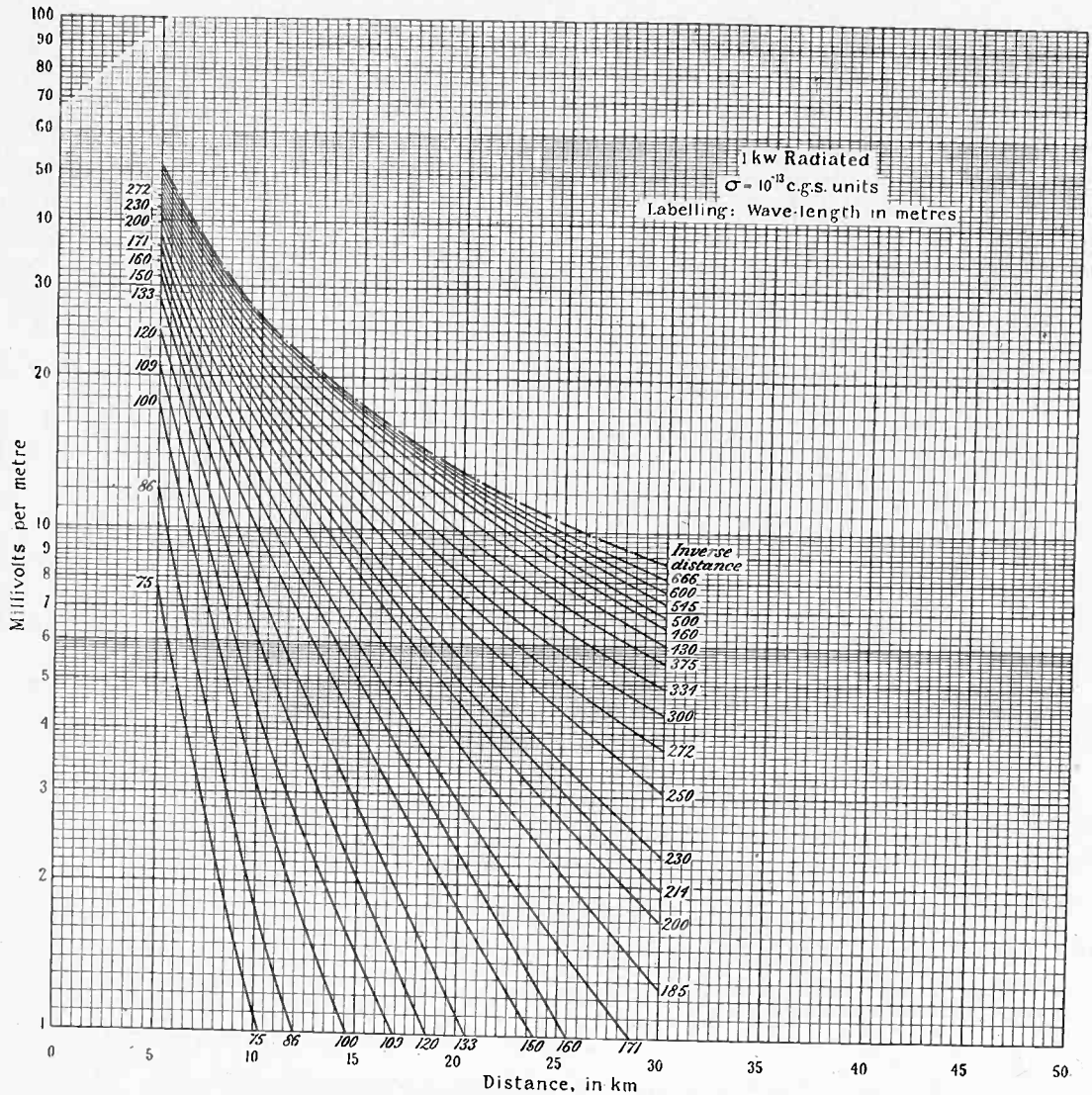

Fig. 2b

Although this might be the case if a lot of other experimental work had not been undertaken, it must be realized that given one set of experimental attenuation curves for a given territory taken on one wavelength only, we could then extrapolate results for any other wavelength. Experience, however, teaches us to believe that an expert, looking at a map and, if possible, knowing the country itself, can without recourse to experiment, come very close to an actual prediction of

service area. This would not be so if a lot of actual experimental work had not been undertaken, but, after touring a field-strength-measuring automobile over 100,000 miles of different types of country, it is fair to state that in general the service area of a station can be predicted without experimental work and with an accuracy sufficient for the needs of the case.

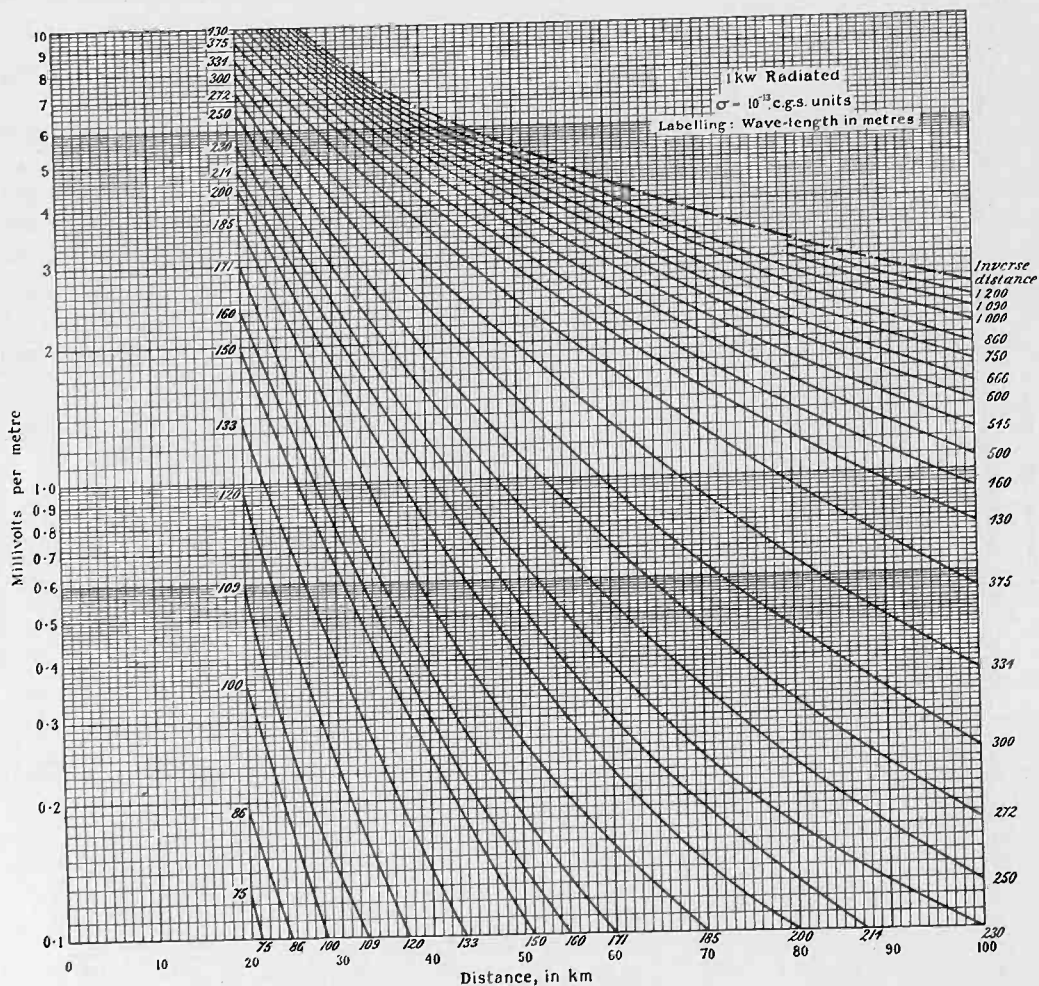

Fig. 2c

The experimental work referred to and to be described in more detail was undertaken by the British Broadcasting Corporation during the time the author was acting as their chief engineer.

There were two main points to be determined:

(1) What is the value of σ for given types of ground and can it be correlated with any physical aspect of that ground?

(2) If a value of σ is found for a given ground on one wavelength, is that value effective for all wavelengths within the gamut of waves

usually occupied by broadcast stations? i.e., does the above theory always hold?

The conclusions arrived at from the study of these questions follow:

(1) The experiments to determine these points were undertaken as a result of previous work of Barfield,⁴ the conclusions to which, however, appeared far too indefinite to rely upon.

In a paper read before the Institution of Electrical Engineers,

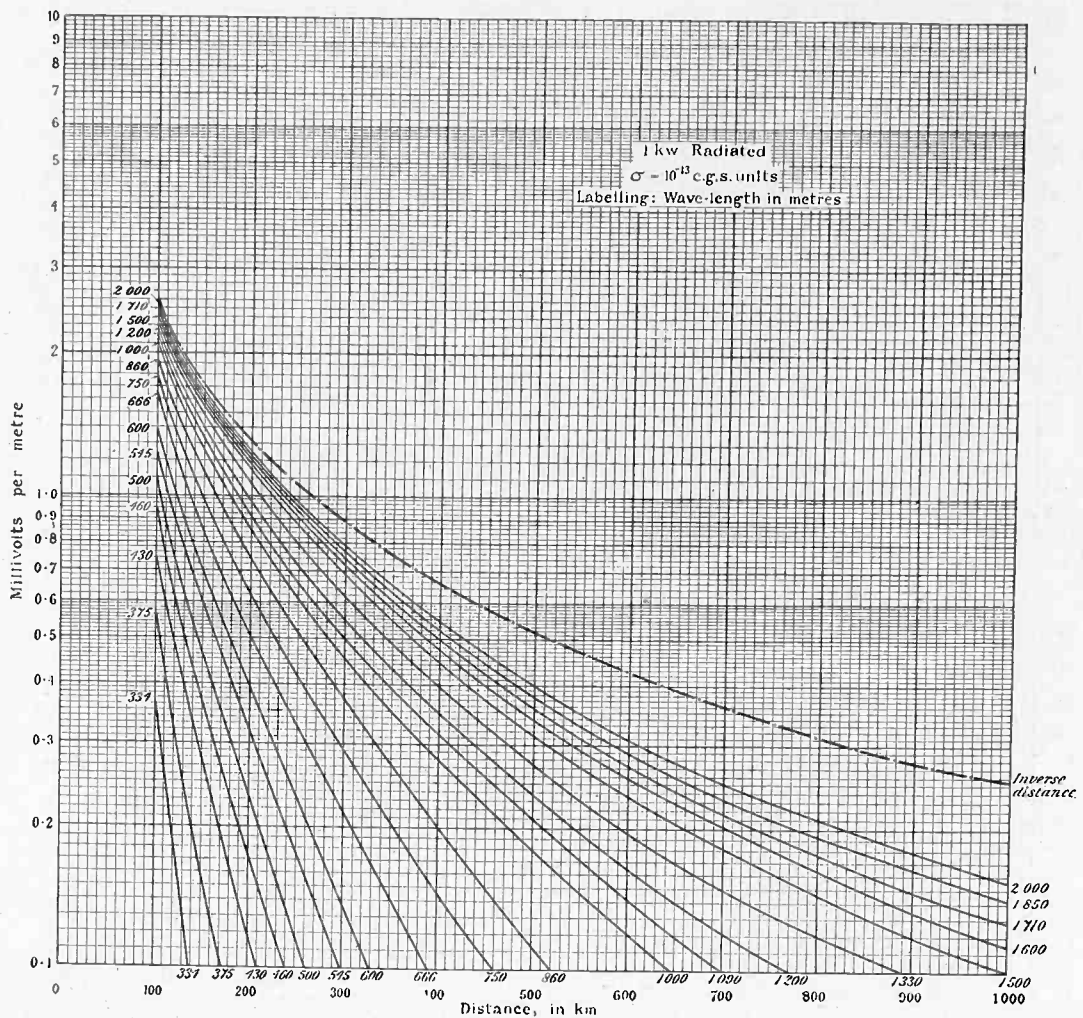

Fig. 2d

Barfield makes the following statement as a result of observations on one station and over one territory:

"With a few obvious exceptions almost all parts of the English countryside can, from any point commanding a good view, be seen to be thickly wooded. With such a view before one it seems hardly possible to doubt that the tree must contribute an appreciable amount to the surface absorption, and *in fact it will now be shown that this factor alone provides a sufficient explanation of the experimental facts.*" (The italics are added by the writer of this paper.)

⁴ loc. cit.

Thus Barfield's theory is that σ is dependent upon two factors, the conductivity of the actual ground and the number of trees per unit area found on that ground.

The author of this paper expressed considerable scepticism as to the soundness of this theory when it was first propounded, and as a result of experiments now finds himself completely in disagreement with any theory which seeks to explain the effective value of σ as wholly influenced by the density of trees. The author is in fact no vegetarian!

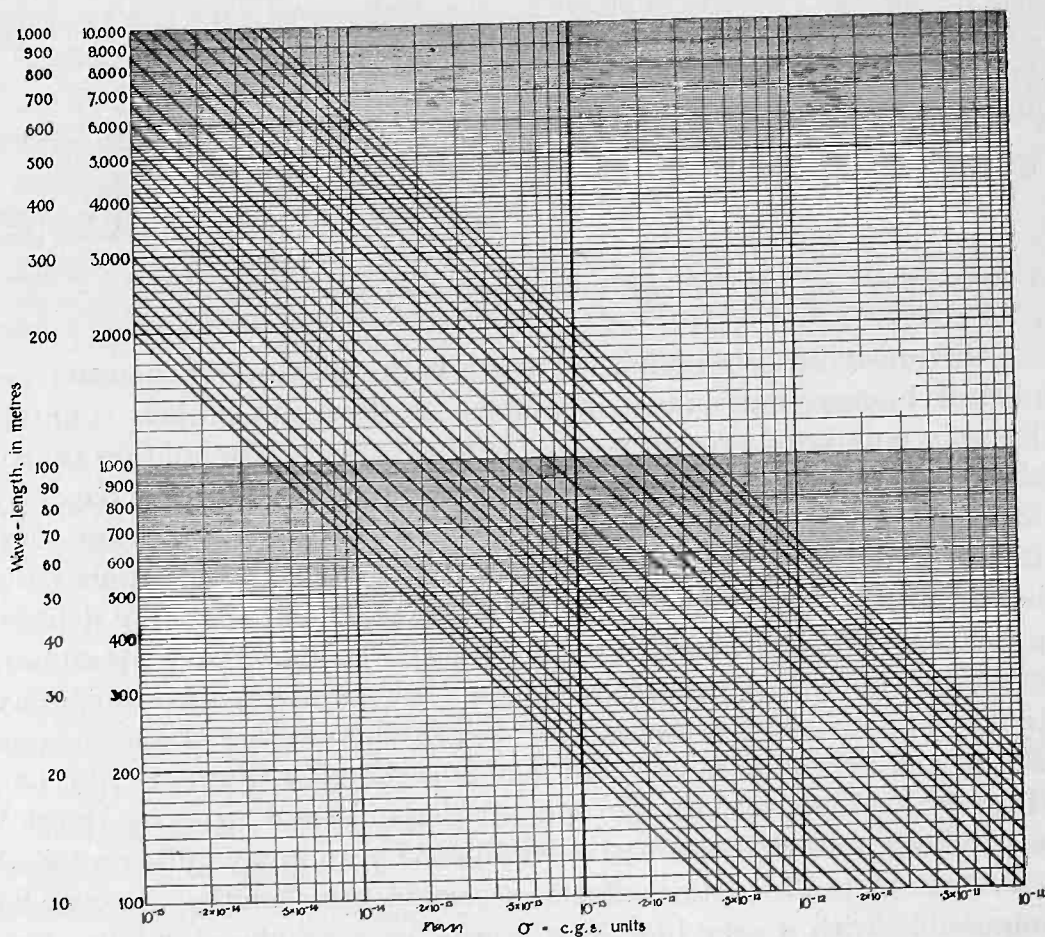

While the very indefiniteness of the description must limit definition it is possible as a result of experiments to write down a guiding value of σ for a different type of ground described in terms of its "brokenness." We may write down a table as follows:

Type of Ground	σ in c.g.s. units	Remarks
Sea water	10^{-11}	Unverified, authority of Dr. van der Pol.
Marshy flat land	10^{-12}	Found in practice.
Open pastoral country	10^{-13}	Typical of most of England.
Hilly country	0.5×10^{-13}	Hills from 1000 ft. max. height to 200 ft. in valleys, (heights as height above sea level).
Very broken country	0.2×10^{-13}	Ravined but not necessarily high.
Mountainous country	10^{-14}	The wilder parts of the Pennine range, maximum height 3000 ft. above sea level, are typical.
Broken mountainous country	0.75×10^{-14}	Spain, Switzerland, etc. heights of 8000 ft., valleys 1000 ft., very broken. (Heights as height above sea level.)
Towns and cities	0.75×10^{-13}	See text hereafter.

Obviously densely populated areas, with their tens of thousands of packed houses, must make an effect as does the broken country. Densely populated areas certainly produce greater attenuation than if the ground were flat and bare. This question is discussed in a paper by Mr. Barfield⁵ read before the Institution of Electrical Engineers. Mr. Barfield seeks to show that waves passing over towns do not obey the Sommerfeld theory. Experiments (based on somewhat more definite principles than those carried out by Barfield) showed that one cannot possibly believe that this assumption is always correct. It is fair to say that σ may be taken as about 0.75×10^{-13} where waves of length from 200 to 600 meters pass over cities such as London, Paris, Berlin, i.e., those typical of northern Europe. Perhaps certain cities in America will exhibit a much less effective conductivity and may quite probably exert complete absorption effects at certain wavelengths. It may be impossible with a city like New York, for example, standing upon rock on the one hand, and consisting of enormously high steel buildings on the other, to express attenuation in terms of the Sommerfeld laws.

Some very interesting conclusions can be drawn from a consideration of the table in conjunction with the foregoing analysis. For instance, we see at once that the field will be the same at a given distance from the station when a wave of length of 200-meters passes over sea as when a wave of length of 2000-meters passes over open pastoral land. It might again require a wave of 1000 meters length to

⁵ R. H. Barfield, *Jour. I. E. E.* (London), 67, No. 386; February, 1929.

cover a given area of very mountainous country, but a similar powered station would cover an equal area of open flat country if the wavelength were reduced to about 300 meters.

(2) The next set of experiments set out to determine whether we could find any type of ground where the Sommerfeld laws did not apply, where, in fact, a given value of σ was not constant for every wavelength likely to be used in broadcasting. It was found that in every type of ground studied, marshy, flat, open, broken, hilly, mountainous, or densely housed, that the Sommerfeld equation could be applied to explain the experimental values. Particular trouble was taken, since Barfield sought to show that the Sommerfeld laws did not apply in connection with densely populated areas, to verify the Sommerfeld law when the waves passed over London. Greater London contains some eight millions of inhabitants and is in places thirty miles from boundary to boundary. The new British Broadcasting Corporation station for regional broadcasting is situated some 5 miles from the northern boundary. Before the site was definitely bought, an experimental transmitter was erected and calibrated to have an equal power in the aerial at every wavelength studied. The results of observations taken on the far side of the metropolis showed that we can express σ as having about the same value (0.75×10^{-13} c.g.s units) at every wavelength, and so it would seem that Barfield's conclusions were too hastily arrived at and are probably influenced by the other factors. For instance, the transmitting aerial in Barfield's experiments was located on the roof of a large steel frame building in the heart of the metropolitan area. Who could tell that perhaps changing wavelength meant changing radiation, different mast absorptions, etc.? The Sommerfeld law was also verified to hold in very mountainous country.

We have thus set out a theory, based on the original Sommerfeld analysis, and we have found that we can give a different value of σ according to the type of ground traversed by the waves, and that the effective value of σ is chiefly influenced by the "brokenness" of the ground, and is very much greater for water than for any land. Perhaps dense forests do produce greater attenuation but in England one can find no ground where the trees are dense enough over a large enough territory to prove the point. Besides, forests have a habit of growing on broken ground!

Taking of Measurements.

A few words on the actual taking of results will be of interest. Measurements are most inconsistent unless the field is measured well away from houses, telephone or electric-power cables. Even then

two quite open sites, only a quarter of a mile apart, may give results differing by 10 per cent to 20 per cent. It is as well when plotting experimental curves to take points at say 10, 20, 40, 60 miles, and so on, away from the originating station (dependent upon wavelength), but at each distance to express the field strength at that point as an average of five readings around that point.

Measurements in Mountainous Districts.

In mountainous districts it will be found that the field on the height of land is from 20 per cent to 30 per cent greater than that found in near-by open valleys. It will further be found that in deep ravines the field will be 50 per cent to 60 per cent less than that on the height of land. The field in a deep valley will generally be less where the run of the valley is along the line joining the point of observation and the station, than when the valley is at right angles to this line. Lastly, if the observations are taken on the edge of a high precipice facing the direction of the station the field may be 100 per cent greater than that on the open plain below. Moving away from the cliff edge about a mile reveals a reduction of field so that values are found 20 per cent to 30 per cent greater than on the open plain below; i.e., readings a mile away from the precipice are equivalent to those on the height of land in ordinary mountainous country.

In making a theoretical prediction of field such facts must be well borne in mind, and the surveying engineer can and should do no more than give very general contours indicating a mean level of field; he must, in fact, neglect the rises and falls of field due to strictly local causes.

THE FIELD STRENGTH OF THE SPACE RAY

Having now arrived at a sufficiently accurate expression for the field of the ground ray at given distances from a given transmitter using a $1/4\lambda$ aerial radiating a definite power, it remains to add to or subtract from this value the field of the space ray. This will give a total value of field strength due to the station at any point at any time.

Theory says that waves are radiated not only parallel to but also at an upward angle to the earth's surface. The upward radiated waves are called space waves. They are said to impinge upon the upper ionized atmospheric layer and are there bent earthwards again. They can be appreciated at great distances from their source, since they do not suffer attenuation as does the ground ray.

A pictorial diagram of what may be assumed to happen is given in Fig. 4. Certain assumptions are now made as follows:

(1) That the strength of upward radiation from a transmitter is determined by multiplying the full radiation in a horizontal direction by the cosine of the angle between the upward and horizontal radiations, i.e., the transmitting aerial has a semicircular vertical polar diagram;

(2) That similarly the receiving aerial has a semicircular vertical polar diagram;

(3) If E_1 is the strength of any ray, A, B, C , (Fig. 4) before entering the layer, and E_2 the maximum strength of the same ray after leaving the layer, then $E_2/E_1 = 1/5$;

(4) That the absorption coefficient is constant for all angles of impinging rays;

(5) That the field strength of the indirect ray varies inversely as the distance travelled from earth to layer and from layer back to earth, i.e., the distance travelled is TQ_1P_1 or TQ_2P_2 , etc.;

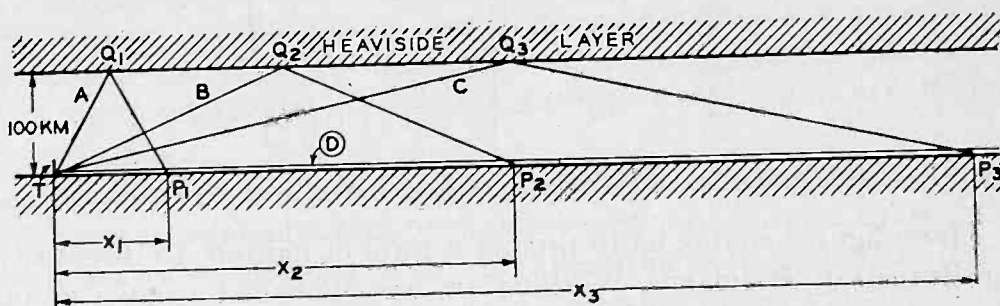

Fig. 4—Illustration of assumptions made in considering effect of space ray.

(6) That the angle of incidence of the ray to the layer is equal to the angle of reflection from it, i.e., that rays A, B, C , etc. always follow the path shown diagrammatically in Fig. 4;

(7) That the height of the layer is 100 km.

It is appreciated that these are somewhat wide assumptions. The fact that they bring a result which agrees with observations must be some justification for their adoption. In support of the assumptions under (1) and (2) most aerials at present in use have a semicircular vertical polar diagram. The reason for choosing this (3) value of absorption coefficient is explained later; it is sufficient at this stage to say that the figure is based on the results of observations. Under (4) E. V. Appleton has postulated a multi-layer structure of the electrified upper atmosphere. A shallow-angle impinging radiation (i.e., a ray nearly parallel to the under surface of the layers) would make a considerable penetration even if it were better reflected, whereas a sharp-angle ray (i.e., one nearly normal to the layer), while it may be worse

reflected, has a shorter path in the layer and therefore loses less of its energy. Under (5) it is fair to assume no ground attenuation. As to (6), it is probably quite wrong to state that the angle of incidence to the layer always equals the angle of reflection but it is arguable, on what is known, that if the indirect ray does not always take this path it takes another of equal length, and its value on the earth's surface does not therefore greatly change. We are trying to find a maximum field-strength value of the indirect ray. Under (7), the height is derived from Professor Appleton's calculations, and is taken as a round figure. It is admittedly an approximation, but for stated reasons this need not greatly upset the final calculations.

We can find from these assumptions actual values of indirect ray (expressed as the maximum they ever obtain) as follows:

Distance from Station (radiating 1 kw from $\frac{1}{4}$ - λ aerial), in km	Maximum Value of Indirect Ray (mv per m)
25	0.012
50	0.026
100	0.05
200	0.09
300	0.10
400	0.09
500	0.08
600	0.05

These figures enable us to predict a *ratio* of indirect to direct ray. The Bureau of Standards, Washington, has published a paper giving this same ratio experimentally measured but expressed as an *average* value of space to ground ray. The theoretical figures are supposed to be a *maximum*. The interest is therefore to see if the theoretical ratio of indirect to direct ray obtainable by the foregoing analysis is proportional to the same ratio observed by independent experimenters in America. The following table indicates the agreement between theory and practice.

Distance from station in km.	Observed ratio of <i>average</i> value of indirect to direct ray at a given wavelength 300 meters	Theoretical ratio of maximum of indirect ray to direct at the given wavelength 300 meters, according to analysis above	Ratio of column 2 to 1 which should be a constant
	Column 1	Column 2	
200	1	2.0	2.0
300	3.5	10.0	2.95
400	9.0	22.5	2.4
500	15.0	40.0	2.6
600	24.0	75.0	3.1

It will be seen that, within the great limits imposed by the nature of the variables, the agreement between practice and theory is quite sufficient for practical purposes.

Observations have also been taken by Professor Appleton and the Radio Research Board, by whose kind permission they are now published. Station 5GB ($\lambda = 480$ m approx. and 25-kw power) was used for the observations. Readings of the maximum field strength on a given night were recorded. This would mean a combination of direct and indirect ray. The direct ray was measured in daylight. This gives a value of the indirect ray. The following table compares the experimental with the author's theoretical assumptions:

Distance from Transmitting Station	Measurement Value of Indirect Ray	The Author's Assumptions; Value of Indirect Ray
km	mv per m	mv per m
120	0.045	0.06
144	0.025	0.07
240	0.0325	0.092
320	0.045	0.1

The author's assumptions appear to be too high and if divided by 2 would be nearer observations. But Professor Appleton's measurements were taken on a few nights only and do not record a possible maximum. Later measurements show that the author's assumptions are, if anything, too low.

However, according to Professor Appleton's figures, Dr. Petersen of Norway in some observations taken in Berlin records a substantial record of agreement. The British Broadcasting Corporation has lately taken observations which bring out a somewhat higher value than the author's assumptions, but still of the right order of quantity.

The chief point worthy of notice is that although the actual results do not agree together experimentally, or theoretically, to within 100 per cent, nevertheless the value of the indirect ray does appear to be largely independent of distance and records do show that the high value assumed in theory does take place, on occasions, in practice.

In order to simplify the analysis, I am summarizing this section by making a very general assumption, namely, *that the maximum value of the indirect ray at distances between 100 and 1000 km is 0.1 mv per m for 1 kw radiated from the transmitter.*

It is most fully realized that this is, to say the least of it, a bold assumption but we do not require very great accuracy for the purposes of our analysis. We are aiming at having a means to arrive at an assessment of service. We know that two localities a few miles apart get field from the same station 100 per cent different due to local idiosyncracies. We know that 100 mv per m is not enough for true service in some rare cases. We know that one or two suffices in others equally rare. It is a question of expressing service as a generality; it is both

useless and impossible to express it quantitatively accurately for every listener whatsoever his location. Thus by just such a generalization we can find out the order of quantity and the order of service and can throw off the useless fetters of pedantic accuracy. This analysis is intended as a quantitative *guide* for engineers, and errors of 100 per cent even are tolerable when dealing with the indirect ray, errors of 20 per cent to 30 per cent with the direct.

Point of Intolerable Fading.

Accepting, then, this simple assumption we can return to a consideration of Fig. 2 and realize that the reason for terminating these curves at a value of 0.1 mv per m was to show a distance where intolerable fading sets in and where, *whatever the power of the sending station*, we must find the limit of true service, since at this point the value of the direct ray equals the value of the indirect ray.

The author must strongly disagree with those who maintain that "a little fading does not matter." With certain too-frequently heard types of program this is perhaps true, but we must assume that those responsible for the entertainment value of broadcasting are as intelligent as the engineer. (It is perhaps pertinent once more to apologize for the number of very general assumptions contained in this paper!) In fact, outside the boundary of intolerable fading where the value of the direct ray equals or nearly equals the indirect, there is worse service than still further away where the indirect ray enormously predominates (the ground ray having petered out altogether), and where fading is only brought about by atmospheric layer variations and not by direct and indirect ray interference.

THE MAXIMUM ECONOMIC POWER OF A BROADCAST STATION

Having assumed that the distance at which the curves of Fig. 2 cut the x axis is the limit of broadcast service due to intolerable fading, we can find a maximum economic power for a broadcast station as that which will produce a sufficient field for service at the distance where intolerable fading sets in. Obviously this distance is independent of power because although a station of n kw produces \sqrt{n} times the field of the ground ray due to a 1-kw station it also produces \sqrt{n} times the value of the indirect ray due to a 1-kw station and intolerable fading will set in at the same distance. It therefore remains to determine a value of field which is required for service at the boundary determined by the point at which direct and indirect ray are equal. My original assumption gave the lower limit of service as 2.5

mv per m (for the more northern latitudes). As we require 1 kw radiated to produce 0.1 mv per m at the point of intolerable fading it requires $(2.5/0.1)^2$ kw, i.e., 625 kw radiated to produce 2.5 mv at this point and we see that theoretically, and using a $1/4\lambda$ aerial, we should require some 800-kw aerial power with $1/4\lambda$ aerial to produce service conditions at the true boundary of the service area. *Note particularly that this figure is theoretically independent of wavelength.*

It would not be proper to pass this point without indicating that in practice such a high value of power is attended by certain economic disadvantages. Take an exaggerated case to point the argument and consider a station forced to use a wavelength of 200 meters in very mountainous country. The equivalent wavelength is about 60 meters, the point of intolerable fading would be found a distance of about fifteen to twenty miles (we must assume less than 0.1 mv per m indirect ray per kilowatt radiated for such short distances) and we should be using 800 kw power producing 2.5 mv per m indirect ray as an interfering signal over about ten million square miles!

This is a somewhat striking example but it shows that such high figures for power are only economic in certain specialized cases as where the wavelength is long and the territory to be served both wide and densely populated.

It is interesting to note that the Union Internationale de Radiodiffusion (which considers in committee all questions relating to European broadcasting, including relevant questions concerning Russia, Turkey in Asia, Egypt, and Morocco) recommended to the *Comité Consultatif International des Techniques des Communications Radio-électriques* that the power of all European broadcast stations should be limited to the order of 100 kw. This recommendation was adopted by the above named Committee and is therefore by implication a restrictive regulation designed in the interests of all European broadcasting. The figure was based upon the analysis given above.

The author's actual recommendations to the C. C. I. R. were more restrictive than this because he proposed that the maximum power should be, for the present, restricted (for all stations having wavelengths below 550 meters) to a figure in kilowatts derived from the wavelength in meters divided by ten. Thus a station using a wavelength of 300 meters would have a maximum power of 30 kw, a station using 500-meter wavelength would have a power of 50 kw and so on. This recommendation was framed on the basis of the practical consideration that, when wavelengths of the order of 250 meters were used it was unlikely that they would do more than cover a small agglomeration of towns, that 25 kw was sufficient, and that the raising

of the power to 100 kw was uneconomic and merely caused interference to other stations. The proposal was not accepted although it still appears practical. It is an unfortunate fact that space rays produce the same field, whatever the wavelength, but that the direct-ray field is enormously weakened as the effective wavelength (for a given territory) decreases. The resolution as stated above was not adopted and so we must face the possibility of power of 100 kw with wavelengths of 200 meters.

The listener is not apt to notice small changes of power however, and we could classify stations in terms of their distinction one from another according to power, as follows:

Local stations	0.5-5	kw power in aerial
Regional stations	5	-50 kw power in aerial
High-power regional stations	50	-200 kw power in aerial
Super-power regional stations	200	-500 kw power in aerial

The point is that wide limits of power do not make a very noticeable difference in listening conditions.

One may summarize by saying that while the maximum economic power of a broadcast station is of the order of 600 kw in the aerial practical considerations usually limit power to a lower value than this, and that using the shorter medium waves it would be absurd in any case to use such a high power.

DESIGN OF TRANSMITTING AERIALS FOR BROADCAST STATIONS

It is obvious that the design of the transmitting aerial must have some influence on service area. It is of course our ideal to produce the maximum ground ray and the minimum space ray. Even if we achieve this ideal however, we should produce interference at a distance because rays tangential to the earth's surface soon fly off the earth and are again reflected downwards. Experiments have in fact proved that the beam system must aim at sending off rays which skim the earth's surface and hit the ionized layer as nearly parallel as possible. Arguing from this basis the more an aerial radiates rays parallel to the earth's surface the more likely are such rays to cause *distant* interference even though the direct ray service area be wider per given power. The parallel radiating aerial has, of course, this compensating advantage that we shall obviously get greater direct-ray field strengths for a given power and, if it is considered an advantage, the liability to fading, at very long distances, when the space ray is alone effective, is lessened.

The author, in consequence of the above considerations, does not believe that the use of special aerials, designed to radiate chiefly along the

ground, substantially affects the assumption for the value of the field of the indirect ray. It is thus only necessary to consider how to design an aerial to give us the widest direct-ray service area possible with a given power.

The curves of Fig. 2 are plotted on the basis of 1 kw radiated. This means by definition that the radiation resistance of the aerial multiplied by the square of the aerial current I gives a power of 1 kw.

It can be shown⁶ that radiation from an aerial situated at ground level can be resolved into radiation due to the aerial itself, and radiation from an image of the aerial in the earth.

Consider that the aerial and its image are composed of elements Δh of h , the physical height, each with elements of high-frequency current i ; then the radiation in any direction can be calculated by adding vectorially the radiation from each element of height, provided the height above the earth of this element is small compared with $\sqrt{\lambda d}$, where λ is the wavelength and d is the distance of the point of measurement of the radiation from the aerial. Clearly if the currents in the elements are in phase, the field strength on the ground nearby is the arithmetical sum of the radiations from the elements.

For aerials of vertical height h less than $1/4\lambda$, the space phase of the element currents in the real aerial, and its image will not be sufficiently different to cause cancellation of radiation in non-horizontal directions. As h is increased to $1/2\lambda$, however, the maximum current I in the aerial is at a distance $1/2\lambda$ (180 deg.) from the maximum image current. There will be in this case considerable cancellation of radiations at high angles. As h is still further increased then, provided the currents are in phase all along the aerial, the cancellation will be greater still in all directions other than the horizontal.

Fig. 5 gives the vertical polar diagrams, calculated by Stuart Ballantine⁷ for $1/4\lambda$ aerials and $1/2\lambda$ aerials for the same field strength on the ground. It is assumed that the earth is a perfectly conducting medium. (Note that the vertical polar diagram of the $1/2\lambda$ aerial is flatter than that of the $1/4\lambda$ aerial, due to angular radiation cancellations). It will be seen that radiation horizontally will be proportional to $fidh$. Consequently a given field strength can be obtained by the use of a high aerial with small current, or a small aerial with large current, i.e., the meter-amperes must be the same.

From the broadcast point of view, all energy not radiated horizontally is wasted. It will therefore appear obvious that the high aerial with small current will be the most efficient.

⁶ T. L. Eckersley, *Jour. I. E. E.* (London), 65, 600, 1927; and Balth. van der Pol, *Jour. Phys. Soc.*, 1917.

⁷ *Proc. I. R. E.*, 12, 836; December, 1924.

Most wireless engineers have been educated to consider only the problems concerned with $1/4\lambda$ aerials. The radiation resistance R_R can, for $1/4\lambda$ aerials, be found from the expression $1,580 h_1^2/\lambda^2$, where h_1 is the effective height of the aerial. Radiation efficiency has been expressed as $R_R/(R_R + R_D)$, where R_D is the dead-loss resistance. In the past it has been considered desirable to make this expression as nearly unity as possible; that is, to get as much radiated energy from a given power as possible. The broadcast engineer, however, requires only ground radiation, and is not concerned with total radiation, which might, as a *reductio ad absurdum*, be all in a vertical direction. Thus

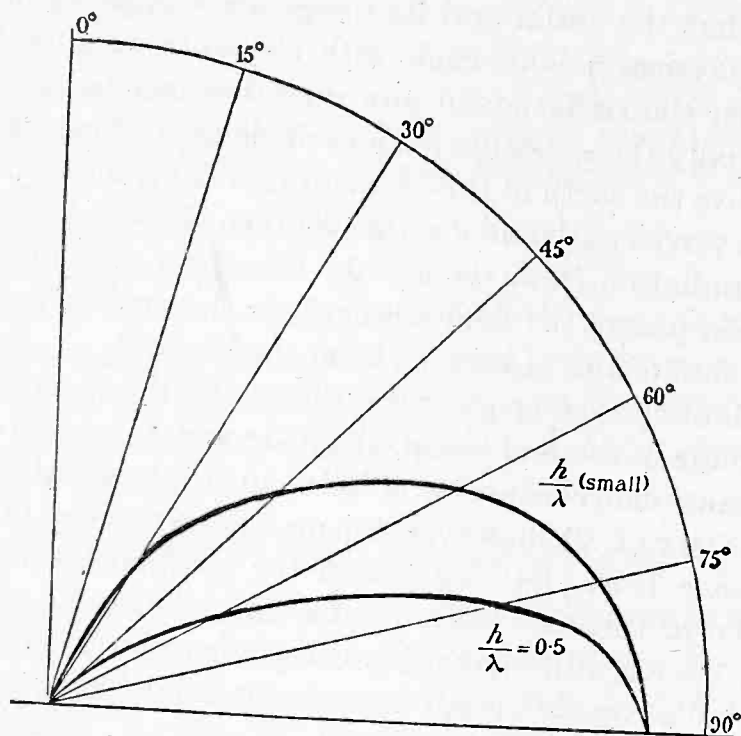

Fig. 5—Vertical polar diagram of radiation for $1/2-\lambda$ and $1/4-\lambda$ (or less) aerials. Drawn for the same maximum radiation intensity in the horizontal plane. (Stuart Ballantine, loc. cit.)

radiation efficiency is not so important as power efficiency to produce a given field strength on the ground. This has come about because in the pre short-wave and broadcast era most aerials had a physical height of $1/4\lambda$ or less.

The field strength on the ground for a given wavelength is proportional to meter-amperes ($h_1 I$). For a given power we must therefore produce a maximum value of $h_1 I/\lambda$. We must answer the question: What is the relative power required to produce a given value of $h_1 I/\lambda$ with $1/4\lambda$ and $1/2\lambda$ aerials? For the reasons explained above, increasing the height of the aerial, by producing cancellations of angular rather than horizontal radiation, flattens the vertical polar diagram

while the ground vector proportional to $h_1 I / \lambda$ remains the same. Thus less power is radiated with the high aerial, while the horizontal vector remains the same. This means that less power is required with a high aerial to produce a given value of meter-amperes. Analyzing this in more detail, we can find a relative power efficiency for each aerial. For a $1/4\lambda$ aerial this efficiency is

$$\eta = \frac{A(h_1^2/\lambda^2)I^2}{(R_R + R_D)I^2} = \frac{\text{watts output}}{\text{watts input}} = \frac{Ah_1^2}{\lambda^2(R_R + R_D)}$$

proportional to $h_1^2/\lambda^2 R$ where R is the total resistance and where A is constant.

Now if, on increasing h , the radiation resistance remained proportional to h_1^2 (given a constant small value of R_D) the above term would

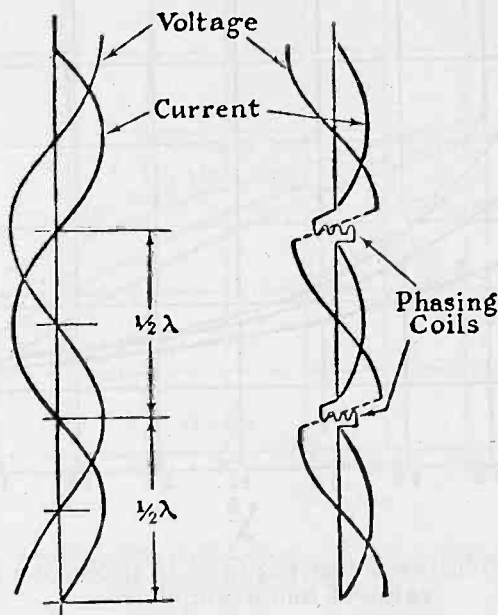

Fig. 6—Current and voltage in a long uniform aerial.

Fig. 7—Current and voltage in a Franklin aerial.

remain nearly constant for any value of h . But less power is radiated as we increase height, and so R_R does not go up in proportion to h^2 , but at a lower rate.

Consider then the term $h_1^2/(\lambda^2 R_R)$. This should be nearly constant for all aerials of height h less than $1/4\lambda$, but should increase rapidly thereafter. Stuart Ballantine⁸ has calculated $h_1^2/(\lambda^2 R_R)$, and Fig. 10 shows the results of his theoretical calculation.

The x axis of Fig. 10 is drawn on a scale of the ratio of $\lambda/(4h)$, and the y axis represents the expression $h_1^2/(\lambda^2 R_R)$ plotted on a purely relative scale. It is reiterated that this curve represents, in fact, $fidh$

⁸ See reference in footnote 7.

and shows the increase of horizontal radiation due to the decreased total radiation for a given power as the number of elements $d h_1$ are added together vertically. A curve of radiation resistance is plotted for future reference. It is also a purely theoretical curve. It will be seen that the curve for radiation resistance gives a value, for $1/2\lambda$ aerials, less than that given by $1,580 h_1^2/\lambda^2$. But more energy is radiated horizontally.

It will be remarked that after the value of h/λ is increased beyond 0.4 the expression $h_1^2/(\lambda^2 R_R)$ decreases abruptly. This is explained by realizing, as shown in Fig. 6, that the phase reverses in the upper part of a long homogeneous aerial unless precautions are taken to avoid this effect. The obvious line to take is to add (see Fig. 7) $1/2\lambda$

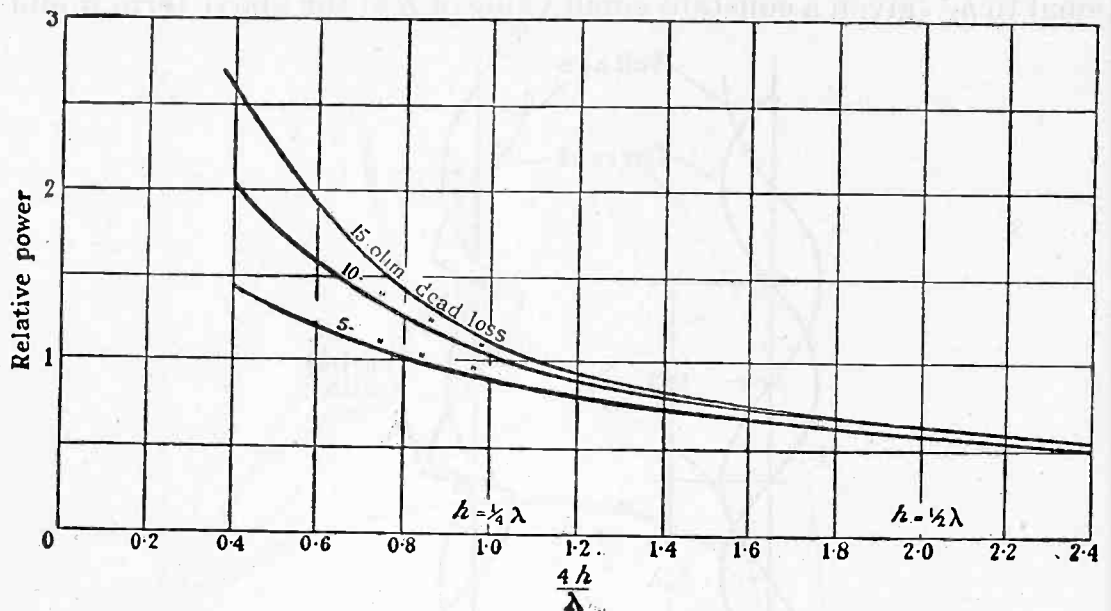

Fig. 8—Relative power required to produce a given value of meter-amperes.

aerials, one above the other, and to introduce a "phasing coil" to reverse the phase at each junction. This device has been adopted by C. M. Franklin in his beam system for short-wave telegraphy. Fig. 8 shows the relative power required to produce a given field strength on the ground with different values of $4h/\lambda$ up to a value of 2. Obviously from the expression for meter-ampere efficiency, $h_1^2/\lambda^2(R_R + R_D)$, the value of the dead-loss resistance R_D affects the result, and so curves are shown for various values of dead-loss resistance.

It will be seen that, theoretically, and with 10 ohms dead-loss resistance, we save about 40 per cent of power by using $1/2\lambda$ instead of $1/4\lambda$ aerials to produce the same field at a given point. Fig. 9 shows the increase of field using different heights of aerial with the same aerial power, W .

Note on Effective Height.

There may be some confusion as to the meaning of h_1 , the effective height. For instance, it is well known that the theoretical effective height h_1 for a $1/4\lambda$ aerial is $(2/\pi)$ times the actual height h . But it is important not to use this value for h_1 if an aerial less than $1/4\lambda$ in height has to be loaded by added inductance to give it the natural wavelength as if it were a vertical wire of length $1/4\lambda$. Effective height is a misleading term for loaded aeriels.

Effective height should, it would seem, be worked back from a measure of the field strength at a distance of a few wavelengths from the aerial calculated from the formula $E = 377 h_1 I / (\lambda d)$ where d is the

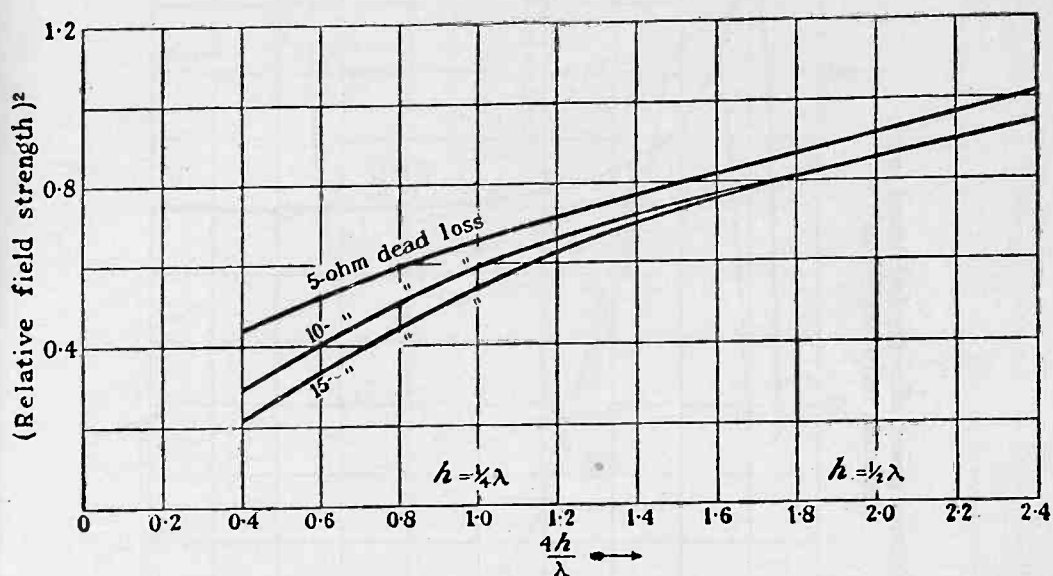

Fig. 9—Relative field strength for a given power for various values of h/λ .

distance of the point of measurement from the aerial. Effective height is thus best expressed as $h_1 = E\lambda d / (377I)$ (I being the maximum current in the aerial, d the distance at which the field strength is measured, and λ the wavelength), whatever the form of aerial. Effective height taken in this way depends upon the distance d . This distance must be chosen so that the field of the waves at that distance does not suffer attenuation.

There is a curious anomaly in respect to the experimental measurement of effective height. If the measurements are taken too close to the aerial it has been noticed that the effective height comes out too high; one finds, in fact, an effective height greater than even the physical height; such a reading is naturally suspect. The effect has been noticed with all sorts of wavelengths but always with T aeriels. It is necessary to move some ten wavelengths away from the aerial to find

a consistent reading and in a few cases when this is done attenuation must be allowed for. Consistent readings are, however, found when the procedure is adopted. The reason for the effect is not understood.

Practical Curves.

It is now possible on the basis of the foregoing to arrive at some useful curves to calculate the effect of the aerial on the field strength at a distance. These curves are referred back to Fig. 2. These give (Fig. 11) as the x axis, the height of the masts in feet and on the y axis a field-multiplier that is a pure number with which to multiply the actual

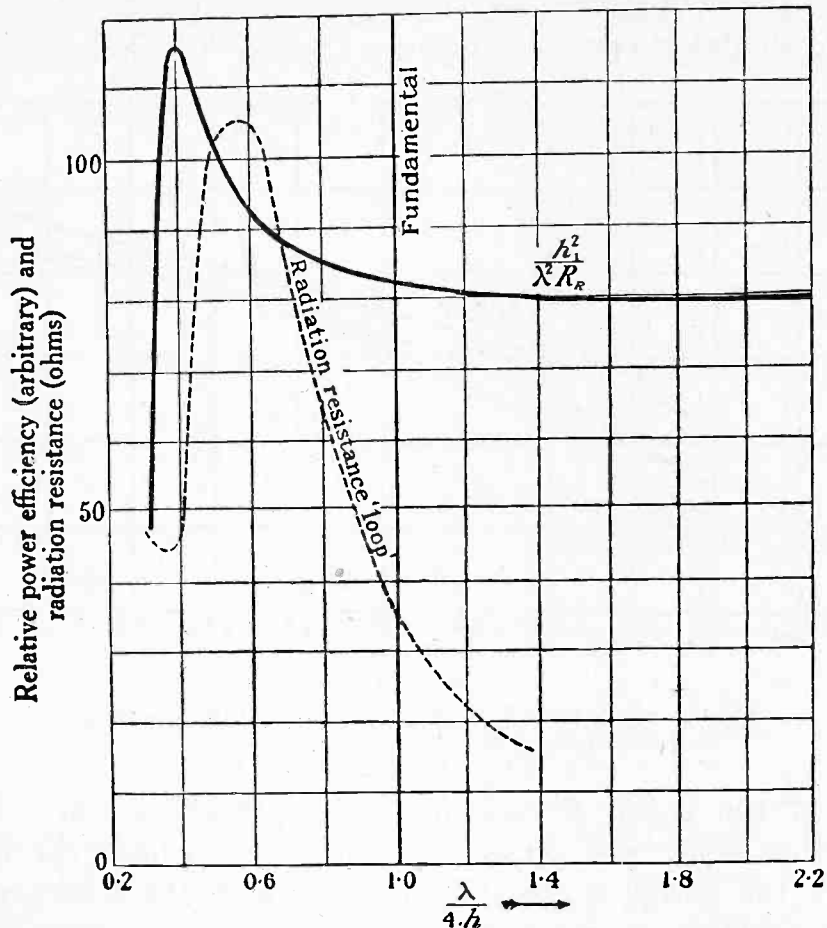

Fig. 10—Relative power efficiency and antenna radiation resistance. (Stuart Ballantine, loc. cit.) h = height of vertical aerial; λ = wavelength; R_R = radiation resistance; h_1 = effective height.

values of field in the curves of Fig. 2. The curves are drawn for 50 kw in the aerial, as a convenient figure, but may of course be increased or decreased at will for other powers inasmuch as the field strength is proportional to \sqrt{W} where W is the power in the aerial. There are several curves so that we may have values for the various wavelengths likely to be met with in practice. It is appreciated that certain of the curves represent aerials with h greater than $1/2\lambda$ but as is shown in Fig. 6 the analysis is applicable up to $\lambda/4h = 0.4$.

As an example we may be using a station of one-kw power, a wavelength of 450 meters and a mast height of 600 ft. We first look up the multiplier for 600-ft. masts, $\lambda = 450$ meters and power = 50 kw, and find this to be 8.25. We divided by $\sqrt{50}$ and find for 1 kw a multiplier of 1.17 for the values of Fig. 2. For 200-m wavelength and 700-ft. masts we find a value of 1.67 and so on. This means that with 200-meter wavelength there is a gain of 1.67-to-1 in field by using 700-ft. rather than about 100-ft. masts.

These curves have been derived on the basis of certain practical assumptions as follows:

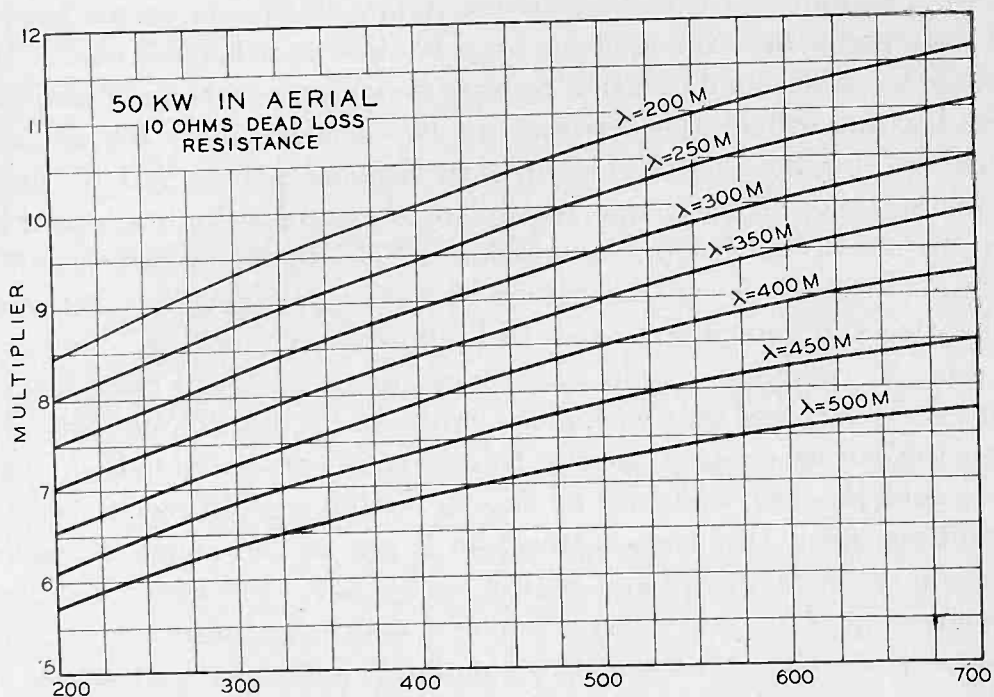

Fig. 11—Multipliers for theoretical attenuation curves.

(1) That the aerial is always of *T* formation and has a sag commensurate with standard mast design.

(2) That a reasonably dimensioned horizontal portion of the aerial is used. (This is determined by the mast spacing allowable for given sag and given cost, and the fact that the free ends of the *T* aerial must not be brought closer to the masts than a distance equal to a third of the distance between the masts.)

(3) That if we plot the current distribution for each case then the ratio of average current to maximum current will give the ratio of effective height to actual height. This gives the effective height and so a radiation resistance from h_1^2/λ^2 . This is now reduced according to

the actual value of h/λ . The total resistance is now calculable from an assumption of 10 ohms dead loss.⁹ Thus the aerial current is calculable assuming 1 kw in the aerial and so we can arrive at hI/λ and this will give us a multiplier for the field-strength curves of Fig. 2.

The author makes no apology for his methods which are intended to be wholly practical. The analysis would appear from experimental verification sufficiently accurate in practice when, as before mentioned, we are only seeking the order of quantity of field strength.

THE USE OF THE ANALYSIS IN TYPICAL CASES

It is perhaps not irrelevant in concluding this paper proper to give an example of how the analysis may be used in a typical case. The author has lately had occasion to propose a unique system of national broadcasting where the territory to be served (Great Britain and Northern Ireland) is divided up into regions each served by high-power stations. This scheme, which has been substantially adopted by the British Broadcasting Corporation as their technical policy, and is unique in that each regional station radiates from effectively the same point two different programs on two different wavelengths. We have, in fact, in principle a twin-wave transmitter at every transmitting center. This means that within the limits set by the different attenuations the service areas of the two transmitters are superimposed. This gives each listener, wherever he may be within a given region, service conditions from two transmitters; he is not at the mercy of casual location of transmitters and with a simple set, need never fear that the wipe-out of one will deprive him of a choice of an alternative. The scheme gives 85 per cent of the population alternative programs in "C" service (or better) conditions (about 65 per cent in "A" service conditions) and 98 per cent "C" service conditions (or better) from one program.

In order to find out the best position for stations, and, once chosen, the number of persons served in various districts, it was necessary to predict the field-strength contours.

We require, first, certain data relevant to the sites and power and aerial height of various transmitters.¹⁰ This is given as follows:

⁹ As the wavelength lengthens to 500 meters this value is a little high, it is also a little low for waves around 200 m. For wavelengths of the order of 1500 to 2000 meters the value is much more like 5 ohms or even less.

¹⁰ These are merely proposed sites; some of the stations are not yet built, and other considerations may make it necessary to choose locations near by but different from those actually indicated in the table.

TABLE OF QUANTITIES FOR FIELD-STRENGTH MAPS FOR REGIONAL SCHEME

Station	Geographical description	Map reading		Power in aerial, kw	Height of aerial, feet	Carrier frequency, kc per sec.	Wave-length, meters	Multiplier for theoretical attenuation curves See Fig. 11.	
		Lat. N	Long. W						
REGIONAL	London	Brookman's Park	51.43	0.11	50	200	842 1040	356 288.5	7 7.5
	Northern	Moorside Edge	53.38	1.53	50	500	626 995	479 301	7.3 9.5
	Scottish	Larbert	56.1	3.51	50	700	797 968*	377 310*	9.5 10.4
	West	Quantock Hills	51.8	3.13	50	700	1148 968*	261 310*	11.0 10.4
	Midlands	Daventry 5XX 5GB	52.16	1.10	50 30	500 300	193 752	1553 399	4.75 5.0
LOCAL	Newcastle	Newcastle	54.58	1.36	1	60	1500	200	0.9
	Aberdeen	Aberdeen	57.10	2.6	1	100	1420	210	0.9
	Belfast	Belfast	54.35	5.56	1	150	1238	240	0.9
	Plymouth	Plymouth	50.22	4.7	0.13	100	968	310	0.1

* These stations are synchronized on the same frequency according to the author's methods. They should give clear broadcasting to the "B" service contour; thereafter distortion sets in.

The method for plotting the general field-strength contours for any particular station is to fix on a site, by trial and error, and, once found, plot theoretical attenuation curves in say eight directions from that site. This will give the distances of the "A", "B", and "C" service contours. One may also find the fading limit (where direct equals indirect ray) if necessary.

In plotting the attenuation curve one proceeds as follows: First the x axis is laid out in distance and then by means of a contour map the attenuation factor over a certain distance is estimated. Thus as in Fig. 12 we may have 40 km of $\sigma = 10^{-13}$, then sea ($\sigma = 10^{-11}$) for 30 km, then hills at 0.5×10^{-13} for 60 km, and then mountains at 0.2×10^{-14} . Fig. 12 is purely diagrammatic but it will be seen that the curve is not smooth as there are different attenuations for different types of ground. One can start for the first 40 km of $\sigma = 10^{-13}$ by multiplying the curves of Fig. 2 by the multiplier for the mast height and for the wavelength. One then arrives at the sea with a certain value of field E_1 . Now, in general, attenuation over sea is, at these distances, practically according to the inverse distance law so that the field E_1 will be reduced to E_2 where $E_2/E_1 = d_1/d_2$, d_1 being the distance from the station where the waves start across the sea and d_2 the distance from the station where they have crossed the sea. Now we arrive at a field E_2 and the next section of land has, as in Fig. 12, a value of $\sigma = 0.5 \times 10^{-13}$. This means an equivalent wavelength of

λ_e less than λ_f the fundamental wavelength of the station. We have 60 km of $\sigma = 0.5 \times 10^{-13}$. Look up, then, the value of field strength at a distance d_2 (see above) and a wavelength λ_e on Fig. 2. This is a value E_a . Now find a new value of field E_b at a distance d_2 plus

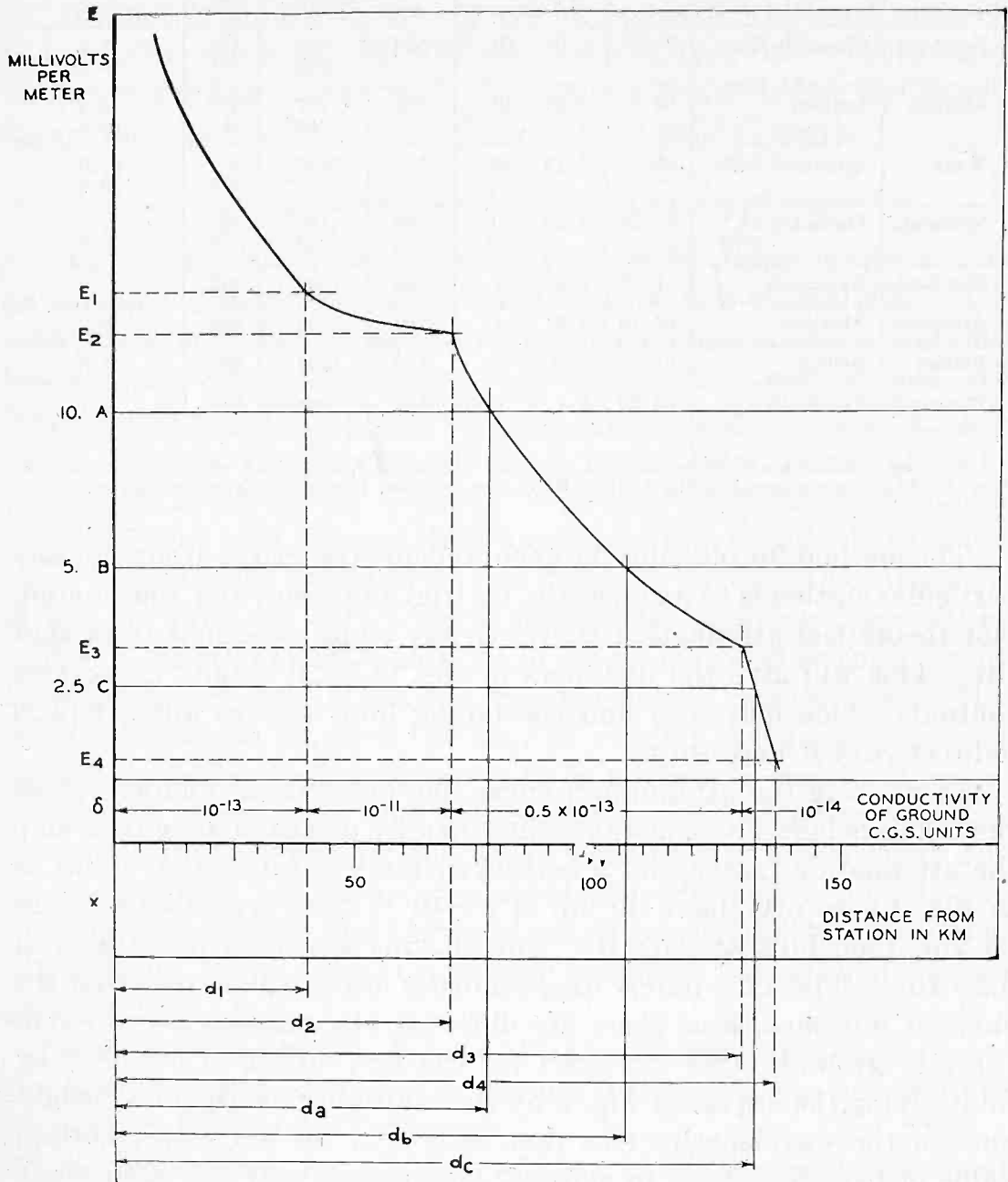

Fig. 12—Imaginary attenuation curve for waves passing over different types of ground with different conductivities.

60 km = d_3 and still at a wavelength λ_e and still using Fig. 2. This is a new field strength E_b . Multiply E_2 (the value of the field strength at the distance d_2) by E_b/E_a and arrive at a field E_3 distance d_3 away from the station which is the new point on the attenuation curve.

This process is continued and a new field E_4 is found. The distance of the "A", "B", and "C" service areas can now be found as d_a , d_b , d_c , at each station in eight directions. With 5 twin-wave stations to work out this means 80 attenuation curves to map out all the territory!

It is interesting to note that check experimental readings on the long-wave Daventry station showed that the estimated attenuation curve over the mountains was never more than 15 per cent different from the experimental attenuation curve at any point. The same applies in the case of the Northern Regional and the London Regional center.

Two maps are given as the result of the calculations in Figs. 13 and 14. These show the field contours for each of two different wavelengths at each station (as well as certain local stations working on one wavelength only).

The particular case of the West and Wales station is very interesting. The object of the station is to serve not only the peninsular region (Devon and Cornwall) running west southwest (in the southwest part of the British Isles) but also the densely populated area of south Wales. The greater part of the Welsh population lives along a fringe of Wales to the south of the Welsh mountains and along the seashore of the Bristol Channel which divides Wales from the Devon and Cornwall peninsula. Thus it was better to place the station on the peninsula to bombard the Welsh coast over the lightly attenuating sea than to try to feed the western parts of the Welsh coast from a station actually in Wales. A station at, say, Cardiff would never reach the west Welsh population at all due to the attenuation of the land but with only the sea between these western populations and the station we give them far better service and include everyone we want to in the service area of the station. This shows how the analysis may be of enormous practical use if used intelligently for just such cases as that indicated.

CONCLUSION

It has been shown that it is possible to predict an average of field (as a combination of space and direct ray) due to a broadcast station, provided we know the wavelength, power, and mast height of that station, and provided we are able to give an approximate estimate of the effective conductivity of the earth in places where the direct rays are appreciable. This paragraph is included only to reiterate that the whole analysis is designed to give an approximation. No doubt time will reveal that the assumptions made are of a too general nature to be relied upon if strict accuracy is required. The broadcast engineer has a responsibility for designing stations or groups of stations to give

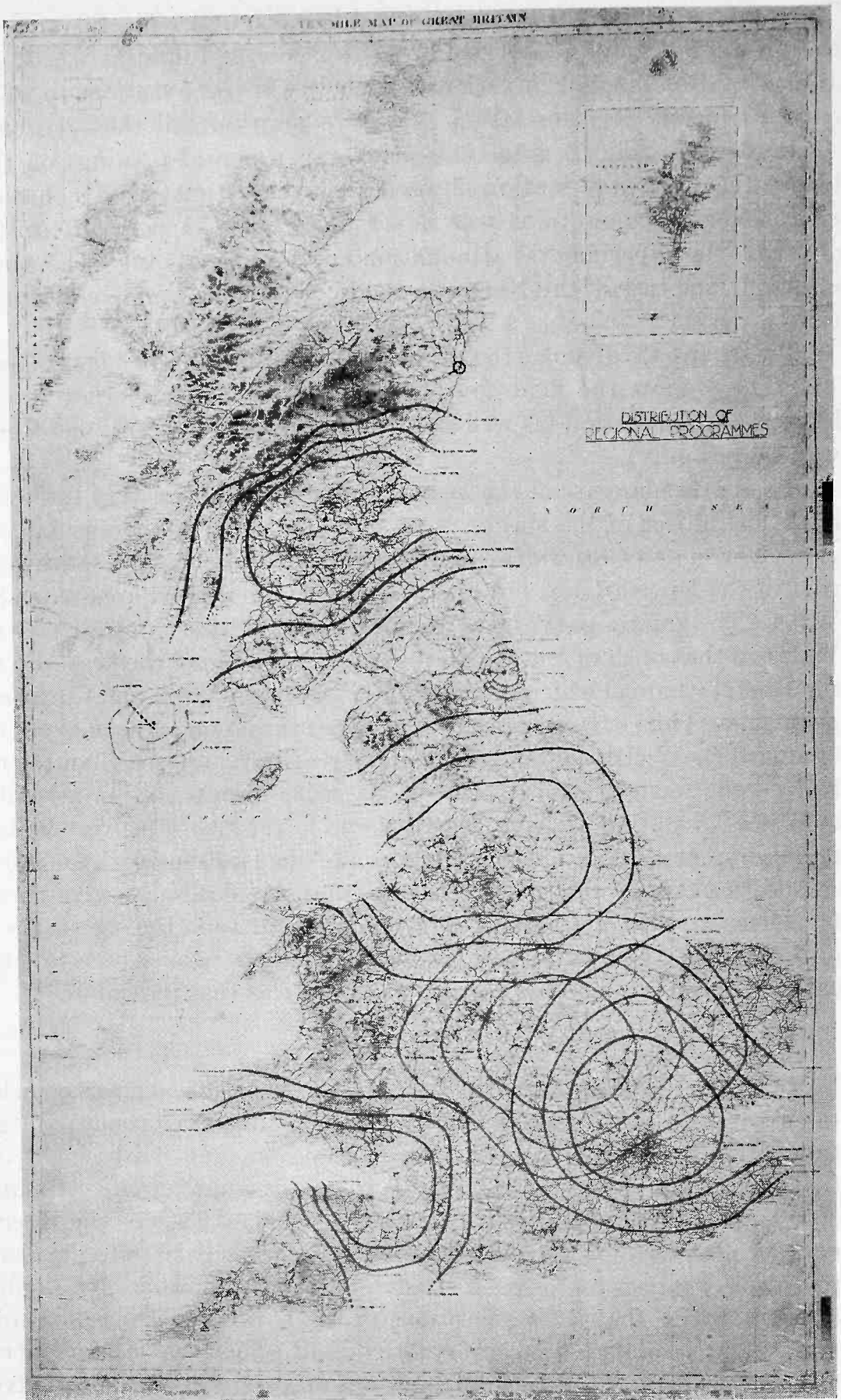

Fig. 13—Field-strength contours, calculated regional programs.

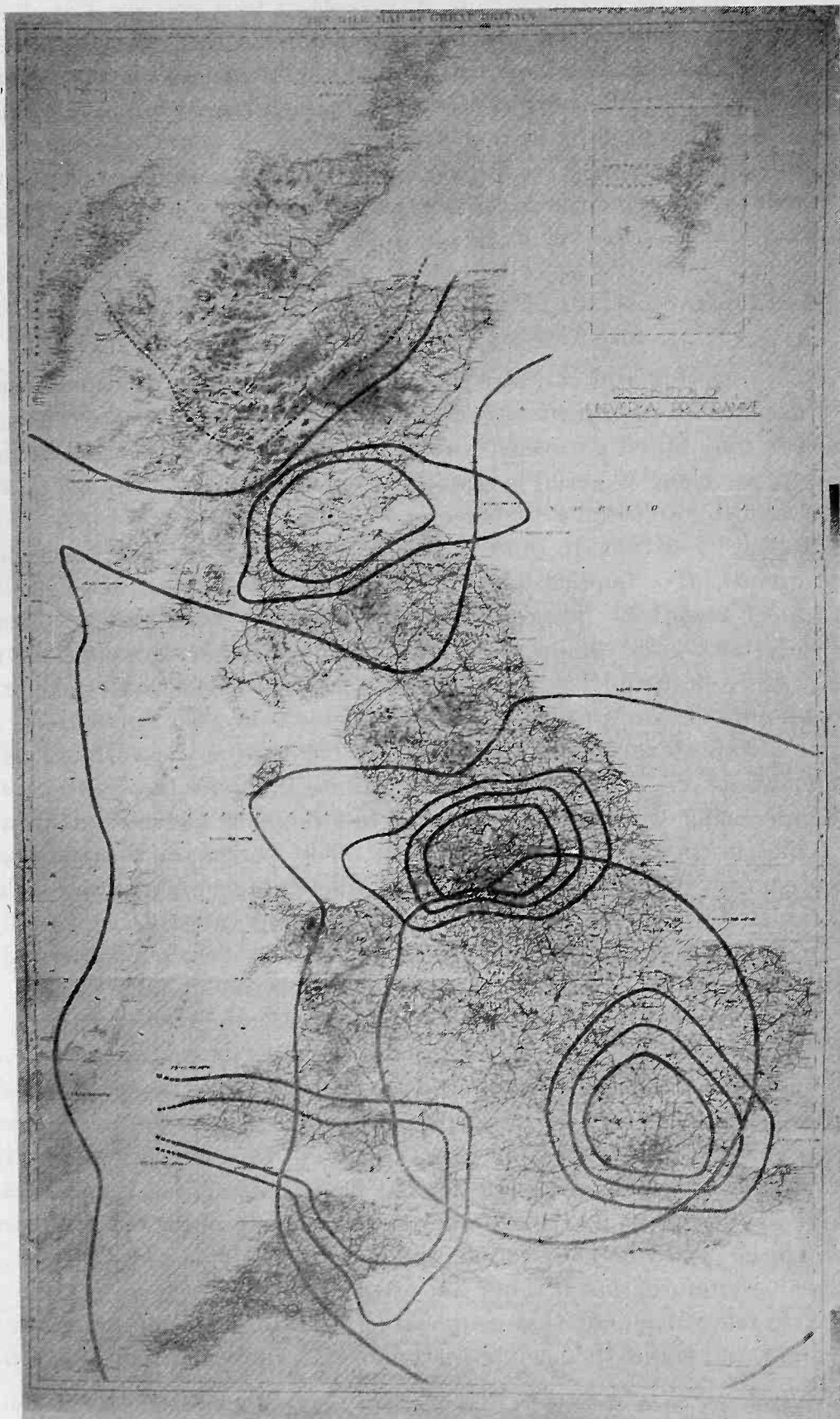

Fig. 14—Field-strength contours, calculated universal programs.

service. In practice this can only be defined within wide limits so many are the variables met with. As we must define service within wide limits we have only need to predict it within wide limits. This paper has attempted to do no more and no less. The author has found the analysis extremely useful in practice where a quick estimate of service is required without the laborious necessity of an experimental survey.

THE UNSUITABILITY OF THE PRESENT WAVELENGTHS ALLOCATED TO THE WORLD'S BROADCAST SERVICES

The experimental verifications of the foregoing analysis show that it is acceptable quantitatively within the limits imposed by the criteria. We can undoubtedly forecast service area given certain factors as the power, wavelength, aerial height, and type of ground (the latter to be estimated by an intelligent person and a map).

It will be obvious to those who take the trouble to observe closely the quantitative implications involved that the shorter wavelengths are most unsuitable for regional broadcasting. A striking case has already been cited where a station of 800-kw power (drawing about 6000 kw from the power-supply mains), only gives true service over an area bounded by a fifteen- to twenty-mile circle around the station. A more striking example can be added. The author has calculated¹¹ that, whatever the power of the stations involved, 24 stations in Canada using waves spaced equally in frequency between 545 and 200 meters could not cover more than 7 per cent of the total area of that country with true service broadcasting whatever the power of the stations. With the same number of stations using waves spaced equally in frequency between 2000 and 280 m, 83 per cent of the area of Canada could be covered by true service broadcasting.

If the basis of the broadcast service is founded not only on giving a service to densely populated towns (where facilities for amusement of all kinds already exists), but also to give lonely people living in out-of-the-way parts, the benefit of keeping in touch with the world's amusement and culture, it is obvious that the present wavelengths are wholly unsuitable. It cannot be gainsaid that broadcasting is of the greatest value to those who by their circumstances are cut off for months from civilization and who have to face the boredom of loneliness. It would appear, therefore, that it is our duty to press for better facilities.

It is true, of course, that people are grateful for a space-ray service at night and count themselves fortunate that they hear anything, but

¹¹ "Service area of broadcasting stations", page 17, section VII; loc. cit. footnote 1.

it is to be hoped that in the future programs will be given that will be so interesting as to suffer materially by their irregular disappearance as coherent sound! Long-wave broadcasting will be the only means by which such programs can be universally and reliably diffused.

The author was one of the first to realize the great value attaching to long-wave broadcasting, and station 5XX Daventry, England, is a practical outcome of early understanding of the problem. This station is useful in Great Britain even, for the lonely listener, and all the poorer listeners in rural districts, are daily brought into contact with programs they would not otherwise hear but for the existence of this station.

Apart from the lonely listener the service in all regions would be greatly improved by the use of longer waves. One station using a longer wave would be enabled to do the work of several, do it more economically *per se*, and cause, since it could be of reasonable power, less interference in the ether.

At the present moment we waste power for an incommensurate gain and to the detriment of other broadcasters and listeners.

The two main reasons cited against the use of long-wave broadcast concern dislocation to other users of the ether who are at present using waves between 600 and 2000 meters, and the added difficulty in designing receiving sets to cover the full-wave range.

As to the former point, the problem is only insoluble as it is left to be discussed by non-technical persons anxious only to preserve a *status quo* and afraid to spend money for progress. The latter problem cannot be insoluble because it is solved in Europe to-day. Even if the designer of a receiver fears the complication of putting in a switch to short circuit or include an inductance in the tuned circuits there is still the possibility of gauging both inductance and capacity which produces a desirable uniformity of circuit performance and which, with one handle control, will cover the full wave range.

There will undoubtedly be a determined move on the part of European broadcasters to secure more "long" wavelengths at the forthcoming Madrid Conference. It is proved without question that they will speak in the interests of tens of millions of listeners who are rightly demanding to be able to hear all sorts of programs without interruption or fading, in fact, to listen to varied programs in true service conditions.

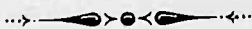

FREQUENCY MODULATION*

BY

BALTH. VAN DER POL

(Physical Laboratory, Philips' Incandescent Lamp Works, Eindhoven, Holland)

Summary—The differential equation of a frequency modulated transmitter is considered and the expression of the current as a function of time is derived.

Frequency analysis of this function is made for two specific cases, (A) sinusoidal frequency modulation (telephony) and (B), right-angle frequency modulation (telegraphy with "marking" and "spacing" wave). The distribution and amplitudes of the frequencies present are seen to depend upon the value of an absolute parameter, the "frequency modulation index," equal to the ratio of the maximum frequency deviation to the imposed modulating frequency. The overall width of the band occupied is found to be approximately double the highest of these two frequencies. In the case of high-speed frequency modulated telegraphy, however, side frequencies of noticeable amplitude may occur outside this band. Charts are included showing the derived frequency spectra.

A CERTAIN amount of discussion has taken place during the last years in engineering circles as to the amount of interference and the width of band used when a generator is modulated in the fashion commonly known as *frequency modulation*. This expression characterizes the case when the imposed signal is caused to vary the instantaneous value of the frequency of the carrier wave, instead of varying its amplitude. The object of this paper is to present the analysis of two specific cases particularly suited to represent the conditions obtaining in telephony and telegraphy, respectively.

1. DERIVATION OF THE TIME FUNCTION OF THE FREQUENCY MODULATED CURRENT

The differential equation for a circuit, consisting of a constant inductance L and a variable capacity $C(t)$ follows at once from the fact that the potential difference across the inductance equals numerically the potential difference over the condenser. †

Hence, calling the current i , the potential difference v , and the charge of the condenser q , we have

* Dewey decimal classification: R148. Paper read before the Dutch Scientific Radio Society (Nederlandsch Radio Genootschap), at its meeting on Sept. 20th, 1929 in The Hague, to which the delegates to the C.C.I. (radio) were invited.

† $C(t)$ is assumed to be varied in such a manner that no amount of q is removed from the circuit at any time.

$$\frac{d}{dt}(Li) + v = 0 \quad (1)$$

where

$$v = \frac{q}{C(t)}$$

As further

$$i = \frac{dq}{dt} \quad (2)$$

(1) becomes

$$L \frac{d^2q}{dt^2} + \frac{1}{C(t)}q = 0$$

or

$$\frac{d^2q}{dt^2} + \omega^2(t) \cdot q = 0 \quad (3)$$

where

$$\omega^2(t) = \frac{1}{L \cdot C(t)} \quad (4)$$

The differential equation (3) is thus seen to be fundamental for the problem of finding the charge q , the potential difference v , or the current i of an oscillatory circuit one element of which is variable with the time.

Modern mathematics is unable to solve (3) generally in a way leading to practical results. Hence we shall have to specify $C(t)$ or $\omega^2(t)$ more precisely.

In this paper two cases will be considered:

$$(a) \quad C(t) = C + \Delta C \cdot \cos pt. \quad (5)$$

(b) $C(t)$ jumps periodically and discontinuously from $(C \pm \Delta C)$ to $(C \pm \Delta C)$ (see Fig. 1).

(a) represents the conditions typical of telephony when a sinusoidal note of frequency $p/2\pi$ is sung in front of a condenser transmitter.

(b) corresponds to telegraphic transmission with one "marking" and one "spacing wave."

Let us consider case (a) first. For a sinusoidal small change of $C(t)$, (4) becomes

$$\omega^2(t) = \frac{1}{LC \left(1 + \frac{\Delta C}{C} \cos pt \right)} \doteq \frac{1}{LC} \left(1 - \frac{\Delta C}{C} \cos pt \right)$$

or

$$\omega^2(t) = \omega^2 \left(1 + 2 \frac{\Delta \omega}{\omega} \cos pt \right)$$

where

$$\omega^2 = \frac{1}{LC}$$

and

$$\frac{\Delta C}{C} = -2 \frac{\Delta \omega}{\omega}$$

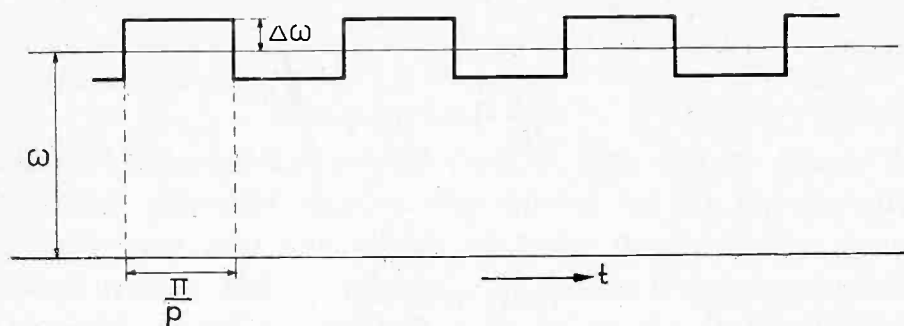

Fig. 1.

Thus $\Delta\omega$ means the maximum deviation of the angular frequency from its mean value ω . Hence (3) becomes

$$\frac{d^2q}{dt^2} + \omega^2 \left(1 + 2 \frac{\Delta\omega}{\omega} \cos pt \right) q = 0, \quad (\text{I})$$

which equation is of the type defining *Mathieu* functions.¹

The same equation (I) is also at the base of *Carson's* well-known paper on frequency modulation,² and otherwise occurs in innumerable problems in many branches of physics.³

It occurs in particular in important astronomical problems and an approximate solution well suited for our present application will now be derived by the method used by *Bruns* in astronomical work.⁴

¹ A complete exposition of the properties of these functions is Humbert, "Fonctions de Lamé et fonctions de Mathieu," Paris 1926.

² J. R. Carson, *Proc. I.R.E.* 10, 57; 1922.

³ A certain number of these applications are listed by Balth. van der Pol and M. J. O. Strutt, "On the stability of the solutions of Mathieu's equation," *Phil. Mag.* 5, 18; 1928, a paper to which the reader is also referred for certain calculations and results connected with the present subject.

⁴ H. Poincaré, "Mécanique Céleste II," page 253.

To that effect we make in (I) the following substitution:

$$q = e^{\int z dt}.$$

Equation (I) thus becomes

$$\frac{dz}{dt} + z^2 + \omega^2 \left(1 + 2 \frac{\Delta\omega}{\omega} \cos pt \right) = 0, \quad (7)$$

which is a first-order equation of the Riccati type.

When the "percentage absolute frequency deviation" $\Delta\omega/\omega$ is small, as is the case in radio applications, and at the same time the modulation frequency p is small compared with the carrier frequency ω , an approximate solution of (7) is

$$\begin{aligned} z_{1,2} &= \pm j \left\{ \omega^2 \left(1 + 2 \frac{\Delta\omega}{\omega} \cos pt \right) \right\}^{1/2} \\ &\doteq \pm j(\omega + \Delta\omega \cdot \cos pt), \end{aligned} \quad (8)$$

and thus the required approximate solution of (I) becomes

$$\begin{aligned} q &= e^{\int z_1 dt} + e^{\int z_2 dt} = A \cdot \cos \left\{ \int (\omega + \Delta\omega \cdot \cos pt) dt \right\} \\ &= A \cdot \cos \left(\omega t + \frac{\Delta\omega}{p} \sin pt \right), \end{aligned} \quad (9)$$

where an arbitrary phase constant has, for the sake of simplicity, been omitted.

It can further be shown that, with the conditions imposed above, namely,

$$\begin{aligned} \Delta\omega &\ll \omega, \\ p &\ll \omega, \end{aligned}$$

the solutions for the potential difference v , and the current i in the circuit are similar to (g), although the differential equations for v and i contain additional terms.⁵

Carson,² who also arrived at the solution (9) but by a different method, points out that, although in the time function (5) of the condenser a $\cos pt$ term occurs, in the solution (9) a $\sin pt$ term presents itself, which may be thought surprising. This point is closely connected with the definition of the momentary frequency of such a function as

$$y = \cos \{ f(t) \},$$

⁵ e.g., as $i = dq/dt$, the equation for i is seen from (3) to be

$$\frac{d^2 i}{dt^2} - \left(\frac{1}{\omega^2(t)} \cdot \frac{d\omega^2(t)}{dt} \right) \cdot \frac{di}{dt} + \omega^2 t \cdot i = 0.$$

² Loc. cit.

Where $f(t)$ is such that $f''(t) \ll f'(t)$.

Helmholtz in his "Lehre von den Tonempfindungen," which was published in 1862, solved the difficulty by defining the momentary frequency $\omega(t)$ of (10) as

$$\omega(t) = \frac{df(t)^*}{dt} \quad (11)$$

According to this definition the momentary frequency of (9) is

$$\frac{d}{dt} \left(\omega t + \frac{\Delta\omega}{p} \sin pt \right) = \omega + \Delta\omega \cdot \cos pt,$$

the square of which approximately equals

$$\omega^2 \left(1 + 2 \frac{\Delta\omega}{\omega} \cdot \cos pt \right),$$

which in turn coincides with the last coefficient in the differential equation (I). In this way the more natural conception consisting in assimilating (I) with the ordinary equation where the frequency is constant, is reconciled with the correct mathematical result (9).

Case *b*, where $C(t)$ jumps periodically and discontinuously from $(C \pm \Delta C)$ to $(C \mp \Delta C)$ with a frequency $p/2\pi$ can now be treated in a similar way.

Let us designate by $\Gamma \cos pt$ the function of t thus defined (see Fig. 1).

Equation (I) now becomes

$$\frac{d^2q}{dt^2} + \omega^2 \left(1 + 2 \frac{\Delta\omega}{\omega} \cdot \Gamma \cos pt \right) q = 0. \quad (II)$$

Using the same method as before and under same conditions, *viz.*,

$$\Delta\omega \ll \omega,$$

$$p \ll \omega,$$

we arrive at the following expression:

$$q = A \cos \left\{ \int (\omega + \Delta\omega \cdot \Gamma \cos pt) dt \right\} = A \cos(\omega t + \Delta\omega \int \Gamma \cos pt \cdot dt), \quad (12)$$

corresponding to (9). Consequences from expressions (9) and (12) will now be derived.

* Helmholtz, "Die Lehre von den Tonempfindungen," Braunschweig, 649-650; 1913.

2. FREQUENCY ANALYSIS OF CASE (A) (TELEPHONY)

Expression (9) lends itself to spectral analysis into its component frequencies by the following process; taking the amplitude A as unity (9) may be written

$$q = \cos \omega t \cdot \cos \left(\frac{\Delta \omega}{p} \cdot \sin pt \right) - \sin \omega t \cdot \sin \left(\frac{\Delta \omega}{p} \cdot \sin pt \right) \quad (13)$$

Now well-known Fourier developments for the *periodic* functions $\cos (x \sin \phi)$ and $\sin (x \sin \phi)$ having Bessel functions of the first type as coefficients are

$$\cos (x \cdot \sin \phi) = J_0(x) + 2J_2(x) \cdot \cos 2\phi + 2J_4(x) \cdot \cos 4\phi + \dots$$

$$\sin (x \cdot \sin \phi) = 2J_1(x) \cdot \sin \phi + 2J_3(x) \cdot \sin 3\phi + 2J_5(x) \cdot \sin 5\phi + \dots$$

Using these expressions (9) is readily decomposed into its component frequencies as follows

$$\begin{aligned} q &= \cos \left(\omega t + \frac{\Delta \omega}{p} \cdot \sin pt \right) \\ &= J_0 \left(\frac{\Delta \omega}{p} \right) \cdot \cos \omega t \\ &\quad - J_1 \left(\frac{\Delta \omega}{p} \right) \cdot \{ \cos (\omega - p)t - \cos (\omega + p)t \} \\ &\quad + J_2 \left(\frac{\Delta \omega}{p} \right) \cdot \{ \cos (\omega - 2p)t + \cos (\omega + 2p)t \} \\ &\quad - J_3 \left(\frac{\Delta \omega}{p} \right) \cdot \{ \cos (\omega - 3p)t - \cos (\omega + 3p)t \} \\ &\quad + \dots \dots \dots \end{aligned} \quad (14)$$

The following frequencies are thus seen to be present

$$\omega, (\omega \pm p), (\omega \pm 2p), \dots$$

The whole practical problem of the amount of disturbance arising from frequency modulation depends therefore upon the value of the ratio

$$m = \frac{\Delta \omega}{p}$$

of the absolute frequency deviation to the imposed audio frequency p . Owing to the importance of this parameter m which may, in practical

conditions, assume any value, whether large or small, it may be found useful to designate it by a special name for which we suggest the expression "*frequency modulation index*," or for short "*index*."

The amplitude of the component frequencies for a given value of the index can easily be got from one of the standard tables of Bessel functions and thus the frequency spectrum of any particular case can be obtained. Fig. 2 presents the results of these calculations for a certain number of values of the index, the audio frequency p being taken as constant and the absolute frequency deviation $\Delta\omega$

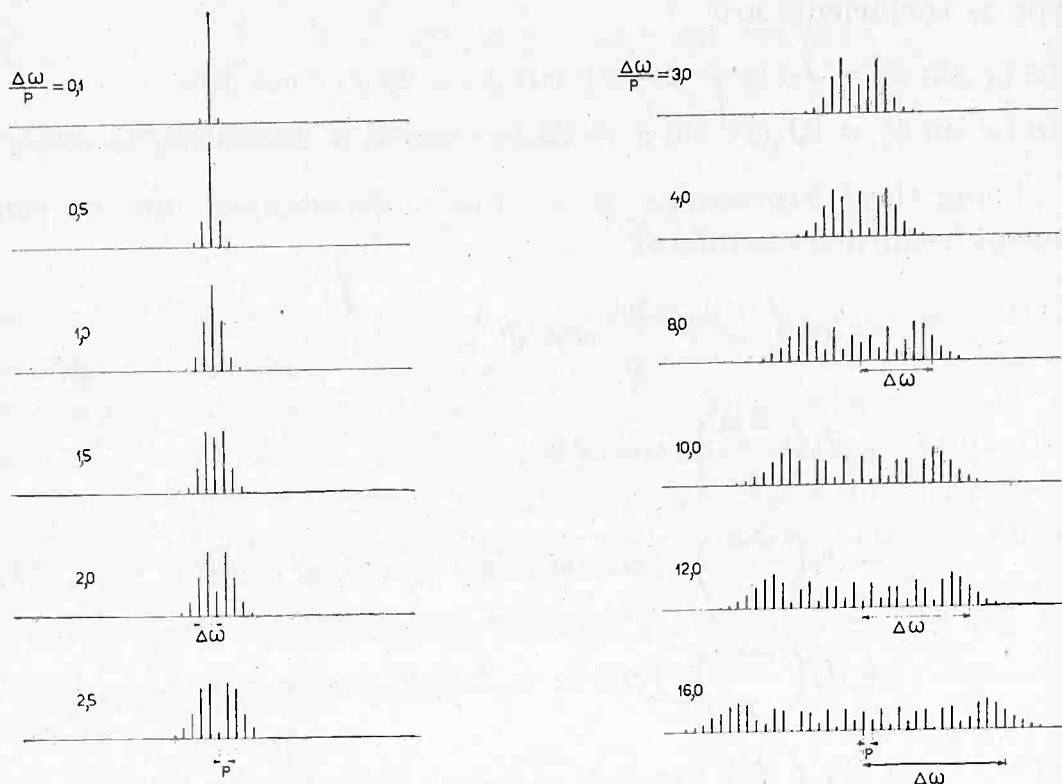

Fig. 2.

being varied accordingly. Fig. 3 shows similar spectra, but $\Delta\omega$ being here kept constant and p varied.

It will be seen from Fig. 2 that for a small index $m = \Delta\omega/p$ the spectrum practically consists of a carrier of frequency ω and two side frequencies $\omega \pm p$ only. It follows from (13) that under these circumstances

$$q = \cos \omega t - \frac{\Delta\omega}{p} \sin pt \cdot \sin \omega t, \quad (15)$$

and that therefore the ratio of the amplitudes of each side frequency to the carrier equals one-half the index, $m/2$. Moreover expression (15) compared to the expression

$$q_1 = \left(1 - \frac{\Delta\omega}{p} \sin pt \right) \cdot \sin \omega t, \quad (16)$$

which is representative of the same carrier frequency, the amplitude of which is modulated by the same signal frequency, shows that in this limiting case both types of modulation yield similar results. The difference is a phase shift of 90 deg. of the carrier wave and of

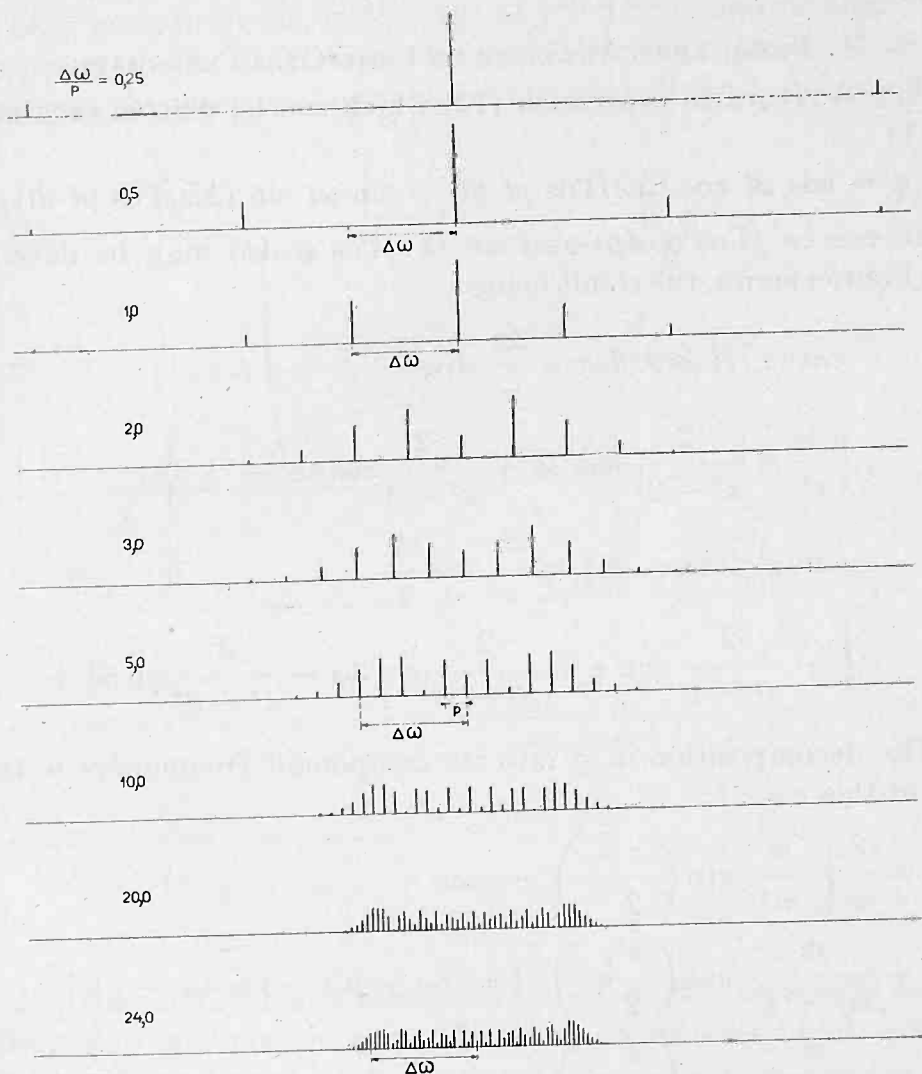

Fig. 3.

the modulating wave. Further increase of $\Delta\omega$ results in successive side frequencies appearing in their turn, the relative amplitudes of all the frequencies present in each specific case depending on the values of the Bessel functions involved. Some of the amplitudes, that of the carrier included, actually happen to be zero when the index m coincides with a root of the corresponding Bessel function.

Fig. 3 shows similar spectra drawn on the supposition that $\Delta\omega$

is kept constant but the audio frequency p varied. In the case of a small index $m = \Delta\omega/p$, the side frequencies appear at a great distance from the carrier. As p decreases and therefore the index increases, successive side frequencies appear, the total space occupied shrinking continuously to the limiting value $2 \Delta\omega$. This limiting value is attained for an infinitesimal value of p , in which case this whole interval $2 \Delta\omega$ is occupied by a continuous band spectrum, such as occurs in optics.

3. FREQUENCY ANALYSIS OF CASE (B) (TELEGRAPHY)

Let us return to expression (12) which can be written (again with $A = 1$)

$$q = \cos \omega t \cdot \cos (\Delta\omega \int \Gamma \cos \phi \cdot d\phi) - \sin \omega t \cdot \sin (\Delta\omega \int \Gamma \cos \phi \cdot d\phi).$$

Again $\cos (x \cdot \int \Gamma \cos \phi \cdot d\phi)$ and $\sin (x \cdot \int \Gamma \cos \phi \cdot d\phi)$ may be developed into Fourier series, the result being

$$\begin{aligned} \cos (x \cdot \int \Gamma \cos \phi \cdot d\phi) &= \frac{2x}{\pi} \cdot \sin \frac{x\pi}{2} \\ &\left\{ \frac{1}{x^2} - \frac{2}{x^2 - 2^2} \cos 2\phi + \frac{2}{x^2 - 4^2} \cos 4\phi - \dots \right\} \\ \sin (x \cdot \int \Gamma \cos \phi \cdot d\phi) &= \frac{2x}{\pi} \cdot \cos \frac{x\pi}{2} \\ &\left\{ -\frac{2}{x^2 - 1^2} \sin \phi + \frac{2}{x^2 - 3^2} \sin 3\phi - \frac{2}{x^2 - 5^2} \sin 5\phi + \dots \right\} \end{aligned}$$

The decomposition of q into its component frequencies is therefore in this case

$$\begin{aligned} q &= \frac{2}{\pi} \left[\frac{m}{m^2} \cdot \sin \left(\frac{\pi}{2} m \right) \cdot \cos \omega t \right. \\ &+ \frac{m}{m^2 - 1^2} \cdot \cos \left(\frac{\pi}{2} m \right) \cdot \{ \cos (\omega - p)t - \cos (\omega + p)t \} \\ &- \frac{m}{m^2 - 2^2} \cdot \sin \left(\frac{\pi}{2} m \right) \cdot \{ \cos (\omega - 2p)t + \cos (\omega + 2p)t \} \\ &- \frac{m}{m^2 - 3^2} \cdot \cos \left(\frac{\pi}{2} m \right) \cdot \{ \cos (\omega - 3p)t - \cos (\omega + 3p)t \} \\ &+ \dots \dots \dots \left. \right] \quad (17) \end{aligned}$$

The same component frequencies ω , $\omega \pm p$, $\omega \pm 2p, \dots$, as in case (A) are thus seen to occur. Their relative amplitudes are easily

calculated from the preceding formula and Figs. 4 and 5 give the graphical representation thereof. Using a similar treatment as in case (A), in Fig. 4, p has been kept constant and $\Delta\omega$ varied, whereas in Fig. 5 $\Delta\omega$ has been kept constant and p varied. A comparison of Figs. 4 and 5 with Figs. 2 and 3, respectively, shows that successive aspects of the spectra are substantially the same in both cases, when the index $m = \Delta\omega/p$ increased or when p decreases. An interesting distinction occurs, however, in the case of p tending towards zero. This corresponds to the case of infinitely slow keying. Under these circumstances the spectrum degenerates into two lines only, of frequencies

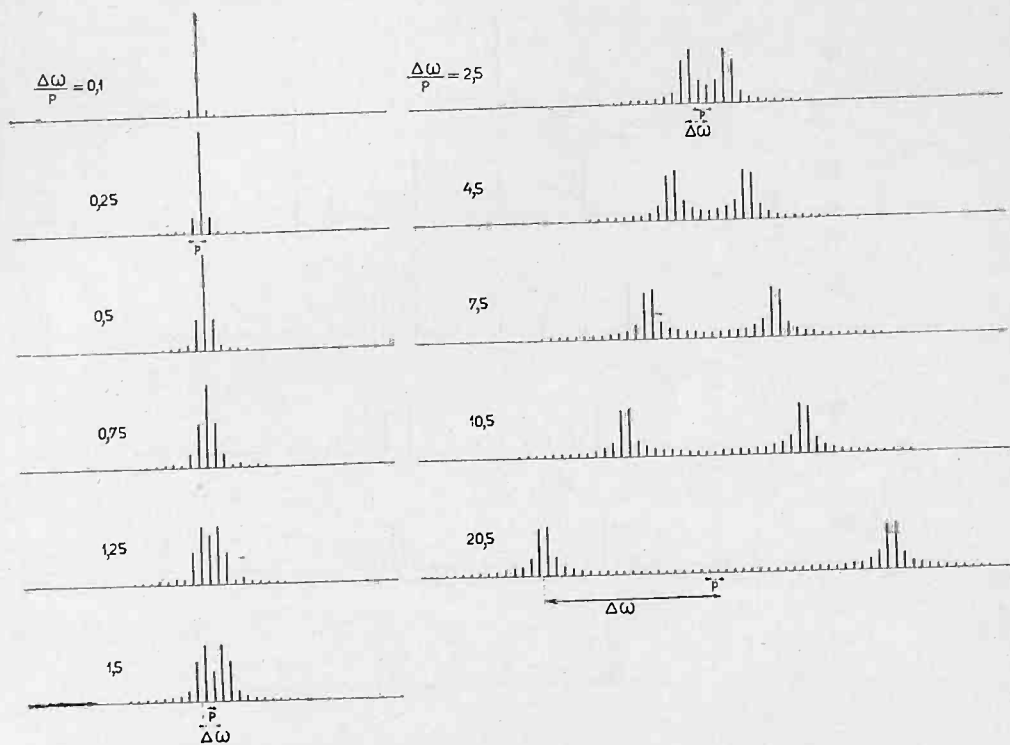

Fig. 4.

$\omega \pm \Delta\omega$, the carrier being absent, whereas in the sinusoidal case infinitely slow modulation gave rise to a continuous band spectrum within the same limits.

It is apparent from (17) that odd side frequencies are absent whenever the index m is equal to an odd number, and even side frequencies whenever the index is an even number.

4. CONCLUSION

The practical consequences of the preceding analysis, as regards the width of the band occupied by a frequency modulated transmitter are the following.

The width of the band occupied depends upon the value of $m = \Delta\omega/p$, i.e., of the ratio of the absolute frequency deviation $\Delta\omega$ to the audio frequency p of the modulation, which was called above the "index of frequency modulation."

Taking up the case of telephony first, it is seen from the above spectra that the width of the band can for practical purposes be approximated by $2\Delta\omega$, as long as p is smaller than $\Delta\omega$, and by $2p$ as

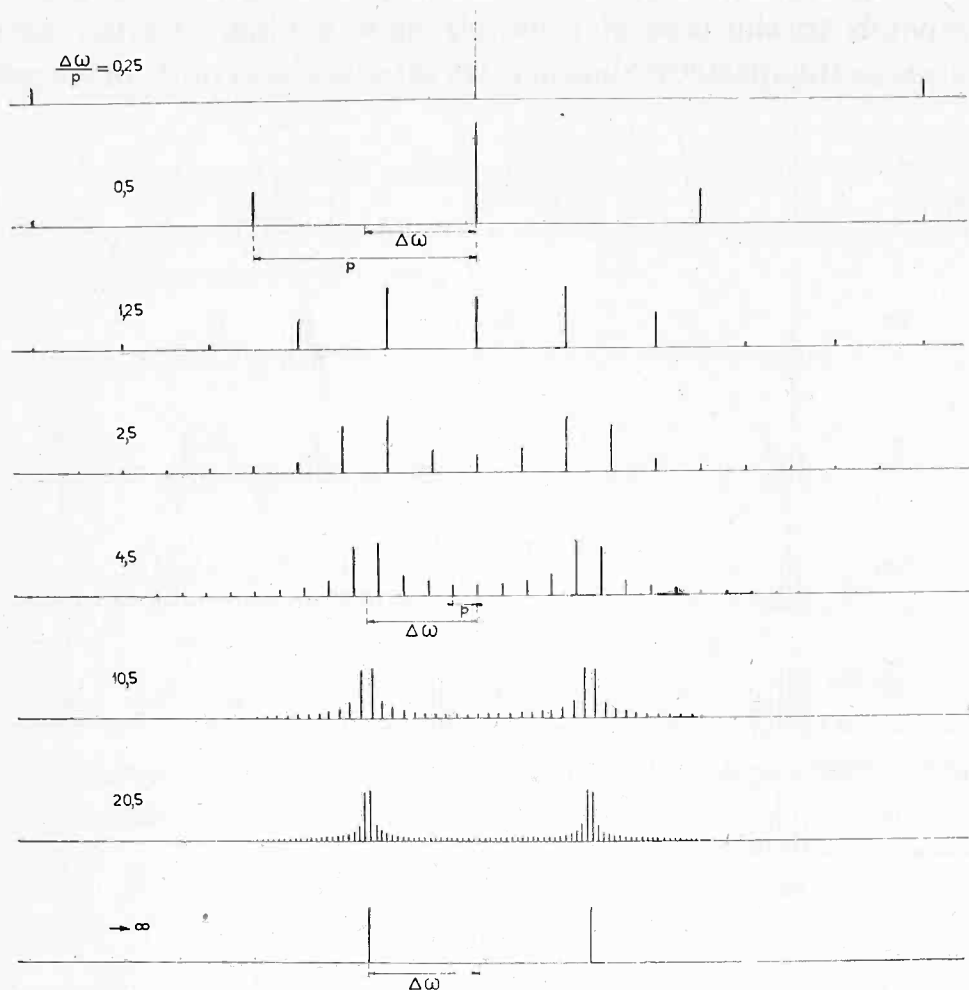

Fig. 5.

long as $\Delta\omega$ is smaller than p . It is therefore the larger of those quantities—the absolute frequency deviation and the audio frequency—which practically determines the width of the band occupied.

In the case of telegraphy the result is practically the same provided the index is not too small, i.e., whenever the frequency of keying is not very great as compared with the frequency deviation. When the frequency of keying, however, is very great as compared with the frequency deviation, the side frequencies cannot be taken as concentrated in a band of width $2p$, but all side frequencies of odd order

re theoretically present with amplitudes which decrease but slowly as the order increases. In practical cases, however, the side frequencies of higher order must be expected to disappear owing to the limited bandwidth passed by the transmitting apparatus.

It must finally be observed that intentional frequency modulation has only been considered in this paper. The same disturbances might (and in fact do) occur in cases where amplitude modulation was intended, but where, due to careless design of the transmitter, frequency modulation actually is present to a more or less objectionable extent.



EFFECT OF CAVITY RESONANCE ON THE FREQUENCY RESPONSE CHARACTERISTIC OF THE CONDENSER MICROPHONE*

BY

STUART BALLANTINE

(President, Boonton Research Corporation, Boonton, N. J.)

Summary—*The effect of the cavity before the membrane in the usual condenser microphone is to cause an increase of pressure at the membrane over that which exists in the undisturbed (free) sound-field, particularly at high frequencies.*

An approximate theory of the effect is given and a specimen case is calculated. In this case the pressure ratio reaches a maximum of 2.5 at 3000 cycles.

Experimental values obtained with the Rayleigh disk are compared with the computations and are in general agreement.

A modified design for a condenser microphone without a diaphragm cavity, and adapted for spherical mounting, is described.

The temperature coefficient of sensitivity due to the unequal thermal expansions of a duralumin membrane in a steel mounting was found to be 0.6 per cent per degree C.

The importance of taking the cavity and reflection effects into consideration in the construction of curves showing the overall fidelity of broadcast transmitters is stressed on account of its intimate relation to the design of radio receivers for uniform frequency response.

THE AIR-DAMPED condenser microphone, devised by E. C. Wente,¹ is extensively used in this country for the measurement and electrical recording of sound-pressure. It is a convenient and rugged instrument, requires little care, and is at the same time sufficiently sensitive for most purposes.

Wente and his colleagues have obtained a satisfactory calibration of the instrument by applying to the membrane known alternating pressures generated by the thermophone and pistonphone.² Such a calibration furnishes the electrical response of the instrument in terms of the pressure actually present at the face of the membrane.

It is recognized, however,³ that when the microphone is employed for the measurement of the pressure in a sound-field the actual pressure at the diaphragm may differ considerably from that which would exist in the sound-field in the absence of the microphone. In these circumstances the "diaphragm pressure calibration" is not of final significance and its use entails considerable error, especially at the

* Dewey decimal classification: 621.385.95.

¹ E. C. Wente, *Phys. Rev.*, 10, 39, 1917; 19, 498, 1922.

² E. C. Wente, *Phys. Rev.*, 19, 333, 1922.

³ E. J. Barnes, *Proc. Wireless Sect., I. E. E.*, 3, No. 7, p. 59, 1928. A. J. Aldridge, *Jour. Post Office Elec. Eng.*, 21, 223, 1928. Stuart Ballantine, *Phys. Rev.*, 32, 988, 1928.

higher frequencies. The departure may apparently be ascribed to two principal effects: In the first place, the pressure at the diaphragm is increased by diffraction (or reflection) around the microphone considering the latter as an obstacle in the sound field. Secondly, in the usual construction of the microphone (Wente²), in which the membrane stretching ring lies in front of the membrane, the membrane is situated in a cup-shaped recess and the pressure ratio is further altered by resonance in this cavity.

The author has attempted a discussion of the first of these effects in an earlier publication, considering particularly the increase of pressure which may be expected by diffraction in the case of a sphere. It was there proposed that in order to make the effect definite and calculable the microphone be mounted in a spherical shell *with the membrane as nearly in the surface of the sphere as possible*. The required

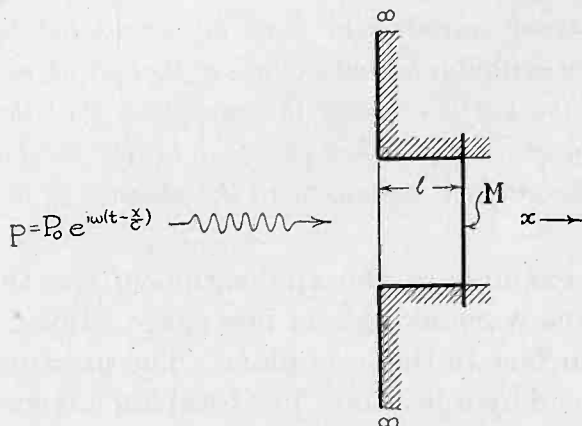

Fig. 1—Illustrating circular membrane at end of cavity of length l ; infinite baffle.

numerical corrections, ranging from 1 to 2, for spherical mountings of various diameters and frequencies were computed and will be found in that paper.

The second effect, which may be called the "cavity effect", is the subject of the present note. A rough theoretical explanation is given and an improved microphone construction is described whereby the cavity in front of the membrane has been eliminated, with a considerable improvement in the overall frequency characteristic.

1. Theoretical Discussion. The following theoretical treatment of cavity resonance, while not sufficiently rigorous for the computation of the necessary corrections, will exhibit the general character of the effect and explain many of the results of comparisons of calibrations made with the thermophone and with the Rayleigh disk.

Fig. 1 represents the membrane M , situated at the end of a tube

² loc. cit.

of length l , whose other end is open and provided with an infinite flange. A plane sound wave of the type $p = P_0 e^{i\omega(t-x/c)}$ is assumed to be incident normally upon the orifice ($x=0$). In accordance with the approximate method of Rayleigh assume that the orifice contains an imaginary, massless, infinitely thin piston; this is tantamount to assuming the velocity over the orifice to be uniform. We wish to calculate the effect of the cavity upon the pressure at M in terms of the pressure which would exist if M were situated in the surface of the baffle.

The mental work connected with acoustical problems may often be considerably simplified by the employment of a theorem which is the acoustic analogue of Thevenin's theorem for electrical networks. This theorem may be stated with sufficient generality for our present needs as follows:

The velocity at a point of an acoustical system in response to an impressed sound field may be calculated by inserting an imaginary suitably shaped surface at that point, measuring the pressure on the surface under the condition that the surface is immovable, and dividing this pressure by the total acoustic impedance of the surface measured in the absence of the impressed sound field.

As a simple example of the application of the theorem consider the case of a plane wave along x in free space. Insert an infinite immovable plane surface in the $y-z$ plane. The pressure on this surface is $2p$, being doubled by reflection. The total impedance reaction on the surface is $2\rho c$ (ρc due to radiation from each side). The velocity is therefore $2p \div 2\rho c = p/\rho c$, which is correct.

Apply this theorem to the imaginary piston in the orifice, Fig. 1. The effective applied pressure is clearly $2P_0$ per unit area, since the pressure in the incident sound wave is doubled by reflection. The impedance on the left-hand face of the piston is that due to the radiation of sound and the accretion of mass which accompanies it. These have been calculated by the late Lord Rayleigh.⁴ In the case of a circular piston of radius R , in an infinite baffle, the total impedance is

$$\begin{aligned} Z_1 &= \rho c S \left[1 - \frac{J_1(2kR)}{kR} + i \frac{K_1(2kR)}{2(kR)^2} \right], \\ &= R_1 + iX_1, \end{aligned} \quad (1)$$

where ρc = the specific impedance of the medium, $k = \omega/c$, c = the velocity of sound, J_1 and K_1 are Bessel's functions. The first, or real term,

⁴ Rayleigh, "Theory of Sound," Vol. 2, pp. 149, *et seq.* (London, 1878).

is usually called the radiation resistance and represents the loss of energy in the radiated sound; the second represents an increase of inertia, and may be called the *inertance*. The forms of these quantities as functions of frequency have been exhibited by Crandall.⁵

The impedance on the right-hand face of the piston is easily calculated from the ordinary theory of the propagation of sound in a uniform conduit. The membrane terminating the tube at $x=l$ is sufficiently stiff to be considered as infinite impedance, so that the right-hand impedance is the pure reactance

$$Z_2 = iX_2 = -ipcS \cot kl. \quad (2)$$

The total reactance $X_1 + X_2$, and X_1 and X_2 are shown in Fig. 2. Resonant frequencies occur at ω_1, ω_2 , etc. These are considerably

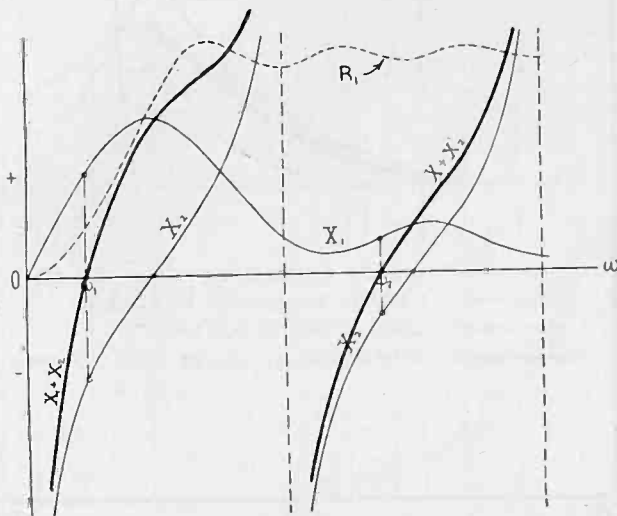

Fig. 2—Reactance and resistance on right- and left-hand faces of imaginary piston in orifice, Fig. 1.

below the resonant frequencies for a narrow tube stopped at one end, due to the inertance of the open end at these frequencies.

The velocity of the imaginary piston at the orifice may now be calculated and is

$$v_0 = \frac{2P_0}{\rho c [R + i(X - \cot kl)]} \quad (3)$$

From the theory of the uniform pipe the relation between the pressure at the membrane end of the pipe ($x=l$) and the velocity at $x=0$ is

$$P_l = v_0 / \sin kl, \quad (4)$$

⁵ I. B. Crandall, "Theory of vibrating systems and sound," p. 172 (New York, 1926).

so that finally

$$P_i = \frac{2P_0}{\sin kl[R + i(X - \cot kl)]} \quad (5)$$

2. Numerical Case. The character of the effect represented by (5) may be exhibited by numerical calculations in a specimen case. For this purpose an old condenser microphone (No. 2) has been chosen in which $R=1.88$ cm; $l=1.23$ cm, and for which Rayleigh disk calibration data are available.

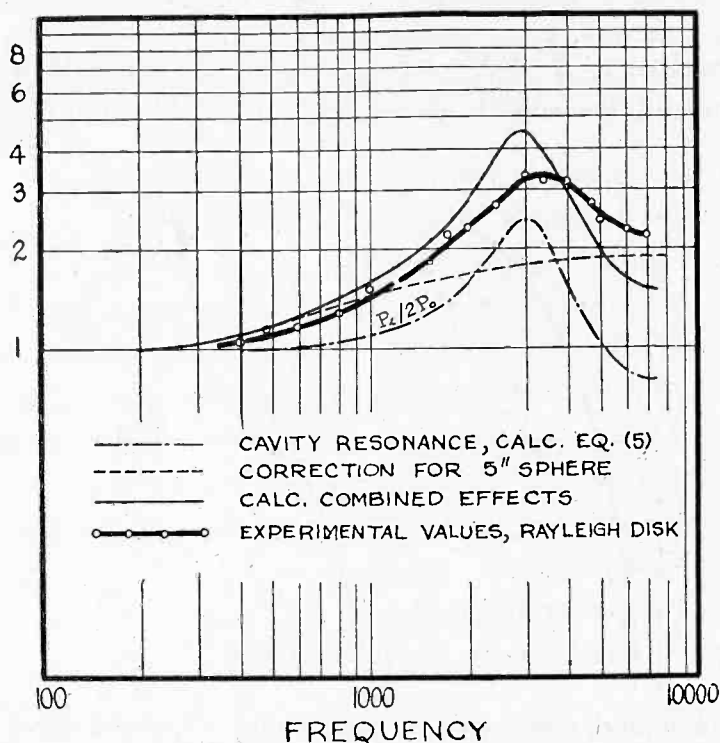

Fig. 3—Calculated and experimental (Rayleigh disk) values of increase of response due to cavity resonance and to reflection; condenser microphone No. 2.

The ratio $P_i/2P_0$ for this microphone, calculated from (5), is plotted against frequency in Fig. 3.

It will be seen that the cavity has the effect of increasing the pressure by a factor of 2.5 at 3000 cycles. The peak occurs at 3000 cycles, although the reactance vanishes at 3710 cycles. This difference is due to the variation of the radiation resistance with frequency.

This microphone was mounted in a 5-in. sphere, for which the diffraction correction, as taken from the author's earlier paper, is shown by the dotted curve in Fig. 3. Assuming that cavity resonance and diffraction operate independently, the overall correction is obtained by multiplying these curves. The resulting curve is also shown in Fig. 3.

3. **Comparison with the Rayleigh Disk Calibration.** A careful calibration of this microphone was performed by means of a Rayleigh disk in an acoustic test chamber which was substantially free of reflection at all frequencies above 500 cycles. In frequency response measurements it is highly important that the Rayleigh disk be suspended in free space and not encumbered with resonating chambers, tubes, and other obstacles which are often employed to increase its sensitivity and to protect it from draughts. The substantially complete absence of reflection from the chamber walls and the distance from the source insured a substantially plane sound wave moving in one direction in which the pressure and velocity are simply related ($p = \rho cv$). The usual diaphragm pressure calibration was obtained by

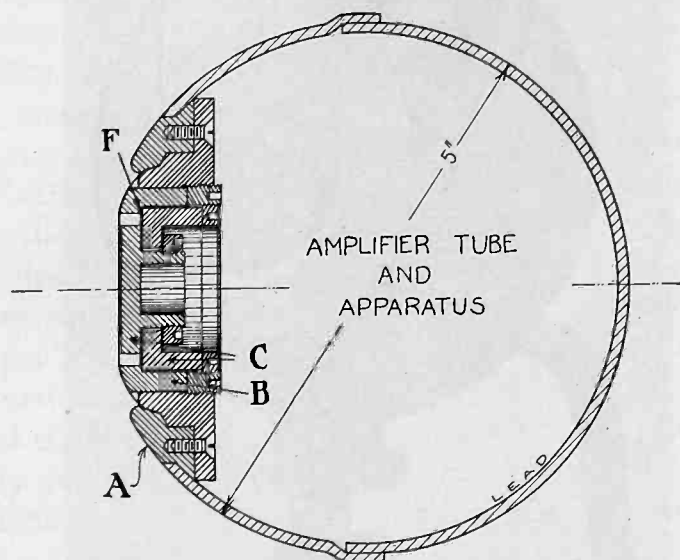

Fig. 4—A modified microphone design for elimination of the cavity.

means of an electrostatic driving grille and checked by the thermophone. This calibration was divided out, leaving the heavy line curve in Fig. 3. As is to be expected, the measured effect of cavity resonance is not so large as that calculated from the simple theory given above; nevertheless the existence of the effect and the general character of the pressure corrections are sufficiently verified.

The relation between electrical response and diaphragm pressure in the Wentz air-damped microphone is generally complementary to the effects of diffraction and cavity resonance so that these latter may, by careful design, be utilized to obtain a uniform overall frequency response. This has the advantage of permitting the use of a smaller air-gap with an improvement in sensitivity.

4. **A Modified Microphone Design for Elimination of Cavity.** For some purposes it may be desirable to eliminate entirely the effect

of the cavity in front of the microphone. This may be accomplished by removing the membrane straining ring from in front of the membrane and placing it in the rear. A design which is particularly adapted for spherical mounting is shown in Fig. 4. The clamping head *A* is curved to conform with the surface of a spherical housing. The straining ring *B* supports the back-plate *C* with relation to the membrane. It is seldom necessary to supply a special vent to permit equalization of pressure in response to barometric variations, since a sufficient



Fig. 5—Assembled microphone and standard spherical mounting.

ventilation is permitted by the natural leakage between *B* and *C* augmented by a few very shallow grooves at the seat *F*. If a special vent is provided it should be long and of capillary diameter; otherwise troublesome fluctuations occur in the audio range due to resonance between the inertance of the plug of air in the vent and the compressibility of the air around the back plate. With the natural leakage between *B* and *C* the resonance is highly damped and also moved below the useful range (e.g., to 30 cycles). For ordinary laboratory use it has not been found necessary to employ a rubber diaphragm, as recommended by Wentz, to prevent the entrance of moisture.

Any difficulties of this nature may be remedied by placing a small quantity of drying agent, such as calcium chloride, in the spherical housing.

The spherical mounting is made of lead, in order to prevent the penetration of sound to the wiring and the amplifier tube. This has been found to be of some importance. With a spun copper housing (thickness = 0.015 in.) which was first used several years ago, the vibration communicated to the wiring and tube elements by sound entering the housing, generated voltages which amounted to as much as 30 per cent of the voltage generated by the diaphragm. This was discovered by tightly screwing a lead disk, 1/2 in. thick, over the face of the microphone and measuring the residual voltage.

A photographic view of the assembled microphone and standard spherical mounting is reproduced in Fig. 5.

5. Stability and Temperature Coefficient. The following experimental data on the stability and temperature coefficient of microphones containing duralumin membranes may be of interest as supplementing Wente's data for steel membranes. They pertain to duralumin membranes 0.0025 in. thick, mounted in microphones made of steel with mica insulating rings.

The duralumin membranes are stretched to a tension of approximately 75 per cent of that required for rupture. They are preferably first subjected to a stretching routine which consists in alternately heating and cooling them (0 deg. - 75 deg. C). The initial stretching is ordinarily complete after several days. A properly mounted and stretched membrane has been found to remain constant in tension to within 4.5 per cent over a period of 3½ years.

Data as to the temperature coefficient will be found in Fig. 6. This represents the change in capacity produced by static pressures at the front of the membrane at three different temperatures, 3 deg., 20 deg., 40 deg. C. The membrane diameter was 1.6 in. The sensitivity at low frequencies is proportional to $d/dp(\Delta C)$ for small pressures. This quantity is shown plotted against temperature in the small diagram. The temperature coefficient of sensitivity due to the unequal thermal expansions of duralumin and steel is found to be 0.6 per cent per degree C. This is well within the usual errors of this technique and ordinarily requires no attention.

6. Fidelity of Broadcast Transmitters. Measurements of sound-pressure play an invaluable part in the development of broadcast receivers. It is usually assumed by those engaged in this work that the fidelity of the transmitter is perfect and consequently that the objective of receiver design is the attainment of a uniform sound-

pressure output at all audio frequencies in response to a standard symmetrically modulated signal in the antenna. Aside from its abstract propriety this assumption appears to be justified by the curves of overall fidelity which have been published by the manufacturers of broadcast transmitters. As the result of inquiries, the author has been informed that these transmitter fidelity curves, in most cases, were a synthesis of the electrical fidelity curve of the transmitter and the thermophone or equivalent calibration curve of the condenser microphone. No account whatever had been taken of the effects discussed in this paper. In view of the considerable effort and money which is

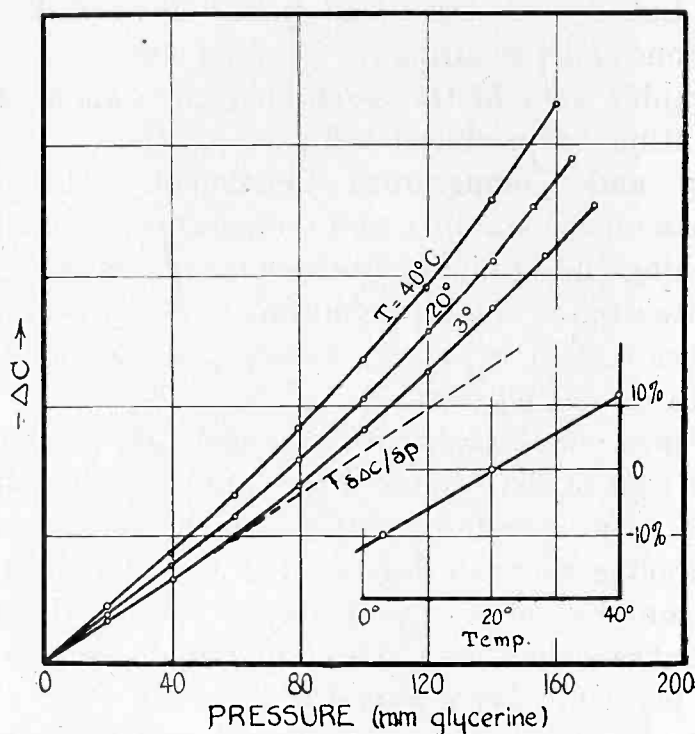

Fig. 6—Data relating to determination of temperature coefficient of sensitivity of duralumin membrane in steel mounting. Temp. coeff. -0.6 per cent per degree C.

being expended each year in receiver development, it would seem to be rather desirable that those engaged in transmitter design should cooperate to the extent of furnishing reliable data regarding overall fidelity and thus allow the designers of receivers to formulate their objective properly. This matter might well be taken up by some committee of the Institute of Radio Engineers.

There is a temptation to argue that if the microphone effects are ignored the errors in the measurement of sound pressure at the receiver will be compensated by the operation of the same effects at the transmitting microphone. While this might be true if the microphones were of identical construction, which is seldom the case, the attitude is rather unscientific and to be discouraged.

Note*: Since the completion of this paper copies of European journals have been received containing two papers relating to this subject which are particularly worthy of citation.

D. A. Oliver⁶ discusses qualitatively the effect of cavity resonance and furnishes a microphone design for eliminating the cavity. Oliver's design resembles that described in this paper (Fig. 4) in that the tension ring is placed behind the diaphragm.

The discrepancies, attributable to reflection and cavity resonance, between the thermophone and Rayleigh disk calibrations of a microphone, are also discussed by C. A. Hartmann.⁷

* Added May 15, 1930.

⁶ D. A. Oliver, "An improved condenser microphone for sound pressure measurements," *Jour. Scient. Inst.*, 7, 113, 1930.

⁷ C. A. Hartmann, *Elek. Nach. Tech.*, 7, pp. 104 et seq.



LOCATING RADIO INTERFERENCE WITH THE OSCILLOGRAPH*

BY

J. K. McNEELY¹ AND P. J. KONKLE²

(¹Electrical Engineer, Iowa Engineering Experiment Station; ²Radio Engineer, Iowa State College, Ames, Iowa)

Summary—Certain kinds of radio interference travel many miles over wires and cause trouble in radio reception. Often this interference originates on one system which is coupled to another and, because of complaints, the interference investigation is started from a point near the second system. The usual methods of locating the trouble are not very effective in such cases. The oscillographic method analyzes the interference more exactly, giving its magnitude, frequency, and phase position. It is also shown that various types of interference give characteristic patterns on the oscillogram and a number of oscillograph records are included illustrating common disturbances found in radio reception. It is thus possible to point out when the interference at two widely separated points originates at a common source.

IN THE larger cities it is not always easy to determine upon which system the interference originates. For example, the trouble might be caused by poor bonding on a street railway, leakage on the a-c high line of the railway, motors on the lines of the light company, railroad automatic train-control apparatus, telegraph printers, or, in the smaller communities, the telephone equipment. The oscillographic method gives valuable records indicating quite definitely the general source of the disturbance. Investigations of interference should determine the amount and the sources of the interference, and should suggest methods for reducing the general noise level to what may be considered a reasonable amount.

The amount of interference allowable must necessarily depend upon the location. It is obviously not possible to obtain a low noise level near an electrically operated factory, particularly if there are a large number of d-c motors in use. In the outlying residence sections, on the other hand, it is relatively easy to eliminate disturbances of the greater magnitudes and thus reduce the noise level to that of the average atmospheric interference. There is more static in summer than during the remainder of the year. This summer static level averages about 1 mv per m. If the noise level is below 0.1 mv per m conditions for reception are good. Satisfactory reception may still be obtained

* Dewey decimal classification: R201.7+R430. Presented at sectional meeting of the Institute with the American Association for the Advancement of Science, Des Moines, Iowa, December 28, 1929.

between 0.1 mv per m and 1 mv per m. Satisfactory reception is not possible when the noise level is above 1 mv per m.

A definite method of measurement is essential in determining the absolute value of the interference. The same method may be used for this as has been used for determining the field strength of stations, namely, that of using the vacuum-tube voltmeter. This method is entirely satisfactory in cases where it is possible to make measurements at times when the field is caused by interference only and not by a combination of interference and broadcast-station carriers. The vacuum-tube voltmeter gives only the total field strength for a partic-

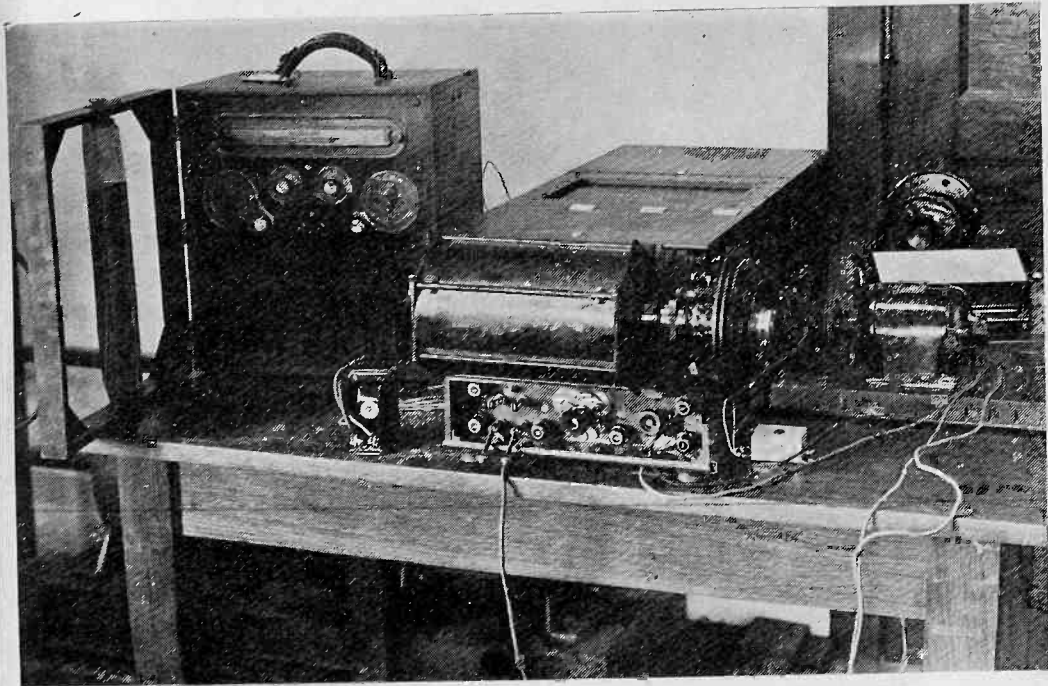

Fig. 1—Portable radio receiver, coupling transformer, and the oscillograph. ular frequency and this gives no indication of the source of interference.

The method generally used to locate interference has been a combination of surveying with a portable set to find the direction in which the noise increased and a procedure of pulling switches in attempts to cut off disturbances.

Methods for eliminating interference, after its source has been located, have been quite thoroughly worked out. These consist of the installation of filters, shielding, soldering connections on electrical systems, replacing broken insulators, cutting tree limbs and replacing electrical devices and equipment that interfere, with those that do not. This paper, however, is mainly concerned with the measurement and location of interference.

The method of location of interference with a portable set has not been entirely satisfactory. In the first place the loop does not point at the source. It may point in any direction. The loop will indicate the direction in which it is receiving its strongest field for a particular dial setting. Its strongest field may be coming from an electrical line or a wire fence in that vicinity. Thus, to locate the source of the disturbance in this manner becomes a complicated matter.



Fig. 2—Vibrator-type battery charger without condensers.

A system of pulling switches combined with the use of the portable set is far more effective. This will usually indicate the cause of the interference, providing the interference originates on a line de-energized during the test. If the interference is coming in through some coupled connection with another circuit, this method is not very effective.

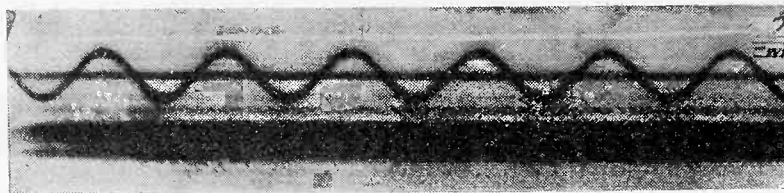

Fig. 3—Vibrator-type battery charger with 2- μ f condenser.

Oscillographic Method and Apparatus

The oscillograms give pictures of the current variations in the speaker circuit of the radio receiver. These records of the currents may be calibrated in mv per m and thus give more accurate measurements of interference than can be made by ear. In other words, a visual record is made of what is heard.

Three groups of these records are shown illustrating the characteristic wave shapes of interference caused by various power-consuming devices, by general interference in a city at certain locations, and by line equipment and grounds, leakage, arcs, and short circuits.

The wave shapes in Fig. 2 are quite characteristic, each occurring

at a definite point on the 60-cycle wave and having an amplitude varying very little from the others in the train.

Fig. 3 illustrates the corrective action of a 2- μ f condenser connected across the contacts of the vibrator.

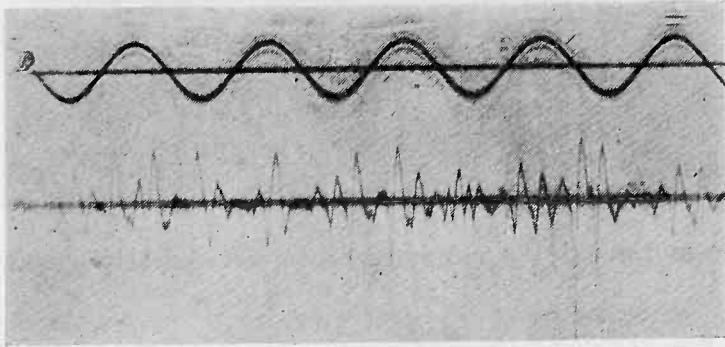

Fig. 4—Mechanical vibrator.

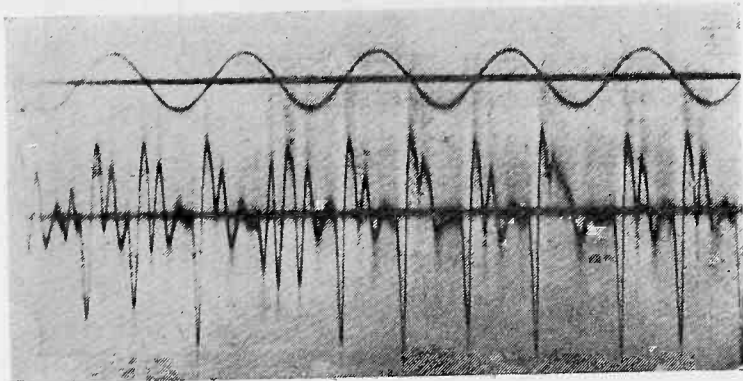

Fig. 5—Violet-ray appliance.

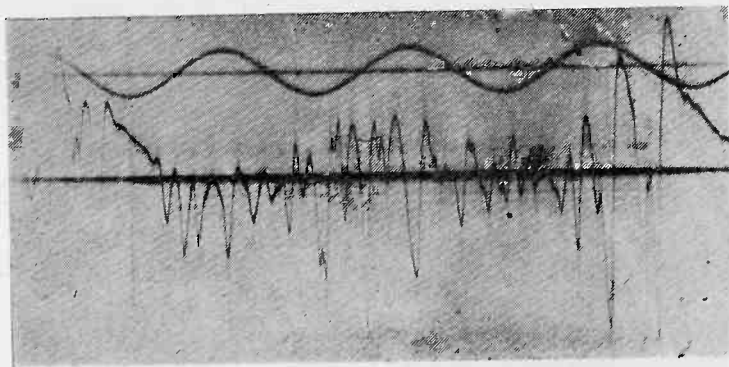

Fig. 6—Loaded motor-generator set.

The wave has varying amplitude and is not periodic in Fig. 4. The record shown in Fig. 5 is definitely periodic but not as regular as that of the battery charger. The amplitudes and wave shapes vary somewhat.

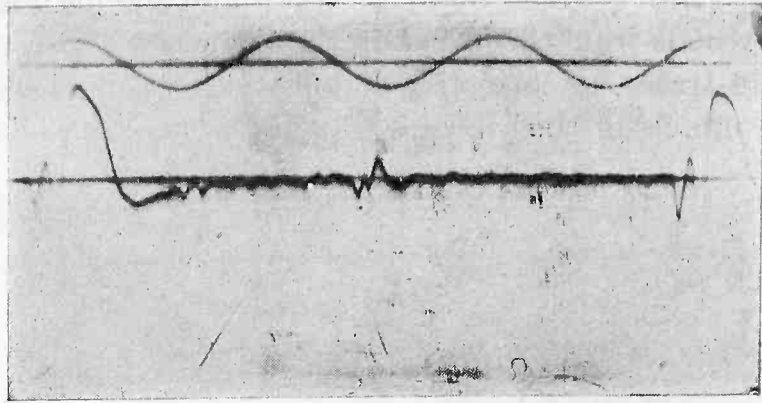

Fig. 7—A-c motor only on motor-generator set—direct current removed.

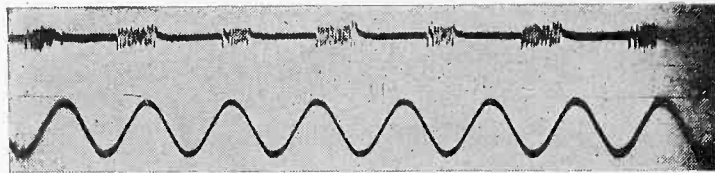

Fig. 8a—Twenty-five cycle interference.

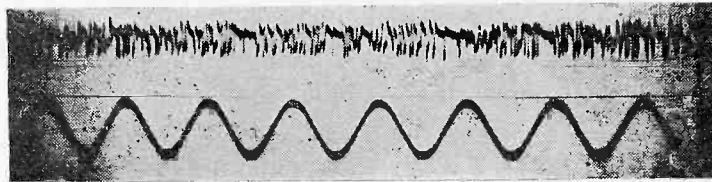

Fig. 8b—Twenty-five cycle and other interference.

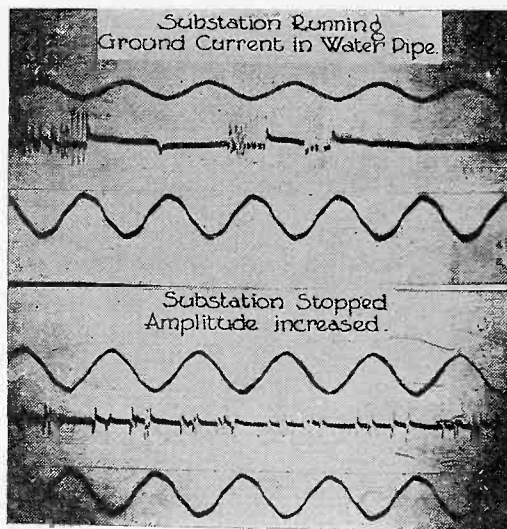

Fig. 9a—Substation running. Ground current in water pipe.
 Fig. 9b—Substation stopped. Amplitude increased.

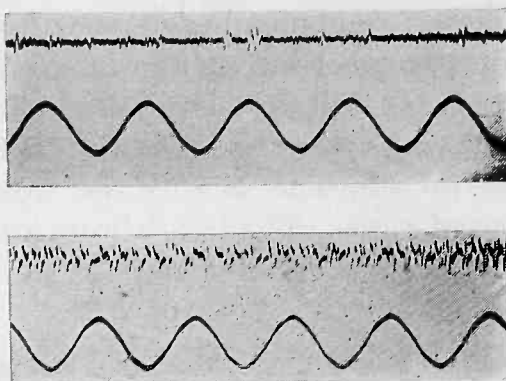

Fig. 10—Interferences sometime found on 33,000-v, 60-cycle line.

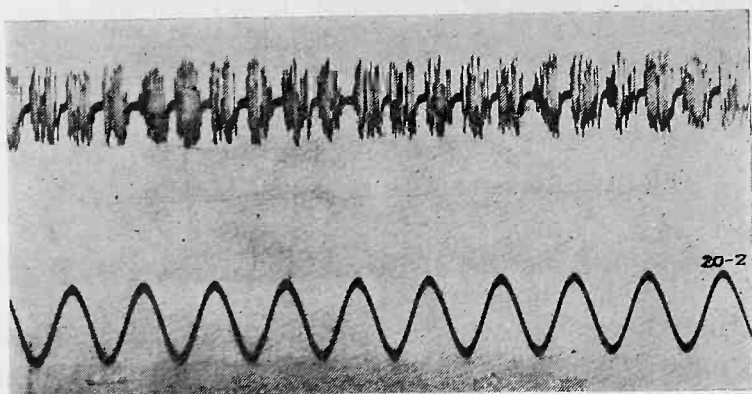

Fig. 11—High resistance found on 6900 v.

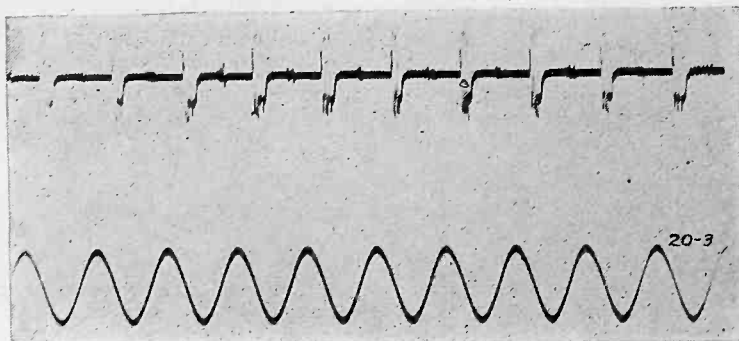

Fig. 12—Leakage across open cut-out 6900 v.

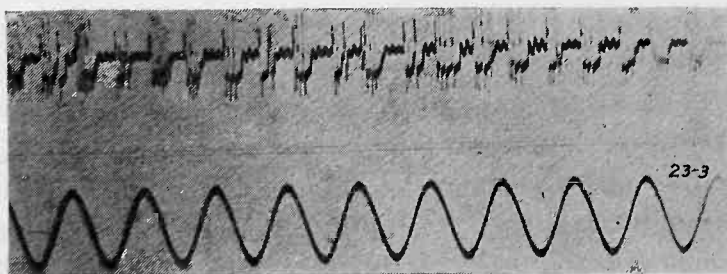

Fig. 13—Leakage from cut-out hangers to brace bolts on cross-arm.

Figs. 6 and 7 show a combined interference from several sources. By opening the direct-current switch the interference is reduced to that shown in Fig. 7. It will now be noticed that the interference is periodic, repeating every third cycle of the 60-cycle timing wave. This indicates that the machine causing the trouble is running at 1200 r.p.m. The trouble was caused by a worn collector ring of the a-c generator.

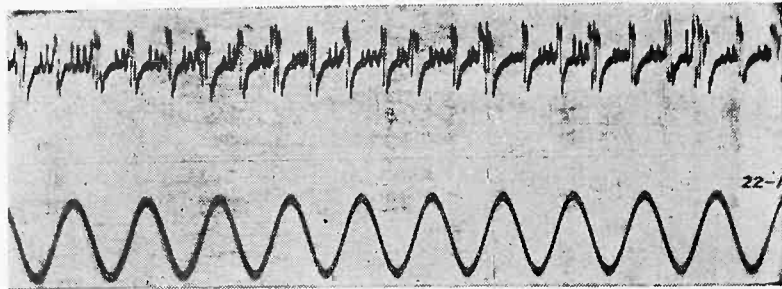

Fig. 14—Cut-out with arcing contact 2880 v.

General Location of Interference in a City

In securing the cooperation of a utility in correcting bad interference conditions in a city, it is necessary to present a written report showing at least the partial responsibility of that utility for the conditions obtaining. Figs. 8, 9, and 10 illustrate the use of the oscillographic method in an interference survey of a city.

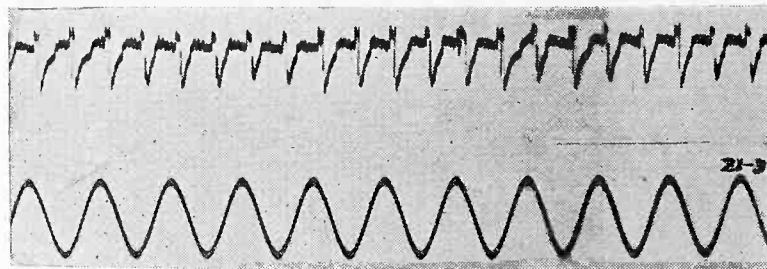

Fig. 15—One-fourth-inch arc between copper 1.03 amperes, 5730 v.

The oscillograms Figs. 8a and 8b were taken at a house in a city in Iowa where the interference conditions were especially bad. The oscillogram, Fig. 8b, is for one dial setting of the set and that above for another setting one point greater. This house is near a 33,000-v, 60-cycle high line and also near telephone and telegraph lines. It was generally thought that the interference was caused by defective equipment on the 33,000-v line. This line was paralleled for a short distance by a 13,000 v, 25-cycle, three-phase line. One line was on the oppo-

site side of the street from the other and this parallel was about a half mile from the house in question. By counting cycles on the oscillogram it is observed that the interference has a 25-cycle frequency.

It is on one phase of a three-phase line and the arc is greater in one direction than in the other. It has the characteristics of a high-resistance ground and may be caused by a broken insulator.

Fig. 8b shows the 25-cycle interference combined with the other

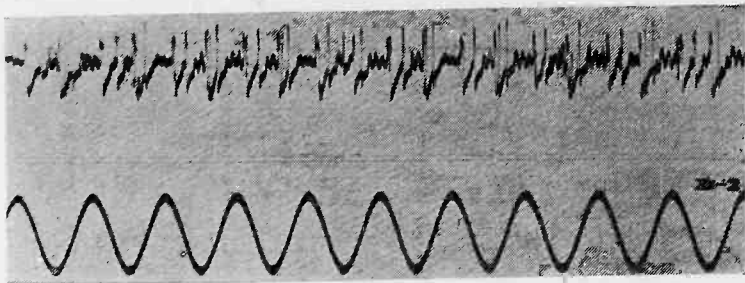

Fig. 16—One-inch arc between copper 1.03 amperes, 5730 v.

interferences and illustrates the separation of different types of interference by tuning the receiver. ■ ■ ■ ■ ■

In Fig. 9a the first curve shows the ground current, which was probably caused by two Y-connected banks of transformers with a grounded neutral. The second curve shows an interference that is not

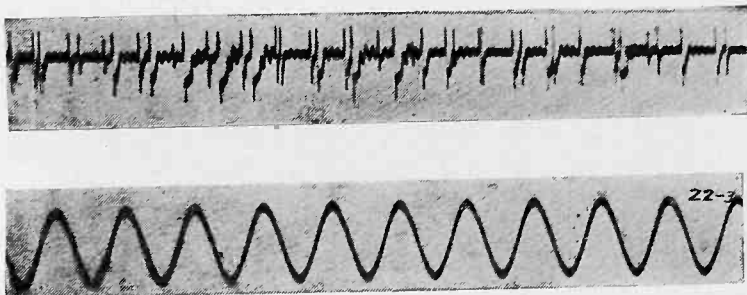

Fig. 17—One-inch arc between steel rods 1.03 amperes, 5730 v.

synchronous and which stopped when the substation was shut down. There was some indication that the insulation on one of the rotary-converters had broken down.

Fig. 9b was taken at the same location as the first but with the substation shut down. Upon increasing the amplitude some 60-cycle interference was shown but the heavy interference of the 25-cycle and d-c systems was eliminated.

The first oscillogram (Fig. 10) was taken with an outside antenna and the second with a loop. Reception at the house where these were

taken was impossible although reception in houses similarly placed with reference to this high line, and four miles away, was good. The trouble was undoubtedly due to arcing disconnects.

Laboratory Tests with Some Types of Interference

The interference shown on these oscillograms (Figs. 11, 12, 13, and 14) was particularly annoying and made any reception unsatisfactory. It will be noted that in Fig. 11 the interference occurred for both direc-

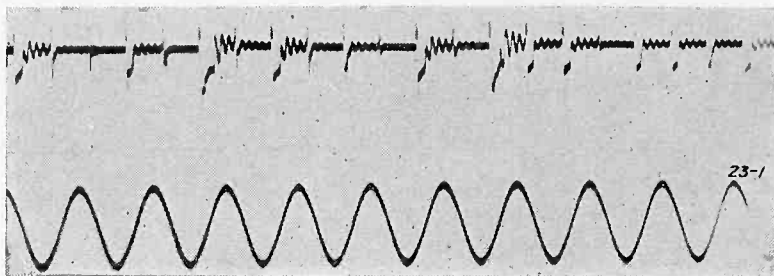

Fig. 18—One-inch arc between carbon 1.03 amperes, 5730 v.

tions of current or in other words, at each half-cycle and lasted for the greater part of the half-cycle. Fig. 12 illustrates interference set up by high-resistance arcs. The major disturbance occurs once each cycle and lasts for about one sixth of a cycle. Fig. 13 shows less variation over the cycle. More disturbance persists throughout the cycle although the maximum amplitude is not as great.

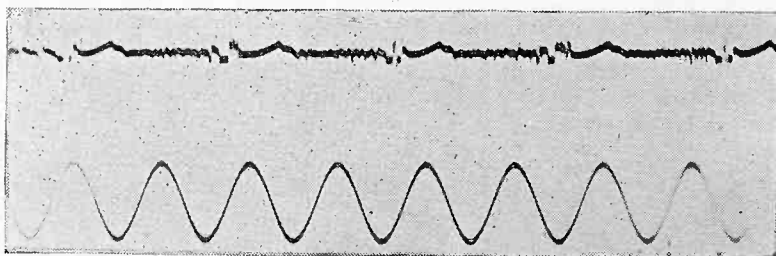

Fig. 19—Old type telephone-pole charger.

In Fig. 14, the maximum amplitudes are of short duration although the disturbance is great throughout the cycle.

The waves shown in Figs. 15, 16, 17, and 18 have characteristic shapes and are periodic with a 120-cycle frequency. In general the arcs of shorter lengths produce more interference in the broadcast band.

It should be relatively easy to distinguish the type of interference shown in Fig. 19 if it can be isolated from other types. This can usually be done by moving the dials of the receiving set and watching the image in the visual attachment of the oscillograph.

Conclusion

The oscillographic method has been shown to give definite results in interference problems of one locality involving disturbances arising from several electrical systems. By careful comparisons of field oscillograms with oscillograms of disturbances from known sources, accurate predictions of sources of interference have been quickly made. Additional research in both laboratory and field will serve to correlate more definitely the nature of the disturbances with the oscillographic records. These additional data and further training of the operators in this method will increase the effectiveness of interference investigations.



Figs. 6 and 7 show a combined interference from several sources. By opening the direct-current switch the interference is reduced to that shown in Fig. 7. It will now be noticed that the interference is periodic, repeating every third cycle of the 60-cycle timing wave. This indicates that the machine causing the trouble is running at 1200 r.p.m. The trouble was caused by a worn collector ring of the a-c generator.

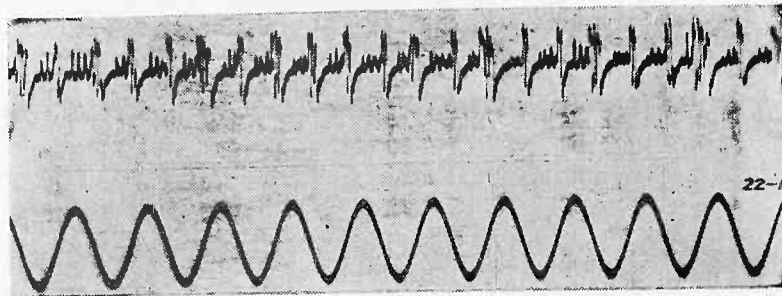

Fig. 14—Cut-out with arcing contact 2880 v.

General Location of Interference in a City

In securing the cooperation of a utility in correcting bad interference conditions in a city, it is necessary to present a written report showing at least the partial responsibility of that utility for the conditions obtaining. Figs. 8, 9, and 10 illustrate the use of the oscillographic method in an interference survey of a city.

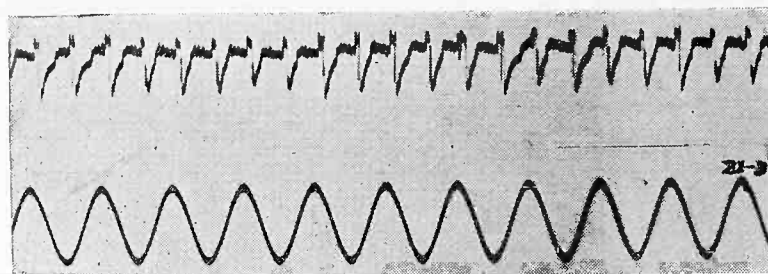

Fig. 15—One-fourth-inch arc between copper 1.03 amperes, 5730 v.

The oscillograms Figs. 8a and 8b were taken at a house in a city in Iowa where the interference conditions were especially bad. The oscillogram, Fig. 8b, is for one dial setting of the set and that above for another setting one point greater. This house is near a 33,000-v, 60-cycle high line and also near telephone and telegraph lines. It was generally thought that the interference was caused by defective equipment on the 33,000-v line. This line was paralleled for a short distance by a 13,000 v, 25-cycle, three-phase line. One line was on the oppo-

side of the street from the other and this parallel was about a half mile from the house in question. By counting cycles on the oscillogram it is observed that the interference has a 25-cycle frequency.

It is on one phase of a three-phase line and the arc is greater in one direction than in the other. It has the characteristics of a high-resistance ground and may be caused by a broken insulator.

Fig. 8b shows the 25-cycle interference combined with the other

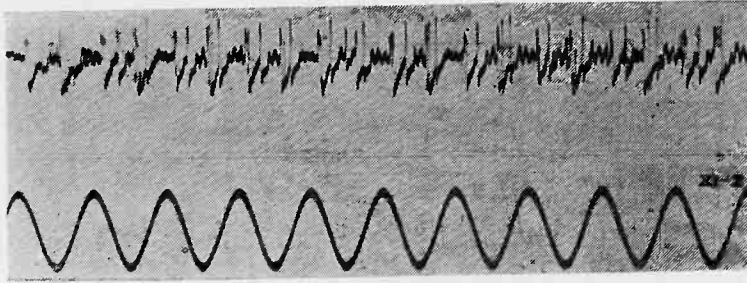

Fig. 16—One-inch arc between copper 1.03 amperes, 5730 v.

interferences and illustrates the separation of different types of interference by tuning the receiver.

In Fig. 9a the first curve shows the ground current, which was probably caused by two Y-connected banks of transformers with a grounded neutral. The second curve shows an interference that is not

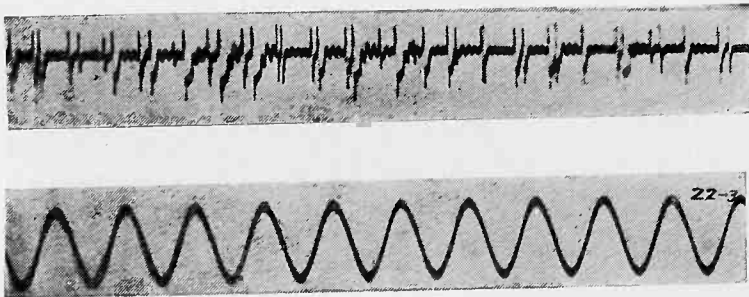

Fig. 17—One-inch arc between steel rods 1.03 amperes, 5730 v.

synchronous and which stopped when the substation was shut down. There was some indication that the insulation on one of the rotary-converters had broken down.

Fig. 9b was taken at the same location as the first but with the substation shut down. Upon increasing the amplitude some 60-cycle interference was shown but the heavy interference of the 25-cycle arc and d-c systems was eliminated.

The first oscillogram (Fig. 10) was taken with an outside antenna and the second with a loop. Reception at the house where these were

Figs. 6 and 7 show a combined interference from several sources. By opening the direct-current switch the interference is reduced to that shown in Fig. 7. It will now be noticed that the interference is periodic, repeating every third cycle of the 60-cycle timing wave. This indicates that the machine causing the trouble is running at 1200 r.p.m. The trouble was caused by a worn collector ring of the a-c generator.

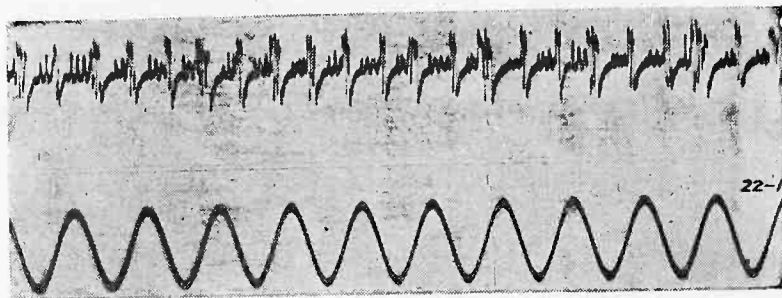

Fig. 14—Cut-out with arcing contact 2880 v.

General Location of Interference in a City

In securing the cooperation of a utility in correcting bad interference conditions in a city, it is necessary to present a written report showing at least the partial responsibility of that utility for the conditions obtaining. Figs. 8, 9, and 10 illustrate the use of the oscillographic method in an interference survey of a city.

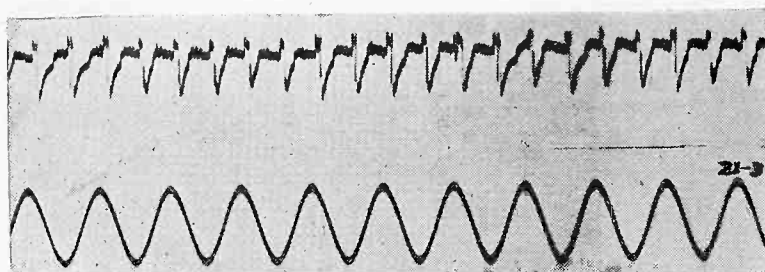

Fig. 15—One-fourth-inch arc between copper 1.03 amperes, 5730 v.

The oscillograms Figs. 8a and 8b were taken at a house in a city in Iowa where the interference conditions were especially bad. The oscillogram, Fig. 8b, is for one dial setting of the set and that above for another setting one point greater. This house is near a 33,000-v, 60-cycle high line and also near telephone and telegraph lines. It was generally thought that the interference was caused by defective equipment on the 33,000-v line. This line was paralleled for a short distance by a 13,000 v, 25-cycle, three-phase line. One line was on the oppo-

site side of the street from the other and this parallel was about a half mile from the house in question. By counting cycles on the oscillogram it is observed that the interference has a 25-cycle frequency.

It is on one phase of a three-phase line and the arc is greater in one direction than in the other. It has the characteristics of a high-resistance ground and may be caused by a broken insulator.

Fig. 8b shows the 25-cycle interference combined with the other

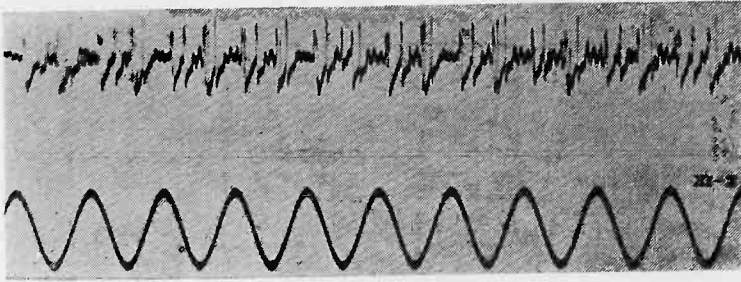



Fig. 16—One-inch arc between copper 1.03 amperes, 5730 v.

interferences and illustrates the separation of different types of interference by tuning the receiver. 

In Fig. 9a the first curve shows the ground current, which was probably caused by two Y-connected banks of transformers with a grounded neutral. The second curve shows an interference that is not

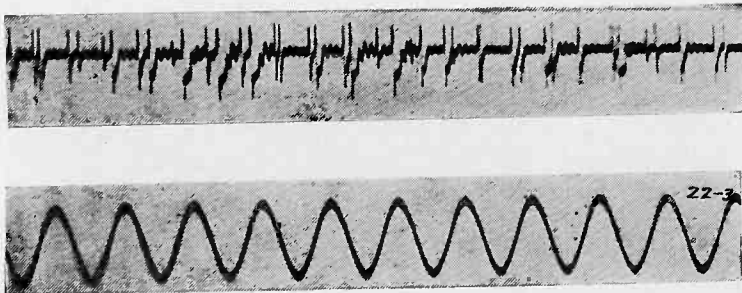

Fig. 17—One-inch arc between steel rods 1.03 amperes, 5730 v.

synchronous and which stopped when the substation was shut down. There was some indication that the insulation on one of the rotary-converters had broken down.

Fig. 9b was taken at the same location as the first but with the substation shut down. Upon increasing the amplitude some 60-cycle interference was shown but the heavy interference of the 25-cycle and d-c systems was eliminated.

The first oscillogram (Fig. 10) was taken with an outside antenna and the second with a loop. Reception at the house where these were

taken was impossible although reception in houses similarly placed with reference to this high line, and four miles away, was good. The trouble was undoubtedly due to arcing disconnects.

Laboratory Tests with Some Types of Interference

The interference shown on these oscillograms (Figs. 11, 12, 13, and 14) was particularly annoying and made any reception unsatisfactory. It will be noted that in Fig. 11 the interference occurred for both direc-

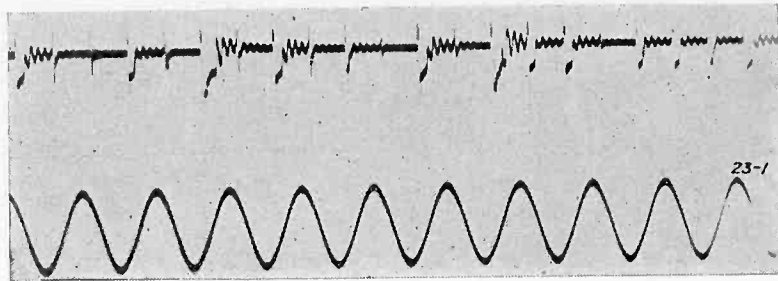

Fig. 18—One-inch arc between carbon 1.03 amperes, 5730 v.

tions of current or in other words, at each half-cycle and lasted for the greater part of the half-cycle. Fig. 12 illustrates interference set up by high-resistance arcs. The major disturbance occurs once each cycle and lasts for about one sixth of a cycle. Fig. 13 shows less variation over the cycle. More disturbance persists throughout the cycle although the maximum amplitude is not as great.

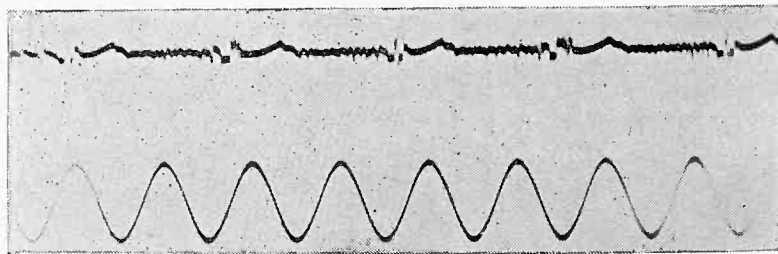

Fig. 19—Old type telephone-pole charger.

In Fig. 14, the maximum amplitudes are of short duration although the disturbance is great throughout the cycle.

The waves shown in Figs. 15, 16, 17, and 18 have characteristic shapes and are periodic with a 120-cycle frequency. In general the arcs of shorter lengths produce more interference in the broadcast band.

It should be relatively easy to distinguish the type of interference shown in Fig. 19 if it can be isolated from other types. This can usually be done by moving the dials of the receiving set and watching the image in the visual attachment of the oscillograph.

Conclusion

The oscillographic method has been shown to give definite results in interference problems of one locality involving disturbances arising on several electrical systems. By careful comparisons of field oscillograms with oscillograms of disturbances from known sources, accurate predictions of sources of interference have been quickly made. Additional research in both laboratory and field will serve to correlate more definitely the nature of the disturbances with the oscillographic records. These additional data and further training of the operators in this method will increase the effectiveness of interference investigations.



THE VARIATION OF THE RESISTANCE OF A RADIO CONDENSER WITH CAPACITY AND FREQUENCY*

BY

R. R. RAMSEY

(Department of Physics, University of Indiana, Bloomington, Ind.)

THE FIRST measurement of the resistance of a radio air condenser at radio frequencies was made by Weyl and Harris.¹ A little later the results of Callis² were published. The results of these investigators agreed in that the resistance of a radio condenser was from about 1 ohm to 10 or 15 ohms, depending on capacity and frequency. The usual assumption made before this time was that the resistance of an air condenser was very small—so small that it was usually assumed to be zero.

Before these measurements were obtained, the method of measuring the resistance of an air condenser was to place the condenser in series with a coil and a thermal meter, tune this circuit to resonance to a radio frequency oscillator and to measure the resistance of the circuit by the resistance variation method, and then place a good condenser whose resistance was assumed to be zero in place of the first condenser and measure the resistance again. The excess of the first measurement over the second was the resistance of the first condenser. In some cases the first resistance came out to be negative, which meant that the resistance of the first condenser was less than that of the standard condenser.

The method used by Weyl and Harris was to construct a single-turn loop of large dimensions, 17 ft. by 20 ft., using large wire, and to calculate the resistance of this loop, assuming that the resistance of the loop was the same as that of a long straight wire whose length was the same as the periphery of the loop. From the resistance of the circuit found by the resistance variation method, the resistance of the loop and meter were subtracted, leaving the resistance of the condenser.

The method of Callis was to eliminate the resistance of the coil. This was done by using two coils which were alike connected in series opposition, making the inductance of the two equal to the inductance of

* Dewey decimal classification: R381. Presented at sectional meeting of the Institute with American Association for the Advancement of Science, Des Moines, Iowa, December 28, 1929.

¹ *Proc. I. R. E.*, 13, 109; February, 1925.

² *Phil. Mag.*, 1, 428; 1926.

a single coil. This was checked by making the coils of very fine wire, solving the equations so as to eliminate the resistance of the condenser, and finding that the coil resistance came out equal to that as measured by ordinary methods. If the wire is small enough the a-c. resistance is equal to the d-c. resistance.

In 1927 Brown, Weisbusch and Colby³ published results obtained by this method, which we shall call the coil-elimination method, that were very much smaller than those referred to above.

The results of all three experiments are shown in Table I in the column marked R . The table gives the capacity of the condenser and the wave length at which the measurements were made.

TABLE I
RESISTANCE OF VARIABLE RADIO CONDENSER COIL ELIMINATION METHOD
 $R_s = R(300/\lambda)(C/0.001)^{3/2}$

	λ	C	R	R_s
WEYL AND HARRIS	96	0.0005	1.2 ohms	1.35 ohms
	96	0.0001	2.6	0.266
	96	0.00005	18.5	0.65
	200	0.0005	0.7	0.57
	250	0.0005	0.66	0.39
	260	0.0005	1.04	0.41
				Mean
CALLIS	300	0.001	1.65	1.65
	300	0.0005	2.8	0.96
	300	0.0001	10.65	0.35
				Mean
BROWN, WEISBUSCH, AND COLBY	43.4	0.00048	0.113	0.26
	63	0.00048	0.15	0.24
	83	0.0018	0.042	0.38
	119	0.0018	0.049	0.30
	119	0.00386	0.0284	0.58
	172	0.0038	0.0305	0.40
			Mean	0.35

It will be noted that Brown, Weisbusch and Colby used relatively low wave length and large capacity. Their coil was a single turn coil whose diameter was a few inches. Like Weyl and Harris, they assumed that the resistance of this coil was the resistance of the same wire when straight. They eliminated any error due to the resistance of the ammeter by using a sensitive vacuum-tube voltmeter.

One of my students, B. D. Morris,⁴ suggested that there was need of a formula to reduce the resistance of a condenser to standard conditions, something like the formula used when we reduce the volume of a gas to standard pressure and temperature. He hit on the empirical formula $R_s = R(300/\lambda)(C/0.001)^{3/2}$, the standard conditions being wave length of 300 meters and a capacity of 0.001 μ f.

The column marked R_s gives the values of the resistance when reduced to standard conditions by this formula. The average of the

³ *Phys. Rev.*, 29, 887; 1927.

⁴ *Proc. Phys. Soc. London*, 40, 285; 1928.

values for R_s indicates that the resistances of all three condensers are of the same order.

Brown, Weisbusch, and Colby used a Bureau of Standards type condenser while the others were commercial variable condensers. It is to be expected that the Bureau of Standards type should have smaller resistance than the commercial condenser. These results indicate that the resistance of a good condenser is from a third to one ohm at standard conditions. However, these results are large compared to zero.

Table II gives results made by the heat method. The heat developed in the condenser is compared to that developed in a known

TABLE II
RESISTANCE OF VARIABLE RADIO CONDENSER HEAT METHOD
 $R_s = R(300/\lambda)(C/0.001)^{3/2}$

	λ	C	R	R_s
RAMSEY	27	0.0008	0.06 ohms	0.015 ohms
	40	0.0008	0.04	0.0068
	80	0.0008	0.06	0.0051
	300	0.0008	0.098	0.0022
				Mean 0.0098
MORRIS	125	0.0001	5.5	0.0132
	280	0.0001	11.0	0.0122
	190	0.00054	0.68	0.0092
	280	0.00054	0.79	0.0106
	320	0.00054	0.96	0.011
	280	0.00013	0.170	0.0086
	306	0.00013	0.195	0.009
	410	0.00013	0.275	0.0095
	290	0.00024	0.0706	0.0086
	325	0.00024	0.076	0.0083
	360	0.00024	0.079	0.0078
	400	0.00024	0.096	0.0085
				Mean 0.0097

resistance by a direct current. This is the same general method as used by Fleming in comparing the a-c and d-c resistance of wires. It will be noted that these results are relatively small when compared with the first results.

As a comparison, Table III is given. The data used in this table

TABLE III
RESISTANCE OF VARIABLE RADIO CONDENSER
 $R_s = R(300/\lambda)(C/0.001)^{3/2}$

	λ	C	R	R_s
DYE	* 200	0.000184	0.045 ohms	0.0021 ohms
	215	0.000314	0.024	0.0060
	300	0.000494	0.011	0.00382
	600	0.000494	0.011	0.0026
	790	0.000184	0.11	0.0033
	1200	0.000314	0.06	0.0025
	1500	0.000494	0.035	0.0026
	2150	0.000184	0.25	0.00272
	2610	0.000314	0.12	0.0024
	3000	0.000494	0.07	0.0025
	4600	0.000184	0.6	0.0031
	5000	0.000314	0.3	0.0032
	6000	0.000494	0.3	0.0028
	15000	0.000494	0.35	0.0028
				Mean 0.0035

* The data in this table were read from curves.

were compiled by Dye⁴ of the National Physical Laboratory. This method is a substitution method in which a special fixed condenser was used as a standard condenser. The resistance of this condenser was calculated very carefully from the dimensions of the condenser taking the distribution of the current in the plates into account. The resistance of this condenser was calculated to be 0.000544 ohm at 1000-kc frequency. Its capacity was 0.000494 μ f.

It will be noted that these data cover a wide range of frequencies or wave lengths and that the values of R_s are nearly constant. The indications are that the empirical formula holds unusually well in this case.

It will be noted also that these results agree very well with those obtained by the heat method in Table II.

The first, or coil-elimination method, gives much larger values for the resistance of a condenser than either of the others. In fact, if the coil resistance and the condenser resistance are measured by the heat method, the sum of the two do not equal the value of the circuit as measured by the resistance-variation method. I have shown this in results published a year or two ago.⁵

In this paper I suggested that there is some resistance associated with the circuit which does not appear as heat in either coil or condenser. Radiation resistance is represented by energy which does not heat the circuit. However, calculations show that radiation resistance will not account for this difference. It is probably the equivalent resistance of objects in the immediate vicinity of the circuit.

It will be noted that this resistance is eliminated in the condenser substitution method of Dye.

The values for R_s as calculated by the empirical formula in some of the data given above are constant and in some other cases there is a gradual variation of the value. It is found that in some cases the value of R_s is more nearly constant if the square root of the ratio of the wave length is used instead of the first power of the ratio.

It will be seen that a formula which applies to one condenser will not necessarily apply to another condenser. One must consider that the resistance of a condenser is partly due to the resistance of connecting bars and the flow of electricity in the plates of the condenser as it is distributed and partly to dielectric resistance. The first resistance may be called metallic resistance, and this is known to increase with frequency due to the skin effect, while dielectric resistance diminishes with frequency. The variation of resistance with frequency will depend upon the relative amount of metallic and dielectric resistance.

⁵ *Phil. Mag.*, 2, 1213; 1913.

The formulas are necessarily empirical, but they will serve to compare results made under various conditions.

CONCLUSION

Three methods have been used for the determination of the effective resistance of air condensers at radio frequencies. The coil-elimination method gives results which are high in comparison with the heat method and the condenser-substitution method. The extra resistance found in the coil-elimination method is probably due to the equivalent resistance of objects near the circuit. This extra resistance does not appear in the heat method and is eliminated in the condenser-substitution method. The resistance of a variable condenser is a measurable amount and whether or not it can be neglected depends upon the accuracy of results wished and upon the relative value of this resistance to that of the rest of the circuit.



WIRELESS TELEGRAPHY AND THE IONIZATION IN THE
UPPER ATMOSPHERE*

BY

E. O. HULBURT

(Naval Research Laboratory, "Bellevue", Anacostia, D. C.)

Summary—A non-mathematical survey is given of the theory of the upper atmosphere and the behavior of wireless waves. The new physics of the atmosphere based on heating by the sun, cooling at night, winds, gaseous diffusion, etc., the observations of the heights reached by wireless waves, the skip distances, ranges, polarization, etc., led to the conclusion that the ionization in the upper atmosphere was caused by the ultra-violet light of the sun and that the electron density had a maximum value of about 3×10^5 at 190 km for summer noon. The calculated ionization agreed well with the wireless facts during the day but fell off too rapidly at night. Below the maximum the ionization was not known exactly. The diamagnetic theory of the diurnal variation in the earth's magnetism called for an ion density of about 5×10^9 from about 150 to 190 km. The drift currents of the ions, due to the earth's gravitation and magnetism, causes the sunset longitude to be at a potential of about 2000 volts above that of the sunrise longitude. This voltage, combined with the earth's magnetic field, causes the ions and electrons to rise at night. They move up into regions of lower molecular density where their recombination is less. Their rate of loss at night is about right to agree with the wireless facts. It is pointed out that quantitative experiments with waves between 70 and 400 meters, of which there have been very few, might contribute valuable information about the ionization.

IN RECENT years knowledge of the behavior of wireless waves has been extended by many investigations. Many new facts have been discovered, those dealing with the short waves being perhaps of unusual theoretical and practical interest. At the same time theoretical explanations of the wireless phenomena have been forthcoming, based on the hypothesis that the waves are refracted in the levels of the upper atmosphere above 60 km which contain ions and electrons. These outer reaches may truly be regarded as a region above the blue sky. For the blue sky is due to the scattering of sunlight by the molecules of the air and 99/100 of the molecules are below a 40-km level; the remaining 1/100 extend upward many hundreds of kilometers with rapidly decreasing density. Therefore the sky has not been the limit and many of the theoretical inferences have involved extrapolation beyond the blue sky. The theory, although sufficiently powerful to point the way, has, on the whole, followed a little behind the experimental advance. For no sooner were certain facts satisfactorily explained than new discoveries appeared both in

* Dewey decimal classification: R113.4. Read before the Philadelphia Section of the Institute of Radio Engineers, December 3, 1929, at the Franklin Institute. Published with the permission of the Navy Department.

theory and experiment which led to modification and extension of the theory. It is the purpose here to describe some of the developments and to point out how matters stand at the present time.

About five years ago a comprehensive investigation of the ranges reached by waves throughout the wireless spectrum from 16 to 3000 meters was published. The skip distances of waves below 40 meters in length were observed and measured. The heights reached by wireless waves were determined by measuring the time for short pulses to travel from the transmitter to the receiver and by measuring the angles of the downcoming rays. The values were found to depend upon the wavelength, time of day, season of the year, latitude, etc. The observed heights, reached by long waves of 6000 and 14,000 meters, were from 75 to 110 km, by 400-meter waves were 100 to 125 km, and by 70-meter waves were 90 to 220 km. It was realized that the heights thus found were in general greater than the true heights reached by the ray because of the unknown manner in which the ray path might be curved in the ionized regions overhead.

These experimental results, as well as many fading and polarization phenomena, indicated clearly that large numbers of ions and electrons existed in the upper atmosphere in the levels above 70 km. The theoretical attack assumed that the refraction and the absorption of the short waves was due mainly to the electrons, and that the electrons increased in density with the height above the earth reaching a maximum density at a certain height, and fell off again above this height. In the theory the influence of the earth's magnetic field on the electrons was taken into account. The result came out that the electron density had a maximum value of 3 or 4×10^5 electrons cm^{-3} at a height between 120 and 240 km. The height could not be calculated more accurately than this, for its exact value depended upon how the ions and electrons were distributed below the maximum. The distribution was not known completely although wireless data offered some information about it. The experimentally determined heights reached by 400-meter waves and longer indicated roughly 10^2 electrons cm^{-3} , or 10^7 ions cm^{-3} , at about 70 km increasing to about 10^4 electrons cm^{-3} , or 10^9 ions cm^{-3} , at 130 km, or a suitable mixture of ions and electrons at the respective levels.

This was all comparatively simple. Many things were still unknown but no marked discrepancies or contradictions had been met. Difficulties began to appear, however, when the cause of the ionization was inquired into. Various writers in turn concluded that the ionization might arise from the ultra-violet light of the sun, from α or β particles emitted by the sun, and from penetrating radiation. But it developed that the ionization calculated for the night hours

was too great. It gave too short nighttime skip distances. The reason for the difficulty was not far to seek. The calculations were based on gas densities and pressures worked out from an old theory of the physics of the upper atmosphere. The theory recognized no difference between night and day in the upper reaches of the atmosphere and assumed a constant cold temperature of about -50 deg. C for day and night in the levels above 40 or 50 km. The atmosphere was thought of as stagnant, with no winds or motion, the lighter gases, such as helium, floating on top of the heavier gases. It became evident that this was hardly a correct conception of the upper atmosphere. Calculation showed that the air at high levels, just as at low levels, is warmed during the day and cooled at night. Such temperature differences would give rise to winds. If the entire atmosphere were thoroughly mixed up, as by a wind, and if the stirring agent were then removed, a separation of the gases would occur, the lighter gases diffusing upward and the heavier ones downward. But calculation showed that in the levels below 130 km it would require weeks or years for an appreciable separation to take place. Above 150 or 200 km the separation is more rapid. Since the upper as well as the lower atmosphere is continually stirred up by winds and since separation by diffusion is slow, the relative proportions of the various gases are much the same up to roughly 150 km as they are at sea level; this result was quite different from the results of the stagnant theory.

The entire physics of the atmosphere was therefore overhauled. Evidence favorable to the new theory was already available. Meteor trails appearing as luminous trails of light in the sky at night sometimes persisting for many minutes gave direct proof of winds. Trails at heights around 100 km were observed to move rapidly and to be distorted as if by winds and air currents of velocities as great as 100 km hr^{-1} . The fading and vagaries of wireless signals indicated motions of the medium through which the waves had passed. The heating of the atmosphere by the sunlight, the cooling at night, and the exchange of radiant energy with the earth were worked out. The calculations could not be made very precise of course, for many quantities, such as the light absorption coefficients, etc., were imperfectly known. Diffusion and wind-mixing of the atmospheric gases were estimated. Daytime temperatures above 100 deg. C were found in the high atmosphere, the night temperatures being around -50 deg. C. New tables were drawn up of the pressures and the molecular densities of the various gases in the atmosphere from sea level to 300 km for night and day and winter and summer conditions. The new tables differed from the old tables at the higher levels, but this difference,

although important in the ionization calculations, was not so important as the new physics of the atmosphere. The realization that the upper atmosphere instead of being quiet, cold, and lifeless is mobile, windy, hot during the day, and cold during the night, meant that in any calculations of the ionization the diffusion of the ions must be considered.

The introduction of diffusion led to considerable mathematical difficulties in the ionization calculations. The matter was hammered through, and the ionization during the day due to the ultra-violet light of the sun was found to agree fairly well with that inferred from the behavior of wireless waves. The calculated electron density had a maximum value of 3×10^5 at a height of about 190 km at summer noon. The electrons at this height were only to a small extent those formed by the direct photoelectric action of the solar ultra-violet on the atmospheric atoms and molecules in this region. They were mainly the electrons formed by the highly absorbed ultra-violet light in the levels above 190 km which diffused rapidly downward. As they moved downward they entered regions of increasing molecular density, the diffusion decreasing and the rate of loss due to recombination with positive ions and attachment to oxygen molecules increasing. At the maximum electron density the rate of loss was approximately equal to the rate of supply from diffusion; below the maximum the loss increased, the supply decreased; and therefore the electron density decreased. The ionization below the maximum could not be calculated exactly because many facts, such as the intensity of the sunlight in various regions of the ultra-violet, the absorption of the light by the atmospheric particles, the exact mechanism of the photoelectric action, etc., were, and still are, unknown. The general conclusion seemed valid, however, that the ionization caused by the solar ultra-violet radiation was sufficient and of the proper sort to explain the wireless facts, and that hypotheses of other ionizing agencies were uncalled for.

In the ionization theory there emerged two discrepancies, one in the day and one in the night. These were not large enough to be very disturbing but were too large to be put aside easily. The maximum intensity of the sunlight is at noon. Because of the time necessary for the light to build up the ionization, the maximum ionization occurs a little later than noon,—calculation put it at 40 minutes past noon. Other things being equal the skip distances are a minimum when the ionization is a maximum. The minimum skip distances were observed to be at about two o'clock. The discrepancy remains unexplained at the present time; it may be due to a shift in the distribution of the ionization causing a warping of the ray paths. The second difficulty arose when it was found that the calculated electron

densities decreased a little too rapidly at night. The skip distances at summer midnight in the temperate zones were about double their noonday values, indicating that the noon electron density 3×10^5 decreased to about 4×10^4 at midnight. To get this decrease required a certain decrement factor, i.e., a certain numerical value of a negative exponent, and the theoretical value was about five times too great. No suggestion as to the cause of the discrepancy was to be had from photoelectric theory or wireless observations. One was forced to wait for some new idea or experimental fact to be brought to light. The clue to the difficulty came indirectly in an unexpected way from an entirely different field of experiment and theory, namely, terrestrial magnetism. Wireless telegraphy and terrestrial magnetism are in some respects closely connected, for certain features of each depend upon the ionization in the atmosphere.

It was well known that the magnetic field of the earth undergoes regular changes with the day and night. The diurnal change is small, less than 0.1 per cent, and varies in a rather complex manner with the latitude. The diamagnetic theory developed recently offered a fairly complete explanation of the diurnal changes in the earth's magnetism at all latitudes. An ion in a magnetic field is diamagnetic, like metallic bismuth, provided the ion has a long free path so that it can execute its magnetic gyration without being disturbed too often by collisions with the gas molecules. Above 160 km at summer noon, and about 100 km during a winter night, the molecular density is low, the free paths are long and the ions are diamagnetic. The theory assumed long free path ions distributed over the daylight hemisphere of the earth with a maximum number of ions above a point on the earth directly underneath the sun, i.e., at equatorial noon equinox, the number falling off with the cosine of the angular distance from this point. Approximately this type of ion distribution would be made by the ultra-violet light of the sun. To account for the 0.1 per cent change in the earth's field from midday to midnight there were required about 2×10^{16} long free path ions at noon equinox at the equator. This meant an ion density of about 5×10^9 ions cm^{-3} in levels from roughly 150 to 190 km. Actually the diamagnetic theory required a density of 5×10^9 charged particles; it was unimportant whether the particles were ions or electrons or a mixture of the two. In the case of wireless, however, electron densities greater than 2×10^5 in these levels were objected to, for this would make the skip distances too short. Therefore ions were specified in the diamagnetic theory, although 2×10^5 of them, or less, per cm^3 could be electrons. The magnetic susceptibility of the long free path region at equatorial noon was about 100 times that of bismuth, as bismuth is the most strongly diamagnetic

substance known. Below 150 km at summer noon, and about 100 km during winter night, the free paths are so short that the ions are not influenced by the earth's magnetic field. The ions are not diamagnetic and the atmosphere in these levels therefore has the electrical properties of an ordinary ionized gas, i.e., its electrical conductivity obeys Ohm's law and may be calculated from the usual formulas of kinetic theory. The diamagnetic theory was not concerned with the ionization in the short free path region, but the refraction of long wireless waves, as has been mentioned, permitted a few deductions. It indicated about 10^7 ions cm^{-3} at 70 km increasing to 5×10^9 ions cm^{-3} at 150 km, or about 10^2 electrons cm^{-3} increasing to 5×10^4 at the respective levels, or a suitable mixture of ions and electrons. These values refer to equatorial noon. Using ions the electrical conductivity of a 1- cm^2 column vertically upward through the short free path region was about 14, 1, and 0.2×10^{-6} c.g.s. e.m.u. at noon, sunset, and midnight on the equator, respectively. These values are equal to the electrical conductivity of 14, 1, and 0.2 mm of mercury.

Assuming the ionization in the 70- to 150-km levels to be mainly ions, the rate of disappearance of the ions at night by recombination was calculated, and the night time ionization thus obtained agreed well with that inferred from the observed heights reached by long waves at night. Disagreement was found if electrons were used, for they were wiped out so rapidly by recombination and attachment that within two hours after sunset practically none were left. Absorption of wireless waves indicated some electrons in the 70- to 150-km levels during the day which disappear at night. For example, it is well known that the intensity of broadcast waves received at some distance increases rather sharply at sunset, passing within less than two hours from its low daylight value to a high night value. Calculations of the absorption due to the ions gave some decrease in absorption after nightfall but probably not quite enough; the calculated absorption due to electrons fell off much more rapidly after sunset. Since one electron is equivalent to about 10^6 ions as far as absorption is concerned and to 10^3 ions for refraction purposes, it seemed possible to explain all the facts by the hypothesis that the refraction in the 70- to 150-km levels during the day was controlled by ions and the absorption by electrons; during the night only ions remained.

This conclusion led to an interesting difficulty. The experiments with the long waves indicated that the polarization of the received wave varies more or less rapidly with the time during the day and the night. These effects were attributed to the electrons, for, in the earth's magnetic field, they cause magnetic double refraction and absorption of the wave and hence cause changes in the polarization.

Ions, on the other hand, are too heavy to give appreciable double refraction except for very long waves outside of the usual wireless range. Thus theory and experiment were in entire agreement during the day. At night, however, theory indicated no electrons in the 70- to 150-km levels. Therefore, if the observations demand electrons we shall conclude that something has been left out of the theory. It is possible, of course, that the interference of a number of rays may give rise to changes in the polarization of the received wave quite apart from magnetic double refraction effects.

The ions in the long free path levels from about 150 to 190 km (summer noon) gave rise to a new effect. A positive ion under the action of gravity and the earth's magnetic field drifts eastward, and a negative ion westward, with a velocity of about 5 cm per sec⁻¹. This constitutes an eastward electric current flowing roughly along the parallels of latitude. The movement of the ions builds up an east-to-west potential gradient on the day side of the earth and a west-to-east potential gradient at night. The potential gradient was found to vary somewhat with the latitude, but on a rough average the sunset longitude of the earth was about 2000 volts above that of the sunrise longitude. This voltage causes a current to flow westward during the day in the short free path region from 70 to 150 km. Thus there is an eastward drift current sheet in the daylight levels above 150 km flowing along the parallels of latitude which divides into two sheets at roughly the sunrise and sunset longitudes, one sheet flowing westward in the underlying levels below 150 km and the other continuing eastward on around the night side of the earth.

The values of the currents in the three sheets from pole to pole are about 12, 9, and 3 million amperes, respectively, of which 4/5 are between the 40th parallels of latitude north and south. The east and west daytime current sheets subtract from each other leaving in effect an eastward current of approximately 3 million amperes flowing around the earth all the time. The current causes a horizontal magnetic field at the equator of about 400×10^{-5} gauss which agrees in magnitude and type with that disclosed by the 1922 analysis of the permanent field of the earth. The analysis showed that a portion, about 4 per cent, of the magnetic field is of external origin and is northward and upward in the northern hemisphere, nearly horizontal at the equator and northward and downward in the southern hemisphere, the value of the horizontal component at the equator being about 450×10^{-5} gauss.

The electric field, eastward in the day and westward at night, combined with the earth's magnetic field, causes ions of both signs and electrons to descend during the day and to rise at night with velocities of 2 or 3 meters per sec. These effects were taken into ac-

count in working out the long free path ions and the current sheets. The electric drift does not modify appreciably the daytime calculations of the electrons with maximum density at 190 km. The agreement with the skip distances and the discrepancy between the observed minimum skip distance at about 2 P.M. and the calculated maximum of ionization at 40 minutes past noon remain unchanged. In the nighttime calculations, however, there is an improvement. The electrical drift at night amounted to about 9 km an hour vertically upward. Therefore the electrons and the ions moved up into regions less molecular density where the recombination and attachment was less. Thus the electrons were actually lifted up out of harm's way and did not disappear as rapidly as the older diffusion theory indicated. The calculated nighttime skip distances now came out quite close to those observed during the early part of the night but were a little too great, by 50 or 100 per cent, in the small hours of the morning. Thus there is still a slight discrepancy, but perhaps a more exact agreement is scarcely to be expected in view of the many approximations in the theoretical treatment.

The upward movement at night of the ionization in the long free path region amounts to about 80 km in 9 hours. At the same time because of collisions between the ions and electrons and the molecules diffusion occurs to some extent and spreads out the ionization upwards and downwards. The exact distribution with height of the ionization and its changes during the night have not been worked out. Until this is done it is difficult to say how much of the increase during the night in the apparent heights of the ionization observed in certain wireless experiments may be a genuine rise and how much may be an apparent rise due to delayed group velocities or to other causes.

In conclusion, it may be pointed out that there is a gap in our experimental knowledge of the facts of wireless phenomena. There have been very few quantitative investigations in the wavelength range between 70 and 400 meters. These waves are supposedly refracted in the atmospheric levels from 130 to 180 km during a summer day. There is a corresponding hiatus in the knowledge of the ionization in these levels. Terrestrial magnetism has filled this in its own way but one would like to know more of the action of wireless waves of this wavelength range. Quantitative measurements of the heights reached by waves from 70 to 400 meters, of the intensity degradation of the waves with the distance from the transmitter, of the polarization of the received wave, etc., might yield valuable results. The experiments would perhaps be of unusual interest in view of the complicated effects to be expected in the vicinity of the critical wavelength at about 200 meters caused by the spiralling of electrons in the earth's magnetic field.

DESIGN OF A PORTABLE TEMPERATURE-CONTROLLED PIEZO OSCILLATOR*

BY

V. E. HEATON AND W. H. BRATTAIN

(Ratio Section, Bureau of Standards, Washington, D. C.)

Summary—This paper describes the essential details of a portable shielded temperature-controlled piezo oscillator constant in frequency to better than one part in 100,000. The quartz plate is mounted in a special plate holder so that the air-gap changes very little as the quartz plate shifts in the holder. The plate holder is mounted in a thermal-attenuating chamber consisting of a copper cylinder and layers of asbestos, contained in a wooden box. The copper cylinder is mounted on heavy bronze coil springs to absorb shocks. A sensitive mercury thermostat, placed in a slot in the side of the copper cylinder, controls the temperature. The heater operates on 110 volts direct current.

The quartz plate is connected between the grid and the filament of the oscillator tube. An inductor, having a natural frequency slightly higher than that of the quartz plate, is used in the plate circuit of the tube. The load is kept constant by loosely coupling to the output through a screen-grid radio-frequency amplifier.

Measurements on the piezo oscillator give the following results; temperature coefficient of 0.0025 per cent per degree centigrade change in temperature of the quartz plate itself; 10 per cent variation of plate or filament voltages from operating point of the oscillator tube causes less than 1 part in 1,000,000 change; jarring has no measurable effect on the frequency.

I. INTRODUCTION

THERE is considerable demand for a portable temperature-controlled piezo oscillator of a high degree of constancy. As a result of considerable experimentation the bureau has made several portable temperature-controlled piezo oscillators, which on preliminary tests have remained constant in frequency to 1 part in 100,000. In order to obtain this constancy, careful consideration in design is necessary, especially in the small details.

A description of the essential details of these piezo oscillators is the purpose of this paper. However, any one wishing to construct such a piezo oscillator will find it necessary to overcome many small difficulties before he obtains, as a finished product, a good portable piezo oscillator. The apparatus is described in three parts, circuit arrangement, temperature control, and quartz plate with holder.

* Dewey decimal classification: 214. Published by permission of the Director of the Bureau of Standards of the Department of Commerce.

II. CIRCUIT ARRANGEMENT

There are a number of circuit arrangements that might be used in the construction of a piezo oscillator. The one chosen had been found previously to be satisfactory, and in this work no attempt was made to compare the various types. A description of various circuit arrangements may be found in an article by A. Crossley.¹

In the arrangement chosen the quartz plate is placed between the grid and the filament of the oscillator tube, and the inductance necessary to produce oscillation is placed in the plate circuit. This inductor is chosen with inductance and distributed capacity so that it has a natural frequency slightly higher than the frequency of the quartz plate without requiring any additional capacity to be shunted across it. A coil having low distributed capacity is best since it emphasizes the harmonics. A grid resistor of several megohms placed in parallel with the quartz plate serves to maintain a constant grid voltage on the oscillator tube.

The output from the piezo oscillator should not be used directly because a variable load at the output will cause a small variation in the frequency. To avoid such variations a constant output is used by means of a constant coupling to a radio-frequency amplifier. This amplifier may consist of one or more stages, depending on the amount of output desired. The coupling to this amplifier should be very loose in order to prevent a possible variation in frequency of the piezo oscillator caused by changes in the amount of power taken from the output of the amplifier. This coupling may be either capacitive or inductive.

A capacitive coupling which is the one chosen makes it a simple matter to change the amount of coupling and it also conserves space. The output circuit of this radio-frequency amplifier is a filter circuit consisting of a radio-frequency choke coil and two condensers. The direct current passes through the choke coil, while the radio-frequency current passes through the condenser to the output terminals. A screen-grid tube is used in the radio-frequency amplifier to prevent changes in the plate circuit from being reflected back into the grid circuit, consequently changing the frequency of the piezo oscillator.

There is also the possibility of external influences affecting the piezo oscillator frequency directly by means of stray coupling and, therefore, all the radio-frequency circuits of both the oscillator and the amplifier are thoroughly shielded by placing them in an aluminum cabinet with each joint connected by a brass angle. Thus it is necessary that all parts of the circuits except the quartz plate and instruments

¹ PROC. I.R.E., 15, 9; January, 1927.

is mounted on a bakelite subpanel which can be placed inside the cabinet after most of the wiring is done. The filament and plate voltages are carried from the outside through a cable to the place where these leads are soldered to the circuit. All connections inside the piezo oscillator are soldered securely. Radio-frequency choke coils are placed in each of the positive "B" battery leads and the radio-frequency current is by-passed by fixed condensers.

The entire circuit arrangement is shown in Fig. 1. The resistance R across the quartz plate, QP , is 7 megohms. The oscillator tube is of a 201-A type. Voltmeter V_1 is used to aid in adjusting the filament voltage. The inductor, L , is a honeycomb coil. As mentioned above, its inductance and distributed capacity give it a frequency above that

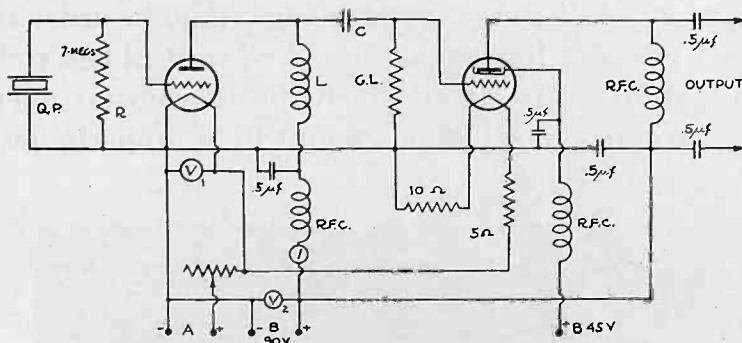

Fig. 1—Complete piezo-oscillator circuit diagram.

of the quartz plate. This difference in frequency is important and should be such that the quartz plate will oscillate freely but so that its amplitude of oscillation will not be very large. The voltmeter, V_2 , indicates the plate voltage on the oscillator tube, and a 0-5 milliammeter, MA , serves to indicate whether or not the quartz plate is oscillating.

The amplifier is coupled to the oscillating circuit through the condenser C . A screen-grid tube is used in the amplifier, with 5- and 10-ohm resistors to give both the proper grid bias and to adapt this 5-volt tube to the 5-volt filament supply. The radio-frequency choke coils RFC have 60-85 mh inductance each with low internal capacity.

III. TEMPERATURE CONTROL

A mounted quartz plate has a temperature coefficient of frequency the amount of which depends on the orientation of the plate with respect to the crystal axes, and on the air-gap between the metal electrodes and the quartz plate. The magnitude of this temperature coefficient of frequency for Curie cut quartz plates is of the order of 0.001 per cent to 0.003 per cent per degree Centigrade.

Variations in temperature with ordinary thermostatic control are usually a few tenths of a degree Centigrade. These variations include long-period changes resulting from gradual aging of the thermostat, short-period changes resulting from amplitude of operation of the thermostat, and variations of temperature with position in the temperature

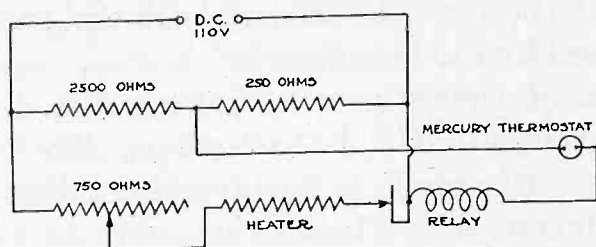

Fig. 2—Temperature-control circuit diagram.

controlled region. It is obvious, therefore, that in order to insure a constancy of 1 part per 100,000 an improved control had to be used.

The changes in the point at which the thermostat operates may usually be reduced to a negligible amount by a properly designed and

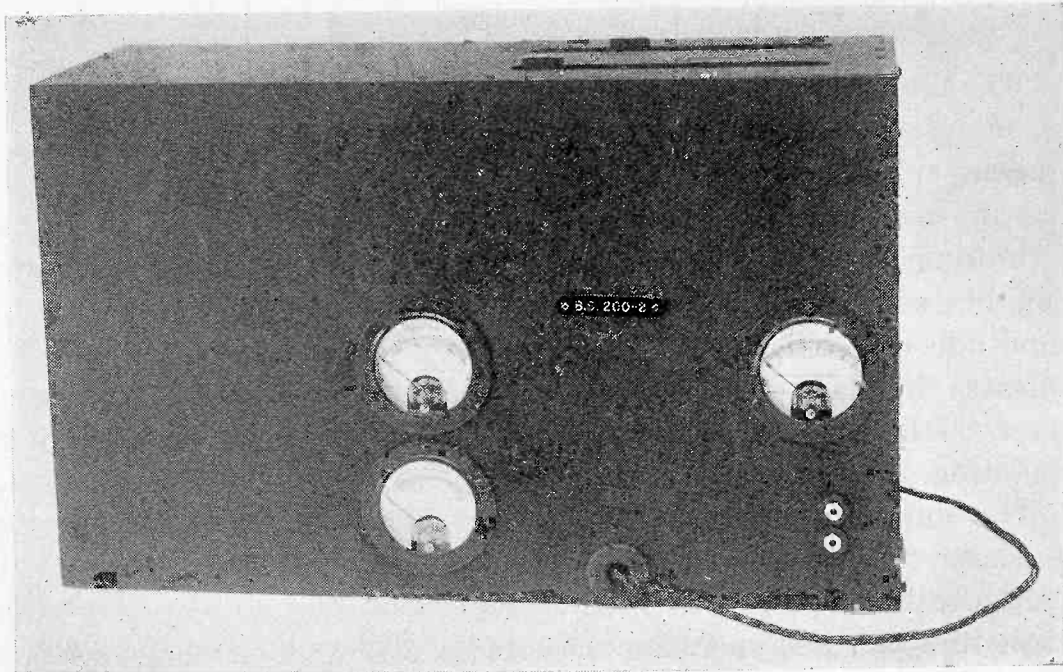

Fig. 3—Front view of piezo-oscillator.

aged mercury thermostat. The short-period changes can be greatly decreased by the method of attenuation as described by W. A. Marrison.² The essentials of the method are; first, a thermostat that will hold its operating temperature to within very narrow limits, and; second, a heating system such that the frequency of operation of the thermostat

² W. A. Marrison, "Thermostat design for frequency standards," *Proc. I.R.E.*, 16, 976; July, 1928

will be of the order of once a minute, and; third, a thermal attenuation which will reduce the effect of the amplitude of thermostat operation. The variations with position in the thermostatically controlled chamber may, of course, be eliminated by fixing the position of the quartz plate in this chamber.

In the construction of the piezo oscillators described here, a heat-insulated box is made with walls of one-half inch pine and one-half inch Balsa wood. A hollow copper cylinder, three-eighths of an inch thick, is placed inside of the heat-insulated box. The copper cylinder is mounted on heavy bronze coil springs which serve to absorb shocks. The outside of the cylinder is covered with a thin layer of

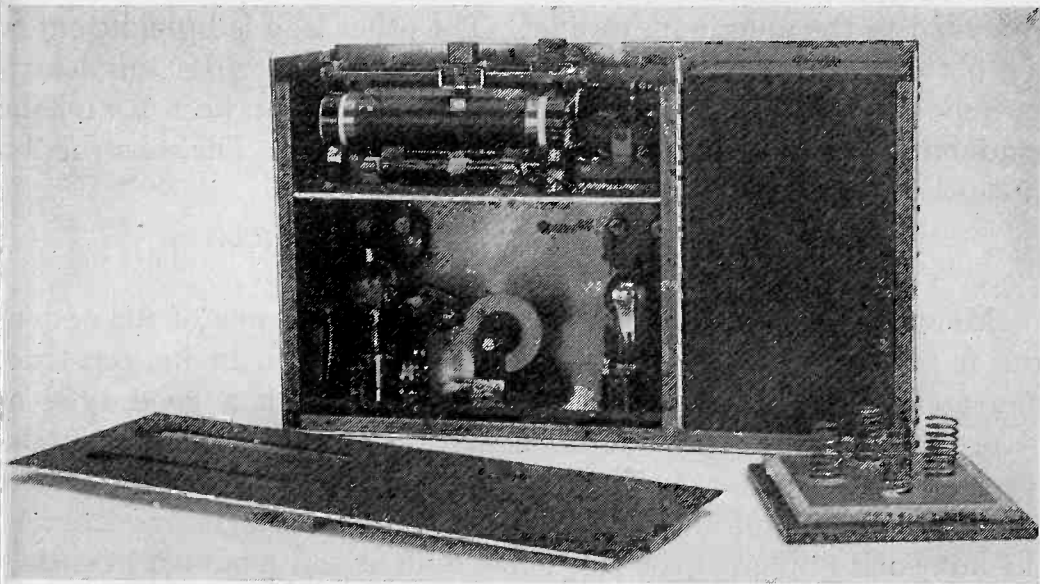

Fig. 4—A view of the piezo-oscillator with the back removed.

asbestos for insulation, and then is wound with nichrome wire, which serves as the heating unit. The nichrome wire is wound so that there are more turns per unit length on each end than in the middle of the cylinder in order to compensate for the heat losses through the ends of the cylinder. A mercury thermostat is used to control the heating current. This thermostat has a sensitivity of 4 deg. C per inch of bore. The thermostat is placed in a groove in the copper cylinder under the heating wire and in close thermal contact with it. A hole drilled deep into the wall of the copper cylinder and parallel to its axis serves as a thermometer well. The inside of the cylinder is lined with asbestos, 3/8 in. thick. Lengthwise of the copper cylinder the space is broken up into three compartments by asbestos disks. The quartz plate and holder are placed in the central compartment, and the other two serve to decrease the end effects. The heating unit operates on

110 volts d.c. The temperature-control circuit shown in Fig. 2 is so designed that the mercury thermostat, when closed, allows a current of 8 ma to flow through the relay which opens the heater circuit. This arrangement is used so that the voltage across the terminals of the thermostat, when open, is small. The thermostat, by means of the relay, turns on and off the entire heating current. This increases the frequency of operation of the thermostat and makes the temperature inside the cylinder independent of large variations in outside temperature. The 750-ohm rheostat is set so that the length of the period that the heating current is on is approximately equal to the length of the period that it is off.

The copper cylinder and one electrode of the plate holder are grounded to the aluminum cabinet. The other lead is brought out at the bottom of the cylinder and is well insulated. Since this lead is entirely surrounded by a conductor, the capacity between it and the conductor is independent of the position of the lead. The construction of this heating chamber is shown in Fig. 4.

IV. QUARTZ PLATE

Mounting—The quartz plate controls the frequency of the system and it is obvious that extreme care must be taken in its construction and mounting. Any good quartz plate with a good type of plate holder can be used, but the holder must be of a nature suitable for a portable instrument. The essentials are a quartz plate cut so that it is a good oscillator and so that it oscillates at a single frequency in the immediate range of the frequency desired and mounted in such a way that the change in frequency due to change in position of the quartz plate is very small. The spacer of the two electrodes must have a small temperature coefficient of expansion so as to diminish that part of the temperature coefficient of frequency, which is due to the change in air-gap.

The quartz plate actually used is cut as a cylinder, the cut used being the Curie cut. The dimensions are such that its thickness frequency corresponds to the required value. Care is taken to grind the two ends of the plate flat and parallel. The holder consists of two metal electrodes separated by means of a pyrex ring. The surfaces of the electrodes are ground flat and the edges of the pyrex ring are ground flat and parallel. The diameter of the pyrex ring is so chosen as to fit the cylindrical quartz plate to within one hundredth of an inch. Care in making the various surfaces flat and parallel assures that motion of the plate in the plate holder will not change the spacing and thereby change the frequency.

The pyrex ring is constructed thicker than the quartz plate to prevent the top electrode from touching the quartz plate. The amount of spacing or air-gap is determined so that it is approximately one-fourth of a wavelength of the supersonic sound waves generated by the quartz plate.³ The exact spacing is unimportant as long as it is between zero and one half wavelength and is uniform throughout the space occupied by the crystal. A photograph of the mounting is shown in Fig. 5.

V. RESULTS

Six of these piezo oscillators have been built in the past 18 months and thoroughly tested. The tests that were made on them were:

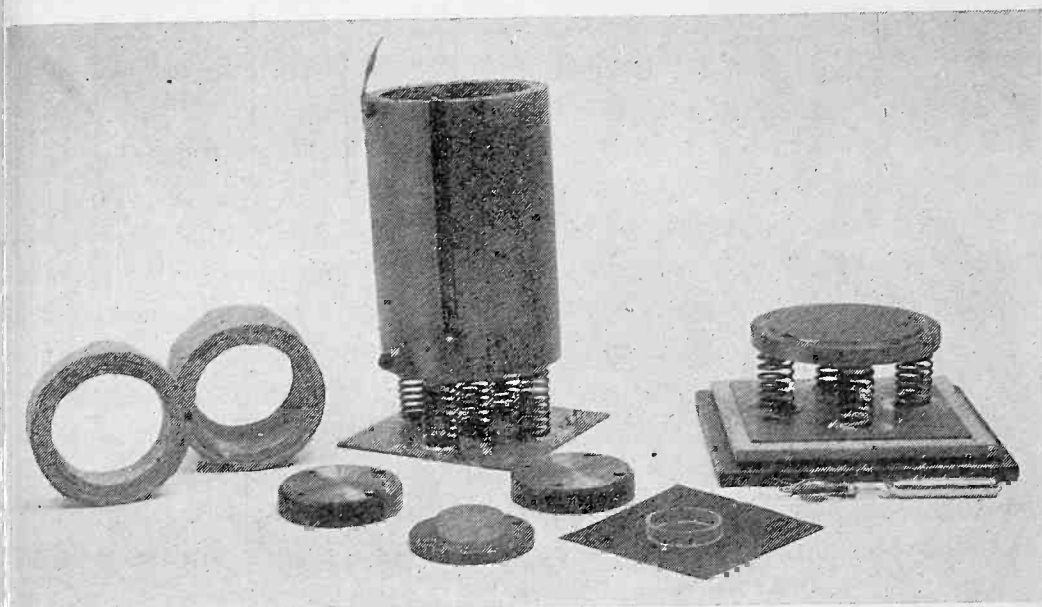

Fig. 5—Quartz plate holder, mercury thermostat, and attenuating cylinder.

determination of temperature coefficient of frequency; measurement of the variation of frequency due to variations in either plate voltage or filament voltage on the oscillator tube; measurement of the variation in frequency due to shocks and to moving; and measurements of the frequency periodically for several months.

The results of such tests in the case of the piezo oscillator described here are: temperature coefficient, 0.0025 per cent per degree Centigrade change in temperature of the quartz plate itself; ten per cent

³ D. W. Dye, "Piezo-electric quartz resonator and equivalent electrical circuit," *Phys. Soc. Proc.*, 38, 399-458; August, 1926. *Elec. Rev.*, 99, 733-735, October 29, 1926. A. Hund, "Notes on quartz plates, air-gap effect and audio-frequency generation," *Proc. I. R. E.*, 16, 1072-1078, August, 1928.

variation of plate and filament voltages from operating point on oscillator tube (201-A) causes less than 1 part in 1,000,000 change; jarring the piezo oscillator has no measurable effect; tipping and moving it around causes a variation of frequency of approximately 7 parts in 1,000,000. Finally measurements taken once every day over a period of three months without disturbing the piezo oscillator show variations less than 5 parts in 1,000,000. It is possible that there may be a drift in frequency over a long period, but no experimental evidence of such a variation has been found.



ELECTROELASTIC AND PYRO-ELECTRIC PHENOMENA*

By

W. G. CADY

(Scott Laboratory, Wesleyan University, Middletown, Conn.)

THIS PAPER is substantially identical with the section under the same title contributed by the author to the International Critical Tables.¹ It summarizes the more important available data gathered from many sources in the fields of electrostriction, piezo-electricity, and pyro-electricity. References are given to sources where further information may be obtained. A few additional references are now included to bring the material to date. The brief paragraph on quartz resonators has been omitted, since this subject has already been more fully covered by previous papers in this and other technical journals. For the same reason, with respect to the applications of piezo-electric crystals to high-frequency circuits, only a few representative references to the literature are given, those publications having been selected which are most directly concerned with the fundamental properties of vibrating piezo-electric crystals.

Electrostriction.—In general, when an isotropic dielectric is subjected to an electrostatic field E , its volume and form are changed. This phenomenon is known as *electrostriction*. The same kinds of effect occur in anisotropic dielectrics, but in them these effects are in many cases obscured by the far larger electro-crystalline ones described as piezo-electric (see below). In electrostrictive effects, the tensions tending to stretch any element of the dielectric are proportional to E^2 and to $d\epsilon/dx$, where ϵ = dielectric constant and x is the amount of stretching in the direction considered. In general, $d\epsilon/dx$ depends upon the inclination of x to E ; it may be either positive or negative, depending upon the nature of the dielectric (2). There are similar forces tending to move the dielectric bodily in such a way as to increase the integral value of ϵE^2 , and if the dielectric is solid and if the field is produced by the charging of electrodes supported by it, then it will be subjected to the pressure arising from the mutual attraction of the electrodes. Deformations resulting from these two types of forces

* Dewey decimal classification: 537.65

¹ International Critical Tables, 6, 207–212; 1929. First edition, six volumes, published for the National Research Council by the McGraw-Hill Book Company, New York. The present paper is published with the permission of the National Research Council.

110 volts d.c. The temperature-control circuit shown in Fig. 2 is so designed that the mercury thermostat, when closed, allows a current of 8 ma to flow through the relay which opens the heater circuit. This arrangement is used so that the voltage across the terminals of the thermostat, when open, is small. The thermostat, by means of the relay, turns on and off the entire heating current. This increases the frequency of operation of the thermostat and makes the temperature inside the cylinder independent of large variations in outside temperature. The 750-ohm rheostat is set so that the length of the period that the heating current is on is approximately equal to the length of the period that it is off.

The copper cylinder and one electrode of the plate holder are grounded to the aluminum cabinet. The other lead is brought out at the bottom of the cylinder and is well insulated. Since this lead is entirely surrounded by a conductor, the capacity between it and the conductor is independent of the position of the lead. The construction of this heating chamber is shown in Fig. 4.

IV. QUARTZ PLATE

Mounting—The quartz plate controls the frequency of the system and it is obvious that extreme care must be taken in its construction and mounting. Any good quartz plate with a good type of plate holder can be used, but the holder must be of a nature suitable for a portable instrument. The essentials are a quartz plate cut so that it is a good oscillator and so that it oscillates at a single frequency in the immediate range of the frequency desired and mounted in such a way that the change in frequency due to change in position of the quartz plate is very small. The spacer of the two electrodes must have a small temperature coefficient of expansion so as to diminish that part of the temperature coefficient of frequency, which is due to the change in air-gap.

The quartz plate actually used is cut as a cylinder, the cut used being the Curie cut. The dimensions are such that its thickness frequency corresponds to the required value. Care is taken to grind the two ends of the plate flat and parallel. The holder consists of two metal electrodes separated by means of a pyrex ring. The surfaces of the electrodes are ground flat and the edges of the pyrex ring are ground flat and parallel. The diameter of the pyrex ring is so chosen as to fit the cylindrical quartz plate to within one hundredth of an inch. Care in making the various surfaces flat and parallel assures that motion of the plate in the plate holder will not change the spacing and thereby change the frequency.

The pyrex ring is constructed thicker than the quartz plate to prevent the top electrode from touching the quartz plate. The amount of spacing or air-gap is determined so that it is approximately one-fourth of a wavelength of the supersonic sound waves generated by the quartz plate.³ The exact spacing is unimportant as long as it is between zero and one half wavelength and is uniform throughout the space occupied by the crystal. A photograph of the mounting is shown in Fig. 5.

V. RESULTS

Six of these piezo oscillators have been built in the past 18 months and thoroughly tested. The tests that were made on them were:

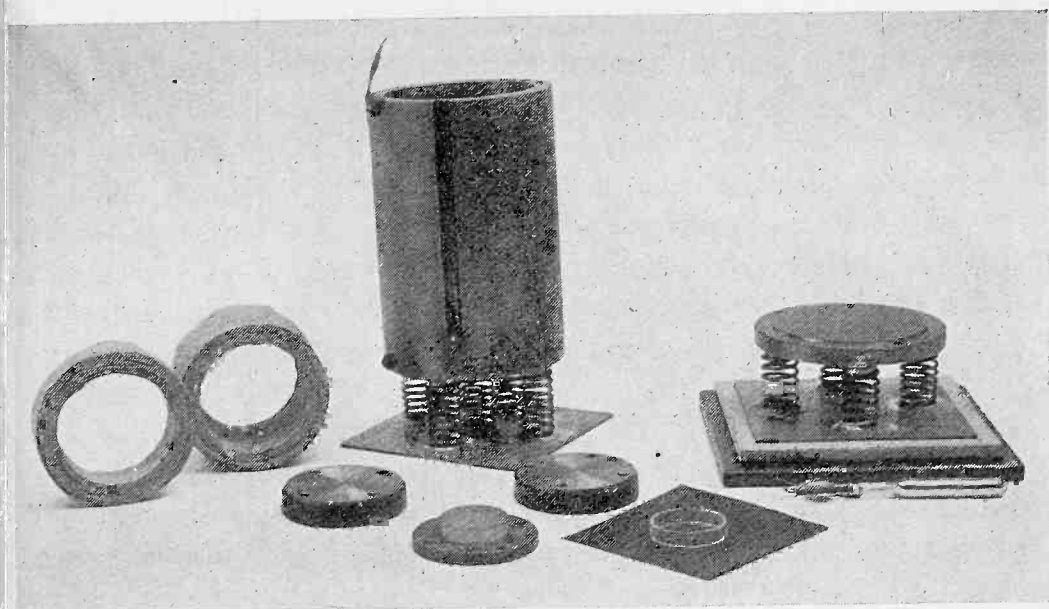

Fig. 5—Quartz plate holder, mercury thermostat, and attenuating cylinder.

determination of temperature coefficient of frequency; measurement of the variation of frequency due to variations in either plate voltage or filament voltage on the oscillator tube; measurement of the variation in frequency due to shocks and to moving; and measurements of the frequency periodically for several months.

The results of such tests in the case of the piezo oscillator described here are: temperature coefficient, 0.0025 per cent per degree Centigrade change in temperature of the quartz plate itself; ten per cent

³ D. W. Dye, "Piezo-electric quartz resonator and equivalent electrical circuit," *Phys. Soc. Proc.*, 38, 399-453; August, 1926. *Elec. Rev.*, 99, 733-735, October 29, 1926. A. Hund, "Notes on quartz plates, air-gap effect and audio-frequency generation," *Proc. I. R. E.*, 16, 1072-1078, August, 1928.

variation of plate and filament voltages from operating point on oscillator tube (201-A) causes less than 1 part in 1,000,000 change; jarring the piezo oscillator has no measurable effect; tipping and moving it around causes a variation of frequency of approximately 7 parts in 1,000,000. Finally measurements taken once every day over a period of three months without disturbing the piezo oscillator show variations less than 5 parts in 1,000,000. It is possible that there may be a drift in frequency over a long period, but no experimental evidence of such a variation has been found.



ELECTROELASTIC AND PYRO-ELECTRIC PHENOMENA*

By

W. G. CADY

(Scott Laboratory, Wesleyan University, Middletown, Conn.)

THIS PAPER is substantially identical with the section under the same title contributed by the author to the International Critical Tables.¹ It summarizes the more important available data gathered from many sources in the fields of electrostriction, piezo-electricity, and pyro-electricity. References are given to sources where further information may be obtained. A few additional references are now included to bring the material to date. The brief paragraph on quartz resonators has been omitted, since this subject has already been more fully covered by previous papers in this and other technical journals. For the same reason, with respect to the applications of piezo-electric crystals to high-frequency circuits, only a few representative references to the literature are given, those publications having been selected which are most directly concerned with the fundamental properties of vibrating piezo-electric crystals.

Electrostriction.—In general, when an isotropic dielectric is subjected to an electrostatic field E , its volume and form are changed. This phenomenon is known as *electrostriction*. The same kinds of effect occur in anisotropic dielectrics, but in them these effects are in many cases obscured by the far larger electro-crystalline ones described as piezo-electric (see below). In electrostrictive effects, the tensions tending to stretch any element of the dielectric are proportional to E^2 and to $d\epsilon/dx$, where ϵ = dielectric constant and x is the amount of stretching in the direction considered. In general, $d\epsilon/dx$ depends upon the inclination of x to E ; it may be either positive or negative, depending upon the nature of the dielectric (2). There are similar forces tending to move the dielectric bodily in such a way as to increase the integral value of ϵE^2 , and if the dielectric is solid and if the field is produced by the charging of electrodes supported by it, then it will be subjected to the pressure arising from the mutual attraction of the electrodes. Deformations resulting from these two types of forces

* Dewey decimal classification: 537.65

¹ International Critical Tables, 6, 207–212; 1929. First edition, six volumes, published for the National Research Council by the McGraw-Hill Book Company, New York. The present paper is published with the permission of the National Research Council.

should not be classed as electrostrictive, although one or the other enters into many measurements of electrostriction.

Electrostrictive effects are generally derived from observations of the change in dimension of a condenser of which the dielectric is the substance to be studied (2, 14, 20, 50, 57, 63, 74, 75, 79, 82, 96, 97, 127). If l is the dimension considered, Δl is the increase in l under action of the electric field, and if μ is the corresponding elastic modulus, then $\mu\Delta l/LE^2$ depends solely upon the configuration of the system, and upon ϵ and its variation with Δl . The changes (Δl) are very small and the sources of error are numerous; consequently the results obtained are frequently quite discordant and at times even qualitatively contradictory.

TABLE I

$$\Delta l/LE^2 \equiv A \times 10^{-n}. \text{ Unit of } A \times 10^{-n} = 1 \text{ cm}^2 \text{ cgse}^{-2} = 1.11 \times 10^{-5} \text{ cm}^2 \text{ volt}^{-2}.$$

Dielectric		Condenser	A	n	Lit.
Glass*	(1)	c_e , length	5.2	13	(10)
	(2)	c_e , length	5.6	13	(10)
	(3)		1.3	13	(84)
	(4)		2.3	13	(84)
	(5)		5.7	13	(18)
	(6)		4.4	13	(19)
	(7)		7.1	13	(19)
	(8)	s , volume	2.6†	7	(84)
Paraffin‡	(1)	c_e , length	8.4	11	(10)
	(1)	c_e , length	9.4	11	(10)
Ebonite§		c_e , length	5.8	12	(10)
			to		
			1.15	10	(10)
		c , length	6.5	10	(10)
			1.0	9	(10)
Rubber	(1)	p , thickness	6.7	9	(10)
	(2)	p , thickness	5.4	9	(10)
	(3)	p , thickness	7.6	9	(10)

* Values for (1) and (2) obtained 15 sec. after application of E ; at 2 or 3 sec. after application of E , A is only 4. From data obtained (125, 126) with various glass tubes, electrodes not supported by the glass, Adams (2) deduces $8\pi\mu\Delta l/LE^2 = -1.35$ to -3.78 ; see also (10, 57, 69, 70, 100).

† Flint glass. $\Delta v/vE^2$ is unchanged by a variation of E in the ratio of 1 to 5.

‡ Values 35 to 40 sec. after application of E ; at 5 sec. after application of E , A is only 4. Temperature, 24 deg. C. Both recorded values are for same tube.

§ Various specimens of the c_e group have been treated so as to vary μ (1.7×10^9 to 27×10^9); the products of $A \times 10^{-n}$ by the corresponding values of μ are constant ($=0.18$). For the c group, μ lay between 1.3×10^9 and 1.7×10^9 .

|| (1) and (2) are vulcanized "para-normal" rubber; (3) is unvulcanized pure rubber. The volume of the plate does not change when E is applied.

For summaries and discussions, see (20, 50, 79, 81, 82); for recent developments, see (2, 10, 14, 33, 34, 55, 57, 74, 75, 92.5, 123); for bibliography, see (10, 100).

The following data are based upon the change in dimensions of a condenser when it is charged. This change frequently increases rapidly for several seconds; the values tabulated are presumably those approximately constant ones corresponding to an application of the field for 15 to 40 sec.

In column 2 the type of the condenser is indicated (c = cylindrical, s = spherical, p = plate) and the quantity corresponding to l in the formula below is stated; c_e = cylindrical condenser with electrodes supported by the dielectric.

Röntgen (93) found that all liquids expanded under the action of E ; Quincke (81, 84) found that some contracted, the contraction for $(C_2H_5)_2O$, almond oil, and rape oil being marked.

For air and CO_2 , Gans (35) found a reduction in pressure in an electric field, in rough agreement with the value predicted by theory. For other work with gases, see (20, 50, 66, 82).

For other experimental work, see (2, 20, 34, 35, 55, 57, 63, 66, 69, 70, 82, 96, 97, 127).

Piezo-Electricity.—In general, when an anisotropic dielectric having no center of symmetry is mechanically strained, it becomes electrically polarized; as stated below, crystals belonging to the plagihedral cubic class are an exception to this rule. The direction and magnitude of the polarization (P) depend upon the nature of the crystal, upon the nature and amount of the strain and upon the direction of the strain with reference to the axes of the crystal. Conversely, when such a dielectric is subjected to an electric field (E), not only are stresses of an electrostrictive nature set up in it, but also others which are usually much larger and which depend upon both the direction and magnitude of E . These effects are described as *piezo-electric*. The production of polarization by strain is called the direct effect; the other is the *converse* effect. With both effects the relation of effect to cause is that of *direct proportionality*: for example, under the direct effect the mechanical stress in a piezo-electric crystal is proportional to the first power of the impressed electric field and therefore changes sign therewith. This feature constitutes an absolute distinction between piezo-electricity and electrostriction.

The relation between the sign of the electric polarization and that of the electric deformation is the same for the converse as for the direct effect.

From experiments with calcite ($CaCO_3$), dolomite ($CaMgC_2O_6$), beryl ($Be_3Al_2Si_6O_{18}$), topaz ($Al_2F_2SiO_4$), barite ($BaSO_4$), and celestite ($SrSO_4$), Voigt (120) concludes that crystals possessing a center of symmetry may possess "central-symmetrical" piezo-electricity. Also some investigators have observed what appears to be a piezo-electric effect for certain apparently non-crystalline substances such as bees-wax and resin (3, 28), sheet rubber (12, 85), ebonite, glass, hornoid, sealing wax, celluloid, and paraffin (12), but it is difficult to determine how much of the observed effect is due to frictional electricity and to the presence of very small piezo-electric crystals. The observations (85) lead to a value of the order 10^{-5} for the strain-constant d for sheet rubber; this is nearly a thousand times as great as the value for most piezo-electric crystals. See also (134, 137, 140).

If P_x , P_y , P_z are the components of the polarization (electric moment per unit of volume), E_x , E_y , E_z , the components of the electric field E ; x_x , y_y , etc., the six strain components; X_x , Y_y , etc., the six stress components; then

$$P_x = e_{11}x_x + e_{12}y_y + e_{13}z_z + e_{14}y_z + e_{15}z_x + e_{16}x_y$$

$$-P_x = d_{11}X_x + d_{12}Y_y + d_{13}Z_z + d_{14}Y_z + d_{15}Z_x + d_{16}X_y$$

The expressions for the components P_y , P_z are obtained from that for P_x by changing the first digit "1" of the subscript of each e to "2," and to "3," respectively: $-P_y$, $-P_z$ are obtained from $-P_x$ by changing similarly the subscripts of each d . For the converse effect

$$x_x = d_{11}E_x + d_{21}E_y + d_{31}E_z$$

$$-X_x = e_{11}E_x + e_{21}E_y + e_{31}E_z.$$

The other five equations of each set (y_y , z_z , y_z , z_x , x_y ; and Y_y , Z_z , Y_z , Z_x , X_y) are obtained in order from these by changing the second digit (1) of the subscript of each d (or e) to 2, 3, 4, 5, 6, respectively. The d 's and e 's are called the piezo-electric constants, the d 's being the *strain constants* and the e 's the *moduli*: they are mutually related by equations involving the elastic constants of the crystal (81, 82, 91, 117). Excepting triclinic asymmetric crystals, in each special case certain of these 18 parameters are necessarily zero. Those which may not be zero are indicated in Table II.

When the polarization is parallel to the stress producing it, it is described as a longitudinal effect; it exists only when one or more of the constants with subscripts 11, 22, 33 are finite.

When the polarization is perpendicular to the direction of the strain producing it, it is described as a transverse effect; it exists whenever one or more of the constants with subscripts 12, 13, 21, 23, 31, or 32 are finite, and also for certain directions of the stress when one or more of the constants with subscripts 14, 25, 36 are finite; see (15, 21, 25, 83, 117).

Owing to the smallness of the effect and to various sources of error such as twinning, faulty orientation of crystal plate being studied, presence of impurities, etc., the data available are in most cases somewhat discordant. For many substances, our exact knowledge is limited to the fact that the piezo-electric constants are not all zero.

For full bibliography, including applications, see (16); for recent summary of information regarding piezo- and pyro-electricity, see (36); for description of piezo-electric phenomena, general theory, and bibliography, see (20, 21, 24, 81, 82, 91, 117); for more recent formulation of theory, see (7, 9, 11, 37, 48, 99, 110, 111, 112); for applications

to high-frequency circuits, see (15, 16, 17, 27, 38, 39, 40, 59, 67, 78, 98, 129-132, 138, 139); for equations giving value of P for a pressure applied in an arbitrary direction, see (82, 91, 103, 117); for representation of P by means of piezo-electric surfaces, see (1, 4, 51, 91, 103, 117); for effect of hydrostatic pressure, see (117); compare (56); for discussion of second-order effects, see (82, 117, 119).

A list of crystals for which piezo-electric effects have been observed, and their constants, are given in Table III.

THE PIEZO-ELECTRIC CONSTANTS PRESENT FOR EACH OF THE 20 CLASSES OF CRYSTALS POSSESSING THE PIEZO-ELECTRIC PROPERTY

Excepting the plagiheral cubic class (117), all of the 21 classes of crystals having no center of symmetry are piezo-electric.

The parameters are denoted by their subscripts in accordance with the scheme of equations. A repetition of a subscript for any crystal

TABLE II
 Cub. =cubic, Hex. =hexagonal, Rho. =rhombic, Mon. =monoclinic, P =polar

Class	1	2	3	4	5	6	7	8	9	10	11	12	13	14	15	16	17	18	19	20	
	Cub.		Hex.*			Trigonal†				Tetragonal‡				Rho.‡		Mon.§					
Polarization	Parameter	Tetrahedral	Tetartohedral	Polar	Trapezohedral	Tripyramidal polar	Holoheral	Polar	Trapezohedral	Tetartohedral	Tetartohedral polar	Polar	Trapezohedral	Tripyramidal polar	Sphenoidal	Tetartohedral	Polar	Sphenoidal	Polar	Clinohedral	Triclinic asymmetric
P_z	11 12 13 14 15 16	14 14		15	14 14	14 15	11 -11		11 -11	11 -11	11 -11		14 14	14 15	14	15	15	14	14	15	16
P_y	21 22 23 24 25 26	14 14		15	-14 -14	-14 -14	-11		-22 22	-22 22	-22 22		-15 14	-14 -14	14	15	24	25	24	25	26
P_x	31 32 33 34 35 36	14 14		31	31 31	31 31		31	31	31	31		31	31 31	33	31 31	31 32	33	33	33	34 35

* z-axis coincides with the c-axis of 6-fold symmetry; where polar, the + direction is direction of the polarization produced by heating the crystal. The y-axis is \perp to a face of the first order prism.
 † z-axis coincides with the c-axis of 3-fold symmetry. The y-axis and the + direction of the z-axis are as for hexagonal (see *).

‡ Coordinate axes x, y, z coincide, respectively, with crystallographic axes a, b, c.

§ z-axis ||c-axis; z-axis ||b-axis; y-axis lies in obtuse angle between the a- and c-axes.

|| Only the asymmetric class is piezo-electric. No convention regarding directions of axes of coordinates.

class indicates that for this class the corresponding parameters have the same value. In writing the equations for the five trigonal classes, a factor 2 must precede each d corresponding to parameters 16 and 26, in all other cases the equations are written as above, those parameters corresponding to blanks in the table being necessarily zero.

The coordinate axes are assumed to be orthogonal, to form a right-handed system, and to be directed as indicated in the foot-notes.

Pyro-Electricity.—The electrical polarization (P) of many substances is changed when the temperature of the substance is changed; this phenomenon is described as *pyro-electric*. For class 20 in Table II, all three components, P_x , P_y and P_z , of the true pyro-electric polarization, are present; for class 19, only P_x and P_y are present; for all the other pyro-electric classes, only P_z exists. False pyro-electricity may exhibit a component in any direction in which a piezo-electric crystal can become polarized by stress. $\delta P/\delta t$ is called the pyro-electric constant of the substance; it decreases with the temperature and perhaps vanishes at absolute zero.

Several types of pyro-electricity are distinguished. The pyro-electric effects are exhibited by those crystals which have a vectorial (polar) structure defining, not merely a line, but a definite direction along that line. The type exhibited by such crystals is called the *polar* or *vectorial* type of pyro-electricity; it is the type properly associated with the word "pyro-electric." This type can be exhibited only by crystals belonging to the classes 3, 5, 7, 10, 13, 15, 16, 18, 19, and 20 of Table II. Another type, in which the effects are much smaller, is known as the *central* or *tensorial* type; it may be exhibited (82, 91, 116, 117, 120, 121) by changing uniformly the temperature of crystals which have a certain type of tensorial symmetry; this type of symmetry occurs in every crystal class except those of the cubic system.

As crystals which are pyro-electric are also piezo-electric, the deformations accompanying changes in temperature give rise to polarizations of piezo-electric origin. These *false* pyro-electric effects are superposed upon the *true* pyro-electric effects which result solely from changes of temperature, effects due to accompanying strain being eliminated. In general, any piezo-electric crystal, when deformed by a change in temperature, whether uniform or not, exhibits false pyro-electric effects. Those produced by non-uniform heating are the more common and are called the false pyro-electric effects of the first kind, those produced by uniform heating being called the false effects of the second kind. As the false effects are generally much greater than the true, it is difficult to determine the latter. Indeed, the true pyro-

electric effect has been investigated only for tourmaline and its existence for that substance is questioned. The magnitude of the pyro effect observed depends markedly upon both the surface and the volume conductivity of the specimen (61, 94, 114, 117).

The converse, or "electro-caloric," effect (the change in temperature resulting from the application of an electric field) has been detected (58, 102, 117).

For general discussion of pyro-electricity, see (20, 36, 41, 60, 81, 82, 83, 91, 117, 133); for its molecular theory, see (6, 7, 8, 20, 36, 82, 83, 91, 110, 112, 117); most complete quantitative data are by Ackermann (1), discussed by Boguslawski (6).

For data for specific substances, see Table III.

In addition to the substances tabulated below, both pyro and piezo effects have been observed (23, 30, 82, 91, 117, 120, 121) in the following crystals possessing a center of symmetry: topaz ($\text{Al}_2\text{F}_2\text{SiO}_4$), barite (BaSO_4), beryl ($\text{Be}_3\text{Al}_2\text{Si}_6\text{O}_{18}$), calcite (CaCO_3), dolomite (CaMgC_2O_6) and celestite (SrSO_4); and by means of a high-frequency method, in which the orientation of the axes of the crystal could not be determined, traces of the piezo-electric effect have been found (38) in the following crystals: proustite (Ag_3AsS_3), urea ($\text{CH}_4\text{N}_2\text{O}$), ammonium oxalate ($\text{N}_2\text{H}_8\text{C}_2\text{O}_4$), asparagine ($\text{C}_4\text{H}_8\text{N}_2\text{O}_3 \cdot \text{H}_2\text{O}$), ammonium acid tartrate ($\text{NH}_4\text{HC}_4\text{H}_4\text{O}_6$), pentaerythritol ($\text{C}_5\text{H}_{12}\text{O}_4$), (128), tetraethylammonium iodide ($\text{N}(\text{C}_2\text{H}_5)_4\text{I}$), triphenylmethane ($\text{CH}(\text{C}_6\text{H}_5)_3$), potassium acid tartrate ($\text{KHC}_4\text{H}_4\text{O}_6$), magnesium sulfate ($\text{MgSO}_4 \cdot 7\text{H}_2\text{O}$), ammonium acid phosphate ($\text{NH}_4\text{H}_2\text{PO}_4$), sodium tartrate ($\text{Na}_2\text{C}_4\text{H}_4\text{O}_6$), sodium sulfoantimonate ($\text{Na}_3\text{S}_4\text{Sb} \cdot 9\text{H}_2\text{O}$), nickel sulfate ($\text{NiSO}_4 \cdot 6\text{H}_2\text{O}$) and zinc sulfate ($\text{ZnSO}_4 \cdot 7\text{H}_2\text{O}$). For other crystals, see (43, 43.5, 44, 45, 46, 49, 64, 65, 68, 135, 137).

No observation of either kind of effect was found recorded for crystals of classes 4, 6, 9, 11, 12, 14, 15 (see Table II.) Of the other classes, no direct piezo observation was found recorded for classes 3, 5, 10, 13, 16, 19, 20, but all crystals which exhibit pyro effects are also piezo-electric.

The numbers in the column "class" indicate the crystal class of the substance, in accordance with the numbers of Table II. The presence of the mark " \checkmark " in a column indicates that the corresponding effect has been actually observed, but the numerical value of the constant is not known with certainty; if the detected pyro effect is necessarily a "false" one, the " \checkmark " is replaced by an "f"; blanks indicate that no record of observations was found. In column "C" is the symbol indicating the piezo-electric strain constant which has the value $A \times 10^{-8}$, A being the value adjacent to the symbol. For example, for

TABLE III
A LIST OF SUBSTANCES FOR WHICH EITHER PIEZO- OR PYRO-ELECTRIC EFFECTS HAVE BEEN OBSERVED, TOGETHER WITH THEIR CONSTANTS AT ROOM TEMPERATURE

Formula	Substance	Class	Pyro		Piezo		Lit.
			$\delta P/\delta t$	Lit.	C	A	
Variable	Tourmaline (see Table IV)	7	1.1 } 1.3 }	(1)	d_{33}	5.78	(89, 115)
Ba(CH ₃ O) ₂	Barium formate	17	f	(45)			(45)
Ba(SbO) ₂ (C ₂ H ₃ O ₅) ₂ · H ₂ O	Barium antimonyl tartrate	13	f	(104, 113)			(81, 113)
(Be, Mn, Fe) ₇ Si ₃ O ₁₂ S	Helvite	1	f	(43, 48.5)			(43, 48.5)
C	Diamond	1	0.0*	(113)			(113) (141)
C ₃ H ₈ N ₄ O ₄	Methylene diisonitramine methyl ester CH ₂ (N ₂ O ₂ · CH ₃) ₂	16	√	(81, 109)	$d_{33}†$	6.4	(103)
C ₄ H ₆ O ₆	Tartaric acid	18	7.5	(47)			(38)
C ₄ H ₁₂ N ₄ O ₆	Ammonium tartarate	18	2.84§	(1, 47)			
C ₅ H ₁₂ N ₄ O ₇	Picric acid	16	√	(13)			
C ₅ H ₈ O ₂	Resorcinol	18	7.7	(47)			(38)
C ₆ H ₁₂ O ₆	Quercitol	18	√	(81)			
C ₆ H ₁₂ O ₆ · H ₂ O	d-Rhamnose (isodulcitol)	18	3.63 } 0.505 }	(47)			
C ₆ H ₁₅ ClN	Triethylamine hydrochloride	3	√	(42)			
C ₇ H ₇ BrO ₄	Bromoshikimilactone	5	√	(107)			
C ₁₀ H ₁₅ NO	Carvoxime C ₁₀ H ₁₄ · NOH	18	√	(81)			
C ₁₀ H ₁₃ Br ₂ O	Carvone pentabromide	18	√	(122)			
C ₁₀ H ₁₇ NO	Fenchoneoxime	18	√	(81)			
C ₁₂ H ₂₂ O ₁₁	Saccharose (cane sugar)	18	0.53	(47)	$d_{33}†$	-10.2	(51)
C ₁₂ H ₂₂ O ₁₁ · H ₂ O	Lactose	18	√	(81)	d_{11}	24	(113)
C ₁₄ H ₁₀ O ₂	Benzil	8	√	(5)	d_{11}	0.14	(113)
C ₁₄ H ₁₂ O	Phenyl p-tolyl ketone C ₆ H ₅ · CO · C ₆ H ₄ · CH ₃	7	√	(92, 108)			
C ₁₅ H ₂₆ O	Patcoholi camphor	8(?)	0.99	(47)			
CaAl ₂ Si ₃ O ₁₀ · 3H ₂ O	Scotelite	19	√	(44)			
2CaO · Al ₂ O ₃ · 3SiO ₂ · H ₂ O	Prehnite	16	√	(44)			
3Ca ₃ P ₂ O ₈ · CaF ₂	Fluorapatite	5	√	(1, 47)			
K ₂ C ₂ H ₂ O ₆ · $\frac{1}{2}$ H ₂ O	Potassium tartrate	18	5.96§	(1, 47)			(38)

* Value is relative to tourmaline (kind not specified) as unity.

† No trace of piezo-electricity.

‡ See Table VII.

K ₂ B ₂ O ₇	Potassium bromate	7	γ	(107)			(46)
K ₂ S ₂ O ₈	Potassium dithionate	8	f	(46)			
KLiSO ₄	Potassium lithium sulfate	5	4.86§	(1.47)			
(KLiSO ₄) _x + (KLiCrO ₄)	Mixture	5	γ	(105)			
(KLiSO ₄) ₁₃ + KLiMoO ₄	Mixture	5	γ	(105)			
K ₂ SO ₄ + Li ₂ CrO ₄	Mixture	5	γ	(105)			
KLiSeO ₄	Potassium lithium selenate	17	γ	(110, 111, 112)		$\{d_{11}$ d_{11}	(80) (111) (38)
KNaC ₄ H ₄ O ₄ · 4H ₂ O	Rochelle salt (see Table VI)						340 to 1180 8100
Li ₂ SO ₄ · H ₂ O	Lithium sulfate	18	23.2§	(1.47)			
Li ₂ SeO ₄ · H ₂ O	Lithium selenate	18	17.17§	(1.47)			
LiNa ₃ (MoO ₄) ₂ · 6H ₂ O	Lithium trisodium molybdate	7	γ	(113)		d_{33}	(113)
LiNaSO ₄ (anhydrous)	Lithium sodium sulfate	7	2.3§	(1.47)			
LiNa ₃ (SeO ₄) ₂ · 6H ₂ O	Lithium trisodium selenate	7	5.38§	(1.47)			
6MgO · 8B ₂ O ₃ · MgCl ₂	Boracite	1	0.07*	(32, 113)			(23, 24, 113)
NaBrO ₃	Sodium bromate	2	f	(46)		d_{11}	(46)
NaClO ₃	Sodium chlorate	2	f	(23, 31, 32, 46)			(80); cf (23, 32, 46)
NaIO ₄ · 3H ₂ O	Sodium periodate	10	γ	(46)			(45)
Pb(CHO ₂) ₂	Lead formate	17	f	(45)			
Pb(SbO · C ₄ H ₄ O ₆) ₂	Lead antimonyl tartrate	5	γ	(106)			
Rb ₂ C ₄ H ₄ O ₆	Rubidium tartrate	8					
SiO ₂	Quartz (see Table V)	8	0.50f*	(31, 113)		d_{11} d_{11}	(113) (22, 95)
Sr(CHO ₂) ₂	Strontium formate	17	f	(45)			(45)
Sr(HC ₄ H ₄ O ₆) ₂ · 4H ₂ O	Strontium acid tartrate	20	{0.73§ {6.7**}}	{(1.47, 113)			
Sr(SbO · C ₄ H ₄ O ₆) ₂	Strontium antimonyl tartrate	5	γ	(106)			
Sr ₂ O ₃ · 4H ₂ O	Strontium dithionate	8	f	(46)			
2ZnO · SiO ₂ · H ₂ O	Calamine (hemimorphite)	16	5.0*	(113); cf (23)			(46)
ZnS(β)	Sphalerite	1	0.13*	(30, 32, 113)		d_{11}	(113)

§ See Table VIII. || Isotropic if $t > 265$ deg. C. ¶ For pressure along an axis of 3-fold symmetry; the resulting polarization is in same direction.

tourmaline at room temperature, $d_{33} = 5.78 \times 10^{-8}$ (es/cm²)/(dyne/cm²). Units are cgse. Data for pyro effect refer to the total effect, the sum of the "true" and the "false."

TOURMALINE: PYRO- AND PIEZO-ELECTRIC CONSTANTS

The z -axis coincides with the ternary (optical) axis of the crystal, and the x -axis lies in any one of the three planes of trigonal symmetry. The positive direction of z passes through the end of the crystal which becomes charged positively when the crystal is uniformly heated. This end is called the "analogous" end of the crystal; frequently it is not possible, by mere inspection, to determine which is the analogous end (124). The opposite end is called the antilogous end. The values found for the constants vary considerably from one specimen to another; in general, those for the darker specimens are the smaller in numerical value. The permanent electrical polarization along the z -axis is about 8×10^4 cgse (87, 90, 91); hydrostatic pressure increases it about 8×10^{-8} cgse per barye (56). Whether tourmaline exhibits "true" pyroelectric effects is doubtful; Voigt (114, 117) thought the true effect

TABLE IV
TOURMALINE
Pyro-Electric $\delta P/\delta T$

T	B. G.*	Y. G.*	R. R.*
23	0.04	0.08	0.08
88	0.142	0.289	0.300
198	0.652	0.974	0.982
253	0.935	1.205	1.219
274	1.005	1.243	1.270
293	1.060	1.281	1.313
(293)	1.057†	1.275†	1.324†
352	1.170	1.337	1.404
372	1.187	1.350	1.426
408	1.217	1.381	1.460
488	1.268	1.490	1.544
578	1.381	1.669	1.723
648	1.525	1.865	1.943

L. G. ‡(94)

T	20.5	79	194	273	313.5	291
$\delta P/\delta T$	0.037	0.20	0.66	0.96	1.10	1.13§

Piezo-Electric Constants||

A_{15}	11.04				B_{15}	7.40
A_{22}	-0.69	-0.94			B_{22}	-0.53
A_{31}	0.74	0.96			B_{31}	3.09
A_{33}	5.78	5.4	5.4	5.6	B_{33}	9.60
Lit.....	(89, 115)	(94)	(113)	(71)	Lit.....	(89, 115)

* B. G. = blue-green, Y. G. = yellow-green, R. R. = rose-red. Data from (1).

† Data from (47).

‡ L. G. = light-green, data from (94). With darker specimens he found values only 83 per cent of these; discussed in (118).

§ From (86) for 5 green Brazilian specimens: $\delta P/\delta T = 1.13 - 0.0104(T - 291)$.

|| Vary but little with changes in pressure and temperature; between 20 deg. C and the temperature of liquid air (62) and for pressures up to 22 megabarye (71), the variation of d_{33} lies within the limits of experimental error. From theoretical considerations, Keys (54) concludes that, for tourmaline, the adiabatic piezo-electric constants, corresponding to suddenly applied stress, are 1.5 times as great as the usual isothermal ones. $d_{15} = A_{15} \times 10^{-8}$, etc.; $e_{15} = B_{15} \times 10^4$, etc.

amounted to 20 per cent of the total, but Röntgen (94, 118), and Lindmann (61) decided that it is too small to measure. The values given below represent the total pyro-electric effect. Writing $\delta P/\delta t = a + 2b(t - t_0)$, where P = the polarization along the z -axis, and t and t_0 are final and initial temperatures, values of a varying, with the specimen, from 0.52 to 2.03, and of b varying from -0.000256 to $+0.0117$ were found (88, 91); experiments extended to $t = 160$ deg. C. For pyro-electric data, see (1, 81, 83, 91, 113, 117); for piezo-electric, see (81, 89, 91, 114, 115, 117, 120). See Table IV. T is the absolute temperature

QUARTZ: PYRO- AND PIEZO-ELECTRIC CONSTANTS

For information regarding all properties of SiO_2 , see (101).

The z -axis coincides with the crystallographic c -axis of 3-fold symmetry, the y -axis is \perp to a face of the hexagonal first order prism, and, in dextro crystals, the $+$ direction of the x -axis is outward through one of the faces (commonly denoted by s) of the trigonal pyramid; in levo crystals, the direction of the x -axis with reference to the s -faces is reversed; in each case, the $+$ direction of the y -axis is such as to form a right-handed system of orthogonal axes. At 573 deg. C, ordinary SiO_2 (trigonal, trapezohedral, known as " α -quartz," becomes transformed to " β -quartz" (hexagonal, trapezohedral) and loses its pyro- and piezo-electric properties (11, 37, 77, 101). Owing to its crystal form, SiO_2 can have no "true" pyro-electric properties; $\delta P/\delta t$ is approximately proportional to the absolute temperature (73), and at room temperature is about half as great as the value for tourmaline (113). Twinning is common; dextro and levo crystals have equally strong electrical properties; hence, specimens which are chirally completely twinned are not piezo-electric. For a discussion of twinning, with special reference to quartz, see (101). On the piezo-electric excitation of quartz plates cut in different orientations, see (26, 39, 81, 95, 117).

Quartz is not electrically excited by hydrostatic pressure. The value of d_{11} is probably unchanged by pressure parallel to x -axis; Nachtikal (71) found it to decrease by 0.16 per cent per megabarye, but Röntgen and Joffé (95) found it was not changed by 0.4 per cent by a pressure of 18 megabarye, and according to Karcher (53) it remains constant to within 0.1 per cent for pressures ≤ 3450 megabarye.

At room temperatures d_{11} is practically independent of temperature. There is some evidence that it increases by about 20 per cent as t goes from room temperature to 60 deg. C, and then with a further increase in t it gradually decreases until at 573 deg. C it vanishes (26.5, 76, 82, 101, 136). On cooling it reappears. On cooling from

+17 to -193 deg. C, d_{11} decreases by 1.2 per cent; cooling from -193 to 253 deg. C causes a change of less than 0.2 per cent (73). Ze (127) reports that the piezo-electric deformation of quartz reaches a saturation value at a field intensity of about 520 cgse units. In the following, the best values are printed in bold-face.

TABLE V
QUARTZ
Unit of d_{11} and $d_{14} = 10^{-8}$ cgse; of e_{11} and $e_{14} = 10^4$ egse.

d_{11}	-6.32	-6.3	-6.45	-6.27	-6.54	-6.3	-6.31	-6.90
Lit.....	(21, 25)	(26)	(89)	(80)	(71)	(113)	(47)	(22)
d_{14}	-6.94	-6.4	d_{14}	+1.7	+1.45	+1.93	$e_{11} = -5.10$	
Lit.....	(95)	(127)	Lit.....	(101)	(89)	(80)	$e_{14} = -1.35$	

ROCHELLE SALT ($\text{KNaC}_4\text{H}_4\text{O}_6 \cdot 4\text{H}_2\text{O}$): PYRO- AND PIEZO-ELECTRIC CONSTANTS

Axes x, y, z coincide, respectively, with crystallographic axes a, b, c . Electrical properties are complicated and are greatly affected by changes in temperature and humidity, and by the past history of the specimen; great differences between individual specimens (29, 52, 72, 110, 111, 112). Valasek (110, 111, 112) thinks it has "true" pyro-electric properties although the crystal form indicates that they cannot exist; his computations (110) indicate a permanent electrical polarization of the order of 50 cgse units; see also (23). Rochelle salt (potassium sodium tartrate) is not electrically excited by hydrostatic pressure; its d_{14} is the largest known piezo-electric constant; see especially (72).

TABLE VI
ROCHELLE SALT
Unit of $d_{14}, d_{25},$ and $d_{36} = 10^{-6}$ cgse. Note: In other tables the unit, or common factor, is 10^{-8} .

t	-70	-50	-30	-20	-10	0	10	20	30	40	deg C.
d_{14}	0.17	0.17	0.65	10.8	60.7	67.5	74.2	81.0	10.8	4.1	(112)

The maximum is much greater than that recorded by any other observer. Later observations (112.5) indicate that with increasing t , d_{14} increases rapidly from a very low value to about 23 at -20 deg, increases slightly from -20 to +25 deg. C, and then decreases rapidly.* Between -60 and +30 deg., d_{25} and d_{36} increase linearly with t , their rates being, respectively, 6.8×10^{-9} and 3.1×10^{-10} cgse unit per 1 deg. C (112.5).

Near 20 deg. C, Pockels(80) finds $d_{14} = 3.40$ to 11.80; $d_{25} = -1.65$, and $d_{36} = 0.35$.

From these data and the elastic constants (66.5) it is found that

* This effect may, however, be due to electric conductivity of the crystal (136).

$e_{14} = 56 \times 10^4$ to 194×10^4 , $e_{25} = -5.33 \times 10^4$, and $e_{36} = 4.34 \times 10^4$ cgse units.

From the density (1.767 g cm^{-3}) and the elastic constants (66.5) the velocity of compressional waves in a bar of Rochelle salt cut with its length perpendicular to the x -axis and at 45 deg. with the y and z axes is found to be 3.98×10^5 cm per sec. Hence, natural frequency (ν) of such vibrations in a bar a cm long is approximately $2.0 \times 10^5/a$ cycle per sec; experimental values may be expected to differ rather widely from this value (17).

TABLE VII

PIEZO-ELECTRIC CONSTANTS OF TARTARIC ACID ($\text{C}_4\text{H}_6\text{O}_6$) AND OF CANE SUGAR ($\text{C}_{12}\text{H}_{22}\text{O}_{11}$)
Room temperature; precision about 3 per cent; system = monoclinic polar. $d_{14} = A_{14} \times 10^{-8}$, etc.
Unit of $d = 1$ cgse.

Formula	A_{14}	A_{15}	A_{24}	A_{25}	A_{31}	A_{32}	A_{33}	A_{36}	Lit.
$\text{C}_4\text{H}_6\text{O}_6$	-24.	28.3	28.5	-36.5	1.95	5.9	6.4	3.8	(103)
$\text{C}_{12}\text{H}_{22}\text{O}_{11}$	1.27	-12.6	-7.2	3.75	2.21	4.4	-10.2	-2.62	(51)

TABLE VIII

PYRO-ELECTRIC EFFECT: VARIATION WITH TEMPERATURE (1)
 T = absolute temperature, deg. K. Unit of $\delta P/\delta t = 1$ cgse unit.

T	23	88	198	253	274	293	293*	352
Formula	$\delta P/\delta t$							
$\text{Sr}(\text{HC}_2\text{H}_3\text{O}_5)_4 \cdot 4\text{H}_2\text{O} \dagger$..	0.04	0.12	0.45	0.64	0.69	0.728	0.73	0.825
NaLiSO_4	0.12	0.29	0.88	1.63	2.03	2.26	2.31	2.74
$\text{C}_4\text{H}_6\text{O}_6 \dagger$	0.15	0.31	1.18	2.41	2.58	2.84	2.84	3.42
KLiSO_4		0.69	2.50	4.09	4.51	4.85	4.88	5.35
$\text{Na}_2\text{Li}(\text{SeO}_4)_3 \cdot 6\text{H}_2\text{O}$	0.35	0.93	2.94	4.58	5.07	5.38	5.38	6.37
$\text{K}_2\text{C}_2\text{H}_3\text{O}_5 \cdot \frac{1}{2}\text{H}_2\text{O} \dagger$	0.39	1.00	3.32	5.10	5.60	5.96	5.98	6.89
$\text{Li}_2\text{SeO}_4 \cdot \text{H}_2\text{O}$	0.92	2.30	9.87	14.54	16.00	17.17	17.14	19.35
$\text{Li}_2\text{SO}_4 \cdot \text{H}_2\text{O}$	1.21	3.81	12.24	18.42	20.45	23.27	23.18	26.90

* (47). † Tartrate. ‡ Ammonium tartrate.

LITERATURE

Key to Books and Periodicals

Note: In each of the references listed below, the periodical (or book) is indicated in italics by the I.C.T. key number. At the end of Vol. 6 of the Critical Tables will be found the key for the entire volume of which the literature on Electroelastic and Pyro-electric Phenomena forms only a small portion. It seems most expedient to retain the same key numbers here.

1. Journal of the American Chemical Society.
2. Physical Review.
3. London, Edinburgh, and Dublin Philosophical Magazine and Journal of Science.
5. Proceedings of the Royal Society (London). A. Mathematical and Physical Sciences.
8. Annalen der Physik.
13. Annalen der Chemie, Justus Liebig's.
22. Atti della reale accademia nazionale dei Lincei. (Rendiconto classe di scienze fisiche, matematiche e naturali.)
- 31A. Bureau of Standards, Bulletin.

34. Comptes rendus hebdomadaires des séances de l'académie des sciences, de l'institut de France.
48. Journal of the Optical Society of America and Review of Scientific Instruments.
51. Journal de Physique et le Radium.
59. Nuovo Cimento.
63. Physikalische Zeitschrift.
- 64P. Proceedings of the Royal Academy of Sciences of Amsterdam.
65. Proceedings of the American Academy of Arts and Sciences.
67. Proceedings of the Physical Society of London.
75. Stzungsberichte, Akademie der Wissenschaften in Wien, mathematisch-naturwissenschaftliche Klasse.
94. Zeitschrift für Krystallographie. (*Name changed in 1921 from Zeitschrift für Krystallographie und Mineralogie.*)
96. Zeitschrift für Physik.
97. Zeitschrift für technische Physik.
101. Elektrotechnische Zeitschrift.
129. Transactions of the American Institute of Electrical Engineers.
143. Journal of the Franklin Institute.
149. Archives des sciences physiques et naturelles.
166. Science.
168. Communications from the Physical Laboratory at the University of Leiden.
188. Nachrichten von der königlichen Gesellschaft der Wissenschaften zu Göttingen. Geschäftliche Mitteilungen; mathematisch-physikalische Klasse.
190. Neues Jahrbuch für Mineralogie, Geologie und Paläontologie.
- 190B. Neues Jahrbuch für Mineralogie, Geologie und Paläontologie, Beilage Band.
191. Bulletin de la société française de minéralogie.
211. Abhandlungen der mathematisch-physischen Klasse der sächsischen Akademie der Wissenschaften zu Leipzig.
219. Proceedings of the Physico-Mathematical Society of Japan.
269. Mineralogical Magazine and Journal of the Mineralogical Society.
524. Abhandlungen der k. Akademie der Wissenschaften, Berlin. (K. preussische Akademie der Wissenschaften.)
529. Proceedings of the Institute of Radio Engineers (New York).
- B76. Winkelmann, Handbuch der Physik. Leipzig, Barth, 1903-09.
- B90. Graetz, Handbuch der Elektrizität und Magnetismus. Leipzig, Barth, 1912-28.
- B91. Sosman, The Properties of Silica. New York, Chemical Catalog Co., 1927.

(1) Ackermann, 8, 46: 197; 15. (2) Adams, 3, 22: 889; 11. (3) Adams, 143, 204: 469; 27. (4) Bidlingmaier, *Diss.*, Göttingen, 1900. (5) Bodewig, 8, 158: 232; 76. (6) Boguslawski, 63, 15: 283, 569, 805; 14. (7) Born, 96, 7: 217; 21. *Atomtheorie des festen Zustandes*. Leipzig, Teubner, 1923. (8) Born, 63, 23: 125; 22. (9) Born and Borman, 8, 62: 218; 20. (10) Bouchet, *Thesis*, Paris, 1919. (11) Bragg and Gibbs, 5 109: 405; 25. (12) Brain, 67, 36: 81; 24. (13) Brugnatelli, 94, 24: 274; 95. (14) Bruhat and Pauthenier, 51, 6: 1; 25. (15) Cady, 529, 10: 83; 22. (16) Cady, 529, 16: 521; 28. (17) Cady, 48, 10: 475; 25. (18) Cantone, 22, 4: 444, 471; 88. (19) Cantone and Sozzani, 59, 12: 155; 00.

- (20) Chwolson, *Lehrbuch d. Physik*, IV. Braunschweig, Vieweg und Sohn 1925. (21) Curie, *Oeuvres*. Paris, Gauthier-Villars, 1908. (22) Curie, *Traité de Radioactivité*, I. Paris, Gauthier-Villars, 1910. (23) Curie and Curie, *34*, 91: 383; 80. (24) Curie and Curie, *51*, 1: 245; 82. (25) Curie and Curie, *51*, 8: 149; 89. (26) Czermak, *75*, 96: 1217; 87. (26.5) Dawson, *2*, 29: 532; 27. (27) Dye, *67*, 38: 399, 457; 26. (28) Eguchi, *219*, 2: 169; 20. (29) Frayne, *2*, 20: 97; 22. 21: 348; 23.
- (30) Friedel, *191*, 2: 31; 79. (31) Friedel and Curie, *191*, 5: 282; 82. *34*, 96: 1262, 1389; 83. (32) Friedel and Curie, *34*, 97: 61; 83. *191*, 6: 191; 83. (33) Frivold, *Fysisk tidsskrift*, 20: 119; 22. *63*, 22: 603; 21. (34) Frivold and Hassel, *63*, 24: 82; 23. (35) Gans, *8*, 11: 797; 03. (36) Geiger and Scheel, *Handbuch d. Physik*, XIII. Berlin, Springer, 1928. (37) Gibbs, *5*, 110: 443; 26. (38) Giebe and Scheibe, *96*, 33: 760; 25. (39) Giebe and Scheibe, *96*, 46: 607; 28.
- (40) Giebe and Schiebe, *101*, 47: 380; 26. (41) Groth, *Physikalische Krystallographie*. Leipzig, Engelmann, 1905. (42) Groth, *Chemische Krystallographie*, I. Leipzig, Engelmann, 1906. (43) Hankel, *211*, 12: 549; 84. (43.5) Hankel, *94*, 9: 414; 84. (44) Hankel, *8*, 19: 818; 83. (45) Hankel, *211*, 24: 469; 99. (46) Hankel and Lindenberg, *211*, 18: 359; 93. 21: 9; 95. (47) Hayashi, *Diss.*, Göttingen, 1912. (48) Heckmann, *96*, 33: 646; 25. (49) Hintze, *Handbuch der Mineralogie*. Leipzig, Veit, 1897.
- (50) Hirsch, *in B90*, I. (51) Holman, *8*, 29: 160; 09. (52) Isely, *2*, 24: 569; 24. (53) Karcher, *31A*, 18: 257; 22. *143*, 194: 815; 22. (54) Keys, *3*, 46: 999; 23. (55) Kliefoth, *96*, 39: 402; 26. (56) Koch, *8*, 19: 567; 06. (57) Kemble, *2*, 7: 614; 16. (58) Lange, *Diss.*, Jena, 1905. (59) von Laue, *96*, 34: 347; 25.
- (60) Liebisch, *Grundriss der physikalischen Krystallographie*. Leipzig, Veit, 1896. (61) Lindmann, *8*, 62: 107; 20. (62) Lissauer, *Diss.*, Munich, 1907. (63) Lorberg, *8*, 21: 300; 84. (64) Lucas, *51*, 4: 491; 23. (65) Lucas, *34*, 178: 1890, 24. (66) Mache, *75*, 107: 708; 98. (66.5) Mandell, *5*, 116: 623; 27. (67) Meissner, *529*, 15: 281; 27. *97*, 7: 585; 26. 8: 74; 27. (68) Miers, *269*, 10: 273; 94. (69) More, *3*, 50: 198; 00. 2: 527; 01.
- (70) More, *3*, 6: 1; 03. 10: 676; 05. (71) Nachtikal, *188*, 1899: 109. (72) Nicolson, *129*, 38: 1467; 19. (73) Onnes and Beckman, *168*, No. 132f. *64P*, 15: 1380; 12. See also Beckman, Onnes Festschrift, Leyden, 1922. (74) Pauthenier, *51*, 5: 312; 24. (75) Pauthenier, *34*, 182: 121; 26. (76) Perrier, *149*, 41: 492; 16. (77) Perrier and de Mandrot, *34*, 175: 622, 1006; 22. (78) Pierce, *65*, 59: 81; 23. 60: 271; 25. (79) Pockels, *Arch. Math. Phys.*, 12: 57; 93.
- (80) Pockels, *88*, 1894: 1. (81) Pockels, *in B76*, IV. (82) Pockels, *in Encyklopädie der Math. Wiss.*, V. Leipzig, Barth, 1907. (83) Poynting and Thomson, *Textbook of physics*, IV. London, Griffin, 1920. (84) Quincke, *8*, 10: 161, 513; 80. 19: 545; 83. (85) Richards, *2*, 22: 122; 23. (86) Riecke, *8*, 28: 43; 86. (87) Riecke, *8*, 31: 889; 87. (88) Riecke, *8*, 40: 264; 90. (89) Riecke and Voigt, *8*, 45: 523; 92.
- (90) Riecke, *63*, 13: 409; 12. (91) Riecke, *in B90*, I. (92) Riess and Rose, *524*, 1843: 59. (92.5) Rocard, *51*, 8: 385; 27. (93) Röntgen, *8*, 11: 780; 80. (94) Röntgen, *8*, 45: 737; 14. (95) Röntgen and Joffé, *8*, 41: 449; 13. (96) Sacerdote, *Thesis*, Paris, 1899. *51*, 8: 457; 99. (97) Sacerdote, *51*, 10: 196; 01. (98) Scheibe, *Z. f. Hochfrequenztechn.*, 28: 15; 26. (99) Schrödinger, *75*, 121 IIa: 1937; 12.
- (100) Shearer, *2*, 14: 89; 02. (101) Sosman, *B91*. (102) Straubel, *188*, 1902: 161. (103) Tamaru, *63*, 6: 379; 05. (104) Traube, *188*, 1892: 362. (105) Traube, *190*, 1892 II: 58. 1894 I: 171. (106) Traube, *190B*, 8: 269; 93. (107) Traube, *94*, 23: 577; 94. (108) Traube, *190B*, 9: 134; 95. (109) Traube, *94*, 29: 595; 98.
- (110) Valasek, *2*, 17: 475; 21. (111) Valasek, *2*, 20: 639; 22. (112) Valasek, *2*, 19: 478, 529; 22. (112.5) Valasek, *166*, 65: 235; 27. (113) van der Veen, *Thesis*, Delft, 1911. (114) Voigt, *8*, 66: 1030; 98. (115) Voigt, *188*, 1898: 166. (116) Voigt, *188*, 1905: 394. (117) Voigt, *Lehrbuch der Krystallophysik*. Leipzig, Teubner, 1910. (118) Voigt, *8*, 46: 221; 15. (119) Voigt, *8*, 48: 433; 15.
- (120) Voigt, *63*, 17: 287, 307; 16. (121) Voigt, *63*, 18: 59; 17. (122) Wallach, *13*, 286: 119; 95. (123) Webb, *1*, 48: 2589; 26. (124) Worobiev, *94*, 33: 263; 00. (125) Wüllner and Wien, *8*, 9: 1217; 02. (126) Wüllner and Wien, *8*, 11: 619; 03. (127) Ze, *51*, 9: 13; 28.

- (128) Mark and Weissenberg, *94*, 65: 499; 27. Mark and Weissenberg, *96*, 47: 301; 28. Hettich and Schleede, *96*, 46: 147; 27. (129) Hitchcock, *Rev. Scientific Instr.*, 1: 13; 30.
- (130) Hund, *529*, 14: 447; 26. (131) Lack, *529*, 17: 1123; 29. (132) Marrison, *529*, 17: 1103; 29. (133) Meissner and Bechmann, *97*, 9: 175; 28. (134) Meissner and Bechmann, *97*, 9: 430; 28. (135) Schneider, *96*, 51: 263; 28. (136) Schulwas-Sorokina, *2*, 34: 1448; 29. (137) Subnikov and Brunovskij, *Bull. Acad. Sc. Leningrad*, No. 4-5: 367; 28. (138) Tawil, *Société Française de Physique, Bull. bimensuel*, No. 268, 129S; 28. (139) Tawil, *34*, 187: 1042; 28. (140) Turpain and Durepaire, *34*, 189: 739; 29. (141) Wooster, *269*, 22: 65; 29.

DISCUSSION ON SOME POSSIBILITIES OF INTELLIGENCE TRANSMISSION WHEN USING A LIMITED BAND OF FREQUENCIES*

FREDERICK EMMONS TERMAN

E. H. Felix:¹ In discussing the effect of utilization of the broadcast band, the author asserts that the real solution of the broadcast situation lies in the development of chain broadcasting on synchronized carrier frequencies. Assuming a system of program synchronization, he asserts the present broadcast band would accommodate 30 nationwide chains, a hundred synchronized stations per channel, and permit simultaneous broadcasting by more than three thousand super-power stations. Three channels with a hundred synchronized stations on each would cover the country with high-grade service, provided a geographical spacing, as indicated in his Fig. 1, were adopted.

With the development of receivers capable of separating one of three adjacent channels without interference from either of two super-power stations less than two hundred miles distant on the adjacent channels and an absolute synchronization of both program and carrier, we should thus eliminate cross-talk interference and carrier heterodyne now experienced with approximate frequency maintenance. But, even with the successful conquest of these exceedingly difficult problems, it is doubtful if the author's estimated capacity of the band would be realized.

If the area of the United States were divided into 100 equal service areas, as proposed, each station's "sphere of influence" is to be 30,267 square miles, necessitating synchronized stations approximately 174 miles apart on each channel. The assumption is that one-third of each area, or 10,089 square miles, would be served by each transmitter and two-thirds of each area would suffer interference. Inasmuch as three channels are devoted to each chain service, every area would be expected to obtain high-grade service from one of the three channels. With stations spaced 174 miles apart, the radius of the "sphere of influence" between stations is 87 miles. Eliminating two-thirds of each area as subject to interference, a high-grade service range of 50 to 71 miles would be required (as indicated in Fig. 1). The author's estimate of the capacity of the broadcast band is therefore based on the assumption that good service can be secured from a station 50 miles distant without distortion from a second station of equal power, synchronized with the first, and 124 miles distant. The relative field strength of the two 50 kw stations might be expected to be about 9.1 mv per m and 3.7 mv per m, or at least in that ratio.

Too much reliance cannot be placed on program synchronization. Consider the attainable reception at point *P*, 50 miles from transmitter *A*. The program is brought to station *A* through a wire circuit of 174 miles from station *B* and then by radio a distance of 50 miles to listening point *P*. At the same time, the signal from station *B* travels 124 miles by radio to point *P*. This signal has somewhat more than one-third the field strength of the signal from station *A* which has traveled 100 extra miles by wire and radio. The lag between the two signals would thus be roughly 1/18,600 of a second, sufficient to have a disastrous effect upon audio quality.

* Proc. I.R.E., 18, 167; January, 1930.

¹ Radio Consultant, National Electric Manufacturers' Association, New York City.

At the present time, it is considered that the ratio of 10 to 1 in field strength is necessary to avoid distorting effects from a synchronized program. Utilizing the following formula² for calculating field strength:

$$E_f = \frac{2.9\sqrt{P}}{d}$$

we find, at a distance of 100 miles from one 50,000-watt station *A* and 400 miles from a second, *B*, station *A* offers a field strength of 6.5 mv per m and station *B*, 0.61 mv per m. This ratio is probably the maximum which would give distortion-free reception. Point *A* is the maximum limit of the high-grade service range of a 50,000-watt station.

Therefore, with program synchronization and high-grade service range only, we find it possible to accommodate an average of only ten 50,000-watt stations per channel within continental United States. Each station would serve approximately 40,000 square miles, or a total of 400,000 square miles per channel for

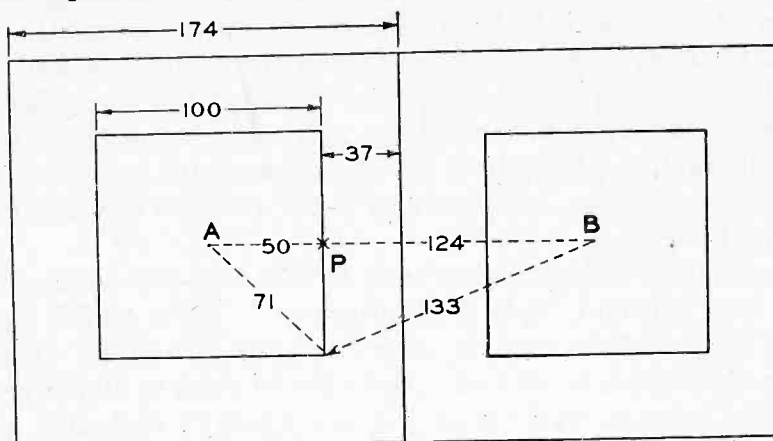

Fig. 1

ten stations. It would require eight channels and 80 stations to give nationwide high-grade synchronized program coverage over the entire country. The maximum number of chain services on this theoretical system would be but ten and the total number of stations 900, neglecting entirely the requirements of neighboring countries.

Of course, all these deductions, both in the original paper and this discussion, are based on purely theoretical considerations. It is fair to conclude, however, even from this imperfect analysis, that synchronized chain broadcasting is prospectively only a minor palliative. Its principal utility is in eliminating existing heterodyne interference on regional channels, utilized by medium-powered stations of 10 kw or less and serving limited areas. It is worthy of note that, as the separation of synchronized stations is increased in order to secure a satisfactory ratio of nearest to more distant signals, the phase distortion difficulties are increased. It seems reasonable to conclude that rural areas can be served best only by stations on cleared channels or by synchronized stations of medium power separated by great distances and that synchronization is applicable principally in the case of stations serving only limited areas and sharing their channels with stations of similar scope.

² J. V. L. Hogan "A study of heterodyne interference," Proc. I.R.E., 17, 1359; August, 1929.

Frederick Emmons Terman:³ It is stated in my paper that it would be technically possible to broadcast a program from 100 high-power stations, using only three channels and to reach substantially all of the radio receivers in the country. As the area of the United States is 3,026,700 square miles, this requires each station to serve 30,267 square miles, or a square 174 miles on a side. This separates adjacent stations 174 miles, but as adjoining stations are not operated on the same frequency, the distance between stations with synchronized carriers is greater, and will be 522 miles with two intervening stations. These figures do not agree with those of Mr. Felix who has apparently misunderstood some of the article.

The actual number of chain stations that might be synchronized on a single carrier in the United States without causing interference cannot be determined by any simple calculation. Thus stations along the seaboard have one side from which no interfering signal arrives. Again, it is necessary to take the distribution of population into account. Thus Nevada, with its 77,000 inhabitants, could not be expected to be given the four stations it would be entitled to on an area basis. Furthermore, local geographical conditions are of importance in the permissible spacing of stations, for transmitters located on opposite sides of a mountain range will interfere much less with each other than when both are in the same flat valley. When all of these factors are taken advantage of it is believed that a 30-kc band with an "interlocking group" method of synchronized broadcasting would probably reach a large majority of the radio receivers in the country, while a 40-kc band would do so without any question.

The receiving difficulties with a system of synchronized chain broadcasting such as proposed are much simpler than one might think at first hand. It is to be remembered that complete separation of channels is unnecessary because the transmitters on adjacent channels are transmitting the same program, that absolute synchronism can be maintained by wire lines, and that the station from which the program is received is always a local station.

The problem of time lag of the more remote transmitters can be corrected by delay networks, but this is entirely unnecessary. If two synchronized carrier frequencies are transmitted from stations separated by two intervening transmitters sending out the same program on other frequencies, a listener at the limit of the service area of one transmitter will receive a field strength from the remote synchronized transmitter that is only 20 per cent of that from the nearby one. As a result this listener may receive some audio frequencies 20 per cent stronger and others 20 per cent weaker than they should be. This represents a distortion of 1.6 db from the proper response, and this distortion exists only for the most unfavorable of audio frequencies, and then only to the listeners at the worst possible location. Most of the audio frequencies will have less distortion even at the unfortunately situated receiver.

When all of these factors are taken into account it would appear that some form of modified synchronization for stations broadcasting chain programs contains the ultimate solution of many of the present broadcast troubles. It is further apparent that synchronization of chain programs has much greater possibilities than synchronization of stations transmitting different programs because the cross-talk problems of the latter case do not exist when all stations on the same channel send out the same program.

³ Assistant Professor, Electrical Engineering, Stanford University, California.

BOOK REVIEW

Transmission Networks and Wave Filters, by T. E. SHEA. D. Van Nostrand Company, New York, 1929, 470 pages, 263 figures. Price, \$6.50.

This addition to the valuable series of treatises in the fields of engineering and physics by members of the technical staff of the Bell Telephone Laboratories brings up to date in a single volume a subject of vital importance to the transmission engineer and to anyone interested in problems of circuit design. It makes a particularly acceptable companion volume to "Transmission Circuits for Telephonic Communication," by K. S. Johnson, which was published in 1924, in which a few chapters dealt with the field which is now the subject of a large volume.

First, there is an introduction of about 50 pages which paints, in not too technical language, a very welcome, general picture of the place which transmission networks occupy in the electrical communication world. The main body of the work is devoted to the physical theory of networks including the equivalence of various forms, and to the general treatment of electric wave filters with specific consideration of different types, their design formula, and performance curves. The application of vector methods to wave filters is also included. A final section of about 75 pages treats of the resolution of steady-state waves and transient waves into frequency components by Fourier series and Fourier integral analysis, respectively.

The bibliography lists about 100 references to original articles and treatises, and nearly 40 patents. These include references to acoustic and mechanical filters, as well as to the electrical art in the language of which the fundamental properties of combinations of reactive elements have been developed in the text.

K. S. Van Dyke*

* Professor of physics, Wesleyan University, Middletown, Conn.

The Technique of Amplification Measurements; Instruments and Methods, by MANFRED VON ARDENNE, in collaboration with WOLFGANG STOFF and FRITZ GABRIEL. Julius Springer, Berlin, 235 pages. Price R.M. 22.50, paper cover; bound, R.M. 24.

The author begins his treatise by the description of a variety of audio-frequency generators, 20 to 20,000 cycles, both electromechanical and purely electrical in nature (vacuum-tube oscillators and beat-frequency oscillators), giving a careful analysis of their relative merits. The technique of radio-frequency generators, 20 to 20,000 kc, both with and without modulation, is then discussed. There follows an analysis of various methods of subdividing alternating voltages and currents. The succeeding section deals with the theory and practice of instruments for the measurement of small alternating currents and voltages, such as thermoelements, electrometers, rectifiers, vacuum-tube voltmeters, and oscillographs.

The second part of the text takes up the various procedures for the measurement of amplification. An analysis of the significance of amplification constants is followed by a careful discussion of the technique of measurement applied to audio systems of amplification. This is followed by a companion analysis of radio-frequency amplification and regeneration, the testing of radio receivers

and the measurement of field-strength intensities, likewise, the determination of decrement and the degree of rectification and modulation. Then follows a discussion of the measurement of harmonics, small capacities, grid currents, and the intensity response curves of loud speakers.

The third portion of the text is devoted to the sources of error frequently encountered in the technique of amplification measurements and a discussion of their remedies. This includes a valuable theoretical and practical analysis of electrostatic and electromagnetic shielding which is worthy of careful study. A useful bibliography is appended.

This text of some 230 pages is profusely illustrated with 246 excellent illustrations, both circuit diagrams and photographs of German instruments used in the art. An interesting and valuable feature is the introduction of X-ray photographs showing the internal construction of certain apparatus to illustrate important features of the text. It is to be hoped that an English translation of this worth-while work will be forthcoming.

HORATIO W. LAMSON*

* General Radio Co., Cambridge, Mass.

BOOKLETS, CATALOGS, AND PAMPHLETS RECEIVED

A leaflet, describing several models of two-button carbon microphones and associated equipment, is available from the Ellis Electrical Laboratory, 337 West Madison St., Chicago.

A loose-leaf catalog from the Cornell Electric Mfg. Co., of Long Island City, N. Y., outlines the tests imposed on, and the manufacture of, by-pass and filter condensers for radio receivers. A copy of the catalog will be mailed upon request.

The National Vulcanized Fibre Co. of Wilmington, Del., has recently issued their "Fact-Sheet of Industry," a 6-page folder of data concerning vulcanized fibre and molded and laminated bakelite.

The following extracts of articles which have appeared in various journals and magazines have been made available in convenient loose-leaf form and may be obtained from Lefax, Ninth and Sansom Streets, Philadelphia:

- An A-C Operated Tube Tester
- The A B C of Filter Design
- Automatic Volume Control
- Interference from Power Lines
- Revising the —99 Type Tube
- A High Gain Direct Coupled Amplifier
- Crystal Grinding
- Antenna Installation
- The Dynatron
- Public-Address and Centralized Radio Systems
- Planning a Public-Address System
- An All-Service Portable Receiver
- Elimination of Line Hum

Two bulletins have recently been received from the RCA-Victor Company, 233 Broadway, New York, and may be obtained by prospective customers upon request. One of these entitled "RCA Radio Broadcast Speech Input Equipment" describes speech input, and outside pick-up amplifiers together with power supply, microphone and similar associated apparatus. The booklet entitled "RCA Radio Telephone Broadcast Transmitter Equipment—Type 100W," describes a complete and self-contained 100-watt broadcast transmitter. Crystal control, the use of mercury vapor rectifiers, and high modulation capability are features of this transmitter.

A two-stage audio amplifier designed especially for experimental purposes is described in the April issue of the General Radio Experimenter. This amplifier, Type 645, is provided with plug-in coupling transformers enabling the entire unit to be used for a variety of purposes in the laboratory by selecting and inserting the proper transformers. A brief description of the amplifier appears in this issue of the Experimenter. An improved type of tuning-fork oscillator, which is available at frequencies of 1000 cycles and 400 cycles, is described and listed in this issue as is also a power level indicator for monitoring broadcast transmission.

A supplement to Bulletin 1C of Jenkins and Adair, Inc., 3333 Belmont Ave., Chicago, describes their mounted type mixing controls suitable for controlling

three microphone circuits. Bulletin No. 7A gives a technical description of their Type 3-D microphone mixing panel for relay rack mounting. Type C level indicator panel, suitable for use in broadcasting, sound pictures, or sound recording, is described in Bulletin 8A. Another bulletin (No. 13) outlines the technical specifications of the Type C monitor panel for audibly monitoring, broadcasting or recording circuits.

"How to Build Home Radiovision Equipment," is a six-page folder describing the construction of a simple radiovision optical system from a kit manufactured by the Jenkins Television Corporation, 346 Claremont Ave., Jersey City. A copy of this folder may be obtained upon request.

The Sensitive Research Instrument Corp., of 142 E. 32nd St., New York City, has for distribution a folder describing a direct-current microammeter having five current ranges in decimal multiples from 6 microamperes full scale, to 60 milliamperes full scale.

Folders issued by the Automatic Coil Winder & Electrical Equipment Co., Ltd., Winder House, Rochester Row, London, S. W. 1, describing the "Avometer," the Douglass automatic coil winder, and the Douglass paper insertion attachment may be obtained upon request. The coil winder is suitable for winding round, square, flat, or irregular shaped coils of single or multilayer. The paper insertion attachment is useful for insulating the several layers of multilayer coils. The Avometer is a portable meter measuring current from 12 milliamperes to 12 amperes, voltage from 0.12 volt to 1200 volts, and resistance from 1000 ohms to one megohm full scale deflection.

The "RCA Radiotron Broadcast Station Directory," is a 44-page directory of broadcast stations, but contains in addition general information, together with a chart, giving the important operating characteristics of all Radiotrons intended for receiving purposes.

Bulletin No. 79 of the Ward Leonard Electric Co., Mount Vernon, N. Y. gives a technical description of their faders and attenuation pads for broadcast or talking picture purposes.

Hallock-Watson & Yonge, 191 Park St., Portland, Ohio, has for distribution a circular describing two types of radio receiving sets designed particularly for locating directive interference in the broadcast frequency spectrum.

REFERENCES TO CURRENT RADIO LITERATURE

THIS is a monthly list of references prepared by the Bureau of Standards and is intended to cover the more important papers of interest to the professional radio engineers which have recently appeared in periodicals, books, etc. The number at the left of each reference classifies the reference by subject, in accordance with the scheme presented in "A Decimal Classification of Radio Subjects—An Extension of the Dewey System," Bureau of Standards Circular No. 138, a copy of which may be obtained for 10 cents from the Superintendent of Documents, Government Printing Office, Washington, D. C. The various articles listed below are not obtainable from the Government. The various periodicals, can be secured from their publishers and can be consulted at large public libraries.

R000. RADIO COMMUNICATION

- R007.9 Hooper, S. C. The Hague Conference. *PROC. I. R. E.*, 18, pp. 762-774; May, 1930.

(A general account is given of the meeting of the International Technical Consulting Committee on Radio Communication at the Hague, September, 1929. The principal agreements made are summarized.)

- R007.9 Recommendations of the International Technical Consulting Committee on Radio Communication, The Hague, September 18-October 2, 1929. *PROC. I. R. E.*, 18, pp. 775-795; May, 1930.

(A translation from the French text of the minutes of the closing plenary session of the International Technical Consulting Committee on Radio Communication summarizes the recommendations of that committee.)

R100. RADIO PRINCIPLES

- R113.4 Eckersley, T. L. Recombination of electrons and positive ions in the upper atmosphere. *Nature* (London), 125, p. 669; May 3, 1930.

(A method of obtaining the recombination coefficient of the electrons and ions in the upper atmosphere is outlined. The method consists in determining by radio transmission the value of the greatest angle at which rays are reflected to earth at various times of night after the ionizing agent, the sun's ultra-violet light, has been removed. The records of facsimile transmission between New York and England provide the necessary data for the evaluation of this angle. The physical significance of the value of the recombination coefficient obtained is discussed.)

- R113.6 Bureau, R. Cartes de propagation d'ondes courtes. (Propagation maps of short waves.) *L'Onde Electrique*, 9, pp. 93-114; March, 1930.

(Propagation maps are presented and discussed. The method of construction, similar to that used in making weather maps, is explained. The various maps show daytime zones of silence on intermediate waves, nighttime zones of audition within zones of silence on short waves, and the birth and development of a zone of silence. (To be continued.)

- R114 Ollendorff, F. Ueber das Strahlungsfeld des Blitzes. (On the radiation field of lightning.) *Elek.-Nach. Tech.*, 7, pp. 108-119; March, 1930.

(Formulas are derived for computing the radiation due to a stroke of lightning and conclusions are drawn that such interference fields, while not disturbing to telegraphic traffic, may seriously interfere with radiotelephony.)

- R125.1 Smith-Rose, R. L. Radio direction finding by transmission and

reception. (Continued from *Nature*, p. 532, April 5, 1930.) *Nature* (London), 125, pp. 568-69; April 12, 1930.

(Night error in radio direction finding by transmission and reception is discussed briefly for the case of transmission over sea water. The possibility of the elimination of night error through the development of the Adcock antenna is noted. The system of direction finding in which a rotating loop beacon is employed is outlined. The practical success of this system in operation is indicated.)

- R130 Forstmann, A. Ueber optimale und maximale Leistungen bei Endröhren. (Concerning optimum and maximum power from power tubes.) *Zeits. für Hochfreq.*, 35, pp. 109-115; March, 1930.

(The circuit conditions for maximum and optimum power output from output tubes are mathematically developed for certain specified cases. Existing literature on this subject is summarized and a bibliography is given.)

- R140 Reed, M. Electrical wave filters (continued from April, 1930, issue.) *Experimental Wireless and W. Engr.* (London), 7, pp. 256-61; May, 1930.

(The general formulas for the propagation constant and the characteristic impedance of a complex type of symmetrical wave filter are applied to the case of a band-pass filter. All the necessary formulas for the design of such a filter are derived, and their use is illustrated by a numerical example. The effect of resistance in the filter circuit on the attenuation and phase constants is discussed. (To be continued.))

- R144 Mathieu, M. Abaque pour le calcul des resistances ohmiques a tous frequences. (Chart for the calculation of ohmic resistance at all frequencies.) *L'Onde Electrique*, 9, pp. 139-140; March, 1930.

(A diagram is presented giving directly the ratio of the a-c ohmic resistance of a conductor to its d-c resistance. The diagram is based on the empirical formula of Levasseur.)

- R145 [Barclay, W. A. Applications of the method of alignment to reactance computations and simple filter theory. Part III. (continued from April issue). *Experimental Wireless and W. Engr.* (London), 7, pp. 242-247; May, 1930.

(The laws of filter combination are briefly considered. The method of alignment is applied to the graphical derivation of the filter reactance of a compound filter of similar stages. An analysis is developed to provide a means of readily computing the values of the characteristic frequency functions of a compound filter of similar stages from the known values of the characteristics of the typical component stage. (To be continued.))

- R150 Fox, G. W. Oscillations in the glow discharge in neon. *Phys. Rev.*, 35, pp. 1066-72; May 1, 1930.

(Radio-frequency oscillations consisting of one or two fundamentals together with a series of harmonics for each fundamental have been observed in large current glow discharges in neon. The observed frequencies lie in the range from approximately 1.5×10^6 to 2×10^6 cycles per sec. The oscillations are very sensitive to pressure changes, their frequency increasing rapidly with decreasing gas pressure. The oscillation frequency also increases markedly with increasing current. The frequency is quite independent of resistance in series with the discharge. The suggestion is made that the oscillations are due to the presence of a reversed electric field in the negative glow of the discharge.)

R200. RADIO MEASUREMENTS AND STANDARDIZATION

- R200 Thomas, H. A. A method of measuring the over-all performance of radio receivers. *Jour. I. E. E.* (London), 68, pp. 475-95; April, 1930.

(An improved method of measuring the amplification of a radio receiver is described, together with the manner in which the method can be applied to practical cases, particularly at high frequencies. The apparatus covers a frequency range of from 10 to 20,000 kc and is capable of dealing with inputs of from 0.25 to 1000 mv over this range. The construction and operation of the apparatus is described in detail and the results of tests on four receiving sets of different types are given.)

- R200 Barnes, E. J. Measurement of the performance of loud speakers. *Experimental Wireless and W. Engr.* (London), 7, pp. 248-255; May, 1930.

(Apparatus developed to test and measure the performance of loud speakers is described. The apparatus includes a specially designed audio-frequency generator of the heterodyne type for use as a source of testing current, a test chamber in which the loud speaker is placed to produce the effect of an infinite space surrounding the speaker, a condenser microphone which is calibrated by means of a Rayleigh disk, and a microphone amplifier. (To be continued.)

- R200 Hartmann, C. A. Schalldruckmessungen an Mikrofonen Telephonen und im freien Schallfeld. (Sound pressure measurements at the microphone, at the reproducer, and in free air.) *Elek.-Nach. Tech.*, 7, pp. 100-107; March, 1930.

(The measurement of sound pressures by an electrostatic compensation method is discussed. This method is applied to the determination of the reproduction characteristics of loud speakers, and the results are compared with those obtained by other methods of measurement.)

- R214 Watanabe, Y. The piezo-electric resonator in high-frequency oscillation circuits—Parts II, III, IV. *Proc. I. R. E.*, 18, pp. 862-893; May, 1930.

(The voltage transformation ratio between primary and secondary voltages of a piezo-electric coupler is investigated. The characteristics of a piezo-electric oscillator and a piezo-electric frequency stabilizer are considered. In the study of the effects of a crystal resonator on an electric circuit in which it is placed, the application of its motional admittance circle diagram is shown to have many advantages. The conditions for the building up of oscillations in a piezo-electric oscillator are obtained. Three types of oscillators are treated. The effectiveness of frequency stabilization of a vacuum-tube radio-frequency generator by means of a coupled piezo-resonator is shown.)

- R220 Bruun, H. Bestimmung der Röhrenkapazitäten C_{oa} und C_{ok} mit Hilfe von Scheinwiderstandsmessungen. (Determination of the vacuum-tube interelectrode capacities C_{op} and C_{of} by the use of apparent resistance measurements.) *Zeits. für Hochfreq.*, 35, pp. 105-108; March, 1930.

(The underlying principles of a method of measuring interelectrode capacities C_{of} and C_{op} of a vacuum tube are given. The method involves a comparison of apparent resistances in the plate circuit. The equations for C_{op} and C_{of} in terms of the apparent resistances are given. The method is applied to several specific examples.)

R300. RADIO APPARATUS AND EQUIPMENT

- R325.1 Berndorfer, F. and Dieckmann, M. Unilaterales Peilwinkelzeigerät mit rotierender Goniometer-Ankopplungsspule. (A unilateral direct-indicating direction finder with rotating goniometer coupling.) *Zeits. für Hochfreq.*, 35, pp. 98-105; March, 1930.

(A device is described which gives a direct and continuous reading of the direction from which a received signal is coming. It employs two loops coupled to the set through a rotating goniometer and a vertical antenna for eliminating 180 deg. ambiguity. Favorable results of practical tests are reported.)

- R325.1 Barfield, R. H. Recent developments in direction finding apparatus. *Experimental Wireless and W. Engr.* (London), 7, pp. 262-265; May, 1930.

(Abstract of paper read before the Wireless Section, Institution of Electrical Engineers on April 2, 1930.)

- R376.3, Stenzel, H. Ueber die Berechnung und Bewertung der Frequenzkurven von Membranen. (On the calculation and evaluation of frequency curves of membranes.) *Elek.-Nach. Tech.*, 7, pp. 87-99; March, 1930.

(The calculation and evaluation of the frequency curves of membranes are theoretically discussed. Application is made to the design of loud speakers.)

R500. APPLICATIONS OF RADIO

- R521 Diamond, H. and Gardner, F. G. Engine-ignition shielding for radio reception in aircraft. *Proc. I. R. E.*, 18, pp. 840-861; May, 1930.

(The work of the Bureau of Standards in the development of satisfactory and safe engine-ignition shielding to permit the use of highly sensitive radio receivers on aircraft is described. The problems of electrical and mechanical design involved are listed. Tests for the practicability of a shielding system are outlined.)

- R525 Sudeck, G. Ueber die Sendecharakteristik von Flugzeugschleppantennen. (Transmission characteristics of airplane trailing-wire antennas.) *Zeits. für Hochfreq.*, 35, pp. 89-98; March, 1930.

(Theoretical formulas for calculating the transmission characteristics of coil and open antennas are given, and their use is illustrated by numerical examples. The procedure and results of test flights are described and the theoretical results are shown to compare favorably with actual results.)

- R526.1 Dellinger, J. H., Diamond, H., and Dunmore, F. W. Development of the visual type radiobeacon system. *PROC. I. R. E.*, 18, pp. 796-839; May, 1930.

(A review is given of the work of the Bureau of Standards through the period 1926-1929 on the development of the visual type airway radiobeacon system. In the review descriptions are given of the aural radiobeacon system, the double-modulation visual beacon system, the triple-modulation visual beacon system, airplane receiving equipment, and marker beacons.)

R600. RADIO STATIONS: EQUIPMENT, OPERATION, AND MANAGEMENT

- R612 Villem, R. La-nouvelle station d'émission a ondes courtes de Sainte Assise. (The new short-wave transmitting station at Ste. Assise.) *L'Onde Electrique*, 9, pp. 116-138; March, 1930.

(The high-frequency transmitting station at Ste. Assise, France, is described. The installation is adapted to telegraph or telephone transmission and permits a choice of one of two high frequencies for utilization. The technical details of the component units of the transmitter are given, and also those of the directive antennas with their feed systems.)

R800. NON-RADIO SUBJECTS

- 535.3 Marx, E. On a new photoelectric effect in alkali cells. *Phys. Rev.*, 35, pp. 1059-1065; May 1, 1930.

(If two monochromatic beams fall simultaneously on an alkali electrode a new photoelectric effect is shown as follows: If the intensity of the high-frequency light v_1 is sufficient to establish the limiting potential corresponding to the Einstein law, the presence of any component of lower frequency v_2 diminishes the potential according to the following equation

$$R = C(n_2/n_1) (v_1/v_2) (v_1 - v_2)h/e$$

where R is the potential decrease and n_2 the ratio of the electronic emission of n_1 the two components measured by the test cell itself. A tentative explanation of the phenomenon is advanced.)

- 537.65 Hund, A. and Wright, R. B. New piezo oscillations with quartz cylinders cut along the optical axis. *PROC. I. R. E.*, 18, pp. 741-761; May, 1930.

(It is shown that oscillations of a new type may be produced using a quartz cylinder cut along the optical axis. To produce them it was found necessary to use highly regenerative circuits to drive the quartz. The oscillations were studied experimentally through the medium of glow discharge patterns and theoretically by comparing the observed frequencies of oscillation with the computed values for the three different modes of vibration. The study indicated that the oscillations were of a true piezoelectric character. Several types of electrode mountings were used.)

- 537.65 Skellet, A. M. Modes of vibration of a round plate cut from a quartz crystal. *Jour. Opt. Soc. of Amer.*, 20, pp. 293-302; May, 1930.

(Photographs showing the antinodal patterns of a round quartz crystal plate of the Curie cut vibrating piezo-electrically in a large number of modes are reproduced. Two general types of vibration are noted. In the first, the plate is symmetrically divided up into nodal and antinodal regions forming patterns peculiar to the exciting frequencies. In the second, vibrations consist of standing waves along chords or diameters of the plate with reflection at the edges. It is concluded that patterns are independent of the electrode arrangement and that the vibrations observed are compressional.)

- 621.385.95 West, W. The pressure on the diaphragm of a condenser transmitter in a simple sound field. *Jour. I. E. E.* (London), 68, pp. 441-446; April, 1930.

(It has been observed that the free air pressure of a sound wave may be increased at the diaphragm of a microphone in a ratio greater than 2 to 1 at certain frequencies when there is concavity in the face of the microphone. A method of calculating the magnitude of this increase is applied to a condenser transmitter of the Wentz type and close agreement is found with experimental results. The calculations involve certain simplifying approximations, the validity of which is discussed.)

- 621.385.95 Oliver, D. A. An improved condenser microphone for sound pressure measurements. *Jour. Scien. Inst.* (London), 7, pp. 113-119; April, 1930.

(An improved condenser microphone of the Wentz type is described, suitable for sound pressure measurements. The cylindrical cavity in front of the diaphragm has been practically eliminated with the result that the free air response characteristic is much improved. Factors influencing the performance and methods of calibration are reviewed. Constructional details and test results are given.)

CONTRIBUTORS TO THIS ISSUE

Ballantine, Stuart: Born September 22, 1897 at Germantown, Pa. Operator, Marconi Co., summers 1913, 1914, 1915; H. K. Mulford Co., bacteriologists, 1916; Bell Telephone Co. of Pa., 1917; expert radio aide, U. S. Navy, in charge of research and development of radio direction-finder apparatus, Philadelphia Navy Yard, 1917-1920; organized Philadelphia Section of the Institute and served as its chairman until 1926. Studied mathematics at Drexel Institute, 1919, and mathematical physics, graduate school, Harvard University, 1920-1921. With L. M. Hull organized technical work at Radio Frequency Laboratories, Inc., Boonton, N. J., 1922-1923. John Tyndall Scholar in mathematical-physics, Harvard University, 1923-1924. Privately engaged in scientific research at White Haven, Pa., 1924-1927. In charge of Research Division, Radio Frequency Laboratories, 1927-1929. President, Boonton Research Corporation, Boonton, N. J., 1929 to date. Fellow, American Physical Society and Acoustical Society of America; Member, Franklin Institute. Associate member, Institute of Radio Engineers, 1916; Fellow, 1928.

Barkhausen, Heinrich: Born December 2, 1881 at Bremen, Germany. Educated at Technische Hochschule and Universität; received Ph.D. degree, Göttingen, 1907. Engineer for Siemens and Halske, Berlin, 1907-1911. Director of the Division for Weak-Current Engineering, and Professor, Institute of Technology, Dresden, 1911 to date. Associate member, Institute of Radio Engineers, 1926; Fellow, 1930.

Brattain, Walter H.: Born February 10, 1902 at Amoy, China. Received B.S. degree, Whitman College, 1924; M.A. degree, University of Oregon, 1926; Ph.D. degree, University of Minnesota, 1929. Assistant Physicist, Radio Section, Bureau of Standards, 1928-1929; Technical Staff, Bell Telephone Laboratories, 1929 to date. Associate member, Institute of Radio Engineers, 1929.

Brown, W. J.: Born 1900 at Stockport, England. Received B.Sc. Hons., degree, Manchester University England, 1920. Affiliated with National Physical Laboratory, Metropolitan Vickers Electrical Co., Ltd., Research and General Engineering Depts. At present, research engineer with the Gramophone Co., Ltd. Associate member, Institution of Electrical Engineers, London. Member, Institute of Radio Engineers, 1925.

Cady, W. G.: Born December 10, 1874 at Providence, Rhode Island. Received Ph.B. degree, 1895; M.A. 1896, Brown University; Ph.D. degree 1900, University of Berlin. Instructor in mathematics, Brown University, 1895-1897. Magnetic observer, U. S. Coast and Geodetic Survey, 1900-1902. Instructor in physics, 1902-1903; associate professor, 1903-1907; professor of physics, Wesleyan University, Middletown, Connecticut, 1907 to date. Member, Board of Direction of the Institute of Radio Engineers, 1928. Associate member, Institute of Radio Engineers, 1914; Fellow, 1927.

Eckersley, P. P.: Born January 6, 1892 at La Puebla, Mexico. Educated at Bedales School and Manchester University. Apprenticed, Mather and Platt and Lancashire Dynamo and Motor Co. Royal Flying Corps, 1915; officer in charge of Wireless Training Southern Brigade, 1916; brigade wireless officer, France; wireless experimental establishment, Biggin Hill, 1917; head of experi-

mental section, aircraft department, Marconi Co., 1919; head of experimental design department, 1921; chief engineer, British Broadcasting Corporation, 1923; His Master's Voice Gramophone and Marconi Company, 1929 to date. Member, Institution of Electrical Engineers, 1924. Fellow, Institute of Radio Engineers, 1925.

Heaton, Vincent E.: Born April 7, 1897 at Greencastle, Indiana. Received B.A. degree in physics, Indiana University, 1919; M.A. degree, 1924. Instructor in Physics, Iowa State College, 1919-1926; research in ballistics and sound ranging apparatus, Aberdeen Proving Ground, Maryland, 1926-1927; Radio Section, Bureau of Standards, 1927 to date. Member, Iowa Academy of Sciences, 1920; Iowa Research Board, 1921; American Physical Society, 1924; American Section, International Scientific Radio Union, 1928. Associate member, Institute of Radio Engineers, 1927.

Hulburt, E. O.: Born October 12, 1890. Received Ph.D. degree in physics, Johns Hopkins University, 1915. Taught undergraduate and graduate courses at Western Reserve University, Johns Hopkins University, and University of Iowa. With A. E. F. in France as lieutenant and later captain of signal corps. At present superintendent of Heat and Light Division, Naval Research Laboratory, "Bellevue," D. C. Author of a number of papers on experimental and theoretical work in spectroscopy, physical optics, and radiotelegraphy. Non-member, Institute of Radio Engineers.

Konkle, P. J.: Received B. S. degree in E. E., Iowa State College, 1927. Radio Engineer, Westinghouse Electric and Manufacturing Co., 1927-1928; radio engineer, in charge of station WOI, Ames, Iowa, 1928 to date. Associate member, Institute of Radio Engineers, 1928.

Macalpine, William W.: Born September 2, 1900 at Kimacalm, Scotland. Received B.S. degree, Carnegie Institute of Technology, 1922; M.A. degree, Columbia University, 1924. Assistant in the Ernest Kempton Adams Precision Laboratory, Columbia University, 1924-1927. Adams Research Fellow, 1927-1928. Radio division, International Communications Laboratories, New York City, 1929 to date. Associate member, Institute of Radio Engineers, 1929.

McNeely, J. K.: Received B.S. degree in E.E., University of California, 1908; M.A. degree, University of Southern California, 1917; E.E. degree, University of Illinois, 1923. Student engineer, Allis-Chalmers, 1908-1910; electrical engineer, Allis-Chalmers, 1910-1912; consulting engineer, 1912-1917. Instructor S. A. T. C. camp, 1917-1918. Assistant professor, Washington University, St. Louis, 1923-1925. Research engineer and professor of electrical engineering, Iowa State College, 1925 to date. Non-member, Institute of Radio Engineers.

Ramsey, R. R.: Born April, 11, 1872 at Morning Sun, Ohio. Received B.A. degree, Indiana University, 1895; M.A. degree, Indiana University, 1898; Ph.D. degree, Cornell University, 1901. Instructor, University of Missouri, 1901-1903; assistant professor, associate professor, and professor, Indiana University, 1903 to date. Author of a number of papers relating to electrolytic conduction, radio-activity, and radiotelegraphy. Author of "Experimental Radio," Fellow, American Physical Society. Member Institute of Radio Engineers, 1926.

* **Uda, Shintaro:** Born June 1, 1896 in Toyama Prefecture, Japan. Graduated Hiroshima Higher Normal School, 1918. Received E.E. degree, Tohoku Imperial University, 1924. Assistant professor, Tohoku Imperial University, 1927 to date. Non-member, Institute of Radio Engineers.

van der Pol, Balth.: See PROCEEDINGS for February, 1930.

* Paper published in June, 1930, PROCEEDINGS-

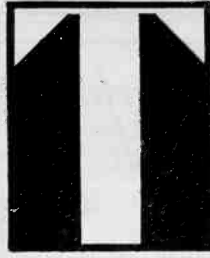

Do think of
TRANSFORMERS

is to think of
THORDARSON

TRANSFORMER SPECIALISTS
Since 1895 / / / / / /

Microphone Transformers ● Line
to Tube, Tube to Line, Line to Line ●
Mixing Transformers ● Coupling
Reactors ● Filter Chokes ● Audio
Transformers ● Impedance Matching
Transformers ● Power Compacts ●
Speaker Coupling Transformers ●
Complete Amplifiers

*Catalog of new Replacement Power and Audio
Transformers will be sent upon request*

THORDARSON ELECTRIC MFG. CO.
Huron, Kingsbury and Larrabee Sts., Chicago, Ill., U. S. A.

When writing to advertisers mention of the PROCEEDINGS will be mutually helpful.



THE BELL TELEPHONE SYSTEM IS ORGANIZED TO GIVE CONSTANTLY IMPROVED SERVICE . . .
QUICK, ACCURATE, EASY TO USE

What you want of the telephone . . . it is our business to give

An Advertisement of the American Telephone and Telegraph Company

WHEN you order a telephone, you want it put in promptly. During the last five years the average length of time needed to have a telephone installed has been cut nearly in half.

You want quick and accurate service, free from trouble. Good as the service was five years ago, today there are a third less troubles per telephone. During this same period there have been marked increases in the already high percentage of perfectly transmitted conversations.

When you make a toll call, you want a prompt, clear connection. Five years ago 70 per cent of all toll and long distance calls were handled while the calling person remained at the telephone. Today all but a very small per cent are handled this way.

The Bell System is organized to give constantly improved service.

Several thousand persons in the Bell Laboratories are engaged in research that improves the material means of telephony. The Western Electric Company, with plants at Chicago, Kearny, N. J., and Baltimore, specializes in the manufacture of precision telephone equipment of the highest quality. From its warehouses all over the country, it supplies the millions of delicate parts for Bell System apparatus.

The operation of the System is carried on by 24 Associated Companies, each attuned to the area it serves. The staff of the American Telephone and Telegraph Company is continually developing better methods for the use of these operating companies. Your telephone service today is better than ever before. The organized effort of the Bell System is directed toward making it even better tomorrow.



When writing to advertisers mention of the PROCEEDINGS will be mutually helpful.



Cornell



Cornell

NEW DeLUXE «CUB» CONDENSER

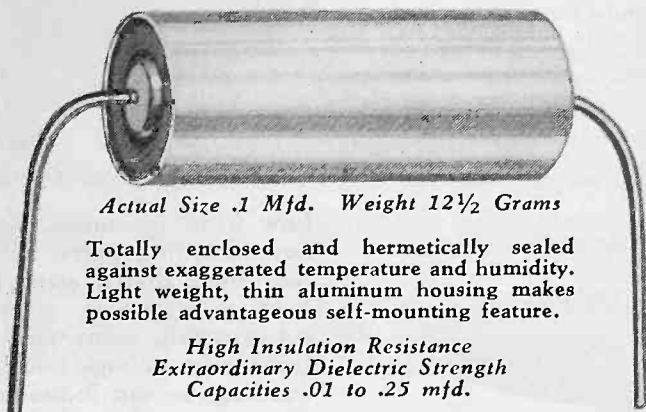

Actual Size .1 Mfd. Weight 12½ Grams

Totally enclosed and hermetically sealed against exaggerated temperature and humidity. Light weight, thin aluminum housing makes possible advantageous self-mounting feature.

*High Insulation Resistance
Extraordinary Dielectric Strength
Capacities .01 to .25 mfd.*

These new DeLuxe «Cub» condensers are compact, light in weight and of attractive appearance. They cut labor operations and cost from 20% to 50% less. *Write for sample.*

Cornell

FILTER CONDENSERS
BY-PASS CONDENSERS
RADIO INTERFERENCE FILTERS
POWER FACTOR CORRECTION BANKS
UNIFORMLY HIGH INSULATION RESISTANCE
PAPER DIELECTRIC CONDENSERS (All Types)

Write for Sample DeLuxe «Cub» Condenser and Catalog of Complete Line of Cornell Products.

Cornell Electric Mfg. Co., Inc.
LONG ISLAND CITY, NEW YORK



Cornell



Cornell

When writing to advertisers mention of the PROCEEDINGS will be mutually helpful.

«ESCO» Power Supply for Radio Equipment

Machines for operating 60-cycle A. C. Radio Receivers, Loud Speakers and Phonographs from Direct Current Lighting Sockets Without Objectionable Noises of any Kind.

The dynamotors and motor generators are suitable for radio receivers and for combination instruments containing phonographs and receivers. Filters are usually required. The dynamotors and motor generators with filters give us good or better results than are obtained from ordinary 60-cycle lighting sockets. They are furnished completely assembled and connected and are very easily installed.

These machines are furnished with wool-packed bearings which require very little attention, and are very quiet running.

Write for Bulletin No. 243-D

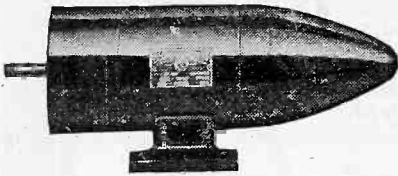

Type NA Aircraft Generator

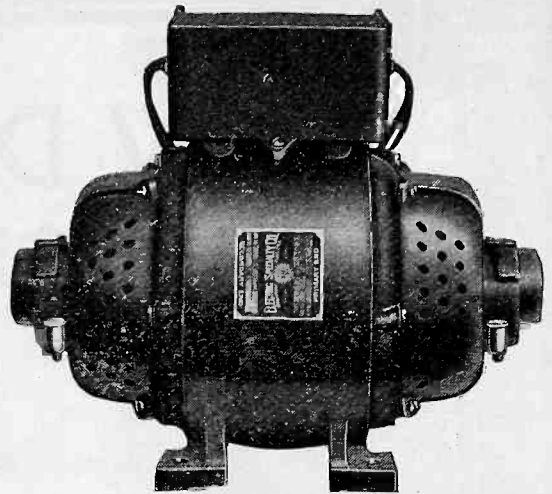

Dynamotor with Filter for Radio Receivers

Low wind resistance, light weight, non-corroding parts, ball bearings, tool steel shafts, steel shells, cast steel pole pieces, weather proof construction, many sizes to choose from, high voltage and low voltage windings to suit individual requirements, are a few of the many reasons for «ESCO» generators or dynamotors being the first choice.

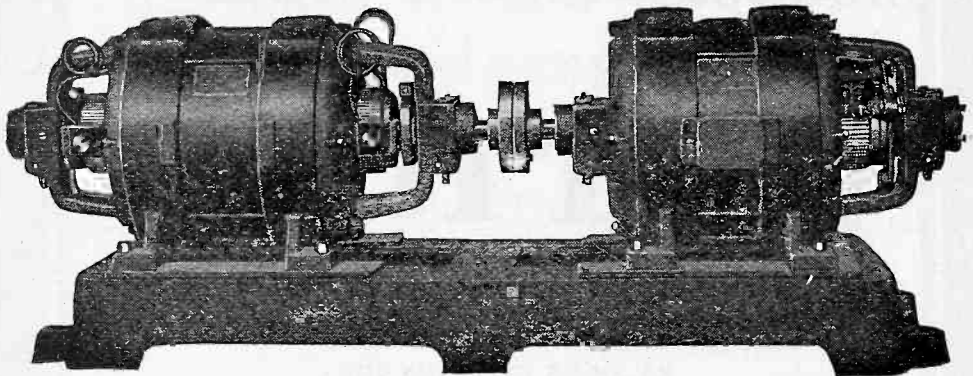

Type BFR, Two Unit Motor Generator Set

«ESCO» two and three unit sets have become the accepted standards for transmission. The «ESCO» line consists of over 300 combinations. These are covered by Bulletin 237G.

«ESCO» also manufactures synchronous motors for television and «talkie» projectors, motor generators and dynamotors for power amplifiers and public address systems.

ELECTRIC  SPECIALTY
COMPANY

300 SOUTH ST., STAMFORD, CONN.

Manufacturers of motors, generators, dynamotors and rotary converters.

When writing to advertisers mention of the PROCEEDINGS will be mutually helpful.

DeJUR-AMSCO

Completely Shielded Condensers

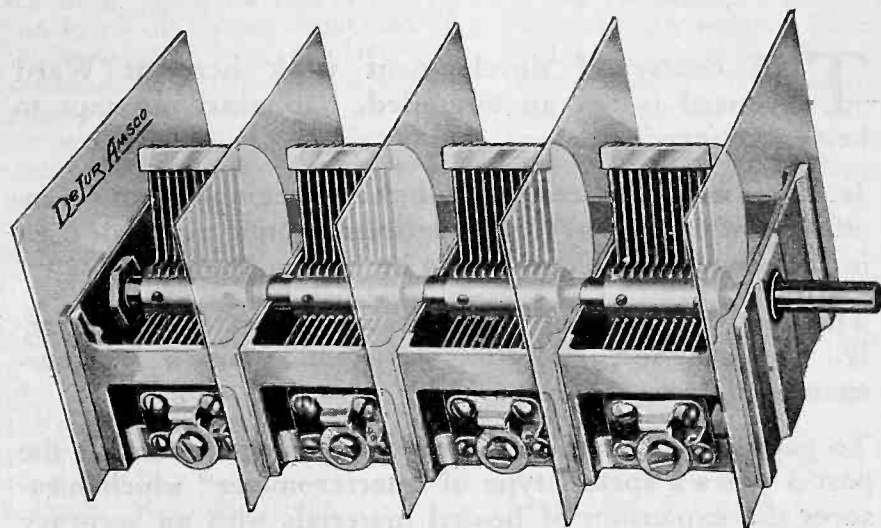

Developed Especially For Screen Grid Receivers

Aluminum cast frame.

Aluminum cast shield plates.

Ball bearings at both ends.

Steel bushings and raceway.

Three-eighths inch steel shaft, centerless ground and highly polished.

Individual spring phosphor bronze wipe contacts to each rotor assuring perfect electrical contact.

Lugs attached for individual returns.

All metal parts except castings, rotor and stator plates heavily cadmium plated.

Mounting studs cast into bottom of frame.

Provision also made for side mounting.

Substantial compensating or trimming condensers.

Available in 2, 3, 4 and 5 gang units.

Write for engineering data and working drawings. Send us your specifications and let us quote. Samples on request.

We are also making special condensers for automobile radio and portable receivers.

DeJUR-AMSCO CORPORATION

Fairbanks Building

BROOME & LAFAYETTE STS., NEW YORK CITY

When writing to advertisers mention of the PROCEEDINGS will be mutually helpful.

down to 1,000,000th of an inch

THE course of development work here at Ward Leonard is not an unguided, haphazard attempt to better our products.

It is of vital importance that the exact temperature coefficient of expansion for the various ceramic materials used in vitreous-enamelled resistors be known.

The relative expansions of these materials determine, largely, the life and operating satisfaction of a vitreous-enamelled resistor.

To gain this knowledge we have had in operation for the past 3 years a special type of interferometer* which measures the expansion of heated materials with an accuracy of one one-millionth of an inch.

This measuring precision may, for special purposes, be increased to include measurements of one ten-millionth of an inch.

That we measure with this accuracy the materials used in our resistors means that you get the best resistors research development and manufacturing skill can offer. Let us quote you on your present and future requirements.

WARD LEONARD ELECTRIC CO.

31 South Street, Mt. Vernon, N.Y.

Resistor Specialists for More Than 39 Years

* The Ward Leonard Interferometer is an apparatus for the determination of the thermal dilation of ceramic (and other) materials. The specimen under test separates two fused quartz plates which refract and reflect monochromatic light.

This action takes place in a carefully calibrated furnace. Heating is accurately controlled in accordance with a schedule.

Expansion of the specimen produces an apparent movement of interference fringes from the practically parallel surfaces of the quartz plates. Each fringe thus produced corresponds to $\frac{1}{2}$ wavelength of the illumination light. This length is accurately known and from it the percentage increase of specimen length is calculated.

YOUR Reasoning Starts From One of These

WE ARE IN NEW TIMES NOW. A lot of thinking in dead-earnest is going on everywhere. And by *all* the parties concerned. Workers, executives, employers, customers. There is no one who is *not* concerned.

Let us take a look at the different parts of the subject, and note how they connect and depend on one another. What they are thinking so hard about is:

1. Pay; earnings, payrolls.
2. Jobs; safety, steadiness, permanence; possibilities of layoffs; or of calling back men now laid off.
3. Volume of work; chances of getting it back, keeping it up, or increasing it.
4. Costs. Margins. Profit.
5. Orders. What they depend on. How to make sure of getting them, under conditions existing now; and under conditions that are coming, before the turn-up, and after it.
6. Customers. Purchasing Power, and Willingness. Present attitude as compared with 1929. Probable attitude in 1931-1932.
7. Adjustments — (of product, costs, price, performance, or other satisfactions)—to meet Customers' present attitude; and probable attitude later.
8. Competition; as it is now; and as it may be, before the turn-up, and afterward. What Competitors are doing, and getting ready

to do; or might do; (about 7, 6, 5, 4, 3, 2, 1, above).

9. The General upward turn of business as a whole. What can be done to ensure it, and to bring it about, soon. What conditions may precede it. When it will come. And what the conditions—(as to 8, 7, 6, etc.)—will be, after the turn-up and while the new prosperity is growing.

10. Own Company's Turn-up. Can it come earlier than the *general* turn-up? Can the Company start "swimming up stream" before the others do? Men of each live concern are figuring this, irrespective of the general trend. What they can do about 5, 2, 1, 4, 8, etc. How they can check their Own Company's dip, flatten its curve, turn it upward *soon*; and make sure that it shall have the strongest position during the prosperity that is coming.

* * *

And through it all, there is a new awakening to the fact that now, too often the REAL drag on profits and on success in competition, is the using of WRONG MATERIAL.

In the New Times, the New Thoroughness,—*reasoning* starts from the *foundation*,—recognition of the supreme importance of—

Thinking in the RIGHT MATERIAL.

NVF

Write today for **FACT-SHEETS OF INDUSTRY No. 1**,—giving practical knowledge which hitherto has not been readily accessible—Mailed **FREE** to any worker or executive. Limited Edition—Write **NOW**, stating work you do, your company's product or business, and whether request is for self. Address Librarian (Dept. G-5), National Vulcanized Fibre Company, Wilmington, Delaware.

NATIONAL VULCANIZED FIBRE COMPANY

Makers of Special Phenolites; "righter" Bakelites; "Peerless" insulation; many kinds of Vulcanized Fibre; Material-Handling equipment, etc. Serving America's industries from smallest to greatest.

When writing to advertisers mention of the **PROCEEDINGS** will be mutually helpful.



**PACENT
MASTER
PHONOVOX**

Model 107

\$15.00

*Slightly higher west of the
Rockies and Canada*

12 months' research have perfected 12 improvements in the NEW MASTER PHONOVOX

The results from the new Pacent Master Phonovox more than justify the time and effort put forth to produce this improved pickup. These are the features which assure the continuance of Pacent leadership in the pickup field:

- | | |
|--|---|
| <ol style="list-style-type: none"> 1 Improved frequency characteristics through scientific placement of weight. 2 Greater range of reproduction — more bass — more highs! 3 Low center of gravity—better record tracking. Lateral play of armature exceeds lateral cut of record grooves. 4 Built-in volume control. 5 Built-in radio-record change-over switch — go from one to the other in an instant. 6 Full swing back head for easy needle changing. | <ol style="list-style-type: none"> 7 Special Cobalt magnets. 8 Pole pieces specially milled, heat treated and precision ground. 9 All parts in the Master Phonovox precision adjusted to insure a new degree of pickup performance. 10 Correct needle pressure applied through scientific design of head. 11 Ball-bearing swivel tone-arm. 12 Beautiful—modernistic, golden bronze finish, delicately embossed. |
|--|---|

Write for literature

PACENT ELECTRIC CO., Inc., 91 Seventh Ave., New York, N. Y.

Manufacturing Licensee for Great Britain and Ireland

IGRANIC ELECTRIC CO., Ltd., Bedford, England

Licensee for Canada: White Radio Ltd., Hamilton, Ont.

When writing to advertisers mention of the PROCEEDINGS will be mutually helpful.

NEW Fields Opened

by the



The New Principle of VOLTAGE CONTROL

Through the Duratrol Principle of Voltage Control the Electrad Laboratories have made greater flexibility possible in the manufacture of radio apparatus using adjustable resistors in single units or gangs.

First expressed in the Super-Tonotrol, now widely used by radio industry for Volume Control, this principle received instant acceptance through its smooth, stepless variation and remarkable endurance characteristics.

A pure silver multiple brush contact floats over a surface of a specially developed resistance element, which is permanently fused to the surface of a vitreous enameled metal plate. Metal construction insures rapid heat dissipation and rugged construction.

Duratrol units can be made with all usual resistance values, with uniform or tapered resistance curves, in single or multiple units. Full construction data on request.

Manufacturers are invited to submit specifications.

Licensed by Technidyno Corp., U.S. Patents 1034103-1034104 and Patents Pending

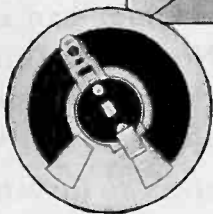
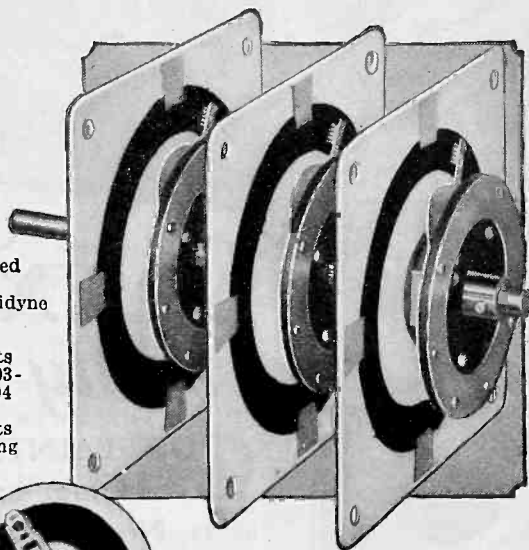

Showing 3 gang Duratrol recently developed for a leading electrical manufacturer. Each plate is 6" square and each element dissipates a full 20 watts.

Adaptions of the DURATROL Principle for Radio Voltage Control

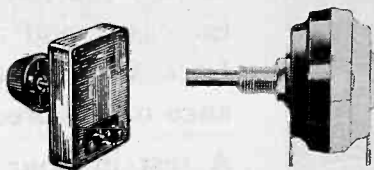

The famous Single Unit Super-Tonotrol embodying the Duratrol principle, dissipates 5 watts. (Left hand illustration.) Double unit, for manufacturers (shown on right) dissipates 3 watts. Available also in single units.

175 Varick St., New York, N. Y.

ELECTRAD

INC.

MAIL COUPON FOR DURATROL CIRCULAR
 ELECTRAD, INC., Dept. PE-7, 175 Varick St., New York, N. Y.
 Please send Duratrol Circular Super-Tonotrol Circular Electrad General Resistor Line

Manufacturer _____
 Address _____

When writing to advertisers mention of the PROCEEDINGS will be mutually helpful.

MANAGER
GENERAL



There is **NO EXCUSE** for using faulty Lock Washers!

COMPLAINTS cost money. A single dissatisfied customer can cause the loss of many future sales. No manufacturer can afford to "save money" by neglecting to protect his product against the damaging action of vibration.

Decide now to investigate Shakeproof Lock Washers. See for yourself how this positive, multiple locking principle holds any nut or screw absolutely tight. Watch the twisted teeth dig in deeper as vibration increases and then you'll know why Shakeproof Lock Washers are adding years of faithful performance to hundreds of products.

A test in your own shop tells the story. Make the trials as severe and exacting as you please. Shakeproof deserves a place on your product and is ready to prove it! Send for free samples today.

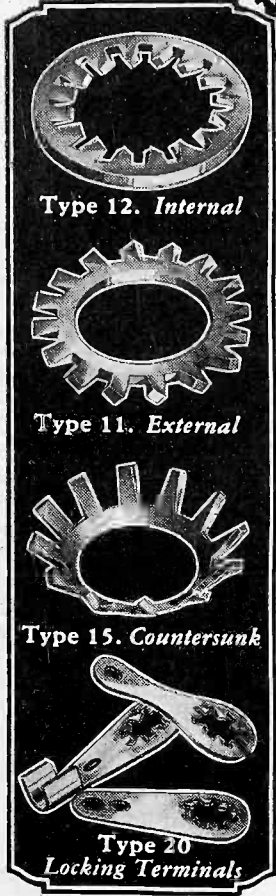

Type 12. Internal



Type 11. External



Type 15. Countersunk

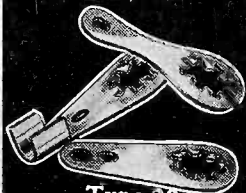

Type 20
Locking Terminals

U. S. Patents 1,419,564
1,604,122 - 1,697,954
Other patents pending.
Foreign patents.

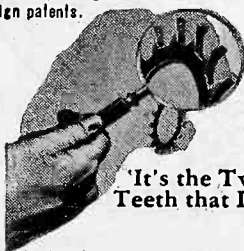

'It's the Twisted
Teeth that LOCK'

SHAKEPROOF *Lock Washer Company*

{Division of Illinois Tool Works}

2529 North Keeler Ave., Chicago, Illinois

When writing to advertisers mention of the PROCEEDINGS will be mutually helpful.

POLYMET PRODUCTS

In the Modern Radio Receiver

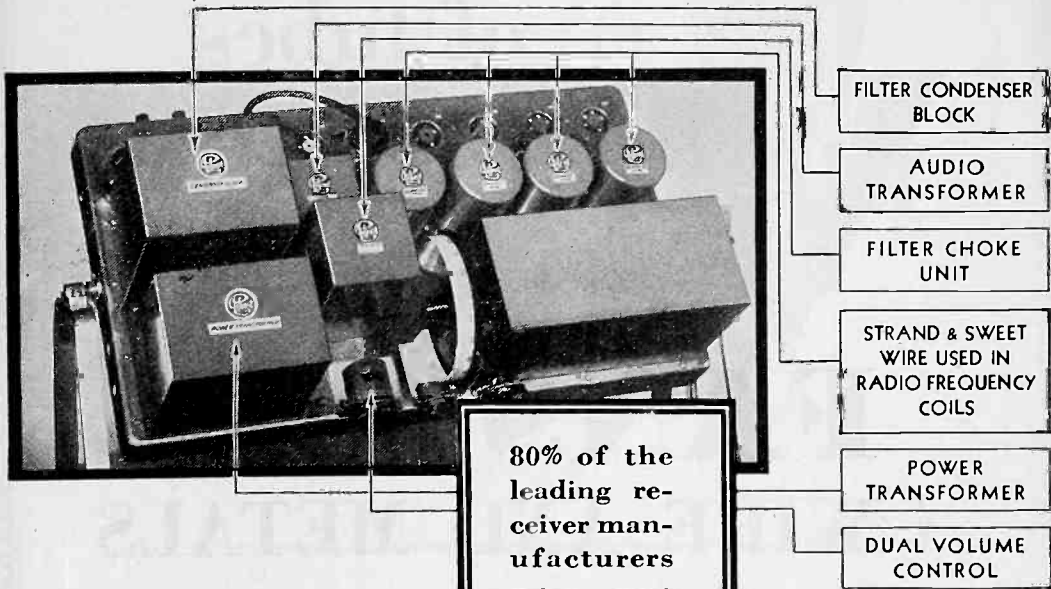

FILTER CONDENSER BLOCK

AUDIO TRANSFORMER

FILTER CHOKE UNIT

STRAND & SWEET WIRE USED IN RADIO FREQUENCY COILS

POWER TRANSFORMER

DUAL VOLUME CONTROL

80% of the leading receiver manufacturers now use standard PARTS by POLYMET

CENTER-TAPPED STRIP RESISTOR

MOLDED MICA CONDENSER

TUBULAR BY-PASS CONDENSER

MOLDED MICA CONDENSERS

BY-PASS CONDENSERS

DUAL VOLUME CONTROL

TAPPED WIRE-WOUND TUBULAR RESISTOR

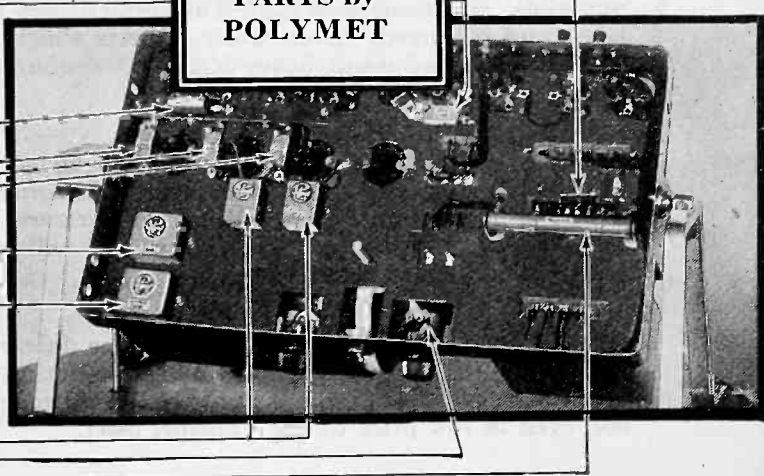

On which of the above may we submit samples or quote you prices? Catalogs and "Engineering Manual" will promptly follow your letterhead request.

Polymet Manufacturing Corporation
 829 EAST 134th STREET NEW YORK

When writing to advertisers mention of the PROCEEDINGS will be mutually helpful.

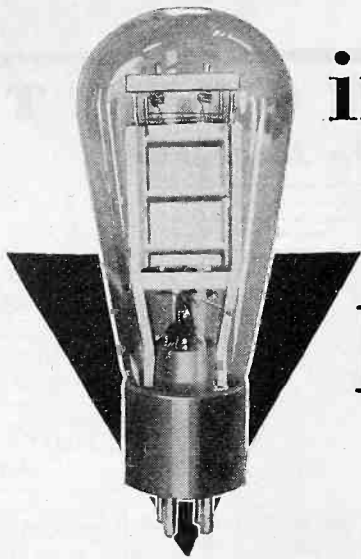

in ALL types
of tubes

IT PAYS

to use

FANSTEEL

WIRE AND METALS

It's false economy to use cheap materials in a tube merely because the tube sells at a low price. For, with cheap materials, rejections run high—meaning losses of material, labor and overhead. Even worse, defects which crop out in performance may mean heavy losses in reputation and good will.

Fansteel Tantalum is absolutely the *best metal obtainable** for grids, plates and support members. It forms and welds easily, it holds its form under high temperatures, it requires no elaborate treatment, it is gas-free, and will absorb gases liberated by other metals.

While Tantalum may cost a little more, the difference is more than saved in lowered rejections and elimination of treating operations. Longer life and improved performance make its use, even in low price tubes, a distinct asset.

*Let us prove this to you. Write today for samples of Tantalum—better still, ask for an engineer to call.

**FANSTEEL PRODUCTS
COMPANY, Inc.
NORTH CHICAGO, ILLINOIS**

When writing to advertisers mention of the PROCEEDINGS will be mutually helpful.

TANTALUM · · · TUNGSTEN · · · MOLYBDENUM · · · CAESIUM · · · RUBIDIUM

TANTALUM · · · TUNGSTEN · · · MOLYBDENUM · · · CAESIUM · · · RUBIDIUM

RADIO ENGINEERS
specify
VITREOSIL

(Fused Pure Silica and Quartz)

Insulation for Heater Type AC Tubes
Heat Treating Tubes for Metal Parts
Optical Details for Television

OBTAINING: Homogeneity; Impermeability; Freedom from Gas; Lowest Expansion; High Electrical Resistance; Freedom from Impurities.

And in TRANSPARENT VITREOSIL Best Transmission of Visible, Ultra-Violet and Infra-Red Rays.

AVAILABLE SHAPES: Transparent Lenses, Prisms, Bulbs, etc.; Rods, Plates and Special Cross Section Strips; Single and Multiple Bore Tubing in All Diameters.

WRITE STATING PROBLEM

THE THERMAL SYNDICATE, LTD.
1716 Atlantic Avenue
Brooklyn, New York

When writing to advertisers mention of the PROCEEDINGS will be mutually helpful.

Continental Resistors

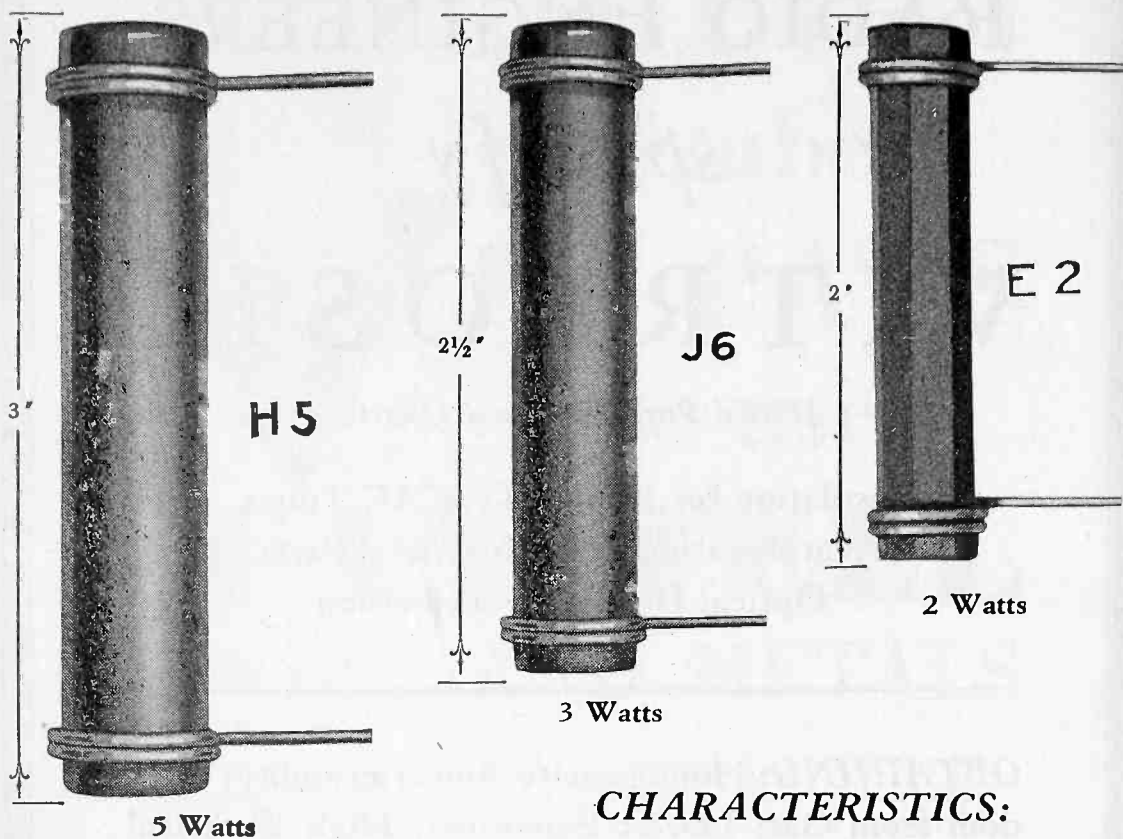

CHARACTERISTICS:

- NOISELESS
- RESISTANCE CONSTANT
- SMALL TEMPERATURE COEFFICIENT
- RUGGED
- FIRMLY SOLDERED TERMINALS
- DEPENDABLE
- COLOR CODED

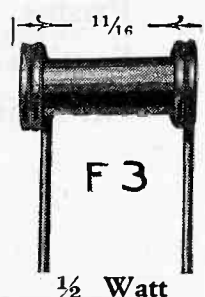
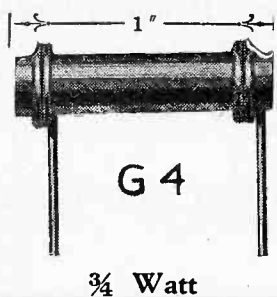
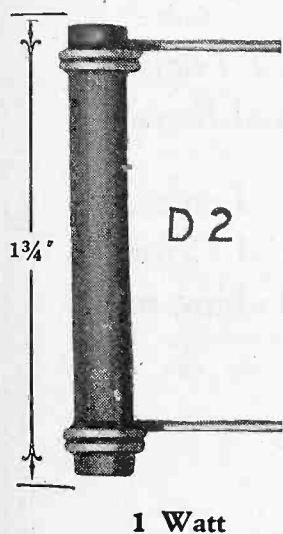

Write for Information and Prices

CONTINENTAL CARBON INC.
WEST PARK, CLEVELAND, OHIO

When writing to advertisers mention of the PROCEEDINGS will be mutually helpful.

SOLVES RADIO'S Most Distressing PROBLEM



INSURES
Perfect Operation of
A.C. Receivers Re-
gardless of Local Line
Variations

[There's a type AMPERITE
for Every Receiver Voltage
Requirement]

THE AMPERITE Self-Adjusting Line Voltage Control makes A.C. Receivers operate with the smoothness usually associated with battery sets. *Automatically* irons out line voltage fluctuations between 95 and 135 volts—thus efficiently correcting the most serious detriment to electrically-operated receivers in many communities.

AMPERITE operates to an accuracy unobtainable by any other practical means. AMPERITE reacts instantly to the slightest line

voltage changes. Operates at low wattage.

AMPERITE maintains steady volume—prevents damage to tubes and filter equipment—reduces servicing costs.

AMPERITE Self-Adjusting Line Voltage Control solves modern radio's most distressing problem. It will improve the quality of your receiver and save much free service for your dealers.

Does not add to chassis cost.

The circuit connection is shown in the diagram.

The type AMPERITE used depends upon the current drain of the set.

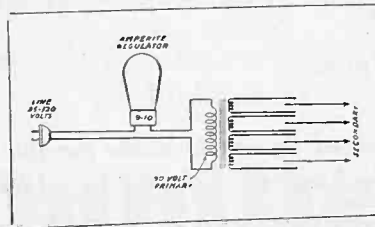

AMPERITE Corporation
561 BROADWAY, NEW YORK

AMPERITE

Self-Adjusting
LINE VOLTAGE CONTROL

MAIL COUPON FOR TECHNICAL DATA

AMPERITE CORPORATION, Dept. PE7,
561 Broadway, New York.
Please send technical data on the AMPERITE
Self-Adjusting Line Voltage Control.

Name
Manufacturer
City
State

When writing to advertisers mention of the PROCEEDINGS will be mutually helpful.

Take Your Choice

Every member of the Institute of Radio Engineers will want to wear one of these three attractive emblems. All of these emblems are appropriately colored to indicate the various grades of membership and each emblem is approximately the size of the following illustrations.



The **Lapel Button** is of 14k gold, with background enameled in the membership color, and with the lettering in gold. The screw-back on the back of this button fastens it securely to your coat.

\$2.75 postpaid—any grade.



The **Pin** is also of 14k gold. It is provided with a safety catch and is appropriately colored for the various grades of membership.

\$3.00 postpaid—any grade.



The **Watch Charm**, handsomely finished on both sides, is also of 14k gold. This charm is equipped with a suspension ring for attaching to a watch fob or chain.

\$5.00 postpaid—any grade.

Orders, accompanied by checks made payable to the Institute of Radio Engineers, should be addressed to

THE INSTITUTE OF RADIO ENGINEERS

33 West 39th Street

NEW YORK CITY, N. Y.

Send in your order now!

When writing to advertisers mention of the PROCEEDINGS will be mutually helpful.

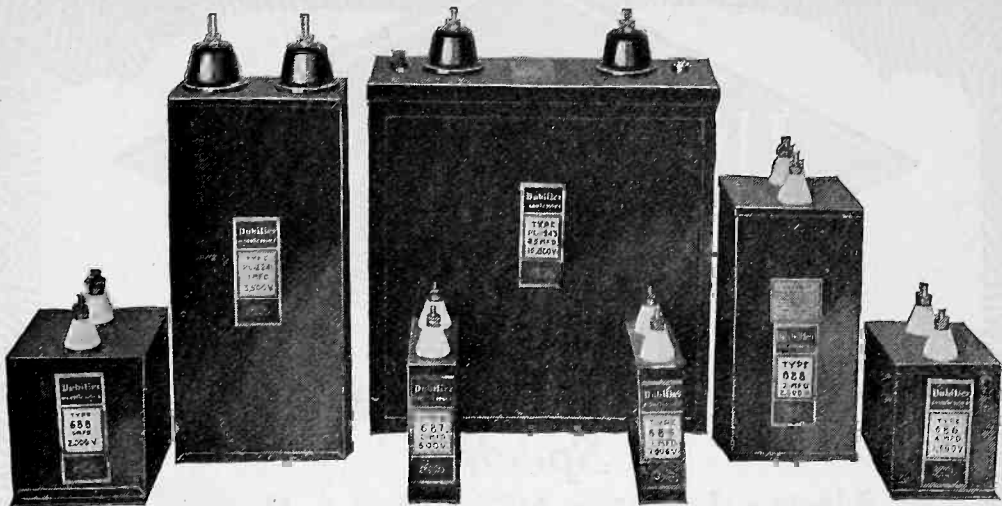

Type	Capacity	D.C. Working Voltage
PL-1943	.25 Mfd.	10,000
PL-2170	1. Mfd.	6,000
PL-2240	1. Mfd.	5,000
PL-2241	1. Mfd.	3,500
PL-2242	2. Mfd.	3,500
Type 688	1. & 2. Mfd.	2,000
Type 687	2. & 4. Mfd.	600
Type 686	1., 2., & 4. Mfd.	1,000

(Any condenser will be specially made to meet special needs)

Leadership

in condenser-art is again evidenced here.

This is a group of types developed to meet today's demands in high-powered radio telegraph and telephone circuits.

Internal construction embodies radical changes over other makes, resulting in improved electrical characteristics and in safety factors which insure that

"You can forget the condensers if they are Dubeliers".

Dubilier

CONDENSER CORPORATION

342 Madison Avenue
New York, N. Y.

When writing to advertisers mention of the PROCEEDINGS will be mutually helpful.



For Exacting Condenser Service
Specify
United Scientific Type S. G.

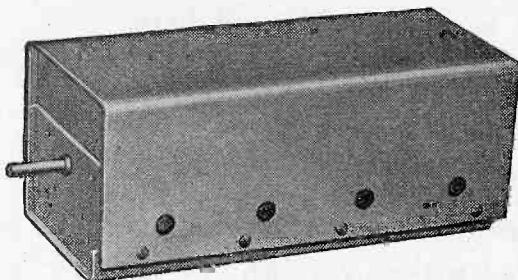
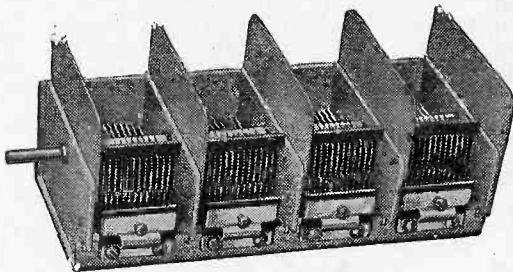

- ★ The completely shielded stators with section shields protruding beyond the grid ends of the stators eliminate every possibility of coupling.
- ★ Individually grounded rotor wipe phosphor bronze contacts.
- ★ Extra heavy steel frame rigidly reinforced by section separators.
- ★ Minimum compensators of novel construction have a ground potential on the adjusting screw. This greatly facilitates balancing because the process of balancing is not effected by screw driver or hand capacity.
- ★ Three brass bearings, including center bearing, are line reamed to assure smooth rotor action and long life.
- ★ Bosses are arranged so that the condenser can be mounted either on bottom or side.
- ★ All metal parts are heavily cadmium plated to prevent tarnish and corrosion.
- ★ Fully enclosed heavy drawn dust-proof cover adds additional rigidity to entire assembly.
- ★ Uniform precision spacing of rotors and stators permits tracking to within 1/2% on any part of the scale.

Write for a Sample, Prices, and More Complete Information

UNITED SCIENTIFIC LABORATORIES, Inc.

115-C Fourth Avenue, New York City

Branch Offices for Your Convenience in

St. Louis
 Chicago
 Boston
 Minneapolis
 Cincinnati



Los Angeles
 Philadelphia
 San Francisco
 London, Ontario

When writing to advertisers mention of the PROCEEDINGS will be mutually helpful.

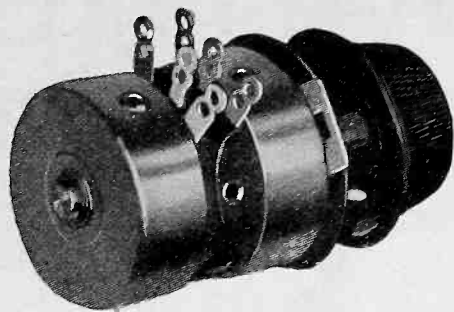

What are your needs?

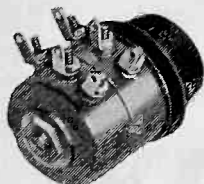

No. 590—590

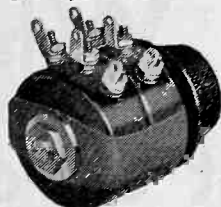

No. 2880—2880

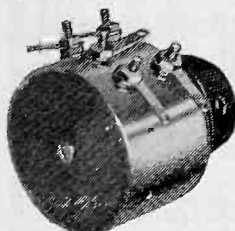

No. 890

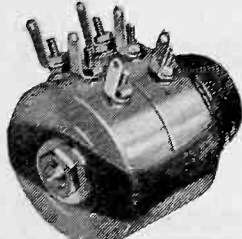

No. 280—280

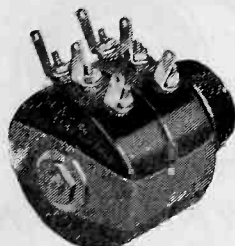

No. 1880—1880

Your volume control requirements no doubt are unusually exacting. Unless a variable resistor precisely meets your needs it will not prove suitable. "Almost" and "nearly" are not a part of your specifications. Absolute exactness alone will satisfy the curve you have established.

If this is the case we suggest you get in touch with us. We have been building variable high resistors for a number of years and during this time have met some of the most exacting requirements of the radio industry. We confidently believe we can meet yours also.

Frost units are famous for smoothness of operation, noiselessness and almost total absence of wear. They are not affected by changes of temperature or by variations in the moisture content of the air.

We make Frost units in two general types and in a wide variety of styles and sizes as well as in combinations of both types. We invite inquiries from manufacturers who have not yet solved their volume control problems but would like to do so.

HERBERT H. FROST, Inc.
Main Offices and Factory: ELKHART, IND.
160 North La Salle Street, Chicago

When writing to advertisers mention of the PROCEEDINGS will be mutually helpful.

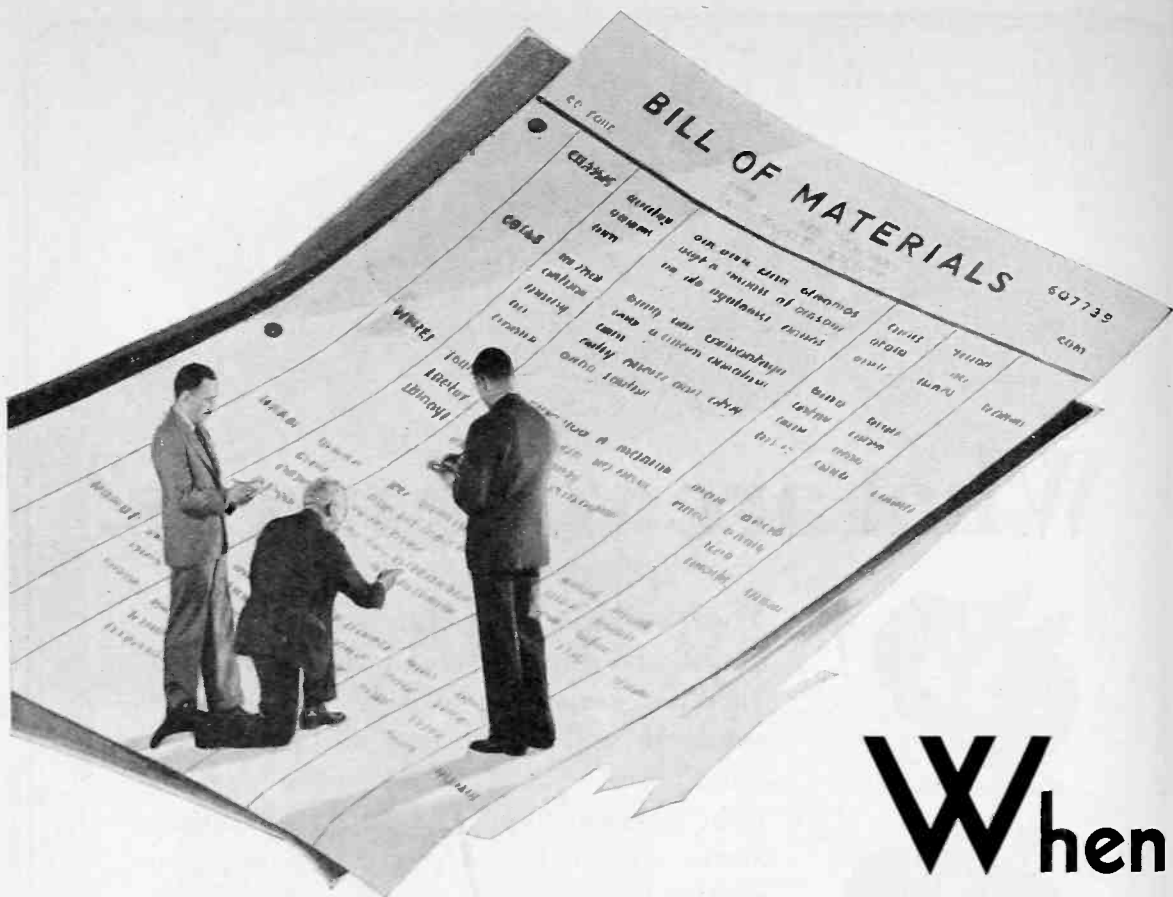

When production costs must be cut

Dudlo's highly specialized engineers are most helpful. Their recommendations lead to important savings on magnet wire wound coils or to equally important economies in the handling of Dudlo Magnet Wire.

Dudlo's self-imposed high standard of quality insures the durability of your finished product . . . *at lowest cost.*

Engineering and manufacturing thoroughness make Dudlo the preferred source of supply for Coils and Magnet wire.

DUDLO

DUDLO MANUFACTURING COMPANY, FORT WAYNE, INDIANA
Division of General Cable Corporation

When writing to advertisers mention of the PROCEEDINGS will be mutually helpful.

DISTINCTLY DIFFERENT

WHEN leading set designers and engineers endorse RCA Radiotrons as being the best, there must be a reason. That reason is quality of product and dependability of operation. It is unprofitable to take chances with inferior products. Use RCA Radiotrons and know you're right. And, if you have special problems, bring them to RCA Radiotron engineers, who are always glad to help you.

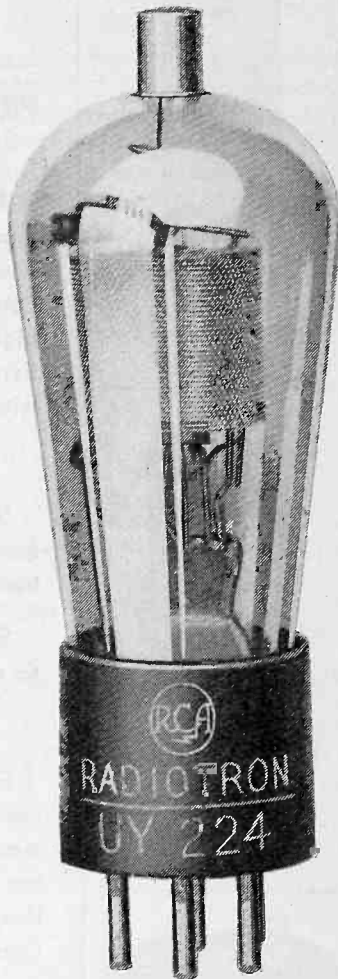

RCA RADIOTRON CO., INC. ~ HARRISON, N. J.

RCA Radiotrons

« « The Heart of Your Radio Set » »

When writing to advertisers mention of the PROCEEDINGS will be mutually helpful.

Standard Types
MERSHON
ELECTROLYTIC
Filter Condenser



Single Anode
Inverted



Single Anode
Upright



Multiple Anode
Upright

HAS LOWERED THE COST
and
ENHANCED THE EFFECTIVENESS
of the products of
a steadily increasing number of
PROMINENT RADIO MANUFACTURERS

The rapidly growing recognition, by prominent radio engineers, of the many advantages offered by the Mershon Electrolytic Condenser employed in power-converters of radio receivers, power-amplifiers and high-voltage transmitters, is a direct result of the inherent goodness of the product alone. Each year has witnessed a larger application of this unit.

Standard Mershon Electrolytic Condensers are manufactured in several sizes and arrangement of electrodes, to fit the conditions of their employment.

Special types, also, are constantly being developed to meet unusual conditions of use.

Engineers who are interested in the development, construction and operation of power-converter equipment will find profitably interesting information regarding Electrolytic Condensers and their applications in the pocket-sized edition of "Puncture Proof Filter Condensers."

You are invited to write for it.

The services of Mershon trained engineers, also, are available to manufacturers, for the asking, in assisting with specific filter problems.

(Sole Manufacturer of the Mershon Electrolytic Condenser)

THE AMRAD CORPORATION

280 COLLEGE AVENUE

MEDFORD HILLSIDE, MASS.

When writing to advertisers mention of the PROCEEDINGS will be mutually helpful.

The Institute of Radio Engineers

Incorporated

33 West 39th Street, New York, N. Y.

APPLICATION FOR ASSOCIATE MEMBERSHIP

(Application forms for other grades of membership are obtainable from the Institute)

To the Board of Direction
Gentlemen:

I hereby make application for Associate membership in the Institute.

I certify that the statements made in the record of my training and professional experience are correct, and agree if elected, that I will be governed by the constitution of the Institute as long as I continue a member. I furthermore agree to promote the objects of the Institute so far as shall be in my power, and if my membership shall be discontinued will return my membership badge.

Yours respectfully,

.....
(Sign with pen)

.....
(Address for mail)

.....
(Date)

.....
(City and State)

References:

(Signature of references not required here)

Mr. Mr.

Address Address

Mr. Mr.

Address Address

Mr.

Address

The following extracts from the Constitution govern applications for admission to the Institute in the Associate grade:

ARTICLE II—MEMBERSHIP

Sec. 1: The membership of the Institute shall consist of: * * * (d) Associates, who shall be entitled to all the rights and privileges of the Institute except the right to hold the office of President, Vice-president and Editor. * * *

Sec. 5: An Associate shall be not less than twenty-one years of age and shall be: (a) A radio engineer by profession; (b) A teacher of radio subjects; (c) A person who is interested in and connected with the study or application of radio science or the radio arts.

ARTICLE III—ADMISSION

Sec. 2: * * * Applicants shall give references to members of the Institute as follows: * * * for the grade of Associate, to five Fellows, Members, or Associates; * * * Each application for admission * * * shall embody a concise statement, with dates, of the candidate's training and experience.

The requirements of the foregoing paragraph may be waived in whole or in part where the application is for Associate grade. An applicant who is so situated as not to be personally known to the required number of members may supply the names of non-members who are personally familiar with his radio interest.

High Voltage Power Supply Systems for Radio Transmission

WHERE a source of high voltage direct current is required, the hot cathode mercury vapor rectifier is pre-eminent in convenience, reliability, and economy.

This recent development in rectifiers is now available in complete power supply units which operate from any standard source of alternating current and deliver filtered direct current suitable for supplying radio telephone, telegraph, or television transmitters.

The absence of moving parts insures noiseless operation and allows for a maximum safety factor without space limitation.

Ample dimensions in transformers and retard coils provide exceptionally fine regulation under varying loads.

Rectifier units can be furnished to deliver up to 10,000 volts at current values of 3 amperes or less.

Write for bulletin stating requirements.

R. C. POWELL & CO., Inc.

350 Madison Ave.
NEW YORK CITY

*Engineers specializing in radio
telephone equipment.*

Volume Controls

TO vary the intensity of the faithful reproduction built into radio receivers without introducing noise or distortion, can only be accomplished by a careful and complete consideration of both mechanical and electrical features of the volume control.

Mechanically—The Centralab exclusive and patented rocking disc contact precludes any possibility of wear on the resistance material. This feature adds to the smoothness of operation since the contact shoes ride only on the disc. The shaft and bushing are completely insulated from the current carrying parts—eliminating any hand capacity when volume control is placed in a critical circuit.

Manufactured in three sizes

Standard

Junior

Midget

*Also Double Standard
and Double Junior*

*Special Combination
Wire Wound and
Graphite Control*

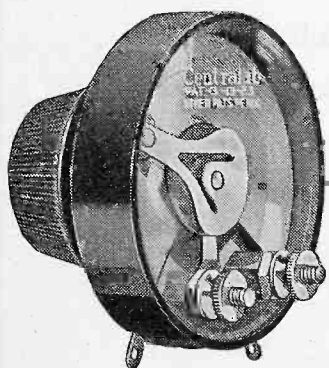

Electrically — Centralab engineers have evolved tapers of resistance that produce a smooth and gradual variation of volume. These tapers have been thoroughly tried and tested for each specific application for current carrying capacity and power dissipation.

Centralab volume controls have been specified by leading manufacturers because of their quality and ability to perform a specific duty—vary the intensity of faithful reproduction—faithfully.

*Write for full particulars of
specific application.*

Centralab
CENTRAL RADIO  LABORATORIES

36 Keefe Ave.

Milwaukee, Wis.

A CENTRALAB VOLUME CONTROL IMPROVES THE RADIO SET

When writing to advertisers mention of the PROCEEDINGS will be mutually helpful.

A SAFE GUIDE

in the selection of insulation for Radio Transmitting and Receiving Sets

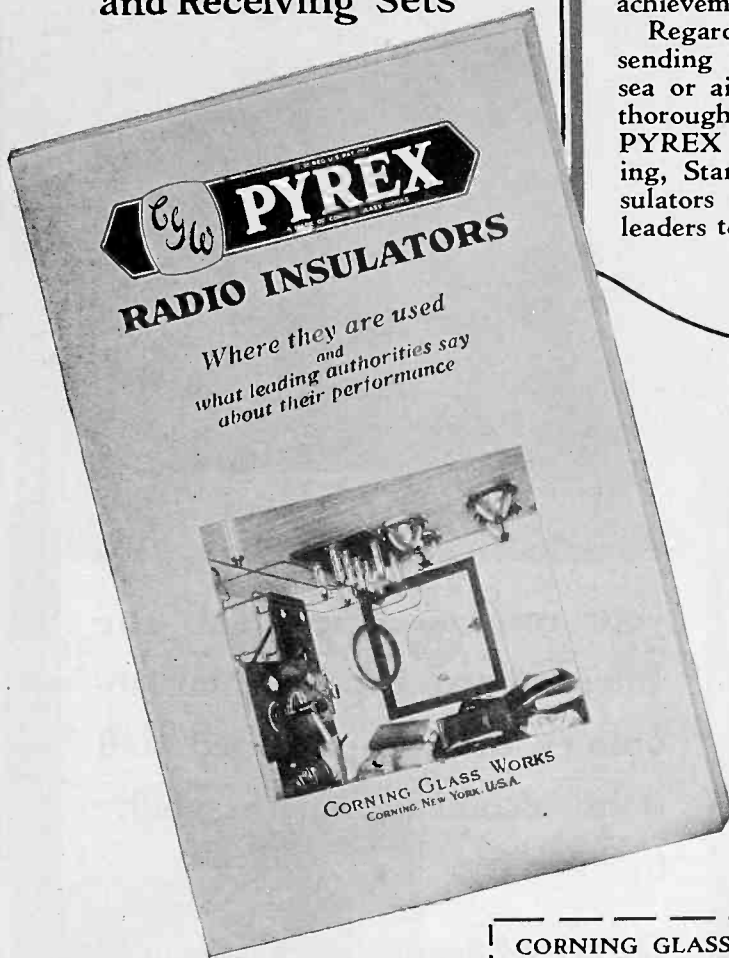

OVER 300 broadcasting stations, leading radio telegraph systems, the United States Army, Navy, Air Mail, Coast Guard and Ice Patrol Services, explorers like Commander Byrd, and exacting amateurs everywhere have utilized PYREX Insulators in many spectacular achievements.

Regardless of whether you are sending or receiving—on land, sea or airplane—you should be thoroughly familiar with the PYREX Antenna, Strain, Entering, Stand-off and Bus-bar Insulators that are helping these leaders to make radio history.

The new PYREX Radio Insulator booklet lists all types and sizes with data that you will want for ready reference.

Return the coupon for your copy, and if you want further advice on any insulation problem, our Technical Staff will answer your questions promptly.

CORNING GLASS WORKS, Corning, N. Y.

Send copy of your new bulletin on Radio Insulators

Name

Address

I. R. E. 7-30

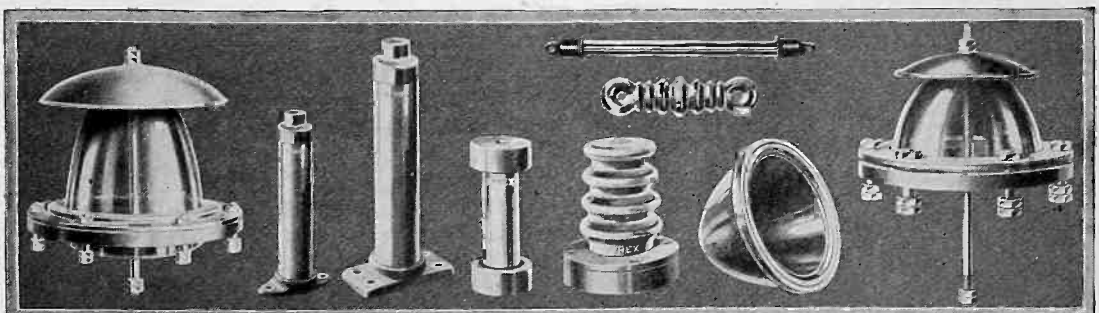

When writing to advertisers mention of the PROCEEDINGS will be mutually helpful.



WHATEVER
your resistance problem, the
International experimental lab-
oratory and its specialized staff
stand second to none in ability
to solve it.

DURHAM Resistances are made in all
values for all electrical work. Samples
and complete engineering data on re-
quest.

DURHAM
METALLIZED

RESISTORS & POWEROHMS
INTERNATIONAL RESISTANCE CO.
2006 Chestnut Street, Philadelphia, Pa.

When writing to advertisers mention of the PROCEEDINGS will be mutually helpful.



The chemistry of molded radio resistors is extremely complex. Chemists are constantly checking every manufacturing process.

Thousands of resistors are tested continuously in these large test racks under all conditions of load, moisture and temperature.

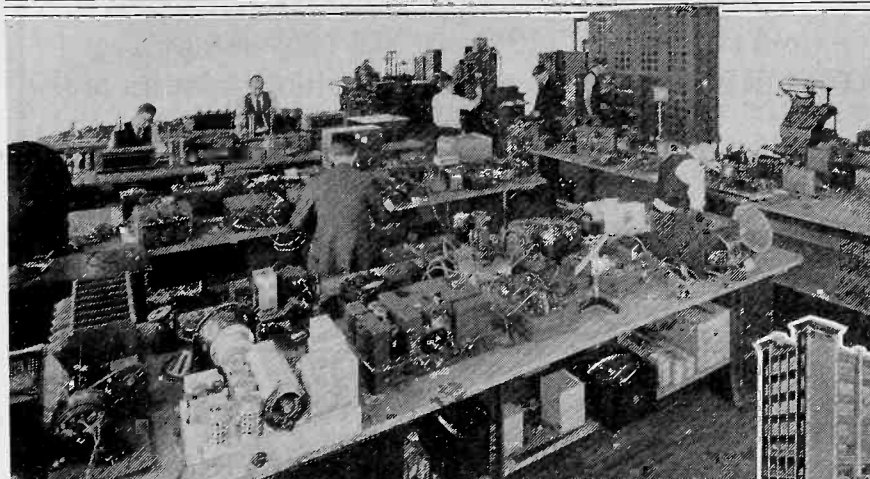
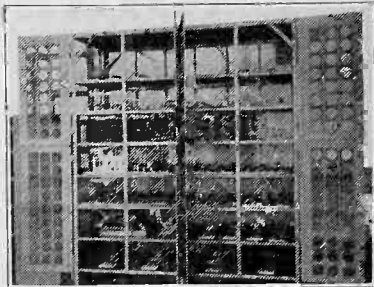

The Allen-Bradley Factory at Milwaukee, Wisconsin.

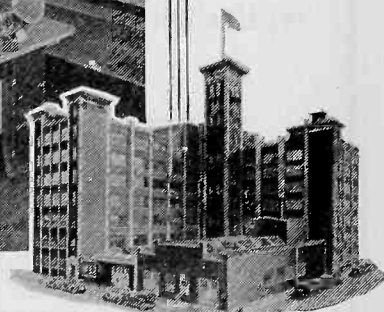

25 Years of Intensive Research are behind the reliable performance of Bradleyunits

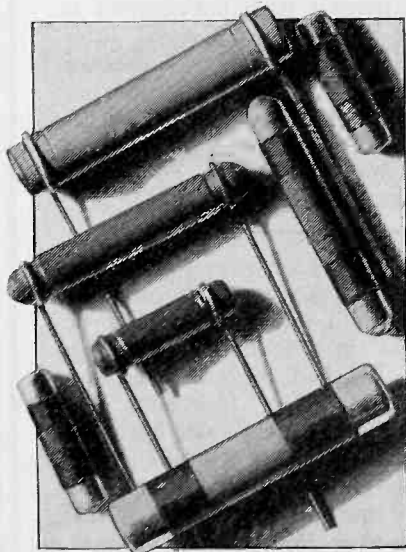

RESearch is the key to successful production, each year, of millions of reliable Bradleyunits. Allen-Bradley Research Laboratories have expended a tremendous amount of time and money investigating resistor materials and their characteristics. Extensive life tests have revealed the essential ingredients of permanent resistors. Incoming materials are constantly checked against rigid specifications. Intricate automatic testing equipment, designed by Allen-Bradley research engineers, assures a continuous output of uniform Bradleyunits.

Such research facilities are your best insurance of a continuous supply of reliable resistors to meet your specifications.

ALLEN BRADLEY CO., 282 Greenfield Ave., Milwaukee, Wis.

ALLEN-BRADLEY RESISTORS

Produced by the makers of Allen-Bradley Control Apparatus

When writing to advertisers mention of the PROCEEDINGS will be mutually helpful.

ENGINEERS AVAILABLE

Advertisements on this page are available only to members of the Institute of Radio Engineers. For rates and further information address the Secretary, The Institute of Radio Engineers, 33 West 39th Street, New York, N.Y.

MANUFACTURERS and others seeking radio engineers are invited to address replies to these advertisements at the Box number indicated, care the Institute of Radio Engineers. All replies will be forwarded direct to the advertiser.

ELECTRICAL ENGINEER and radio operator, graduate of foreign universities, having several years experience in development and design of radio and associated apparatus with leading American concern, in addition to very extensive training abroad, desires to make permanent connection with nationally known and well established concern in another part of the country, preferably in the Pacific northwest or in New England. Will consider work on advanced development, design or manufacturing in radio communication or its by-products. Relations with present employer satisfactory. American citizen. Single. Age 25. Box 26.

RADIO ENGINEER, thoroughly experienced in design and operation of transmitting equipment for communication, broadcast, and aircraft service. Holds responsible position with large radio manufacturer. Desires connection with large manufac-

turer or consulting engineering firm. B.S. in Engineering. Fellow, I.R.E. Age 37. Box 27.

INSPECTION AND TEST FOREMAN, formerly in charge of all factory inspection and test personnel and equipment, with background of servicing broadcast receivers. Interested in keeping down inspection costs and in building up inspection and test department for radio or electrical manufacturer. One year college. Age 25. Box 28.

ENGINEER, and former broadcast operator, with one year pioneer development in television and radio movies. Worked on design and construction of high frequency and broadcast transmitters both high and low power. Desires position installing or developing high frequency or broadcast transmitters. B.S. in E.E. in 1926. Age 26. Box 29.

When writing to advertisers mention of the PROCEEDINGS will be mutually helpful.

Piezo Electric Crystals and Constant Temperature Equipment

Piezo Electric Crystals:

We are prepared to grind Piezo Electric Crystals for POWER use to your assigned frequency in the 550 to 1500 KC band, *accurate to plus or minus 500 cycles* for \$55.00 fully mounted. Crystals for use in the HIGH FREQUENCY BROADCAST BAND (4000 to 6000 KC) for POWER use, accurate to plus or minus .03% of your assigned frequency, fully mounted, \$85.00. In ordering please specify type of tube used, plate voltage and operating temperature. All crystals guaranteed with respect to output and accuracy of frequency. Deliveries can be made within three days after receipt of order.

Constant Temperature Equipment

In order to maintain the frequency of your crystal controlled transmitter to a high degree of constancy, a high grade temperature control unit is required to keep the temperature of the crystal constant. Our unit is solving the problem of keeping the frequency within the 50 cycle variation limits. Our heater unit maintains the temperature of the crystals constant to **BETTER THAN A TENTH OF ONE DEGREE CENTIGRADE**; is made of the finest materials known for each specific purpose and is absolutely guaranteed. Price \$300.00. Further details sent upon request.

Low Frequency Standards:

We have a limited quantity of material for grinding low frequency standard crystals. We can grind them as low as *15,000 cycles*. These crystals will be ground to your specified frequency accurate to **ONE HUNDREDTH OF ONE PER CENT**. Prices quoted upon receipt of your specifications.

Scientific Radio Service

"The crystal specialists"

P. O. Box 86

Dept. R6

Mount Rainier, Md.

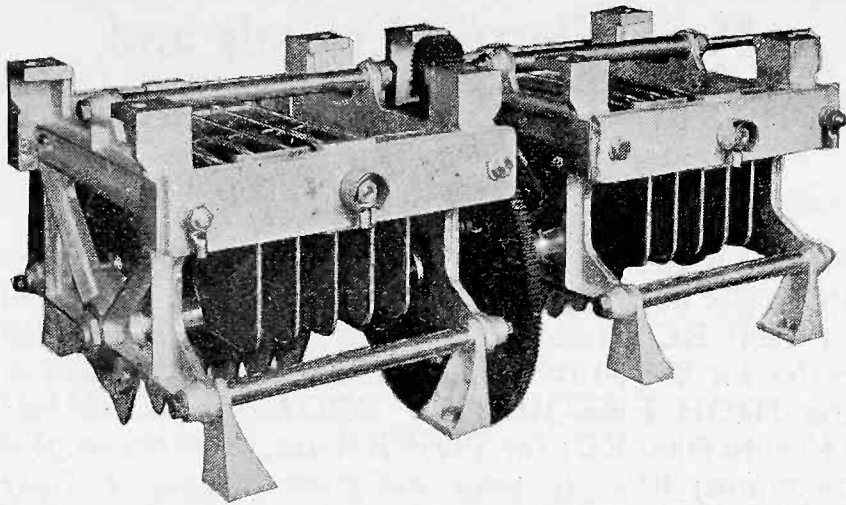

ENGINEERS KNOW *and appreciate*

Though the false economy is apparent, competition, increasingly keen, sometimes makes necessary the employment of cheaper parts than prudence dictates.

Engineers know the spur of lower production costs, but when efficiency alone dictates and there is real work to be done, the condenser that is *indubitably right*, the good Cardwell, simple, rugged and strong, receives the Engineer's appreciation and becomes his first choice.

Cardwell condensers (air dielectric) fixed and variable, are made for transmitting and receiving in many types and sizes. Your request for information will be promptly replied to.

CARDWELL CONDENSERS

THE ALLEN D. CARDWELL
MFG. CORPN.

81 PROSPECT ST. BROOKLYN, N.Y.

Since Broadcasting Began

"THE STANDARD OF COMPARISON"

When writing to advertisers mention of the PROCEEDINGS will be mutually helpful.

Compare The New "Acrakon" Electrolytic Condenser

Note These 15 Characteristics:

1. Capacity
8 mfd.
2. Peak voltage
440 volts.
3. One hole
mounting.
4. Anode connection
under chassis.
5. Compactly
built.
6. Neat
appearance.
7. Rigid internal
construction.
8. Self
healing.
9. Long
life.
10. Leakproof
construction.
11. No surface
corrosion.
12. Electrode free from gas
accumulation.
13. Leakage less than .2 mil-
liamperes per micro-
farad.
14. Low power
factor.
15. Size $1\frac{1}{2} \times 4\frac{3}{8}$ "
high.

"Acrakon" By-Pass Condensers

Over 240 combinations of capacity voltages and lug or lead arrangements are available in the complete new line of "Acrakon" By-Pass Condensers. Write today, enclosing your specifications. Our Engineering Dept. will gladly give assistance upon any condenser problem.

CONDENSER CORPORATION OF AMERICA
259-271 Cornelison Ave. Jersey City, N. J.

Factory Branches in:

CHICAGO
CINCINNATI

LOS ANGELES
TORONTO

When writing to advertisers mention of the PROCEEDINGS will be mutually helpful.

The popular 566 Vapor Rectifier at a *new* NET PRICE

Its popularity, which is due to its special cathode construction, enables us to lower the price to meet the demand of the average amateur.

TYPE 566
VAPOR RECTIFIER
NOW \$9.00

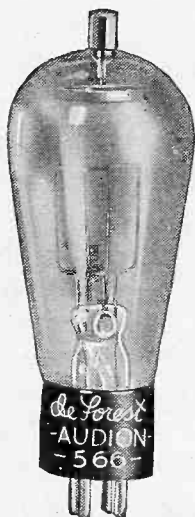

A HALF-WAVE
mercury vapor rectifier of special hot cathode construction, emitting a wave form easy to filter. Raises flash-over breakdown point to 7500 volts inverse peak. A low and practically constant voltage drop. The special

oxide coated filament insures ample emission, and the low temperature of this filament makes for long life.

THE *NEW* NET PRICES ON DE FOREST TRANSMITTING TUBES:

510- 15 Watt Oscillator.....	\$ 9.00
503A- 50 Watt Oscillator and R. F. Power Amplifier.....	30.00
511- 50 Watt Oscillator, R. F. Amplifier, modulator or R. F. Power Amplifier.....	30.00
545- 50 Watt A. F. Amplifier and Modulator.....	33.75
552- 75 Watt Oscillator and R. F. Amplifier.....	24.25
504A- 250 Watt Oscillator Modulator or R. F. Power Amplifier..	105.00
500- 500 Watt Special Oscillator..	97.50
520B- 5000 Watt Oscillator water cooled.....	187.50
565- 7½ Watt Screen Grid R. F. Amplifier.....	16.50
560- 75 Watt Screen Grid R. F. Amplifier.....	37.50
561- 500 Watt Screen Grid R. F. Amplifier.....	292.50
566- "Half wave" hot cathode mercury vapor rectifier.....	9.00
572- "Half wave" hot cathode mercury vapor rectifier.....	22.50

DE FOREST Radio Tubes, in both receiving and transmitting types, are designed by engineers whose skill and experience are a valid guarantee of precision and rugged construction.

DE FOREST RADIO COMPANY, PASSAIC, N. J.
Export Department, 304 E. 45th Street, New York City, N. Y., U. S. A.

de Forest
(AUDIONS)

RECEIVING
AND
TRANSMITTING **TUBES**

When writing to advertisers mention of the PROCEEDINGS will be mutually helpful.

ROLLER-SMITH

Type BME Tester

For No. 6 Dry Cells



Tester in Use

The Type BME No. 6 Cell Tester is offered to meet the need for an instrument with which the real condition of dry cells can be ascertained quickly in order that dead or nearly dead cells can be eliminated from groups.

As is generally known there are two ordinary methods used in checking up dry cells, neither of which is satisfactory. They are

(1) The voltage check with a voltmeter. Unsatisfactory, because a voltage reading is not a *true* indication of battery condition.

(2) The current check with an ammeter. Unsatisfactory, because an ammeter test means a "dead short" on a battery and that is not good for the battery.

The BME Tester replaces these unsatisfactory methods and enables rapid testing of cells without the need of any special knowledge on the part of the user.

The tester is built without polarity.

The terminals fit directly over the terminals of a No. 6 standard cell.

There are no loose parts. Nothing in the instrument can become demagnetized and with ordinary care the instrument should last indefinitely.

New Supplement No. 2 to Bulletin No. K-210 is now ready. Send for your copy.

Over thirty-five years' instrument experience is back of

ROLLER-SMITH COMPANY

Electrical Measuring and Protective Apparatus

Main Office:
2134 Woolworth Bldg.
NEW YORK



Works:
Bethlehem,
Pennsylvania

Offices in principal cities of U. S. A. and Canada.

When writing to advertisers mention of the PROCEEDINGS will be mutually helpful.

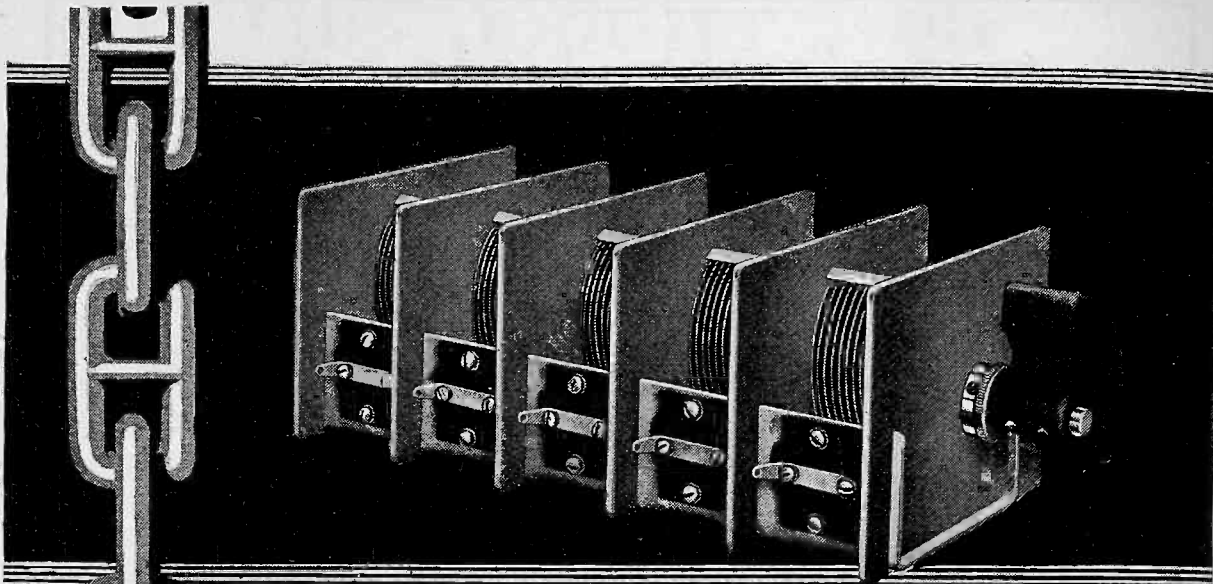

The Chain is Only as Strong . . .

IN the early days the weakest link in radio was the condenser—its inaccuracy often made tuning difficult and prevented clear reception.

Thanks to the radio engineer, the condenser is now one of the least troublesome of radio parts. But even now condensers may give dissatisfaction unless they are made by a manufacturer who knows how. Radio today is a quantity production problem and quality is not always attained where quantity and economy are also demanded.

Scovill, having worked with the radio industry from its beginnings, believes it knows how to make radio condensers and other parts both accurately and economically. Scovill quality is a byword in the industry.

Naturally, Scovill is proud of this reputation and welcomes inquiries from radio manufacturers who believe more prestige, more sales and more profits can be obtained by giving their customers the best.

SCOVILL

Established 1802

MANUFACTURING COMPANY

· WATERBURY · CONNECTICUT ·

BOSTON
ATLANTA
CHICAGO
PROVIDENCE
CLEVELAND



LOS ANGELES
NEW YORK
DETROIT
SAN FRANCISCO
PHILADELPHIA
CINCINNATI

In Europe—THE HAGUE, HOLLAND

When writing to advertisers mention of the PROCEEDINGS will be mutually helpful.



Tubing

FOR INDUCTANCES

FORMICA tubing for inductances may be had in all the sizes, machined in any way the circuit may be required.

Formica has adequate equipment to thread it, punch it, turn it in large quantities to meet difficult delivery schedules.

You can depend on tubing of excellent quality accurately machined.

Send your blue prints for quotations.

THE FORMICA INSULATION COMPANY
4636 Spring Grove Avenue
Cincinnati, Ohio



FORMICA

When writing to advertisers mention of the PROCEEDINGS will be mutually helpful.



Features of the Jewell 199

- 1 Makes every essential field test.
- 2 Endorsed by manufacturers and engineers.
- 3 Used by largest radio service organizations.
- 4 Simple to operate.
- 5 Backed by the most complete data service.
- 6 The most popular radio set analyzer.

The greatest value obtainable in a Radio Set Analyzer

IT may be possible to buy lower cost testing apparatus than the Jewell Pattern 199, but no instrument on the market today provides so much value per dollar.

The two large $3\frac{3}{4}$ inch Jewell instruments are unusually accurate and remarkably easy to read. The Jewell selective push button switches make for rapid and accurate testing. Workmanship and material of the entire set analyzer are of the best.

Jewell Pattern 199 Set Analyzers are not only accurate when received, but they withstand the hardships of service work and remain accurate.

Jewell Pattern 199's are backed by a

thorough data service which is kept up to date. When used in conjunction with Jewell Instructions for Radio Servicing and Jewell Data they eliminate guesswork and make for accurate, methodical testing.

It will pay you to recommend Jewell Pattern 199 Set Analyzers to your dealers as the best set analyzer value on the market and the correct foundation for effective and economical radio service work.

If you are not familiar with the Jewell Pattern 199, as well as the Jewell Complete Line of Radio Service Equipment, write for the new radio bulletin, "Service Equipment that Pays for Itself."

Jewell Electrical Instrument Company

1642-D Walnut Street, Chicago



When writing to advertisers mention of the PROCEEDINGS will be mutually helpful.

CHANGE IN MAILING ADDRESS OR BUSINESS TITLE

Members of the Institute are asked to use this form for notifying the Institute office of a change in their mailing address or any change in the listing of their company affiliation or title for the Year Book membership list.

The Secretary,
THE INSTITUTE OF RADIO ENGINEERS,
33 West 39th Street,
New York, N.Y.

Dear Sir:

Effective please note change in my address
(date)

for mail as follows:

FROM

.....
(Name)

.....
(Street Address)

.....
(City and State)

TO NEW ADDRESS

.....
(Street Address)

.....
(City and State)

Also for the membership list for next year's Year Book note change in my business address (or title) as follows, this ^{is} _{is not} my mailing address:

.....
(Title)

.....
(Company Name)

.....
(Address: Street, City and State)

PLEASE FILL IN, DETACH, AND POST TO THE
INSTITUTE PROMPTLY

Back Numbers of the Proceedings Available

MEMBERS of the Institute will find that back issues of the Proceedings are becoming increasingly valuable, and scarce. For the benefit of those desiring to complete their file of back numbers there is printed below a list of all complete volumes (bound and unbound) and miscellaneous copies on hand for sale by the Institute.

The contents of each issue can be found in the 1914-1926 Index and in the 1929 Year Book (for the years 1927-28).

BOUND VOLUMES:

Vols. 10 and 14 (1922-1926), \$8.75 per volume to members

Vol. 17 (1929), \$9.50 to members

UNBOUND VOLUMES:

Vols. 6, 8, 9, 10, 11 and 14 (1918-1920-1921-1922-1923-1926), \$6.75 per volume (year) to members

MISCELLANEOUS COPIES:

Vol. 1 (1913) July and December

Vol. 2 (1914) June

Vol. 3 (1915) December

Vol. 4 (1916) June and August

Vol. 5 (1917) April, June, August, October and December.

Vol. 7 (1919) February, April and December

Vol. 12 (1924) August, October and December

Vol. 13 (1925) April, June, August, October and December

Vol. 15 (1927) April, May, June, July, August, October, November and December

Vol. 17 (1929) April, May, June, July, August, September, November and December

These single copies are priced at \$1.13 each to members to the January 1927 issue. Subsequent to that number the price is \$0.75 each. Prior to January 1927 the Proceedings was published bi-monthly, beginning with the February issue and ending with December. Since January 1927 it has been published monthly.

Make remittances payable to the Institute of Radio Engineers and send orders to:

THE INSTITUTE OF RADIO ENGINEERS

33 West 39th Street

NEW YORK, N. Y.

A GREAT ORGANIZATION DEDICATED TO BUILDING THE FINEST RADIO TUBES POSSIBLE EVEREADY RAYTHEON TUBES

National Carbon Company, Inc., has no ambition to sell *all* the tubes in the industry. But it has definitely succeeded, with Eveready Raytheons, in producing the finest tubes that infinite skill and boundless facilities can assemble.

Eveready Raytheon superiority is based on the patented and exclusive *4-Pillar construction*, whereby the tube-elements are anchored at *four* points instead of the conventional *two*. This feature has the obvious advantage of safeguarding the elements against misalignment caused by the jolts of shipment, handling and installation, and by vibration from dynamic speakers.

It has the additional advantage of placing a premium on precision in the assembly of Eveready Raytheon elements. The elements are assembled on jigs, and the great accuracy thus effected is certain to be maintained under all conditions of actual usage. The result is exceptional uniformity of tube-characteristics and performance.

Another feature of this sturdy construction is the added value it gives to the exacting inspections and tests which all Eveready Raytheon Tubes must undergo. Inspection of complete cathodes, for example, is made by X-ray, to guard against partial short-circuits in heater-coils, which are exceedingly difficult to detect under ordinary test conditions.

These rigid standards produce tubes of unusual quality. And the Eveready Raytheon *4-Pillar construction*

maintains this same quality in the tubes, from the time they are shipped until they have completed their term of usefulness in the radio-set of the consumer. With Eveready Raytheons, owners of your sets are assured of tubes with remarkably uniform characteristics, and with an exceptionally high standard of performance.

Eveready Raytheons come in all types, fit every standard A. C. and battery-operated receiver, and are sold by dealers everywhere. We are glad to co-operate on any tests you may wish to make with these tubes.

National Carbon Company, Inc.

General Offices: New York, N. Y.

Branches: Chicago, Kansas City, New York, San Francisco



Unit of Union Carbide and Carbon Corporation

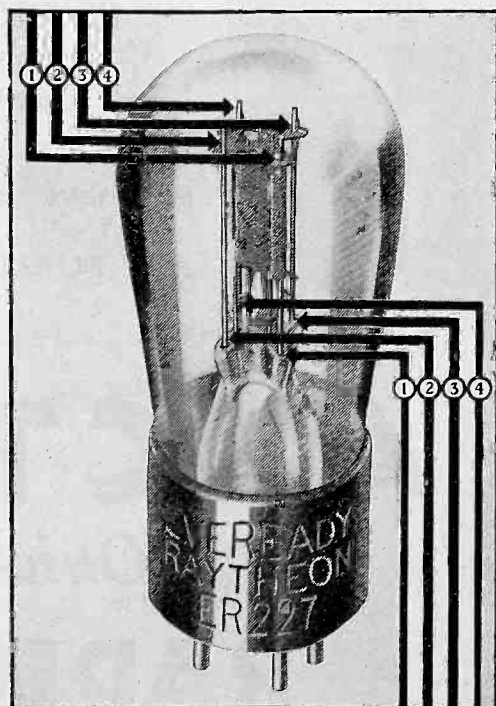

EVEREADY RAYTHEON

TRADE-MARKS

When writing to advertisers mention of the PROCEEDINGS will be mutually helpful.

Make the most of your CAREFUL ENGINEERING

by George Lewis, Vice President, Arcturus Radio Tube Company

THE best radio set designing, the most painstaking workmanship, will not and cannot insure satisfactory reception unless the tubes are right.

It's important to use dependable tubes in factory testing, and it's even more important to make sure your dealers use the right tubes in demonstrating sets.

Because Arcturus Tubes combine every feature needed to make any set perform at its best, they are the favorite demonstrating tubes of thousands of successful dealers.

They bring in programs in 7 seconds—no delay to annoy prospects or users.

Their *world's record* for long life means minimum servicing after the set is sold.

They insure clear, humless reception of any program.

Critical engineers, testing many tubes, know that these Arcturus features help to increase sales. Why not make sure that *your* sets have this *extra* selling help?



ARCTURUS RADIO TUBE COMPANY

Newark, N. J.

ARCTURUS

Quick Acting

RADIO TUBES

When writing to advertisers mention of the PROCEEDINGS will be mutually helpful.

PROFESSIONAL ENGINEERING DIRECTORY

For Consultants in Radio and Allied Engineering Fields

THE MAGNAVOX COMPANY

Oakland, Calif. & Chicago, Ill.

**PIONEERS AND SPECIALISTS
IN THE ART OF
SOUND PRODUCTION.**

**DYNAMIC SPEAKERS SINCE
1911.**

ELECTRICAL TESTING LABORATORIES

Tests of Inductances.
Condensers. Transform-
ers etc. Life and charac-
teristics of Radio Tubes

80th. Street and East End Ave.
• • NEW YORK, N.Y. • •

RADIO ENGINEERS

Ten dollars will introduce you directly to over 7,500 technical men, executives, and others with important radio interests. For details write to

Advertising Dept., I.R.E.

**The J. G. White
Engineering Corporation**

Engineers—Constructors

*Builders of New York Radio
Central*

43 Exchange Place New York

Radio



Engineers

Your card on this professional card page will give you a direct introduction to over 7,500 technical men, executives, and others with important radio interests.



Per Issue—\$10.00

When writing to advertisers mention of the PROCEEDINGS will be mutually helpful.

Alphabetical Index to Advertisements

A

Aerovox Wireless Corp.....LVI
 Allen-Bradley Co.....XXXIX
 American Tel. & Tel. Co.....XII
 American Transformer Co.....LVII
 Amperite Corp.....XXV
 Amrad Corp.....XXXII
 Arcturus Radio Tube Co.....LII

C

Cardwell, Allen D., Mfg. Corp...XLII
 Central Radio Laboratories...XXXVI
 Cohn, Sigmund.....LVIII
 Condenser Corp. of America...XLIII
 Continental Carbon Inc.....XXIV
 Cornell Electric Mfg. Co.....XIII
 Corning Glass Works.....XXXVII

D

DeForest Radio Co.....XLIV
 DeJur-Amsco Corp.....XV
 Dubilier Condenser Corp.....XXVII
 Dudlo Manufacturing Co.....XXX

E

Electrad, Inc.....XIX
 Electric Specialty Co.....XIV
 Engineers Available.....XL

F

Fansteel Products Co., Inc.....XXII
 Formica Insulation Co.....XLVII
 Frost, H. H., Inc.....XXIX

G

General Radio Co., Outside Back Cover
 Grebe, A. H., and Co., Inc.....
Inside Back Cover

I

International Resistance Co..XXXVIII
 I.R.E.....
 XXVI, XXXIII, XXXIV, XLIX, L

J

Jewell Electrical Instrument Co.....
XLVIII

N

National Carbon Co.....LI
 National Vulcanized Fibre Co...XVII

P

Pacent Electric Co.....XVIII
 Polymet Manufacturing Corp....XXI
 Powell, R. C. & Co., Inc.....XXXV
 Professional Engineering Directory
LIII

R

R.C.A. Radiotron Co., Inc.....XXXI
 Roller-Smith Co.....XLV

S

Scientific Radio Service.....XLI
 Scovill Manufacturing Co.....XLVI
 Shakeproof Lock Washer Co.....XX
 Sprague Specialties Co.....LV

T

Thermal Syndicate, Ltd.....XXIII
 Thordarson Electric Co.....XI

U

United Scientific Labs.....XXVIII

W

Ward Leonard Electric Co.....XVI

When writing to advertisers mention of the PROCEEDINGS will be mutually helpful.

The
"Little
GIANT"

Capacity
8 MFD
Peak Voltage
430 DC
Can Negative



HERE'S the real "surprise package" of the radio industry. The new, perfected Sprague electrolytic condenser—with the exclusive one-piece, rolled-edge anode—concentrating 8 MFD capacity into a space of only $1\frac{3}{8}$ " diameter and 5" long.

Individual socket mounting makes it instantly adaptable to any circuit. Protected vent integral with top prevents all liquid leakage. And because there isn't a soldered or welded joint anywhere—the Sprague gives you in practical performance the maximum of efficiency.

It has the endorsement of the leading "hams" for transmitting use (names on request). Write for information of special interest to "hams."

SPRAGUE SPECIALTIES CO.
Offices & Laboratories: Quincy, Mass.
Factories: North Adams, Mass.

SPRAGUE
Electrolytic **CONDENSER**

When writing to advertisers mention of the PROCEEDINGS will be mutually helpful.

AEROVOX

BUILT BETTER
CONDENSERS AND RESISTORS

Without A Doubt The Most Complete Line of Condensers & Resistors

NO matter what your requirements may be in the fixed condenser or resistor field, you are sure to find an Aerovox unit exactly suited to your needs.

Dry Electrolytic Condensers
Filter Condenser Blocks
Buffer Condenser Blocks
Socket Power Condensers
High Voltage Condensers
Transmitting Condensers
Bypass Condensers
"A" Power Condensers
Bakelite Moulded Mica
Condensers

Pyrohm Heavy Duty Resistors
Edison Base Pyrohm Resistors
Tapped Pyrohm Resistors
Wire Wound Resistor Units
Grid Suppressor Resistors
Center-tapped Resistor Units
Non-Inductive Lavite Resistors
Grid Leak Resistors
Resistor Mountings
Interference Filters

In addition to the large number of stock sizes of condensers and resistors, the Aerovox Wireless Corporation is equipped to supply to manufacturers special types and sizes of condensers, filter blocks and resistors in all fixed and tapped combinations on short notice.

SEND FOR COMPLETE CATALOG

Complete specifications of all Aerovox units, including insulation specifications of condensers, carrying capacities of resistors and all physical dimensions, electrical characteristics and list prices of condensers and resistors, are contained in a complete 1929-30 catalog which will be sent gladly on request.





The Aerovox Research Worker is a free monthly publication that will keep you abreast of the latest developments in radio. Your name will be put on the mailing list free of charge on request.

AEROVOX WIRELESS CORP.

80 Washington Street, Brooklyn, N. Y.

PRODUCTS THAT ENDURE





When writing to advertisers mention of the PROCEEDINGS will be mutually helpful.

New!

the

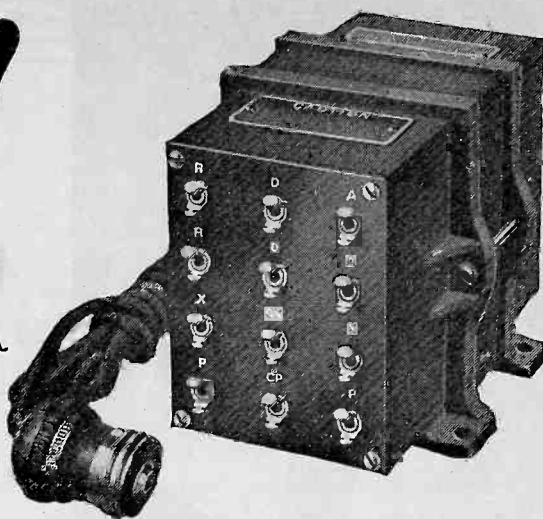
PF 245 A



AmerTran Power Transformer

Continuing its progress in the development of power transformers for all radio receiving sets the American Transformer Company announces the perfection of the new type PF245A. This new power transformer operates a radio receiver equipped with 2½ volt heater for heater type A.C. tubes and 2½ volt filament for a power tube (UX245 or CX345) which closely approaches the 210 in undistorted watts output.]

The AmerTran Power Transformer Type PF245A is designed for a 60 cycle 115 volt line source, and has a continuous rating of 100VA. with primary taps for 100—108—115—120 volts. A four point radial switch regulates the operation for different primary voltages. There are five secondary windings. Because of its lower maximum voltages, all secondary connections terminate in solder lugs attached to a bakelite terminal board.

This new, heavy duty power transformer is compact, sturdy, beautifully machined and mounted in cast iron end clamps provided with mounting feet. Like all AmerTran Transformers the PF245A is built to deliver sufficient excess voltage for maximum requirements. Fill out and mail the coupon for AmerTran Bulletin No. 1088 giving complete description of the PF245A Power Transformer.

List Price \$22. East of the Rocky Mountains.

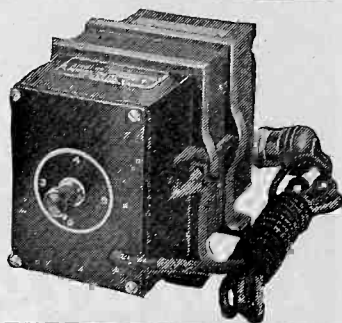

AMERTRAN

TRADE MARK REG. U.S. PAT. OFF.

AMERICAN TRANSFORMER CO.
Transformer builders for over 29 years
178 Emmet Street
Newark, N. J.

AMERICAN TRANSFORMER CO.,
178 Emmet St., Newark, N. J.

Please send me complete information on
the new PF 245A Power Transformer.

Name.....

Address.....

I.R.E. 7-30

When writing to advertisers mention of the PROCEEDINGS will be mutually helpful.

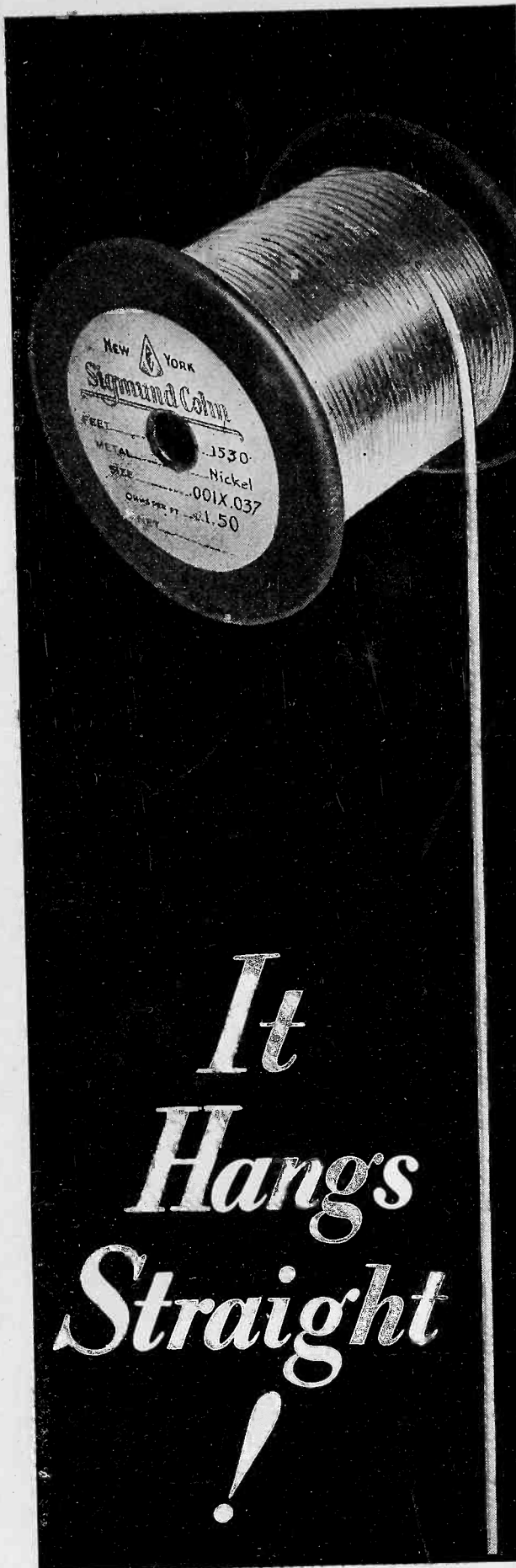

*It
Hangs
Straight
!*

**PRECISION
FILAMENT**
(Uncoated)

for
**Radio
Vacuum
Tubes**

Scientifically controlled—
chemically, physically
and electrically



A PRODUCT OF
SIGMUND COHN
44 Gold Street
New York

When writing to advertisers mention of the PROCEEDINGS will be mutually helpful.



A.H.GREBE & CO., Inc.

RICHMOND HILL, NEW YORK

**Grebe
radio**

SUPER-SYNCHROPHASE 

WESTERN BRANCH

443 South San Pedro Street

Los Angeles, California

MAKERS OF QUALITY RADIO SINCE 1909

SINCE 1915

General Radio Company has been designing and manufacturing electrical measuring instruments for use at communication frequencies (0 to several million cycles per second). A list of the most important items in the line is given below. Many of them have application outside the laboratory.

Frequency Standards and Measuring Devices—Magnetostriiction Oscillators—Piezo-Electric (Quartz) Oscillators—Wavemeters.
Vacuum-tube Oscillators—Radio-Frequencies—Audio-Frequencies
Bridges for Measuring—Resistance, Inductance, Capacitance—
Vacuum-tube Characteristics
Resistance Boxes
Precision Condensers
Calibrated Inductors
Attenuation Networks and Voltage Dividers
String Oscillograph
A-C Voltmeters—Vacuum-tube Type—Oxide-rectifier Type
Standard-Signal Generator (for radio-frequency voltage measurements)
Galvanometer Shunts
Transformers
Relays
Miscellaneous Accessories—Vacuum-tube Sockets—Rheostats and Potentiometers—Switches—Plugs, Jacks, Plug-in Mounting Bases.

Our Engineering Department publishes a monthly magazine, *The General Radio Experimenter*, for free distribution to anyone interested in technical developments in communication engineering and allied fields. A memorandum with your name, mailing address, and business affiliation will place you on the mailing list.



GENERAL RADIO COMPANY

CAMBRIDGE A, MASSACHUSETTS