

VOLUME 17

DECEMBER, 1929

NUMBER 12

PROCEEDINGS
of
**The Institute of Radio
Engineers**



General Information and Subscription Rates on Page 2090
Form for Change of Mailing Address or Business Title on Page XXXV

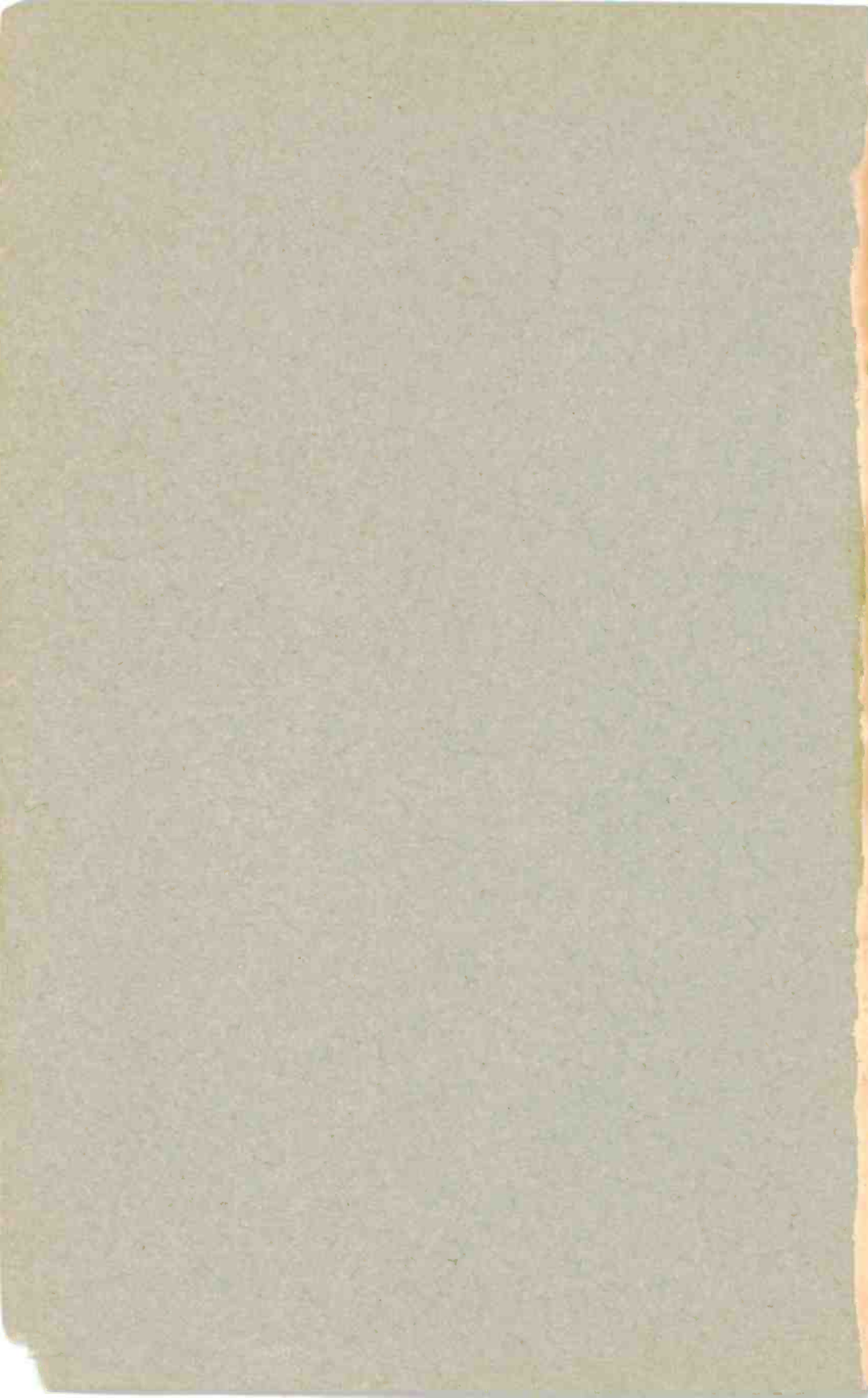

PROCEEDINGS OF
The Institute of Radio Engineers

Volume 17

December, 1929

Number 12

Board of Editors, 1929

WALTER G. CADY, *Chairman*
 STUART BALLANTINE G. W. PICKARD
 RALPH BATCHER L. E. WHITTEMORE
 CARL DREHER W. WILSON

CONTENTS

PART I

| | Page |
|---|------|
| General Information | 2090 |
| Suggestions for Contributors | 2091 |
| Institute Sections | 2092 |
| Frontispiece, George Washington Pierce | 2094 |
| Institute News and Radio Notes | 2095 |
| November Meeting of Board of Direction | 2095 |
| A Request from the Committee on Admissions | 2095 |
| Radio Standardization | 2097 |
| Meeting of the A. A. A. S. | 2100 |
| Institute Meetings | 2100 |
| Committee Work | 2107 |
| Personal Mention | 2108 |
| Geographical Location of Members Elected November 6, 1929 | 2110 |
| Applications for Membership | 2113 |
| Officers and Board of Direction | 2118 |
| Institute Committees | 2118 |

PART II

Technical Papers

| | |
|---|------|
| Typical Wireless Apparatus Used on British and European Airways, by EDWARD H. FURNIVAL | 2123 |
| Radio for the Air Transport Operator, by LESTER D. SEYMOUR | 2137 |
| The Civil Airways and Their Radio Facilities, by H. J. WALLS | 2141 |
| Applying the Visual Double-Modulation Type Radio Range to the Airways, by H. DIAMOND | 2158 |
| Radio in Aeronautics—Its Technical Status and the Organization for its Application in Germany, by F. EISNER AND H. FASSBENDER | 2185 |
| The Constants of Aircraft Trailing Antennas, by L. A. HYLAND | 2230 |
| On the Daylight Transmission Characteristics of Horizontally and Vertically Polarized Waves from Airplanes, by F. H. DRAKE AND R. M. WILMOTTE | 2242 |
| Temperature Rating of Wind-Driven Aircraft Radio Generators, by C. B. MIRICK | 2259 |
| Applying the Radio Range to the Airways, by F. G. KEAR AND W. E. JACKSON | 2268 |
| Effect of Flight on Hearing, by C. B. MIRICK | 2283 |
| Book Reviews, "Radiotechnik: VI," "Elements of Radio Communica- tion" | 2297 |
| Books Received | 2298 |
| Booklets, Bulletins, and Catalogs Received | 2298 |
| Monthly List of References to Current Radio Literature | 2299 |
| Contributors to This Issue | 2303 |
| Chronological Index to the PROCEEDINGS for 1929 | 2305 |
| Subject Index | 2311 |
| Authors' Index | 2318 |

Copyright, 1929, by the Institute of Radio Engineers

The Institute of Radio Engineers

GENERAL INFORMATION

- The PROCEEDINGS of the Institute is published monthly and contains papers and discussions thereon submitted for publication or for presentation before meetings of the Institute or its Sections. Payment of the annual dues by a member entitles him to one copy of each number of the PROCEEDINGS issued during the period of his membership.
- Subscription rates to the PROCEEDINGS for the current year are received from non-members at the rate of \$1.00 per copy or \$10.00 per year. To foreign countries the rates are \$1.10 per copy or \$11.00 per year.
- Back issues are available in unbound form for the years 1918, 1920, 1921, 1922, and 1926 at \$9.00 per volume (six issues) or \$1.50 per single issue. Single copies for the year 1928 are available at \$1.00 per issue. For the years 1913, 1914, 1915, 1916, 1917, 1918, 1924, and 1925 miscellaneous copies (incomplete unbound volumes) can be purchased for \$1.50 each; for 1927 at \$1.00 each. The Secretary of the Institute should be addressed for a list of these.
- Discount of twenty-five per cent on all unbound volumes or copies is allowed to members of the Institute, libraries, booksellers, and subscription agencies.
- Bound volumes are available as follows: for the years 1918, 1920, 1921, 1922, 1925, and 1926 to members of the Institute, libraries, booksellers, and subscription agencies at \$8.75 per volume in blue buckram binding and \$10.25 in morocco leather binding; to all others the prices are \$11.00 and \$12.50, respectively. For the year 1928 the bound volume prices are: to members of the Institute, libraries, booksellers, and subscription agencies, \$9.50 in blue buckram binding and \$11.00 in morocco leather binding; to all others, \$12.00 and \$13.50, respectively. Foreign postage on all bound volumes is one dollar, and on single copies is ten cents.
- Year Books for 1926, 1927, and 1928, containing general information, the Constitution and By-Laws, catalog of membership etc., are priced at seventy-five cents per copy per year.
- Contributors to the PROCEEDINGS are referred to the following page for suggestions as to approved methods of preparing manuscripts for publication in the PROCEEDINGS.
- Advertising rates for the PROCEEDINGS will be supplied by the Institute's Advertising Department, Room 802, 33 West 39th Street, New York, N. Y.
- Changes of address to affect a particular issue must be received at the Institute office not later than the 15th of the month preceding date of issue. That is, a change in mailing address to be effective with the October issue of the PROCEEDINGS must be received by not later than September 15th. Members of the Institute are requested to advise the Secretary of any change in their business connection or title irrespective of change in their mailing address, for the purpose of keeping the Year Book membership catalog up to date.

- The right to reprint limited portions or abstracts of the papers, discussions, or editorial notes in the PROCEEDINGS is granted on the express condition that specific reference shall be made to the source of such material. Diagrams and photographs published in the PROCEEDINGS may not be reproduced without making special arrangements with the Institute through the Secretary.
- It is understood that the statements and opinions given in the PROCEEDINGS are views of the individual members to whom they are credited, and are not binding on the membership of the Institute as a whole.
- All correspondence should be addressed to the Institute of Radio Engineers, 33 West 39th Street, New York, N. Y., U. S. A.
- Entered as second class matter at the Post Office at Menasha, Wisconsin.
- Acceptance for mailing at special rate of postage provided for in the Act of February 28, 1925, embodied in paragraph 4, Section 412, P. L. and R. Authorized October 26, 1927.

Published monthly by

THE INSTITUTE OF RADIO ENGINEERS, INC.

Publication office, 450-454 Ahnaip Street, Menasha, Wis.

BUSINESS, EDITORIAL, AND ADVERTISING OFFICES,

33 West 39th St., New York, N. Y.

SUGGESTIONS FOR CONTRIBUTORS TO THE PROCEEDINGS

Preparation of Paper

Form—Manuscripts may be submitted by member and non-member contributors from any country.

To be acceptable manuscripts should be in final form for publication and accompanied by a summary of from 100 to 300 words. Papers should be typed double space with consecutive numbering of pages. Footnote references should be consecutively numbered and should appear at the foot of their respective pages. Each reference should contain author's name, title of article, name of journal, volume, page, month, and year. Generally, the sequence of presentation should be as follows: statement of problem; review of the subject in which the scope, object, and conclusions of previous investigations in the same field are covered; main body describing the apparatus, experiments, theoretical work, and results used in reaching the conclusions and their relation to present theory and practice; bibliography. The above pertains to the usual type of paper. To whatever type a contribution may belong, a close conformity to the spirit of these suggestions is recommended.

Illustrations—Use only jet black ink on white paper or tracing cloth. Cross-section paper used for graphs should not have more than four lines per inch. If finer ruled paper is used, the major division lines should be drawn in with black ink, omitting the finer divisions. In the latter case, only blue-lined paper can be accepted. Photographs must be very distinct, and must be printed on glossy white paper. Blueprinted illustrations of any kind cannot be used. All lettering should be $\frac{3}{16}$ in. high for an 8 x 10 in. figure. Legends for figures should be tabulated on a separate sheet, not lettered on the illustrations.

Mathematics—Fractions should be indicated by a slanting line. Use standard symbols. Decimals not preceded by whole numbers should be preceded by zero, as 0.016. Equations may be written in ink with subscript numbers, radicals, etc., in the desired proportion.

Abbreviations—Write a.c. and d.c., (a-c and d-c as adjectives), kc, μ f, $\mu\mu$ f, e.m.f., mh, μ h, henries abscissas, antennas. Refer to figures as Fig. 1, Figs. 3 and 4, and to equations as (5). Number equations on the right in parentheses.

Summary—The summary should contain a statement of major conclusions reached, since summaries in many cases constitute the only source of information used in compiling scientific reference indexes. Abstracts printed in other journals, especially foreign, in most cases consist of summaries from published papers. The summary should explain as adequately as possible the major conclusions to a non-specialist in the subject. The summary should contain from 100 to 300 words, depending on the length of the paper.

Publication of Paper

Disposition—All manuscripts should be addressed to the Institute of Radio Engineers, 33 West 39th Street, New York City. They will be examined by the Committee on Meetings and Papers and by the Editor. Authors are advised as promptly as possible of the action taken, usually within one month.

Proofs—Galley proof is sent to the author. Only necessary corrections in typography should be made. *No new material is to be added.* Corrected proofs should be returned *promptly* to the Institute of Radio Engineers, 33 West 39th Street, New York City.

Reprints—With the galley proof a reprint order form is sent to the author. Orders for reprints must be forwarded promptly as type is not held after publication.

INSTITUTE SECTIONS

| <i>Chairmen</i> | ATLANTA | <i>Secretaries</i> |
|----------------------|--------------------|--|
| H. P. Thornton | | |
| | BOSTON | |
| George W. Pierce | | Melville Eastham, 30 State St., Cambridge, Mass. |
| | BUFFALO-NIAGARA | |
| L. Grant Hector | | E. C. Waud, 235 Huntington Ave. Buffalo, N. Y. |
| | CHICAGO | |
| H. E. Kranz | | J. H. Miller, Jewell Electrical Inst. Co., 1650 Walnut St., Chicago, Ill. |
| | CINCINNATI | |
| R. H. Langley | | W. W. Boes, 622 Broadway, Cincinnati, Ohio |
| | CLEVELAND | |
| Bruce W. David | | D. Schregardus, Ohio Bell Tel. Co., 750 Huron Road, Cleveland, Ohio |
| | CONNECTICUT VALLEY | |
| Q. A. Brackett | | F. C. Beekley, 96 S. Main St., W. Hartford, Conn. |
| | DETROIT | |
| A. B. Buchanan | | W. R. Hoffman, 615 West Lafayette Blvd., Detroit, Mich. |
| | LOS ANGELES | |
| Thomas F. McDonough | | W. W. Lindsay, Jr., 1348 Club View Drive, Los Angeles, Calif. |
| | NEW ORLEANS | |
| Pendleton E. Lehde | | Anton A. Schiele, 1812 Masonic Temple, New Orleans, La. |
| | PHILADELPHIA | |
| J. C. Van Horn | | <i>Acting Secretary</i> E. T. Darlington, 2848 Idaho Road, Camden, N. J. |
| | PITTSBURGH | |
| L. A. Terven | | T. D. Cunningham, 513 Holmes St., Wilkesburg, Pa. |
| | ROCHESTER | |
| E. C. Karker | | A. R. Barfield, Valley Appliances, Inc. Rochester, N. Y. |
| | SAN FRANCISCO | |
| Donald K. Lippincott | | Paul R. Fenner Custom House, San Francisco, Calif. |
| | SEATTLE | |
| Austin V. Eastman | | Abner R. Willson, 8055-14th Ave., N. E., Seattle, Wash. |
| | TORONTO | |
| V. G. Smith | | G. E. Pipe, 90 Chestnut St., Toronto, Canada |
| | WASHINGTON | |
| C. B. Jolliffe | | J. B. Brady, Ouray Bldg., Washington, D. C. |



GEORGE WASHINGTON PIERCE
President of the Institute, 1918 and 1919

George Washington Pierce was born in Webberville, Texas, January 11, 1872. He received the B.Sc. degree, University of Texas, 1893; M.A. degree, 1894; Harvard, 1898-1900, A.M. degree, 1899, Ph.D. degree, 1900; Leipzig, 1900-01. Asst. professor of physics, 1907-17; professor, 1917-21; Rumford professor, 1921 to date, Harvard University. Director of the Cruft High Tension Electrical Laboratory, 1914 to date; chairman of the Division of Physical Sciences, Harvard, 1927 to date. Fellow of the American Academy of Arts and Sciences; member of the National Academy of Sciences, American Physical Society, American Institute of Electrical Engineers, Deutsche Physikalische Gesellschaft, American Acoustical Society, Inventors' Guild; Fellow and twice president of the Institute of Radio Engineers. Author of "The Principles of Wireless Telegraphy," 1910; "Electric Oscillations and Electric Waves," 1920; and of papers on crystal rectifiers, sound, electrical resonance, electric waves, transmission lines, theory of the antenna, piezo-electric crystal control of frequency, and applications of magnetostriction to frequency control and to the production and detection of sound. Inventor of devices for submarine signalling, vacuum-tube detectors, frequency control apparatus, etc.

INSTITUTE NEWS AND RADIO NOTES

November Meeting of Board of Direction

The regular monthly meeting of the Board of Direction of the Institute was held on November 7, 1929 in the offices of the Institute.

Those present were: W. G. Cady, acting chairman; Melville Eastham, treasurer; John M. Clayton, secretary; Arthur Batcheller, R. A. Heising, L. M. Hull, R. H. Manson, and R. H. Marriott.

The following were transferred or elected to the higher grades of membership in the Institute:

Transferred to the Fellow grade: R. H. Langley, W. D. Terrell, and Balth. van der Pol. Transferred to the Member grade: C. S. Agate, G. L. Beers, H. A. Brown, I. S. Coggeshall, H. I. Danziger, H. B. Deal, W. F. Diehl, Malcolm Ferris, H. C. Forbes, J. K. Hilliard, A. V. Loughren, J. R. Nelson, E. B. Ferrell, and O. W. Towner. Elected to the Member grade: Arthur S. Fish, J. Plebanski, T. C. Rives, and D. M. Sokolcow.

One hundred and thirteen Associate members and six Junior members were elected.

K. W. Wagner, president of the Electrotechnical Association, with headquarters at Berlin, invited the Institute to appoint a representative to the fiftieth anniversary celebration of the Association to be held in Berlin in January, 1930. The Board accepted the invitation, nominating Vice-President Alexander Meissner as the Institute's representative.

Melville Eastham has been appointed a member of the Radio Broadcasting Committee of the American Engineering Council.

A Request from the Committee on Admissions

The Institute of Radio Engineers has attained a high standing among engineering societies through the quality of its publications and the calibre of its membership. The Committee on Admissions is charged with the important responsibility of maintaining proper standards of membership. The Committee feels it to be important to every member of the Institute that the standards of membership, set by the Constitution, be maintained.

The Committee on Admissions occasionally experiences difficulty in passing upon applications for the higher grades of membership

because of great reluctance on the part of many references to state frankly and fully their knowledge and opinions concerning the applicant. There seems to be a disinclination to say anything about the applicant unless he can be recommended highly. It is in such uncertain cases that the Committee particularly needs the assistance of every reference. The Committee cannot take the failure to return the reference blank as non-indorsement since there are many cases where such a course would do great injustice to the applicant. This condition does not hold among our British members. A healthy critical attitude prevails that has been of great help to the Committee. This desirable attitude is prevalent in England and has been instrumental in maintaining the high standards of their engineering societies. The development of such an attitude is absolutely necessary if the Institute wishes to maintain or improve its standards of membership. The Committee earnestly requests all references to be sure to reply and, for the good of the Institute, to express themselves frankly and honestly regardless of personal or business relations. All replies from references are kept in the strictest confidence by the Committee.

January, 1930, New York Meeting

Since the normal date of the New York meeting in January next falls on the first of the month, this meeting will be changed to Wednesday, January 8th.

1930 Membership Dues

It is planned that bills for members' dues for 1930 will be in the mails shortly before January 1st. Prompt payment of these bills will insure the regular receipt of the PROCEEDINGS and other Institute publications, and, due to the small office staff and limited bookkeeping facilities, will be of great assistance to the Institute office.

Change in Business Title

Members are advised that any change in their business title from that shown in the 1929 Year Book should be communicated to the Secretary of the Institute immediately if he has not been advised thereof previously. The catalog of membership in the 1930 Year Book comprises the names and addresses of the paid membership as of

December 31, 1929. Changes in mailing address, business address, or business title will not appear in the 1930 book unless received at the Institute office by December 31st. A form for notification of change in address is published monthly in the advertising section of the PROCEEDINGS. It will be found on page xxxv of this issue.

Radio Standardization

While the members of the Institute know that a considerable amount of standardization work is in progress, they may not have a very extensive knowledge of the important part the Institute is playing in this field.

There are, in general, four major bodies keenly interested in standardization in the radio field. These are the American Standards Association, the Institute of Radio Engineers, the Radio Division of the National Electrical Manufacturers' Association, and the Radio Manufacturers' Association.

In 1918, five of the major engineering societies decided it would be extremely desirable to have an organization whose chief duties it would be to encourage and coordinate standardization in the engineering field, to determine upon suitable methods of procedure which would entail the minimum loss of time and effort commensurate with a high standard of accuracy and suitability of the standards formulated, and which would maintain sufficient supervision of the process of developing and promulgating standards to insure that those which received its approval were truly representative of all those in the industry having a vital interest in the subject. With these thoughts in mind, the American Engineering Standards Committee was organized.

As time passed, other organizations became affiliated with the A. E. S. C. and the scope of its activities naturally broadened until, in 1928, it was considered advisable to reorganize the committee along much broader lines which would also allow for future expansion. In this reorganization, the name was changed to the American Standards Association.

At the present time the A. S. A. has forty-one member-bodies which comprise technical societies, trade associations, and governmental bodies, all of which are keenly interested in the problems confronting a large number of industries.

The broad scope of the work may be readily demonstrated by going through the list of projects for standardization under the A. S. A.

procedure. These concern such items as Portland cement, tests for the toughness of rock, safety codes for ladders and for window washing, dimensional standards for screws and pipe threads, gears, refrigerators, radio, power-line insulators, mercury-arc rectifiers, storage batteries, street traffic signs, liquid soap, fire hose, bed sheeting, blankets, mine timbering, wood poles, preferred numbers, and many others.

The A. S. A. radio standardization program is sponsored by the Institute of Radio Engineers and the American Institute of Electrical Engineers, jointly, through the Sectional Committee on Radio which has for the scope of its work, "nomenclature, methods of testing and of rating, specifications of apparatus and equipment, and dimensions to secure interchangeability where this may be found desirable."

One of the most important duties of the A. S. A. is to scan carefully the personnel of all its sectional committees to insure that there is a suitable balance of power among the producers, distributors, consumers, and general interests. In compliance with this requirement, it will be found that practically every important organization in the radio industry in this country is represented on the Sectional Committee on Radio.

In granting its approval of a standard, the A. S. A. does not concern itself with the content and merits of the standard, but guarantees that it is the consensus of opinion of all who are or should be vitally interested in the subject.

As a result of unavoidable conditions existing in the organization in the past, the work of the Sectional Committee on Radio was considerably hampered, and culminated in the acceptance by the A. S. A. of but one "American Tentative Standard." This covers the "Specifications for Vacuum-Tube Bases" and has already been published in the PROCEEDINGS. However, the Sectional Committee on Radio has recently been completely reorganized, radically revising its plan of work, and it is expected that the results of its operation during 1929 and 1930 will be materially greater.

In addition to its sponsorship of the Sectional Committee on Radio, the Institute has its own Committee on Standardization which has done effective work for a number of years. Its efforts to date have been confined to matters of nomenclature, definitions, symbols, and methods of rating and of testing equipment and apparatus. In this way, it has expended its energies on such matters as are of greatest importance to radio engineers.

In the manufacturing field, the Radio Division of the National Electrical Manufacturers' Association and the Radio Manufacturers' Association have each sponsored a program of standardization. They

have made no attempt to formulate standards in that portion of the field already covered by the Institute, but have taken these standards bodily from the Institute's reports and given them their own approval as well. These standards, therefore, have the united approval of the Institute and the two major manufacturers' associations. It is anticipated that a goodly portion of these will be accepted by the Sectional Committee on Radio during the ensuing year. They will then be presented to the A. S. A. for approval.

The programs of the N. E. M. A. and R. M. A. have been confined to matters of concern in the manufacture of equipment, particularly such items as are of importance as regards the size and fit of component parts to secure interchangeability, markings for identification, which include such things as color codes for wiring, and terminal marking for polarity, and many matters of similar nature.

It will thus be seen that the field has been divided into two parts, the Institute providing for the more fundamental engineering aspects as regards nomenclature, methods of test, etc., and the manufacturers' associations assuming the obligation of providing standards covering interchangeability of parts and such matters of a more distinctly manufacturing nature.

Because of the nature of the products sold to the general public, it is not customary for identifying labels to be appended to items complying with formulated standards. Neither is there any coercive force applied to compel compliance with these standards; general recognition of their suitability and excellence is relied upon to encourage their acceptance by the industry. This procedure has met with good success and is but a continuation of the methods employed in generation of the standards.

These standards have made it possible for the manufacturer and those from whom he purchases materials and those to whom he, in turn, sells, to speak the same language as regards nomenclature, ratings, and methods of test. In this way more accurate computation of costs, not only of component parts but of the finished receiver as well, may be made.

By standardizing on the dimensions of component parts, the manufacturer is enabled to dispose of his stock to a large number of purchasers who can all use the same item but who, under less favorable conditions to the manufacturer, would demand their own particular sizes, shapes, etc., thus increasing the manufacturing cost per unit. It also allows the manufacture of materials and parts during the less active portions of the year under conditions which will not make it impossible to find a reasonable market for them when the busier months arrive and time and materials are at a premium.

The advantages and benefits to the industry from standardization are manifold, and practically all result in a general saving to the ultimate consumer in the cost and ease of servicing and maintaining his receiving set and in lowered cost of construction, installation, and maintenance of broadcast stations, which, in turn, make his receiver so desirable. This lowered cost and improved service tend to encourage those who have not already purchased receivers to do so, making a larger total volume of business and a further reduction in the cost per unit.

Standardization, therefore, helps not only the ultimate consumer but also the manufacturer, distributor, and all others in the industry. By its means, industries are encouraged to grow—and continue to grow, and the savings made become available for new research and for improvements in the methods and processes.

Meeting of the A. A. A. S. in December

Under the chairmanship of Professor J. C. Jensen of Nebraska Wesleyan University a committee of Institute members has been appointed to arrange a program for Institute members at the meeting of the American Association for the Advancement of Science which will be held in Des Moines, Iowa, December 27 to 31, 1929. The committee membership follows: J. C. Jensen, chairman; S. T. Hutchinson, Charles A. Culver, H. M. Carrouters, and John H. Miller.

It is expected that several papers on radio subjects will be presented at the Institute meeting. Members desiring further information should communicate either with the Institute office or Professor Jensen.

Institute Meetings

TOUR TO SECTIONS BY K. S. WEAVER

During the month of October, K. S. Weaver of the Westinghouse Lamp Company of Bloomfield, N. J., visited five sections of the Institute to deliver the paper, "Production Testing of Vacuum Tubes," by W. S. Jones and himself.

The meetings in each section were arranged as follows:

Chicago Section.—On October 18th, in the Electric Club, Chicago. G. W. Wilcox presided. Seventy members of the section were present. The paper was discussed by Messrs. Wilcox, Oxner, Miller Harper, and others.

Cincinnati Section.—On October 17th in the engineering building, University of Cincinnati. R. H. Langley, chairman of the section,

presided. Seventy-four members and guests attended. Messrs. Kigour, Felix, Israel, and others participated in the discussion of the paper.

Connecticut Valley Section.—On October 14th in the auditorium of the Hartford Electric Light Company. Thirty-seven members were present.

Detroit Section.—On October 16th in the conference room of the Detroit News building. A. B. Buchanan, chairman of the section, presided. Seventy-five members and guests were present. The paper was largely discussed.

Toronto Section.—On October 15th in the Westinghouse Auditorium at Hamilton, Ontario. V. G. Smith, chairman of the section, presided. One hundred and twenty-five members and guests were present. The paper was discussed by Messrs. Patience, Mitchell, Thompson, and others.

This paper, which will be published in a forthcoming issue of the PROCEEDINGS, is summarized as follows:

“The factory testing of vacuum tubes is becoming more specialized every year. In the early days of broadcasting a few tubes served many purposes and actual performance in its relation to tube characteristics was not as widely studied and understood as it is today.

“Increasing knowledge of the ‘how’ and ‘why’ of tube and set operation has led to the development of many more or less special tubes designed for a specific function in the set. The increasing use of accurate set measuring equipment has enabled designers to work out the optimum circuit arrangements for the use of these specially designed tubes in the various stages.

“As a result of this growth of the industry the testing of vacuum tubes has required more and more attention to set operation, a constant elaboration of test methods and equipment being necessary in order to exercise the necessary control over tube characteristics.”

CHICAGO SECTION

The regular meeting of the Chicago section for the month of November was held on the fourth in the Engineering Hall, Engineering Building, Chicago. John H. Miller, chairman, Telegraph, Telephone and Radio Section, Western Society of Engineers, and secretary of the Chicago section, presided.

M. Merwin Eells, manager of communications of National Air Transport, presented a paper, “Radiobeacon Systems for Aircraft.” The paper described in some detail the work of National Air Transport with aural beacons.

Preceding the paper’s presentation a reel of motion pictures depicting the radiobeacon system and airplane radio systems described in the paper was shown.

This was a joint meeting with the Telephone, Telegraph and Radio Section of the Western Society of Engineers. One hundred and fifty-seven members and guests were present.

CLEVELAND SECTION

On November first the Cleveland section held a meeting in Case School of Applied Science. Bruce W. David, chairman of the section, presided.

Herbert A. Erf presented an illustrated talk on "Acoustics and Radio Engineering." After giving an historical setting to the study of acoustics the speaker discussed such topics as interference, resonance, echo, and reverberation. In the general discussion which followed Mr. Erf's paper many interesting points were brought out in connection with acoustical design of broadcast studios.

In the business meeting preceding the presentation of the paper the following nominating committee was appointed to make nominations for 1930 section officers: J. R. Martin, Ralph Farnham, and G. B. Schneeberger.

LOS ANGELES SECTION

On October 21st a meeting of the Los Angeles section was held at Fox Hills Studio, Beverly Hills. A dinner was served at the Cafe



DINNER OF LOS ANGELES SECTION AT FOX HILLS STUDIO, OCTOBER 21, 1929

de Paris within the studio grounds. During the dinner hour, music was furnished by a portable equipment. H. Keith Weeks, executive manager of Fox Studios, introduced the speaker of the evening, K. E. Morgan, who gave a very interesting talk on the subject, "Electrical Engineering of Sound Picture Systems." Mr. Morgan is associated with the Electrical Research Products Corporation.

The talk was illustrated by means of a complete portable movietone projector showing a set of stereopticon slides and three especially prepared reels of motion pictures with sound effects.

Following the talk those present visited one of the new sound stages where the various equipment in the stage, control room, and recording room was explained in detail and shown in operation.

Four hundred and eighty members and guests attended this meeting. A photograph of the dinner gathering can be obtained from the secretary of the section, W. W. Lindsay, at a nominal sum.

NEW ORLEANS SECTION

A meeting of the New Orleans section was held on October 10 at Loyola University, New Orleans. J. N. Dutreil presided. Two motion pictures, "Man-made Miracles" and "The Nation's Market Place," were shown. Following the meeting members inspected the 5-kw broadcast station operated by the University.

NEW YORK MEETING

The regular monthly New York meeting was held on November 6 in the Engineering Societies Building, 33 West 39th Street. In the absence of President Taylor, W. G. Cady presided.

The first of two papers presented was divided into two parts. The first part was read by I. F. Byrnes, of General Electric Company, Schenectady, and the second part by J. B. Coleman, Westinghouse Electric and Manufacturing Company, Chicopee Falls. Messrs. Coleman and Byrnes were the joint authors of the paper entitled "Short-Wave Communication." The paper is summarized as follows:

"One of the major parts of the short-wave communication system is the transmitter converting 60-cycle power into a frequency in the order of millions of cycles. Although the first communication work on short waves was accomplished by the radiation of a few watts, reliable and rapid communication requires power of the order of tens of kilowatts. The technique in producing a transmitter of relatively large power to feed an antenna for radiating short waves, has been found to be quite different from that required for previous design and test of radio transmitters. This paper presents the results of intensive work of the last two years. It describes some of the interesting problems which have had to be solved. Not least

among these were methods of providing a satisfactory artificial load, the determination of keying characteristics and the like. Illustrations showed the concrete form of the equipment giving an interesting comparison between present communication equipment and its immediate predecessor, the Alexanderson alternator."

The second paper, "Some Problems in Short-Wave Telephone Transmission," by J. C. Schelleng of Bell Telephone Laboratories, New York, was presented by Mr. Schelleng. This paper is summarized as follows:

"Certain phases of short-wave telephony, primarily, though not entirely, from the point of view of the transmitter are described. The field strengths which the transmitting station must provide at the receiver are considered. Typical data are given showing results obtained in transmission from Deal, N. J., to England. This is followed by a discussion of requirements and limitations of the transmitting antenna. The gains which arrays may reasonably be expected to provide are considered. The phenomenon of non-synchronous fading at nearby points is examined as to its bearing on the dimensions and performance of directive arrays. It is concluded that in a broadside antenna a loss of about 1 db is entailed when the length of the structure equals the minimum distance of random fading. Other directional properties of the transmitting medium are also considered. Attention is then directed to the transmitting equipment, particular attention being given to the high power part of it. Requirements, rather than circuit details, are emphasized. These include stability of operation, flexibility and freedom from amplitude distortion, and phase and frequency modulation. The latter two types of distortion, while having much in common, arise in different manners and have certain distinguishing characteristics. The results of tests in which some of these matters were considered quantitatively are given."

It is expected that both of these papers will appear in a forthcoming issue of the PROCEEDINGS.

Four hundred and fifty-five members of the Institute attended the meeting.

PHILADELPHIA SECTION

The Philadelphia section met on October 3 in the Franklin Institute, 15 S. 7th Street.

J. C. Van Horn, chairman of the section, presided. Elmer L. Brown, of the Engineering and Test Laboratory, Radio-Victor Corporation of America, presented a paper, "The Progress of Aircraft Radio." This paper constituted a resumé of aircraft radio engineering from the beginning of the World War to the present date.

The rigid requirements for this type of apparatus, specific problems encountered, special apparatus developed specifically for aircraft

needs and the principles of popular types of altimeters and beacons were discussed. The trend of future development was suggested.

Messrs. Kenrick, Snyder, and others participated in the discussion which followed the presentation of the paper.

Sixty-four members of the section and guests attended the meeting.

On November 5th a meeting of the section was held in the Franklin Institute, Philadelphia. J. C. Van Horn, chairman of the section, presided.

Stuart Ballantine, of Boonton Research Corporation, presented a paper on "Recent Developments in RFL Broadcast Receivers." This paper was, in a sense, a continuation of one presented by the present author at a meeting of the Philadelphia section on May 21, 1926, entitled "Recent Developments in Radio Receivers." The present paper included a historical review of RFL receiver developments from 1922 to 1927, particularly the development of monodic (one-way or neutralized) radio-frequency amplifiers, single-tuning control, and complete shielding. Methods of measuring the overall electrical performance of a radio receiver as indicated by the sensitivity, fidelity, and selectivity were described. Then followed a discussion by Mr. Ballantine of more recent research projects of commercial interest including the use of shielded tetrodes in r-f amplifiers, volume control, detection by diode, grid and plate rectification at high signal levels, the design procedure in such systems, preventing of detector overloading, linear detectors, distortion in detection due to high modulation, systems for automatic volume control, and the use of a pentode in the power output stage.

Two hundred and fifteen members attended the meeting.

PITTSBURGH SECTION

The Pittsburgh section met in the Chamber of Commerce Building, Pittsburgh, on October 15th jointly with the Pittsburgh section of the A. I. E. E. J. A. Cadwallader, chairman of the latter section, presided.

John B. Taylor, of the Research Laboratory, General Electric Company, presented a lecture on "Making Sound Visible and Light Audible."

Seven hundred members of the two sections were present.

SAN FRANCISCO SECTION

On October 23rd the San Francisco section met in the Engineers' Club, 206 Sansome Street, San Francisco. Donald K. Lippincott, chairman of the section, presided.

Dr. Lester E. Reukema presented a lecture on "Radio Research and Research Men in Europe," describing his recent visit to research laboratories in England, France, Germany, Austria, Italy, Sicily, North Africa, Switzerland, and Holland. He related an account of various research problems under way in laboratories in these countries.

Fifty-one members attended the meeting.

SEATTLE SECTION

A meeting of the Seattle section was held on October 25th in Philosophy Hall, University of Washington. Austin V. Eastman, chairman of the section, presided.

James Gordon Bennett, radio electrician, Airways Division, Department of Commerce, presented a paper, "Airways Division Organization, Operation, and Service Rendered." The paper pointed out that the Airways Division was organized in 1926 after some fourteen years of consideration and investigation. It was established to aid airplane navigation, as at that time there were no facilities for regulation and information. Some of the duties of the airways division are the testing and inspecting of the new ships, the testing and inspecting of engines, the erection and maintenance of beacon lights and radio stations to send out weather reports and other information of use to airplane pilots.

Fifty-nine members of the section attended the meeting.

WASHINGTON SECTION

On October 10th in the Continental Hotel, North Capitol Street, Washington, a meeting of the Washington section was held. Thomas McL. Davis, vice-chairman of the section, presided.

R. H. Ranger, of the Radio Corporation of America, presented a talk on "Photoradio." His paper is summarized as follows:

"The development of an accurate system of photoradio successfully used between London, New York, and San Francisco is described and the circuits by which multiplex facsimile transmission and reception are accomplished is described. The talk was illustrated by lantern slides showing the different circuits employed for multiplex facsimile transmission. The method of electrically commutating the several multiplex channels in lieu of mechanical distributor separation employed in radiotelegraph circuits was explained. The fact that no mechanical device is employed in the multiplex transmission and reception system for opening and closing the circuit permits higher speeds and more accurate operation of the circuits to be obtained. The multiplex system involves separate banks of electron tube amplifiers, the number of banks corresponding to the number of channels. These amplifiers are associated with independent transmission circuits and permit these circuits to function in successive order by electrical commuta-

tion; that is, the tube circuits of the different amplifier banks are interconnected so that when one bank is functioning the grids of the other banks are positive, and as the bank operates in successive order the grids are made successively positive or negative by a tripped system, or released by the circuits in adjacent banks."

The discussions of the paper were made by Messrs. Taylor, Gunn, Mirick, Smith, Brady, Davis, and others.

Seventy-five members and guests attended this meeting.

Committee Work

COMMITTEE ON ADMISSIONS

A meeting of the Committee on Admissions was held on November 6th in the Institute office. Those present were: R. A. Heising, chairman; E. R. Shute, A. F. Van Dyck, and H. F. Dart. The committee considered twenty-two applications for transfer or election to higher grades of membership.

SUBCOMMITTEE ON RECEIVERS AND PARTS

The Subcommittee on Receivers and Parts of the Institute's Committee on Standardization for 1929 held its first meeting in the Institute office on the morning of November 6th. Members present were: E. T. Dickey, chairman; G. C. Crom, C. E. Brigham, W. A. MacDonald, C. M. Sinnett, V. M. Graham, E. J. T. Moore, I. G. Maloff, and H. P. Westman, secretary.

SUBCOMMITTEE ON TRANSMITTERS AND ANTENNAS

The Subcommittee on Transmitters and Antennas of the Committee on Standardization held its first meeting in the Institute office on November 7th. Those present were: Haraden Pratt, chairman; R. M. Wilmotte, H. E. Hallborg, J. J. Lamb, and H. P. Westman, secretary.

BOARD OF EDITORS

A meeting of the Board of Editors of the PROCEEDINGS was held the afternoon of November 6th. The following members of the Board were present: W. G. Cady, chairman; Ralph Batcher, and L. E. Whittemore.

The Board decided upon several typographical changes to the PROCEEDINGS to be effective with the January, 1930, issue. Many questions relative to policies were discussed.

SECTIONAL COMMITTEE ON RADIO

At a meeting on October 7th, 1929, in the office of the Institute, the reorganization of the Sectional Committee on Radio of the American Standards Association, of which the Institute and the A. I. E. E. are joint sponsors, was undertaken.

Officers of the new Committee were elected as follows: Alfred N. Goldsmith, chairman; C. H. Sharp, vice chairman; and H. P. Westman, secretary.

The membership of the reorganized Sectional Committee and the organizations represented is as follows: Lloyd Espenchied, Bell Telephone System; L. W. Chubb, W. R. G. Baker, and R. H. Manson, National Electrical Manufacturers' Association; Alfred N. Goldsmith, Radio Corporation of America; W. E. Holland, R. H. Manson, and R. H. Langley, Radio Manufacturers' Association; J. J. Lamb, American Radio Relay League; R. H. Langley, National Association of Broadcasters; J. J. Graf, Telephone and Telegraph Section, American Railway Association; T. A. M. Craven, United States Navy Department; F. W. Hoorn, United States War Department; C. H. Sharp, Adam Stein, Jr., and William Wilson, American Institute of Electrical Engineers; L. E. Whittemore, J. V. L. Hogan, and L. M. Hull, Institute of Radio Engineers; R. N. Conwell, National Electric Light Association; R. B. Shepard, National Fire Protection Association and Underwriters' Laboratories; E. W. Ely, United States Department of Commerce; J. H. Dellinger, United States Interdepartment Radio Advisory Committee; and O. H. Caldwell, at large.

As chairmen of the Technical Committees the following were appointed: Haraden Pratt, radio transmitters and parts; W. A. Macdonald, radio receivers and parts; J. C. Warner, vacuum tubes; Irving Wolff, electro-acoustic devices.

Personal Mention

J. E. Anderson, formerly radio engineer of Commercial Radio Service Company of Columbus, Ohio, has recently become laboratory assistant at Day Fan Electric Company of Dayton, Ohio.

Major Arthur L. Harris has been transferred from Royal Signals, War Office, London, to China Command Signal Company at Hong Kong, China.

J. R. Harrison, until recently assistant in physics department of Wesleyan University at Middletown, Conn., is now on the staff of the Department of Physics, University of Pittsburgh.

Clifford E. Himoe has resigned from the operating staff of Station WEAJ at Bellmore, L. I., to become associated with DeForest Radio Company of Passaic, N. J., in the engineering laboratories.

Commander C. H. Maddox has been transferred from the *USS Putnam* to the Navy Department, Washington, D. C.

B. F. McNamee, until recently chief engineer of Advance Electric Company of Los Angeles, California, is now employed as chief production engineer with Colin B. Kennedy Radio Corporation at South Bend, Indiana.

H. P. Miller, Jr., has resigned from Federal Telegraph Company, Newark, N. J., where he was employed as radio transmission engineer to become radio engineer in International Communications Laboratories, New York City.

A. F. Murray has joined the engineering department of Jenkins Television Laboratory at Jersey City, N. J. Mr. Murray was formerly associated with Wireless Specialty Apparatus Company of Boston.

Alan N. Ramsay, until recently general sales manager of Precision Electric Manufacturing Corporation of Los Angeles, is now production engineer, projection department, Vitovox Talking Pictures Company at Los Angeles.

Philip A. Richards, for the past two years in the radio department of General Electric Company at Schenectady, has been transferred to the Nela Park office as vacuum-tube engineer.

R. Oliver Rippere, recently student at Brooklyn Polytechnic Institute, is now in the telephone engineering department of Bell Telephone Laboratories.

Arthur W. Steinberger, a former acoustic engineer with Charles Freshman Company, is now employed by Colonial Radio Corporation, Long Island City, as acoustic engineer.

C. M. Jansky, Jr., until recently associate professor, radio engineering, University of Minnesota, has opened an office as consulting radio engineer with headquarters in the Munsey Building, Washington, D. C. Professor Jansky is a member of the Board of Direction of the Institute.

W. P. Koechel, until recently radio engineer, Westinghouse Lamp Company, Bloomfield, N. J., is now engineer, Ken-Rad Tube and Lamp Company, Owensboro, Kentucky.

B. H. J. Kynaston is now managing director, The Harmonic Radio Company, Ltd., Nottingham, England. Mr. Kynaston was formerly radio engineer of A. Holt and Company, Liverpool, England.

James McNary has recently resigned from the Radio Division, Department of Commerce, to become associated with Bell Telephone Laboratories in New York City.

GEOGRAPHICAL LOCATION OF MEMBERS ELECTED NOVEMBER 6, 1929

| | | |
|--------------------|--|----------------------------|
| | Transferred to the Fellow grade | |
| Ohio | Cincinnati, 5449 Hamilton Ave..... | Langley, Ralph H. |
| | Transferred to the Member grade | |
| California | Hollywood, 1041 N. Formosa Ave..... | Hilliard, John K. |
| Dist. of Columbia | Washington, Radio Division, Dept. of Commerce... | Terrell, William Dandridge |
| Illinois | Urbana, 301 Elec. Eng. Lab., University of Illinois | Brown, Hugh A. |
| Massachusetts | Longmeadow, 86 Dover Road | Forbes, Henry C. |
| New Jersey | Boonton, Fairview Ave..... | Ferris, Malcolm |
| | Deal, Box 122..... | Ferrell, Enoch B. |
| | East Orange, 102 N. Arlington | Towner, Orrin W. |
| | Haddonfield, 19 Evergreen Lane | Diehl, William F. |
| New York | New York City, Western Union Tel. Co., 195 Broadway | |
| | New York City, 40 E. 10th St. | Coggeshall, Ivan S. |
| | Schenectady, Radio Eng. Dept., General Electric Co. | Danziger, Harold I. |
| Ohio | Cleveland, Research Laboratories, National Carbon Co. | Loughren, Arthur V. |
| Pennsylvania | Philadelphia, 570 W. Clapier St. | Nelson, James R. |
| | Wilkinsburg, 435 Ave. D | Deal, Harmon B. |
| England | South Croydon, 33 Dornton St. | Beera, G. Lisle |
| Holland | Eindhoven, 12 Jan Smitzlaan | Agate, C. S. |
| | | van der Pol, Balth. |
| | Elected to the Member grade | |
| New York | New York City, Dept. of Commerce, Radio Service, Subtreasury Bldg. | Fish, Arthur S. |
| Philippine Islands | Manila, Fort Santiago, Radio Cable & Telegraph Office | Rives, Tom C. |
| Poland | Warsaw, Wspolna 32 | Plebanski, Jozef |
| | Warsaw, Mokotowska 6, Radio Technical Institute | Sokolcow, Dmitri M. |
| | Elected to the Associate grade | |
| Alabama | Birmingham, 901 S. 38th St..... | Duran, Albert E. |
| | Montgomery, 418 Adams Ave. | Persons, S. G. |
| Arizona | Prescott, O. A. Heala Co., Box 658 | deWitt, Harold |
| Arkansas | Little Rock, Y. M. C. A. | Tracy, Kernit F. |
| California | Los Angeles, 6220 La Mirada St. | Greger, J. G. |
| | Los Angeles, 405 E. Pico St. | Kruger, Bernard |
| | Los Angeles, 1467 Temple St. | Richards, W. S. |
| | Los Angeles, 5327 Monte Vista St. | Roberts, Russell B. |
| | Palo Alto, Federal Telegraph Co. | Lacabanne, Washington D. |
| | Palo Alto, 1040 Channing Ave. | Penther, Carl Joseph |
| | Palo Alto, 551 Lytton Ave. | Wagener, Winfield G. |
| | Redwood City, 523 King St. | Christensen, C. W. |
| | San Diego, 3000 A St. | Kinney, E. S., Jr. |
| | Tuolumne, Box 134 | Elliott, William H. |
| Dist. of Columbia | Washington, c/o Bureau of Navigation, Navy Dept. | Pierrepont, John Jay |
| | Washington, Dept. Terres. Mag., Carnegie Inst. of Wash. | |
| Illinois | Chicago, 1634 S. Springfield Ave. | Seaton, Stuart L. |
| | Chicago, 6415 Stewart Ave. | Chernikoff, Leo J. |
| | Chicago, 1925 Granville Ave. | Chatlos, Albert |
| | Chicago, 3710 LeClaire Ave. | Clark, Paul H. |
| | Chicago, c/o Shure Bros. Co., 335 W. Madison St. | Fitzgerald, John J. |
| | Chicago, 3240 Evergreen Ave. | Gram, Shirley L. |
| | Chicago, 5751 62nd St. | Grossman, Seymcur M. |
| | Chicago, 122 S. Michigan Ave. | Hissong, Alfred |
| | Chicago, 2611 N. Albany Ave. | Lorch, George H. |
| | Chicago, 809 Lill Ave. | Michalowicz, Leon V. |
| | Chicago, Montgomery Ward & Co., Div. 62, Radio & Elect. Lab. | Shanafelt, Lysle O. |
| | Chicago, 4500 N. Sacramento Ave. | Thompson, Sidney J. |
| | Glenview, c/o WBBM | Waterman, S. S. |
| | Hinsdale, 206 Ayres Ave. | Fancy, Raymond C. |
| | Gary, 540 Lake St. | Doyle, E. J. |
| | Springfield, Sangamo Elec. Co. | Gunther, W. J. |
| Indiana | Valparaiso, Stiles Hall | Kunz, H. L. |
| Iowa | Cedar Rapids, 1718 C St. W. | Reynolds, Clay Elmer |
| | Red Oak, 104 W. Reed St. | Hajny, George F. |
| | | Anderson, Donald C. |

| | | |
|-------------------------------|---|--|
| Louisiana | New Orleans, 4515 Freret St. | Elliott, Harry M. |
| | New Orleans, 3421 Prytania St. | Dumestre, Alexis M. |
| | New Orleans, 1114 Pere Marquette Bldg. | Hancock, Olan W. |
| | New Orleans, c/o Western Union Tel. Co. | Hilkeidick, W. C. |
| | New Orleans, 717 Greenwood St. | Scheffer, Roy J. |
| Massachusetts | New Orleans, 605 Belleville St. | Voegtlin, Elmo |
| | Chelsea, 124 Williams St. | Fox, Robert |
| | Marion, Radio Corporation of America | Brunette, Deo Z. |
| Michigan | Roxbury, 120 George St. | Ashenden, G. K., Jr. |
| | Springfield, 547 Page Blvd. | Cole, Neil D. |
| | Springfield, 32 Ardmore St. | Knapp, Harold D. |
| | Bay City, Radio WBCM | Carpenter, Ralph Harvey |
| Minnesota | Detroit, 4322 Grand Ave. W. | Davis, Chester |
| | East Lansing, 348 Oakhill Ave. | Clark, Ralph L. |
| Mississippi | Tecumseh | McConnell, Harley H. |
| | Detroit Lakes | Hetland, L. C. |
| New York | Minneapolis, 3848 Harriet Ave. S. | Brooke, Robert O. |
| | Minneapolis, 915 Queen Ave. N. | Tynan, Thomas E. |
| New York | Corinth, P. O. Box 541 | Essary, William M. |
| | Auburn, 10½ Pleasant St. | Lumb, Frank J. |
| | Jackson Heights, L. I., 7517-41 Ave. | Fredendall, Beverly |
| | Long Island City, 3986 47th St. | Gileher, V. J. |
| | New Brighton, 62 Westervelt Ave. | Macken, H. I. |
| | New York City, 961 Tiffany St. | Cilin, Louis |
| | New York City, Bell Telephone Labs., Inc., 463 West St. | Cole, Burton R. |
| | New York City, 195 Broadway, Room 2014 | Herrmann, Henry J. |
| | New York City, 43 Exchange Place | Palmer, Robert T. |
| | New York City, 655 W. 160th St. | Stokvis, Morris, Jr. |
| | New York City, 1020 Walton Ave. | Weiland, Christian Frederick |
| | New York City, 281 E. 7th St. | Weiss, Samuel |
| | New York City, 615 W. 113th St. (Apt. 42) | Wilson, H. Warden |
| | New York City, c/o Technidyne Corp., 644 Broadway | Yolles, Jacob |
| | North Carolina | Schenectady, Research Lab., General Electric Co. |
| Asheville, Radio Station WUNC | | Lance, Hubert H. |
| Ohio | Cincinnati, 3881 Reading Road | Klein, Helen |
| | Columbus, 625 W. 5th St. | Blum, Louis M. |
| Oklahoma | Lakewood, 17545 Madison Ave. | KaDell, Harold W. |
| | Tulsa, 1309 E. 15th St. | Banks, J. Vernon |
| | Tulsa, 2628 E. 6th St. | Carpenter, Hugh |
| Pennsylvania | Tulsa, Radio Station KVOO | Richardson, Harry K. |
| | Chester, 1219 Walnut St. | Mitchell, J. C. |
| | Cresson, R. D. #1 | Vaughan, Kenneth A. |
| | Jenkintown, 309 Florence Ave. | Greenway, William L. |
| | Kane, 805 Welsh St. | Bentley, Rue Thompson |
| | Knox, Box 102 | Smith, Jesse W. |
| | Philadelphia, 893 N. 48th St. | Chesny, John J. |
| | Philadelphia, 3422 Barclay St., E. Falls | Gerhard, Charles E. |
| | Philadelphia, 5220 Wayne Ave., 412 Qu Wayne Apts. | Morrow, Lorentz Arnold |
| | Philadelphia, 5531 Master St. | Stark, Harry W. |
| | Pittsburgh, 6503 Landview St. | Stayer, David |
| | Upper Darby, 202 Heather Road | Cahill, James A. |
| | Wilkinsburg, 414 Ella St. | Ballard, Randall C. |
| | Wilkinsburg, 815 Rebecca Ave. | Lehman, James N. |
| | Wilkinsburg, R. D. #1, Box 223 | Sinnett, Chester M. |
| Williamsport, 904 Railway St. | Petta, Ronald G. | |
| South Carolina | Clemson College | Wilson, Walter B. |
| | Nashville, 1918 Adelia Ave. | Berry, Melvern H. |
| Tennessee | Beaumont, c/o KFD M, Magnolia Petroleum Co. | Bryan, William J. |
| Texas | Salt Lake City, c/o Radio KDYL | Barbre, Tom |
| Utah | Yakima, Tieton Drive | McQueen, Harry D. |
| Washington | Melbourne, University of Melbourne, Natural Phys. Lab. | Cherry, Richard O. |
| | Australia | |
| Canada | Montreal, P. Q., c/o Northern Electric Co., 637 Craig St. | Ketiladze, George S. |
| England | Enfield Wash, Middlesex, 22 Chestnut Road | May, John |
| | Hull, E. Yorks, Beverley Road, 42 Washington St. | Pereira, Francis Edward Duncan |
| Holland | London, NW3, Hampstead, 10 Belsize Crescent | Goord, H. V. |
| | London, N7, Holloway, 46 Hildrop Road | Huxter, Harold Charles |
| | Skipton, Dyneley House | Carr, John |
| | Watford, Herts, 31 Malden Road | Bartlett, A. C. |
| India | Hilversum, Nederlandsche Seintsestellen fabriek | Langendam, S. G. C. |
| | Dharmasala Punjab, Govt. College | Vasudeva, D. N. |
| New Zealand | Christchurch, 180 Rolleston St. | Gibbs, R. J. |
| | Marton, Ngahims St. | Ruscoe, Chas. R. |
| Peru | Wanganui, Post and Telegraph Dept. | Bradley, Ernest A. |
| Philippine Islands | Lima, Giron Camana 224 | Maldonado, Arthur |
| | Cebu, 37 Tres de Abril St. | Lauza, Nemesio D. |

| | | |
|--------------|--|-------------------------|
| South Africa | Cape Province, Klipheuvcl, Beam Wireless Station | Osborn, Eugene Wilson |
| South Wales | Johannesburg, 62 Persimmon Street Malvern | Lukat, John Frederick |
| | Cardiff, Llanishen, "Ciscar," Hilary Gardens, Cyn Coed Road | Jinman, Arthur Melville |
| Sweden | Stockholm, Kungsholmsgatan 21 | Elmquist, Torsten |

Elected to the Junior grade

| | | |
|------------|--|----------------------|
| California | San Francisco, Cal. Victor Dist., 536 Mission Ave. | Lathrope, Kenneth W. |
| Indiana | Valparaiso, 712 Calumet Ave. | DeHart, Delmar W. |
| Louisiana | New Orleans, 2434 Valence St. | Dahlstrom, Hugo Wolf |
| Minnesota | Minneapolis, 3848 Harriet Ave. S. | Brooke, Robert O. |
| Oklahoma | Alva, Radio KGFF, 709 Noble St. | Sears, Garold D. |
| Canada | Montreal, P. Q., 637 Craig St., Room 808 | Harvey, Fred E. |



APPLICATIONS FOR MEMBERSHIP

Applications for election or transfer to the various grades of membership in the Institute have been received from the persons listed below, and have been approved by the Committee on Admissions. Members objecting to election or transfer of any of these applicants should communicate with the Secretary on or before January 3, 1929. These applications will be considered by the Board of Direction at its January 8th meeting.

For Election to the Fellow grade

Germany Berlin, Ludende, Karlstrasse 4 Fassbender, Heinrich

For Transfer to the Member grade

Massachusetts Cambridge, General Radio Co., 30 State St. Thiessen, Arthur E.
 Pennsylvania Irwin, 728 Grant St. Marsteller, I. O.
 Canada Toronto, 45 Jarvis St. Meredith, C. C.
 France Asnieres (Seine), 16 Rue de Chateaudun Kraemer, G. I.

For Election to the Member grade

California San Pedro, c/o Postmaster, *USS West Virginia* Cooper, Lowell
 Massachusetts Springfield, 120 Ardmore St. Lavallee, J. A.
 Springfield, 72 Princeton St. Fortier, Ralph L.
 New Jersey Upper Montclair, 9 Bradford Parkway DuMont, Allen B.
 New York New York City, c/o Radio Corporation of America,
 233 Broadway Grover, Harry G.
 Ohio Cleveland, Nela Park, Cleveland Vacuum Tube Works
 of G. E. Ritter, E. W.
 Pennsylvania Pittsburgh, 5529 Bryant St. Roth, Albert
 Wilkensburg, 584 Lenox Ave. Carlisle, Richard W.
 Siam Bangkok, Post and Telegraph Dept. Prakit, Phya

For Election to the Associate grade

California Berkeley, 1524 Scenic Ave. Dempster, Everett R.
 El Centro, 864 Olive St. Irey, Earl R.
 Glendale, 1211 Winchester Ave. Klingensmith, W. B.
 Hollywood, 4909 Sunset Boulevard Brockway, Don C.
 Hollywood, 2144 Beachwood Drive Heineman, John T.
 Los Angeles, 1129 4th Ave. Brown, Cutler
 Los Angeles, 10231 Blaine St. Flickinger, J. H.
 Napa, P. O. Box 86 Streich, Robert J.
 Oakland, 1741 Seminary Ave. Weaver, Chester E.
 Palo Alto, 151 Churchill Ave. Boyson, Carl V.
 Palo Alto, 213 Fulton St. Green, Irving L.
 Pasadena, 3209 E. Colorado St. Craft, Walter C.
 San Francisco, 140 New Montgomery St. Franklin, Lyman T.
 San Francisco, c/o San Francisco Examiner, Station
 KUP Martin, Ronald G.
 San Jose, 87 E. San Antonio St. Cooper, Charles A.
 Venice, 806 Marco Place DuVall, Charles
 Connecticut Hartford, 52 Beacon St. Grammer, George
 Naugatuck, Field St., R.F.D. #1 Wood, William Forrest
 Waterbury, 50 Hewlett St. Buckley, Francis P.
 Dist. of Columbia Bellevue, Naval Research Laboratory Kosar, William S.
 Takoma Park, P. O. Box 4253 Aurynger, John J.
 Washington, 911 Barr Bldg. Codel, Martin
 Washington, 928 Madison St. N. W. Dawson, William B.
 Washington, 226 8th St. S. E. Guthrie, Robert C.
 Washington, 3333 P St. N. W. Keough, Bayard Cole
 Washington, 3217 Brother's Place S. E. Link, John C.
 Washington, 1319 F St. N. W. Pierce, James F.
 Washington, 2807 Connecticut Ave. Reynolds, George E.
 Washington, 214 17th St. N. E. Shepherd, Henry Clayton
 Washington, 663 F St. N. E. Taylor, Kenneth B.
 Washington, Navy Yard, Radio Test Shop Tinsley, W. M.
 Florida Hialeah, c/o Tropical Radio Telegraph Co., Box 488 Corrigan, C. J.
 Tampa, 907 Florida Ave. Weaver, Henry Ray
 Illinois Argo, 7806 W. 65 Place O'Connor, James M.
 Chicago, 2543 S. Avers Ave. Burger, Emil S.
 Chicago, 4614 N. Paulina Ave. Elliott, John S.
 Chicago, 6800 Hilldale Ave. Erwood, John
 Chicago, 656 W. Washington Boulevard Huntley, Wilfred Eliot
 Chicago, 1305 S. St. Louis Ave. Lyon, Alex

| | | |
|-------------------|--|-----------------------------|
| Illinois (cont'd) | Chicago, Radio Station WENR | McCluer, Paul |
| | Chicago, c/o Electrical Research Products Co., 910 S. Michigan Blvd. | Manchester, Raymond Mark |
| | Chicago, 3333 N. Marshfield Ave. | Menon, Geoffrey J. |
| | Chicago, 7712 Emerald Ave. | Mower, Irving F. |
| | Chicago, 3942 Lake Park Ave. | Rulison, Earl Wm. |
| | Chicago, Electrical Research Products Co., 910 S. Michigan Blvd. | Sterling, M. F. |
| | Chicago, 4742 W. Adams St. | Stokes, Howard S. |
| | Chicago, 1329 N. Wells St. | Thineman, Edward H. |
| | Chicago, 2715 S. Komensky Ave. | Tomas, Charles Frank, Jr. |
| | Elmhurst, 633 Spring Road | Walter, L. B. |
| | Glenview, Radio Station WBBM | Frisk, Caleb C. |
| | La Grange, 341 S. Kensington Ave. | Beckley, John G. |
| | Plainfield | Barch, Henry Stefan |
| | Plainfield, Universal Wireless Comm. Co. | Graham, Maxwell S. |
| | Plano | Littlepage, Orvale Herbert |
| Indiana | Valparaiso, 305 Monroe St. | Hays, Clarence W. |
| | Valparaiso, Box 301 | Heaton, George C. |
| | Valparaiso, 458 1/2 S. Locust Ave. | Terrill, Jeannette |
| | Blairstown | Schultz, Harvey R. |
| | Neodesha, 912 Indiana St. | Crimmel, Henry W. |
| Iowa | New Orleans, 2430 Gen. Taylor St. | Labe, Henry, Jr. |
| Kansas | New Orleans, 859 Roosevelt Place | Lurry, Thomas M. |
| Louisiana | Annapolis, 69 Fifth St. | Howard, David G. |
| Maryland | Baltimore, 2111 W. Baltimore St. | Anderson, John H. |
| | Baltimore, 1233 W. Baltimore St. | Berman, Henry O. |
| | Baltimore, 3818 Old Frederick Ave. | Garvey, Joseph M. |
| | Baltimore, 223 N. Curley St. | Vacek, George John |
| Massachusetts | Boston, Electrical Research Products, Inc., 20 Providence St. | Compton, G. Edwin |
| | Boston, c/o J. H. Burke Co., 221 Columbus Ave. | O'Donnell, Edward Francis |
| | Boston, c/o R. C. A. Institutes, Inc., 899 Boylston St. | Serreze, Victor C. |
| | Brighton, 103 Antwerp St. | Yurt, F. X. |
| | Brookline, 105 Kilsyth Road | Michelman, Edward A. |
| | Chicopee Falls, 18 Arlington St. | Gough, John Henry |
| | East Springfield, 26 Prentice St. | Robbins, Lynn R. |
| | Haverhill, Ward Hill Section | Phinney, Harold |
| | Maynard, 8 Elm Court | Stuckert, E. M. |
| | Melrose Highlands, 283 Vinton St. | Jewett, Raymond Bryce |
| | Quincy, 1511 Hancock St. | Dunleavy, Frank S. |
| | Quincy, 10 Empire St. | Steen, J. Ralph |
| | Seekonk | Stackpole, Nelson B. |
| | Springfield, 59 Olmstead Drive | Boyd, Bruce |
| | Springfield, 97 Orleans St. | Cameron, J. A. |
| | Springfield, 46 Osborne Terrace | Valentine, Francis B. |
| | Watertown, 29 Oakley Road | Anderson, Homer G. |
| | West Springfield, 60 Armstrong St. | Sutherland, Edgar F. |
| Michigan | Detroit, 1938 Sharon | Grote, Ernest A. |
| | Detroit, 2909 David Stott Bldg. | Russ, John A. |
| | Detroit, 2800 Fisher Bldg. | Jones, Clarence Wm. |
| | Detroit, 1518 Pennsylvania, Apt. 21 | Keller, John G. |
| | Detroit, 7-218 General Motors Bldg. | Lesinsky, Frank |
| | Detroit, Marine P. O., SS Alpena | MacCormack, Edwin A. |
| | Jackson, 3000 Francis St. | Adams, Eugene C. |
| | Lansing, 417 Oak Ave. | Aman, Bernard H. |
| | Port Huron, 1107 Center Ave. | Fountain, J. Clarence |
| | South Haven, 242 Hubbard St. | Hollands, L. C. |
| | South Haven, 311 Park Ave. | Klein, Albert G. |
| Missouri | Columbia, Radio Station KFRR | White, Robert F. |
| | Jefferson City, Radio Station WOS | Wilson, W. W. |
| | Kansas City, 3143 Cleveland Ave. | Cox, Everett E. |
| Montana | Butte, 117 Hamilton St. | Setterquist, Charles Ragnar |
| | Great Falls, P. O. Box 1054 | Van Blaricom, S. |
| Nebraska | Lincoln, University of Nebraska, Dept. of Elec. Engr. | Norris, Ferris W. |
| | Lincoln, 2511 R St. | Spencer, Herbert Logan |
| New Jersey | Arlington, 573 Elm St. | Gelardin, Benjamin |
| | Bergenfield, 16 S. Summit St. | Munzer, Louis F. |
| | Bergenfield, 3 S. Washington Ave. | Sonberg, Kenneth T. |
| | Bloomfield, 17 Floyd Ave. | Bryan, Oscar F. |
| | Bloomfield, 89 Watsessing Ave. | Hansen, Rolf Krohn |
| | Bogota, 110 Queen Anne Road | Bisbee, Robert Hause |
| | Caldwell, 35 Gould Place | Winans, Roswell R. |
| | Deal, Box 122 | Smith, Phillip H. |
| | East Orange, 106 N. Grove St. | Bagnall, Vernon B. |
| | East Orange, 106 N. Walnut St. | Bohner, Chance E. |
| | East Orange, 18 Girard Ave. | Green, Ralph W. |
| | East Orange, 526 Park Ave. | Grosswendt, Carl |
| | East Orange, 182 S. Arlington Ave. | Lewis, Elmer F. |

| | | |
|---------------------|---|------------------------------|
| New Jersey (cont'd) | East Orange, 54 Glenwood Ave. | Mabey, Charles A. |
| | East Orange, 293 N. Oraton Parkway | Salmmons, George C. |
| | East Orange, 59 Ampere Parkway | Vermillion, Charles O. |
| | East Orange, 5 S. Maple Ave. | Wallace, Milton W. |
| | East Orange, 141 Park Ave. | Walter, John C. |
| | Long Branch, 130 Second Ave. | McCollum, Harry J. |
| | Maplewood, 20 Colonial Terrace | Brown, Bayne |
| | Merchantville, 2431 Merchantville Ave. | Swanson, Milton A. |
| | Mount Ephraim, P. O. Box 206, King's Highway | Williams, Ernest R. |
| | Mountain Lakes, 23 Howell Road | Currie, Alexander |
| | Newark, 65 Wakeman Ave. | Cavanaugh, John D. |
| | Newark, 476 S. Eighteenth St. | Penk, Charles, Jr. |
| | Rutherford, 26 Monona Ave. | Henacnel, Earle B. |
| | Verona, 128 Sunset Ave. | Paret, F. Murray |
| | Weehawken Heights, 480 Palisade Ave. | Spinner, Robert F., Jr. |
| | Whippany, Bell Telephone Laboratories | Hensel, W. G. |
| New York | Brooklyn, 651 Wythe Ave. | Amendolara, Patrick |
| | Brooklyn, 2337 85th St. | Camarda, Frank |
| | Brooklyn, 274-A Ninth St. | Evans, Nicholas O. |
| | Brooklyn, 1502 E. 9th St. | Kay, Samuel Robert |
| | Brooklyn, 2220 Pacific St. | Kovacs, S. |
| | Brooklyn, 902 Avenue C | Love, Nathan |
| | Brooklyn, 55 Hanson Place | Pierce, Norman J. |
| | Brooklyn, 124 E. 3rd St. | Seekamp, Walter J. |
| | Brooklyn, 548 Clinton St. | Simeone, Frank |
| | Brooklyn, 1305 Foster Ave. | Traeger, Sam Harry |
| | Buffalo, 55 Harvard Place | Burns, Homer M. |
| | Buffalo, 374 High St. | Jennings, Russell G. |
| | Buffalo, 224 Jersey St. | Showalter, John L. E. |
| | Buffalo, 245 Highgate Ave. | Walls, Norman F. |
| | Elmira, 405 E. Church St. | Beyer, Raymond G. |
| | Ithaca, Cornell University, Rockefeller Hall | Minging, Charles R. |
| | Kenmore, 66 Legion Drive | Thomas, Lawrence F. |
| | New York City, 2486 Grand Ave., Brcnx | Bennett, Don |
| | New York City, 44 Seaman Ave. | Beyer, Haim |
| | New York City, 600 W. 178th St. | Blaufox, Jos. David |
| | New York City, 506 W. 163rd St. | Bohmann, Louis |
| | New York City, 162 E. Broadway | Brave, Harry J. |
| | New York City, 463 West St. | Budenbom, H. T. |
| | New York City, c/o Mr. C. Y. Hsu, 500 Riverside Drive | Chung, C. F. |
| | New York City, 463 West St. | Dale, George V. |
| | New York City, Pier 27 E. River | Ellis, T. H. |
| | New York City, International Comm. Lab., 89 Broad St. | Harris, Charles S. |
| | New York City, c/o Bell Tel. Labs., 463 West St. | Hartmann, Albert |
| | New York City, c/o R. C. A. Institute, 326 Broadway | Horman, Frederick L. |
| | New York City, 300 W. 107th St. | Kott, Herman |
| | New York City, International House, 500 Riverside Drive | Kruse, Sigurd |
| | New York City, Bell Tel. Labs., 463 West St. | Lindsay, Maxwell H. A. |
| | New York City, 152 W. 72nd St. | Mix, Charles L. |
| | New York City, 204 W. 106th St. | Ornstein, Eugene |
| | New York City, 212 E. 18th St. | Schanz, John A. |
| | New York City, c/o Radiomarine Corp. of America, 326 Broadway | Shandy, G. P. |
| | New York City, 133 W. 71st St. | Simpson, S. H., Jr. |
| | New York City, c/o Mr. C. Y. Hsu, 500 Riverside Drive | Ward, Zangwill |
| | North Pelham, 129 Second Ave. | Seibert, George William, Jr. |
| | Queens Village, L. I., 104-16 223rd St. | Sypher, Edgar L., Jr. |
| | Rochester, 62 Minnesota St. | Albright, Gordon E. |
| | Rochester, 634 Lexington Ave. | White, J. W. |
| | Rocky Point, L. I., c/o R. C. A. Communications, Inc. | Peterson, Lloyd E. |
| | Rocky Point, L. I., c/o R. C. A. | Russell, H. J. |
| | Rocky Point, L. I., c/o R. C. A. | White, W. L. |
| | Scotia, Spring Road, R. D. #2 | Batchelor, Harold |
| | Southampton, L. I., c/o Mackay Radio | Hayward, Walter |
| | Syracuse, 747 James St. | Turner, Walter V. |
| | Troy, D. K. E. House | Hadley, Raymond F. |
| | Ulster Park | Wickery, John B. |
| | White Plains, 20 Trenton Ave. | Bayne, James W. |
| North Dakota | Mandan, 708 W. Main St. | Templeman, E. J. |
| Ohio | Cincinnati, 3027 Feltz Ave. | Platts, George F. |
| | Cincinnati, 3353 Wabash Ave. | Winget, Donald N., Jr. |
| | Clayton | Jones, Carl C. |
| | Cleveland, Allerton Club, Room 1203 | Pierce, R. Morris |
| | Lakewood, 14415 Delaware Ave. | Cooper, William H. |
| | Norwood, 4810 Beech St. | Boerstler, Loren L. |

| | | |
|--------------|--|----------------------------|
| Oklahoma | Norman, 221 E. Main St. | Coston, E. G. |
| | Oklahoma City, 2904 N. Robinson St. | Ehret, Kenneth Marion |
| | Shawnee, 309 S. Penn Ave. | Barron, Arthur Joseph |
| Oregon | Elgin, P. O. Box 206 | Bussear, Lillian M. |
| Pennsylvania | East Pittsburgh, Research Dept., Westinghouse E. & M. Co. | Kilgore, G. Ross |
| | East Pittsburgh, Radio Operation Dept., Westinghouse E. & M. Co. | McKeel, P. D. |
| | East Pittsburgh, Research Bldg., Westinghouse E. & M. Co. | Osbon, W. O. |
| | East Pittsburgh, Radio Eng. Dept., Westinghouse E. & M. Co. | Reifsteck, C. N. |
| | East Pittsburgh, Westinghouse E. & M. Co. | Upp, Charles B. |
| | Emporium, Sylvania Products Co. | Kronenwetter, Harold G. |
| | Erie, 1119 W. 4th St. | Persio, Louis N. |
| | Johnsonburg, c/o Johnsonburg Radio Corp. | Carson, W. G. |
| | Philadelphia, 243 E. Upsal St., Mt. Airy | Blackwood, George Campbell |
| | Philadelphia, 251 S. 38th St. | Chambers, Carl C. |
| | Philadelphia, 3422 Barclay St., E. Falls | Gerhard, Charles E. |
| | Philadelphia, 756 N. Preston St. | Guzik, N. J. |
| | Philadelphia, 1816 W. Sulis St. | Hertrich, John H. |
| | Philadelphia, 3846 Lancaster Ave. | McCloskey, George W. |
| | Philadelphia, 1635 Poplar St. | Miller, George Anthony |
| | Philadelphia, 2651 S. Fairhill St. | Moss, Stanley Allen |
| | Philadelphia, 4636 Hazel Ave. | Prow, Albert H. |
| | Philadelphia, The Gladstone, 11th and Pine Sts. | Somerville, Harry V. |
| | Philadelphia, 1121 Spruce St. | Stanton, Russell S. |
| | Pittsburgh, 340 Rochelle St. | Curtiss, A. N. |
| | Pittsburgh, 5550 Beacon St. | Green, M. L. |
| | Pittsburgh, (21), 817 Rebecca Ave. | Harness, L. R. |
| | Pittsburgh, 306 Live Stock Exchange Bldg., Herr's Island | Thompson, R. G. |
| | St. Mary's Speer Carbon Co. | Abbott, Harold W. |
| | Turtle Creek, 131 Grant St. | Walker, M. C. |
| | Uniontown, Box 802. | Vincent, Charles William |
| | Wilkinsburg, 309 Penwood Ave. | Bokovoy, Sam A. |
| | Wilkinsburg, 442 Ross Ave. | Furth, Ernest L. |
| | Wilkinsburg, 707 Lamar Ave. | Miller, Horace G. |
| | Wilkinsburg, 584 Celeron St. | Mitkewich, W. |
| | Wilkinsburg, 1139 Franklin Ave. | Tiedje, J. Q. |
| | Wilkinsburg, 723 Whitney Ave. | Whitelock, L. D. |
| | Wilkinsburg, 1666 Laketon Road. | Wilson, Arthur C. |
| South Dakota | Lennox, Box 332. | Van Bockern, John H. |
| | Watertown | Sigelman, S. S. |
| Tennessee | Memphis, 1221 Jefferson St. | Shafer, Arthur B. |
| Texas | Amarillo, Amarillo Inn. | Chini, Carl J. |
| | Amarillo, 140 Wayside Drive | Martin, J. Laurance |
| | Tyler, Tyler Commercial College | Daniel, Charles L. |
| | Wichita Falls, 2213 9th St. | Drollinger, Kyle M. |
| Virginia | Winchester, 440 National Ave. | Smalts, Franklin W. |
| Washington | Seattle, 904 E. Pike St. | Gable, M. |
| Wisconsin | Gilman, P. O. Box 207. | Lowitz, W. V. |
| | Milwaukee, 543 Jefferson St., Apt. 37 | Osterloo, John D. |
| Alaska | Eyak, Mile 7 | Brightman, R. B. |
| | Juneau, U. S. Naval Radio Compass Station, Soapstone Point. | Derry, F. R. |
| Argentine | Buenos Aires, Navarro 4159, V. Devoto | Acuna, Segundo P. |
| | Buenos Aires, c/o Transradio 329, San Martin | Noizeux, Pierre |
| Australia | New South Wales, North Road, Eastwood | Craggs, Herbert Harold |
| | Victoria, 157 Raglan St., Preston N 18. | Skelton, Thomas H. |
| Austria | Vienna 18, Wahringenstrasse 123 | Ehrlich, Karl |
| Canada | Halifax, N. S., Acadian Hotel | Howard, William B. |
| | Hamilton, Ont., 72 Ontario Ave. | Olson, E. |
| | Montreal, P. Q., Northern Elec. Co., Ltd., 637 Craig St. | James, Cliff C. |
| | Toronto 9, Ont., 549 Indian Road. | Cronk, Harold W. |
| | Toronto, Ont., 886 Danforth Ave. | Dix, George |
| | Toronto, Ont., 192 Pape Ave. | Grant, Ingol M. |
| | Toronto, Ont., 91 St. George St. | Irwin, L. D. |
| | Toronto 6, Ont., 686 Broadview Ave. | McKichan, Donald Brandon |
| | Toronto, Ont., Canadian National Carbon Co., Ltd., 805 Davenport Road. | Potter, N. M. |
| | Toronto, Ont., c/o Saugamo Electric Co. of Canada, 183 George St. | Waite, Griffin Grant |
| | Toronto, Ont., 131 Lawrence Ave. W. | Hawes, Isaac E. |
| | Toronto 3, Ont., 12 Ellis Ave. | Tran, T. A. |
| | Winnipeg, Man., 399 Beaverbrook St. | Young, M. D. |
| Cuba | Havana, P. O. Box 1368. | Sebasco, Jorgh Gourafer |

| | | |
|--------------------|---|------------------------|
| England | Cambridge, Downing College | Vedy, Louis George |
| | Sidecup, Kent, Sidecup Hill, "Uplands" | Robertson, N. C. |
| | Lancaster, Lancashire, 5, Coverdale Road | Salt, William |
| | Cleethorpes, Lincolnshire, 39, St. Peter's Ave. | Poppleton, John |
| | Liverpool, Bootle, 29, Middlesex Road | Hughes, William Morris |
| | London N 7, Tufnell Park, 67, Carleton Road | Graham, C. |
| Hawaii | London NW 2, Dollis Hill Ave., 3, Hill Close | Horn, C. O. |
| | Norwich, Thorpe Hamlet, 34, Cedar Road | Cooper, G. R. |
| Italy | Hilo, Moses Stationery Co., Ltd. | Hill, Otis |
| | Honolulu, Box 3287 | Jackson, N. H. |
| Japan | Rome, 24 Lungotevere Mellini | Gabriello, Giannini |
| | Rome, Viale Mazzini 6 | Marino, Algeri |
| New Zealand | Tokyo, Azabuku, Banchi, Amishiroco -1 | Akamatsu, Kaworu |
| | Tokyo, Marunouchi, Japan Wireless Telegraph Co. | Kiyota, Y. |
| | Tokyo, Marunouchi 2 Chome, Japan Wireless Telegraph Co. | Mizuhashi, Tosaku |
| | Tokyo, Marunouchi 2 Chome, Japan Wireless Telegraph Co. | Nakagami, Minoru |
| North Ireland | Tokyo, 419 Ikebukuro (near Tokyo) | Takeuchi, H. |
| | Christchurch, c/o District Telegraph Engineer | Rubenstein, S. J. |
| Philippine Islands | Dannevirke, Rawhiti St. | Claridge, R. |
| | Queensland, S. Brisbane, Annerley, Rose St. | Bauer, A. T. |
| Scotland | Belfast, 128 University Ave. | Waite, D. |
| | Cebu, Cebu, P. O. Box 525 | Rivera, T. L. |
| South Africa | Aberdeen, 102 Stanley St. | Wilkie, J. McKenzie |
| | Edinburgh, 6 th Royal Circus | Gee, Harry L. |
| South Australia | Beaufort West, Telegraph Repeater Room | Hendry, J. S. |
| | Northern Rhodesia, c/o N'Changa Copper Mines, via Ndola | Yule, T. M. |
| | Rosewater, Margaret Terrace | Sawford, L. F. |

For Election to the Junior grade

| | | |
|---------------|---|--|
| California | San Francisco, 625 Bush St. | Simpson, Charlotte Frances |
| Georgia | Atlanta, P. O. Box 742 | Barker, Howard J. |
| Illinois | Chicago, 5509 Everett Ave. | Palmer, James |
| | Valparaiso | Gallinger, Lester E. |
| Indiana | Valparaiso, 401 E. Monroe | Gunnlaugson, Jacob |
| | Valparaiso | Jones, W. R. |
| Iowa | Vincennes, Terre Haute Road | Kopp, Clarence |
| | Douds | Greenfield, Daniel C. |
| Massachusetts | Cambridge, M. I. T. Dorm '93 | Dyer, John Newton |
| | Cambridge, M. I. T. Dorm, Room 93-508 | Hollywood, John M. |
| Missouri | Gloucester, 13 Beauport Ave. | Hoyt, Edward C. |
| | Hannibal, 1030 Church St. | Cox, T. Alfred |
| Nebraska | Carleton | Damm, Fred |
| | Passaic, 330 Gregory Ave. | Mercer, Ira G., Jr. |
| New Jersey | Weehawken, 62 Liberty Place | Pollack, Dale |
| | Brooklyn, 2977 W. 3rd St. | Daniels, Murray |
| New York | Brooklyn, 441 Eastern Parkway | Hartley, John Harrison |
| | Brooklyn, 839 Monroe St. | Salvante, Louis Eugene |
| Ohio | New York City, 1575 Grand Concourse, Bronx | Sheffield, Berthold |
| | Schenectady, Union College, Delta Phi House | Peck, Caid H. |
| Pennsylvania | Skaneateles, 65 Genesee St. | Roberts, Edward |
| | Lakewood, 15104 Detroit Ave. | Hoff, Henry B. |
| Texas | Westerville, R. R. #1, Box 9-A | Nafzger, Lester H. |
| | Scranton, 323 Madison Ave. | Richards, Jack E. |
| Canada | San Antonio, 205 E. Looust | James, Vir N. |
| | Toronto, Ont., 48 Albermarle Ave. | Morton, Howard J. |
| New Zealand | Dunedin, Northeast Valley, 30 Calder Ave. | Collett, William George |
| | Peru | Lima, All American Cables, Inc., Radio Staff |

OFFICERS AND BOARD OF DIRECTION, 1929

(Terms expire January 1, 1930, except as otherwise noted)

President

A. HOYT TAYLOR

Vice-President

ALEXANDER MEISSNER

Treasurer

MELVILLE EASTHAM

Secretary

JOHN M. CLAYTON

Editor

WALTER G. CADY

Managers

R. A. HEISING
J. V. L. HOGAN

L. M. HULL
R. H. MARRIOTT

L. E. WHITTEMORE
J. H. DELLINGER
(Serving until Jan. 1, 1931)

R. H. MANSON
(Serving until Jan. 1, 1931)

ARTHUR BATCHELLER
(Serving until Jan. 1, 1932)

C. M. JANSKY, JR.
(Serving until Jan. 1, 1932)

Junior Past Presidents

RALPH BOWN
ALFRED N. GOLDSMITH

Board of Editors, 1929

WALTER G. CADY, *Chairman*

STUART BALLANTINE
RALPH BATCHER
CARL DREHER

G. W. PICKARD
L. E. WHITTEMORE
W. WILSON

Committees of the Institute of Radio Engineers, 1929

Committee on Meetings and Papers

K. S. VAN DYKE, *Chairman*
E. V. APPLETON
WILSON AULL
W. R. G. BAKER
STUART BALLANTINE
V. T. BASHENOFF
R. R. BATCHER
M. C. BATSEL
ZEH BOUCK
RALPH BOWN
H. H. BUTTNER
W. G. CADY
L. M. CLEMENT
E. T. DICKEY
CARL DREHER
EDGAR FELIX
V. M. GRAHAM
O. B. HANSON
L. C. F. HORLE
J. W. HORTON
L. M. HULL
S. M. KINTNER
S. S. KIRBY

F. H. KROGER
D. G. LITTLE
ALEXANDER MEISSNER
WM. H. MURPHY
E. L. NELSON
H. F. OLSON
G. W. PICKARD
R. H. RANGER
B. E. SHACELFORD
N. H. SLAUGHTER
H. M. TURNER
BALTH. VAN DER POL
PAUL T. WEEKS
JULIUS WEINBERGER
HAROLD A. WHEELER
L. P. WHEELER
W. C. WHITE
L. E. WHITTEMORE
W. WILSON
R. M. WISE
IRVING WOLFF
H. YAGI

All chairmen of Meetings and
Papers Committees of Institute sec-
tions, *ex officio*.

Committees of the Institute—(Continued)

Committee on Admissions

R. A. HEISING, *Chairman*
ARTHUR BATCHELLER
H. F. DART
C. P. EDWARDS
C. M. JANSKY, JR.
F. H. KROGER
A. G. LEE
GEORGE LEWIS
ALEXANDER MEISSNER
E. R. SHUTE
J. S. SMITH
A. F. VAN DYCK
All chairmen of Institute sections,
ex officio.

Committee on Awards

MELVILLE EASTHAM, *Chairman*
L. W. AUSTIN
RALPH BOWN
W. G. CADY
A. HOYT TAYLOR

Committee on Broadcasting

L. M. HULL, *Chairman*
ARTHUR BATCHELLER
PAUL A. GREENE
RAYMOND GUY
J. V. L. HOGAN
C. W. HORN
R. H. MARRIOTT
E. L. NELSON

Committee on Constitution
and Laws

R. H. MARRIOTT, *Chairman*
RALPH BOWN
E. N. CURTIS
W. G. H. FINCH
H. E. HALLBORG
J. V. L. HOGAN
G. W. PICKARD
HAROLD ZEAMANS

Committee on Membership

I. S. COGGESHALL, *Chairman*
F. R. BRICK
W. W. BROWN
H. B. COXHEAD
H. C. GAWLER
R. S. KRUSE
PENDLETON E. LEHDE
H. P. MAXIM
S. R. MONTCALM
A. F. MURRAY
M. E. PACKMAN
J. E. SMITH
JOHN C. STROEBEL, JR.
All secretaries of Institute sections,
ex officio.

Committee on Nominations

MELVILLE EASTHAM, *Chairman*
ALFRED N. GOLDSMITH
DONALD McNICOL
R. H. MANSON
G. W. PICKARD

Committee on Publicity

W. G. H. FINCH, *Chairman*
H. W. BUCKAT
ZEH BOUCE
C. E. BUTTERFIELD
ORRIN E. DUNLAP
FRED EHLERT
A. H. HALLORAN
R. D. HEINL
LOYD JACQUET
ARTHUR H. LYNCH
J. F. J. MAHER
A. H. MORSE
U. B. ROSS
J. G. UZMANN
WILLIS K. WING

Committee on Institute Sections

E. R. SHUTE, *Chairman*
AUSTIN BAILEY
M. BERGER
L. A. BRIGGS
F. E. ELDRIDGE
D. H. GAGE
F. P. GUTHRIE
C. W. HORN
A. F. MURRAY
B. E. SHACKELFORD
All chairmen of Institute sections,
ex officio.

Committee on Standardization

J. H. DELLINGER, *Chairman*
M. C. BATSEL
W. R. BLAIR
C. E. BRIGHAM
E. L. CHAFFEE
T. A. M. CRAVEN
T. McL. DAVIS
E. T. DICKEY
H. W. DREYER
C. P. EDWARDS
S. W. EDWARDS
GENERAL FERRIE
H. A. FREDERICK
ALFRED N. GOLDSMITH
O. B. HANSON
J. V. L. HOGAN
W. E. HOLLAND
C. B. JOLLIFFE
R. S. KRUSE
GEORGE LEWIS
R. H. MANSON
ALEXANDER MEISSNER
C. B. MIRICK
GINO MONTEFINALE
E. L. NELSON
L. G. PACENT
HARADEN PRATT
H. B. RICHMOND
C. E. RICKARD
A. F. ROSE
H. M. TURNER
K. B. WARNER
W. C. WHITE
C. E. WILLIAMS
HIDETSUGU YAGI

PART II
TECHNICAL PAPERS

TYPICAL WIRELESS APPARATUS USED ON BRITISH AND EUROPEAN AIRWAYS*

By

EDWARD H. FURNIVAL

(Marconi's Wireless Telegraph Company, Limited, Marconi House, London, England)

Summary—The information given in this paper is based in the main on the system in operation on British airways. European airways follow to a greater or less degree the general principles underlying the system described.

SERVICE REQUIREMENTS

THE apparatus is designed to comply with the following service requirements:—

(a) Two-way communication is required, i.e., from ground to air and from air to ground.

(b) Reliable working is required normally up to distances of 100 to 150 miles, with the possibility of longer ranges being attainable up to a maximum of 250 miles when working with a main airport station.

(c) Radiotelephony is required for European airways. CW telegraphy, with the possibility of telephony, is employed on the Empire air routes, and also on certain European routes.

(d) Ground station receiving apparatus must be capable of giving directive reception so that bearings can be taken on transmission from aircraft, and by coordinated operation by a group of such stations, positions can be worked out by triangulation and passed to aircraft requiring information. Alternatively, a single bearing can be passed from one ground station alone.

(e) The wavelength on which communication is carried out between aircraft and ground stations is 900 meters.

(f) A separate hand-speed simplex telegraph service on a different wavelength is provided for inter-aerodrome traffic.

(g) A telegraphic broadcasting service is provided on another wavelength for the dissemination of meteorological information.

EXPLANATION OF SERVICE REQUIREMENTS

(a) Communication from aircraft to the ground stations is needed for the following main purposes:—

For distress calls. (This service is of primary importance to commercial aircraft flying to and from the Continent, owing to the channel crossing.)

* Dewey decimal classification: R520. Original manuscript received by the Institute, October 31, 1929.

For reporting positions and progress.

For the acknowledgment of messages received from the ground stations

For position finding by the ground station direction-finders.

For reporting weather conditions of the upper atmosphere.

For announcing changes of course or destination.

For service messages, etc.

Communication from ground stations to aircraft is required for the following purposes:-

For passing weather reports.

For passing bearings and positions.

For giving information as to the proximity of other machines.

For acknowledging messages received from aircraft.

For passing service instructions, etc.

(b) As regards working range, this in the main is governed by the length of the stage or trip from one terminal to another. This distance may be of the order of 200 to 300 miles. Although intermediate aerodrome stations are available it is generally considered desirable to provide apparatus which will enable contact to be maintained by the aircraft with one or other of the main terminal stations, hence a reliable telephonic range of 100 to 150 miles is needed, telegraph ranges being proportionately greater.

(c) The most suitable type of transmission to employ has been the subject of much careful investigation. The reason for telephony is twofold. In the main it is to enable adequate communication to be carried out by flying personnel (either pilot or flying mechanic) without the intervention of the professional wireless operator. By this means encroachment on "pay load" is avoided, excepting by the carriage of the apparatus itself.

Incidentally it happens, however, that wireless telephony is particularly suitable in some respects for aerial communications. Given good intelligibility (by no means an easy attainment under flight conditions, but nevertheless one which can be obtained with well developed technique) communication is quick, and the pilot is enabled to maintain direct contact with the responsible official on the ground.

In the big machines and flying boats employed on the Empire air routes an operator is carried. Longer ranges are often needed, and it becomes advantageous to use CW telegraphy, with telephony as a stand-by, if required.

(d) It is a well-known fact that the directive properties of wireless can be used as a valuable aid to navigation. There are several ways which are capable of employment, but the one most generally used in Europe is by directive reception on the ground, and a network of such stations has grown up to serve the needs of commercial aviation.

It is usual to carry out normal communications on the direction-finding receiver, which can be immediately employed as a directional instrument when a call for a bearing or a position is received.

This system has the advantage that no extra weight or complication is involved so far as the aircraft is concerned, but where machines have to fly long distances, off the track of organized routes, then it becomes a case for carrying the direction-finding receiver on the plane, and special instruments have been developed for this purpose.

It is therefore normal to equip the modern airport with a direction-finding receiver of high grade. As is the case at the London Terminal Aerodrome, this may be situated actually in the control tower, the corresponding transmitting equipment being located outside the boundary of the aerodrome, remotely controlled from the control tower receiving station.

(e) For inter-aerodrome traffic separate transmitting and receiving equipment is installed to form an entirely independent channel of communication.

Messages concerning the arrival and departure of machines, service instructions, etc., are handled in this way.

(f) For the dissemination of meteorological information a separate wavelength is used, and the more important centers employ a separate station which sends out reports at stated intervals in the form of telegraphic broadcast messages in code. At present the following wavelengths are used:—

(a) For working between aircraft and ground stations 900 meters (this wave may be supplemented by others within the band 850 to 950 in the future, owing to traffic congestion).

(b) For inter-aerodrome working, 1400 meters. (214 kc per sec.)

(c) For meteorological services, 1260 meters. (238 kc per sec.)

(d) For emergency working between aircraft and ships and coast stations, 600 meters.

As it is possible that there will be a considerable revision in the allotment of wavelengths in the future, it was thought necessary to

cope with this probable development by providing fairly generous wave ranges in all standard apparatus.

TECHNICAL DESCRIPTION OF APPARATUS—AIRCRAFT EQUIPMENT

A typical aircraft set which is commonly employed is the Marconi type AD6. This set is suitable for the transmission and reception of continuous wave, interrupted continuous wave, and telephone messages with aerodrome ground stations up to distances of 100 to 300 miles. Where space and personnel permit, the apparatus can be installed in such a position that the operator or observer has access to and full control over all adjustments, and can therefore take full advantage of the wave range and flexibility of the installation. In such cases, the dual control equipment is particularly useful, as it enables the pilot and the observer to communicate with one another without using the wireless.

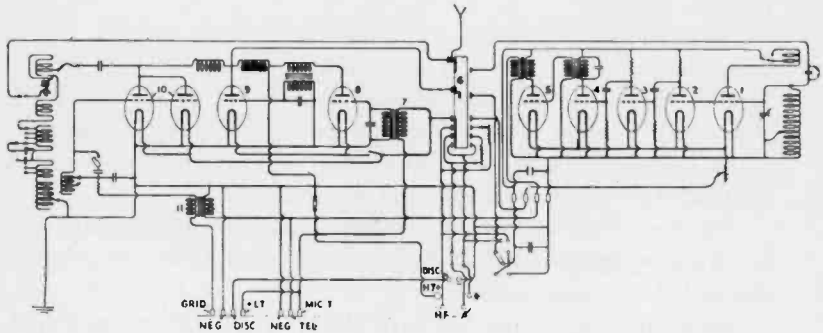

Fig. 1

- | | |
|--------------------------------------|-----------------------------|
| (1) High-frequency amplifying valve. | (6) "Send-receive" switch. |
| (2) High-frequency amplifying valve. | (7) Microphone transformer. |
| (3) High-frequency amplifying valve. | (8) Sub-modulating valve. |
| (4) Detector valve. | (9) Modulating valve. |
| (5) Low-frequency amplifying valve. | (10) Oscillating valves. |
| (11) Side tone transformer. | |

Where space is restricted and where no observer or operator is carried, the set can be mounted in any convenient part of the machine, the remote control unit enabling the pilot to operate the set himself.

The wave range obtainable depends to a certain extent on the electrical capacity of the machine to which the set is fitted, which, in turn, depends largely on the size of the aircraft. When installed on a machine having an electrical capacity of about $0.0003 \mu f$, the transmitter is adjustable to any wavelength between the limits 300 meters to 1,500 meters. The receiver is adjustable to any wavelength between 200 meters to 1,800 meters.

Owing to the extremely efficient radiator which is formed by a weighted wire suspended in space from the machine, this system has found universal application. Its advantages are twofold:— First, it enables the maximum range to be obtained from the minimum of power and weight, and secondly, such an aerial forms an extremely good “pickup” for the receiver, and this helps materially to maintain a favorable signal strength to ignition noise ratio, thereby tending to avoid ignition interference problems. Its disadvantage is the attendant risk of losing the aerial, especially during low flying under bad weather conditions, or by inadvertent loss when letting it out.

The modern tendency is to fit a supplementary fixed aerial on the larger aircraft, for low flying, especially in the vicinity of the aerodrome. The risk of loss due to operational causes is practically eliminated by the specially designed aerial winch which automatically controls the speed of release of the aerial.

The components of both transmitter and receiver are mounted in one box fitted externally with strong lugs, to which the rubber shock absorber suspensions can be conveniently attached. In spite of the extreme compactness of the apparatus, all components are readily accessible and can be removed by any qualified mechanic for examination or repair. A simplified diagram of connections is shown in Fig. 1.

The transmitting system comprises:—

(1) An aerial tuning inductance with tappings for varying the wavelength in steps and a variometer for obtaining intermediate values of wavelengths.

(2) Two oscillation valves for energizing the aerial circuit coupled to the aerial by means of a grid variable reaction coil and an anode tap connection on the aerial tuning inductance. A useful provision is the side tone circuit which enables the operator to overhear his own speech and to check whether the speech is being correctly transmitted.

(3) A modulating system consisting of a control valve and a sub-control valve connected in cascade across the generator and speech choke.

The receiving system comprises:—

(4) A tuner for high-frequency selection.

(5) A five-valve amplifier. One valve is used for reaction, two for high-frequency amplification, using “resistance-capacity” intervalve couplings, one for rectification and one for low-frequency amplification.

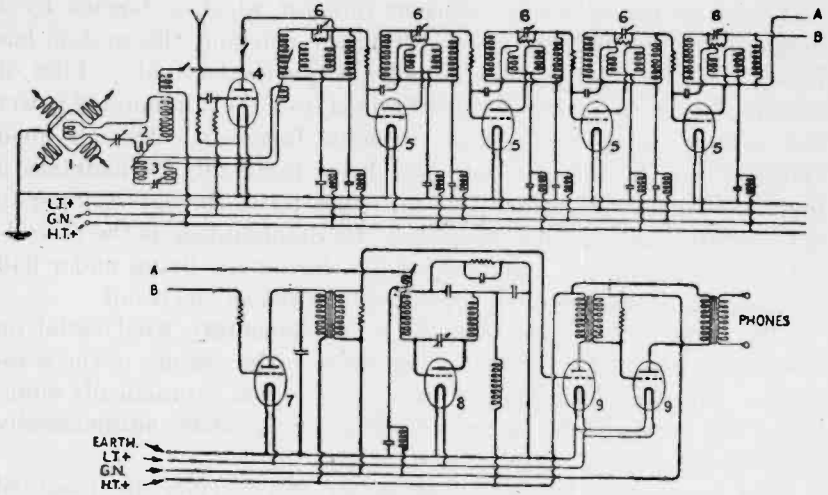

Fig. 2—Simplified diagram of connections of type R.G.14 receiver.

- | | |
|---------------------------------|--|
| 1. Directional selector. | 6. Tuned high-frequency grid circuits. |
| 2. Tuned search coil circuit. | 7. Rectifying valve. |
| 3. Intermediate tuning circuit. | 8. Local oscillation generator. |
| 4. Open aerial coupling valve. | 9. Low-frequency amplifiers. |
| 5. High-frequency amplifiers. | |

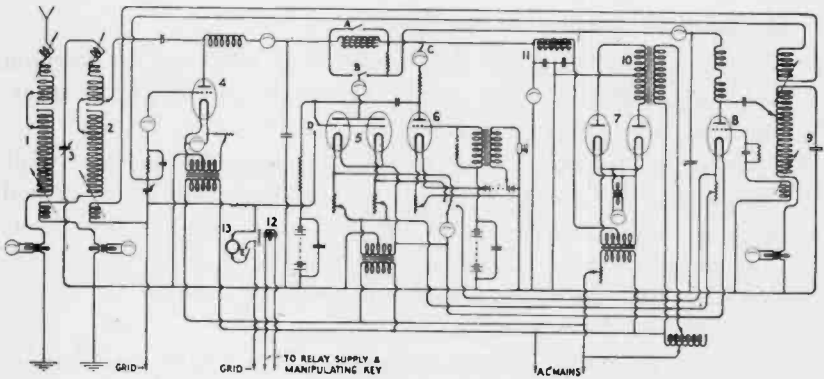

Fig. 3—Simplified diagram of connections of 4-kw type T.A.1 telegraph-telephone transmitter.

- | | |
|-------------------------------|-----------------------------|
| 1. Aerial tuning inductance. | 7. Rectifying valves. |
| 2. Closed circuit inductance. | 8. Independent drive valve. |
| 3. Closed circuit condenser. | 9. Drive closed circuit. |
| 4. Power amplifier valve. | 10. Power transformer. |
| 5. Modulating valves. | 11. Smoothing system. |
| 6. Sub-modulating valve. | 12. Signalling relay. |
| 13. Interrupter disk. | |

Switches A, B, C, D, and E change the circuits to CW-ICW or telephony and are controlled by a single two-way lever.

The anode circuits of receiving valves are supplied with current from the generator. With the "send-receive" switch on the receive side the high-tension voltage of the generator is reduced to about 100 volts by the insertion of a high resistance in the high-voltage field of the generator.

The remote control unit is purely a mechanical device with four levers which operate, through Bowden cables, the following adjustments:—

- (1) Change-over "send-receive" switch.
- (2) Aerial tuning condenser.
- (3) The receiver valve filament resistance.
- (4) The receiver reaction coupling.

The unit is designed in a convenient form for mounting within easy reach of the pilot, and can readily be detached from the respective handles if and when required.

For the power supply a wind-driven generator is employed, operated by an automatic constant speed propeller. The generator used with the AD6 has a total output of about 180 watts, made up as follows:—

- 100 milliamperes at 1350 volts.
- 6 amperes at 7.5 volts.

The low-voltage output is sometimes increased and arranged to feed the lighting circuits of the aircraft through a suitable switchboard.

A small thin plate accumulator battery is connected so as to float across the low-voltage output. This arrangement is found very convenient for smoothing the ripple from the machine, and also for routine testing on the ground.

One or two other features are worth mentioning, namely:—

The microphone is of special construction, being highly damped to cause it to be relatively insensible to extraneous noise. The acoustic properties of the telephones are selected with care to ensure a quality of speech reproduction which can be readily understood above the surrounding noise. It is possible to shut out a considerable amount of noise by carefully designing the flying helmet, and it has been found desirable to issue a special helmet to ensure the most favorable results for reception, especially on noisy machines.

Intercommunication between pilot and operator or mechanic is arranged for by a separate attachment, while if telegraphy is required a keying unit with selector switch can be plugged into the main set.

The weight of the complete equipment is approximately 100 lbs.

Where greater power is required, such as in the flying boats operating in the Mediterranean section of the London to Karachi air route, the Marconi type AD8 installation is in use. The characteristics of

this set are generally similar to the AD6, but the power input is increased to about 400 watts.

IGNITION INTERFERENCE

Where necessary this source of trouble is removed by the screening of the ignition system. Metal braided wire is used for the ignition leads associated with covers for the magnetos, and if necessary the spark plugs. Switch wires are often offenders, and require similar protection. Care has to be given to the application of this system, and it is desirable to make it as far as possible weatherproof.

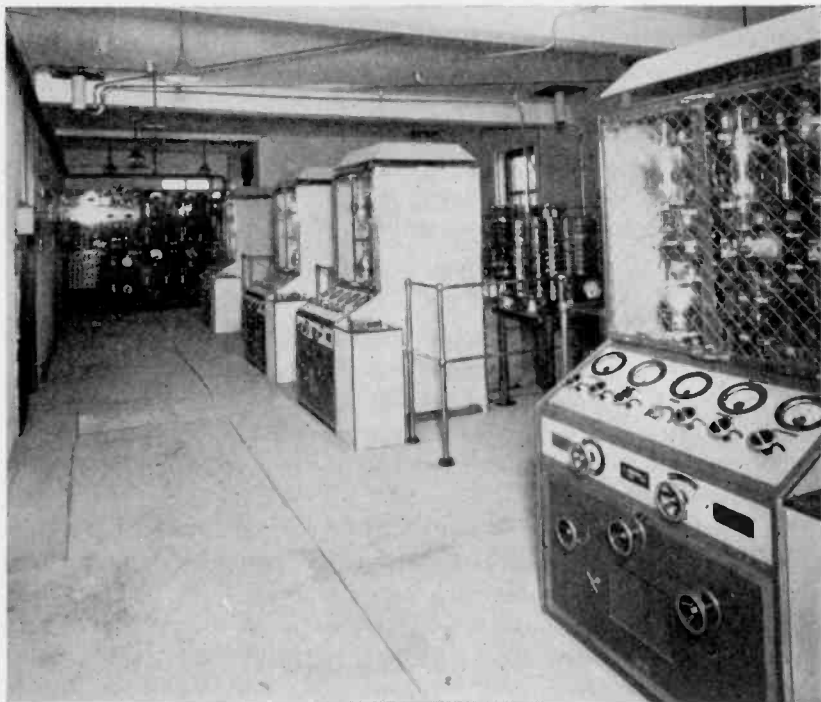

Fig. 4—Transmitting station at Croydon.

TESTING EQUIPMENT

In order to provide the simple routine procedure necessary for the effective testing and adjustment of aircraft wireless apparatus, the Marconi Company has developed a series of standard testing sets to permit of a series of accurate and precise tests. Their application enables an expert technician to carry out ground tests expeditiously and with the minimum of time and effort.

The principal item of this equipment which is in use at the terminal aerodrome is an instrument comprising a combination of an artificial aerial and a wavemeter. By the use of this device the equipment can be tested either *in situ* or on the bench. Oscillation condition, wavelength, and modulation characteristics of the transmitter can be readily checked while the receiver can be tested for sensitivity and wavelength with sufficient accuracy for practical purposes. For tests during flight a set of meters suitably mounted in unit form can be plugged into the set to test the power distribution to the filament, plate circuits, etc.

For tests on the ground a portable petrol engine is employed to provide power in place of the usual wind-driven generator.

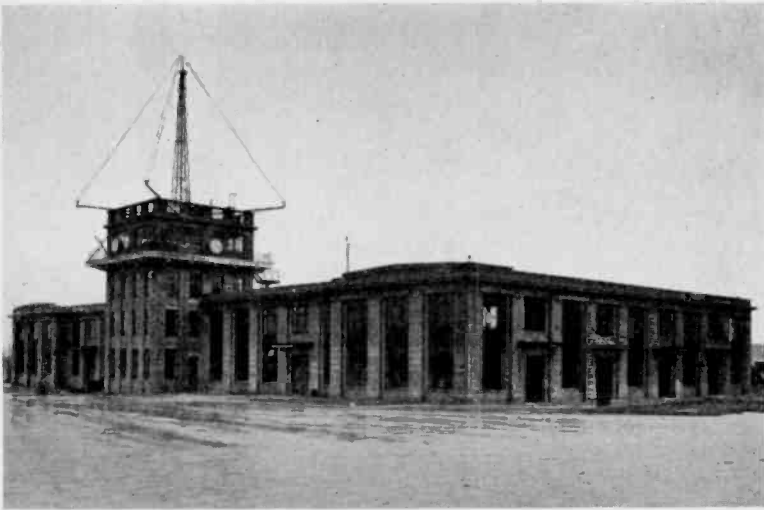

Fig. 5—Control tower showing direction-finding aerial system, Croydon.

By a carefully arranged system of ground tests aided by this equipment the maintenance engineers, assisted by reports from flying personnel and ground stations, are able to keep the equipment in an efficient state although they seldom have the opportunity of handling the apparatus in flight along the routes.

GROUND STATION EQUIPMENT

A typical modern ground station equipment for a main terminal aerodrome is the station recently established by the Air Ministry at the London airport at Croydon. This comprises a group of four transmitters working in conjunction with direction-finding receiving equipment.

In order to centralize and co-ordinate control, the direction-finding receiver is situated at the top of the control tower on the aerodrome. From here the operator, who works virtually side by side with the traffic officer, controls the transmitting equipment placed some $2\frac{1}{2}$ miles from the boundary of the aerodrome.

Under the control of this operator the direction-finding receiver, on which all messages are received, was specially developed by the Marconi Company for this service, and is designed for the reception of CW, ICW, and telephone signals. A local oscillation generator is embodied in the receiver for the purpose of reception.

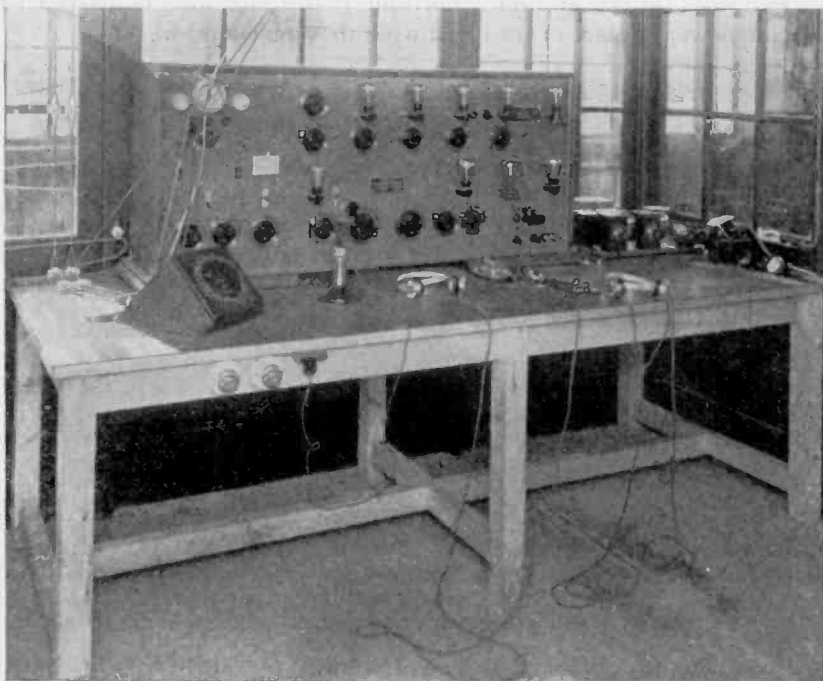

Fig. 6—RG14 installed in control tower at Croydon.

Three types of reception are provided for, namely, the "circle" or all-round diagram, the double directional or "figure-of-eight" diagram, and the uni-directional or "heart shape" diagram. A valve-coupled phasing unit incorporated in the receiver enables the uni-directional diagram to be made any desired shape, thus adding considerably to the selective properties of the receiver.

The receiver is used with two triangular fixed loop aerials and a single-wire open aerial, and radiogoniometers or directional selectors have been designed whereby more than one receiver can operate upon

a common aerial system, thereby saving considerable expense when multi-way reception is required. The degree of accuracy obtainable with either the single or multi-way equipment is exceedingly high. For single-way reception the receiver is provided with a single direction-finding unit, and for multi-way working each receiver is provided with a double direction-finding unit, and a small artificial aerial unit.

The search coil of the radiogoniometer is tuned by a condenser, and can be coupled direct or via a tuned intermediate circuit to the special four-stage high-frequency amplifier. Each of the four high-frequency amplifying stages and the intermediate circuit is tuned by means of a condenser, and a gang control enables quick searching over a band of about ten per cent on either side of any desired spot wavelength to be obtained, at the same time keeping the overall amplification constant.

The various units of the receiver comprising the high-frequency tuning circuits, the high-frequency amplifier, the rectifiers, the local oscillation generator, and the low-frequency amplifier are mounted on the back of a vertical metal panel fixed to a rigid framework which slides into a teak containing case. The units are mounted in screening cases which can be easily removed when necessary. The various circuit adjustments and valves are mounted on the front of the panel.

With regard to the transmitting station, four separate and complete transmitters of the Marconi type T.A.1 are provided, each having a power input of 3 to 4 kw.

These sets are grouped together in one building, and are supplied with power from a motor alternator of sufficient capacity to feed the four units simultaneously. The motor alternator is duplicated, and a petrol electric plant is provided in reserve in case of failure of power from the supply mains.

Each transmitter has its own aerial system and each can be adjusted to operate on any wavelength between the limits of 800 and 2000 meters.

Provision is made in this type of set for the transmission of telephony and telegraphy, either by CW or ICW, while an independent drive is incorporated to ensure a sufficient degree of wave constancy.

Modulation is by the well-known choke control method, the main control valves being arranged to act as absorber valves while keying.

The oscillation generator, modulating and rectifying system is contained in a metal cabinet, together with the independent drive apparatus, while external to this are mounted the astatically connected aerial tuning and closed circuit inductances and condensers.

Four inverted *L* aerials of the four-wire cage type are grouped around the building supported by 100-ft. towers.

Power for each of the transmitters is supplied from the main alternator at 350 volts at 300 cycles and this is stepped up by a transformer

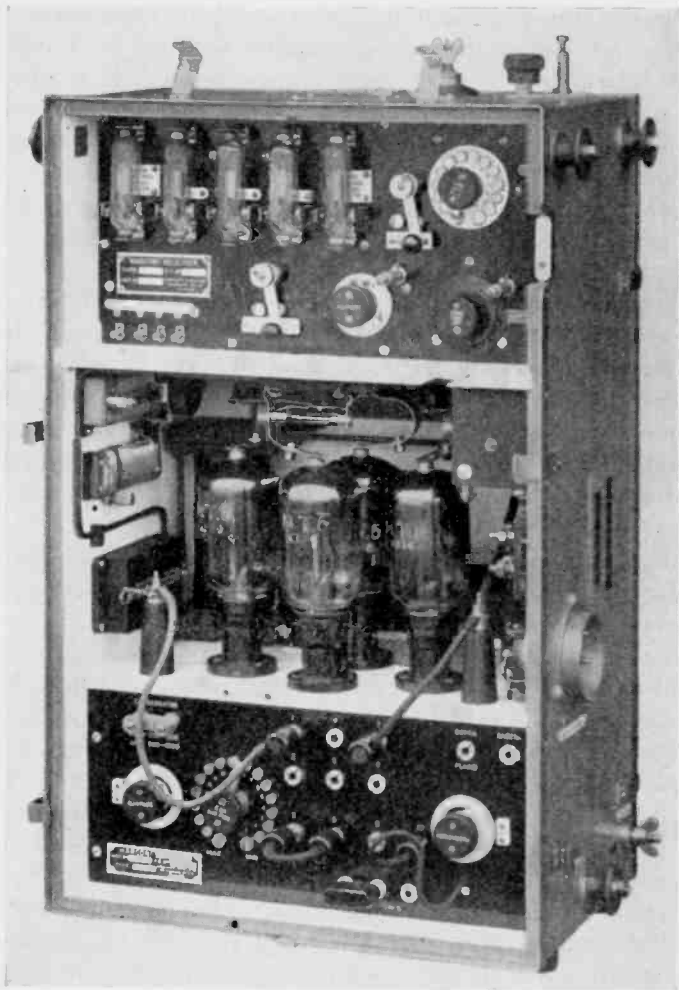

Fig. 7—Type AD6H instrument box.

to from 5000 to 10,000 volts, rectified by two rectifying valves, and smoothed by condensers and chokes.

Filament heating is arranged from the same source except for the sub-modulators, which are heated from a separate d-c supply.

A system of relays is provided to enable the plant (which is in charge of a station attendant) to be under the complete control of the

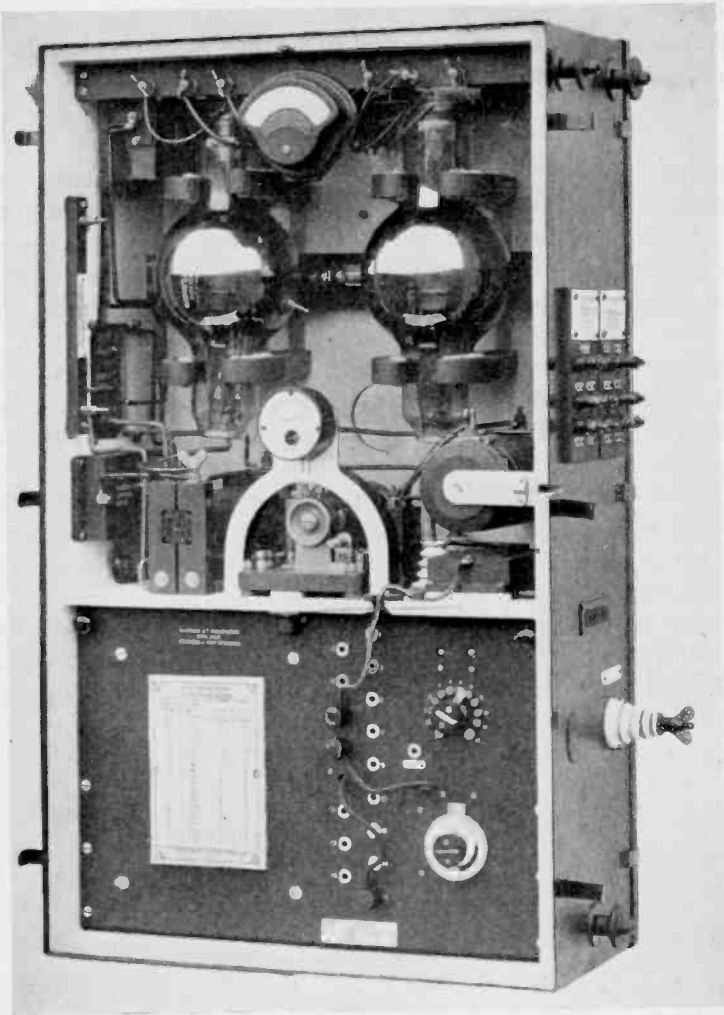

Fig. 8—Type AD8 instrument box.

aerodrome operator, the two stations being connected by a suitable multiwire underground cable for this purpose.

Two of these transmitters are allocated to aircraft services; another is for the 1400-meter inter-aerodrome traffic; while the fourth is a stand-by set.

This plant has a guaranteed telephonic range of 250 miles to a standard aircraft set of the type A.D.6.

At intermediate airports similar telegraph-telephone and direction-finding receiving equipment is provided, but less power is required and the transmitting plant is simplified in various ways. Generally only one complete transmitter is installed.

CONCLUSION

It has only been possible within the scope of this paper briefly to touch on the salient features of the apparatus described; furthermore, it has only been possible to mention one or two of the main types of stations employed. Constant expansion and improvement are taking place and what is current today will no doubt soon be superseded.

New methods and improvements in direction-finding are constantly being envisaged, while the employment of short-wave transmission, either as an alternative or as an adjunct to the existing long-wave system, has certain attractive possibilities.

The advent of the light plane movement also opens up rather a new field and special apparatus suitable for the private owner (the type AD.22) has therefore been developed and is now available for the light plane private owner.

A new type of set suitable for air-route working has also recently been developed (the AD.18). It is more powerful than the A.D.6, incorporates an independent drive, and has improved modulating and receiving circuits.



RADIO FOR THE AIR TRANSPORT OPERATOR*

BY

LESTER D. SEYMOUR

(General Manager, National Air Transport, Inc., Chicago, Ill.)

Summary—This paper deals with the aid of radio to an air transport operator; first, with merely long-wave receiving equipment on the plane, and, secondly, with the additional use of a short-wave plane transmitter. The tendency is noted toward establishment of short-wave two-way communication systems by the operators themselves. Requirements for apparatus under these conditions are discussed.

ALTHOUGH air transportation has already demonstrated that it is an economic factor in modern life, it is equally true that radio in various types of application must play a large part in the program. This was wisely anticipated by Congress when they authorized the Department of Commerce to provide radio aids for air navigation. This work has been carried on admirably, and regular use is made of the present Airways Stations' weather and emergency broadcasts. Their radiobeacons, too, are helping to guide fliers through storm and night.

This is the simplest application of radio to the needs of air transportation in that the equipment on the airplane is light in weight, easy to install and operate, and least complicated in construction. To be sure, it does not offer the pilot communication to the ground, but it has a wide usefulness especially in single-man mail planes where the pilot is already seriously overworked in bad weather.

One of the oldest air mail carriers, National Air Transport, Inc., relies on the practical aid offered by this one-way radio service. This company has been experimenting with radio for almost two years and now has its Chicago-New York mail planes equipped with long-wave beacon and voice receivers, for routine operation. These are very sensitive instruments, using screen-grid tubes and are mounted in a compartment within the fuselage between the cockpit and the tail. Remote controls run up to the pilot so that tuning and adjustment of volume are very conveniently accomplished.

Some idea of the gain of the receiver may be indicated by the fact that 2-kw voice transmitters on 1000 meters are frequently picked up, in daylight, at distances of 300 to 400 miles using merely a 6-ft. mast as the antenna. This mast projects vertically from the fuselage about half-way between the cockpit and the tail of the plane. Much study

* Dewey decimal classification: R520. Original manuscript received by the Institute, September 12, 1929. Presented by M. M. Eells before New York meeting of the Institute, October 2, 1929.

and experimentation was necessary, of course, before the ignition interference from the engine could be reduced to negligible proportions.

Before "taking-off" with his mail cargo, the pilot studies the weather map and the latest reports available at the local Weather Bureau, concerning the actual conditions reported from observation stations along the airway. Certain regions along his line may look questionable, but he knows that subsequent weather reports will be broadcast regularly. However, he may request a special broadcast to be made at a specific time after his departure to give certain weather conditions as they may have developed in that particular questionable area.

Further than this, the one-way radio service has been of immeasurable value to National Air Transport, Inc., in a number of recent instances where the terminal fields have been closed in by fog. Emergency broadcasting by the Airways Radio Station was arranged with the assistance of the local field manager who could hear the plane as it roared through the fog near the field. By personal radio instructions to this pilot it was possible to bring him back and forth across the field until he could be brought down gradually in safety.

The fund of experience National Air Transport, Inc., has gained in flying these radio-equipped planes has proved that the ground-to-plane radio aids are of tremendous value in bad weather flying, with assistance offered in the four following degrees:

- (1) Reduction in flying time by more direct navigation.
- (2) Flights made that would not otherwise have been attempted.
- (3) Prevention of pilots becoming lost and having to leave plane.
- (4) Avoidance of crashes and fatalities in thick weather.

To consider the completion of the communication setup, it is obvious that much additional assistance can be given the pilot if he is able to talk with the ground. With these facilities, he can materially aid the Weather Stations in their collection of information, by reporting conditions he meets in flight. He is able to ask for specific information which may be of most vital importance if he is shut in by fog or storms. In case of a forced landing, the operation of the transmitter even if in only an inefficient emergency manner, may mean everything in assistance to those trying to help him.

Ground receiving equipment can be maintained by the operating personnel at the fields, but there is the question of getting the reply back to the plane. Where there is a local Department of Commerce voice broadcaster, the message can be handled by them as an emergency broadcast, if the reply is of the nature of life, property, or cargo.

It is recognized, however, that the large air transport operators

will prefer ultimately to have two-way communication systems of their own. Short waves, below 200 meters, will be used for both ground-to-plane and plane-to-ground. Ground stations will be owned and operated individually by the air transport operators or cooperatively if the routes of two or more operators join or are parallel. Such a system of privately operated radio facilities will provide means for dispatching planes, communication at times of distress for safety of life and property, and means of handling commercial messages to and from passengers in planes at such a time when this may be an economic step. Course indication or triangulation may be made where direction-finding ground equipment is provided. Pan American Airways and Transcontinental Air Transport have been employing this means as an aid to navigation.

Telephone is the preferred form of communication especially for single-pilot planes on account of greater speed message-sending and because of the simplification of the operator problem. Certain of the larger transport planes are, however, using code, especially where greater distances must be covered or where static is unusually heavy. This means a saving in equipment weight against which is balanced the extra radio operator.

The question of communication between airports is naturally a very vital one, not only for plane dispatching but also for weather dissemination. Interfield communication should not be conducted by radio where existing land lines can handle the traffic without hazardous delay. Such a practice, if adopted generally, would clutter frequency channels sorely needed for legitimate services that can use only radio.

The air transport operator has a difficult problem in finding suitable equipment. A good portion of this is due to the comparative lack of experimental data on short-wave airplane operation. Ordinary commercial equipment is not suitable until it has been thoroughly redesigned from the standpoint of weight, size, extreme durability, and reliability. Cushioning of the parts against vibration in flight, or jars due to heavy landing, presents a problem in itself.

The balancing of weight against reliability of operation must always be a compromise. When it is realized that failure of the installation in flight may mean loss of life and property, too much attention cannot be given to each slightest detail.

However, it must not be forgotten that the air transport operator pays dearly for each extra pound of weight carried. It is not impossible to load the airplane with so much extra material in the interest of safety and reliability that there is no room left for economic pay load.

Two of the most difficult problems are the source of power and

the antenna for the transmitter. If the plane is to be able to transmit from a forced landing, a dynamotor driven from the plane's 12-volt battery is preferred to an engine-driven or wind-driven generator. A heavy current is drawn, in the neighborhood of 55 amperes, which, with the 70-ampere landing lights, makes a lot of work for the charging generator. There seems to be good promise in a double-voltage engine-driven generator where a disconnecting clutch can be incorporated to allow the generator to be driven as a dynamotor in emergencies. Wind-driven generators are easy to install and their cooling problems are somewhat simplified, but they make testing and ground operation a very complicated matter. Their wind resistance may be enough to raise the equivalent weight to such a point that the air transport operator loses interest.

The antenna, of course, depends upon the frequency used. Again a compromise comes up as to whether the operator wishes the increased operating range obtainable with a trailing wire or a shorter working distance in order to have a fixed antenna structure. In either event caution must be exercised so that no maneuver or breakage of the antenna can result in fouling control cables. If the fixed antenna is definitely required, it appears that frequencies above 3000 kc must be used. To give adequate day operating range, the operator will probably have to change frequencies, which seriously complicates the maintenance problem. It may be necessary to answer some of these questions by locating ground transmitters more closely together.

There is no question as to the assistance radio can give to the air transport pilot. The problem is to insure against failure of the system. A catastrophe may be easily caused if the pilot relies on radio at a future instant and it fails him for one cause or another. It would be far better to have had no radio at all. The simplest installation of today is far too complicated and too fragile. Some of the best technical brains in the country are studying this vital phase of reliability, but it is a far-reaching complication.

The one realization remains that radio is the only means of contacting with airplanes in flight; that a communication system is vital to the economic development of this wonderful means of transportation; and that this all-important need will eventually overcome obstacles that now may seem insurmountable.



THE CIVIL AIRWAYS AND THEIR RADIO FACILITIES*

By

H. J. WALLS

(Airways Radio Engineer, Bureau of Lighthouses, Dept. of Commerce, Washington, D. C.)

Summary—This paper describes the establishment of the radio facilities on the civil airways of the United States and their importance for air navigation. The legislation which created the Aeronautics Branch of the Department of Commerce and its organization is discussed.

Description is given of the radiotelephone and radiotelegraph equipment used in the collection and broadcasting of weather information to aircraft. The transmitter used is rated at 2-kw output and is of the master-oscillator controlled type.

A directive radio transmitting system using crossed coil antennas is employed to guide aircraft over the established airways. It is of such a type that the pilot receives one signal while within a narrow zone on the course, and other signals if off the course. This greatly facilitates flying under conditions of poor visibility.

The regulations that have been proposed for the installation of radio equipment on aircraft are briefly given together with the more important frequencies allocated for aircraft work. The purpose and needs for these radio facilities and the way in which they have developed are also discussed.

THE Air Commerce Act, approved May 20, 1926, provided for the promotion and regulation of civil aeronautics by the Department of Commerce.

The Act authorized the establishment and maintenance of civil airways equipped with intermediate landing fields, beacon lights, signal and radio apparatus, and other aids to air navigation, including facilities for weather-reporting service; the promulgation and enforcement of rules and regulations to control traffic in the air; the marking of all civil aircraft by identification number and the regular inspection and licensing of commercial aircraft engaged in interstate flying; the examination and licensing of airmen, i. e., pilots and mechanics; the charting of airways and the publication of air maps; the dissemination of information about air commerce, especially including data concerning accidents and their causes; scientific research and experimentation designed to improve the facilities for air navigation and transport; and, generally, the promotion of air commerce, industry, and trade.

To carry out the above purposes the Aeronautics Branch of the Department of Commerce was organized. This Branch is a part of the Office of the Secretary of Commerce and embraces services of several Bureaus of the Department. The following divisions are

* Dewey decimal classification: R520. Original manuscript received by the Institute, September 16, 1929. Presented before New York meeting of the Institute, October 2, 1929.

included in the Aeronautics Branch: Division of Air Regulations, which examines and licenses pilots and mechanics, inspects aircraft to determine their air-worthiness, enforces the air traffic rules and studies airplane engines and designs; the Division of Air Information, which collects and disseminates information about civil aeronautics; the Airways Division (a part of the Lighthouse Service), which establishes and maintains aids to navigation along commercial air routes; the Airways Mapping Section, (a part of the Coast and Geodetic Survey) which produces the special maps needed; and the Aeronautical Research Division, (a part of the Bureau of Standards) for conducting research which would tend to improve the facilities of air navigation.

There are at present in the United States approximately 52 air transport companies flying regular schedules covering approximately 40,000 miles per day. Twenty-seven of these companies carry mail over the lighted airways, and about 15,000 miles of the flying takes place at night.

A double mail schedule is now in operation on the Transcontinental Airway, which saves a business day in each direction as compared with the former schedule. Mail gathered at the close of one business day on the Pacific coast will be delivered 36 hours later in cities on the Atlantic seaboard, the mail being in transit two nights and one day. Two transport companies have established a coast-to-coast passenger service and many other companies are carrying passengers over lesser distances.

The success of these services will depend very largely upon safety, regularity of flying, and percentage of trips completed on scheduled time. This can be assured only by the use of radio, a comprehensive weather service, and improved instruments aboard airplanes, making it possible to fly safely with regularity regardless of weather conditions and visibility. With proper facilities a schedule efficiency of 98 per cent should be possible.

Radio, by its fundamental nature, can provide for air navigation two very important services, viz., communication between the aircraft and the ground, and directional indications. The value of such services has been well demonstrated in marine navigation but, it is believed, they will be of even greater value to aircraft. The value of radio in this connection was appreciated by Congress and the establishment of radio systems was included in the Air Commerce Act.

When plans for the establishment of an aeronautical radio communication system were being formulated there was little experience in this country that might be followed. European practice, however, favored the use of frequencies in the 315-350-kc band for this purpose.

At about this time also, preparations were being made for the International Radiotelegraph Conference to be held in Washington in October, 1927, and the European countries had proposed that the 315-350-kc band be internationally used for aeronautical services. With a need for such a service in the United States, the American delegation agreed to this arrangement, and these frequencies were adopted internationally for this service. International agreement was also secured on the band 285-315 kc for radiobeacons for both the marine and aircraft services.



Fig. 1—Interior of aeronautical radio station at Glendale, Calif.

In providing a radio service for the transmission of weather and safety messages to pilots in the air it was considered that radiotelephony would be most practicable. For this class of service, a combined telephone and telegraph transmitter was believed most desirable, since it would provide not only for the broadcasting of weather information to aircraft, but also for the collection of such information by radio from similar radio stations. In the selection of this equipment, the experience of the Navy and the Army was carefully considered. A type of transmitter was finally adopted that was generally similar to one that had been widely used by the Navy, both afloat and ashore. This transmitter is of the master-oscillator, intermediate-

amplifier, power-amplifier type, and will deliver 2 kw of radio-frequency power to an antenna. Either CW, ICW, or telephone operation is provided. The transmitter will operate on frequencies from 100 to 550 kc. This transmitter is shown on the right of Fig. 1. A 400-watt crystal-controlled high-frequency telegraph transmitter is shown on the left. This transmitter is also used in collecting weather information as mentioned above, but is not capable of telephone operation. The performance of the intermediate-frequency transmitter has in

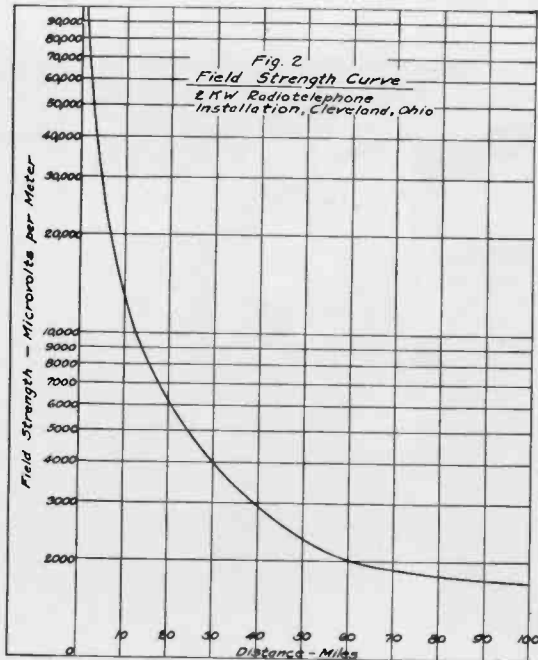

Fig. 2—Field-strength curve. 2-kw radiotelephone installation, Cleveland, Ohio.

general been satisfactory. Harmonic radiation has been excessive, but this is being reduced by working the power amplifier into a tuned tank circuit with capacitive antenna coupling instead of an untuned transformer. A single-wire antenna 125 ft. high and 375 ft. long is used with this transmitter.

The field strength ¹ produced by this transmitter as measured on the ground is shown in Fig. 2. No field-strength measurements have been made in the air although this is contemplated as soon as a plane can be made available. The field-strength curve has an attenua-

¹ These measurements were made on an installation at Cleveland, Ohio, by the Supervisor of Radio of Detroit, Mich.

tion of approximately 0.0062, which is somewhat lower than found on frequencies in the broadcast band. Telephone transmissions are regularly received at ground receiving stations at a distance of 200 miles in daytime through ordinary static. When received on a airplane equipped with commercial receivers, the reliable range is approximately 150 miles under ordinary conditions and approximately 60 miles under severe conditions. An improvement in performance is expected with changes and improvements in receiver design, reduction in motor and air noises, sound-proofing of cabins, better bonding of the plane's members, and better ignition shielding.

Radio stations as described above have been located at intervals of about 200 miles along the airways. This spacing was determined partly by the estimated reliable range of this power transmitter and partly because a given mail plane usually covers a 400-mile section with a stop midway for gas. Large cities served by the air mail service also appear at approximately 400-mile intervals. The first transmitter of this type was installed at Hadley Field, New Brunswick, N. J., in December, 1927, and since that time twenty-four additional stations have been completed and placed in operation. The map (Fig. 3) shows the installation program as of June 30, 1929. Stations now in operation are located at New Brunswick, N. J.; Bellefonte, Pa.; Cleveland, Ohio; Bryan, Ohio; Maywood, (Chicago), Ill.; Iowa City, Iowa; Bellevue, (Omaha), Nebr.; North Platte, Nebr.; Cheyenne, Wyo.; Rock Springs, Wyo.; Salt Lake City, Utah; Elko, Nevada; Reno, Nevada; Oakland, Calif.; Fresno, Calif.; Glendale, (Los Angeles), Calif.; Medford, Ore.; Portland, Ore.; Seattle, Wash.; Anglum, (St. Louis), Mo.; Kansas City, Mo.; Wichita, Kans.; La Crosse, Wis.; and Key West, Fla.

Equipment has been purchased for additional stations at Albany, N. Y.; Atlanta, Ga.; Birmingham, Ala.; Boise, Idaho; Boston, Mass.; Buffalo, N. Y.; Fort Worth, Tex.; Greensboro, N. C.; Houston, Tex.; Jacksonville, Fla.; Miami, Fla.; Milford, Utah; Mobile, Ala.; Nashville, Tenn.; New Orleans, La.; Oklahoma City, Okla.; Pasco, Wash.; Richmond, Va.; Spartanburg, S. C.; and Washington, D. C.

The establishment of directive radio facilities, however, was more of a problem. The U. S. Lighthouse Service had had considerable experience with the non-directive type of radiobeacon² in its Marine Service, using the system of radio direction-finding in which the transmitting equipment is located on shore and radiocompass is located on the ship. This system has been in operation since 1921

² G. R. Putnam, "Radio fog signals and their use in navigation with the radio compass." U. S. Bureau of Lighthouses, 1924.

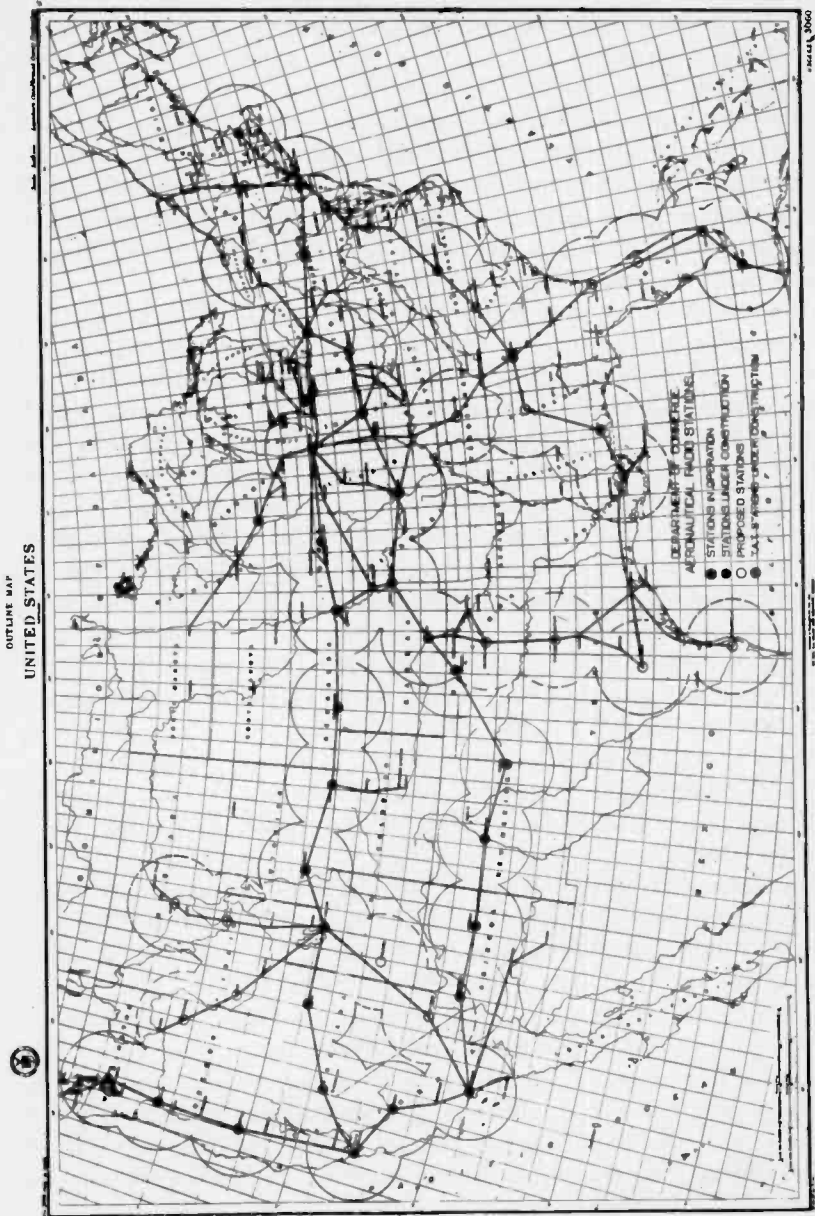

Fig. 3—Aeronautical radio stations.

with radiobeacons installed at important lighthouses and on lightships. Many bearings on these installations are being taken every day by masters of vessels by means of the radiocompass aboard their ships. This system has many advantages, but did not seem applicable to present day aircraft. It is believed, however, that with larger aircraft such a system may yet come in general use. The radiobeacons required for such a system are as a matter of fact provided at the present time, since the radiotelephone equipment described above is operated on definite schedules and will provide, with its circular radiation char-

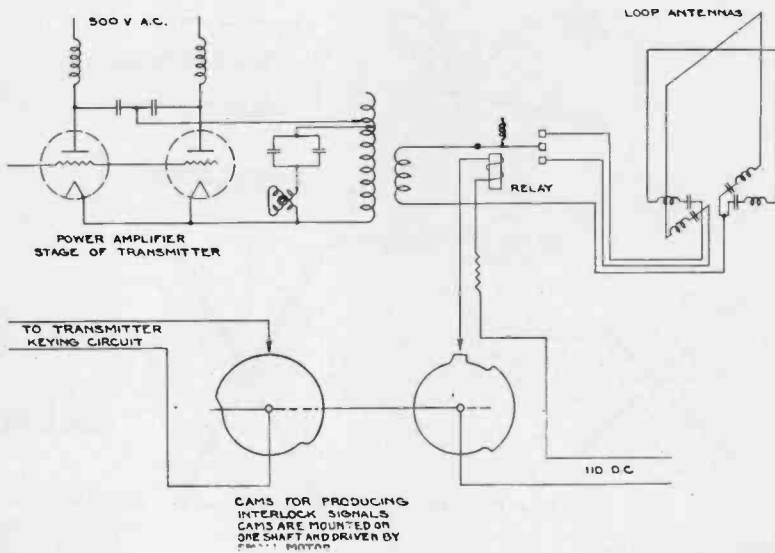

Fig. 4—Essential circuits of a radio range.

acteristic, a suitable signal on which bearings may be taken with a radiocompass. With one-man planes in which the pilot is navigator, engineer, captain, and radio operator combined, it did not seem possible for him to take bearings with a radiocompass and it was considered undesirable to use a fixed loop on the plane and take bearings by changing the course of the plane. This eliminated the non-directive type of radiobeacon. Consideration was also given the revolving radiobeacon,³ which requires an ordinary receiver and a stop watch, but this was considered unsatisfactory also since it required some manipulation on the part of the pilot. The so-called "aural" type of directive radiobeacon, or "radio range" as it is now called, was

³ Smith-Rose and Chapman, *Jour. I. E. E.* (London), 66, 256-69; March, 1928.

finally considered to be most applicable to the Airways Service. Some preliminary experiments with this type of directive radiobeacon had been made in 1921 by several departments of the Government in cooperation with the Lighthouse Service, in which observations were made by the Lighthouse Tender "Maple" in the Potomac River and Chesapeake Bay, and also by airplanes,⁴ on signals transmitted from

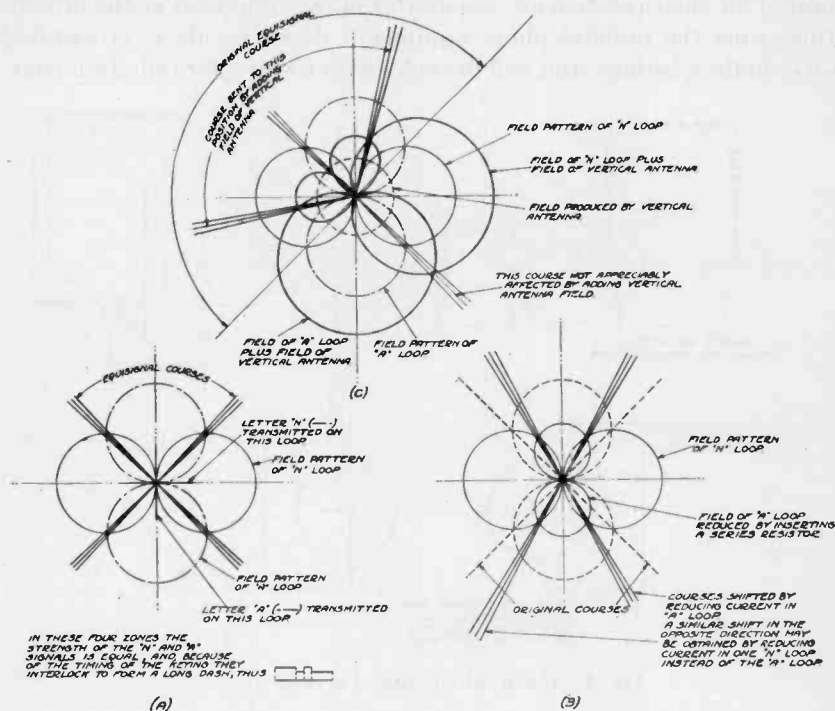

Fig. 5—Field patterns of radio range transmitter.

Washington. Further improvements on this type of directive radiobeacon were made by the Signal Corps of the U. S. Army.⁵

The transmitter used by the Airways Division in its radio range installations is of the master-oscillator, intermediate-amplifier, power-amplifier type, with special precautions taken to maintain constant frequency. Transmitters with an output of about 1500 watts are now used which give a reliable service up to approximately 100 miles. The field strength produced is much less than that given in Fig. 2, since loop antennas with their poor radiation characteristic are required.

⁴ Engel and Dunmore, "A directive type of radio beacon and its application to navigation," Bureau of Standards Scientific Paper No. 480, 1923.

⁵ Murphy and Wolfe, *Jour. S. A. E.*, 19, 209; September, 1926.

Briefly, the radio range consists of the transmitter mentioned above, working into two loop antennas placed at 90 deg. to each other, with a relay that connects the radio-frequency power alternately to the two loops. The essential parts of the radio range are shown in Fig. 4, and the radiation characteristics produced are shown in Fig. 5. The

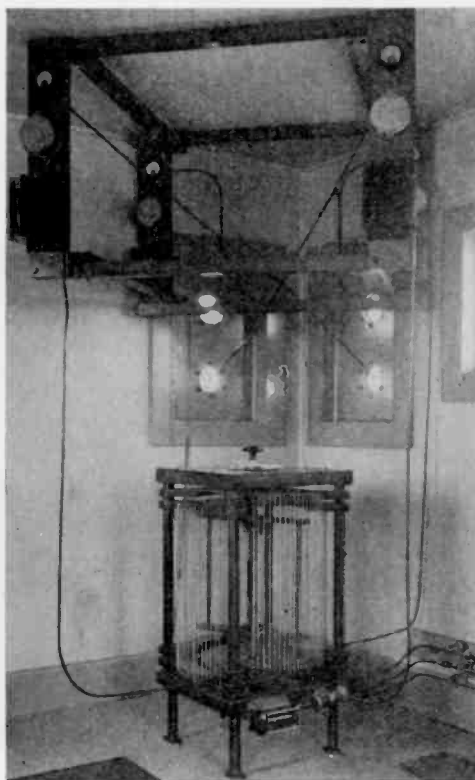

Fig. 6—Goniometer and loop tuning equipment originally installed at Hadley Field.

transmitter is keyed so as to produce long dashes, and the relay in the output circuit breaks up the dash so that the letter *N* (dash dot) is transmitted on one loop and the letter *A* (dot dash) on the second loop. By examination of the radiation characteristic, Fig. 5(a), it is noted that there are four zones each 90 deg. apart in which the signals from both loops have the same strength, and the letters *N* and *A* add together or interlock to produce the long dash of the transmitter keying. The equisignal zones may be directed along the airways to be served by

proper orientation of the loops. A pilot, in flying the airway, would hear a long dash when he was on the course and should he drift to the *A* side the *A* signal would increase and become predominant while the *N* would fade to the background and vice versa.

In order to direct the courses more easily along the route desired and to facilitate installation, use is made of a "goniometer" similar to that used in the Bellini-Tosi direction-finder.

This type of directive radio transmission appeared to meet the problem best of all, since radio courses can be established along given

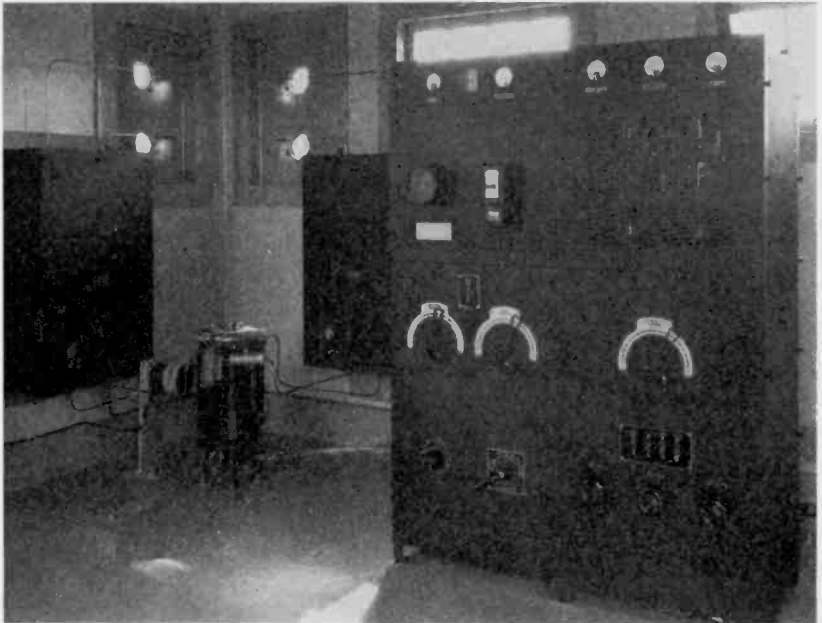

Fig. 7—Radio range installation at Hadley Field.

airways which would carry the pilot on a straight line over the best flying country along which weather observations were made, and intermediate landing fields established.

This type of equipment also has the important advantage of eliminating drift errors caused by a cross wind. Another important advantage is that the sense of hearing is employed rather than the sense of sight, since in bad weather flying the pilot must of necessity be watching the ground carefully to check up on landmarks. In blind flying, this system is equally advantageous since the pilot must concentrate on certain instruments to keep his ship on an even keel.

In order to gain in experience with this directive radio system a complete installation was made in cooperation with the General Electric Co., and this equipment was installed at Hadley Field near New Brunswick, N. J., in June, 1927. Tests made on this installation extending over a period of about seven months indicated the need for further improvements but confirmed the belief that this system was adequate for the purpose intended. Utilizing the experience gained, specifications were prepared covering the improved apparatus desired, and six complete transmitters of this type were purchased. Fig. 6 shows the original goniometer and loop tuning equipment installed at Hadley Field. Fig. 7 shows the improved transmitter which replaced the test equipment. Fig. 8 shows the radio range building and loop antennas.

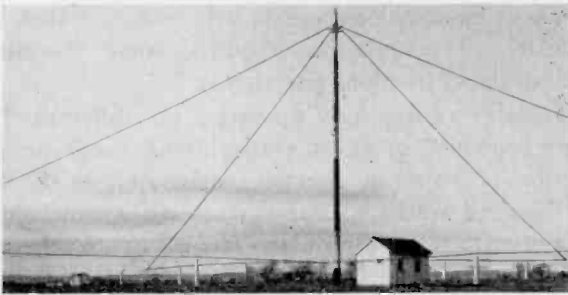

Fig. 8—Exterior of Hadley Field radio range.

A glance at Fig. 9, a map issued by the Department of Commerce, showing the civil airways of the United States, reveals the fact that airways are not always straight lines nor do they radiate from the larger cities with any mathematical relation. To adapt the directive radio system described above to these airways required that methods be developed whereby the four courses set up by the loop antennas could be shifted or "bent" as required to line up with the already established airways. The engineers of the Airways Division developed two methods whereby this can be effected. Fig. 5(a) gives the normal radiation characteristic of the radio range. Four courses are provided at 90 deg. apart since the radiation of each loop is the same. The first method of shifting the courses is by increasing or decreasing the current in either loop as by removing or inserting resistance. The effect of this is shown in Fig. 5(b). The second method of shifting or "bending" is accomplished by adding the circular radiation from an open vertical antenna to that of the loops. This pro-

duces courses "bent" as shown in Fig. 5(c), and the degree of "bending" is proportional to the current in the vertical antenna. In some installations an inherent bend has been noted which it is believed is caused by the circular radiation set up by currents induced in an iron conduit carrying an obstruction light circuit to the top of the center antenna pole.

Radio ranges are now in operation at the following locations: Hadley Field, New Brunswick, N. J.; Bellefonte, Pa.; Cleveland, Ohio; Goshen, Ind.; Sterling, Ill.; and Des Moines, Ia. Two additional installations are being completed at Boston, Mass., and Chicago, Ill. It is now possible to fly from Hartford, Conn., to Omaha, Nebr., utilizing directive radio signals from these installations, without ground observations that would be otherwise required. This is of much importance at times of poor visibility. Fig. 10 shows the courses marked by these installations and it will be noted that the courses from practically all installations required some "bending" of the courses to serve the cities along the airway.

Adjacent radio ranges are operated on different frequencies, and "marker beacons" of short transmitting range are located at the intersection of adjacent courses (designated as *M* in Fig. 10). The marker beacons send a special characteristic signal modulated at about 1000 cycles, alternately on the frequencies of the intersecting courses, thereby informing the pilot that the intersection has been reached and that his receiver should be re-tuned to the frequency on which the adjacent radio range is operating. Marker beacons operating on a single frequency are also located at high points on the airway and at other points to mark particular obstructions. These marker beacon transmitters have a maximum output of about 5 watts, and while it is desirable to have their maximum effect (i.e., transmitting range) not more than five miles, difficulty is experienced in keeping them within this range.

This system, like all other radio systems, is not free from peculiar phenomena of wave transmission. Particularly at night, shifting of the equisignal zone is observed.⁶ This shifting has not appeared to be a serious matter when a vertical pole antenna is used, for, by taking the on-course and off-course significance of signals over a short interval the average is approximately along the proper course, and over distances of less than the hundred miles which are here involved, the shifting is of small magnitude.

There has been considerable research on a type of radio range that

⁶ H. Pratt, "Apparent night variations with crossed coil radio beacons," *Proc. I. R. E.* 16, 652; May, 1928.

AIRWAY MAP OF THE UNITED STATES

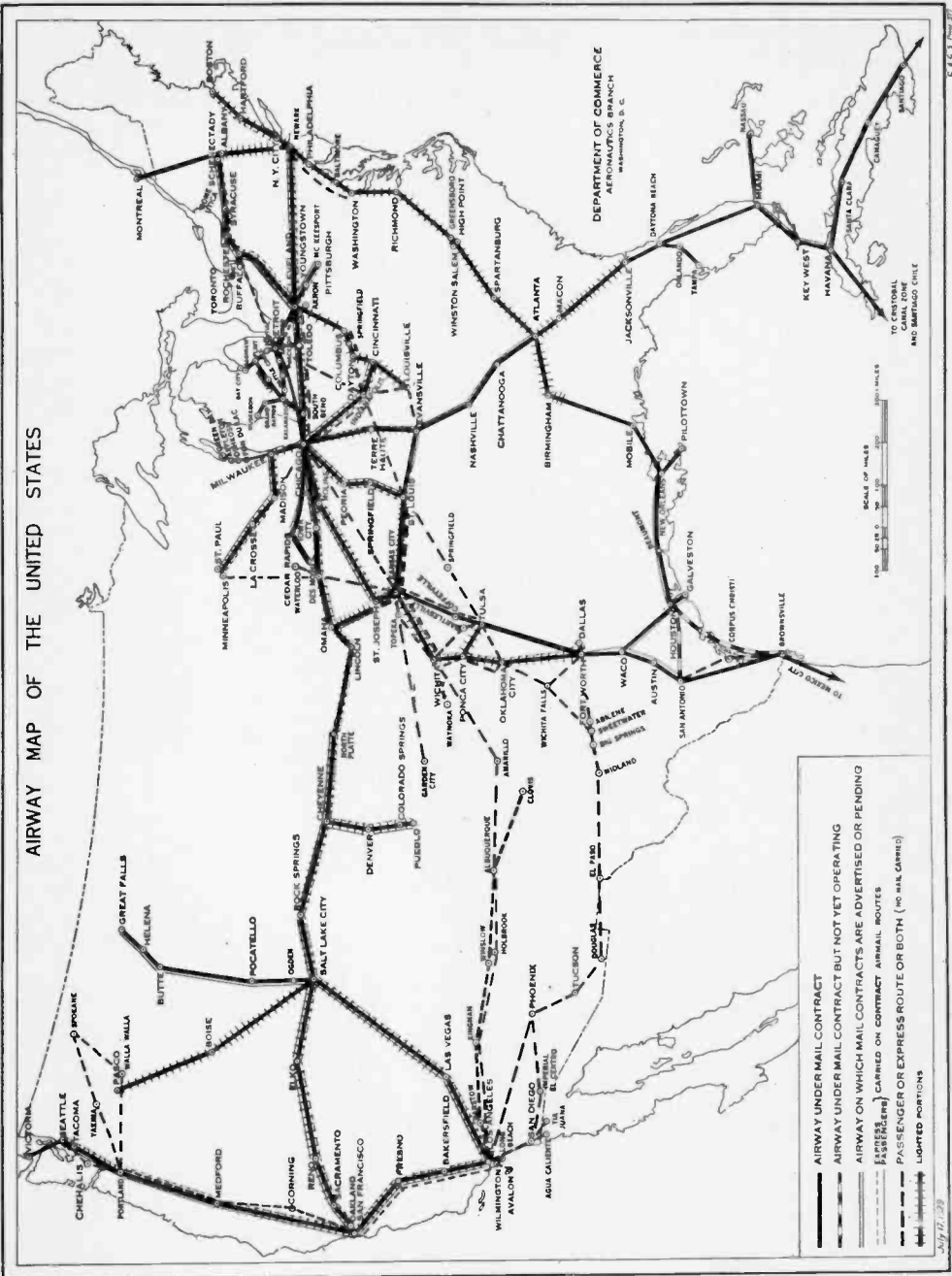

Fig. 9—Airways map of the United States.

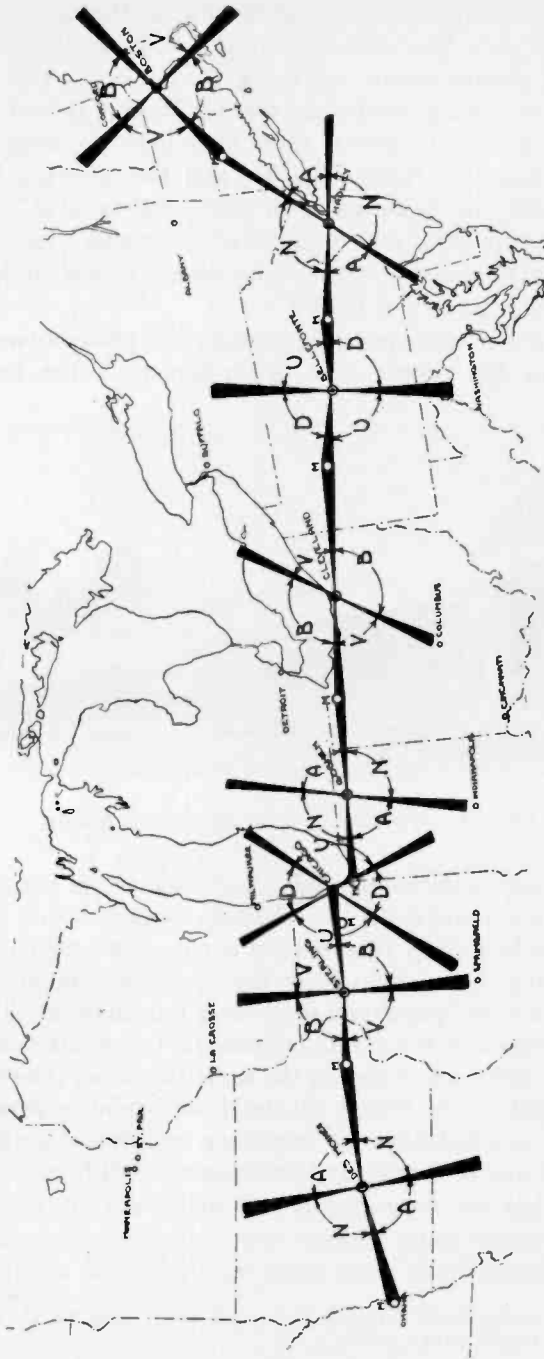

Fig. 10—Radio range courses marking a portion of the Transcontinental Airway and important side routes.

will operate a visual indicating instrument on the instrument panel of a plane.⁷ A type has been developed to a stage that shows some promise, and arrangements are being made to try this apparatus under actual operating conditions for a sufficient period of time to determine its merit. However, there should be no delay in the installation of directive radio facilities, and the Airways Division is proceeding with the installation of the aural-type of radio range pending the commercial development of the visual type equipment. Equipment for fifteen aural type radio ranges is now under contract for installation in the fall of 1929.

To determine proper operating procedure is probably as important as determining the proper type of equipment. The first method



Fig. 11—Airways Division cabin monoplane.

tried was to operate the radio range on a frequency in the radiobeacon band (285–315 kc) and make the telephone broadcasts on a frequency in the 135–350-kc band. This method is not satisfactory since a pilot may be listening to the radio range for directional signals and miss a telephone broadcast containing important information. The method now in use between New York and Chicago is to operate both the radio range and the radio telephone on the same frequency, the radio range operating continuously except during four 3-minute periods at the quarter hours at which time the telephone broadcasts are made. This service is operated continuously throughout the 24 hours.

In order that the Airways Division may have full information as to the performance of its various radio and other aeronautical facilities two airplanes have been radio-equipped, one an open cockpit

⁷ Dellinger and Pratt, "Development of radio aids to air navigation," *Proc. I. R. E.*, 16, 890; July, 1928.

biplane equipped with receiving apparatus only, the second a six-passenger cabin monoplane in which are installed two commercial receiving sets and a 50-watt intermediate-frequency transmitter. This plane is shown in Fig. 11.

These planes make periodic flights over the civil airways, check up on performance of radio and other facilities, and furnish information regarding the performance of the radio installations particularly. Fig. 12 shows the antenna on the monoplane mentioned above, and is of the vertical type being generally adopted for radio



Fig. 12—Receiving antenna on Airways Division monoplane.

reception. This type of antenna is somewhat ineffective compared to the trailing wire type and reduces the effective range of transmission somewhat. It has the advantage of being permanently in place and reducing certain errors in the reception of radio range signals.

The engine ignition system of both planes is shielded with copper braid in the usual manner, and standard type spark plugs are used. The front set of plugs are provided with copper shields to reduce radiation from the plugs themselves. However, experience has shown that when receiving on intermediate frequencies the rear set of plugs may be left unshielded, since they are apparently shielded sufficiently well by the exhaust manifold, cowling, etc.

At the present time there are comparatively few civil airplanes equipped for radio transmission. However, regulations are being considered which will require complete radio installations on certain classes of planes. Briefly the regulations proposed are as follows:

(a) Aircraft carrying one or more passengers in interstate travel shall be equipped with radio receiving apparatus of a satisfactory type so that the benefit of the aeronautical radio facilities on the airway navigated may be secured.

(b) Aircraft carrying six or more passengers in interstate travel shall be provided with radio transmitting and receiving equipment capable of dependable communication with ground stations during the entire period of flight and shall be capable of making a distress call on some designated common frequency assigned as a calling wave. Such plane shall carry a radio operator holding a satisfactory radio license.

These regulations have been submitted to a committee of air transport operators for consideration, and in accordance with established procedure may be put in effect one year after submission.

Consideration is also being given to the inspection and certification of both receiving and transmitting equipment installed on aircraft.

Where air navigation facilities have not been installed by the Department of Commerce, or where present installations do not suffice, it may be necessary to install privately established and maintained radio facilities. The air transport operators have a peculiar responsibility in the carrying of passengers and mail, and the liability for the safety of life and property cannot be transferred to any other agency. The operators have therefore requested the reservation of frequencies for their use through the operation of privately established radio stations. A total of 89 frequency channels have been set up for this service by the Federal Radio Commission, of which 64 are in the 1500-6000-kc band. These frequencies are being assigned to the various air routes. That is, a particular channel is used along a given route regardless of the number of transport companies flying that route. All companies have equal rights now and in the future as to this service and provide their own installations jointly, sharing equally in the installation costs, operation costs, and liability.

The following important distress and calling frequencies have been established.

278 kc Calling and working frequency used by airports only.

Power not to exceed 10 watts.

333 kc International air calling frequency.

- 375 kc Radiocompass service (mobile transmitters, fixed compass on the ground).
- 500 kc International calling and distress frequency for ships and aircraft over the seas.
- 3106 kc National calling frequency for all transport and itinerant airplanes.

Since communications to airplanes under conditions of poor visibility must necessarily be made by radio, it will be necessary to provide for communicating landing directions at airports by means of the radiotelephone. The frequency of 278 kc mentioned above was set up by the Federal Radio Commission for this purpose. The radio transmitters at airports must have limited power and a range not in excess of five miles so as to prevent interference between neighboring airports. Under this plan of having all airport transmitters on the same frequency, the pilot will listen in for landing directions upon approaching an airport and will follow the orders as to landing procedure received from the airport manager.

There can be no doubt that air transportation from now on will depend in a large measure upon radio for its safety and flying efficiency. The radio facilities that are now being established have been planned so that all classes of fliers may make use of the service by installing a simple receiving set on the airplane, and receive practically all of the information required to fly the civil airways safely. The comprehensive weather service that is now being established, and the facilities provided to make this information immediately available to the pilot in the air, are important. In addition to the weather broadcasting service, and probably of equal importance, are the directive radio signals. These will indicate to the pilot his exact course, and should he deviate, the signals will permit him to locate the course again and bring his flight to a successful conclusion at the airport. Accidents due to weather conditions as well as other causes will thus be greatly reduced.



APPLYING THE VISUAL DOUBLE-MODULATION TYPE RADIO RANGE TO THE AIRWAYS*

BY

H. DIAMOND

(Bureau of Standards, Washington, D. C.)

Summary—This paper deals with methods for aligning the courses of the visual radio range with the fixed airways. It has previously been shown that the courses of the aural radio range may be shifted by the use of a vertical wire antenna in conjunction with the transmitting loop antennas or by varying the relative power in the two antennas. These methods are, in part, applicable to the visual system. In the aural system the goniometer primaries are excited alternately. This permits independent consideration of the field patterns due to the primaries. In the visual system this is not the case as both goniometer primaries are excited all the time. Two cases present themselves, the condition when the currents in the primaries are in time phase and the condition when they are in quadrature time phase. The former condition results in two beacon courses which are 180 deg. apart and cannot be shifted from this relationship. The latter condition yields four beacon courses. A mathematical analysis is made of this case and the amounts of angular variation possible using several methods of attack are tabulated.

A method of obtaining small amounts of shift by an adjustment of the receiving equipment aboard the airplanes is also described; one of the reeds is shunted by a suitable resistance in order that the reeds will vibrate equally when on one side of the equisignal zone. This method permits a great flexibility in securing a desired course and is suitable only for employment with the visual system. Sample calculations are made for actual airway routes to demonstrate the several methods of attack.

I. INTRODUCTION

METHODS for aligning the courses of the aural type radio range (i.e., directive radiobeacon) with the fixed airways are described in a paper by Kear and Jackson.¹ Extensions of these methods may be used to make the visual double-modulation type radio range equally flexible. This paper describes a number of circuit arrangements, the application of which makes possible the use of a single visual type radio range for serving two, three, or four courses radiating from a given airport at arbitrary angles with each other.

The procedure of aligning the courses of the visual type radio range with the fixed airways is necessarily somewhat different from that followed in the aural type, owing to the essential difference between the signals used for marking out the beacon courses in the two

* Dewey decimal classification: R526.1. Original manuscript received by the Institute, October 8, 1929. Published by permission of the Director of the Bureau of Standards of the U. S. Department of Commerce. To be published in a forthcoming issue of the Bureau of Standards Journal of Research.

¹ Kear and Jackson, "Applying the radio range to the airways," this issue of the Proc., page 2268. Also to be published in the Bureau of Standards Journal of Research.

systems. With the aural system, a pilot's position on either side of the course is indicated by the relative strength of two Morse characters. When on the course these characters blend into one long dash of constant signal strength. In order to obtain proper interlocking no portions of the two characters used can be transmitted simultaneously. With the visual system, a course is indicated by the equality of vibration amplitude of two reeds mechanically tuned to the two modulation

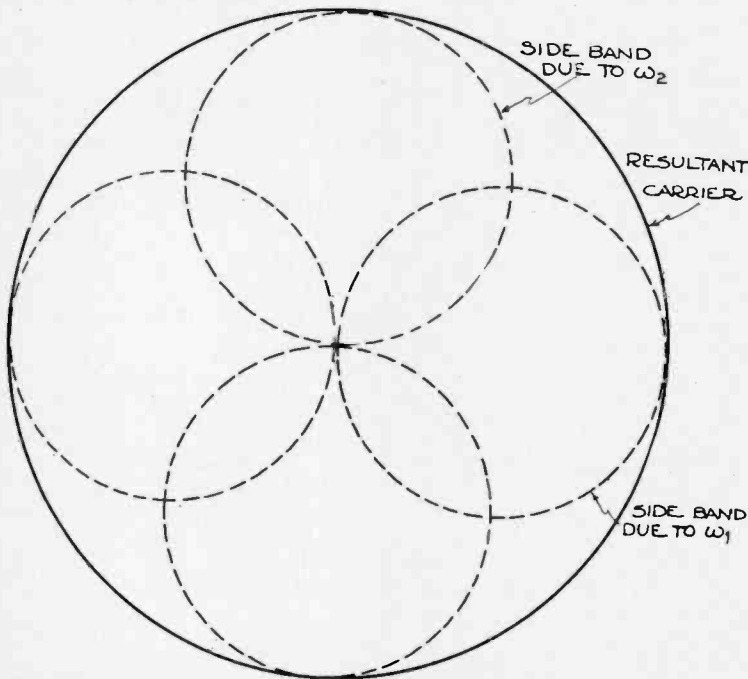

Fig. 1—Space pattern radiated by double-modulation type radio range when antenna currents are 90 deg. out of phase.

frequencies used at the beacon. For maximum reed amplitude, it is desirable to provide continuous modulation at both modulation frequencies. The two distinguishing signals of the beacon are, therefore, always sent out simultaneously, resulting, under normal conditions, in a space pattern quite different from that obtained from an aural radio range.² Two, rather than four, beacon courses are obtained. To produce four beacon courses it is necessary to advance the time phase of one of the carrier frequencies of the system 90 deg. beyond that of

² This was shown by Pratt in Fig. 2 of his paper on "Field intensity characteristics of double modulation type of direction radio beacon," Proc. I. R. E., 17, 875; May, 1929.

the other. The space pattern is then as indicated in Fig. 4, page 877, of Pratt's paper, the four beacon courses being displaced by 90 deg. from each other. For convenience in reference, this figure is reproduced here as Fig. 1. The received polar pattern is shown in Fig. 2. The trigonometric expression for the beacon space pattern is given in

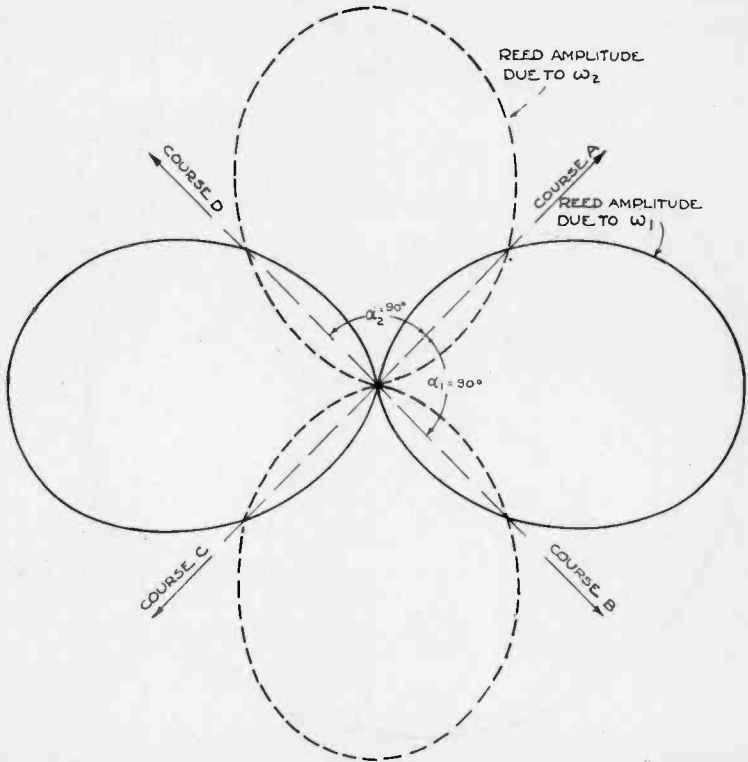

Fig. 2—Received polar pattern corresponding to the space pattern of Fig. 1.

equation (1).³ The corresponding expression for the polar pattern as received on the reeds is given in equation (2), which assumes square-law detection.

$$e_p = K \left\{ \begin{array}{l} E_0 [\cos \omega t \sin \theta + \sin \omega t \cos \theta] \\ -\frac{E_1}{2} [\sin (\omega - \omega_1)t - \sin (\omega + \omega_1)t] \sin \theta \\ +\frac{E_2}{2} [\cos (\omega - \omega_2)t - \cos (\omega + \omega_2)t] \cos \theta \end{array} \right\} \quad (1)$$

³This is equivalent to equation (5), page 876 of Pratt's paper.

where e_p is the field intensity at any point P in space as a polar function of the angle θ , and, as is apparent, consists of a carrier and two sets of sidebands; $E_1/E_0 \times 100$ is the percentage modulation in amplifier branch 1 due to ω_1 ; $E_2/E_0 \times 100$ is the percentage modulation in amplifier branch 2 due to ω_2 . In this and all the following equations we will assume $E_1 = E_2 = E_0$ unless otherwise stated.

$$e_r = K K' E_0 \{ E_1 \sin \omega_1 t \sin^2 \theta + E_2 \sin \omega_2 t \cos^2 \theta \} \quad (2)$$

where e_r is the received signal strength at any point P as a polar function of the angle θ . A course occurs whenever the two terms to the right of the equality sign of equation (2) are equal.

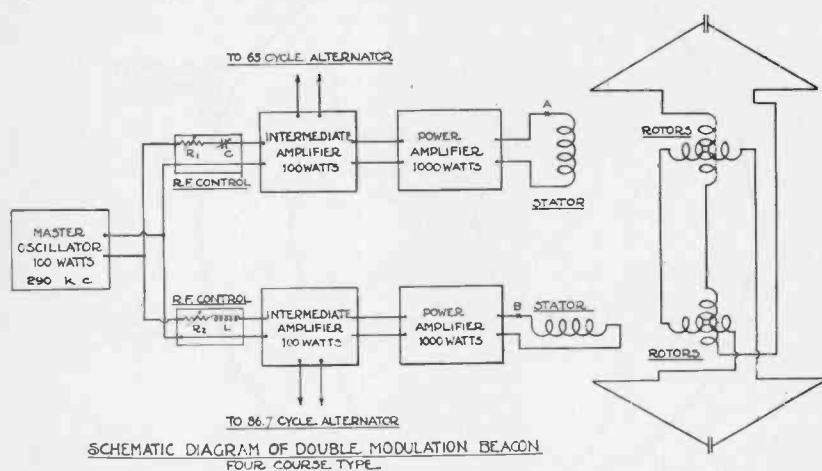

Fig. 3—Schematic diagram of double-modulation radio range—four-course type.

From a study of equations (1) and (2), it is interesting to note that the useful signal due to ω_1 is the result of the beating of the carrier of branch 1 (not the resultant carrier) with the sidebands transmitted by branch 1. Similarly, the useful signal due to ω_2 is the result of the beating of the carrier and sidebands transmitted by branch 2. These relationships are true, however, only in the special case when the time phase between the two carriers of the system is equal to 90 deg.

A schematic diagram of the circuit arrangement used for obtaining four beacon courses at 90 deg. with each other is shown in Fig. 3. The means for producing a 90-deg. time-phase displacement between the two carrier-frequency currents of the system consists simply of inserting a suitable capacitive reactance in the supply lead from the master oscillator to one amplifier branch and a suitable inductive

reactance in the supply lead to the other amplifier branch. For convenience in phase adjustment the condenser is made variable, and a variable resistor is connected in series with each reactance.

II. METHOD A. SHIFTING COURSES BY AMPLITUDE REDUCTION

One method of shifting the four beacon courses from their 90-deg. space relationship is to reduce the percentage modulation of one amplifier branch, keeping the magnitude of the carrier unchanged. The space pattern radiated by the beacon is then as shown in Fig. 4, and

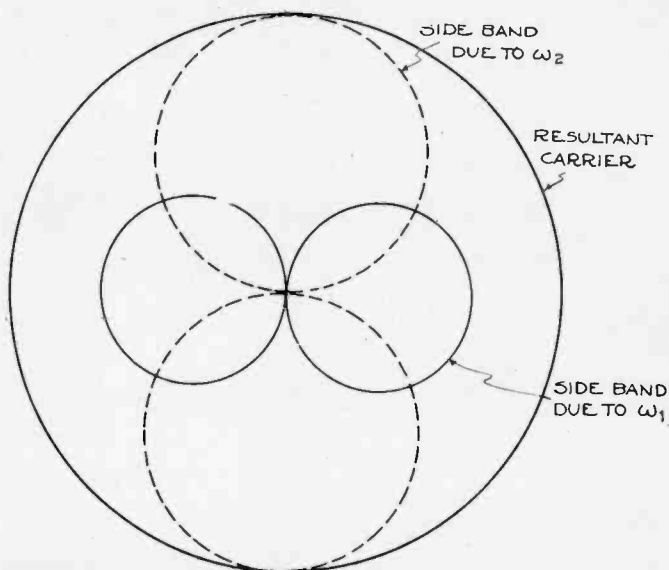

Fig. 4—Space pattern when percentage modulation in one amplifier branch is reduced.

the received polar diagram as shown in Fig. 5. A 30 per cent reduction in the percentage modulation of one amplifier branch is assumed. The trigonometric equations for the radiated space pattern and received polar pattern are then, respectively:

$$\begin{aligned}
 e_p = & K [E_0 \{ \cos \omega t \sin \theta + \sin \omega t \cos \theta \} \\
 & - \frac{0.7 E_1}{2} \{ \sin (\omega - \omega_1)t - \sin (\omega + \omega_1)t \} \sin \theta \} \quad (3) \\
 & + \frac{E_2}{2} \{ [\cos (\omega - \omega_2)t - \cos (\omega + \omega_2)t] \cos \theta \}]
 \end{aligned}$$

$$e_r = KK'E_0 [0.7 E_1 \sin \omega_1 t \sin^2 \theta + E_2 \sin \omega_2 t \cos^2 \theta] \quad (4)$$

A course occurs whenever the two terms to the right of the equality sign of equation (4) are equal. It will be observed from Fig. 5 that the two sets of 180-deg. courses, (A, B) and (C, D), are now displaced by $\alpha_1 = 80$ deg. and $\alpha_2 = 100$ deg. as compared with $\alpha_1 = \alpha_2 = 90$ deg. when the degree of modulation in the two amplifier branches is the same.

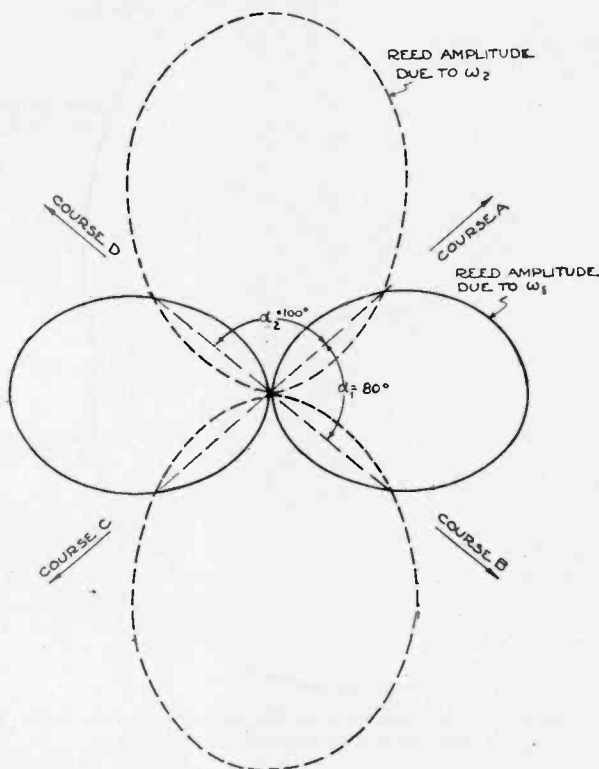

Fig. 5—Received polar pattern corresponding to Fig. 4.

The method of modulation adopted in the visual radio range transmitter, consisting of plate excitation of the intermediate amplifiers from sources of a-c supply of suitable frequencies, does not permit an easy adjustment of the percentage modulation. It is more convenient to reduce the magnitude of both carrier and sidebands of one amplifier branch. This is accomplished by increasing the value of the resistor R_1 of the radio-frequency control (Fig. 3) and readjusting C to keep the phase of the voltage applied to the grid of the intermediate amplifier tube unchanged. Assuming a 30 per cent reduction in the amplitude of carrier and sidebands of one amplifier branch, the radiated

space pattern becomes that of Fig. 6, while the polar diagram as received on the reeds is shown in Fig. 7. The trigonometric expression for the space pattern is given in equation (5).

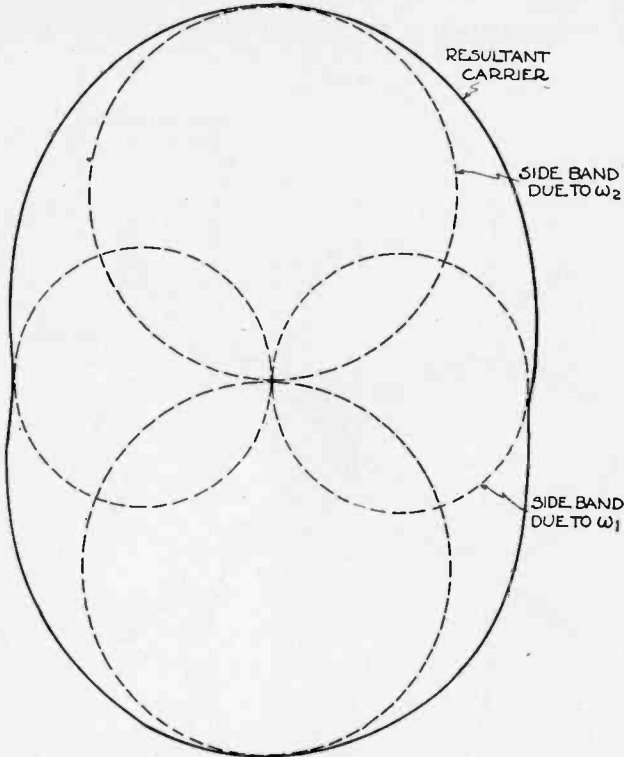

Fig. 6—Space pattern when magnitude of the carrier and sidebands transmitted by one amplifier branch is reduced.

$$\begin{aligned}
 e_p = K [& E_0 \{ 0.7 \cos \omega t \sin \theta + \sin \omega t \cos \theta \} \\
 & - 0.7 \frac{E_1}{2} \{ [\sin (\omega - \omega_1)t - \sin (\omega + \omega_1)t] \sin \theta \} \\
 & + \frac{E_2}{2} \{ [\cos (\omega - \omega_2)t - \cos (\omega + \omega_2)t] \cos \theta \}].
 \end{aligned} \quad (5)$$

The corresponding expression for the received signal becomes

$$e_r = KK'E_0 [0.49E_1 \sin \omega_1 t \sin^2 \theta + E_2 \sin \omega_2 t \cos^2 \theta]. \quad (6)$$

A course will occur whenever the two reed deflections are of equal magnitude, i.e., when

$$|0.7 \sin \theta| = |\cos \theta|. \quad (7)$$

Equation (7) follows from the facts that the observed reed deflections are determined by the maximum instantaneous values of $E_1 \sin \omega_1 t$ and $E_2 \sin \omega_2 t$ and that the reeds are adjusted for equal sensitivity. Note that the courses have been shifted in greater amount

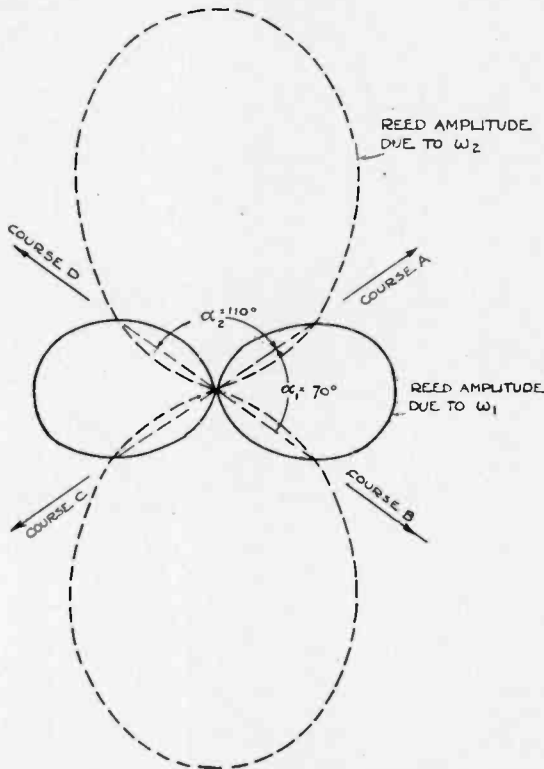

Fig. 7—Received polar pattern corresponding to Fig. 6.

than in Fig. 5. The values for the angles α_1 and α_2 are now 70 deg. and 110 deg., respectively. The relative reduction in strength of signal received when on course is, however, also greater.

Two factors determine the minimum value for α_1 (or the maximum value for α_2) that can be obtained: (a) the signal strength received when on any given course should not be reduced below 50 per cent of that received when the four courses are displaced by 90 deg.; (b) a deviation of at least 20 deg. on either side of the course should be possible without losing indications as to the direction back to the

course. Keeping in mind these requirements, both methods described above yield as tolerable limits ($\alpha_1 = 60$ deg., $\alpha_2 = 120$ deg.). Using these methods, then, it becomes possible to fit two of the beacon courses to any two airways separated by an angle in the range 60 deg. to 120 deg.

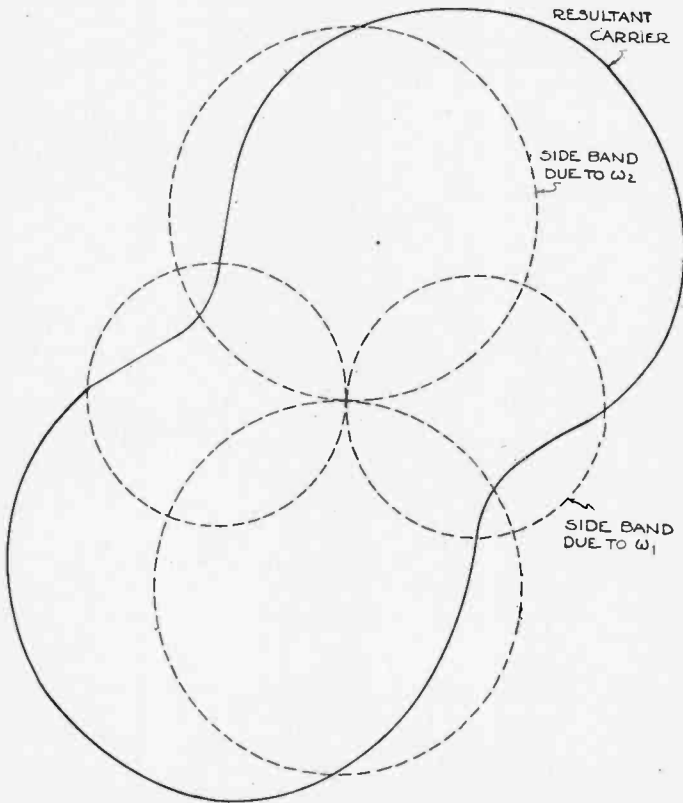

Fig. 8—Space pattern for same conditions as in Fig. 6 except that antenna currents are 45 deg. out of time phase instead of 90 deg.

Before passing on to further methods for making the other two beacon courses useful, it is of interest to study the effect of changing the time phase displacement between the two modulated waves of the transmitting system. As noted above, the difference in time phase is normally adjusted to 90 deg. Suppose that the time phase difference is made 45 deg. (by adjusting L and C , Fig. 3). For the condition that the magnitude of carrier and sidebands transmitted by one amplifier branch is reduced to 70 per cent that of the other amplifier

branch, the beacon space pattern becomes that shown in Fig. 8 and the received polar pattern as shown in Fig. 9. The expression for the radiated space pattern under these conditions is given in (8) and for the received polar pattern in (9).

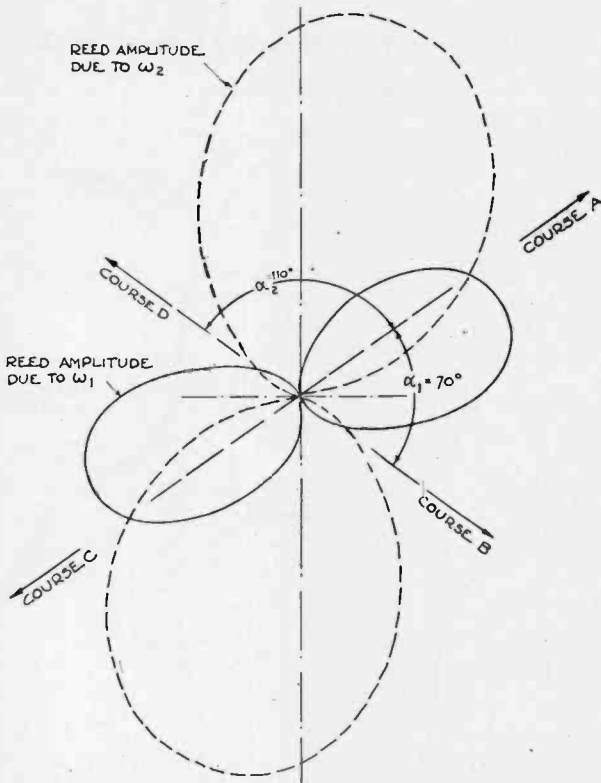

Fig. 9—Received polar pattern corresponding to Fig. 8.

$$e_p = K \left\{ \begin{aligned} & E_0 \left[0.7 \sin \left(\omega t - \frac{\pi}{4} \right) \sin \theta + \sin \omega t \cos \theta \right] \\ & + 0.7 \frac{E_1}{2} \left[\cos \left(\omega t - \frac{\pi}{4} - \omega_1 t \right) \right. \\ & \quad \left. - \cos \left(\omega t - \frac{\pi}{4} + \omega_1 t \right) \right] \sin \theta \\ & + \frac{E_2}{2} \left[\cos (\omega - \omega_2) t - \cos (\omega + \omega_2) t \right] \cos \theta \end{aligned} \right\} \quad (8)$$

$$e_r = KK'E_0 \left[E_1 \sin \omega_1 t \left\{ 0.7 \times \frac{1}{\sqrt{2}} \sin \theta \cos \theta + 0.49 \sin^2 \theta \right\} + E_2 \sin \omega_2 t \left\{ 0.7 \times \frac{1}{\sqrt{2}} \sin \theta \cos \theta + \cos^2 \theta \right\} \right] \quad (9)$$

Note that since the two carrier frequency currents of the system are

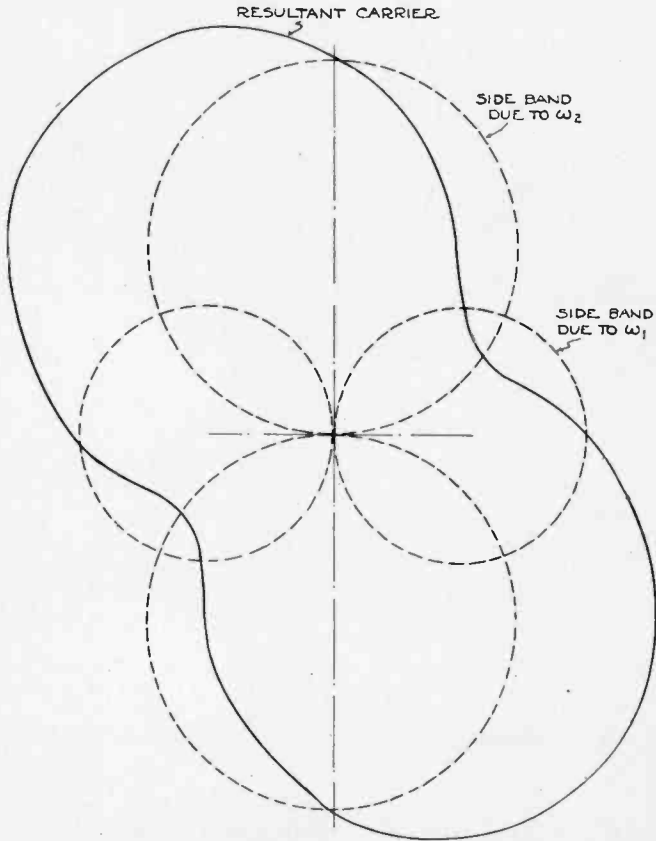

Fig. 10—Space pattern for same conditions as in Fig. 6 except that antenna currents are 135 deg. out of time phase instead of 90 deg.

no longer displaced in time phase by 90 deg., the relationship observed in connection with equations (1) and (2) no longer holds.

If the time phase displacement is made 135 deg., the resultant space pattern is as shown in Fig. 10, and the received polar pattern as shown in Fig. 11. The trigonometric equations corresponding to these patterns are similar to (8) and (9) and will not be given here. Note

that a change in the time phase displacement does not result in a shifting of the beacon courses. An exact adjustment of time phase displacement to 90 deg. is therefore not necessary. By varying this displacement, however, it is possible to control at will the relative signal strength on the two sets of 180-deg. courses. In this way, if the two airways to be served by a given radio range differ in length, a stronger course signal may be directed along the longer airway.

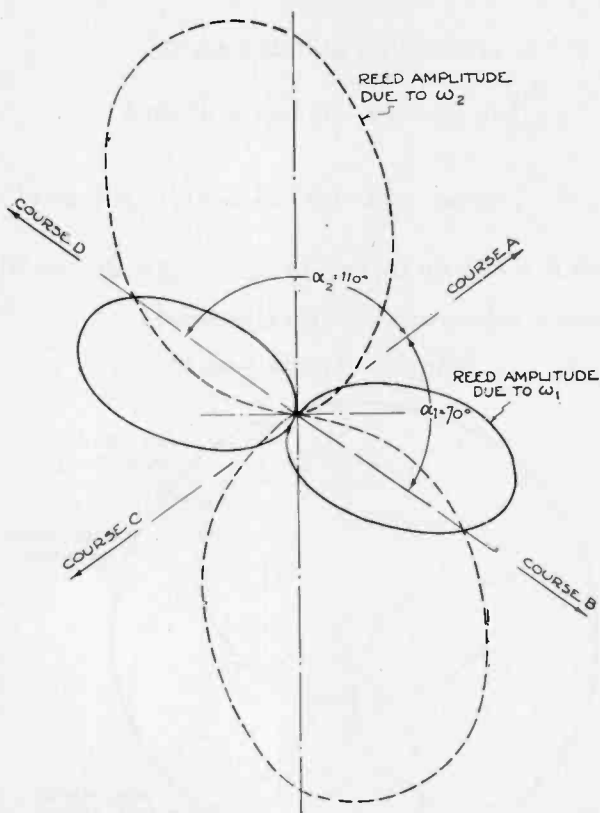

Fig. 11—Received polar pattern corresponding to Fig. 10.

III. METHOD B. USE OF AUXILIARY VERTICAL ANTENNA FOR SHIFTING COURSES

A further method for shifting the courses from their 90-deg. space relationship consists of supplying a circular radiation of the carrier and sidebands transmitted by one amplifier branch, in addition to the figure-of-eight radiation due to the loop antenna fed by that amplifier branch. A vertical antenna, running the length of the beacon

tower and inductively coupled to the output circuit of one of the two amplifying branches of the transmitting system, is employed for obtaining this additional radiation. Assuming a ratio of amplitude of circular radiation to maximum amplitude of figure-of-eight radiation equal to 0.28, the radiated space pattern becomes as shown in Fig. 12, and the received polar diagram as shown in Fig. 13. The expression for the radiated space pattern is given in (10) and for the received pattern in (11).

$$e_p = K \left\{ \begin{array}{l} E_0 [\cos \omega t \sin \theta + \sin \omega t (0.28 + \cos \theta)] \\ -\frac{E_1}{2} [\sin (\omega - \omega_1)t - \sin (\omega + \omega_1)t] \sin \theta \\ +\frac{E_2}{2} [\cos (\omega - \omega_2)t - \cos (\omega + \omega_2)t] [0.28 + \cos \theta] \end{array} \right\} \quad (10)$$

$$e_r = KK'E_0 \{ E_1 \sin \omega_1 t \sin^2 \theta + E_2 \sin \omega_2 t [0.28 + \cos \theta]^2 \} \quad (11)$$

A beacon course will occur when (12) is satisfied.

$$|\sin \theta| = |0.28 + \cos \theta| \quad (12)$$

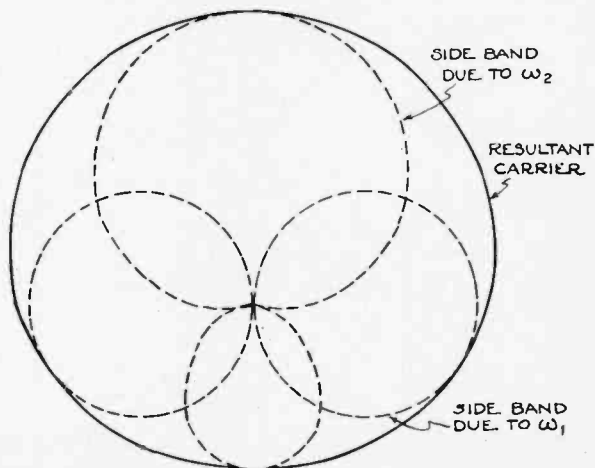

Fig. 12—Space pattern when circular radiation of the modulated wave transmitted by one amplifier branch is added to the normal figure-of-eight radiation due to that branch.

In (10) the current in the vertical antenna is taken as in time phase with the current in loop antenna (2). This is the condition of maximum course shift for a given vertical antenna current. If these two currents were in time quadrature, no course shift would occur. It is, therefore, important to insure that these currents are in phase;

(a) by keeping the vertical antenna and loop antenna (2) accurately in tune; and (b) by connecting the primary of the coupling transformer to the vertical antenna in the output circuit of the same amplifier stage in which the primary winding of the coupling arrangement to loop antenna (2) is connected (i.e., at point *B*, Fig. 3).

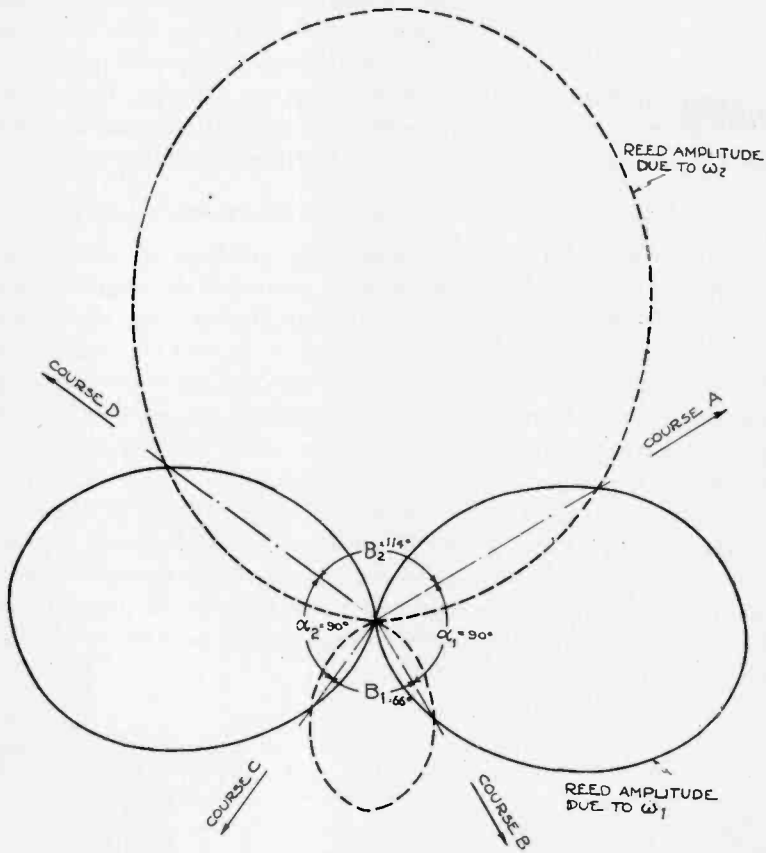

Fig. 13—Received polar pattern corresponding to Fig. 12.

Comparing the received polar diagram of Fig. 13 with that for the beacon normally adjusted (see Fig. 2), it will be observed that the addition of a circular component to the normal radiation characteristic of the modulated wave due to ω_2 results in decreasing the angle β_1 between courses *B* and *C* and increasing the angle β_2 between courses *D* and *A*. The angles α_1 between courses *A* and *B* and α_2 between courses *C* and *D* remain equal to 90 deg. Applying the same criteria as were used in the method of course shifting by amplitude reduction,

(namely, that the signal strength on course should not be reduced below 50 per cent of normal, and that a deviation of 20 deg. on either side of a course be possible), the minimum tolerable value for β_1 is 60 deg. and the maximum value for β_2 is 120 deg.

A comparison of methods A and B for varying the angle between two beacon courses is of interest. Using method A, two airways separated by any angle in the range 60 deg. to 120 deg. may be served. This is also true using method B. In method A, however, each of the two remaining beacon courses is displaced by 180 deg. from one of the two courses used, while in method B each of the two remaining courses is displaced by 90 deg. from one of the two courses employed.

IV. METHOD C. COMBINATION OF METHODS A AND B

Methods A and B may be combined, yielding an arrangement for serving three airways simultaneously, provided the angles between these airways are within the limits tabulated below. For convenience in tabulation, the three airways are called *A*, *B*, and *C'*, respectively. Any two of these (say *A* and *B*) may be from 60 deg. to 90 deg. apart. The third airway (*C'*) may then be disposed from either *A* or *B* by any angle within the range given in the table. The two criteria noted above under methods A and B are fulfilled in this table. As shown, the practicable range of angles between *C'* and either *A* or *B* depends upon the angle between *A* and *B*. A greater variation can of course be obtained if it is permissible to reduce the signal strength received when on course. The third column of Table I shows the possible range if the minimum permissible signal strength when on any given course is taken as 33 per cent of normal.

TABLE I

| Angle between <i>A</i> and <i>B</i> | Range of Permissible Angles between <i>C'</i> and either <i>A</i> or <i>B</i> if $E_r'/E_r = 0.5$ | Range of Permissible Angles between <i>C'</i> and either <i>A</i> or <i>B</i> if $E_r'/E_r = 0.33$ |
|--|---|--|
| 60 deg. | 120 deg., 180 deg. | 90 deg.-210 deg. |
| 65 deg. | 105 deg.-125 deg., 170 deg.-190 deg. | 80 deg.-215 deg. |
| 70 deg. | 90 deg.-130 deg., 160 deg.-200 deg. | 70 deg.-220 deg. |
| 75 deg. | 82.5 deg.-127.5 deg., 157.5 deg.-202.5 deg. | 65 deg.-220 deg. |
| 80 deg. | 75 deg.-125 deg., 155 deg.-205 deg. | 60 deg.-220 deg. |
| 85 deg. | 67.5 deg.-122.5 deg., 152.5 deg.-207.5 deg. | 55 deg.-135 deg., 140 deg.-220 deg. |
| 90 deg. | 60 deg.-120 deg., 150 deg.-210 deg. | 50 deg.-130 deg., 140 deg.-220 deg. |

The results indicated in Table I are obtained by reducing the amplitude of carrier and sidebands transmitted by one amplifier branch to obtain any angle from 60 deg. to 90 deg. between courses *A* and *B*, and then introducing a circular radiation of the carrier and sidebands transmitted by the other amplifier branch in addition to the normal figure-of-eight radiation for that branch. The space pattern as radiated from the beacon then becomes as shown in Fig. 14, and the

received polar diagram in Fig. 15. The trigonometric equation for the radiated space pattern is given by (13), and for the received pattern by (14).

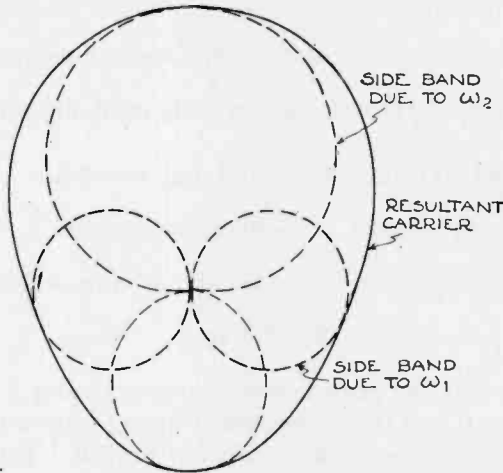

Fig. 14—Space pattern when methods A and B for course-shifting are combined.

$$e_p = K \left\{ \begin{array}{l} E_0 [C_1 \cos \omega t \sin \theta + \sin \omega t (K_2 + \cos \theta)] \\ - C_1 \frac{E_1}{2} [\sin (\omega - \omega_1) t - \sin (\omega + \omega_1) t] \sin \theta \\ + \frac{E_2}{2} [\cos (\omega - \omega_2) t - \cos (\omega + \omega_2) t] [K_2 + \cos \theta] \end{array} \right\} \quad (13)$$

where $K_2 = \frac{\text{amplitude of circular radiation due to } \omega_2}{\text{maximum amplitude of figure-of-eight radiation due to } \omega_2}$

$C_1 = \text{reduction factor for carrier and sidebands due to } \omega_1$

$$e_r = K K' E_0 \{ C_1^2 E_1 \sin \omega_1 t \sin^2 \theta + E_2 \sin \omega_2 t [K_2 + \cos \theta]^2 \} \quad (14)$$

In Figs. 14 and 15, $C_1 = 0.7$ and $K_2 = 0.22$.

Referring to (14), a course will occur whenever

$$| K_2 + \cos \theta | = | C_1 \sin \theta | \quad (15)$$

This equation will have four solutions, one for each quadrant. In the first quadrant

$$K_2 + \cos \theta_1 = C_1 \sin \theta_1 \quad \theta_1 = \text{angle of course A} \quad (16)$$

In the second quadrant

$$K_2 - \cos \theta_2 = C_1 \sin \theta_2 \quad \theta_2 = \text{angle of course B} \quad (17)$$

In the third quadrant

$$K_2 - \cos \theta_3 = -C_1 \sin \theta_3 \quad \theta_3 = \text{angle of course } C \quad (18)$$

In the fourth quadrant

$$K_2 + \cos \theta_4 = -C_1 \sin \theta_4 \quad \theta_4 = \text{angle of course } D \quad (19)$$

In (16), (17), (18), and (19) the factors $\sin \theta_1$, $\cos \theta_1$, etc., are constants of positive sign.

Subtracting (17) from (16) and solving, we obtain

$$\theta_2 - \theta_1 = 2\alpha \quad \text{where } \alpha = \tan^{-1} C_1 \quad (20)$$

Similarly, subtracting (19) from (18) and solving, we obtain

$$\theta_4 - \theta_3 = 2\alpha. \quad (21)$$

We note, then, that the angle between courses *A* and *B*, and likewise between courses *C* and *D*, are dependent upon C_1 , the reduction factor of carrier and sidebands in one amplifier branch. These angles are independent of the amount of circular radiation of carrier and sidebands added to the normal figure-of-eight radiation of the other amplifier branch.

Again, subtracting (18) from (17), and solving, we obtain

$$\theta_3 = -\theta_2. \quad (22)$$

Similarly, subtracting (16) from (19) and solving, we obtain

$$\theta_4 = -\theta_1. \quad (23)$$

Equations (22) and (23) indicate that courses *B* and *C*, and also courses *D* and *A*, are symmetrical about the 0-deg.-180-deg. axis. This may be seen by reference to Fig. 15. The angle between courses *B* and *C* is decreased, and the angle between courses *D* and *A* increased in like amount, as the ratio of maximum amplitude of circular to figure-of-eight radiation due to the second amplifier branch is increased. If the phase of the circular radiation is reversed with respect to the phase of the figure-of-eight radiation, an increase in this ratio will result in an increase in the angle between courses *B* and *C* and a decrease in the angle between *D* and *A*. In either case, for a given fixed value of C_1 , the angles between the courses *A* and *B* and between *C* and *D* remain fixed at a value $2 \tan^{-1} C_1$.

The procedure of determining the proper values for C_1 and for K_2 in order to serve three courses at given angles with each other is as follows:

(a) Suppose that courses A and B are 75 deg. apart.

Place $2 \tan^{-1} C_1 = 75$ deg.

Then $C_1 = \tan 37.5$ deg. $= 0.767$.

(b) Now, suppose that course C' is 90 deg. from course B . For convenience in fixing ideas, refer to Fig. 15. Under normal adjustments, i.e., with no additional vertical radiation, course C would be

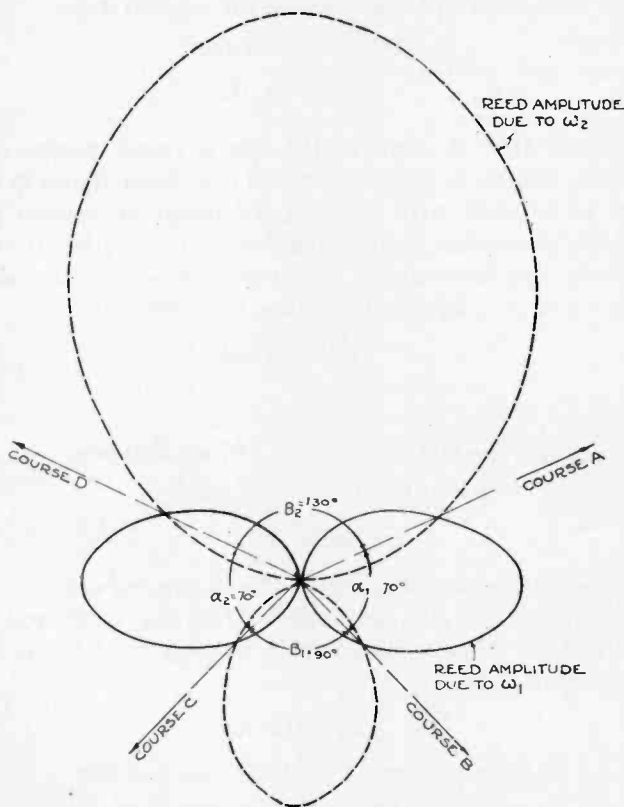

Fig. 15—Received polar pattern corresponding to Fig. 14.

105 deg. from course B . To decrease this angle to 90 deg., circular radiation of proper phase must be introduced. Since B and C are symmetrically disposed about the 0-deg.-180-deg. axis, and the angle between courses B and C equals 90 deg., the angle of course C must be 225 deg. Place

$$|K_2 + \cos(225 \text{ deg.})| = |0.767 \sin(225 \text{ deg.})|$$

then

$$|K_2 - 0.707| = |-0.542|$$

and

$$K_2 = 0.165.$$

(c) If course C' were to be, say, 120 deg. from course B , the vertical radiation to be introduced must be of the same magnitude as in (b) but of opposite phase. Thus, θ_3 becomes 240 deg. and

$$\begin{aligned} |K_2 + \cos 240 \text{ deg.}| &= |0.767 \sin 240 \text{ deg.}| \\ |K_2 - 0.5| &= |-0.665| \\ K_2 &= -0.165. \end{aligned}$$

(d) Suppose that an angle of 165 deg. between courses B and C' were desired. Course D is normally 180 deg. from B and is therefore the course to be used, with the proper amount of circular radiation introduced to obtain the desired angular shift. Courses D and A are symmetrically displaced about the 0-deg.-180-deg. axis and course A is 75 deg. from B . The angle of course D is therefore

$$\theta_4 = 300 \text{ deg.}$$

and

$$\begin{aligned} |K_2 + \cos 300 \text{ deg.}| &= |0.767 \sin 300 \text{ deg.}| \\ |K_2 + 0.50| &= |-0.665| \\ K_2 &= 0.165. \end{aligned}$$

Note that for this value of K_2 , course C is 90 deg. from B .

(e) Again, suppose that an angle of 195 deg. is desired between courses B and C' . Course D will again be used but circular radiation of negative sign is necessary.

$$\begin{aligned} \theta_4 &= 315 \text{ deg.} \\ |K_2 + \cos 315 \text{ deg.}| &= |0.767 \sin 315 \text{ deg.}| \\ |K_2 + 0.707| &= |-0.542| \\ K_2 &= -0.165. \end{aligned}$$

Note that for this value of K_2 , course C is 120 deg. from B .

V. METHOD D. EXTENSION OF METHOD B

It is frequently desirable to shift two of the four beacon courses from their 180-deg. relationship (viz., B and D) without disturbing the 180-deg. relationship between the other two beacon courses (A and C). This can be accomplished by the introduction of circular radiation in equal amounts of the carrier and sidebands transmitted

by both amplifier branches in addition to their normal figure-of-eight radiation. Fig. 16 shows the beacon space pattern for a case of this type, and Fig. 17 shows the corresponding received polar pattern. The mathematical expressions corresponding to these patterns are given in (24) and (25), respectively.

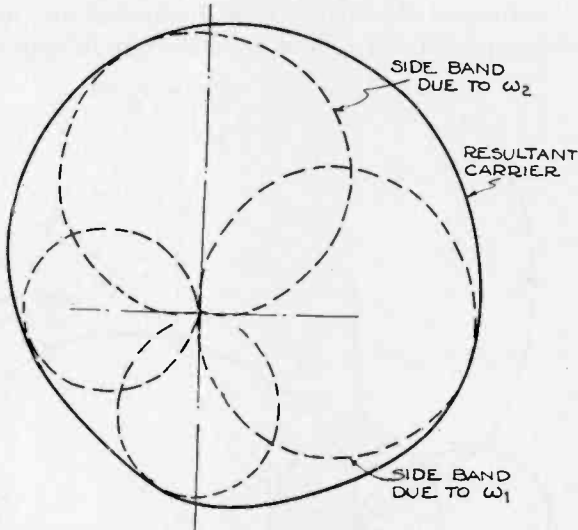

Fig. 16—Space pattern when circular radiation in equal amounts of the modulated waves transmitted by both amplifier branches is added to their normal figure-of-eight radiation.

$$e_p = K \left\{ \begin{array}{l} E_0 [\cos \omega t (K_1 + \sin \theta) + \sin \omega t (K_2 + \cos \theta)] \\ - \frac{E_1}{2} [\sin (\omega - \omega_1)t - \sin (\omega + \omega_1)t] [K_1 + \cos \theta] \\ + \frac{E_2}{2} [\cos (\omega - \omega_2)t - \cos (\omega + \omega_2)t] [K_2 + \cos \theta] \end{array} \right\} \quad (24)$$

where $K_1 = \frac{\text{amplitude of circular radiation due to } \omega_1}{\text{max. amplitude of figure-of-eight radiation due to } \omega_1}$

$K_2 = \frac{\text{amplitude of circular radiation due to } \omega_2}{\text{max. amplitude of figure-of-eight radiation due to } \omega_2}$

$$e_r = KK'E_0 \{ E_1 \sin \omega_1 t [K_1 + \sin \theta]^2 + E_2 \sin \omega_2 t [K_2 + \cos \theta]^2 \}. \quad (25)$$

A course will occur when (26) is satisfied.

$$| K_1 + \sin \theta | = | K_2 + \cos \theta |. \quad (26)$$

In Figs. 16 and 17, $K_1 = K_2 = 0.2$

Applying method D, the minimum practicable angle that can be obtained between courses *B* and *D* is 145 deg. This angle can be made smaller, however, if the weakest course (*C*) is not to be used. For example, suppose that a radio range installed at Richmond, Va., is to serve the routes to Quantico, Va., Norfolk, Va., and Greensboro, N. C. The bearings of these cities from Richmond are, respectively, 1 deg., 126 deg., and 237 deg. These are plotted in full lines in Fig. 18,

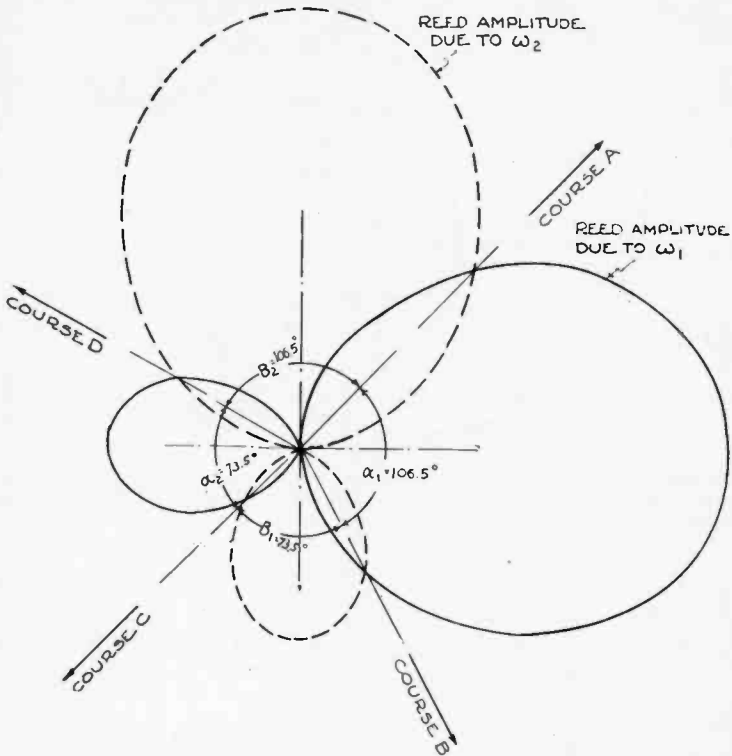

Fig. 17—Received polar pattern corresponding to Fig. 16.

together with the proper beacon space pattern for serving the routes to these cities. The method of arriving at this pattern is of interest. Allowing an error of 0.5 deg., the courses to Norfolk, Va., and Greensboro, N. C., are equally displaced from the course to Quantico, Va. The bearings of two of the three courses may therefore be substituted successively in (26), and the values for K_1 and K_2 determined. Since the course directed on Quantico, which has a bearing of 1 deg., corresponds, obviously, to course *A*, Fig. 17, having a bearing of 45 deg., a correction factor of (+ 44 deg.) to the bearings of the two courses to be substituted in (26) must be applied. Thus

$$|K_1 + \sin(1 \text{ deg.} + 44 \text{ deg.})| = |K_2 + \cos(1 \text{ deg.} + 44 \text{ deg.})|$$

$$|K_1 + \sin(125.5 \text{ deg.} + 44 \text{ deg.})| = |K_2 + \cos(125.5 \text{ deg.} + 44 \text{ deg.})|$$

Solving these two equations simultaneously, we have

$$K_1 = 0.40$$

$$K_2 = 0.40$$

A verification that these values are correct may be had by determining whether $|0.4 + \sin(236.5 \text{ deg.} + 44 \text{ deg.})| = |0.4 + \cos(236.5 \text{ deg.} + 44 \text{ deg.})|$. Solving $|0.582| = |-0.582|$, which is correct.

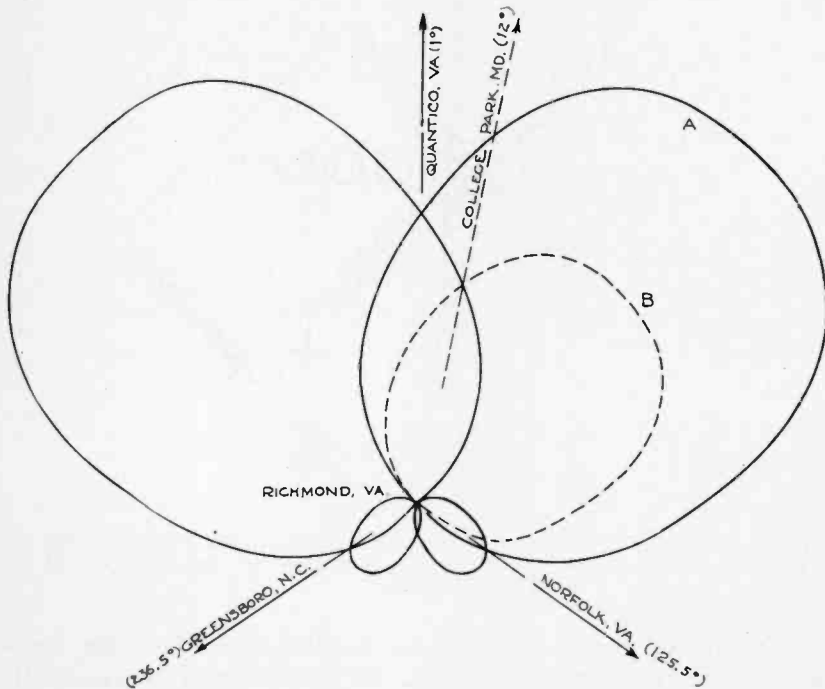

Fig. 18—Application of the method of course-shifting illustrated by Figs. 16 and 17 to actual airway routes.

Some difficulty arises in the application of this method due to the fact that no coupling should exist between amplifier branches of the beacon transmitter. Referring to Fig. 3, introducing circular radiation of the modulated waves transmitted by both amplifier branches of the system involves coupling the vertical antenna to suitable inductances inserted at *A* and at *B*. This at once introduces coupling between amplifiers and tends to destroy the beacon pattern. To over-

come this difficulty the arrangement indicated in Fig. 19 must be employed. The inductances, S_1 and S_2 , are inserted at A and at B as previously, but S_1 and S_2 are crossed at 90 deg. with each other. The secondary coils, R_1 and R_2 , are mounted concentrically with S_1 and S_2 and are also at 90 deg. with each other. R_1 is connected in series with the tuned antenna circuit while R_2 is connected in a tuned circuit of constants identical with those of the antenna circuit. R_1 and R_2 may be made rotatable, making the coupling arrangement similar

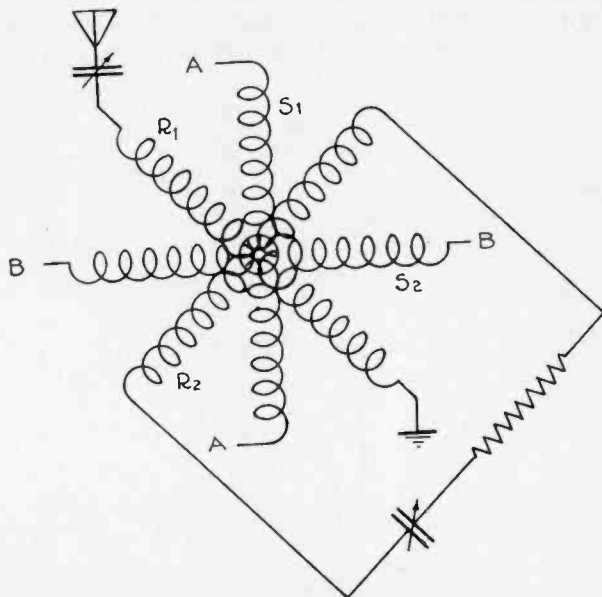

Fig. 19—Neutralizing arrangement to prevent intercoupling between the two amplifier branches even though these are coupled to the same vertical antenna.

to the four-coil goniometer used for coupling the radio range transmitter to the loop antenna system. As was shown in the case of the four-coil goniometer, no coupling exists between amplifier branches, provided the loop antennas are in accurate tune.⁴ The coupling between S_1 and S_2 by virtue of their mutual induction with R_1 is exactly neutralized by the coupling between S_1 and S_2 by way of R_2 . This holds true for every angular position of the rotor system $R_1 R_2$.

The position of R_1 to obtain equal circular radiation of the modulated waves transmitted by the two amplifier branches is, of course, at 45 deg. with S_1 and S_2 . Changing the angular setting of R_1 results

⁴ J. H. Dellinger and H. Pratt, "Development of radio aids to air navigation," Proc. I. R. E., 16, 910-912; July, 1928.

in a change in the relative amount of circular radiation for the two modulated waves. This provides an added feature of flexibility, since it makes it possible to shift the two sets of 180-deg. courses (*A*, *C* and *B*, *D*) from their 180-deg. relationship in varying amounts. This may best be illustrated by the results collected in Table II. The received polar diagrams shown in Figs. 13 and 17 correspond, respectively, to the 90-deg. and 45-deg. rotor settings in Table II.

TABLE II

| Rotor Setting | K_1 | K_2 | Angle of Course <i>A</i> | Angle of Course <i>B</i> | Angle of Course <i>C</i> | Angle of Course <i>D</i> | Angle between Courses <i>D</i> and <i>A</i> | Angle between Courses <i>D</i> and <i>B</i> |
|---------------|-------|-------|--------------------------|--------------------------|--------------------------|--------------------------|---|---|
| 0 deg. | 0 | 0.283 | 33.5 deg. | 146.5 deg. | 236.5 deg. | 303.5 deg. | 203 deg. | 157 deg. |
| 14 | 0.068 | 0.274 | 36.6 | 149.0 | 233.4 | 301.0 | 196.8 | 152 |
| 18.5 | 0.090 | 0.268 | 37.5 | 149.8 | 232.5 | 300.2 | 195 | 150.4 |
| 26.5 | 0.126 | 0.253 | 40 | 150.5 | 230.0 | 299.5 | 190 | 149 |
| 45 | 0.200 | 0.200 | 45 | 151.4 | 225 | 298.6 | 180 | 147.2 |
| 63.5 | 0.253 | 0.126 | 50 | 150.5 | 220.0 | 299.5 | 170 | 149 |
| 71.5 | 0.268 | 0.090 | 52.5 | 149.8 | 217.5 | 300.2 | 165 | 150.4 |
| 76 | 0.274 | 0.068 | 53.4 | 149 | 216.6 | 301 | 163.2 | 152 |
| 90 | 0.283 | 0 | 56.5 | 146.5 | 213.5 | 303.5 | 157 | 157 |

VI. METHOD E. COMBINATION OF METHODS D AND A

A typical example will best explain the combination of methods D and A to give a flexible procedure for shifting the beacon courses so that they may coincide with the airways radiating from a given airport. Considering the Bureau's experimental station at College Park, Md., suppose that it is desired to direct courses on Hatboro, Pa., Norfolk, Va., Quantico, Va., and Bellefonte, Pa. The bearings of these cities from College Park are, respectively

| | |
|-----------------|-----------|
| Hatboro, Pa. | 48.5 deg. |
| Norfolk, Va. | 160.5 " |
| Quantico, Va. | 219.5 " |
| Bellefonte, Pa. | 343 " |

These courses are plotted in Fig. 20, the angles between these courses being as indicated. The four courses can obviously be approximated by the method of amplitude reduction (method A) for shifting courses. Thus, draw line *AC* through the origin, equally displaced from the courses to Hatboro, Pa., and Quantico, Va. Also draw line *BD* through the origin, equally displaced from the courses to Norfolk, Va. and Bellefonte, Pa. The angle between these two lines is 62.2 deg. Placing $2 \tan^{-1} C_2 = 62.2$ deg. where C_2 is the reduction factor for the carrier and sideband in amplifier branch 2, we obtain

$$C_2 = 0.603.$$

It is now necessary to introduce sufficient circular radiation of both modulated waves to make courses *A*, *B*, *C*, and *D* coincide with the

desired routes. The proper values for K_1 and K_2 may be determined by substituting the bearings of two of the desired courses in equation (27)

$$|K_1 + \sin(\theta - 12.9 \text{ deg.})| = |K_2 + 0.603 \cos(\theta - 12.9 \text{ deg.})| \quad (27)$$

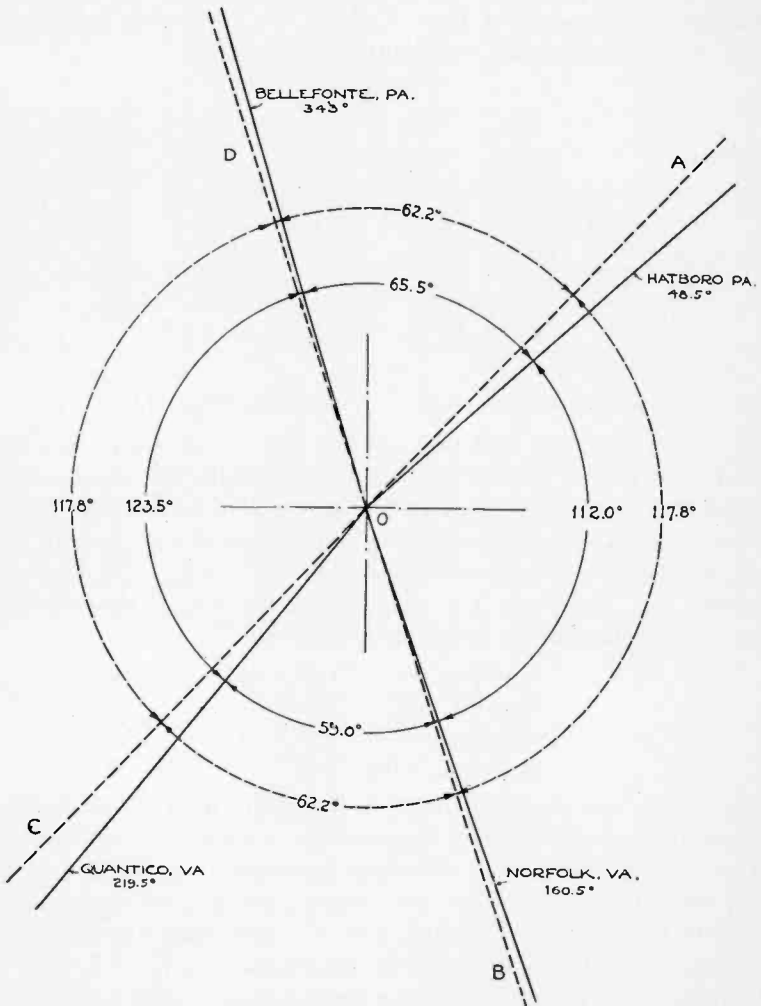

Fig. 20—First approximation toward serving the four airway routes shown.

The correction angle 12.9 deg. is necessary to make courses A and D symmetrical about the 0-deg.-180-deg. axis (see Fig. 7). Substituting the bearings for the courses to Hatboro, Pa., and Norfolk, Va., in (27), we have

$$\begin{aligned}
 |K_1 + \sin(48.5 \text{ deg.} - 12.9 \text{ deg.})| &= |K_2 + 0.603 \cos(48.5 \text{ deg.} - 12.9 \text{ deg.})| \\
 |K_1 + \sin(160.5 \text{ deg.} - 12.9 \text{ deg.})| &= |K_2 + 0.603 \cos(160.5 \text{ deg.} - 12.9 \text{ deg.})|
 \end{aligned}$$

Solving

$$K_1 = -0.060$$

$$K_2 = 0.033.$$

The corresponding angular setting of R_1 (Fig. 19) is easily computed. The resultant space pattern is given in Fig. 21.

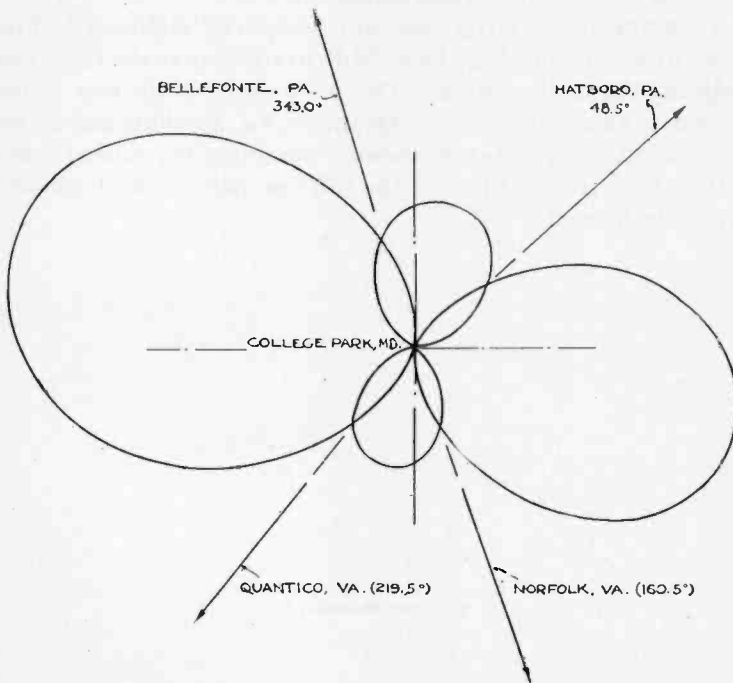

Fig. 21—Final polar pattern for serving the four routes shown simultaneously.

VII. METHOD F. SHIFTING THE COURSES BY CHANGES AT THE RECEIVING STATION

The methods for shifting the beacon courses as described above all require certain adjustments at the beacon transmitting station. Another possible method utilizes an adjustment of the receiving equipment aboard the airplane. This is accomplished by shunting a suitable resistance across the coil actuating one of the two reeds comprising

the course indicator, thereby reducing the sensitivity of that reed. The course, as determined by equality of reed deflections, is therefore shifted from the true equisignal zone of the beacon in the direction of the shunted reed. The same effect is thus accomplished as by shifting the courses at the beacon.

This method may be used alone, that is, with the beacon normally adjusted for four courses at 90 deg. to each other, or it may be used in conjunction with any of the methods outlined above. In the former case, a course shift of 15 deg. on either side of the four-beacon courses can be obtained. In the latter case, the degree of course shift possible (at the same time fulfilling the criteria set up under method A), depends upon the polar pattern employed.

An example of the latter case may be seen by reference to Fig. 18. A course directed on College Park, Md., in addition to the three courses already indicated, is desired. The pilot may obtain this course in preference to the one directed on Quantico, Va., by shunting the proper reed by a suitable resistance, thereby obtaining the dotted line pattern *B* on that reed in place of the full line pattern *A* obtained with the reed unshunted.



RADIO IN AERONAUTICS—ITS TECHNICAL STATUS AND THE ORGANIZATION FOR ITS APPLICATION IN GERMANY*

BY

F. EISNER AND H. FASSBENDER

(Deutschen Versuchsanstalt für Luftfahrt E.V., Berlin-Adlershof, Germany)

Summary—The paper gives a review of the present status of radio in aeronautics in Germany. Not only does it describe the apparatus used at the present time in German aircraft communications, but it also gives results of measurements on the fundamentals of radio in aeronautics, which have been made by the Deutschen Versuchsanstalt für Luftfahrt E. V. Further, it indicates the trend that German aircraft radio will probably follow in the next few years.

It takes up the subjects of long-wave sets, sets for short- and ultra-short waves, navigation apparatus for aircraft using radio waves, and airship radio sets. Finally, the German organization for the application of radio in aeronautics is described.

I. INTRODUCTION

PEOPLE who are not in contact with radio in aeronautics are frequently of the opinion that it is sufficient to build given transmitting and receiving apparatus for radio aircraft communication to meet its special problems. The use of radio apparatus in aircraft imposes on its design the requirements of minimum weight and bulk. In order to meet this condition, the construction of such apparatus is made difficult and expensive, because the utilization of space must be carried to such a point that installation frequently becomes exceedingly difficult. In addition to these requirements of weight and bulk that have been placed on aircraft radio, there is an additional requirement that the apparatus must be so designed and built that, considered purely mechanically, it will withstand vibrations during flight. This includes mounting the tubes on springs, special construction of the variable condensers in order to prevent displacement by vibration, and many other things. But it is even more important that the apparatus be electrically adapted to its special problems as far as possible. This is true of the transmitting as well as receiving apparatus.

Because of the extremely great restriction in weight, the most suitable selection of the aircraft radio wave, with due consideration of the

* Dewey decimal classification: R520. Original manuscript received by the Institute, September 26, 1929; translation received, October 4, 1929. Report of the Deutschen Versuchsanstalt für Luftfahrt E. V., Radio and Electrical Engineering Division, Berlin-Adlershof.

problem of propagation, is much more important than in immobile stations. The determining factor for propagation is the so-called attenuation constant, the knowledge of which is necessary over land and sea. Over the sea, the propagation process with long waves has been sufficiently covered by the researches of Austin and many other investigators.¹ The work² done by Deutschen Versuchsanstalt für Luftfahrt E. V. is of value for the attenuation constants over land in relation to the wavelength, and the data can be used in planning aeronautical radio connections.

In the short-wave region, propagation cannot be expressed by formulas. Here the knowledge of the so-called "dead zones" or, to use a better term, "fading zones," is particularly important.

In connection with the transmitter, the current supply brings up special problems. In aircraft radio stations, the energy is frequently taken from a propeller, so that the question of constant voltage in spite of variable speed of the aircraft in relation to the surrounding air is not a simple technical problem.

Also, the question whether pure undamped or audio-modulated undamped waves are the most suitable type for airplane transmission is also important. Here this question must be considered separately for transmitting and receiving. In telephony, for example, there are special difficulties in transmitting from airplanes because the microphone is affected not only by the acoustic speech waves, but also by all general noises.

With short waves other questions come to the front in connection with transmission, such as the suitability of quartz control.

A special question is raised by the shape of antenna suitable for aircraft. First, the antenna must be so shaped that it will cause, aerodynamically, only a slight reduction in the flying speed. Then, in special cases, such as low flying, it should interfere with the flight as little as possible. Finally, the exact knowledge of the radiation resistance and of the effective height of the airplane antenna is more important than in land stations, as these two magnitudes determine the range, and the necessary ranges can be obtained with low powers only with the correct shape of antenna. In aviation, no shape of antenna should be used if we do not know its aerodynamic action, and especially its radiation efficiency and its effective height. This requirement had not been met up to a short time ago. In addition to the

¹ Sacklowski, "The propagation of electromagnetic waves," Berlin, *Weidmannsche Buchhandlung*, 1928.

² F. Eisner, H. Fassbender, and G. Kurlbaum, "Investigations on the attenuation of electromagnetic waves and the ranges of radio stations in the wave region from 300 to 2000 m," (to appear shortly).

requirements placed on the electrical properties of the antenna, it must also be ascertained that the shape of the antenna does not endanger the aircraft. This might be the case if a fixed antenna breaks as a result of overstressing, and parts of it get into the power plant and control surfaces.

There are also a number of fundamental matters on the receiving side, in which aircraft radio apparatus differs from that in immobile radio stations. For example it must first be decided whether telephone

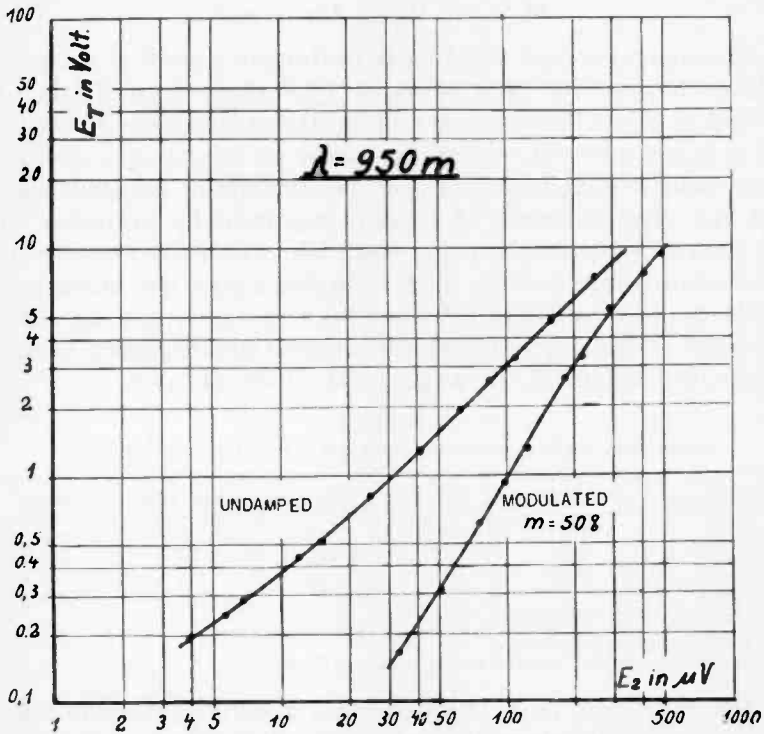

Fig. 1—Output voltage E_T as a function of input voltage E_2 .

or telegraph signals are better suited for reception in an airplane. This is tested by a type of articulation test³ similar to that generally employed in cable work at the present time. The data applying in stationary radio communication concerning the relation between the wireless telegraph and telephone ranges do not hold at all in aeronautic radio; in this case the ratio favors telegraphy. There are other general

³ F. Eisner, "Use of articulation measurements in radiotelegraphy (from experiments made with G. Kurlbaum). *Zeitschrift für technische Physik* (to appear shortly).

questions on reception in connection with this, especially the receiving field intensity that is necessary in a given airplane, as compared with the field intensity necessary for equivalent reception on the ground.

The list of questions in which aircraft radio differs essentially from that of ordinary radio engineering could be increased still further, but the points that have been mentioned above are sufficient to show that the old view is incorrect; the problems of aircraft radio are not merely special problems of design.

II. LONG-WAVE APPARATUS

The apparatus most widely used in German aircraft at the present time is the so-called 70-watt set of Telefunken, type 262 F. The method of rating the power of a radio station is not absolutely fixed, and it is not sufficient to characterize the set according to one of the many possible definitions of power; the product of transmitting current and effective height of aerial is important for operation. But this data depends on the aerial used, and which the manufacturing firm cannot always control. Aside from this, a set is best characterized by the power that can be delivered between the terminals: antenna—ground. According to the measurements of the Deutschen Versuchsanstalt für Luftfahrt E. V.⁴ we get for the Telefunken set:

TABLE I
POWER DATA FOR TELEFUNKEN TYPE 262F AIRCRAFT TRANSMITTER (70 WATT).

| Wavelength m | Frequency kc | N_a watt | N_{ak} watt | N_{ant} watt | J_{ant} heff |
|--------------|--------------|------------|---------------|----------------|----------------|
| 450 | 667 | 193 | 64 | 28 | 19.5 |
| 650 | 462 | 193 | 73 | 24 | 18.8 |
| 950 | 316 | 193 | 81 | 23 | 19.8 |
| 1350 | 222 | 193 | 90 | 14 | 16.3 |

N_a power taken at the anode

N_{ak} total power in the antenna circuit including the tuning apparatus.

N_{ant} power in the antenna wire

heff effective height of the usual trailing antenna in Germany

The wavelength range of the Telefunken set is from 300 to 1350 m. It contains a separately excited tube transmitter. The master oscillator has a 3-point regenerative connection in which the wavelength is changed by adjusting a variable condenser and variometer, both of which are on the same shaft. The grid circuit of the power tube is inductively coupled to the master oscillator. In the plate circuit of the power tube are the coupling coils for the antenna, likewise coupled inductively. The couplings are variable in steps together with the tuning of the antenna circuit. A variometer permits fine tuning of the antenna cir-

⁴ F. Eisner, H. Fassbender, and G. Kurlbaum, "Power and radiation measurements on airplane and ground stations," 99th Report of the Deutschen Versuchsanstalt für Luftfahrt E. V., Berlin-Adlershof, *Jahrbuch der drahtlosen Telegrafie und Telefonie*, 31, No. 4/5, 1928.

cuit. Power tubes and control tubes are those of the RS31 and RS231 type, respectively, with a filament potential of 14 volts, a filament

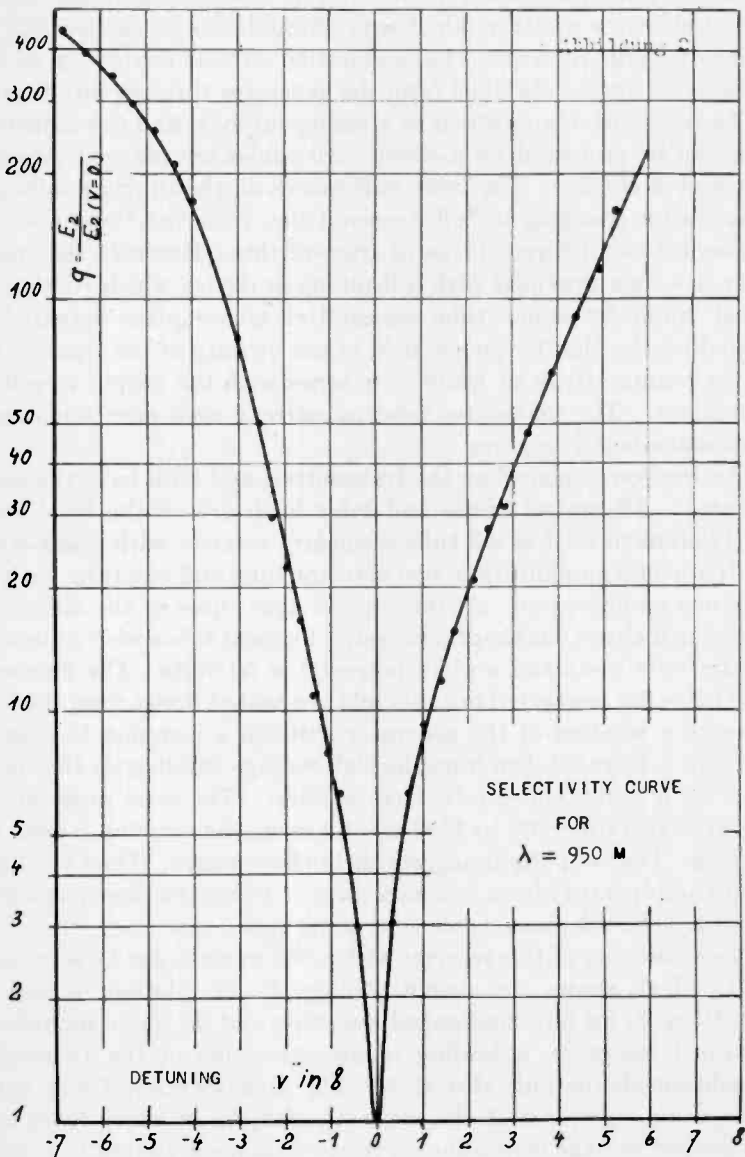

Fig. 2

current of 5 amperes, and a plate potential of 1500 volts. Although the control tubes could be considerably smaller, two tubes of the same

size have been chosen in order to use the same voltage for both tubes and to simplify the storage of spare parts. The transmitter permits the use of pure undamped waves and is also arranged for audio-modulated waves and for telephony. Modulation is carried out by varying the grid current. The modulation tube is heated by an a-c voltage of 80 cycles, obtained from the generator through slip rings.

The transmitter is enclosed in a mahogany box, and the adjusting knobs can be protected by a cover. All cables are plugged into the lower wall of the box. The front wall carries all the tuning knobs and the knobs for changing to "off, transmitting, receiving," and also the switches for the different types of transmitting. Recently the transmitter has been provided with a listening-in device which consists of a small audio-frequency tube transmitter whose plate potential is supplied by the high-frequency field in the vicinity of the transmitter and the output circuit of which is in series with the output circuit of the receiver. The maximum antenna current with pure undamped transmission is 2.3 amperes.

The receiver is placed on the transmitter, and both have the same base area. All control knobs and cable leads are on the front wall. The Telefunken set has a 3-tube secondary receiver with single-stage high-frequency amplification, one detector tube and one tube for low-frequency amplification. At the present time tubes of the RE1 type are used, which are double-grid tungsten-filament tubes with a filament potential of 4 volts and a plate potential of 50 volts. The filaments of the tubes are connected in series and are heated direct from the low-voltage d-c winding of the generator through a common resistance. The plate voltage is taken from the high-voltage winding for the transmitter by a potentiometer (voltage divider). The wave range of the receiver is also from 300 to 1350 m. An aperiodic antenna is used for receiving. The coupling is adjustable in three stages. The two tuned circuits are operated by a common drive. Adjustable regeneration is provided. The telephone receiver is sewn into a cap.

The sensitivity of this receiver with a 950-m wave can be seen from Fig. 1, which shows the output voltage E_T in relation to the input voltage E_2 for pure undamped reception and for audio-modulated undamped reception, according to measurements of the Deutschen Versuchsanstalt für Luftfahrt E. V. Fig. 2 shows a selectivity curve for the same receiver with the same wavelength, in which for a constant output voltage depending on the percentage detuning V , a value q has been plotted, which gives the ratio of the input voltage required for constant output to that corresponding to resonance.

Transmitter and receiver are supplied with energy from a generator driven by a regulator-type wind-propeller. The speed is 4800 r.p.m.

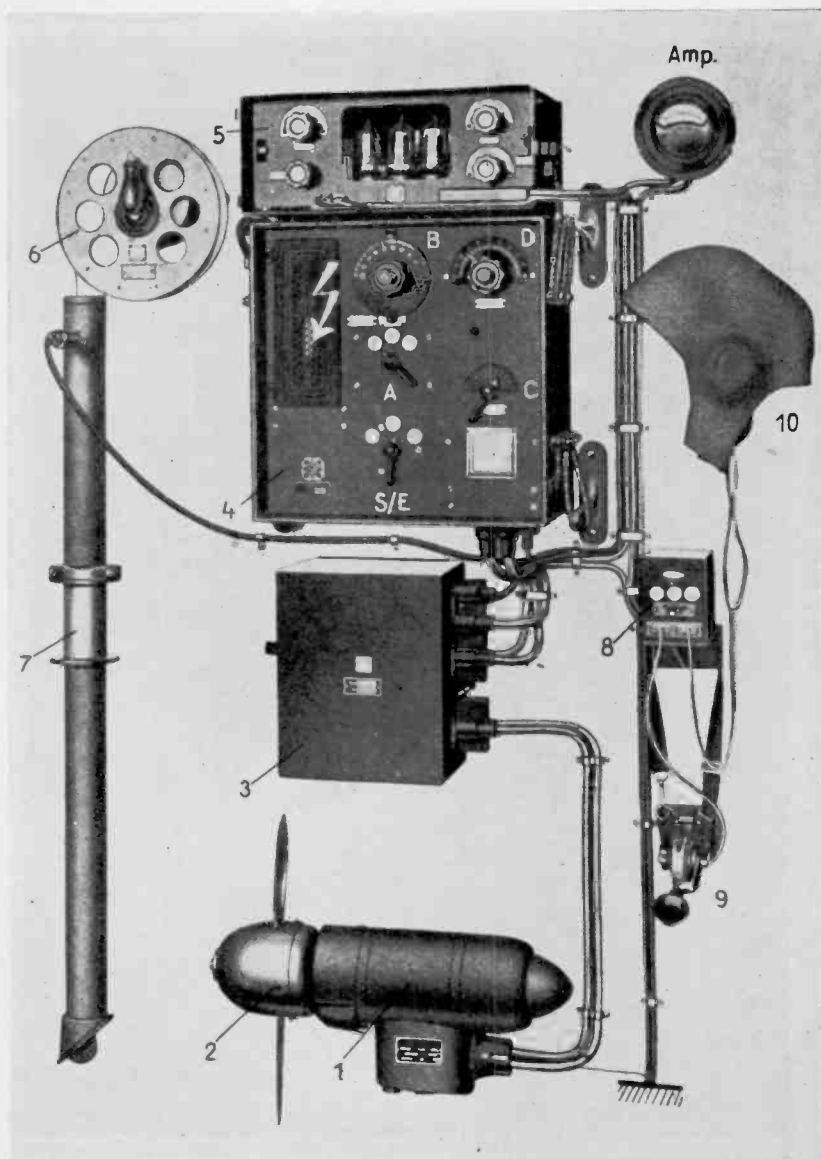

Fig. 3—Separate parts of Telefunken transmitter 262F.

The generator delivers 14 volts direct current for heating the transmitter and receiver tubes, 2000 volts direct current for the plate

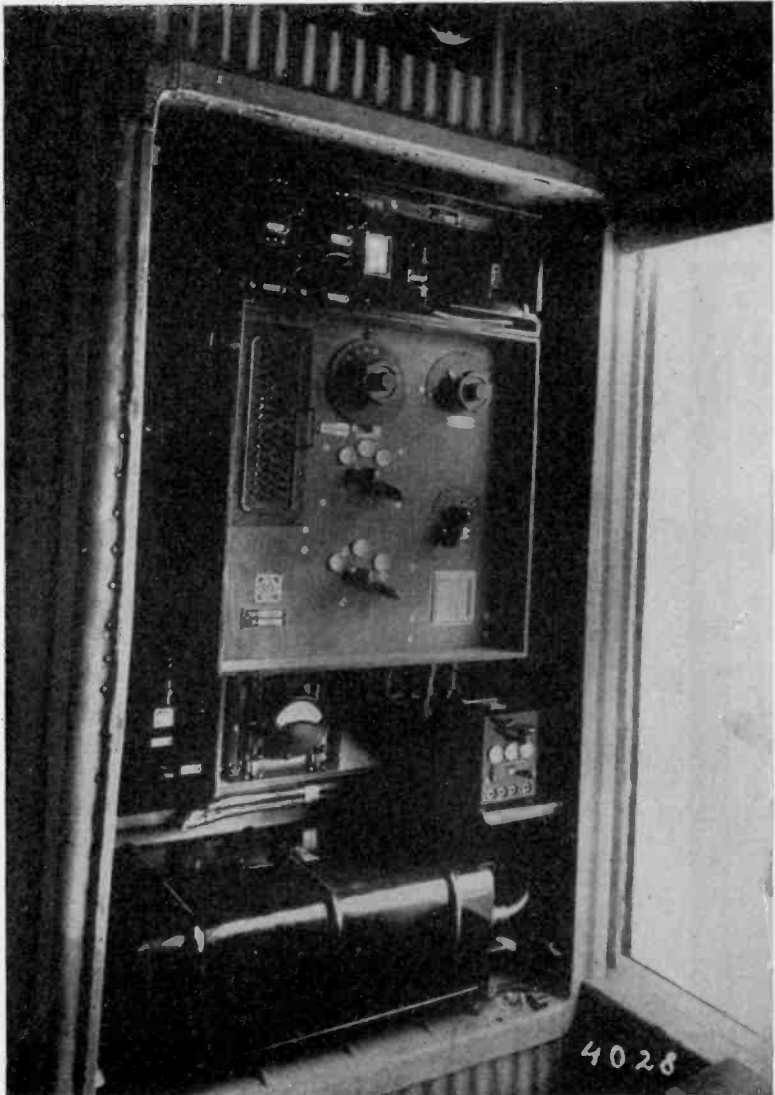

Fig. 4—Telefunken station, type 262F, installed in the radio cabin of a Junkers G31.

potential, and alternating current at about 9 volts at 80 cycles, for heating the modulation tubes. According to measurements of the

Deutschen Versuchsanstalt für Luftfahrt E. V.⁵ the propeller absorbs 1100 watts of power from the wind. The latest type of generator has a waterproof casing. In order to reduce the commutator noise, the high-tension winding is connected in parallel to a large condenser, and chokes are placed in the line for the filament current of the receiver. The chokes are all placed in one sheet metal case, which also contains the resistances for balancing the transmitter and receiver filament current and the potentiometer.

The antenna is a bronze braid 70 m long, which is weighted at the end by a "fish" weighing 0.5 kg; it is put out through an antenna well, generally through the bottom of the airplane. The exact determination of the effective heights of airplane antenna offers considerable difficulties. The Deutschen Versuchsanstalt für Luftfahrt E. V. has found 8.5 m for the trailing antenna 70 m long.⁴ The antenna well is a "pentinax" (bakelized paper) tube about two meters long which has recently been given a stream-line profile. The aerial is wound on a reel and runs out automatically when operation starts. A centrifugal brake controls the speed. Turning the handle on the reel operates a stopping device.

The key is separated from the apparatus, and controls the grid current. The Telefunken set weighs about 49.0 kg (100 lbs.). Its certain range with telegraphy using pure undamped signals and with normal atmospheric conditions is 500 km (310 miles) for transmitting from airplane and receiving from a 1-kw airport transmitter. Fig. 3 shows the individual parts, and Fig. 4 shows a set installed in the radio cabin of a G31 Junkers plane.

The C. Lorenz A. G., type Serf 01 V 28, airplane radio set is externally similar to the Telefunken set. It also consists of transmitter and receiver, but has in addition a so-called panel, on which are placed all switches and fuses. It differs from the Telefunken type in many interesting ways. The weight of the set is about 48.2 kg and its rated power is 100 to 120 watts. Measurements by the Deutschen Versuchsanstalt für Luftfahrt E. V. on this set gave the figures in the following table.

TABLE II
POWER DATA FOR LORENZ, TYPE SERF 01 V 28, 100-WATT AIRPLANE TRANSMITTER.

| Wavelength m | Frequency kc | N_g watt | N_{ak} watt | N_{ant} watt | $J_{ant} \cdot h_{eff}$ |
|--------------|--------------|------------|---------------|----------------|-------------------------|
| 650 | 462 | 640 | 198 | 71 | 32.3 |
| 950 | 316 | 476 | 196 | 52 | 28.9 |
| 1350 | 222 | 420 | 132 | 29 | 23.7 |

The letters have the same meaning as in Table I.

⁵ W. Brintzinger, "Driving electric generators by wind," 101st Report of the Deutschen Versuchsanstalt für Luftfahrt E. V., Berlin-Adlershof, *Luftfahrtforschung*, 1, No. 4, 1928.

The Lorenz transmitter is a self-excited intermediate circuit transmitter. Its wavelength range is from 550 to 1350 m. The wavelength adjustment is done in steps by plugging-in. Fine adjustment is furnished by a variometer and in addition, the antenna coupling, antenna tuning and also grid and plate coupling of the transmitter tube can be changed in steps. A variometer is provided for fine tuning

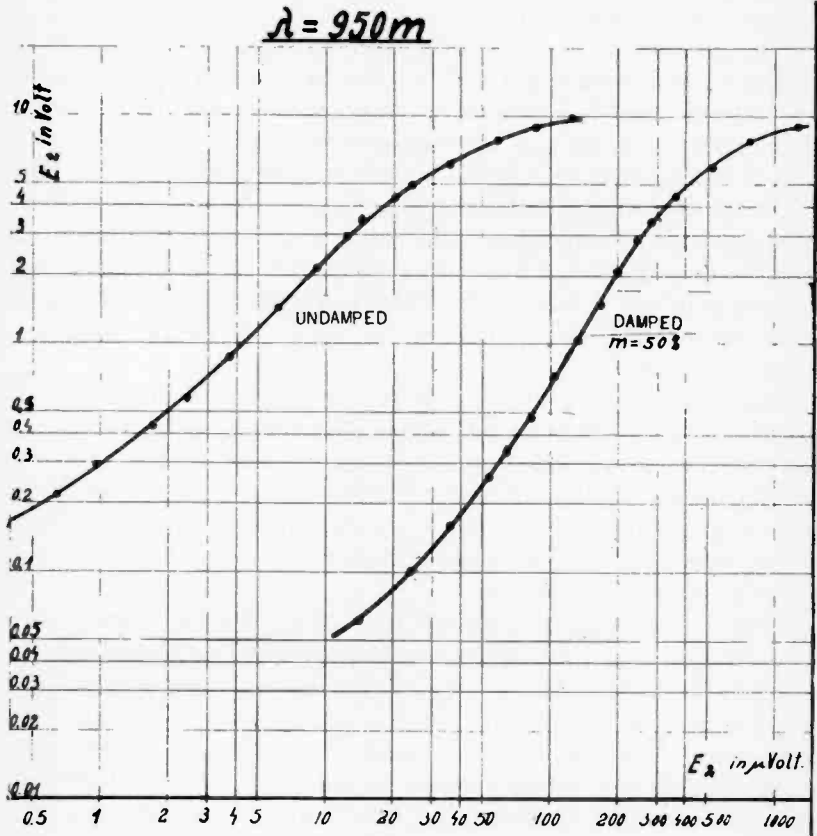

Fig. 5—Output voltage E_T as a function of input voltage E_2 .

of the antenna. The filament current of the transmitter tube is measured by an ammeter and can be adjusted by a sliding resistance. All cable connections are at the lower wall of the box. The maximum antenna current is about 3.3 amperes and is measured by a hot-wire ammeter connected in the ground wire. The transmitter is adjusted for pure undamped and audio-modulated undamped transmission as well as for telephony. The modulation is magnetic.

The receiver has four tubes of the RE11 type, which are employed as high-frequency amplifier, detector and 2-stage audio-frequency amplifiers. In this receiver the antenna is tuned, and for this purpose the tuning device of the transmitter is used. If transmission and reception are on different waves, it seems inconvenient to change the

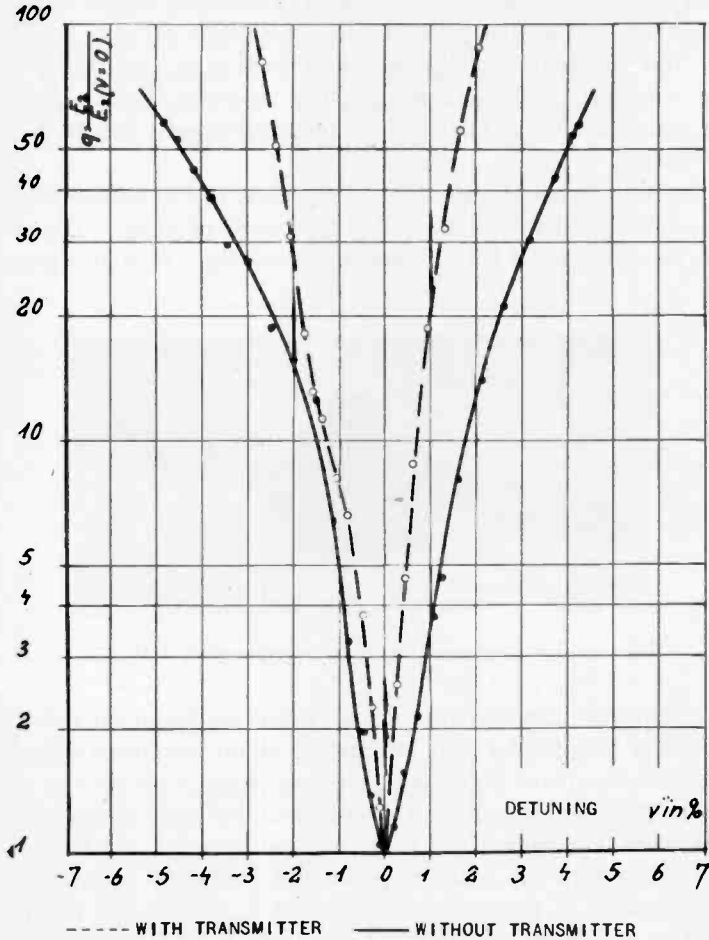

Fig. 6—Selectivity curve for $\lambda = 950$ m.

antenna tuning for each shift, but the receiver does not have a sufficient range with an untuned antenna.

In the receiver there are two tuned circuits which are adjusted by turning two knobs. Fine tuning is provided for the second circuit. The regenerative coupling is variable. The receiver in the airplane can receive from the 1-kw airport transmitter at a distance of about

600 km (375 miles). The sensitivity of this receiver on the 950-m wave can be seen from Fig. 5, which shows the output voltage E_T as dependent upon the input voltage E_2 for pure undamped and for audio-modulated undamped reception, according to measurements of the Deutschen Versuchsanstalt für Luftfahrt E. V. The selectivity curve ($\lambda = 950$ m) for the Lorenz receiver is shown in Fig. 6.

The receiver is heated by a 24-v direct-current winding on the generator, and the plate voltage is taken from a special 220-v direct-current winding on the generator. The receiver remains connected during transmission, so that the transmitted signals can be heard in the telephone.

In the Lorenz set the receiver is attached to the transmitter. All cables are fastened to the underside by means of plugs. The current for this set is supplied by a generator driven by a regulator propeller.

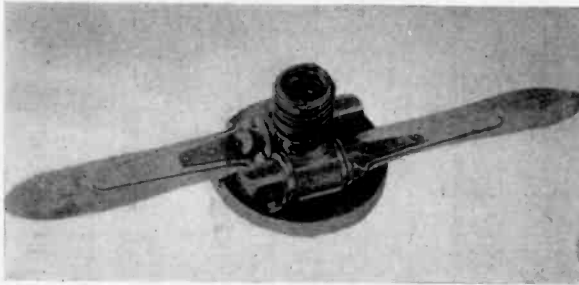

Fig. 7—Telefunken adjustable propeller type ED 2574.

Fig. 7 shows the propeller for this set made by Seppeler-Telefunken. Each of the two blades can be turned about its longitudinal axis. Regulation takes place as follows: the centrifugal force acts on weights which are placed eccentric to this longitudinal axis, so that with increased speed the blades are given a smaller angle of attack. The propeller shown in the figure supplies the necessary counterforce by cable tension. The generator supplies 165 w at 24 v for heating the transmitter and receiver tubes, 370 w at 2000 v for the plate circuit of the transmitter, and 15 w at 220 v for the plate circuit of the receiver. The generator also supplies 5 va at 1000 cycles for modulation in audio-modulated transmission. It should be mentioned in connection with the generator that it is provided with a cowling which gives the least possible air resistance. In addition, the shaft is hollow for better cooling, so that the inside of the machine, which heats up more, is cooled most.

A condenser is connected to the plate-voltage winding of the transmitter to remove harmonics, and filament and plate currents for the receiver are sent through a series of chokes for the same reason.

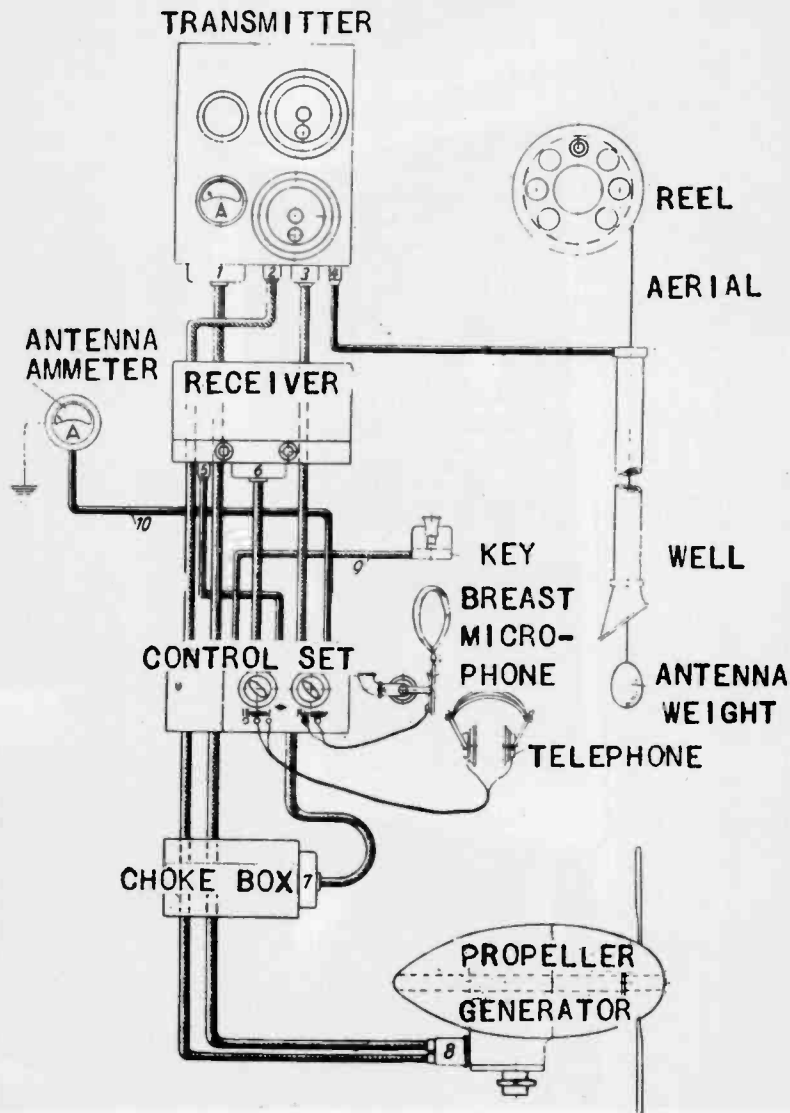

Fig. 8—Lorenz set, type SERF 01V28. Separate parts.

The Lorenz set also uses as antenna a bronze braid 70 m long, which is wound on a hand-operated reel equipped with a brake. The reel has a stop which is activated by turning the handle. Here also, the well is a

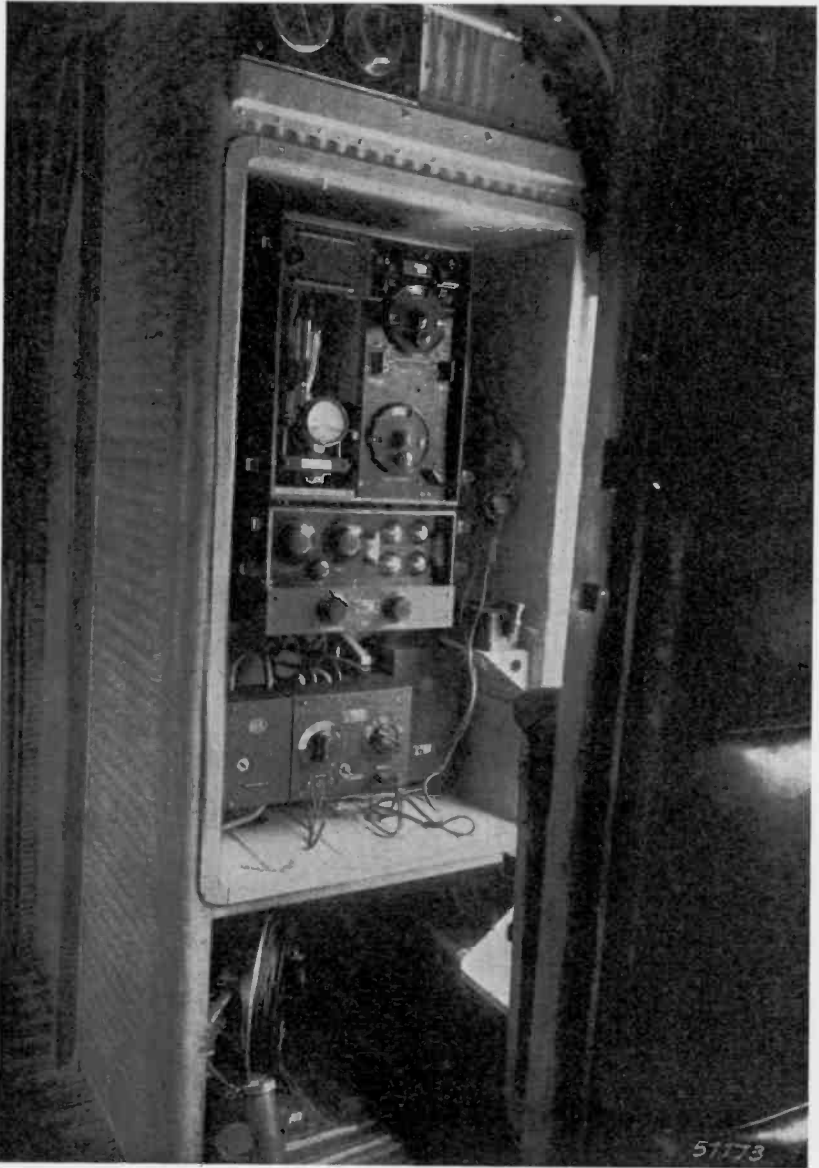

Fig. 9—Lorenz set, type SERF 01V28, installed in the radio cabin of a Junkers G31.

pertinax tube about 2 m long, which has such a wide internal diameter that, if an antenna weight is lost, the metal tube can be removed during flight, in order to replace the weight by another.

The Lorenz set and a 1-kw airport set can maintain reliable communication with pure undamped operation and normal atmospheric conditions, for 600 km (375 miles).

Fig. 8 shows an assembly of the parts of this set, and Fig. 9 shows an installation in a G31 Junkers plane belonging to Lufthansa.

To summarize, we can say, in regard to the two airplane sets in common use at the present time in German aircraft radio, that they fully meet the requirements placed on the apparatus by this special

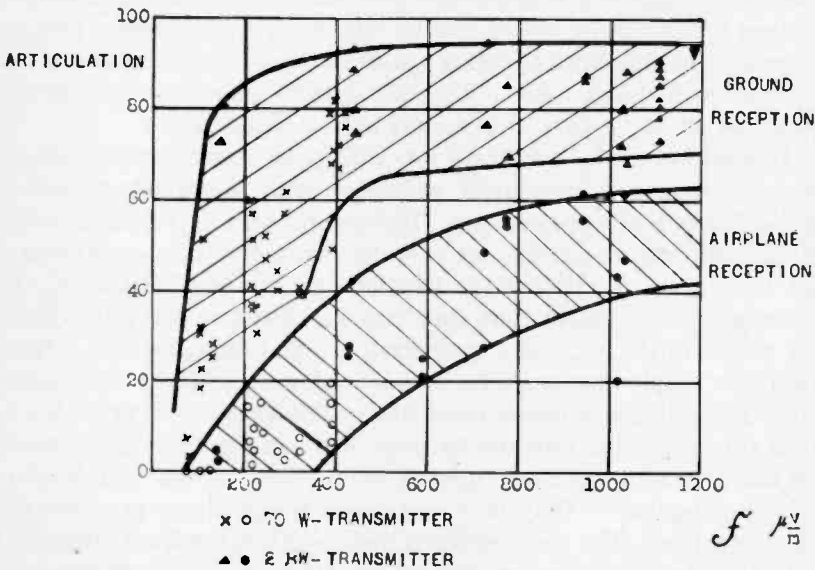

Fig. 10—Articulation in relation to receiving field intensity. Receiver (1).

type of operation. The sets possibly give too much, for in communication within Germany, distances of more than 500 to 600 km (315–375 miles) are never required. Use is rarely made of the possibility of audio-modulated transmission. At most, it will be used for communication in the vicinity of the coast, with ship and coast stations which as yet have no heterodyne receivers. Telephony is not used in Germany because thorough investigations have shown that, especially for reception in airplanes, this will require such great field intensities that the range will be restricted to very short distances. The Deutschen Versuchsanstalt für Luftfahrt E. V. took up experimentally the question of the extent to which telephone reception is poorer in airplanes

than on the ground, using the same type of receiver and the same reception field intensity.³ Fig. 10 shows for aircraft and ground reception the percentage articulation as a function of the necessary field intensity. The disadvantages for the development of telephone operation also consist in the fact that more errors can occur in transmission than with telegraphy. The disadvantage of having a skilled operator on board for telegraph operation is more tolerable.

Work is now in process to simplify the two sets that have been described and which have proved to be good. It is intended to change the present form of the sets in such a way that the arrangements for audio-modulated and speech-modulated transmission can be omitted. This gives simplified construction and less weight, and in addition requires fewer repairs and a smaller supply of spare parts. The receiver is to be simplified by using low-drain (sparröhren) tubes instead of tungsten filament tubes. This will greatly reduce the energy required by the set so that its generator can be made lighter.

In addition to the long-wave sets that have been described, short-wave sets have been developed, which are being tested as sample sets by Lufthansa at the present time. These were made by Telefunken and Lorenz after the technical and scientific bases for their construction had been given by Deutschen Versuchsanstalt für Luftfahrt E. V. These sets are so small that they can be placed in the pilot-cabin. The weight of the set, ready to operate, is about 20 kg (40 lbs.). Operation is so simple that it can be done by the second pilot or radio operator. The sets are adjusted for definite wavelengths and provision is made for tuning the antenna to these wavelengths. Fluctuations of the antenna capacity have just as little effect on the wavelengths as in the large sets. Only pure undamped telegraphy is provided for the transmitter. The receiver has a wavelength range from about 850 to 950 m and only tuning and regenerative-coupling adjustments. The set is supplied by a 12-v, 18 ampere-hour battery. The antenna is a trailing wire 70 m long. The transmitting antenna current is 1 ampere. The reliable range is 200 to 250 km (125-160 miles) over land.

The small sets are intended to fill an important gap in aircraft radio engineering. They make reliable aircraft radio communication with the numerous airport radio stations in Germany possible at any point. They make it possible for the medium and small airplanes for which they are designed, to orient themselves above the storms, and to get bearings. Even after forced landings, communication can be carried on from the airplane, if the aerial is removed and fastened temporarily in some manner.

The ground stations necessary in German aircraft radio service generally consist of a transmitting and a receiving set, but there are

also airports that have only radio receiving sets, and some landing fields are connected with the other airports only by cable. The airport transmitters are most generally tube transmitters with a power of 0.3 to 1.5 kw in the antenna circuit. Only the Lindenberg transmitting station, which takes a part of the radio traffic of Berlin when necessary, has a high-frequency machine-transmitter supplied by the Lorenz firm, with a power of 5 kw; another Lorenz machine-transmitter is also installed in the transmitting station of the Munich airport. The wavelength range of the machine transmitter is from 800 to 1900 m.

The tube transmitters built by the Lorenz firm are separately excited and have intermediate circuits. The current supply in most cases is from 500-cycle machines whose current is rectified by thermionic valves. Some transmitters are also equipped with direct-current high-voltage machines. The wavelength range of these transmitters is from 500 to 2400 m.

The transmitters made by Telefunken are self-excited and have an intermediate circuit. Here also the high potential is produced by rectified alternating current of 500 cycles. Direct-current machines are used for cathode heating.

Almost all airport transmitters are at some distance from the flying field, generally 1 to 2 km, so that the aerial towers do not interfere with flying, and also in order to avoid interference in reception by its own transmitting. They are remote-controlled from the receiving room. The aerial towers are self-supporting iron masts. A few transmitting stations, such as Berlin, in which ground could not be obtained in the vicinity of the flying field, have been built on airport territory and have self-supporting wooden masts. The antennas are generally of a 3 or 4 wire, *T* or *L*, type. Grounding is done by radiating buried copper wires. The transmitters are in brick houses which, in addition to the operating and engine rooms, also contain a dwelling for the chief of the transmitting station or for the radio operator. Fig. 11 shows a view of the Nurnberg transmitting station, which can be regarded as characteristic of the airport transmitting stations.

The receiving sets belonging to the airport radio stations are always in the immediate vicinity of the airport. In general, they are placed in the administration building of the company operating the airport and near the weather bureau office.

A receiving station generally has three receivers. Most of the receivers are the Telefunken type E 266, consisting of detector and two audio-frequency amplifier stages which, in part, operate with separate heterodyne oscillators. Modern receivers such as DEBEG type E364S, or the Lorenz 6-tube neutrodyne receiver, type ERNC II

627, are being introduced more and more. As the international weather service uses very long waves (up to 12,000 m) each station is provided



Fig. 11—Nurnberg airport transmitting station.

with a receiver whose wavelength range can be increased to the longest waves by changing coils. The E 266 is very suitable for this.

The receiving aerials are ordinary low steel pipe masts and the grounds are buried conductors connected to the water pipe.

It is noteworthy that, as a result of uninterrupted operation, the wear of the plate batteries was so great that all receiving stations had to be equipped with net plates (Netzanoden). Storage batteries are used for heating.

III. SHORT-WAVE APPARATUS

The greatest value of aircraft communication lies in bridging great distances. The range that can be attained with long-wave sets does not meet the justified demands when constant communication with the home station is to be maintained on long flights. Here, distances of several thousand km come into consideration.

The trailing antenna (70 m long) used in the present sets hinders operation of the airplane, particularly in poor weather, so that for a long time there has been a demand for fixed antennas. But, as the distances available on the body of the airplane are very small as compared with the wavelengths customary in aircraft communication at the present time, fixed antennas have a decidedly low efficiency in the present sets, so that they have only very short ranges.

Further, the problem of so building a set that it can be used during flight as well as after landing on the ground, or after alighting on the sea, is very difficult with long-wave sets. But this problem is one of considerable importance, as wireless communication is particularly essential after a forced landing. Even though in the present long-wave sets the trailing antenna can be replaced by an auxiliary antenna in such cases, these have a very short range and also, because of the lack of wind, the 70 or 100-watt sets must have a generator driven by an auxiliary motor, which is a great load for the airplane.

Short waves make it possible to meet all these requirements simultaneously. First the power requirement is so low, even at long ranges, that the total weight of the radio installation can be extraordinarily small. Then, the short waves require antenna lengths, which are within the order of magnitude of the present-day dimensions of airplanes, so that good radiating conditions can be obtained even with permanently stretched aerial wires. Finally, a small storage battery can be used for the low primary power, so that the set can be operated even after landing, and particularly after a forced landing.

According to what has been said, one might wonder why short waves were not used in aircraft radio long ago. There have been a large number of objections until the present time. For a long time even the possibility of short-wave reception in airplanes was doubted. It was believed that the ignition noises of the airplane engine, and the vibrations during flight, would make short-wave reception impossible.

But it was primarily the so-called dead zones that made the use of short waves seem to offer very few prospects of success.

For this reason, the propagation of short waves between airplane and ground station was thoroughly investigated by the Deutschen Versuchsanstalt für Luftfahrt.⁶ At short and average distances the waves can always be so selected that fading zones do not appear. At greater distances, and especially in transoceanic aircraft communication, waves must be used which show fading zones. The fading of reception is so great that it is impossible to receive in the fading zones with the power available in the aircraft. If direct communication is to be maintained within the same airport station, a change in wave-

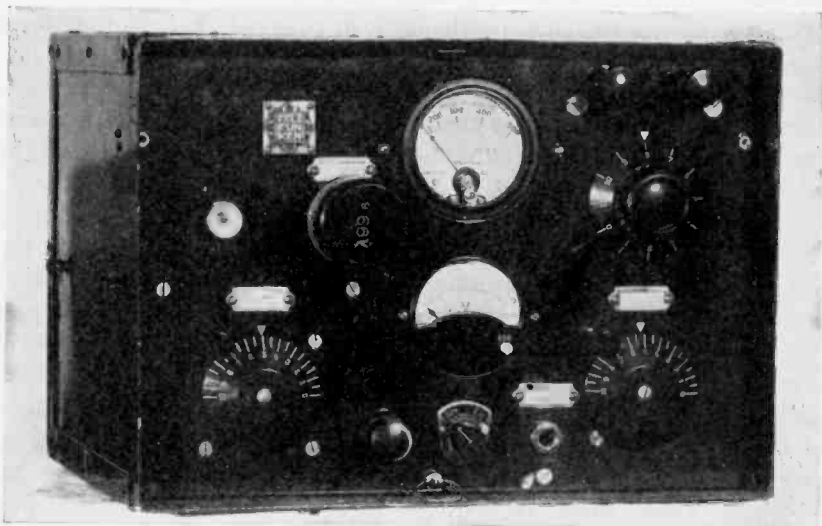

Fig. 12—Airplane short-wave transmitter, DVL Telefunken type.

length during flight cannot be avoided. In long flights or during trips of airships, conditions are more favorable insofar as there is generally not merely one receiving station, but an entire series of stations available for receiving, so that with a given wavelength, it might frequently happen that communication might be broken off with one of these stations while with another ground station, outside the fading zone, communication could be maintained.

The construction of short-wave sets for airplanes is still in such a

⁶ K. Krüger and H. Plendl, "On the propagation of short waves with low power in the 1000-km region," 124th Report of the Deutschen Versuchsanstalt für Luftfahrt E. V., Berlin-Adlershof, *Jahrbuch der drahtlosen Telegrafie und Telefonie*, 33, No. 3, 1929.

state of flux that a final type cannot yet be described, but in the following we shall briefly describe some examples.

Fig. 12 shows a short-wave transmitter developed by Deutschen Versuchsanstalt für Luftfahrt E. V. in conjunction with Telefunken. Fig. 13 shows its wiring diagram. The first stage is controlled by a quartz crystal. In the second stage the frequency is doubled. In this set the plate potential is controlled in the doubling stage, while the quartz-controlled stage is always oscillating. The second stage has a wavelength range from 30 to 70 m. The pure beat note produced by such a transmitter can be heard above the disturbing noises. An improved form of this transmitter was used by the Deutschen Versuchsanstalt für Luftfahrt E. V. at the time of its first test in the airship *Graf*

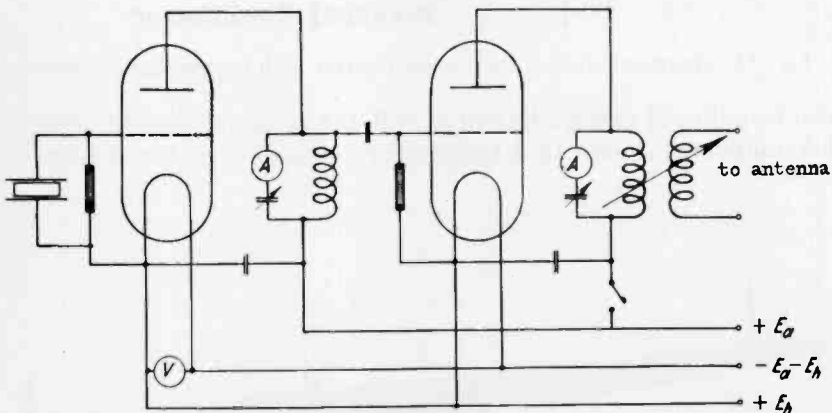

Fig. 13—Schematic wiring diagram of a quartz-controlled transmitter with frequency doubling.

Zeppelin. This transmitter will be described specially, in the section on airship sets.

Short-wave reception causes considerably greater difficulties than transmitting in the airplane. These consist, first, in the particularly unpleasant disturbances caused by the ignition spark of the engine, and then especially in the vibrations which cause fluctuations of the frequency of the heterodyne wave, and pitch fluctuations or complete cessation of tone in the receiver.

The first difficulty can be overcome by suitable screening of the ignition wires. The disturbances caused by vibrations cannot be removed even by very stable construction of the receiver. For this reason a quartz-controlled short-wave receiver with long-wave intermediate frequency was developed by the Deutschen Versuchsanstalt

für Luftfahrt E. V.⁷ In this receiver the heterodyne frequency of the receiver should be stabilized and then the pitch of the receiving tone

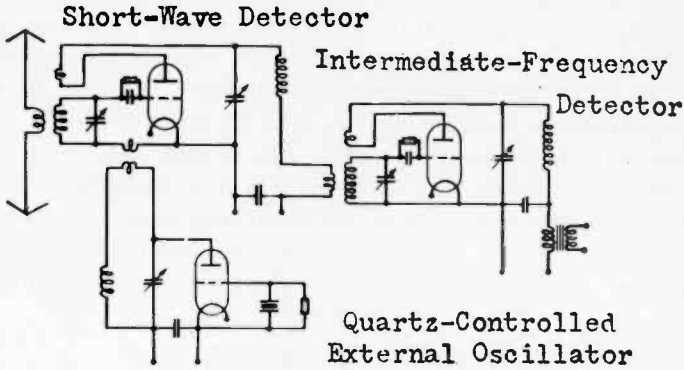

Fig. 14—Quartz-controlled short-wave receiver with intermediate receiver.

can be adjusted and readjusted at will, if any change should occur in heterodyne tone due to a temperature change or other influences.



Fig. 15—Transverse dipole on a Möve.

For this purpose, the quartz wavelength of the receiver is so selected in relation to that of the transmitter, as to produce beats of radio frequency. This r-f beat frequency is received by a tube detector.

⁷ P. v. Handel, K. Krüger, and H. Plendl, "Quartz-control of short-wave receivers," 141st Report of the Deutschen Versuchsanstalt für Luftfahrt E. V., Berlin-Adlershof, *Jahrbuch der drahtlosen Telegrafie und Telefonie*, 34, No. 1, 1929.

If the quartz wave of the receiver varies, the pitch of the receiving tone in the long-wave tube detector can be readjusted without difficulty.

Fig. 14 shows the wiring diagram of such a receiver. It is essential that the first (short-wave) detector should not oscillate and its regenerative coupling should only be used for the reduction of damping.

All difficulties in short-wave reception in airplanes can be removed if, according to the proposal of the Deutschen Versuchsanstalt für

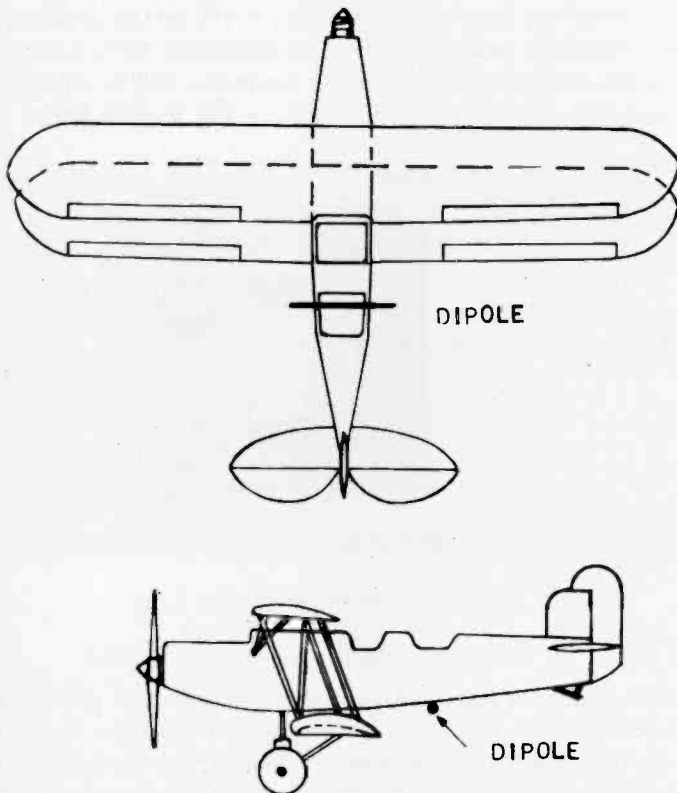

Fig. 16—Position of the dipole on the airplane.

Luffahrt E. V., the short waves are used only for transmitting from the airplane, while long waves are used from the ground to aircraft. The disadvantage resulting from this, namely, the use of a ground transmitter with very high power, is less important if ground stations are available with sufficient power for long distance communication.

Securely stretched dipoles are most commonly used by Deutschen Versuchsanstalt für Luftfahrt E. V. Fig. 15 shows the installation of such a dipole antenna on a Lufthansa airplane. The antenna as tuned

to a fixed transmitting wavelength can be used for receiving on any wavelength as the receiver described above works with an aperiodic antenna. The aerodynamic resistance of this aerial was determined by the Deutschen Versuchsanstalt für Luftfahrt E. V.⁸ It is approximately equal to that of a trailing antenna 70 m long.

Up to the present time short waves have been tested in Germany only superficially in the operations of the German Lufthansa. According to past experiences, short waves are particularly suitable for radio communication over very long distances. It will be the problem of the immediate future to perfect short-wave apparatus more and more in order that the reliability of short-wave operation will be equal to that of long waves in aircraft communication at the present time.

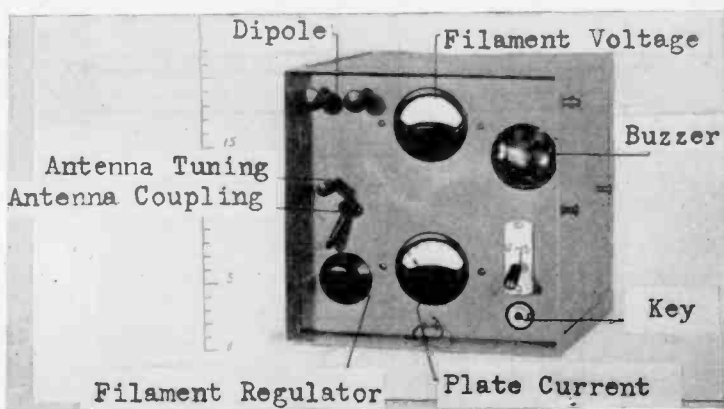

Fig. 17—Telefunken transmitter for 3.7 m.

IV. THE USE OF ULTRA-SHORT WAVES

Ultra-short waves have not been tested up to the present in the German aeronautical radio service, but tests have been made in airplanes^{9, 10} equipped with these waves. Thus it was intended to determine experimentally whether the idea of the so-called optical propagation of these waves corresponded to fact, and this question was to be answered by range measurements in relation to the height of the

⁸ F. Liebers, "On the resistance of airplane antenna and the reduction in flying power caused by it," 100th Report of the Deutschen Versuchsanstalt für Luftfahrt E. V., Berlin-Adlershof, *Luftfahrtforschung*, 1, No. 4, 1928.

⁹ H. Fassbender and G. Kurlbaum, "The dependence of the range of very short waves on the height of the transmitter above the earth," 125th Report of the Deutschen Versuchsanstalt für Luftfahrt E. V., Berlin-Adlershof, *Jahrbuch der drahtlosen Telegrafie und Telefonie*, 33, No. 2, 1929.

¹⁰ F. Gerth and W. Scheppmann, "Investigations on the propagation processes of ultra-short waves," *Jahrbuch der drahtlosen Telegrafie und Telefonie*, 33, No. 1, 1929.

airplane above the earth. The extent to which ultra-short waves can be used in aviation depends on the result of such investigations.

A small transmitter built by the Telefunken G. m. b. H. for a wavelength of 3.7 m was placed in the wooden airplane of the Albatross L 74 type. The maximum height reached by the airplane during the test was 2700 m (9000 ft.). The antenna was a dipole 170 cm long, made of copper tubing which, as seen in Fig. 16, was placed below the fuselage perpendicular to the axis of the airplane. The connection from the transmitter to the dipole consisted of an electric line screened by a metal cylinder. In Fig. 16 we see plainly the small dimensions of the

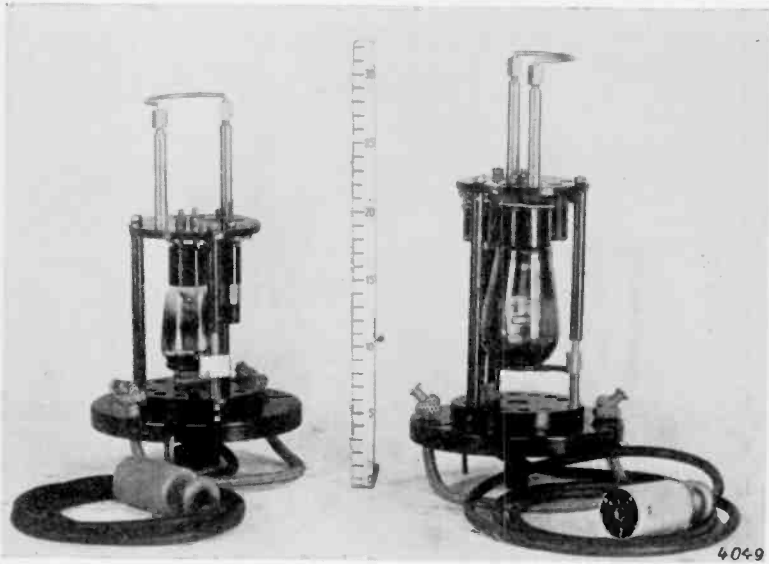

Fig. 18—Lorenz transmitter for ultra-short waves; high-frequency part of transmitter and receiver.

antenna tube as compared with the airplane, so that the airplane could not be hindered by this, as with the normal long-wave trailing antenna.

Fig. 17 shows the Telefunken transmitter used in the previous experiments. Fig. 18 shows the high-frequency part of the transmitter and receiver of the Lorenz set. The antenna is the small loop shown above the tube. This part must be so placed in the airplane that the passage of the electromagnetic waves to the receiving station is not hindered by parts of the body of the airplane. Fig. 19 shows the low-frequency part of the set (arrangement for modulation and super-regeneration).

TABLE III
LIMITS OF TELEGRAPHIC RECEPTION WITH $\lambda = 3.7$ M, IN RELATION TO FLYING ALTITUDE
(AIRPLANE FLYING AWAY FROM THE RECEIVER)

| Flying Altitude (meters) | Limits of Telegraphic Reception (km) |
|-----------------------------|--|
| 190 | 36 |
| 200 | 34 |
| 220 | 36 |
| 450 | 54 |
| 510 | 54 |
| 680 | 67 |
| 890 | 65 |
| 2620 | 130 |

Table III and Fig. 20 tabulate the limits for telegraphic reception in relation to the flying altitude for reception on the ground

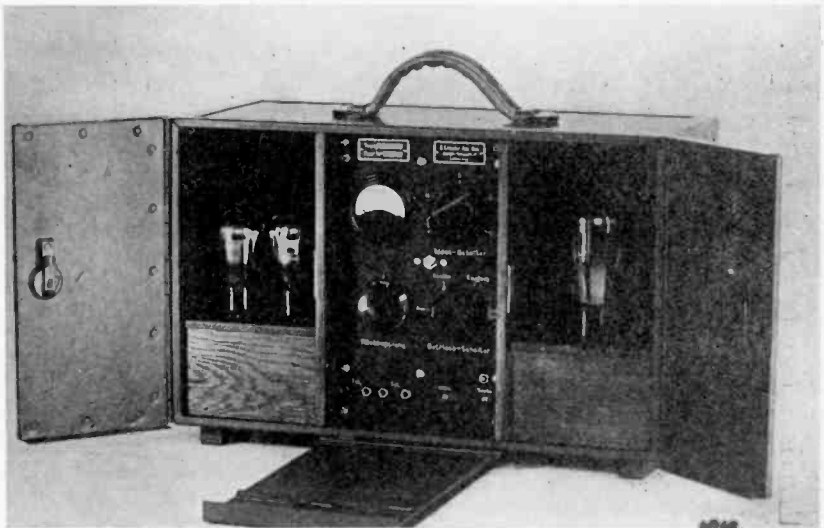

Fig. 19—Lorenz transmitter for ultra-short waves. Low-frequency part.

and in the airplane. The results were obtained with a super-regenerative receiver.¹¹ According to the idea that with these waves there must be optical vision between transmitter and receiver, reception will be possible as long as the airplane is above the plane tangential to the surface of the earth at the place of reception. If we designate the flying height by h (Fig. 21), the range by a , the radius of the earth by r we get

$$\cos \varphi = \frac{r}{r+h} \text{ and } \varphi = \frac{a}{r}$$

¹¹ E. Busse, "Super-réactions," *L'Onde Electrique*, 7, 217-259, 1928. Extensive literature, *Jahrbuch der drahtlosen Telegrafie und Telefonie*, 33, 153, 1929.

For $a \ll r$ we get $a = 2 rh$. For the radius of the earth $r = 6,370$ km; the theoretical range $a_{km} = 3.55h_m$.

The values thus calculated are drawn as dashed lines in Fig. 20, while the solid curve gives the ranges actually found.

Ultra-short waves seem to be particularly well suited for communication between two airplanes.

A certain competition is to be expected in this field of application of ultra-short waves by the waves between 100 and 150 m. The radiation is extraordinarily great for these waves also. The range can be regarded as definite, because of the small space radiation. Fading is present it is true, but is endurable. Communication with distant ground stations is not possible with these waves, as the waves traveling along the surface of the earth are subject to extraordinarily large attenuation. But nothing prevents the use of these waves for communication between two airplanes. Whether the waves below 10 m or those between 100 and 150 m are the most suitable for this field of application, cannot be decided at the present time, and depends upon the development of receivers for these two wave regions. It must be mentioned, as an essential advantage of the 3-m wave, that spacial damping due to the ground can be disregarded at relatively low flying heights.

V. DIRECTION-FINDING APPARATUS

In order to maintain regular aerial transportation, the pilot at each instant must have an exact knowledge of his location, or at least of the course being followed. Radio bearings are an important aid to navigation in the airplane.

All radio direction-finding methods can be divided into two large groups: direction-finding by a fixed station and direction-finding with the aid of a radiocompass on the plane. The German air transportation system has a number of ground direction-finding stations which determine the location of an airplane by bearings on request and then radio it to the airplane. The long-wave airplane transmitter used for communication is used as a bearing transmitter. The ground direction-finding stations all have Telefunken goniometers and use the apparatus that was developed a long time ago for German ships. The ground installation consists of a receiver, an 8-tube set with quadruple high-frequency amplification, a detector and triple low-frequency amplification, a loop-antenna which can be rotated, the azimuth of which can be read to $1/2$ deg. on the bearing disk, and the auxiliary or sense-finder antenna. The sense-finder is necessary to compensate for the so-called antenna effect of the goniometer, which is due to the fact that in the loop there are produced not only the re-

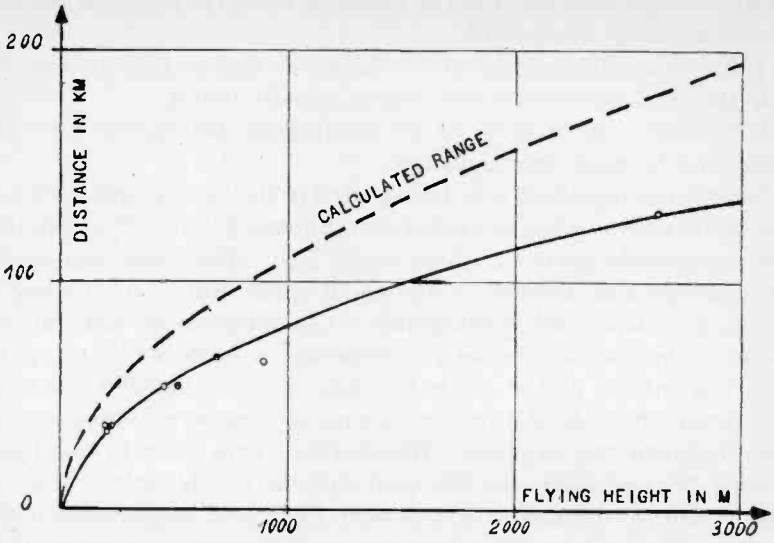

Fig. 20—Limits of telegraphic reception, depending on flying height—flying away.

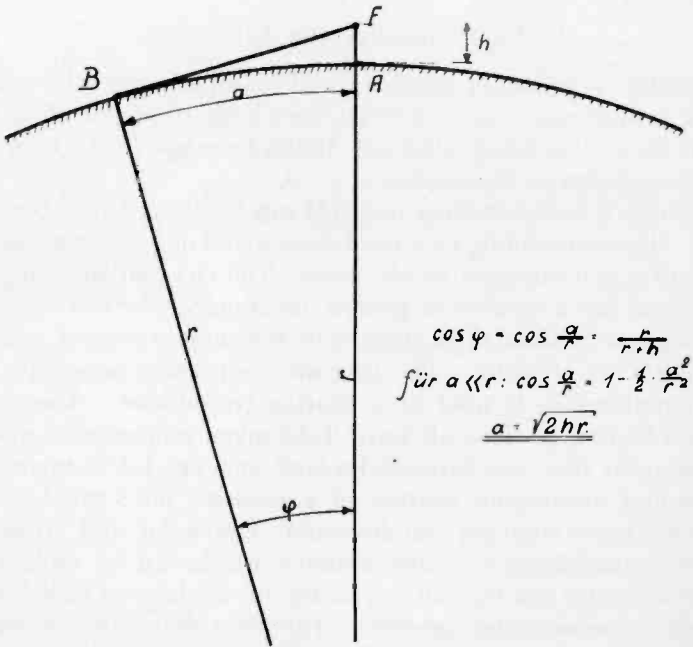

Fig. 21—Calculation of theoretical range.

ception alternating potentials due to the magnetic field, but a potential is also produced by the electric field which is present simultaneously. If the loop is turned to determine the direction of minimum reception, the potential caused by the antenna effort remains, and frequently causes considerable indistinctness in the position of the minimum. This error is compensated by the fact that, due to the auxiliary antenna, there is induced in the loop circuit, a potential equal to the antenna effect and with a phase of displacement 180 deg. By the correct adjustment of this auxiliary antenna and the loop, extraordinarily sharp minima are obtained.

As the characteristic curve of the direction-finding shows two minima which are displaced 180 deg., it is necessary to make a lateral



Fig. 22—Munich ground direction-finding station. Outside view.

determination for the establishment of the airplane location. Here the sense-finder is used, the characteristic curve of which is circular. Superposition of this characteristic curve on that of the loop, with the correct balancing, gives a unilateral curve with only one minimum, from the position of which it can be determined on which side the loop of the airplane is located.

Direction-finding by a fixed station has the advantage that no additional apparatus is necessary in the airplane, and that the airplane crew is not bothered with difficult plotting problems. It is proving valuable in Germany to an increasing extent. Its disadvantage is

that such a direction-finding method requires a certain amount of time so that, particularly in bad weather, if determination of locations are frequently necessary, one airplane must wait for another, and the value of such bearing determinations by fixed stations can be greatly reduced under certain circumstances.

The ground direction-finding stations are placed in small brick houses which are located in such a position on the flying field that the disturbing influences of neighboring aeri-als are as slight as possible. A view of the ground direction-finding station in Munich is shown in Figs. 22 and 23, in which the rotating loop and the auxiliary antenna are clearly visible.

In direction-finding by means of radiocompasses in the plane the determination of location is made in the airplane. For this pur-

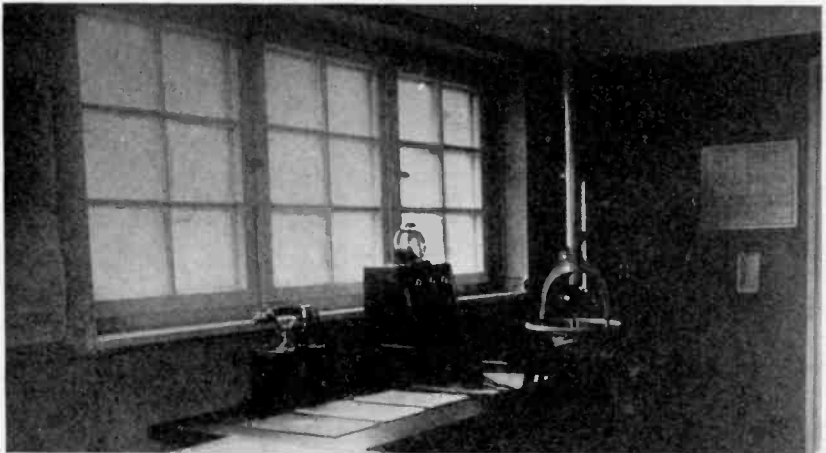

Fig. 23—Munich ground direction-finding station. Interior view.

pose a receiver sensitive to direction must be on board. The radio-compass used for a long time in ships and in an improved form in airport ground direction-finding stations, a somewhat lighter type of which was also used in zeppelins, has recently been developed into the airplane compass¹² by the cooperation of Deutschen Versuchsanstalt für Luftfahrt E. V. and Telefunken, and promises to be a necessary navigation instrument for long flights. It has proved its suitability for this purpose in many flights made by Deutschen Versuchsanstalt für Luftfahrt E. V. and Lufthansa.

¹² M. H. Gloeckner, "The radio compass receiver in the airplane," 126th report of the Deutschen Versuchsanstalt für Luftfahrt E. V., Berlin-Adlershof, *Jahrbuch der drahtlosen Telegrafie und Telefonie*, 33, No. 4, 1929.

The new airplane radiocompass consists of a light-weight rotating loop, the design of which has been carried out with special consideration

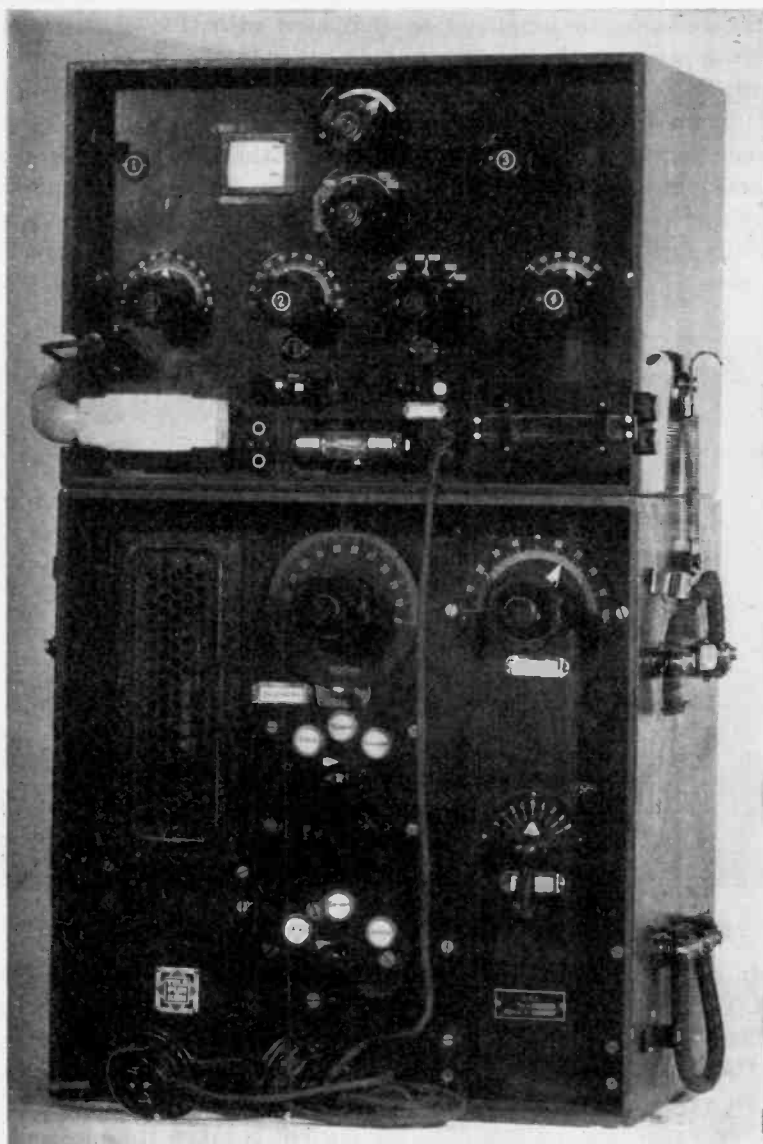

Fig. 24—Airplane transmitter, type 262F, with radiocompass.

of its wind resistance. The radiocompass set, which operates as an ordinary airplane receiver when taking a bearing, has nine tubes and the

auxiliary-antenna requirement is taken care of by an antenna fixed on the airplane, whose electromotive forces must be increased by a special tube. The two tuned circuits have single-knob control. The method of sense-finding is simplified as compared with that of the ground radiocompass. As the bearing must be taken by the radio operator on board, an indicator apparatus has been developed whereby the pilot can quickly be informed of his course in a very simple manner. The current supply for the radiocompass set is taken from the propeller generator of the airplane radio set, which has a special current filter for this purpose. Fig. 24 shows such a radiocompass, the dimensions of which are so selected that it can be placed on the transmitter like the receiver of the Telefunken set 262 F.



Fig. 25—Dornier Wal with emergency antenna and compass loop.

In Fig. 25 we see the direction-finding loop mounted on a Dornier-Wal. The closeness of the adjacent metal mass causes errors in direction-finding, which are taken into account by drawing calibration curves. On the Wal illustrated, the emergency transmitting mast has been drawn out and serves for maintaining radio communication after landing on the sea. In this case, the current is taken from a benzine-electric emergency transmitting unit.

At the present time the Telefunken radiocompass is the only one that is used to any great extent on the ground or on the airplane as a direction-finder in German aviation. Work is being done on the devel-

opment of other direction-finding methods. We shall mention here two methods that are possible for direction-finding from the airplane.

It has long been desired to have a direct-indicating direction-finder in aerial navigation for flights to a given point, which makes it possible with only one adjustment to read on the indicator of the instrument in the pilot cabin, whether the airplane is deviating from the direction to a radiobeacon. Experiments along this line have been made by Dieckmann and Hell.¹³

The Lorenz firm in Germany has also made tests on the method of directional transmission. The practicability of this method is being tested at the present time by Deutschen Versuchsanstalt für Luftfahrt E. V. This method, described by Scheller¹⁴ and Kiebitz,¹⁵ has been developed further in America. It has the advantage that a relatively small receiving set on the airplane is sufficient to maintain at all times the direction toward or away from the directional transmitter. It has the disadvantage of requiring a special transmitter.

At this point we also wish to mention short-range direction-finding methods which make it possible for pilots to find the flying field and landing area in weather of low visibility if he has been brought to the vicinity of the airport by one of the long-distance direction-finding methods. Radio offers a large number of methods which have been described, but because of the difficulties of this work none of them has led to a decisive result. We may mention here, as examples, the method of low-frequency and high-frequency "leader" cables, which have been used in marine navigation as well as short waves. Short waves can be focussed, but their range is restricted.

VI. AIRSHIP SETS

The special technical requirements for radio communication with airships are as follows:

1. The radio set must make it possible for the airship to keep in communication with the land and coast stations, as well as ships, that are on the course.

2. The radio set should make it possible for the airship to remain in constant direct communication with the home port, if possible.

The first requirement can be fulfilled only by long waves at the present time.

¹³ R. Hell, "Direct-indicating radio-telegraphy direction finding," *Jahrbuch der drahtlosen Telegrafie und Telefonie*, 33, No. 4, 1929.

¹⁴ O. Scheller, "Special applications of wireless telegraphy," *Jahrbuch der drahtlosen Telegrafie und Telefonie*, 2, 341, 1909.

¹⁵ F. Kiebitz, "New experiments on radio-telegraphic directional transmission," *Jahrbuch der drahtlosen Telegrafie und Telefonie*, 15, 209, 1920.

For propagation over the sea, we have the well-known Austin formula which can be applied to communication between airships and ground:

$$E = \frac{0.12 \cdot \pi \cdot J \cdot h_{\text{eff}}}{d \cdot \lambda} \cdot e^{-\frac{\alpha \cdot d}{\sqrt{\lambda}}}$$

E = receiving field intensity in volts per meter

J = transmitting current in amperes

h_{eff} = effective height of transmitting antenna in km

d = distance between transmitter and receiver in km

λ = wavelength in km

α = attenuation constant (over sea = 0.0015)

— Field Intensity Depending on Wavelength at Different Distances

----- Best Wavelength for Each Distance

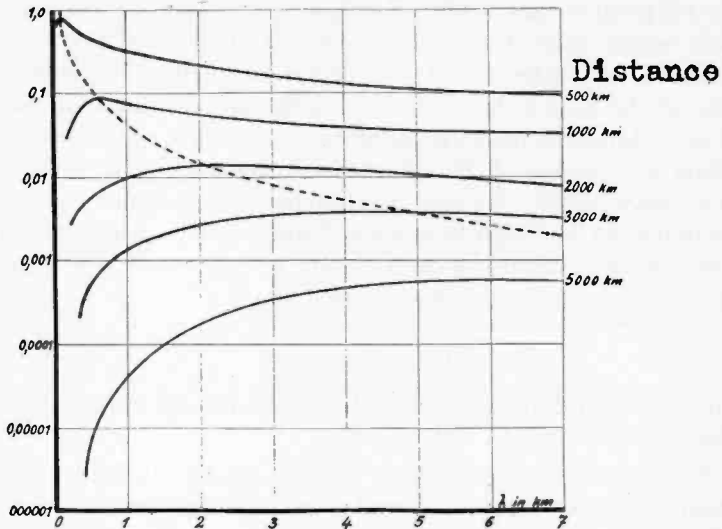

Fig. 26—Calculated field intensities over sea for 1 meterampere, depending on wavelength.

In Fig. 26 there are plotted the field intensities μV per meter according to Austin for different distances in relation to the wavelength, for a current intensity in the transmitting antenna of 1 ampere and for an effective height of transmitting antenna of 1 meter. Fig. 27 shows the receiving field intensities in relation to distance, for different wavelengths, likewise for 1 meterampere. The airship *Graf Zeppelin* has two trailing antennas, one over the other, each 120 m long. The antenna-

weights are streamlined. The effective height of the aerials was determined by the Deutschen Versuchsanstalt für Luftfahrt E. V. by field-intensity measurements with the Anders apparatus at the edge of the skip zone. It was about 29 m. This is an especially good value if it is considered that airplane antennas 70 m long, such as are generally used at the present time, have an effective height of only 8.5 m. The antenna current intensity of the long-wave *Zeppelin* set is about 5 amperes. Therefore we can count upon about 145 meteramperes in the transmitter antenna. The field intensities resulting from this are shown graphically in Fig. 28. The curves in Figs. 26 and 28 show that there is a most favorable wavelength for each distance. These values are

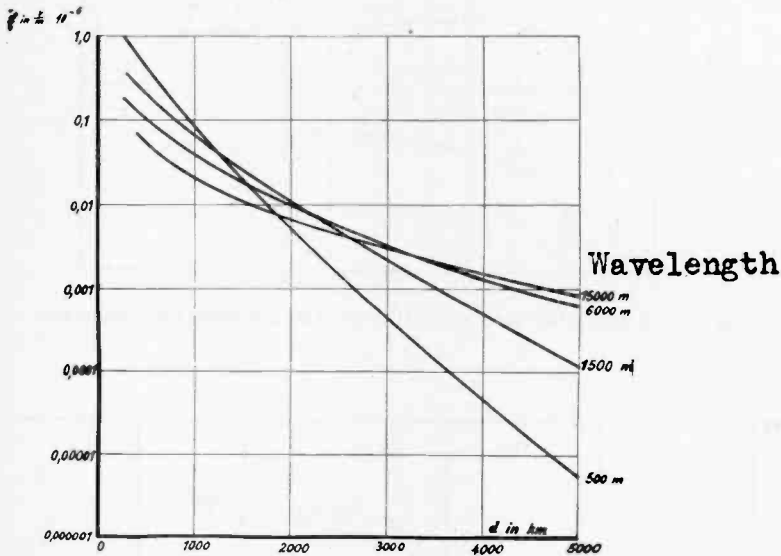

Fig. 27—Calculated field intensities over sea for 1 meterampere, depending on distance.

connected by a dash line in Fig. 26. Therefore, if especially favorable ranges are to be obtained, one must determine the correct operating waves for the different distances.

An electromagnetic field intensity of $3\ \mu v$ per meter is sufficient for reception on the ground. From Fig. 28 we see that a range greater than 2000 km is not certain in the daytime. Under particularly favorable conditions, and at night, this maximum range can be greatly increased. It must also be remembered that during heavy atmospheric disturbances, very much smaller distances are covered.

The above considerations hold for communication across the sea. The Deutschen Versuchsanstalt für Luftfahrt E. V.² has completed an

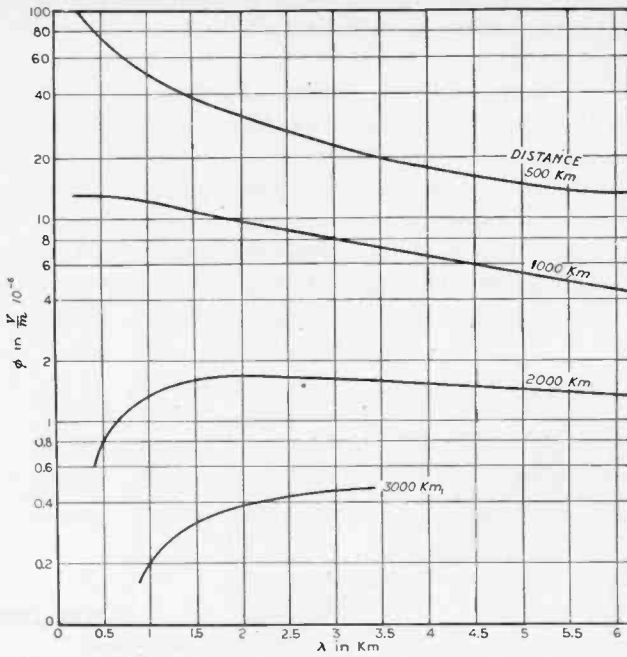

Fig. 28—Calculated field intensities for the Zeppelin long-wave set.

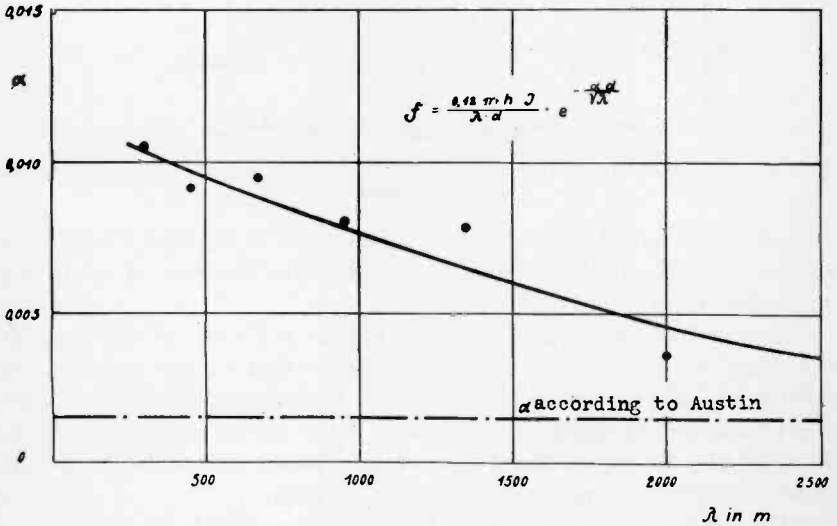

Fig. 29—Attenuation constants α over land.

investigation on long waves and distances up to some hundreds of kilometers over land, which, for communication between airplane and ground, determines the decrease in reception field intensity with distance, for the wavelength range of 300 to 2000 m. The dependence of the attenuation α on the wavelength is shown in Fig. 29. These values gave very small field intensities with the *Zeppelin* antenna. These considerations hold not only for airship radio communication, but also for communication with large airplanes over the long distances, which may be expected.

An increase in the range with long waves would naturally have to be obtained by increasing the effective height of the transmitting antenna and by increasing the antenna current intensity. The use of this method is blocked by the increased load that it would place on the airship. For this reason, the Deutschen Versuchsanstalt für Luftfahrt E. V. made short-wave tests during the first trip of the airship *Graf Zeppelin* to America, the result of which caused the Deutschen Versuchsanstalt für Luftfahrt to install a short-wave set in addition to the long-wave set in the airship.

The radio installation of the airship consists of the following apparatus:

(a) Long-Wave Apparatus.

1. Separately excited Telefunken transmitter type spez 188S, with a power of 140 watts and a continuously adjustable wave range from 500 to 3000 m, which was built basically like the airplane transmitter 262 F, described in detail in an earlier paragraph.

2. Separately excited 70-watt Telefunken transmitter of the airplane long-wave transmitter type 262 F with a wave range from 300 to 1300 m, for use as an emergency transmitter.

Fig. 30, which shows the radio cabin of the LZ 127, also shows these two transmitters on the table at the right.

The current supply for the installation is normally from a generator with self-regulating wind-propeller. In order that it may be possible to transmit even when the propeller is not turning, a second generator is provided, which is fed from a storage battery used for lighting. This battery is normally charged by the wind-driven propeller-generator, and in cases of emergency, by a special benzine unit.

The long-wave set is supplemented by a receiving set which consists of three Telefunken receivers, type E 363S, E 362S, and E 365S with triple-circuit tuning and a wave range from 125 to 25,000 m. Two of these receivers are illustrated in Fig. 31, which shows the other side of the airship cabin.

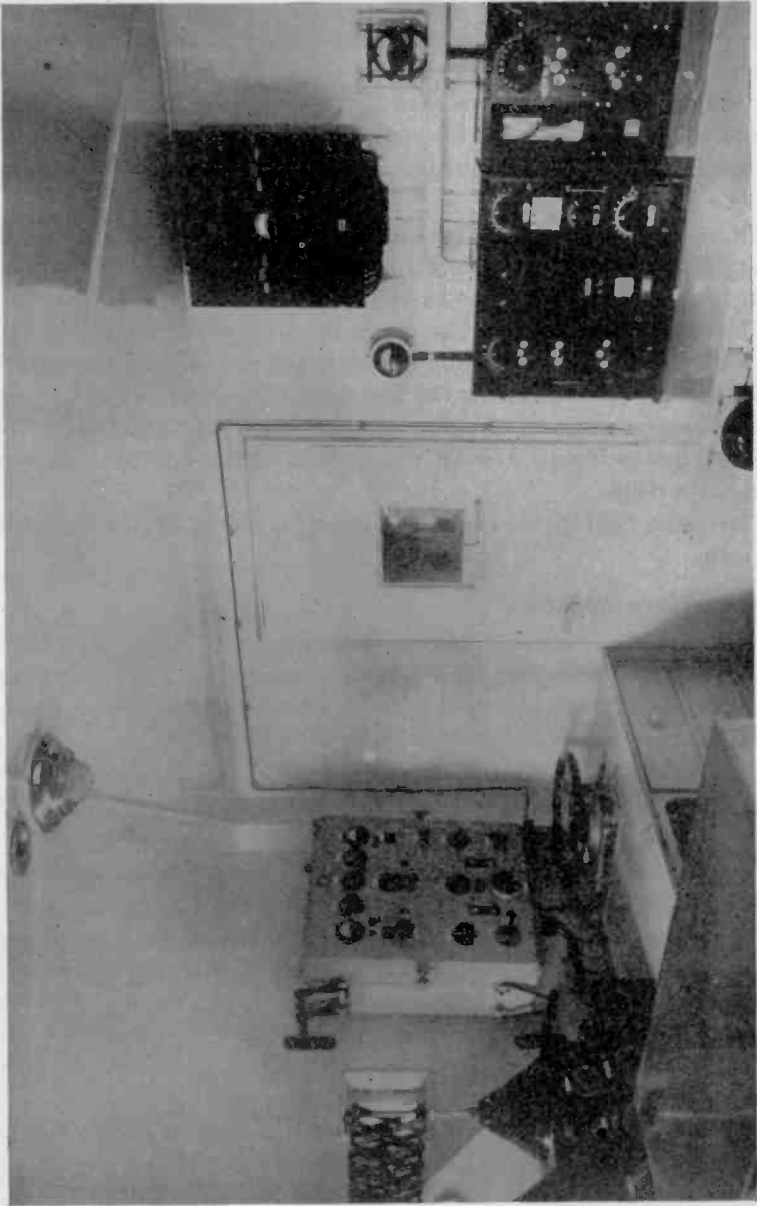

Fig. 30—Radio cabin of the LZ 127, view 1.

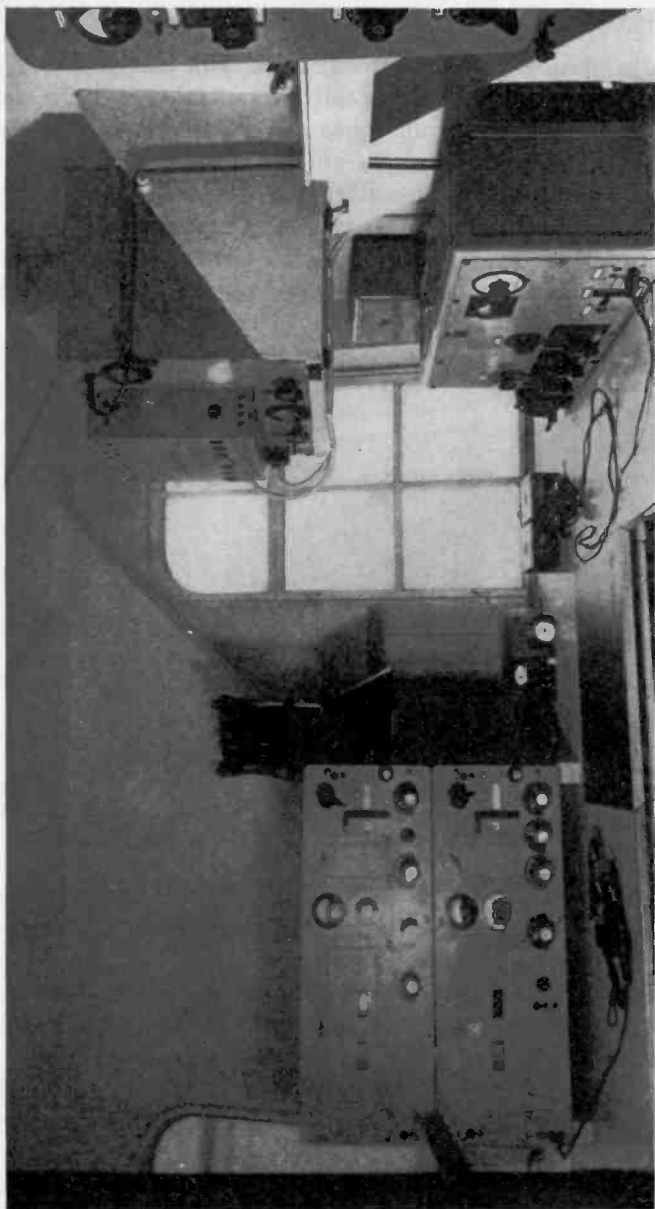

Fig. 31—Radio cabin of the LZ 127, view 2.

(b) Short-Wave Sets.

As stated, the first short-wave transmitter was put in the airship by Deutschen Versuchsanstalt für Luftfahrt E. V. and was in operation on the first trip to America¹⁶ in October, 1928. This transmitter, developed by the Deutschen Versuchsanstalt für Luftfahrt E. V., is shown in Fig. 32. It is quartz-controlled, has one or two stages of frequency-doubling, and has a wave range from 15 to 60 m. During the later trips, the experimental transmitter was replaced by a short-wave Telefunken transmitter. The short-wave transmitter is shown in the top center of Fig. 31. It has an antenna power of about 50 watts, a wave range from 16 to 80 m, and operates just like the two long-wave

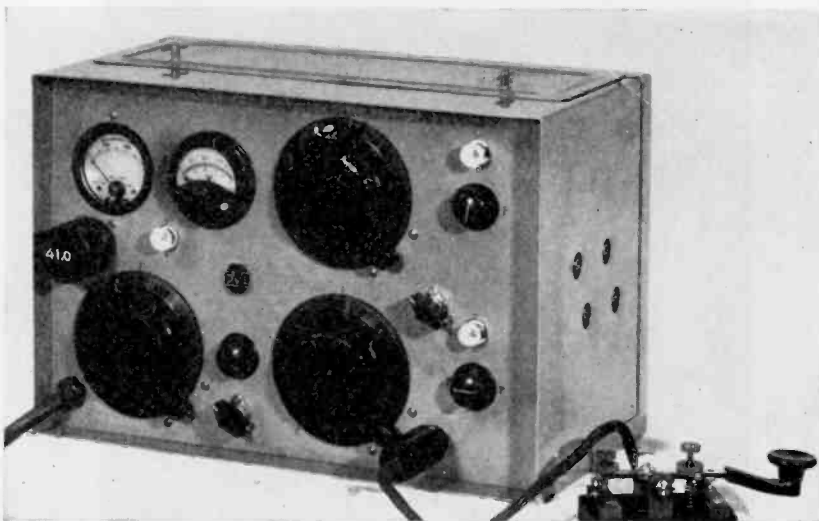

Fig. 32—Experimental airship short-wave transmitter DVL type.

transmitters with separate excitation. The current supply is taken from the same generators as for the long-wave sets.

The Deutschen Versuchsanstalt für Luftfahrt E. V. short-wave set operates with the dipole shown in Fig. 33. Although the shape of an airplane generally offers no difficulty in the adjustment of the dipole, the shape of the dirigible is not favorable for this, as can be seen in Fig. 33. The Telefunken short-wave set contains a trailing antenna 15 m long.

The short-wave receiver, which can be seen on the table below the short-wave transmitter in Fig. 31, consists of a 5-tube set containing a

¹⁶ "Short-wave experiments on the American trip of the airship *Graf Zeppelin*," 123rd Report of the Deutschen Versuchsanstalt für Luftfahrt E. V., Berlin-Adlershof, *Elektrotechnische Zeitschrift*, 50, 16, 1929.

regenerative detector in a push-pull connection and two stages of low-frequency amplification. It is equipped with a special oscillator circuit for receiving undamped telegraphy. The wave range of this receiver is 10 to 150 m.

(c) Radiocompass.

The radiocompass receiver in the airship, which, in its essentials, is similar to the radiocompass previously described, has a wave range from 300 to 4000 m. It can be seen in Fig. 30 on the left beside the door. On the table in front of the radiocompass is the gear for operating the compass loop. The loop is placed below the gondola in the so-called landing buffer.

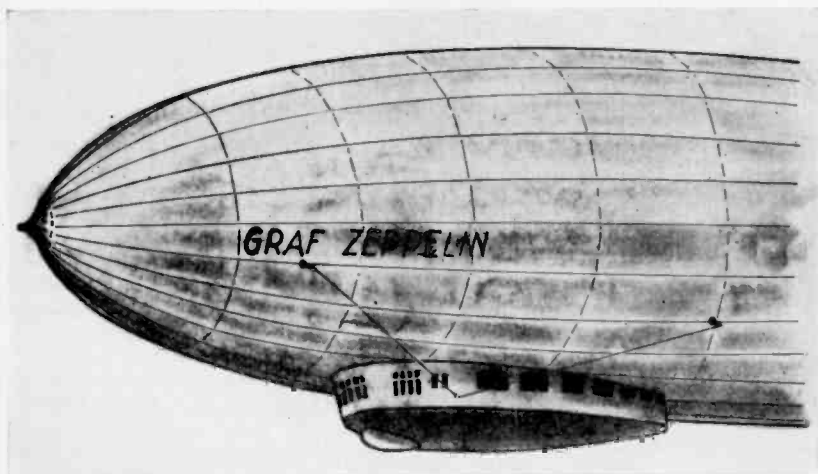

Fig. 33—Dipole on the LZ 127.

VII. OPERATING ORGANIZATION

The operation of the German aircraft radio stations and its organization is invested in a special official board, the "Zentralstelle für Flugsicherung," which is under the Communication Ministry. Ground radio stations have been installed in almost all airports. Table IV gives additional data concerning them. In some airports (see table) direction-finding stations are also installed in addition to these receiving and transmitting sets. Radio operation is controlled by "the operating regulations for international airplane radio together with regulations for the German Airplane Communication Service," agreed upon at the 27th International Aviation Conference in The Hague in September, 1928. Among these regulations, the following are generally important.

TABLE IV
TABULATION OF AIRPORT RADIO STATIONS

| No. | Transmitting station | Made by | Antenna power | Wave range | Direction-finder |
|-----|----------------------|---------------------------------------|---------------|------------|------------------|
| 1 | Berlin, FV | Telef. Röhren-Sd. | 1500 | 800-1800 | yes |
| 2 | Breslau, FV | Lorenz-Röhren-Sd. | 400 | 500-2400 | yes |
| 3 | Dortmund, FV | Lorenz-Röhren-Sd. | 300 | 500-2400 | yes |
| 4 | Dresden, FV | Lorenz-Röhren-Sd. | 300 | 500-2400 | yes |
| 5 | Erfurt, FV | Lorenz-Röhren-Sd. | 300 | 500-2400 | yes |
| 6 | Frankfurt/M., FV | Lorenz-Röhren-Sd. | 300 | 500-2400 | yes |
| 7 | Halle-Leipzig | Lorenz-Röhren-Sd. | 300 | 500-2400 | — |
| 8 | Hamburg, FV | Lorenz-Röhren-Sd. | 300 | 500-2400 | yes |
| 9 | Hannover, FV | Telef. Röhren-Sd. | 1500 | 800-1800 | yes |
| 10 | Hof | Telef. Röhren-Sd. | 800 | 800-1800 | — |
| 11 | Köln | Telef. Röhren-Sd. | 800 | 800-1800 | — |
| 12 | Königsberg, FV | Telef. Röhren-Sd. | 1000 | 800-1800 | yes |
| 13 | Lindenberg | Lorenz-Hochfrequ. Masch.-Sd. | 5000 | 800-1900 | — |
| 14 | München, FV | Lorenz-Hochfrequ. Masch.-Sd. | 1000 | 800-1900 | yes |
| 15 | Nürnberg, FV | Lorenz-Röhren-Sd. | 300 | 500-2400 | yes |
| 16 | Stettin, FV | Lorenz-Röhren-Sd. | 300 | 500-2400 | — |
| 17 | Stolp, FV | Lorenz-Röhren-Sd. | 300 | 500-2400 | — |
| 18 | Stuttgart, FV | Lorenz-Röhren-Sd. (Röhren = tubes) | 300 | 500-2400 | yes |

In aircraft radio service, only undamped waves may be used and these are:

- pure undamped waves
- tone-modulated undamped waves
- speech-modulated undamped waves

Under no circumstances will spark (damped) waves be permitted.

Radio communication may take place on the following waves:

TABLE V

| | Aviation Weather Radio Service | | Flight Radio Service | | Airplane Radio Service | |
|-------------|-----------------------------------|------|-------------------------|------|---------------------------|------|
| | kc per sec. | m | kc per sec. | m | kc per sec. | m |
| Long waves | 207.5 | 1444 | 217.5 | 1380 | 323 | 930 |
| | 228 | 1316 | 243 | 1235 | 333 | 900 |
| | 233 | 1288 | 248 | 1210 | 345 | 870 |
| | 238 | 1260 | 273 | 1100 | — | — |
| Short waves | 2830 | 106 | 2804 | 107 | 5660 | 53 |
| | 6977 | 43 | 5455 | 55 | 6593 | 45.5 |
| | 9380 | 32 | 7407 | 40.5 | 11111 | 27 |
| | 11494 | 26.1 | 12000 | 25 | 16750 | 17.9 |

In the airplane radio service, the waves given in the table will be used under the following conditions:

- Calling wave, 333 kc per sec. (900 m) pure undamped, tone and speech-modulated undamped;
- Main communication and bearing wave 333 kc per sec. (900) pure undamped, tone and speech-modulated undamped;
- Modulation and compass bearing wave, 345 kc per sec. (870 m) pure undamped and tone-modulated undamped.
- Modulation and compass bearing wave, 323 kc per sec. (930 m) speech-modulated undamped.

In communication with radio stations of the naval radio service, there will be used the wave 500 kc per sec. (600 m) tone-modulated undamped, and in bearing communication with the same radio stations, the wave 375 kc per sec. (800 m) tone-modulated undamped.

In the service of aviation radiobeacons (radio stations whose transmitting makes it possible for a receiving station to determine its location or a direction in relation to the beacon) there will be used waves in the frequency range 285-315 kc per sec. (1050 to 950 m) pure-undamped and tone-modulated undamped.

Radio communication between airport radio stations is developed fundamentally on telegraphy with undamped, unmodulated waves. Radiotelephony can be used in emergency.

Radio communication between airport and airplane stations is developed fundamentally as follows:

- (1) On aircraft whose radio apparatus is not operated by a radio operator: radiotelephony (calling and communication);
- (2) On aircraft that have a radio operator: radiotelegraphy on undamped waves as follows:

Airplane station: calling is tone-modulated undamped, communication wave is pure undamped;

Ground station: calling and communication wave, pure undamped.

As regards the use of tone-modulated undamped and speech-modulated undamped transmitting in practice, we wish to refer to the statements made in Section II.

For the purpose of safety in flight, Germany has been divided into fourteen radio communication districts, the radio stations of which have been indicated by "FV" in the table. The airplane will only communicate with the airport radio station in whose radio communication district it is flying, or believes it is flying.

In direction-finding by fixed stations (Frendpeilung) three types of aircraft radio bearings are differentiated:

- (a) Target bearing, which is for the purpose of guiding aircraft, by means of an aircraft radiobeacon, from any point to the port at which this beacon is located, by transmitting the deviating course to the objective, once or several times to the airport.
- (b) Course bearings, by which the course to any location is communicated after determining the location by two or more direction-finding stations, the course to another location is transmitted to the aircraft.

- (c) Location finding in which the location of the aircraft is determined by ground direction-finding stations, and is transmitted to the aircraft by radio.

The radio communication districts of the airport radio stations serve as aircraft radio direction-finding districts.¹⁷ The chief beacon guide station is that airport radio station in whose district the aircraft is flying or in which it believes it is flying.

In direction-finding from radiobeacons, one must differentiate between flight toward a fixed point and the determination of location.

Flight to a fixed object is done very simply with the aid of the radio-compass and requires no special calculations in the airplane. But, on

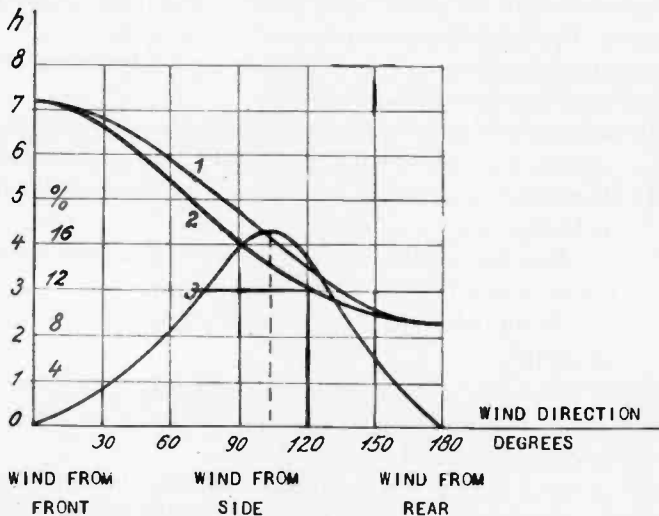

Fig. 34—Time loss in a pure target flight as compared with the great-circle flight.
 Curve 1—Flying time without correction angle.
 Curve 2—Flying time with correction angle.
 Curve 3—Per cent time loss in a flight without correction angle as compared to a flight with correction angle.
 Assumptions: flying distance..... 500 km
 airplane speed..... 140 km per hour
 wind speed..... 70 km per hour

the other hand, it is necessary that a transmitter be in operation at the airport to which the airplane is flying. This can be the airport transmitter, or a special transmitter (radiobeacon for aircraft). If an airplane is to make a flight to a fixed point using its radiocompass, the radio operator sets the loop perpendicular to the longitudinal axis of the airplane after he has first determined the course to be followed by taking bearings on the beacon. If the airplane proceeds on this course, the

¹⁷ *Nachrichten für Luftfahrer*, 17, 2231, 1928.

operator need only observe that reception is always a minimum in the head piece, and then the airplane is certain to approach its port. Drift, due to wind, keeps it from following the shortest path, but it can be compensated by suitable preliminary setting of the loop. Since the loss in time is very little when the drift is not considered, this compensation is not generally necessary. Fig. 34 shows the loss in time for true target flight as compared with a great-circle flight.

The location of position on an airplane requires bearings from two ground transmitters. The location of the airplane must be calculated from the angles that are measured. The determination of location requires rapid work and considerable calculation on the airplane, so that it is only used when, as in large airplanes for transoceanic flights, there are available other members of the crew experienced in navigation in addition to the radio operators.

Up to the present, direction-finding has been of particular importance in the trips of the zeppelins which are equipped with such radio-compass apparatus.

CONCLUSION

From the above it can be seen that radio engineering plays a very important part in German aviation. Radio sets are required in increasing numbers for transmitting information, for the determination of location and course for safety in flight. Many flights cannot be completed at all without the aid of radio. It can probably be asserted that although one can fly without aircraft radio sets, well-planned air transportation is hardly possible without aircraft radio, and regularity of air transportation cannot be attained without the aid of radio. Aircraft radio engineering serves not merely the flying industry, but it can also be useful in the development of wireless telegraphy in many ways. For example, the aid of the airplane made it possible to take rapid and reliable measurements of attenuation constants, and only with the airplane was it possible to determine the characteristic curve of a short-wave directional antenna, both problems which were taken up by the Deutschen Versuchsanstalt für Luftfahrt E. V. and the results of which are of very general importance for radiotelegraphy.



THE CONSTANTS OF AIRCRAFT TRAILING ANTENNAS*

BY

L. A. HYLAND

(Aircraft Section, Radio Division, Naval Research Laboratory, Bellevue, Anacostia, D. C.)

Summary—This paper constitutes a report on the results of the measurement of the trailing antenna constants on several types of aircraft including the dirigible Los Angeles. A brief description of the apparatus and method is given. Curves for a typical airplane and dirigible are presented and from these curves conclusions are drawn as to the center of radiation and the relation between antenna resistance and the center of radiation. The uniformity of antenna constants of heavier-than-aircraft is noted, also the negligible effect of structural differences, speed, and weight on antenna characteristics.

SINCE the available quantitative information concerning airplane trailing antennas has been limited to constants derived from types of aircraft now obsolete,¹ it seemed desirable to make new determinations with a view to the modernization and extension of the knowledge of this phase of the radio art. Changes in airplane structural design especially in the amount and disposition of conducting elements together with the re-allocation of frequencies, have contributed to the need for accurate antenna information for all types of aircraft.

A survey of the equipment usually employed for the measurement of antenna constants disclosed that none of the existing apparatus could meet the major requirements of space, ruggedness, frequency range, ease of manipulation, and accuracy. Hence, it was necessary to design new measuring equipment, limiting the dimensions to the available space in the smallest of the types of aircraft to be measured.

In its final form the driver, two views of which are shown in Fig. 1, took the form of a 7 1/2-watt Hartley oscillator. The antenna inductance, coupling, resistance, and indicating devices are contained in the unit shown in Fig. 2, which is similar in size to and intended to be clamped on the driver box.

A dynamotor and battery supply power to the driver in the usual case, but in the smaller types of aircraft where space is at a premium a wind or engine-driven generator is employed.

The switching, metering, and regulation of the power supply

* Dewey decimal classification: R525. Original manuscript received by the Institute, August 21, 1929; revised manuscript received, September 19, 1929.

¹ J. M. Cork, "Airplane antenna constants," 15, Scientific Papers, Bureau of Standards, p. 199.

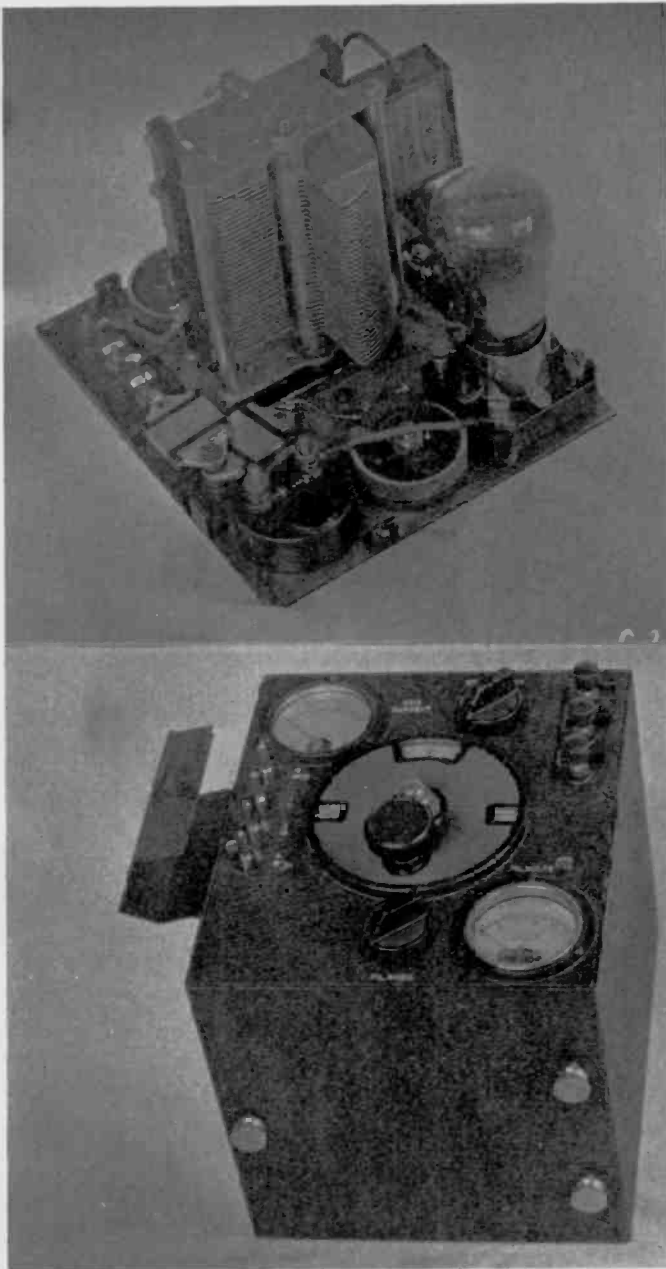

Fig. 1—The driver unit, a 7 1/2-watt Hartley oscillator.

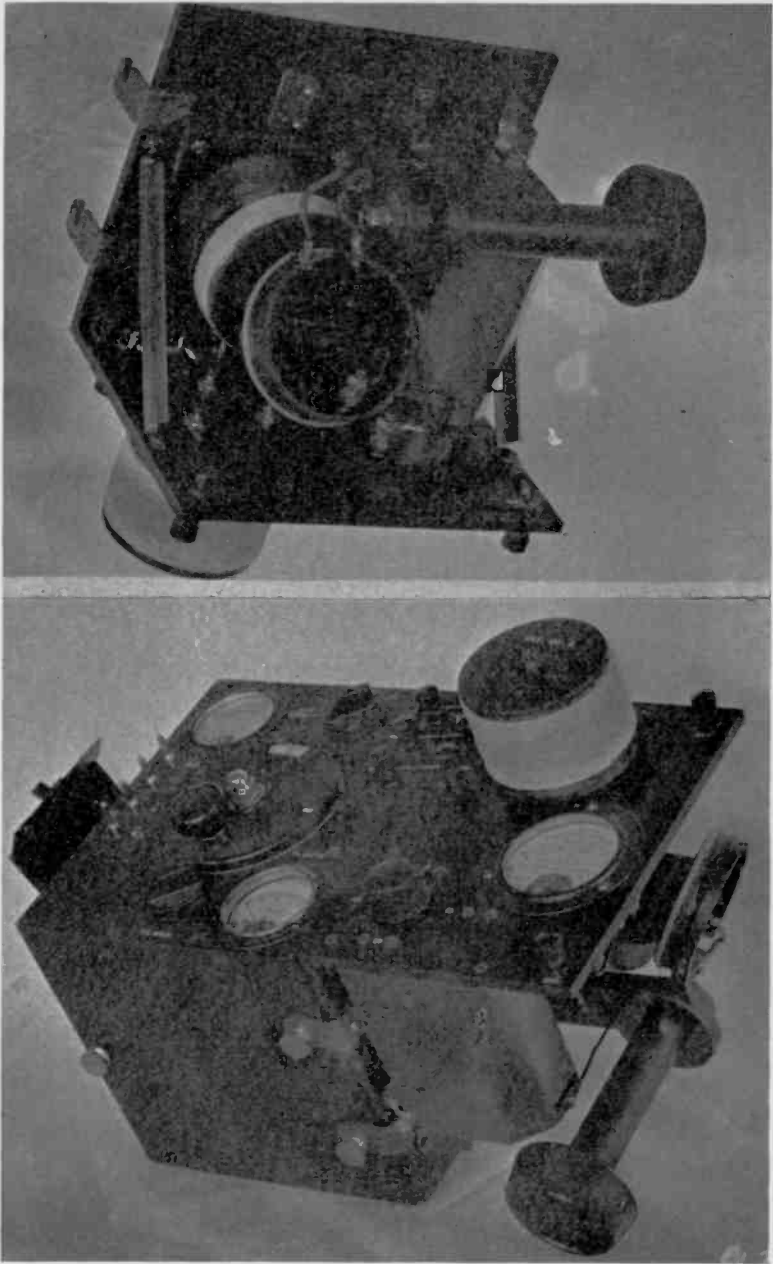

Fig. 2—The antenna unit, with coupler resistors, meter, and jacks for plug-in coils.

inserted values is approximately the same as the combined antenna and circuit resistance to be measured.

On each of the types of aircraft it is the practice to measure the characteristics of the ten lengths of antenna between 50 and 500 ft. in increments of 50 ft. Each length is loaded over the range 5 to 2500 μ h, and the resistance and frequency measured for each loading. Flight operations are restricted to the notation of dial and meter readings, all computing being done on the ground. Such an arrangement requires a minimum of flight work—2 hours in the ordinary case where about 250 readings are taken—at no sacrifice in accuracy.

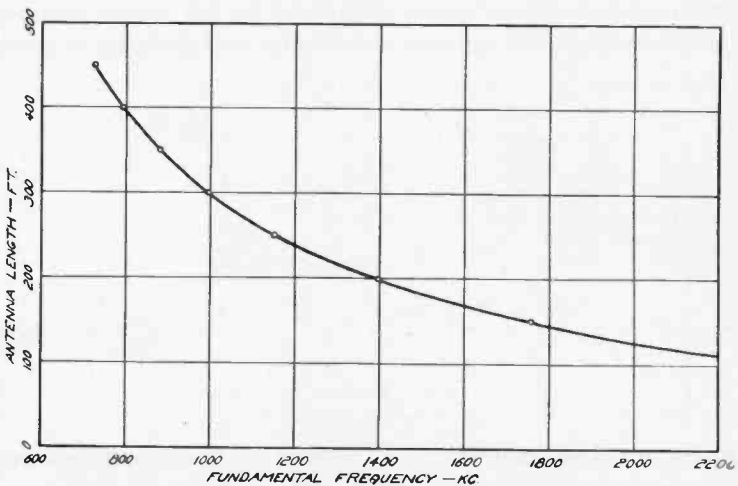

Fig. 4—Fundamental frequency. Ford trimotor all-metal airplane.

Repeated measurements made with the instruments described above agree very closely even when flight conditions vary between a flat calm and strong gusts.

Twelve types of aircraft, varying in size from the single seater pursuit plane to the largest of the patrol flying boats and the dirigible *Los Angeles*, have been covered by the investigation to date. The resultant curves form a voluminous collection not suitable for publication. Instead, a condensed series of curves for the Ford trimotor all-metal ship are shown herein as representative of heavier-than-air ships, while a few of the unique *Los Angeles* curves are given for comparative purposes.

The data obtained from the measurements on the Ford plane and the *Los Angeles* are presented in the form of five series of curves. Two of these are conventional; that is, fundamental frequency

vs. antenna length (Figs. 4 and 5), and resistance (Figs. 6 and 7). Figs. 8 and 9 show the loading inductance plotted against frequency of

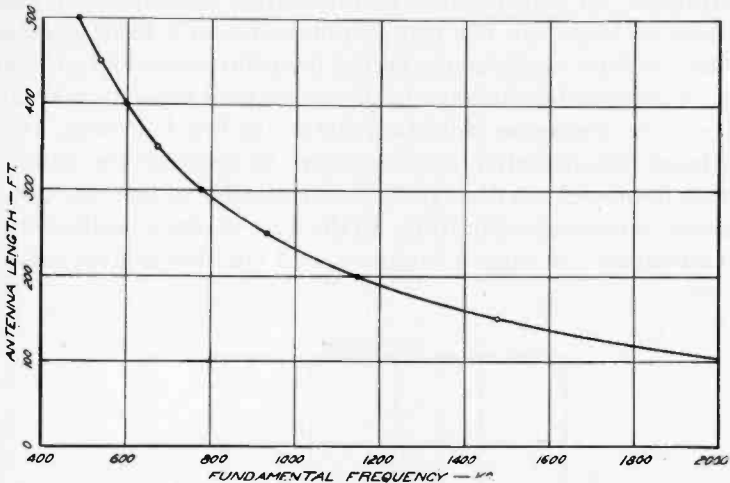

Fig. 5—Fundamental frequency. Rigid dirigible *Los Angeles*.

resonance. This curve varies from usual practice though it is similar in scope to the equivalent capacity curve ordinarily given for an

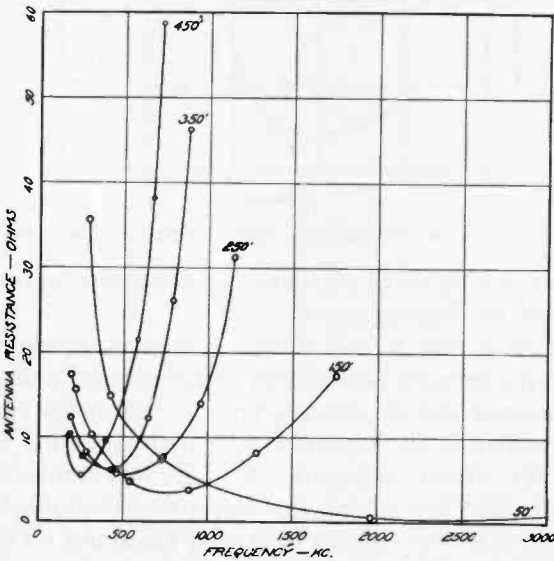

Fig. 6—Antenna resistance. Ford trimotor all-metal airplane.

antenna. Loading curves have been chosen, however, as more nearly representative of true conditions and as being more informative to

the designing engineer. The "equivalent capacity" of an antenna is, at best, a nebulous quantity which must be calculated or measured by substitution. At and near the natural period the substituted capacities become large, are not readily obtainable in a form suitable for field use, and are cumbersome and of doubtful accuracy in the laboratory. A substantial variation in the substituted capacity makes little change in the resonance indication due to the low L/C ratio. On the other hand, the inductive load necessary to resonate the antenna at a certain frequency is a finite quantity susceptible to accurate measurement and permanent calibration. In the form of plug-in coils such loading inductances are rugged, compact, and lend themselves readily to field use.

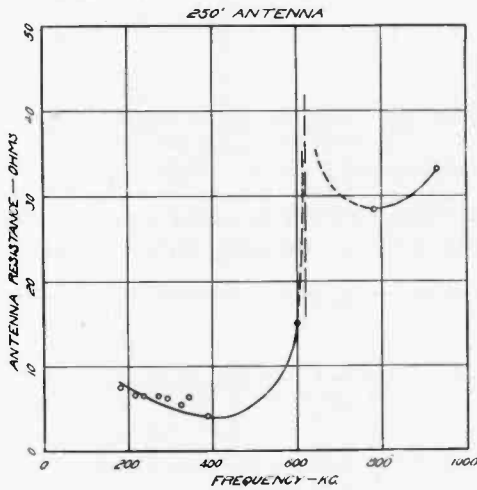

Fig. 7—Antenna resistance. Rigid dirigible Los Angeles.

Equivalent and effective capacities and effective inductance may be derived from the loading curves.

In the curves of Figs. 10 and 11 the length of the antenna is plotted against the ratio between one-quarter of the natural unloaded wavelength as measured and the antenna length. Where the ratio is unity the center of radiation is considered to be at the junction between the antenna and the aircraft structure. A larger ratio indicates that the center of radiation² lies within the aircraft structure while a ratio less than one points to a current loop somewhere out on the antenna wire. The values which this ratio may assume are proportional

² For the purposes of this paper the center of radiation is defined as the point in the quarter wavelength antenna-counterpoise system where there is a current loop (voltage node).

roughly to the physical size of the aircraft and may be considered as a good index of electrical size. The table given below shows the length of the trailing antenna at which unity ratio is found on each of

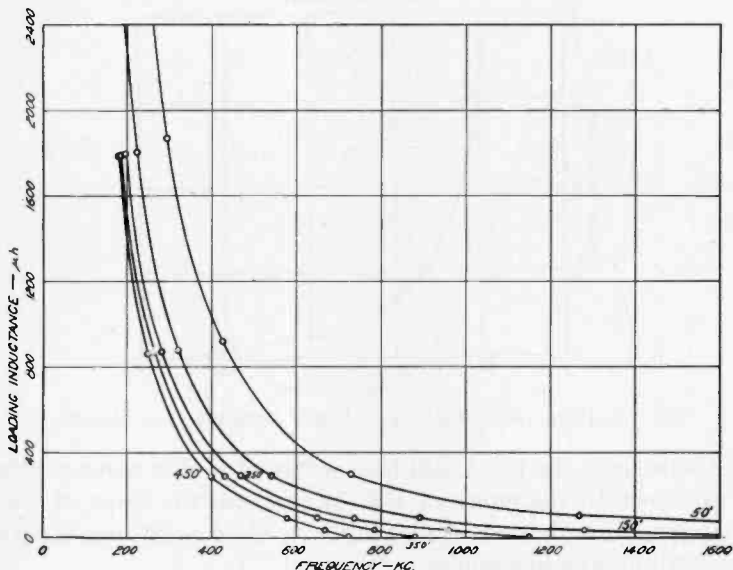

Fig. 8—Inductance loading. Ford trimotor all-metal airplane.

several types of heavier-than-air craft. This table forms a convenient means for comparing the “electrical size” or “effective counterpoise” of aircraft.

| Type | Antenna Length for Unity Ratio $\lambda/4l$ |
|---|---|
| Naval Aircraft Factory H-16 Flying Boat | 173 ft. |
| Loening Amphibian | 120 " |
| Sikorsky Amphibian | 120 " |
| Ford Transport | 113 " |
| Vought Corsair | 102 " |
| Curtiss Two Place Fighter | 97.5 " |
| Vought Observation (Whirlwind) | 93 " |

It will be noted that the antenna resistances at the natural period as shown in the curves of Figs. 6 and 7 vary between wide limits for different lengths of antenna on the same aircraft. The values for similar lengths of antenna for different aircraft also disagree. These variations are due to the locations of the center of radiation. In general, where the current loop is at the junction between the antenna and the airplane structure, the resistance at the fundamental frequency will approximate 12 ohms. With the current loop out on the antenna the resistances will be higher and vice versa.

There is a definite relation between the antenna resistance and the length of the trailing wire. If the length of the antenna divided by its natural wavelength be plotted against antenna resistance, both on a

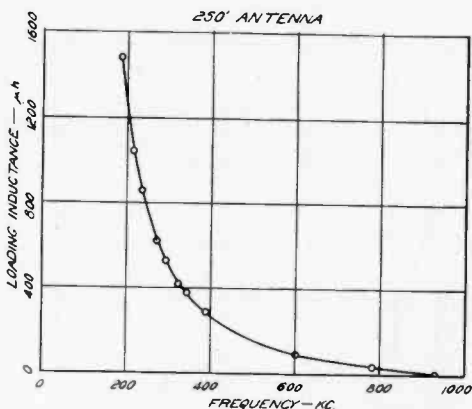

Fig. 9—Inductance loading. Rigid dirigible *Los Angeles*.

logarithmic scale, the result will be a series of points along a straight line as shown in the curve of Fig. 12.³ From the slope of the line an empirical formula may be developed to show resistance in terms of frequency and antenna length.

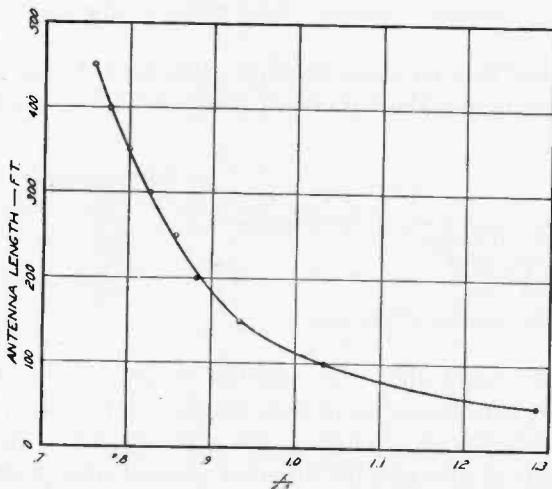

Fig. 10—Center of radiation. Ford trimotor all-metal airplane.

A striking feature of the measurements made on heavier-than-air craft has been the uniformity of the results and the regularity of

³ For convenience in plotting the value $10 l/\lambda$ has been taken instead of l/λ .

the curves drawn from the data. Resistance curves compiled from measurements made on the rigid dirigible *USS Los Angeles* bear small

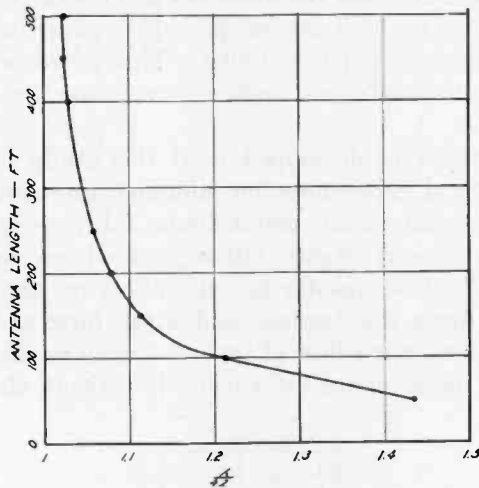

Fig. 11—Center of radiation. Rigid dirigible *Los Angeles*.

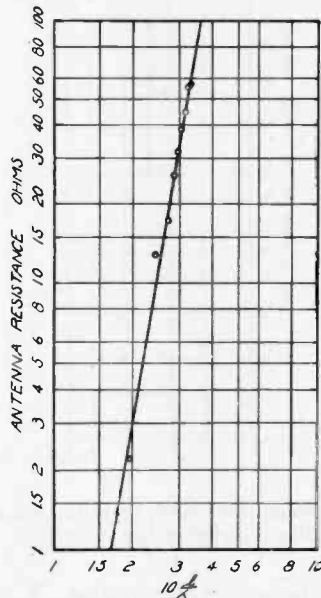

Fig. 12—The relation between the center of radiation and antenna resistance. Ford trimotor all-metal airplane.

resemblance, however, to corresponding airplane curves. Several irregularities are present, and it is believed that the closed loops formed

by the metal framework are the absorbing mediums responsible for the unique results.

It will be noted also that the curve of Fig. 11 of the *USS Los Angeles* (length vs. ratio length to natural period) is never unity even when the curve is extrapolated to infinity. This is taken to mean that the center of radiation for a structure of such size and type is always within the hull.

An interesting fact developed from this study is the negligible effect of structural differences on antenna constants. The three structural types—all metal, metal frame fabric covered, and composite wood and wire frame fabric covered are interchangeable (when properly bonded) insofar as major effect on antenna constants is concerned. Since the fuselage and wings form a counterpoise of similar proportions, regardless of type, it can be readily seen that the substitution of metal plates for a metallic network should make but

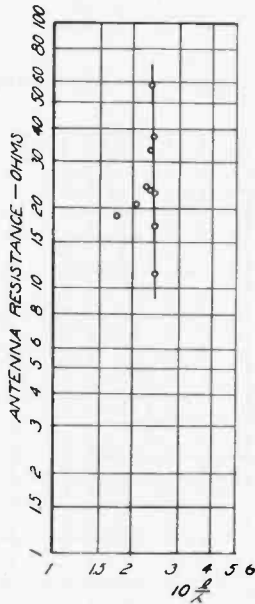

Fig. 13—The relation between the center of radiation and antenna resistance. Rigid dirigible *Los Angeles*.

little change in counterpoise characteristics. A common ground analogy is met with in large high-voltage condensers where the pipe rack type have nearly the same capacity as plate condensers of the same dimensions.

Some data were obtained on the effect of speed and weight changes on antenna constants. It is well known that changes in the shape

and position of the antenna resulting from speed and weight variation produce marked directional effects due to shifts in polarization. Whether there is a corresponding change in antenna characteristics has been a controversial point. In a large plane having a wide speed range a measurement was taken at a speed of forty knots per hour followed immediately by another at 120 knots. A second series of measurements was made with various weights attached to the antenna.

With the longer antenna lengths where shifts in polarization are comparatively large, no measurable change in antenna constants was found under any conditions of speed and weight. A noticeable shift in the resonant point and resistance became evident at the 200-ft. length and was well defined below 100 ft. Apparently the shift in position of that portion of the antenna nearest the plane, say the first 20 or 30 ft., is the cause of the change of characteristics. Such a shift is greater in its percentage change at the shorter antenna lengths but is present without doubt at all lengths of antenna. A case in point was the attempt to measure the characteristics of a Lœning amphibian on a very gusty day. Determinations were impossible on the 50-ft. length, but little difficulty was met with in the investigation of the longer antennas.



ON THE DAYLIGHT TRANSMISSION CHARACTERISTICS OF HORIZONTALLY AND VERTICALLY POLARIZED WAVES FROM AIRPLANES*

BY

F. H. DRAKE AND RAYMOND M. WILMOTTE

(Aircraft Radio Corporation, Boonton, N. J.)

Summary—The investigation described below was carried out for the purpose of comparing the transmission characteristics from an airplane of horizontally and vertically polarized waves in daytime. A frequency of about 6 megacycles was arbitrarily chosen. In view of the fact that modern practice is tending towards the elimination of the trailing wire antenna, an antenna producing vertically polarized waves must of necessity be of small dimensions. The transmissions were therefore compared using a doublet antenna, each arm of which stretched from wing tip to tail for the horizontally polarized wave, and a rigid antenna six feet high for the vertically polarized wave. It was found that the sky ray began to be appreciable with the horizontally polarized wave at a distance of 20 miles, while on the vertically polarized wave it became important at a distance of 50 miles. The signal from the sky ray for distances of the order of 150 miles was always stronger with horizontal polarization than with vertical. The result with the direct ray was different. The signal from the vertically polarized wave was stronger than that from the horizontally polarized wave over highly conducting ground, while the reverse was the case over badly conducting ground. For this reason, the signal from the vertically polarized wave sometimes became very weak at a distance of 40 to 50 miles, before the sky ray was able to arrive with sufficient strength. This occurred particularly on badly conducting ground and when the airplane was flying low. From the horizontally polarized wave, strong signals were received in all conditions continuously for distances up to 600 miles, and there did not appear to be any tendency for the signal to decrease in intensity as this distance was approached.

A very effective ground antenna was investigated, which possesses the property, when used horizontally, that the signal received is little affected by the height of the antenna above the ground. This permits the use of a very low antenna.

The effect of the conductivity of the ground was considered and, in the appendix, a method is described by which it is possible to deduce the transmission characteristics for flights at any altitude, when those at given altitude are known. The results of the experiments are qualitatively explained on the basis of the present knowledge of transmission phenomena.

WITHIN recent years much data have been accumulated regarding the propagation of electromagnetic waves. Most of the data have been obtained by investigating the variations of the signals received at a given distance from one ground station to another. Where the distance between the stations has been a variable, the results were obtained largely by statistical means from a number of

* Dewey decimal classification: R115. Original manuscript received by the Institute, November 5, 1929.

ground stations. Such a method is not very satisfactory, for the variations in the ground conditions at the various stations may cause considerable differences in the results, and these differences may often be wrongly attributed to the effect of the distance from the transmitting station. An ideal way of obtaining data giving the variation of signals with distance over land is to employ an airplane as one of the stations. Significant distances can thus be covered in comparatively short time, and the antenna at both the receiving and the transmitting stations is exactly the same at all distances. The data obtained by two methods are not quite the same. The sky ray from a ground station can be expected to be identical in nature with that from an airplane, but the attenuation of the direct ray is very different in the two cases.

In order to obtain as useful data as possible, it was considered desirable to choose a wavelength such that the sky ray could be expected to appear before the direct ray fell to an undetectable value. Then from the results available, the effect of varying the wavelength above or below that employed might be predicted with a fair degree of certainty. An airplane is a comparatively small structure, and it is impossible to install on it a rigid antenna which would be efficient at long wavelengths. On this score it is desirable to use short waves. On the other hand, the sky ray on very short waves does not make an appearance for some considerable distance, while the direct ray is much more rapidly attenuated on short waves than on long waves. A compromise had to be reached, and a wavelength in the neighborhood of 50 meters was finally chosen for the investigation. A longer wavelength might have been chosen if a trailing wire antenna had been employed on the airplane, but, as modern practice seems to be tending towards the elimination of this type of antenna, it was not considered desirable to employ it. If a trailing wire antenna is not used, the antenna for vertically polarized waves is necessarily of very small dimensions. In this investigation, the properties of the horizontally and vertically polarized waves were compared, not with similar antennas on the airplane, but with such antennas as could be reasonably employed in practice. The vertical antenna was a small self-supporting mast 6 ft. high above the fuselage, while the horizontal antenna was a doublet, each arm of which stretched from wing tip to tail of a Fokker Super-Universal monoplane having a wooden wing and a fuselage framework of metal. The general dimensions are shown in Fig. 1. All the results were obtained during the daytime.

Among the data already published, which have a bearing on this investigation, may be mentioned the work of R. A. Heising, J. C.

Schelleng, and G. C. Southworth,¹ between ground stations at various wavelengths. Their results differ from those given below essentially in the distance at which they found the sky ray to become greater than the direct ray. This distance in daytime they found to be of the order of 100 miles, while from an airplane it was found to be 50 miles. The discrepancy is the more astonishing as the direct ray is likely to be more attenuated between ground to ground stations than between ground to airplane.

Not much data have been published for transmissions from airplanes. K. Kruger and H. Plendl² made rough audibility tests on low

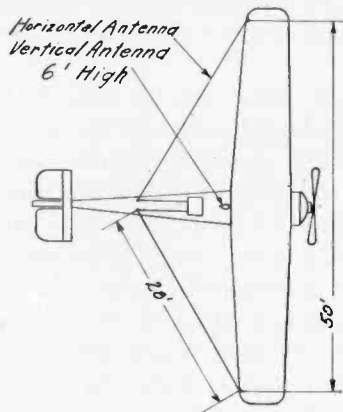

Fig. 1—Antenna arrangement on test plane.

power up to 1000-km distance using a horizontal antenna on the airplane. Their results differ from those given below only in their statement that the altitude of the airplane had no effect on the signal strength. This result, though confirmed by F. Eisner, H. Fassbender, and G. Kurlbaum³ on long waves, is contradicted by D. K. Martin.⁴ On very short waves of 3.7 m, H. Fassbender and G. Kurlbaum obtained results on local flights. The difficulties of measurement at such wavelengths probably account for their failure to obtain agreement between theory and experiment.

APPARATUS AND METHOD

The vibrations and other physical disturbances associated with airplanes made it advisable to carry out the measurements of the

¹ Proc. I. R. E., 14, 613-647; October, 1926.

² "Propagation of low power short waves in the 1000-kilometer range," Proc. I. R. E., 17, 1296-1315; August, 1929.

³ Zeits. f. Hochfreq., 31, 109-116; 1928.

⁴ "Laying the foundation for aircraft communication," Bell Laboratories Record, 7, 315-318, 1929.

signal strength on the ground and transmit from the airplane. The transmitter used was the same for both the vertical and the horizontal antennas. The antennas were excited at the smallest level of power input, as found by experiment, which would produce a conveniently measurable field intensity at the receiving point, throughout the zones of distance at which successively the ground ray predominated, the ground and sky rays were comparable, and the sky ray predominated. The use of larger currents in the transmitting antennas would not alter the relative extent of these zones. The current at the center of the horizontal doublet antenna was 0.3 ampere corresponding to a power dissipation of approximately three watts, while in the vertical antenna the current was of the order of 0.5 ampere, throughout the experiments. This current was tone-modulated at approximately 200 cycles for convenience in aurally identifying the transmitted signal.

Two methods are available for measuring signal or field intensities at 6 megacycles. A radio receiver and output instrument may be used as a comparator of received voltage with known voltages from a local adjustable source; or a receiver of suitable design provided with an adjustable sensitivity control and an output meter may be calibrated in voltage sensitivity as a function of the sensitivity control and used directly as a measuring device. Both methods derive their ultimate accuracy from the original calibration of a local signal source. The latter involves two calibrations and is subject further to accidental variations. It is experimentally cumbersome on this account, but this disadvantage is offset by the highly important consideration that during an experimental run readings may be taken much more rapidly than with the comparator scheme. Since the present measurements were made under simultaneous conditions of fading and rapidly changing distance, preliminary experiments quickly emphasized the desirability of the direct-measurement method. The simplicity of the apparatus was another desirable feature.

A tuned carrier-frequency amplifier was designed for the measurements, comprising four one-way tetrode stages feeding a triode detector. The output indicator was a microammeter in the plate circuit of this detector, and a single low-frequency amplifier stage was included, for aural identification of incoming signals and interference. The amplifier input circuit was untuned, and the apparatus was calibrated in carrier microvolts impressed on the input circuit required to produce a suitable reading (usually $10\mu\text{a}$) upon the output instrument, for various settings of the gain control. This gain control covered a range of about 6000 to 1 in sensitivity, which was adequate for the measure-

ments in hand. For facilitating measurements with various types of antennas, an untuned input circuit was employed.

A voltage of $20\ \mu\text{v}$ applied to the input of the receiver produced a deflection of $10\ \mu\text{a}$ on the output instrument when the gain control was set at maximum sensitivity. A 30 per cent modulated input voltage of this magnitude produced a potential difference of 8 volts across the telephones.

The quantity measured was the high-frequency voltage impressed upon the input terminals of the receiver from an antenna of known geometry exposed to the wave field as described below. The process of taking readings consisted of manually adjusting the gain control to maintain the reading of the output instrument constant, and observing these gain control readings as a function of time or distance to the transmitting source during flights away from and toward the receiver.

THE GROUND ANTENNA

The most suitable type of antenna which can be used on a receiving set depends upon the impedance of the input circuit. With a high resistance input circuit, such as employed, the most suitable antenna has its maximum impedance when the receiver input current is a minimum: it is then very nearly half a wavelength long. Such an antenna has particularly interesting properties.

The current distribution along an open-ended straight wire is very nearly sinusoidal, as shown in Fig. 2. This figure is not quite correct,



Fig. 2—Current distribution along a straight wire.

for the current never falls absolutely to zero. In the neighborhood of the anodes of current there is a very rapid change of phase of the current through $180\ \text{deg.}$, but the amplitude of the current never falls absolutely to zero, although it reaches a very small value. This is a result of the resistance of the antenna. In the ideal theoretical case of an antenna having no resistance the current would fall to zero. The so-called effective height of an antenna is equal to the integral of the current along its length divided by the input current. Many writers prefer to refer the effective height to the maximum current in the antenna, but there appears to be very little reason for this, as any apparatus connected to the antenna is independent of the fact that the current reaches a mathematical maximum. It is only concerned with the constants of the antenna measured at the point at which the

apparatus is connected. We shall therefore refer the constants of the antenna to the current flowing from it into the receiver. In this case, the effective height of the antenna is approximately equal to

$$\left[\int_0^l \sin(2\pi x/\lambda) dx \right] / \sin(2\pi l/\lambda)$$

It will be seen that this becomes infinite when $l = \lambda/2$. That is so because we have not taken into consideration the effect of the resistance of the antenna. This is a more complicated problem than appears at first sight, for the resistance of the antenna per unit length is by no

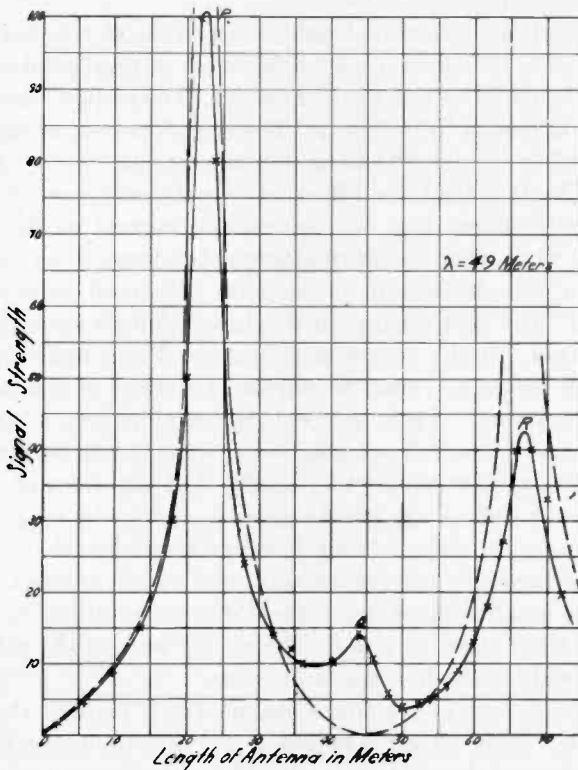

Fig. 3—Variation of effective height of antenna with length $\lambda = 49$ meters.

means constant. The radiation resistance will vary considerably with the length of the antenna.

The variation of effective height with the length of a horizontal antenna was investigated experimentally by finding the effect of the variation of the length of the antenna on the signal received from a steady source situated at a distance which was large compared to the length of the antenna. The results are shown in Fig. 3. The antenna

used was horizontal and set at a height of 3 ft. above badly conducting ground. The receiver was connected at one end of the antenna and kept at a height of 3 ft. above the ground. No ground connections were used. The full line shows the experimental result, while the dotted line is the curve

$$\left[\int_0^l \sin(0.9 \cdot 2\pi x/\lambda) dx \right] / \sin(0.9 \cdot 2\pi l/\lambda)$$

The factor 0.9 occurs probably because of end effects and the difference in the speed of propagation of electromagnetic waves along a wire in the above conditions and *in vacuo*.

The very large effective height obtainable is noteworthy. The agreement with the theoretical calculations is very good except near the nodes of current as was to be expected. The peak *P* corresponds to an antenna of length *OP*. (Fig. 2) The area *A* is greater than the area *B*, so that when the length of the antenna is equal to *OQ* the signal is not zero. The fact that the effective height reaches a mathematical maximum at *Q* shows that the decrease in current as the point *Q* is approached more than counterbalances the decrease in the effective current area. The maximum at the point *Q* is small, however, as is to be expected. The next maximum *R* is large, though not so large as the first maximum. If the length were increased still more the effective height curve would be found to consist of a series of alternately large and small maxima. From the experimental curve, if we take the effective height of a small antenna to be equal to half its length we deduce that the maximum effective height is of the order of 55 meters.

A vertical antenna was briefly investigated in the neighborhood of the optimum condition by adding short horizontal lengths. This method is very approximately correct, because the e.m.f. induced in the antenna in the neighborhood of a node of current produces very little effect on the total effective e.m.f. The results were of the same order as those obtained for the horizontal antenna.

From the nature of the curve obtained it is evident that the controlling factor of the effective height at the optimum length is the current at the foot of the antenna rather than the integral of the current along the length. It can be shown by applying the simple transmission line theory that the ratio of this current to the maximum current flowing in the antenna is very approximately proportional to the resistance of the antenna (measured with respect to the maximum current). The effective height of the antenna of optimum length will therefore be inversely proportional to the resistance, so that the signal received will be proportional to

$$E/(R_a + R)$$

where $(R+R_a)$ is the total resistance of the antenna, R_a is the radiation resistance, and E is the electric intensity of the oncoming wave. When the antenna is a small fraction of a wavelength above the ground the radiation distribution from it will be very nearly of the same shape for all heights above the ground. In these conditions E^2 is proportional to R_a . If R_a is large compared to R , as will occur, when the height of the antenna above the ground is not very small, the signal will become smaller the greater the value of R_a , that is, the higher above the ground the antenna is laid, the weaker the signal. Very near the ground R begins to *preponderate*, not only because R_a is smaller but also because of increased losses; the signal in that case should decrease as the antenna is lowered. These two effects may counteract each other. It was actually found that increasing the height of the antenna from 0.65 m to 1.7 m produced only a 56 per cent increase of the signal strength when the antenna was stretched over ground of high conductivity, both for the sky ray, which must arrive at a high angle of elevation, and for the direct ray, which was generally at an angle of elevation of but a few degrees.

It must be realized that the signal received is produced by the resultant of the oncoming wave and the reflected wave on the ground. A signal is received only by virtue of the fact that these two waves are not of the same amplitude and phase, owing to the imperfect conductivity of the ground, and also because the finite distance between the antenna and its image in the ground produces a difference of phase between these two waves. On highly conducting ground, the phase difference between the two waves produced by the distance between the antenna and its image is probably the predominating factor in producing a signal in the antenna, while on badly conducting ground the most important factor is probably due to the poor reflecting properties of the ground. Over badly conducting ground one would expect, therefore, that the radiation properties of the antenna would be practically independent of the height of the antenna above the ground. This was found to be the case. The height above the ground for these conclusions to hold must never be more than a small fraction of a wavelength.

PROPAGATION MEASUREMENTS

The variation of signal strength with distance can be divided on any one run into two and sometimes three very definite stages. In the first stage, the signal received is produced by the direct ray. There is no fading, and the signal strength varies rapidly with the distance. In the last stage the sky ray is very much stronger than the direct ray, there is strong fading but the variation of the average signal strength with distance is very slow. It may sometimes happen that the direct

ray falls to inaudible values before the sky ray appears. When it does appear it comes very suddenly. From a barely audible signal the strength rises to a strong signal in the course of only four or five miles. This phenomenon is a well-known characteristic of the sky ray. The intermediate stage that occurs between the point when the direct ray is too weak to be heard and the sky ray has not appeared is commonly known as the *skip distance*. It is evidently not an actual distance, for although the sky ray makes its appearance at a fairly definite distance

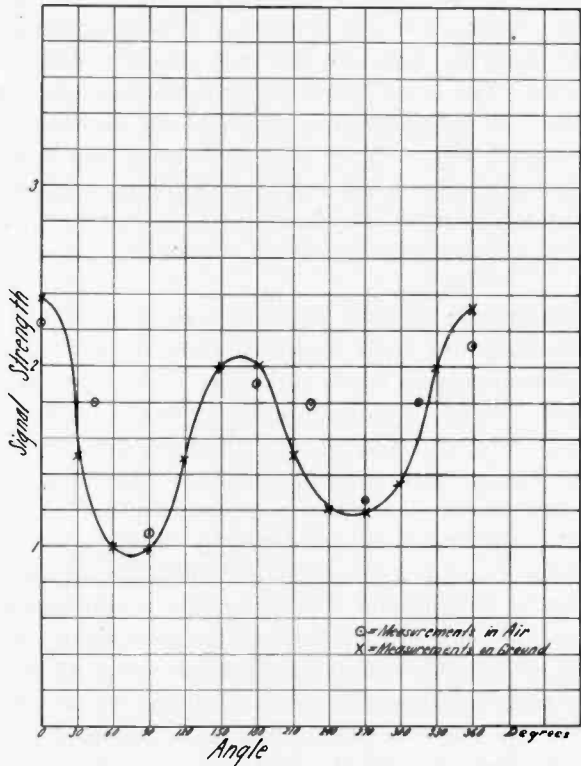

Fig. 4—Radiation distribution diagram in horizontal antenna on airplane.

depending on the wavelength, the line of demarcation where the ground ray stops is very indefinite. This line depends entirely upon the power of the transmitting apparatus and the sensitivity of the receiving system.

The curves to be shown were not all obtained under quite identical conditions, the antennas used for reception being slightly different. For the purposes of comparison, the values obtained were adjusted for the case of an antenna of optimum length using a reduction factor

deduced from the curve shown in Fig. 3. Some twenty flights were made under various conditions.

The radiation distributions of the airplane antennas in the horizontal plane were found both on the ground and in the air. Measurements were made as the airplane flew in different directions over a given point some five miles distant. In Fig. 4 is shown the result for the horizontal antenna. The crosses correspond to the points found with the airplane on the ground, while the circles correspond to the readings made in the air. It will be seen that the two sets of readings lie fairly on the same curve, a satisfactory result, considering the difficulty of

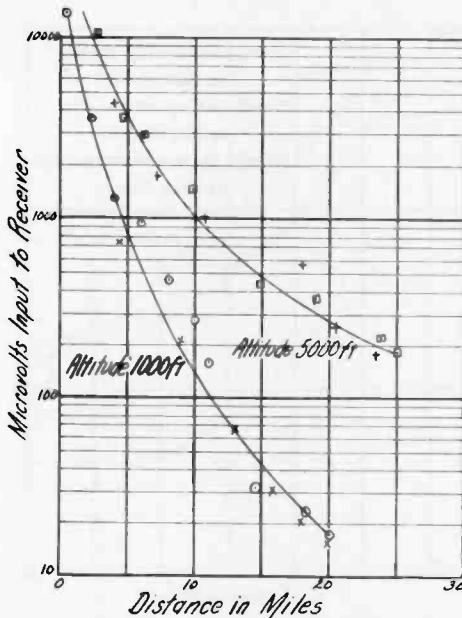

Fig. 5—Variation of strength of direct ray with distance, using horizontal antenna on badly conducting ground.

flying the airplane accurately over a given point and in a given direction. The 0-deg. position corresponds to the airplane facing the ground station, positive angles being measured as the airplane is rotated in a clockwise direction looking from above it. The radiation distribution in the horizontal plane of the vertical antenna was found to be accurately circular.

The first experiments referred to the direct ray. In the appendix a method supported by experimental evidence is given by which the effect of the altitude of the airplane can be calculated, when the variation of signal strength with distance is known at a given altitude. This

refers essentially to the direct ray, for the altitude has practically no effect on the sky ray.

Typical curves for the direct ray are shown in Fig. 5. This figure shows two curves corresponding to altitudes of 1000 ft. and 5000 ft., respectively, using a horizontal antenna over poorly conducting ground. The crosses correspond to readings taken with the antenna 2 ft. above the ground, while the enclosed dots are the readings taken with the antenna 15 ft. above the ground. It will be seen, as mentioned above, that the height of the antenna above the ground does not materially affect the signal strength.

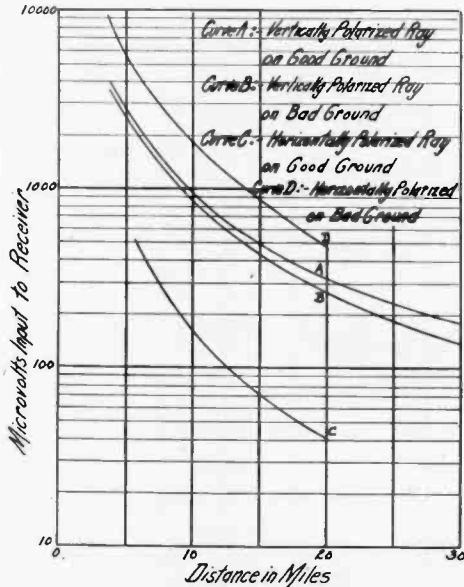

Fig. 6—Variation of signal strength of direct ray with distance.

Similar curves were obtained for the horizontally and vertically polarized rays over both good and poorly conducting ground. The average results of a number of flights reduced to a common altitude of flight of 5000 ft. are shown in Fig. 6. In this figure four curves are shown giving the relative signal strength of the direct ray for vertically and horizontally polarized waves on both high and low conductivity ground.

A typical curve for a longer distance flight is shown in Fig. 7. Many such curves were obtained and were chiefly remarkable for the similarity. In this figure, which corresponds to reception of the horizontally polarized ray over bad ground while flying at an altitude of 5000

ft. the two stages referred to alone are well brought out. In the first stage up to a distance of 20 miles, the signal is very steady but decreases very rapidly with the distance. In the second stage, the signal is very unsteady, varying over a large range of amplitudes in the course of a few seconds. In order to show this fading effect on the diagram, each reading covered a period of 5 to 10 sec., and the maximum and minimum values of the signal during that period were noted. These values are plotted and joined by a vertical line. It will be noted that the mean signal strength is remarkably constant over the distance investigated. Flights as long as 600 miles were undertaken; measure-

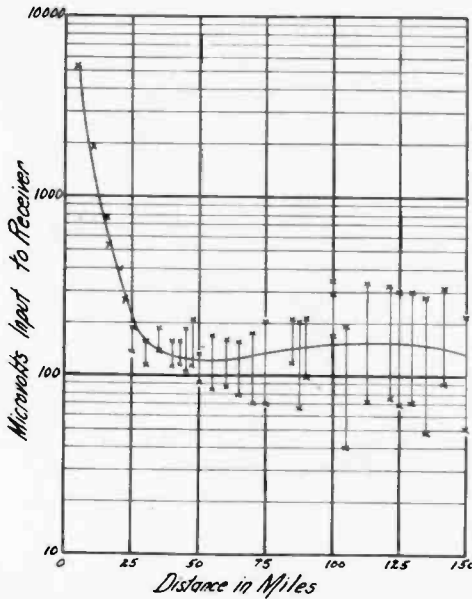

Fig. 7—Variation of signal strength with distance, using horizontal antenna on badly conducting ground.

ments were not carried out over the whole distance, but signals were received continuously on telephone and there did not appear to be any very large variation of the mean signal strength. In fact, the signal seemed to tend to increase in intensity towards the end of the flight, that is, at distances of 400 to 600 miles.

The altitude of the airplane was not found to have any appreciable effect on the intensity of the signal received by the sky ray.

The test was repeated over high conductivity ground, and the signal was found to be considerably weaker, the mean being of the order of 25- μ v input to the receiver. With the vertical antenna, the sky ray

became appreciable only at a distance of 50 miles. From that distance up to 150 miles the mean signal was fairly constant in value, but its intensity was only about $20 \mu\text{v}$. The effect of the conductivity of the ground on the signal received on the vertical antenna is small. When flying at very low altitudes, of the order of 500 ft., a skip distance is liable to occur on the vertical antenna, because of the fact that the sky ray is comparatively weak. This distance is, however, small, lying between 40 and 50 miles, and would disappear if greater power were used in the transmitter.

The explanation of these results is to be found in the difference in the radiation distribution in the vertical plane of the horizontal and vertical antennas both on the airplane and on the ground.

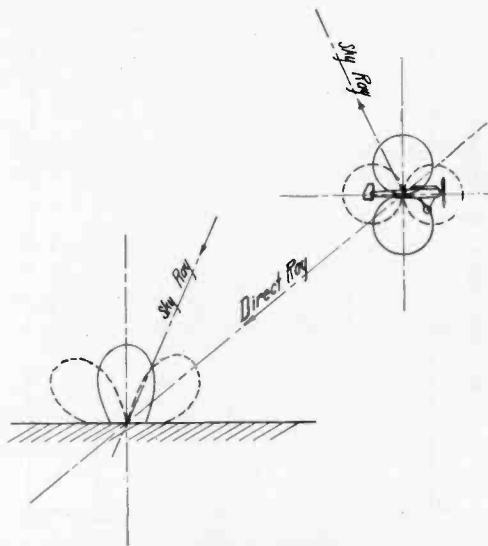

Fig. 8—Approximate radiation distribution in the vertical plane of antennas on ground and on airplane.

The direct ray is incident at the ground antenna at a very low angle of elevation. In Fig. 8 is shown roughly the radiation distribution diagram in a vertical plane of the vertical antenna (shown by the dotted lines) and of the horizontal antennas (shown by the full lines) both on the airplane and on the ground. It is readily seen that on the vertical antenna the effect of the sky ray is weak compared to that of the direct ray, while on the horizontally polarized wave the opposite is the case. This is in complete agreement with the experimental results obtained.

The effect of the conductivity of the ground is also in agreement with the theory. Over good ground the image of the horizontal antenna very nearly neutralizes the effect of the antenna itself, so that any

decrease in the conductivity is likely to have a very appreciable improvement in the strength of the signal received. With the vertical antenna, the image in the ground actually helps the antenna (unless the ray is coming at very nearly grazing incidence) so that, though an improvement is to be expected when the antenna is set over highly conducting ground, the extent of this improvement is not likely to be very appreciable.

CONCLUSION

The results obtained can be conveniently summarized by means of the following table:

| Ray | Type of Ground | Signal Strength (μv on input) | |
|---|----------------|---|----------------------|
| | | Horizontally Polarized | Vertically Polarized |
| Direct Ray at 20 miles and 3000 feet altitude | Bad Conductor | 500 | 280 |
| | Good Conductor | 40 | 320 |
| Sky Ray | Bad Conductor | 120 | 20 |
| | Good Conductor | 25 | 20 |
| Sky ray becomes appreciable at a distance of | | 20 miles | 50 miles |

In reading this table it must be remembered that the figures refer to reception with a particularly effective antenna, the effective height of which is about 55 meters, and that transmissions from the airplane were carried out on an antenna only 6 ft. high for the vertically polarized and with a horizontal antenna, which, from its size, may be expected to be fairly efficient. There is little doubt that, if it were practicable to employ on the airplane a vertical antenna as efficient as the horizontal antenna, transmissions with vertically polarized waves would be far more favorable than those with horizontally polarized waves. As it is, the preference between the horizontally and vertically polarized waves for the direct ray depends on the ground constants, while for the sky ray the horizontally polarized ray seems to be preferable. All these results refer to a frequency of 6155 kc. If this frequency were decreased, the short vertical antenna would be slightly less effective, while the horizontal antenna would lose much of its efficiency. This applies not only to the airplane antenna, but also to the horizontal ground antenna. At lower frequencies we might well expect the vertical antenna to be more suitable than the horizontal. At higher frequencies, the airplane antennas could both be improved, the horizontal only to a small extent and the vertical one quite appreciably, while the horizontal ground antenna would also be improved. Another factor would, however, enter into consideration. The sky ray would make its appearance only at a considerably greater distance, and the

phenomenon of the skip distance might occur. If it is desired to work on the direct ray only to eliminate fading, specially designed antenna which will radiate very poorly at high angles of elevation will be necessary. It is gratifying to find that such intense signals can be received with suitably designed apparatus using only two to three watts in the transmitter for distances as large as 600 miles without the signal giving signs of failing, and it is even more gratifying to find that, at any rate during daytime when all the above measurements were made, no period was found during which a telegraph signal disappeared or became too weak to be read.

The results given in this paper, though obtained with very small powers, will apply in proportion to higher powers, for the sky ray will be increased in the same ratio as the direct ray. Fading will begin to appear when the direct ray falls to a value comparable with the sky ray, and, since the ratio of the two is independent of the power of the transmitter, fading will start at the same distance away regardless of the power transmitted.

In conclusion, the authors wish to thank L. M. Hull for very helpful suggestions made during the whole course of this investigation.

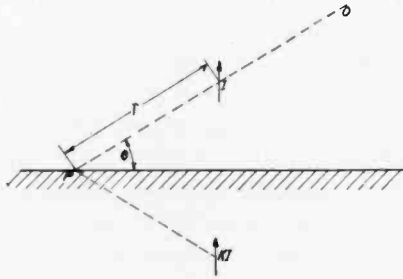

Fig. 9—Effect of conductivity of ground on image.

Appendix

REDUCTION OF AIRPLANE TRANSMISSION CHARACTERISTICS FROM ONE ALTITUDE TO ANOTHER

The method described here for reducing a signal strength vs. distance curve for a flight at a known altitude to another at another altitude is based on the theory put forward by T. L. Eckersley¹, and amplified in the discussion by one of the present authors. In this theory which has been used by S. Ballantine for computing a special case²

¹ "Short-wave wireless telegraph," *Jour. I. E. E.* (London), 65, 600-638; 1927.

² *Proc. J. R. E.*, 16, 513-518; April, 1928.

it is pointed out that the image of an antenna element I is KI , as shown in Fig. 9, that the value of K is usually a complex number and depends on the angle θ and the electrical constants of the ground in the neighborhood of the point P . If this theory is correct and only the direct ray reaches the point P , the signal strength as the antenna element is moved along any radial line such as PO will be inversely proportional to the distance r of the element I . That is, when θ is kept constant, the

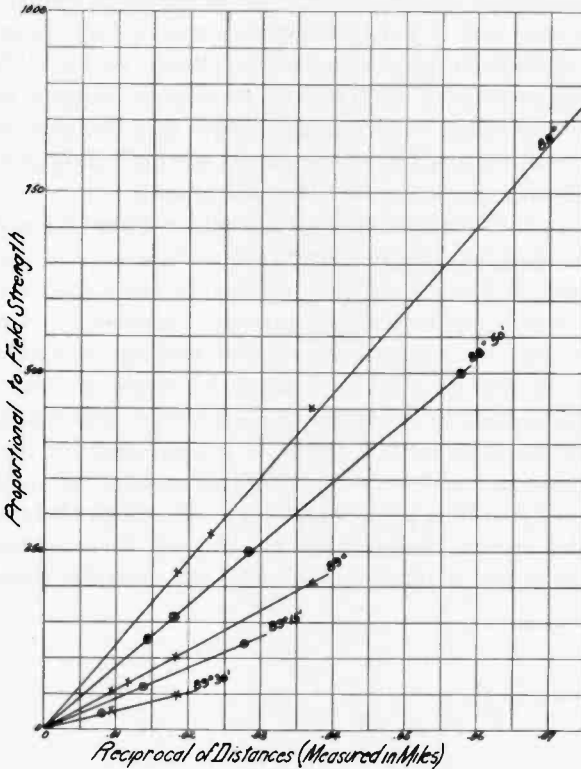

Fig. 10—Signal strength plotted against reciprocal of distance for various inclinations to the vertical.

signal strength will be inversely proportional to the distance. If the element is moved horizontally the signal will decrease more rapidly, the law tending to an inverse square law.

These results were confirmed from the careful data accumulated by D. K. Martin³. In these experiments the signal strength was measured with the airplane traveling horizontally at various heights above the

³ "Laying the foundation for aircraft communication," *Bell Laboratories Record*, 7, 315-318, 1929.

ground for distances as great as 120 miles from the ground station. From the data published Fig. 10 has been obtained. This shows the variation of field strength, with distance for various inclinations to the vertical of the line joining the airplane to the ground station. It will be seen how accurately the values lie on straight lines even for such smaller angles of elevation as $1/2$ deg. as the theory outlined would lead one to expect.

An examination of Fig. 5 leads to an identical result. From this inverse distance law, it is not difficult to reduce any curve for a flight at a given altitude to one at another. Suppose we have the curve for a flight at an altitude of 1000 ft. and we require to know the result at an altitude of 5000 ft. The signal strength at a distance of five miles at 1000 ft. will be five times the signal strength at a distance of 25 miles at 5000 ft., and so on for other distances.

The fact that this law appears to hold with such accuracy would tend to show that it is only the constants of the ground in the immediate neighborhood of the ground station that produce attenuation of the waves, in excess of the inverse distance law, for otherwise one would expect the constants of the ground at a distance from the ground station to become effective as the distance of the airplane from the ground stations is increased, even though the angle θ remains constant.

This inverse distance law holds, of course, only for the direct ray, and in reducing curves from one altitude to another the reduction must be applied only to that part of the curve for which there is no fading. When fading occurs, that is when the sky ray becomes predominant. The altitude of the airplane produces no effect on the signal strength.



TEMPERATURE RATING OF WIND-DRIVEN AIRCRAFT RADIO GENERATORS*

By

C. B. MIRICK

(Naval Research Laboratory, Bellevue, Anacostia, D. C.)

Summary—Measurements of temperature rise of generator under load are given for still air and in flight. Theory of heat emission is briefly reviewed, constants of emissivity are given from which rising and final temperatures of generators can be approximated. Conditions governing the rating of wind-driven aircraft radio generators are discussed.

IN the past the usual source of power for aircraft radio transmitters has been the wind-driven generator, which is mounted on the wings or other structure of the plane, usually in such a position that it comes in the slip stream of the main propellers. Exact knowledge of the cooling conditions which exist in generators operated in this manner has not been hitherto available, which fact has led to some uncertainty in their ratings.

In order to throw light on this condition it was undertaken to determine the relative temperature rise in such generators in flight and in still air. As a means of measurement thermocouples were applied to various points of the generator under test. Through the kindness of Dr. E. G. Lunn, of the Naval Research Laboratory, a number of group thermocouples were made up for use with a standard Leeds and Northrup temperature bridge. Each group consisted of six elements in series, each element being made of No. 28 iron and constantan wire. The cold junctions were in glass tubes to permit use of ice in thermos bottles to fix temperature at cold junction. The apparatus for use in flight is shown in Figs. 1, 2, and 3 as installed in a standard O2-U land plane.

A generator selected for test was given a run in the laboratory at three values of loading during which temperature was recorded as shown in Figs. 4, 5, and 6. The generator was then installed on plane and temperature runs made in flight with the same load conditions, as indicated on Figs. 7, 8, and 9.

To review briefly the physical conditions which govern temperature rise and heat emission, heat develops in the structure of a generator at various points in proportion to the losses. These may be I^2R losses in the windings of the armature and field, or a result of eddy currents,

* Dewey decimal classification: 621.313.23. Original manuscript received by the Institute, October 7, 1929.

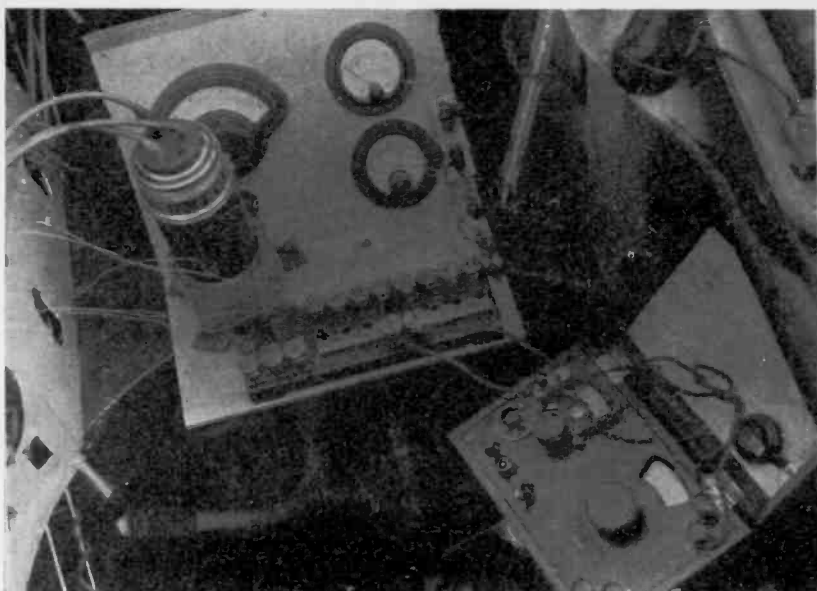

Fig. 1—View down into cockpit showing temperature bridge, instruments, and switching arrangement.

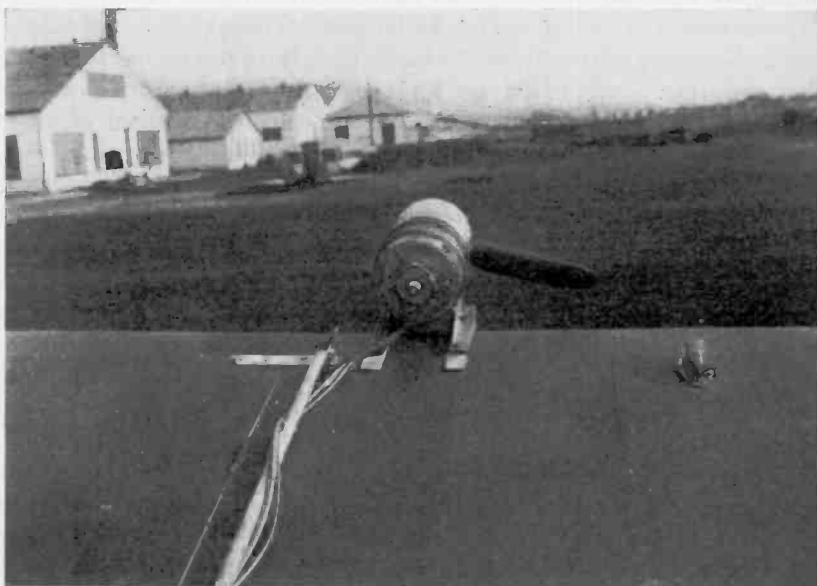

Fig. 2—Generator mounted on upper wing showing leads to thermocouples.

hysteresis, losses in the iron core, friction losses, etc. From the point of formation, the heat flows toward the surface of emission following the laws of conduction and is there emitted. The temperature gradient between the points of heat generation and the emitting surfaces is proportional to the length of the path, the conductivity of the material, and is inversely proportional to the cross section of the path.

At the surface the heat is emitted in three ways. A certain amount passes by conduction to the supports of the machine. A certain other

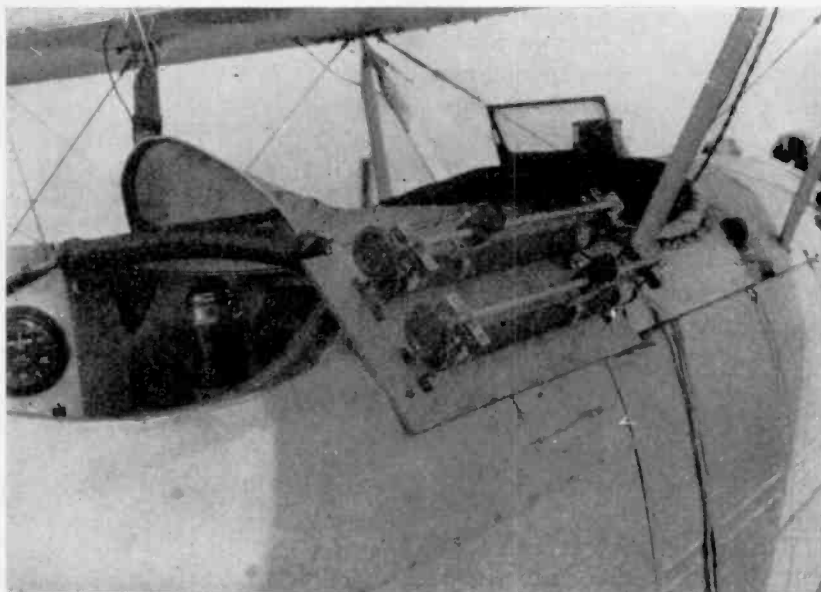

Fig. 3.—Rheostats for generator load.

amount passes directly to surrounding bodies by radiation. This is proportional to the difference in fourth powers of the absolute temperatures of the heat emitting and the heat receiving bodies. It is independent of the temperature of intervening air, but varies greatly with the nature of the heat emitting surface. A certain other amount of heat is taken up by convection in warming the air which comes in contact with heat emitting body. Dr. Langmuir¹ has shown that in still air the emission by convection about equals the heat flow, which would be occasioned through an air film 4.3 mm in thickness by the temperature difference between hot body and the cooling air. The

¹ Laws of heat transmission in electrical machinery, *Trans. A. I. E. E.*, XXXII, 301.

emission by convection is probably independent of the nature of the emitting surface.

The heat given out in these three ways comprises the total emission, and is related to the dimensions of the cooling body by Newton's well-known law of emissivity, which may be stated as follows:

$$T = T_f - T_r e^{-(Ca/mh)t} \quad (1)$$

Where:

- T = temperature at any time
- T_f = final temperature
- T_r = temperature rise
- e = naperian base
- a = area of emitting surface
- m = mass
- h = specific heat of material
- t = time
- C = constant of emissivity

When final temperature is reached a state of equilibrium exists, in which the heat emitted equals the heat supplied from losses.

$$CaT_r = W \quad \text{or} \quad T_r = \frac{W}{Ca} \quad (2)$$

An attempt has been made to apply this theory to the experimental curves here given with a view to establishing constants for the pre-determination of temperature rise. In making the preliminary attempt several assumptions are made.

- (a) Owing to the small mass the temperature rise in test generator will be relatively fast.
- (b) Owing to the small dimensions, the temperature gradient between internal points and surface, as equilibrium is approached, will be relatively small.
- (c) Under flight conditions the very intense convection will take up the greater part of the emission. The heat transferred by conduction will be small as the mass and conductivity of generator supports are small.

Considering the generator under test as a cylinder omitting the stream line tail piece, dimensions were found as follows: weight in

pounds, 18.75; weight in grams, 8500.; area in square inches, 161.9; area in square cm, 1042. Using these values in (1) and using the

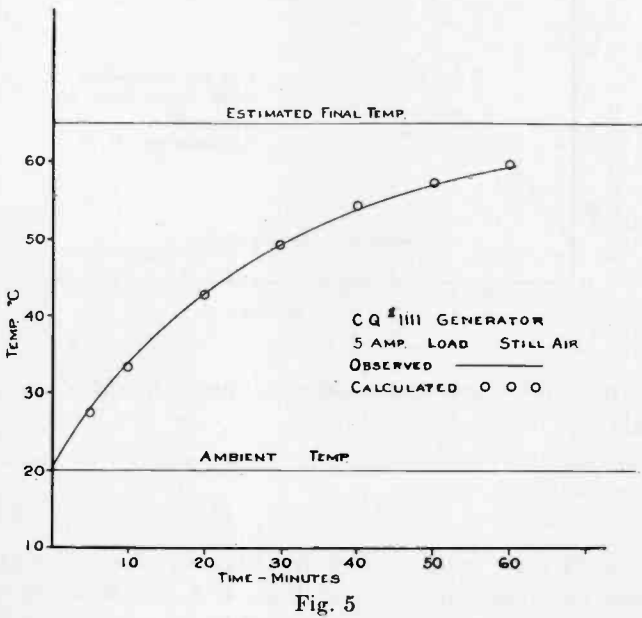
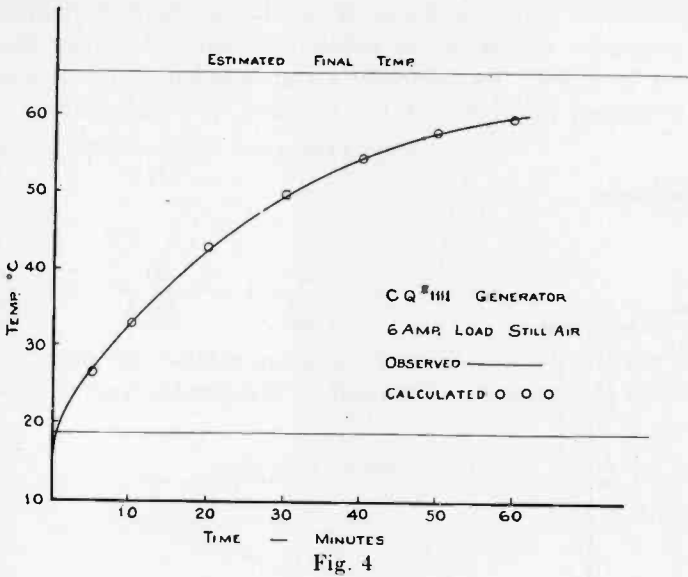

temperature limits as observed in Fig. 4 a value of C was determined as 0.0287. Using this value computed values were found as shown by

circles in Figs. 4, 5, and 6. The close agreement with the observed curves is obvious.

Equation (2) indicates means of estimating the final temperature which generator will reach at which heat emitted equals the heat generated by losses. By means of a transmission dynamometer, the overall efficiency and losses in the machine were determined.

| | Losses in Watts | 6-ampere load | 5-ampere load | 4-ampere load |
|----------------------------|-----------------|---------------|---------------|---------------|
| A-C armature | | | | |
| Friction and windage | 28.8 | 18. | 12.5 | 8. |
| Brush friction | 18. | | | |
| Field loss | | | | |
| Copper | 26. | | | |
| Iron | 44. | | | |
| Exciter arm | 3.2 | 120 | 120 | 120 |
| Total watts lost | | 138 | 132.5 | 128 |
| Total gram cal. per minute | | 1980 | 1915. | 1835 |

One watt is equivalent to 14.33 gram calories per minute. The specific heat of generator is taken as 0.1. Temperatures are in degrees C.

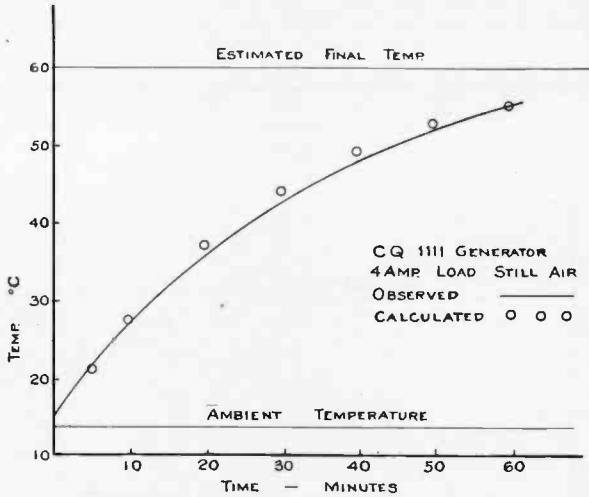

Fig. 6

Weight is used for mass, and constants found should be interpreted accordingly.

| Final Temp. rise | 6-ampere load | 5-ampere load | 4-ampere load |
|--|---------------|---------------|---------------|
| For still air computed from equation (2) | 66 deg. | 64 deg. | 64 deg. |
| Observed, Figs. 4, 5, and 6 | 46 | 45 | 46 |

The calculated final temperatures resulting by this procedure were higher than the observed curves of Figs. 4, 5, and 6 would indicate. However, a value of 0.04 for *C* when used in (2) with losses as above measured gives a final temperature which agrees closely with the observed data.

Extending this method to observations on several other machines, both in still air and in flight, average values for emissivity constant were found as follows: in still air, 0.033; in flight, 0.0925. It is found that both rising and final temperatures agree with the computed temperatures derived from these constants within about 20 per cent, sometimes much closer.

Several unusual features affect the rating of wind-driven aircraft radio generators. The load during transmission of radio code is intermittent as the key is open about 1/3 of the time even during sending. The periods of use in aircraft service are short, a 10-minute message being a rather long one. The temperature of surrounding air normally

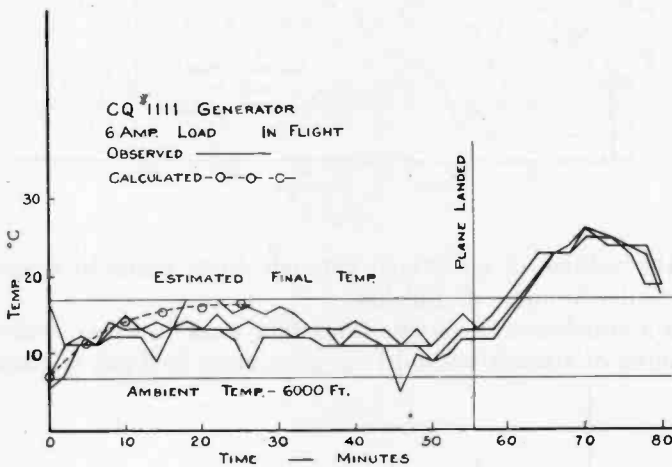

Fig. 7

decreases with the altitude of the plane at about 2 deg. per 1000 ft. All these conditions are favorable. Against this is the effect of the reduction in atmospheric pressure on cooling conditions. At first this might seem important since the cooling effect of rarified air is materially reduced, a fact which is taken account of by builders of stationary machines which are to be used at high altitudes.² It must be remembered, however, that wind-driven aircraft generators are usually mounted in the direct blast from the slip stream of the main propellers. As the air becomes rarified as a result of increasing altitude, the driving propeller of the plane turns faster, forcing a greater volume of air past the wings. While the volume is greater the mass tends to remain constant, for it is the action of the *mass* of air passing the wings which keeps the plane up. The cooling effect on the generator

² Carl Fechheimer, *Trans. A. I. E. E.*, p. 124, February, 1926.

is also proportional to the mass of air, and as long as sufficient air is passed to keep the plane in flight the cooling cannot be seriously decreased. This is a different condition from that which prevails when a stationary generator at high altitude is cooled by exhaust fans.

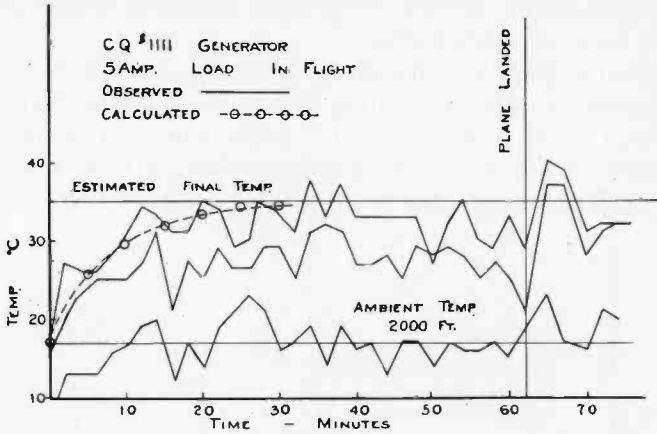

Fig. 8

Then the volume of air driven through ducts tends to remain constant, while the mass diminishes.

As a conclusion, from the preceding work it seems evident that the cooling of aircraft wind-driven generators in flight is about three

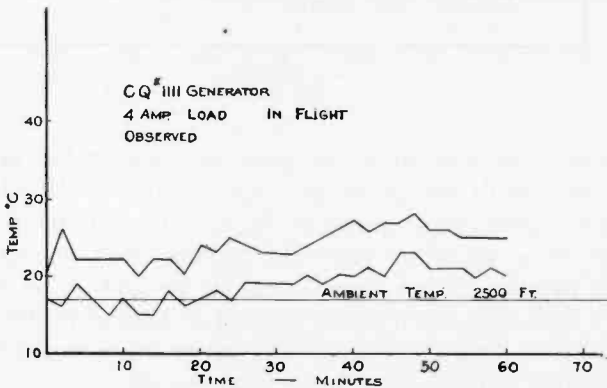
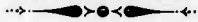

Fig. 9

times as great as it is in still air. Because of this and the favorable conditions of operation just cited, it is believed that in the past such generators have been consistently underrated. One point, however must be taken into consideration. It is evident from Fig. 7 showing temperature measurements in flight that there was a sudden rise

of temperature immediately after the plane landed. This accomplished the sudden stoppage of forced cooling, which permitted a momentary increase in temperature of 30 per cent over that prevailing during flight. A similar momentary rise in temperature also takes place in the adjacent motor of the plane, which may have some reaction on the generator. Though of short duration, the effect must be taken into account.

It is desired to acknowledge the valuable cooperation of Assistant Radio Inspector A. H. Johnson, of the Naval Research Laboratory, who made the installations and took the measurements in flight.



APPLYING THE RADIO RANGE TO THE AIRWAYS*

By

F. G. KEAR† AND W. E. JACKSON‡

(†Bureau of Standards, Washington, D. C.; ‡Bureau of Lighthouses, Washington, D. C.)

Summary—*In pursuance of the program of radio aids to flight undertaken by the Department of Commerce, experimental and installation work has progressed in the application of the radio range (directive radiobeacon) along the airways. To date, only the aural type has been put into routine daily operation, and it is the only type of beacon considered in this paper, which discusses methods of adjusting the space pattern of the beacon system in order that the courses may align with the fixed airways. These beacons also need to be readily distinguished from one another, and so designed that a minimum of interference is met.*

By using a vertical wire antenna in addition to the loop antennas and varying the relative power in the two loop antennas it was found possible to secure practically any array of courses desired. The radio ranges at Hadley Field, N. J., and Bellefonte, Pa., were employed in the experimental work with excellent results. The field-intensity measurements made gave space patterns which checked very well with the theoretical patterns for such antenna systems.

Careful spacing of the radio ranges within the frequency band, as well as distinctive coding of each beacon, solved the problem of interference.

In selecting the proper coding for the beacons a study of the physiological effects of various sound groups was made, and the final coding chosen was such as to give a signal of equal time duration on each side of the course. The signals still interlock to give the customary long dash when on the course.

The technique of applying these modifications was developed to the point where the adjustments could be made by the installation crew in the field without the aid of an engineer.

INTRODUCTION

THE aural type of radio range¹ was installed by the Department of Commerce at Hadley Field, N. J., Bellefonte, Pa., and Cleveland, Ohio, in 1927 and 1928. After the first tests, it became necessary to adjust the beacon system in order to make the courses provided coincide with the fixed airways. The original aural type radio range established an equisignal zone of about 3 deg. width extending in a straight line through the beacon approximately 100 miles either way. Another equisignal zone, at right angles thereto, approximately 12 deg. in width, was also present, but on account of

*Dewey decimal classification: R526.1. Original manuscript received by the Institute, October 7, 1929. Publication approved by the Director of the Bureau of Standards of the U. S. Department of Commerce. To be published in a forthcoming issue of the Bureau of Standards Journal of Research.

¹F. H. Engel and F. W. Dunmore, "A directive type of radio beacon and its application to navigation," Scientific Paper, Bureau of Standards No. 400, January, 1924. Murphy and Wolfe, "Stationary and rotating equisignal beacons," *Jour. S.A.E.*, 19, 209; September, 1926. J. H. Dellinger and Haraden Pratt, "Development of radio aids to air navigation," *Proc. I. R. E.*, 16, 890; July, 1928.

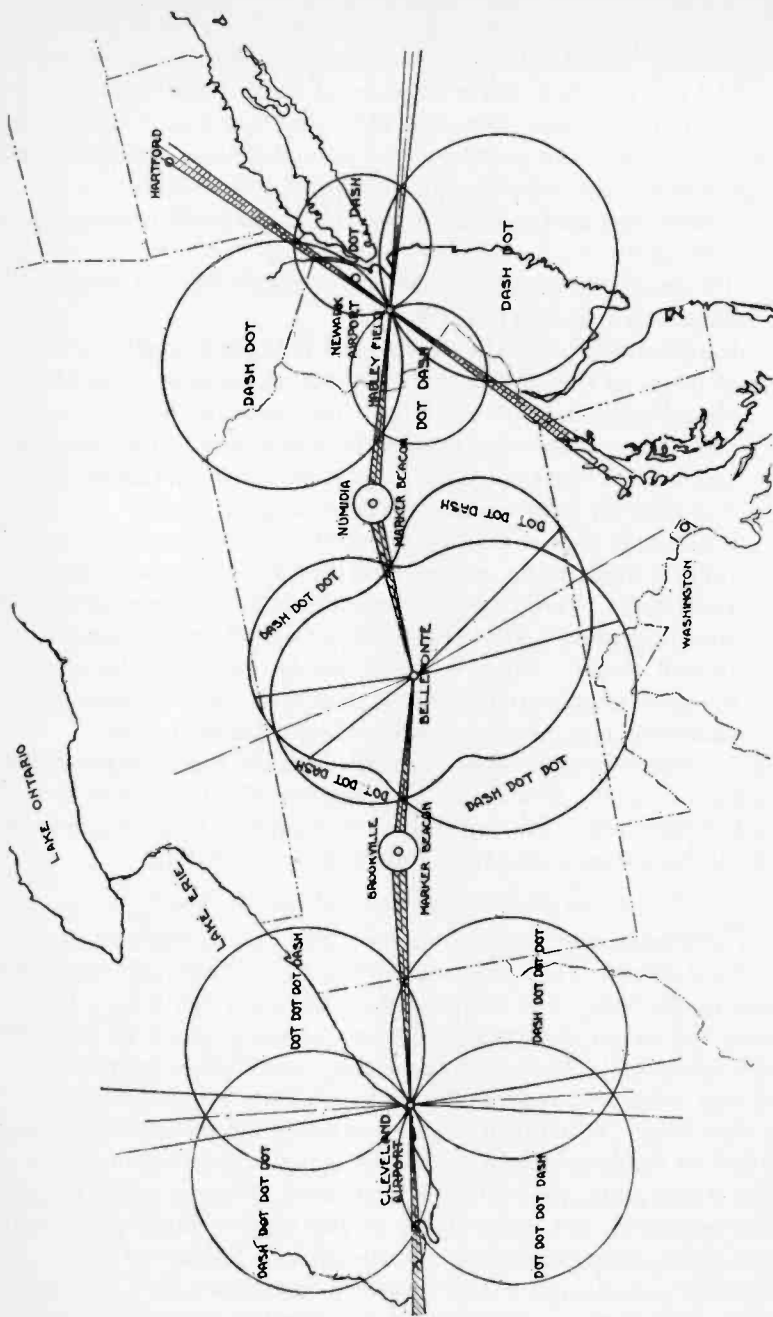

Fig. 1—Air route, Cleveland to New York.

its excessive width was not usable. An airway extending 200 miles in a straight line with a field at its center is a situation seldom encountered. The use of lower power beacons at more frequent intervals, and between fields, might solve this difficulty, but would raise problems of interference and economy. In the actual use of the beacons along the airways the following problems had to be solved.

- (a) Interference had to be kept to a minimum in order to prevent confusion.
- (b) The course outlined had to be easily recognizable so that a slight deviation might be noticed.
- (c) Radio ranges had to be so designed that they could be located at bends in the airway route; that is, the course given by the beacon must not be a straight line through the beacon but an obtuse angle of controllable magnitude. Furthermore, both legs of the angle must be capable of simultaneous operation in order to accommodate increasing air traffic.
- (d) Finally, it was necessary to service more than one course from a single radio range, a further development of the previous idea. Terminals in larger cities have many air routes entering, and each of these routes should be outlined by a beacon course. Since it would not be economically possible to install a separate beacon for each route the previous system had to be modified, to accommodate multiple routes.

These conditions have all been satisfied on the radio range system as now in use on the airways, if the number of courses to be served does not exceed four. The purpose of this paper is to give a detailed account of the means employed to meet these conditions.

I. INTERFERENCE BETWEEN RADIO RANGES

Two methods have been successfully adopted to differentiate between radio ranges. The first method was to allocate different frequencies in the band from 285 to 315 kc to each radio range. Particular care was taken to separate adjacent beacon frequencies as much as could consistently be done in the limited available frequency range. In no case were adjacent radio range station frequencies selected closer than 8 kc. When utilizing the ordinary aircraft receiver using two stages of shield-grid tube, radio-frequency amplification, detector and two stages audio with a 6-ft. rod antenna, it was possible to tune in either a beacon 100 miles ahead or 100 miles behind, when both were operating simultaneously on frequencies separated by 8 kc. The average power output from a beacon installation is 2 kw.

The second method used to eliminate possible confusion between radio ranges was to establish a system of distinctive code signals.

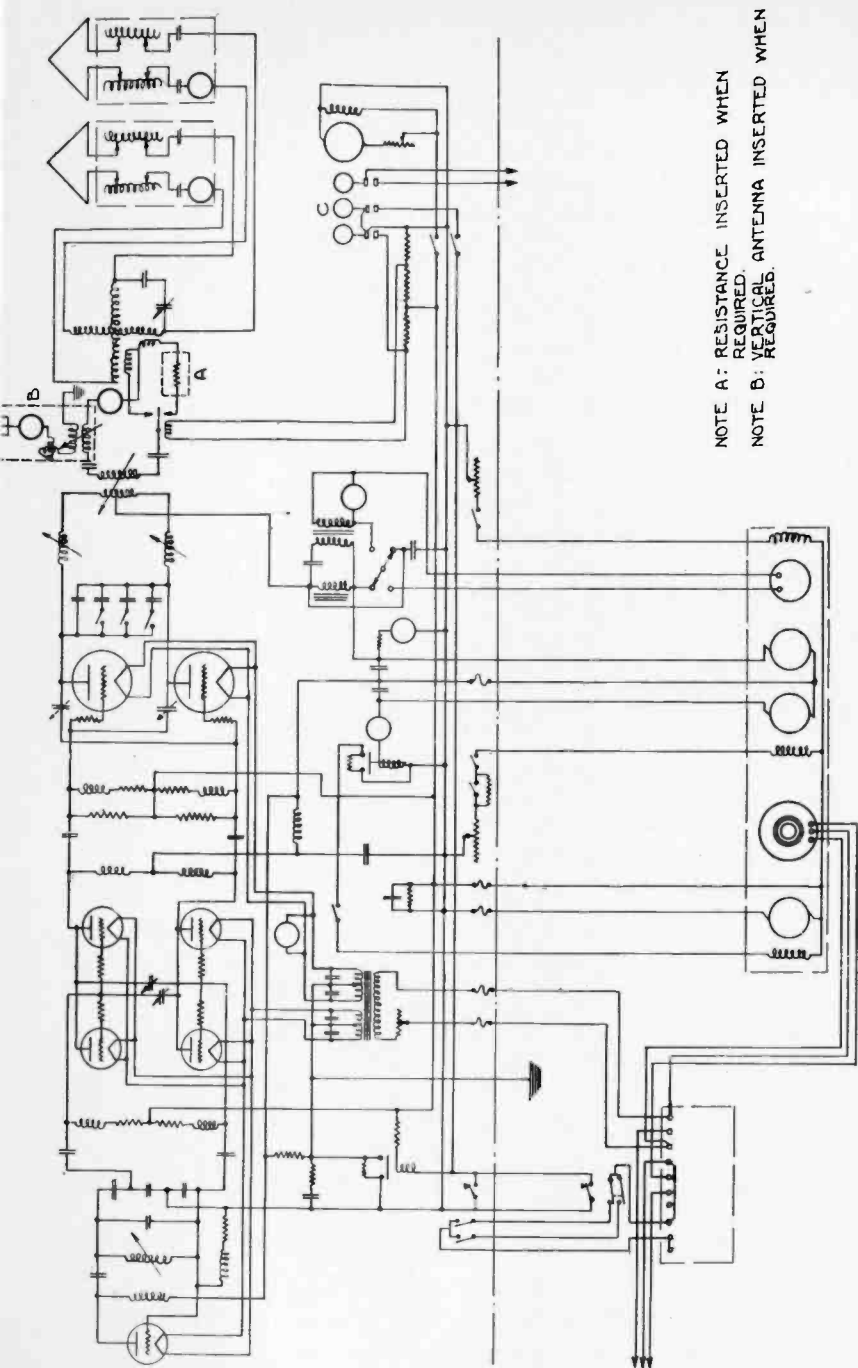

NOTE A: RESISTANCE INSERTED WHEN REQUIRED.
 NOTE B: VERTICAL ANTENNA INSERTED WHEN REQUIRED.

Fig. 2—Schematic diagram of radio range. The master oscillator is a 50-watt tube employing the Colpitts circuit. This is amplified by a set of four 50-watt tubes operating in a push-pull circuit and cross-neutralized. The final power amplifier contains two 1-kw tubes of which the plate circuit is tuned. The tuned plate circuit is coupled by an untuned link circuit to the goniometer primaries and keying is accomplished at this point. The keying cams are shown at C. One cam controls the input power and another connects the primaries of the goniometer alternately to the circuit. The resistance at A permits shifting the 90-deg. courses as desired and the vertical wire antenna shown at B introduces the shift of the 180-deg. courses. Either or both may be employed as desired.

The signals of necessity had to be such that they interlocked and gave the resulting long dash when on the course. The first group of signals adopted were (— . and . —); (— . — and ..); (— . . — and . . .); and (— — and ..); two characteristic signals being required for each interlocking radio range. Results showed that radio ranges using the — . and . — characteristics gave very distinctive courses. However, when the characters — . — and .. were used as interlocking signals, a peculiar physiological offset was observed. Tests indicated that the

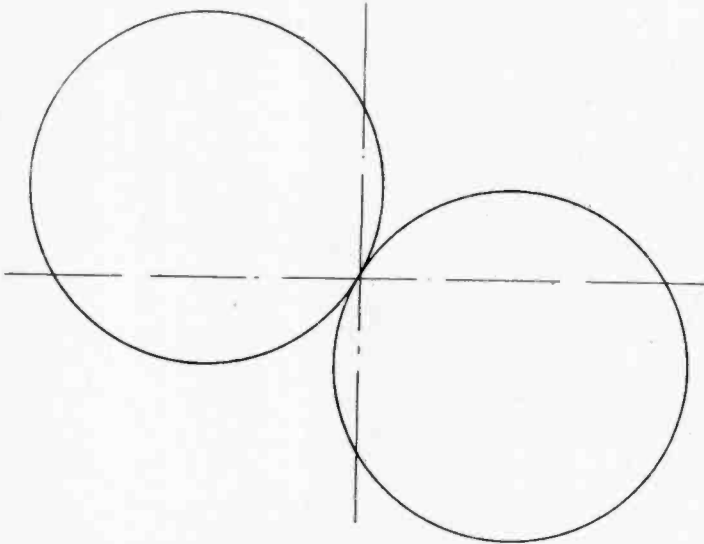

Fig. 3—Theoretical field-intensity pattern of a single phantom loop antenna without the use of a vertical antenna.

course was apparently bent slightly in an *S* shape. In reality, field-strength measurements proved the course to be straight. When close to the range and on the course as indicated by field-intensity measurement, the character — . — would apparently predominate, causing the pilot to bear toward the .. side of the course. When at approximately 100 miles from the range, tests indicated that the .. character would predominate while on the course, thus causing the pilot to compensate for this effect by flying on the — . — side of the course. As a result the pilot does not fly on the true course but flies on a curved course which does not coincide with the airway.

In order to eliminate this confusing effect it was found necessary to use characteristics that had equal time durations and were the inverse of each other. This plan was adopted since the — . and . — were found to give such excellent results. The characteristics chosen were

(— . . and . . —); (— . . . and . . . —). These have been used for some time and have eliminated difficulties encountered with dissymmetrical arrangements, but are not favored by the pilot.

Recently the Airways Division changed signals to —. and —. combinations, transmitted in groups of 2 to 12 signals per cycle. By counting the number of signals the station may be identified, this system being similar to a clock tolling the hour. In addition, beacons are identified by station announcement every 15 minutes.

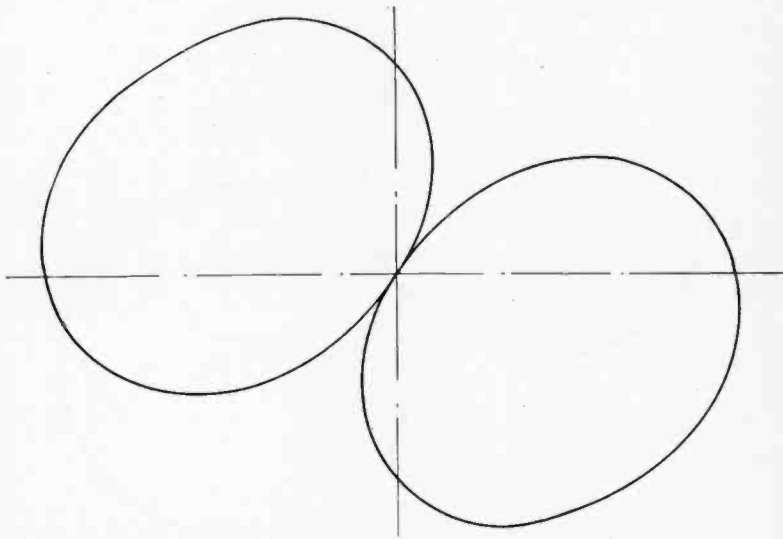

Fig. 3a—Observed field-intensity pattern of a single phantom loop antenna without the use of a vertical antenna.

II. ALIGNMENT OF COURSES WITH AIRWAYS

It has long been appreciated that a limitation of the radio range in its early form has been the fact that the four courses emanating from a single radio range have been at fixed angles of 90 deg. to each other. It is obvious that such an arrangement could serve only one course at a time situated at an airport except where by rare coincidence two courses extended at 90 deg. or 180 deg. from an airport. In order to make at least two of the four available courses useful, the radiobeacon installations could be situated half-way between points on the straight airways at distances of approximately 200 miles. This would make it possible to use two of the four courses, and at the same time to reduce the angular width of the equisignal zone since the two courses were displaced 180 deg. This is accomplished by increasing the angle be-

tween the two primary coils of the goniometer to about 120 deg. instead of 90 deg. See Fig. 4. Some installations of this type were made along the Transcontinental Airway.

Placing radio ranges in this manner has one particularly annoying feature in that the course is usually broadest where it should be narrowest. To make this statement clear, it should first be understood that an equisignal course is a true angular function, i.e., directly over

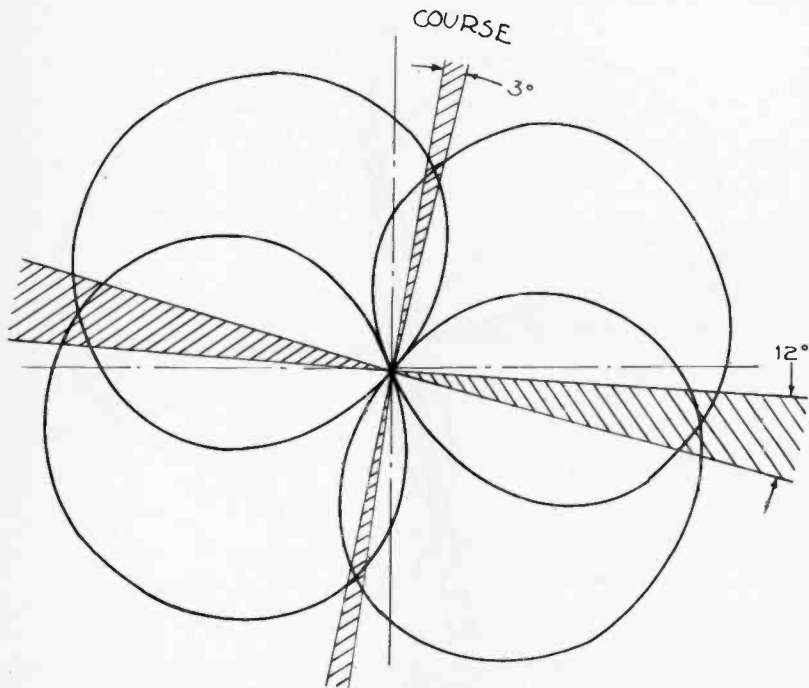

Fig. 4—Observed field-intensity patterns of each phantom loop antenna energized separately; goniometer primaries set at 120 deg.

the center of the loop antenna the courses have an infinitesimal width, and gradually the width increases to approximately 6 miles at a hundred mile distance from the radio range. When a pilot flies from a point at a distance from the radio range, it is evident that his course gradually becomes sharp and narrower as he approaches the beacon installation, and if he keeps on his course it will take him directly over the radio tower. This feature alone is one of paramount importance and cannot be neglected, since experience has shown that when the radio range is located adjacent to the terminal airport, pilots are able to locate the airport and make safe landings when conditions are such that they would otherwise be unable to find the terminal airport. Hence, when

a radiobeacon is located at a terminal airport there are two very distinct advantages: first, the course becomes narrower as the pilot approaches the beacon; secondly, the beacon informs the pilot definitely when he has passed over the tower. Therefore, it practically fixes a point in space directly over the antennas. It is apparent that such a point in space would be of unquestionable value if located adjacent to a terminal airport instead of halfway between two air-

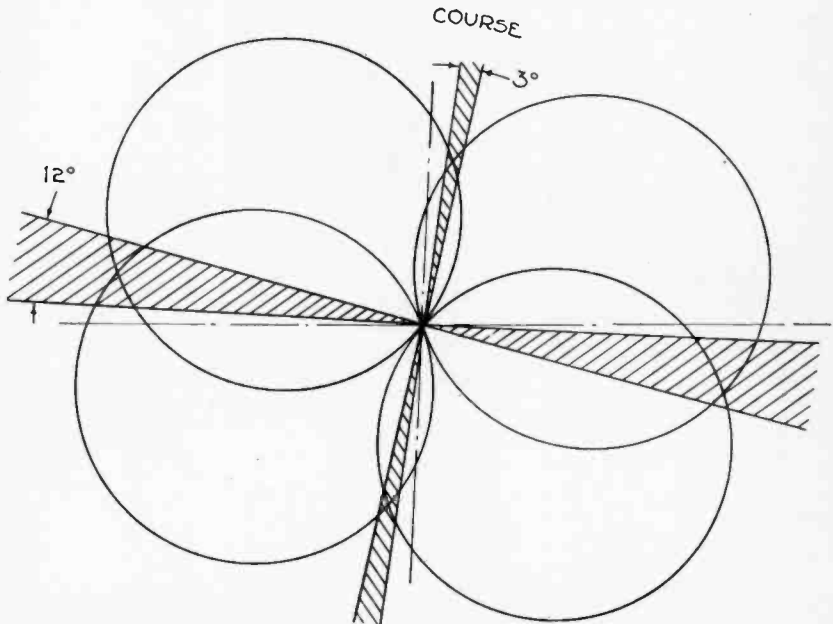

Fig. 4a—Theoretical field-intensity patterns of each phantom loop antenna energized separately; goniometer primaries set at 120 deg.

ports. It was with these particular features in mind that the problem of fitting radio ranges to the airways was attacked.

Two fundamental schemes have been developed which permit the use of two fixed courses displaced at any angle varying between 45 deg. and 180 deg. Courses emanating at angles less than 45 deg. cannot practically be serviced with one installation, because an excessive decrease in power results from such an attempt.

Method Used for Courses Emanating at Angles between 45 Deg. and 135 Deg. The method used to serve courses emanating from an airport at angles varying between 45 deg. and 135 deg. is as follows: a non-inductive resistance is inserted in the link circuit in series with one of the goniometer primaries. This reduces the power in one phantom

loop antenna² while the power in the other phantom loop antenna is left unaffected. By varying the ratio of power in the two phantom loop antennas by means of resistance the courses may be made to shift from their normal 90-deg. displacement to any angle between 45 deg. and 135 deg. See Fig. 5. It should be carefully noted that this variation depends upon several variables including loop antenna resistance, mutual induction between primary and secondary of goni-

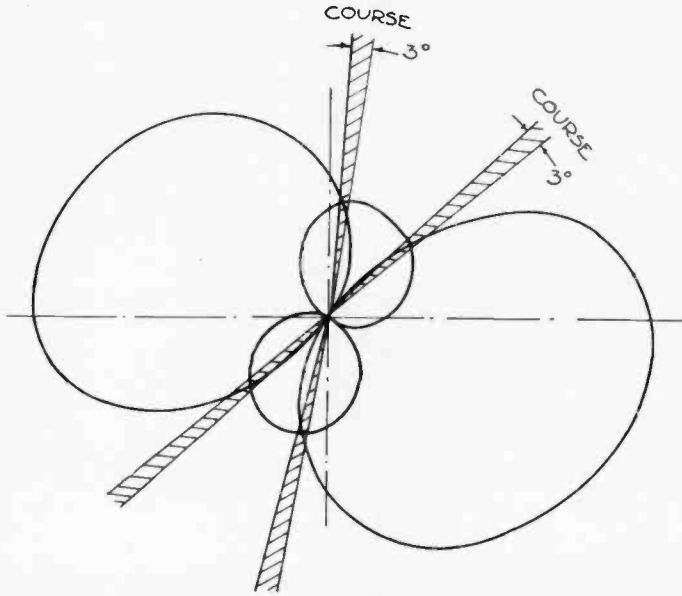

Fig. 5—Observed field-intensity patterns of each phantom loop antenna with 32 ohms resistance inserted in series with one goniometer primary; goniometer primaries set at 90 deg.

ometer, and power factor of link circuits. These should be taken care of jointly in each particular installation.

Method Used for Courses Emanating at Angles between 135 Deg. and 180 Deg. The normal polar pattern of crossed loop antennas is a pair of figures-of-eight at 90 deg. This gives four equisignal zones which are referred to as "courses" in beacon terminology. See Fig. 6. In order to increase the sharpness of the course the goniometer primaries are frequently set at 120 deg. instead of 90 deg. This gives

² A phantom loop antenna is the resultant figure-of-eight space pattern occurring when both loop antennas are coupled to one goniometer primary. The angular relation of the phantom loop antennas is the same as that of the goniometer primaries. For a further treatment of this subject see Murphy and Wolfe, "Stationary and rotating equisignal beacons," *Jour. S. A. E.*, 19, 209; Sept., 1926.

four courses, two of which are about 3 deg. wide, while the remaining two are 12 deg. wide. See Fig. 4.

If a vertical wire is now permitted to radiate in time phase with the radiation from the phantom loop antenna the field-intensity pattern will be distorted as shown in Figs. 7 and 8. It will be noted that two lobes diminish and two increase. This changes the relative position of the equisignal zones so that the course approaching the beacon is no longer 180 deg. from the one leaving. The amount of this shift

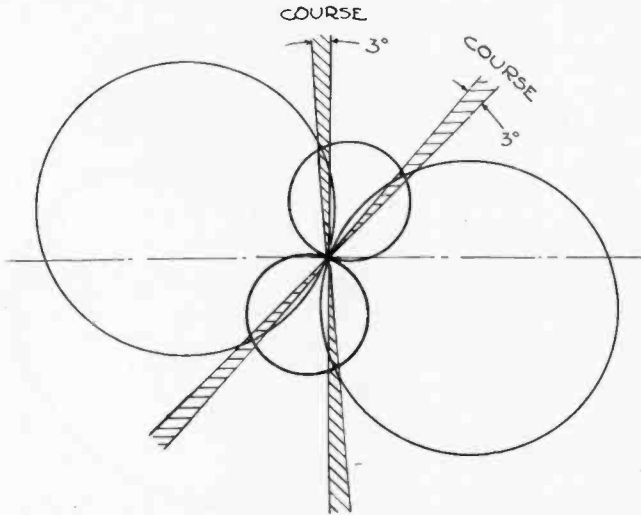

Fig. 5a—Theoretical field-intensity patterns of each phantom loop antenna with 32 ohms resistance inserted in series with one goniometer primary; goniometer primaries set at 90 deg.

may be controlled by adjusting the magnitude of the current in the vertical wire. This shift is limited only by the disappearance of two of the lobes,³ forming two cardioid patterns at right angles, thus giving two equisignal zones displaced 180 deg. instead of four displaced at various angles.

It has previously been mentioned that in the original beacon system the goniometer primaries were set at an angle of 120 deg. to secure a narrow course. When means are employed to bend the course, this is not advisable. There is danger of one lobe shrinking so far that it intersects the adjacent lobe on the wrong portion of its contour. This will be apparent from Fig. 9. Four courses are present so far as the ear can detect, but as the lobe decreases the course will no longer

³ E. Z. Stowell, "A unidirectional radio beacon for aircraft," Bureau of Standards Journal of Research, December, 1928.

shift properly. Furthermore, the course at this intersection is not sharp enough to be used. In order to prevent this in beacon installations the primaries are frequently set at 90 deg. when the courses are to be bent.

III. APPLICATION OF THEORY

Having decided upon a method for aligning the courses of the radio range with the airways, the next problem was to develop a means of

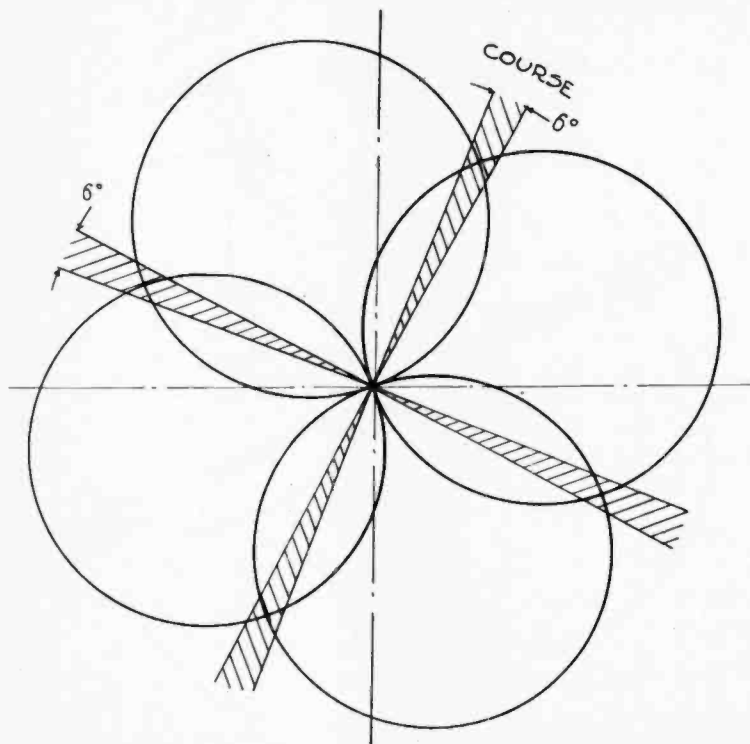

Fig. 6—Theoretical field-intensity patterns of each phantom loop antenna energized separately; goniometer primaries set at 90 deg.

applying it to the beacon installations. The radio ranges at Hadley Field, New Brunswick, N. J., and Bellefonte, Pa., were selected for these tests.

The airway route through Bellefonte has a 14-deg. bend at Bellefonte, and consequently, the antenna effect method was employed.

A vertical wire antenna was installed on the radio range tower and this was tuned to resonance by a suitable series inductance. The circuit was of sufficiently high resistance to have a broad resonance curve.

The antenna was at first excited by coupling it to the master oscillator. The results from this were poor, and analysis showed that a pronounced phase shift occurred between the master oscillator and the goniometer, due to the particular coupling circuits employed. To eliminate this, a coupling coil was inserted in the common goniometer primary circuit, and the antenna coupled to this. This resulted in excellent control of the amount of shift, displacements of 28 deg.

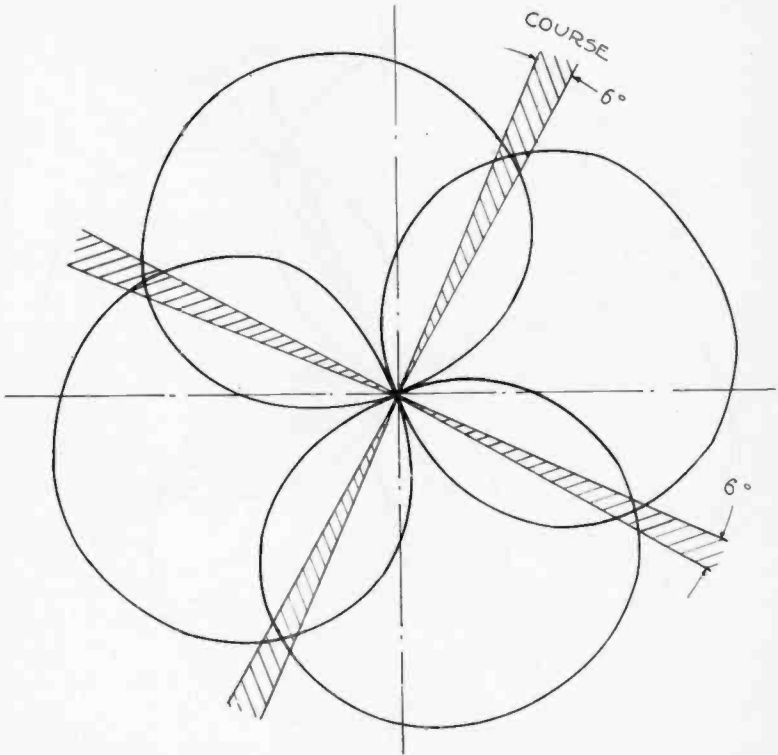

Fig. 6a—Observed field-intensity patterns of each phantom loop antenna energized separately; goniometer primaries set at 90 deg.

being readily obtainable. The goniometer primaries were set at 90 deg. for this work.

The final adjustment of antenna current was made by controlling the degree of the antenna coupling. It is necessary that the antenna be in tune to prevent dephasing; consequently, detuning will not accomplish the desired result.

It was also necessary to have an accurate knowledge of the amount of shift, in order that the course might be properly oriented. For

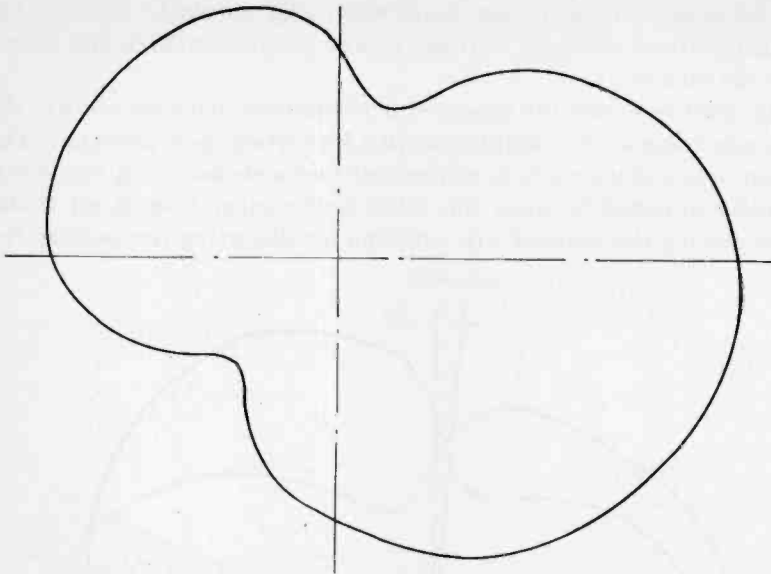

Fig. 7—Observed field-intensity pattern of one phantom loop antenna and vertical antenna energized simultaneously.

first adjustments a receiving set using a six-foot vertical antenna was mounted in a truck and driven around the loops at a distance of about 100 yards from the base of the tower. Readings were very sharp at

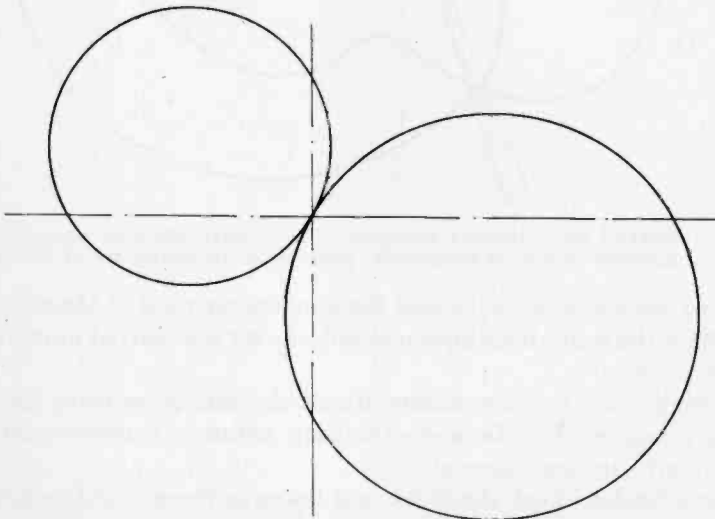

Fig. 7a—Theoretical field-intensity pattern of one phantom loop and vertical antenna energized simultaneously.

this distance and the 14-deg. bend was easily checked. By locating landmarks from compass bearings it was possible to align the course with the airways.

In order to secure the observed field-intensity patterns shown, the same receiving set was employed with its vertical pole antenna. The output was connected to a calibrated thermoelement and the signal intensity adjusted to keep the tubes under saturation at all times. In employing the vertical wire antenna for distorting the pattern the

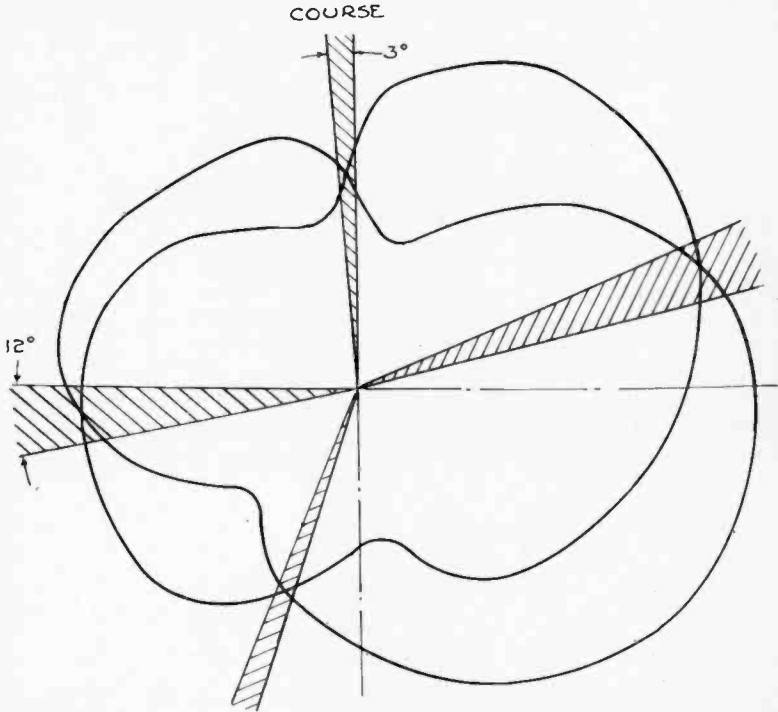

Fig. 8—Observed field-intensity patterns of each phantom loop antenna and vertical antenna energized separately; goniometer primaries set at 60 deg.

receiving set was stationary and the goniometer rotated through 360 deg. With the series resistance method, the set was moved around the beacon tower.

Discrepancies between observed and theoretical patterns are due chiefly to phase shift between the loop antenna currents and the vertical wire antenna current.

For a further check the truck was taken to Snowshoe Junction to the west and to Aaronsburg to the east. (These are, respectively, ten and twenty miles from the radio range). The readings here checked

with those taken at the beacon tower to within half a degree, which is well within the accuracy of measurement. As a final check, the course was flown again, and once more the readings checked those taken at the beacon. From this and from data secured on later occasions, it was decided that an accuracy of 1 deg. could be expected from measurements made at the beacon tower, in spite of the predominating induction field.

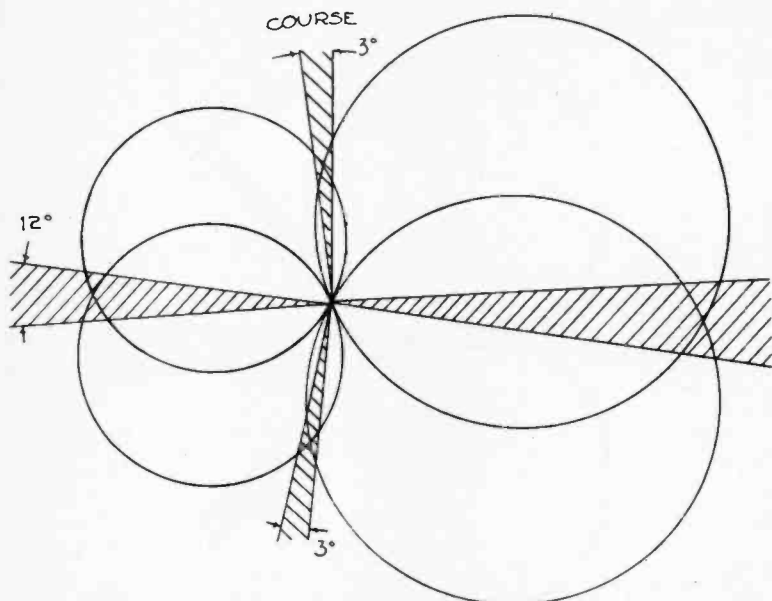

Fig. 8a—Theoretical field-intensity patterns of each phantom loop antenna and vertical antenna energized separately; goniometer primaries set at 60 deg.

Hadley Field, besides being the eastern terminus of the Transcontinental Airway, has two other air lines entering it. Hartford to the north, and Washington to the south, need to be served by the same radio range. Washington and Hartford lie in a straight line through Hadley Field, but the course to the west is not at 90 deg. to these. This presented an opportunity to use the first method described, namely that of inserting resistance in the link circuit of one of the goniometer primaries, which, as before explained, shifts the 90-deg. courses.

With the current in one goniometer primary approximately one-half the value of the other, the courses were shifted the desired amount.

Here also it was found desirable to adjust the goniometer primaries to 90 deg. in order that the courses might be of equal power. This change in relative field intensity of the two phantom loops has another advantageous effect in that it sharpens the course to a considerable

degree. By referring to Fig. 5 it will be seen that since the intersection of the smaller figure-of-eight comes at the point of rapid change of the large figure-of-eight, the resulting course is quite sharp. By measurement the courses have been found to be approximately 3 deg. wide. This is much sharper than the usual course resulting from a 90-deg. separation of the goniometer primaries.

The courses were checked here in a manner similar to that used at Bellefonte.

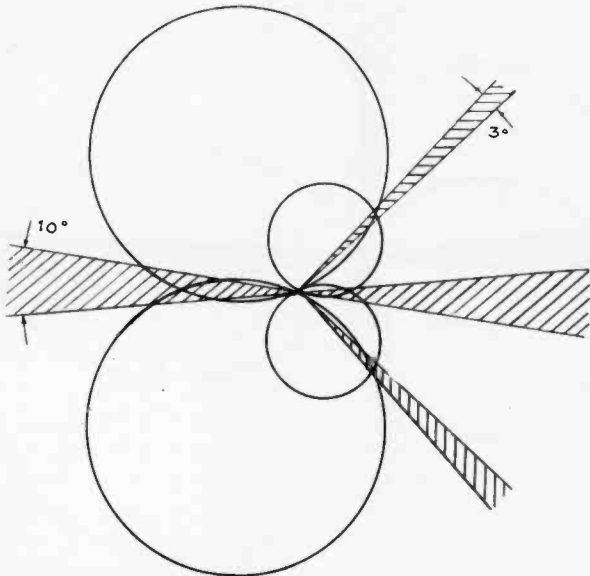

Fig. 9—Result of incorrect time phase of vertical antenna.

Another modification of the system is possible. When using a vertical wire antenna it may be keyed by a relay in the same circuit as the one goniometer primary. The result of this will be to affect only one phantom loop and thus shift both the 90-deg. and the 180-deg. courses.

With these three means at hand it becomes a relatively simple matter to satisfy almost any requirement where the number of courses to be served does not exceed three, and also a great number of four-course air terminals. The adjustments are not so critical as to be unstable, and once made remain indefinitely. Very little extra apparatus is required and the maintenance is not difficult. All the requirements for the aural type of radio range, as listed in the early part of this paper, are therefore fulfilled.

EFFECT OF FLIGHT ON HEARING*

By

C. B. MIFICK

(Naval Research Laboratory, Bellevue, Anacostia, D. C.)

Summary—The unusual conditions imposed by flight on the sense of hearing are stated, showing the need of audiometric study. After brief review of the theory of the audiometer, data are submitted covering: (a) fatigue as indicated by measurements before and after flight, (b) fatigue as indicated by measurements taken during flight, (c) initial impairment coincident with flight, (d) group measurements of fliers and non-fliers as a test for permanent impairment. The results are discussed with particular view to their bearing on aircraft radio operation.

OF the senses engaged in flying probably none is subjected to more unusual conditions than that of hearing. The ears receive during flight a continuous and intense bombardment of complex sound caused by the motor exhaust, propeller, and wind noises. There are also changes of pressure and temperature of greater range and rapidity than are usually encountered elsewhere. Because of these conditions, conversation can be carried on in a closed cabin plane with greatest difficulty only, while in an open cockpit during normal flight it becomes utterly impossible.

This condition was early recognized as a dominant factor in the use of radio in airplanes, and it was at first doubted if such use was possible except with visible means of reception. However, by employing special telephones and protective covering to the ears, remarkable success has been attained in spite of the highly adverse conditions.

In addition to the initial reduction in efficiency of the flight radio operator due to flight conditions, there is a cumulative effect due to fatigue as evidenced by the temporary deafness of fliers noticeable immediately after flight. It was suggested after the memorable transatlantic flight of Commander Byrd that one reason for the ineffectiveness of the radio during the last critical hours of this flight was the result of this fatigue over a long period.

As this subject appeared to be one of immediate practical importance, as well as of some scientific interest, an investigation was undertaken by the United States Naval Research Laboratory beginning in July, 1927. This work was authorized by the Bureau of Medicine and Surgery, and carried out at the Anacostia Naval Air Station.

The tool for making the study was available in the form of a standard Western Electric audiometer. This instrument is based on re-

* Dewey decimal classification: R529. Original manuscript received by the Institute, October 28, 1929.

search work of the Bell Telephone Laboratories which is covered in a comprehensive paper by Harvey Fletcher.¹ In order to make the results here presented more easily interpreted by those unfamiliar with this instrument, a brief outline of the underlying theory is offered.

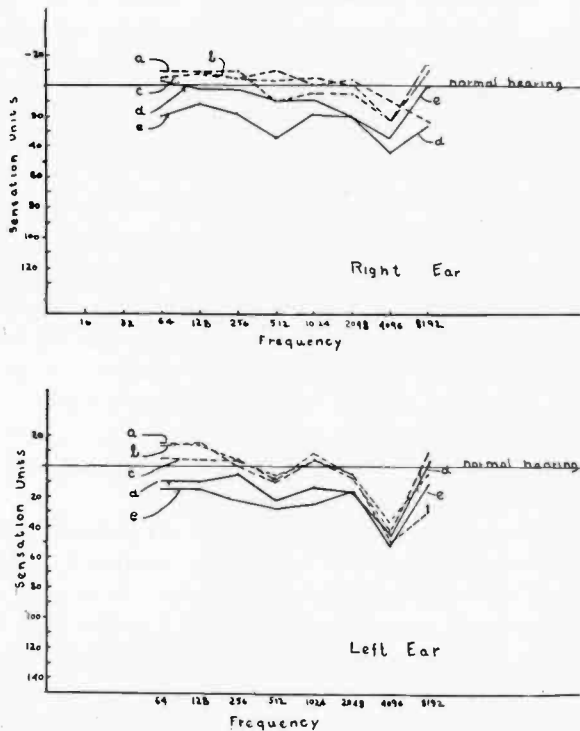

Fig. 1

- (a) 11/7/27; before.
 (b) 11/8/27; before.
 (c) 11/9/27; before.
 (d) 11/9/27; after. Time, 40 min. Plane, D. H. Motor, Liberty. Position, front cockpit. Altitude max., 3000. Altitude avg., 2500. Motor speed, 1400.
 (e) 11/9/27; after. Time, 2 hr. 20 min. Plane, D. H. Motor, Liberty. Position, front cockpit. Altitude max., 8000. Altitude avg., 7500. Motor speed, 1300.

A pure sound has two qualities or dimensions which lend themselves readily to quantitative measurement, namely amplitude and frequency. This suggests a plain figure or area to represent such measurements. Experiment determines the limit of frequency to which the normal ear will respond as from 16 to 16,000 cycles per second. Likewise the maximum limits of intensity which lie in the mid fre-

¹ *Jour. Franklin Institute*, 196, 289, 1923.

quency region, when measured in dynes r.m.s. pressure on the ear drum, fall between 0.001 and 10,000 dynes. This fixes the limiting dimensions of the area of hearing.

The scale for such dimensions is next determined. From observation of the least discernible increment which the ear can detect, it

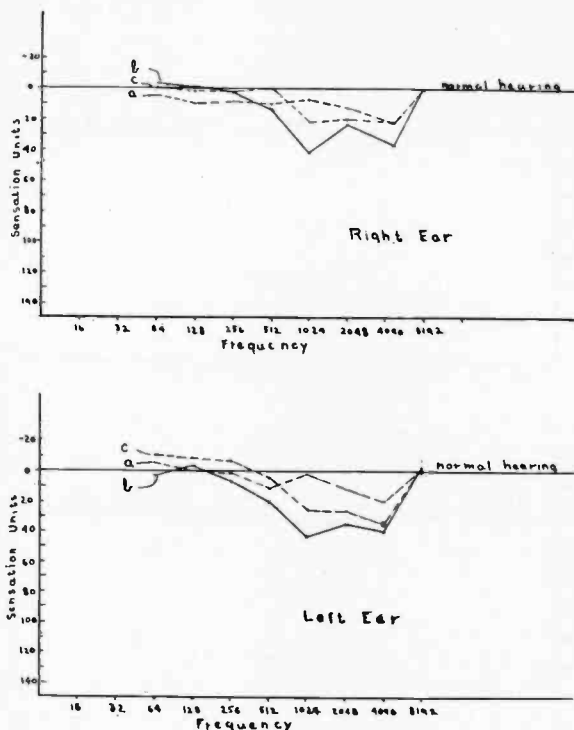

Fig. 2

(a) 11/14/27; before.

(b) 11/16/27; after. Time, 1 hr. 50 min. Plane, 02B2. Motor, Liberty. Position in plane, rear cockpit. Altitude max., 1600. Altitude avg., 1500. Motor speed, 1500 R P M.

(c) 11/16/27; before.

develops that such increments are not constant, but increase logarithmically both for frequency and intensity. It is convenient to choose for the intensity scale a unit which is twenty times the common logarithm of the approximate ratio of least discernible increments in the r.m.s. pressure on the ear drum. This unit is the same as the decibel. For the frequency scale the logarithm of the one hundredth root of two ($\sqrt[100]{2}$) is chosen. The area of audible sound plotted in this fashion has a maximum amplitude dimension at 1000

cycles per second of 270 increments, and a maximum frequency dimension near the one dyne pressure level of 1300 increments.

The entire area represents a total of some 300,000 sounds or sensation units, each differing from all the others in either frequency or intensity. This is the sensation unit which is the basis of the audiometric chart used with the audiometer.

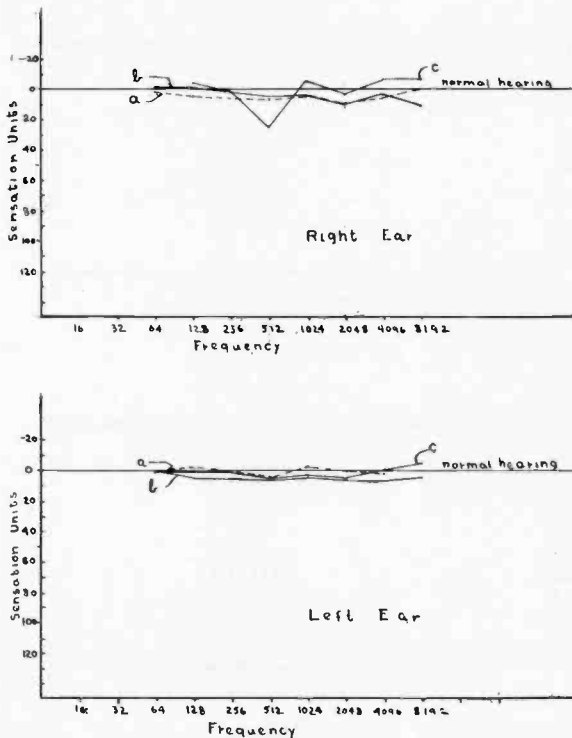

Fig. 3

- (a) 9/13/28; before.
 (b) 9/13/28; after. Time, 1 hr. 15 min. Plane, V01. Motor, Whirlwind (J5). Position in plane, rear cockpit. Altitude avg., 4500. Altitude max., 5000. Motor speed, 1700.
 (c) 7/18/29; after. Time, 7 hr. 20 min. Plane, T4M1. Motor, Pratt Whitney. Position in plane, radiocompass. Altitude max., 5000. Altitude avg., 3000.

The audiometer itself consists of a vacuum-tube oscillator for producing sounds of different frequency, an attenuator for reducing such sounds, and a telephone through which they are applied to one ear of the person whose hearing is to be investigated. The frequency at which the instrument operates is not continuously variable, but changes by multiples of two from 32 cycles to 8192 cycles per second. The

attenuator scale, modified for each frequency, reads directly in sensation units. In use, the attenuator is set for the weakest sound which the subject can hear. The scale then reads loss of hearing in sensation units at that frequency. Dividing by the total number of sensation units discernible to the normal ear at said frequency gives the loss of hearing in percentage.

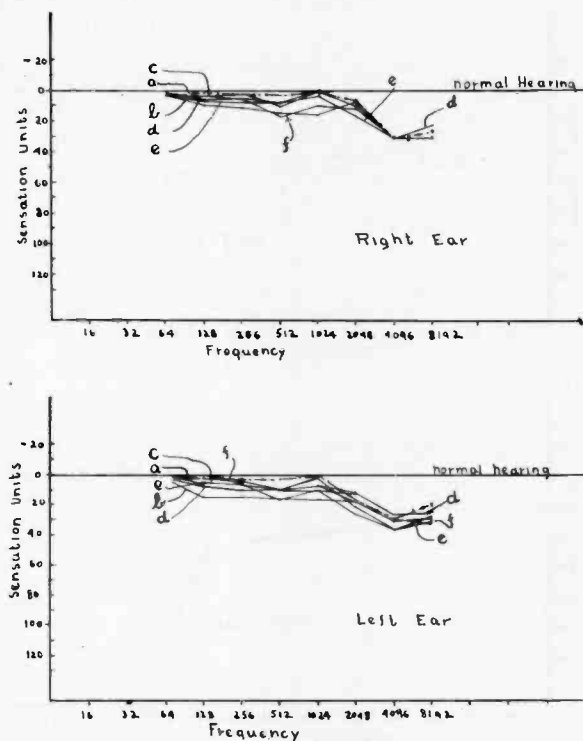

Fig. 4

(a) Average, before 9/12/28; 9/14/28; 9/25/28; 9/28/28.

(b) 9/10/28; after.

(c) 9/14/28; after. Time, 1 hr. 30 min. Plane, V01. Motor, Whirlwind-J5. Position, rear cockpit. Altitude max., 5000. Altitude avg., 5000. Motor speed, 1800.

(d) 9/25/28; after. Time, 50 min. Plane V01. Motor, Whirlwind-J5. Position, rear cockpit. Altitude max., 5000. Altitude avg., 3000. Motor speed, 1750.

It was first undertaken to determine the effect of fatigue by taking measurements before and after flying. The measurements before flight were repeated on several days to check accuracy of procedure and magnitude of variations due to causes other than flight fatigue. The results of such preliminary measurements are shown in separate dotted lines of Figs. 1 to 6, except that to avoid confusion the dotted

line in Fig. 4 is the average of four separate measurements which fell close together.

Each of the subjects for Figs. 1, 2, 3, and 4 had flown for a period of years with total flight time approaching or in excess of 1000 hours, and each has fairly normal hearing. Case one is for a pilot, while the other three are aircraft radio operators of exceptional experience and

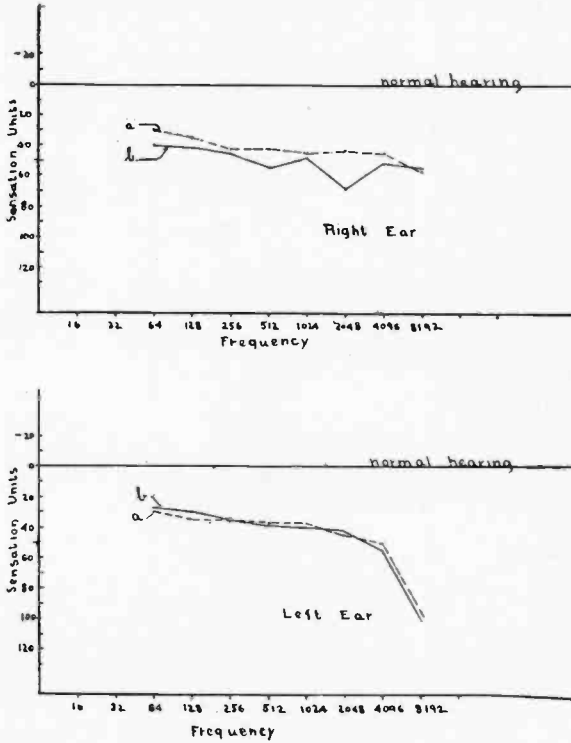

Fig. 5

(a) 9/17/28; before.
 (b) 9/17/28; after. Time, 45 min. Plane, V01. Motor, Whirlwind.
 Position, rear cockpit. Altitude max., 5000. Altitude avg., 5000.

ability. Figs. 5 and 6 are given to show effect of flight where hearing is abnormal. These cases were for observers who had done intermittent flying for a period of years, but with less total flight time than any of the first four. There is no direct evidence that the defects of hearing in either of these cases are in any way due to flying. Fig. 7 shows the results of measurements taken during actual flight to determine the initial loss of hearing due to flight conditions as well as the cumulative effect. Fig. 9 is the result of measurements of two groups, one consisting of 22 men whose duties require regular flights of at least four hours

per month, while the other includes 45 men whose duties require no flying. They have, therefore, flown only occasionally if at all. The purpose of this part of the survey was to determine whether or not flying produced any permanent effect on hearing.

In discussing the results, it may first of all be noted that the method of measurement before and after flight, as shown in Figs. 1, 2, 3 and

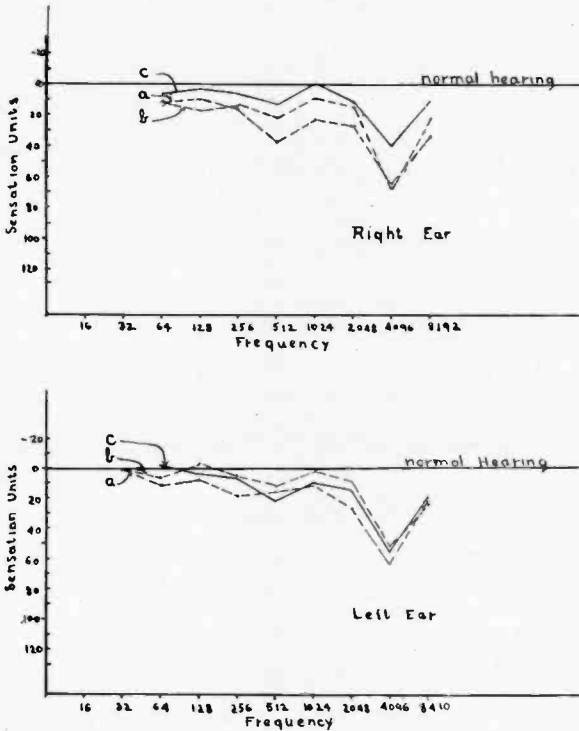

Fig. 6

- (a) 9/29/27; before.
- (b) 9/30/27; before.
- (c) 9/30/27; after. Time, 30 min. Altitude, 8000.

4, gives definite evidence of fatigue, though it varies widely with the individual. On the other hand, method of measurement at successive periods during a long continued flight, as shown in Figs. 7 and 8, shows no evidence of fatigue. This might seem a direct conflict. However, in the first case the measurements were made on a single pure tone in a quiet room, while in the second case the measurements are at a high intensity level, in the presence of strong interference or masking. Putting it another way, the ground measurements deal with only the lower edge of the hearing area previously referred to,

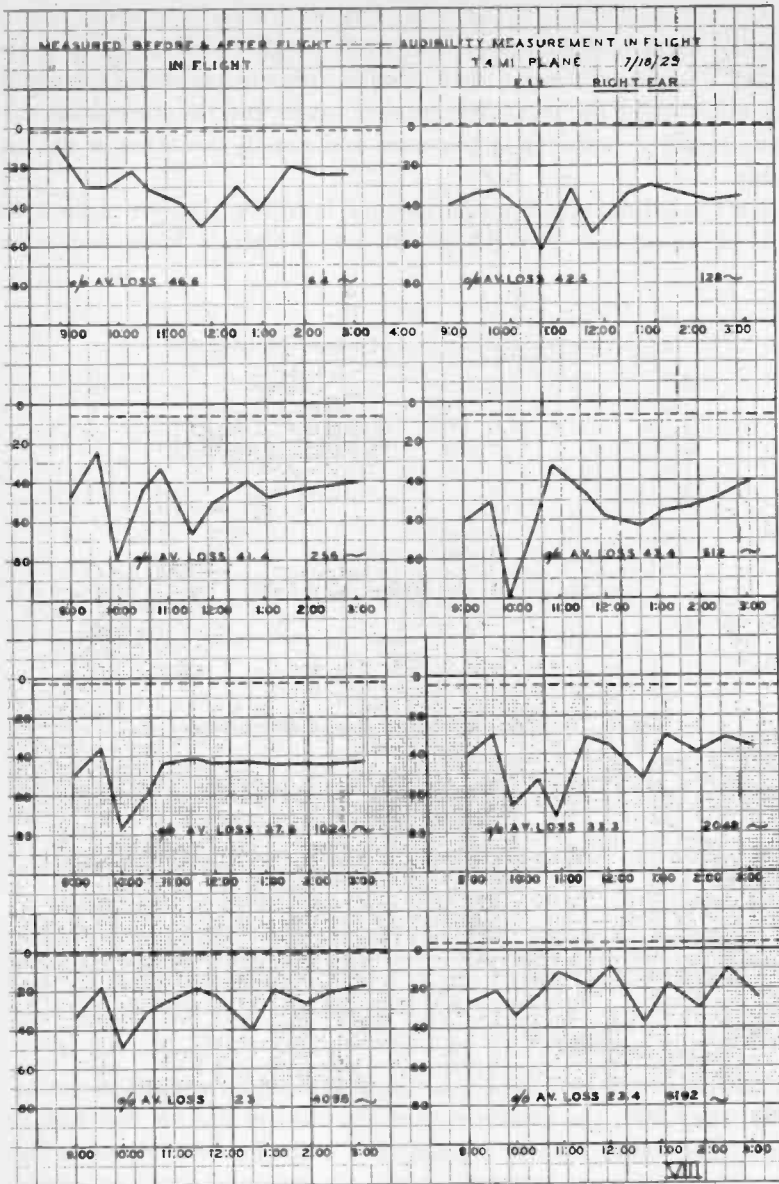

Fig. 8

| Hearing Loss Per cent | 22 Fliers | | | | 45 Non Fliers | | | | Avg. |
|-----------------------|-----------|-----|------|-------|---------------|-------|-------|-------|-------|
| | 64 | 128 | 256 | 512 | 1024 | 2048 | 4096 | 8192 | |
| <i>Right ear</i> | | | | | | | | | |
| (a) Fliers | 8.6 | 6.4 | 8.85 | 11.7 | 9.6 | 12.15 | 26.2 | 22. | 13.19 |
| (b) Non-fliers | 10.9 | 10. | 11.7 | 11.9 | 7. | 8.5 | 17.05 | 15.7 | 11.59 |
| | | | | | | | | diff. | 1.60 |
| <i>Left Ear</i> | | | | | | | | | |
| (a) Fliers | 5.9 | 7. | 7.75 | 10.8 | 8.6 | 14.2 | 25.5 | 21. | 12.59 |
| (b) Non-fliers | 12.9 | 8.7 | 9.8 | 11.35 | 7. | 9.5 | 16.15 | 12.95 | 11.04 |
| | | | | | | | | diff. | 1.55 |

while the flight measurements deal with a region well up toward the middle. There is evidently, then, a wide difference between the conditions under which the measurements are taken, and the conception that fatigue might be evident in one case and not in the other is not untenable.

It is the second set of measurements, however, that are of the most practical importance from the standpoint of aircraft radio communica-

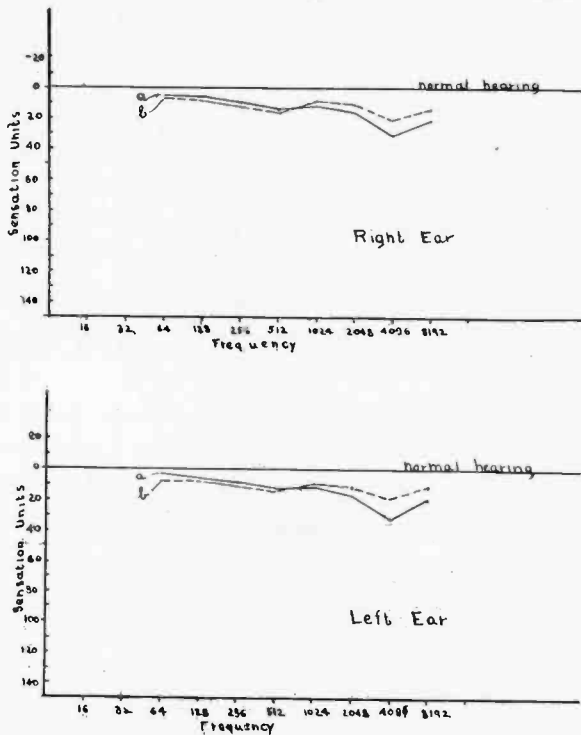

Fig. 9

tion, as these represent the actual conditions under which the operator works; therefore, the evidence that the subject of this test had lost none of his ability to hear signals after eight hours continuous flight is considered of great interest. Again the personal equation must be considered. The subject for this test was the same as for test of Fig. 4, and the record in that case also shows no fatigue, except the loss at 500 cycles shown on curve (c), which is doubted, as there may have been outside interference when this point was taken.

Another condition bearing on this case is that during the flight measurements the subject was in the radio space of a bombing plane

and was much better protected against flight noises than had he been in an open cockpit, as were the subjects during most of the other measurements. But these are the conditions which the radio operator on a long flight would be most apt to have.

Weighing all the evidence here presented, it seems doubtful that flight noises alone will produce any cumulative action which would effect the efficiency of a radio operator during even the longest flights. However, there is still a possibility that such a cumulative effect may result indirectly from the abnormally loud signals required in the telephones to get through the masking of flight noises. It has been noted that a voltage of $\frac{1}{2}$ to 1 volt at telephones is required to be audible in flight, and that during flight such a signal is *barely* audible, while a signal of equal strength on the ground seems almost intolerably loud to the normal ear. One of the experienced operators used as a subject during these tests remarked that he did not experience the buzzing sensations and deafness after flight that he had previously noticed after flights during which he had handled radio traffic almost continuously. In addition to outside signals, his set would naturally be adjusted so that he could hear himself send on his own transmitter, which was of a type confined to output on a single audible frequency. It is then suggested that continued exposure to still more intense sound confined to a single frequency may produce serious cumulative fatigue, though a complex sound covering much of the sound spectrum does not. This point is not covered by experimental work here reported, and therefore remains for future investigation.

It is further to be noted that there is no evidence in Figs. 1 to 4 that fatigue is noticeably intensified at any particular frequency. Neither is one conscious of any excessively pronounced pitch when listening to the flight noises. Though the audiometer does not permit measurement at all frequencies, but only at multiples of one particular frequency, it explores enough of the total area of audition so that the possibility that fatigue at any particular frequency could have existed without detection seems remote.

Figs. 5 and 6 were taken to show the effect of flight on an abnormal ear. Fig. 5 is in line with those preceding it in that such change as is shown in the measurements taken after flight is in the nature of a loss of hearing. Fig. 6, however, is unique in that the right ear showed a marked *gain* after a short flight at high altitude, though the gain is not apparent in measurements of the left ear. This subject is known to have a catarrhal condition of his right ear such as would very possibly produce stoppage of the eustachian tube. It is suggested that the rapid pressure variation due to the quick change in altitude may have

cleared up this stoppage in much the same way that a physician would have done by catheterizing the ear, which might well account for the gain indicated. This case may throw some light on the claims sometimes advanced in the press of "cures" of deafness produced by flying.

Passing to the question of initial impairment of hearing under flight conditions, irrespective of fatigue, Figs. 7 and 8 yield interesting information. The subject for this test was chosen because of his unusually normal hearing, which averaged for all frequencies practically 100 per cent. This is indicated on the charts for each frequency by the dotted lines. The loss in sensation units during flight is shown by the solid lines, while the average percentage loss of hearing is given in Table I.

TABLE I

| AVERAGE PERCENTAGE LOSS OF HEARING DURING FLIGHT FROM FIGURES 7 AND 8 | | |
|---|--------------------|----------|
| Frequency | Right Ear | Left Ear |
| 64 | 46.6 | 56.4 |
| 128 | 42.5 | 46. |
| 256 | 41.4 | 42.4 |
| 512 | 43.4 | 48.5 |
| 1024 | 37.6 | 32.3 |
| 2048 | 33.3 | 26. |
| 4096 | 23. | 14.5 |
| 8192 | 23.4 | 5.6 |
| | Average 36.4 | 33.9 |
| | Average both ears, | 35.1 |

This shows that a normal operator during flight is equivalent in aural efficiency to a man on the ground who has lost about one third of his hearing. That is, one third the total number of sounds making up the sensation area for the normal ear are inaudible to him. It further indicates that the loss diminishes as the frequency increases. This is in line with some of the work on masking.² It immediately suggests itself that a gain might result if radio communication in flight were carried on at a high audible frequency. However, the normal ear is most sensitive to pitches around 1000 cycles per second, and falls off for frequencies both above and below this point.

Therefore, though the loss percentage at higher frequency may be less, the efficiency at lower frequency may remain greater. In any event code reception in planes is usually by continuous wave where the pitch of the received note is under the ready control of the operator. Therefore, he naturally makes the selection of pitch which best suits the conditions and his individual ear. For telephone communication, of course, no selection of audible frequency is possible.

Considerable irregularity in measurements is indicated in Figs. 7 and 8, particularly during the early part of the record. This may have

² H. L. Wegal and C. E. Lane, "Auditory Masking and Dynamics of the Inner Ear," *Phys. Rev.*, February 1924; *Proc.*, American Physical Society, April, 1923.

been due to variation of flight noises with change of engine speed and other conditions of flight, or it may have resulted from lack of experience in taking audiometric measurements under flight conditions. As the subject became more familiar with the procedure he gave a more uniform and positive response to the sound of the instrument. It is not believed that these variations could affect the conclusions which have been drawn from this part of the work.

An angle of the study of interest to all fliers, radio operators or not, is brought out in Fig. 9. This deals with the question of whether the hearing of aviators is permanently affected by continued flight. It shows the measurement of thirty-two fliers as compared with forty-five non-fliers. Many of the measurements were repeated one or more times, so that about 150 sets were taken in all. Unfortunately, no detailed information is available as to the total individual flight time of the flying group, but they were most all experienced men who had flown regularly and continuously for a period of years. The results show an average loss by the fliers about 1.5 per cent greater than for the non-fliers, most of this being at the higher frequencies. Thus at 4096 cycles the hearing of the fliers falls below that of non-fliers about 8 per cent. Whether this lowering of sensitivity at the upper frequencies is a particular effect of flying, or because the general run of ear troubles involve these frequencies first, is not determined. While there is this evidence of a definite permanent loss of hearing resulting from flight, it is quite clear that it does not always result. For example, the subject of Figs. 4, 7, and 8, who, as previously stated, shows exceptionally good hearing, is one of those who has done the most flying.

While it is felt that the subject is far from exhausted, and that the work here described is by no means complete, fairly definite conclusions on several important points seem to be justified:

- (a) From the standpoint of the normal radio operator on the ground the best operator in flight is at least one third deaf and his receiving equipment should be designed with due reference to this fact.
- (b) While there is definite evidence of fatigue *after* flight, the fatigue produced by normal flight noises does not appear to be selective as to frequency.
- (c) There is no evidence of fatigue produced by normal flight noises *during* flight.
- (d) There is evidence of a small but definite permanent loss of hearing among experienced aviators, though such loss is not universal and is limited to the high frequencies.

(e) It would seem highly desirable that service men chosen for training as aircraft radio operators be carefully selected by means of audiometric measurements; to be sure that they possessed good hearing, particularly at the higher frequencies. Moreover, such measurements should be repeated from time to time as their service progressed.

It is desired to acknowledge the cooperation of the officers and men of the Anacostia Naval Air Station who became subjects for these tests, and to express particular appreciation of the collaboration of the medical officer, Lt. Comdr. W. W. Davies, under whose supervision the work was carried out.



BOOK REVIEWS

Radiotechnik: VI. Die Elektrischen Wellen, by DR. F. KIEBITZ. Sammlung Göschen, Berlin and Leipzig, Walter de Gruyter & Co., 1929, 125 pages. Price 1.50 RM.

This excellent semi-popular account of electric waves forms the sixth volume on radio to appear in the well-known Göschen series. Commencing with the elements of electrical theory, the book deals successively with the Hertz experiments, radiation resistance, the nature of electromagnetic waves, and wave propagation around the earth. Considerable space is devoted to directive antennas. Unfortunately but little attention is paid to the ionized layer, skip distances, and echoes.

W. G. CADY†

† Wesleyan University, Middletown, Conn.

Elements of Radio Communication, by JOHN H. MORECROFT, John Wiley & Sons, Inc., 1929. 269 pp. 170 illus.

"The Elements of Radio Communication" is an adequate and comprehensive text book on radio communication stressing particularly the field of broadcast receiver design. It develops the subject in a natural and conventional progression using language suited to the needs of an elementary college course. The fundamental principles of apparatus design are largely applied to the broadcast receiver and its associated equipment. The mathematical treatment, with very few exceptions, does not range beyond the field of advanced algebra.

As one would expect from such an experienced teacher as Professor Morecroft, his scholarly style and workmanlike presentation have been skilfully applied with the requirements of instruction purposes in mind. Practical problems for each chapter are given to test the student's mastery of the text. The keynote throughout the work is practical application rather than theoretical dissertation. Complete data descriptive of the vacuum tubes used in modern receivers, radio-frequency amplifiers of conventional design used in broadcast reception, and the full gamut of associated equipment, such as power supply devices and reproducers, are adequately covered. Although broadcast transmission equipment is naturally stressed in the consideration of that field, the spark transmitter, the high-frequency alternator, and single sideband transmission are not overlooked.

The work is a needed contribution to radio literature, successfully bridging the gap between the more comprehensive studies of the subject, of which there is no better example than the same author's "The Principles of Radio Communication," and the "popular" works on the subject which confine themselves to the generalities. It is suited to the needs of the embryo commercial engineer and laboratory worker and as a text book for elementary college courses.

EDGAR H. FELIX†

† Radio consultant, National Electric Manufacturers' Association, New York City.

BOOKS RECEIVED

Transmission Networks and Wave Filters, by T. E. Shea, member of the technical staff, Bell Telephone Laboratories. Published by D. Van Nostrand Company, Inc., 1929. 470 pages, illustrated, 6 x 9 inches, cloth binding. Price \$6.50. Contents: Part I, principles of transmission networks; external performance of networks—conditions for network equivalences—some important network parameters; effect of impedance mismatching at the terminals of a network—reflection factor—interaction factor; properties of two-terminal impedance arms. Part II, electric wave filters: general—conditions for free transmission and for attenuation; the more common types of filter sections; the formation of multisection filters—low-pass, high-pass, band-pass, and band-elimination types; terminal effects: reflection and interaction losses—total insertion loss characteristics. Part III, composition of transient waves: resolution of steady state waves into frequency components by Fournier series analysis; resolution of transient waves into frequency components by Fournier integral analysis. Appendix A, bibliography; Appendix B, relation between decibels and current, voltage and power ratios; index.

Fundamentals of Radio, by R. R. Ramsey, Professor of Physics, Indiana University. Published by Ramsey Publishing Company, Bloomington, Indiana. 372 pages, illustrated, 6 x 9 inches, cloth binding. Contents: electricity, direct current; batteries; measurement of resistance; alternating current; introduction to radio; capacity; inductance; radio waves—radio current—transmission; detectors; vacuum tubes; vacuum-tube constants; the vacuum tube used as a detector; the tube as an amplifier; the tube as an oscillator; coupled circuits; how radio messages are transmitted by the ether; radiation from an aerial; aeriels; radio-frequency instruments and apparatus; radio resistance; spark transmission; long-wave CW transmitters; vacuum-tube transmitters; radio telephone; receivers; audio amplification; balanced circuits; loud speakers; rectified alternating current; applications of the vacuum tube.

BOOKLETS, BULLETINS, AND CATALOGS RECEIVED

The Central Scientific Company of 460 East Ohio Street, Chicago, Ill., has available for free distribution copies of its new technical publication, "High Vacuum Engineering," which deals with vacuum pumps and their specific application to the exhaustion of radio tubes.

The "Resistance Handbook" of the Gilby Wire Company, Newark, N. J., contains a considerable amount of data concerning nickel and its alloys, particularly those used in radio equipment.

Two booklets, "About Vitreosil" and "Vitreosil for the Laboratory" are available from the Thermal Syndicate, Ltd., 58 Schenectady Avenue, Brooklyn, N. Y. These describe the uses of, its characteristics, and the forms in which vitreosil may be obtained.

"Rare Metals," distributed by the Fansteel Products Co., Inc., of North Chicago, Ill., is a booklet devoted to the history, properties, and uses of tantalum, tungsten, and molybdenum.

A booklet describing bakelite varnish can be obtained from the Bakelite Corporation, 247 Park Avenue, New York City.

A very brief list of the physical and electrical characteristics of isolantite may be obtained from the Isolantite Company of America, Inc., 551 Fifth Avenue, New York City.

Hardwick-Hindle, Inc., of 215 Emmet Street, Newark, N. J., have recently issued their new catalog No. 929 covering "Volume Faders" and catalog No. 429 on "Resistors." These may be had upon request.

A series of folders describing synthane, a laminated bakelite, may be obtained by addressing the Synthane Corporation, Oaks, Pa.

The Shallcross Mfg. Co. will be pleased to supply without charge copies of its catalog on Super Akra-Ohm, wirewound resistors which may be obtained in values up to five megohms. They may be addressed at 700 Parker Avenue, Collingdale, Pa.

The Supreme "Diagnometer" is described in a booklet issued by the Supreme Instruments Corporation of Greenwood, Miss.

"Instructions for Servicing Radio Receivers" is the name of a new booklet issued by the Jewell Electrical Instrument Co. of 1640 Walnut Street, Chicago, Ill. It may be obtained upon request and contains service data in chart form on more than a hundred standard commercial receivers.

MONTHLY LIST OF REFERENCES TO CURRENT RADIO LITERATURE

THIS is a monthly list of references prepared by the Bureau of Standards and is intended to cover the more important papers of interest to professional radio engineers which have recently appeared in periodicals, books, etc. The number at the left of each reference classifies the reference by subject, in accordance with the scheme presented in "A Decimal Classification of Radio Subjects—An Extension of the Dewey System," Bureau of Standards Circular No. 138, a copy of which may be obtained for 10 cents from the Superintendent of Documents, Government Printing Office, Washington, D. C. The various periodicals can be secured from their publishers and can be consulted at large public libraries.

R100. RADIO PRINCIPLES

- R113.4 Hulburt, E. O. Ionization in the atmosphere of Mars. *Proc. I. R. E.*, 17, pp. 1523-27; September, 1929.

(The composition of the atmosphere of Mars to great heights is calculated on certain assumptions and the electron density in the atmosphere due to the ultraviolet light of the sun is theoretically found. Calculated skip distances indicate 47 meters as the shortest wave for reliable long distance wireless communication over the surface of Mars. The improbability of interplanetary radio communication is pointed out.)

- R113.4 Hafstad, L. R. and Tuve, M. A. Further studies of the Kennelly-Heaviside layer by the echo method. *Proc. I. R. E.*, 17, pp. 1513-23; Sept., 1929.

(Recent observations of the Kennelly-Heaviside layer by the echo method are reported. Two 24-hour series of observations showed a marked diurnal variation in the effective height of the layer and in the echo pattern received for each transmitted "peak." The pattern was most complex at night. Observations during magnetic disturbances showed an unusually great effective height and a change in the echo pattern.)

- R113.5 Anderson, C. N. Notes on the effect of solar disturbances on transatlantic radio transmission. *Proc. I. R. E.*, 17, pp. 1528-35; Sept., 1929.

(The effects of magnetic storms on 60-kc transatlantic radio transmission and also on short-wave radio transmission are shown. In general individual storms tend to increase 60-kc daylight signal intensities and to decrease high-frequency signal field intensities.)

- R113.6 Breit, G. Group velocity and long retardations of radio echoes. *Proc. I. R. E.*, 17, pp. 1508-12; Sept., 1929.

(van der Pol's hypothesis that group velocity may account for the retardations (up to 15 sec.) of echoes observed by Störmer is analyzed. It is shown that only under special circumstances can the electron distribution in the Kennelly-Heaviside layer be proper. A favorable condition is obtained if the refractive index decreases exponentially with the height.)

- R113.6 Taylor, A. H. and Young, L. C. Studies of echo signals. *Proc. I. R. E.*, 17, pp. 1491-1507; September, 1929.

(Work reported in the *Proc. I. R. E.* for May, 1928, by the same authors has been continued as a more extended study of echo signals with particular reference to directional characteristics and to diurnal variations. Attention has been given to the relations between echo signals, frequency and the effective height of the Kennelly-Heaviside layer.)

- R113.6 Pedersen, P. O. Wireless echoes of long delay. *Det. Kgl. Danske Videnskabernes Selskab* (Mathematical and Physics number, 48 pages), 9; 1929.

(Shows mathematically that radio echoes occurring after 10 seconds cannot be due to propagation of waves within the earth's atmosphere, that echoes occurring after intervals up to 30 seconds are due to propagation along or reflection from Störmer bands as explained in *Nature* (122, p. 681, 1928) that echoes after several minutes must be from outside the space in which the earth's magnetic field exerts appreciable effect. Transmissions at various wavelengths are also treated.)

- R125 Zusammenfassender Bericht: Ueber Fehlweisung bei der Funkpeilung (Summary report: On errors observed in direction-finder bearings). *Zeits. fur Hochfrequenztechnik*, 34, pp. 60-65; August, 1929.
- R130 Chaffee, E. L. Equivalent circuits of an electron triode and the equivalent input and output admittance. *Proc. I. R. E.*, 17, pp. 1633-48; Sept., 1929.
(Two fundamental equivalence theorems concerning a triode and its circuits are derived. They give the single circuits which are equivalent to the plate and grid circuits of the triode, and contain only constant circuit elements and fictitious electromotive forces, the use of which greatly simplifies the calculation of currents in the triode circuits when the electrical variations are small. The equivalence theorems are used to obtain the equivalent input and internal output admittances of a triode with its associated circuits.)
- R130.4 Rockwood, A. C. and Ferris, W. R. Microphonic improvement in vacuum tubes. *Proc. I. R. E.*, 17, pp. 1621-32; September, 1929.
(The causes and effects of microphonic disturbances in small receiving tubes is discussed. Methods of testing the microphonic qualities of tubes are described. A new type of tube with low microphonic output but with low filament power for use when microphonic troubles may be serious is also described and its characteristics are given.)
- R131 Sowerby, A. L. M. The pentode as an anode rectifier. *Wireless Wld. and Radio Rev.*, 25, pp. 283-286; Spet. 18, 1929.
(Curves, experimentally obtained are given to show the high sensitivity and large output obtainable through the use of the pentode as a plate rectifier. (To be concluded).)
- R131 Colebrook, F. M. The triode valve equivalent network. *Experimental Wireless and W. Engr.* (London), 6, pp. 468-87; September, 1929.
(From an analysis of the equivalent network of a tube expressions are developed for the input admittance and the voltage amplification in terms of the known tube constants and the lead in the anode circuit. Deductions are made from the expressions for audio frequencies and for radio frequencies and are expressed in curves.)
- R132 Möller, H. G. Berechnung des günstigsten Durchgriffes der Röhren in Widerstandsverstärker. (Calculation of the optimum amplification factor for tubes used in resistance-coupled amplifiers.) *Zeits. fur Hochfrequenztechnik*, 34, pp. 53-56; August, 1929.
(Theory and method of measurements.)
- R133 Heegner, K. Ueber Schwingungserzeugung mittels eines Elektronenrohrensystems, bei welchem die Kapazität von untergeordneter Bedeutung ist. (The production of oscillations by means of vacuum tube systems wherein the capacity is of subordinate importance.) *Zeits. fur Hochfrequenztechnik*, 34, pp. 49-52; Aug., 1929.
(Description and theory of operation of two-tube circuit containing only L and R . Discussion of its peculiar properties is given.)
- R134 Beers, G. L. Power detectors produce superior results in radio receivers. *Electric Journal*, 26, pp. 413-415; September, 1929.
(Curves experimentally obtained are given to show the superiority of the negatively biased detector over the grid-leak-condenser detector in receivers using a power detector and a single stage of audio-frequency amplification.)
- R140 Winter-Gunther, H. Ueber die selbsterregten Schwingungen in Kreisen mit Eisenkernspulen. (The self-induced oscillations in circuits containing iron-cored inductance.) *Zeits. fur Hochfrequenztechnik*, 34, pp. 41-49; August, 1929.
(Description and mechanical analogy.)
- R141.1 Pack, S. W. C. The frequency departure of thermionic oscillators from the LC value. *Experimental Wireless and Wireless Engr.* (London), 6, pp. 472-80; September, 1929.

(The preliminaries of an investigation into the departure of the frequency of a tube a-c generator from the "LC" value under varying conditions of grid coupling, grid bias, filament current, plate voltage, and added resistance in the oscillatory circuit are described. The theory of the frequency of an electron tube generator is outlined.)

- R150 Vincent, J. H. Experiments on magnetostrictive oscillators at radio frequencies. *Proc. Phys. Soc. (London)*, 41, pp. 476-86; August, 1929.

(An account is given of the behavior of two magnetostriction oscillators 6 mm and 4.5 mm in length, when placed in a coil in series with the main induction coil of a simple electron tube maintained oscillating circuit. The frequency characteristic of the smaller oscillator was 540 kc per sec.)

- R162 Colebrook, F. M. The definition of selectivity. *Experimental Wireless and W. Engr. (London)*, 6, 422-24; August, 1929.

(The distinction between the selectivity of a radio circuit and its sharpness of tuning is discussed and a formulation is suggested. The application of the formulation to certain cases is made in an appendix.)

- R170 Van Etta, E. and White, E. L. Radio interference from line insulators. *Jour. A. I. E. E.*, 48, pp. 682-86; September, 1929.

(Discussion of the causes of radio interference from insulators on high-voltage equipment. Present methods of eliminating this kind of disturbance are explained and the question of future design is discussed.)

R200. RADIO MEASUREMENTS AND STANDARDIZATION

- R214 Harding, J. W. and White, F. W. G. On the modes of vibration of a quartz crystal. *Philosophical Mag. (London)*, 8, pp. 169-179; August, 1929.

(Four models showing the possible normal modes of vibration of a quartz crystal are constructed—a longitudinal and a transverse mode for each of the two directions of the alternating field. The patterns formed by lycopodium powder on the surfaces of the vibrating crystal are the bases of the construction.)

R300. RADIO APPARATUS AND EQUIPMENT

- R344.3 Page, R. M. An investigation of the phenomena of frequency multiplication as used in tube transmitters. *Proc. I. R. E.*, 17, pp. 1649-55; September, 1929.

(An experimental investigation of the commonly used method for obtaining crystal control of high-frequency transmitters from crystals of lower frequency by means of a frequency multiplying vacuum-tube amplifier is described. Satisfactory operation of the amplifier is shown to depend upon the inductive reactance in the grid circuit which produces regeneration through the grid-plate feedback in the tube.)

- R386 Hirsch, C. J. Notes on the design of r. f. band-pass filters. *Radio Engineering*, 9, pp. 31-33; September, 1929.

(Mathematical treatment of band-pass filter design in reference to the screen-grid tube.)

R500. APPLICATIONS OF RADIO

- R565 Hooper, S. C. Naval communications—Radio Washington. *Proc. I. R. E.*, 17, pp. 1595-1620; September, 1929.

(The radio facilities of Radio Washington are described. There is included a brief description of receiving equipment, and of methods of control of transmitters in use at the Navy Department, Radio Central, and of the transmitting equipment installed at Arlington, Va., and Annapolis, Md.)

- R582 Jenkins, C. F. The drum scanner in radiomovies receivers. *Proc. I. R. E.*, 17, pp. 1576-1583; September, 1929.

(A description is given of the Jenkins drum scanner for use in television. Its advantages over the disk scanner are pointed out.)

- R582 Horton, J. W. The electrical transmission of pictures and images. *Proc. I. R. E.*, 17, pp. 1540-63; September, 1929.

(Some of the important principles underlying the electrical transmission of pictures are discussed. The subject is treated as a special form of electrical communication. The dependence of the rate at which information is transmitted upon the frequency range occupied by the signal is shown to be of fundamental importance. The relations between the original picture and the transmitted signal as it appears in the several factors of the system are studied.)

- R582 Goldsmith, A. N. Image transmission by radio waves. *Proc. I. R. E.*, 17, pp. 1536-39; September, 1929.

(A general outline of the problems of facsimile transmission and television, and their development, introductory to papers presented at the 1929 Institute of Radio Engineers Convention in Washington, D. C.)

- R582 Ranger, R. H. Mechanical developments of facsimile equipment. *Proc. I. R. E.*, 17, pp. 1564-75; September, 1929.

(Recent mechanical developments in equipment for photoradio facsimile transmission are described.)

- R582 Weinberger, J., Smith, T. A., and Rodwin, G. The selection of standards for commercial radio television. *Proc. I. R. E.*, 17, pp. 1584-94; September, 1929.

(The basis of a system of television standards suitable for commercial television service with specific standards is discussed. The elements considered in this paper are: picture proportion, number of scanning elements, number of picture repetitions per second, scanning method and direction, and phase of transmitted current.)

R600. RADIO STATIONS: EQUIPMENT, OPERATION AND MANAGEMENT

- R613 Lamb, J. J. WTIC, a modern 50-kw broadcast station. *QST*, 13, pp. 9-16; October, 1929.

(Description of a modern broadcast station.)

RS00. NON-RADIO SUBJECTS

- R537.1 Biedermann, E. A. Potential difference and electromotive force. *Experimental Wireless and W. Engr.* (London), 6, pp. 481-485; September, 1929.

(A discussion of the definition of "potential difference" proposed by R. M. Wilmotte (*Experimental Wireless and W. Engr.*, November, 1928) is presented. Faults are found and it is proposed to generalize the definition of potential difference between points as the line integral between those points of only that force which depends on the charge distribution.)



CONTRIBUTORS TO THIS ISSUE

Diamond, Harry: See PROCEEDINGS for February, 1929.

Drake, F. H.: See PROCEEDINGS for February, 1929.

Eisner, Franz: Born December 13, 1893 at Berlin, Germany. Graduate of Königstadtische Oberrealschule of Berlin; studied electrotechnics at Technical University of Berlin; training in Railway Workshop I, Markgrafendamm. War service, field artillery regiment No. 18, October, 1914, to November, 1918. Honorary assistant, helping assistant, and regular assistant, Electrotechnical Laboratory, Technical University of Berlin, 1920-1926. Received Dr. Ing. degree, Technical University of Berlin, 1927. Assistant at German Institute for Aviatric Research, Inc., Berlin-Adlershof, Department of Radio Business and Electrotechnics since January 1, 1927.

Fassbender, Heinrich: Born June 23, 1884 at Frankfort-on-Main. Received Ph. D. degree, University of Marburg, 1908. Engineer, Siemens and Halske A. G., 1908-1910; assistant at the Physikalisch-Technische Reichsanstalt, 1910-1913; lecturer and construction engineer, Electrotechnical Institute, Technical University of Berlin, 1913-1920. Substituting president, Electrotechnical Institute, University of Aachen, summer of 1919; editor Year Book of Wireless Telegraphy and Telephony, 1921; regular professor and director, Department of Electrotechnics and Machine Building of the Engineers' Faculty, University of La Plata, 1922-1926; professor, Technical University of Berlin and manager of the Department of Radio Business and Electrotechnics of the German Institute for Aviatric Research, Inc., Berlin-Adlershof, since 1926.

Hyland, Lawrence A.: Born 1897. U. S. Army, 1917-1919; U. S. Navy, 1920-1926; Army field communications, naval aviation communications ashore and afloat. Associate radio engineer, Aircraft Section, Radio Division, Naval Research Laboratory engaged in development of aviation communications equipment, 1926 to date. Associate member, Institute of Radio Engineers, 1929.

Jackson, William E.: Born May 8, 1904 at Bridgewater, Mass. Received B. S. degree in E. E., Brown University, 1925. Westinghouse Electric and Manufacturing Company, 1923; New England Telephone and Telegraph Company, 1924; radio engineer, Radio Department, General Electric Company, 1925-1927; radio engineer, Department of Commerce, Airways Division, Bureau of Lighthouses, 1927 to date. Associate member, Institute of Radio Engineers, 1929.

Kear, F. G.: Born 1903 at Minersville, Pennsylvania. Received E. E. degree, Lehigh University, 1926; M. S. degree, Massachusetts Institute of Technology, 1928. Instructor. M. I. T., 1926-1928. Engaged in research on machines for solving differential equations by graphic methods. Assistant physicist, Bureau of Standards, 1928 to date, working on radio aids to air navigation. Associate member, Institute of Radio Engineers, 1924.

Mirick, C. B.: See PROCEEDINGS for June, 1929. Transferred to Member grade, Institute of Radio Engineers, September, 1929.

Seymour, Lester D.: Born 1892 at Wolcott, New York. Received E. E. degree, Syracuse University, 1916; post graduate course in aeronautical engineer-

ing, Ecole Superieure d'Aeronautique, Paris; served in France in U. S. Air Service and, after war, as consulting aeronautical engineer in office of chief of Air Service. General manager, National Air Transport, Inc. Member, Society of Automotive Engineers and International Aviators' club.

Walls, H. J.: Born January 7, 1898 in West Virginia. Received B. S. degree in E. E., West Virginia University, 1920. Western Electric engineering laboratory, 1921; instructor in electrical engineering, West Virginia University, 1921-1922; Radio Section, Bureau of Standards, 1922-1925; Bureau of Lighthouses, 1925 to date.

Wilmotte, Raymond M.: Born 1901. Received B. A. degree, Cambridge University, England, 1922; M. A. degree from same institution. Metropolitan Vickers Manufacturing Co.; scientific staff, National Physical Laboratory, Teddington, England, 1923-1929. At present radio engineer, Aircraft Radio Corporation, Boonton, New Jersey. Associate member, Institution of Electrical Engineers, London. Received several awards for research work. Member, Institute of Radio Engineers, 1929.



INDEX TO THE PROCEEDINGS
of the
INSTITUTE OF RADIO ENGINEERS
Volume 17—1929

This index contains a list of all papers, discussions, and book reviews published in the PROCEEDINGS during 1929. It is a continuation of the 14-year index* (1909–1926 inclusive) published in 1927, and of the subsequent index (1927–1928) published in the 1929 Year Book. † Papers, discussions, and book reviews are listed chronologically, alphabetically by subject, and alphabetically by author.

Numberings in the chronological index are in sequence, the first paper below bearing the number following the last number listed in the 1927–1928 index. In the subject and author indices numbers refer to the chronological list.

CHRONOLOGICAL INDEX

| | <i>Page</i> |
|---|-------------|
| Number 1; January, 1929 | |
| 550. A Direct Reading Radio-Frequency Meter, by R. C. Hitchcock . . . | 24 |
| 551. On the Determination of the Optimum Radiation Angle for Horizontal Antennas, by A. Meissner and H. Rothe | 35 |
| 552. Magnetostriction Oscillators, by George W. Pierce | 42 |
| 553. The Importance of Radiotelegraphy in Science, by J. Zenneck . . . | 89 |
| 554. An Auxiliary Frequency Control for R. F. Oscillators, by G. F. Lampkin | 115 |
| 555. A Method of Treating Resistance Stabilized Radio-frequency Amplifying Circuits, by B. L. Snavely and J. S. Webb | 118 |
| 556. The Piezo-Electric Crystal Oscillator, by J. Warren Wright | 127 |
| 557. Fading Curves and Weather Conditions, by R. C. Colwell | 143 |
| 558. Detection Characteristics of Three-Element Vacuum Tubes, by Frederick Emmons Terman and Thomas M. Googin | 149 |
| 559. Filtering Antennas and Filter-Valve Circuits, by Jozef Plebanski . . | 161 |
| 560. Discussions on The Receiving System for Long-Wave Transatlantic Radio Telephony (Dec. 1928, pp. 1645, by Austin Bailey, S. W. Dean, and W. T. Wintringham) | 174 |
| 561. Discussion on Detection with the Four-Electrode Tube, (June, 1928, pp. 822, by J. R. Nelson) by F. B. Llewellyn | 185 |
| 562. Book Review: A Bibliography of Electrical Literature, prepared by Massachusetts Institute of Technology; reviewed by R. R. Batcher | 187 |
| Number 2; February, 1929 | |
| 563. On the Mechanism of Electron Oscillations in a Triode, by H. E. Hollmann | 229 |
| 564. A Convenient Method for Referring Secondary Frequency Standards to a Standard Time Interval, by L. M. Hull and J. K. Clapp | 252 |

* Can be obtained from the Institute. Price \$1.00.

† Can be obtained from the Institute. Price \$1.50.

| | <i>Page</i> |
|--|-------------|
| 565. A System for Frequency Measurements Based on a Single Frequency, by E. L. Hall | 272 |
| 566. Receiving Sets for Aircraft Beacon and Telephony, by Haraden Pratt and Harry Diamond | 283 |
| 567. An Aircraft Radio Receiver for Use with Rigid Antenna, by F. H. Drake | 306 |
| 568. Circuit Analysis Applied to the Screen-Grid Tube, by J. R. Nelson | 320 |
| 569. The Effect of Regeneration on the Received Signal Strength, by Balth. van der Pol | 339 |
| 570. Reception Experiments in Mount Royal Tunnel, by A. S. Eve, W. A. Steel, G. W. Olive, A. R. McEwan, and J. H. Thompson | 347 |
| 571. A Note on the Directional Observations on Grinders in Japan, by Eitaro Yokoyama and Tomozo Nakai | 377 |
| 572. On the Behavior of Networks with "Normalized" Meshes, by E. A. Guillemin and W. Glendinning | 380 |

Number 3; March, 1929

| | |
|---|-----|
| 573. Radio Direction-Finding by Transmission and Reception, (with particular reference to its application to marine navigation), by R. L. Smith-Rose | 425 |
| 574. Some Experiments in Short-Distance Short-Wave Radio Transmission, by J. K. Clapp | 479 |
| 575. Wireless Telegraphy and Magnetic Storms, by E. O. Hulburt and H. B. Maris | 494 |
| 576. Recent Developments in Superheterodyne Receivers, by G. L. Beers and W. L. Carlson | 501 |
| 577. An Extension of the Method of Measuring Inductances and Capacities, by Sylvan Harris | 516 |
| Discussion by R. R. Batcher | 518 |
| 578. Apparent Equality of Loudspeaker Output at Various Frequencies, by L. G. Hector and H. N. Kozanowski | 521 |
| 579. Facsimile Picture Transmission, by V. Zworykin | 536 |
| 580. Notes on Grid-Circuit Detection, by J. R. Nelson | 551 |
| 581. The Radiation Resistance of Beam Antennas, by A. A. Pistolokors | 562 |
| 582. Discussion on Simple Inductance Formulas for Radio Coils, (October, 1928, pp. 1398, by Harold A. Wheeler) by R. R. Batcher and Harold A. Wheeler | 580 |

Number 4; April, 1929

| | |
|---|-----|
| 583. Frequency Multiplication by Shock Excitation, by E. A. Guillemin and P. T. Rumsey | 629 |
| 584. On the Short-Wave Limit of Magnetron Oscillations, by Kinjiro Okabe | 652 |
| 585. The Use of the Electron Tube Peak Voltmeter for the Measurement of Modulation, by C. B. Jolliffe | 660 |
| 586. Radio Receiver Testing Equipment, by Kenneth W. Jarvis | 664 |
| 587. Measurements of the Height of the Kennelly-Heaviside Layer, by G. W. Kenrick and C. K. Jen | 711 |
| 588. Measurement of the Frequencies of Distant Radio Transmitting Stations, by G. Pession and T. Gorio | 734 |
| 589. Note on Earth Reflection of Ultra Short Radio Waves, by E. H. Lange | 745 |
| 590. Discussion on Principles of Grid-Leak Grid-Condenser Detection (October, 1928, pp. 1384, by F. E. Terman), by W. J. Polydoroff | 752 |
| 591. Book Reviews: <i>Donnees Numeriques de Radioelectricite</i> , edited by R. Mesny; reviewed by W. G. Cady | 755 |

Number 5; May, 1929

| | |
|--|-----|
| 592. Double and Multiple Signals with Short Waves, by E. Quack and H. Mogel | 791 |
| 593. Short Range Echoes with Short Waves, by E. Quack and H. Mogel | 824 |
| 594. Detection Characteristics of Screen-Grid and Space-Charge-Grid Tubes, by F. E. Terman and Birney Dysart | 830 |
| 595. A Direct Reading Frequency Bridge for the Audio Range, Based on Hay's Bridge Circuit, by Chester I. Soucy and B. DeF. Bayly | 834 |
| 596. Voltage Surges in Audio-Frequency Apparatus, by Elmer H. Fisher | 841 |
| 597. Cold Cathode Rectification, by A. E. Shaw | 849 |
| 598. Vacuum-Tube Voltmeter Design, by Harry R. Lubeke | 864 |
| 599. Field Intensity Characteristics of Double Modulation Type of Directive Radio Beacon, by Haraden Pratt | 873 |
| 600. Logarithmic Scale for Beat-Frequency Oscillator, by E. R. Meissner | 879 |
| 601. Radio Interference, by James G. Allen | 882 |
| 602. Discussion on Reception Experiments in Mount Royal Tunnel (February, 1929, pp. 347), by Carl R. Englund and A. S. Eve | 892 |
| 603. Discussion on Facsimile Picture Transmission (March, 1929, by V. Zworykin) | 895 |
| 604. Book Review: Handbuch der Experimentalphysik, edited by Wein-Harms; reviewed by K. S. Van Dyke | 901 |

Number 6; June, 1929

| | |
|---|------|
| 605. Reciprocity in Electromagnetic, Mechanical, Acoustical, and Interconnected Systems, by Stuart Ballantine | 929 |
| 606. Reciprocal Theorems in Radio Communication, by John R. Carson | 952 |
| 607. The Measurement of Direct Interelectrode Capacitance of Vacuum Tubes, by A. V. Loughren and H. W. Parker | 957 |
| 608. Photoradio Developments, by R. H. Ranger | 966 |
| 609. Grid Losses in Power Amplifiers, by E. E. Spitzer | 985 |
| 610. Mathematical Theory of the Four-Electrode Tube, by J. G. Brainerd | 1006 |
| 611. Design Methods for Soft Magnetic Materials in Radio, by John Minton and I. G. Maloff | 1021 |
| 612. A New Method of Determining the Height of the Kennelly-Heaviside Layer, by C. B. Mirick and E. R. Hentschel | 1034 |
| 613. Some Observations of Short Period Radio Fading, by T. Parkinson | 1042 |
| 614. Discussion on Detection Characteristics of Three-Element Vacuum Tubes (January, 1929, pp. 149, by F. E. Terman and T. M. Googin), by J. C. Warner and F. E. Terman | 1062 |

Number 7; July, 1929

| | |
|--|------|
| 615. A High Precision Standard of Frequency, by W. A. Marrison | 1103 |
| 616. Observations on Modes of Vibration and Temperature Coefficients of Quartz Crystal Plates, by F. R. Lack | 1123 |
| 617. The Kyle Condenser Loud Speaker, by V. Ford Greaves, F. W. Kranz, and W. D. Crozier | 1142 |
| 618. Detection at High Signal Voltages—Plate Rectification with the High-Vacuum Triode, by Stuart Ballantine | 1153 |
| 619. Transmitting Antennas for Broadcasting, by A. Meissner | 1178 |
| 620. Correlation of Directional Observations of Atmospherics with Weather Phenomena, by S. W. Dean | 1185 |
| 621. Experiments in Recording Radio Signal Intensity, by L. W. Austin | 1192 |
| 622. The Relation of Radio Propagation to Disturbances in Terrestrial Magnetism, by I. J. Wymore | 1206 |
| 623. Some Measurements on the Directional Distribution of Static, by A. E. Harper | 1214 |
| 624. The Routine Measurement of the Operating Frequencies of Broadcast Stations, by Henry L. Bogardus and Charles T. Manning | 1225 |

| | <i>Page</i> |
|---|-------------|
| 625. East-West and North-South Attenuations of Long Radio Waves on the Pacific, by Eitaro Yokoyama and Tomozo Nakai | 1240 |
| 626. Book Review: Matter, Electricity, Energy, by Walter Gerlack; reviewed by W. G. Cady | 1248 |

Number 8; August, 1929

| | |
|---|------|
| 627. The Mutual Impedance Between Adjacent Antennas, by Carl R. Englund and Arthur B. Crawford | 1277 |
| 628. The Propagation of Low Power Short Waves in the 1000-Kilometer Range, by K. Kruger and H. Plendl | 1296 |
| 629. Further Note on the Ionization in the Upper Atmosphere, by J. C. Schelleng | 1313 |
| 630. An Electromagnetic Monochord for the Measurement of Audio-Frequencies, by J. H. Owen Harries | 1316 |
| 631. An Empirical Equation for Determining the d^2i_0/de_0^2 of Detectors, by Sylvan Harris | 1322 |
| 632. Engineering Aspects of the Work of the Federal Radio Commission, by J. H. Dellinger | 1326 |
| 633. Some Characteristics of Modern Radio Receivers and their Relation to Broadcast Regulation, by L. M. Hull | 1334 |
| 634. (Abstract) The Regulation of Broadcasting Stations as a Systems Problem, by E. L. Nelson | 1342 |
| 635. Some Principles of Broadcast Frequency Allocation, by L. E. Whittimore | 1343 |
| 636. A Study of Heterodyne Interference, by J. V. L. Hogan | 1354 |
| 637. An Outline of the Radio Inspection Service, by Arthur Batcheller | 1365 |
| 638. The Problems Centering About the Measurement of Field Intensity, by S. W. Edwards and J. E. Brown | 1377 |
| 639. The Radio Engineer's Responsibility in Coping with Man-Made Interference, by Edgar H. Felix | 1385 |
| 640. Radio Coordination, by M. D. Hooven | 1390 |
| 641. United States Radio Broadcasting Development, by R. H. Marriott | 1395 |
| 642. Discussion on Radio Direction-Finding by Transmission and Reception (March, 1929, pp. 425, by R. L. Smith-Rose) | 1440 |
| 643. Discussion on Recent Developments in Superheterodyne Receivers (March, 1929, pp. 501, by G. L. Beers and W. L. Carlson), by F. K. Vreeland and G. L. Beers | 1454 |

Number 9; September, 1929

| | |
|---|------|
| 644. Studies of Echo Signals, by A. Hoyt Taylor and L. C. Young | 1491 |
| 645. Group-Velocity and Long Retardations of Radio Echoes, by G. Breit | 1508 |
| 646. Further Studies of the Kennelly-Heaviside Layer by the Echo Method, by L. R. Hafstad and M. A. Tuve | 1513 |
| 647. Ionization in the Atmosphere of Mars, by E. O. Hulburt | 1523 |
| 648. Notes on the Effect of Solar Disturbances on Transatlantic Radio Transmission, by Clifford N. Anderson | 1528 |
| 649. Image Transmission by Radio Waves, by Alfred N. Goldsmith | 1536 |
| 650. The Electrical Transmission of Pictures and Images, by J. W. Horton | 1540 |
| 651. Mechanical Developments of Facsimile Equipment, by R. H. Ranger | 1564 |
| 652. The Drum Scanner in Radiomovies Receivers, by C. Francis Jenkins | 1576 |
| 653. The Selection of Standards for Commercial Radio Television, by Julius Weinberger, Theodore A. Smith, and George Rodwin | 1584 |
| 654. Naval Communications—Radio Washington, by S. C. Hooper | 1595 |
| 655. Microphonic Improvements in Vacuum Tubes, by Alan C. Rockwood and Warren R. Ferris | 1621 |

| | <i>Page</i> |
|---|-------------|
| 656. Equivalent Circuits of an Electron Triode and the Equivalent Input and Output Admittances, by E. L. Chaffee | 1633 |
| 657. An Investigation of the Phenomena of Frequency Multiplication as Used in Tube Transmitters, by R. M. Page | 1649 |
| Number 10; October, 1929 | |
| 658. Static and Motional Impedance of a Magnetostriction Resonator, by E. H. Lange and J. A. Myers | 1687 |
| 659. Calculation of Characteristics and the Design of Triodes, by Yuziro Kusunose | 1706 |
| 660. Wireless Echoes of Long Delay, by P. O. Pedersen | 1750 |
| 661. An Echo Interference Method for the Study of Radio Wave Paths, by L. R. Hafstad and M. A. Tuve | 1786 |
| 662. On the Relation between Long-Wave Reception and Certain Terrestrial and Solar Phenomena, by K. Sreenivasan | 1793 |
| 663. The Significance of Observations of the Phase of Radio Echoes, by G. Breit | 1815 |
| 664. Inductance as Affected by the Initial Magnetic State, Air-Gap, and Superposed Currents, by H. M. Turner | 1822 |
| 665. Notes on the Detection of Large Signals, by Sylvan Harris | 1834 |
| 666. Single-Wire Transmission Lines for Short-Wave Antennas, by W. L. Everitt and J. F. Byrne | 1840 |
| 667. Circuit Tuning by Wave Resonance and Applications to Radio Reception, by Louis Cohen | 1868 |
| 668. Wave Resonance Tuning and Application to Radio Transmission, by William R. Blair and Louis Cohen | 1893 |
| 669. Discussion to Radio Direction Finding by Transmission and Reception (March, 1929, pp. 425, by R. L. Smith-Rose) by R. L. Smith-Rose | 1897 |
| 670. Discussion on Microphonic Improvement in Vacuum Tubes (September, 1929, pp. 1621, by Alan C. Rockwood and Malcolm Ferris) | 1899 |
| 671. Book Review: Radio Encyclopedia, by Michael Adam | 1903 |
| Number 11; November, 1929 | |
| 672. Technical Achievements in Broadcasting and its Relation to National and International Solidarity, symposium, with papers as follows: | |
| Introduction, by Alfred N. Goldsmith | 1939 |
| Radio Broadcasting Transmitters and Related Transmission Phenomena, by Edward L. Nelson | 1949 |
| The National Broadcasting Company, a Technical Organization for Broadcasting, by Julius Weinberger | 1969 |
| Speech Input Equipment, by D. G. Little | 1986 |
| Wire Line Systems for National Broadcasting, by A. B. Clark | 1998 |
| Radio Broadcasting Regulation and Legislation, by J. H. Dellinger | 2006 |
| 673. Measurement of Frequency, By S. Jimbo | 2011 |
| 674. Further Observations of Radio Transmission and the Heights of the Kennelly-Heaviside Layer, by G. W. Kenrick and C. K. Jen | 2034 |
| 675. The Calculation of the Inductance of Single-Layer Coils and Spirals Wound with Wire of Large Cross Section, by F. W. Grover | 2053 |
| 676. Operating Characteristics in Photoelectric Tubes, by G. F. Metcalf | 2064 |
| 677. The Penetration of Rock by Electromagnetic Waves and Audio Frequencies, by A. S. Eve, D. A. Keys, and F. W. Lee | 2072 |
| 678. A Vacuum-Tube Voltage Regulator for Large Power Units, by L. C. Verman and H. J. Reich | 2075 |
| 679. Book Review: Vibration Problems in Engineering, by S. Timoshenko; reviewed by S. S. Kirby | 2082 |

| | <i>Page</i> |
|--|-------------|
| Number 12; December, 1929 | |
| 680. Typical Wireless Apparatus Used on British and European Airways, by J. M. Furnival | 2123 |
| 681. Radio for the Air Transport Operator, by Lester D. Seymour | 2137 |
| 682. The Civil Airways and their Radio Facilities, by H. J. Walls | 2141 |
| 683. Applying the Visual Double Modulation Type Radio Range to the Airways, by H. Diamond | 2158 |
| 684. Radio in Aeronautics—Its Technical Status and Organization for Its Application in Germany, by F. Eisner and H. Fassbender | 2185 |
| 685. Measurement of Aircraft Antenna Constants, by L. A. Hyland | 2230 |
| 686. On the Daylight Transmission Characteristics of Horizontally and Vertically Polarized Waves from Airplanes, by F. H. Drake and R. M. Wilmotte | 2242 |
| 687. Temperature Rating of Wind-Driven Aircraft Radio Generators, by C. B. Mirick | 2259 |
| 688. Applying the Aural Directive Radio Range to the Airways, by F. G. Kear and W. E. Jackson | 2268 |
| 689. Effect of Flight on Hearing, by C. B. Mirick | 2283 |
| 690. Book Review: Radiotechnik, by F. Kiebitz; reviewed by W. G. Cady | 2297 |
| 691. Book Review: Elements of Radio Communication, by J. H. Morecroft; reviewed by Edgar H. Felix | 2297 |

SUBJECT INDEX

A

- Aircraft Radio: 681
 - Civil Airways and their Facilities for: 682
 - Measurement of Antenna Constants: 685
 - Temperature Rating of Wind-Driven Generators: 687
 - The Aural Radio Range and Airways: 688
 - Typical Apparatus Used on British and European Airways: 680
 - Visual Double Modulation Type Radio Range: 683
- Aircraft:
 - Receiver for Use with Rigid Antenna: 567
 - Receivers for Beacon and Telephony: 566
- Allocation:
 - Frequency, Some Principles of Broadcast: 635
- Amplifiers:
 - Grid Losses in Power: 609
- Amplifying Circuits:
 - Treating Resistance Stabilized R-F: 555
- Antenna:
 - Rigid, for Aircraft Receiver: 567
- Antennas:
 - Determination of Radiation Angle: 551
 - Filtering, and Filter-Valve Circuits: 559
 - Measurement of Aircraft Constants: 685
 - Mutual Impedance between Adjacent: 627
 - Radiation Resistance of Beam: 581
 - Transmitting, for Broadcasting: 619
- Atmospherics:
 - Correlation of Directional Observations with Weather Phenomena: 620
- Attenuation of Long Waves in East-West and North-South Directions on the Pacific: 625
- Audio-Frequency Apparatus:
 - Voltage Surges in: 596
- Auxiliary Control for R-F Oscillators: 554

B

- Beacon:
 - Aircraft Receiving Sets for: 566
 - Directive Radio, Field Intensity Characteristics of Double Modulation Type: 599

- Beam Antennas:
 - Radiation Resistance of: 581
- Beat-Frequency Oscillator:
 - Logarithmic Scale for: 600
- Behavior of Networks with Normalized Meshes: 572
- Book Reviews:
 - A Bibliography of Electrical Literature, by Massachusetts Institute of Technology (reviewed by Ralph Batcher); 562
 - Données Numeriques de Radioelectricite, by R. Mesny (reviewed by W. G. Cady): 591
 - Elements of Radio Communication, by J. H. Morecroft (reviewed by Edgar H. Felix): 691
 - Handbuch der Experimentalphysik, edited by Weins-Harms (reviewed by K. S. Van Dyke): 604
 - Matter, Electricity, Energy, by Walter Gerlach (reviewed by W. G. Cady); 626
 - Vibration Problems in Engineering, by S. Timoshenko (reviewed by S. S. Kirby): 679
 - Radio Encyclopedia, by Michael Adam: 671
 - Radiotechnik, by F. Kiebitz (reviewed by W. G. Cady): 690
- Bridge:
 - Direct Reading Frequency, for Audio Range: 595
- Broadcast Frequency Allocation:
 - Some Principles of: 635
- Broadcasting:
 - U. S. Radio, Developments in: 641
 - Wire Line Systems for National: 672
- Broadcasting Antennas:
 - Transmitting: 619
- Broadcasting Stations:
 - Regulation of, as a Systems Problem: 634

C

- Calculation of Characteristics and the Design of Triodes: 659
- Calculation of Inductance of Single-Layer Coils and Spirals Wound with Wire of Large Cross Section: 675
- Capacitance:
 - Measurement of Direct Interelectrode, of Vacuum Tubes: 607
- Capacity:
 - Method of Measuring: 577

- Characteristics:
 Detection, of Three-Element Tubes: 558
 of Modern Radio Receivers and their Relation to Broadcast Regulation: 633
 Circuit Analysis Applied to Screen-Grid Tube: 568
 Circuit Tuning by Wave Resonance and Applications to Radio Reception: 667
 Circuits:
 Filter-Valve, and Filtering Antennas: 559
 Civil Airways and their Radio Facilities: 682
 Coils:
 Calculation of Inductance of: 675
 Cold Cathode Rectification: 597
 Control:
 Auxiliary Frequency, for R-F Oscillators: 554
 Condenser Loud Speaker
 The Kyle: 617
 Coordination:
 Radio: 640
 Correlation of Directional Observations of Atmospherics with Weather Phenomena: 620
- D
- Daylight Transmission Characteristics of Horizontally and Vertically Polarized Waves from Airplanes: 686
 Design Methods for Soft Magnetic Materials in Radio: 611
 Design of A Vacuum-Tube Voltmeter: 598
 Detection:
 at High Signal Voltages: Plate Rectification with the High-Vacuum Triode: 618
 of Large Signals, Notes on: 665
 Detection Characteristics:
 of Screen-Grid and Space-Charge-Grid Tubes: 594
 of Three-Element Tubes: 558
 Detectors:
 Empirical Equation for Determining the d^2i_p/dc_0^2 of: 631
 Direct Reading Frequency Bridge for Audio Range: 595
 Direction-Finding by Transmission and Reception: 573
 Directional Distribution of Static: Measurements on: 623
 Directional Observations of Atmospherics:
 Correlation of, with Weather Phenomena: 620
 Directional Observations on Static in Japan: 571
 Directive Radio Beacon:
 Field Intensity Characteristics of: 599
 Discussions on papers as follows:
 The Receiving System for Long-Wave Transatlantic Radio Telephony (by A. Bailey, S. W. Dean, and W. T. Wintringham, December, 1928, p. 1645): 560
 Detection with the Four-Electrode Tube (by J. R. Nelson, June, 1928, p. 822): 561
 Detection Characteristics of Three-Element Vacuum Tubes (by F. E. Terman and T. M. Googin, January, 1929, p. 149): 614
 An Extension of the Method of Measuring Inductances and Capacities (by Sylvan Harris, March, 1929, p. 516): 577.
 Principles of Grid-Leak Grid-Condenser Detection (by F. E. Terman, October, 1928, p. 1384): 590
 Simple Inductance Formulas for Radio Coils (by H. A. Wheeler, October, 1928, p. 1398): 582
 Facsimile Picture Transmission, by V. Zworykin, March, 1929, p. 536): 603
 Reception Experiments in Mount Royal Tunnel (by A. S. Eve, W. A. Steel, G. W. Olive, A. R. McEwan, and J. H. Thompson, February, 1929, p. 347): 602
 Radio Direction-Finding by Transmission and Reception (by R. L. Smith-Rose, March, 1929, p. 425): 642
 Recent Developments in Superheterodyne Receivers (by G. L. Beers and W. L. Carlson, March, 1929, p. 501): 643
 Microphonic Improvement in Vacuum Tubes (by Alan C. Rockwood and Warren R. Ferris, September, 1929, p. 1621): 670
 Double and Multiple Signals with Short Waves: 592
 Drum Scanner in Radiomovies Receivers: 652
- E
- Earth Reflection of Ultra Short Radio Waves: 589
 East-West and North-South Attenuation of Long Radio Waves on the Pacific: 625
 Echo Interference Method for Study of Radio Wave Paths: 661

- Echo Method:
 Studies of Height of Kennelly-Heaviside Layer by: 646
 Echo Signals:
 Studies in: 644
 Echoes:
 Group-Velocity and Long Retardations of: 645
 of Long Delay: 660
 Short Range, with Short Waves: 593
 Significance of Observation of Phase of: 663
 Effect of Flight on Hearing: 689
 Electrical Transmission of Pictures and Images: 650
 Electromagnetic Monochord for Measurement of Audio Frequencies: 630
 Electron Oscillations in a Triode: 563
 Empirical Equation for Determining the d^2i_o/de_g^2 of Detectors: 631
 Engineering Aspects of Work of Federal Radio Commission: 632
 Equality of Loud Speaker Output at Various Frequencies: 578
 Equipment for Testing Radio Receivers: 586
 Equivalent Circuits of an Electron Triode and the Equivalent Input and Output Admittances: 656
 Experiments in Recording Radio Signal Intensity: 621
 Experiments in Short-Distance Short-Wave Transmission: 574
- F**
- Facsimile Equipment:
 Mechanical Developments of: 651
 Facsimile Picture Transmission: 579
 Fading:
 Some Characteristics of Short Period: 613
 Fading Curves and Weather Conditions: 557
 Federal Radio Commission:
 Engineering Aspects of Work of: 632
 Field Intensity Characteristics of Double Modulation Type of Directive Radio Beacon: 599
 Field Intensity:
 Problems of Measuring: 638
 Filtering Antennas and Filter-Valve Circuits: 559
 Four-Electrode Tube:
 Mathematical Theory of: 610
 Frequencies:
 Routine Measurement of Operating, of Broadcast Stations: 624
- Frequency:
 High Precision Standard of: 615
 Measurement of: 673
 Frequency Bridge:
 Direct Reading for Audio Range: 595
 Frequency Measurements:
 A System for, Based on a Single Frequency: 565
 of Distant Transmitting Stations: 588
 Frequency Multiplication:
 Investigation of, in Tube Transmitters: 657
 by Shock Excitation: 583
 Frequency Standards:
 Method of Referring Secondary, to Standard Time Interval: 564
 Further Note on Ionization in Upper Atmosphere: 629
 Further Observations of Radio Transmission and the Heights of the Kennelly-Heaviside Layer: 674
 Further Studies of the Kennelly-Heaviside Layer by the Echo Method: 646
- G**
- Grid-Circuit Detection:
 Notes on: 580
 Grid Losses in Power Amplifiers: 609
 Grinders:
 Note on Directional Observations in Japan: 571
 Group-Velocity and Long Retardations of Radio Echoes: 645
- H**
- Hearing:
 Effect of Flight on: 689
 Height of Kennelly-Heaviside Layer:
 Measurements of: 587
 Studies of, by Echo Method: 646
 Heterodyne Interference:
 A Study of: 636
 High Precision Standard of Frequency: 615
 Horizontal Antennas:
 Determination of Radiation Angle: 551
- I**
- Image Transmission by Radio Waves: 649
 Images:
 Electrical Transmission: 650
 Impedance:
 Mutual, between Adjacent Antennas: 627
 Impedances:
 Static and Motional, of Magnetostriction Resonator: 658

- Inductance: 664
 Calculation of: 675
 Method of Measuring: 577
 Input Equipment:
 Speech: 672
 Inspection Service:
 Outline of: 637
 Interference:
 Radio Engineer's Responsibility in
 Coping with Man-Made: 639
 Introduction to Symposium on Techni-
 cal Achievements in Broad-
 casting: 672
 Ionization:
 in the Upper Atmosphere: 629
 in the Atmosphere of Mars: 647
 Interference:
 Radio: 601
 Study of Heterodyne: 636
 Investigation of Phenomena of Fre-
 quency Multiplication as used in
 Tube Transmitters: 657
- K**
- Kennelly-Heaviside Layer:
 Heights of: 674
 Measurements of Height of: 587
 Method of Determining Height of:
 612
 Kyle Condenser Loud Speaker: 617
- L**
- Legislation:
 Radio Broadcast: 672
 Logarithmic Scale for Beat-Frequency
 Oscillator: 600
 Loud Speaker:
 Kyle Condenser: 617
 Output, Apparent Equality at Vari-
 ous Frequencies: 587
- M**
- Magnetic Materials:
 Design Methods for, in Radio: 611
 Magnetic Storms:
 and Wireless Telegraphy: 575
 Magnetostriction Oscillators: 552
 Magnetostriction Resonator:
 Static and Motional Impedances of:
 658
 Magnetron Oscillations:
 Short-Wave Limit of: 584
 Man-Made Interference:
 Radio Engineer's Responsibility in
 Coping with: 639
 Mathematical Theory of the Four-
 Electrode Tube: 610
 Measurement:
 of Aircraft Antenna Constants: 685
 of Audio Frequencies by Electro-
 magnetic Monochord: 630
 of Direct Interelectrode Capacitance
 of Vacuum Tubes: 607
 of Field Intensity, Problems of: 638
 of Frequencies of Broadcast Sta-
 tions: 624
 of Frequency: 673
 of Frequency of Distant Trans-
 mitting Stations: 588
 of Modulation, Use of Electron Tube
 Voltmeter for: 585
 Measurements:
 A System of Frequency, Based on a
 Single Frequency: 565
 of Height of Kennelly-Heaviside
 Layer: 587
 on Directional Distribution of Static:
 623
 Mechanical Developments of Facsi-
 mille Equipment: 651
 Mechanism of Electron Oscillations in
 a Triode: 563
 Meter:
 Radio-Frequency: 550
 Method of Measuring Inductance and
 Capacities:
 Extension of: 577
 Microphonic Improvements in Vac-
 uum Tubes: 655
 Modulation:
 Measurement of, with Electron
 Tube Peak Voltmeter: 585
 Mount Royal Tunnel:
 Reception Experiments in: 570
 Multiple Signals with Short Waves:
 592
 Multiplication of Frequency by Shock
 Excitation: 583
 Mutual Impedance between Adjacent
 Antennas: 627
- N**
- National Broadcasting Company: 672
 Navigation:
 Marine, Application of Direction-
 Finding to: 573
 Networks:
 Behavior of, with Normalized
 Meshes: 572
 New Method of Determining the
 Height of the Kennelly-Heaviside
 Layer: 612
 Note on Earth Reflection of Ultra-
 Short Radio Waves: 589
 Notes on Effect of Solar Disturbances
 on Transatlantic Radio Trans-
 mission: 648
 Notes on Grid-Circuit Detection: 580
- O**
- Observations of Short Period Radio
 Fading: 613

- Observations on Modes of Vibration and Temperature Coefficients of Quartz Crystal Plates: 616
- Operating Characteristics in Photoelectric Tubes: 676
- Operating Frequencies of Broadcast Stations:
Routine Measurement of: 624
- Oscillations:
Magnetron, Short-Wave Limit of: 584
- Oscillator:
Logarithmic Scale for Beat-Frequency: 600
Piezo-Electric Crystal: 556
- Oscillators:
Auxiliary Frequency Control for Radio-Frequency: 554
Magnetostriction: 552
- Outline of the Radio Inspection Service: 637
- Output:
Loudspeaker: Apparent Equality at Various Frequencies: 578
- P**
- Penetration of Rock by Electromagnetic Waves and Audio Frequencies: 677
- Photoelectric Tubes:
Operating Characteristics in: 676
- Photoradio Developments: 608
- Pictures:
Electrical Transmission of: 650
- Picture Transmission:
by Radio Waves: 649
Facsimile: 579
- Piezo-Electric Crystal Oscillator: 556
- Piezo-Electric Plates:
Observations on Modes of Vibration and Temperature Coefficients: 616
- Plate Rectification with the High-Vacuum Tube: 618
- Problems Centering about Measurement of Field Intensity: 638
- Propagation:
of Low Power Short Waves in the 1000-km Range: 628
Relation of, to Disturbances in Terrestrial Magnetism: 622
- R**
- Radiation Angle:
Determination for Horizontal Antennas: 551
- Radiation Resistance of Beam Antennas: 581
- Radio Broadcasting Transmitters and Related Transmission Phenomena: 672
- Radio Coordination: 640
- Radio Direction-Finding by Transmission and Reception: 573
- Radio Engineer's Responsibility in Coping with Man-Made Interference: 639
- Radio for the Air Transport Operator: 681
- Radio-Frequency Meter:
Direct Reading: 550
- Radio Inspection Service:
An Outline of: 637
- Radio Interference: 601
- Radio Range:
Applying the Aural Directive Type, to the Airways: 688
Applying the Visual Double Modulation Type, to the Airways: 683
- Radio Receiver Testing Equipment: 586
- Radiotelegraphy:
The Importance of, in Science: 553
- Receiver Testing Equipment: 586
- Receivers:
Aircraft: 566
Aircraft, for Use with Rigid Antennas: 567
Characteristics of Modern Radio, and their Relation to Broadcast Regulation: 633
Developments in Superheterodyne: 576
Drum Scanner in Radiomovies: 562
- Reception:
Circuit Tuning and its Applications to: 667
Experiments in Mount Royal Tunnel: 570
- Reciprocal Theorems in Radio Communication: 606
- Reciprocity in Electromagnetic, Mechanical, Acoustical, and Interconnecting Systems: 605
- Recording Radio Signal Intensity: 621
- Rectification:
Cold Cathode: 597
- Regeneration:
Effect of, on Signal Strength: 569
- Regulation:
of Broadcast Stations as a Systems Problem: 634
Radio Broadcast: 672
- Relation between Long-Wave Reception and Certain Terrestrial and Solar Phenomena: 662
- Relation of Radio Propagation to Disturbances in Terrestrial Magnetism: 622
- Resistance:
Radiation, of Beam Antennas: 581
Resistance Stabilized R-F Amplifying Circuits: 555

- Rock Penetration by Electromagnetic Waves and Audio Frequencies: 677
- Routine Measurement of Operating Frequencies of Broadcast Stations: 624
- S**
- Science:
The Importance of Radiotelegraphy in: 553
- Secondary Frequency Standards:
Referring, to Standard Time Interval: 564
- Screen-Grid Tube:
Circuit Analysis Applied to: 568
- Screen-Grid Tubes:
Detection Characteristics of: 594
- Selection of Standards for Commercial Television: 653
- Shock Excitation:
Frequency Multiplication by: 583
- Short Period Fading:
Some Observations of: 613
- Short Range Echoes with Short Waves: 593
- Short-Wave Radio Transmission:
Experiments in: 574
- Short Waves:
Double and Multiple Signals with: 592
Earth Reflection of Ultra: 589
Propagation of, in 1000-km Range: 628
Short Range Echoes with: 593
Short-Wave Limit of Magnetron Oscillations: 584
- Signal Intensity:
Experiments in Recording: 621
- Signal Strength:
Effect of Regeneration on: 569
- Significance of Observations of the Phase of Radio Echoes: 663
- Solar Disturbances:
Effect of, on Transatlantic Radio Transmission: 648
- Some Principles of Broadcast Frequency Allocation: 635
- Space-Charge-Grid Tubes:
Detection Characteristics of: 594
- Speech Input Equipment: 672
- Standard of Frequency:
High Precision: 615
- Static and Motional Impedances of a Magnetostriction Resonator: 658
- Static:
Measurements on Directional Distribution of: 623
Note on Directional Observations in Japan: 571
Studies of Echo Signals: 644
Study of Heterodyne Interference: 636
- Superheterodyne Receivers:
Developments in: 576
- Surges:
Voltage, in Audio Apparatus: 596
- T**
- Technical Achievements in Broadcasting and Its Relation to National and International Solidarity: 672
- Telephony:
Receiving Sets for Aircraft: 566
- Television:
Selection of Standards for: 653
- Temperature Coefficients:
Quartz Plates: 616
- Temperature Rating of Wind-Driven Aircraft Radio Generators: 687
- Terrestrial Magnetism:
Relation of Radio Propagation to: 622
- The Penetration of Rock by Electromagnetic Waves and Audio Frequencies: 677
- Transatlantic Radio Transmission:
Effect of Solar Disturbances on: 648
- Transmission Characteristics:
Waves from Airplanes: 686
- Transmission:
Experiments in Short Distance Short-Wave: 574
Facsimile Picture: 579
Images by Radio Waves: 649
Wave Resonance Tuning and Application to: 668
- Transmitters:
Radio Broadcasting, and Related Transmission Phenomena: 672
- Transmitting Antennas for Broadcasting: 619
- Transmitting Stations:
Measurement of Frequency of Disturbance: 588
- Tube:
Theory of Four-Electrode: 610
Voltage Regulator, for Large Power Units: 678
Voltmeter Design: 598
- Tubes:
Calculation of Characteristics and Design of: 659
Detection at High Signal Voltage: 618
Detection Characteristics of: 558
Detection Characteristics of Screen-Grid and Space-Charge-Grid: 594
Equivalent Circuits and Equivalent Input and Output Admittances: 656
Input and Output Admittances: 656
Mechanism of Electron Oscillation in: 563

Measurement of Direct Interelectrode Capacitance: 607
Microphonic Improvement in: 655
Photoelectric, Operating Characteristics in: 676
Screen-Grid, Circuit Analysis Applied to: 568
Typical Wireless Apparatus used on British and European Airways: 680

U

Ultra Short Radio Waves:
 Note on Earth Reflection of: 589
Use of Electron Tube Peak Voltmeter for Measuring Modulation: 585
United States Radio Broadcasting Development: 641

V

Vacuum-Tube Voltage Regulator for Large Power Units: 678

Vacuum-Tube Voltmeter Design: 598
Vibration and Temperature Coefficients of Quartz Plates: 616
Voltage Surges in Audio-Frequency Apparatus: 596
Voltmeter:
 Vacuum-Tube, Design: 598

W

Wave Resonance and Application to Reception: 667
Wave Resonance Tuning and Application to Radio Transmission: 668
Weather Conditions:
 Fading Curves and: 557
Wireless Echoes of Long Delay: 660
Wireless Telegraphy and Magnetic Storms: 575
Wire Line Systems for National Broadcasting: 672

AUTHORS' INDEX

Numbers refer to the chronological list. Bold-face type indicates papers, light-face type indicates discussions, and italics refer to book reviews.

- A**
- Allen, James G., 601
 Anderson, Clifford N., 648
 Austin, L. W., 621
- B**
- Bailey, Austin, 560
 Ballantine, Stuart, 605, 618, 642
 Ballentine, E. C., 603
 Batcheller, Arthur, 637
 Batchler, Ralph R., 562, 577, 582
 Bayly, B. De F., 595
 Beers, G. L., 576, 643
 Blair, William R., 668
 Bogardus, Henry L., 624
 Bohn, William C., 642
 Bonn, N. E., 603
 Brainerd, J. G., 610
 Breit, G., 645, 663
 Brown, J. E., 638
 Byrne, J. F., 666
- C**
- Cady, W. G., 591, 626, 690
 Carlson, W. L., 576
 Carson, John R., 606
 Chaffee, E. L., 656
 Clapp, James K., 564, 574
 Clark, A. B., 672
 Cohen, Louis, 667, 668
 Colwell, R. C., 557
 Crawford, Arthur B., 627
 Crozier, W. D., 617
- D**
- Dean, S. W., 620, 642
 Dellinger, J. H., 632, 672
 Dewhirst, Thornton P., 603
 Diamond, H., 566, 683
 Drake, F. H., 567, 686
 Dysart, Birney, 594
- E**
- Edwards, S. W., 638
 Eisner, F., 684
 Englund, Carl R., 602, 627
 Eve, A. S., 570, 602, 677
 Everitt, W. L., 666
- F**
- Fassbender, H., 684
 Felix, Edgar H., 639, 691
 Ferris, Warren R., 655
 Fisher, Elmer H., 596
 Furnival, J. M., 680
- G**
- Glendinning, W., 572
 Goldsmith, Alfred N., 560, 603, 649, 672
 Googin, Thomas M., 558
 Gorio, T., 588
 Greaves, V. Ford, 617
 Grover, F. W., 675
 Guillemin, E. A., 572, 583
 Guthrie, F. P., 560
- H**
- Hafstad, L. R., 646, 661
 Haglund, H. H., 603
 Hall, E. L., 565
 Hallborg, H. E., 642
 Harper, A. E., 623
 Harris, Sylvan, 577, 631, 665
 Hector, L. G., 578
 Hentschel, E. R., 612
 Hitchcock, R. C., 550
 Hogan, J. V. L., 636
 Hollman, H. E., 563
 Hooper, S. C., 654
 Hooven, M. D., 640
 Horton, J. W., 650
 Hulburt, E. O., 575, 647
 Hull, L. M., 564, 633, 642
 Hund, August, 560
 Hyland, L. A., 686
- J**
- Jackson, W. E., 688
 Jarvis, Kenneth W., 586
 Jen, C. K., 674
 Jenkins, C. Francis, 652
 Jimbo, S., 673
 Jolliffe, C. B., 585
- K**
- Kear, F. G., 688
 Kelly, M. J., 670
 Kenrick, G. W., 587, 674
 Keys, D. A., 677
 Kirby, S. S., 679
 Kozanowski, H. N., 578
 Kranz, F. W., 617
 Kruger, K., 628
 Kusunose, Yuziuro, 659
- L**
- Lack, F. R., 616
 Lampkin, G. F., 554
 Lange, E. H., 589, 658
 Lee, F. W., 677

Little, D. G., 672
 Lewellyn, F. B., 561
 Loughren, A. V., 607
 Lubcke, Harry R., 598

M

Maloff, I. G., 611
 Manning, Charles T., 624
 Maris, H. B., 575
 Marriott, R. H., 641
 Marrison, W. A., 615
 McCullough, M. B., 603
 McEwan, A. R., 570
 Meissner, A., 551, 619
 Meissner, E. R., 600
 Metcalf, G. F., 676
 Minton, John, 611
 Mirick, C. B., 612, 687, 689
 Mögel, H., 592, 593
 Murray, F. H., 580
 Myers, J. A., 658

N

Nakai, Tomozo, 625, 571
 Nelson, E. L., 634, 672
 Nelson, J. R., 561, 568, 580
 Nyman, Alex., 603

O

Okabe, Kinjiro, 584
 Olive, G. W., 570
 Owen Harries, J. H., 630

P

Page, R. M., 657
 Parker, H. W., 607
 Parkinson, T., 613
 Pedersen, P. O., 660
 Pession, G., 588
 Pierce, G. W., 552
 Pistol Kors, A. A., 581
 Plebanski, Josef, 559
 Plendl, H., 628
 Polydoroff, W. J., 590
 Pratt, Haraden, 560, 566, 599
 Pristas, J. E., 670
 Putnam, George R., 642

Q

Quäck, E., 592, 593

R

Ranger, R. H., 603, 608, 651

Reich, H. J., 678
 Rockwood, Alan C., 655, 670
 Rodd, A. E., 670
 Rodwin, George, 653
 Rothe, H., 551
 Rumsey, P. T., 583

S

Schelleng, J. C., 629, 642
 Seymour, Lester D., 681
 Shannon, J. E., 603
 Shaw, A. E., 597
 Smith, Theodore A., 653
 Smith-Rose, R. L., 573, 669
 Snavely, B. L., 555
 Soucy, Chester I., 595
 Spitzer, E. E., 609
 Sreenivasan, K., 662
 Steel, W. A., 570
 Sutherlin, Lee, 670

T

Taylor, A. Hoyt, 560, 642, 644, 670
 Terman, F. E., 558, 594, 614
 Thompson, J. H., 570
 Turner, H. M., 664
 Tuve, M. A., 646, 661

V

van der Pol, Balth., 569
 Van Dyke, K. S., 560, 604
 Verman, L. C., 678
 Vreeland, F. K., 643

W

Walls, H. J., 682
 Warner, J. C., 614
 Webb, J. S., 555
 Weinberger, Julius, 653, 672
 Wheeler, Harold A., 582
 Whittemore, L. E., 635
 Wilmotte, R. M., 686
 Wintringham, W. T., 560
 Wood, K. H., 670
 Wright, J. Warren, 556
 Wymore, I. J., 622

Y

Yokoyama, Eitaro, 571, 625
 Young, L. C., 644

Z

Zenneck, J., 553
 Zworykin, V., 579, 603



Refinement

THE many processes involved in the manufacture of Thordarson transformers show refinement such that the completed unit is more than mere copper and steel. The steel housing of a power transformer is an example of this. An uninteresting piece of flat steel is drawn with perfect precision into an intricate graceful unit of assembly. A battery of powerful presses combined with a corps of skilled mechanics change a drab metal slab into a beautiful specimen of modern handicraft—a fit housing for the excellence of transformers by Thordarson.

THORDARSON

Transformer Specialists Since 1895

THORDARSON ELECTRIC MANUFACTURING CO.

Huron, Kingsbury and Larabee Streets, Chicago, Ill., U.S.A.

When writing to advertisers mention of the PROCEEDINGS will be mutually helpful.

A manufacturer looks at the Screen grid tube

The coming season will undoubtedly witness a general stampede in the direction of screen grid equipment. As we view this new development these facts seem to furnish the reason:

The principal reason why the screen grid tube is better than the conventional three element type is that it overcomes some of the disadvantages of the three-electrode tube. In adapting radio circuits to the triode, the limiting factor is always present in the form of a grid-to-plate capacity. With the screen grid tube, the grid-to-plate capacity is reduced to a very small value, removing the principal stumbling block to the development of more sensitive circuits.

In addition, the average circuit using the three-element tube has a gain per stage of only about six. With the screen grid tube, gains of from twenty to twenty-five per stage are possible. Using these figures as a basis of comparison it can be seen that the screen grid tube is the best by at least three or four to one over the three-element type.

By putting in several stages of screen grid the unit gain is vastly multiplied.

Of course, beyond a certain point, no advantage arises from high amplification on account of reaching the noise level. However, the generous supply of signal delivered by the screen grid amplifiers permits the use of detection methods which although not sensitive are excellent from a quality reproduction standpoint.

Efficient screen grid circuit design permits the use of fewer tubes both in the radio and audio frequency stages. From an engineering standpoint many things are possible with the screen grid tube and, although we now have enough advantages to justify its universal use, the future will certainly reveal still more possibilities in its favor.

The CeCo Manufacturing Company introduced the first A. C. operated Screen Grid Tube in April 1928 and is recognized as the pioneer in this development.—Engineering Department

CeCo tubes

When writing to advertisers mention of the PROCEEDINGS will be mutually helpful.

**YOUR
GUARANTEE
OF
QUALITY**



CONDENSERS

by

FAST

3123 N. CRAWFORD AVE. CHICAGO ILLINOIS

When writing to advertisers mention of the PROCEEDINGS will be mutually helpful.

The New Model "B" ELECTRAD Super-TONATROL

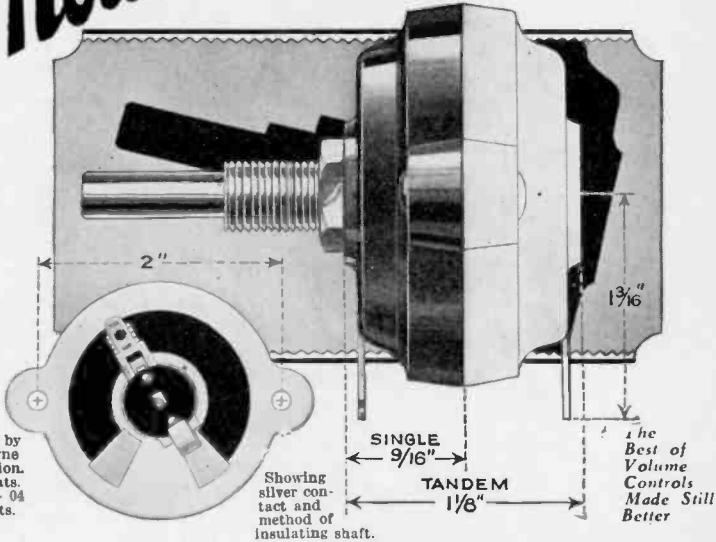

Licensed by
Technidyne
Corporation.
U. S. Pats.
1034103 - 04
and Pats.
Pend.

5 Advanced Features

1. Resistance element permanently fused to enameled metal plate. 3-watt dissipation.
2. Tandem or single units.
3. Completely isolated circuits due to insulated shaft.
4. Enclosed Bakelite Case.
5. Lighter, smaller, sturdier.

THE New Model "B" Super-TONATROL offers manufacturers all of the superior operating characteristics and long life of the original Super-TONATROL, plus greater compactness, superior finish and tandem units, if desired, controlled by a single shaft.

The special resistance element, permanently

fused to a vitreous enameled metal plate safely dissipates 3-watts (per unit) and completely obviates the use of low current paper elements or fine wire with its well-known hazards.

A pure silver floating contact—completely insulated by Bakelite from the metal shaft—provides a smoothness of variation and freedom from noise that is revolutionary.

Laboratory tests, equivalent to more than 10 years' average use show no material signs of wear or variation in resistance, amply proving its remarkable endurance.

Completely enclosed construction, with Bakelite case—for panel or base-board mounting. Practically immune to temperature and humidity changes. Single or tandem units can be made with all usual resistance ratings with uniform or tapered curves.

Write Dept., PE 12, for Data and Blueprint.

175 Varick St., New York, N.Y.

ELECTRAD

INC.

ELECTRAD manufactures a complete line of resistances and voltage controls for every radio and power supply need, including Television.

When writing to advertisers mention of the PROCEEDINGS will be mutually helpful.



To All Tube
Manufacturers

GILBY SELVAGE MESH

CUT the shrinkage in your production—add to the strength of your product and at the same time enhance its *appearance*.

Gilby Selvage Mesh is an important improvement in this type screen grid material. A practically solid metal selvage of even surface offers high conductivity with a minimum of transport losses and in addition will lend itself to accurate forming. Simplifies welding operations.

Notice is given that we have applied for patent on this product.

We will gladly supply detailed information on request.



GILBY WIRE COMPANY

Wilbur B. Driver, President
NEWARK, NEW JERSEY



When writing to advertisers mention of the PROCEEDINGS will be mutually helpful.

the Coils the thing!

In every radio hook-up an ideal coil is specified for each function in the set.

Each Dudlo coil is backed by its reputation as the utmost in coil perfection, and though tucked away in the chassis of a set . . . forgotten, yet depended upon . . . will give years of faithful performance.

Continuous performance is *assumed*. Tubes may come and tubes may go . . . condensers may break down . . . but the coils must go on forever.

Dudlo coils are superbly engineered, and constructed by experts to fit individual requirements . . . no matter how complex or difficult.

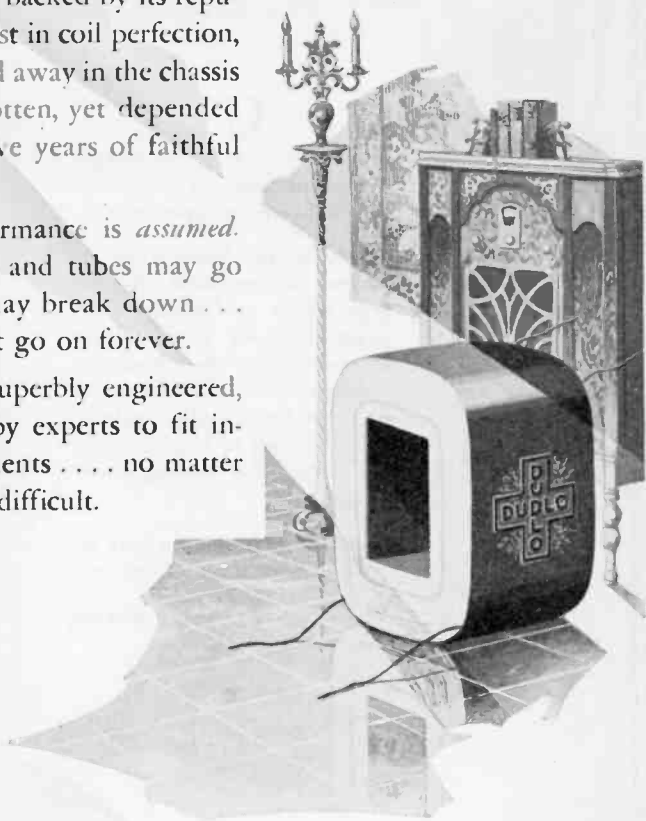

DUDLO

DUDLO MANUFACTURING COMPANY, FORT WAYNE, INDIANA
Division of General Cable Corporation

When writing to advertisers mention of the PROCEEDINGS will be mutually helpful.

Continental Resistors



A
½ Watt Size



W
1 Watt Size



X
2 Watt Size

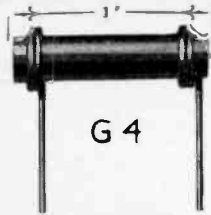

¾ Watt
Size

G 4



½ Watt
Size

F 3

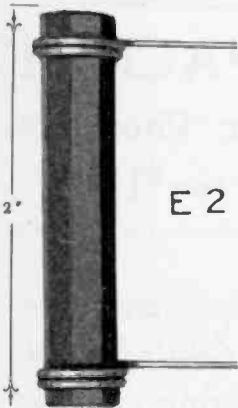

E 2

2 Watt Size

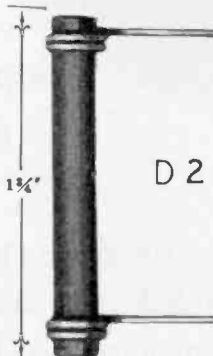

D 2

1 Watt Size

Types G4 and F3 are small resistors for use where economy of space is a factor and where they carry only a fraction of a watt.

Types A, W and X for standard spring clip mounting.

Types E2, D2, G4 and F3 are for soldering permanently into position.

Our soldered wire resistors never have open circuits. They are noiseless and permanent. Made in values of 25 ohms to 20 megohms.

Seven years experience making resistors, selling to largest manufacturers. Now in a new modern plant.

Buying from Continental insures service and prompt delivery in large quantity lots.

Write for Information and Prices

CONTINENTAL CARBON INC.
WEST PARK, CLEVELAND, OHIO

When writing to advertisers mention of the PROCEEDINGS will be mutually helpful.

Flawless TONE

results from these technical features



PACENT
Super Phonovox

List Price \$15.00

Slightly higher west of the Rockies

THE Super Phonovox has extreme sensitivity thru the use of *English 36 per cent Cobalt Magnets*. It is free from troublesome rubber bearings and the balanced tone arm insures correct needle pressure. Now equipped with new combination switch and volume control and adapter for screen grid tubes at no extra cost. Two new low impedance models available.

PACENT ELECTRIC CO., INC., 91 Seventh Ave., N. Y.

Pioneers in Radio and Electric Reproduction for over 20 years

*Manufacturing Licensee for Great Britain and Ireland: Igranic Electric Co., Ltd., Bedford, Eng.
Licensee for Canada: White Radio Limited, Hamilton, Ont.*

When writing to advertisers mention of the PROCEEDINGS will be mutually helpful.

The New HAMMARLUND

(MULTIPLE—
QUADRUPLE) "MQ"

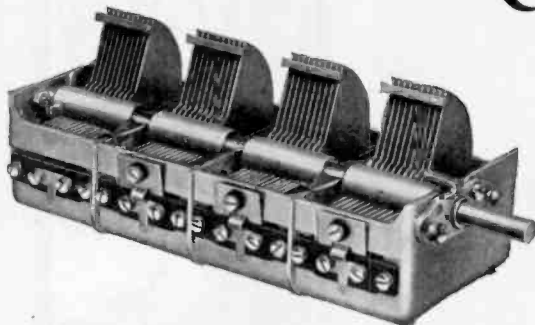

"MIDLINE" CONDENSER *for Manufacturers*

HAMMARLUND Quality at a PRICE! A four-gang multiple condenser with every feature a manufacturing asset. Stamina, accurate matching, fine finish and good looks—plus a price that appeals to careful buyers.

It looks like a Hammarlund—it IS a Hammarlund—merely simplified, but retaining all of the famous Hammarlund precision essentials.

Check the details:—Rigid, reinforced die-cast aluminum frame with perfect shield-

ing between sections; steel shaft working in long hand-reamed bearings; aluminum plates firmly anchored and reinforced to prevent microphonics; wiping contacts to rotor sections to prevent coupling of circulating currents; separate stator insulating strips, non-warping and of high leakage resistance; trimmer condensers of large area, perfectly insulated and designed for easy adjustment and permanence of setting.

You couldn't ask more of a condenser and you can't get more for the price than this new Hammarlund offers.

[Write us your needs. Hammarlund co-operation and facilities are yours for the asking. Address Dept. PE12.]

HAMMARLUND MANUFACTURING COMPANY
424-438 W. 33RD STREET, NEW YORK

For Better Radio
Hammarlund
PRECISION
PRODUCTS



When writing to advertisers mention of the PROCEEDINGS will be mutually helpful.

IT'S THE TWISTED TEETH THAT LOCK

TANGLEPROOF

Pack them together—bunch them as much as you like—Shakeproof Lock Washers can't link or tangle. Manufacturers are finding that the time saved in this one feature alone oftentimes pays their entire washer bill. Speed up your production line—stop delays—adopt Shakeproof Lock Washers, designed to prevent linking.

MULTIPLE LOCKING

Twisted teeth of steel set around the circumference of the washer. Tighten down the nut and each tooth bites in with a grip of steel—they can't let go. For sure locking demand Shakeproof.

SPREADPROOF

No matter how much pressure is applied you just can't spread a Shakeproof Lock Washer. This eliminates breaking of washers, too, and saves you time and money. With its multiple advantages, it is no wonder that manufacturers, large and small alike, the country over are adopting Shakeproof.

PRODUCTION SPEED

Slip them onto the bolt as fast as the hand can move. Easy to handle—just as easy to apply. Shakeproof will win new friends in your production department and speed up their work for you.

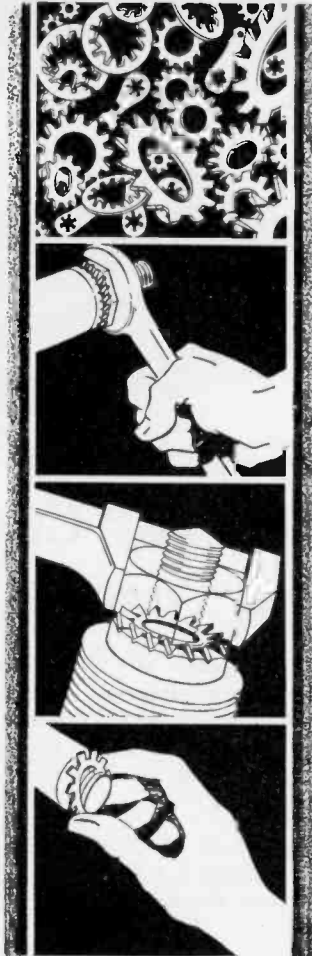

Type 11 External



Type 12 Internal



Type 20 Terminal

SHAKEPROOF Lock Washer Company

[Division of Illinois Tool works]

2501 North Keeler Avenue Chicago, Illinois

FREE SHOP TEST SAMPLES

Shakeproof Lock Washer Co., 2501 N. Keeler Ave., Chicago, Ill.

Please send me samples of

- Shakeproof Lock Washers to fit bolt size _____
- Shakeproof Locking Terminals, size _____

Firm Name _____

Address _____ Town _____ State _____

By _____

The roll call of America's manufacturers is the roll call of Shakeproof users. Pick any car on the road—the radio in your home—the cash register in your neighborhood store—the vacuum cleaner your wife uses—the typewriter on your stenographer's desk—it is a hundred to one they are all locked with Shakeproof.

U. S. Patents
1,419,564; 1,604,
122; 1,697,954.
Other Patents
Pending. Foreign
Patents.

When writing to advertisers mention of the PROCEEDINGS will be mutually helpful.

**PRECISION
FILAMENT**
UNCOATED
RIBBON & WIRE
FOR RADIO TUBES

New York
Sigmund Cohn
FEET..... J530
METAL..... C 13
SIZE..... .001X.037
GROSS WT.....
NET..... 1.50

ACCURATE
WITHIN .00005"
OF SPECIFIED
THICKNESS

UNIFORM
SIZE WEIGHT
AND
RESISTANCE

**HANGS
STRAIGHT**
FREE FROM
SURFACE
IMPURITIES

A Product of
SIGMUND COHN
44 Gold Street
New York

When writing to advertisers mention of the PROCEEDINGS will be mutually helpful.

The Straight and Narrow Path



Yes, there is a sermon to preach in radio, just as there is in affairs of religion. And the radio sermon today, with socket-power operation, is simply this:

Keep within the straight and narrow path—the 5% plus or minus limits set by tube manufacturers for the safe and sane operation of their A-C tubes. Tubes are made to operate with specific filament, plate and grid-bias voltages. But electric light and power companies, unfortunately, allow their line voltages to meander anywhere from 95 to 135 volts as proved by a country-wide survey. The results of straying away from the straight and narrow path of 110 volts are briefly as follows:

With excessively low voltage, it is virtually impossible to provide a satisfactory demonstration of a socket-power radio set. The filament, heater, plate and grid-biasing voltages are sub-normal, and the results are progressively so. Hence many sales are lost in the very territories—suburban and rural—where your enterprising dealer today is making his biggest play for business.

With excessively high voltage, the demonstrations are brilliant, but so are the tubes which soon lose their emission, characteristics, and even their life. One of the greatest causes of bad will, bad name and bad business these days is excessive line voltage operation, which means excessive tube replacements, service calls, and general dissatisfaction.

And so we urge you, as set designer, set manufacturer, or set service man, to keep within the straight and narrow path—within that 5% plus or minus voltage specified by tube manufacturers. All of which is simple enough, if you make use of the

LINE BALLAST CLAROSTAT

The perfected and inexpensive method of regulating line voltage automatically, now employed in the better type socket-power radio sets. It costs little, but saves much.

The Line Ballast Clarostat is foolproof. No chemicals to spill or wear out, no glass bulb to break, no delicate filaments, nothing to play with. Simply a sturdy metal cartridge which plugs into receptacle provided in chassis. Internal details comprise sturdy brass and mica framework holding non-oxidizing wire winding. Each cartridge is designed for a specific power transformer, providing ideal automatic regulation. The device maintains a constant voltage on the primary, even though the line voltage may fluctuate between the limits of 95 and 135 volts, with the secondary voltages held to within the plus or minus 5%.

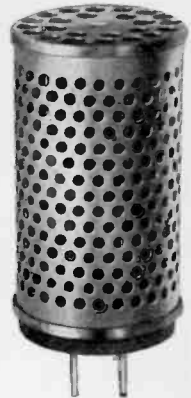

1/2 Actual Size

Write for technical data regarding the Line Ballast Clarostat, the improved Volume Control Clarostats, and other Clarostat radio aids.

If you are a radio manufacturer or designing engineer, send us a sample power transformer, together with complete data as to primary and secondary voltages and loads, and we shall gladly submit a matched ballast for your tests.

Clarostat Manufacturing Company, Inc.



289 North Sixth Street

::

Brooklyn, N.Y.

Specialists in Radio Aids

When writing to advertisers mention of the PROCEEDINGS will be mutually helpful.

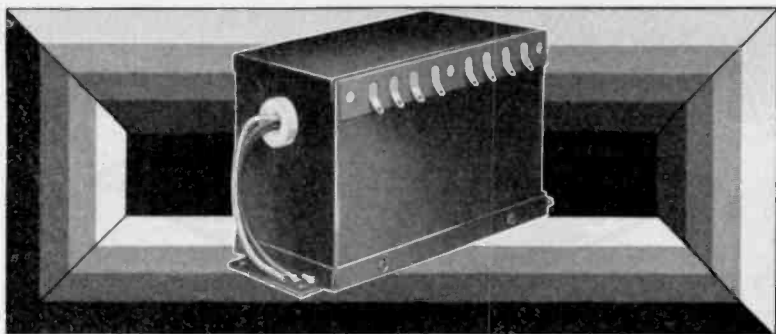

New Jefferson Power Pack for use with the new 245 and A.C. 222 power tubes.

Transformers and Chokes for New Power Tubes

Specially Engineered by Jefferson

A GAIN Jefferson Engineers have anticipated the need of the Radio Industry. The transformer and choke problems which will be met in building sets around the newly developed power tubes have already been solved by Jefferson Engineers.

A new power transformer has been designed, perfected, and thoroughly tested for use with the new tubes No. 245 and No. A.C. 222 shield grid tube.

A wide choice of choke units are ready—heavy single duty chokes, double chokes of the conventional design—or staggered choke units consisting of one heavy and one light choke. The last is an especially economical method which minimizes hum and allows maximum

voltage on the tubes without overloading the rectifier.

Special audio transformers have been developed with improved design to make use of all the possibilities of these new tubes.

Jefferson reputation, backed and maintained by Jefferson engineering, is your guarantee of quality, service, and satisfaction on these new units. And the foresight of Jefferson Engineers together with the Jefferson production capacity are your insurance of prompt deliveries now and throughout the season.

Take advantage of this engineering work already done for you by writing us your problems. Complete electrical specifications and quotations will be supplied on request.

JEFFERSON ELECTRIC COMPANY
1591 West 15th Street, CHICAGO, ILLINOIS

JEFFERSON

AUDIO and POWER TRANSFORMERS and CHOKES

When writing to advertisers mention of the PROCEEDINGS will be mutually helpful.



Pointing Out the Features
of the New Type B. T. 4 Gang
ARMORED CONDENSER

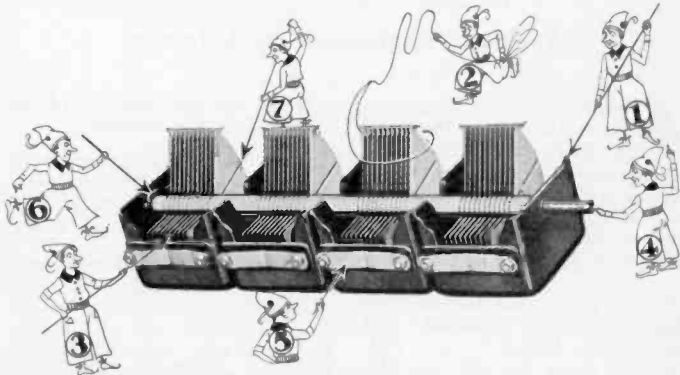

1. Rigid frame made of heavy drawn steel.
2. Rotors and stators are precision spaced and soldered.
3. Accuracy and calibration in ganging is assured by wide spacing between plates.
4. Permanent and perfect alignment of rotors is assured because the removable shaft is independent of bearings.
5. Circuit adjustments are facilitated by the gradual curve on the minimum capacity adjuster.
6. Adjustable smooth acting end thrust and tension fork.
7. The split end rotor plate permits additional adjustment for the entire wave band.

Samples now ready for delivery. Write for prices and full information.

UNITED SCIENTIFIC LABORATORIES, Inc.
 115-C Fourth Avenue, New York City

Branch Offices for Your Convenience in

St. Louis
 Chicago
 Boston
 Minneapolis
 Cincinnati

Los Angeles
 Philadelphia
 San Francisco
 London, Ontario



When writing to advertisers mention of the PROCEEDINGS will be mutually helpful.



Symington Precision Manufacture Begins Here

IN THIS modern tool room costly machines, skilled workmen fashion the accurate jigs, tools, dies and fixtures necessary for volume production at low cost. Here begins the precision which distinguishes the Symington product.

This tool room spells quick production on new designs, complete facilities for prompt design changes where a manufacturer's altered specifications so require.

Supporting this tool room is a million dollar plant geared up for large scale production of the Symington Reproducer—a quality speaker at the lowest possible price.

Write for illustrated folder showing this great one-profit plant in detail.

A view of the big Valley Plant. We invite executives and engineers to visit us in Rochester.



CHASSIS

The Symington Electro-Dynamic used by leading independent radio set manufacturers as "standard equipment."

VALLEY APPLIANCES INCORPORATED Rochester, New York

When writing to advertisers mention of the PROCEEDINGS will be mutually helpful.

Piezo Electric Crystals and Constant Temperature Equipment

Piezo Electric Crystals:

We are prepared to grind Piezo Electric Crystals for POWER use to your assigned frequency in the 550 to 1500 KC band, *accurate to plus or minus 500 cycles* for \$55.00 fully mounted. Crystals for use in the HIGH FREQUENCY BROADCAST BAND (4000 to 6000 KC) for POWER use, accurate to plus or minus .03% of your assigned frequency, fully mounted, \$85.00. In ordering please specify type of tube used, plate voltage and operating temperature. All crystals guaranteed with respect to output and accuracy of frequency. Deliveries can be made within three days after receipt of order.

Constant Temperature Equipment

In order to maintain the frequency of your crystal controlled transmitter to a high degree of constancy, a high grade temperature control unit is required to keep the temperature of the crystal constant. Our unit is solving the problem of keeping the frequency within the 50 cycle variation limits. Our heater unit maintains the temperature of the crystals constant to **BETTER THAN A TENTH OF ONE DEGREE CENTIGRADE**; is made of the finest materials known for each specific purpose and is absolutely guaranteed. Price \$250.00. Further details sent upon request.

Low Frequency Standards:

We have a limited quantity of material for grinding low frequency standard crystals. We can grind them as low as *15,000 cycles*. These crystals will be ground to your specified frequency accurate to **ONE HUNDREDTH OF ONE PER CENT**. Prices quoted upon receipt of your specifications.

Scientific Radio Service

"The crystal specialists"

P. O. Box 86

Dept. R6

Mount Rainier, Md.

RADIO ENGINEERS
specify
VITREOSIL

(Fused Pure Silica and Quartz)

Insulation for Heater Type AC Tubes
Heat Treating Tubes for Metal Parts
Optical Details for Television

OBTAINING: Homogeneity; Impermeability; Freedom from Gas; Lowest Expansion; High Electrical Resistance; Freedom from Impurities.

And in TRANSPARENT VITREOSIL Best Transmission of Visible, Ultra-Violet and Infra-Red Rays

AVAILABLE SHAPES: Transparent Lenses, Prisms, Bulbs, etc.; Rods, Plates and Special Cross Section Strips; Single and Multiple Bore Tubing in All Diameters.

WRITE STATING PROBLEM

THE THERMAL SYNDICATE, LTD.
1716 Atlantic Avenue Brooklyn, New York

When writing to advertisers mention of the PROCEEDINGS will be mutually helpful.



Faradon

**ELECTROSTATIC
CONDENSERS**

for All Purposes



*The Accepted Standard
for Exacting Service as well as
General Application on
Land and Sea and
in the Air*

**WIRELESS SPECIALTY
APPARATUS COMPANY**

Est. 1907

Jamaica Plain

Boston

When writing to advertisers mention of the PROCEEDINGS will be mutually helpful.

The Institute of Radio Engineers

Incorporated

33 West 39th Street, New York, N. Y.

APPLICATION FOR ASSOCIATE MEMBERSHIP

To the Board of Direction
Gentlemen :

I hereby make application for Associate membership in the Institute.

I certify that the statements made in the record of my training and professional experience are correct, and agree if elected, that I will be governed by the constitution of the Institute as long as I continue a member. I furthermore agree to promote the objects of the Institute so far as shall be in my power, and if my membership shall be discontinued will return my membership badge.

Yours respectfully,

.....
(Sign with pen)

.....
(Address for mail)

.....
(Date)

.....
(City and State)

References:

(Signature of references not required here)

Mr. Mr.

Address Address

Mr. Mr.

Address Address

Mr.

Address

The following extracts from the Constitution govern applications for admission to the Institute in the Associate grade:

ARTICLE II—MEMBERSHIP

- Sec. 1: The membership of the Institute shall consist of: * * * (d) Associates, who shall be entitled to all the rights and privileges of the Institute except the right to hold the office of President, Vice-president and Editor. * * *
- Sec. 5: An Associate shall be not less than twenty-one years of age and shall be: (a) A radio engineer by profession; (b) A teacher of radio subjects; (c) A person who is interested in and connected with the study or application of radio science or the radio arts.

ARTICLE III—ADMISSION

- Sec. 2: * * * Applicants shall give references to members of the Institute as follows: * * * for the grade of Associate, to five Fellows, Members, or Associates; * * * Each application for admission * * * shall embody a concise statement, with dates, of the candidate's training and experience.
- The requirements of the foregoing paragraph may be waived in whole or in part where the application is for Associate grade. An applicant who is so situated as not to be personally known to the required number of members may supply the names of non-members who are personally familiar with his radio interest.

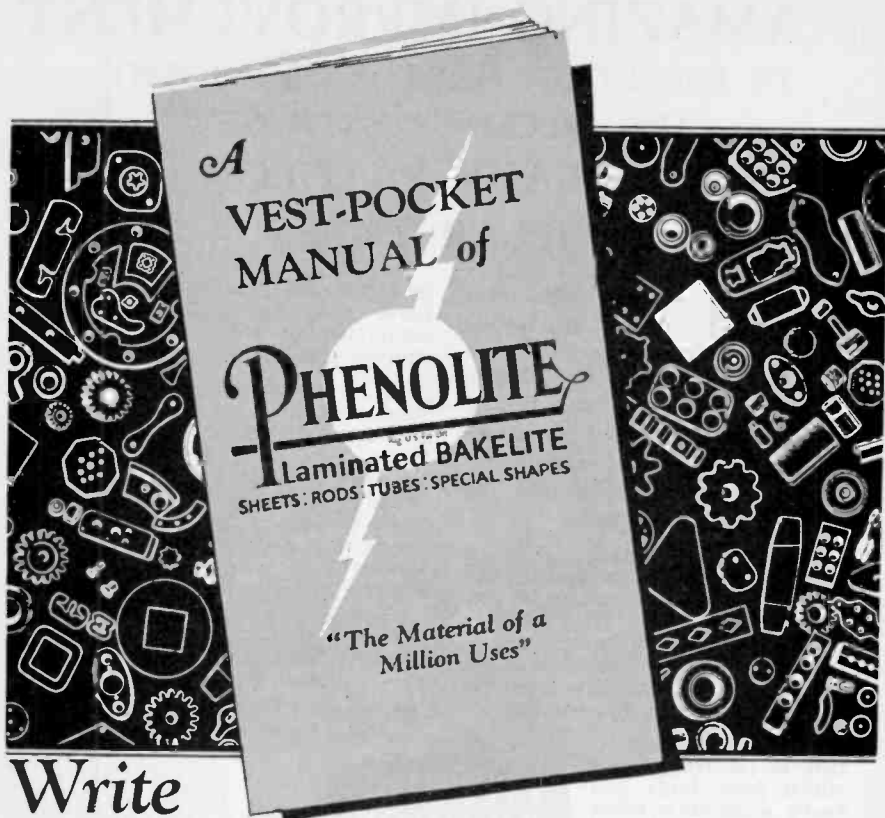

Write for the Phenolite Manual

Know why Phenolite is replacing Hard Rubber, Metals, Porcelain and Glass, Wood. Find out how you can use Phenolite in many different ways, for many different purposes. Inform yourself as to its Toughness, Rigidity, Permanence, High Tensile and Dielectric Strength, Noiseless Operation, Resistance to Solvents and Moisture. The Phenolite Vest-Pocket Manual tells you how and why Phenolite punches, turns, mills, taps, threads, saws and drills with astonishing ease, speed, accuracy.

Read the facts that make the proof of Phenolite superiority. Then, let our Service Engineering Department help you determine whether or not Phenolite will bring you benefits of improved quality of product with added economy. Let these specialists help you determine which grade of Phenolite is best suited to your requirements. Our laboratory is the place "where known requirements meet known performance." Anyway, let us mail the Manual. Write for it today.

NATIONAL VULCANIZED FIBRE COMPANY, WILMINGTON, DEL., U. S. A.
Offices in Principal Cities



When writing to advertisers mention of the PROCEEDINGS will be mutually helpful.

AN AMAZING IMPROVEMENT IN RECEPTION FROM YOUR PRESENT RADIO RECEIVER WITH NEW EVEREADY RAYTHEON 4-PILLAR TUBES

THE inevitable jolts and jars of shipment and handling can't budge the elements in an Eveready Raytheon Tube by as much as a thousandth of an inch. Their accurate spacing, which assures maximum performance, is immune to these common hazards.

The *4-Pillar construction*, which gives Eveready Raytheon Tubes their remarkable strength, is patented and exclusive. With no other tube can you get all its advantages. If you examine the illustration at the bottom of this page, you will see the superiority of this construction.

This is especially important in receiving tubes which have large and heavy elements—tubes such as the 224 screen-

grid, the 280 rectifier, and power tubes used for push-pull audio amplification, requiring perfectly uniform characteristics.

People everywhere, using Eveready Raytheons in their receivers, report increased distance, more power, better tone and quicker action. To get the most from your receiver, put a new Eveready Raytheon in each socket. Your dealer has them in all types—including the famous B-H tube for "B" power units.

NATIONAL CARBON CO., INC.

General Offices:
New York, N.Y.

Branches: Chicago, Kansas City,
New York, San Francisco.



TRADE-MARKS



Unit of Union Carbide
and Carbon Corporation



4-PILLAR TUBES

Showing the exclusive, patented Eveready Raytheon *4-Pillar construction*. Notice the sturdy four-cornered glass stem, the four rigid supports, and the stiff mica sheet bracing the top.



4-PILLAR SCREEN-GRID

Eveready Raytheon Screen-Grid Tube, ER 224. The weight of the four large elements in this type of tube makes the exclusive Eveready Raytheon *4-Pillar construction* vitally important.

When writing to advertisers mention of the PROCEEDINGS will be mutually helpful.

Your *Personal* Instrument

FOR

Checking radio circuits.

Measuring resistances.

Locating blown fuses.

Testing motor coils.

Locating faults in auto lighting
or ignition circuits.

Finding shorts or open circuits
in electrical appliances and
cords.

Hundreds of "personal" uses
aside from its place in the kit
of the maintenance or repair
man.

The word "personal" describes aptly a majority of the uses to which you will put this portable, direct reading ROLLER-SMITH HTD CIRCUIT TESTER.

That is because it is so light and compact that you will slip it into your pocket to test radio circuits or ignition circuits or to search out the cause of improper operation of *any* piece of electrical apparatus at home.

While essentially a CIRCUIT TESTER for the wireman, repair man, maintenance man or laboratory man, there are a limitless number of uses to which it may be put by every man who, in a personal or business way, has anything to do with electrical circuits—where it is necessary to determine whether a circuit exists or to read the resistance of a circuit.

It is safe to say that right *now* you can think of several places at your office or home where this Tester would help you.

The small cost of the HTD CIRCUIT TESTER is still another reason for making it a "personal" instrument.

Scale reads direct in ohms 0 to 10,000, also 0-100,000 and 0-200,000 ohms. Adjustment to compensate for drop in battery voltage. All details in Bulletin K-300. Send for it.

ROLLER-SMITH CO., 2134 Woolworth Bldg., NEW YORK, N.Y.

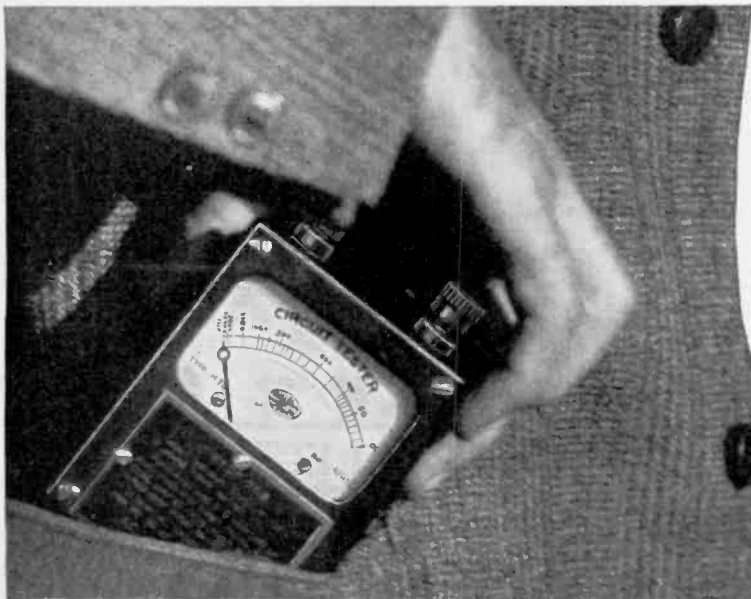

When writing to advertisers mention of the PROCEEDINGS will be mutually helpful.

THE LEADERS STANDARDIZE
ON DURHAM RESISTANCES



MODEL K-45



DURHAM Metallized RESISTORS and POWEROHMS are available for every practical resistance purpose in radio and television circuits, 500 to 200,000 ohms in power types; 1 to 100 Megohms in resistor types; ratings for all limited power requirements; standard, pigtail or special tips.

KOLSTER

*... another leader
who standardizes*

on DURHAM RESISTORS and POWEROHMS

KOLSTER!—another great name in radio—another great leader who has set the pace in quality receivers for many years—another leader who has long

recognized the superiority of the metallized principle upon which DURHAM Resistors and Powerohms are manufactured. Yes, KOLSTER is another of America's quality receivers which standardizes on Durham resistance units . . . because they are absolutely unfailing both in accuracy and uniformity. DURHAMS may cost a slight fraction more than average resistances, but their aid to quality reception is well worth the slight difference in price. Furthermore, their presence in a receiver is a guide to the quality of other parts. Write for engineering data sheets, samples for testing and complete literature. Please state ratings in which you are interested.

DURHAM

METALLIZED

RESISTORS & POWEROHMS

International Resistance Co., 2006 Chestnut Street, Philadelphia, Pa.

When writing to advertisers mention of the PROCEEDINGS will be mutually helpful.

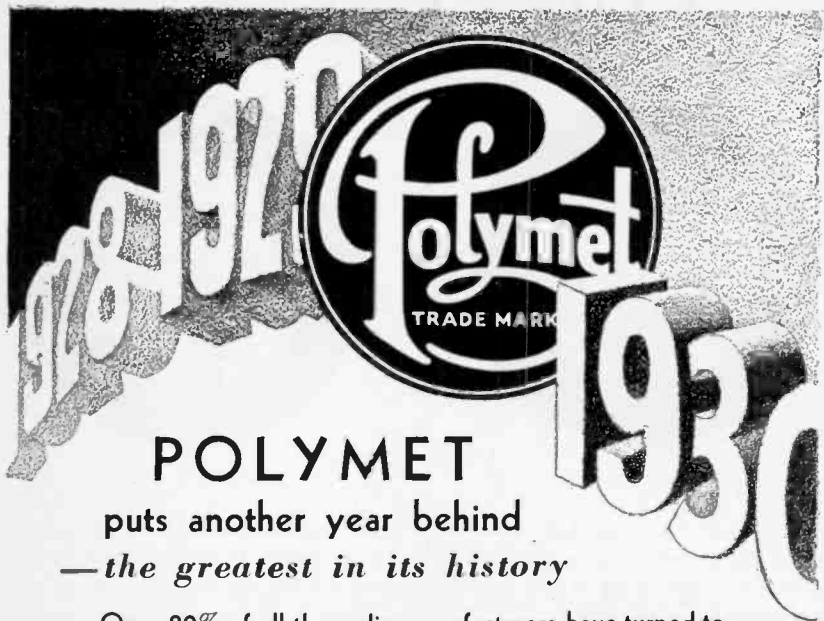

POLYMET

puts another year behind
—the greatest in its history

Over 80% of all the radio manufacturers have turned to Polymet in 1929 for standard radio essentials for incorporation in their sets. But December 31st ends nothing but a calendar; January 1st begins nothing but another.

Starting right where 1929 leaves off, Polymet will strive in 1930 to occupy an even more dominating position in the radio parts industry than ever before, by the simple expedient of offering to radio manufacturers the same unapproachable Quality, incomparable Service, and unexampled Dependability in

**CONDENSERS
RESISTANCES
COILS
and other**

Polymet Manufacturing Corp.
829 East 134th Street New York City

POLYMET PRODUCTS

Two Jewell Instruments of Ultra Sensitivity

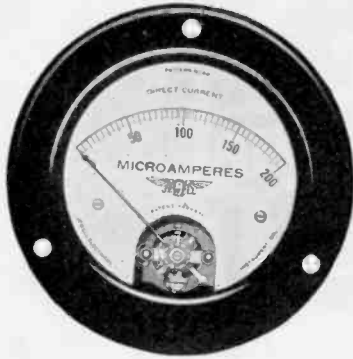

Pattern 88



Pattern 68

Now the Jewell Pattern 88 flush type bakelite case, direct current instrument is available with full scale ranges of 200, 300, and 500 microamperes, respectively.

These ultra sensitive instruments are valuable in research work and for deflection galvanometers in bridge circuits, plate microammeters in vacuum tube voltmeters, and similar uses.

Despite the difficulty of manufacturing these ultra sensitive instruments, due to the economy of quantity production they are priced at \$24.00 each in the microampere ranges. Higher scale ranges are lower in price.

Jewell Pattern 68 thermo couple instrument is now available in standard full scale ranges of 10, 25, 50, and 100 milliamperes.

These instruments are especially suited for wavemeter work, as well as for the determination of circuit constants, using radio frequency current. Coil resistance, decrement, parasitic oscillations, and many other determinations can be made by using these ultra sensitive instruments instead of laboratory type galvanometers with separate thermo couples.

List prices: 10 MA Range, \$40.00; 25 MA Range, \$37.50; 50 MA Range, \$35.00; and 100 MA Range, \$32.50.

*Write today for prices and descriptions
of these ultra sensitive instruments.*

Jewell Electrical Instrument Co.

1650 Walnut St.,
Chicago, Illinois

*Manufacturers of a complete line of high grade A.C. and D.C. instruments,
including switchboard instruments from 2" to 9" in diameter, and portable
instruments from small pocket sizes to laboratory precision standards.*

29 YEARS MAKING GOOD INSTRUMENTS
JEWELL

When writing to advertisers mention of the PROCEEDINGS will be mutually helpful.



The public looks for the RCA mark on the vacuum tubes of a new radio set. That is one important test of the quality of the instrument. RCA Radiotrons are standard equipment throughout the radio industry.

RADIOTRON DIVISION OF THE
RADIO-VICTOR CORPORATION OF AMERICA

RCA RADIOTRON
MADE BY THE MAKERS OF THE RADIOLA

When writing to advertisers mention of the PROCEEDINGS will be mutually helpful.

U. S. NAVAL INSTITUTE

FOUNDED IN 1873

*For the Advancement of Professional, Literary
and Scientific Knowledge in the Navy*

ADMIRAL DAVID D. PORTER
Was Its First President

For Over Half a Century

U. S. Naval Institute Proceedings

Has Been the Navy's Forum

Published Monthly—Illustrated

Its pages cover a wide range of subjects by foreign and American contributors, officers and civilians, many of whom are distinguished in their specialties, so written as to interest the Institute's large civilian associate membership. An attempt is made each month to put out a well balanced issue: some theory, some discussion of present-day methods with constructive criticism, book reviews, professional notes, international notes, some naval history, some narrative and occasionally general engineering subjects.

UNTIL FURTHER NOTICE all Grades of Membership of the Institute of Radio Engineers are Invited to Become Associate Members of the Naval Institute upon Application and Payment of ANNUAL DUES \$3.00 (Including Proceedings). (Regular Subscription \$5.00 Per Year.)

Address: U. S. NAVAL INSTITUTE, ANNAPOLIS, MD., U. S. A.

When writing to advertisers mention of the PROCEEDINGS will be mutually helpful.

EVERY OPERADIO POWER UNIT MUST THIS PASS TEST!

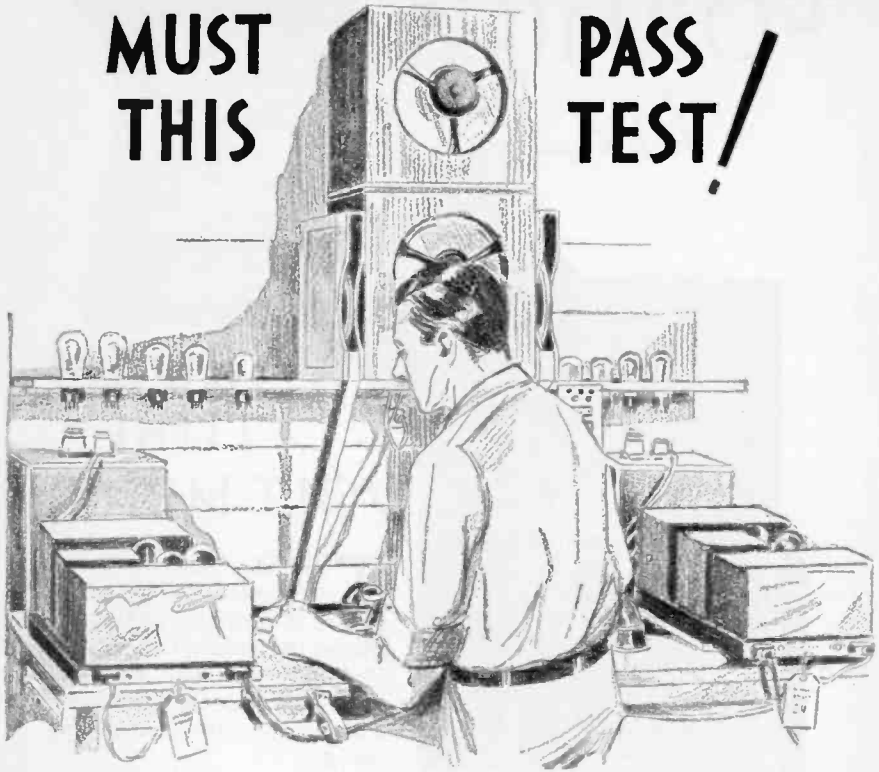

ON the right is the standard Power Unit, on the left is the production Power Unit. Using a Comparator Switch, an *instantaneous comparison* is made between the Power Units, connecting the same pick-up and the same speaker to each in turn. Matched sets of tubes are used so that the Power Unit itself is the only variable introduced. This means *assured uniformity of performance* in every Operadio Power Unit leaving the plant—Operadio's standards of quality are *conscientiously maintained* at the highest point.

OPERADIO MANUFACTURING CO.
ST. CHARLES, ILL.

OPERADIO

When writing to advertisers mention of the PROCEEDINGS will be mutually helpful.

FORMICA

in a

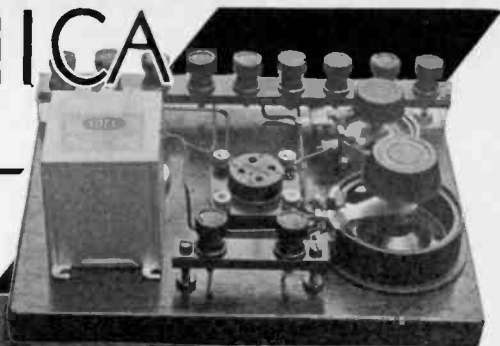

VACUUM TUBE VOLT METER

THESE vacuum tube voltmeters designed by Harry R. Lubcke, 2831 Clay Street, Alameda, California, illustrate the use of Formica for panels, terminal strips, etc., in instrument design.

Leading technical men throughout the Radio and Electrical industries have confidence in Formica. It has served them well for 16 years and they have loyally supported it with their patronage for many years.

It is available promptly in any quantity in sheets, tubes and rods, or in parts of any type that may be machined from those parts.

Send your blueprints for quotations.

THE FORMICA INSULATION COMPANY

4646 Spring Grove Avenue
CINCINNATI, OHIO

FORMICA
Made from Anhydrous Bakelite Resins
SHEETS TUBES RODS

When writing to advertisers mention of the PROCEEDINGS will be mutually helpful.

XXX



The Master Hand of Reproduction

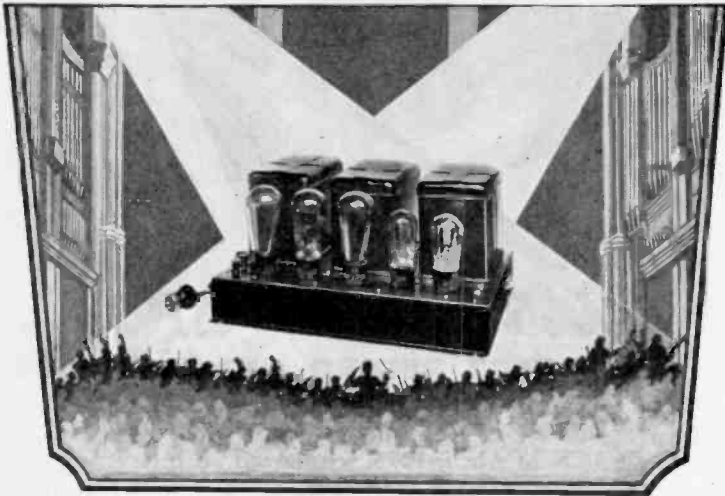

THE master hand of the conductor . . . blended effects . . . and the great symphony concert is the final result.

Likewise Powerizer Sound System is the final result of blended unity . . . the master hand of reproduction. Thousands upon thousands of dollars have been expended in matching every element that enters into an audio amplifying system . . . every element that acoustics of auditoriums, varying in size and structure, demand for perfect balance.

Our vast fund of experience is generously offered to the Electrical Engineer. He may use it to his advantage. Send for our booklet I R 1029. It is yours for the asking.

RADIO RECEPTOR COMPANY, INC.

106A Seventh Avenue, New York City

Licensed by Radio Corporation of America and Associated Companies

POWERIZER

SOUND SYSTEMS

(IR-12-29)

When writing to advertisers mention of the PROCEEDINGS will be mutually helpful.

Engineering Facts Have A Utility Value

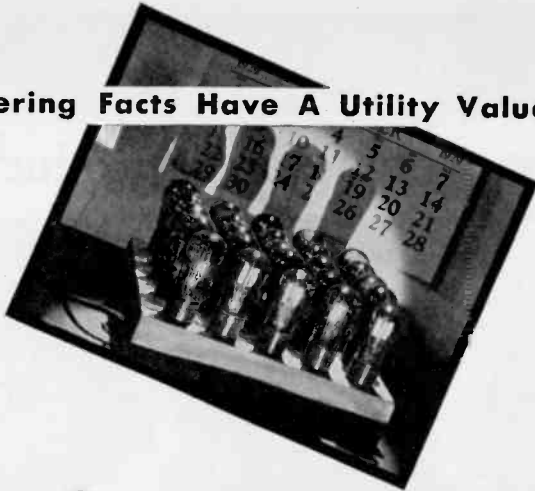

12,500 HOURS...

A WORLD'S RECORD FOR TUBE LIFE!

By **GEORGE LEWIS**

Vice President, Arcturus Radio Tube Company

BACK in April, 1928, we started an interesting experiment with Arcturus Radio Tubes. We wanted to know how long our tubes would last. So we took 25 standard quick heating tubes at random from stock, put them in a test rack, and turned on the current.

Eighteen months have passed. These 25 tubes have been burning continuously day and night. They have piled up a world's endurance record of *more than 12,500 hours, yet not one tube has burned out.*

We believe you will agree that this is a remarkable record. It proves that Arcturus design is sound... that there are no weak spots in Arcturus construction. It proves that Arcturus engineers have not sacrificed durability to gain the quick action and clear tone which have made Arcturus Tubes famous.

Critical set engineers and radio manufacturers endorse Arcturus Tubes because of this all-around performance. They know that any a. c. set gives best results with Arcturus Blue Tubes in every socket.

ARCTURUS

A-C

RADIO TUBES

ARCTURUS RADIO TUBE CO., NEWARK, N. J.

When writing to advertisers mention of the PROCEEDINGS will be mutually helpful.

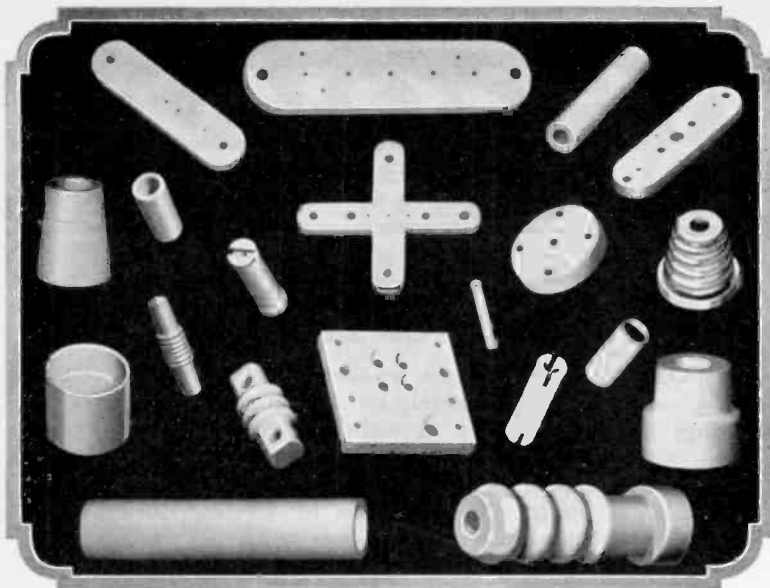

Typical
Isolantite
Radio Insulating Products

ISOLANTITE is a *logical* insulator for use in radio receivers and transmitters both electrically and mechanically. Get the facts on this scientifically processed and accurately fabricated ceramic. Send us your specifications for quotations.

Isolantite Company of America
(Incorporated)

New York Sales Office: 551 Fifth Avenue, NEW YORK

When writing to advertisers mention of the PROCEEDINGS will be mutually helpful.

XXXIII



How Do You Buy Condensers?

MOST filter condensers, condenser blocks and bypass units are bought merely on the basis of price, voltage ratings and their ability to withstand ordinary short-time tests, without sufficient consideration to the fact that these are not dependable indicators of the ability of a condenser to stand up under all conditions of service, during the entire life of the receiver or power unit.

Nothing is apt to prove as costly as a cheaply made, over-rated condenser or resistor. Whether you are a manufacturer, professional set builder or experimenter, you cannot afford the high cost luxury of a cheap condenser or resistor.

Aerovox condensers and resistors are conservatively rated and thoroughly tested. The Aerovox Wireless Corporation makes no secret of the Insulation Specifications

of their filter condensers and filter condenser blocks. This information is contained in detail in the 1928-29 catalog.

The next time you are in the market for filter condensers or filter condenser blocks, make your comparison on the basis of Insulation Specifications. Aerovox condensers are not the most expensive, nor the cheapest, but they are the best that can be had at any price.

Send For Complete Catalog

Complete specifications of all Aerovox units, including insulation specifications of condensers, carrying capacities of resistors and all physical dimensions and list prices are contained in a fully illustrated, 20-page catalog which will be sent free of charge on request.



When writing to advertisers mention of the PROCEEDINGS will be mutually helpful.

CHANGE IN MAILING ADDRESS OR BUSINESS TITLE

Members of the Institute are asked to use this form for notifying the Institute office of a change in their mailing address or any change in the listing of their company affiliation or title for the Year Book membership list.

The Secretary,
THE INSTITUTE OF RADIO ENGINEERS,
33 West 39th Street,
New York, N.Y.

Dear Sir:

Effective please note change in my address
(date)
for mail as follows:

FROM

.....
(Name)

.....
(Street Address)

.....
(City and State)

TO NEW ADDRESS

.....
(Street Address)

.....
(City and State)

Also for the membership list for next year's Year Book note change in my business address (or title) as follows, this ^{is} my mailing address: _{is not}

.....
(Title)

.....
(Company Name)

.....
(Address: Street, City and State)

PLEASE FILL IN, DETACH, AND POST TO THE
INSTITUTE PROMPTLY

Back Numbers of the Proceedings Available

MEMBERS of the Institute will find that back issues of the Proceedings are becoming increasingly valuable, and scarce. For the benefit of those desiring to complete their file of back numbers there is printed below a list of all complete volumes (bound and unbound) and miscellaneous copies on hand for sale by the Institute.

The contents of each issue can be found in the 1914-1926 Index and in the 1929 Year Book (for the years 1927-28).

BOUND VOLUMES:

Vols. 8, 9, 10, 11 and 14 (1920-1921-1922-1923-1926), \$8.75 per volume, to members.

Vol. 16 (1928), \$9.50 to members.

UNBOUND VOLUMES:

Vols. 6, 8, 9, 10, 11 and 14 (1918-1920-1921-1922-1923-1926), \$6.75 per volume (year) to members.

MISCELLANEOUS COPIES:

Vol. 1 (1913) July and December

Vol. 2 (1914) June

Vol. 3 (1915) December

Vol. 4 (1916) June and August

Vol. 5 (1917) April, June, August, October and December

Vol. 7 (1919) February, April and December

Vol. 12 (1924) August, October and December

Vol. 13 (1925) April, June, August, October and December

Vol. 15 (1927) April, May, June, July, October and December

These single copies are priced at \$1.13 each to members to the January 1927 issue. Subsequent to that number the price is \$0.75 each. Prior to January 1927 the Proceedings was published bi-monthly, beginning with the February issue and ending with December. Since January 1927 it has been published monthly.

Make remittances payable to the Institute of Radio Engineers and send orders to:

THE INSTITUTE OF RADIO ENGINEERS

33 West 39th Street

NEW YORK, N. Y.

You can forget the Condensers, if they are DUBILIER'S



PL-1826

A special purpose, high voltage, short wave, transmitting condenser.
Another example of most advanced construction in condensers using mica as the dielectric.

A Dubilier development.

Note the electrical characteristics:

| | | | |
|-----------------------|--------------|-----------------|------------|
| Capacity | 0.00074 Mfd. | Current | 25 amperes |
| Volts Effective | 50,000 | Frequency | 3,000 K.C. |

Technical Ability in Sales

is an important complement to ability in engineering and manufacture.

Do not hesitate to ask for a Dubilier Sales-Engineer.

You will find him capable of thoroughly understanding the problems involved in your job.

Dubilier
CONDENSER
CORPORATION

342 Madison Avenue
New York, N. Y.

When writing to advertisers mention of the PROCEEDINGS will be mutually helpful.

INSTITUTE SUPPLIES

EMBLEMS



Three styles of Institute emblems, appropriately colored to indicate the various grades of membership in the Institute, are available. The approximate size of each emblem is that of the illustrations.



The lapel button is of 14k gold, the background being enamelled in the membership color, the lettering being gold. The button is supplied with a screw back with jaws which fasten it securely to the coat. This style emblem can be obtained for \$2.75, postpaid, for any grade.



The pin is also of 14k gold. It is provided with a safety catch and is appropriately colored for the various grades of membership. Price, for any grade, \$3.00 postpaid.

The watch charm is handsomely finished on both sides and is of 14k gold. The charm is equipped with a suspension ring for attaching to a watch fob or chain. Price for any grade \$5.00 postpaid.

BINDERS

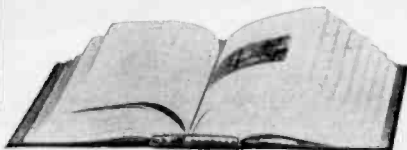

The binder pictured here contains over three inches of filing space. It serves either as a temporary transfer binder or as a permanent cover. It is made of handsome Spanish Grain Fabrikoid in blue and gold. The binder is so constructed that each individual copy

of the PROCEEDINGS will lie flat when the pages are turned. Copies can be removed from the binder in a few seconds and can be permanently preserved in undamaged condition. Hundreds of these binders are sold each year. Price, \$1.50 each, or \$2.00 with the member's name or the PROCEEDINGS Volume Number stamped in gold.

BACK ISSUES OF THE PROCEEDINGS

Back issues of the PROCEEDINGS are available in unbound form for the years 1918, 1920, 1921, 1922, 1923, and 1926 at \$6.75 per year (six issues). Single copies for any of the years listed to 1927 are \$1.13 each. From 1927 on (where available) the single copy price is \$0.75. Foreign postage on the volume is \$0.60 additional. On single copies \$0.10.

A number of individual copies for years other than those listed above are available. For a list of these, members should apply to the Secretary.

Bound volumes in Blue Buckram binding are available for the years 1920, 1921, 1922, 1923, and 1926 at \$8.75 per year. The bound volume for 1928 is priced at \$9.50. Foreign postage is \$1.00 per volume.

Bound volumes, for the above years, in Morocco Leather binding are available at \$11.00 each.

These prices are to members of the Institute.

FOURTEEN YEAR INDEX

The PROCEEDINGS Index for the years 1909-1926, inclusive, is available to members at \$1.00 per copy. This index is extensively cross indexed.

YEAR BOOK

The 1927 and 1928 year books are available to members at \$0.75 per copy, per year. The 1929 year book, including the report of the 1928 Committee on Standardization, is available to members at \$1.00 per copy.

When ordering any of the above, send remittance, with order to The Secretary, The Institute of Radio Engineers, 33 West 39th Street, New York, N. Y.

When writing to advertisers mention of the PROCEEDINGS will be mutually helpful.

Solid Molded



**Bradleyunit
Fixed
Resistors**

Rugged-Accurate-Permanent

Compare These Oscillograms

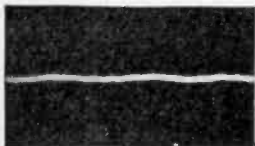

Oscillogram showing noiseless performance of Bradleyunit Resistors.



Oscillogram showing noisy performance of other types of resistors.

SOLID MOLDED—that is the secret of the superior performance of the Bradleyunit. Made in ratings from 500 ohms to 10 megohms, these accurate, noiseless fixed resistors are the choice of the leading set manufacturers for grid leaks and plate coupling resistors.

All Bradleyunits are color-coded for quick and easy identification. They are not fragile. There are no production losses due to breakage. Temperature, moisture, and age do not affect Bradleyunit accuracy.

Follow the example of leading radio manufacturers, and standardize on the Bradleyunit. Write for further information and prices.

ALLEN-BRADLEY CO., 282 Greenfield Ave., Milwaukee, Wis.

Allen-Bradley

PERFECT RADIO  RESISTORS.

When writing to advertisers mention of the PROCEEDINGS will be mutually helpful.

OIL IMPREGNATED FILTER CONDENSERS

FOR THOSE WHO WANT AND APPRE-
CIATE THE HIGHEST QUALITY.
SEND SPECIFICATIONS FOR QUOTA-
TIONS AND SAMPLES.



CONDENSER CORPORATION OF AMERICA
259-271 CORNELISON AVE. JERSEY CITY, N. J.

The Ekko Co.
Daily News Bldg.
Chicago, Ill.

W. C. Laing
Southern Ohio Bank Bldg.
Cincinnati, Ohio

When writing to advertisers mention of the PROCEEDINGS will be mutually helpful.

"ESCO"

*Operate Standard A. C. Radios in D. C. Districts
on Yachts or Farm Plants with*

"ESCO" Dynamotors or Motor Generators

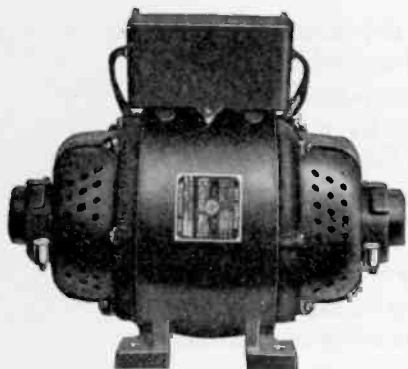

Dynamotor with Filter for Radio Receivers

"ESCO" manufacturers for regular stock four sizes of dynamotors known as RL2 (75 watts) RL4 (160 watts) LF3 (350 watts) and LF5 (550 watts)—These are wound for 32 volt, 110 volt, or 220 volt. Special voltages and sizes made to order. Prompt delivery and low prices. Dynamotors require no starting controllers.

All "ESCO" Radio Armatures are dynamically balanced—assuring minimum of vibration.

All machines are equipped with "ESCO" filter specially designed for sensitive radio sets—The filtration is as near perfect as scientific research can develop.

Where it is desired to vary the A.C. voltage, the use of a motor generator is recommended. Suitable rheostats are furnished by "ESCO," at a slight additional cost. While the motor generators are stocked only in the 300 watt size with 110, 220 or 32 volt primary, special sizes and voltages may be made to order.

Both dynamotors and motor generators are furnished with special wool packed bearings assuring minimum attention and quiet operation.

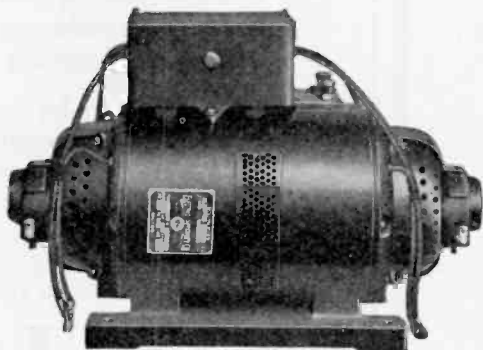

Motor-generator with Filter for Radio Receivers

ELECTRIC  **SPECIALTY**
COMPANY

300 SOUTH ST., STAMFORD, CONN.

*Manufacturers of motors, generators, dynamotors and
rotary converters.*

When writing to advertisers mention of the PROCEEDINGS will be mutually helpful.

RECTIFIERS

Since the advent of dry metallic rectifiers Elkon has always led in perfection of design and record of performance. Many of the leading manufacturers have brought their rectifier problems to Elkon for solution.

The signal success of Elkon rectifiers in the "A" Eliminator and battery charging fields was followed by outstanding achievements with low voltage rectifiers for dynamic and other moving coil speakers.

Again, this year, looking ahead and interpreting the need, Elkon introduced the new high voltage rectifiers which eliminate the power transformer in dynamic speakers and others of moving coil type.

Whatever may be your problem of rectification, Elkon engineers will be glad to co-operate with you in working out its solution.

ELKON, INC.

Division of P. R. Mallory & Co., Inc.
INDIANAPOLIS, IND.

by *ELKON*

When writing to advertisers mention of the PROCEEDINGS will be mutually helpful.

Radio Condensers for Every Set Manufacturer

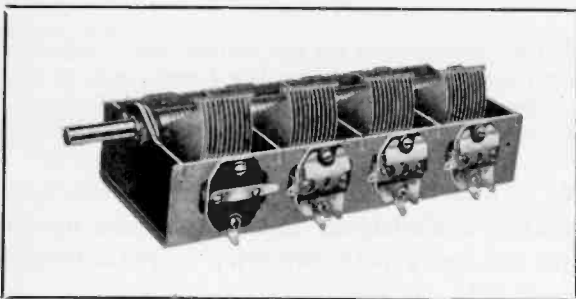

THE SCOVILL MANUFACTURING COMPANY has facilities for handling large orders for radio condensers. It is prepared to manufacture condensers to meet the individual requirements of each set manufacturer. Not limited to any particular style, we can produce in quantity any special or standard variable condenser that may be required.

In addition to correct metal and expert workmanship, Scovill offers to set manufacturers a research department whose constant activity insures condensers always slightly ahead of the market trend in design and construction. Find out *today* how Scovill can help you.

Every step in the manufacture of Scovill radio parts is under strict laboratory supervision.

SCOVILL

Established 1802

MANUFACTURING COMPANY

· WATERBURY · CONNECTICUT ·

NEW YORK
LOS ANGELES
PROVIDENCE
ATLANTA
CLEVELAND
SAN FRANCISCO



PHILADELPHIA
CINCINNATI
BOSTON
DETROIT
CHICAGO

In Europe—THE HAGUE, HOLLAND

When writing to advertisers mention of the PROCEEDINGS will be mutually helpful.

The Graf Zeppelin's radio signals received half way around the earth over an antenna equipped with PYREX Insulators

"PYREX Insulators on my new antenna and counterpoise are simply great. Since installing them I notice quite an increase in antenna current. Picked up the Graf Zeppelin twice when she was about 800 miles east of Tokyo." (August 24th, 1929)

C W. GILBERT who wrote the above, owns Radio Station W3MS, Philadelphia, has been a radio operator for 19 years and can speak with authority on radio insulation.

His achievement in bringing in signals from the small set on the Zeppelin with his own 3-circuit detector, 2-stage audio set in Philadelphia, 12000 miles away, caused much favorable comment.

Most of the American Broadcasting Stations are enthusiastic advocates of PYREX Insulators; Radio telegraph companies depend upon PYREX Insulators to aid in keeping their service reliable; and explorers who must often depend upon radio communication for safety, find that PYREX Insulators enable them to get long range with very small sets.

Proper types for professional and amateur needs are shown in the PYREX Radio Insulator Booklet, which will be sent on request.

CORNING GLASS WORKS, DEPT. 63

Industrial and Laboratory Division
CORNING, NEW YORK

Worlds Largest Manufacturer of Technical Glassware



When writing to advertisers mention of the PROCEEDINGS will be mutually helpful.

"THE STANDARD OF COMPARISON"

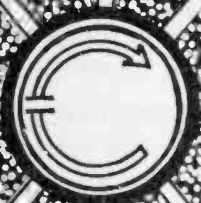

The REAL Test

FOR
ELECTRICAL EFFICIENCY—
MECHANICAL STRENGTH—
ALL AROUND STURDINESS—
SOUND CONSTRUCTION—

CARDWELL CONDENSERS

Will give you the most in *real*
results for your money. They
are the choice of those who
know condensers.

TRANSMITTING CONDENSERS

For
AMATEURS, BROADCASTING
STATIONS AND
COMMERCIAL TRANSMITTERS

Receiving Condensers in Several
Types and Many Capacities

Send for Literature

THE ALLEN D. CARD-
WELL MFG. CORPN.

81 Prospect St.
Brooklyn, N. Y.

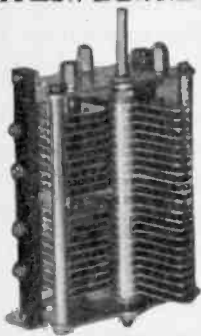

Cardwell Condensers

When writing to advertisers mention of the PROCEEDINGS will be mutually helpful.

Volume Controls

TO vary the intensity of the faithful reproduction built into radio receivers without introducing noise or distortion, can only be accomplished by a careful and complete consideration of both mechanical and electrical features of the volume control.

Mechanically—The Centralab exclusive and patented rocking disc contact precludes any possibility of wear on the resistance material. This feature adds to the smoothness of operation since the contact shoe rides only on the disc. The shaft and bushing are completely insulated from the current carrying parts—eliminating any hand capacity when volume control is placed in a critical circuit.

Electrically — Centralab engineers have evolved tapers of resistance that produce a smooth and gradual variation of volume. These tapers have been thoroughly tried and tested for each specific application for current carrying capacity and power dissipation.

Centralab volume controls have been specified by leading manufacturers because of their quality and ability to perform a specific duty—Vary the intensity of faithful reproduction—faithfully.

Manufactured in three sizes

Standard

Junior

Midget

*Also Double Standard
and Double Junior*

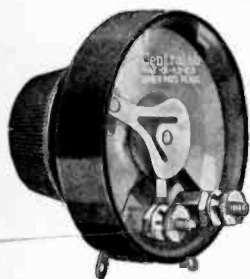

*Write for full particulars of
specific application.*

Centralab
CENTRAL RADIO  LABORATORIES

36 Keefe Ave.

Milwaukee, Wis.

A CENTRALAB VOLUME CONTROL IMPROVES THE RADIO SET

When writing to advertisers mention of the PROCEEDINGS will be mutually helpful.



Bring the Studio to your Home



*AmerTran DeLuxe
Audio Transformer—
List Price \$10.00. Type
151—Between one in-
put and two output
tubes—List Price \$15.00*



*Type AF-8 Audio Trans-
former—Either 1st or 2nd
stage audio. Turn ratio
3½ — List Price \$6.00*

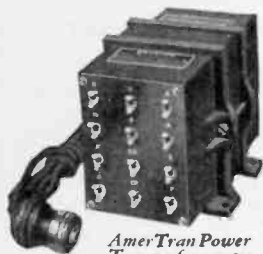

*AmerTran Power
Transformer
Type PF-245A—
List Price \$22.00*

There is no excuse for imperfect radio reception. But even today, receiving sets fail to reproduce music and the speaking voice in true tone identical with the range of pitch and the rich fullness of sound quality as broadcast in the studio.

The weak point in most receiving sets is in the audio system.

AmerTran Audio Transformers and Power Transformers shown here perfect the audio system and bring the programs into your home exactly as they go over the air through the microphone. For further descriptions of these and thirty-odd products in the field of radio reproduction that have attained the perfection necessary to AmerTran Standard of Excellence, write for Bulletin 1065.

The facilities of our engineering department are at the service of everyone interested in better radio reproduction.

AMERTRAN

TRADE MARK REG. U.S. PAT. OFF.
QUALITY RADIO PRODUCTS

AMERICAN TRANSFORMER COMPANY
178 EMMET STREET, NEWARK, N. J.
Transformer Builders for over 29 years

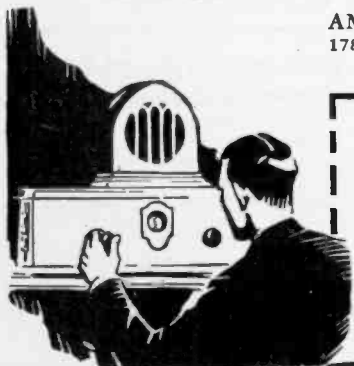

AMERICAN TRANSFORMER CO.
178 Emmet St., Newark, N. J.

Please send me Bulletin 1065 containing complete information on AmerTran Transformers, for better radio reception.

Name

Address

IRE-12-29

When writing to advertisers mention of the PROCEEDINGS will be mutually helpful.

PROFESSIONAL ENGINEERING DIRECTORY

For Consultants in Radio and Allied Engineering Fields

**The J. G. White
Engineering Corporation**
Engineers—Constructors

*Builders of New York Radio
Central*

Industrial, Steam Power, and Gas
Plants, Steam and Electric Rail-
roads, Transmission Systems.

43 Exchange Place New York

Amy, Aceves & King, Inc.

Consulting Engineers

DESIGN—TEST—DEVELOPMENT

Radio Transmitters, Receivers and Sound
Reproducing Apparatus

Research Laboratories

55 West 42nd Street, New York
Longacre 8579

**THE MAGNAVOX
COMPANY**

Oakland, Calif. & Chicago, Ill.

**PIONEERS AND SPECIALISTS
IN THE ART OF
SOUND PRODUCTION.**

**DYNAMIC SPEAKERS SINCE
1911.**

BRUNSON S. McCUTCHEN

Consulting Radio Engineer

17 State Street

NEW YORK

*Electrical Testing
Laboratories*
RADIO DEPARTMENT
also

**Electrical, Photometric,
Chemical and Mechanical
Laboratories**

80th Street and East End Ave.
NEW YORK, N. Y.

P A T E N T S

WM. G. H. FINCH

Patent Attorney

(Registered U. S. & Canada)

Mem. I. R. E. Mem. A. I. E. E.

303 Fifth Ave. New York
Caledonia 5331

**For EXPORT of material
made by:**

Allen D. Cardwell Mfg. Corp.
Clarostat Mfg. Co.
Corning Glass Works
Dubilier Condenser Corp.
Elkon, Inc.
Radio Engineering Labs.
Raytheon Mfg. Co.
United Scientific Labs.
Weston Electrical Inst. Corp.

apply to

AD. AURIEMA, INC.

116 Broad Street, New York, N. Y.

JOHN MINTON, Ph.D.

Consulting Engineer

for

Developing — Designing —
Manufacturing
of

Radio Receivers, Amplifiers, Transform-
ers, Rectifiers, Sound Recording and
Reproducing Apparatus.

Radio and Electro-Acoustical
Laboratory

8 Church St. White Plains, N. Y.

When writing to advertisers mention of the PROCEEDINGS will be mutually helpful.

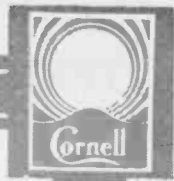
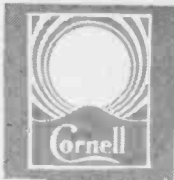

**CORNELL
"CUB"
CONDENSERS**

**Cut Labor Operations
and Cost 20% to 50% Less**

The "Cub" is a non-inductive paper condenser ranging in capacity from .0001 to .1 Mfd. The unit is flash tested at 1600 volts D.C. and is rated at 600 volts D.C. continuous. It is self-mounting, weighs up to one-third ounce, and can be used with the carbon type resistance or any pig-tail grid-leak. Contacts are hot trimmed and do not become loose or noisy.

ACTUAL
SIZE

Cornell

- FILTER CONDENSERS
- BY-PASS CONDENSERS
- RADIO INTERFERENCE FILTERS
- POWER FACTOR CORRECTION BANKS

The most rigid comparative tests prove the superior ability of Cornell Condensers to stand strains and over loads; to give better and longer service and to meet all demands of modern radio. Let us quote on your requirements or special specifications. Your inquiry will receive immediate quotations and samples will be furnished upon request.

*Write for Catalog of Complete Line of
Cornell Products.*

Cornell Electric Mfg. Co., Inc.
LONG ISLAND CITY, NEW YORK



When writing to advertisers mention of the PROCEEDINGS will be mutually helpful.

TEMPERATURE CONTROL UNITS

designed for

PIEZO CRYSTAL OSCILLATORS



Catalogue No. 211

Automatic thermostatically controlled heater compartments, designed to house from one to three piezo crystals—Jacks are provided to fit any type of crystal holder (When ordering give dimensions and type of holder employed)—Uniquely constructed adjustable thermostat units, which are guaranteed to keep the temperature constant to within 0.1 of one degree at the desired setting—Adjustable working limits 30° to 50° C—Fitted with precision thermometers having large graduated scales capable of indicating tenths of a degree centigrade—The cases are constructed along scientifically correct lines, having an inner lining of special asbestos board; an intermediate non-circulating air chamber and air exterior covering of heavy sheet aluminum—Supported with aluminum end castings.

Easily adapted to present day transmitters—Operates direct from any 110 volt A.C. or D.C. line—Current consumption only one-half ampere—Furnished with pilot light which gives instantaneous check on operation.—Dimensions 7½" x 11½" front x 12" deep.

Broadcasting, commercial, experimental and other stations, which are required to keep within 100 cycles of a specified frequency, will find these REL Cat. 211 units very necessary—Quantity production has enabled us to offer these at a very reasonable price.

Information and Prices on Application



MANUFACTURES A COMPLETE LINE OF
APPARATUS FOR SHORT WAVE TRANS-
MISSION AND RECEPTION

Radio Engineering Laboratories, Inc.

100 Wilbur Ave.

Long Island City, N.Y., U.S.A.

When writing to advertisers mention of the PROCEEDINGS will be mutually helpful.

SM

A. C. Screen-Grid Custom Receivers that Satisfy the Most Exacting Requirements

A Superior Value at \$74.75

Combining practically all the advanced receiver features, the S-M 722 is, without question, the outstanding buy of the year at \$74.75 net, completely wired, less tubes and cabinet. 3 screen-grid tubes (including detector), band-filter, 245 push-pull stage—are all included in the 722. Component parts total \$52.90. Tubes required: 3—'24, 1—'27, 2—'45, 1—'80.

Full-A.C. Short-Wave Reception!

The first a. c. short-wave receiver on the American market, the 735 is easily first in performance as well. Newly-designed plug-in coils, a regenerative power detector, a screen-grid r.f. stage, a typically excellent S-M audio amplifier, built-in power unit—all these combine with other features to present astonishing quality in a remarkably inexpensive and flexible receiver. Price, wired complete, with built-in ABC power unit, less tubes and cabinet, only \$64.90. Component parts total \$44.90. Tubes required: 1—'24, 2—'27, 2—'45, 1—'80. Two extra coils, 131P and 131Q, cover the broadcast band at an added cost of \$1.65. For battery use (735DC) price, \$44.80, less cabinet and tubes. Component parts total \$26.80. Tubes required: 1—'22, 4—'12A.

The New "Boss of the Air"

Developed along the peculiar lines of design which resulted last year in the unprecedented supremacy of the Sargent-Raymont 710, the 712 has five tuned circuits, all-electric operation, strictly one-dial control (no verniers) band-selector tuning, power detection. Even where cost is no object as in the best rack-and-panel construction, the S-M 712 is absolutely ideal. Low-impedance power detector permits its use with any standard amplifier. It uses 3—'24 tubes, and 1—'27. All ABC power obtainable from S-M 677 amplifier. Less tubes, \$64.90 net as shown. Component parts total \$40.90.

An Amplifier to Depend On

The new S-M 677 is ideal both for the 712 and for record pick-up. Requires 1—'27, 2—'45, 1—'80. Wired complete, less tubes \$58.50. Component parts total \$43.40. For 25-40-cycle current, \$72.50 wired.

And a Great New Transformer!

The new S-M 233U universal output transformer shows a curve flat to within 1.7 DB, even from 30 to 10,000 cycles. With three windings (twelve lugs) it works perfectly out of '71, '45, or '50 tubes, singly or in push-pull. It can be connected to match almost any impedance, as of multiple speakers (hotels, etc.) May be used inductively coupled, or as auto transformer—as tube-to-line or line-to-tube or load transformer. Separate low-resistance winding gives high efficiency when working into low-impedance load. Price \$9.00.

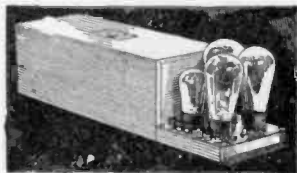
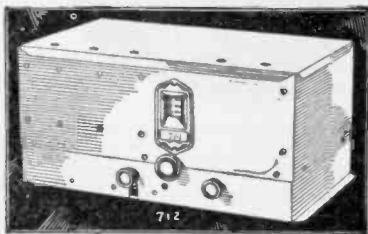
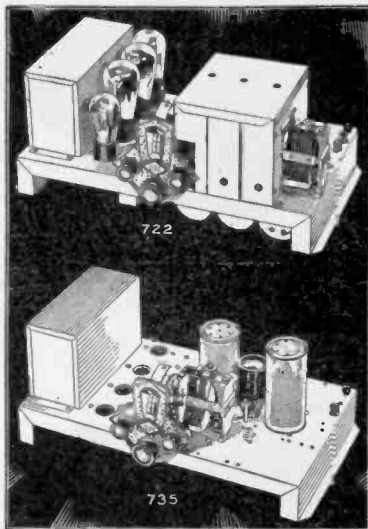

Detailed suggestions on 712 rack-and-panel installation were given in the *RADIO-BUILDER* for October—also new data on television amplification. If you are not getting it regularly, write us.

SILVER-MARSHALL, Inc. 6411 WEST 65TH STREET
CHICAGO, U. S. A.

When writing to advertisers mention of the PROCEEDINGS will be mutually helpful.

These six new Frost-Radio Volume Controls are representative of the service rendered by Herbert H. Frost, Inc., in meeting the demands of the manufacturers of receiving sets of today and tomorrow. Tandem units such as these operate smoothly, noiselessly and with an almost total absence of wear. They are non-inductive, unaffected by temperature or humidity changes. They may be obtained in any desired curve. Wire wound or carbon-element type. Clockwise or counter-clockwise knob rotation. Shaft and thimble length to suit your needs.

As the world's largest manufacturers of high grade variable resistors, we are singularly well equipped to supply your requirements, no matter what they may be. Write us in detail regarding your variable resistor problems, and have us submit samples to meet your specifications.

HERBERT H. FROST, Inc.
Main Offices and Factory; Elkhart, Ind.
160 North La Salle Street, CHICAGO

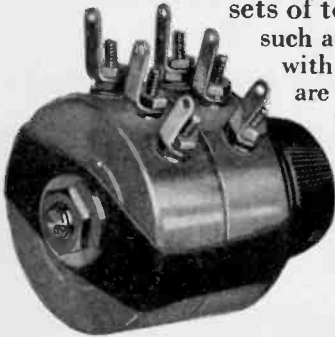

No. 280-280. Combination metal shell wire wound and composition elements. Wire wound up to 15,000 ohms. Composition, 5,000 1 megohm. Rheostat or potentiometer type in either unit. Units insulated from each other. Diameter, 1 11/16 in. Depth of shell, 1 3/8 in.

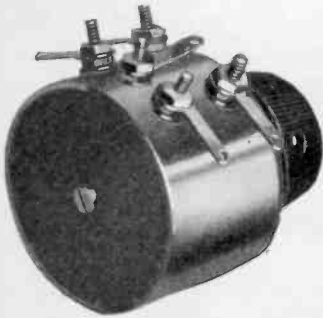

No. 890. Double depth metal shell unit in rheostat or potentiometer type. Rotors in same electrical connection. Composition elements, 5,000 ohms to 1 megohm in each unit. Diameter, 1 7/8 in. Depth of shell, 1 3/16 in.



No. 200-200. Metal shell type wire wound resistors with resistances from 5 ohms to 10,000 ohms. Split windings. Rheostat or potentiometer types. Units insulated. Diameter, 1 7/16 in. Depth of shell, 1 1/2 in.



No. 2880-2880. Bakelite shell composition element only. Resistance range from 5,000 ohms to 1 megohm. All curves. Potentiometer or rheostat types. Units insulated from each other. Diameter, 1 1/2 in. Depth of shell, 1 1/8 in.

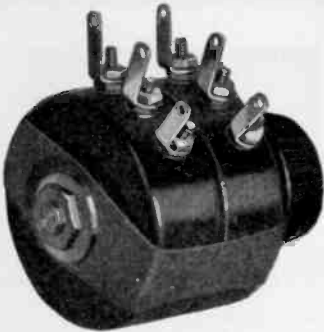

No. 1880-1880. Same as 280-280 except all bakelite.

No. 590-590. Metal shell, composition element only. Resistances from 5,000 ohms to 1 megohm. All curves. Potentiometer or rheostat types. Units insulated from each other. Diameter, 1 5/16 in. Depth of shell, 1 1/8 in.



When writing to advertisers mention of the PROCEEDINGS will be mutually helpful.

Alphabetical Index to Advertisements

A

Aerovox Wireless Corp.XXXIV
 Allen-Bradley Co.XXXIX
 American Transformer Co.XLVII
 Arcturus Radio Tube Co.XXXII

C

Cardwell, Allen D., Mfg. Corp. ...XLV
 CeCo Mfg. Co., Inc.II
 Central Radio LaboratoriesXLVI
 Clarostat Mfg. Co., Inc.XII
 Cohn, SigmundXI
 Condenser Corp. of AmericaXL
 Continental Carbon Inc.VII
 Cornell Electric Co.LIV
 Corning Glass WorksXLIV

D

Dubilier Condenser Corp. ...XXXVII
 Dudlo Manufacturing Co.VI

E

Electrad, Inc.IV
 Electric Specialty Co.XLI
 Elkon, Inc.XLII
 Eveready Raytheon Co.XXII

F

Fast, John E. & Co.III
 Formica Insulation Co.XXX
 Frost, H. H.LI

G

General Radio Co., Outside Back Cover
 Grebe, A. H., and Co., Inc.
 Inside Back Cover
 Gilby Wire Co.V

H

Hammarlund Mfg. Co.IX

I

International Resistance Co.XXIV
 Isolantite Co. of America ...XXXIII

J

Jefferson Electric Co.XIII
 Jewell Electrical Instrument Co. XXVI

N

National Vulcanized Fibre Co. ...XXI

O

Operadio Mfg. Co.XXIX

P

Pacent Electric Co., Inc.VIII
 Polymet Manufacturing Corp. ...XXV
 Professional Engineering Directory
 XLVIII, XLIX

R

Radio Corporation of America XXVII
 Radio Engineering Laboratories ...
 LIII
 Radio Receptor Co.XXXI
 Roller-Smith Co.XXIII

S

Scientific Radio ServiceXVI
 Scovill Manufacturing Co.XLIII
 Shakeproof Lock Washer Co.X
 Silver-Marshall Co.LII

T

Thermal Syndicate, Ltd.XVII
 Thordarson Electric Co.I

U

United Scien. Labs.XIV
 U. S. Naval InstituteXXVIII

V

Valley Appliances Co.XV

W

Wireless Specialty Apparatus Co. ...
 XVIII

When writing to advertisers mention of the PROCEEDINGS will be mutually helpful.

PROFESSIONAL ENGINEERING DIRECTORY

For Consultants in Radio and Allied Engineering Fields

(Continued)

4th Edition

Thoroughly Revised—Up-to-Date
"RADIO THEORY AND
OPERATING"

992 Pages 800 Illustrations

By MARY TEXANNA LOOMIS

President and Lecturer on Radio

Loomis Radio College

Member Institute of Radio Engineers

Price \$3.50—Postage Paid

LOOMIS PUBLISHING CO.

Dept. 6, Washington, D.C.

FERRANTI, Inc.

★

Consulting Engineers

Audio Amplification

Design-Construction-Advice

★

130 West 42nd St., New York

Radio



Engineers

Your card on this new professional card page
will give you a direct introduction to over 6,500
technical men, executives, and others with im-
portant radio interests.



Per Issue—\$10.00

When writing to advertisers mention of the PROCEEDINGS will be mutually helpful.

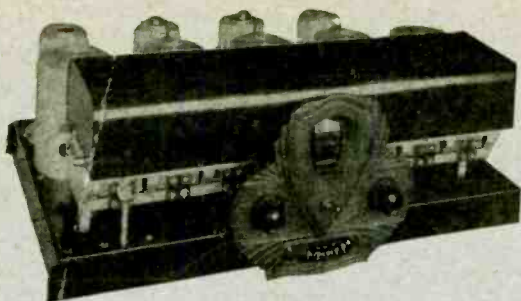

Three Screen Grid and Power Detector Circuit

Three screen grid radio amplifier stages adjusted for uniform gain. Use of separate filters in each control grid, screen and plate circuit closes feedback paths and permits operation at great amplification level.

Linear detector—27 type feeding directly into push-pull amplifier.

Radio amplifier stages are adjusted for standard gain in final electrical test.

*One of the many features of
this outstanding new receiver*

A. H. GREBE & CO., INC.
Richmond Hill, N. Y.

WESTERN BRANCH
443 So. San Pedro Street, Los Angeles, California

Grebe radio

SUPER-SYNCHROPHASE 

MAKERS OF QUALITY RADIO SINCE 1909

TEMPERATURE-CONTROL BY GENERAL RADIO



Type 547-A Temperature-Control Box

IN the course of research that has extended over more than a year, the General Radio Company discovered that a temperature-control unit which is to operate satisfactorily outside of a constant-temperature room must be more than an assembly of thermo-regulators, heaters, and insulating materials. As a result of this work, we announce two single-stage, constant-temperature boxes with excellent characteristics.

The Type 547-A Temperature-Control Box maintains its temperature at any assigned value between 40 and 60 degrees C. within ± 0.1 degrees C. for a varia-

tion in room temperature of ± 20 degrees F. The heater operates from the 110-volt power supply. There is provision for controlling two Type 376 Quartz Plates, but the box is by no means limited to that use. Price: \$150.00.

The Type 547-B Temperature-Control Box is similar, but it maintains its temperature to within ± 1.0 degrees C. under the above-mentioned conditions. Its price is \$140.00.

GENERAL RADIO COMPANY
30 STATE STREET
CAMBRIDGE A, MASSACHUSETTS

GENERAL RADIO INSTRUMENTS

FOR MEASURING ELECTRIC
QUANTITIES AT
ALL FREQUENCIES



STANDARD AND SPECIAL
ITEMS FOR LABORATORY
AND INDUSTRIAL USE