

VOLUME 16

AUGUST, 1928

NUMBER 8

PROCEEDINGS
of
**The Institute of Radio
Engineers**



Published Monthly By
THE INSTITUTE OF RADIO ENGINEERS
Publication Office: 450-454 Ahnaip St., Menasha, Wis.

BUSINESS, EDITORIAL AND ADVERTISING OFFICES
33 West 39th Street, New York, N.Y.

Subscription \$10.00 per Annum in the United States
\$11.00 in all other Countries

General Information and Subscription Rates on Page 1019



THE CHOICE
of
LEADING
MANUFACTURERS

For over four years Thordarson transformers have predominated in the receivers and power units of leading radio manufacturers.

Such patronage is not an accident. It stands as a positive proof of a superiority of product. It demonstrates the effectiveness of a policy of service rendered to the n'th degree by an efficient and smooth running organization.

We are at present manufacturing over twelve hundred different types of transformers. Among our customers are more than a hundred radio manufacturers.

Thordarson engineers always stand ready to help you with your transformer problems.

PROMPT DELIVERY
RIGHT PRICES

THORDARSON
RADIO

Supreme in Musical Performance
TRANSFORMERS

THORDARSON ELECTRIC MANUFACTURING CO.
Transformer specialists since 1895
WORLD'S OLDEST AND LARGEST EXCLUSIVE TRANSFORMER MAKERS
Chicago, U.S.A.

(3576)

When writing to advertisers mention of the PROCEEDINGS will be mutually helpful.

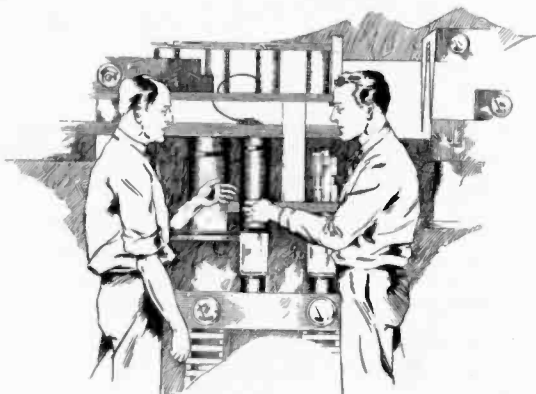

In the *modern* Broadcasting Station

In amateur transmitting and receiving sets as well as in quality radio receivers for home use, Faradon Capacitors play a very definite part in maintaining satisfactory service, meriting its widespread utilization.

More than twenty years of the application of electrical engineering skill combined with highest quality materials have made Faradon Capacitors the standard of electrostatic condenser long life and reliability.

Our engineers stand ready to co-operate on special equipment which cannot be taken care of by the more than 200 types of Faradon Capacitors ready for prompt delivery.

WIRELESS SPECIALTY APPARATUS CO.

Jamaica Plain

BOSTON, MASS., U.S.A.

Established 1907

Faradon

*Electrostatic Condensers
for All Purposes*

2144

When writing to advertisers mention of the PROCEEDINGS will be mutually helpful.

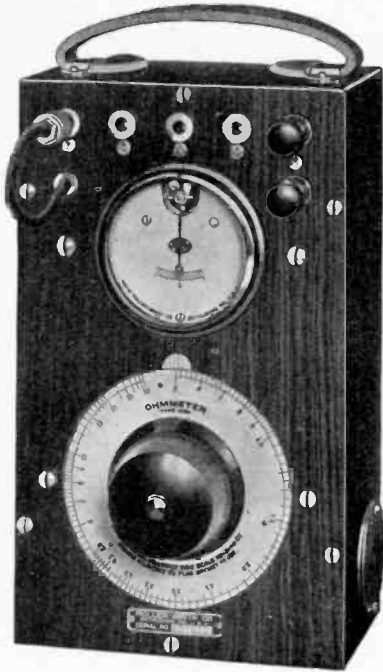

Roller-Smith COM Ohmmeter

Portable direct reading, small, compact, light, rugged, accurate, entirely self-contained. Measures resistance values from .5 ohm to 50,000 ohms. List price \$70.00, subject to discount. Send for new Bulletin No. K-300.



Roller-Smith HTD Circuit Tester

Instantly locates open circuits in coils and circuits. Shows approximate resistance up to 10,000 ohms. Small, compact, self-contained, rugged and dependable. List price \$21.00, subject to discount. Send for new Bulletin No. K-300.

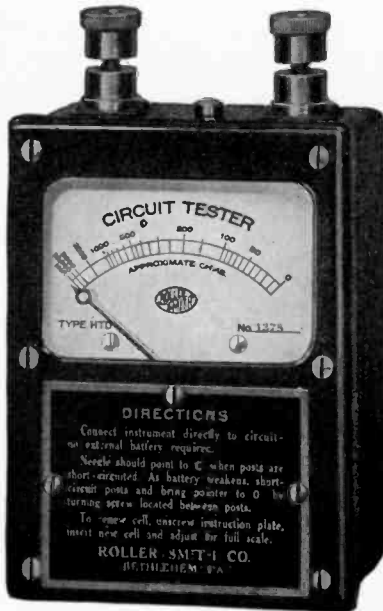

ROLLER-SMITH COMPANY

2134 Woolworth Bldg.

NEW YORK, N. Y.

Offices in principal cities in U. S. and Canada. Representatives in Australia, Cuba, and Japan.

When writing to advertisers mention of the PROCEEDINGS will be mutually helpful.

CARDWELL CONDENSERS

ORDERS AND RE-ORDERS

From the most representative concerns in the country constitute concrete evidence that **CARDWELL CONDENSERS** are *Right*.

Names synonymous with prestige and sterling worth, representing the greater part of the astonishing progress of the past quarter century in radio and other electrical installations of all descriptions, will be found on our list of customers.

Where performance counts and not pennies, Engineers and manufacturers stake their reputations on the confidence they have in **CARDWELL CONDENSERS** and their ability to "Stand the Gaff" and come through.

A Typical example
of High voltage
CARDWELL
Construction type
1666-B

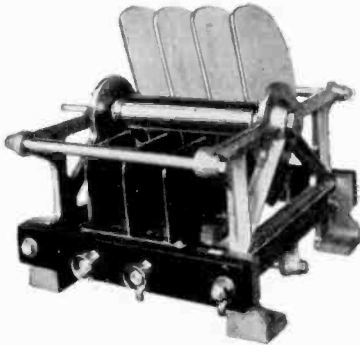

Send for
Literature
or
State your
requirements

High voltage transmitting condensers. Transmitting condensers for medium and low power. Air dielectric condensers. Receiving condensers.

THE ALLEN D. CARDWELL MFG. CORP'N.
81 Prospect Street
BROOKLYN, N.Y.

THE STANDARD OF COMPARISON

When writing to advertisers mention of the PROCEEDINGS will be mutually helpful.

SMOOTH Power for Dynamic Speakers from the AC Line with the **ELKON** DRY Rectifier

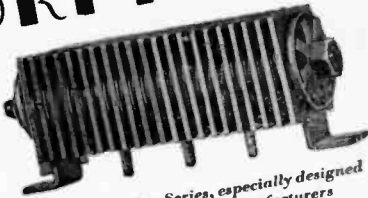

Dynamic Speaker Series, especially designed to meet the needs of Manufacturers

THE Elkon Engineers have worked exceedingly closely with many of the manufacturers of dynamic speakers. The result of this work is an intimate knowledge of the problems of supplying smooth power to moving coils, and a complete series of rectifiers supplying just the voltage and current desired.

Already the Elkon Dry Rectifier has been specified by a majority of the Dynamic Speaker manufacturers. We would like to work with you as we have with them. Simply tell us your specifications, and we will submit a sample rectifier — May be supplied with or without power transformer.

Self healing, the Elkon Rectifiers have an exceptionally long life, are noiseless and require no attention or adjustment.

Let Rectifier Headquarters solve your problems. Send the coupon which will bring you the Engineering Bulletins on the Elkon Rectifiers and High Capacity Dry Condensers.

Radio Department
ELKON, INC.
Division of
P. R. Mallory & Co., Inc.
PORT CHESTER, N. Y.

Row upon row of Elkon Rectifiers being seasoned under the careful eyes of skilled workers

Radio Department, **ELKON, INC.**, 110 Fox Island Road
Port Chester, N. Y.

We are interested in Elkon Rectifiers for..... Dynamic Speakers
..... "A" Eliminators. Send the Engineering Bulletins to



National Advertising Selling the Dynamic Idea and Elkon Rectifiers

A consistent newspaper campaign has already started and will continue for 10 weeks in the following cities: — New York, Chicago, Philadelphia, Boston, Pittsburgh, Detroit, Cleveland, St. Louis, Kansas City, Atlanta, Seattle, San Francisco, Los Angeles. And a special campaign in Radio, Radio News, Popular Radio and Radio Broadcast. The copy will help sell the dynamic speaker idea and at the same time will tell the consumer to look for the Elkon name on the Rectifier.

National Advertising which will help every dynamic speaker manufacturer using the Elkon Rectifier to get immediate consumer acceptance of his product.

Every junction must have just the right pressure—16 meters to watch in this operation

When writing to advertisers mention of the PROCEEDINGS will be mutually helpful.



CONDENSERS

Seven Features That Make Them
Ideal Production Units

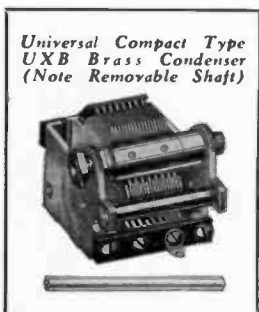

*Universal Compact Type
UXB Brass Condenser
(Note Removable Shaft)*

1st—The new United Scientific Type UXB condensers are so designed that their assembly is greatly simplified. This feature speeds up your production.

2nd—They are rigid and accurate, so as to improve the performance and increase the life of your receivers.

3rd—They have patented leveled brass rotors and stators.

4th—Precision spacing assures accurate calibration.

5th—The removable shaft can be adjusted to any desired length and is therefore adaptable to ganging in any number.

6th—Universal mounting permits clockwise or counter clockwise rotation. Integral frame lugs are provided for sub-panel mounting.

7th—Modified straight-line frequency wave takes care of all present day broadcasting wavebands.

Type UXB Three Gang Condenser

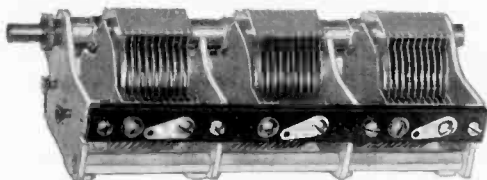

This fine job, which is small and compact is especially suited for shielded work. The popular type UXB Condensers are used. They can be had in either .005MF or .00035MF Capacities.

Let the USL Engineers co-operate with you in solving your condenser problems. We are always glad to quote on special specifications.

UNITED SCIENTIFIC LABORATORIES, INC.

115-C Fourth Avenue, New York City

Branch Offices for Your Convenience In

St. Louis
Chicago
Boston

Minneapolis
Cincinnati
Los Angeles

Philadelphia
San Francisco
London, Ontario

When writing to advertisers mention of the PROCEEDINGS will be mutually helpful.

QUALITY AND PERFECTION



THE sweeping success and growth of the radio has had very few counterparts in our industrial development. But in this industry a stage has been reached where the public demands a product that will function consistently and well. Radio manufacturers have come to realize that this means quality and perfection in every part, no matter how small. No wonder they turn to Scovill for assistance in their manufacturing problems. Scovill will fill orders for large quantities of parts such as condensers, condenser parts, metal stampings, screw machine parts, switches, etc. Escutcheons and similar parts can be stamped or etched to meet your requirements. A wide variety of butts and hinges, continuous hinges and machine screws are kept on hand.

Scovill means SERVICE to all who require parts or finished products of metal. Great factories equipped with the last word in laboratories, and modern machinery manned by skilled workmen, are at your disposal. Phone the nearest Scovill office.

SCOVILL

MANUFACTURING COMPANY

Waterbury, Connecticut

NEW YORK - CHICAGO - BOSTON - SAN FRANCISCO
DETROIT - PHILADELPHIA - LOS ANGELES - ATLANTA
PROVIDENCE - CLEVELAND - CINCINNATI

Member, Copper and Brass Research Association

When writing to advertisers mention of the PROCEEDINGS will be mutually helpful.

The new Kolster Radio Compass provides

*Greater Safety—
Visual Bearings—
Simple, Positive Operation*

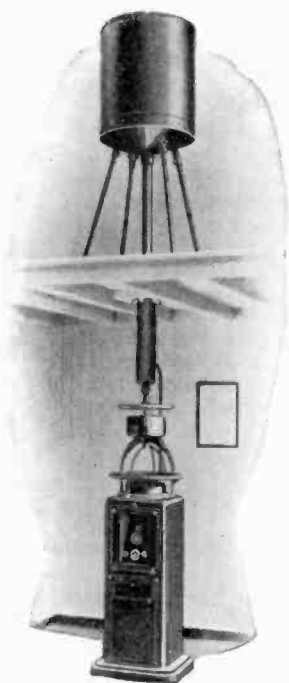

From its aluminum pedestal to the new enclosed loop, the new Kolster Radio Compass [Type AM-4490] embodies every improvement radio science has to offer. The insulated cylindrical housing of the loop affords complete protection against wind, ice, snow, and spray. A tiny lamp flashes the signals of nearby stations. While for long-distance bearings, a Kolster eight-tube receiver with a new circuit especially designed for radio compass work provides the maximum of selectivity and sensitiveness.

No knowledge of radio is necessary to operate the Kolster Radio Compass. It is built for the navigator. The positive unidirectional indicator gives instantaneous readings without guesswork or computation. A new and improved Kolster automatic compensator corrects all natural errors, and makes direct readings absolutely accurate.

Kolster Radio is also setting new standards of performance in broadcast receiving sets for the home.

KOLSTER RADIO CORPORATION
200 Mt. Pleasant Avenue
Newark, N. J.

© 1928, Kolster Radio Corporation

When writing to advertisers mention of the PROCEEDINGS will be mutually helpful.



A New Simple Tube Checker



*Pattern
No. 150
A. C. Tube
Checker*

Jewell has developed a Tube Checker that is indeed simple. It is so simple that all that is required to prepare it for testing tubes is to plug the attached cord into a 110 volt 60 cycle outlet.

This new tube checker known as Pattern No. 150 is somewhat similar in appearance to other Jewell tube checkers which have earned an enviable reputation for accuracy and reliability, but differs in that all tubes can be tested without resorting to batteries of any kind. This is accomplished by incorporating a transformer which furnishes the required voltages, making use of alternating current instead of the conventional A and B batteries.

All tubes can be tested from the WD-11 and 199 tubes up to the 210.

A five-prong socket is supplied with an adapter for 4-prong tubes and a rheostat enables adjusting the filament in conjunction with the 0-48 volt A.C. voltmeter. Plate current is read on a 0-15 Milliammeter.

This new tube checker is described in our Form No. 2004. Write for a copy.

"28 Years Making Good Instruments"

Jewell Electrical Instrument Co.
1650 Walnut St., Chicago

When writing to advertisers mention of the PROCEEDINGS will be mutually helpful.

RADIOTRONS

are the standard
for experimental work

Leading manufacturers use RCA Radiotrons for testing, initial equipment, and replacements. They have national distribution and public acceptance. They are the ideal vacuum tube for engineers to use in experimental work. There is a Radiotron for every purpose, and one that fits that purpose best.

RADIO CORPORATION OF AMERICA
New York Chicago San Francisco

RCA Radiotron

MADE BY THE MAKERS OF THE RADIOLA

When writing to advertisers mention of the PROCEEDINGS will be mutually helpful.

SUGGESTIONS FOR CONTRIBUTORS TO THE PROCEEDINGS

Preparation of Paper

Form—Manuscripts may be submitted by member and non-member contributors from any country. To be acceptable for publication manuscripts should be in English, in final form for publication, and accompanied by a summary of from 100 to 300 words. Papers should be typed double space with consecutive numbering of pages. Footnote references should be consecutively numbered, and should appear at the foot of their respective pages. Each reference should contain author's name, title of article, name of journal, volume, page, month, and year. Generally, the sequence of presentation should be as follows: statement of problem; review of the subject in which the scope, object, and conclusions of previous investigations in the same field are covered; main body describing the apparatus, experiments, theoretical work, and results used in reaching the conclusions; conclusions and their relation to present theory and practice; bibliography. The above pertains to the usual type of paper. To whatever type a contribution may belong, a close conformity to the spirit of these suggestions is recommended.

Illustrations—Use only jet black ink on white paper or tracing cloth. Cross-section paper used for graphs should not have more than four lines per inch. If finer ruled paper is used, the major division lines should be drawn in with black ink, omitting the finer divisions. In the latter case, only blue-lined paper can be accepted. Photographs must be very distinct, and must be printed on glossy white paper. Blueprinted illustrations of any kind cannot be used. All lettering should be $\frac{3}{16}$ in. high for an 8 x 10 in. figure. Legends for figures should be tabulated on a separate sheet, not lettered on the illustrations.

Mathematics—Fractions should be indicated by a slanting line. Use standard symbols. Decimals not preceded by whole numbers should be preceded by zero, as 0.016. Equations may be written in ink with subscript numbers, radicals, etc., in the desired proportions.

Abbreviations—Write a.c. and d.c., $k\omega$, μf , $\mu\mu f$, emf , mh , μh , henries, abscissas, antennas. Refer to figures as Fig. 1, Figs. 3 and 4, and to equations as (5). Number equations on the right, in parentheses.

Summary—The summary should contain a statement of major conclusions reached, since summaries in many cases constitute the only source of information used in compiling scientific reference indexes. Abstracts printed in other journals, especially foreign, in most cases consist of summaries from published papers. The summary should explain as adequately as possible the major conclusions to a non-specialist in the subject. The summary should contain from 100 to 300 words, depending on the length of the paper.

Publication of Paper

Disposition—All manuscripts should be addressed to the Institute of Radio Engineers, 33 West 39th Street, New York City. They will be examined by the Committee on Meetings and Papers and by the Editor. Authors are advised as promptly as possible of the action taken, usually within one month.

Proofs—Galley proof is sent to the author. Only necessary corrections in typography should be made. *No new material is to be added.* Corrected proofs should be returned *promptly* to the Institute of Radio Engineers, 33 West 39th Street, New York City.

Reprints—With the notification of acceptance of paper for publication, reprint order form is sent to the author. Orders for reprints must be forwarded promptly as type is not held after publication.

PROCEEDINGS OF
The Institute of Radio Engineers

Volume 16

August, 1928

Number 8

CONTENTS

	Page
Officers and Board of Direction	1020
Committees	1020
Institute Sections	1022
Institute Activities	1031
Institute Meetings	1032
Committee Work	1034
L. P. Wheeler and W. E. Bower, "A New Type of Standard Frequency Piezo-Electric Oscillator"	1035
Balth. van der Pol, "The Effect of Regeneration on the Received Signal Strength"	1045
J. M. Thomson, "Characteristics of Output Transformers"	1053
Alfred N. Goldsmith, "Cooperation between the Institute of Radio Engineers and Manufacturers' Associations"	1065
August Hund, "Notes on Quartz Plates, Air-Gap Effect, and Audio-Frequency Generation"	1072
August Hund, "Notes on Aperiodic Amplification and Application to the Study of Atmospherics"	1077
Sylvan Harris, "Effect of the Antenna in Tuning Radio Receivers and Methods of Compensating for It"	1079
W. J. Kimmell, "The Cause and Prevention of Hum in Receiving Tubes Employing Alternating Current Direct on the Filament"	1089
J. H. Dellinger, "The International Union of Scientific Radiotelegraphy"	1107
J. Warren Wright, "The Tuned-Grid, Tuned-Plate, Self-Oscillating Vacuum-Tube Circuit"	1113
R. R. Ramsey and Robert Dreisback, "Radiation and Induction"	1118
George B. Crouse, "Development of a System of Line Power for Radio"	1133
Book Review, "History of Radio Telegraphy and Telephony"	1149
Monthly List of References to Current Radio Literature	1150
Applications for Membership	1156

GENERAL INFORMATION

The PROCEEDINGS of the Institute is published monthly and contains the papers and the discussions thereon as presented at meetings.

Payment of the annual dues by a member entitles him to one copy of each number of the PROCEEDINGS issued during the period of his membership.

The right to reprint limited portions or abstracts of the articles, discussions, or editorial notes in the PROCEEDINGS is granted on the express conditions that specific reference shall be made to the source of such material. Diagrams and photographs in the PROCEEDINGS may not be reproduced without securing permission to do so from the Institute through the Secretary.

It is understood that the statements and opinions given in the PROCEEDINGS are the views of the individual members to whom they are credited, and are not binding on the membership of the Institute as a whole.

Entered as second class matter at the Post Office at Menasha, Wisconsin.

Acceptance for mailing at special rate of postage provided for in the Act of February 28, 1925, embodied in paragraph 4, Section 412, P. L. and R. Authorized October 26, 1927.

Copyright, 1928, by
THE INSTITUTE OF RADIO ENGINEERS, Inc.
 Publication Office 450-454 Ahnaip Street, Menasha, Wis.
 BUSINESS, EDITORIAL, AND ADVERTISING OFFICES, 33 WEST 39TH ST.,
 NEW YORK, N. Y.

OFFICERS AND BOARD OF DIRECTION, 1928

(Terms expire January 1, 1929, except as otherwise noted)

President

ALFRED N. GOLDSMITH

Vice-President

L. E. WHITTEMORE

Treasurer

MELVILLE EASTHAM

Secretary

JOHN M. CLAYTON

Editor

ALFRED N. GOLDSMITH

Managers

ARTHUR BATCHELLER

L. F. FULLER

R. H. MARRIOTT

W. G. CADY

A. H. GREBE

R. A. HEISING
(Serving until Jan. 1, 1930)

J. V. L. HOGAN
(Serving until Jan. 1, 1930)

J. H. DELLINGER
(Serving until Jan. 1, 1931)

R. H. MANSON
(Serving until Jan. 1, 1931)

Junior Past Presidents

DONALD McNICOL

RALPH BOWN

Committees of the Institute of Radio Engineers, 1928

Committee on Meetings and Papers

J. H. DELLINGER, *Chairman*
E. F. W. ALEXANDERSON
STUART BALLANTINE
W. R. G. BAKER
M. C. BATSEL
R. R. BATCHER
ZEH BOUCK
B. RAY CUMMINGS
W. G. CADY
FRANK CONRAD
CARL DREHER
E. T. DICKEY
EDGAR FELIX
W. G. H. FINCH
H. A. FREDERICKS
J. D. R. FREED

VIRGIL M. GRAHAM
KARL HASSEL
C. R. HANNA
SYLVAN HARRIS
LEWIS M. HULL
S. S. KIRBY
D. G. LITTLE
W. H. MURPHY
E. L. NELSON
G. W. PICKARD
R. H. RANGER
A. HOYT TAYLOR
PAUL WEEKS
W. WILSON
IRVING WOLFF
W. C. WHITE

All chairmen of Meetings and Paper Committees of Institute Sections,
ex officio.

Committees of the Institute—(Continued)

Committee on Admissions

R. A. HEISING, *Chairman*
H. F. DART
LEWIS M. HULL
LEONARD F. FULLER
H. E. KRANZ
F. H. KROGER
A. G. LEE
C. L. RICHARDSON
E. R. SHUTE
F. K. VREELAND

Committee on Publicity

W. G. H. FINCH, *Chairman*
H. W. BAUKAT
ZEH BOUCK
C. E. BUTTERFIELD
DAVID CASEM
ORRIN E. DUNLAP
FRED EHLERT
EDGAR FELIX
E. H. HANSEN
A. H. HALLORAN
L. W. HATRY
J. F. J. MAHER
HUGH S. POCOCK
J. J. RIEGER
J. G. UZMANN
WILLIS K. WING
R. F. YATES

Committee on Membership

H. F. DART, *Chairman*
W. R. G. BAKER
M. BERGER
F. R. BRICK
I. S. COGGESHALL
H. B. COXHEAD
C. M. JANSKY
R. S. KRUSE
PENDLETON E. LEHDE
M. E. PACKMAN
C. L. RICHARDSON
JOHN STROEBEL

Committee on Institute Sections

DONALD McNICOL, *Chairman*
QUINTON ADAMS
ARTHUR BATCHELLER
M. BERGER
W. G. CADY
L. J. DUNN
F. E. ELDRIDGE
L. F. FULLER
H. C. GAWLER
EARLE D. GLATZEL

E. I. GREEN
F. P. GUTHRIE
L. C. F. HORLE
W. A. KLEIST
HARVEY KLUMB
JOHN R. MARTIN
JOHN H. MILLER
A. M. PATIENCE
GEORGE W. PIERCE
E. R. SHUTE
L. TAUFENBACH
J. C. VAN HORN
WALTER VAN NOSTRAND

Committee on Standardization

L. E. WHITTEMORE, *Chairman*
M. C. BATSEL
EDWARD BENNETT
WILLIAM R. BLAIR
E. L. CHAFFEE
J. H. DELLINGER
C. P. EDWARDS
GENERAL FERRIE
A. N. GOLDSMITH
J. V. L. HOGAN
W. E. HOLLAND
L. M. HULL
C. M. JANSKY
C. B. JOLLIFFE
F. A. KOLSTER
R. S. KRUSE
GEORGE LEWIS
ELMORE B. LYFORD
R. H. MANSON
ALEXANDER MEISSNER
GINO MONTEFINALE
E. L. NELSON
H. S. OSBORNE
H. B. RICHMOND
W. J. RUBLE
CARL E. SCHOLZ
H. M. TURNER
K. B. WARNER
A. D. G. WEST
C. A. WRIGHT
HIDETSUGU YAGI

Committee on Constitution and
Laws

R. H. MARRIOTT, *Chairman*
E. N. CURTIS
W. G. H. FINCH
H. E. HALLBORG
J. V. L. HOGAN
G. W. PICKARD
HAROLD ZEAMANS

INSTITUTE SECTIONS

<i>Chairmen</i>	<i>Secretaries</i>
	ATLANTA
Walter Van Nostrand	George Llewellyn, Room 524, Post Office Bldg., Atlanta, Ga.
	BOSTON
George W. Pierce	Melville Eastham, 30 State St., Cambridge, Mass.
	BUFFALO—NIAGARA
L. C. F. Horle	C. J. Porter, 325 McKinley Ave., Kenmore, New York
	CANADIAN
A. M. Patience	C. C. Meredith, 110 Church St., Toronto, Ontario
	CHICAGO
John H. Miller	H. E. Kranz, 4540 Armitage Ave., Chicago, Ill.
	CLEVELAND
John R. Martin	B. W. David, 3223 Ormond Road, Cleveland Heights, Ohio
	CONNECTICUT VALLEY
W. G. Cady	George W. Pettengill Jr., 70 Edendale Street, Springfield, Mass.
	DETROIT
Earle D. Glatzel	W. R. Hoffman, 615 West Lafayette Blvd., Detroit, Mich.
	LOS ANGELES
Don C. Wallace	W. W. Lindsay, Jr., 927 La Jolla Ave., Hollywood, Cal.
	PHILADELPHIA
J. C. Van Horn	John C. Mevius, 1533 Pine St., Philadelphia, Pa.
	PITTSBURGH
W. K. Thomas	A. J. Buzzard, 911 Penn Ave., Pittsburgh, Pa.
	ROCHESTER
A. B. Chamberlain	A. L. Schoen, Kodak Park, Rochester, N. Y.
	SAN FRANCISCO
L. F. Fuller	D. B. McGown, 435 Pacific Bldg., San Francisco, Cal.
	SEATTLE
W. A. Kleist	Oliver C. Smith, 904 Telephone Bldg., Seattle, Wash.
	WASHINGTON
F. P. Guthrie	A. Crossley, Naval Research Laboratory, Bellevue, D. C.



JONATHAN ZENNECK
of Munich, Germany
who comes to New York to receive the 1928 Institute Medal
of Honor on September 5th.

JONATHAN ZENNECK

Jonathan Zenneck was born in Ruppertshofen, a small town in Wurttemberg, on April 15, 1871. After the usual education in the elementary schools, in the fall of 1885 he entered the Evangelical-Theological Seminary in Maulbronn, and in 1887 the seminary in Blaubeuren where he learned Latin, Greek, French, and Hebrew. In the fall of 1889 he enrolled in the Tuebingen University in the well-known Tuebingen Seminary where he studied mathematics and natural sciences. His teacher in physics was Professor Ferdinand Braun. In the spring of 1894 Professor Zenneck took the State examination in mathematics and natural sciences and immediately afterwards the examination for his doctor's degree.

During the summer of 1894 Professor Zenneck undertook zoological research at the Natural History Museum in London. From the fall of 1894-1895 he fulfilled the military service requirements in the First Naval Battalion (Marines) in Kiel, in which he later became a reserve officer. From 1895 to 1905 he was associated with the Physikalischen Institute in Strassburg, Alsace, first as assistant to Professor Braun and later as assistant lecturer.

Late in 1899 Professor Zenneck turned his attention to wireless telegraphy, conducting experiments along the lines indicated by Professor Braun. These experiments were mainly carried on on light ships in the North Sea. In the following year Professor Zenneck turned his attention to the many fundamental questions in wireless telegraphy which were unexplained and during the next year he turned to the theoretical and experimental explanation of the physical fundamentals of wireless telegraphy. The result of this work was the classical book "Electromagnetic Oscillations and Wireless Telegraphy," which appeared in 1906 and which, for so many years, was the standard textbook on the subject.

In the spring of 1905 he was appointed assistant professor at the Danzig Technical High School, and a year later became professor of experimental physics in the Braunschweig Technische Hochschule. In order to take part in experiments on the fixation of atmospheric nitrogen, in 1909 Professor Zenneck joined the staff of the Badische Anilin und Sodafabrik, one of the largest German chemical concerns.

In the fall of 1911 he returned to the Danzig Technische Hochschule as professor of experimental physics, and in 1913 he went to the Munich Technische Hochschule in the same capacity.

At the beginning of the World War Professor Zenneck went to the front as a Captain in the Marines. Early in December of 1914 he was sent to the United States as technical advisor for the Atlantic Communication Company, taking part in experiments with the machine senders in Sayville, and with patent processes.

After the United States entered the war he was interned first at Ellis Island and then in Fort Oglethorpe, Georgia, returning to Germany in July of 1919 to resume his duties as Professor of Experimental Physics at the Technische Hochschule in Munich. For the past two years he has been President of the Technische Hochschule.

Professor Zenneck has been a Fellow in the Institute since 1915.

THE INSTITUTE MEDAL OF HONOR

Each year the Institute awards a gold Institute Medal of Honor to that person who has made public the greatest advance in the science or art of radio communication, regardless of the time of performance or publication of the work on which the award is based.

The contribution may be an unpatented or patented invention which has been completely and adequately described in a scientific or engineering publication of recognized standing, and must be in actual operation.

It may also be a scientific analysis or explanation of hitherto unexplained phenomena of distinct importance to the radio art, although the application thereof need not necessarily be immediate.

The advance may further be a new system of traffic regulation or control; a new system of administration of radio companies or of service of steamship, railroad or other companies; a legislative program beneficial to the radio art, or any portion of the operating or regulating feature of the art.

In the past the medal has been awarded to the following engineers and scientists: Edwin H. Armstrong, 1918; E. F. W. Alexanderson, 1919; G. Marconi, 1920; R. A. Fessenden, 1921; Lee DeForest, 1922; John Stone Stone, 1923; M. I. Pupin, 1924; G. W. Pickard, 1926; L. W. Austin, 1927.

The Board of Direction of the Institute at its April 4th meeting decided that the 1928 Medal of Honor should be awarded to Professor Jonathan Zenneck for his contributions to original research on radio circuit performance and for this scientific and educational contributions to the literature of the pioneer radio art.



THE INSTITUTE MEDAL OF HONOR—1928

CONTRIBUTORS TO THIS ISSUE

Bower, Ward E.: Born in Schell City, Mo., April 4, 1884. Graduate Platts Commercial College, St. Joseph, Mo. Studied at Bush Temple of Music. Professional musician for many years. Studied mechanical electrical engineering, and mathematics by special instruction from Armour Institute, Chicago. Enrolled at University of Minnesota in radio engineering. Instructor in junior radio engineering at Wm. Hood Dunwoody Industrial Institute, Minneapolis, Minn. Designed and installed station WHDI and 9YX for the same institution. Radio manufacturing business in Minneapolis, Minn., 1920-1923. Since June 25, 1925, at Naval Research Laboratory as assistant radio engineer engaged in special research.

Crouse, George B.: Born at Arlington, N. J. in 1892; 1912-14 designer of high-frequency generators and automatic switching devices for the "Telharmonium"; 1914-21, department engineer in charge of gyro-compass and radio design with Sperry Gyroscope Company; 1921-22, chief engineer, Ford Instrument Company, working on gun fire control equipment; 1922-23, with Connecticut Instrument Company on development of acoustical apparatus; 1923 to date, development of power supply for radio apparatus with Rader Appliance Company and Conner Crouse Corporation.

Dellinger, J. H.: (See PROCEEDINGS for May, 1928).

Dreisback, Robert H.: Born at Fort Wayne, Indiana, March 12, 1907. Edison Lamp Works, Fort Wayne, Indiana, 1923. Test department, General Electric Company, Fort Wayne, 1926-27. Engaged in private work on short-wave communication, field intensity measurements, frequency measurement of short waves, broadcast station design, 1923-28. Received the A.B. degree in physics from Indiana University, 1928.

Goldsmith, Alfred N.: (See PROCEEDINGS for March, 1928).

Harris, Sylan: Born at Philadelphia, Pa., May 5, 1898. Graduated from Central High School, Philadelphia; E.E. degree from University of Pennsylvania, 1922; engaged in power maintenance work, Midvale Steel Ordnance Company, Philadelphia, 1917-18; Leeds and Northrup, 1918; technical editor, *Lefax*, 1922-23; managing editor, *Radio News*, 1923-25; director of research and design, Stewart-Warner Speedometer Corporation, Chicago, 1926-27; 1927 to date in the laboratories of Brandes Products Corporation, Newark, N. J. Member in the Institute.

Hund, August: Born at Offenburg, Baden, Germany, December 17, 1887. Educated at Karlsruhe, Heidelberg and California; E.E. degree, 1911 and Dr. Eng. degree, 1913 from Karlsruhe. Research engineer in Research Laboratory of the General Electric Company at Schenectady, 1912-14, part of the time in Dr. Steinmetz's private laboratory; assistant professor of physics and electrical engineering, University of Southern California, 1915-17; consulting research engineer in San Francisco, 1918-22. Since November, 1922, electrical engineer at the Bureau of Standards doing research work in radio and electro-acoustics. Fellow in the Institute.

Kimmell, William J.: Born at Pittsburgh, Pa., May 4, 1905. Undergraduate work in physics at Carnegie Institute of Technology and degree of B.S. in physics, 1926. Since employed as research engineer in vacuum tubes and vacuum-tube circuits by the Westinghouse Electric and Manufacturing Company at East Pittsburgh. Also has taken graduate courses in physics at Harvard University, University of Chicago, and University of Pittsburgh.

Ramsey, R. R.: Born at Morning Sun, Ohio, April 11, 1872. Received A.B. degree from Indiana University, 1895; A.M. degree, Indiana University, 1898; Ph.D. degree, Cornell University, 1901. Instructor, University of Missouri, 1901-03; assistant professor, associate professor and professor, Indiana University, 1903 to date. Author of a number of papers relating to electrolytic conduction, radio-activity and radio telegraphy. Author of "Experimental Radio." Fellow of American Physical Society and Member of the Institute of Radio Engineers.

Thomson, J. M.: Graduated from the University of Toronto in applied science, 1924. General Electric test course, 1924, specializing in radio receivers; transformer engineer, English Electric, 1925-26; 1927 to date in charge of Toronto Research Laboratory of Ferranti Electric, Limited.

van der Pol, Balth.: Born at Utrecht, Holland, January 27, 1889. Received doctor's degree from University of Utrecht, 1916. Research work in radiotelegraphy and allied subjects at Cambridge University, England, 1917. Conservator of Physical Research Laboratory, Teyler's Institute, Holland, 1919. Research Laboratory, Philips' Glowlamp Works, Ltd., Eindhoven, Holland, 1928. Member of the Institute.

Wheeler, L. P.: Born at Bridgeport, Conn., July 27, 1874. Received the Ph.B. degree from Yale University, 1894, and the Ph.D. degree in 1902; laboratory assistant in physics, Sheffield Scientific School, Yale University, 1895-97; assistant, 1897-01; instructor, 1901-06; assistant professor, 1906-23; and associate professor, 1923-26. Physicist, U. S. Naval Research Laboratory, 1926 to date.

Wright, James Warren: Born at Springfield, Ohio, 1899. Received A.B. degree from Ohio Wesleyan and the M.A. degree from Ohio State University, with additional graduate work at Ohio State University. Teaching experience in physics department of Ohio State, Ohio Wesleyan, and Syracuse Universities. Member of technical staff, radio division, U. S. Naval Research Laboratory since June, 1926. Work has been in connection with precision, electrical and radio measurements, piezoelectric crystal and vacuum-tube transmitter circuits.

INSTITUTE ACTIVITIES

DINNER TO PROFESSOR ZENNECK

Members of the Institute are afforded the very unusual opportunity of honoring a distinguished fellow-member from a foreign country who comes to this country to receive the Institute Medal of Honor and to address the Institute. Professor Jonathan Zenneck arrives in the United States early in September to be the guest of honor at a dinner which the Institute gives him at the Hotel McAlpin, Broadway and 34th Streets, New York, on the evening of September 5th.

Following the dinner, a meeting of the Institute will be held in the Engineering Societies Building, 33 West 39th Street, at which Professor Zenneck will be presented with the Medal of Honor and will deliver a paper on, "What Science Owes to Radio Telegraphy."

All members and their friends are invited to attend the dinner, which will be informal. Admission to the dinner will be by ticket only. Reservations, at \$3.00 per plate, must be accompanied by remittances, and *must* be in the hands of the Secretary of the Institute not later than August 23rd. Members' wives and guests are invited to the dinner and the Institute meeting which follows.

PRELIMINARY 1928 STANDARDIZATION REPORTS

Only a few copies of the preliminary draft of report of the Institute's Committee on Standardization for 1928 are now available. All persons interested in radio standardization should receive a copy of the preliminary draft. Copies may be obtained free of charge by addressing a request to the Institute office.

PUBLICATION PROGRAM

Due to the greatly increased number of pages which are being published in the PROCEEDINGS each month, the publication program for the PROCEEDINGS has been considerably expanded. Manuscripts submitted for publication can appear in the PROCEEDINGS in approximately one quarter of the time formerly required.

The Institute's Committee on Meetings and Papers will welcome any manuscripts on any phase of radio or its closely allied arts. Manuscripts should be forwarded to the office of the Institute, 33 West 39th Street, New York City.

NEW MEMBERS TO BE ELECTED

On page 1156 of this issue will be found a list of applicants for the several grades of membership. All of these have been favorably acted upon by the Committee on Admissions for submission to the Board of Direction for election at its September 5th meeting. Members objecting to the transfer or election of any persons listed should communicate with the Secretary of the Institute on or before September 2nd, 1928.

Institute Meetings

CLEVELAND SECTION

The first dinner-meeting of the Cleveland Section was held in the Hotel Winston on Friday evening, June 8th. The meeting was one of the most enjoyable and profitable ones of the year.

Donald McNicol, Chairman of the Institute's Committee on Sections, was present and delivered an address. Musical entertainment was provided during the dinner. The first speaker was Edward L. Viets, who gave a discussion of present day radio conditions from a strictly humorous point of view.

A comedy skit in black face worthy of "big time" was presented by Messrs. Schonvisner and Hirshfield, senior students at Case School of Applied Science.

Chairman John R. Martin in introducing Mr. McNicol spoke of the excellent co-operation and friendly assistance which is afforded by the New York Headquarters. Informal discussion followed Mr. McNicol's talk in which Section problems were discussed.

The attendance at this meeting was forty-seven.

DETROIT SECTION

On April 20th a meeting of the Detroit Section was held in the Detroit News Building. E. D. Glatzel, chairman of the Section, presided.

A. B. Buchanan, of the Detroit Edison Company, presented a paper on "Sources and Mitigation of Radio Noises" in which the routine employed by the larger electric power utilities in handling complaints of radio disturbances was explained, special reference being made to the problems presented by the popularity of the new a.c. receiver. The causes of trouble with these receivers, in some cases, were explained and remedies suggested. The fallacy of the "leaky transformer" was pointed out. A number of the

more common peculiarities of radio disturbances were described and it was pointed out that experience is the most valuable asset in locating sources of radio interference, although difficult cases of trouble are frequently located as a result of persistence rather than brilliance on the part of the investigator.

A device for recording interference was described. This device is designed for use in cases of intermittent troubles at some distance from headquarters.

An analysis of more than 6,000 cases of trouble reported to the power company showed a surprisingly small number of cases of trouble actually caused by their equipment.

Thirty-five members and guests attended this meeting.

The Detroit Section held a meeting on May 18th in the Detroit News Building. Earle R. Glatzel presided.

The speaker, W. W. Brown of the radio engineering department of the General Electric Company, presented a paper on "Directive Antennas." The paper contained a detailed explanation of the fundamental principles of directive radiation from a simple arrangement of two radiators. The effect of time and space relations was considered. Patterns showing directive properties of single unit radiators were presented, including reference to horizontal and inclined directivity. Descriptions of various types of directive antennas in commercial use were given. These included the extended half wave, parabola, and the degenerate parabola with infinite and zero focal adjustments. Theoretical improvements by use of certain of these types compared with single units were given. An outline of additional data which is being obtained, and lines of further scientific investigation which are being followed were presented.

SAN FRANCISCO SECTION

The June meeting of the San Francisco Section was held in the Engineers' Club on June 20th. S. W. Edwards, radio supervisor of the 8th Inspection District, and J. E. Brown, radio inspector from that district, were present as guests, and spoke briefly upon the radio test cars of the Department of Commerce and their use in field-strength measurements. Elmer L. Brown, service engineer of the California Victor Company, presented a paper, "A Unique Portable Instrument for Radio Testing." He outlined, briefly, the service requirements leading up to the design of the instrument, and described in detail the circuits and construction which permit all necessary tests on a radio

receiver to be made with a single piece of equipment, readily carried and easily used.

The attendance at this meeting was thirty-two.

Committee Work

A 1928 Committee on Nominations, with membership as follows, has been appointed by President Goldsmith: J. H. Dellinger, Chairman; Donald McNicol, R. H. Marriott, Arthur Batcheller, and L. M. Hull.

This committee is to make recommendations to the Board of Direction as to possible candidates for the offices of President, Vice President, and members of the Board of Direction (two) at the September 5th meeting of the Board. The Committee desires to receive suggestions from the membership as to the names of possible candidates for these offices.

As authorized in the amendment to the Constitution of the Institute, dated January, 1921, "Nomination by Petition shall be made by letter, addressed to the Board of Direction, setting forth the name of the proposed candidate and the office for which it is desired he be nominated. For acceptance, a letter of Petition must reach the Board of Direction on or before October 15th of any year, and shall be signed by at least thirty-five Fellows, Members, or Associates."

COMMITTEE ON ADMISSIONS

A meeting of the Committee on Admissions was held in the office of the Institute on July 12th. Messrs. F. H. Kroger, E. R. Shute, and H. F. Dart were present.

The committee passed upon eighteen applications for transfer or election to the Member or Fellow grade.

Erratum

In connection with the paper by W. A. Marrison appearing in the July, 1928 issue of the PROCEEDINGS, the following caption was omitted from Figure 3, page 979:

Fig. 3. Illustration of the Effect of Using a Thermal Attenuating Layer.

Material of Attenuating Layer	Temperature Variation at B	
	For 1 Min. Period	For 10 Min. Period
Wool felt	± 0.002	± 0.14 deg.
Equal alternate layers of felt and copper	± 0.0002	± 0.06 "
Felt and copper in tapered arrangement as described in text.	± 0.00006	± 0.03 "

A NEW TYPE OF STANDARD FREQUENCY PIEZO-ELECTRIC OSCILLATOR*

By

LYNDE P. WHEELER AND WARD E. BOWER

(Naval Research Laboratory, Bellevue, Anacostia, D. C.)

Summary—In this paper is described a system for producing alternating current of audible frequency of a very high degree of precision. The chief novelty in the system consists in the manner in which the energy necessary to sustain the oscillations of the quartz bar is returned to it. This "feed-back" is accomplished acoustically and the extremely loose coupling thereby secured insures that the generated frequency is practically uninfluenced by inertia effects of electrodes or variations in tube constants.

There is also described the installation of the auxiliary apparatus to permit the continuous operation of the oscillator over very long periods of time and to measure the generated frequency with the highest possible precision.

SEVERAL methods of using a crystal-controlled vacuum-tube oscillator as a standard of frequency are described¹ in the literature. In none of these methods is the generated frequency exactly that of the free mechanical oscillations of the quartz plate. This is because the combination of piezo-electric quartz plate and the vacuum tube with its associated circuits form a coupled system of more than one degree of freedom, and moreover one in which the coupling has to be fairly "tight" in order to secure the energy necessary for self-sustaining operation. From the point of view of its use as a frequency standard, the fact that the generated frequency is not the natural frequency of the quartz plate would make no difference, provided that the former remained constant. Unfortunately, however, it is precisely those factors which cause the generated to differ from the quartz-plate frequency that are subject to variations difficult to control where the highest precision is desired. The most important of these factors is the internal capacity between the grid and plate of the tube. Its magnitude affects the numerical value of the generated frequency in two ways. First, being a condenser

* Original Manuscript Received by the Institute, June 20, 1928. Read at April, 1928 meeting of the International Union of Scientific Radiotelegraphy.

¹ Cady, *Proc. I. R. E.*, 10, p. 83; April, 1922.

Pierce, *Proc. Am. Acad. Arts and Sciences*, 59, p. 83; Oct., 1923.

Dye, *Proc. Phys. Soc. London*, 38, p. 399; Aug., 1926.

Hund, *Proc. I. R. E.*, 14, p. 447; Aug., 1926.

Horton and Marrison, *Proc. I. R. E.*, 16, p. 137; Feb., 1928.

Worrall and Owens, *Proc. I. R. E.*, 16, p. 778; June, 1928.

in series with the capacities representing the quartz plate in its electrical analogue,² it affects the equivalent LC value; and second, forming as it does the coupling element of the system it affects the frequency through the dependence of the latter on the coupling coefficient. Thus, any variation of this tube capacity with time is doubly important, necessitating rather frequent calibrations, and in case of tube replacements it may require readjustment of circuit constants.

The very considerable experience with this type of oscillator obtained at the U. S. Naval Research Laboratory leads us to believe that these inherent limitations in the constancy of the oscillator represent, under ordinary laboratory conditions, an unavoidable error of somewhat less than 0.001 per cent. Under the *best* conditions—that is, at the time of a calibration and with better than ordinary temperature control—it is possible to be certain of the oscillator frequency values to slightly less than 0.0001 per cent. Such accuracy is, however, not easily obtainable as a routine procedure.

Now, while measurement of frequency to better than one part in 100,000 is amply accurate for most purposes in the radio art today (this means an uncertainty of less than 200 cycles in 20 megacycles), it would be rash to say that it will suffice even five years hence. Further, it does not seem practicable at present to attain even this precision of frequency in the radiations of service transmitters, where 0.01 per cent would seem to represent the best modern practice. As the same principles are involved in the design of crystal-controlled transmitters as in laboratory apparatus for the measurement of frequency, it is reasonable to expect that improvements in the latter will be applicable to the former, thus raising transmitter performance to a point (in respect to frequency stability) more nearly adequate to the demands of the radio art of the present, not to mention those of the future. Finally, if any further justification for playing with the ultimate decimal places is needed, it must be urged that mere intellectual curiosity to explore the limits of the possibilities of such a marvelous device as the piezo-electric oscillator is the best possible reason for doing so.

In casting about for means of improving the performance of the usual types of standard oscillator, it seemed logical to look for improvement by reducing the coupling between the mechani-

² See, e.g., Dye, loc. cit.

cal and electrical features of the device. This would entail, of course, a reduction in the output energy available, but that, from the point of view of a measuring apparatus, was a secondary consideration. In order to attack intelligently the problem of reducing the coupling it seemed advisable to obtain more information than is available in the literature as to the magnitude of the voltages obtainable from the mechanically vibrating quartz plates. In other words, since reducing the coupling would mean a reduction in the energy transferred between what may be regarded as the primary and secondary of a transformer, it is necessary to have some idea as to the amount of energy available in the primary, in order to determine the feasible limit to which the coupling may be reduced.

For this purpose an apparatus was constructed for mechanically vibrating a quartz plate at frequencies and amplitudes readily controllable, and the piezo-electric voltages developed were measured with a sensitive vacuum-tube voltmeter. It is unnecessary at this time to go further into the details of this investigation, as owing to various causes it is as yet incomplete. Suffice it to say that it soon developed that even with very small amplitudes and at frequencies far removed from those proper to any of its known modes of oscillation, there were piezo-electric differences of potential produced of the order of 100 microvolts. It then became immediately obvious that given sufficient amplification, the driver of our mechanical vibrator could be actuated, and we would have a self-sustained oscillator, in which the vacuum tubes would play the part of amplifiers only and not function at all as a coupling or regenerative element between the mechanical and electrical oscillations. Thus, variations in the interelectrode capacities or in the external circuits due to any cause whatever could not affect the frequency except as slight changes in the amount of amplifier output energy furnished the driver of the mechanical vibrator might change the amplitude of its output and hence conceivably, by varying the amplitude of the quartz-plate oscillations, alter the frequency of the latter. As a little consideration showed that such changes could with careful design be reduced to insignificance, there remained only the problem of the method to be used to vibrate the quartz mechanically.

There are, of course, a number of more or less obvious solutions to this problem, most of which, however, involve rather

formidable difficulties in the way of complicating the apparatus, or make the application of the necessary temperature control awkward. The simplest solution that suggested itself, and that finally adopted, was to vibrate the quartz plate by a resonant air column. This naturally restricts the frequency obtainable to relatively low values, but otherwise adapts itself so perfectly to the requirements of a standard of the highest precision, that

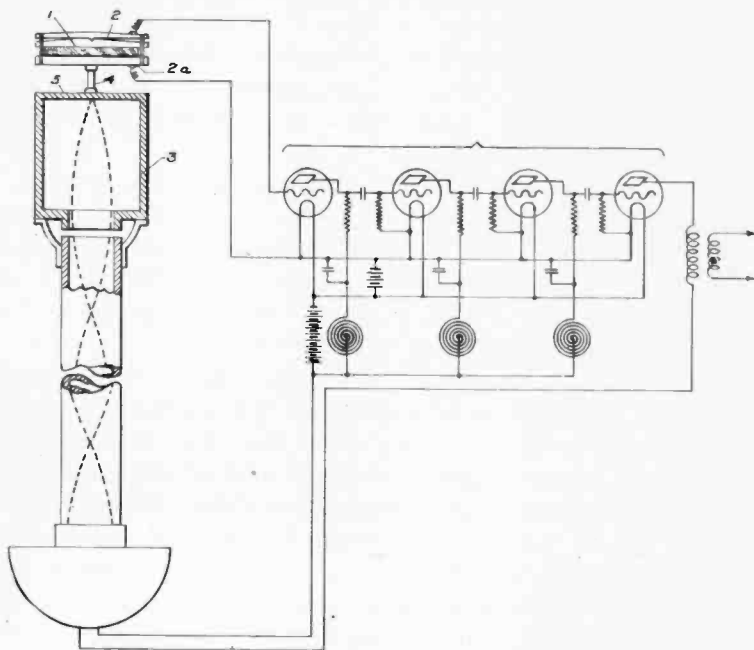

Fig. 1

there was no question of its adoption after the idea had presented itself.³ In all the changes of form which the apparatus had undergone up to and including that which it is the purpose of this paper to describe, this feature of the acoustical "feed back" of the energy necessary to sustain the oscillations has remained unchanged. In all the stages of development the amplified piezo-electric voltage operates a loudspeaker element, which in turn actuates a tunable air column and resonator from which the quartz bar receives its sustaining energy. All of the essential changes which have been made are in the method of

³ The idea of maintaining the oscillations of the bar by the return of energy to it acoustically was first suggested by Mr. Bower.

mounting the bar and in the manner of collecting the piezo-electric charges which its motion develops. It will be profitable to trace in some detail certain of these changes because one point that emerged is of considerable importance in its bearing on the function of the apparatus as a primary frequency standard.

The first form which the apparatus took is shown schematically in Figs. 1 and 1a. With what has been said above the functioning of the various parts will be evident without further description. Attention is here directed only to the method of mounting of the quartz bar (1), which is so cut that the electric axis is parallel to its shortest and the optic axis to its intermediate dimension. It will be noted that the bar is clamped at the center between small electrodes (2) and (2a) insulated from

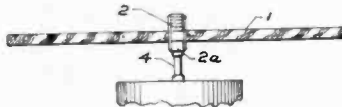

Fig. 1a

each other and connected to the amplifier. It receives its energy from the resonator (3) through the stem (4) rigidly attached to the thin-walled bottom (5) of the resonator. The electrodes were attached to a place of maximum stress in order to get as large a voltage as possible and so make extreme amplification unnecessary.

Although this form of the apparatus functioned well it was feared that the existence of a clamp with a member of its assembly inferior both mechanically and as an electrical insulator to the material of the bar would lead to a damping coefficient for the oscillations of the latter which would be variable with time and thus cause variations in frequency of the order of magnitude of those inherent in the usual type of standard oscillator. It was in addition desired to leave the bar free of electrodes if possible in order to get away from any complications due to loading effects of attached metal. Hence the mounting shown in Fig. 2 was substituted, the rest of the apparatus remaining as in Fig. 1.

In this form of mounting the bar (1) was supported on cork or felt strips (2) and (2a) placed at the nodes of the mode of vibration which it was desired to use. The piezo-electric voltage was developed on auxiliary crystal plates (3) and (4) which were vibrated by their attachment to the walls of the resonator (2).

With this arrangement the bar does not need to be of piezoelectric material, and in fact the apparatus has been used successfully with metallic bars. This method of mounting represented a material advance over the previous one in that the bar is left practically free to execute its own transverse vibrations as a bar supported at the nodes uninfluenced by mechanical reactions of electrodes. However, an electric reaction which might be unfavorable still remained, as was shown by the following observation. When the bar was of crystalline quartz and the air column was adjusted to return the energy in the proper phase to sustain the oscillations, it was noticed that the bar would not

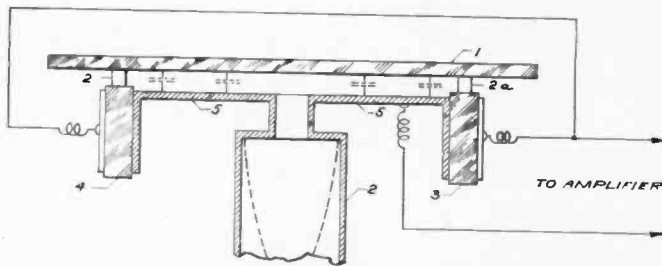

Fig. 2

vibrate continuously if it were turned over so that its other face was opposite the resonator opening. This behavior is due to the fact that the bar is urged to move not only by the alternate rarefactions and condensations of the air at the mouth of the resonator, but also by the electrostatic attractions and repulsions between the charge developed on the near surface of the bar and that on the electrode (5) which originates from the motion of the auxiliary crystal plates (3) and (4). If the two resulting forces conspire the oscillations of the bar will persist, but if they oppose the oscillations quickly die out.⁴

Now this effect, though interesting, is not of particular importance, except for the rather surprising magnitude of the electrostatic forces involved. This immediately suggested that the auxiliary crystals as well as electrodes on the bar could be dispensed with and resulted in the finally adopted form of mounting shown in Fig. 3. In this mounting the bar is held at the nodes of its fundamental mode (very closely 1000 cycles) by stout silk threads between spring metal supports. The elec-

⁴ A detailed study of the type of vibration utilized in this oscillator is in course of preparation.

trodes for various reasons connected with questions of design are placed much nearer the bar than is necessary for successful operation. A bar has been satisfactorily operated with electrodes distant as far as five or six centimeters.

We thus arrived at a design for an oscillator in which, (1) the coupling between the mechanical and electrical oscillations involved has been very much reduced; (2) the values of the tube constants (provided they are such as to give sufficient amplification) cannot affect the generated frequency except through the effect of very small changes in the amplitude of the oscillations of the bar due to changes in the energy supplied by the loud-speaker element to the air column; (3) inertia effects of electrode

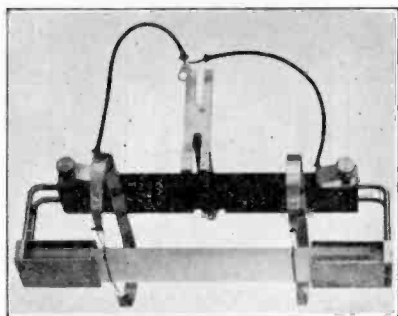

Fig. 3

loading have been reduced to an unavoidable minimum (in the absence of the possibility of utilizing a vacuum mounting); (4) the generated frequency is more nearly that determined by the dimensions and elastic properties of the quartz plate than has previously been possible.

In order to test out quantitatively the performance of this new system a rather elaborate equipment has been designed and installed at the U. S. Naval Research Laboratory.⁵ The mounting of the quartz bar together with the amplifier and the acoustic feed-back system, the latter provided with micrometer tuning adjustment, have been combined into a self-contained unit (see Fig. 4), which when in service is immersed up to the point (a) in the water bath of a large thermostat. The latter is located in a triple-walled booth provided with automatic temperature control. Both the booth and the water thermostat heaters and

⁵ For the details of this design Mr. Bower is responsible.

stirrers are operated from the service mains with automatic switching devices to provide storage-battery supply in case of failure of the regular service. The amplifier is provided with two sets of tubes, two filament and two plate supply batteries. By means of a control box located on the outer wall of the booth the change from one set of tubes to the other, the change from one set of batteries to the other, and the charging of the set of batteries not in use, is provided for without interrupting the

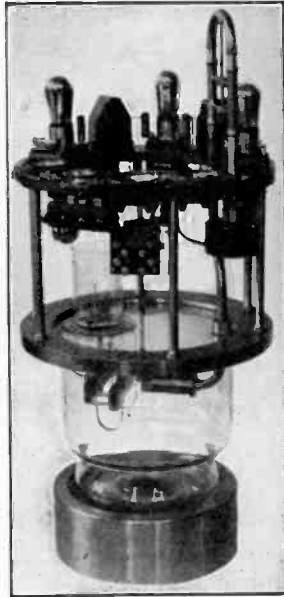

Fig. 4

oscillator. These precautions are taken to ensure continuous operation at a definite temperature over long periods of time.

The equipment provided for determining the value of the generated frequency consists of four units: (1) an amplifier fed from the output of the oscillator unit which in turn supplies the current to operate; (2) a synchronous motor clock; (3) a radio receiver unit for the reception of the U. S. Naval Observatory time signals from Arlington and which, when those signals arrive, automatically starts; (4) a tape recorder on which they are printed simultaneously with signals from the synchronous motor clock which latter are sent out ten times in each of its

seconds. The amplifier driving the synchronous motor clock like that in the oscillator unit is provided with two sets of tubes and is operated from the same batteries through the same control box. The clock gearing is such that if supplied with exactly one-thousand-cycle current it will keep correct time. Thus, at each period that the time signals are sent out, we obtain a permanent record from any two points of which the frequency generated by the oscillator can be determined with very considerable accuracy, which can be made (by choosing a long enough time interval) to be as great as that of the time signals themselves. That is, of course, providing the oscillations of the quartz bar remain constant in frequency throughout the whole interval. In any case, the measurements made as outlined above will give the *average* value of the frequency of the bar to that accuracy.

To check the constancy of frequency over such long periods of time, a second oscillator unit has been provided equipped with a duplicate set of controls and a second clock, printing on the same tape recorder. The two oscillator units are immersed in the same thermostatically-controlled bath. Switching arrangements are provided so that either clock may be recorded against the time signals, or one clock against the other, or either clock against any other standard frequency source. Thus, from these permanent daily records of the performance of the two bars it would seem that in time we should obtain very exact information as to the degree of constancy of the oscillations of the bars.

At the present time the equipment has been in operation for too short a time to permit a quantitative statement of its performance to be made. In fact, the second oscillator unit and the tape recorder have but just been installed. However, from such tests of the first oscillator as have been made without the recorder, it is fairly certain that the *average* frequency of its quartz bar has not varied by as much as one part in a million and that in all probability the variations are much smaller than that.

Before the final measurements on the relative rates of the clocks with respect to each other and of each one separately with respect to Naval Observatory time can be made, two experiments will have to be performed. First, the effect on the generated frequency of slight changes in the amplitude of oscillation of the bars must be determined. This can be conveniently accomplished with the aid of the micrometer adjustment provided for the air column of the acoustic feed-back system.

Secondly, the temperature coefficient of frequency for this type of vibration must be determined. This will be accomplished, of course, by varying the temperature at which the thermostat operates.

From one's instinctive confidence in the immutability of quartz, aged as it has been through geologic time, as well as from our experimental experience with short time comparisons of the relative frequencies of the older type of crystal-controlled oscillators, and from that which we have already had with the present apparatus, it seems reasonable to expect that our measurements will show when extended over a period of some years that the ratio of bar number one's second to bar number two's second will remain constant to a higher degree of accuracy than the ratio of either's second to that of the Naval Observatory's second. There is, however, a consideration which renders the prediction of such a result uncertain. It may be argued that although crystalline quartz as found in nature is a very permanent substance, it nevertheless has not been subjected to the particular kind of periodic stresses which it must now suffer, and that in consequence there may occur slight secular changes difficult or impossible to determine.

With the idea of accentuating any possible changes of this nature, one of our bars is polished and the other left relatively rough ground. Thus, as in the case of unaged metals after machining operations, we should be able to detect any changes of this nature more readily. But "sufficient unto the day is the evil thereof"! It will be time to face the consequences of the advent of a more constant timekeeper than the earth, if and when such measurements as we expect to make in the next few years show that it has really arrived.

THE EFFECT OF REGENERATION ON THE RECEIVED SIGNAL STRENGTH*

BY

BALTH. VAN DER POL

(Physical Laboratory, Philips' Glowlamp Works, Ltd., Eindhoven, Holland)

Summary—It is the purpose of this paper to give a theory of the effect of regeneration using the solution of a non-linear differential equation, and to present experimental verification of the theory.

It is shown that: (a) as a first approximation, detection has no effect on the radio-frequency grid voltage developed under the influence of an incoming signal, (b) the amplification obtained through regeneration equals the two-thirds power of the ratio of the "grid space" to the amplitude obtained with zero regeneration. It is apparent from (b) that much greater gain is obtained through regeneration with weak signals than with strong signals.

The verification of the theory is made with a circuit arrangement operating at 500 cycles per second. Application is made to radio frequencies using this as a model of a high-frequency system, following a theorem for model systems which is stated.

THE considerable increase in signal strength obtainable through the use of regeneration is well-known. It is also common knowledge that this increase in signal strength is considerably greater when the incoming signal is weak than when it is strong. It is the purpose of this paper to provide a non-linear theory of this effect of regeneration and the experimental verification thereof.

Suppose a triode system of one degree of freedom, as in Fig. 1 where L , C , r form the tuned circuit and the mutual induction M provides the regeneration.

Let further an emf, $E \sin \omega_1 t$, representing the "incoming signal," be applied to the oscillatory system. Neglecting the grid current and calling the current in the LCr circuit i , and the deviation of the anode current from its steady value i_a and the alternating grid P.D. V_g , we have

$$L \frac{di}{dt} + ri + \frac{1}{C} \int idt - M \frac{di_a}{dt} = E \sin \omega_1 t \quad (1)$$

$$\frac{1}{C} \int idt = V_g \quad (2)$$

* Original Manuscript Received by the Institute, May 26, 1928. Paper read at the meeting of the International Union of Scientific Radiotelegraphy, October, 1927.

In the "tuned grid" circuit, the variations of anode potential are usually small compared with the variations of the grid potential, so that as a first approximation, the anode current variation i_a is a function of the grid potential variation only, i.e.,

$$i_a = \int (v_g) \tag{3}$$

In order to avoid complexity we neglect the grid current and we therefore imagine a negative grid bias to be provided. Our system of coordinates in the i_a, v_g plane is therefore as shown in Fig. 2. This differs from the usual notation insofar as the zero point of the coordinate system is shifted towards the steady d.c. position round which the oscillations occur.

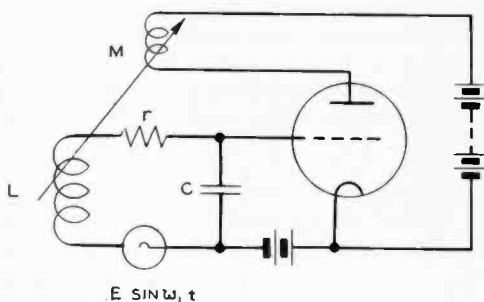

Fig. 1

We approximate equation (3), representing the curved plate current-grid voltage characteristic of the triode, by the cubic:

$$i_a = S_1 v_g + S_2 v_g^2 - S_3 v_g^3 \tag{3a}$$

where S_1 is the usual "mutual conductance" for infinitesimal grid-potential variations. S_2 and S_3 are further determined by the form of the characteristic. As the latter bends round both at the top and at the bottom we write in (3a) $-S_3 v_g^3$ instead of $+S_3 v_g^3$.

The elimination of i and i_a from (1), (2), and (3a) results in:

$$\frac{d^2 v_g}{dt^2} + \left\{ \left(\frac{r}{L} - \frac{MS_1}{LC} \right) - \frac{2MS_2}{LC} v_g + \frac{3MS_3}{LC} v_g^2 \right\} \frac{dv_g}{dt} + \omega_0^2 v_g = \omega_0^2 E \sin \omega_1 t. \tag{4}$$

where

$$\omega_0^2 = \frac{1}{LC}$$

Calling further

$$\frac{r}{L} - \frac{MS_1}{LC} = \alpha,$$

$$\frac{MS_2}{LC} = \beta,$$

$$\frac{MS_3}{LC} = \gamma,$$

(4) becomes

$$\ddot{v}_g + (-\alpha + 2\beta v_g + 3\gamma v_g^2)v_g + \omega_0^2 v_g = \omega_0^2 E \sin \omega_1 t. \quad (4^a)$$

which is a non-linear inhomogeneous differential equation of the second order with non-linear resistance terms. The usual elementary approximation of a linear characteristic would make $\beta = \gamma = 0$ and for resonance (i.e. $\omega_0^2 = \omega_1^2$) and critical regeneration (i.e. $\alpha = 0$) the developing grid voltage V_g would become infinite. In order to obtain a satisfactory theory of the response of a regenerative triode system to an impressed emf a non-linear problem must therefore be solved.

The equation (4a) was fully considered in a former paper¹; from the results obtained there it follows that the steady state solution in the neighborhood of resonance ($|\omega_0 - \omega_1| \ll \omega_1$) can be written:

$$v_g = C \sin(\omega_1 t + \phi)$$

where the amplitude C of the resulting grid potential variation is given by:

$$C^2 \{ 4(\omega_0 - \omega_1)^2 + (\alpha - \frac{3}{4}\gamma C^2)^2 \} = \omega_0^2 E^2 \quad (5)$$

a cubic equation in C^2 . It is further seen from (5) that the asymmetrical term in (4a) (with β) (which determines the detection) has, in the first approximation here considered, no influence on the resulting V_g . *Therefore as a first approximation detection has no effect on the r.f. grid potential difference developing under the influence of an incoming "signal."*

Further if (5) is compared with the usual linear case as represented by

$$C^2 \{ 4(\omega_0 - \omega_1)^2 + \alpha_0^2 \} = \omega_0^2 E^2,$$

it follows that in the non-linear case ($\alpha - \frac{3}{4}\gamma C^2$) is substituted for

¹ *Phil. Mag.* 3, 65 1927.

α_0 , i.e. the system behaves as if for the resistance r a new resistance r' were substituted of a value given by

$$r' = r - \frac{M}{C} \left(S_1 - \frac{3}{4} C^2 S_3 \right) \quad (6)$$

which therefore depends upon the amplitude C already present in the system.²

When the regeneration is pushed so far that

$$MS_1 > rC \quad (7)$$

it is seen from (6) that the first order differential resistance of the system becomes negative and therefore the system has the tendency to oscillate spontaneously. However, as was shown in the *Phil. Mag.* paper quoted above, the forced oscillations may suppress the development of the free oscillations. The phenomenon manifests itself through the presence of a "silent region" extending at both sides of resonance. As was shown by Professor Appleton³ the width of this silent region is determined by the amplitude of the incoming signal. For strong signals this width is given by

$$\frac{\omega_0 - \omega_1}{\omega_0} = \pm E \sqrt{\frac{3\gamma}{\alpha}} \quad (8)$$

It is of interest to investigate the resultant grid amplitude b if (a), the system is tuned exactly to resonance, i.e.,

$$\omega_0 = \omega_1$$

and (b), it is brought on the verge of free oscillation, i.e., when

$$S_1 M = Cr. \quad (9)$$

For this case we at once obtain from (5)

$$\frac{3}{4} \gamma C^3 = \pm \omega_0 E, \quad (10)$$

which expression will now be considered in detail.

First, it follows from (10) that *the resulting grid amplitude is proportional to the cube root of the emf applied to the system.*

Further, it is easy to assign an approximate value to γ directly from the triode characteristic. Referring to (3a), (4a) and Fig. 2,

² This property of the non-linear system was first derived in 1920. See Balth. van der Pol, *Radio Review*, Nov., Dec. 1920.

³ E. V. Appleton, *Proc. Camb. Phil. Soc.*, 23, 231, 1923.

and taking the symmetrical case for which $S_2 = 0$, it follows that a good approximation to S_3 can be found from the maximum and minimum value of the cubic (3a), for $i_a = i_{a \text{ max}}$ when

$$v_g^3 = \frac{S_1}{3S_3}$$

Calling, therefore, the grid voltage change necessary to bring the anode current from zero to its saturation value the "grid space" and designing it by V_{g0} (see Fig. 2), we obtain

$$V_{g0}^2 = \frac{4S_1}{3S_3} \tag{11}$$

hence

$$\gamma = \frac{M}{LC} \cdot \frac{4S_1}{3V_{g0}^2}$$

But, when the system has critical regeneration (9) obtains, i.e.,

$$M = \frac{Cr}{S_1}$$

hence

$$\gamma = \frac{r}{L} \cdot \frac{4}{3V_{g0}^2}$$

When we further call V_{g1} the grid-voltage amplitude which would be obtained with no regeneration at all, ($M = 0$), or (which is the same thing) with reduced filament current, we find from (5)

$$v_{g1}^2 = \frac{\omega_0^2 L^2}{r^2} \cdot E^2,$$

hence we obtain from (10):

$$C^3 = v_{g1} \cdot V_{g0}^2$$

or

$$C = \sqrt[3]{v_{g1} \cdot V_{g0}^2} \tag{12}$$

reading in words:

The grid amplitude developing in resonance and with critical regeneration equals the cube root of the product of the grid amplitude

which would be obtained with no regeneration at all, and the square of the "grid space", as defined by Fig. 2.

(12) can further be written:

$$\frac{C}{v_{g1}} = \left(\frac{V_{g0}}{v_{g1}} \right)^{2/3} \quad (13)$$

which means that: *the amplification obtained through regeneration equals the two-third power of the ratio of the "grid space" V_{g0} into the amplitude obtained with zero regeneration.* The much greater gain obtained through regeneration with small signals than with stronger ones is at once apparent by (13).

Some measurements provided a very satisfactory experimental verification of the theory outlined above.

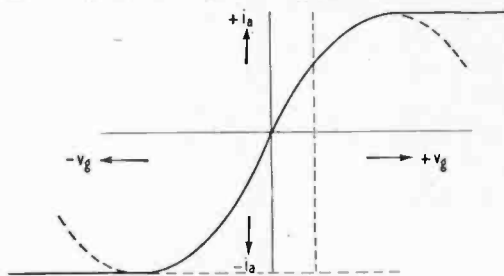

Fig. 2

The measurements were taken with relatively low frequency, thus avoiding obvious errors. That the results are, however, equally applicable to high-frequency circuits follows at once from the following theorem:

If a model is made of a high-frequency system consisting of linear inductances, linear capacities and non-linear resistances (e.g. triodes) and if the values of all the inductances (self and mutual) and capacities in the model are made n times these values in the original high-frequency system, but if the resistances (linear and non-linear) in the model are made equal to the resistances in the original circuit, the currents and potentials occurring in this model will be exactly equal in magnitude to the currents and potentials in the original high-frequency system but, considered as a function of the time, they will vary n times slower.⁴

⁴ Incidentally, in this model system the stray capacities are reduced n times in magnitude. Therefore, in order to investigate the effect of a specified stray capacity in the original high-frequency circuit it is only necessary to insert at its place in the model circuit a capacity n times the original stray capacity.

Therefore, the natural periods of the model will be n times those of the original system, and the building up and decay of currents in the model will also occur n times slower.

This simple theorem at once follows from a dimensional consideration of the coefficients such as r , ωL , $1/\omega C$, $M\omega$, occurring in the differential equations, because, e.g.

$$\omega L = \frac{\omega}{n} \cdot nL, \text{ etc.}$$

In fact, with a system having a natural frequency of 500 Hertz (cycles per second) and with critically adjusted retroaction it often took a minute for the free oscillation of the triode system to reach its final value, hence it was not easy to decide, before the external emf was applied, whether the retroaction was exactly critical or not. Therefore, an intermediate way was chosen and a model of a receiving set was made having a natural frequency of 15000 Hertz.

Four sets of readings were taken⁵ with a standard triode tungsten filament $V_f = 4.0$ volts, saturation current 11 milliamperes, anode potential varying between 100 and 200 volts, negative grid bias varying between -4.5 and -7.5 volts.

The applied emf $E \sin \omega_1 t$ was varied between $2 \cdot 10^{-6}$ and 10^{-2} volts, the resulting alternating grid voltage V_{g1} with no regeneration varied between $100 \cdot 10^{-6}$ and 0.5 volts, and the resulting alternating grid voltage b with critical regeneration varied between ca. 0.2 and 4 volts. The exponent S in the formula

$$C = (V_{g0}^2 \cdot v_{g1})^s$$

which, according to the above theory, should be

$$s = 0.33$$

was found from the four sets of measurements to be

$$\begin{aligned} s &= 0.36 \\ &0.36 \\ &0.36 \\ &0.32 \end{aligned}$$

$$\text{mean: } s = 0.35$$

⁵ The experiments and calibration of the necessary amplifiers were performed by Messrs. K. Posthumus and R. Veldhuyzen. Care was taken that the receiver did not react on the transmitter.

while the "grid space" V_{g0} calculated from these measurements was

$$\begin{array}{r} V_{g0} = 26 \text{ volts} \\ 25 \\ 20 \\ 15 \\ \hline \end{array}$$

mean: $V_{g0} = 22 \text{ volts}$,

as compared with the value

$$V_{g0} = 27 \text{ volts}$$

obtained directly from the characteristic.

The experimental value for the exponent S fits in well with the theoretical value; provided only those parts of the characteristic are considered for which no oscillation hysteresis occurs. The representation of the i_a, V_g characteristic, by a cubical parabola, with three constants S_1, S_2 , and S_3 only, obviously cannot yield very accurate values for V_{g0} obtained with a voltage swing of not more than 0.35 volts.

Therefore, there is no doubt that for all practical purposes the theory given above fits in well with experiment.

Finally, we give some practical figures calculated from formula (12) with the following data:

$$\frac{\omega L}{r} = 40,$$

$$V_{g0} = 27 \text{ volts.}$$

Electromotive force E working in grid circuit	Resulting alternating grid voltage with no regeneration (V_{g1})	Resulting alternating grid voltage b , with critical regeneration	Amplification obtainable through critical regeneration (C/V_{g1})
10^{-6} Volts	0.04×10^{-3} Volts	0.31 Volts	7700
10^{-5} "	0.4×10^{-3} "	0.66 "	1600
10^{-4} "	4.0×10^{-3} "	1.4 "	360
10^{-3} "	0.04 "	3.1 "	77
10^{-2} "	0.4 "	6.6 "	16

CHARACTERISTICS OF OUTPUT TRANSFORMERS*

By

J. M. THOMSON

(Radio Engineer, Ferranti Electric, Limited, Toronto, Canada)

Summary—The paper deals with the operating characteristics of the Output Transformer, which are developed in terms of the known speaker, tube and transformer constants. In the first part of the paper the general formula for the speaker current is developed and the effect of varying the transformer constants shown. The turn ratio of the transformer for maximum speaker current is considered in relation to the commonly used impedance ratio formula. The limitation of the impedance ratio formula is then pointed out and limits set for its general use. The general form of the current frequency characteristic for exponential horns and dynamic cone speakers is then obtained and a general method for matching the speaker to the output tube is given.

In the latter part of the paper, curves are given to show the results obtained in the mathematical part of the paper. The curves also include the results of tests made to check the fundamental formula. The effect of the turn ratio on the form of the current frequency characteristic is shown and a method of using the turn ratio of the output transformer to match the speaker to the output tube is given. A perfect transformer is also compared with a good commercial transformer and the general effect of the leakage inductance and the self capacity of the transformer shown.

THE general use of output transformers to protect the speakers and at the same time balance the power input at the high and low frequencies has created a great deal of interest in the operating characteristics of these transformers. In this paper the operating characteristics are developed in terms of the known transformer, speaker and tube constants.

The following assumptions will be made with respect to the characteristics of the transformer, speaker and output tube.

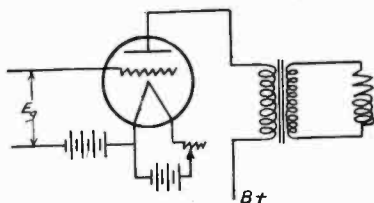

Fig. 1

The primary and secondary inductance are independent of frequency. This is true as long as the flux is uniformly dis-

* Original Manuscript Received by the Institute, April 27, 1928. Presented before joint meeting of Buffalo-Niagara, Rochester and Canadian Sections at Buffalo, April 11, 1928.

tributed across the core. The inductance will vary with the amount of d.c. in the primary coils. It will also vary with the value of the a.c. voltage used in measuring it. However, for a fixed value of direct current and a given a.c. flux density the inductance will be essentially constant. Since the component of the self inductance due to the flux which passes through the

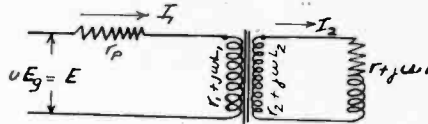

Fig. 2

coil itself is small, the unequal distribution of the current across the conductor will have very little effect on the inductance.

The resistance of the primary and secondary coil is independent of frequency. The correctness of this assumption will depend on the size and shape of the conductors used and on the lengths of the leakage paths. This increase in resistance will

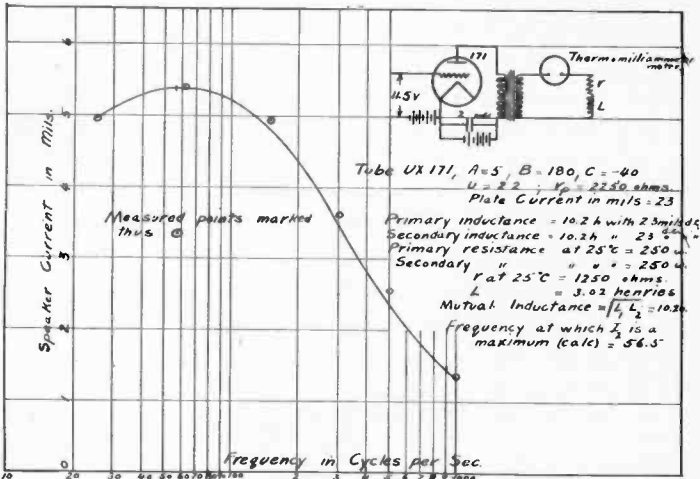

Fig. 3

usually be less than 5 per cent at 10,000 cycles, except possibly in very low ratio transformers made of few turns of relatively large wire.

The self capacities of the primary and the secondary coils are neglected.

The core loss has been neglected. It will be very small but could be represented by making the mutual inductance M a vector quantity instead of a pure number.

The amplification factor and the plate impedance of the tube will be assumed to be constant. The tube will also be assumed to be powerful enough to supply the required currents.

The two really unknown quantities are the speaker resistance and inductance. These are assumed to be independent of frequency. Actually they will vary a great deal with frequency. This in actual practice will necessitate measuring these quantities at each frequency and using the measured values in the formulas.

Let:

r_p = plate impedance of the tube in ohms

r_1 = resistance of the primary coil in ohms

r_2 = resistance of the secondary coil in ohms

r = resistance of the speaker coil in ohms

L = inductance of the speaker in henries

L_1 = inductance of the primary coil in henries

L_2 = inductance of the secondary in henries

M = mutual inductance in henries

U = amplification factor of the tube

$W = 2 \times 3.14 \times \text{frequency in cycles per second}$

f = frequency in cycles per sec.

n = turn ratio of the transformer

I_1 = primary current

I_2 = secondary current

A = filament voltage in volts

B = plate voltage

C = grid bias in volts

E_g = a.c. voltage on the grid of the tube

$E = UE_g$

$j = \sqrt{-1}$

$L_e = L_2 + L$

$R_1 = r_1 + r_p$

$R_2 = r_2 + r$

$Z_1 = R_1 + j\omega L_1$

$Z_2 = R_2 + j\omega L_e$

The connection of the output transformer in the set is given in Fig. 1. Fig. 2 gives the equivalent circuit for alternating currents and voltages. The following currents were obtained by the use of Kirchoff's Laws.

$$E + j\omega MI_2 = Z_1 I_1 \quad (1)$$

$$j\omega MI_1 = Z_2 I_2 \quad (2)$$

On solving for I_1 and I_2 we get:

$$I_1 = \frac{EZ_2}{Z_1 Z_2 + W^2 M^2} \quad (3)$$

$$I_2 = \frac{j\omega ME}{Z_1 Z_2 + W^2 M^2} \quad (4)$$

$$I_2 = \frac{j\omega ME}{(R_1 + j\omega L_1)(R_2 + j\omega L_e) + W^2 M^2} \quad (5)$$

$$I_2 = \frac{j\omega ME}{R_1 R_2 - W^2 L_1 L_e + W^2 M^2 + j(R_1 \omega L_e + R_2 \omega L_1)} \quad (6)$$

$$I_2^2 = \frac{W^2 M^2 E^2}{(R_1 R_2 - W^2 L_1 L_e + W^2 M^2)^2 + (R_1 \omega L_e + R_2 \omega L_1)^2} \quad (7)$$

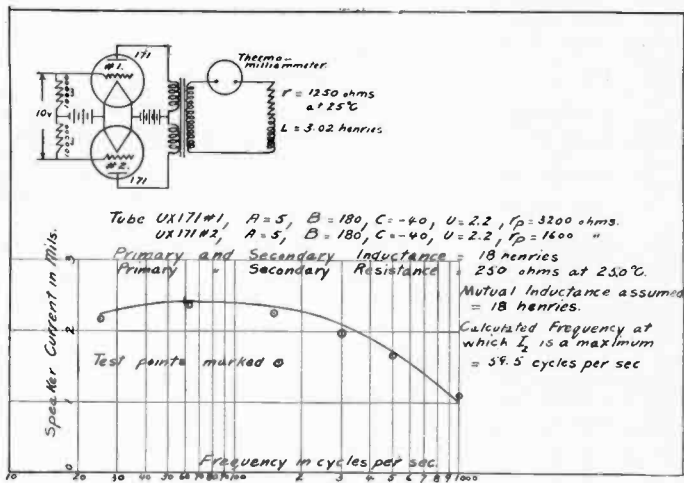

Fig. 4

The power input to the speaker will be a maximum when the current I_2 is a maximum, but I_2 is a maximum when I_2^2 is a maximum. Assume ω to vary while $R_1, R_2, L_1, L_2, L_e, M$ and E remain constant, then I_2 will be a maximum when

$$\frac{d}{d\omega} \left\{ \frac{W^2}{(R_1 R_2 - W^2 L_1 L_e + W^2 M^2)^2 + (R_1 \omega L_e + R_2 \omega L_1)^2} \right\} = 0 \quad (8)$$

From this we obtain:

$$W = \sqrt{\frac{R_1 R_2}{L_1 L_2 - M^2}} \tag{9}$$

Let $L_2 = n^2 L_1$ and $M = n L_1$ (10)

then

$$W = \sqrt{\frac{R_1 R_2}{L_1 L}}$$

This is the frequency at which the current in the speaker will be a maximum. It is independent of the turn ratio "n" but depends directly on the value of the primary inductance. When L_1 is infinite the transformer is perfect.

$$W = 0 \tag{11}$$

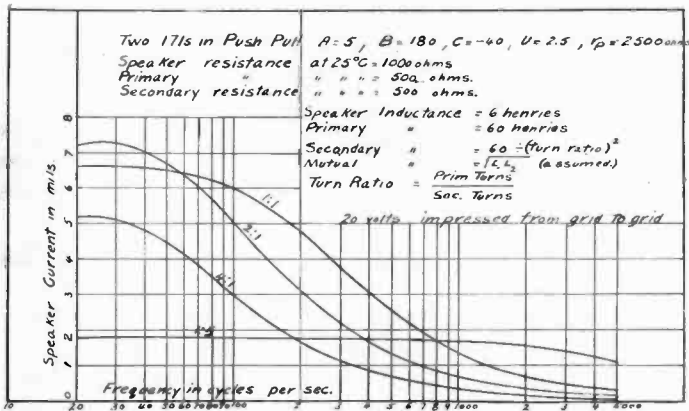

Fig. 5—Effect of Changing the Turn Ratio of the Output Transformer.

The current I_2 is limited only by the equivalent resistance of the system. Actually, at zero frequency the transformer will not function and I_2 will be zero. However, as long as the frequency is not zero the transformer will operate and a current will flow. This current will increase as the frequency is decreased until the limiting value as determined by the total equivalent resistance is reached. From then on the current will be constant.

When $L = 0$

$$W = \alpha \tag{12}$$

and the current is a maximum for all values of W that make $W L_1$ very large as compared with R_1 .

Assume $M = \sqrt{L_1 L_2} = nL_1$ and $L_2 = n^2 L_1$ in (7), which indicate that the coefficient of coupling between L_1 and L_2 is unity. The leakage inductance in a good transformer should be less than $\frac{1}{2}$ of 1 per cent. On making the above substitution in (7), we get:

$$I_2^2 = \frac{w^2 n^2 L^2 E^2}{(R_1 R_2 - w^2 L_1 L)^2 + (R_1 w L + R_1 w L_1 n^2 + R_2 w L_1)^2} \quad (13)$$

Assume n to vary while R_1 , R_2 , L_1 , w , L_1 , M , and E remain constant. Then I_2 is a maximum when

$$\frac{d}{dn} \left\{ \frac{n^2}{(R_1 R_2 - w^2 L_1 L)^2 + (R_1 w L + R_1 w L_1 n^2 + R_2 w L_1)^2} \right\} = 0 \quad (14)$$

On solving we get:

$$n^2 = \sqrt{1 + \frac{R_1^2}{w^2 L_1^2}} \times \sqrt{\frac{R_2^2 + w^2 L^2}{R_1^2}} \quad (15)$$

Equation (15) will give us the value of n for which the current I_2 is a maximum. Since in general n varies with w , each frequency will require a different turn ratio to give the maximum

input. When $L = 0$ and $\left(\frac{R_1}{w L_1}\right)^2$ is very much smaller than 1,

n^2 will be equal to R_2/R_1 and is then independent of frequency. In a properly designed transformer n^2 will be equal to the ratio of the secondary and primary impedances of the transformer. Therefore the impedance ratio of the transformer windings is equal to

$$\sqrt{1 + \frac{R_1^2}{w^2 L_1^2}} \times \sqrt{\frac{R_2^2 + w^2 L^2}{R_1^2}}$$

This ratio will depend on the value of the primary reactance as compared with the total resistance in the primary circuit.

When L_1 is very large, $1 + \frac{R_1^2}{w^2 L_1^2}$ becomes equal to one and

$$n^2 = \sqrt{\frac{R_2^2 + w^2 L^2}{R_1^2}} \quad (16)$$

This is the commonly used impedance ratio rule and it is generally stated as follows:

The current I_2 will be a maximum when the impedance ratio of the transformer windings is equal to the impedance of the secondary load divided by the plate impedance of the tube. This is incorrect unless the primary resistance of the transformer is added to the plate resistance and the secondary resistance is added to the load resistance. In any case this rule fails as soon as wL_1 begins to approach r_p in value. When this occurs (15) must be used to obtain the correct turn or impedance ratio.

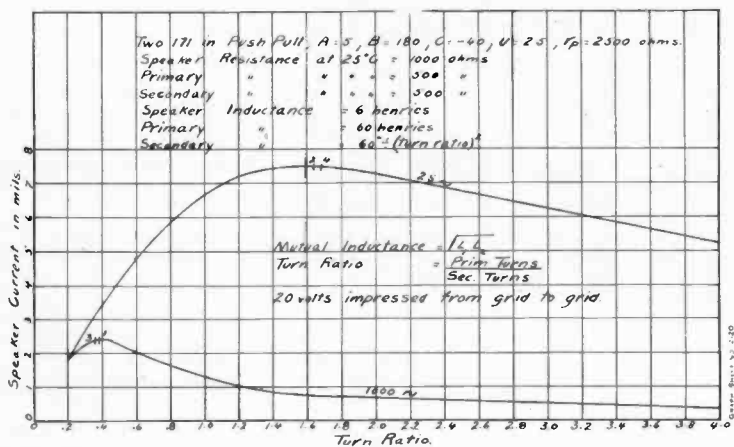

Fig. 6

In (13) assume L_1 to vary while w, n, E, R_1, R_2 and L remain constant. I_2 will be a maximum when

$$\frac{d}{dL_1} \left(\frac{L_1^2}{(R_1 R_2 - w^2 L_1 L)^2 + (R_1 w L + R_1 w L_1 n^2 + R_2 w L_1)^2} \right) = 0 \quad (17)$$

Solving we get

$$L_1 = -\frac{R_2^2}{w^2 n^2 L} - \frac{L}{n^2} \quad (18)$$

This means that the transformer primary inductance must have the properties of a condenser.

When $L=0$

$$L_1 = \alpha \quad (19)$$

When W^2L is very large as compared with R_2^2

$$L_1 = -\frac{L}{n^2} \quad (20)$$

To obtain this condition in practice would require a transformer with excessive self capacity in the primary and secondary coils, and this would lead to a cut-off of the higher frequencies.

To obtain an idea as to what values of capacity are required, assume $L=6$ henries and $n=1$, with $f=50$ cycles per second. Then $\omega L_1 = -6 \times 314 = -1880$ ohms. The capacity required to give this will be equal to $1.69 \mu\text{f}$. This would act as a short circuit for all frequencies above 500 cycles.

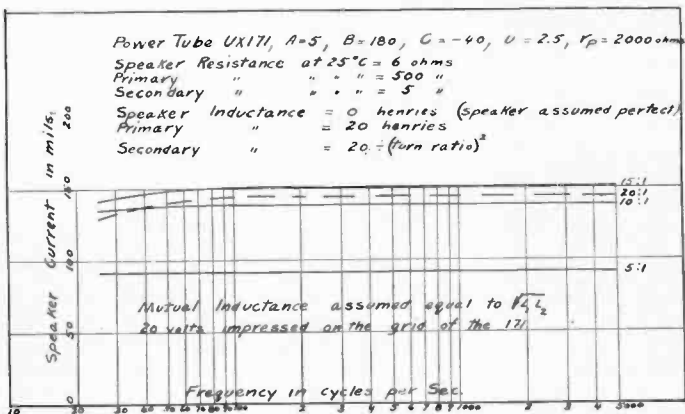

Fig. 7—Effect of Changing the Turn Ratio of the Output Transformer with Inertia-Controlled, Electro-Dynamic Cone Speakers.

The following curves have been plotted to show visually some of the results obtained in the mathematical part of the paper.

The curves in Figs. 3 and 4 give the results of tests made to check the basic formula for I_2 as given in equation (6). The test points are substantially in agreement with the calculated. The frequency for maximum I_2 as calculated by (10) is marked on the curves. As the curve is quite flat at these points it is rather difficult to pick out the frequency at which the current is a maximum. The leakage inductance of the transformer used in the tests of Fig. 3 was less than 0.0025 henries. In spite of the bad unbalance in the tubes used in the push-pull tests of Fig. 4, the calculated currents are a close approximation to the test results. The maxi-

imum error was less than 10 per cent. This test was made to determine the limits that must be set for the leakage inductance in a good transformer.

The remaining curves give calculated results only but the approximate tube conditions are marked on each curve.

Figs. 5 and 6 give the effect of varying the turn ratio for speakers of the ordinary exponential horn and cone types. It is easily seen from these curves why the power tube overloads so easily when amplifiers which bring in the low notes are used.

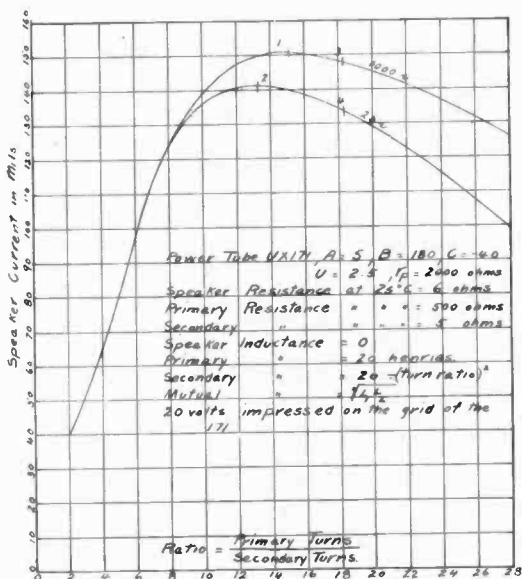

Fig. 8

For example, in the 1:1 ratio curve of Fig. 5 the current at 30 cycles is 4.9 times the current input at 1000 cycles. With the 2:1 ratio the current ratio for the same frequencies is 11:1. The ratio of the power at the lower frequencies can thus be changed within wide limits. But since the frequencies that give the sense of volume lie between 200 to 2500 cycles, it will be found that as the lower frequencies are increased the higher frequencies are decreased and the volume will fall off. These curves can be used to match the speaker to the tube. The speaker characteristic required for this is the current input required to give constant response from the speaker at the different frequencies. The average curve neglecting the pronounced resonant peaks must

be used. The transformer ratio which gives a current frequency characteristic similar in form to the speaker characteristic is the correct one to use. It is not usually possible to make the transformer correct the resonant peaks of the speaker. Special filter systems are usually required for this.

The curves in Fig. 6 give the speaker currents at 25 and 1000 cycles for different ratios. Points 1 and 2 give the turn ratio as calculated by (15), while points 3 and 4 give the turn ratio as calculated by the usual impedance ratio method. As L_1 is large, the two results are close, with (15) giving the correct result.

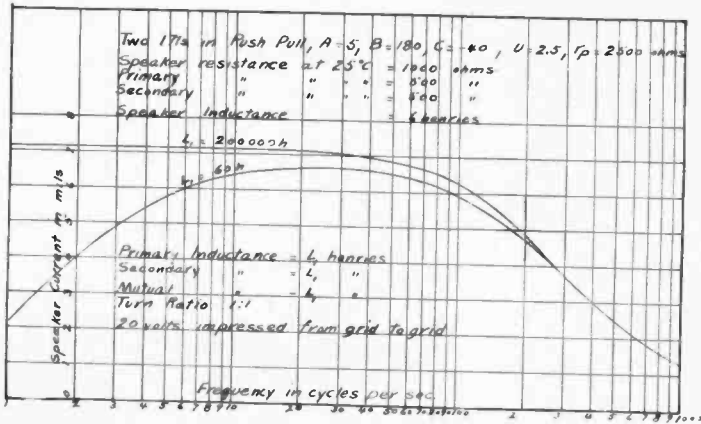

Fig. 9—Effect of Changing the Primary Inductance of the Output Transformer.

Figs. 7 and 8 give the results obtained with perfect speakers of the electro-dynamic cone type. These curves also show the need for power tubes when speakers of this type are used. The current frequency characteristic required for the perfect speaker of this type is a straight line with the current input independent of frequency.

Fig. 8 gives the turn ratio for maximum speaker current at 25 and 1000 cycles. The correct ratio to use with a perfect speaker will be 8. This will give a speaker current of 124 m/ls independent of frequency. Points 1 and 2 give the turn ratio as calculated by equation (15). Points 3 and 4 give the turn ratio as calculated by the impedance ratio method. The error in the impedance ratio method is greater in this case because ωL_1 is not very much greater than r_p and the secondary resistance of the transformer is almost equal to the speaker resistance. This

would be a very inefficient transformer. With this type of speaker the secondary resistance should be less than 1/10 of the speaker resistance.

The curves of Fig. 9 show the difference between a good transformer and a transformer with almost perfect primary inductance. The commercial product at 10 cycles is 90 per cent as efficient as the perfect transformer. At 30 cycles it is 94 per cent efficient.

The curves of Fig. 10 show the effect of the primary inductance on the turn ratio. For very low values of inductance

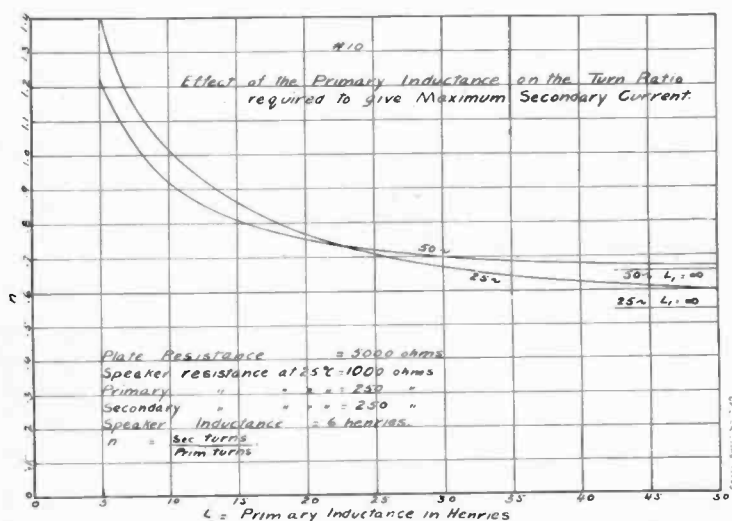

Fig. 10—Effect of the Primary Inductance on the Turn Ratio Required To Give Maximum Secondary Current.

the impedance ratio method may be as much as 100 per cent in error.

The curves of Fig. 11 show the effect of the leakage inductance of the transformer on the shape of the current frequency characteristic. The curve for M59 would correspond to a very poor commercial transformer. The curve marked M59, C-100 \times 10-12 farads shows the combined effect of the leakage inductance and the self capacity of the secondary coil. In general at the higher frequencies the self capacity tends to neutralize the effect of the leakage inductance.

In conclusion some idea should, perhaps, be given of the use of the developed formulas. Knowing the speaker characteristic,

the primary inductance is first chosen so as to make at least the maximum current occur at the lowest frequency desired. The turn ratio is then varied until the form of the speaker and the transformer current frequency characteristics are the same.

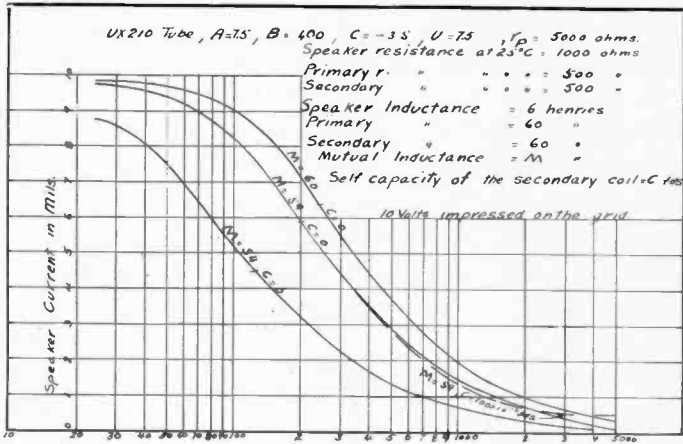

Fig. 11—Effect of Leakage Reactance on the Current in the Speaker.

It must be emphasized that the turn ratio has no effect on the frequency at which the current is a maximum. This will depend on the total resistances in the primary and secondary circuits and on the inductance of the primary and speaker.

CONCLUSION

Operating characteristics of output transformers used to protect the loudspeaker and to balance the power at various frequencies are developed in this paper.

The necessary conditions for maximum current in the speaker

are $\omega = \sqrt{\frac{R_1 R_2}{L_1 L}}$ with the frequency varying.

With the frequency constant, I_2 is a maximum when,

$$n^2 = \sqrt{1 + \frac{R_1^2}{w^2 L_1^2}} \times \sqrt{\frac{R_2^2 + w^2 L^2}{R_1^2}}$$

When wL_1 is very large this reduces to $\sqrt{\frac{R_2^2 + w^2 L^2}{R_1^2}}$

and this is known as the impedance ratio formula. Test and calculated curves are then given to show the effect of the primary inductance, turn ratio, leakage inductance and self capacity on the current-frequency characteristic of the transformer.

COOPERATION BETWEEN THE INSTITUTE OF RADIO ENGINEERS AND MANUFACTURERS' ASSOCIATIONS*

BY

ALFRED N. GOLDSMITH†

(Chief Broadcast Engineer, Radio Corporation of America, New York City)

IT is at once a real privilege and an unusual opportunity to address the Radio Division of the National Electrical Manufacturers' Association on the subject of cooperation between the Institute of Radio Engineers and the organizations representing radio manufacturers. In the early stages of the development of any new industry, and its corresponding division of technology, there is frequently little understanding or cooperation between the engineer and the industrial executive, or between the associations of which these two are members. Everyone is too busy dreaming, planning, developing, manufacturing, selling and servicing to have much time to consider effective methods of cooperation with members of the other group. As a result, industry proceeds for a while along comparatively disorderly lines, imperfectly controlled by sound engineering principles. And, on the other hand, the engineer (perhaps somewhat discouraged by an apparent lack of interest in what he can contribute to the development of the industry) is less effective in producing new ideas and having them commercially applied than would be the case under more favorable auspices.

Fortunately, radio has now reached a stage of development where the workers in that interesting field occasionally have a chance to "take stock" and to lay out broad plans for the systematic and effective development of their art by closer cooperation between the engineers and the industrial officials and executives.

I appreciate very much the invitation to address you on behalf of the Institute of Radio Engineers. At the risk of needless repetition (since I have no doubt that most of you are well-acquainted with the nature of the Institute and its activities) I will only say that it is a scientific society of international character, having as its object the advancement of the science and art of radio communication. It numbers among its 4500 mem-

* Original Manuscript Received by the Institute, June 18, 1928. Address before Annual Convention of Radio Division of the National Electrical Manufacturers' Association at Chicago, Ill., June 7, 1928.

† President of the Institute, 1928.

bers a large percentage of the leading engineers and workers in the world scattered from Singapore to Saskatchewan and from Paris to Portland. It encourages progress in radio engineering through the publication of engineering and scientific papers, through cooperation with other scientific societies, through the award of prizes for especially meritorious advances in radio, through standardization activities and in other ways. Its principal publication, the PROCEEDINGS of the Institute of Radio Engineers, has the distinction of having presented in its pages the original descriptions of many of the greatest radio advances of the last twenty years and of being a standard reference book to radio engineers and students alike. Its Board of Direction is continually cognizant of the importance of maintaining its reputation as a disinterested scientific body. In its activities it endeavors to function as an unbiased organization fostering the general interchange of sound engineering information.

In the United States, the Institute of Radio Engineers, with its headquarters in New York, has Sections in Atlanta, Boston, Buffalo, Chicago, Cleveland, the Connecticut Valley, Detroit, Los Angeles, New Orleans, Philadelphia, Pittsburgh, Rochester, San Francisco, Seattle, and Washington. There is a vigorously active Canadian Section with headquarters at Toronto.

It is the desire of the Board of Direction of the Institute that the facilities and capabilities of the Institute be fully utilized in friendly cooperation with manufacturing associations to the end that the radio art may be more rapidly advanced. My remarks today have been assembled with due regard to the viewpoints of the members of the Board of Direction of the Institute rather than as an original contribution. They have suggested many points in connection with the following four principal types of cooperation which the Institute of Radio Engineers can work out with the manufacturing associations.

I. MEETINGS OF THE INSTITUTE AS AN INFLUENCE IN THE TRAINING OF ENGINEERS

It is self-evident that prospective radio engineers gain a valuable type of training and education through attendance at Institute Meetings and through study of its publications. These young engineers are sooner or later employed by the member companies of manufacturing associations and any information

they have gained through listening at meetings of the Institute, through articles in the PROCEEDINGS, and through contact with other engineers at the meetings is an intangible but nevertheless real asset of the companies which employ them.

It is therefore a reciprocal responsibility of the member companies to permit the timely release of information on new radio methods and devices originating in their organization through the presentation of papers before the Institute of Radio Engineers since in this way the technical information of today becomes the capital of the engineers of tomorrow who, employed by the various manufacturing companies, will return in full measure the benefits of their training. Manufacturing associations should therefore encourage to the utmost the presentation of papers by their member companies on new radio equipment and method of operation.

II. MUTUAL INTEREST IN THE PUBLICATION OF CONTRIBUTIONS TO ENGINEERING KNOWLEDGE

As has already been intimated, most of the important radio advances during the last twenty years have been described in the PROCEEDINGS. The practicing engineers who have read these pioneer articles have benefitted from them and they have helped to keep the organization with which they were connected in the vanguard of progress.

The Institute prints and distributes a great deal of information of interest to manufacturers themselves in the PROCEEDINGS, in its Standards Hand Book, its Year Book, and its Index. It is expected that these activities will show a healthy and steady expansion and that the manufacturers and their engineers will be able to gain increasing practical benefit from the material in the Institute publications. Among the more recent interesting offshoots along these lines is the publication of features of general news interest together with the notes on the activities of the various sections and of individual members of the Institute.

The radio manufacturers have the duty and privilege of encouraging, even at the cost of time and money, the preparation of technical papers by their research and engineering staffs. The Institute has the duty of publishing this material and of thus making it available to the world. The issuance of the PROCEEDINGS on a monthly basis rather than bimonthly as formerly is of definite value in accomplishing this.

This Institute of Radio Engineers, in endeavoring to publish reputable and sound technical information from whatever source, is following a policy which must certainly have the support of the manufacturers' associations.

Responsible radio manufacturers have consistently avoided disclosures of supposedly marvelous but actually unproven developments in the radio field. They have shown by the truthful and conservative character of their publications descriptive of new equipment or methods that they appreciate the injurious effect upon public confidence of premature and exaggerated descriptions of trivial or inconsequential modifications of existing methods or equipment. The leading radio manufacturers of the United States have frowned upon every instance of technical journal or newspaper publicity which corresponds not to actual accomplishment in the field of service to the public or scientific and engineering advancement but to occasional, imperfect or doubtful results. The Institute of Radio Engineers is heartily in accord with this policy and may be depended upon to proceed on the basis of a similar code for publications.

III. MUTUAL INTEREST IN STANDARDIZATION

There is available to all the experience of the Institute of Radio Engineers in the formation of the language of radio. For nearly twenty years the Institute has been working at this task of formulating definitions of terms and the standardization of symbols, and has published one edition after another of its standards during the last fifteen years.

Quoting part from a publication of the Institute, I may say that during the course of 1927 there has been some discussion of the relation between the standardization work of the Institute of Radio Engineers and that of the associations of radio manufacturers. The chairman of the Institute Standardization Committee has had some correspondence with a number of persons interested in this question and has found that the following appears to meet with general acceptance as an expression of the relationship between the standardization work of these two groups. It is recognized, of course, that in this new field it is impossible at the present time to determine upon any hard and fast dividing line.

Institute of Radio Engineers:

- (1) Terms, definitions and symbols, and

(2) Methods of testing materials and apparatus in order to determine their important characteristics. This work may consist of purely advisory discussion as to convenient forms of tests, precautions to be taken, etc., or it may include standardization of definite test procedures to serve as a common basis of comparison of the properties of performance of material or apparatus.

Manufacturers' Groups:

(1) Standardization of size and characteristics of apparatus, to promote interchangeability of parts, either mechanical or electrical, and

(2) Setting of standard ratings for the properties or performance of material or apparatus.

While the above statement has never been formally adopted the general principles which it expresses are being followed by the several organizations concerned. Although the dividing line between the several fields of work cannot be rigidly drawn, it is believed nevertheless that the above classification will help in guiding the efforts of the committees which are working on various aspects of radio standardization.

As has been indicated above, the Institute is active in the formulation of methods of testing materials and equipment. The importance of such an activity to the manufacturer is obvious. Success and progress depend upon a definite knowledge of the performance of the raw materials which go into apparatus or equipment as well as the performance of the finished article. In developing technically correct and readily usable standard test methods, the Institute of Radio Engineers is helping the manufacturers' associations. The manufacturers, on the other hand, can reciprocate by adopting as standard the test methods developed by the Institute in relation to radio apparatus and circuits. In doing this, the manufacturers can adopt any limits or tolerances required for a particular product or particular performance using the Institute test methods.

It should be added that the Institute of Radio Engineers and the American Institute of Electrical Engineers are the sponsor bodies of the Sectional Committee on Radio organized according to the procedure of the American Engineering Standards Committee and that the Sectional Committee is entrusted with the task of recommending the final American standards to the American Engineering Standards Committee. There are therefore no

organization difficulties in the way of as large a measure of radio standardization as is consistent with the growth and development of the art.

IV. MUTUAL INTEREST IN TECHNICAL PROBLEMS OF RADIO REGULATION

The Institute stands ready, through the appointment of committees, or by otherwise utilizing its facilities, to cooperate in the study of various technical problems of general interest to its membership. For example, the Institute of Radio Engineers sent representatives to the several National Radio Conferences held at the call of the Department of Commerce in Washington. These representatives participated in the formulation of the recommendations which, informally adopted as guides by the Department of Commerce in the administration of the law, were markedly instrumental in the rapid development of the radio art. It is believed that one of the most important fields for cooperation between the Institute and other parts of the radio industry is in the technical aspects of radio regulation. The study and formulation of the requirements which must be met in the allocation of frequencies to stations and services are of fundamental importance if interference is to be kept at a minimum in the crowded radio spectrum.

The problem of securing a maximum of radio service with minimum of interference but without excessive cost is a matter of mutual interest to engineers, manufacturers, operating agencies, and the public. While the public does not, of course, care so much about the mechanism as it cares for satisfactory reception and radio service generally, the other agencies are interested in the various elements which contribute to the correct solution of this sort of a problem.

It is clear that it is generally advantageous for the Federal regulatory body entrusted with the enforcing of the law to consult with the manufacturers and the radio engineers before reaching definite conclusions. It is therefore important that the manufacturers and the engineer shall cooperate to the end that sound engineering principles may be supplemented by full knowledge of the conditions of the industry and that feasible recommendations shall emanate from both the manufacturing and engineers' groups.

An instance of this sort occurred recently. The Federal Radio

Commission, as you know, in its effort to disentangle the threads of radio broadcasting allocation, invited the Institute of Radio Engineers, the broadcasters, the manufacturers' associations and others to present their suggestions as to a concrete plan for the betterment of broadcasting service to the public, to be consistent with the existing law. It is greatly to be hoped that with the constructive cooperation of the entire industry, the Commission will be able to work out a solution, which is at the same time practical and based on sound technical considerations.

The Institute has furnished information to the Federal Radio Commission on other matters, from time to time, and it desires the closest possible contact with the manufacturers' association to the end that the information which it furnishes shall be not only scientifically correct but economically feasible and capable of ready application. If the manufacturers' associations will appoint representative committees to consider matters involving Federal radio regulation with corresponding committees of the Institute there can be no doubt that there will be much wisdom in the combined recommendations.

Some additional concrete recommendations which I should like to make are that members of manufacturers' associations should become members of the Institute of Radio Engineers, that they should place the publications of the Institute before their employees, and that they should look to the publications of the Institute of Radio Engineers for some assistance in the solution of the problems which confront them, and that they should encourage their employees to become active members of the Institute committees. The manufacturers' associations will do well to remember that what they sell to the public is nothing more than a mixture of raw materials and engineers' brains.

One final important aspect of the relationship between manufacturers' associations representing the radio industry and the Institute of Radio Engineers is its ever-continuing nature. Problems once tentatively solved immediately arise again with new aspects and with new interests injected into them. Cooperation is not a thing of today and tomorrow, it is an unending task, a fundamental need, and a provider of rich rewards both in public esteem and commercial success.

NOTES ON QUARTZ PLATES, AIR GAP EFFECT, AND AUDIO-FREQUENCY GENERATION*

By

AUGUST HUND

(Bureau of Standards, Washington, D. C.)

Summary—Experiments on the frequency of piezo-electric elements are described with special reference to the effect due to supersonic sound waves generated in the air gap of the holder and due to its capacity. It is shown that a mechanical load on the crystal increases its thickness frequency and that an air gap has a similar effect. The velocity of the supersonic sound waves is about the same as for ordinary sound waves. The value found is 338.68 meters per second at 24.5C deg. An appropriate air gap gives even more high-frequency output than a mechanically-loaded crystal and procures a steady frequency operation. Two sputtered piezo-electric elements can produce a beat frequency which is correct within a few parts in 100,000. A method is shown by means of which a low-frequency standard can be obtained by harmonic division of a high frequency due to piezo-electric element.

ANYONE experimenting with piezo-electric plates will notice that the temperature, the load in the anode branch, and the holder of the piezo-electric element affect somewhat the frequency of the output current.

The effect is very pronounced when the beat frequency of two vibrating crystals is to be taken as a standard since the percentage error in the beat frequency is larger in the ratio

$$\frac{\text{average value of the two high frequencies}}{\text{beat frequency}}$$

than the percentage error in any one of the two high frequencies.

The temperature effect can be checked by a suitable thermostatic control and the circuit effect by using a fixed anode load.



Fig. 1—Piezo-Electric Element and Its Electrodes.

The holder effect which is the subject of this discussion is twofold: One being due to the supersonic sound waves displaying

* Original Manuscript Received by the Institute, May 15, 1928. Presented before meeting of the American Section of the International Union of Scientific Radiotelegraphy April 19, 1928. Publication Approved by the Director of the Bureau of Standards of the U. S. Department of Commerce.

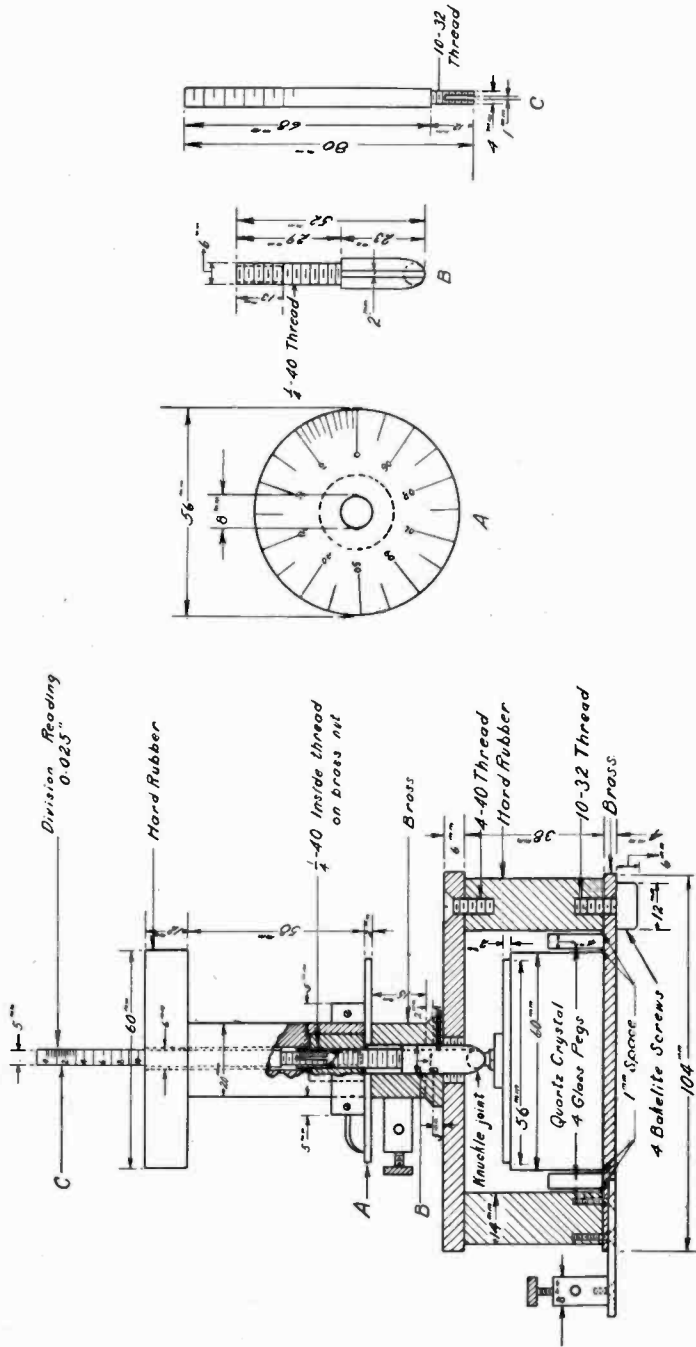

Fig. 2—Piezo-Electric Crystal Holder with Micrometer Adjustment.

themselves between the two reflecting walls A-A and B-B (Fig. 1) and the other due to the capacity of the crystal holder. The first one can be avoided by putting the holder with the piezo-electric element under a vacuum and the other can be kept fixed by using metal coated crystals. When a contact brush is used as the upper electrode and the crystal rests on a metal plate, operation can be obtained which gives beat frequencies accurate to a few parts in a hundred thousand. It will be found advantageous to work the two high-frequency currents into a shielded grid tube so that the back action of the load is practically avoided.

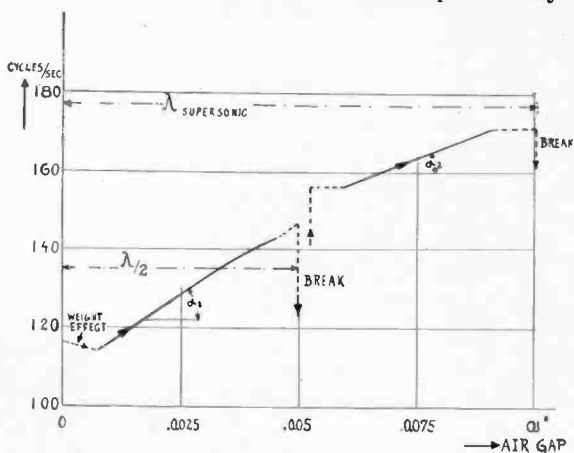

Fig. 3—Frequency Change with Air Gap.

In the course of this study the following was observed: The true crystal frequency is never used. It is either

- (a) "the metallized crystal" frequency (crystal-coated with two metal layers), or
- (b) the "crystal-crystal holder" frequency, or
- (c) the latter partly affected by the load at a certain temperature.

Putting a mechanical load such as the metal electrode on the piezo-electric element increases its frequency, removing the electrode very gradually produces for a moment the true crystal frequency, while a very small air gap gives again a somewhat higher frequency. Fig. 2 indicates one of the plate holders with which the above effects were studied.

Fig. 3 verifies some of the above statements. For this case two large disk crystals were excited in the thickness vibration (frequency about 130 kc per second) and the output branches

coupled to a common coil which had a rectifier in the circuit. The ordinates give the beat frequency and the abscissas the air-gap distance in inches.

It is seen that with the upper electrode just resting on the piezo-electric element the frequency is about 118 cycles per second. It drops then to a value of about 116 cycles per second and ascends again as indicated. The oscillation suddenly stops since the condition for one-half wavelength of the supersonic sound wave exists, and from the $\lambda/2$ as well as from the λ con-

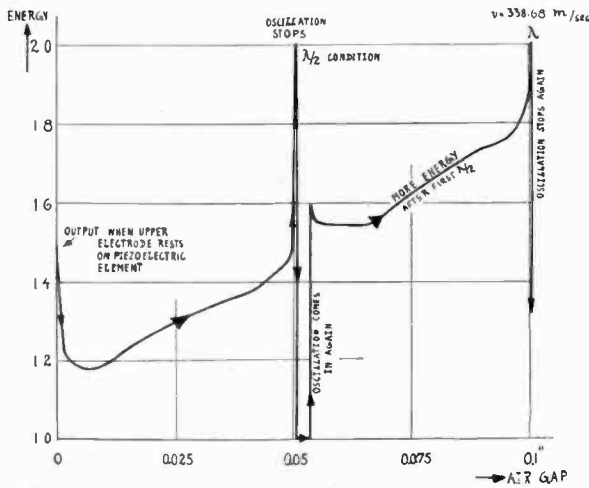

Fig. 4—Energy Curve with Respect to the Air Gap.

dition, the sound velocity in the gap is found as $v = 0.258064 \times 131240 = 338.68$ meters per second at 24.5 deg. C. This shows that the velocity of supersonic sound waves is about the same as found for audible sounds as was also found by G. W. Pierce.¹

After the $\lambda/2$ condition the oscillation starts in again and proceeds along a slope α_2 somewhat different than before. Many other crystals show about the same behavior.

Fig. 3 indicates that it is not wise to work with such a small air gap that the upper electrode nearly touches the piezo-electric element or with a gap distance very close to $\lambda/2$, λ , $3/2\lambda$, etc., of the supersonic sound wave. This is also shown by the curves of Fig. 4 where the ordinates stand for the energy output and the abscissas for the air gap. A very good position seems to be that which provides an air gap of $3/4$ of the super-

¹ Proc. American Acad. of Science, 10, 271; 1925.

sonic sound waves. Fig. 4 is a typical example of many tests of this kind.

The settings with an air gap are no doubt of value for high-frequency work while the metal sputtered piezo-electric elements seem at the present time most promising for low-frequency work.

When, therefore, a metal-coated piezo-electric element is used the accuracy of the high frequency must be very great, and a subharmonic in the audio-frequency range should give an audio-frequency standard which is just as accurate as the high

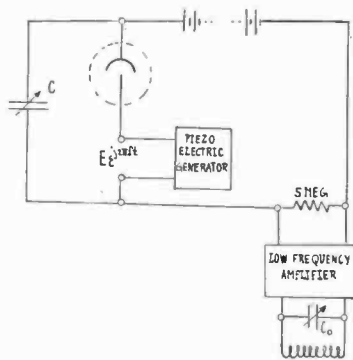

Fig. 5—Stepping Down of the Frequency of a Piezo-Electric Element.

frequency. One of the best-methods of producing subharmonics is indicated in Van der Pol's paper on Relaxation Oscillations.² Applying such oscillations to our case suggests the new method for piezo-electric frequency standardization as indicated in Fig. 5. The voltage $E e^{j2\pi f t}$ is taken from a piezo-electric oscillator utilizing sputtered metal electrodes. The condenser C is varied and the output will produce audio-frequency currents which are sub-multiples of the high-frequency voltage $E e^{j\omega t}$ applied to the gas discharge system. Only frequencies which are submultiples will be given off at the output end. As the condenser C is varied the tones observed in the output branch will vary in steps producing the frequencies $f, f/2, f/3, f/4$, etc. The system will work just as well when the terminals for $E e^{j\omega t}$ are short-circuited and the emf due to the piezo-electric element is applied across the condenser C . A multivibrator and other arrangements using relaxation oscillations whose period is roughly given by $T = \pi/2 \cdot CR$ can also be used for frequency division.

² Z. f. Hochfrequenztechnik, Dec. 1926, 178-187; April, 1927, 114-118.

NOTES ON APERIODIC AMPLIFICATION AND APPLICATION TO THE STUDY OF ATMOSPHERICS*

By

AUGUST HUND

(Bureau of Standards, Washington, D. C.)

Summary—It is shown that ordinary amplifiers cannot produce true repeater action when aperiodic transients are impressed on the system. The output current can, however, be interpreted in terms of the coupling. For true aperiodic amplification the time constants have to be chosen such that the system gives true repeater action. An aperiodic amplifier using space-charge tubes is shown.

THAT a certain type of an amplifier produces harmonic output currents for harmonic voltages of the same frequency is by no means a proof that the system would give correct repeater action in all cases, as, for instance, when aperiodic discharges, study of atmospherics and the like are to be investigated with respect to their shape.

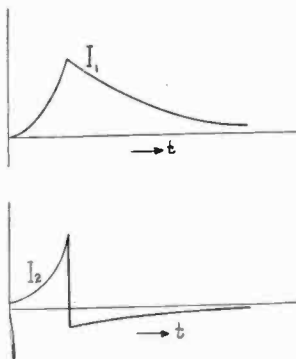

Fig. 1—Current-Time Curves.

A transformer-coupled amplifier produces, for instance, a voltage variation in each succeeding stage which depends on the time derivative of the current flowing in the primary of the transformer while for a condenser coupling the time integral of the current causes a change of the shape of an aperiodic transient. When sinusoidal variations are amplified the wave

* Original Manuscript Received by the Institute, May 15, 1928. Presented before meeting of the American Section of the International Union of Scientific Radiotelegraphy, April 19, 1928. Publication Approved by the Director of the Bureau of Standards of the U. S. Department of Commerce.

shape remains the same since only a phase shift (of 90 degrees for no losses) takes place and the output current such as noted with a suitable oscillograph will give a picture of the true display.

Fig. 1 gives a characteristic aperiodic curve I_1 , as atmospherics have sometimes been shown in the literature while the I_2 curve is the time derivative of it to some arbitrary scale. The upper curve can therefore also be looked upon as being due to the time integral of the I_2 curve.

It is therefore evident that the shape of the output current has to be interpreted when such effects occur either along an amplifier or are due to a coupling to an oscillograph.

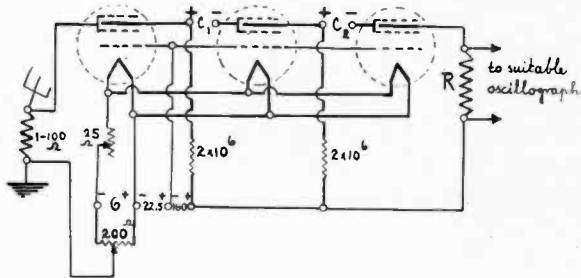

Fig. 2—Aperiodic Amplifier.

There are several means for preserving the original shape of the transient. One method is to use such time constants that almost true repeater amplification prevails, and no noticeable change in the shape occurs. Another means is to use a straight resistance-coupled amplifier such as is shown in Fig. 2, where UX-222 tubes or their equivalent are used in the space charge connection. In many cases two stages of amplification are sufficient. When an ordinary oscillograph is used a UX-210 or its equivalent may be employed in the last stage.

EFFECT OF THE ANTENNA IN TUNING RADIO RECEIVERS AND METHODS OF COMPENSATING FOR IT*

BY

SYLVAN HARRIS

(Engineering Laboratory, Brandes Products Corp., Newark, N. J.)

Summary—The reflected effect of the primary circuit of a resonance transformer, or of the antenna circuit of a radio receiver, upon the secondary coupled to it, is discussed. Equations are given for determining the apparent change of inductance in the secondary and methods of compensating for these changes are given.

IT is a common practice in designing radio receivers to make the inductance of the antenna or input circuit so small that the resonance frequency of that circuit is higher than any frequency to which the receiver is to be tuned. Moreover, the mutual inductance of the input coupling transformer is kept small, so that the effect of the primary (antenna) circuit upon the tuning conditions of the secondary circuit coupled to it is as small as possible. By so doing, it becomes possible to build radio receivers in which the circuits of the cascade amplifier can be tuned in unison by a master control.

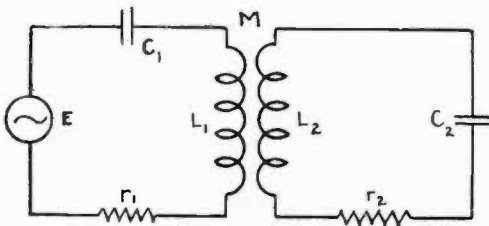

Fig. 1

It is clear, however that much of the ability of the amplifier to absorb power from the antenna circuit is lost; besides, there is always sufficient coupling between the circuits to cause detuning of the first stage. The detuning effect is more marked the higher the frequency, and would be very considerable at or near the resonance frequency of the primary or antenna circuit.

It is the purpose of this paper to study the effects of the antenna circuit upon the secondary circuit, to derive equations whereby these effects may be calculated, and to present several

* Original Manuscript Received by the Institute, April 24, 1928.

methods of compensating for these effects. The theory employed applies rigidly to the resonance transformer circuit of Fig. 1, and also applies to an antenna coupling system insofar as the antenna may be regarded as equivalent to a lumped inductance in series with a lumped capacity. The discrepancy, however, is small enough to neglect for all ordinary purposes, especially since any errors which might arise are mitigated by the variable nature of the compensators to be described. For simplicity, therefore, the discussion will be centered around the circuits of Fig. 1.

APPARENT CHANGE OF INDUCTANCE

Since, in the circuits usually employed all the tuning is done by adjustments of the secondary constants, maximum current is obtained in the secondary circuit when the following relation exists:

$$\frac{x_2}{x_1} = \frac{\omega^2 M^2}{z_1^2} \quad (1)$$

This relation is termed by Pierce¹ "Partial Resonance Relation *S*," and may be written in the form

$$\begin{aligned} \frac{1}{\omega C_2} &= \omega \left[L_2 - \frac{\omega M^2}{z_1^2} x_1 \right] \\ &= \omega [L_2 - \Delta L_2] \\ &= \omega L_a \end{aligned} \quad (2)$$

Eq. (2) indicates that the apparent secondary inductance L_a differs from the true inductance L_2 by the amount ΔL_2 , and whether it is greater or smaller than the true value depends upon the sign of x_1 . The complete expression is

$$\Delta L_2 = \frac{\omega M^2 \left(\omega L_1 - \frac{1}{\omega C_1} \right)}{r_1^2 + \left(\omega L_1 - \frac{1}{\omega C_1} \right)^2} \quad (3)$$

The apparent secondary inductance may be expressed as

$$\begin{aligned} L_a &= L_2 - \Delta L_2 \\ &= L_2 \left[1 - \frac{\omega M^2}{L_2 z_1^2} x_1 \right] \\ &= L_2 [1 - K^2] \end{aligned} \quad (4)$$

¹ "Electric Oscillations and Electric Waves," G. W. Pierce, p. 162.

in which K is a quantity which might be termed the "apparent coefficient of coupling between the circuits," and is defined as

$$K^2 = \frac{\omega M^2}{L_2 Z_1^2} x_1 \tag{5}$$

It will be noted that K^2 can be positive or negative, depending on the algebraic sign of x_1 , whence it might appear that K would be imaginary when $\omega^2 > \frac{1}{L_1 C_1}$, or when x_1 is negative. This ambiguity arises from the arbitrary definition of K^2 , and the alge-

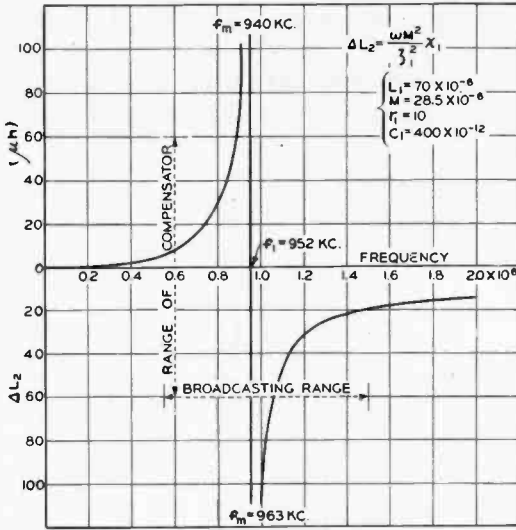

Fig. 2—Curves of Secondary Inductance Coil Variation.

braic sign of K should be considered as merely indicating the sense of the effects produced on the secondary. When $\omega^2 > \frac{1}{L_1 C_1}$, K^2 is positive, and $L_a > L_2$; and when K^2 is negative $\omega^2 < \frac{1}{L_1 C_1}$, and $L_a < L_2$.

The quantity K^2 has been so defined in order to be consistent with the definition of the ordinary coefficient of coupling, viz.,

$$k^2 = \frac{M^2}{L_1 L_2} \tag{6}$$

Thus, when $r_1 = 0$ and there is no condenser in the primary circuit ($C_1 = \infty$) or, when the frequency is very much higher than the resonance frequency of the primary, expression (5) reduces to expression (6), or K^2 becomes equal to k^2 . On account of this arbitrary definition, therefore, K can be given the same sign as K^2 , the negative sign being disregarded when extracting the square-root.

From Eqs. (4) and (5) it follows that

$$\Delta L_2 = K^2 L_2 \quad (7)$$

K and ΔL_2 are zero when $\omega = 0$ and when $\omega = \frac{1}{L_1 C_1}$. At very high frequencies K approaches $k = \frac{M}{\sqrt{L_1 L_2}}$ and ΔL_2 approaches $\frac{M^2}{L_1}$.

The frequencies at which K and ΔL_2 are greatest are obtained by differentiating with respect to ω and equating to zero. A quadratic is obtained:

$$\left[\omega L_1 - \frac{1}{\omega C_1} \right]^2 \left[L_1 + \frac{1}{\omega^2 C_1} \right] = \left[r_1^2 + \left(\omega L_1 - \frac{1}{\omega C_1} \right)^2 \right] L_1$$

The solution gives

$$\omega_m^2 = \frac{1 \pm r_1 \sqrt{\frac{C_1}{L_1}}}{L_1 C_1 - r_1^2 C_1^2} \quad (8)$$

In practice $r_1^2 C_1^2$ is generally $\ll L_1 C_1$. Therefore

$$\omega_m^2 = \pm \frac{r_1}{L_1} \omega_1 - \omega_1^2 \quad (9)$$

$$f_m^2 = \pm \frac{r_1}{2\pi L_1} f_1 - f_1^2 \text{ (approx.)}$$

Here again an ambiguity may arrive in respect to the algebraic sign of ω_m^2 . The sign of ω_m^2 , however, is again to be taken as merely signifying whether ω_m is $>$ or $<$ ω_1 . As an example, for the values given in Fig. 3

$$f_1 = 952,000 \text{ cycles per second}$$

$$f_m = 940,000 \text{ and } 963,000 \text{ cycles per second.}$$

A calculated curve showing the variation of ΔL_2 with frequency is shown in Fig. 2, for the values indicated.

Eqs. 2 and 4 suggest a means of easily measuring K . Suppose in Fig. 1 a voltage E at a given frequency is imposed upon the primary circuit, and C_2 is adjusted for maximum secondary current. Partial Resonance Relation S then obtains, and

$$C_2 = \frac{1}{\omega^2 L_a} = \frac{1}{\omega^2 L_2 (1 - K^2)}$$

If now the primary circuit be broken, and the generator be inserted in the secondary circuit, the frequency being unchanged, a new setting of C_2 will be required to produce resonance, viz:

$$C_2' = \frac{1}{\omega^2 L_2}$$

The ratio of C_2 to C_2' results in

$$K^2 = 1 - \frac{C_2'}{C_2}$$

As mentioned before, when there is no condenser in the primary this procedure gives the ordinary coefficient of coupling directly.

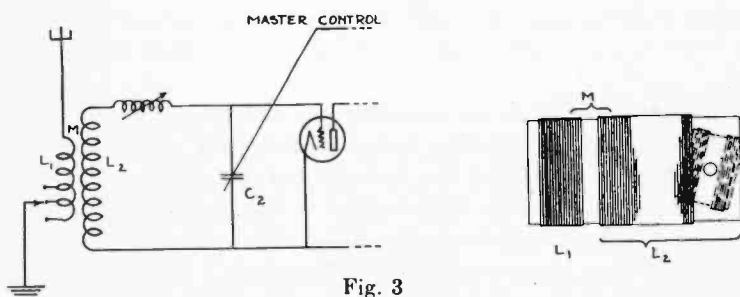

Fig. 3

The actual procedure employed is simple. The transformer is coupled loosely to an oscillator and a current indicator is placed in the secondary. Adjustment of C_2 for maximum indication of the meter furnishes C_2 . The primary circuit is then opened and a readjustment of the condenser furnishes C_2' .

In radio receivers employing a master control, in which all of the variable tuning condensers are identical, in order that all the tuned circuits may be in resonance, it is necessary that all the secondary inductances be identical.

In all but the first stage, which is coupled to the antenna, the apparent secondary inductance does not vary appreciably with

frequency in ordinary practice, on account of the high resistance in the primary circuits (the r_p of the tube to which it is connected), and it is practically equal to the inductance of the secondary alone.

The first stage, however, is subject to variation, due to the primary load. Such a variation for a circuit of the given constants is shown by Fig. 2. The apparent secondary inductance is greater or less than the true secondary inductance by the amount ΔL_2 . In order to tune exactly, it should at all times have the same value as the apparent secondary inductance of the other stages of the receiver.

In order to compensate for this apparent variation of inductance, it must be possible to change L_2 in the same amount as ΔL_2 but in the opposite sense. By doing so, L_a will be kept constant, and the first stage will be in resonance as well as the other stages of the receiver.

Fig. 3 indicates how this may be done. When the field of the rotor, on which is wound part of the secondary winding, is perpendicular to the field of the stator, the total secondary inductance L_2 is the same as the secondary inductances in the other stages. On turning the rotor, L_2 may be increased or decreased in order to compensate for the change of secondary inductance, ΔL_2 .

The range of such an experimental variometer was about 60 microhenries; its operating range is indicated on Fig. 2. The curves of Fig. 4 indicate the operation of the compensator when installed in a receiver, the values C_1 indicating the antenna capacity. Three taps were provided on the primary winding, numbered 1, 2, and 3 in Fig. 4. Tap No. 3 included the full winding, and tap No. 1 the smallest section. The heavy black lines in Fig. 4 indicate the tuning range of frequency for tap No. 3.

The curves are essentially flat excepting when tuning at frequencies at or close to the resonance frequency of the primary circuit. It is, therefore, necessary to rotate the variometer only a very slight amount while tuning from one frequency to another with the master control, excepting when operating with a large antenna on tap No. 3. The gaps in the black lines indicate regions of indefinite tuning.

It will be noted in Fig. 3 that the variable part of the secondary winding has been placed at the end of the coil away

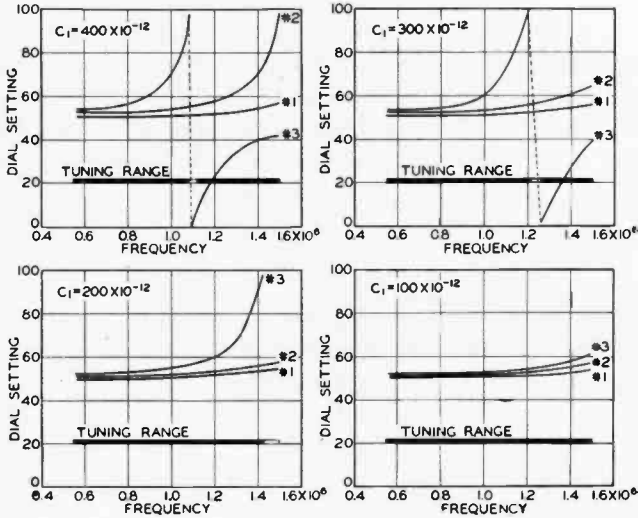

Fig. 4—Tuning Curves of Variometer.

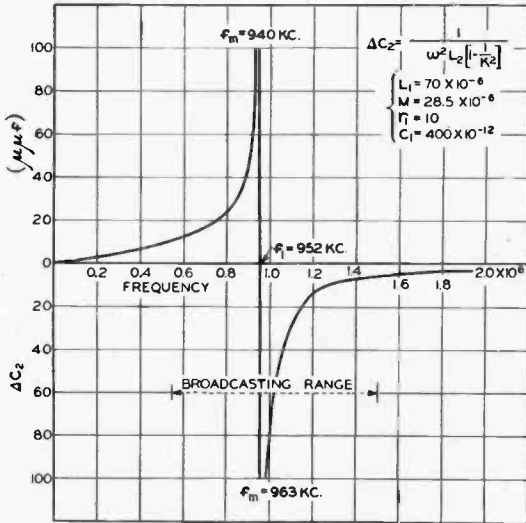

Fig. 5—Curves of Secondary Capacity Variation.

from the primary winding. This has been done to prevent, as far as possible, any increase of mutual inductance between the primary and secondary windings as the rotor is turned. An increase in the value of M as the rotor is turned to compensate for ΔL_2 would make ΔL_2 still greater and aggravate conditions, especially when operating near the resonance frequency of the primary. For the construction used M varied hardly more than a few microhenries, throughout the 180 degrees rotation of the variometer.

APPARENT CHANGE OF CAPACITY

If, instead of compensating for the effect of the primary by varying the inductance of the secondary, it is desired to do so by varying the capacity, (1) may be written

$$\begin{aligned} \omega L_2 &= \frac{1}{\omega C_2} + \frac{\omega^2 M^2}{z_1^2} x_1 \\ &= \frac{1}{\omega \left[\frac{C_2}{1 + \omega^2 L_2 C_2 K^2} \right]} = \frac{1}{\omega [C_2 + \Delta C_2]} = \frac{1}{\omega C_a} \end{aligned} \quad (10)$$

Combining these equations and putting ΔL_2 for $L_2 K^2$ (Eq. 5) and $\frac{1}{L_a}$ for $\omega^2 C_2$;

$$\frac{\Delta C_2}{C_2} = - \frac{\Delta L_2}{L_2} \quad (11)$$

But $C_2 = \frac{1}{\omega^2 L_a}$. Therefore

$$\Delta C_2 = - \frac{1}{\omega^2 L_2 \left[\frac{L_2}{\Delta L_2} - 1 \right]} = + \frac{1}{\omega^2 L_2 \left[1 - \frac{1}{K^2} \right]} \quad (12)$$

Values of ΔC_2 are shown plotted in Fig. 5. The circuit arrangement is shown in Fig. 6.

A method of compensating for ΔC_2 is to arrange the tuning condenser of the input stage of the receiver so that while the rotor is turned by the same shaft that turns the rotors of the condensers in the other stages, the stator can be rotated by means of an individual control. The angle through which the stator must

rotate is determined by the variation of ΔC_2 at and near the primary circuit resonance.

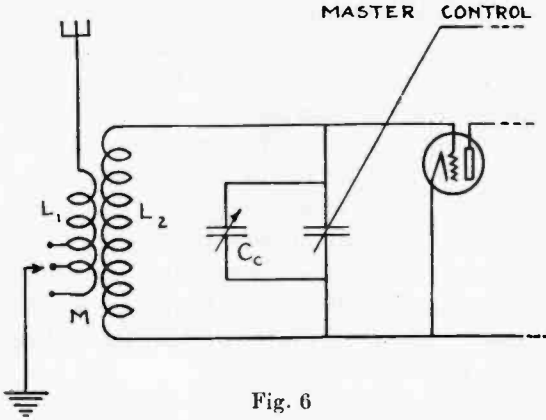

Fig. 6

A simpler means is to use a variable condenser operated by an individual control and connected in parallel with the main tuning condenser of the first stage. Since the compensating condenser is connected in parallel with the main tuning condenser of the first

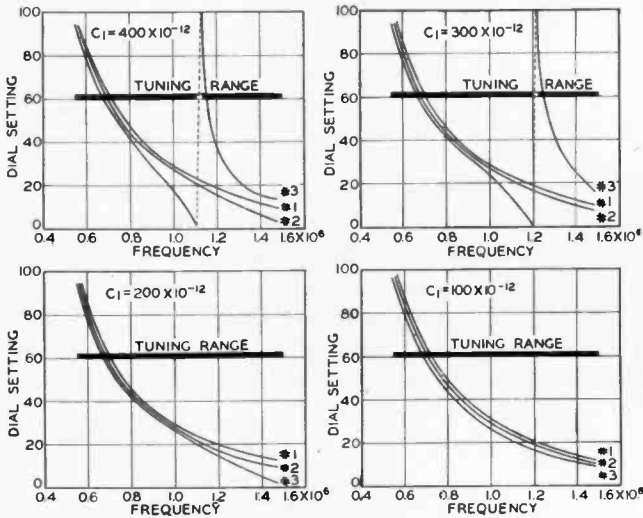

Fig. 7—Tuning Curves of Condenser.

stage, and C_a of this stage must be the same as the capacity in the other stages, the main tuning condenser of the first stage must be smaller than those of the other stages. For example, when the

compensating condenser is set at its maximum, the total capacity must be the same as the maximum capacity in the other stages plus whatever is required to compensate for a given antenna load. Then the total capacity in the first stage at any frequency can be made greater or less than the capacity in the other stages at that frequency in an amount sufficient to compensate for the effect of the primary. The steepness of the curves of Fig. 7 is due to the fact that the capacity of the main condenser has been decreased, and consequently the additional condenser performs the two functions of assisting the main condenser in tuning and of compensating for the antenna load simultaneously. This, however, causes no difficulty in tuning, although of course the flatter curves obtained with the variometer and the rotating stator are more desirable.

For this case let

C_2 = capacity of the tuning condenser in the second or third stage of the receiver.

mC_2 = capacity of main tuning condenser of the first stage

C_c = capacity of compensating condenser

Then

$$C_c = C_2(1 - m) + C_2 \quad (13)$$

$$= \frac{1}{\omega^2 L_2 \left[\frac{1}{1 - m} \right]} + \frac{1}{\omega^2 L_2 \left[1 - \frac{1}{K^2} \right]} \quad (14)$$

The first term of the right hand member of (14) is the difference of capacity between C_2 of the other stages and the capacity of the main tuning condenser of the first stage. The second term is the capacity required to compensate for the antenna load. Operating curves for such an arrangement are shown in Fig. 7, the heavy black lines indicating the tuning range for tap No. 3 and the gaps in these lines indicating the regions of indefinite tuning.

THE CAUSE AND PREVENTION OF HUM IN RECEIVING TUBES EMPLOYING ALTERNATING CURRENT DIRECT ON THE FILAMENT*

BY
W. J. KIMMELL

(Research Laboratory, Westinghouse Electric and Manufacturing Co., East Pittsburgh, Pa.)

Summary—The various factors affecting the variation of plate current of a receiving tube when the filament is heated with a.c. are analyzed, and their composite effect considered. The variation in temperature of the filament is found to be of minor importance while the predominant factor is the voltage drop along the cathode. The smallest variation in I_p is obtained from a tube having a properly designed V-shaped oxide filament. When straight filaments are used, their characteristics should be so chosen that the magnetic and electrostatic effects are neutralized.

THE direct heating of the cathode of a thermionic tube by alternating instead of direct current is generally attended by a variation in plate current having a fundamental frequency which is twice that of the a.c. supply. When a so-called a.c. tube is used for the reception of radio signals, this variation in plate current gives rise to an objectionable hum in the sound output device. The design of a tube for this service necessarily entails a unique filament construction in which the main consideration is to minimize the influence of the factors tending to produce the hum. The purpose of this paper is to segregate these factors and to indicate in a qualitative manner their importance in affecting the magnitude of the composite hum. A rigorous treatment of the problem has not been attempted, it being desired to show only the order of magnitude of the quantities involved.

A careful analysis has revealed the following possible sources of hum:

- (1) Temperature variation of the filament due to the sinusoidal power supply resulting in a variation in plate current.
- (2) Variation in plate current due to the voltage drop along the filament.
- (3) Variation of plate current due to the effect of the magnetic field of the alternating current.

In addition, there are possibilities of hum resulting from an emf induced in the metallic parts of the tube structure by the

* Original Manuscript Received by the Institute, March 7, 1928.
Revised Manuscript Received May 29, 1928.

filament heating current. However, in dealing with this detail it was impossible to detect any effect originating from this source in a.c. tubes so designed as to obtain the optimum relation among the three previously mentioned factors such as in the Radiotron UX-226. Promiscuously arranged wiring in the associated tube circuits may also result in induced currents which increase the hum.

In the treatment of the main causes of hum, each has been taken up separately and considered as though it alone produces the hum, the effect of each on the resultant hum then being considered.

TEMPERATURE EFFECT

It is evident that a filament supplied by a.c. power will undergo a temperature variation about a mean value. Whether or not this temperature change is effective in varying the electron emission from the filament depends upon the magnitude of the temperature change and upon the proximity of the magnitude of the electron current to its saturation value. The general im-

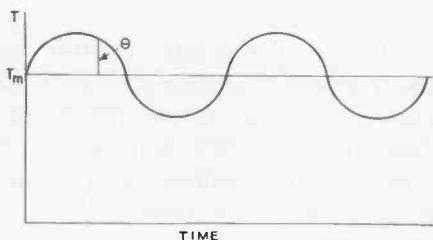

Fig. 1

pression has prevailed that most of the hum from a.c. tubes is due to temperature effects. The following considerations indicate that the temperature change which filaments of even quite small cross-section undergo is very small. To measure directly this change in temperature is difficult. It is possible, however, to calculate the theoretical value by making assumptions which will cause the calculated value, if in error, to be larger than the true value.

Consider a length of filament from which the heat dissipated (by radiation and conduction) is expressed as $f(T)$. $f(T)$ is assumed to remain constant over the temperature range through which the filament passes. Although this is not strictly true, since the rate of radiation varies with the temperature, the

variations of T will be found to be of small magnitude and symmetrical about a mean value so that the error introduced is quite small. Equating the rate at which energy is received by the filament to the rate at which it is dissipated and stored in the filament:¹

$$RI^2 \sin^2 \omega t = f(T_m + \theta) + c \frac{d}{dt}(T_m + \theta) \quad (1)$$

where T_m = Average temperature of the filament (Fig. 1)
 θ = Temperature above or below T_m at any time t .
 R = Resistance of the section of the filament having heat capacity c . Both c and R are considered to be constant over the range $T_m \pm \theta$ which will be true for most cathode materials for small values of θ only.

$I \sin \omega t$ = Filament heating current.

Expanding $f(T_m + \theta)$ into a Taylor's series and neglecting second and higher powers of θ

$$RI^2 \sin^2 \omega t = f(T_m) + \theta f'(T_m) + c \frac{dT_m}{dt} + c \frac{d\theta}{dt} \quad (2)$$

Since $f(T_m)$ is the rate of heat dissipation at T_m :

$$f(T_m) = \frac{RI^2}{2}$$

Also since $f(T_m)$ is considered as being constant,

$$f'(T_m) = 0$$

Also

$$c \frac{dT_m}{dt} = 0$$

Equation (2) then reduced to:

$$\begin{aligned} \frac{RI^2}{2} (1 - \cos 2\omega t) &= \frac{RI^2}{2} + c \frac{d\theta}{dt} \\ \frac{d\theta}{dt} &= -\frac{RI^2}{2c} \cos 2\omega t \\ \theta &= \frac{RI^2}{4c\omega} \cos \left(2\omega t - \frac{\pi}{2} \right) \end{aligned} \quad (3)$$

¹ Bockstahler—*Physical Review*, May, 1925.

This indicates that θ varies with twice the frequency of the heating current and lags by an angle $\pi/2$.

The maximum value of θ is given by:

$$\theta_{\max} = \frac{RI^2}{4c\omega} \quad (4)$$

Modifying (4) so that it can be applied more readily, one obtains:

For a filament of circular cross section:

$$\theta_M = \frac{0.152W}{s\rho df} \quad (5)$$

where θ_M = Range in temperature in deg. C from $+\theta_{\max}$ to $-\theta_{\max}$.

W = Heat dissipated from unit area of the filament expressed in watts per cm^2

s = Specific heat of the filament material

ρ = Density of the filament material in grams per cm^3

d = Diameter of the filament in centimeters

f = Frequency of the a.c. power supply

For rectangular cross section:

$$\theta_M = \frac{0.076W(a+b)}{s\rho abf} \quad (6)$$

where a and b are the length and width of the cross section in centimeters. A circular cross section, of course, results in the lowest value of θ_M for a given cross-sectional area.

It will be noticed that no correction has been applied to compensate for the change in heat capacity effected by the oxide coating on oxide filaments. This error is undoubtedly appreciable and tends to make the values calculated by the above formulas larger than the true value. However, as indicated previously, the formulas are not exact but give an indication of the maximum possible temperature excursions to which an a.c. heated filament is subjected. It will be evident from the following calculated values of θ_M for several well-known types of tubes, that the temperature variation is so small that negligible variation in emission can be attributed to this cause.

Tube	Type of Filament	θ_M	
UX-226	Oxide	1	deg. C
UX-112	"	3	"
WX-12	"	10	"
UX-201A	Thor. Tungsten	16	"

$f = 60$ cycles

A consideration of the familiar temperature saturation curve (Fig. 2) for a two-electrode thermionic tube will show that the cathode must undergo quite large temperature variations before

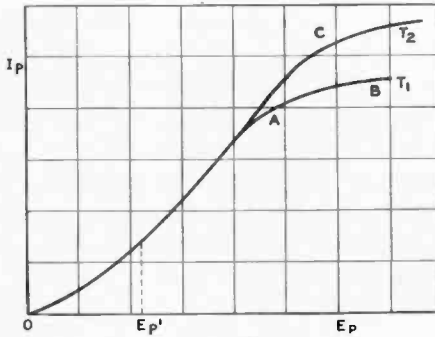

Fig. 2

sub-saturation values of plate-filament current are affected. Curve *OAB* represents variation in plate current with variation in plate-filament potential for a filament temperature T_1 . Increasing the cathode temperature from T_1 to T_2 raises the upper bend of the curve from *A* to *C*, but has no effect upon the value of I_p corresponding to a value of E_p such as E_p' which is considerably smaller than the saturation value of E_p . In actual three-electrode tubes used for receiving purposes, the filaments are capable of giving saturation values of I_p of from 25 to 200 milliamperes, while I_p under normal operating conditions seldom exceeds from 2 to 10 milliamperes. It is more or less evident then that an appreciable cathode temperature variation can be tolerated without producing any change in the operating value of I_p .

VARIATION IN PLATE CURRENT DUE TO THE VOLTAGE DROP ALONG THE CATHODE

The grid and plate returns to the cathode of an a.c. operated tube are connected to the center rather than to one side of the filament, as is usually the case with receiving tubes for d.c. service. This center return is effected either by a tap on the transformer filament winding or by means of a voltage divider (commonly known as a potentiometer in radio parlance).

It is desirable to determine the effect produced upon the plate current by having the return to the filament connected

to some point other than the electrical center. Consequently, in considering the variation in plate current produced by the voltage drop along the filament, a cylindrical two-element structure in which the anode return is connected to the cathode at a point distant mL from one end, L being the length of the structure considered and $0 < m < 1$, will be taken up. The cathode is considered to be a cylinder of small radius coincident with the axis of the cylinder forming the anode, the entire structure being a section taken from an infinite length. The cathode, moreover, will be considered to give uniform emission throughout its length under equi-potential and equi-temperature conditions. Also the initial electronic velocities are assumed to be zero.

Langmuir's relation²

$$i = \frac{2}{9} \sqrt{\frac{e}{m}} \frac{L}{r} E^{3/2}$$

is used in the form

$$I_p = k L E_p^{3/2}$$

Considering the potential of the point of the filament to which the plate return is connected (Fig. 3) to be zero, the potential difference between the plate and point A of the filament will be e^2

$$E_p - \frac{x}{L} E_f \sin t (E_p \gg E_f)$$

The emission from length dx of the cathode will be:

$$\Delta I_p = k \left(E_p - \frac{x}{L} E_f \sin \omega t \right)^{3/2} dx$$

From the entire length L of the cathode:

$$\begin{aligned} I_p &= k \int_{-mL}^{(1-m)L} \left(E_p - \frac{x}{L} E_f \sin \omega t \right)^{3/2} dx \text{ where } 0 < m < 1 \\ &= -\frac{2kE_p^{3/2}L}{5E_f \sin \omega t} \left[\left(1 - \frac{E_f}{E_p} \sin \omega t \right)^{5/2} \right. \\ &\quad \left. - \left(1 + m \frac{E_f}{E_p} \sin \omega t \right)^{5/2} \right] \end{aligned}$$

² Van der Bijl, "Thermionic Vacuum Tube."

$$= kLE_p^{3/2} \left\{ 1 - \frac{3}{4} \frac{E_f}{E_p} \sin \omega t [(1-m)^2 - m^2] + \frac{1}{8} \left(\frac{E_f}{E_p} \sin \omega t \right)^2 \right. \\ \left. [(1-m)^3 + m^3] + 1/64 \left(\frac{E_f}{E_p} \sin \omega t \right)^3 [(1-m)^4 - m^4] \dots \right\} \quad (7)$$

For $m=0.5$ which is the case when connection is made to the electrical center of the filament:

$$I_p = KLE_p^{3/2} \left\{ 1 + 1/32 \left(\frac{E_f}{E_p} \sin \omega t \right)^2 \right. \\ \left. + \frac{3}{10240} \left(\frac{E_f}{E_p} \sin \omega t \right)^4 \dots \right\} \quad (8)$$

For a value of $E_f/E_p = 10^{-1}$ the amplitude of the third term in the above series (8) is 10^{-4} times the amplitude of the second term,

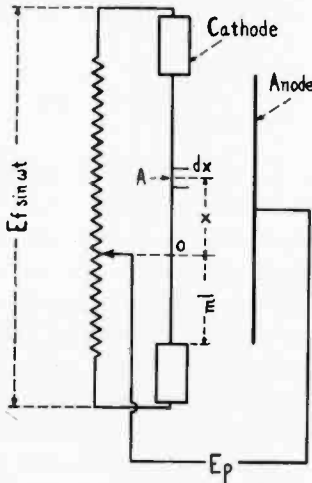

Fig. 3

enabling one to express the plate current to a first approximation as

$$I_p = kLE_p^{3/2} \left[1 + \frac{1}{32} \left(\frac{E_f}{E_p} \right)^2 \sin^2 \omega t \right] \quad (9)$$

$$= kLE_p^{3/2} \left[1 + \frac{1}{64} \left(\frac{E_f}{E_p} \right)^2 - \frac{1}{64} \left(\frac{E_f}{E_p} \right)^2 \cos 2\omega t \right] \quad (10)$$

Equation (10) indicates that the plate current has added to it a d.c. value given by the second term of the equation and an a.c. component of twice the frequency of the power supply given by the third term.

It is also desirable to determine the value of plate potential which, if added to E_p when the cathode is emitting under equipotential conditions, would give the same expression for I_p as (10). Let this value of potential difference be represented by ϕ . Then from (9)

$$I_p = kL(E_p + \phi)^{3/2} = kLE_p^{3/2} \left[1 + \frac{1}{32} \left(\frac{E_f}{E_p} \right)^2 \sin^2 \omega t \right]$$

$$(E_p + \phi)^{3/2} = E_p^{3/2} \left[1 + \frac{1}{32} \frac{E_f^2}{E_p^2} \sin^2 \omega t \right]$$

To a first approximation, omitting terms of higher order than the second

$$\phi = \frac{1}{48} \frac{E_f^2}{E_p} \sin^2 \omega t \quad (11)$$

$$= \frac{1}{96} \frac{E_f^2}{E_p} (1 - \cos 2\omega t) \quad (12)$$

Before discussing the application of these formulas to three-element tubes, the physical significance of the preceding development will be considered. In Fig. 4a the effect of voltage drop in the filament is graphically indicated. AB represents the filament, one end of which is at the maximum positive potential and the other end maximum negative potential, the center O being at zero potential. Ordinates represent emission, and are greatly exaggerated to make the phenomena more evident. CD shows how the emission varies over the length of the filament when A is +, that is, the difference in potential between the anode and A is $E_p - E_f/2$ and between the anode and B is $E_p + E_f/2$. This emission variation is a three-halves power relation with respect to E_p .

If the emission were a linear relation, conditions would be represented by Fig. 4b. Line EF (as in 4a) indicates the value of the emission at the instant the potential difference between A and B is zero, resulting in a potential difference from every point on the filament to the plate of E_p . When the potential between A and B is other than zero, the average emission from

the entire filament remains the same regardless of the magnitude of the drop between *A* and *B*, since the increase in emission from one half of the filament represented by *FO'D* equals the decrease in emission from the other half, represented by *CO'E*. If it were possible to design a tube having a linear relation between cathode emission and anode-cathode potential, supplying the filament with a.c. would produce no hum due to potential drop along the cathode. In this case the emission center would always be at the same point as the electrical center, the emission center of the cathode being defined as that point which divides the cathode into two equi-emitting parts, so that each part of the cathode so divided contributes half of the emission forming the plate current.

However, when dealing with actual conditions where the emission from the cathode is governed by the three-halves power

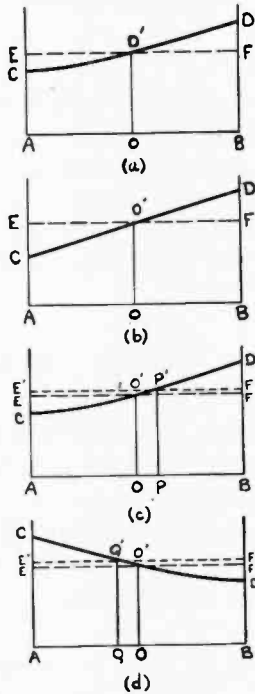

Fig. 4

relation, supplying the cathode with a.c. power causes the emission center to oscillate about instead of remaining coincident with the electrical center. In Fig. 4c, the line *E'F'* is

so drawn that the area $PP'DB$ equals the area $PP'AC$, making P the emission center at the instant when the potential difference between A and B causes the emission to be represented by the line CD . Fig. 4d represents conditions when the potentials of A and B are of opposite sign to those indicated for Fig. 4c. The emission center has moved along the filament from P to Q on the other side of the electrical center. For intermediate values of potential drop along the cathode, the emission center assumes some corresponding point between P and Q .

It is evident that a difference in potential exists between the electrical and emission centers of the cathode and that the electrical center of the cathode is not at zero potential with respect to the cathode but has impressed upon it a sinusoidal potential. To determine the approximate magnitude of this potential, consider the familiar expression

$$I_p = f(kE_o + E_p)$$

which specifies that in a three-electrode tube the electrostatic field effective in controlling the electron emission from the cathode is expressed as $(kE_o + E_p)$, where (k) is a structural constant of the tube and is a measure of the shielding action of the grid. It is seen that the electric field in the two-element tube is determined by E_p alone. Adapting equation (12) to a three-electrode structure, one obtains

$$\phi' = \frac{E_f^2}{96(kE_o + E_p)}(1 - \cos 2\omega t) \quad (13)$$

ϕ' acts in the grid circuit as well as in that of the plate, since the return lead from the grid to the cathode is also connected to the electrical center of the cathode.

The effect, then, of heating the filament of a three-electrode tube by alternating current is that of introducing a potential in the plate circuit of the tube given by

$$(\mu + 1)\phi' = \frac{(\mu + 1)E_f^2}{96(kE_o + E_p)}(1 - \cos 2\omega t) \quad (14)$$

where μ is the dynamic amplification factor of the tube. In actual tubes, where the theoretical conditions are considerably modified, the magnitude of the above quantities will be at variance with the true values. However, they serve to indicate the

nature of the phenomena occurring and afford a basis for so choosing tube dimensions and characteristics as to decrease the variation in I_p to a minimum.

VARIATION OF PLATE CURRENT DUE TO THE EFFECT OF MAGNETIC FIELD OF THE ALTERNATING CURRENT

The influence of the magnetic field due to the heating current of the filament is in general a negligible quantity when dealing with currents of the order of magnitude encountered in the filaments of receiving tubes. Due to the fact, however, that the variation in I_p produced by a.c. on the filament is a second order quantity itself, one must take the effect of the magnetic field into consideration. Referring to Fig. 5, AA is the cylindrical anode of a two-element thermionic tube and F is the filament coincident with the axis of the cylinder. OD represents the path followed by an electron emitted perpendicular to the filament through which the filament current is zero. Under these conditions there will be no magnetic field and the velocity with which

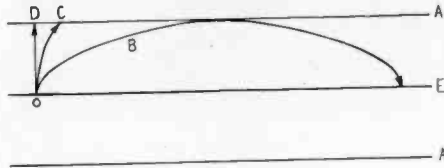

Fig. 5

the electron strikes the plate will be determined wholly by the difference in potential between the anode and cathode and upon the initial velocity of the electron. OB represents the path followed when the field due to the heating current is of just sufficient intensity to cause the electron to return to the filament before it encounters the plate. A. W. Hull³ has given equations for the behavior of an electron under such conditions. OC indicates the path followed when the magnetic field assumes a value intermediate between zero and the critical value necessary for path OB .

It is evident that the radial velocity of the electron under conditions attending the pursuing of path OC will be different than that for path OD when considering points equi-distant from the cathode. This is due to the unvarying magnetic field being unable to contribute any energy to the electron, it being assumed

³ A. W. Hull, *Physical Review*, May, 1925.

that the filament is heated by direct current or low-frequency alternating current. The resultant velocity then at any distance from the cathode will be the same for path OD as for OC .

The equation

$$\begin{aligned} I_p &= 2\pi R d v \\ &= K v \end{aligned} \quad (15)$$

represents the current in the external circuit per unit length of the two-element structure under consideration where d is the electron density at the plate, v is the radial electron velocity at the plate, and R the radius of the plate.

To obtain an expression for the hum or I_p variation associated with a tube as a result of the varying magnetic field about the filament when an a.c. power supply is used, the difference in the velocity with which an electron strikes the plate in the presence of a magnetic field and with no magnetic field present may be compared. However, for the present development it was



Fig. 6

found unnecessary to obtain a quantitative expression for this effect. It is sufficient to note that v and consequently I_p vary sinusoidally with and at twice the frequency of I_f . If the filament voltage and current are in phase, the hum component due to the effect of the magnetic field is 180 deg. out of phase with that due to the filament potential drop. This is evident from a consideration of the conditions existing when there is maximum potential difference between the ends of the filament. At this instant the voltage drop along the filament tends to produce maximum emission to the plate, while at the same time the maximum current through the filament establishes the maximum value of magnetic field which tends to reduce the emission to the plate in the manner previously indicated.

APPLICATION OF THE PRECEDING CONSIDERATIONS

A considerable number of three-electrode tubes were constructed, having different filament characteristics, in an attempt

to obtain a design which would be satisfactory for use as an amplifying tube in radio receiving sets. Oxide-coated filaments were used exclusively and it was found possible to use as small a diameter filament as 0.103 millimeters and still obtain very low hum values. To justify the assumption that the temperature variation of this size filament (about 0.9 deg. C for 60 cycles by calculation) is so small as to have no effect upon varying the emission, an oscillogram of the plate current of a tube having a filament whose calculated temperature variation was about 1.2 deg. C was taken, and is shown by trace (b) of Fig. 6. In Fig. 7 is given the wiring diagram of the apparatus used to

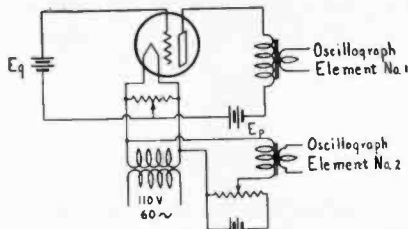

Fig. 7

obtain this oscillogram. The double-frequency curve was traced by oscillograph element No. 1 which was actuated by the current in the secondary winding of a step-down transformer whose primary winding was in the plate circuit of the tube under consideration. The lower frequency curve represents the filament voltage applied to the tube and was traced by element No. 2 which was actuated by a similar step-down transformer having the same d.c. component flowing through its primary.

It is evident that the I_p variation (hum) is a double-frequency effect (compared to the frequency of the filament heating current) and is very nearly in phase with the filament voltage. These curves are very similar to the plot (Fig. 12) of $A/2(1 - \cos 2\omega t)$ and $A \sin \omega t$ predicted by equation (10) for the hum.

Trace (a) of Fig. 6 was taken under conditions similar to those for trace (b) except that a tube having a thoriated tungsten filament for which the calculated temperature variation was approximately 15 deg. C was substituted for the oxide-filament tube. The filament voltage drop and current were the same for both of the tubes, but the mutual conductance of the oxide filament tube was about three times that of the other accounting for the greater amplitude of the hum curve given by trace (b).

The significant fact indicated by trace (a) is that the hum is out of phase with the filament voltage. Equation (3) shows that the temperature change lags behind the filament power supply so that if part of the hum is due to temperature effects, the resultant hum should be out of phase with the filament voltage by an angle whose magnitude would depend upon the relative magnitudes of the hum components.

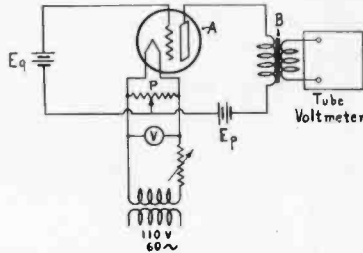

Fig. 8

In studying the other causes affecting the hum, it was considered permissible to assume that the hum due to temperature variation was practically zero since the calculated temperature change for the filaments used did not exceed about 1.2 deg. C.

Fig. 8 is the wiring diagram for the apparatus used to measure the intensity of the hum produced by the tubes studied. The tube under observation is indicated by A. The filament in all cases was supplied by 60-cycle current from a step-down transformer. The plate and grid returns were made to the variable contact of a rheostat *P* connected across the filament terminals. The plate, grid, and filament voltages could be adjusted to any desired value. A vacuum-tube voltmeter connected to the secondary winding of a nickel-iron core audio-frequency amplifying transformer *B* whose primary winding was in the plate circuit of the tube being measured indicated the magnitude of the hum. This voltmeter was calibrated in terms of millivolts at 120 cycles applied to the primary winding of transformer *B*.

Equation (13) indicates that a definite a.c. voltage is applied to the grid of a tube whose filament is heated by a.c. Increasing the amplification factor of the tube should consequently increase the hum obtained from the tube. To determine the authenticity of this deduction, a number of tubes were constructed as nearly alike as possible except for a difference in grid mesh so as to obtain tubes of similar filament construction but with different

amplification factors. Fig. 10 shows the variation of hum with amplification factor as determined by measurements of these tubes. Equation (13) predicts a linear relation between the hum and the amplification factor. However, the tubes which had the

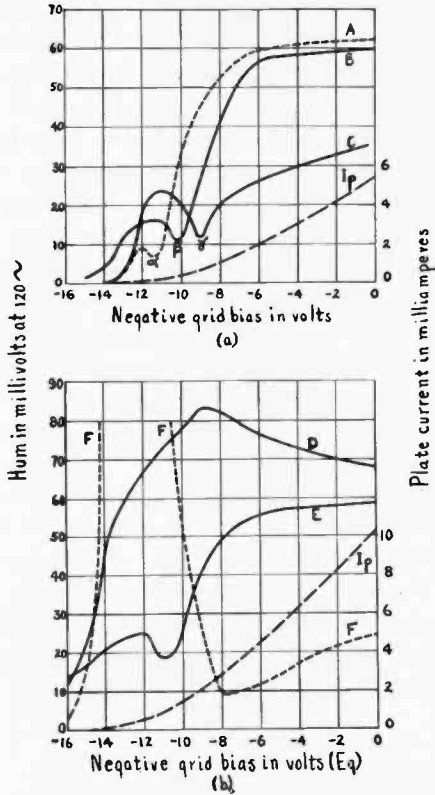

Fig. 9—Variation of Hum with E_g .
 $E_p = 90$ volts; $\mu = 8.0$

higher amplification factors necessarily had high impedances. The transformer used in the plate circuit of the a.c. tube in the hum measuring set had too low a primary impedance to give as great amplification for the higher impedance tubes as for the lower impedance tubes, accounting in part for the bending over of the curve.

In Fig. 9 are given curves for the variation of hum with grid bias as measured by the hum measuring set, for several tubes whose filament characteristics are given in Table I.

TABLE I

TUBE	TYPE OF FILAMENT	I_f (R.M.S.)	E_f (R.M.S.)
A	0.170 mm. Round Oxide Single Strand	1.2 amps.	0.8
B	0.155 " " " " "	0.9 " "	0.7
C	0.103 " " " " "	0.5 " "	1.1
D	0.178 (Approx) " " Two Strands	2.5 " "	1.0
E	0.155 " " " " "	1.8 " "	1.7
F	(UX-226) Ribbon Oxide V-Shape	1.05 " "	1.5

All of the tubes had a flat anode structure and the tubes whose curves are given in (9a) had filaments consisting of a single strand of the oxide coated base metal through the center. The minimum hum points, (α , β , γ) give evidence of the balancing effect of the two hum components and as the diameter of the filament is decreased, the minimum position moves toward more positive values of grid bias. Further decreasing the filament diameter should accordingly move the minimum hum position farther to the right. It was considered, however, that filaments of smaller diameter than that of tube C (0.103 mm) would probably be subject to objectionable temperature variations and would also be very fragile. In order to cause the minimum position to occur on the operating part of the characteristic ($E_g = -4$ to -6 volts for $E_p = 90$ volts), a different filament construction had to be resorted to.

This was effected by use of a V-shaped filament. Curve F of Fig. 9b gives the variation of hum with E_g for the Radiotron UX-226 which incorporates this type of filament. It will be observed that the hum produced by this tube at the operating value of E_g is considerably lower than that obtained from any straight filament construction considered, regardless of the magnitude of the voltage drop along the filament.

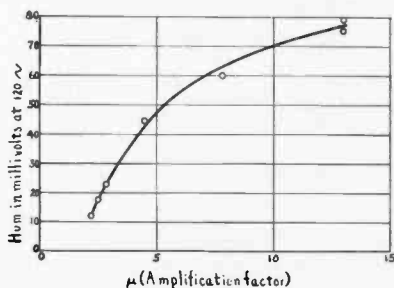

Fig. 10—Variation of Hum with Amplification Factor.

The explanation advanced for the low value of hum obtained with this tube is that there is a passage of electrons between the two legs of the V-shaped filament. Considering the instant

when there is maximum potential difference between the ends of the filament, which is in a negative or only slightly positive electrostatic field due to the negative potential on the grid, some of the electrons emitted by the negative end of the filament are attracted to the positive end instead of to the plate. It is at this instant that there is maximum emission from the filament due to the maximum potential drop along the filament. This increase in emission is partly reduced by the exchange of electrons between the two portions of the filament.

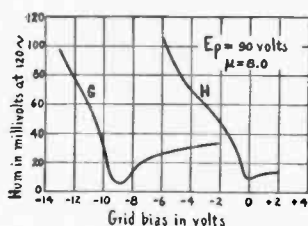

Fig. 11—Hum Curves for V-Shaped Filament Tubes.

Fig. 11 shows the effect produced on the hum curve by varying the distance between the ends of the filament V . If the assumption that the reduction in hum results from a flow of electrons between the filament legs is correct, bringing the ends of the V closer together should cause a greater number of electrons to pass to the positive side of the V due to the increased potential gradient. The minimum hum position should then move to a more positive value of E_0 where I_p is greater. Curve G represents

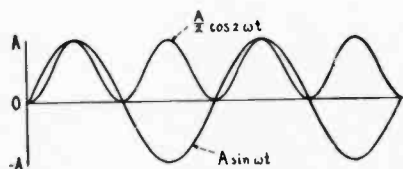

Fig. 12

the variation of hum with E_0 for the greatest spread between the ends of the filament possible for the tube structure used. Curve H shows the variation of hum when the sides of the V are almost in contact with each other. The other structural details of these two tubes were as nearly similar as possible, and the same filament and plate voltages were used in making the measurements.

CONCLUSION

(1) The foregoing considerations have shown that the temperature variations encountered when oxide filaments of ordinary size heated by a.c. power are used are so small that it is unnecessary to resort to a circular cross section and heavy current construction.

(2) Neutralizing Effects:

a. The hum component due to temperature variation cannot be neutralized by the other factors since it lags by very nearly 90 deg. behind the power supply. This component, however, can be made so small as to be negligible.

b. With the use of straight filaments, the lowest hum is obtained by so choosing the filament characteristics that the hum components due to voltage drop and magnetic field neutralize each other.

c. The use of *V*-shaped filaments enables a very low minimum hum value to be obtained. The position of minimum hum on the E_g axis can be varied at will by choosing the proper filament design.

(3) The effect of the alternating voltage drop along the filament is to place a sinusoidal potential on the grid. Consequently, the hum produced by an a.c. tube increases with the amplification factor.

THE INTERNATIONAL UNION OF SCIENTIFIC RADIO-TELEGRAPHY*

By

J. H. DELLINGER

(Chief of Radio Section, Bureau of Standards, Washington, D.C.)

THE International Union of Scientific Radiotelegraphy was organized in 1919. It is commonly designated as the URSI (from its French name, Union Internationale de Radio-télégraphie Scientifique). Its aims are: (1) to promote the scientific study of radio communication; (2) to aid and organize researches requiring cooperation on an international scale and to encourage the discussion and publication of the results; (3) to facilitate agreement upon common methods of measurement and the standardization of measuring instruments. The International Union itself is an organization framework for carrying on the international phases of the administrative work, and operates under the International Research Council. The actual technical work is done by the various national sections. The officers are: President, General G. Ferrié, France; Vice-Presidents, Dr. L. W. Austin, United States, Dr. W. H. Eccles, England, Dr. G. Vanni, Italy, Dr. V. Bjerknes, Norway; General Secretary, Dr. R. B. Goldschmidt, Belgium.

The General Secretary's office, and the headquarters of the organization, are located at 54 Avenue des Arts, Brussels, Belgium. The organization is financed by contributions of the various governments, through the International Research Council, but the total amount of such support is very small. In fact, the routine of the organization is carried on largely through voluntary service. The General Secretary's office carries on the international correspondence and duplicates documents originating in the various National Sections, distributing them to all the other Sections.

The American Section was organized in 1920, under the National Research Council. It is made up of a group of technical committees and an executive committee. The executive committee is as follows:

Dr. L. W. Austin, chairman, representing the International Union as its vice president.

* Original Manuscript Received by the Institute, May 26, 1928. Publication Approved by the Director of the Bureau of Standards in the U. S. Department of Commerce.

Dr. J. H. Dellinger, technical secretary, representing the Department of Commerce.

Dr. W. E. Tisdale, corresponding secretary, representing the Division of Physical Sciences, ex-officio.

Prof. D. C. Miller, representing the Division of Physical Sciences, ex-officio.

Dr. A. N. Goldsmith, representing the Institute of Radio Engineers.

Major-General G. S. Gibbs, representing the Army, ex-officio.

Major W. R. Blair, representing the Army.

Captain T. T. Craven, representing the Navy, ex-officio.

Dr. A. H. Taylor, representing the Navy.

Members at large: E. F. W. Alexanderson, Dr. A. E. Kennelly, Major-General G. O. Squier, Dr. Wm. Wilson, Prof. E. M. Terry, F. Conrad, G. W. Pickard, Prof. E. L. Chaffee, Dr. G. Breit, H. T. Friis.

The American section holds an annual meeting in Washington, D.C., in April. At this meeting the chairmen of the several technical committees present progress reports on the status of work in the field of the committee, and technical papers are presented by the various members of the committees.

Membership in the American Section is open to anyone actively interested in radio. Anyone desiring to join should write to the Technical Secretary, stating in which of the technical committees he is most interested. The technical committees are as follows:

1. Radio measurements.
 - 1a. Measurement of interference.
2. Wave propagation.
 - 2a. Wave direction.
 - 2b. Phenomena above 3 megacycles.
3. Atmospherics.
4. Cooperation.
5. Oscillations.

The chairman of the first committee is Dr. J. H. Dellinger, Chief of the Radio Section of the Bureau of Standards. This committee is concerned with radio measurements and standards, particularly as regards measurement work performed by other committees of this organization. The committee promotes and participates in the improvement and standardization of methods for measuring frequency, field intensity of received waves, in-

tensity of atmospheric disturbances, automatic recording devices, fading, and other types of radio measurements.

The committee on the measurement of interference is headed by E. F. W. Alexanderson, of the General Electric Company. It studies all forms of interfering signals and radiation, other than atmospheric disturbances. It deals particularly with undesired emissions, including harmonics and broad waves.

The committee on radio wave propagation is headed by Dr. L. W. Austin, in charge of the Bureau of Standards laboratory for special radio transmission research. This committee encourages and conducts measurements upon received field intensities. It investigates, in connection with these measurements, diurnal and seasonal variations and effects of transmission under day and night conditions, sunset and seasonal effects, and correlations with other natural phenomena.

The chairman of the committee on radio wave direction is Dr. Gregory Breit, department of terrestrial magnetism, Carnegie Institution. This committee encourages and correlates research on the variations of wave direction with time, effects of topography on direction-finder work, and the bearing of polarization and other variations upon apparent observed phenomena.

The committee on wave phenomena above three megacycles is under the direction of Dr. A. H. Taylor, of the Naval Research Laboratory. The work covers such phenomena as daily and seasonal variations of received field intensities from high-frequency stations, character of fading and atmospheric determination of skip distances, comparison of radio phenomena with magnetic and solar variations, weather, etc.

The committee on atmospheric disturbances, under H. T. Friis, of the Bell Telephone Laboratories, as chairman, promotes and coordinates measurements upon the intensity and direction of atmospheric disturbances, including daily and seasonal variations, characteristics of the various types of atmospheric disturbances, their frequency distribution, and methods of recording and measuring.

Professor A. E. Kennelly, of Massachusetts Institute of Technology, is chairman of the committee on cooperation. This committee seeks to enlist the cooperation of experimenters, amateurs, and others in radio observation programs. It also maintains contact with the workers in related sciences, such

as geophysics, astronophysics, terrestrial magnetism, and atmospheric electricity.

The chairman of the committee on "oscillations" is Professor E. L. Chaffee of Harvard University. This committee promotes progress in the general theory of oscillations and its radio applications. Its interest covers, e.g., the general theory of vacuum tubes, telephone receivers, modulation, and circuit networks. It covers in general the broad radio field not included under the other committees.

The International Union itself holds annual meetings. The 1927 meeting was held in October in Washington, at the same time as the International Radio Conference. The 1928 meeting is to be held in September in Brussels, Belgium. The Washington meeting was prolific in the presentation of important scientific results and in the exchange of information and ideas among the radio scientists of the world. It was attended by about 70 persons from the following countries: Australia, Belgium, Canada, France, Germany, Great Britain, Holland, India, Ireland, Italy, Japan, Norway, Switzerland, and the United States. Sixteen sessions were held, between October 10 and 28. These included one public and two general sessions, held under the chairmanship of the President, General Ferrié, and sessions of the several "commissions." The presiding officers at the latter were as follows:

- I. Radio Measurements, Dr. D. W. Dye (England)
- II. Wave Phenomena, Dr. L. W. Austin (U. S. A.)
- III. Atmosphericics, Prof. R. Mesny (France).
- IV. Cooperation, Prof. G. Vanni (Italy).

The great variety of work covered is illustrated by the titles of papers presented at the public session such as:

Employment in combination of photoelectric cells and vacuum tubes in the solution of various problems of time measurements. General G. Ferrié.

International comparison of frequency standards. Dr. J. H. Dellinger.

Precision determination of frequency. J. W. Horton and W. A. Marrison.

The Navy's primary frequency standard. R. H. Worrall and R. B. Owens.

A radio-frequency oscillator for receiver investigations. G. Rodwin and T. A. Smith.

An automatic recorder for radio signals and atmospheric disturbances. E. B. Judson.

Experiences in radio compass calibration. F. A. Kolster.

Apparent night variations in crossed-coil radio beacons. H. Pratt.

Ionization in the outer atmosphere of the earth. Dr. E. O. Hulburt.

The constitution of the earth's atmosphere up to great heights. H. B. Maris.

Ultrashort waves. Prof. R. Mesny.

Height of the reflecting layer in August, 1927, and the effect of the disturbances of August 19. O. Dahl and L. C. Gebhardt.

The relation between radio reception, sun-spot position, and area. G. W. Pickard.

Solar activity and radio transmission. Dr. L. W. Austin and Miss I. J. Wymore.

The effect of polarization on the received signal strength. Dr. B. van der Pol.

Investigation of downcoming waves. Prof. E. V. Appleton.

Experiments on radio wave projectors. E. F. W. Alexander-son.

Seasonal variation of the 20-meter wave from Nauen in Japan. T. Nakagami and T. Ono.

Diurnal variation in signal strengths of short waves. T. Nakagami and T. Ono.

Note on short-wave long-distance transmission. T. Minohara and K. Tani.

Directional observations on atmospherics in Japan. E. Yokoyama and T. Nakai.

Relations between atmospherics and meteorological phenomena. R. Bureau.

The office of the general secretary is preparing a special publication which will include all the papers presented and the discussions at the sessions of the commissions. The success of the meeting also led to certain decisions having in view the further promotion of international effort in radio research. It was determined that a campaign for funds for this purpose would be conducted, primarily with a view to permitting the general secretary's office to establish and maintain extensive bibliographical and library service, to disseminate scientific information internationally, and to serve as a clearing-house for radio data.

This organization has a distinct field of usefulness in furnishing a meeting ground for the numerous workers on the various aspects of radio research. Meetings and committee activities have furnished a means of promoting acquaintance and a meeting place of ideas. The work should be fruitful in the years just ahead in contributions to the better understanding and use of radio and in related problems of geophysics, composition of the atmosphere, etc. Observers contemplating participation in the work should, wherever possible, plan to continue for at least a year thus covering seasonal variations. It has been demonstrated that radio is unique among the fields of scientific work in having special adaptability to a large scale international research program. The phenomena that must be studied are world-wide in extent, and yet are in a measure subject to control by the experimenters.

THE TUNED-GRID, TUNED-PLATE, SELF-OSCILLATING VACUUM-TUBE CIRCUIT*

By

J. WARREN WRIGHT

(U. S. Naval Research Laboratory, Bellevue, Anacostia, D. C.)

Summary—Certain discrepancies in published reports on this circuit are pointed out and it is shown that the frequency of oscillation is given by the real terms and the necessary condition for these oscillations to start by the imaginary terms of the general equation.

Equations are set up for the frequency and for the necessary conditions for the generation of oscillations of a frequency determined by the tuning of the grid circuit. The feedback is assumed to be through the grid-plate capacity of the vacuum tube.

THIS is not a new circuit, and it has been discussed¹ many times in the past. Recently, however, a published report gave results which were not in accord with previous theoretical or experimental work. It seemed advisable, therefore, to investigate these discrepancies and the following article is concerned with presenting the result of this investigation in a simplified manner.

The above-mentioned report² stated that if the frequency of oscillation is determined by the tuning of the grid circuit, this frequency is greater than the natural frequency of the load in the plate circuit. This would mean that the reactance of the plate circuit load would be capacitative, which is contrary to the investigation of Miller,³ who showed that the load in the plate circuit must be inductive if resistance neutralization is to take place in the grid circuit. Miller also pointed out that oscillations would occur if the resistance of the grid circuit is completely neutralized.

An examination of that report² showed that the effect of the feed-back current upon the total plate current was neglected. (See Fig. 1.) This is not believed to be justified; because the feed-back in such a circuit is through the grid-plate capacity of the tube,

* Original Manuscript Received by the Institute, April 4, 1928. Published by permission of Navy Department.

¹ Oscillating audion circuits—L. A. Hazeltine, Proc. I. R. E., 6, p. 63; April, 1918.

² The tuned-grid tuned-plate circuit—J. B. Dow, Proc. I. R. E., 15, p. 397; May, 1927.

³ Dr. John Miller, Bureau of Standards Scientific Paper No. 351.

and this current serves as the connecting link between the grid and the plate circuits.

It was also noted² that the frequency of oscillation was obtained from the imaginary terms and the condition for oscillation from the real terms. This is in error, for the frequency is given by the real terms and the condition for the starting of oscillations by the imaginaries.

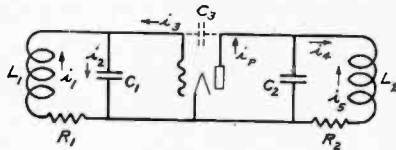

Fig. 1

This will be seen if one refers to Fig. 2 and assumes that free oscillations exist in the circuit. Then if i is the instantaneous current

$$Ri + j\omega Li + \frac{i}{j\omega C} = 0 \quad (1)$$

which can be written as

$$\omega^2 LC - j\omega RC - 1 = 0 \quad (2)$$

Equating the real terms to zero

$$\omega^2 = \frac{1}{LC} \quad (3)$$

It is obvious that (3) gives the frequency.

Equating the imaginary term to zero and substituting for ω

$$R\sqrt{\frac{C}{L}} = 0 \quad (4)$$

for the condition for sustained oscillations.

If one remembers that the logarithmic decrement is sometimes written⁴ as $\pi R\sqrt{C/L}$ it is at once obvious that $R\sqrt{C/L}$ is a damping term. In case the damping term does not equal zero⁵ the oscillations will die out as shown in Fig. 3a; but if the damping term is zero the oscillations will be undamped, as shown in Fig.

⁴ Bureau of Standards Circular No. 74.

⁵ (Author's Note: It is assumed that the damping term cannot be positive.)

3b. In order for (4) to hold the losses in the circuit must be supplied, and to do this in the case of the grid circuit of a vacuum-tube oscillator the load in the plate circuit must be inductive.

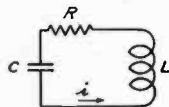

Fig. 2

In order to set up the necessary equations for the tuned-grid tuned-plate circuit refer to Fig. 1 and assume, for simplicity, that the grid does not draw current, that the tube has a linear characteristic, and consider only small oscillations. In addition, assume that the resistance of the coils L_1 and L_2 is small compared to the reactance. Then the conductance of the L_1R_1 branch is $R_1/\omega^2L_1^2$ and that of the L_2R_2 branch is $R_2/\omega^2L_2^2$. Call these conductances g_1 and g_2 , respectively. The condensers C_1 , C_2 and C_3 are assumed to be perfect.

Now express the various currents of Fig. 1 in terms of the product of a voltage and an admittance. Thus in the grid circuit

$$i_1 = e_g \left(g_1 - \frac{j}{\omega L_1} \right) \quad (5)$$

$$i_2 = e_g j \omega C_1 \quad (6)$$

$$i_3 = (e_p - e_g) j \omega C_3 \quad (7)$$

$$i_3 = i_1 + i_2 \quad (8)$$

Substitute (5), (6), and (7) in (8), collect terms and solve for e_p

$$e_p = \frac{e_g (g_1 + j b_1)}{j \omega C_3} \quad (9)$$

where $b_1 = [\omega(C_1 + C_3) - 1/\omega L_1]$

Similarly in the plate circuit

$$i_p = i_3 + i_4 + i_5 \quad (10)$$

$$i_4 = e_p \left(g_2 - \frac{j}{\omega L_2} \right) \quad (11)$$

$$i_5 = i_p j \omega C_2 \quad (12)$$

$$i_p = -e_p G \quad (13)$$

where G is the mutual conductance of the plate circuit.

Substituting (7), (11), (12) and (13) in (10) and collecting terms

$$-e_p G = l_p(g_2 + j b_2) - e_p j \omega C_3 \tag{14}$$

where $b_2 = [\omega(C_2 + C_3) - 1/\omega L_2]$

Next substitute the value of e_p as given by (9) in (14) and arranging terms

$$G j \omega C_3 + g_1 g_2 + j b_1 g_2 + j b_2 g_1 - b_1 b_2 + \omega^2 C_3^2 = 0 \tag{15}$$

The real terms of (15), if $g_1 g_2$ and $\omega^2 C_3^2$ (which are very small) are neglected, become

$$[(C_1 + C_3)(C_2 + C_3)L_1 L_2] \omega^4 - [L_1(C_1 + C_3) + L_2(C_2 + C_3)] \omega^2 + 1 = 0 \tag{16}$$

This is a quadratic equation in ω^2 and if the theorem relating to the product and to the sum of the roots is recalled, the following can be written from inspection

$$\omega_1^2 \omega_2^2 = \frac{1}{L_1 L_2 (C_1 + C_3)(C_2 + C_3)} \text{ and } \omega_1^2 + \omega_2^2 = \frac{1}{L_1(C_1 + C_3)} + \frac{1}{L_2(C_2 + C_3)} \tag{17}$$

From (17) it can be seen that

$$\omega_1^2 = \frac{1}{L_1(C_1 + C_3)} \text{ and } \omega_2^2 = \frac{1}{L_2(C_2 + C_3)} \tag{18}^7$$

Here L_1, L_2 and C_1, C_2 are the grid and plate inductances and capacities respectively. The grid-filament capacity is supposed

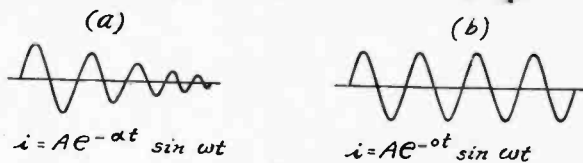

Fig. 3

to be a part of C_1 and the plate-filament capacity of the tube a part of C_2 . C_3 is the grid-plate capacity of the tube.⁸

⁶ Hazeltine, loc. cit., and Van der Bijl, "Thermionic Vacuum Tube," McGraw-Hill.

⁷ (Author's Note: These equations are correct to a first approximation. More extended and rigorous methods give results which differ slightly but do not invalidate these conclusions.)

⁸ (Author's Note: This is an approximation which is very close if C_1 and C_2 are large compared to the grid-plate capacity of the tube. This is usually true in practice.)

The condition for oscillations to occur is obtained from the imaginary terms of equation (15) or

$$G\omega C_3 + b_1 g_2 + b_2 g_1 = 0 \quad (19)$$

Now the condition for oscillation, when the frequency is determined by the tuning of the grid circuit, is desired, and for this case

$$\omega^2 = \omega_1^2 = \frac{1}{L_1(C_1 + C_3)}$$

Then (19) becomes, on solving for G

$$G = \frac{R_1(C_1 + C_3) [L_1(C_1 + C_3) - L_2(C_2 + C_3)]}{L_1 L_2 C_3} \quad (20)^7$$

This means that the adjustment must be made so that the value of G as given by (20) is not greater than that obtainable from the vacuum tube. G will have a minimum value when

$$L_1(C_1 + C_3) = L_2(C_2 + C_3)$$

and as G cannot become negative

$$L_1(C_1 + C_3) \geq L_2(C_2 + C_3) \quad (21)$$

but as C_3 is very small (see equation (20)) $L_1(C_1 + C_3)$ cannot be much greater than $L_2(C_2 + C_3)$ if G is to be of such value that oscillations are possible.

It is evident that if this circuit is to generate oscillations, of a frequency determined by the tuning of the grid circuit, the load in the plate circuit must have a natural frequency slightly greater than the frequency of the generated oscillations. The load in the plate circuit will be inductive under these conditions.

RADIATION AND INDUCTION*

By

R. R. RAMSEY AND ROBERT DREISBACK

(Department of Physics, Indiana University, Bloomington, Indiana)

Summary—In this paper the formulas for induction fields are derived in two elementary ways. From the definition of potential and by means of analogy the form of the vector potential, $A = Ih/x$ is obtained.

From this the formulas for radiation fields are given following Dellinger's derivation. The second part of the paper gives experimental data verifying the formulas for radiation and induction when the distance is short.

THE formula for radiation from an antenna aerial and a coil has been worked out by Dellinger¹ using a vector potential. The mathematical conception of a vector potential seems to be a stumbling block. Many texts do not attempt an explanation of the radiation formulas. One text states that the development requires more mathematics than that possessed by the average engineer. Others make statements which lead to erroneous conclusions.

This paper is not intended to be a rigorous mathematical development of the theory or an improvement on Dellinger's admirable paper. It is hoped, by means of analogies using the ordinary definitions of field and potential and their application to circuits carrying direct current and without doing violence to mathematical principles, to clear up some of the difficulties which are encountered by the man who has not the time or training to look more deeply into the subject.

Radiation theory has been experimentally verified with a considerable degree of accuracy when the distances involved have been hundreds of miles. This, of course, involves an attenuation factor the uncertainty of which explains any discrepancy. There seems to have been no attempt made to verify the formula when the distance is small—one wavelength or less. In the experimental part of the paper the junior author has verified the laws of radiation and induction close to a loop aerial.

It has been customary in giving an elementary picture of radiation to picture a vertical wire with a large ball at the top for capacity. When the ball is charged positively the electric field is pictured by means of lines extending from the ball to

* Original Manuscript Received by the Institute, November 30, 1927.

¹ Scientific Paper of the Bureau of Standards No. 354.

the earth, very much like streams of water from a spray nozzle. The magnetic field is represented by concentric circles about the wire. This elementary picture serves very well until we remember that the electric and magnetic fields as shown by Maxwell's equations for electromagnetic waves are in time phase while the fields in the picture are out of phase. The electric field extending from the ball is a maximum when the charge on the ball is a maximum, which is at a time when the current in the wire is zero, and our ordinary conception of magnetic field tells us that it is zero when the current is zero.

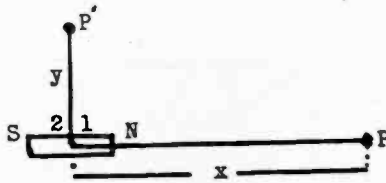

Fig. 1

This will be shown to be due to the fact that magnetic fields as we usually think of them are what have been called by Dellinger induction fields and not radiation fields.

To understand magnetic fields and potentials it will be necessary to refer to some elementary theory which is worked out in detail in such books as Starling's "Electricity and Magnetism." First we shall define magnetic potential at a point as the work² done in carrying a unit north magnetic pole from infinity to the point in question. The value of the potential at a point, is $V = m/d$ where m is the pole strength and d is the distance of the point P from the pole, m . In the derivation it will be seen that we first get the difference of potential between two points and then assume that the farthest point is at infinity. In fact we do what we always do when we measure potential. We find the difference of potential between two points.

A second definition of potential is a mathematical one which we shall use as the occasion arises. This definition is: Potential is a quantity whose negative space rate of variation in any direction is the strength of the field in that direction.

As an illustration we shall find the potential at a point, P , due to a short magnet (Fig. 1). Since $V = m/d$ we have the

² (Author's Note: Strictly speaking the potential V is numerically equal to the work done in carrying unit north pole.)

potential due to the north end as $m/(x-l)$ where $2l$ is the length of the magnet and x is the distance of P from the center of the magnet. The potential due to the south end is $m/(x+l)$. Then

$$V = m(1/(x-l) - 1/(x+l)) = \frac{m(x+l) - (x-l)}{(x^2 - l^2)}$$

$V = 2ml/(x^2 - l^2)$ which when the magnet is short enough to neglect l in comparison with x , becomes $V = M/x^2$, where $2ml = M$, the magnetic moment of the magnet. We can get

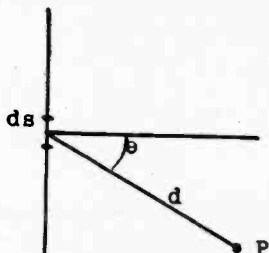

Fig. 2

the field, H , by taking the negative space derivative of the potential. The field $H = -dV/dx = 2M/x^3$. This follows from the second definition of potential.

If we apply the same general process as that used in deriving the potential due to a magnet, Fig. 1, the field at the point P can be found as follows: Since the field H is defined as being

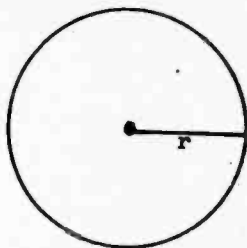

Fig. 3

numerically equal to the force on a unit pole if the unit pole were at the point P , and since force is equal to the product of pole strength divided by the square of the distance,

$$\begin{aligned} H &= m/(x-l)^2 - m/(x+l)^2 = \frac{m((x+l)^2 - (x-l)^2)}{(x^2 - l^2)^2} \\ &= \frac{4mlx}{(x^2 - l^2)^2} = \frac{2Mx}{(x^2 - l^2)^2}, \text{ where } M = 2ml, \end{aligned}$$

which when the magnet is short becomes $H = 2M/x^3$, which is the same as that derived above.

In the same manner for a point P' , Fig. 1, placed broadside on the magnet at a distance y , the potential is $V = 0$, and the field is $H = M/y^3$. Although the potential is zero the derivative of V in a direction parallel to the axis of the magnet is M/y^3 as shown below.

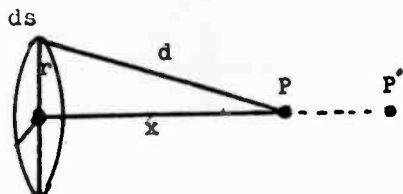

Fig. 4

The general relation of magnetic field, H , to a current in a wire may be given by the equation, $H = Ids \cos \theta / d^2$, where I is the current in an elemental length ds and θ is the angle between d and the normal to ds , Fig. 2. If this applies to a coil of wire the field at the center of the coil is $H = I2\pi r / r^2 = 2\pi I / r$, (Fig. 3.). If the point P is on the normal to the plane of the coil at a distance x from the coil (Fig. 4) we have

$$H = \frac{2\pi r I}{x^2 + r^2} \frac{r}{\sqrt{x^2 + r^2}}$$

which becomes, when x is great compared to the radius r ,

$$H = 2\pi r^2 I / x^3 = 2IA / x^3,$$

where A is the area of the coil. If we assume that IA is the mag-

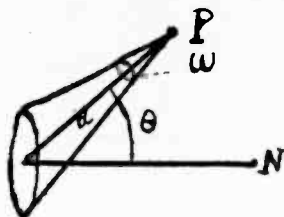

Fig. 5

netic moment of the coil we have $H = 2M/x^3$, which corresponds to the value derived for a short magnet. And

$$V = M/x^2 = IA/x^2 = I\omega,$$

where $\omega = A/x^2$ is the solid angle at P subtended by the area of the coil. When the point P is not on the perpendicular to the coil, Fig. 5, the solid angle is $A \cos \theta/d^2$, where θ is the angle between d and the normal.

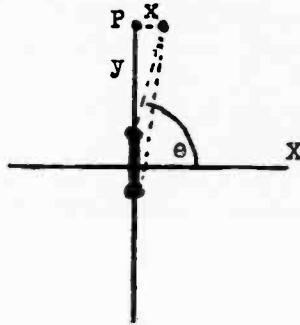

Fig. 6

In the neighborhood of the point P , Fig. 6, the potential is $V = IA \cos \theta/y^2$ or $V = (IA/y^2)(x/y)$ and $H = -dV/dx = IA/y^3$.

In the cases cited, H is the value of the field in the x direction, the direction along which the space derivative is taken which is perpendicular to the face of the coil. The potential V is scalar, that is, independent of direction and the negative derivative with respect to x gives the field along x .

If we apply the equation $H = Ids \cos \theta/x^2$ to a vertical antenna, Fig. 7, and consider the point P to be so situated that for practical purposes $\cos \theta = 1$, we have $H = Ih/x^2$, where h is the effective height of the aerial.

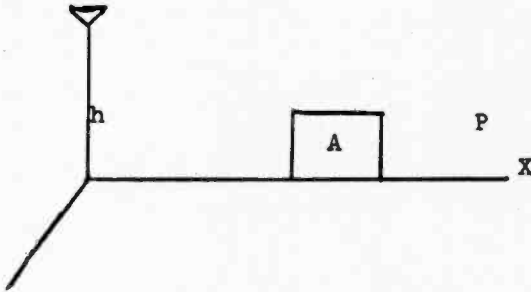

Fig. 7

Since $H = Ih/x^2$ and the potential is such that $-dV/dx = H$, then the potential must be $V = Ih/x$ since the negative derivative

of this value gives the field H . In this case we know that the field H is represented by concentric circles with the aerial, h , as a center and that H at the point P is perpendicular to the direction of x . The expression Ih/x has the same form as Dellinger's vector potential, $(i)h/x$.

So far we have assumed that the current, I , is direct current or if alternating current the virtual field due to the alternating current, I , is numerically the same as that produced by a direct current of the same value. Since the current in an aerial is alternating current, I must be replaced by the expression $I = I_0 \sin \omega t$. If we use this value of I in the expression for V and take the space derivative and use the "root mean square" we get the same value for H as before. This is the field which is called induction. Thus induction is the field we usually think of when we speak of self-induction, of mutual induction, of transformers and induced currents. Due to induction, energy is stored up in the field when the current is increasing and the energy is again absorbed by the circuit when the current is decreasing. In a pure inductive circuit with alternating current no energy is dissipated. All the energy stays at home. None is radiated into space. The current is "wattless."

In the case of the aerial we know that the field at any particular instant is different at different positions. The field at a particular time at a particular point is due to the current which was in the aerial a fraction of a second before. The current may have reversed several times in the meantime. To take this into account we must change our equation for the current to $I = I_0 \sin \omega(t - t')$ where t' is the time it has taken for the wave to travel from the aerial to the point in question. Since $t' = x/v$ where v is the velocity of light our value of the vector potential is

$$V = \frac{hI_0 \sin \omega(t - x/v)}{x}$$

Then

$$H = -\frac{dv}{dx} = \frac{d}{dx} \frac{(hI_0 \sin \omega(t - x/v))}{x}$$

$$H = \frac{hI_0}{x^2} \sin(\omega t - x/v) + \frac{hI_0 \omega}{xv} \cos \omega(t - x/v).$$

Thus we see that the field, H , consists of two parts. The first is the field we get by considering the current to be constant, or if

alternating current, by considering the field to be independent of the sine of the angle. This virtual field is numerically the same as the field due to a direct current.

The second part is that in which we consider the angle to depend on the distance x . The two parts are out of phase by 90 degrees. We remember we had trouble with the ordinary field in our elementary picture because it was out of phase with the electric field. This second part is in phase with the electric field.

The first part is induction. The second part is radiation. The first part, the induction, diminishes as the square of the distance while the second, the radiation, diminishes as the distance.

We can write the virtual values of the magnetic field by considering the sine and cosine to be unity, and writing I for the virtual current, then

$$\text{Induction, } H = hI/x^2$$

$$\text{Radiation, } H = hI\omega/vx.$$

If I is measured in amperes, $I/10$ will give the value of I to make the field in lines per square centimeters. Since

$$\frac{\omega}{v} = \frac{2\pi}{\lambda}$$

$$\text{Radiation, } H = \frac{hI2\pi}{10\lambda x}$$

Equating the two values and solving for x we find that the two components of H are numerically equal when $x = \lambda/2\pi$. At a

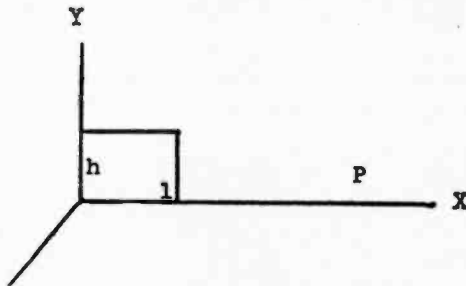

Fig. 8

distance equal to $1/6.28$ of a wavelength the two values are numerically equal. Since they are in time quadrature the measured value will be 1.414 times the calculated value of one. Closer to the aerial the value of H is nearly all induction and

diminishes as the square of the distance. Beyond this point the field is mostly all radiation and varies inversely as the distance.

If instead of an antenna aerial we have a coil aerial the induction can be calculated as is done in the first part of the paper. Induction is the ordinary field due to direct current. It is found to diminish as the cube of the distance from a coil. It is $2IA/d^3$ perpendicular to the plane of the coil and IA/d^3 in the plane of the coil.

For radiation we follow Dellinger, considering a square coil in the XY plane of height h , and length l , Fig. 8. The horizontal parts will not contribute to field at a point P in the horizontal plane. Then the radiation at P consists of two components,

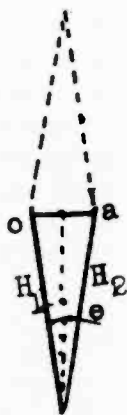

Fig. 9

one each from the two vertical wires. These two will be equal but slightly out of phase because the distance of one is greater than the other by l centimeters. The resultant field at P is the vector difference of the two equal vectors which differ in direction by a small angle, θ . $\theta/2\pi = l/\lambda$ or $\theta = 2\pi l/\lambda$. In the diagram, Fig. 9, $oa = 2H_1 \sin \theta/2$. Since θ is small, $\sin \theta/2 = \theta/2$, then

$$oa = H = 2\pi \left(\frac{hI}{\lambda x} \right) \frac{2\pi l}{\lambda} = 4\pi^2 hI / \lambda^2 x.$$

Thus the radiation from a coil varies inversely as the distance while the induction varies inversely as the cube of the distance.

The radiation from a coil varies inversely as the square of the wavelength while from an antenna inversely as the wavelength.

The induction from a coil is IA/d^3 and the radiation from the same coil is $4\pi^2IA/\lambda^2d$. Equating the two values we get $1/d^2 = 4\pi^2/\lambda^2$ or $d = \lambda/2\pi$. Thus the two components are equal at a distance $\lambda/6.28$, the same being true for an antenna aerial. Close to the coil or antenna aerial the field is primarily induction.

For practical purposes when the distance is less than $1/20$ of a wavelength the radiation can be neglected, and when the distance is greater than $1/2$ wavelength the induction can be neglected.

The energy represented by induction does not leave the aerial. It is stored in the medium during the first fourth of a cycle and then returns to the aerial during the second fourth of the cycle in the same manner as the field of an ordinary transformer or choke coil. The induction is the field which stays at home. The energy of the field of the radiation does not return to the aerial but passes out to infinity unless it is absorbed by intervening objects. The energy is radiated into space.

Of course it is possible to absorb a part of the energy of induction if the absorber is in the field of the induction, that is, near the aerial. This is the same as in a transformer part of the energy may be absorbed by the secondary coil in which case it cannot return to the primary.

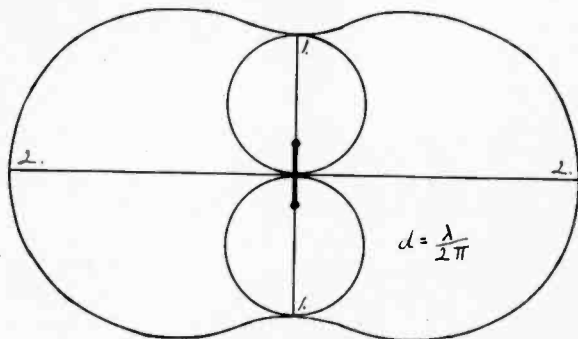

Fig. 10—Showing the Distribution of Radiation and Induction when the distance $d = \lambda/2\pi$. In the plane of the coil the radiation and induction are equal. Perpendicular to the coil the radiation is zero while the induction is twice the value in the coil's plane.

It will be noted that radiation from a given aerial depends upon the frequency or wavelength. Induction is independent of frequency. The virtual value of induction field for 60 cycle, 300 meters or 41 meters is numerically the same as that produced by direct current.

The induced emf in a vertical receiving aerial is equal to the number of lines of force cut per second. This for a magnetic field of H moving with a velocity of v (velocity of light) centimeters per second past a receiving antenna of height h , is $e = h_r H v$ absolute units of electromotive force. Since in an electromagnetic wave there is always an electric field, E , perpendicular to the magnetic field, H , the emf in the antenna is $e = E h_r$, E being expressed in absolute units per centimeter. Since the induced electromotive force is the same in both cases $e = E h_r = h_r H v$, and $E = H v = 3 \times 10^{10} H$.

It turns out that if E is expressed in microvolts per meter the numerical value is the same as if expressed in absolute units per centimeter.

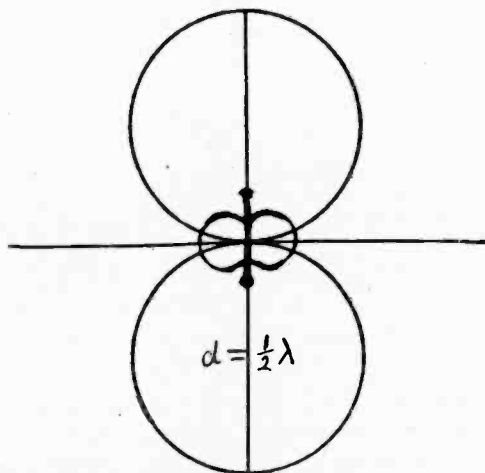

Fig. 11—Showing the Distribution of Radiation and Induction when the distance $d = \frac{1}{2} \lambda$. The induction can be neglected.

If a coil is used as receiver the induced emf is calculated from the rate of change of the field through the coil, Fig. 7.

Thus $E = H A_r 2 \pi n / 10^8$ volts.

The effective height of a coil is the height, h , of a receiving antenna in which the theoretical induced emf is the same as that in the coil for the particular radiation. This height changes with frequency. The higher the frequency the greater the effective height of a particular coil.

From the fundamental equations as given above, Dellinger's four equations for received current in coils and antennas can

be derived. Since they are well-known they do not need to be repeated here.

To sum up the above, the potential and field due to a short magnet and to a coil have been derived, and from a rather loose analogy the vector potential has been derived in the case of an antenna. From this vector potential the radiation has been derived.

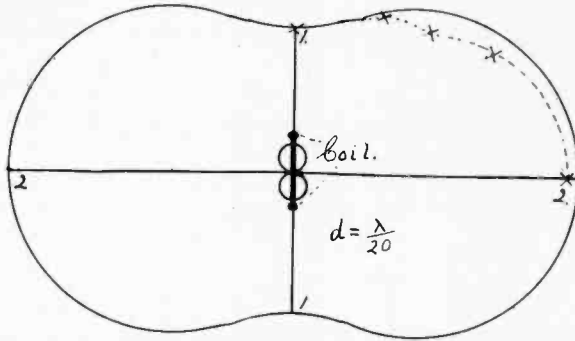

Fig. 12—Showing the Distribution of Induction about a coil according to the equation $H = IA/d^3 \sqrt{1 + 3 \cos^2 \theta}$ where θ is measured from the normal to the coil. The dotted line shows the measured values. The two small circles at the center show the relative values of the radiation when $d = \lambda/20$.

Experimental Results. In the above formula it will be noted that the shorter the wavelength or greater the frequency the greater the radiation field from a coil or antenna. And since the received current in a coil increases with frequency, it is advantageous to use short waves. Since the height of an antenna is an uncertain quantity, a coil was used. The frequency selected compared to a wavelength of 16 meters. Short waves are an advantage since the radiation and induction are numerically equal at $\lambda/2\pi$ and at a distance greater than $1/2$ wavelength the induction field can be neglected.

Fig. 10 shows the relative distribution of radiation and induction when the distance is $\lambda/2\pi$. The circles show the radiation, and the "squeezed" elliptical figure shows the induction. The values are numerically equal in the plane of the coil.

Fig. 11 shows the relative values of radiation and induction when the distance is $\lambda/2$. In this case the small figure-eight figure shows the induction which can be neglected.

Fig. 12 shows the distribution when the distance is $\lambda/20$. In this case the radiation can be neglected.

The radiating coil used in radiation determinations was a square coil of one turn whose area was 3140 square centimeters connected in a Colpitts circuit and made to oscillate at 16 meters. Fig. 13 shows the diagram of hook-up. The receiving coil was a

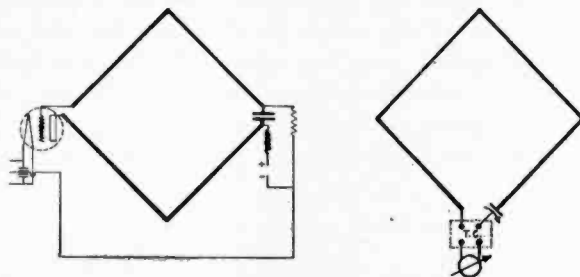

Fig. 13—Diagram of Oscillator Circuit and receiving Circuit Used in Radiation Experiments. The wavelength was 16 meters.

single-turn coil, area 1913 square centimeters. A thermojunction was connected in the circuit and a micro-ammeter was used to register the current. The maximum received current was about 80 milliamperes and the minimum was about 5 milliamperes. The resistance of the receiving coil was 3.2 ohms.

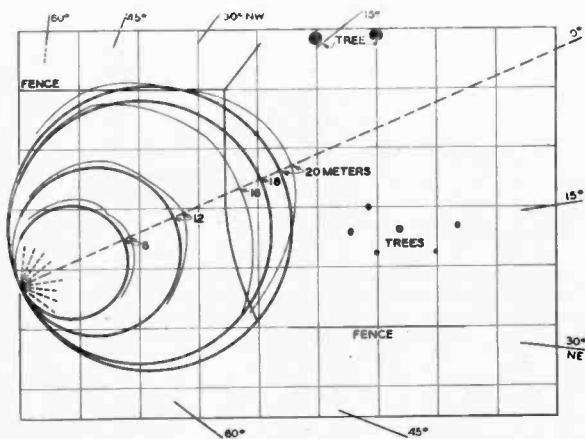

Fig. 14—Showing the General Lay of the Ground and Obstructions Such as Trees and Fence.

The heavy circles show the theoretical distribution of radiation when d is 8, 12, 18, and 20 meters. The lighter lines show the measured distribution.

Two fifty-watt tubes were used in the oscillating circuit. The filament supply was a 12-volt 60-cycle transformer regulated by a rheostat in the 110-volt side. The plate supply was a

1500-volt transformer with a rheostat in the 110-volt supply. The tubes were the only rectifier used. This variable supply caused the wave to be rather broad. The decrement factor was determined by connecting the tubes to a high potential d.c. generator and adjusting the circuit until the normal oscillating current was the normal value, about 5 amperes, and comparing the received current with that received when the same value, 5 amperes, was generated with the a.c. supply, the position of transmitter and receiver being the same in both cases. The ratio of the two received currents was found to be 1.2. This factor

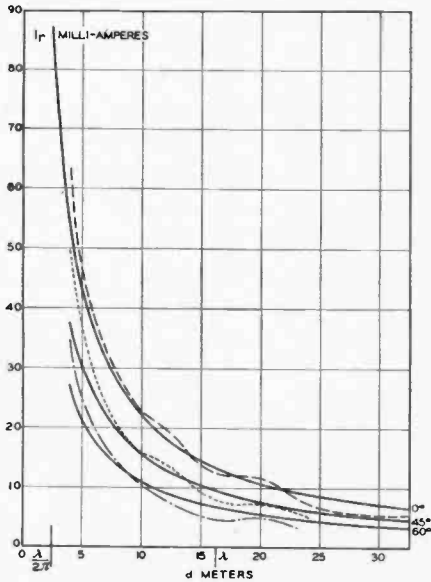

Fig. 15—Showing the Relative Values of Radiation in Terms of Received Current, with Distance for Various Angles. The angle is measured from the plane of the coil. The heavy line shows the theoretical value of the current and the broken lines the observed current.

was used to correct the received current. The transmitter and transformers were mounted on a table. The only supply line was a long lamp cord through which the 110-volt alternating current was conducted. Radio-frequency chokes were placed in the supply. The simplicity and safety of this was thought to outweigh any advantage that a high-potential, d.c. supply might have.

The location was a comparatively open space in front of Science Hall, Indiana University. This was not ideal, since at points removed some distance from the oscillator the reflection

from trees and other objects could be easily noticed. A more open space is desirable but the question of a convenient power supply led to the choosing of this location. A small island or rock in a lake would be ideal, a boat being used to carry the receiver.

Fig. 14 gives the general contour of the plot. The northwest quadrant was relatively free from reflections and the results check with theory for distances about 10 to 20 meters from the oscillator. Closer than 10 meters the induction was an appreciable quantity and at greater distances than 20 meters the reflections

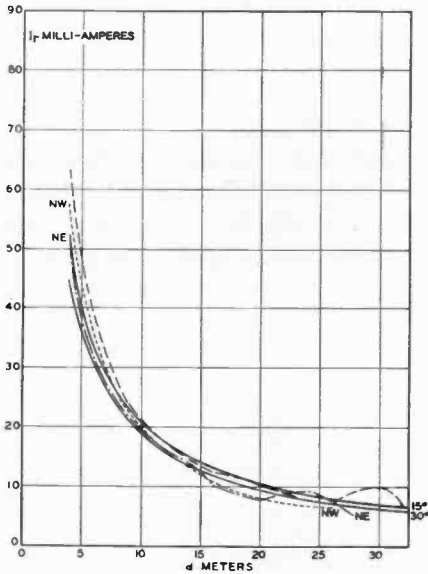

Fig. 16

from objects were appreciable. Fig. 14 gives the theoretical distribution of the radiation field and the measured distribution. The theoretical field is shown by heavy lined circles and the measured values by the lighter lines. A guard fence of a single iron wire and several trees are also shown in Fig. 14. Figs. 15 and 16 also show the distribution in another way. Fig. 15 shows by the heavy curve the theoretical distribution which varies inversely as the distance for angles of 0 deg., 45 deg., and 60 deg. from the plane of the transmitting coil. The broken lines show the measured values. Fig. 16 shows the same thing for 15 deg. and 30 deg. Values in this case are given for measurements in the northeast

and northwest quadrants. The periodic variations in the measured results are without doubt due to reflections.

For induction fields the measurements must be made so close to the aerial that radiation does not make an appreciable reading. This must be close to the aerial but not too close, since for short distances there is a question as to the point of the coil from which measurements of the distance are to be made. The distance must be great compared with the diameter of the coils. On this account short waves are not advantageous.

An oscillator of seven turns connected in the Hartley circuit and adjusted to oscillate at 500 meters was used. Fig. 12 gives the theoretical variation of the induction field with the angle. The irregular flattened elliptical figure gives the induction; the two circles give the radiation distribution. The broken line gives the measured distribution.

The measured values do not agree in every detail, but all the discrepancies can be explained in terms of reflections or reradiation from trees or other objects. The distribution of radiation about a tree makes an interesting study in itself.

DEVELOPMENT OF A SYSTEM OF LINE POWER FOR RADIO*

By

GEORGE B. CROUSE

(Conner Crouse Corporation, New York City)

Summary—A short history of the development of power supply apparatus for radio receivers is given, including a brief discussion of the technical requirements, such as the most desirable suppression characteristics, the necessity for voltage regulation, etc.

The various devices which have been developed are described.

The present status of the art and the scope and limitations of the different types of apparatus are discussed.

The series wired radio set with common power supply for plate filament and grid circuit is discussed in some detail, and curves of the operating characteristics of such a set are given.

THE history of the development of radio socket power is interesting, not alone from the technical standpoint, but also as teaching a number of valuable commercial lessons.

This interest from either viewpoint arises largely from the fact that while most commercial devices stand very largely on their own feet, the radio socket power has to be coordinated in a peculiar and unusual degree with the radio receiver which it serves. Furthermore, socket powers are a combination of two elements, a rectifier and a filter. The problems in the design and manufacture of these two elements are so different that their development has always been in separate hands. Because of this separation the development of the complete unit was not in the early days well-coordinated and the influence of the separation has been felt throughout the entire history of the art.

But despite the difficulties, both natural and artificial, which surrounded the development of this art, we have now reached the point where radio, operated from the electric light socket, is an established fact. Socket-power sets are now available to the public at reasonable prices, which are reliable in operation and satisfactory in results.

When radio socket powers first appeared on the market about three years ago the regenerative circuit was almost universally used with reproducers of the head-set type and because of the comparatively small number and low power of the transmitting

*Original Manuscript Received by the Institute, March 10, 1928. Revised Manuscript received March 30, 1928. Presented before Rochester Section, January 13, 1928.

stations it was necessary to reach out for distance to get full and satisfactory programs. Because of the sensitivity of the head set and because of the low value of the available signal strength, the problem of filtering was all-important. The design of filter networks of the type required for this service was not well understood. While the mathematics of band-pass filters for telephone work had been very thoroughly worked out very little was known by radio engineers in general about the design of networks for the suppression of alternating-current components in a direct-current line.

The two problems are quite different. Let us digress for a moment to discuss the differences, for the sake of clarity.

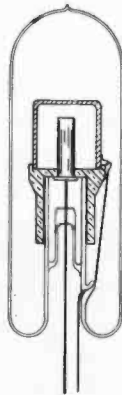

Fig. 1—"Karbo" Tube without Base.

In the first place, the telephone filter is "frequency-selective." That is, its function is to pass certain frequencies with as little loss as possible, and to suppress completely, all other frequencies. The socket-power filter, on the other hand, must very thoroughly suppress every alternating component which may be present in the output of the rectifier. These frequencies cover an enormous band. In devices operating from sixty-cycle supply, and using full-wave rectification, there will be present a large component of 120 cycles, a small 60-cycle component, and long series of higher harmonics, extending as far as the sixteenth. Of these components of course the 120-cycle is by far the largest, and it ordinarily requires the greatest suppression.

Another difference between the two types is the presence of direct current in large amounts in the socket-power filter. This

means that the inductances must be of special design, and that any shunt capacities employed have a dual function, acting not only as capacities in the mesh, but as direct-current energy-storing devices.

The obvious solution was found to be the use of very high capacities, which were obtained at low cost by means of electrolytic condensers. Furthermore, since the problem of filtering is made less difficult by a decrease in the direct current, means were worked out for operating the filaments of the radio set in series.

A successful device along this line appeared on the market in the fall of 1924. The rectifiers, two in number, were of the cold cathode, gas-filled type. In Fig. 1 a line drawing of these early rectifiers is shown. In Fig. 2 is shown a diagram of the complete unit and its suppression characteristic.

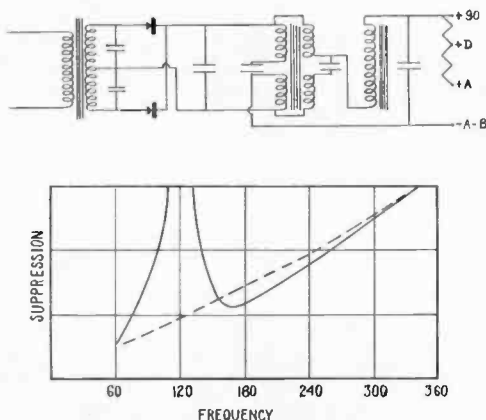

Fig. 2—Original Socket-Power and Suppression Characteristic.

In the filter of this unit appeared a principle which we have retained to the present time. As stated above, the 120-cycle component is by far the largest in amplitude, and because of its low frequency it is difficult to filter. The filter of Fig. 2 is designed to exert its maximum suppression at this frequency. For comparison, there is shown in dotted lines the suppression characteristic of the usual type of filter, using series inductance and shunt capacity. The great advantage of the former curve will be readily appreciated.

The difficulties encountered with this first unit had to do principally with the electrolytic condensers. These devices, which because of their low cost per unit of capacity appear very attrac-

tive, have the serious defect that their operation depends upon a very high degree of chemical purity of all of the substances used in their manufacture. They are particularly sensitive to chlorine and sulphur ions, and most extreme precautions must be taken in the manufacture to exclude these substances and to prevent their entrance at any time during the life of the cell.

These difficulties with the electrolytic condenser appeared early, necessitating intensive work on the theoretical and practical study of filter meshes, with the result that very shortly the electrolytic devices were replaced by paper condensers of much smaller total capacity. When this change was made the result was a complete socket-power device capable of delivering *A*, *B*, and *C* power to a set of any size, and while many improvements in details have been made since then, this early device is still commercial and could be marketed today. However, the opposition to the use of series wiring of filaments on the part of radio manufacturers has prevented the introduction of this system until two seasons ago.

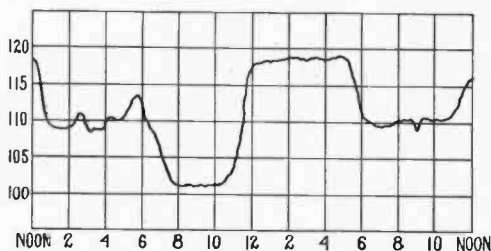

Fig. 3—Typical Line Voltage Chart.

As a result of this opposition, socket-power manufacturers had to be content with turning out a device for supplying *B* power alone, which theoretically at least could be applied to any radio set. Most of the early models of the *B*-power units, however, had very poor performance. The manufacturers had no knowledge of the demands which their devices placed on the rectifier tube, with the result that this replaceable element generally had a very short life. At the same time radio sets were in general exceedingly sensitive to inter-stage coupling, in both the radio and audio stages, and the *B*-battery unit introduced a larger inter-stage coupling than the dry battery. Despite these difficulties, however, the public eagerly absorbed everything that was put out.

While the technical knowledge and skill required to build suitable rectifiers were available at that time, it was some time before the tube manufacturers could be brought to realize the possibilities of this branch of industry. However, they have nobly made up for their lack of early effort, and now exceedingly satisfactory rectifiers are available for practically every class of service.

TABLE I
RECTIFIERS AVAILABLE IN 1924

Name	Description	Direct Current	D. C. Volts
Tungar	Hot Cathode Gas-Filled	2 Amps.	40-50
Tungar	Half Wave	5 "	80
Karbo	Cold Cathode Gas-Filled	15 "	180
_____	Half Wave Various Types of Electrolytic Devices		

An idea of how thoroughly this work has been done may be gained from consideration of Tables I and II. Table I gives the characteristics of the types of rectifiers available in 1924. Table II is a similar table of the various types of present-day rectifiers. It will be seen that today, whatever voltage or current the socket-power designer may require, he can find an economical rectifier commercially available for his purpose.

TABLE II
RECTIFIERS AVAILABLE IN 1928

Name	Description	Direct Current	D. C. Volts
Tungar	Hot Cathode Gas-Filled	Half Wave	40
		" "	80
		" "	100
		Full "	30
Radiotron	Hot Cathode High Vacuum	Up to 0.125	550
Raytheon	Cold Cathode Gas-Filled	Full Wave	300
		Full Wave	320
		Crystal Type Full Wave	8-10

In the meantime the character of radio reception was changing; new and larger broadcasting stations were being built and the radio listener became more and more interested in the entertainment value of radio. The head set was replaced by the loudspeaker. This change naturally reacted on the design of the socket-power units. Because of the lower sensitivity of the loudspeaker and of the high available signal strength, the problem of

residual ripple became less important, and this, together with the continually increasing knowledge of filter design, made the socket-power devices smaller and more economical. However, a new problem now arose. In the old days when the listener sat immediately in front of the set, his hands continually poised to readjust several controls, it made very little difference whether the voltages applied to the set were constant or not. The users of loudspeakers, however, desire to adjust the set and then leave it. Since the radio-set designers had found that the most satisfactory volume control was one which varied the electron emission in one or more radio stages, and since the voltage at most sockets varies through several volts, as will be seen from a typical voltage record in Fig. 3, it became absolutely essential to develop cheap and reliable voltage-control devices. Two successful types of regulator which are cheap to build, economical in operation, and reliable, are shown in Figs. 4 and 5. The device shown in Fig. 4 employs a temperature-variant resistance, while the device shown in Fig. 5 is purely magnetic.

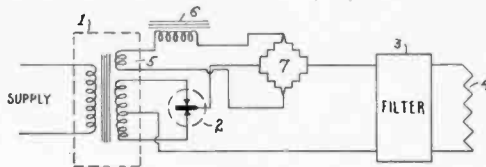

Fig. 4—Resistance Type Voltage Regulator.

In Fig. 4 the parts included in block 1 comprise a transformer; 2 is a rectifier, 3 the filter, and 4 the load. The voltage regulator comprises three elements: an additional secondary winding 5 on the transformer, an iron core inductance 6, whose core is magnetically saturated, and a temperature-variant resistance 7, arranged in the form of a bridge inserted in one of the leads connecting the rectifier to the filter.

The operation of the device may be briefly described as follows: Suppose the voltage of the supply to rise above some normal minimum value. This will cause an increase in voltage across the terminals of the secondary 5, and because of the presence of the saturated core inductance 6 in this circuit, a considerably increased alternating current will be caused to flow from the secondary 5 through the bridge resistance 7. Because of the positive temperature coefficient of this resistance its value will be

much increased and will thereby absorb the additional potential across the rectifier output caused by the increased supply voltage. Owing to the balanced bridge arrangement of the resistance 7, the direct current to the filter is electrically isolated from the alternating regulating current supplied by the secondary 5, so that no direct current will be wasted in the regulating circuit and no alternating components will be introduced by the regulating circuit into the d.c. circuit.

This device is, of course, not instantaneous in action, but by proper mechanical design of the resistance 7 may be made to operate in a few seconds.

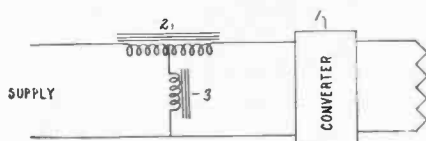

Fig. 5—Magnetic Type Voltage Regulator.

The second device, shown in Fig. 5, operates entirely in the primary side of the a.c. circuit, and the transformer, rectifier, and filter are all included in the block 1 marked "Converter." The regulator comprises a series inductive element 2, so designed that its iron core never becomes saturated throughout the normal working range of the device, and a shunt inductive element 3 whose iron core is normally saturated. The theory of operation of the device is somewhat involved, but it may be roughly stated that an increased supply voltage causes a magnified increase of current through the saturated element 3. This magnified current flowing through a portion of the inductance 2 causes an increased potential drop across that element to affect regulation, and this increase of potential drop is multiplied by the ratio of total turns to the turns included between the supply and the connection of the coil 3.

This device is instantaneous in operation and, as will have been noted, requires no temperature-variant resistance.

The great number of sets in service, together with the opposition of the manufacturers to series filament wiring, gave considerable impetus to research work directed toward the design of a filter which would supply $1\frac{1}{2}$ to 2 amperes of A current to radio sets with parallel filament wiring. One or two abortive attempts along this line found their way to the market in 1925. These

devices were inductance-resistance types, employing series inductance and shunt resistance elements. Such an arrangement has two serious disadvantages; in the first place, the amount of current which must be by-passed through the shunt elements is very large, and, secondly, its suppression characteristic is unsuited to the filtering of rectified current.

The problem was finally solved, as will be discussed more fully later, and successful filters of this type are now in operation.

We may go back at this point and trace the development of the so-called a.c. tube. Obviously, the current flowing in the filament of an audion has no function other than to heat the filament to the point where emission in satisfactory quantities takes place. It would therefore seem that since alternating current is just as satisfactory for heating purposes as direct current, it would be possible to use alternating current directly on the filaments. Alternating current had been so used as early as 1916 to heat filaments of large audions in transmitting stations. A part of the difficulty arising from the variation in potential drop across the filament (which variation is introduced into the grid circuit) was overcome by the scheme proposed, apparently independently, by White and Heising, of connecting the grid and plate returns to the center point of the filament, or the center point of an impedance connected across the filament. For transmitting tubes this worked very well, but when it was attempted to apply it to radio receivers where the signal energy was very small, it was found that even with the midpoint connection both radio and audio difficulties developed. It was at first thought that these difficulties were connected in some way with variations in filament temperature at different parts of the a.c. cycle. In the early part of 1923 the writer performed a series of experiments with tubes having wide variation of ratio of filament mass to filament radiating area, which showed conclusively that the difficulty was in no way connected with the alternate heating and cooling of the filament, except with very fine filaments such as were used in the 60-milliampere tubes. The trouble was caused entirely by the varying drop across the filament. Tubes in which the drop has been reduced to $1\frac{1}{2}$ volts are now on the market and their sphere of usefulness will be discussed a little later.

With the investigation of these phenomena another method of solution presented itself. I am not sure where the suggestion originated; however, in 1919 Professor Morecroft described in his

book, "Radio Communication," an equi-potential cathode tube in which alternating current might be used to heat an element which in turn radiated heat on to a cathode in no way connected to the a. c. circuit. This line of development has also been brought to a commercial point and several manufacturers have placed such tubes on the market within the past year. These tubes are much more satisfactory from the radio designer's standpoint but seem to be inherently expensive to build.

Having taken a brief view of the history of line-power device, we now turn to a discussion of the various types of apparatus available to the radio-set manufacturer and the public, and the scope of usefulness of each type.

The a. c. tube has for some reason proved very alluring to radio-set manufacturers. Its principal advantage seems to be compactness. A number of sets have appeared employing an indirect heater type of tube in the radio socket and the low-voltage cathode type in the other sockets. It is too early to say much concerning the practical performance of these sets. It seems fairly definitely established, however, that in the present state of development of these tubes it is not possible to build as good a radio or audio amplifier as with the d. c. type. Sets employing indirect heaters in all stages may be made to give high quality of reproduction, but this greatly increases both the first cost and the cost of replacement.

Another of the principal difficulties met with in the a. c. tubes has been their sensitiveness to the filament excitation voltage. Since wide variations of line voltage are encountered in the United States this has proved very troublesome. The only satisfactory solution seems to be the inclusion of a voltage regulating device as a part of the radio receiver. Since at least one cheap and satisfactory device for voltage regulation is now available, it seems quite probable that this step will be taken on a large scale in the near future.

The parallel filament device with a suitable *B* socket power has its field of usefulness in connection with high-grade sets and also as an accessory for converting sets now in the users' hands.

Turning to the first mentioned field, the radio-set manufacturer is beginning to realize that it is very costly to change the design of his product radically every season. The money invested in special tools is obviously thrown away. What is not generally appreciated is that the money invested in the time of the engi-

neers is also thrown away. It may of course be said that engineers are a necessary part of the radio manufacturers' organization and may as well be kept occupied, but it seems probable that at the present time research work along the line of detail improvement is more profitable than the design of an entirely new receiver every year.

The large current socket power furnishes a means of converting a d.c. radio set into a socket-power set, without any change in the radio set itself; so far as the high-priced complicated units are concerned, this has proved very attractive.

Two types of units are available for this service. In Fig. 8 is shown a diagram of one electrical type, which is already in successful commercial operation.

In Fig. 6 the voltage regulator is represented by 1—the voltage regulator was described previously,—2 is the transformer, and 3 the rectifier, of the Tungar full-wave type. The filter, shown in 4, is of the inductance-resistance type. What may be termed the "Siamese System" comprises the three coils 5, 6, and 7, and the band 8, all mounted as shown on the two adjacent iron cores 9 and 10. Two resistances are employed, one, 11, connected across the coil 5, and the other, 12, connected between the junction point of the coils 5 and 6, and the negative side of the d.c. line. This device has some interesting and valuable properties. It is a "blanket filter," having a high degree of suppression at all frequencies, and, curiously, although it employs only resistance and inductance, it has a distinct "anti-resonance" point which by suitable design may be made to fall at 120 cycles, or at any other desired point.

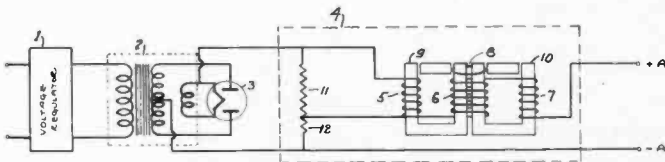

Fig. 6—High-Current Socket Power.

The total inductance of the device, under full d.c. load, is less than one henry, but the r.m.s. value of the unfiltered ripple at the output is less than one-tenth of one per cent. This high filtering efficiency with low values of inductance is very desirable. It should be emphasized that, particularly in high-current filters for this class of service, the physical size of the inductance units

is not determined by the temperature to which the insulation may be worked, as in most electrical apparatus. The size is determined by the effect of the change in temperature of the coils on their resistance, which in turn causes a change in the output voltage as the device heats up. For this reason the coils must be worked at a very low temperature. This makes them very large and expensive, unless, as in this case, special circuits are employed to increase their effectiveness.

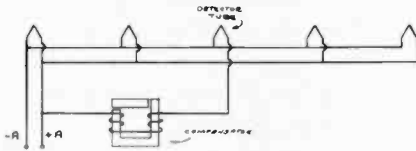

Fig. 7—Detector Filter.

Where the socket-power unit is intended for use with a particular set, its size and cost may be further reduced by the use of the simple arrangement shown in Fig. 7. It is well-known, of course, that the residual unfiltered ripple in the output of the socket power is amplified by the audio amplifier of the set, and it is therefore obvious that this ripple is more troublesome in the filament of the detector tube than anywhere else. By the simple use of the small coil shown in the figure, inserted in the filament circuit of the detector tube, the filaments of all of the other tubes of the set are made to act as the shunt resistance element of a one-section filter added to the filter of the socket-power device, for the benefit of the detector tube.

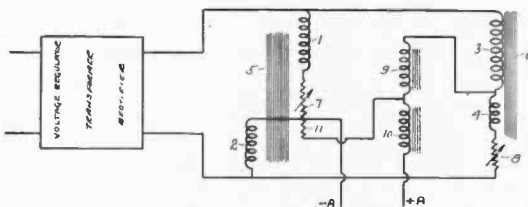

Fig. 8—Bridge-Type A Socket Power.

In Fig. 8 is shown a bridge type of filter for the same class of service. In this figure, the filter only is shown, the details of the voltage regulator, transformer, and rectifier being the same as in Fig. 6. The filter comprises two sections, the first being a bridge section, formed by the coils 1, 2, 3, and 4 wound on the cores 5

and 6 as shown, and the resistances 7 and 8; and a T section, formed by the two inductances 9 and 10 and the resistance 11. The bridge is balanced to the most troublesome frequency of the rectifier output and completely suppresses this frequency. At the same time the bridge, by the peculiar arrangement of the elements and by the use of the "reversed mutual" inductance between the coils 1 and 2 and 3 and 4, has a fairly good suppression characteristic at all higher frequencies. This has a double advantage in that it leaves very little to be done at the higher frequencies by the T section, and at the same time makes the bridge balance insensitive to change of frequency. A reduction in size of this unit may also be effected by the use of the arrangement shown in Fig. 7.



Fig. 9—Usual B Circuit.

Both of the units just described may be used as accessories. That is, they may be applied to sets now in service. They are dry, have nothing to wear out, with the exception of the rectifier, and can be marketed at a reasonable list price. It is not probable that those who now own high-grade sets operated from batteries will be willing lightly to dispose of them, and these units are a solution of that problem.

Within the last few months, a new type of electrolytic condenser for use in low-voltage, high-current filters has been incorporated in at least two socket-power devices now on the market, but no operating data are yet available on them.

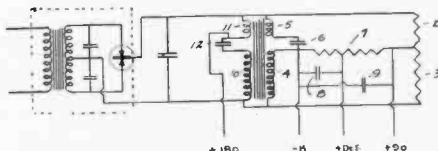

Fig. 10—Improved B Circuit.

The filament-supply devices just described may be used with B batteries, or with any form of B socket-power device. The most commonly used circuit is that shown in Fig. 9, and is too well-known to need description. In Fig. 10 is shown a type of B

socket-power which presents a number of advantages over the older form. In this figure, the transformer and rectifier are shown in block 1. The filter for all of the amplified stages except the last is of the bridge type, two arms being formed by the resistances 2 and 3, one arm by the inductance winding 4, and another arm by the inductance 5 and the condenser 6. The detector voltage is reduced to the proper value by means of the resistor 7, and the usual signal by-pass condensers 8 and 9 are provided. For the last tube, the two resistive arms are replaced by the arms formed by the coils 10 and 11 and the capacity 12. For a given size of parts (and therefore, for a given cost) this filter has much better filtering efficiency and better voltage characteristics under change of load than the older type.

What appears to be a very satisfactory solution of the socket-power problem for the radio-set builder is the series wired filament set, using a single rectifier and filter for supplying *A*, *B*, and *C* power.

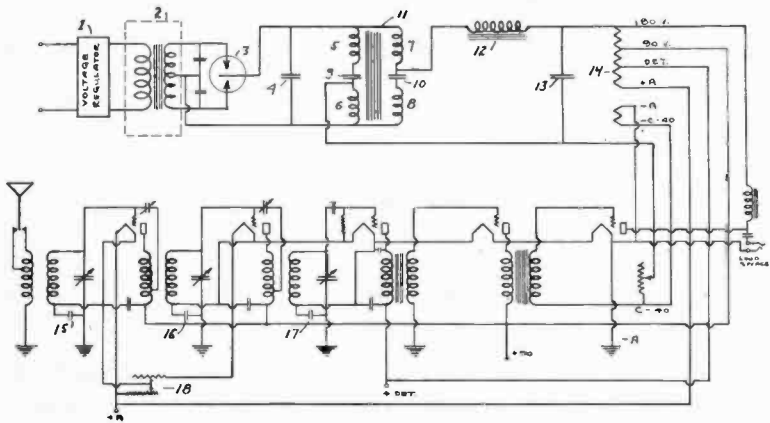

Fig. 11—Series Set—Socket Power.

In Fig. 11 is shown a complete diagram of the socket-power device and the radio set. In this figure, 1 is the voltage regulator, which may be of the type shown in Fig. 5. The parts in block 2 compose the transformer. The full-wave rectifier is shown at 3, working into the condenser 4. The filter is composed of the bridge section comprising the four coils 5, 6, 7, and 8, and the two condensers 9 and 10. This bridge is designed to be balanced at 120 cycles for a 60-cycle supply circuit. The coils of the bridge are all wound on a single iron core 11. An additional iron core induc-

tance 12 is provided, and the entire reactive network is terminated in the capacity 13.

For sets using the 171-A tube in the last stage, the socket power is designed to deliver approximately 300 milliamperes of filtered direct current at the terminals of the condenser 13, at a potential of 220 volts, the various voltages being tapped off from the potentiometer 14, as shown.

The very small number of changes that have been made in the radio set to accommodate the series wiring of the filaments should be especially noted. In order that it may not be necessary to insulate one variable condenser from another, paper condensers

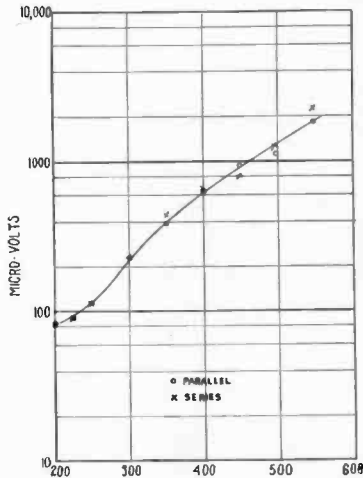

Fig. 12—Sensitivity Comparison, Parallel and Series.

have been used at 15, 16, and 17. The volume control 18 has been changed to the double type shown. These are the only changes that are necessary, and they add but little to the cost, in no way making any change in the operating characteristics of the set.

A very careful check of this latter point was recently made. A high-grade receiver, built by a well-known manufacturer, was selected, and its characteristics with battery supply determined by the Radio Frequency Laboratories of Boonton. They tested it for sensitivity, selectivity, and fidelity, the results of these tests being shown respectively on Figs. 12, 13, and 14 in dotted lines. The set was then re-wired in series, according to the diagram of Fig. 11, and retested with the socket power. The results of these tests are shown in the full lines in the same figures. It

will be seen that no appreciable difference in any of these characteristics is apparent.

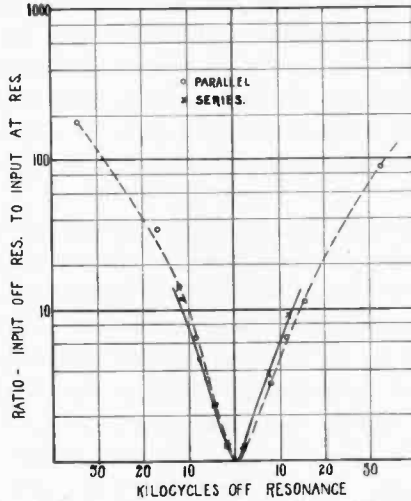

Fig. 13—Selectivity Comparison, Parallel and Series.

These tests show conclusively that the use of series wiring of the filaments with d.c. tubes, together with a socket-power device, imposes no new limitations on the radio-set designer. He does not have to use an inferior method of volume control; he

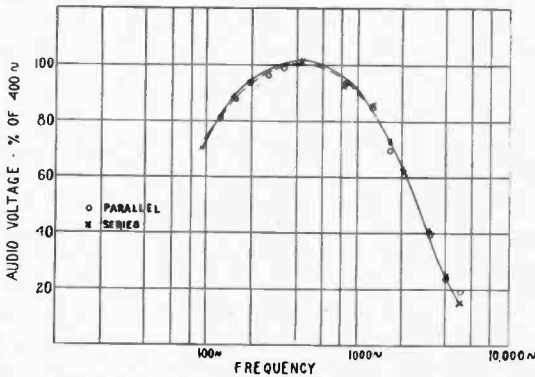

Fig. 14—Comparison of Fidelity, Parallel and Series Wiring.

can use the old reliable filament control of the r.f. stages. He does not have to sacrifice audio quality. He can use all his past experience, and all his standard parts.

In cost of construction the system is more economical than anything which has so far been proposed. Practically no expense is added to the receiver, and the socket-power device costs but little more than the *B* socket power which is a necessary part of any system. It will be noted that the socket power shown in the figure employs the same number of parts required for a *B* socket power alone. The transformer and coils are slightly larger than in a *B* device, whereas the requisite amount of capacity is usually somewhat less.

Another item of cost must be considered when comparing this system to, say, the a.c. tube system. Means have been worked out whereby the wiring of the set may be made universal. That is, the same set may be used interchangeably as a parallel-wired, battery-operated set, or as a series-wired, socket-power set. The simplification thus gained in all of the problems of manufacture and distribution hardly needs pointing out.

The development of this art to its present state has been the work of four years. We now find the major technical problems solved, and while the commercial situation is in general anything but satisfactory, we have every reason to believe that this difficulty also will be overcome in the near future.

BOOK REVIEW

HISTORY OF RADIO TELEGRAPHY AND TELEPHONY, BY G. G. BLAKE. Published by Chapman and Hall, Ltd., London. 440 pages, 270 illustrations. Price 25 shillings, net.

This book is not strictly a "history," but might more logically be called an "encyclopedia," containing as it does references to hundreds of inventions and developments pertaining to radio and associated sciences, which have been disclosed during the last half century. These items are roughly listed under sixteen chapter headings with the name of the inventor in each case displayed in bold face type.

In general the fundamental idea only of each of the items is set down in a brief summary, in non-technical language, without mathematics or other scientific proof. For this reason it makes an excellent reference book for those who have recently taken up the study of radio and are unacquainted with the many now little known steps of progress in radio technic. The old timers as well will find in the book many interesting processes described which have been all but forgotten now.

The reviewer (although acquainted with nearly all of the histories, etc., since the time he was awed with his first radio book—the first edition, then current, of Fleming's "Principles") found a great number of ideas and processes new to him. The inclusion of so many of these unique items contributes the greatest value to the book, since many of them are based on obscure physical phenomena and may again prove to be adaptable to other fields, such as television, broadcasting, etc.

It should not be gathered from the above that no present day appliances are included, for they are fairly well represented. The layman might experience difficulty, however, in distinguishing the items of present day equipment from those which are to be found in the museums. This classification, however, is so elastic, varying not only with time but with the country in which used, that this is not a defect.

One of the best features is the inclusion of a reference to the very extensive bibliography, with each item described. This bibliography contains over eleven hundred items so that the reader can continue the study of such processes as are of interest to him.

The book is clearly printed with easily read diagrams and clear photographs, is well-indexed for ready reference, and should make a valuable addition to any reference library.

R. R. BATCHER†

† Decatur Manufactory Co., Inc., Brooklyn, N. Y.

MONTHLY LIST OF REFERENCES TO CURRENT RADIO LITERATURE*

THIS is a list of references prepared by the Bureau of Standards for the months of May and June, 1928. It is intended to cover the more important papers of interest to professional radio engineers which have recently appeared in periodicals, books, etc. The number at the left of each reference classifies the reference by subject, in accordance with the scheme presented in "A Decimal Classification of Radio Subjects—An Extension of the Dewey System," Bureau of Standards Circular No. 138, a copy of which may be obtained for 10 cents from the Superintendent of Documents, Government Printing Office, Washington, D. C. The articles listed below are not obtainable from the Government. The various periodicals can be consulted at large public libraries or at The Engineering Societies Library, 33 West 39th Street, New York City.

R100. RADIO PRINCIPLES

- R110 Lambert, A. Sur la vitesse de propagation des ondes radio-telegraphiques. (On the velocity of propagation of radio waves.) *Comptes Rendus*, **186**, pp. 686-688; March 12, 1928. *Experimental Wireless* (London), **5**, p. 285; May, 1928.
- R113 Mesny, R. Observations et travaux recents sur la propagation des ondes electromagnetiques. (Recent observations and work on the propagation of electromagnetic waves.) *L'Onde Electrique*, **7**, pp. 129-155; April, 1928.
(Review of work done for two years on the question of propagation).
- R113 Taylor, A. H. and Young, L. C. Studies of high-frequency radio wave propagation. *Proc. I. R. E.*, **16**, pp. 561-578; May, 1928.
(Studies of multiple signals. Time of propagation of round-the-world signals and also of echoes having a very much shorter transmission distance. Method worked out for predicting in advance when round-the-world signals are likely to appear).
- R113.3 Pratt, H. Apparent night variations with crossed-coil radio beacons. *Proc. I. R. E.*, **16**, pp. 652-57; May, 1928.
(Describes night direction shifts and fading of signals from directive type of radio beacon as received on an airplane in flight.)
- R113.3 Friis, H. T. Oscillographic observations on the direction of propagation and fading of short waves. *Proc. I. R. E.*, **16**, pp. 658-665; May, 1928.
(Observations made on the 16-meter transatlantic signals to determine variation of direction of propagation and amount of fading.)
- R113.5 Nodon, A. Relations entre la propagation des ondes electromagnetiques, l'activite solaire et l'etat atmospherique. (Relations between the propagation of electromagnetic waves, solar activity and amount of atmospherics.) *L'Onde Electrique*, **7**, pp. 136-161; April, 1928.
(Values for speed of propagation of radio waves deduced from other data always leads to figures less than 300,000 km per second.)
- R113.6 Munro, G. H. The reflecting layer of the upper atmosphere. *Experimental Wireless* (London), **5**, pp. 242-44; May, 1928.
(Experiments carried on in New Zealand during Dec., 1925 for estimation of height of reflecting layer for waves of 500 kc.)

* Original Manuscripts Received by the Institute, May 21, 1928 and June 16, 1928.

- R120 Green, E. Short-wave aerial systems—An elementary theory of the transmission of high-frequency energy along the feeders. *Experimental Wireless* (London), 5, pp. 304–311; June, 1928.
(Discussion based on theory of Heaviside. Results of transmission along feeder lines under different conditions.)
- R125.1 Aicardi, J. Sur un nouveau dispositif d'alignement par émissions Hertiennes. (On a new method of course setting by wireless.) *Comptes Rendus*, 186, pp. 305–307; January 30, 1928. *Experimental Wireless* (London), 5, p. 288; May, 1928.
(Uses two antennas short distance apart radiating same radio-frequency waves from one antenna pure CW and from other modulated. Course indication is produced by interference pattern.)
- R127 The equivalent inductance and capacity of an aerial. *Experimental Wireless* (London), 5, pp. 297–299; June, 1928.
(Calculation of inductance and capacity of antenna by considering it as a transmission line.)
- R130 von Ardenne, M., and Stoff, W. Zusammenfassender Bericht—Über die Kompensation der schädlichen Kapazitäten und ihrer Rückwirkungen bei Elektronenröhren. (Summarized report—On the compensation of the properties capacities and their reaction in electron tubes.) *Zeits. für Hochfrequenztechnik*, 31, pp. 122–128, April; pp. 152–157, May, 1928.
(Theoretical discussion.)
- R130 Ashworth, M. H. Graphical computations. *Experimental Wireless* (London), 5, pp. 311–314; June, 1928.
(Applies graphical method of integration to electron tubes.)
- R131 Doring, E. Über den Einfluss hoher ohmscher Anodenwiderstände auf den Gitterwiderstand von Verstärkeröhren. (Influence of higher plate resistance on the grid resistance of amplifier tubes.) *Zeits. für Hochfrequenztechnik*, 31, pp. 116–120; April, 1928.
(Experimental data on the mutual effects of the two internal resistances.)
- R131 Lange, H. Die Stromverteilung in Dreielektrodenröhren und ihre Bedeutung für die Messung der Voltaspannung. (The current distribution in three-electrode tubes and their importance for the measuring of voltages.) *Zeits. für Hochfrequenztechnik*, 31, pp. 105–109, April; pp. 133–140, May, 1928.
(Theoretical discussion of tube characteristics.)
- R132 Baggally, W. On banks of parallel valves feeding resistance loads without distorting the wave form. *Experimental Wireless* (London), 5, pp. 315–321; June, 1928.
(Mathematical theory of design of bank of electron tubes for supplying power to loudspeakers. Treatment confined to case of a non-reactive load.)
- R134 Ballantine, S. Detection by grid rectification with the high-vacuum triode. *Proc. I. R. E.*, 16, pp. 593–613; May, 1928.
(Method for experimentally ascertaining frequency distortion in detection. Method of securing efficient grid rectification in superheterodyne systems.)
- R141 Bird, L. T. Reactance and admittance curves applied to tuned circuits with and without resistance. *Experimental Wireless* (London), 5, pp. 327–334; June, 1928.
(Reactance and admittance curves developed from considering vector diagrams and properties of inductance and capacity.)
- R143 Reed, M. Damping due to grid current in the case of a valve oscillator. *Experimental Wireless* (London), 5, pp. 322–324; June, 1928.
(Calculation of damping introduced in an oscillatory circuit by grid current.)
- R145.5 Allen, R. G. The establishment of formulæ for the self-inductance of single turn circuits of various shapes. *Experimental Wireless* (London), 5, pp. 259–63; May, 1928.
(Development of formulas.)

- R152 Busse, E. Über eine Methode zur Erzeugung von sehr kurzen elektrischen Wellen mittels Hochfrequenzfunken. (On a method of production of very short electric waves by means of high-frequency sparks.) *Zeits. für Hochfrequenztechnik*, 31, pp. 97-105; April, 1928.
(Production and measurement of characteristics.)
- R200. RADIO MEASUREMENTS AND STANDARDIZATION
- R201.6 Zickner, G. A bridge for the measurement of inductance and capacity. *Experimental Wireless* (London), 5, pp. 280-282; May, 1928.
(Application of the Maxwell Bridge to measurements made by radio experimenters.)
- R201.7 Schneider, W. A. Use of an oscillograph for recording vacuum-tube characteristics. *Proc. I. R. E.*, 16, pp. 674-80; May, 1928.
(Results obtained with oscillograph for plotting photographically vacuum-tube characteristics.)
- R210 Dellinger, J. H. The status of frequency standardization. *Proc. I. R. E.*, 16, pp. 579-92; May, 1928.
(Accuracy of frequency standards. Intercomparison of frequency standards of U. S. with foreign countries reported.)
- R210 Dellinger, J. H. Finding the "yardsticks" of radio at the Bureau of Standards. *Popular Radio*, 13, pp. 290-91; April, 1928.
(Work of Radio Section of Bureau of Standards in frequency standardization.)
- R210 Pierce, G. W. Magnetostriction oscillators. *Proc. American Academy of Arts and Sciences*, 63, pp. 1-47; April, 1928.
(Description of method of using magnetostriction in connection with electron-tube circuits to produce and control frequency of electrical and mechanical oscillations. Range of frequencies from few hundred cycles per second to three hundred thousand cycles per second.)
- R210 Black, K. C. A dynamic study of magnetostriction. *Proc. American Academy of Arts and Sciences*, 63, pp. 49-66; April, 1928.
(Measurements of dynamic electrical characteristics of magnitude of vibration of various magnetostrictive rods and tubes.)
- R213 Namba, Y. and Namba, S. Study on the operation of the multivibrator. *Researches of the Electrotechnical Laboratory* No. 218, November, 1927. Tokyo, Japan.
(Experimental and mathematical discussion of multivibrator.)
- R214 Jouaust, R. Quelques modes particuliers de vibration des quartz piezoelectriques. (Certain modes of vibration of piezo-electric quartz plates.) *L'Onde Electrique*, 7, pp. 125-128; March, 1928.
(Shows deformations of quartz plates which are more complex than have been found before.)
- R220 Roberts, W. Van B. A capacity measurement method. *Jnl. Franklin Institute*, 205, pp. 699-701; May, 1928.
(Method of calibrating condensers at radio frequencies.)
- R230 Coil calculations—Design data for short wave coils. *Wireless World and Radio Rev.*, 22, pp. 466-68; May 2, 1928.
(Charts giving calculations for coils in the 40-110 and 110-240 meter bands.)
- R240 Jackson, W. Dielectric losses in single layer coils at radio frequencies. *Experimental Wireless* (London), 5, pp. 255-258; May, 1928.
(Experiments to measure the increase of effective resistance of coils at radio frequencies.)
- R251.2 Spot welded thermojunctions. *Experimental Wireless* (London), 5, p. 314; June, 1928.
(Description of instruments.)

- R270 Judson, E. B. An automatic recorder for measuring the strength of radio signals and atmospheric disturbances. *Proc. I. R. E.*, 16, pp. 666-670; May, 1928.
(Apparatus described for automatically recording field intensity of low-frequency signals and atmospheric disturbances.)
- R270 Sreenivasan, K. A short survey of some methods of radio signal measurement (concluded from April issue). *Experimental Wireless* (London), 5, pp. 273-78; May, 1928
(Description of methods of measurement of field intensity used in various laboratories.)
- R275 Robinson, E. H. The power in a modulated oscillation. *Experimental Wireless* (London), 5, pp. 252-254; May, 1928.
(Interpretation of voltmeter and ammeter readings in terms of power dissipated in case of circuits carrying modulated radio-frequency currents.)
- R300. RADIO APPARATUS AND EQUIPMENT
- R320.8 Smith-Rose, R. L. Wireless masts and screening. *Wireless World and Radio Rev.*, 22, pp. 460-462; May 2, 1928.
(Shielding action of metal masts used at Rugby station.)
- R334 Decaux, B. Applications nouvelles des lamps a quatre electrodes. (New applications of four-electrode electron tubes.) *L'Onde Electrique*, 7, pp. 119-124; March, 1928.
(Uses of these electron tubes for relays, multivibrators, etc. Plate on electron tube can be small and so the signal itself can be used to operate the tube.)
- R334 Screened grid valves—Informal discussion at meeting of Wireless Section, Institution of Electrical Engineers of London. *Experimental Wireless* (London), 5, pp. 335-38; June, 1928.
(Application of these tubes to radio-frequency amplification.)
- R342 Kafka, H. Zur Niederfrequenzverstärkung mit Drosselspulenkopplung. (On the low-frequency amplification with impedance coupling.) *Zeitschrift für Hochfrequenztechnik*, 31, pp. 87-90; March, 1928.
(How to design impedance-coupled amplifiers.)
- R342.6 Thomas, H. A. Retro-action in amplifiers. *Experimental Wireless* (London), 5, pp. 245-251; May, 1928.
(Gives general properties of regeneration and analysis of conditions to be fulfilled for advantageous use in amplifiers.)
- R342.6 Glasgow, R. S. Tuned radio-frequency amplifiers. *Jnl. A. I. E. E.*, 47, pp. 327-331; May, 1928.
(Simplified method of calculating performance of tuned-circuit amplifying set with curves showing performance obtained with various types of tubes.)
- R343.7 A German H.T. mains unit with glow discharge rectifier. *Experimental Wireless* (London), 5, p. 251; May, 1928.
(A receiving tube for use on alternating current.)
- R344 Über die gleichzeitige Erregung zweier Schwingungen in einer Dreielektrodenröhre. (On the simultaneous excitation of two oscillations in a three-electrode tube.) *Zeitschrift für Hochfrequenztechnik*, 31, pp. 72-84; March, 1928.
(Discussion of possibilities of generating two oscillations within the same tube. Methods and use.)
- R344.3 Byrnes, I. F. Recent developments in low-power and broadcasting transmitters. *Proc. I. R. E.*, 16, pp. 614-651; May, 1928.
(Description of various types of radio-transmitting equipment ranging in output from 200 to 2000 watts. Application of master-oscillator, power-amplifier circuits for low- and medium-frequency transmitting sets. Uses of piezo-oscillator control for high-frequency and broadcasting transmitting sets. Brief explanation given of equi-signal system of radio-beacon transmission.)
- R351 Lampkin, G. F. How to build a beat-frequency oscillator. *Radio Broadcast*, 13, pp. 156-158; July, 1928.
(Construction details of laboratory-type oscillator are given.)

- R384.1 Griffiths, W. H. F. Substandard wavemeter design. *Experimental Wireless* (London), 5, pp. 324-26; June, 1928.
(Design of a radio-frequency frequency meter with new type of inductances for 30,000 kc.)
- R384.1 Griffiths, W. H. F. The demonstration of a new precision wavemeter condenser. *Experimental Wireless* (London), 5, pp. 278-279; May, 1928.
(Sullivan-Griffiths variable air condenser for use as part of a substandard wavemeter.)
- R385.5 Jakowleff, A. J. Analyse einer Elektrischen Schaltung für des Kondensatormikrophon. (Analysis of an electrical connection for the condenser microphone.) *Zeitschrift für Hochfrequenztechnik*, 31, pp. 85-87; March, 1928.
(Theory of the condenser microphone.)
- R388 Rangachari, T. S. The harmonic comparison of radio frequencies by the cathode-ray oscillograph. *Experimental Wireless* (London), 5, pp. 264-267; May, 1928.
(Use of cathode-ray tube for comparison of harmonics of radio frequencies.)

R400. RADIO COMMUNICATION SYSTEMS

- R402 Kruse, R. S. Getting started at 30 megacycles. *QST*, 12, pp. 9-10; May, 1928.
(Description and design of receiving and transmitting apparatus for 10-meter work.)
- R412 Blackwell, O. B. Transatlantic telephony—The technical problem. *Bell System Technical Jnl.*, 7, pp. 168-186; April, 1928.
(Non-technical description of engineering problems involved in developing transatlantic radio circuits by means of which the American Telephone and Telegraph Company's system is used for communication with England.)
- R412 Waterson, K. W. Transatlantic telephony—service and operating features. *Bell System Technical Jnl.*, 7, pp. 187-194; April, 1928.
(Description of differences in operating practice on the two sides of the Atlantic. Data given on the extent to which transatlantic connection was used during first year.)

R500. APPLICATIONS OF RADIO

- R520 Donisthorpe, H. de A. Air service and amateur cooperation. *Wireless World and Radio Rev.*, 22, pp. 491-492; May 9, 1928.
(Report of coast-to-coast flight of all American airplane equipped with radio apparatus and assistance rendered by amateurs.)

R500. APPLICATIONS OF RADIO

- R525 Eisner, F., Fassbender, H., Kurlbaum, G. Leistungs- und Strahlungsmessungen an Flugzeug- und Bodenstationen. (Energy and radiation measurements on aircraft and ground stations.) *Zeits. für Hochfrequenztechnik*, 31, pp. 109-116, April; pp. 141-151, May, 1928.
(Measurements of power in antennas on aircraft and ground stations. T-shaped antenna used at ground station and trailing wire antenna on aircraft.)
- R526.2 Franck, P. Le radiocompass et la navigation aeriennne. (The radio compass and aerial navigation.) *L'Onde Electrique*, 7, pp. 109-118; March, 1928.
(Discusses an ideal radiocompass which could be used on aircraft for direct reading of bearings.)
- R536 Eve, A. S. and Keys, D. A. Geophysical prospecting. *Scientific American*, 138, pp. 414-417, May; pp. 508-511, June, 1928.
(Description of various methods used. Based on Bureau of Mines Tech. Paper No. 420.)

- R550 Eckersley, P. P. The design and distribution of wireless broadcasting stations for a national service. *Jnl. I. E. E.* (London), 66, pp. 501-528; May, 1928.
(Discusses problems in the distribution and design of broadcasting stations.)
- R582 Clarkson, R. P. What hope for real television? *Radio Broadcast*, 13, pp. 125-128; July, 1928.
(Resumé of the different methods of television.)

R800. NON-RADIO SUBJECTS

- 512 Ratcliffe, J. A. Symbolical algebra. *Experimental Wireless* (London), 5, pp. 239-242; May, 1928.
(Discussion of errors which occur in applying process of symbolical algebra to treatment of problems containing sine and cosine functions.)
- 621.3 Buckley, O. E. High-speed ocean-cable telegraphy. *Bell System Technical Jnl.*, 7, pp. 225-267; April, 1928.
(Brief history of development of permalloy-loaded cables and discussion of problems concerned with their design, construction, and operation.)
- 621.374.2 Herman, J. Bridge for measuring small time intervals. *Bell System Technical Jnl.*, 7, pp. 343-349; April, 1928.
(Measurement of time intervals from about one ten-thousandths of a second up to several seconds is described.)
- 621.382 Pages, A. La telegraphie multiple par courantes de frequences audibles. (Multiplex telegraphy for currents of audible frequencies.)
(Description of cable system used by French company which uses band filters in cable telegraphy so that speed of signal will not be impeded by deformations which occur at certain frequencies.)

APPLICATIONS FOR MEMBERSHIP

Applications for transfer or election to the various grades of membership have been received from the persons listed below, and have been approved by the Committee on Admissions. Members objecting to transfer or election of any of these applicants should communicate with the Secretary on or before September 2, 1928. These applications will be considered by the Board of Direction of the Institute at its September 5th meeting.

For Transfer to the Fellow grade

New Jersey	Freehold, 54 Court Street	England, Carl R.
	South Orange, 332 Melrose Place	Hartley, R. V. L.
New York	New York City, R. C. A., 66 Broad Street	Beverage, Harold H.
	New York City, 195 Broadway	Blackwell, O. B.
	New York City, 64 Broad Street	Kroger, Fred H.
	New York City, R. C. A., 66 Broad Street	Ranger, Richard H.
	New York City, General Electric Co., 120 Broadway	Young, Owen D.
	Schenectady, General Electric Co.	Baker, W. R. G.

For Transfer to the Member grade

Illinois	Chicago, 2022 The Engineering Bldg.	Turner, George S.
Maryland	Baltimore, Room 13, Custom House	Sterling, George Edward
Massachusetts	Auburndale, 21 Laell Street	Clapp, James K.
	Cambridge, 10 Wyman Road	Weeks, Paul T.
New Jersey	Newark, 200 Mt. Pleasant Avenue	Rypinski, Maurice C.
New York	Grasmere, S. I.	Grimes, David
	Great Neck, L. I.	Rigney, Douglas
	New York City, 40 Broad Street	Blenheim, William J.
	New York City, R. C. A., 70 Van Cortlandt Park So.	Engel, Francis H.
	New York City, 420 Lexington Avenue	Melhuish, Harold T.
	New York City, R. C. A., 66 Broad Street	Winterbottom, W. A.
Pennsylvania	East Pittsburgh, 124 Avenue A	Sutherland, Lee

For Election to the Member grade

California	Coronado, P. O. Box 362	Pierce, Francis E.
	Palo Alto, Federal Telegraph Co.	Brower, William M.
Dist. of Columbia	Washington, Radio Division, Dept. of Commerce	Downey, W. E.
Illinois	Chicago, 2022 The Engineering Bldg.	Sloan, F. V.
New York	Rochester, 25 Leighton Avenue	Bickford, Milton F.
	Rochester, 25 Leighton Avenue	Haugh, A. T.
Ohio	Barberton, Ohio Insulator Co.	Hillebrand, W. A.
Peru	Lima, c/o Marconi's Wireless Telegraph Co., Ltd.	Madgwick, G.

For Election to the Associate grade

Arkansas	Hot Springs, 122 Harrell Avenue	Peel, DeLacy J.
California	Los Angeles, 741 1/2 S. Alvarado	Richards, A. H.
	Los Angeles, 1224 Wall Street	Sorge, Barthold W.
	Palo Alto, 804 Bryant Street	Dow, Clifford J.
	Santa Barbara, c/o Lamb Electric Co.	Cooper, Harold Grant
	Yosemite, c/o Ahwahnee Hotel	Campbell, Wm. N.
Connecticut	Hartford, 52 Girard Avenue	Briggs, Perry Orswell
	Hartford, 1711 Park Street	Meserve, G. Donald
	Stamford, Y. M. C. A.	Carlson, Einar C.
	Waterbury, P. O. Box 188	Cohen, Edward
Delaware	Claymont	Tatnall, Joseph S.
Dist. of Col.	Washington, 2067 Park Road, N. W.	Gilliland, Ted R.
	Washington, 3320-19th Street, N. W.	Zandonini, Elizabeth M.
Georgia	Atlanta, A. T. & T. Co., 193 S. Pryor St.	Bellinger, Andrew L.
	Columbus, 2303 Hamilton Avenue	Lewis, William J.
	Fort Benning, Radio Station	Allen, Otis T.
	Savannah, S. S. City of Savannah, Chief Radio Op.	Rushing, Wallace E.
Illinois	Chicago, 1648 N. La Salle Street	Cohen, Hans
	Chicago, 1035 Belden Avenue	James, Gerald W.
	Chicago, 711 Buckingham Place	McCullah, Arthur B.
	Collinsville, 307 W. Main Street	Gasparotti, Ralph G.
	Joliet, Box 1037	Crowley, Wm. J., Jr.
	Oak Park, 916 South Lombard Avenue	Roe, Douglas J.
Indiana	Terre Haute, 705 So. 20th Street	Brooks, Kenneth Earle
	Valparaiso, 307 Monroe Street	Hershman, J. B.
	Valparaiso, Dodge's Institute	Larrowe, Harvey F.
Iowa	Sioux City, 302 Pierce Street	Kerby, Edward J.
Kentucky	Owensboro, Ken-Rad Corporation	Wuertz, John L.
	Paducah, P. O. Box 440	Shelton, Raymond W.
Maryland	Baltimore, 10 E. Centre Street	Leight, Edward Roy

Massachusetts	Beverly, c/o Neutron Corporation	O'Neill, George D.	
	Boston, 30, 20 Eggleston Street	Wolf, Edwin A.	
	Chicopee Falls, Westinghouse Radio Lab.	Brewer, Noble E.	
	Dedham, 116 Riverside Drive	Cowan, Edward J.	
	East Springfield, 92 Windemere Street	Madsen, Carl J.	
Michigan	Lynn, 89 New Park Street	Little, Roy Scott	
	Detroit, 3760 Jefferson Avenue E.	Bailey, Stuart L.	
	Detroit, Marine P. O., Steamer <i>W. H. McGean</i>	Leonhardt, Charles C.	
Minnesota	Wyandotte, 344 Orchard Street	Steffin, V. J.	
	Minneapolis, 4512 Harriet Avenue	Sharpless, William M.	
	St. Paul, 1795 Lincoln Avenue	Cotton, Richard J.	
	St. Joseph, 635 N. 22nd Street	Bauer, Fritz	
New Jersey	Springfield, 517 E. Walnut Street	Hicks, Kenneth F.	
	Bloomfield, 118 Washington Street	Newell, Guy	
	Caldwell, 14 Farrington Street	Wheeler, C. M.	
	Camden, 220 Cooper Street	Reeser, Delbert A.	
New York	East Orange, 10 Kensington Place	Clarry, Harold E.	
	Fort Hancock	Mallon, William H.	
	Glen Ridge, 163 Linden Avenue	Scherer, W. M.	
	Hoboken, Stevens Tech.	Paulding, Herbert L.	
	Jersey City, 276 Sunmit Avenue	Sullivan, S. Edward	
	Buffalo, 281 Emslie Street	Roberts, Alfred E.	
	Edgemere, L. I., 447 Beach 46 Street	Carduner, William	
	Ithaca, Cornell University, Physics Dept.	Verman, Lal Chand	
	New York City, 211 Bedford Park Blvd.	Baker, Brothwell H.	
	New York City, 631 Eagle Avenue Bronx	Fielding, Edward J.	
	New York City, 144 E. 208th Street	Howard, Edward J.	
	New York City, 1 Broadway, S. S. <i>Michael Tracy</i>	Kelly, Delbar P.	
Ohio	New York City, 67 Broad Street, Inter. Stand. Elec. Co.	Putnam, R. E. A.	
	New York City, 67 Broad Street, Inter. Stand. Elec. Co.	Sanborn, J. W.	
	Rochester, Box 5, Brighton Station	Worrell, Richard A.	
	Schenectady, 12 Snowden Avenue	Meahl, Harry R.	
	Schenectady, 11 Grove Place	Spitzer, Edwin E.	
	Southampton, Box 488	Homer, Edward C.	
	Whitestone, L. I., 14th Avenue, and 166th Street	Adler, Benjamin	
	Woodhaven, L. I., 9001-78th Street	Jahnsen, Oscar H.	
	Cleveland, Engineer's National Bank Bldg.	Gove, Edward L.	
	Dayton, 432 Ludlow Arcade Bldg.	Gerstle, John	
	Dayton, 267 Park Street	Zimmerman, Robert F.	
	Oklahoma	Greentown	Myers, Willard Daniel
Hamilton, 533 Ridgelawn Avenue		Probst, John E.	
Tulsa, 5 Skelly Oil Co., Radio Dept.		Lovell, Herman J.	
Tulsa, 436 South Gillette Avenue		Phillips, H. W.	
Tulsa, c/o KVOO, Voice of Oklahoma		Sams, Eddleman E.	
Pennsylvania	Tulsa, 204 Central National Bank Building	Thomason, W. H.	
	Tulsa, 218 E. Latimer Street	Wilson, O. G.	
	Harrisburg, 217 Walnut Street, c/o Mandarin Restaurant	Lee, William J.	
	Palmyra, 113 E. Cherry Street	Balsbaugh, Clair L.	
	Palmyra, 13 E. Main Street	Krieder, James L.	
	Philadelphia, 2506 N. 34th Street	Borland, Albert S.	
	Tarentum, 1008 Crescent Street	Jones, Roy L.	
	Wilksburg, 1103 Center Street	Mumma, Earle L.	
	Memphis, 1292 Linden Street	Cowles, Alfred L.	
	Houston, c/o Rice Institute	Waters, James S.	
	Norfolk, Station WTAR	McConnel, W. G.	
	Tennessee	Norfolk, 117 W. Main Street, Pocahontas S. S. Co.	Trigger, V. H.
Puyallup, Experiment Station		Shoup, Allen	
Seattle, c/o Postmaster, U. S. S. <i>Black Hawk</i>		Hodges, Arthur T.	
Texas	Seattle, Dept. of Lighting and Power	Ross, J. W.	
	Seattle, 5811-5th Avenue, N. E.	Winningham, H. W.	
	Wheeling, 1229 Main Street	Risley, F. S.	
Virginia	Milwaukee, 1395 Prospect Avenue	Weiss, Tobias	
	Waukesha, 1107 White Rock Avenue	Golding, Robert M.	
Washington	Sao Paulo, Avenida Sao Joao 24	Cesar, Amarel	
	Edmonton, Alberta, 1732-89th Street	Ryley, Raymond	
	Hamilton, Ontario, 185 Sanford Avenue, N.	Weber, Rennie I.	
	Nanaimo, B. C., c/o Spencer Rooms	Mawson, John T., Jr.	
	Timmins, N. Ontario, P. O. Box 1827	Newman, John R.	
	Toronto, Ontario, 474 Palmerton Blvd.	Price, Harold W.	
	Winnipeg, 529 Dominion Street	Pound, Harris D.	
	West Virginia	Peking, University of Communications, Electrical Dept.	Nieh, C. R.
		Bath, Kennington Road, Warwick Villa	Young, Alfred W.
	Wisconsin	Birkenhead, 11 Dawson Avenue	Purcell, James
		Bradford, W. Yorks, Allerton Road, 33 Bullroad Avenue	Haigh, Norman E.
		Caversham, Reading, 4 Matlock Road	Hill, Ernest N.
Frinton-on-Sea, Shirley, Old Road		Harries, John Henry O.	
London, N. 7, 15 Courtney Road		Downing, Geo. E. C.,	
Brazil			
Canada			
China			
England			

Applications for Membership

England (Continued)	London, N. W. 3, 85 King Henry's Road	Ferdinando, Christie
	Upminster, Essex, "Hillys," Cedar Gardens	Jones, John E. Rhys.
India	Hyderabad Sind, Gidu Road, Porch House	Samtani, R. C.
New Zealand	Wellington, 248 The Terrace	Taylor, James O.
For Election to the Junior grade		
California	Los Angeles, 219 South Alexandria Avenue	Dawson, W. Robert
Connecticut	Mystic, 21 W. Mystic Avenue	Wheeler, Lester B.
Illinois	Chicago, 3128 Warren Avenue	Demikis, Anton Jr.
	Chicago, 3725 N. Tripp Avenue	Wegner, Charles W.
	Pittsfield, Box 514	Lewis, Rupert S.
Indiana	Valparaiso, 156 S. Franklin Avenue	Barber, D. G.
Iowa	Clarinda, 514 Main Street	Huntsinger, P. R.
Massachusetts	Cambridge, 11 Carlisle Street	Sullivan, Edwin T.
New York	Brooklyn, 322 E. 31st Street	Gabel, Morris
	Brooklyn, 1819 Newkirk Avenue	Rippere, R. Oliver
	New York City, 1297 Lexington Avenue	Bruggeman, John T.
	New York City, U. S. S. <i>Gresham</i> , Barge Office Rm. 10	Mandell, Benjamin F.
Oregon	Falls City	Paul, Byron R.
Pennsylvania	Ambridge, 303 Maplewood Avenue	Svegel, Peter J.
	Harrisburg, 1712 Forster Street	Chambers, William B.
Canada	Parry Sound, Ontario, Box 175	Crump, Albert E.

Your New Radio Specification



Dial Light Socket



No. 2912
Flush Jack



No. 2912
and Plate



No. 130
Cord Connector
and K. T. Cap



No. 5113
Receptacle

Planning Next Season's Receiver!

What dependable, economical switches, receptacles, plugs, dial lights, etc., will you buy? The Bryant Electric Company asks your consideration with experience of 39 years in the successful manufacture of wiring devices and in efficient factory production.

Write today for a copy of our catalog illustrating and describing over three thousand "Superior Wiring Devices."



No. 3888
D. P. D. T. Flush
Switch



No. 5142
Tumbler Switch



No. 67B
Cord Switch

THE BRYANT ELECTRIC COMPANY
BRIDGEPORT, CONN.

New York, Philadelphia, Chicago, San Francisco
Manufacturers of "Superior Wiring Devices" since 1888

Manufacturers of HEMCO Products

When writing to advertisers mention of the PROCEEDINGS will be mutually helpful.

In Radio—as in other industries
ALUMINUM DIE CASTINGS
Make for Quality, Speed and Economy

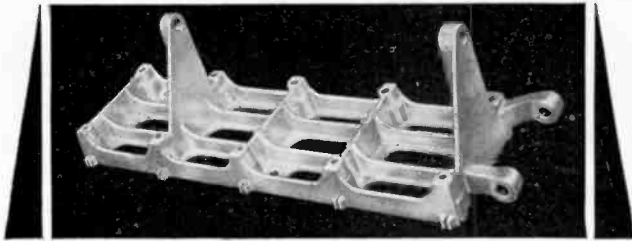

RADIO Engineers are using Alumac Die Castings (of Alcoa Aluminum) for loud speaker frames, bases and housings, chasses, condenser frames and cradles for drum dials and cabinets

Because:

Aluminum has high electrical conductivity.

Aluminum Die Castings are both strong and light—equal strength with less than half the weight of other die casting metals.

Aluminum Die Castings have a usual tolerance of $\pm .0015$ inch per linear inch.

Holes and inserts may be cast in with a high degree of accuracy.

Much machining, finishing and polishing eliminated.

Economy and faster production results.

Your production problems may be materially aided by a consultation with one of our Die Casting Specialists. May we send one to you? There will be no obligation on your part.

ALUMINUM COMPANY OF AMERICA

Aluminum in Every Commercial Form

2469 Oliver Building, Pittsburgh, Pa.

Offices in 19 Principal Cities

ALUMINUM
ALUMAC
DIE CASTINGS
For Strength, Lightness, Economy

When writing to advertisers mention of the PROCEEDINGS will be mutually helpful.

the Modern Necessity for Electrical Radio... the MERSHON CONDENSER

The Mershon Condenser gives a *very large capacity* in a very small space. Is self-healing in case of puncture, and is unaffected by changes in temperature, or by moisture.

Expert radio amateurs used the Mershon Condenser for more than six years in their transmitting equipment. Today the Mershon Condenser is being widely used over the whole country in connection with electrical radio sets, whether new AC tubes are used, or battery sets are attached to house current thru the use of Eliminators.



Send for
Your Free Copy
of
This Book....

The AMRAD Corporation
Medford Hillside, Mass.

Please send a copy of your new book
on the MERSHON CONDENSER, showing
hook-ups and designs.

Name

Address

When writing to advertisers mention of the PROCEEDINGS will be mutually helpful.



FORMICA

THE word "Formica" is the mark of an exceptionally good and exceptionally uniform insulating material—phenol fibre at its best.

It means that your shipment comes from the largest plant in its industry; with a most varied equipment of modern fabricating machinery.

That plant is near the center of industry—with the shortest possible average haul and the quickest possible average delivery to manufacturers everywhere.



THE FORMICA INSULATION CO

4626 Spring Grove Ave.

CINCINNATI, OHIO



FORMICA
Made from Anhydrous Bakelite Resins
PANELS FOR SIGNS

When writing to advertisers mention of the PROCEEDINGS will be mutually helpful.

Real Insulation

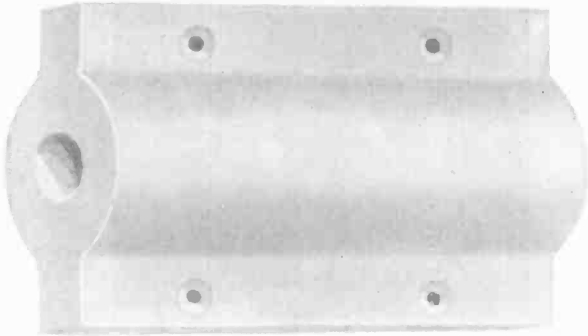

at

20,000 KILOCYCLES

ISOLANTITE is a ceramic product of outstanding merit as an electrical insulator at extremely high frequencies. Moreover the Isolantite processes of manufacture permit the commercial production of a wide range of shapes and designs, enabling the manufacturer to effect economy of assembly or general construction.

These two distinct advantages are capitalized in the production of the stand-off insulator, illustrated above, which was designed by Isolantite engineers to meet the particular requirements of commercial radio service.

Low in electrical loss, rugged, provided with accurately spaced holes and fully glazed, this insulator is only one of many types—readily available—that are rapidly placing Isolantite in the fore as the logical radio insulator.

Write for Bulletin 100B

Isolantite Company of America

New York Sales Offices

551 Fifth Ave., New York City

When writing to advertisers mention of the PROCEEDINGS will be mutually helpful.

Radio - Is - **BETTER** - With - Dry - Battery - Power



made to run
the *full* race!

ANY horse can make a good start But it takes real stamina to *finish!* ¶So it is with batteries. *Staying* power is the quality to look for—unfailing power over a long period of service. Millions prefer Burgess *Chrome* Batteries for just this reason. They hold up They *last.* ¶Next time, buy black and white striped Burgess *Chrome* Batteries. You are certain to get longer and better service for your money.

Chrome —the preserving element used in leather, metals, paints and other materials subject to wear, is also used in Burgess Batteries. It gives them unusual *staying* power. Burgess *Chrome* Batteries are patented.

Ask Any Radio Engineer

BURGESS BATTERY COMPANY

General Sales Office: CHICAGO

Canadian Factories and Offices: Niagara Falls and Winnipeg



BURGESS BATTERIES

When writing to advertisers mention of the PROCEEDINGS will be mutually helpful.

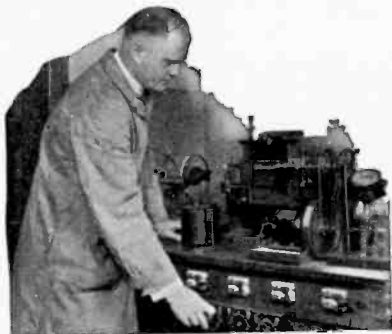

EVERY FACILITY FOR EXPERT RESEARCH

THE Research and Development Laboratory of Automatic Electric Inc., manufacturers of Strowger Automatic condensers, is one of the most completely equipped of its kind in the world. The use of its many sensitive and complex instruments enables the development engineers to know exactly rather than to guess what occurs in any electrical circuit at any time.

The design and manufacture of satisfactory condensers for radio purposes is dependent upon such exact scientific knowledge. The reliability and efficiency which have become synonymous with the name Strowger in automatic telephony, are incorporated to a like extent in the line of filter, by pass and high voltage condensers now available to the radio trade. The company's research facilities are always at the disposal of any interested parties requiring condensers of special design for special purposes.

*[See that your radio set is equipped
with Strowger Automatic condensers]*

A.G. BURT, JR.

1033 WEST VAN BUREN ST.

CHICAGO, U. S. A.

REPRESENTING

**STROWGER  AUTOMATIC
CONDENSERS**

MADE BY

Automatic Electric Inc.
CHICAGO, U.S.A.

When writing to advertisers mention of the PROCEEDINGS will be mutually helpful.

Faithfully reproducing every note in the register—from the lowest to the highest—with all the accidentals. Any instrument—any volume.



COILS for the NEW Dynamic Speakers

Again Dudlo keeps pace with Radio development in meeting the demand for special coils required by this latest trend in speakers.

All would give that wonderful clarity of tone characteristic of Dynamic type units.

Transformer Coils—Field Coils—Choke Coils

Superior insulation of Dudlo wire, highly skilled operators on the winding machines, trained engineers who are coil specialists, tremendous stocks and facilities—all contribute to make this the industry's headquarters for these new coils.

DUDLO

DUDLO MANUFACTURING CO., FORT WAYNE, INDIANA

Division of the General Cable Corporation

56 Earl Street
NEWARK, N. J.

105 West Adams St.
CHICAGO, ILL.

4143 Bingham Ave.
ST. LOUIS, MO.

274 Brannan St.
SAN FRANCISCO, CALIF.

When writing to advertisers mention of the PROCEEDINGS will be mutually helpful.

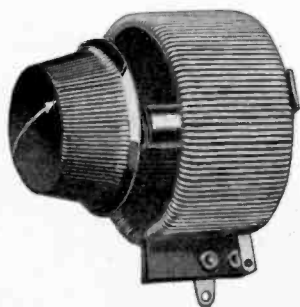

Giant Power Rheostat

SMALL IN DIAMETER, but large in capacity, this rheostat will safely carry any power load of 70 watts. Constructed of heat proof materials throughout. There is no fibre to warp or burn out. Wire is wound on a steel core insulated with asbestos. Extra wide core assures large area for quick heat dissipation.

This unit is ideal for primary control of "AC" receivers or "A" Power Units. It will keep the line at a constant workable average, keeping the secondary output well within rated limits. These units connected in series across the output of a Rectifier and Filter system for "B" Power will provide all necessary voltage taps.

These units can be used in any power circuit position without any danger of burning out—the capacity is only limited by the capacity of the wire.

Manufactured with two or three terminals. Diameter 2", depth 1 $\frac{1}{4}$ ". Write for new booklet on "Volume Controls and Voltage Controls—their use."

Centralab

CENTRAL RADIO  LABORATORIES
16 KEEFE AVENUE, MILWAUKEE

A CENTRALAB CONTROL IMPROVES THE SET

When writing to advertisers mention of the PROCEEDINGS will be mutually helpful.

XVIII

High Voltage Power Units

FOR TRANSMITTERS AND LABORATORIES

*Complete Rectifier Units Supplying Plates and Filament
Voltage Employs Standard UX-852 Tube.*



OUTPUT RATINGS

PLATE
2000 Volts D.C.
At 300 Watts
(150 Mils)

FILAMENT
10 Volts A.C.
At 80 Watts
(8 Amps)

A COMPLETE power supply for the medium power Amateur Transmitters using either telephone or telegraph. Ready for immediate use. Plugs into the ordinary light socket. Operates from 110 volt, 50 to 60 cycle, single phase alternating current power source, supplies sufficient power for operating either one or two UX-852 tubes or one UV-204A tube or any other tubes having similar characteristics.

COMPRISES Plate Transformer—Separate Filament Transformer—Two 30 Henry Filter Choke Coils—Three 2 Mfd. 2000 Volt Filter Condensers—One UX-852 Tube Holder—Pilot Light Control Switch—8-Foot Connecting Cord and Plug—Housed in heavily constructed metal case which is finished in black crystalline lacquer—Plainly marked Terminal Panel—Employs One Standard UX-852 Tube in a Conventional Half Wave Rectifier Circuit.

DIMENSIONS—20 in. x 9½ in. front x 13 in. deep—Weight 70 lbs. net.

Rectifier Unit—Cat. 172—Price \$85.00

Price does not include UX-852 Tube.



MANUFACTURES A COMPLETE LINE OF
APPARATUS FOR SHORT WAVE TRANS-
MISSION AND RECEPTION.

RADIO ENGINEERING LABORATORIES

100 Wilbur Ave.

Long Island City, N.Y., U.S.A.

When writing to advertisers mention of the PROCEEDINGS will be mutually helpful.

SM

NEW 720 Screen Grid Six

ENGINEERING excellence, taken for granted in any kit bearing the S-M guarantee, is found in overflowing measure in the 720. A set assembled from the standard kit was tested on a summer evening, in a Chicago apartment building. In two hours, 41 stations were logged, 5 of which (in N.Y., N.J., Fla., Ga., and La., respectively) were on adjacent 10-kilocycle channels to local stations then on the air! Three screen grid tubes are used in individually copper shielded R.F. stages, with a tuned antenna circuit showing voltage step-ups as high as 100 times at 550 K.C. Two audio stages utilize the 255 and 256 transformers described below. The 720 is offered at \$69.75 for the complete kit, with a beautiful metal shielding cabinet, finished in two-tone brown, available at \$8.50 additional.

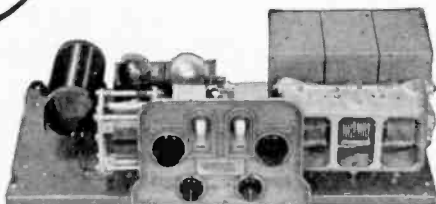

New Clough System Audio Transformers



S-M 225 Audio Transformer—See Curve E

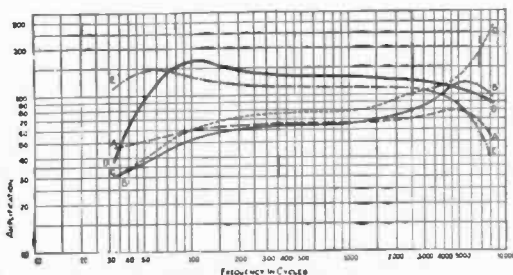

SILVER-MARSHALL has ready new audio transformers giving double the amplification of the best existing types, a far better frequency characteristic, and practical elimination of hysteric distortion. Curve "D" above illustrates the performance of a pair of the new small S-M 255 and 256 transformers listing at \$6.00 each, as compared to three pairs of \$8.00 to \$10.00 transformers on the open market. It tells the story of doubled amplification and improved bass amplification. Curve E is for a pair of S-M 225 and 226 transformers, listing at \$9.00 each. These new transformers are available to manufacturers at surprisingly low prices. At the June R. M. A. trade show was demonstrated a comparison amplifier which audibly proved the superiority of the new \$6.00 transformers over any standard existing types!

A postcard will bring the complete S-M catalog, and a sample copy of the "RADIOBUILDER."

**SILVER-MARSHALL, Inc., 846 W. Jackson Blvd.
CHICAGO, U. S. A.**

When writing to advertisers mention of the PROCEEDINGS will be mutually helpful.
XX

TRUE A.C. CONSTANTS

of Radio Tubes Can Now Be Obtained By Means of
A DIRECT READING INSTRUMENT

Known As The Weston Model 526
RADIO TUBE TESTER

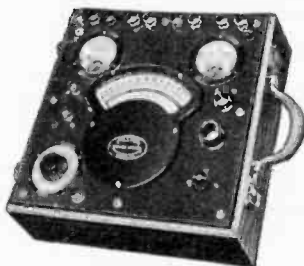

ITS principle of operation is based upon the fundamental definition of the tube constants and thus it becomes an absolute tester, affording quick and accurate measurements without the use of telephone or other complicated auxiliary devices. These values could be obtained formerly only by means of complicated bridge methods.

The Weston Model 526 will measure:

Voltage amplification factor; plate impedance in ohms; mutual conductance in microohms; plate current—as well as plate, grid and filament voltage.

The values indicated are the true A.C. values of the tube constants which are obtained by applying to the plate and grid circuits an alternating current. This current may be from an ordinary lighting circuit, and the values obtained are independent of variations in voltage of the A.C. circuit used.

For complete information write direct to

WESTON ELECTRICAL INSTRUMENT CORP.
589 Frelinghuysen Ave. Newark, N. J.

WESTON RADIO INSTRUMENTS

When writing to advertisers mention of the PROCEEDINGS will be mutually helpful.

To An Engineer

of the professional type—a college graduate or post-graduate who is as familiar with higher mathematical theory as with the practical mechanical design of radio broadcast receiving and power apparatus of every character, we can offer a connection with one of the fastest growing organizations in the industry—now medium sized, but the definite leader in its field. The personnel relations as well as the policy of management and financing will be found to be unusually conducive to effective concentration on the problems in hand. The opportunity is an outstanding one; location is Chicago; compensation will be adequate for the unusual type of man from whom, only, we would like to hear. Correspondence will be entirely confidential; our own technical staff are advised.

Address Box 808, I.R.E.

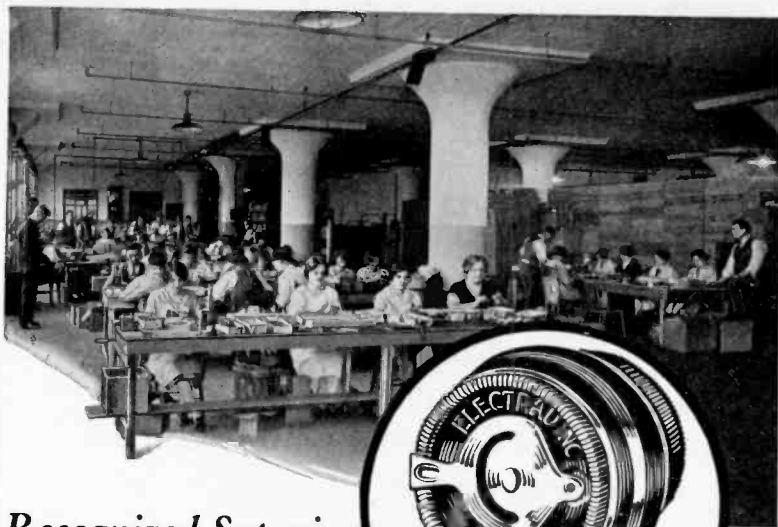

*Recognized Superior
by Prominent
Engineers . . .*

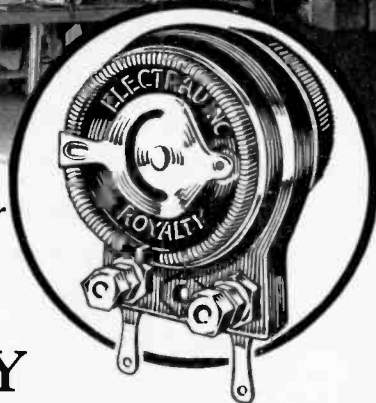

ROYALTY VARIABLE HIGH RESISTANCES

THESE quality resistances have been selected by the engineers of famous radio manufacturers for use in their receivers. Actual tests in their laboratories proved Royalties to be of superior accuracy and efficiency.

Royalties are so constructed that only a minimum of metal and the best quality insulating material are used. This results in their being remarkably free from harmful inductance and capacity effects.

They are especially adapted to fill every need of a resistance in high frequency circuits where a heavy current load is not carried, but a minimum of inductance and capacity is important.

This device is attractive in appearance as it is made with genuine bakelite. The whole resistance range is covered in a turn and the same resistance is always secured at the same point.

Our engineering staff will recommend special resistance gradients for any requirements.

Complete information and circuit data furnished on request. Write for complimentary copy of Electrad Control Manual. Electrad Specializes in a Complete Line of Resistances for All Radio Purposes.

ELECTRAD Inc.

Dept. A-8, 175 Varick Street, N. Y.

When writing to advertisers mention of the PROCEEDINGS will be mutually helpful.

CLEVELAND ACME OHIO



HERE THEY ARE



ACME'S SUPER-LINE OF RADIO PRODUCTS *as announced at the* R.M.A. Exposition

A great range of voltage is available with ACME'S Dry "B" Power Unit through the use of a 12,000 ohm voltage divider. It delivers voltage at $22\frac{1}{2}$, 45, 67, 90, 135 and 180.

ACME's Dry "BC" Power Unit delivers both "B" and "C" current to meet the requirements of your set.

The ACME ABC-4 and ABC-5 convert A.C. operated sets to D.C. operation. Bring your old set up-to-date.

The Acme Universal Dry "A" Power Unit, takes raw A.C. current and delivers smooth D.C. Current at the proper voltage for your set. This unit will give you real satisfaction because its built right.

Send for Bulletin 99
on New ACME
A.C. Receiver.



THE ACME ELECTRIC AND MFG. CO.
1439 Hamilton Avenue Cleveland, Ohio
Member R.M.A. Established 1917
Representatives in all principal cities.

When writing to advertisers mention of the PROCEEDINGS will be mutually helpful.

3 NEW Time-Saving and Money-Saving RADIO WIRE PRODUCTS

THROUGHOUT the radio industry—from novice builder to professional and actual manufacturer—Acme Wire is used by the thousands of feet for every radio hook-up requirement.

Now we announce the three new wire products shown and described on this page. As with all other products manufactured by The Acme Wire Co., these three new items have been made to meet actual existing needs—to

simplify wiring operations, thus saving the time and money of the men who build and repair radio apparatus. Each can be relied upon to give perfect service for the individual purpose for which it has been designed.

Made by THE ACME WIRE CO., New Haven, Conn., manufacturers of magnet and enameled wire, varnished insulations, coil windings, insulating tubing and radio cables.

ACME TWISTED A.C. CELATSITE WIRE

For A. C. Filament Hook-up. One strand of Red and one of Black 16/30 Flexible Celatsite twisted together; so that, if desired, the same sides of all filaments can be maintained at the same relative potential. 25-ft. coil in carton.

ACME PUSHBAK WIRE

This is the speediest hook-up wire for the Professional Set Builder—simply push back the insulation! No. 19 solid tinned copper wire covered with cotton wrap and braid, thoroughly impregnated with wax. 25-ft. coil in carton; 6 colors—black, yellow, brown, green, red, blue.

ACME POWER SUPPLY CABLES

R-112 cable is universal for A.C. or D.C. use for 12 conductors or less. Has four twisted pairs and four single wires. One of twisted pairs has extra heavy current capacity. 100-ft. coils. Enclosed in full glazed cotton braid with rayon tracer.



ACME CELATSITE WIRE PRODUCTS

ENAMELED AERIAL WIRE

Enameled copper wire in both standard and solid types. Also direct Lead-ins, Runners, Cables, Indors and Long Aerial Wires.

CELATSITE WIRE, FLEXIBLE and SOLID

For all types of radio services. High dielectric value; non-inflammable. 20 sizes.

ACME COILS, MAGNET WIRE, & VARNISHED INSULATION

ACME SPAGHETTI

All metric number tubing for all practical radio and other electrical requirements. Supplied in 10' coils.

Made by the Manufacturers of

ACME PARVOLT CONDENSERS

When writing to advertisers mention of the PROCEEDINGS will be mutually helpful.

No Adjustments Needed on the New Air-Chrome Speaker

THIS year, more than ever before, particular stress is being laid on the tone performance of the set. Reception from even the most perfect hook-up,—containing units of the highest possible quality—will be far below the accepted standard unless your speaker is of the most advanced type.

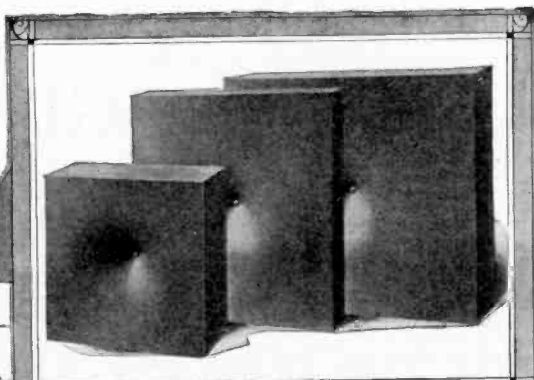

Natural Reproduction on All Frequencies is Essential

Whether your set favors low, intermediate or high frequencies, the standard Air-Chrome Speaker will reproduce *naturally*, everything the audio amplifier gives it. It would however be ridiculous for us to claim that the standard Air-Chrome will operate with the same efficiency on every set, but by building up the high or low frequencies, as the occasion demands, we are thus able to match the output of your set exactly.

The Custom-Built Air-Chrome

The Air-Chrome Speakers for set manufacturers are made in 3 standard sizes as shown above, 24" x 24", 18" x 23", 14" x 14". These will fit practically every cabinet.

Special sizes built if quantities warrant.

Test the Air-Chrome in Your Own Laboratory

The only way to tell whether you want to use the Air-Chrome on your set is to try it. Try to make it chatter—demonstrate it against any speaker—if you find that some frequencies are over-emphasized, remember that we can give you exactly what you want. The tone of the Air-Chrome is unaffected by atmospheric changes. A sample speaker will be sent on memorandum to responsible set and cabinet manufacturers. Send the coupon or write us today for complete information.

AIR-CHROME STUDIOS, INC.
181 Coit Street, Irvington, N. J.

Air-Chrome Studios, Inc.,
181 Coit Street, Irvington, N. J.
Please send us a sample
speaker on memorandum:
 24" x 24"
 18" x 23"
 14" x 14"



When writing to advertisers mention of the PROCEEDINGS will be mutually helpful.

OIL

IT IS OUR UNIQUE OIL
PROCESS THAT GIVES
ACRACON FILTER
CONDENSERS THEIR
EXTREMELY
LONG LIFE



CONDENSER CORPORATION OF AMERICA
259-271 CORNELISON AVE. JERSEY CITY, N. J.

When writing to advertisers mention of the PROCEEDINGS will be mutually helpful.

STRUCTURAL STRENGTH!



TO WITHSTAND the ravages of time and the elements, quality and strength in a Filter Condenser or Block must be inbuilt.

Beneath the attractive exteriors of Aerovox Filter Condensers and Filter Blocks lies a sturdy framework built to endure the onslaughts of voltage surges and unusual service conditions.

The Aerovox complete line of Condensers and Resistors includes Moulded Mica and Filter Condensers, Heavy Duty Pyrohms, Non-Inductive Lavites and Metalohm Grid Leaks and Resistors. The Aerovox Research Worker is a free monthly publication that will keep you abreast of the latest developments in Radio. Write for it today.

[The Aerovox Research Worker is a free monthly publication that will keep you abreast of the latest developments in Radio. A postcard will put your name on the mailing list. Write today.]

AEROVOX

"Built Better"
78 Washington St., Brooklyn, N. Y.

When writing to advertisers mention of the PROCEEDINGS will be mutually helpful.

XXVIII

LEUTZ

Universal Transoceanic

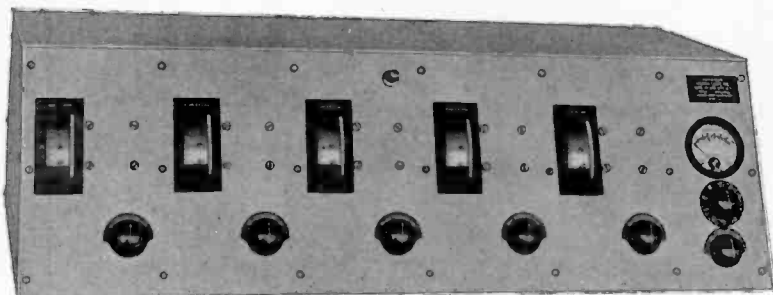

THE following partial list of TRANSOCEANIC owners speaks for itself:

Mrs. Herbert Pulitzer	Ignacio G. Javellana, P.I.
Mr. Percy Woodward, President, Waldorf System	Mr. P. Van Leyden, Amsterdam
Mr. J. S. Coffin, President, Lima Locomotive Co.	Mr. Joao Tenuto S. Paulo
Mr. Robert B. Gable, President, Wm. F. Gable Co.	Mr. M. Suarez Gonzalez, Villahermosa, Mex.
Mr. George S. Pomery, President, Pomeroy's Inc.	Mr. James L. Breese, Southampton, L.I.
Mr. Joseph B. Sessions, President, Sessions Foundry Co.	Mr. D. T. Hitchen, Sydney
Yacht "Happy Days"	Mr. Henry A. Hogg, Dunedin, N. Z.
U. S. S. Brooks, Officers Wardroom	Electrical Testing Laboratories, New York City
U. S. S. Dobbins, Officers Wardroom	Mr. Horacio Carmona Vial, Tacna, Chile.
U. S. S. Utah, Officers Wardroom	Mr. Thorne Donnelley, Chicago
U. S. S. Bridge, Officers Wardroom	Continental Photo Stores, Bombay
U. S. S. Vega, Officers Wardroom	Grace Line Inc., New York City
U. S. S. Arkansas, Officers Wardroom	Okura & Co., New York and Tokio
U. S. S. King, Officers Wardroom	American Transformer Co., Newark
Mr. Gil Anderson, Stutz Co.	Consul Gunther Eisemann, Berlin
	U. S. Veterans Hospital, Wipple, Arizona
	Capt. M. S. Goldsborough, U. S. N., retired.

THE UNIVERSAL TRANSOCEANIC is a powerful nine tube receiver designed for the advanced broadcast listener and experimenter. The normal wavelength range is 200 to 560 meters which can be extended down to 35 meters and up to 3600 meters by adding extra interchangeable tuned transformers.

Each Transoceanic is made to special order. The most advanced Transoceanic uses four 222 Screened Grid Tubes in the radio amplifier, 200A detector and a four stage audio amplifier. Two of the four stages are power amplifiers in a push pull system using either 2-210 or 2-250 power tubes. Power units are available to supply 450 volts of B current and the necessary C and A currents, giving complete electric operation.

Write for Latest Literature Today

C. R. LEUTZ, Inc.
 195 Park Place, Long Island City, New York
 Cables "EXPERINFO" New York

When writing to advertisers mention of the PROCEEDINGS will be mutually helpful.



on *half* of the Keyboard

AND that is what the majority of people who own Radio sets are trying to do . . . And the worst of it is that they do not know any better. They have been listening to "Radioed Music" so long that their ears have become accustomed to only about half of the program which was being broadcast.

Now it is possible to transform those sets so that all of the program is heard.

The AmerTran Power Amplifier, a complete 2 stage Push-Pull Amplifier and its companion Unit, the AmerTran Hi-Power Box supplying 500 volts to the plates of the Power Tubes will make your set superior to the finest manufactured sets.

Learn what radio can be—listen to the whole keyboard as it is played in the studio. Write to us now and let us arrange a demonstration for you. No obligation, of course, but prepare yourself for a musical treat.

Before you buy a new set—let us show you what your old set, AC or DC, will do when it is brought up to date with AmerTran Products.

AmerTran Push-Pull Amplifier—complete 2 stage audio amplifier. First stage AmerTran Push-Pull for two power Tubes. Choice of standard amplifier or UX 227

AC for 1st stage and two 171 or two 210 power tubes for second stage. Price, east of Rockies—less tubes—\$60.00



AmerTran ABC Hi-Power Box—500 volts DC plate voltage, current up to 110 ma; AC filament current for rectifier, power tubes and sufficient

226 and 227 AC tubes. Price, east of the Rockies—less tubes—\$95.00

AMERTRAN
TRADE MARK REG. U.S. PAT. OFF.

American Transformer Company
Transformer Builders for over 23 years
 221 Emmet Street : : : Newark, N. J.

When writing to advertisers mention of the PROCEEDINGS will be mutually helpful.

XXX

"ESCO"

HIGH VOLTAGE GENERATORS MOTOR-GENERATORS AND DYNAMOTORS

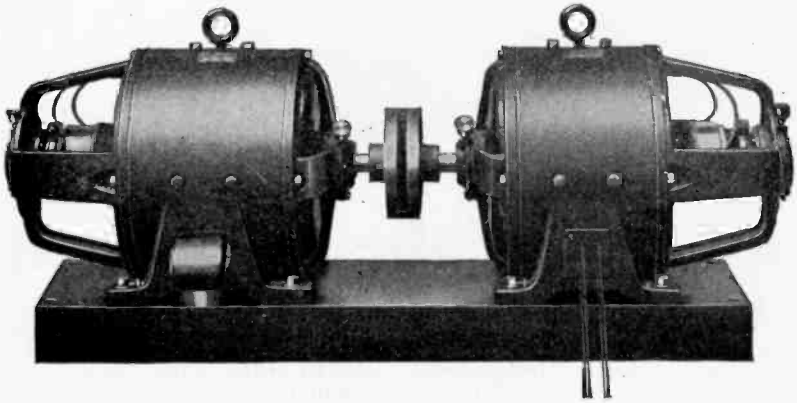

Type P Two Unit Motor Generator

"ESCO" two and three unit sets have become the accepted standards for transmission. The "ESCO" line consists of over 200 combinations. These are covered by Bulletin 237D.

Our engineers are always willing to cooperate in the development of special sets.

"ESCO" is the pioneer in designing, developing and producing Generators, Motor-Generators, Dynamotors and Rotary Converters for all Radio purposes.



How can "ESCO" Serve You?

ELECTRIC SPECIALTY COMPANY

TRADE "ESCO" MARK

300 South Street



Stamford, Conn.

When writing to advertisers mention of the PROCEEDINGS will be mutually helpful.

XXXI



The logo features the word "Polymet" in a large, stylized, white script font with a black outline, set within a black circular background. Below "Polymet", the word "CONFIDENCE" is written in a bold, blocky, three-dimensional font with a grey-to-black gradient and a drop shadow effect, giving it a metallic appearance.

Confidence in Polymet *quality*.

Confidence in Polymet *service*.

Confidence in Polymet *dependability*.

Confidence in Polymet to produce the best in every electric set essential led to the adoption of Polymet by two-thirds of the R.C.A. licensed radio manufacturers. It's the "little bit more" put into Polymet Products that brings the results which inspire this confidence.

We don't ask *your* confidence 'till we've won it.



Send for our new catalogue showing the complete line of Polymet electric set essentials.



**POLYMET
MANUFACTURING CORP.**

591 Broadway New York City

POLYMET PRODUCTS

When writing to advertisers mention of the PROCEEDINGS will be mutually helpful.

XXXII

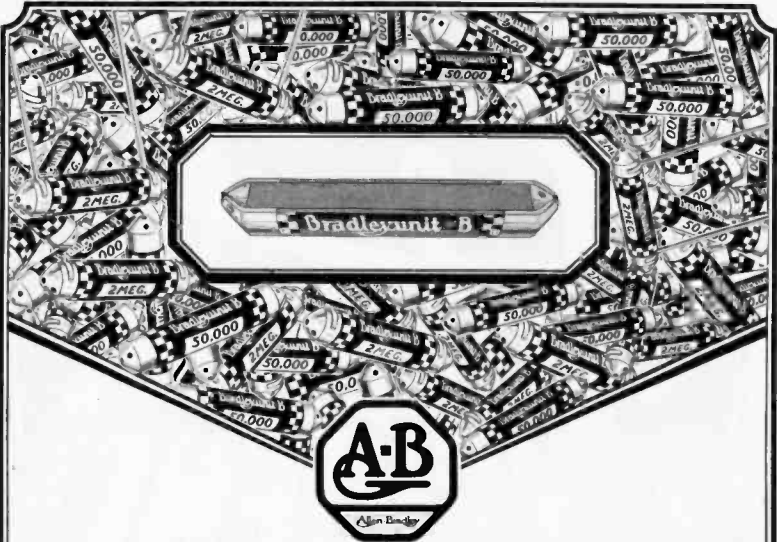

No Grid Leak Interference with this SOLID-MOLDED RESISTOR

Bradleyunit-B solid-molded resistors eliminate the noise and interference in radio circuits caused by inferior grid leaks. Oscillograph tests show the Bradleyunit-B to be remarkably quiet in operation.

The Bradleyunit-B Fixed Resistor is made of a special, uniform mixture, baked and solid-molded at high pressure. This creates a solid, uniform unit, providing a constant resistance regardless of voltage used.

Radio manufacturers are assured of an accurately calibrated resistor which will retain its initial rating indefinitely.

FOR RADIO MANUFACTURERS

These remarkable solid-molded resistors are practically unaffected by moisture, altho not depending on a glass enclosure for protection.

The Bradleyunit-B is furnished with or without tinned leads for soldering. Made in values from 500 ohms to 10 megohms.

Tapped Bradleyunit Resistors are also furnished to meet your specifications.

ALLEN-BRADLEY CO., 282 Greenfield Ave., Milwaukee, Wisconsin

Allen-Bradley Resistors

When writing to advertisers mention of the PROCEEDINGS will be mutually helpful.

XXXIII



The name TEMPLE and its Compelling Significance

THE name TEMPLE is recognized wherever radio exists as perfection in speaker design and construction. And herein lies a tale of an organization that has earned the name of being "Leaders in Speaker Design." An exacting standard of measurement—an organization that is unequalled anywhere for its laboratory and manufacturing facilities, that is why TEMPLE is synonymous with quality.

The TEMPLE laboratory staff, headed by Prof. Paul G. Andres, consists of nine graduate engineers. These men are constantly at work developing reproducers worthy of the TEMPLE name. TEMPLE speakers, therefore, are not the result of mere ideas, but of careful and painstaking research in an electro-acoustical laboratory that is second to none in the country.

TEMPLE speakers are available to manufacturers in two types—the famous TEMPLE Air Column and the new and sensational TEMPLE Air Chrome. Both are outstanding for their faithful reproduction, response to all frequencies and ability for handling tremendous volume without distortion. They may be had in a variety of models that will meet every dimension and cabinet requirement for size.

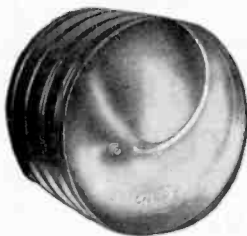

Model 150
U. S. Pats. Pend.

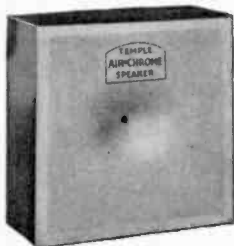

Model K
U. S. Pat. No. 1,672,796

Air Column Models

Model 150—The circular type has a center line air column length of 60". This is a correct mathematical exponential design making for maximum response and true brilliancy in the entire audible range. 11½" diameter, 7½" deep and weighs but 6½ lbs. without unit.

Model 180—The larger circular model. Similar in design to Model 150, but larger. It has a center line air column length of 75", is 18" in diameter, 11½" deep and weighs 36 lbs.

Air Chrome Models

Model Z—A small rectangular model. Wonderful in tone—small in size. Size 9¾"x21", depth 5". Weight 4 lbs.

Model R—A small rectangular model. Size 9"x24". Weight 4 lbs.

Model S—A small rectangular model. Size 9½"x18½". Weight 4 lbs.

Model F—The oblong model. May be installed either in an upright position or horizontally. Size 18"x23", depth 8½", weight 6 lbs.

Model K—The small square model. Size 14"x14", depth 7", weight 4½ lbs.

Write for complete information.

TEMPLE, Incorporated

1935 So. Western Ave. Chicago, U. S. A.

LEADERS IN SPEAKER DESIGN

When writing to advertisers mention of the PROCEEDINGS will be mutually helpful.

PROFESSIONAL ENGINEERING DIRECTORY

For Consultants in Radio and Allied Engineering Fields

The J. G. White Engineering Corporation

Engineers—Constructors

*Builders of New York Radio
Central*

Industrial, Steam Power, and Gas
Plants, Steam and Electric Rail-
roads, Transmission Systems.

43 Exchange Place New York

Q R V RADIO SERVICE, Inc.

JOHN S. DUNHAM
J. F. B. MEACHAM

*Devoted to Servicing Broadcast
Receivers Exclusively*

1400 BROADWAY, NEW YORK
WISCONSIN 9780

ROBERT S. KRUSE

*Consultant for development of
Short-wave Devices*

103 Meadowbrook Road
WEST HARTFORD, CONN.
Telephone, Hartford 45327

BRUNSON S. McCUTCHEN

Consulting Radio Engineer

17 State Street
NEW YORK

Electrical Testing Laboratories RADIO DEPARTMENT *also*

Electrical, Photometric,
Chemical and Mechanical
Laboratories

80th Street and East End Ave.
NEW YORK, N. Y.

J. E. JENKINS and S. E. ADAIR *Engineers*

Broadcasting Equipment
General Radio Telephone
Engineering

1500 N. DEARBORN PARKWAY
CHICAGO, ILLINOIS

ARCTURUS A-C TUBES

*Detector—Amplifier—
Hi-Mu Power*

A-C Adaptorless Cable
For Batteryless Radio

John Minton I. G. Maloff

JOHN MINTON, Ph.D. *Consulting Engineer*

for
Developing — Designing —
Manufacturing
of

Radio Receivers, Amplifiers, Transform-
ers, Rectifiers, Sound Recording and
Reproducing Apparatus.

Radio and Electro-Acoustical
Laboratory

8 Church St. White Plains, N. Y.

When writing to advertisers mention of the PROCEEDINGS will be mutually helpful.

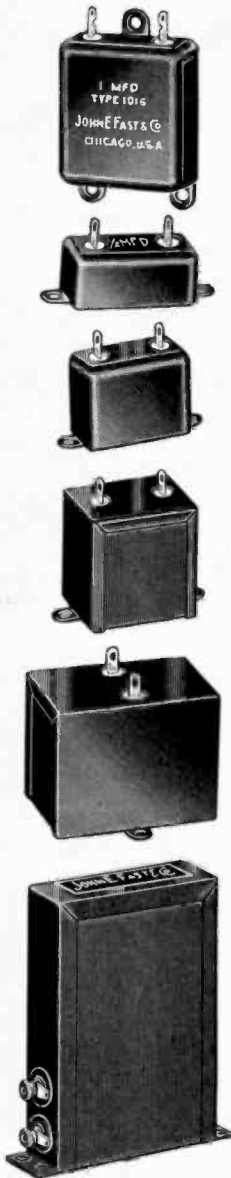

Let Us Solve Your Condenser Problems

WE make one thing and one thing only—wax impregnated paper condensers in die-press steel jackets, in medium and large capacities to fit every known need in radio sets, power units, etc. We make no set hardware, no eliminators, no transformers, no parts, no sets. Our entire concentrated effort is on one product alone—condensers. Such specialization assures highest quality, economical production and real service.

Millions of Fast by-pass and filter condensers are in daily use in radio sets made by the leading set manufacturers. They are renowned for their high insulation resistance and excellent and dependable electrical characteristics.

Manufacturers looking for a dependable source of supply, keyed to meet large production problems, on short notice, will find here one of the largest organizations of its kind in the world.

Send us your specifications.

JOHN E. FAST & CO



Established 1919

3982 Barry Avenue, Dept. I.R.E., Chicago, U.S.A.

Alphabetical Index to Advertisements

A	
Acme Electric and Manufacturing Co.....	XXIV
Acme Wire Co.....	XXV
Aerovox	XXVIII
Air-Chrome Studios	XXVI
Allen-Bradley Co.	XXXIII
Aluminum Co. of America.....	XI
American Transformer Co.	XXX
Amrad Corporation	XII
Automatic Electric Inc.	XVI
B	
Bryant Electric Co.	X
Burgess Battery Co.	XV
C	
Cardwell, Allen D., Mfg. Corpn.	III
Central Radio Laboratories	XXVIII
Condenser Corp. of America	XXVII
D	
Dudlo Manufacturing Company	XVII
E	
Electrad, Inc.	XXIII
Electric Specialty Co.....	XXXI
Elkon, Inc.	IV
F	
Fast, John E. & Co.....	XXXVI
Federal-Brandes, Inc.	VII
Formica Insulation Co.....	XIII
G	
General Radio Co.....	Outside Back Cover
Grebe, A. H. and Co., Inc.....	Inside Back Cover
H	
Hammarlund Mfg. Co.	XL
I	
I. R. E.....	XXII, XXXIX, XLI
Isolantite Co. of America.....	XIV
J	
Jewell Electrical Instrument Co.....	VIII
L	
Leutz, C. R., Inc.....	XXIX
P	
Polymet Manufacturing Co.....	XXXII
Professional Engineering Directory	XXXV
R	
Radio Corporation of America.....	IX
Radio Engineering Laboratories	XIX
Radio Receptor Co.....	XXXVIII
Roller-Smith Co.	II
S	
Scovill Manufacturing Co.	VI
Silver-Marshall, Inc.	XX
T	
Temple Incorporated	XXXIV
Thordarson	Inside Front Cover
U	
United Scientific Laboratories	V
W	
Weston Electrical Instrument Corp.....	XXI
Wireless Specialty Apparatus Co.....	I

When writing to advertisers mention of the PROCEEDINGS will be mutually helpful.

POWERIZER

announces a complete line of

POWER AMPLIFIERS

Power amplification is a highly profitable business for radio dealers and professional set builders. In every city, town or country, there is a real active demand for power amplification in all its various phases. Powerizer—made by the pioneers in power amplification—there is a Powerizer power amplifier to meet every requirement.

The PX-2 Power Amplifier is a two-stage power amplifier which can be energized from either the detector tube of a radio set or through any form of magnetic pickup, providing sufficient volume for homes or small halls—frequently used for demonstrating records or speakers by dealers.

List Price.....\$75.00

(Tubes extra)

Uses the No. 226 in the first stage, the No. 210 in the second, and the No. 281 as rectifier; is provided with volume control.

Powerizer PX-3 is a very powerful amplifier, three stages, using the UY-227 in the first stage, UY-227 in the second stage, and the new UX-250 in the third stage; has a tapped input and a tapped output and has both a volume and tone control. Special scratch filter. It has a tapped input and tapped output so that it may be applied to a detector of a radio set, a microphone, or a phonograph. It can handle from six to eight speaker units, and can fill a house of 1,800 seats.

List Price.....\$185.00

(Tubes necessary—two (2) UY-227, two (2) UX-281, and one (1) UX-250.)

Powerizer PXP-250 is a very powerful three-stage push-pull amplifier. It is unique in that the amount of amplification is unlimited, using our own system of sectional units. Push-pull 250 units may be added at will. Two units are sufficient to fill a house with at least 2,500 people; consists of one-stage UY-227, one-stage push-pull No. 171, and one-stage push-pull No. 250; has a tapped input and output.

For tonal quality and power, this is the last word in power amplification.

List price.....\$250.00

(Tubes necessary—one (1) UY-227, one (1) UX-280, two (2) UX-171, two (2) UX-281, and two (2) UX-250—tubes extra.)

All of our units use alloy steel transformers, insuring maximum volume over the entire audible range. We would be very glad to handle any special problem that you may have on amplification.

Write for Special Engineering Bulletin on Power Amplification, I.R. which will bring you a wealth of information.

RADIO RECEPTOR COMPANY

106 Seventh Ave.

New York City

Licensed by Radio Corporation of America and Associated Companies

When writing to advertisers mention of the PROCEEDINGS will be mutually helpful.

XXXVIII

A Particular Engineer ~

THERE is an excellent opportunity available for an engineer who has the following qualifications:

1. A clear thinker who can "Carry the Message to Garcia."
2. A thorough familiarity with the methods of manufacture of the component parts used in the production of radio devices, in particular condensers, resistors and small parts of this general nature.
3. A successful past record of accomplishment.
4. Some imagination.
5. Willingness to devote all effort necessary to produce satisfactory results, without regard to time.
6. A knowledge of production equipment and efficient small plant management.

This man will be given a full opportunity to get into action quickly without restriction and with ample encouragement.

Please address your reply, which will be held in confidence, to

**Room 1603
67 West 44th Street
New York City**

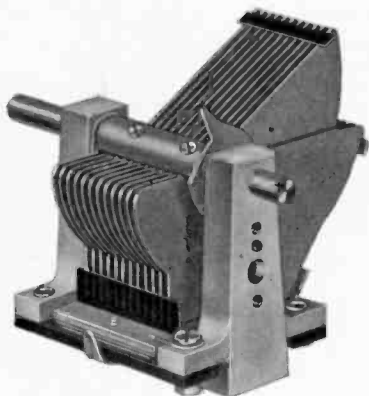

Every essential feature of the famous standard Midline Model—Only simplified to Better Meet the Set Manufacturers' Requirements.

**ASK US TO QUOTE
ON YOUR
REQUIREMENTS**

The New **HAMMARLUND** *Manufacturers' Model* **MIDLINE CONDENSER**

SO MANY manufacturers have asked us why we didn't make a simplified Midline Condenser, designed for receiver production in large volume.

The answer now is:—"We DO!"

And the new manufacturers' model illustrated here is a real achievement. For not only does it embody every essential technical characteristic of the standard Midline Model, it will give the same high degree of precision accuracy and faithful service.

Die-cast frame of new design—built for hard usage. Soldered brass plates with tie-bars. Smoothly operating bearings. Positive spring-friction contact. Convenient terminal lugs.

Your receiver should have the extra prestige of using Hammarlund Condensers—*famous for quality the world over.*

The price is unusually attractive.

May we quote on your needs for the current season?

HAMMARLUND
Manufacturing Company
424-438 W. 33rd St., New York

For Better Radio
Hammarlund
PRECISION
PRODUCTS



When writing to advertisers mention of the PROCEEDINGS will be mutually helpful.

DON'T MISS "The Engineering History of Radio"

by Donald McNicol
Fellow A. I. E.E. Fellow I. R. E.
Past President of I. R. E.

It is appearing serially in Radio Engineering beginning with the June 1928 issue

A new section covering Commercial Developments now appears in each issue.

It deals with Aeroplane and train communication, talking movies, picture transmission, speech amplifiers, etc.



NOTE

The June and July numbers will be sent gratis to those using the coupon below in subscribing.

Editor—M. L. Muhleman
Managing Editor—G. C. B. Rowe

Associate Editor—Austin C. Lesca boura
Associate Editor—John F. Rider

Some of the other articles in the June issue are:

- The Sulphide Rectifier - - - - by Dr. H. Shoemaker
- Selecting a Band of Radio Frequencies - by G. F. Lampkin
- Radio Set Power Supply - - - - by George B. Croise
- A. C. Tubes vs. Series Filament Operation - by W. P. Lar
- Mathematics of Radio - - - - - by John R. Jer
- High Voltage D. C. Generators - by J. H. Blankenbue ller

Radio Engineering is NOT sold on newsstands. If you are not a subscriber already, use the coupon below.

RADIO ENGINEERING, Inc.
52 Vanderbilt Ave., New York, N.Y.

Enclosed find { \$2.00 for 1 year } subscription to Radio Engineering to be-
gin August 1928.
Enclosed find twenty cents (20c) for which send sample copy of Radio Engineering.

(PLEASE PRINT NAME AND ADDRESS)

Name..... Address.....
City..... State.....

NOTE—June and July issues will be mailed gratis to new subscribers so they will have the entire McNicol series.

Please check your classification—Engineer
Technician

When writing to advertisers mention of the PROCEEDINGS will be mutually helpful.



"When fits this cross
from man to man,
Vich Alpine summons
to his clan."

When a Swiss chieftain
desired to summon his
clan, a fly cross was
placed in the hands of
relays of the swiftest
runners. They carried
it over hill and
dale, shouting calling
to arms. They ran from
altitude to altitude. On one
occasion during the civil
war of 1845, the fly
symbol was carried over
a tract of three to four miles
in three hours.



Get it Better with a Grebe



Doctor W. H. Grebe



Clannishness might be a well-chosen word to describe the spirit of the Grebe organization of radio engineers which, after the manner of an Old World guild-hall, have for nineteen years contributed so materially to the complete enjoyment of radio.

Throughout all these years they have been working together to produce the receiver that has so eagerly been awaited by all radio enthusiasts — the alternating current receiver that does away with the bother of batteries. The Grebe Synchronphase A-C Six is their contribution to perfect radio reception. No longer a non-battery receiver, but one that combines



convenience and ease of operation with superb tone qualities, unbelievable range and selectivity, freedom from A-C hum and other new Grebe improvements for better local and distance reception.

The Grebe Synchronphase A-C Six will convince you of the wisdom of the careful Grebe method of production. Hear it today, or send for Booklet I, which fully describes the distinctive features of this new receiver.

Other Grebe sets and equipment: Grebe Synchronphase Seven A-C, Grebe Synchronphase Five, Grebe Natural Speaker (Illustrated), Grebe No. 1750 Speaker.

GREBE

TRADE MARK U.S. PAT. OFF.

SYNCHROPHASE

A-C Six

RADIO

A. H. Grebe & Co., Inc., 109 W. 57th St., New York City
 Factory: Richmond Hill N. Y. Western Branch: 443 S. San Pedro St., Los Angeles, Cal.
 Makers of quality radio since 1909

When writing to advertisers mention of the PROCEEDINGS will be mutually helpful.

Laboratory Variometer

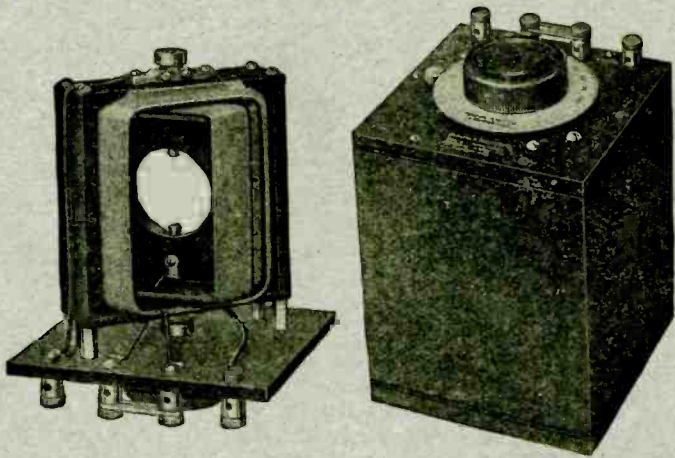

Type 107 Laboratory Variometer

The type 107 Laboratory Variometer is suitable for tuning of filter and oscillating circuits, as well as for use as a standard of self or mutual inductance in bridge circuits.

Described in Catalog E.

Type 107-F approximately 0.02 MH to 0.4 MH.

Type 107-G approximately 0.10 MH to 4.0 MH.

Type 107-H approximately 0.4 MH to 18 MH.

Price—All types \$27.00.

GENERAL RADIO COMPANY

*Manufacturers of Electrical and
Radio Laboratory Apparatus*

30 STATE STREET

CAMBRIDGE, MASS.