

VOLUME 15

JULY, 1927

NUMBER 7.

PROCEEDINGS  
*of*  
**The Institute of Radio  
Engineers**



PUBLISHED MONTHLY BY  
**THE INSTITUTE OF RADIO ENGINEERS**  
Publication Office 21 Center St., Middletown, N. Y.

Editorial and Advertising Departments  
37 West 39th Street, New York, N. Y.

Subscription \$10.00 per Annum in the United States  
\$11.00 in all other Countries

General Information and Subscription Rates on Page 549

Entered as second-class matter, at the Post-Office, at Middletown, N. Y.,  
under the Act of March 3, 1879.

Acceptance for mailing at special rate of postage provided for in Section 1103,  
Act of October 3, 1917, authorized October 7, 1918.

# Cunningham RADIO TUBES

Round out the circle  
of vacation joys

For real summer enjoyment you cannot do without Radio. To increase that pleasure, Cunningham Radio Tubes are most essential to your set.

No matter where you plan to be,—the mountains, the seashore or the back country—you can depend upon Cunningham Radio Tubes to bring you the world's best music with song, dance and laughter.

Your nearest Radio dealer will tell you the best combination of Cunningham Tubes for your particular set.

**E. T. Cunningham, Inc.**  
New York

Chicago      San Francisco



# “What condensers do they specify?”

Experts in the radio field know from experience that Faradon Capacitors can be counted on to give long and satisfactory service.

Manufacturers particularly, recognize the value of specifying Faradon Capacitors. They know that a reputation for quality equipment warrants the inclusion of only the highest grade condensers.

There is a Faradon designed for each particular purpose, and constructed from high-quality materials with the experience of twenty years specialization on fine condensers.



WIRELESS SPECIALTY APPARATUS CO.

Established 1907

JAMAICA PLAIN, BOSTON, MASS., U. S. A.

673

## *Faradon*

---

ELECTROSTATIC CONDENSERS  
FOR ALL PURPOSES

It will be of mutual benefit to mention Proceedings in writing to advertisers

# Roller-Smith Announces A NEW OHMMETER TYPE COM



Portable, direct reading, small, compact, light, rugged, accurate, entirely self-contained.  
Measures resistance values from .5 ohm to 50,000 ohms. List price \$70.00, subject to discount. Send for new Supplement No. 1 to Bulletin No. K-300.

*"Over thirty years' experience is back of  
ROLLER-SMITH"*

**ROLLER-SMITH COMPANY**  
Electrical Measuring and Protective Apparatus

MAIN OFFICE  
2134 Woolworth Bldg., New York



WORKS  
Bethlehem, Penna.

*Offices in principal cities in U. S. A. and Canada.  
Representatives in Australia, Cuba and Japan.*

It will be of mutual benefit to mention Proceedings In writing to advertisers

## Two New AmerTran Transformrse For Use with New Tubes!

### AmerTran Filament Heating Transformer

Type H-67, \$12.00 each

This transformer is intended for use with the new RCA UX-226 raw AC amplifier tubes and the new UY-227 detector tube. It also has a third filament winding capable of handling two UX-171 tubes. In connection with the new AC tubes, the type H-67 becomes the power source for the filament and is therefore a real "A" battery eliminator.

If you have a good plate supply system and a set with the new AC tubes and one or two UX-171 power tubes in the last stage, the H-67 AmerTran is ideal, transforming the 50 or 60 cycle, 110 volt AC house light current down to the lower voltages for the correct operation of the new tubes.

### AmerTran Power Transformer Type PF-281

The unit is designed for use with the new UX-281 rectifying tube; which can be operated at 550 volts plate up to a maximum of 750 volts plate and deliver 110 milliamperes DC as a half wave rectifier. A 750 volt plate winding with a tap for 550 volts enables the transformer to be used either with a UX-281 or 216-B rectifying tube, where the output plate voltage is not required to be in excess of 450 volts.

By using this transformer and our Type 709 and 854 Amer-Chokes in connection with the new AC tubes and a suitable filter circuit, it is possible to construct a radio receiver which can be entirely operated from the AC house lighting circuit without an A eliminator, trickle charger or batteries.

Like all AmerTran power devices this transformer has been generously designed to operate at a very low core density reducing the hum from stray fields to a minimum. Utmost efficiency has been sought regardless of cost.

*Write for further information including booklet*

**"IMPROVING THE AUDIO AMPLIFIER"**

## The American Transformer Co.

178 EMMET STREET

NEWARK, N. J.

*"Transformer Builders for Over 26 Years"*

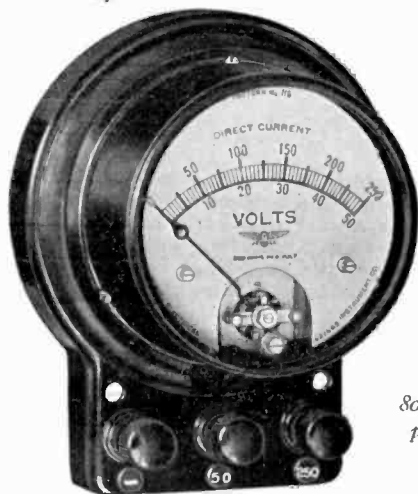

*Pattern  
No. 116  
High Resistance  
Voltmeter*

*A Quality  
Product*

*800 ohms  
per volt*

## *Mr. Radio Engineer:-*

You are, of course, familiar with the fact that voltage from a "B" power supply device must be accurately adjusted for best results. You also know from experience that this is next to impossible if the ear alone is your measuring device.

An accurate high resistance voltmeter is absolutely essential if proper adjustment of the power supply unit and resultant satisfactory operation of the radio set is expected.

For the Radio Engineer, for the radio dealer and his service men we recommend our Pattern No. 116 high resistance voltmeter. It can be used for counter, bench or wall mounting, or for portable work. The double scale is very flexible in use—the high range for checking B-eliminator voltage—the low range for checking A and C voltages. Close readings can be obtained on the long fifty division scale.

Where highest accuracy in voltage measurements are required the pattern No. 116 will give complete satisfaction.

Write for descriptive circular No. 1018.

*Jewell Electrical Instrument Co.*

*1650 Walnut St. - Chicago*

*"27 Years Making Good Instruments"*

It will be of mutual benefit to mention Proceedings In writing to advertisers  
IV



## Beyond All Expectation

We had scarcely hoped for such performance. New as today—old as Grebe's reputation and experience—the Synchronphase Seven typifies Grebe leadership of over seventeen years—a leadership built on the production of only the best that engineering skill could devise.

For nearly a score of years Grebe has developed device after device—radical, practical, permanent—for the improvement of radio reception.

And now—the Synchronphase Seven—the latest proof of Grebe leadership.

- 1 *Controlling Dial*  
that tunes accurately without aid of additional dials.
- 3-*Point Tuning Drive*  
—smooth-running, permanent adjustment.
- 5 *Tuning Stages*  
for maximum selectivity and fidelity of tone.
- 7 *Useful Tubes*  
each playing a distinct and important part in the production of tone, volume and distance.

The cabinet, of selected butt grain walnut, has a panel of French marquetry exquisitely designed and wrought.

*Booklet 1 gives the details.  
Your dealer will demonstrate.*

A. H. Grebe & Co., Inc., 109 West 57th Street, New York City

*Western Branch: 443 So. San Pedro St., Los Angeles, Calif.*

*Factory: Richmond Hill, N. Y.*

*The oldest exclusive radio manufacturer*

**GREBE SYNCHROPHASE RADIO**  
TRADE MARK REG. U.S. PAT. OFF.  
**SEVEN**



It will be of mutual benefit to mention Proceedings In writing to advertisers

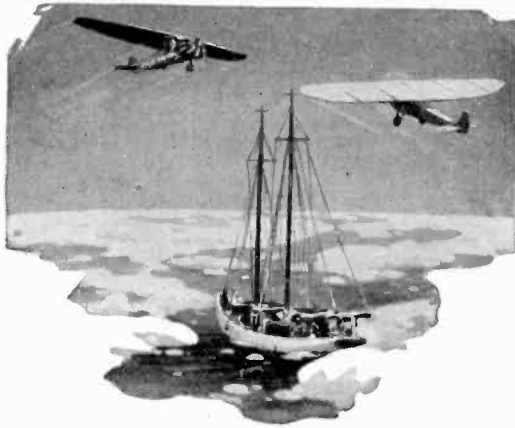

## The Crowning Adventure of Burgess Radio Batteries

*They flew over the North Pole with Byrd*

**O**N MAY 9, 1926, history was made. . . . .  
 American history. . . . . World history  
 . . . . . undying history.

Lieut. Commander Byrd in his fearless 1500-mile flight across the top of the world, adds another thrilling triumph to the long, proud list of American achievements.

Radio went along, for radio has become vital to the lives and success of explorers and adventurers. Burgess Batteries went along, sharing the fate—sharing the hardships and the glory of Commander Byrd, the Detroit Arctic Expedition, and Capt. Donald MacMillan.

It is eminently significant that in these glorious triumphs of American courage and American equipment where the test of men and their tools was the test of the survival of the fittest, that the standard products of the Burgess Battery Company were selected, used and "carried on" under extreme and unprecedented conditions.

**BURGESS BATTERY COMPANY**

General Sales Office: Chicago

*Canadian Factories and Offices:* Niagara Falls and Winnipeg



# BURGESS RADIO BATTERIES

It will be of mutual benefit to mention Proceedings in writing to advertisers



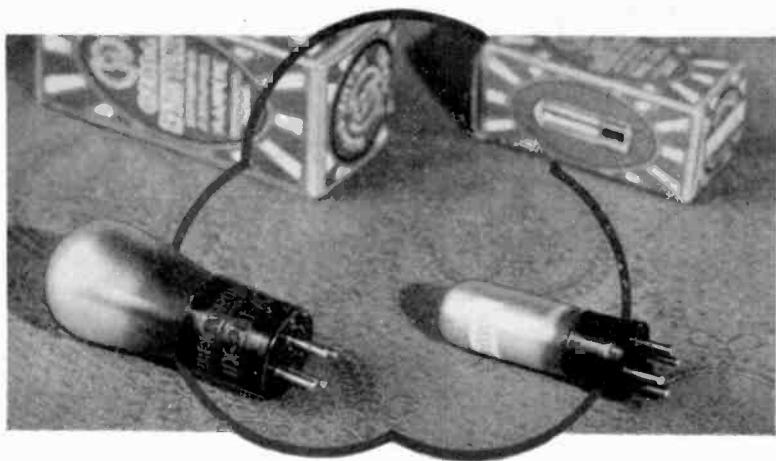

## Ken-Rad engineers insist on Bakelite Molded

For three years the Ken-Rad Co. has been using Bakelite Molded tube bases exclusively on Architron radio tubes, and have found it so superior that no other material will be approved by Ken-Rad engineers.

The use of Bakelite Molded has so many advantages for radio tube bases, that it has practically displaced all other materials. It not only possesses high insulation value, but it also effects economies in manufacture and improves the appearance of a tube.

Bakelite engineers and research laboratories are at the service of radio manufacturers in adapting Bakelite to their particular needs, and we invite you to enlist this cooperation in the solution of your insulation problems. Write for Booklet 33.

### BAKELITE CORPORATION

247 Park Ave., New York, N. Y. Chicago Office: 635 W. 22nd St.  
BAKELITE CORP. OF CANADA, LTD., 163 Dufferin St., Toronto, Ont.

# BAKELITE

THE MATERIAL OF  A THOUSAND USES

The registered Trade Mark and Symbol shown above may be used only in products made from materials manufactured by Bakelite Corporation. Under the symbol "B" is the registered logo for safety or unobstructed quantity. It indicates the volume number of patent and foreign patents of Bakelite Corporation's products.

It will be of mutual benefit to mention Proceedings in writing to advertisers

# RCA RADIOTRON UX-240

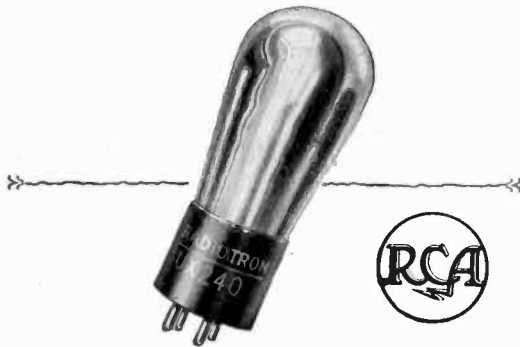

The new, Mu 30, thoriated filament tube  
for detection and amplification in  
resistance coupled amplifiers.

### CHARACTERISTICS

Filament Volts	5.
Filament Amperes	.25
Plate Milliamperes (approx.)	.2
Amplification factor	.30

"B" Volts	Plate Coupling Resistance (ohms)	Amplifier "C" Volts
180	250,000	3
135	250,000	1.5

Stopping Condenser—.005 to .05 mfd.

Amplifier Grid Leak—2 megohms

Price	\$2.25
-------	--------

RADIO CORPORATION OF AMERICA  
New York Chicago San Francisco

# RCA Radiotron

MADE BY THE MAKERS OF THE RADIOLA

PROCEEDINGS OF  
**The Institute of Radio Engineers**

Volume 15

JULY, 1927

Number 7

**CONTENTS**

	Page
Officers and Board of Direction . . . . .	550
Committees, 1927 . . . . .	550
Institute Sections . . . . .	552
Institute Activities . . . . .	553
News of the Sections . . . . .	554
Committee Work . . . . .	557
C. A. Boddie, "Telephone Communication Over Power Lines by High Frequency Currents" . . . . .	559
Sylvan Harris, "Measurements of Radio Frequency Ampli- fication" . . . . .	641
Book Review . . . . .	649
J. B. Brady, Digest of U. S. Radio Patents . . . . .	651
Geographical Location of Members Elected June 1, 1927 . . . . .	655

**GENERAL INFORMATION**

The Proceedings of the Institute are published monthly and contain the papers and the discussions thereon as presented at meetings.

Payment of the annual dues by a member entitles him to one copy of each number of the Proceedings issued during the period of his membership.

Subscriptions to the Proceedings are received from non-members at the rate of \$1.00 per copy or \$10.00 per year. To foreign countries the rates are \$1.60 per copy or \$11.00 per year. A discount of 25 per cent is allowed to libraries and booksellers.

The right to reprint limited portions or abstracts of the articles, discussions, or editorial notes in the Proceedings is granted on the express conditions that specific reference shall be made to the source of such material. Diagrams and photographs in the Proceedings may not be reproduced without securing permission to do so from the Institute through the Secretary.

It is understood that the statements and opinions given in the Proceedings are the views of the individual members to whom they are credited, and are not binding on the membership of the Institute as a whole.

---

Copyright, 1927, by  
**THE INSTITUTE OF RADIO ENGINEERS, Inc.**  
Publication Office 21 Center Street, Middletown, N. Y.  
Editorial and Advertising Departments, 37 West 39th St., New York, N. Y.

# OFFICERS AND BOARD OF DIRECTION, 1927

(Terms expire January 1, 1928, except as otherwise noted)

## PRESIDENT

RALPH BOWN

## VICE-PRESIDENT

FRANK CONRAD

## TREASURER

WARREN F. HUBLEY

## SECRETARY AND EDITOR

ALFRED N. GOLDSMITH

## MANAGERS

MELVILLE EASTHAM

R. H. MANSON

L. E. WHITTEMORE  
(Serving until Jan. 1, 1929)

L. A. HAZELTINE

A. E. REOCH

J. F. DILLON  
(Serving until Jan. 1, 1930)

J. V. L. HOGAN

R. H. MARRIOTT  
(Serving until Jan. 1, 1929)

R. A. HEISING  
(Serving until Jan. 1, 1930)

---

## JUNIOR PAST PRESIDENTS

J. H. DELLINGER

DONALD McNICOL

---

## ASSISTANT SECRETARY

JOHN M. CLAYTON

## ASSOCIATE EDITOR

GEORGE R. METCALFE

---

## COMMITTEES OF THE INSTITUTE OF RADIO ENGINEERS, 1927

---

### COMMITTEE ON MEETINGS AND PAPERS

R. H. MARRIOTT, Chairman  
STUART BALLANTINE  
R. R. BATCHER  
CARL DREHER  
W. G. H. FINCH  
ERICH HAUSMANN  
S. S. KIRBY  
G. W. PICKARD  
PAUL WEEKS  
W. WILSON

### COMMITTEE ON ADMISSIONS

F. CONRAD, Chairman  
ARTHUR BATCHELER  
HARRY F. DART  
C. P. EDWARDS  
A. H. GREBE  
L. A. HAZELTINE  
R. A. HEISING  
L. M. HULL  
F. H. KROGER  
A. G. LEE  
F. K. VREELAND

## COMMITTEES OF THE INSTITUTE—(Continued)

### COMMITTEE ON REVISION OF THE CONSTITUTION

J. H. DELLINGER, Chairman  
J. V. L. HOGAN  
DONALD McNICOL

### COMMITTEE ON PUBLICITY

W. G. H. FINCH, Chairman  
DAVID CASEM  
ORRIN E. DUNLAP  
F. EHLERT  
L. W. HATRY  
E. H. HANSEN  
LLOYD JACQUET  
J. F. J. MAHER  
J. G. UZMANN  
WILLIS K. WING  
R. F. YATES

### COMMITTEE ON MEMBERSHIP

HARRY F. DART, Chairman  
M. C. BATSEL  
M. BERGER  
GEORGE BURGHARD  
E. M. DELORAINE  
COL. J. F. DILLON  
DR. L. J. DUNN  
C. P. EDWARDS  
W. G. H. FINCH  
C. M. JANSKY, JR.  
ROBERT S. KRUSE  
WILLIAM J. LEE  
PENDLETON E. LEHDE  
C. L. RICHARDSON  
F. H. SCHNELL  
E. R. SHUTE  
G. S. TURNER  
E. H. ULRICH

### COMMITTEE ON INSTITUTE SECTIONS

DAVID H. GAGE, Chairman  
M. BERGER  
L. F. FULLER  
D. HEPBURN  
L. G. PACENT  
M. C. RYPINSKI  
E. R. SHUTE

### COMMITTEE ON STANDARDIZATION

L. E. WHITTEMORE, Chairman  
M. C. BATSEL  
EDWARD BENNETT  
A. J. CARTER  
E. L. CHAFFEE  
J. H. DELLINGER  
MELVILLE EASTHAM  
C. P. EDWARDS  
GENERAL FERRIE  
A. N. GOLDSMITH  
L. A. HAZELTINE  
J. V. L. HOGAN  
L. M. HULL  
F. A. KOLSTER  
MAJOR J. O. MAUBORGNE  
R. H. MANSON  
DONALD McNICOL  
E. L. NELSON  
H. S. OSBORNE  
LT. COMDR. W. J. RUBLE  
E. H. SHAUGHNESSY  
H. M. TURNER  
C. A. WRIGHT  
HIDETSUGU YAGI  
J. ZENNECK  
W. E. HOLLAND

ALL SECTION SECRETARIES EX-OFFICIO

## INSTITUTE SECTIONS

### ATLANTA SECTION

CHAIRMAN Walter R. Van Nostrand, Jr.  
SECRETARY-TREASURER George Llewellyn, Room 524, Post Office Bldg., Atlanta, Ga.

### BOSTON SECTION

CHAIRMAN George W. Pierce  
SECRETARY-TREASURER Melville Eastham, 11 Windsor St., Cambridge, Mass.

### CANADIAN SECTION

CHAIRMAN A. M. Patience  
SECRETARY C. C. Meredith, 110 Church St., Toronto, Ontario

### CHICAGO SECTION

CHAIRMAN G. M. Wilcox  
SECRETARY H. E. Kranz, 4540 Armitage Ave., Chicago, Ill.

### CLEVELAND SECTION

CHAIRMAN John R. Martin  
SECRETARY-TREASURER L. L. Dodds, 6528 Carnegie Ave., Cleveland, Ohio

### CONNECTICUT VALLEY SECTION

CHAIRMAN W. G. Cady  
SECRETARY-TREASURER K. S. Van Dyke, Scott Laboratory, Middletown, Conn.

### DETROIT SECTION

CHAIRMAN Thomas E. Clark  
SECRETARY-TREASURER W. R. Hoffman, 615 West Lafayette Blvd., Detroit, Mich.

### LOS ANGELES SECTION

CHAIRMAN L. Taufenbach  
SECRETARY L. Elden Smith, 340 N. Painter Ave., Whittier, Cal.

### PHILADELPHIA SECTION

CHAIRMAN J. C. Van Horn  
SECRETARY John C. Mevius, 1533 Pine St., Philadelphia, Pa.

### ROCHESTER, N. Y. SECTION

CHAIRMAN V. M. Graham  
SECRETARY F. W. Reynolds, 1060 University Ave., Rochester, N. Y.

### SAN FRANCISCO SECTION

CHAIRMAN J. F. Dillon  
SECRETARY-TREASURER D. B. McGowan, Custom House, San Francisco, Cal.

### SEATTLE SECTION

CHAIRMAN Tyng Libby  
SECRETARY-TREASURER W. A. Kleist, 1039 Dexter Horton Bldg., Seattle, Wash.

### WASHINGTON SECTION

CHAIRMAN A. Hoyt Taylor  
SECRETARY-TREASURER F. P. Guthrie, 122 Conn. Ave., Washington, D. C.

## INSTITUTE ACTIVITIES

### JUNE MEETING OF THE BOARD OF DIRECTORS

At the meeting of the Board of Direction of the Institute, held at 4:00 P. M. on June 1, 1927 in the Institute Offices, the following were present: Dr. Ralph Bown, President; Frank Conrad, Vice-President; Dr. J. H. Dellinger, Donald McNicol, Melville Eastham, R. A. Heising, R. H. Marriott, L. E. Whittemore, and J. M. Clayton, Assistant Secretary.

Upon recommendation of the Committee on Admissions, the following applications for admission and transfer were approved: Transfer to the grade of Fellow: Dr. A. Hund. Transfer to the grade of Member: E. A. Laport and L. Spencer. Election to the grade of Member: F. K. Dalton and C. L. Lyons.

One hundred and forty-four Associates and nineteen Juniors were elected.

A petition from Institute members residing within the vicinity of Atlanta, Georgia, for the formation of an Atlanta Section of the Institute was approved, and the Section was recognized.

### BINDERS FOR COPIES OF THE PROCEEDINGS

From the office of the Institute there are now available binders which hold twelve copies of the PROCEEDINGS. These binders are fitted with wire straps which hold each copy in place. They are finished with Spanish grained and buffed blue fabrikoid with suitable engraved titles on the backbone and front cover. They can be purchased by members of the Institute for \$1.50 each.

### NEW YORK MEETING

At the meeting of the Institute held on June 1, 1927 in the Engineering Societies Building, 33 West 39th Street, New York City, a paper entitled, "Telephone Communication Over Power Lines By High Frequency Currents" was

presented by C. A. Boddie of the Radio Engineering Department of the Westinghouse Electric and Manufacturing Company.

General discussion followed the presentation of this paper.

The attendance at this meeting was one hundred and seventy-five.

Copies of the paper, in pamphlet form, are available to members of the Institute upon application to the Institute Offices.

## News of the Sections

### ATLANTA SECTION

The Atlanta Section held its first formal meeting on the evening of July 6, 1927.

This Section is an outgrowth of the Atlanta Association of Radio Engineers which was formed over three years ago for the purpose of creating sufficient interest, in Atlanta and its vicinity, in radio engineering meetings to enable it to function as a Section of the Institute.

Major Walter Van Nostrand is the Chairman of the Section Organizing Committee.

The Publicity Committee of the Section has been appointed and is composed of the following members: Lambdin Kay, Henry L. Reid and Will Smith.

### BUFFALO TEMPORARY ORGANIZATION

A petition for the formation of a Buffalo Section of the Institute has been received at Institute Headquarters.

The officers of the temporary organization are as follows: L. C. F. Horle, Chairman; Dr. L. G. Hector, Vice-Chairman; C. J. Porter, Secretary-Treasurer. Two temporary Committees have been appointed as follows: J. Eichenman, Chairman, Membership Committee; I. R. Lounsberry, Chairman, Meetings and Papers Committee.

A meeting was held on June 6th at which time a talk was delivered by Dr. L. G. Hector on "Radio Transmission Phenomena."

The attendance at this meeting was fifty.



### CHICAGO SECTION

A meeting of the Chicago Section was held in the rooms of the Western Society of Engineers on May 31, 1927.

Professor G. M. Wilcox was the presiding officer. A paper was presented by C. W. Horn, of the Westinghouse Electric and Manufacturing Company on the subject of "The Synchronizing of Radio Stations."

### CLEVELAND SECTION

On May 27, 1927 a meeting of the Cleveland Section was held in the Case School of Applied Science.

John R. Martin presided. W. C. Blackburn presented a paper on "High Quality Reproduction" with which were included demonstrations.

The attendance at this meeting was fifty-one.

### CONNECTICUT VALLEY SECTION

A meeting of the Connecticut Valley Section was held on June 10, 1927 in the Scott Laboratory of Physics, Wesleyan University, Middletown, Connecticut. Dr. W. G. Cady was the presiding officer.

Dr. A. Hoyt Taylor of the Naval Research Laboratory presented a paper on "Some Peculiarities in High Frequency Transmission and Reception."

Messrs. Bourne, Cady, Laport, Warner, Lyford, Kruse and others participated in the discussion which followed.

After adjournment the forty-one members attending the meeting inspected the Laboratory and the research work in progress.

### DETROIT SECTION

On April 15, 1927 the Detroit Section held a meeting in the Conference Room, Detroit News Building, 615 West Lafayette Street, Detroit.

Thomas E. Clark presided. A paper by James E. McNary entitled "Some Experimental Radio Field Intensity Measurements and Observations" was read by Mr. McNary.

Twenty-eight members and guests attended this meeting.

The Detroit Section held a meeting on May 20, 1927 in the Conference Room of the Detroit News.

A talk by Otis H. Trowbridge on "Receiving Set Design" was given. The discussion was participated in by Messrs. Glatzel, Morse, Buchanan, Hoffman and others.

The attendance was thirty-one.

A meeting of the Detroit Section will be held in the Detroit News Building on June 24, 1927, at which time E. D. Glatzel will read a paper, "Some Experiences in Short Wave Transmission."

#### LOS ANGELES SECTION

The Los Angeles Section held a meeting on May 16, 1927 in the Los Angeles Elks Club. L. Taufenbach presided.

Two papers were presented at this meeting. The first, by Mr. Hutson of the Radio Power Corporation of America, was entitled "A-B-C Power Devices, Their Design and Uses." This paper was discussed by Messrs. Wallace, Waters and Chester.

The second paper by W. W. Lindsay, Jr. was on "A Method of Maintaining Constant Radio Frequency Amplification over the Broadcast Range."

The attendance at this meeting was forty.

#### PHILADELPHIA SECTION

The Philadelphia Section held a meeting on May 26, 1927 in the Bartol Laboratories, Philadelphia. J. C. Van Horn was the presiding officer.

W. J. Healy delivered a talk on "Sensitive Measuring Instruments used in Radio."

The attendance at this meeting was thirty-five.

The next meeting of the Philadelphia Section will be held on June 24, 1927 in the Franklin Institute, at which time C. Francis Jenkins will present a paper on, "Radio Vision."

#### WASHINGTON SECTION

On May 12, 1927 a meeting of the Washington Section was held in Harvey's Restaurant, 11th and Pennsylvania Avenue, N. W., Washington, D. C. Dr. A. Hoyt Taylor was the presiding officer.

Commander S. C. Hooper, U. S. N., delivered a paper,

"The Mission and Scope of Naval Radio." This paper was discussed by Admiral Bullard and others.

The attendance was forty at this meeting.

## Committee Work

### COMMITTEE ON SECTIONS

A meeting of the Committee on Sections was held on May 27, 1927. The following attended this meeting: D. H. Gage, Chairman, M. Berger, E. R. Shute and J. M. Clayton.

The Committee reports satisfactory progress on the preliminary draft of a booklet being prepared for the information of Institute members interested in Section formation.

The Committee considered the application from the Atlanta, Georgia members for the formation of an Atlanta Section, and approved the petition submitted.

It is planned to hold additional meetings of this Committee throughout the summer.

### COMMITTEE ON MEMBERSHIP

A meeting of the Committee on Membership was held on June 13, 1927.

The Committee has outlined a very intensive plan whereby many desirable and eligible non-members of the Institute who are not familiar with the Institute will receive information regarding it.

Plans for circularization of a number of organizations are being laid with the view of securing desirable members.

### TECHNICAL COMMITTEE ON VACUUM TUBES, A. E. S. C.

#### SECTIONAL COMMITTEE ON RADIO

The Technical Committee on Vacuum Tubes had a meeting on May 4, 1927 at the Institute office. Those present were: A. M. Trogner (acting Chairman), A. F. Van Dyck, C. H. Sharp and A. V. Loughren.

The Committee took action on a number of subjects which have been considered by correspondence in recent months.

The Committee adopted as standard for recommendation to the Sectional Committee on Radio, the two UX bases widely used commercially for vacuum tubes, and also the

vacuum tube terminology as published in the 1926 Standardization Report of the Institute of Radio Engineers.

There was a discussion of filament voltage tolerances but it was decided that further commercial standardization is necessary before action on this subject would be appropriate.

The Committee took cognizance of a proposal which has come from the International Electrotechnical Commission for standardization of tube bases. The Committee determined to assemble data on the several types of tube bases used in the United States and to place this information at the disposal of Dr. J. H. Dellinger, who will be the United States representative on this subject at the meeting of the International Electrotechnical Committee in Italy in September.

#### PRELIMINARY REPORTS OF I. R. E. STANDARDIZATION SUB-COMMITTEES

As mentioned in this portion of the PROCEEDINGS last month, copies of preliminary drafts of reports of three of the Sub-committees of the I. R. E. Standardization Committee are available for distribution to all persons interested in radio standardization.

Copies of these drafts will be mailed upon application to Institute headquarters.

# TELEPHONE COMMUNICATION OVER POWER LINES BY HIGH FREQUENCY CURRENTS \*

C. A. BODDIE

(Radio Engineering Department, Westinghouse Electric and  
Manufacturing Company.)

High frequency currents have been in use for telephone communication over high voltage power lines for four or five years. In this time a considerable amount of equipment has been installed and is now in operation. The primary object aimed at is to provide a reliable channel of communication between the load dispatcher of a power system and the operators in charge of the various sub-stations under his control.

Before the development of this type of high frequency communication the only system available was the ordinary wire telephone. Power companies were accustomed to provide themselves with communication facilities of their own design and construction, or they might lease circuits from the commercial telephone companies. Companies operating large city systems often found it convenient to lease their telephone circuits from the telephone company. Companies operating long transmission lines however, found that leasing circuits from the telephone company was less satisfactory as well as very costly. In many cases no telephone circuits were available between the points where communication was desired so it became necessary for the power companies to build their own telephone lines. Communication between the load dispatcher and his various sub-stations must be prompt and sure. Much valuable time was lost in going through telephone company exchanges. For this reason privately owned lines were much more satisfactory, due to the promptness with which communication could be established.

It was natural that in building its own telephone lines a power company should follow the same right of way as the

\*Received by the Editor, May 5, 1927.

power line itself, or even to string the telephone wires on the same poles or towers as the power line. Privately owned telephone lines were therefore exposed directly to the induction from the power line for long distances, and were thus likely to be noisy. This was especially the case when the telephone wires were strung on the same poles as the power line.

Excepting for the noise, the privately owned lines usually worked out best. In case of disturbance on the power line such as failure of an insulator, telephone communication was almost invariably interrupted due to blowing of fuses and a discharge over the lightning arresters. This usually occurred on leased lines as well as on the power companies own line. In case of sleet or wind storms the power companies telephone line was often of stronger construction, and was likely to stay up as well or better than telephone companies line. Thus from the viewpoint of continuity of telephone service, leased lines had little to offer as compared with private lines and private lines had a marked advantage from an operating point of view.

Reliable telephone communication is a matter of vital importance to a power company. Its wire telephone circuits being directly exposed to the power line are rather sensitive to disturbances in the power line. The problem of protection is also a rather serious matter when the telephone line is run on the same poles as the power line. This problem has been worked out by the power companies themselves with little or no assistance.

With the rapid development of radio as a means of communication, it was natural that the large manufacturers of power apparatus who had also become deeply interested in radio, should turn their attention to the possibility of using radio apparatus and radio methods in an attempt to provide a better solution for the communication problem of power companies. This work was undertaken by the manufacturer of power apparatus in the belief that anything which assists the power companies more effectively or more efficiently to operate their apparatus, must be a benefit to the whole industry.

The special advantage to be derived by the use of high frequency currents flowing in the power conductors is that the communication circuit is then as strong mechanically as

the power line itself. The general experience is that wind and sleet which will completely carry away a telephone line, does no great harm to a power line because of its sturdy mechanical construction. The elimination of noise arising from induction from currents in the power line was a second important consideration. The omission of the telephone conductors themselves together with their maintenance and the location of communication equipment at accessible points in power stations and substations, were additional advantages to be gained by the use of high frequency currents.

There are at present three manufacturers of high frequency power line telephone equipment. The equipment of each manufacturer differs rather sharply both in fundamental principles of design and in many minor features from the equipment of the other manufacturers. These striking differences are largely the result of a difference in viewpoint and experience of the engineers making the designs. In addition to a difference in the engineering viewpoint there is also a difference in the theoretical conception, and the analysis of some of the factors entering the problem.

The major outstanding differences in the several designs are:

1. Power level i. e. the amount of high frequency energy which should be provided for a given communication.
2. Number of frequencies used per channel.
3. Method of obtaining duplex in two frequency systems i. e. filters vs. balancing by means of potentials derived from transmitter.
4. Method of calling i. e. interrupted continuous wave (cw), or modulated cw.
5. Type of selector i. e. automatic telephone versus train dispatching selector and code key.
6. Protective equipment.
7. Method of coupling to power line i. e. by condenser or antenna.

#### POWER LEVEL

Perhaps the first and most striking difference in the designs of the several manufacturers is that due to a difference in power level. Two manufacturers have developed equip-

ment which might be called low power equipment, while one manufacturer provides a transmitter developing so much greater power that it might be called high power by contrast. The low powered equipment provides a transmitting energy of the order of 1 watt, whereas the high powered equipment provides 250 watts. This great difference in power is due directly to the different estimate the various designers place on the value of telephone communication to a power company. The greater the amount of power provided, the greater the margin over the minimum necessary for successful operation. That is, the more power provided for a given communication the greater the factor of safety.

The low powered set is more in line with previous practice in telephone communication over wires. It is also in accord with wire telephone practice which assumes that another circuit is always available in the case of failure of the one under consideration, and that therefore large margins of operating energy are unnecessary. In this case the failure of a circuit means merely switching to another circuit. In this respect a power line telephone is not comparable with the usual wire line telephone, since the failure of the circuit in question means total interruption of communication and this communication is vastly more important than that usually going forward on ordinary commercial telephone lines.

In addition to the much greater importance of load dispatching telephone communication, there are other very strong reasons for using considerable power when the communication circuit is the power line itself. The circuit offered by a power line differs from an ordinary telephone circuit in that it consists not merely in two simple wires connecting the transmitter and receiver, but contains at least three wires and very often six wires. On this circuit is connected a great variety of apparatus. The circuits branch repeatedly and these branches often are tied back into the main circuit forming loops so that the whole becomes a network, rather than simply a line. The transmission properties of this network are not constant, but change sometimes seriously every time a switch is thrown on the high tension system. It is almost impossible to foretell just what will happen when any given switch is opened or closed. In order to provide for these uncertainties, provision must



be made for an ample supply of communication energy.

Perhaps the most serious difference between a simple telephone line and a communication circuit formed by a power line is that the high voltage gives rise to line noises. All lines are noisy more or less. The magnitude of these line noises vary greatly as between lines. It also varies widely from day to day and from hour to hour. The origin of these line noises seems to be in what are called "spitting insulators". This is a slight static discharge often invisible, occurring between parts of the hardware and the insulator surfaces, or between sections of the insulator itself. This discharge releases the stored energy in the parts involved and constitutes a miniature radio transmitter, which sends a shock disturbance or wave down the line. In character it manifests all the properties of ordinary radio static. The only answer to the noise problem is to increase the communication energy level to such a value that the noise is relatively small in comparison. No amount of amplification at the received end can correct for lack of communication energy.

There has been an attempt to meet the varying conditions of noise and attenuation by providing the transmitter with two sets of tubes, one for low power operation and one for high power operation. As an answer to the line noise problem this is not satisfactory, since with such a system the receiving equipment is always adjusted to a rather high state of sensitivity in order to operate on low power. In case the noise level of the line rises to such a point as to make the use of the high power necessary, the detector is already blocked with noise and when the high power is applied the detector is abused still further. The result is that when the noise level rises to a point which puts the low powered channel out of business the distortion is so great that communication is almost impossible.

From the engineering viewpoint it is clear that it would be unwise to hazard the operation of so important a function as load dispatching telephone communication by the use of low power in an effort to economize. The apparatus discussed in this paper is of the high powered type. In its design it was assumed that the service for which it was intended was of vital importance. It was intended that the reliability and continuity of service should be of the same

high order as the factor of continuity of the power line itself. In the selection of circuits and the design of the parts the same ample margins are provided over and above the bare operating requirements as are provided in the matter of power. No circuit elements are employed about whose stability and certainty there can be any doubt.

#### NUMBER OF FREQUENCIES PER CHANNEL

The equipment now available for communication over power lines may be divided into two classes:

1. The system providing two frequencies for each channel.

2. The system providing only one frequency per channel.

The two frequency system is the pioneer and still represents the safest and best method of providing duplex communication. In this system each station is assigned two frequencies, one frequency for the transmitter and one frequency for the receiver. The selection of two entirely different frequencies for transmission and reception renders these two functions entirely independent. When properly worked out they are just as separate as if separate wires were provided for each function. With this system the functions of transmission and reception can go forward simultaneously just as in ordinary conversation. The system is very flexible and very stable. It may be modified to do many things which the original design did not contemplate owing to its inherent stability. For example, it may be used as a repeater owing to the fact that the functions of transmission and reception may go forward simultaneously and not alternately.

The single frequency system has been developed along the lines of space radio communication where the transmitter and receiver are tuned to the same frequency, but are alternately connected to the antenna. With this system communication is normally possible in only one direction at a time, it being necessary for each of the parties to throw over in order to reverse the direction of transmission. The first single frequency system was of this throw over type and was manually operated. The superiority of the two frequency duplex system soon drove out the manually operated single frequency simplex system. One company still

manufactures single frequency simplex equipment, but this manual throw-over has been modified so that it is now automatic. In this system the receivers are normally connected to the antenna in a condition to receive and the transmitters are inactive. A voice operated relay is used to unlock the transmitter and allow it to oscillate and at the same time block the receiver, thus accomplishing automatically the throw-over which was formerly manual. The system is

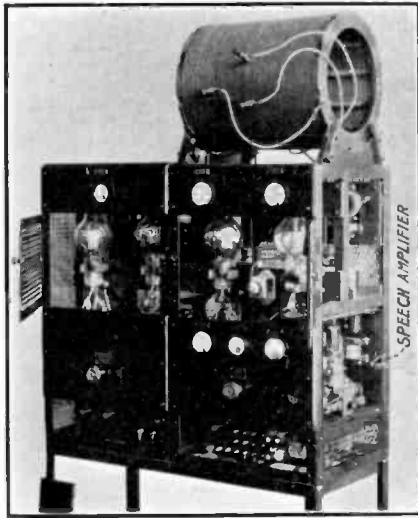

Fig. 1.

not really duplex, but is automatic simplex. The functions of transmission and reception go forward alternately and not simultaneously as is essential in true duplex. It is not so flexible as the two frequency system nor so stable. It cannot be used as a repeater without complete duplication of equipment, owing to the fact that the functions of transmission and reception take place alternately, whereas a repeater requires them to go forward simultaneously. Such a system is much more susceptible to noise picked up on a line extension. If the noise level is appreciable it will seriously interfere with the operation of the equipment.

It is believed that the two frequency duplex system will

be finally adopted owing to its superior stability and flexibility.

### GENERAL DESCRIPTION OF HIGH POWERED SET

A view of the transmitter of the high powered equipment is shown in Fig. 1. It is built around a 250-watt tube as the fundamental element. The tubes used have plain tungsten filaments and were selected because of their stur-

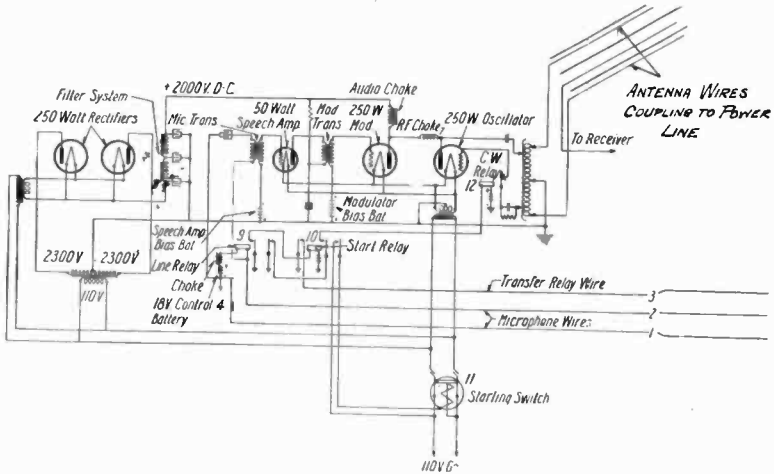

Fig. 2.

diness and great reliability. The transmitter has two power tubes, one used as an oscillator or power amplifier and one used as a modulator. A 50-watt tube is used as a speech amplifier to control the grid of the 250-watt modulator. The speech amplifier is seen at the right of Fig. 1. The power supply is obtained directly from the 110-volt, 60-cycle system or from a motor generator converting from d-c. to a-c. if the 60-cycle supply is interrupted. This voltage is stepped up by means of a transformer and rectified in the usual manner to provide 2000 volt d-c. plate supply for the transmitter. The rectifier is seen at the left of Fig. 1. The general nature of the circuits used is shown schematically in Fig. 2. These circuits are those commonly used and need no further description. In order to reduce the number of wires on the diagram, the customary method of showing a separate battery and ground for each relay is employed.

A general view of the receiver used is shown in Figs. 3 and 4. The circuits employed are shown in Fig. 5. The apparatus is grouped and mounted on separate panels. The top panel Fig. 3 contains all the radio circuits. The second panel contains all vacuum tubes, transformers and accessories which have to do with detection and amplification. The third panel carries the plate rectifier for supplying plate voltage to the amplifier tubes. It also carries a group of B

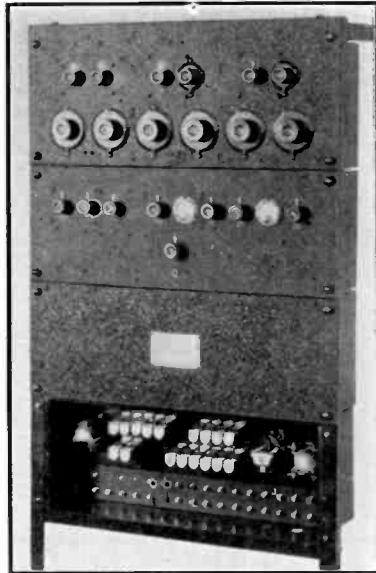

Fig. 3.

batteries which float on the plate supply rectifier for the purpose of stabilizing the voltage. This B battery does not furnish plate current except in emergencies when the power supply is off or the voltage low. The lower panel carries all control relays and provides an ample terminal board.

The system is entirely automatic. It is controlled by a standard form of automatic telephone desk stand. When the receiver is lifted from the hook, current is drawn from an 18 volt control battery shown in Fig. 2 over the microphone wires 1 and 2. This current is drawn through relay 9 which picks up and energizes relay 10, which in turn closes the starting contactor 11, and applies 110 volts, 60 cycles to

the transmitter. The tubes light and the plate rectifier supplies the necessary 2000 volt d-c. potential to the transmitter. The output of the transmitter is fed into the power line by means of coupling wires or antenna associated with the power line.

Calling is accomplished by interrupting the flow of high frequency current by means of the calling dial on the desk

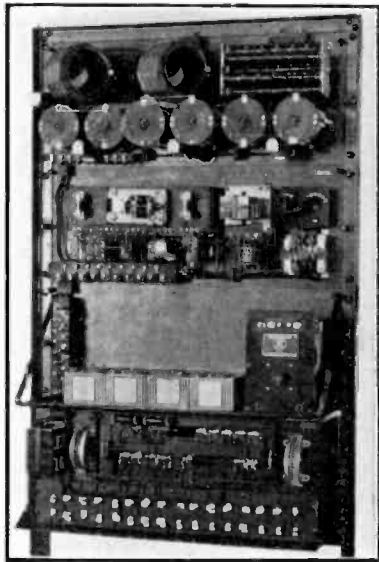

Fig. 4.

stand. When the calling dial is operated, the microphone circuit is momentarily interrupted, which causes relay 9 to drop out at each interruption. A circuit is formed through a back contact on one of the armatures of relay 9 and a front contact on relay 10 to energize relay 12. This relay opens the grid circuit of the oscillator and thus stops the flow of high frequency current in the power line. Thus at each interruption of the microphone circuit by the calling dial there is a corresponding interruption of the flow of high frequency current into the power line. The number of these interruptions is controlled by the number on the calling dial.

### HETERODYNE SYSTEM OF CALLING

The circuits of the receiver are of the simple coupled circuit type. The tubes are kept lighted at all times and the detector is in a state of continuous oscillation at all times except during talking. When a signal is received a beat note is produced by the oscillating detector in the usual manner. The amplified beat note is fed into a pair of tubes in parallel indicated at 15, Fig. 5. These tubes are provided with grid leak and condenser and act as detectors. The plate current

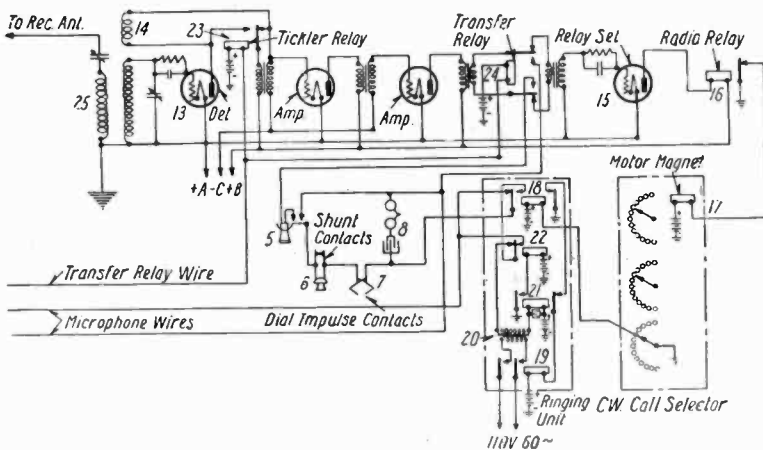

Fig. 5.

of these tubes is drawn through a polarized relay 16 which is normally energized. The incoming signal reduces the plate current and allows the relay armature to drop out and close the contacts. Two tubes are used in order to insure ample power to actuate the relay contacts. The heterodyne system was adopted because of its well known superiority over all other methods of reception. It has demonstrated its value in the service of power line communication. With this system it is possible to call through disturbances and line conditions which it is impossible to talk through. This is just the reverse of the situation when the earlier system using modulated impulses was used. It has a singular ability to work through line disturbances which would put other methods previously used out of business.

## SELECTOR

The selector used is one of the simple types used in automatic telephony. It consists of a motor magnet shown in Fig. 6, which by means of a ratchet and pawl drives an arm over a bank of contacts. At each impulse of the calling dial the motor magnet is advanced one step. By means of a combination of fast and slow relays a circuit is closed at the final pause in the dialing operation, which rings a bell in

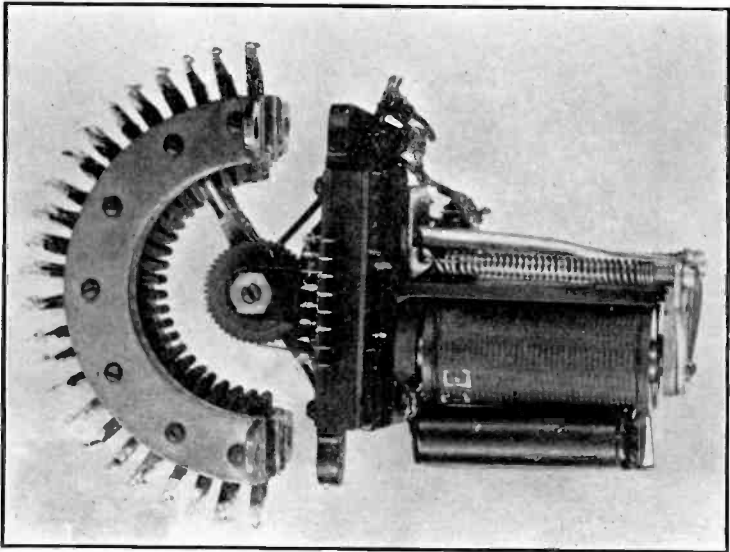

Fig. 6.

case the number dialed corresponds to the number of the station called.

When the party called answers, by lifting the receiver, a relay in the receiver is energized which stops the oscillating detector. Another relay transfers the output of the amplifier from the relay tubes to the desk telephone receiver. The two parties are now in two way communication just as in the case of an ordinary wire telephone line.

## MODERATE POWERED SET

There are many applications for communication over power lines where the voltage is low and the distance is



short. For this class of service a moderate powered set has been developed as shown in Fig. 7. It is entirely self-contained, the one unit carrying the complete transmitter, receiver and selective equipment. The circuits are substantially the same as on the large set. The transmitter consists of five tubes, two of which are power amplifiers and two modulators, one being used as a master oscillator. A new type coated filament tube is used which gives the set a rat-

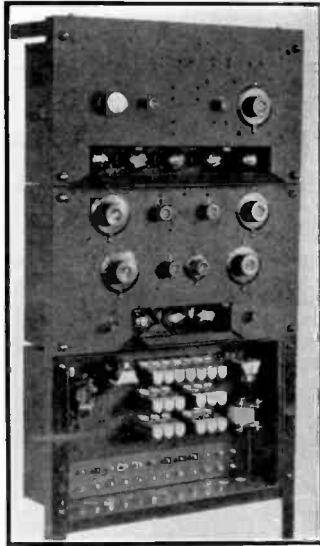

Fig. 7.

ing of 30 watts. This little set is much more powerful than the low powered sets now in use. The receiver consists of three tubes, one-step radio, a detector, and one step of audio amplification.

#### PROTECTIVE APPARATUS

The protective apparatus required for this class of service requires special consideration. The equipment used is shown in Fig. 8. It comprises a drain coil, two spark gaps, a high voltage fuse and a protective condenser. The elements are connected as shown in the diagram. It is not intended to attempt to open the circuit in case of contact be-

tween the antenna and a power conductor. The rush of current in this case is so great that nothing less than large station oil circuit breakers could be expected to open the circuit. The intention here is to divert the current rush to ground and clear the apparatus from the main circuit. The spark gaps are of very sturdy construction, having sufficient metal to prevent their being volatilized during the time the station circuit breaker is opening. The gap nearest to the apparatus is set somewhat closer than the one connected directly to the antenna. The drain coil which is of

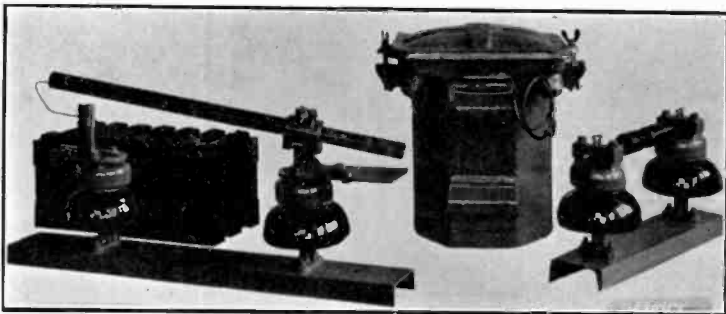
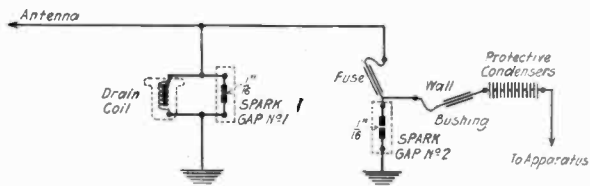

Fig. 8.

relatively fine wire may volatilize and clear itself. If this occurs the main current rush goes through the fuse and the second spark gap. In the act of trying to clear, the fuse will raise the potential sufficiently to flash over the first spark gap, which then takes the discharge and allows the fuse to clear. This was the first adequate protective system developed for this kind of service. It has demonstrated its efficiency in the several instances where it has been called upon to act.

#### METHOD OF COUPLING TO POWER LINE

The method of coupling to the power line which should be adopted is one over which there is considerable difference

of opinion. Two methods of coupling the communication equipment to the power line are now in use.

The first method is to run antenna or coupling wires parallel to the power line and to use these wires to induce currents in the line, and to receiver currents from the line. This method is commonly called antenna coupling.



Fig. 9.

The second method is to connect the communication equipment to the proper conductors of the power line by suitable high voltage condensers. This method is called condenser coupling.

It is said and quite generally believed that "condenser coupling is much more efficient than antenna coupling". This statement seems so self-evident that it is generally accepted without question. The basis of the claim is found in the fact,

that, of the total electric field emanating from an antenna wire, only a small part is intercepted by an intervening power conductor. This means only a small part of the antenna current flows in the power conductor, and it is taken to indicate that the antenna is inefficient. The measure of its inefficiency is thought to be represented by the ratio of



Fig. 10.

the induced current in the power conductor to the inducing current in the antenna.

#### EARLY CONDENSER INSTALLATION

If this view were correct, there would be a very great advantage in directly coupling the transmitter to the power conductor by condensers. Acting on this supposition, a set of condensers was built and installed on the lines of the Duquesne Light Company at Brunots Island where they still exist. These condensers are believed to be the first coupling

condensers to be connected to a high voltage line in this country. Figs. 9 and 10 give a view of this original condenser installation. Two condensers were used, each consisting of a 132,000 volt condenser type bushing supported in a tank filled with oil. This condenser bushing is a standard bushing used in high voltage transformers and switches. It consists of layers of micarta insulation between which are interposed sheets of tin foil. The micarta paper and tin foil are wound on a central brass tube layer on layer.

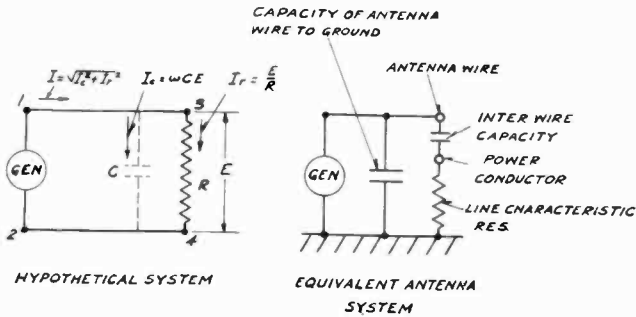

Fig. 11.

The length of the layers of tin foil is reduced progressively as the diameter increases so that the capacity between layers is a constant, the object of the design being to provide a uniform voltage stress on all parts of the insulating material. The capacity of such a bushing is .0003  $\mu$ f.

### RESULTS OF TESTS

After these condensers were connected to the line, tests were made and compared with the results obtained using antenna coupling. It was found that the signal received at the distant end of the line was not appreciably different from that obtained when using antennae. This was something of a surprise but the reason was soon discovered. The fact is that *antenna coupling is not "inefficient"* as had been previously supposed.

The fact that such a large part of the total electric field from an antenna goes to ground, or to the other antenna wire, does not in itself mean loss, in the sense that there is a loss of energy. The true nature of the relation between condenser coupling and antenna coupling can be obtained

readily by reference to Fig. 11-a, where a non-inductive resistance is connected to terminals 3, 4 the energy being supplied from a generator at terminals 1, 2. The current through the resistance is determined by ohms law  $I_r = \frac{E}{R}$ .

The energy dissipated in the resistance is  $\frac{E^2}{R}$ . The generator current under these conditions is  $I_r$  as determined above. If now we connect across the terminals 3, 4 a condenser and still maintain the same potential  $E$ , the same current will flow through the resistance and the energy dissipation will be  $\frac{E^2}{R}$  as before. The current flowing through the condenser will be  $I_c = \omega CE$ . The total current carried by the generator is the resultant of these two currents or  $I = \sqrt{I_r^2 + I_c^2}$ . The generator current is now much larger, but the power factor is correspondingly reduced so that the energy supplied is just the same as before. It is obvious in this case that from the mere fact that the entire generator current does not flow through the work circuit, it does not follow that there is a loss in efficiency.

The above hypothetical case represents exactly the conditions existing when a high frequency transmitter is coupled to a power line by antennae. The useful current delivered to the power line flows against a considerable resistance. If the line is very long this resistance is the characteristic resistance of the line. It amounts to some 800 or 900 ohms for a typical power line at 50,000 cycles as measured between wires or approximately half this value between one wire and ground. If the transmitter is coupled to the line by condensers the entire output is fed directly into the line characteristic resistance. This resistance being high, the current flowing into the line is small. If an antenna is used to couple the transmitter to the line characteristic resistance, there exists a considerable capacity shunted across the work circuit, exactly as indicated in Fig. 11-b. If we consider the case of coupling "phase to ground", the capacity of this shunting condenser is the capacity of the antenna wire to ground minus the capacity from antenna to power conductor.

The current going into the power line with antenna coupling is precisely the same as with condenser coupling,

if we assume the same amount of energy to be delivered by the transmitter.

The difference between antenna coupling and condenser coupling lies in the existence of a relatively large shunting condenser in the case of antenna coupling and the practical elimination of this shunt capacity in the case of condenser coupling. Both methods provide the same interwire coupling capacity. This shunting capacity does no particular harm since the dielectric is air and therefore the losses are negligible.

#### COUPLING VIEWED FROM LAW OF CONSERVATION OF ENERGY

The above conclusion may also be arrived at more generally from the view point of the law of conservation of energy. If we assume the shunting condenser "C" Fig. 2 has no resistance, it follows immediately that the entire output of the generator must appear in the load resistance 3, 4, Fig. 2, since there is no other place for the energy delivered by the generator to go.

Applying this to the case of the antenna it assumes that the antenna wires themselves have no resistance, and that there is no other loss such as radiation or dielectric absorption in which energy might be dissipated. These two assumptions are not strictly accurate since the antenna wires do have some resistance and there is some radiation, but under the conditions obtaining in practice, these values are so small as not to effect seriously the result.

#### GENERAL ANALYSIS OF ANTENNA COUPLING

While the elementary analysis on the basis of conservation of energy is quite sufficient to dispose of the prevalent belief in the inefficiency of antenna as a means of coupling to a power line, the idea is so widespread that it is felt that a more detailed analysis of the mechanism of antenna coupling might be helpful. The mechanism of the electric field and its fundamental theorems have been pretty well established since the days of Faraday and Maxwell. In the development of various phases of the electrical industry practical problems are continually presenting themselves, which require a correct understanding of fundamental relations. The phenomena or mechanism of antenna coupling

to a power line is one of these. In order to show just how the theorems on the electric field apply to the problem of antenna coupling, it may be desirable to plot the electric field in terms of lines of force and equi-potential surfaces and point out the reasoning on which this is based.

### ELEMENTARY PRINCIPLES

In order that the discussion be complete it is necessary to reproduce the equation determining the potential of the point in space due to a charged wire. The electric strains in free space emanating from a charged sphere act in radial lines. The force at any point is measured by the mechanical pull on a unit charge. A unit charge is defined as being such that it will repel an equal charge with a force of one dyne if the distance between the charges is one centimeter. The force at any point is calculated by

$$F = \frac{Q}{r^2} \quad (1)$$

The quantity of electric flux emanating from a charged body is measured in lines or rather in tubes of force. This flux is measured by the mathematical quantity obtained by multiplying the component of electric force resolved perpendicular to the surface by the area over which the force acts. If the force varies from point to point over a surface, this flux is calculated by integrating the normal component of force over the area. This quantity is called "normal induction" and is expressed

$$\Phi = \int N dS \quad (2)$$

where  $N$  is the component of force normal to the element of area  $dS$ .

The quantity of flux passing through the surface of an imaginary sphere having a charge  $Q$  at its center is obtained by multiplying the actual force at the surface of the sphere by the area of the sphere, since the force in this case is everywhere normal to the surface thus

$$\Phi = \int N dS = \frac{Q}{r^2} \times 4\pi r^2 = 4\pi Q \quad (3)$$

It is to be noted that the quantity of flux is dependent only on the value of the charge within the sphere and is independent of its radius. It is also true that the quantity of flux



passing through the sphere is exactly the same whether the charge  $Q$  is located at its center or at any other point within its interior.

This theorem is not limited to a sphere but is quite general in that the flux passing through any closed surface, regardless of its size or shape is  $\frac{1}{4} \pi Q$ . This may be demonstrated by reference to Fig. 12. Let  $A, B, C$  represent any

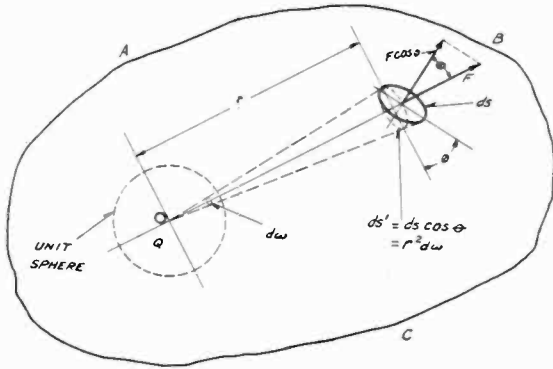

Fig. 12.—Flux through a closed surface  $\frac{1}{4} \pi Q$ .

closed surface in which is located a charge  $Q$  at some point  $O$ . Consider any small element of the surface  $dS$ . The force acting at the surface  $dS$  is  $F = \frac{Q}{r^2}$ . In order to calculate the normal induction through  $dS$ , we must resolve the force perpendicular to the surface  $dS$ . If the surface makes an angle  $\theta$  with a plane perpendicular to the radius, the value of normal induction for the area  $dS$  is

$$N dS = F \cos \theta dS = \frac{Q}{r^2} \cos \theta dS \tag{4}$$

Consider the cone whose vertex is  $O$  and base  $dS$ . Let the area subtended at the surface of a unit sphere at  $O$  be  $dw$ . The area subtended at the surface of a sphere of radius  $r$  is  $dw.r^2$ . This area is equal to the projection of  $dS$  along the radius  $r$ , that is

$$dS' = dS \cos \theta = dw.r^2 \tag{5}$$

Substituting this in the above equation we get

$$N dS = \frac{Q}{r^2} \times dw.r^2 = dw.Q \tag{6}$$

It is to be observed that the flux passing through the sur-

face  $dS$  is independent of the distance of the charge or the inclination of the surface to the radius. The total flux passing through the surface is found by integration.

$$\Phi = \int N dS = Q \, dw = 4\pi Q \quad (7)$$

the integral of  $dw$  being  $4\pi$  since this is the area of a unit sphere. The normal induction over a surface of any shape due to a charge  $Q$  at any point within the surface is  $4\pi Q$ .

### FIELD AROUND A WIRE

These principles may now be used to calculate the field distribution around a wire in space. Referring to Fig. 13 let  $A, B$  represent a wire of diameter  $d$ . Describe a cylindrical surface around the wire of radius  $r$ . Let  $EF$  and  $GH$

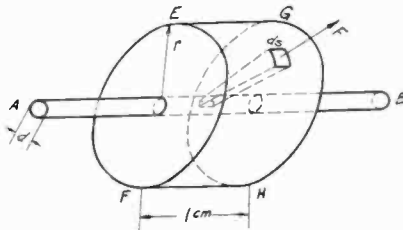

Fig. 13.—Force at any point  $= \frac{2Q}{Y}$

drical surface around the wire of radius  $r$ . Let  $EF$  and  $GH$  be two planes perpendicular to the wire and one centimeter apart. Let  $Q$  be the charge per unit length on the wire. If  $F$  is the force at the surface of the cylinder, the normal induction over the cylindrical surface bounded by the plane is

$$\Phi = \int N dS = F (2\pi r) \quad (8)$$

Now from the foregoing theorem the total induction over any surface having in its interior a charge  $Q$  is  $4\pi Q$ . Since by symmetry there is no force parallel to the conductor the entire flux must pass out radially through the cylindrical surface and must therefore be equal to the value calculated above. Hence we may write

$$F(2\pi r) = 4\pi Q. \quad (9)$$

$F = \frac{2Q}{r}$  which gives the force at any distance  $r$ .

Electric potential is defined in terms of work. The potential difference between two points is the work required

to carry unit charge from one point to the other. If we consider a unit charge at a distance  $r$  from the center of the conductor to be moved radially outward through a small distance  $dr$ , the work done is  $F dr$ . This work is a measure of the change in potential in moving through the distance  $dr$ . The potential will fall as we move away from the con-

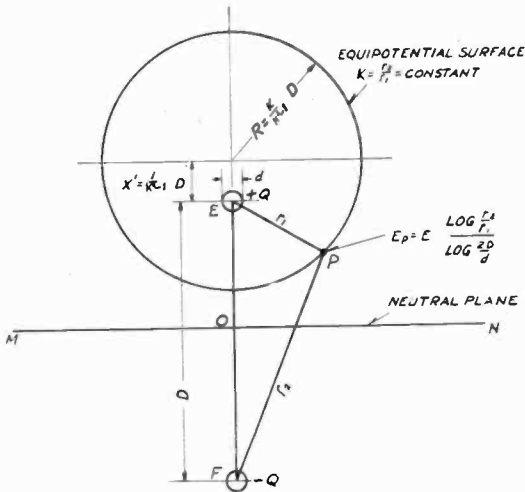

Fig. 14.—Equipotential surface.

ductor, hence the increment in potential is negative and we may write

$$-dE = F dr = 2Q \cdot \frac{dr}{r} \quad (11)$$

integrating this we get

$$-E = 2Q \log r + C \quad (12)$$

where  $C$  is the constant of integration and is to be determined by conditions.

#### FIELD BETWEEN TWO OPPOSITELY CHARGED WIRES

We may now apply this equation to the determination of the field between two wires. Referring to Fig. 14 let  $P$  be any point at distances  $r_1$  and  $r_2$  from two cylindrical conductors of diameter  $d$  and distance  $D$ , having charges  $+Q$  and  $-Q$  respectively. The potential at the point  $P$  is the

resultant of the charges on the two wires. The potential due to the positive charge is

$$-(2Q \log r_1 + C) \quad (13)$$

The potential due to the charge on the negative wire is

$$+(2Q \log r_2 + C) \quad (14)$$

The resultant potential is the algebraic sum of these which gives

$$\begin{aligned} E_p &= 2Q(\log r_2 - \log r_1) \\ &= 2Q \log \frac{r_2}{r_1} \end{aligned} \quad (15)$$

This equation enables us to calculate the potential at any point  $P$  in space provided we know the charge  $Q$  per unit length of conductor. It is one of the most important equations having to do with the electric field, due to charges on wires. The factor  $2 \log \frac{r_2}{r_1}$  is known from the physical dimensions of the system. This factor is called a potential coefficient since when multiplied by the charge  $Q$  it gives the potential of  $P$ . The value of  $Q$  in any given case is to be determined by the conditions of the problem.

If the potential between the wires is known, we can determine the value of  $Q$  in equation 15 by moving the point  $P$  toward the wire  $E$  until it coincides. It will then have the same potential as the wire and equation 15 becomes

$$E = 2Q \log \frac{D}{d} \quad (16)$$

or

$$Q = \frac{E}{2 \log \frac{2D}{d}} \quad (17)$$

Substituting this value of  $Q$  in equation 15 we get

$$E_p = \frac{E \log \frac{r_2}{r_1}}{\log \frac{2D}{d}} \quad (18)$$

This is a most important practical working equation since it enables us to calculate the potential of any point in space whose distance  $r_1$  and  $r_2$  from the charged conductors are known.

## CAPACITY OF A WIRE TO GROUND

The capacity of a body or a system is measured by the charge required to raise its potential from zero to unity when all other neighboring bodies are grounded. Equation 17 gives the capacity of a cylindrical conductor with respect to the ground plane since

$$C = \frac{Q}{E} = \frac{1}{2 \log_e \frac{2D}{d}} \quad (19)$$

This gives the capacity in electrostatic units.

When converted into electromagnetic units it becomes

$$C = \frac{0.0388}{\log_{10} \frac{2D}{d}} \mu\text{f.} \quad (20)$$

## EQUIPOTENTIAL SURFACES

It should be noted that the potential (equation 18) is dependent upon the ratio of the distances and not upon their actual magnitude. Thus if a series of points be so located that the ratio of the distances  $\frac{r_2}{r_1}$  is constant these points will all be at the same potential. Such a series of points determine an equipotential surface.

If a curve is drawn so that the ratio of the distances from any point  $P$  Fig. 14 to two fixed points  $E$  and  $F$  is a constant  $K = \frac{r_2}{r_1}$  then the curve is a circle. The radius of the circle is  $R = \frac{K D}{K^2 - 1}$  and its center lies on the line  $E, F$  produced at a distance  $X^1 = \frac{D}{K^2 - 1}$  above one of the fixed points  $E$ . Such a circle is a section of an equipotential surface whose potential is defined by equation 18. A system of such circles representing sections of equipotential surfaces may be drawn for uniform increments of potential and is useful in mapping out the field.

Fig. 15 represents the equipotential surfaces due to two conductors  $E, F$  one inch in diameter and 100 feet from conductor to the neutral surface  $M N$ . The curves are drawn at intervals of 5%. The potential between the conductor and the neutral plane is taken as unity. For example, a point 21 feet above the neutral plane  $M N$  on the line  $O E$

has a potential equal to 5% of the potential between the neutral plane and the conductor *E*. A point 10 feet below *E*

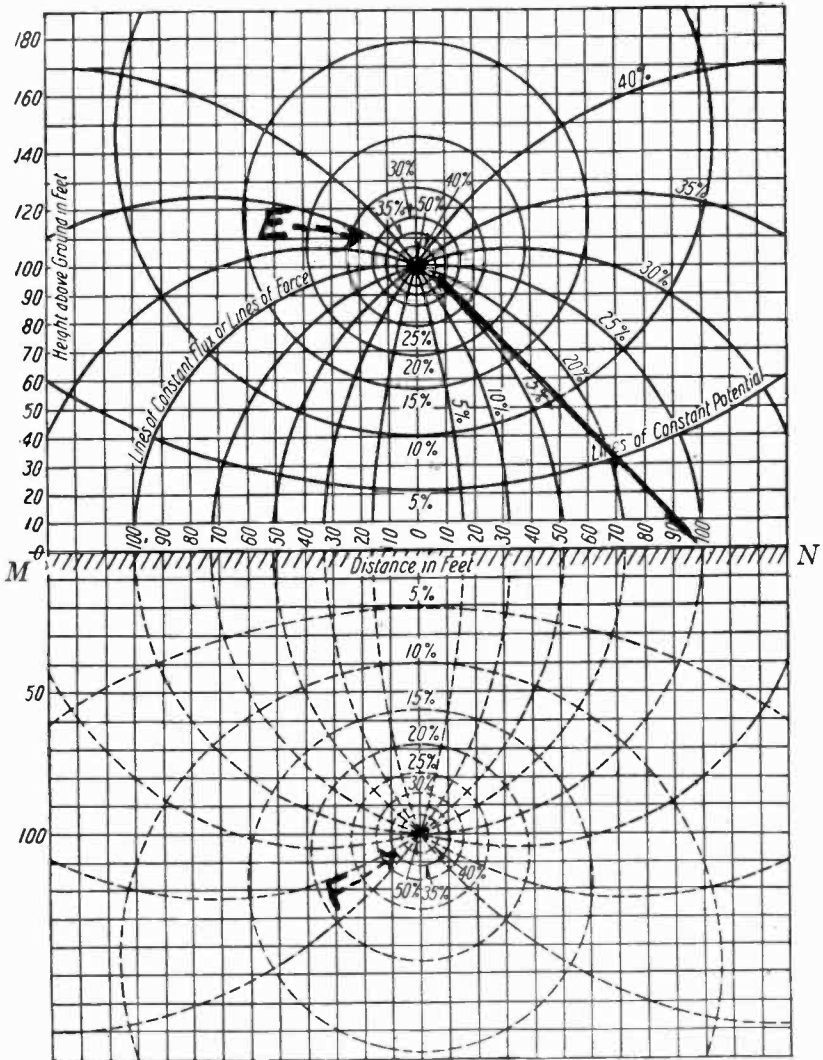

Fig. 15—Electric field due to a wire 1 inch diameter and 106 feet above ground plane.

has a potential 35% of the conductor potential. The potential gradient is greatest nearer the wire, 65% of the total drop occurring in the first 10 feet while the remaining 35%

is spread out over a distance of 90 feet. Notwithstanding this fact, points at a distance of 20 to 30 feet from the conductor still have a very considerable potential. For example, a point 22 feet below the conductor  $E$  has a potential of 25% of the conductor potential and a point 44 feet below has a potential of 15%. As the potentials get lower the centers of the circles are higher and the radius gets larger until at zero potential the circle has an infinite radius and its center is at an infinite distance above  $E$  thus giving the straight line  $M N$ . The closer we approach to the charged conductor the higher the potential of the circle and the more nearly its center coincides with the center of the conductor.

The values given on the equipotential circles in Fig. 15 apply not only to a conductor 100 feet above the neutral

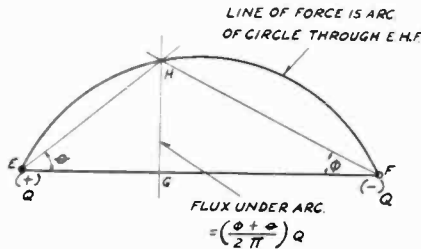

Fig. 16.—Line of Force.

plane and 1 inch in diameter but apply to any conductors so long as the ratio between the conductor diameter and the distance between conductors is constant. For example, the diagram would apply directly to the case of a conductor  $\frac{1}{2}$  inch in diameter and 50 feet above the neutral plane, or to a conductor  $\frac{1}{4}$  inch in diameter and 25 feet above the neutral plane, or to a conductor  $\frac{1}{4}$  inch in diameter and 25 feet above the neutral plane. The distances are then not measured in feet but on the basis  $O-E = 100$  and read in % of  $O E$ . The scale of the diagram is such that it will apply well to conductors and spacings of power lines.

#### LINES OF FORCE

The lines of force may also be plotted on the diagram. The method of accomplishing this may be developed by reference to Fig. 16, where  $E$  and  $F$  represent the two opposite

charged wires. Considering each conductor by itself, the electric flux will pass out into space radially and uniformly in all directions and the quantity of flux passing through any given area is proportional to the angle subtended at the center of the wire. For example, the flux issuing from conductor  $E$  and passing through the plane  $G, H$  seen on edge is proportional to the angle  $\theta$  subtended at  $E$  by the line  $G, H$ . Similarly the flux passing through  $G, H$  due to the conductor  $F$  is proportional to the angle  $\theta$  subtended at  $F$  by the line  $G, H$ . The total normal induction, that is the total flux, passing through  $G, H$  is the arithmetic sum of that due to each conductor individually since they are on opposite sides of the plane  $G, H$  and the charges are of opposite sign making the effects additive. The flux passing from  $E$  through the angle  $\theta$  is that part of the flux  $Q$  which the angle  $\theta$  is of the circumference  $2\pi$ . That is, the flux passing through  $G, H$  issuing from  $E$  is  $\frac{\theta}{2\pi} Q$  and the flux issuing from  $F$  is  $\frac{\Phi}{2\pi} Q$ . The total flux crossing the line  $G, H$  is  $\frac{\theta + \Phi}{2\pi} Q$ . Thus the flux passing between the point  $H$  and the line joining the centers of conductors  $E, F$  depends only upon the sum of angles  $\theta$  and  $\Phi$ . A curve described by the point  $H$ , such that the sum of the angles remains constant will enclose a constant amount of flux. The curve so described will be at every point tangent to the resultant electric force and is called a line of force. Every such line of force, between two parallel wires, is the arc of a circle since it is a property of a circle that the angle subtended by a chord at any point on the arc is constant. The line  $E, F$  is a chord and the point  $H$  is a point on the arc drawn through these three points,  $E, H, F$ . The circular arc  $E, H, F$  is a line of force passing through  $H$  and encloses the total and constant quantity of flux  $\frac{\theta + \Phi}{2\pi} Q$ .

Referring now to Fig. 15 the lines of force are laid out so as to enclose definite quantities of electric flux. Radial lines are drawn from the point  $E$  until they intercept the line  $M N$ . A circle is then drawn through the point of intersection  $H$  and the two points  $E, F$ .



The percentages marked on the flux curves are the percentages included between the flux curve and the vertical  $E, F$ . The value on each curve is  $\frac{\theta}{2\pi}$  since the flux intercepted by the line  $O, H$  is  $\frac{\theta}{2\pi} Q$ .

The lines of force and equipotential surfaces are everywhere at right angles.

### NEUTRAL PLANE REPLACED BY GROUND PLANE

If we assume the neutral plane  $M N$  to be replaced by a conductor and that this conductor is maintained at zero potential the electric field will be everywhere undisturbed. The field above the line  $M N$  may therefore be taken to represent the field of a conductor  $E$  above the ground plane by the height  $E, O$ . The conductor  $F$  below the ground plane is called the image of  $E$  and is useful mainly in deriving the field distribution above the ground plane.

### APPLICATION OF PRINCIPLES TO ANTENNA COUPLING

We may now apply these principles to the problem of antenna coupling. Referring to Fig. 17 let  $E$  be the antenna wire and let  $P$  represent a power conductor on an equipotential surface  $E'$ . If the conductor  $P$  is insulated and is of small dimensions relative to the height its presence will not disturb the electric field.

If the conductor  $P$  is connected to ground, a charge  $Q'$  will flow from ground up into the conductor just sufficient to lower the potential of the conductor  $P$  to zero. This quantity of electricity is exactly the same as that necessary to raise the potential of the conductor  $P$  to the potential  $E'$ . Hence

$$Q' = C' E' \quad (21)$$

where  $C'$  is the capacity of the conductor  $P$  to ground. The reaction of the charge  $Q'$  on the charge  $Q$  is here neglected for simplicity since its effect is small.

So far we have been considering the question of field distribution in the steady state, that is, we have assumed the potentials and charges to be constant. If we now assume an alternating potential to be applied to the antenna wire,

the charges and field distribution at any instant may still be determined by the foregoing methods.

If the potential  $E$  of the antenna wire varies according to a sine law, the instantaneous potential is

$$e = E \sin \omega t \quad (22)$$

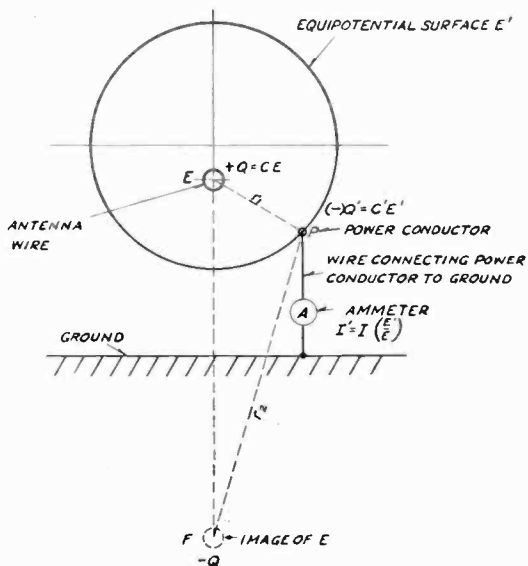

Fig. 17.—Charge induced on grounded power conductor  $Q' = C'E'$ .

where  $\omega = 2\pi f$  and  $E$  is the maximum value of  $e$ . The value of the induced charge  $q'$  at any instant is also a sine function.

$$q' = Q' \sin \omega t. \quad (23)$$

The current passing through an ammeter in the ground wire at any instant is the rate of change of charge or

$$i' = \frac{dq'}{dt} = \omega Q' \cos \omega t \quad (24)$$

The maximum value of the induced current  $i'$  is

$$I' = \omega Q' \quad (25)$$

and since  $Q' = C'E'$  we have

$$I' = \omega C'E' \quad (26)$$

In the same way, the current flowing in the antenna wire is the rate of change of the charge hence

$$I = \omega CE \quad (27)$$

The ratio of the induced current in the grounded power

conductor to the inducing current in the antenna is

$$\frac{I'}{I} = \frac{\omega C' E'}{\omega C E} = \frac{E'}{E} \quad (28)$$

The capacity  $C'$  of the power conductor is in practice very nearly equal to the capacity of the antenna wire and hence cancels out in the above equation.

Equation 28 gives a most important relation in the theory of antenna coupling. It states that the ratio of the current induced in the power conductor to the inducing current in the antenna is the same as the ratio of the potential induced at the location of the power conductor to the inducing potential of the antenna.

The potential ratio  $\frac{E'}{E}$  may be determined from the dimensions of the system by equation 18. The induced current may then be expressed as,

$$I' = I \frac{E'}{E} \quad (29)$$

$$= \frac{I \log \frac{r_2}{r_1}}{\log \frac{2D}{d}} \quad (30)$$

#### INTERWIRE CAPACITY

The capacity between two wires in free space may be obtained from equation 20 which gives the capacity from one wire to the neutral plane. The mistake is commonly made in supposing that this equation will always give the correct capacity between two wires without regard to other conditions. It should be clearly recognized that this equation is limited specifically to the case where the two wires are in free space and have *equal and opposite charges*. Unless these conditions are fulfilled it does not apply. For instance it does not apply to the case of two wires above a ground plane when one wire is grounded. The field distribution in this case is totally different from that shown in Fig. 15 to which equation 20 applies.

In general the capacity of a body is the charge on the body per unit potential. The capacity between two bodies in a system is measured by the charge or quantity of electric flux leaving one body and terminating on the other, divided by their potential difference, all other bodies being

held at zero potential. In the case of an antenna wire and grounded power conductor the capacity is measured by the charge on the grounded power conductor divided by the potential of the antenna to ground. The induced charge on the power conductor is given by equation 21 as

$$Q' = C' E'$$

This means that a quantity of electric flux equal to  $Q'$  leaves the antenna wire and terminates on the grounded power conductor. The capacity between the antenna wire and the grounded power conductor is then measured by this quantity of flux or charge divided by the potential between the two wires, that is

$$C'' = \frac{\text{induced charge}}{\text{potential difference}} = \frac{Q'}{E} = \frac{C' E'}{E} \quad (31)$$

which may be written

$$C'' = C \left( \frac{E'}{E} \right) \quad (32)$$

since  $C' = C$  very nearly. That is, the capacity effective between the antenna wire and a power conductor is equal to the capacity of the antenna to ground multiplied by the potential of the equipotential surface on which the power conductor is located measured in per cent.

If the power conductor were not present, or if it were insulated from ground, the total electric flux emanating from the antenna would all fall on the ground and the field distribution would be as shown in Fig. 15. When the power conductor is grounded, the total flux issuing from the antenna does not change much, but the distribution is changed considerably. The total antenna flux has then two paths to ground, one by way of the power conductor and the other direct to ground. The part going to ground through the power conductor is merely diverted from its natural path. The part going direct to ground may be obtained by subtracting that through the power conductor from the total. We may obtain the effective antenna capacity to ground by subtracting the interwire capacity which is proportional to the interwire flux from the total antenna capacity which is proportional to the total antenna flux.

$$\begin{aligned} C_g &= C - C'' \\ &= C \left( 1 - \frac{E'}{E} \right) \end{aligned} \quad (33)$$

## CALCULATION OF ANTENNA EFFICIENCY

These relations may now be used to determine the efficiency of antenna coupling. As an example let us assume the simple case indicated in Fig. 17, where  $E$  represents the antenna wire, 50 feet above the ground plane, and  $P$  represents the power conductor 10 feet below the antenna. Assume the diameter of both wires to be .5 inches. The potential of the point  $P$  with respect to the antenna potential may be calculated from equation 18, or it may be taken directly from the equipotential lines in Fig. 6, the point being  $\frac{10}{50} = 20\%$  below  $E$  or at a height of 80% on the diagram. The value of this potential is 26%. The capacity of the antenna with respect to the ground plane may be calculated from equation 20.

$$C = \frac{.0388}{\log \frac{2D}{d}} = \frac{.0388}{\log \frac{2 \times 12 \times 100}{.5}} = .01055 \text{ } \mu\text{f. per mile}$$

If we assume the antenna to be 1500 feet long its capacity will be  $.01055 \times \frac{1500}{5280} = .003 \text{ } \mu\text{f.}$

The capacity between the antenna wire and the power conductor is  $C'' = C \frac{E'}{E} = .003 \times 26\% = .00078 \text{ } \mu\text{f.}$  This is the useful or effective capacity of the coupling. The shunt capacity to ground, that is, the capacity representing no useful electric flux, is the total antenna capacity minus the useful coupling capacity or

$$C_g = C - C'' = .003 - .00078 = .00222 \text{ } \mu\text{f.}$$

The power line of which  $P$  represents one conductor may be regarded as a line of infinite length. In this case the impedance which it presents at the sending end is its characteristic impedance. At frequencies of the order of 50,000 cycles which we are considering here the characteristic impedance is a practically pure resistance of approximately 400 ohms. We may therefore cut the exposed power conductor free from the rest of the line and replace the effect of the line by 400 ohms of non-inductive resistance as shown in Fig. 18.

The current flowing to ground through the 400 ohms terminating resistance is slightly less than the current flowing to ground when the power conductor is directly

grounded. For simplicity we will assume the current passing through the 400 ohm resistance is determined by

$$I' = I \frac{E'}{E} = I \times .26 = .26 \text{ amps. per amp. in antenna.} \quad (34)$$

The error in the above assumption is not large enough to make any practical difference in our results. The current flowing through this 400 ohm resistance represents the useful current delivered to the power line. The energy delivered to the power line is

$$R' I'^2 = 400 \times .26^2 = 27.08 \text{ watts} \quad (35)$$

This is the useful energy delivered to the power line with one ampere in the antenna. This energy comes from the antenna and therefore the antenna input must contain an energy component equal to this, on the basis of the law of conservation of energy. The reaction of the power line on the antenna is then such as to introduce a resistance into the antenna circuit which when multiplied by the square of the antenna current, will equal the energy delivered to the power line. Thus

$$RI^2 = R'I'^2$$

$$\text{or } R = R' \left( \frac{I'}{I} \right)^2 \quad (36)$$

In this case

$$R = 400 \left( \frac{.26}{1.} \right)^2 = 27.0 \text{ ohms}$$

This means that the power line under the conditions assumed, reacts into the antenna circuit like a resistance of 27 ohms and represents useful energy.

#### ANTENNA TRANSFORMATION RADIO SAME AS FOR A STEP-UP TRANSFORMER

This transformation of the resistance on the line side into its equivalent on the antenna side of the system is exactly analogous to the usual method of converting a resistance on one side of a transformer to its equivalent on the other side by multiplying by the square of the ratio of transformation. If, instead of an antenna system, we had a transformer with a step-up ratio arranged to deliver .26 amps. to a 400 ohm resistance on its secondary with one ampere in its primary, the equivalent primary resistance would be

$$R = 400 \times (\text{ratio})^2 = 400 \times \left( \frac{.26}{1.0} \right)^2 = 27 \text{ ohms}$$

Hence the antenna acts exactly like a transformer having a step-up ratio of  $\frac{1.0}{.26} = 3.85$ .

It is interesting to note that the ratio of transformation of this electrostatic transformer is determined by the potential ratio  $\frac{E'}{E}$  of the power conductor with respect to the antenna. If we regard the system as a step-up transformer with the power line as a load on the secondary, the step-up ratio is the reciprocal of the potential ratio  $\frac{E'}{E}$ , that is, it is  $\frac{E}{E'}$ .

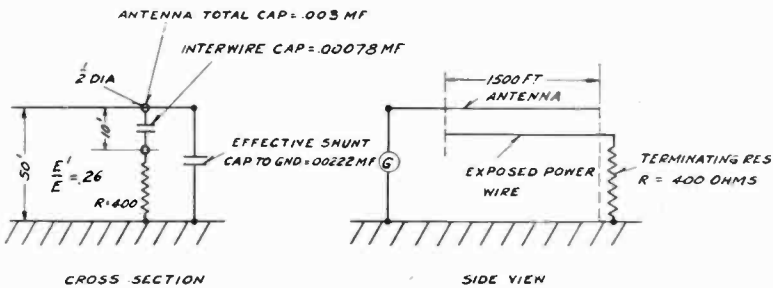

Fig. 18.—Antenna efficiency =  $\frac{\text{Total Input Res.}}{\text{Useful Res.}} = \frac{27.0}{27.76} = 97.5\%$

Since a power line represents a relatively high resistance as a load, a step-up ratio of voltage transformation is exactly what is wanted to couple a low resistance generating system to such a line.

In determining the efficiency of a transformer it is usual to arrive at the input by adding all the known losses to the output and dividing the output by the input. This practice may be followed in the case of antenna coupling system. The losses in the antenna system are due to dielectric absorption, radiation and the resistances of the primary and secondary conductors. The resistances of the primary and secondary are the resistances of the antenna wire and the resistance of the power conductor immediately under the antenna, since this part of the power line may be charged against the antenna as part of the coupling system.

#### RESISTANCE OF ANTENNA CONDUCTORS

The resistance of a copper conductor .5 inches in diameter at 50,000 cycles, as determined by the method recom-

mended by the Bureau of Standards is 10.86 multiplied by its d-c. resistance which gives 2.47 ohms per mile of one wire. Tests on actual power lines show that the resistance per mile is much higher than the above figure. This is probably due to the effective resistance as measured including the various other losses, such as radiation and absorption, etc. The value of resistance as determined by test on a typical power line is approximately 8.0 ohms per mile of one wire and this value will be used in calculating the losses in the antenna. It is assumed that the antenna current is uniformly diminished toward the open end at which point it is of course zero. The effective resistance of a wire having such a current distribution is  $\frac{1}{3}$  the total resistance. If the current were distributed according to a sine law the effective resistance would be  $\frac{1}{2}$  the total resistance. The distribution is sufficiently close to the straight line law to be assumed correct in this case. The resistance of 1500 feet of antenna wire is 2.28 ohms. Assuming a straight line current distribution the effective antenna resistance is .76 ohms. The total antenna resistance is  $.76 + 27.0 = 27.76$  ohms. The efficiency of the system is

$$\frac{\text{useful res.}}{\text{total res.}} = \frac{27.0}{27.76} = 97.5\%$$

#### GROUND LOSSES NEGLECTED

It will be observed in the foregoing that the ground is assumed to be a perfect conducting plane. In practice there are appreciable losses in the ground under the antenna and there are much more serious losses at the ground stake or system of ground stakes where the circuit makes contact with the ground. If we were interested in the practical case of efficiency of an antenna to ground these losses would have to be taken into consideration, and would make a reduction in the efficiency calculated. The ground stake losses, however, can be reduced almost as much as we like by subdividing the ground currents among a number of stakes. Such losses therefore are not chargeable directly to the mechanism of coupling, but rather to the existing conditions in any specific case. The case with which we have to deal in practice is usually one in which the ground does not enter, so the foregoing analysis will apply directly except that the dimensions of the coupling system are somewhat different.



Ground losses are eliminated in much the same way as is done in radio by using a counterpoise in connection with an antenna. The antenna currents then flow entirely in metallic conductors and the electric field is not intercepted by the ground plane. The dielectric is air which is the best dielectric known so that the losses in the electric field due to absorption are very low as is assumed in the foregoing.

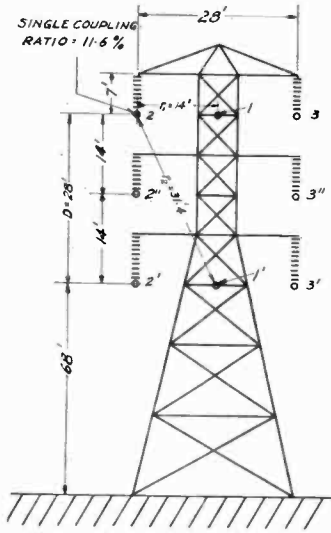

Fig. 19a.

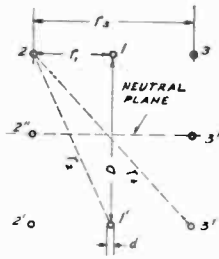

Fig. 19b.

Fig. 19.—Typical tower carrying 2-3 phase 132,000 volt circuits. Total coupling ratio  $\frac{I'}{I} = 23.2\%$ . Antenna efficiency 94%.

### PHASE TO PHASE COUPLING

This method of coupling requires two coupling wires or antenna. These coupling wires are associated with the power conductors as intimately as possible. Fig. 19 shows a typical steel tower carrying two three phase power circuits. The position of the antenna is indicated at  $I$  and  $I'$ . These are arranged to be on a level with the top and bottom phase wires if possible. The antenna wires  $I$  and  $I'$  are connected to the transmitter loading coil so as to be at equal and opposite potentials with respect to ground at all times. By this arrangement charges of opposite polarity are induced in the top and bottom pairs of power conductors, which thus causes opposing currents to flow in these wires.

Such a coupling system avoids the use of ground as a part of the circuit both in the antenna and in the line. The system is sometimes referred to as phase to phase, inter-phase or metallic circuit coupling.

As an example of phase-to-phase coupling, assume the distance between the antenna wires to be 28 feet with 14 feet between the antenna at the center of the arm, and the power conductor on the same level. If the conductors are all 300,000 cir. mils the coupling potential will be

$$\frac{E'}{E} = \frac{\log \frac{r_2}{r_1}}{\log \frac{2D}{d}} = \frac{\log \frac{31.4}{14.0}}{\log \frac{2 \times 12 \times 28}{.63}} = 11.6\%$$

The characteristic impedance of a power line having this size conductor and spacing is about 850 ohms per circuit. If we assume the two circuits to act independently, each would be terminated in its characteristic resistance of 850 ohms or they may be in parallel giving a resultant of 425 ohms. Since the coupling percentage of 11.6% applies to both circuits the total current appearing in the power lines will be 23.2% of the antenna current. The terminating resistance of 425 ohms reacts into the antenna side of the coupling system as

$$R = R' \left( \frac{I'}{I} \right)^2 = 425 \times (.232)^2 = 22.8 \text{ ohms}$$

Assuming as before 8 ohms per mile of single conductor as an approximation of the conductor resistance, the resistance of 1500 feet of antenna consisting of two wires is 4.56 ohms. Since the current is not constant throughout this length but diminishes from a maximum to zero at the open end, its effective resistance will be 1/3 of this or 1.52 ohms. The overall antenna efficiency will be

$$\frac{\text{useful Res. Coeff.}}{\text{total Res.}} = \frac{22.8}{22.8 + 1.52} = 94\%$$

#### ANALYSIS TAKING REACTION BETWEEN WIRES INTO CONSIDERATION

In the analysis up to this point no consideration has been given to the reaction of the charge on the power conductors on the charge on the antenna. These effects may be readily calculated by the method given by Maxwell. This method is based on the principle that the potential at any point is

equal to the sum of the potentials produced independently by the several charges. As pointed out in connection with equation 15, the potential produced at a given point  $P$  by a charge  $Q$  above a conducting plane is equal to

$$E_p = 2q \log \frac{r_2}{r_1}$$

This relation consists of a factor  $2 \log \frac{r_2}{r_1}$  which multiplied by the charge  $q$  gives the potential at the desired point and may be written

$$E = qp \quad (37)$$

The factor  $p$  is called a potential coefficient. If we have several charges such as  $q_1, q_2, q_3$ , all acting to produce a resultant potential at  $P$  and if each of the charges acting independently has a potential coefficient  $p_1, p_2, p_3$  respectively the resultant potential will be

$$E_p = q_1 p_1 + q_2 p_2 + q_3 p_3 \quad (38)$$

Applying this principle to the case of a single antenna wire, Fig. 17 acting on a grounded power conductor, the resultant potential of the antenna wire is made up of two parts, first that produced by the charge on the antenna wire itself, and second by the effect of the charge on the grounded power wire. Using the usual notation

$$E_1 = q_1 p_{1,1} + q_2 p_{2,1} \quad (39)$$

$$E_2 = q_2 p_{2,2} + q_1 p_{1,2} \quad (40)$$

The first part of each subscript of the potential coefficient indicates the body on which the charge is located and the second part indicates the point or body on which the potential is induced.

In equation 39 the first term  $q_1 p_{1,1}$  gives the potential of the antenna wire due to its own charge  $q_1$ . The potential coefficient in this case is simply reciprocal of the antenna capacity i. e.,  $p_{1,1} = \frac{1}{C} = 2 \log \frac{2D}{d}$  as in equation 19. The second term  $q_2 p_{2,1}$  gives the potential induced on the antenna by the charge  $q_2$  on the power conductor. The potential coefficient in the case is  $p_{2,1} = 2 \log \frac{r_2}{r_1}$  where  $r_1$  and  $r_2$  are the distances from the power wire to the antenna and its image respectively.

If we assume that the charge  $q_1$  is positive and that the power conductor is grounded, its potential will be zero and

the charge  $q_2$  induced upon it will be negative. The equations may then be rewritten

$$E_1 = q_1 p_{11} - q_2 p_{21} \quad (41)$$

$$0 = -q_2 p_{22} + q_1 p_{12} \quad (42)$$

The values of the potential coefficients are:

$$p_{11} = p_{22} = 2 \log \frac{2D}{d} \quad p_{12} = p_{21} = 2 \log \frac{r_2}{r_1}$$

Substituting these values in equations 41 and 42

$$E_1 = q_1 \left( 2 \log \frac{2D}{d} \right) - q_2 \left( 2 \log \frac{r_2}{r_1} \right) \quad (43)$$

$$0 = -q_2 \left( 2 \log \frac{2D}{d} \right) + q_1 \left( 2 \log \frac{r_2}{r_1} \right) \quad (44)$$

From equation 44, we get the ratio of the charges on the two wires.

$$\frac{q_2}{q_1} = \frac{\log \frac{r_2}{r_1}}{\log \frac{2D}{d}} \quad (45)$$

From equation 18

$$\frac{E'}{E} = \frac{\log \frac{r_2}{r_1}}{\log \frac{2D}{d}}$$

Hence

$$\frac{q_2}{q_1} = \frac{E'}{E} \quad (46)$$

That is, the ratio of induced to inducing charge is exactly equal to the ratio of induced to inducing potential as assumed in equations 28, 29, and 30. Since the currents in the power line and antenna are proportional to the charges, it follows that  $\frac{I'}{I}$  is just the same whether we take into account the reaction of the charge on the power conductor or neglect it. The ratio of transformation, which of course is the ratio of primary and secondary currents, is therefore unaltered by including the reaction of the charges on the power conductor. The equivalent primary resistance of the secondary load is therefore unaltered, which means that the efficiency of the antenna system works out to be correct even though we do neglect the reaction of the charge on the power conductor.

## INCREASE IN ANTENNA CAPACITY

The actual antenna capacity, however, is slightly increased. Substituting the values of  $q_2$  determined from the equation 45 in the equation 43, we get

$$\begin{aligned}
 E_1 &= q_1 \left[ 2 \log \frac{2D}{d} \right] - \frac{q_1 \log \frac{r_2}{r_1}}{\log \frac{2D}{d}} \cdot 2 \log \frac{r_2}{r_1} \\
 &= q_1 2 \log \frac{2D}{d} - 2 q_1 \frac{\left[ \log \frac{r_2}{r_1} \right]^2}{\log \frac{2D}{d}} \quad (47)
 \end{aligned}$$

The capacity of the antenna is measured by the charge required to raise its potential 1 volt, that is

$$C = \frac{q_1}{E_1} = \frac{1}{2 \log \frac{2D}{d} - 2 \frac{\left[ \log \frac{r_2}{r_1} \right]^2}{\log \frac{2D}{d}}} \quad (48)$$

It may be noted that the first term in the denominator is identical with the denominator of equation 19, which represents the antenna capacity without regard to the presence of the charge on the power conductor. The second term makes a correction for the effect of the charge on the power conductor. It is to be subtracted from the first term and therefore causes the total effective capacity to be somewhat greater than the capacity of the antenna wire alone.

The increase in capacity can be obtained by taking the ratio of the capacity including reactions as given in equation 48 to the capacity of the antenna wire alone given in equation 19. This gives

$$\frac{C'}{C} = \frac{2 \log \frac{2D}{d}}{2 \log \frac{2D}{a} - 2 \frac{\left[ \log \frac{r_2}{r_1} \right]^2}{\log \frac{2D}{d}}} \quad (49)$$

For the case given in the example shown in Fig. 18 for a  $\frac{1}{2}$ -in. antenna wire, 50 feet above the ground plane and

having a power conductor 10 ft. below it, the values are

$$\log \frac{2D}{d} = \log \frac{2 \times 100 \times 12}{.5} = 3.681$$

$$\log \frac{r_2}{r_1} = \log \frac{90}{10} = .955$$

Substituting these values in equation 49

$$\frac{C'}{C} = \frac{2 \times 3.681}{2 \times 3.681 - 2 \frac{.955^2}{3.681}} = 1.075 \quad (50)$$

Hence the antenna capacity in this case is increased 7.5% by the presence of the power conductor 10 ft. below it.

#### APPLICATION TO DOUBLE CIRCUIT LINE

The method of potential coefficients may be applied to the case of a double circuit power line having phase to phase antenna coupling. In this case we have a total of six power conductors to be considered. Under the conditions arising in practice where the antenna coupling wires are on the same level as the upper and lower pairs of power conductors, or are at least symmetrically arranged with respect to the middle power conductors, the case is greatly simplified by omitting the middle conductors entirely from consideration. This may be done since by symmetry the middle conductors are always located on the neutral plane, and therefore have no charge and hence do not enter the problem. The case may be further simplified by considering only the upper two power conductors and the upper antenna wire, the neutral plane being assumed to be a perfectly conducting ground plane. The potentials are then calculated by regarding the lower power conductors and lower antenna wire as images. These images are *real* in this case. Since the antenna wire is located symmetrically with respect to the upper two power conductors the currents and charges on these two wires must be equal. Referring to Fig. 19-b the potential equations are

$$E_1 = q_1 p_{11} - q_2 p_{21} - q_3 p_{31} \quad (51)$$

$$0 = -q_2 p_{22} + q_1 p_{12} - q_3 p_{32} \quad (52)$$

Since by symmetry

$$q_2 = q_3 \quad p_{11} = p_{22} \quad p_{12} = p_{21} = p_{31}$$

$$\text{and } p_{11} = 2 \log \frac{2D}{d} \quad p_{12} = 2 \log \frac{r_2}{r_1} \quad p_{32} = 2 \log \frac{r_4}{r_3}$$

$$E_1 = q_1 \left( 2 \log \frac{2D}{d} \right) - 2q_2 \left( 2 \log \frac{r_2}{r_1} \right) \quad (53)$$

$$0 = -q_2 \left( 2 \log \frac{2D}{d} + 2 \log \frac{r_4}{r_3} \right) + q_1 \left( 2 \log \frac{r_2}{r_1} \right) \quad (54)$$

The last equation gives the ratio of transformation, that is, the ratio of charge induced on the grounded power conductor to the charge on the antenna.

$$\frac{q_2}{q_1} = \frac{\log \frac{r_2}{r_1}}{\log \frac{2D}{d} + \log \frac{r_4}{r_3}} \quad (55)$$

Since there are two power conductors, each of which has a charge  $q_2$ , the over-all ratio of transformation is just twice the above or

$$\frac{q'_2}{q_1} = \frac{2q_2}{q_1} = \frac{2 \log \frac{r_2}{r_1}}{\log \frac{2D}{d} + \log \frac{r_4}{r_3}} \quad (55a)$$

It will be noted by comparison with equation 18 that the ratio is identical with the potential ratio  $\frac{E'}{E}$  for the conductors involved *except* that the denominator is increased by the term  $\log \frac{r_4}{r_3}$ . The charge induced on conductor No. 2 therefore is slightly less by reason of the presence of power conductor No. 3. The greater the distance between the power conductors the less this effect and the more nearly they act like independent circuits.

Substituting the value of  $q_2$  from equation 55 in 53

$$E_1 = 2q_1 \log \frac{2D}{d} - 4q_1 \frac{\left( \log \frac{r_2}{r_1} \right)^2}{\log \frac{2D}{d} + \log \frac{r_4}{r_3}} \quad (56)$$

The capacity of the antenna wire to the neutral plane taking into consideration the reaction of the charges on the two power conductors above the neutral plane, is

$$C = \frac{q_1}{E_1} = \frac{1}{2 \log \frac{2D}{d} - 4 \frac{\left( \log \frac{r_2}{r_1} \right)^2}{\log \frac{2D}{d} + \log \frac{r_4}{r_3}}} \quad (57)$$

If we omit the entire second term in the denominator the equation gives the capacity of the antenna wire to the neutral plane, neglecting the reaction of the power conductors, as in equation 19. The effect of this reaction is to somewhat increase the antenna capacity.

The interwire capacity, that is, the capacity between the antenna wire and the two associated top power conductors is

$$C'' = C \frac{2q_2}{q_1} = C \frac{2 \log \frac{r_2}{r_1}}{\log \frac{2D}{d} + \log \frac{r_4}{r_3}} \quad (58)$$

where  $C$  is the total or effective antenna capacity as determined by equation 57. This reduces to

$$C'' = \frac{2 \log \frac{r_2}{r_1}}{2 \left( \log \frac{2D}{d} \right)^2 + 2 \log \frac{2D}{d} \times \log \frac{r_4}{r_3} - 4 \left( \log \frac{r_2}{r_1} \right)^2}$$

The last term in the denominator corrects for the effect of the reaction of the power conductors. If this term is omitted the equation reduces to the interwire capacity obtained by neglecting the reaction of the charges on the power conductor. These equations may be applied to the case of phase-to-phase antenna coupling previously worked out. They now take into consideration the reaction of the charges on the power conductors. Referring to Figures 19-a and 19-b

$$\log \frac{2D}{d} = \frac{2 \times 12 \times 28}{.63} = 3.0273$$

$$\log \frac{r_2}{r_1} = \log \frac{31.4}{14} = .350 \quad \text{and} \quad \log \frac{r_4}{r_3} = \log \frac{39.6}{28} = .1507$$

The ratio of transformation is

$$\frac{q_2'}{q_1} = \frac{2 \log \frac{r_2}{r_1}}{\log \frac{2D}{d} + \log \frac{r_4}{r_3}} = \frac{2 \times .350}{3.027 + .150} = 22.0\%$$

It will be noted that this is changed but very slightly from the previous value of 23.1% obtained by neglecting the second term in the denominator. Hence in this case the power conductors are so far apart that they have but little effect on each other.



Using the new value of 22.0% as the correct ratio of transformation, we get the equivalent primary resistance due to the secondary resistance of 425 ohms, of

$$R = R' \left( \frac{E'}{E} \right)^2 = 425 \times .22^2 = 21 \text{ ohms}$$

The resistance of the antenna wire is 1.52 ohms, therefore the efficiency of the circuit is

$$\frac{21.0}{21.0 + 1.52} = 93.5\%$$

the previous efficiency was 94%

The capacity of an antenna wire to the neutral plane is

$$C = \frac{1}{2 \log \frac{2D}{d}}$$

The ratio of the total effective capacity of an antenna wire to the simple capacity of the single wire to the neutral plane is obtained by combining this with the equation 57, which gives

$$\frac{C'}{C} = \frac{2 \log \frac{2D}{d}}{2 \log \frac{2D}{d} - 4 \left( \log \frac{r_2}{r_1} \right)^2} \frac{\log \frac{2D}{d} + \log \frac{r_4}{r_3}}{\log \frac{2D}{d} + \log \frac{r_4}{r_3}} \quad (59)$$

Applying this to the line under consideration we get

$$\frac{C'}{C} = \frac{2 \times 3.027}{2 \times 3.027 - \frac{4 \times .35^2}{3.027 + .150}} = 1.025$$

Where  $\log \frac{2D}{d} = 3.027$ ,  $\log \frac{r_2}{r_1} = .35$  and  $\log \frac{r_4}{r_3} = .150$

Hence the antenna capacity is increased by only 2.5%.

The interwire capacity, that is, the effective capacity between the antenna and the power line as determined by equation 58 is

$$C'' = C \frac{2q_2}{q_1} = C \times 1.025 \times 22\%$$

The value of  $C$ , the capacity of the free antenna wire to the neutral plane is

$$C = \frac{.0388}{\log \frac{2D}{d}} = \frac{.0388}{3.027} = .0128 \text{ } \mu\text{f. per mile of one wire.}$$

Assuming the antenna length to be 1500 feet this gives

$$C = .0128 \times \frac{1500}{5280} = .00364 \mu\text{f.}$$

$$C' = .00364 \times 1.025 = .00374 \mu\text{f.}$$

Substituting this value for  $C$  in equation 58 we get

$$C'' = .00364 \times 1.025 \times 22\% = .00082 \mu\text{f.}$$

This is the total capacity which couples the antenna wire to the upper two power conductors. The capacity to each conductor is one half of this or  $.00041 \mu\text{f.}$

It is important to note that the presence of the group of wires represented by a double circuit power line increases the antenna capacity by so small a value as 2.5%. It is also of interest to note that this increase in capacity is less than in the previous case of phase-to-ground coupling where the increase is 71½%. This would seem rather inconsistent, but a study of the equations involved will show that the effect is due to the low coupling ratio in the phase-to-phase case, which is only 11% to each wire, whereas in the phase-to-ground case the coupling ratio is 26%. This striking difference in coupling ratio is the result of the very great change in distances involved. The value of  $D$  in the phase-to-ground case is the distance between the conductor and its image, or 100 feet, while in the phase-to-phase case, it is only 28 feet.

### EFFECT OF LINE TERMINATING RESISTANCE

The analysis up to this point, while taking into consideration all the capacity reactions between the antenna and the various wires of the power line, it has been assumed that the induced current in the power line due to the current in the antenna is the same as the current in the power line, when the power line is shorted to ground in the case of phase-to-ground coupling. In other words, it is assumed that the effect of the line characteristic impedance is negligible in comparison with the impedance of the interwire capacity. That this is true may be demonstrated by calculating the current through the terminating impedance as indicated in Figs. 20-A and 20-B, which shows the relations of the various elements in an antenna system. It is assumed that the line characteristic resistance is 850 ohms. This is represented in the section 2, 3 of the diagram. The total an-

tenna capacity involving all reactions for the double circuit line previously calculated is  $.00374 \mu\text{f}$ . Of this,  $.00082 \mu\text{f}$  is interwire capacity. The capacity of each power conductor to the neutral plane is  $.00374$ , but when two wires are tied in parallel at the given spacings the capacity of each wire is only 95% of the original, or both wires have together 1.90% of one wire. Thus the capacity of the two power conductors to the neutral plane is  $1.90 \times .00374 = .00712$ , of which  $.00082$  is the interwire capacity between them and the antenna. The net capacity of the two power conductors to the

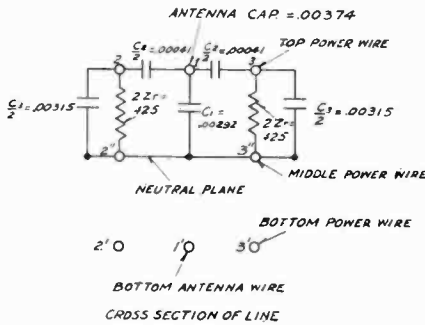

Fig. 20a.

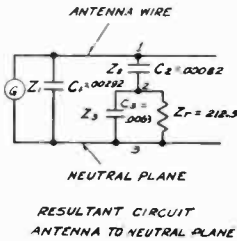

Fig. 20b.

Fig. 20.—Complete analysis of phase-to-phase antenna coupling to double circuit power line efficiency = 92.2%.

neutral plane which shunts the line terminating resistance is  $.00712 - .00082 = .0063 \mu\text{f}$ . This capacity is in shunt with the characteristic impedance of the two lines in parallel to neutral, or 212.5 ohms. The interwire capacity is shown by the condenser in the link 1, 2. The capacity of the antenna-to-ground shunting the whole system is  $.00374 - .00082 = .00292 \mu\text{f}$ .

The impedance of the parallel mesh 2, 3 is

$$Z_{2,3} = \frac{Z_3 Z_r}{Z_3 + Z_r} \tag{60}$$

The impedance of the total path from 1 to 3 which includes the interwire capacity is

$$Z_{13} = Z_{12} + Z_{23} = Z_2 + \frac{Z_3 Z_r}{Z_3 + Z_r} \tag{61}$$

The current passing from 1 to 3 by way of the interwire capacity is

$$I_{13} = \frac{E}{Z_{13}} = \frac{E}{Z_2 + \frac{Z_3 Z_r}{Z_3 + Z_r}} \quad (62)$$

The drop across the resistance is

$$E_r = I_{13} Z_{23} = \frac{E}{Z_2 + \frac{Z_3 Z_r}{Z_3 + Z_r}} \times \frac{Z_3 Z_r}{Z_3 + Z_r} \quad (63)$$

$$I_r = \frac{E_r}{Z_r} = \frac{E}{Z_r} \frac{\frac{Z_3 Z_r}{Z_3 + Z_r}}{Z_2 + \frac{Z_3 Z_r}{Z_3 + Z_r}} \quad (64)$$

The total current in the antenna is

$$I = \frac{E}{Z_1} + I_{13} = \frac{E}{Z_1} + \frac{E}{Z_2 + \frac{Z_3 Z_r}{Z_3 + Z_r}} \quad (65)$$

$$\frac{I_r}{I} = \frac{1}{Z_r} \frac{\frac{\frac{Z_3 Z_r}{Z_3 + Z_r}}{Z_2 + \frac{Z_3 Z_r}{Z_3 + Z_r}}}{\frac{1}{Z_1} + \frac{1}{Z_2 + \frac{Z_3 Z_r}{Z_3 + Z_r}}} \quad (66)$$

If we neglect the term  $\frac{Z_3 Z_r}{Z_3 + Z}$  which is small in comparison with  $Z_2$  we get

$$\frac{I_r}{I} = \frac{Z'}{Z_2} \times \frac{Z_3}{Z_3 + Z_r}$$

where  $Z'$  is the total antenna impedance.

This relation will enable us to calculate the current going into the power line per ampere of antenna current.  $\frac{I_r}{I}$  is the coupling ratio and can be used in determining the final overall efficiency.

Applying this to the example of the double circuit line we get

$$\begin{aligned} Z' &= \frac{1}{j \omega C} = -j \frac{1}{6.28 \times 50,000 \times .00374 \times 10^{-6}} \\ &= -j 853 \text{ ohms} \end{aligned}$$

$$Z_2 = \frac{1}{j \omega C_2} = -j \frac{1}{6.28 \times 50,000 \times .00082 \times 10^{-6}}$$

$$= -j 3900 \text{ ohms}$$

$$Z_3 = \frac{1}{j \omega C_3} = -j \frac{1}{6.28 \times 50,000 \times .0063 \times 10^{-6}}$$

$$= -j 507 \text{ ohms}$$

$$Z_r = \frac{425}{2} = 212.5$$

$$\frac{I_r}{I} = \frac{Z'}{Z_2 \cdot Z_3 + Z_r} = \frac{-j853 (-j507)}{(-j 3900) (212.5 - j 507)}$$

$$\frac{I_r}{I} = \frac{853 \times 507}{3900 \times 546} = 20.3\% \text{ which is the transforma-}$$

tion ratio with all reactions considered. The terminating resistances on the two power lines in parallel transformed into the equivalent primary or antenna resistance is

$$R = 425 \times \left( \frac{I_r}{I} \right)^2 = 425 \times (.203)^2 = 17.5 \text{ ohms.}$$

The total antenna resistance  $= 17.5 + 1.52 = 19.02 \text{ ohms.}$

The resultant efficiency is  $\frac{17.5}{19.02} = 92.2\%$  taking every-

thing into account.

#### CONCLUSION REGARDING ANTENNA EFFICIENCY

From the foregoing analysis it is quite apparent that the present popular idea that antenna coupling is inefficient, is not well founded. The analysis shows that with the coupling distances ordinarily obtainable in practice, the efficiency of antenna coupling is so high that the coupling losses do not seriously affect the energy actually delivered to the line by the transmitter.

Of the two methods of coupling available, namely, antenna coupling and condenser coupling, there is little preference either way on the score of coupling efficiency. The decision as to whether antenna coupling or condenser coupling should be used in any given case, must be made on altogether different grounds than that of coupling efficiency.

For high-voltage lines, antenna coupling is in general to be preferred. This preference is because of the fact that with antenna coupling the dielectric is air, which is the best insulation obtainable. There is no progressive deterioration to be feared in a condenser having an air dielectric. The coupling wires are out in the open and always accessible for inspection. The method of supporting the coupling

wires is exactly the same as that used in regular line construction, and is therefore something with which a power man has much experience and in which he has great confidence. Antenna coupling is in general much safer than condenser coupling, and for high voltage lines it is less expensive.

There are circumstances under which antenna coupling is at a disadvantage. These considerations are mechanical rather than electrical. Sometimes the lines leaving a station swing immediately across a river and the supporting structures are such that no provision can be made for carrying the necessary antenna wires, without seriously altering or rebuilding the steel work. In such a contingency coupling condensers find a proper application. The physical arrangement of the high tension apparatus, and the manner in which the lines leave the station sometimes make it difficult properly to locate antenna wires. Sometimes an adjacent circuit, in which we have no interest, will be exposed to the inducing field of the antenna and thus rob us of useful communication energy. For low voltage lines, the cost of condenser coupling is often less than for antenna coupling. It might be said in general that where for mechanical reasons there are objections to mounting antenna coupling wires, coupling condensers have a legitimate application.

#### PROPAGATION OF ALTERNATING CURRENTS ON AN INFINITE LINE

In the study of lines, especially when transmitting high-frequency currents, their properties are more easily understood when the length is made infinite. The behavior of an infinite line is much more simple than that of a finite line, because it is not complicated by reflections from the end. With such a line all disturbances originating at the sending end are propagated down the line and can never return to combine with, and interfere with the advancing waves coming from the sending end generator.

When alternating currents are propagated down an infinite line, the amplitude of the voltage vector is progressively reduced as the distance from the sending end is increased. The percentage decrease in amplitude per mile is a constant throughout the length of the line. The amplitude

of the voltage vector at a point  $x$  miles from the sending end may be expressed as

$$E_x = E_1 e^{-ax} \quad (67)$$

The reduction in amplitude per mile is given by the factor  $e^{-a}$ . It is the attenuation ratio per mile of line. The exponent  $a$  is the attenuation constant.

In addition to being progressively reduced in amplitude, the phase of the voltage vector is progressively shifted backwards as the distance from the sending end increases. That is, the vector representing the potential between wires at a given point on the line, differs in phase from the vector representing the potential at a point farther down the line. The potential at the more distant point always lags behind the potential at a point nearer the sending end. This phase displacement is the same for each mile of line, that is, it is a constant. The phase lag per mile is called the wavelength constant. The phase lag of the voltage vector at a point  $x$  miles from the sending end is

$$\theta = Bx \quad (68)$$

where  $B$  is the wave length constant.

The attenuation of the voltage or current vectors as well as the retardation in phase, can be represented diagrammatically as in Fig. 21. The line conductors are represented by  $A, B$  and  $C, D$ . The potential between lines at the point  $A$  is represented by the length of the vector  $E_1$ , which is drawn vertically as a position of reference. At points representing one mile intervals circles are drawn whose radii are progressively reduced by the factor  $e^{-a}$ . Thus the radius of the circle at the end of the first mile is  $E_1 e^{-a}$ . The circle at the end of the second mile is  $E_1 e^{2-a}$  etc. The circle at the distance  $x$  is defined by equation 67. The voltage vector at the end of the first mile is drawn so as to lag behind  $E_1$  by the angle  $B$ . The voltage vector at the end of the second mile lags by the angle  $2B$  etc.

The potential at the point  $x$  may be completely represented by combining equations 67 and 68 thus

$$E_x = E_1 e^{-ax} \cdot e^{-jBx} \quad (69)$$

The factor  $e^{-jBx}$  is an operator ( $\cos Bx - j \sin Bx$ ) which rotates the vector it acts on through the angle  $(-Bx)$ . It performs the operation required by equation 68 in that it locates the vector  $E_x$  behind  $E_1$  by the angle  $Bx$ . The whole expression therefore gives the vector  $E_x$  both in magnitude

and in phase with respect to  $E_1$ . Adding the exponents in equation 69 we get

$$E_x = E_1 e^{-(a + jB)x} = E_1 e^{-Px} \quad (70)$$

where  $P = a + jB$ . The quantity  $P$  is known as the propagation constant. It may be demonstrated to be\*

$$P = \sqrt{R + j\omega L} \sqrt{G + j\omega C} \quad (71)$$

where  $R, L, G,$  and  $C$  are the fundamental constants of the line per unit length.

The current in an infinite line is attenuated just like the

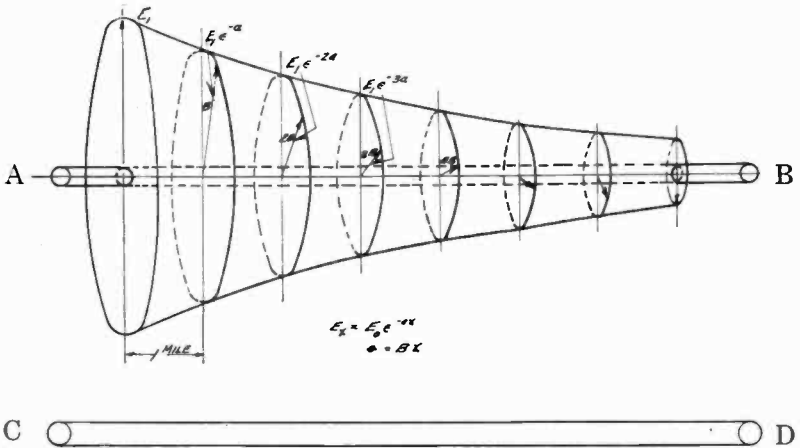

Fig. 21.—Diagram showing the phase and magnitude of potential at various points along a line.

voltage. The current at any point in the line without regard to phase is expressed by an equation similar to equation 67.

$$I_x = I_1 e^{-ax} \quad (72)$$

If we insert an ammeter at the sending end and another at a point in the line  $x$  miles away, we can use the ratio of these two readings to determine the attenuation constant  $a$ . Thus,

$$\frac{I_2}{I_1} = e^{-ax} \quad (73)$$

from which we get the attenuation constant,

$$a = \frac{\log_{10} \frac{I_1}{I_2}}{.4343 x} \quad (74)$$

This equation is of importance since it enables us to deter-

\*See "Propagation of Electric Currents" by Fleming.



mine the attenuation constant by making observations on the line.

### CHARACTERISTIC IMPEDANCE

The current entering an infinite line may be expressed in terms of the sending end applied voltage and the impedance which the line offers to the sending end generator. Thus,

$$I_1 = \frac{E_1}{Z_o} \quad (75)$$

where  $Z_o$  is the vector impedance of the line viewed from the sending end. If a piece of the given infinite line were cut off and the sending end generator connected to the remainder, the current flowing into the line will still be defined exactly by equation 75. The impedance which the line presents to the sending end generator will still be exactly  $Z_o$  as before since the line is infinite. It is a property of an infinite line, therefore, that it presents a constant impedance to the sending generator irrespective of the point where the generator may be connected. This constant impedance is called the "characteristic impedance" of the line.

If a piece of an infinite line is cut off and the open end closed by an impedance equal to the characteristic impedance, it will act on the sending generator exactly like the corresponding infinite line. Under this condition the currents at the sending and receiving ends may be measured, and the attenuation constant determined by the relations expressed in equations 73 and 74. It is important to note that the attenuation constant can be determined directly from the ratio of sending and received currents *only in case the line is infinite*, or has been converted into its equivalent infinite line by being terminated in its characteristic impedance. It is therefore necessary to determine accurately the characteristic impedance of the line in order that it shall be properly terminated before making measurements of current ratio.

The usual method of determining the characteristic impedance of an actual line under test is to measure the impedance of the line with the distant end open, and again with the distant end short. The characteristic impedance is then the square root of the product of these open and short impedances thus,

$$Z_o = \sqrt{Z_{sh} \times Z_{op}} \quad (76)$$

\*The analytical basis of this equation is clearly set forth in standard works on the subject. This method is theoretically applicable to lines at all frequencies. It is quite satisfactory at low frequencies, but is not quite so well suited to work at high frequencies. Unless great precautions are taken serious errors are likely to occur which carry with it corresponding errors in the attenuation ratio.

#### SIMPLE METHOD FOR DETERMINING CHARACTERISTIC IMPEDANCE

A much more simple and more reliable method has been developed for use on lines at high frequency. As pointed out above the impedance looking into a finite line from the sending end, will be the characteristic impedance, provided the distant end is closed through an impedance equal to the characteristic impedance. If therefore an impedance can be found such that when bridged across the open end of a finite line, the measured sending end impedance is equal to it, then this impedance is the characteristic impedance of the line. The method then is to place a trial impedance across the open end of the line under test, and measure the impedance at the sending end. The terminating impedance is varied until the impedance measured at the sending end is equal to it. The terminating impedance is then the characteristic impedance of the line and the ratio of received to sending end current gives the attenuation ratio correctly.

For work on overhead lines at high frequencies, this method is easily carried out in practice, since in this case the characteristic impedance is always a simple non-inductive resistance. This can be seen by inspection of the fundamental equation for characteristic impedance in terms of the fundamental line constants,

$$Z_o = \frac{\sqrt{R + j\omega L}}{\sqrt{G + j\omega C}} \quad (77)$$

At high frequencies the value of  $R$  is always negligible when compared to  $\omega L$  and  $G$  is negligible when compared to  $\omega C$ . The equation therefore reduces to

$$Z_o = \sqrt{\frac{L}{C}} \quad (78)$$

Since the  $j$  component does not appear, the quantity is a pure resistance. Hence for work at high frequencies on open

\*See "Propagation of Alternating Currents," by Fleming.

wire lines, it is known beforehand that the characteristic impedance is a resistance. The trial terminating impedance, therefore, is a simple non-inductive resistance. The work of measurement at the sending end is also simplified since it is known that when the correct adjustment is reached, the sending end impedance will contain no reactive com-

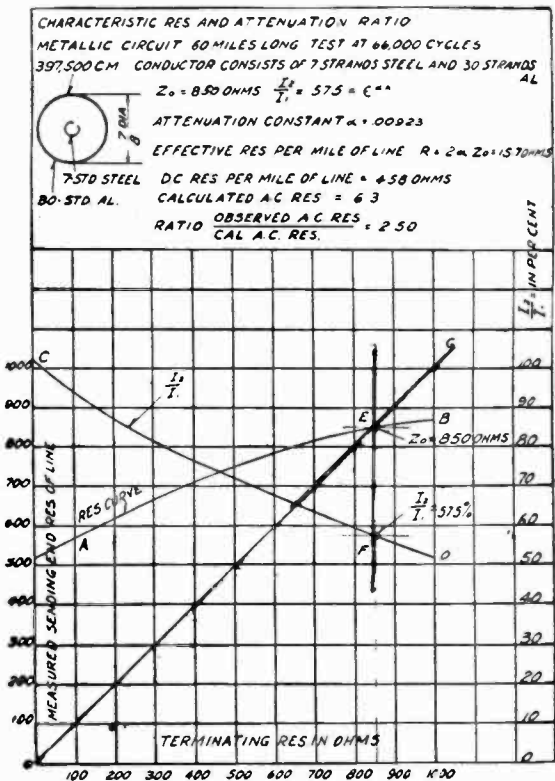

Fig. 22.

ponent. Hence only the resistance component of the sending end impedance need be measured.

In actually determining the characteristic impedance of a line under test a series of values of terminating resistance are used. For each value of terminating resistance the corresponding sending end resistance is measured. These data are then plotted in the form of a curve as shown in Fig. 22. The terminating resistances are plotted as abscissae and the measured sending end resistances are plotted as ordinates.

The smooth curve  $A, B$  is then drawn through these points. The characteristic resistance is represented by a point on this curve whose coordinates are equal. This point may be determined by drawing the line  $OG$  so as to bisect the right angle at  $O$ . The coordinates of any point in this bisector are equal. Hence the intersection of  $OG$  with the resistance curve  $A, B$  determines the point " $E$ ", whose abscissas or ordinates are each equal to the characteristic impedance. The characteristic impedance for the line shown in Fig. 22 is 850 ohms.

In taking the data for the resistance curve, ammeters are placed at the sending and receiving ends. Readings of these meters are taken for each value of terminating resistance. The ratio of these currents  $\frac{I_2}{I_1}$  is then plotted as curve  $C, D$  Fig. 22. The received currents for any value of terminating resistance can then be picked off this curve. The ratio of received to sending current for the case where the line is terminated in its characteristic impedance, is determined by drawing a vertical line through  $E$ . Its intersection  $F$  with the curve  $C, D$  gives the attenuation ratio. The value of the attenuation ratio for the line under consideration is 57.5%.

The line to which the data in Fig. 22 applies is a single circuit three phase line, whose configuration is given in Fig. 23. The test was made on a metallic circuit formed by using the two outside wires 1 and 3. The middle wire was open at both ends during the test. The frequency used was 66 kc. The power conductors were 397,500 cir. mil. aluminum steel reinforced. They consist of thirty strands of aluminum and seven strands of steel, the outside diameter being  $\frac{7}{8}$  inch.

#### APPARATUS USED IN LINE MEASUREMENTS

The method of making the resistance measurements from which the curves in Fig. 22 were plotted is very simple. The only standardized apparatus required is a resistance box and an ammeter at each end of the line. The method is that commonly used in making resistance measurements at ratio frequencies, and is generally known as the resistance variation method. The arrangement is shown diagrammatically in Fig. 24. The measuring system consists

of a condenser  $C$  and inductance  $L$ , a standard resistance box  $R$ , and a calibrated ammeter  $A$  connected in series to the hinges of a double throw switch. When this switch is thrown one way the line is introduced in series with the measuring circuit. When the switch is thrown the other way the line is cut out and the measuring circuit closed on itself. Energy for making the measurements is obtained by inductively coupling an oscillator to the inductance as indicated at  $M$ . The resistance of the measuring circuit is determined by throwing the double throw switch on short and adjusting the measuring circuit to resonance by the variable condenser. The coupling is adjusted so that a good reading preferably full scale is obtained on the ammeter. Enough resistance is then cut in to reduce the current to one half. The inserted resistance is then equal to the resistance already in the circuit. This gives the resistance of the measuring circuit. The double throw switch is then thrown on the line and the condenser adjusted for resonance. The resistance is again measured as before. This resistance is the total of the line plus the measuring circuit. By subtracting the resistance of the measuring circuit we get the resistance of the line. These measurements may be made very quickly and with considerable accuracy. The results obtained are much more reliable than those taken by more expensive equipment using the open and short impedance method. In the determination of characteristic resistance and attenuation by this method the frequency does not enter the observations or calculations. This eliminates one source of possible error.

The impedance of the line may be determined by the same apparatus if the condenser  $C$  is calibrated, and the frequency of the test is known. When the switch is thrown on short and the measuring circuit tuned to resonance, the reactance of the condenser  $C$  is just equal to the reactance of the inductance  $L$ . When the switch is thrown on the line and the condenser readjusted to resonance, the reactance of the condenser plus the reactance of the line must still be just equal to the reactance of the inductance. Hence if  $X_1$  is the reactance of the condenser when tuning the measuring circuit alone, and  $X_2$  is the reactance of the condenser when the measuring circuit contains the line in series we have,

$$\begin{aligned}
 X_1 &= X_2 + X' \\
 \text{or } X' &= X_1 - X_2 \\
 &= \frac{1}{\omega C_1} - \frac{1}{\omega C_2}
 \end{aligned}
 \tag{79}$$

where  $X'$  is the reactance of the line and  $C_1$  and  $C_2$  are the values of condenser capacity under the first and second conditions respectively. By this method the reactance component of the line can be determined for each frequency and for each condition of termination.

#### ATTENUATION CONSTANT AT HIGH FREQUENCIES

The attenuation constant is the real part of the propagation constant  $P$  as defined by equation 71. At high frequencies such that  $R$  is negligible in comparison with  $\omega L$  the first radical may be expanded by the binomial theorem. The real part of the resulting expansion may be expressed as

$$a = \frac{R}{2} \sqrt{\frac{C}{L}} \tag{80}$$

By comparing with equation 78 we can substitute for  $\sqrt{\frac{C}{L}}$  its value  $\frac{1}{Z_0}$ . The relation then becomes

$$\begin{aligned}
 a &= \frac{R}{2} \frac{1}{Z_0} \\
 \text{or } R &= 2 a Z_0
 \end{aligned}
 \tag{81}$$

This equation is quite useful in making experimental studies of open wire lines at high frequencies. By the foregoing methods the attenuation constant  $a$  and the characteristic impedance  $Z_0$  are determined readily by direct observation. Equation 81 enables us to use this data to calculate the effective resistance per mile of line. This is very useful since it is not possible to make direct measurement of line resistance at high frequencies owing to the distributed inductance and capacity. This effective resistance includes losses of all kinds which may be present in the line, in addition to the actual resistance losses in the conductors themselves. The conductor resistances alone may be calculated with accuracy from the tables and methods given by the Bureau of Standards. A comparison of the effective high frequency resistance of the line as observed with the calculated high frequency resistance of the conductors, gives data of considerable value.

## TESTS ON 397,500-CIR. MIL ALUMINUM CONDUCTORS.

In the case of the line whose data are plotted in curve Fig. 22 the characteristic impedance was found to be 850 ohms, and the ratio of received to transmitted current was .575 thus

$$e^{ax} = \frac{1}{.575}$$

$$.4343 ax = \log_{10} \frac{1}{.575} = .24033$$

The line on which the measurements were made was 60 miles long hence  $x = 60$  which gives

$$a = \frac{.24033}{.4343 \times 60} = .00923$$

This is the attenuation constant of the line at the frequency of 66,000 cycles. The effective resistance of the line per mile is

$$R = 2a Z_0 = 2 \times .00923 \times 850 = 15.7 \text{ ohms}$$

The conductor of which this line was made consists of 30 strands of aluminum, giving a total aluminum cross section 397,500 cir. mils. These aluminum strands were assembled around a steel core of 7 strands, the total outside diameter being  $\frac{7}{8}$  inch. The d-c. resistance of the aluminum part of the cable is .458 ohms. The ratio of measured effective a-c. resistance to d-c. resistance is  $\frac{15.7}{.458} = 34.3$ .

The ratio of a-c. to d-c. resistance calculated for this conductor by the method of the Bureau of Standards is

$$\frac{R}{R_0} = 13.69$$

where  $R$  is the a-c. resistance and  $R_0$  is the d-c. resistance. Using .458 ohms as the d-c. resistance  $R_0$  in the above we get the a-c. resistance at 66,000 cycles to be

$$R = .458 \times 13.69 = 6.3 \text{ ohms}$$

The ratio of the observed a-c. resistance of the circuit per mile to the calculated a-c. resistance of the conductors alone is  $\frac{15.7}{6.3} = 2.50$ . Hence there are losses in the circuit

such that the effective resistance is 2.50 times as great as the resistance known to exist in the conductors themselves. These extra losses then amount to 150% of the losses in the conductors. By reference to Fig. 23 it will be seen that

there are two insulated conductors twelve feet above the level of the power conductors whose resistances were being measured. These conductors are transposed with respect to the power line every five miles. Currents induced in these conductors from the currents flowing in the power line probably account for some of the losses in excess of the con-

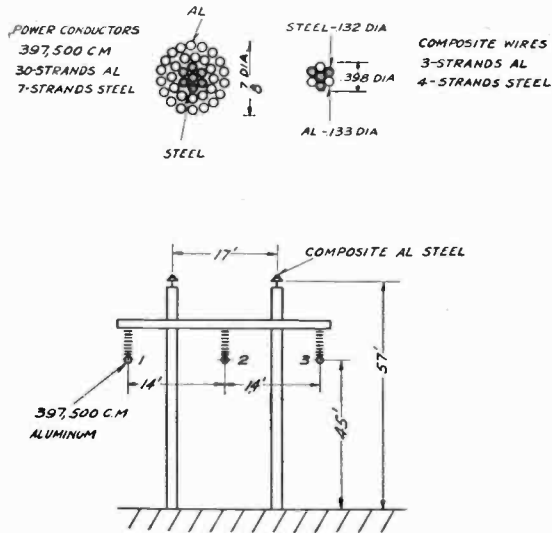

Fig. 23.

ductor resistance losses. In addition to this about 0.9% of the electric field between conductors 1 and 3 is intercepted by the ground plane. There are thus currents in the ground due to stray field from the line. It is of interest to note that the total value of the stray losses is not greater than 150% of the conductor losses. The value of  $Z_0$ , the line characteristic resistance may be determined by calculating the value of inductance and capacity per mile from the physical dimensions of the line thus,

$$L = 14.8 \times 10^{-4} \log_{10} \frac{2D}{d} \text{ henrys per loop mile.}$$

$$C = \frac{.01941}{\log_{10} \frac{2D}{d}} \mu\text{f. per mile between wires}$$



$$Z_o = \sqrt{\frac{L}{C}} = \sqrt{\frac{14.8 \times 10^{-4} \log \frac{2D}{d}}{.01941 \times 10^{-6} \log \frac{2D}{d}}}$$

$$= 276 \log_{10} \frac{2D}{d} \text{ ohms}$$

For the line shown in Fig. 21 using the outside power conductors 1 and 3 this becomes

$$Z_o = 276 \times \log \frac{2 \times 12 \times 28}{.875} = 796 \text{ ohms}$$

The measured characteristic impedance was 850 ohms which is 6.5% higher than the calculated value.

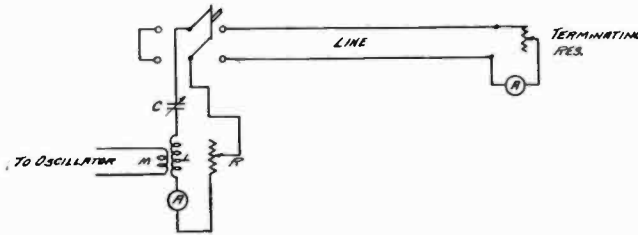

Fig. 24.—Apparatus and circuit used in making line measurements.

### VELOCITY OF PROPAGATION

The velocity of propagation at high frequencies may be determined from

$$V = \frac{1}{\sqrt{LC}} \quad (82)$$

Comparing this with the relation

$$Z_o = \sqrt{\frac{L}{C}}$$

it will be apparent that if the velocity were known and the characteristic impedance  $Z_o$  were also known, the values of  $L$  and  $C$  would be determined thus

$$L = \frac{Z_o}{V} \quad (83)$$

and  $C = \frac{1}{Z_o V} \quad (84)$

Thus in the case of the line Fig. 22 in question, assuming

the velocity to be 186,000 miles per second we get

$$L = \frac{Z_0}{V} = \frac{850}{186,000} = 4.57 \text{ milli-henrys per mile.}$$

$$C = \frac{1}{Z_0 V} = \frac{1}{850 \times 186,000} = .00633 \text{ MF. per mile}$$

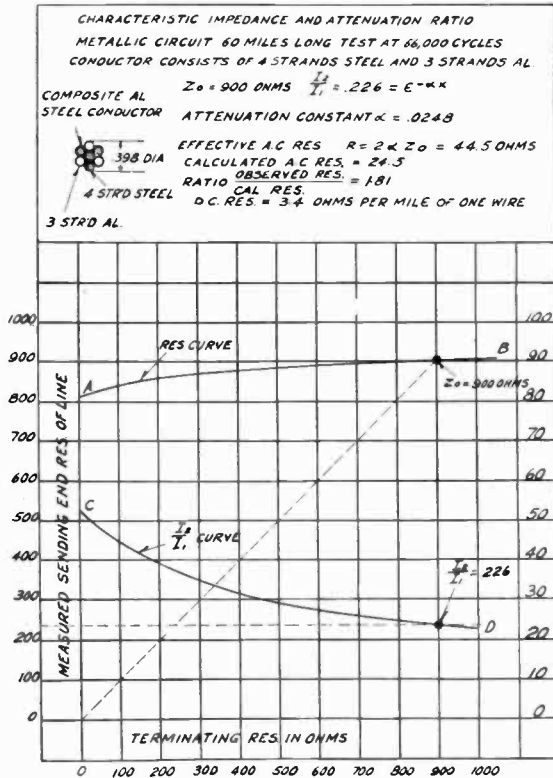

Fig. 25.

The value of  $L$  calculated from the dimensions of the line are

$$L = 14.8 \times 10^{-4} \log \frac{2D}{d}$$

$$= 14.8 \times 10^{-4} \times 2.8853 = 4.25 \text{ milli-henrys}$$

and the value of  $C$  is

$$C = \frac{.0194}{\log \frac{2D}{d}} = \frac{.0194}{2.8853} = .00672 \text{ } \mu\text{f.}$$

Hence the ratio of the value of  $L$  deduced from observation

of  $Z_0$  to that calculated from the dimensions of the line is

$$\frac{L \text{ observed}}{L \text{ calculated}} = \frac{4.57 \times 10^{-3}}{4.25 \times 10^{-3}} = 107.5\%$$

and

$$\frac{C \text{ observed}}{C \text{ calculated}} = \frac{.00633}{.00672} = 94.2\%$$

Thus the observed inductance is 7.5% high and the observed capacity is 5.8% low. If we substitute in equation 82 the

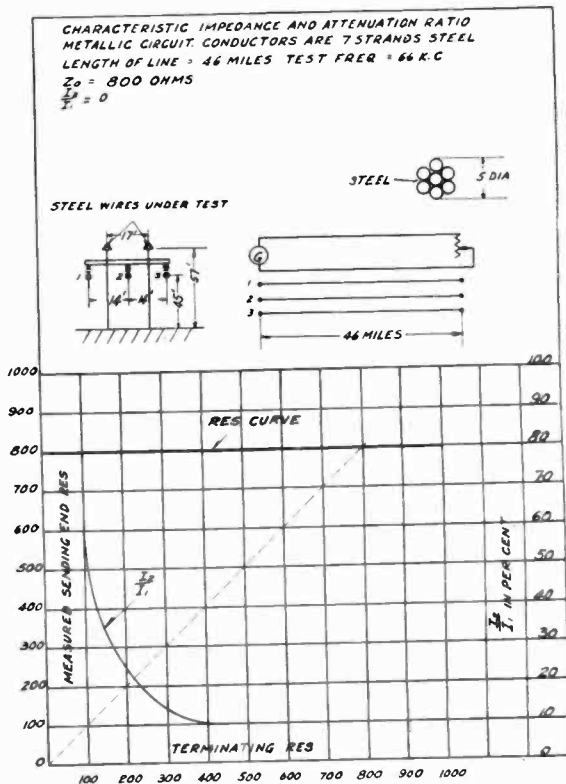

Fig. 26.

values of  $L$  and  $C$  calculated from line dimensions, we get the velocity of light.

$$V = \frac{1}{\sqrt{LC}} = \frac{1}{\sqrt{14.8 \times 10^{-4} \log \frac{2D}{d} \times \frac{.0194}{\log \frac{2D}{d}} \times 10^{-6}}}$$

$$= 186,000 \text{ miles per sec.}$$

The assumption that the velocity of propagation on over-

head conductors is very nearly the velocity of light may be justified by calculating the velocity from the value of the propagation constant. If the velocity were different from the velocity of light, it would be due to losses in the

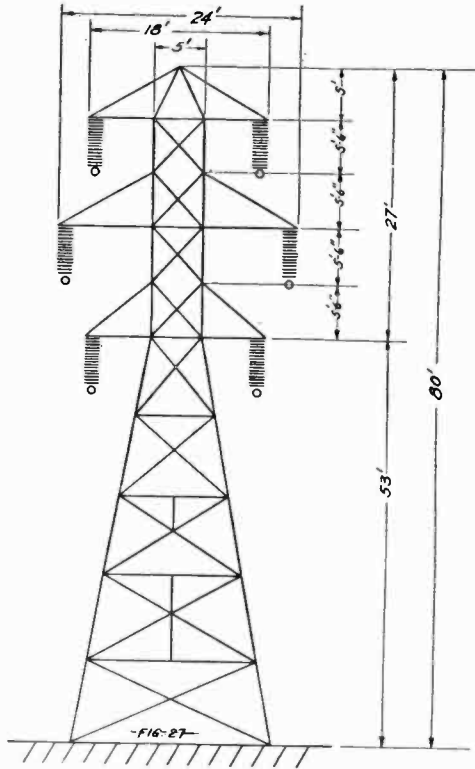

Fig. 27.—Dimensions of tower carrying 132-kv. line on which tests were made.

circuit as represented by the  $R$  and  $G$  equation. Taking the observed values as

$$Z_o = 850 \text{ ohms}$$

$$a = .00923$$

$$R = 15.7 \text{ ohms}$$

$$L = 4.57 \text{ mh.}$$

$$G = 0$$

$$C = .00633 \text{ } \mu\text{f.}$$

Frequency = 66,000 cycles

$$P = \sqrt{R + j\omega L} \times \sqrt{G_1 + j\omega C}$$

$$= a + jB$$

$$= \sqrt{15.7 + j1890} \times \sqrt{0 + 2.62 \times 10^{-3}}$$

$$= 2.225 / 90^\circ - 14.25$$

$$a = P \cos(90^\circ - 14.25) = .00923$$

$$B = 2.225 \text{ radians per mile}$$

$$\lambda = \frac{2\pi}{B} = \frac{6.2832}{2.225} = 2.83$$

$$V = f \times \lambda = 66,000 \times 2.83 = 186,800 \text{ miles per sec.}$$

From this it will be apparent that the velocity of propagation on overhead lines at high frequencies must be very nearly equal to the velocity of light.

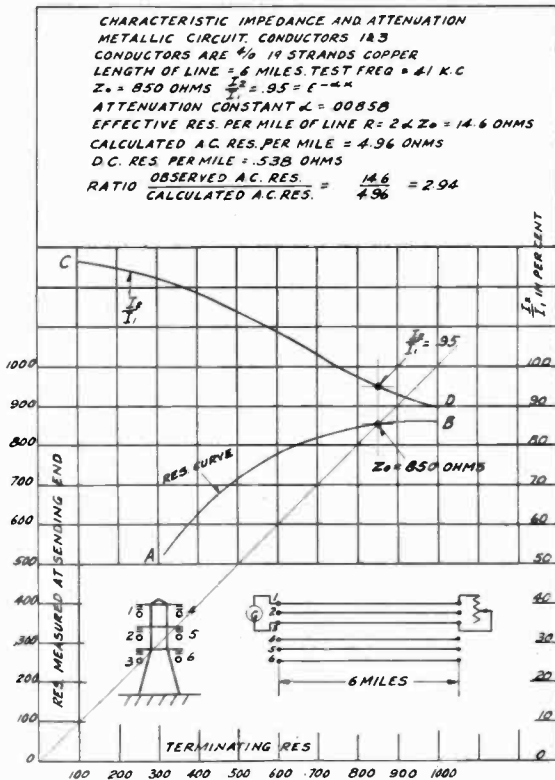

Fig. 28.

By assuming the velocity of propagation to be the velocity of light we are enabled to calculate the effective values of inductance and capacity per mile of line, if  $Z_0$  is accurately determined thus

$$L = \frac{Z_0}{V} \qquad C = \frac{1}{Z_0 V}$$

where  $V$  is assumed to be 186,000 miles per second. The values of  $L$  and  $C$  so determined should not differ greatly

from those calculated from the dimensions of the system by equations page 60. These relations therefore serve as a check on the accuracy of the observed data.

### TESTS ON ALUMINUM STEEL CONDUCTORS

In Fig. 25 is shown data applying to the conductors supported above the power line Fig. 23. These conductors are made of aluminum and steel strands, four strands of steel

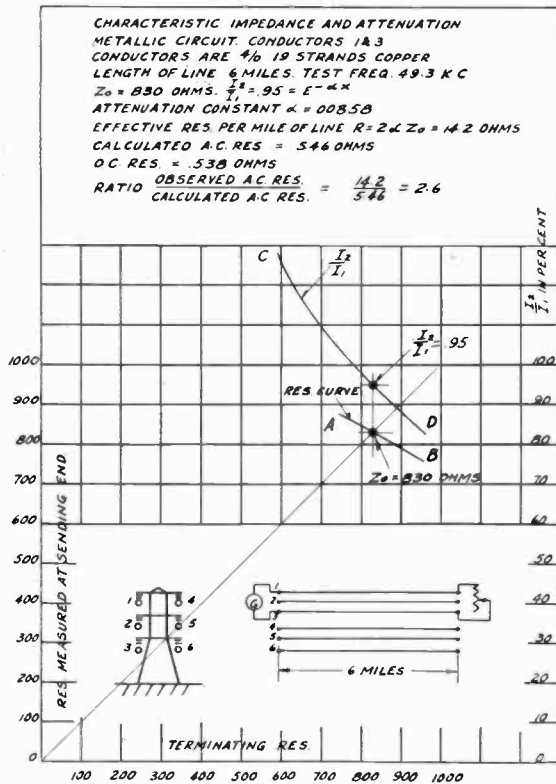

Fig. 29.

and three strands of aluminum. The diameter of each strand is .133 inches, the over-all diameter of the conductor being .398. The characteristic resistance is seen from diagram to be 900 ohms. The attenuation ratio  $\frac{I_2}{I_1} = .226 = e^{-ax}$ . From this we get the attenuation constant  $a = .0248$ , the distance  $x$  being 60 miles. The effective resistance is

$$R = 2a Z_0 = 2 \times .0248 \times 900 = 44.5 \text{ ohms per mile}$$

The calculated ratio of a-c. to d-c. resistance using Bureau of Standards methods is  $\frac{R}{R_0} = 7.22$  assuming the conductor to be 7 strands of aluminum. If we assume that the field distribution in the actual aluminum and steel cable is

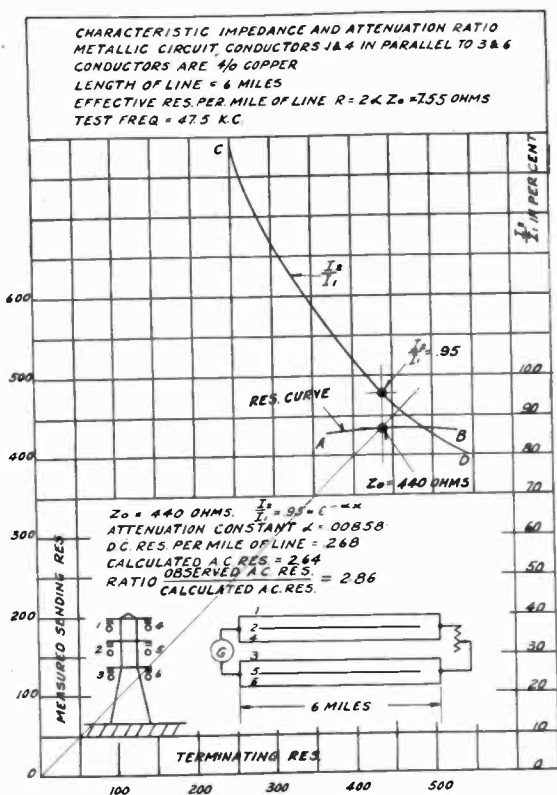

Fig. 30.

substantially the same as if the strands were all aluminum, but using the actual d-c. resistance of the aluminum strands alone, we get  $R = 7.22 \times 3.4 = 24.5$  ohms as the calculated resistance of one loop mile at 66,000 cycles. The ratio of observed effective resistance to the calculated conductor resistance is

$$\frac{\text{observed resistance}}{\text{calculated resistance}} = \frac{44.5}{24.5} = 1.81$$

Hence there are line losses other than those in the conductors amounting to 81% of the conductor losses.

The calculated value of the characteristic resistance is

$$Z_0 = 276 \log_{10} \frac{2D}{d} = 276 \log_{10} \frac{2 \times 204}{.398} = 832 \text{ ohms}$$

$$\frac{Z_0 \text{ observed}}{Z_0 \text{ calculated}} = 1.08$$

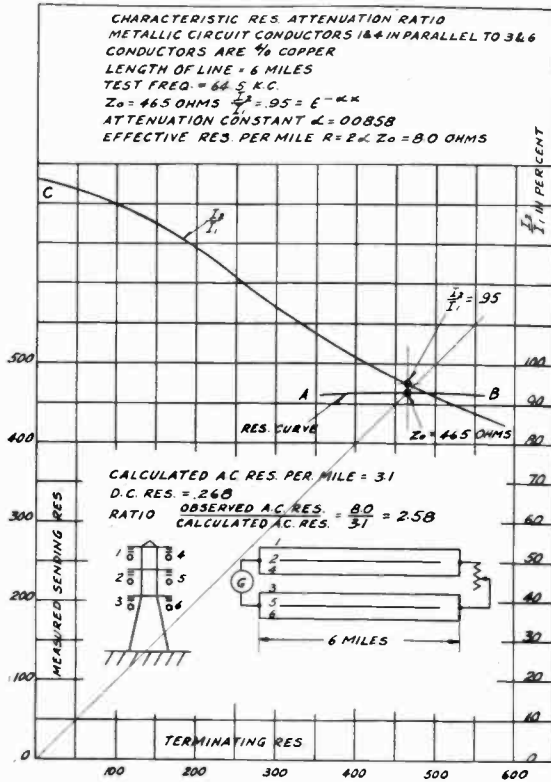

Fig. 31.

Hence the observed value is 8% higher than that obtained by calculation from the physical dimensions of the line.

TEST ON 1/2 IN. STEEL LINE

Tests were made on a line consisting of two half-inch steel conductors, each conductor consisting of seven steel strands. The data are plotted in Fig. 26. The attenuation



on this line was so high that virtually no current was received at the distant end 46 miles away. The characteristic resistance, however, was determined to be 800 ohms. This was simply the resistance of the line as measured at the sending end, the attenuation being so high that there was no observable difference whether the distant end was open or short. This line therefore in its natural condition acted

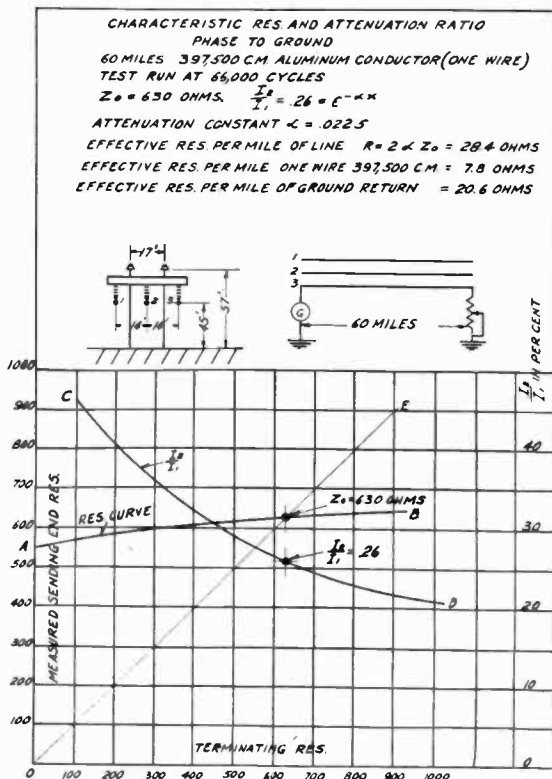

Fig. 32.

like a really infinite line. The value of the characteristic resistance in this case was calculated to be

$$Z_0 = 276 \times \log_{10} \frac{2 \times 204}{.5} = 810 \text{ ohms}$$

The observed value of  $Z_0$  being 800 ohms was very nearly equal to the observed value.

## TESTS ON 4/0 COPPER DOUBLE CIRCUIT LINE

Tests were made on a double circuit power line built for 132,000 volts. The conductors were No. 4/0 copper, consisting of 19 strands of 105.5 cir. mils diameter. The outside diameter of the conductors was .528 inches. Fig. 27 shows the spacing of the conductors and Fig. 28 shows tests run at 41,000 cycles, using conductors 1 and 3 only. The other

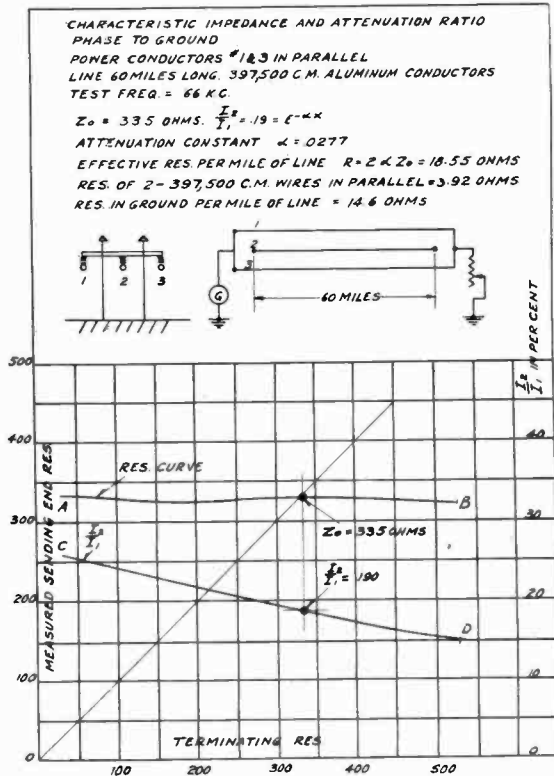

Fig. 33.

conductors were open at both ends. The characteristic resistance is seen to be 850 ohms, while the attenuation ratio is  $\frac{I_2}{I_1} = .95 = e^{-ax}$ . The length of the line in this case is only six miles, so  $x = 6$  from which we get  $a = .00858$ , which is the attenuation constant. The resistance of the line per mile is

$$R = 2 a Z_0 = 2 \times .00858 \times 850 = 14.6 \text{ ohms per mile.}$$

The ratio of a-c. to d-c. resistance at 41,000 cycles for this conductor is calculated by the method of the Bureau of Standards to be  $\frac{R}{R_0} = 9.23$ . The d-c. resistance of No. 4/0 copper conductor per loop mile is .538 ohms. Hence the

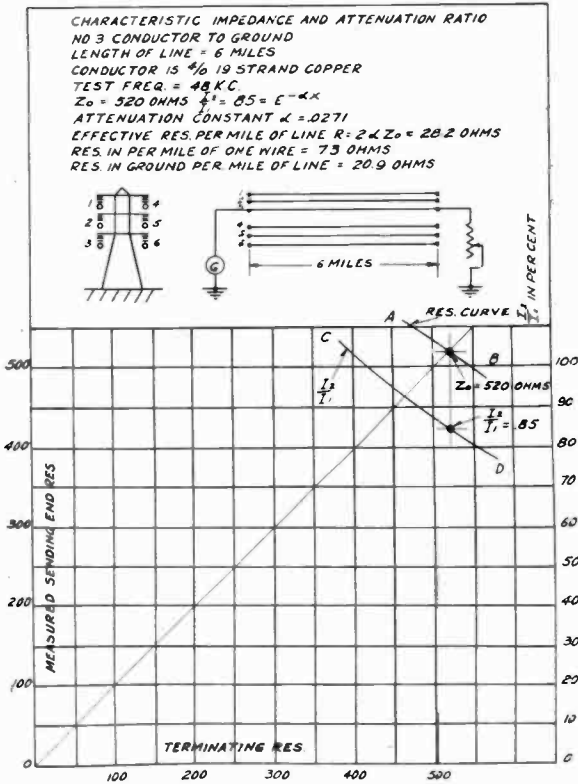

Fig. 34.

calculated a-c. resistance is  $9.23 \times .538 = 4.96$  ohms.

$$\frac{\text{observed resistance}}{\text{calculated resistance}} = \frac{14.6}{4.96} = 2.94$$

Hence in this circuit it would seem that there must be losses other than those in the copper conductors amounting to 194% of the copper losses.

The spacing of the conductors is 22 feet. This gives a calculated value of characteristic resistance of

$$Z_0 = 276 \log_{10} \frac{2D}{d} = 276 \times \frac{\log 2 \times 22 \times 12}{.528} = 828 \text{ ohms}$$

$$\frac{Z_o \text{ observed}}{Z_o \text{ calculated}} = \frac{850}{828} = 102.5\%$$

Similar tests were run on the same conductors at 49.3 kc. and are plotted in Fig. 29. The characteristic resistance  $Z_o = 830$  ohms. The attenuation ratio is  $\frac{I_2}{I_1} = .95 = e^{-ax}$ . The attenuation constant is  $a = .00858$  from which

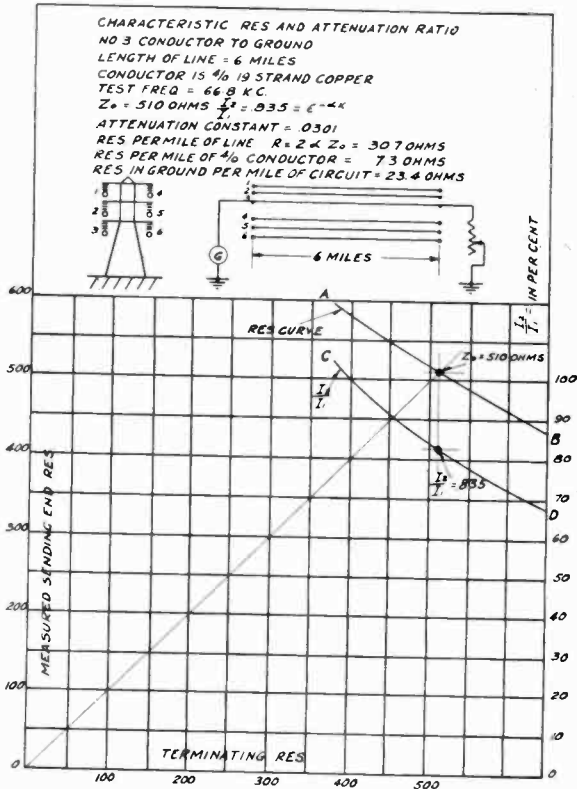

Fig. 35.

the effective resistance is 14.2 ohms. The calculated value of  $\frac{R}{R_o} = 10.15$  which gives the calculated conductor resistance as 5.46 ohms.

$$\frac{\text{observed resistance}}{\text{calculated resistance}} = \frac{14.2}{5.46} = 2.6$$

## TESTS ON TWO 4/0 COPPER LINES IN PARALLEL

In Fig. 30 are shown data for a circuit consisting of wires 1 and 4 in parallel as one side of the circuit, and wires 3 and 6 in parallel as the other side or return. The characteristic impedance  $Z_o = 440$  ohms. The attenuation ratio is

$$\frac{I_2}{I_1} = .95. \text{ The circuit is the same as shown in Fig. 27 sup-}$$

ported on steel towers with 4/0 copper conductors and is six miles long. The attenuation constant is .00858. The effective resistance per mile of circuit is

$$R = 2a Z_o = 2 \times .00858 \times 440 = 7.55 \text{ ohms}$$

The resistance of one of the circuits alone would be

$$2 \times 7.55 = 15.1 \text{ ohms per mile of single circuit.}$$

This corresponds to the previous data giving 14.6 ohms per mile. The test was made at 47,500 cycles. The data is not sufficiently accurate to draw exact conclusions as regards the resistance of wires in parallel. A very slight error in the value of  $Z_o$  makes an appreciable change in the attenuation ratio on so short a line, and therefore gives a different value of calculated resistance.

Fig. 31 gives similar data on the same line except that the test was made at 64,500 cycles. The characteristic resistance is 465 ohms. The attenuation ratio  $\frac{I_2}{I_1} = .95$ . The attenuation constant is as before .00858. The value of circuit resistance per mile is

$$R = 2a Z_o = 2 \times .00858 \times 465 = 8.0 \text{ ohms.}$$

This makes the resistance of each circuit by itself  $2 \times 8 = 16$  ohms, which is in general agreement with the previous data.

From these data it is evident that the resistance of one mile of 4/0 copper conductor lies between 14.6 and 16.0 ohms per loop mile depending upon the frequency. The resistance per mile of one wire is therefore 7.3 ohms to 8.0 ohms, and we may use these values in future calculations with confidence.

## GROUND RETURN CIRCUIT

There has been considerable discussion regarding the relative merits of a line having complete metallic circuit and a line with ground return. In making measurements on

ground return circuits employing the usual methods, serious errors have been introduced, and wrong conclusions drawn. Even with reasonable precautions using improved methods of measurement, erroneous conclusions are likely to be drawn from test data unless due allowances are made for the resistances of the ground stake at both the sending and receiving end. In most test data on ground return cir-

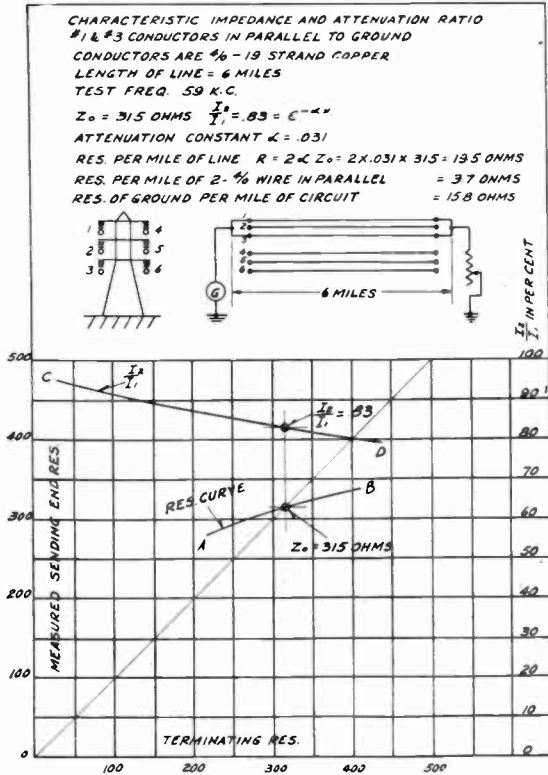

Fig. 36.

cuits the effect of ground stake resistance has been entirely neglected. By taking these details into account and calculating the circuit resistances according to the preceding method, considerable interesting information is brought to light.

### ONE CONDUCTOR TO GROUND

In Fig. 32 are shown the data on a sixty-mile circuit having ground return. The conductor is 397,500-cir. mil.

aluminum cable. The measurements plotted in the figure apply to the case where only one conductor was used, the remaining conductors being insulated at both ends. The line construction is the same as shown in Fig. 23. The test was run at 66 kilocycles. The curves as plotted have been corrected for ground stake resistance at both ends. The

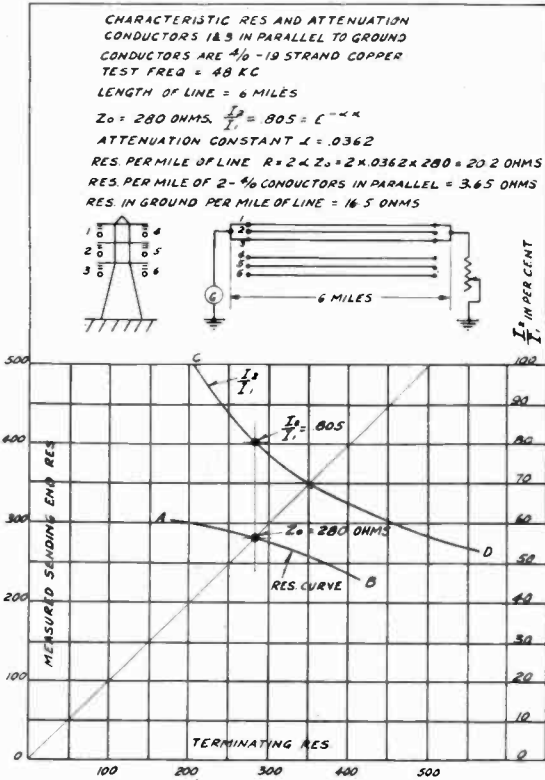

Fig. 37.

characteristic resistance is found to be  $Z_0 = 630 \text{ ohms}$ . The attenuation ratio  $\frac{I_2}{I_1} = .26 = e^{-ax}$  from which we get the attenuation constant  $a = .0225$ , the length of the line  $x$  being 60 miles. The effective resistance per mile of circuit is  $R = 2aZ_0 = 2 \times .0225 \times 630 = 28.4 \text{ ohms}$ . This is the total resistance per mile including all losses. The resistance of the cable used in this test was previously determined as in Fig. 22 to be 15.7 ohms per loop mile. The

resistance per mile of one wire is  $\frac{15.7}{2} = 7.85$  ohms. Subtracting this from the total resistance per mile of circuit we get 20.6 ohms as the resistance per mile, excluding the resistance in the metallic conductor, and also the dielectric and radiation losses associated with it. This 20.6 ohm resistance per mile must therefore *represent the resistance per mile of ground return path.*

The existence of a definite measurable resistance in the ground per mile of line is in striking contrast to the ideas commonly held regarding ground resistance in general. It is generally believed that the resistance of the ground part of a ground return system is so low as to be negligible in comparison with the conductor resistance of the line. The only resistances regarded as of practical importance are those occurring at the ground stakes or at whatever point the circuit makes contact with the ground. For direct current and for 25 or 60 cycles this view is admitted to be correct. The low ground resistance in the case of d-c. or power frequencies is due to the ground currents spreading out over enormous areas after the current once really enters the ground.

At high frequencies such as those under which the accompanying tests were made, the ground resistance seems to be very appreciable and to have a rather definite value. The fact that the ground does present a resistance of approximately 20 ohms per mile of circuit, indicates that the ground current does not spread out over a very wide area. If we assume that the ground resistance per foot cube is 250 ohms, then the cross sectional area of the ground path which gives a resistance of 20 ohms per mile is 66,000 square feet. That is, if the current were uniformly distributed under the line over a strip 1000 feet wide and a depth of 66 feet, the resistance would be 20 ohms per mile. It is not intended to convey the idea that the current is uniformly distributed, but merely to suggest the order of magnitude of the cross sectional area of the ground return path. The actual current density is greatest at the surface and immediately under the line. The density falls off rapidly with the depth and somewhat less rapidly with the width. The analysis of current distribution in the ground is a problem similar to skin effect on conducting wires, the density being greatest at the surface.



TWO CONDUCTORS IN PARALLEL TO GROUND

In Fig. 33 is given results of a test made on the same line as in Fig. 32 except that the two outside conductors are connected in parallel. The characteristic impedance  $Z_0 = 335$  ohms. The attenuation ratio is  $\frac{I_2}{I_1} = .19 = e^{-ax}$  which gives

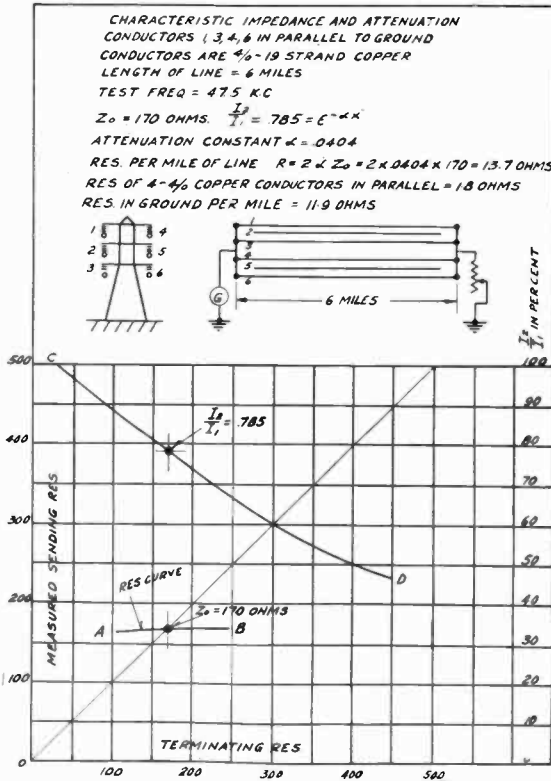

Fig. 38.

the attenuation constant  $a = .0277$ . The effective resistance per mile of circuit is

$$R = 2aZ_0 = 2 \times .0277 \times 335 = 18.5 \text{ ohms}$$

The resistance of two 397,500-cir. mil aluminum conductors in parallel is 3.92 ohms. Subtracting this from the total of 18.5 ohms we get 14.6 ohms as the resistance chargeable to the ground return per mile of circuit.

It is of considerable interest to note that the resistance

of the ground return path is less when two conductors are used in parallel, than with a single conductor.

#### TESTS ON DOUBLE CIRCUIT 4/0 COPPER LINE ONE WIRE TO GROUND

In Fig. 34 are given the results of a test made on one conductor of a double circuit line shown in Fig. 27. The conductors are 4/0 19 strands copper. The length of the line is 6 miles. One of the bottom conductors indicated as No. 3 was connected to ground, while all other conductors were open at both ends. The test is similar to that shown in Fig. 32. The test frequency was 48 kc. The characteristic resistance  $Z_o = 520$  ohms. The attenuation ratio is  $\frac{I_2}{I_1} = .85 = e^{-ax}$  which gives the attenuation constant  $a = .0271$ . The effective resistance per mile of line is

$$R = 2aZ_o = 2 \times .0271 \times 520 = 28.2 \text{ ohms}$$

The resistance per mile of one 4/0 copper conductor is 7.3 ohms which leaves 20.9 ohms as the resistance chargeable to the ground return.

Fig. 35 is a test similar to Fig. 34 except that the test frequency is 66.8 kilocycles. The value of  $Z_o$  is 510 ohms and the attenuation ratio  $\frac{I_2}{I_1} = .835 = e^{-ax}$ . The attenuation constant  $a$  is .0301 and the resistance per mile of line is

$$R = 2aZ_o = 2 \times .0301 \times 510 = 30.7 \text{ ohms}$$

Subtracting 7.3 ohms for the copper conductor we have 23.4 ohms as the resistance per mile of ground return.

#### TWO CONDUCTORS IN PARALLEL TO GROUND

In Fig. 36 are given test data on the same line as Fig. 35 except that conductors number 1 and 3 are connected in parallel. The frequency is 59 kc. The value of  $Z_o$  is 315 ohms. The attenuation ratio  $\frac{I_2}{I_1} = .83$ . The attenuation constant  $a = .031$ . The resistance per mile of line is

$$R = 2aZ_o = 2 \times .031 \times 315 = 19.5 \text{ ohms}$$

Subtracting 3.7 ohms, the resistance of two 4/0 wires in parallel leaves 15.8 ohms as the resistance per mile of ground return. This result compares with 14.6 ohms in Fig. 33.

In Fig. 37 are given the results of a test similar to Fig.

36, except that the test frequency is 48 kc. The value of  $Z_0$  is 280 ohms. The attenuation ratio is  $\frac{I_2}{I_1} = .805$ . The attenuation constant is .0362. The resistance of the circuit per mile is

$$R = 2aZ_0 = 2 \times .0362 \times 280 = 20.2 \text{ ohms}$$

Subtracting 3.65 ohms as the resistance of two conductors

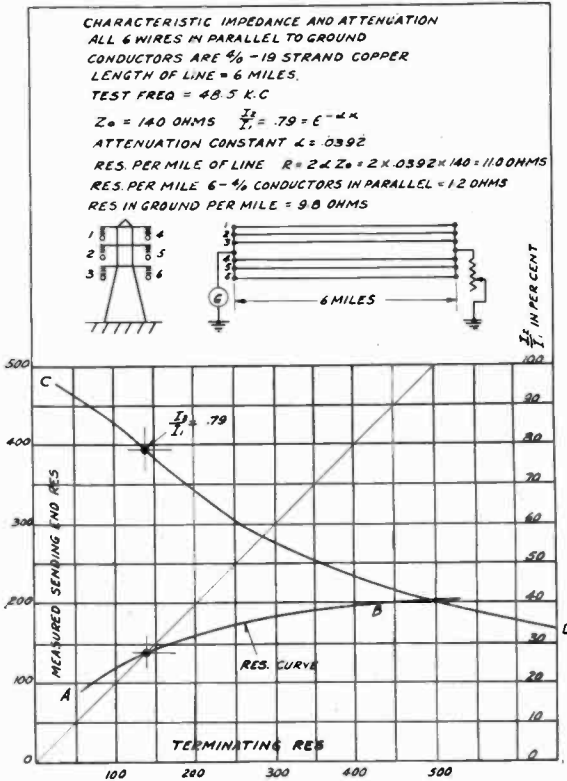

Fig. 39.

in parallel we get 16.5 ohms as the resistance per mile of ground return. This compares with the value of 15.8 ohms in Fig. 36.

#### FOUR CONDUCTORS IN PARALLEL TO GROUND

In Fig. 38 are given the test data on the same line as in Fig. 37, except that conductors 1, 3, 4 and 6 are tied in parallel to ground. The test frequency is 47.5 kc. The

characteristic impedance  $Z_o = 170$  ohms. The attenuation ratio  $\frac{I_2}{I_1} = .785 = e^{-ax}$ . The attenuation constant  $a = .0404$ .

The resistance per mile of line is

$$R = 2aZ_o = 2 \times .0404 \times 170 = 13.7$$

The resistance of four 4/0 conductors in parallel is 1.8 ohms. Subtracting this from the total gives 11.9 ohms per mile as the resistance of the ground return.

### SIX CONDUCTORS IN PARALLEL TO GROUND

In Fig. 39 are given the results of a test similar to Fig. 31, except that all six conductors are tied in parallel to ground. The value of the characteristic impedance is  $Z_o = 140$  ohms. The attenuation ratio  $\frac{I_2}{I_1} = .79 = e^{-ax}$ . The attenuation constant  $a = .0392$ . The resistance per mile of line is

$$R = 2aZ_o = 2 \times .0392 \times 140 = 11.0 \text{ ohms}$$

The resistance of six 4/0 copper conductors in parallel is 1.2 ohms. Subtracting this from the total gives 9.8 ohms as the resistance per mile of ground return.

### DISCUSSION OF RESULTS

It will be noticed that the ground resistance indicated by the preceding tests is progressively less each time conductors are added in parallel. The explanation of this is not clear at present as it would seem that the ground resistance should remain substantially constant.

In making these tests it will be remembered that all wires not included in the tests were open at both ends. It has been suggested that currents are induced in these idle conductors and that the losses in these appear as added resistance in the circuit under test. Such losses of course are not chargeable against ground resistance.

This explanation is not tenable since it can be shown that no currents flow in a wire paralleling an energized wire provided it is insulated throughout and open at both ends.

Although the interpretation of the results applying to ground return circuits may be open to question so far as the actual magnitude of the ground resistance is concerned, the

data would seem to establish beyond question the fact that the ground does have a very definite resistance per mile and that this resistance is comparable with the resistance of the conductors. It is this ground resistance which makes the attenuation of a ground return circuit higher than for a metallic circuit. This attenuation, however, is not nearly so great as is generally supposed.

Studies on power lines at high frequencies such as the foregoing are of value entirely aside from the question of communication. For example, the values of characteristic impedance, attenuation in metallic and in ground return circuits have immediate application in the study of many problems which arise from switching surges and lightning protection. The methods here developed in the analysis of antenna coupling may be used to calculate the reduction of induced potential due to the presence of ground wires above a power line.

The reactions taking place in the ground portion of a ground return circuit are similar to those taking place on the ground side of an advancing radio wave. A further study of ground return circuits may throw considerable light on radio phenomena.

#### SUMMARY

Communication is a matter of vital importance in the operation of large power systems. The difference between ordinary wire communication and communication over high voltage power lines is discussed. The necessity for using energy levels greatly in excess of that commonly used on ordinary wire lines is indicated. The importance of selecting and utilizing only those circuit elements which are inherently stable is discussed. The superior stability of the two frequency system of duplex is brought out. A standard 250-watt communication equipment is described in detail. The great value of the heterodyne principle for calling is noted. The theory of antenna coupling is developed beginning with elementary principles. Several numerical examples are given to show the application of the theory. It is shown that the efficiency of antenna coupling is quite high contrary to the general opinion prevailing at present. A brief description of the propagation of high frequency

currents over wires together with some of the principal equations is given. Tests are given which show a close agreement with accepted line theory. A simple method of determining line characteristic resistance and method of determining the effective line resistance is described. This method is applied to ground return circuits and discloses the existence of considerable resistance per mile in the ground return path.

# MEASUREMENTS OF RADIO FREQUENCY AMPLIFICATION

BY  
SYLVAN HARRIS

The need for a simple and accurate method of measuring radio frequency amplification and for studying the over-all characteristics of radio receivers is urgent, and it is hoped that the work described in this paper may help somewhat to fill this need. Many investigators have made measurements of "gain-per-stage" of radio frequency amplifiers, and in all cases which have come to the attention of the writer, such measurements required a knowledge of the values of input and output voltages.

Due to the difficulty of measuring voltages of the order of a few microvolts, the voltage impressed on the state under consideration in these various measurements, was generally far above the value of the radio frequency voltages encountered in radio receivers. In one instance,<sup>1</sup> the impressed voltage was obtained as an inductive drop in a short straight wire surrounded by a concentric return conductor. The voltage was computed from the current flowing in the wire and the inductance of this wire. Although measurements made by this method agreed, as to order of magnitude, with computed values, there is no means of determining the accuracy of the method. Furthermore, this method was applied to a radio frequency amplifier in which the gain-per-stage was great, so that small errors would not be noticeable.

Some experimenters have been in the habit of attempting to measure the gain in an isolated stage, that is, a stage not connected to other stages, as is the case in radio receivers. Such measurements do not give any fair idea of the actual gain, for, due to reaction of the other stages, it may be much different from the values so obtained. Especially is this true

<sup>1</sup>A. W. Hull, Phys. Rev. Vol. 27, No. 4, page 442.

\*Received by the Editor April 5, 1927.

of amplifiers in which there is regeneration present, even when totally shielded.

The advantages of the method described in this paper may be summarized as follows:

(a) the measurements are independent of the values of the input and output voltages;

(b) the measurements are made on the stage in question while actually in a radio receiver, under actual operating conditions;

(c) no connections are made to the stage in question for purposes of measurement, excepting a switch for cutting this stage in and out of the amplifier;

(d) no special apparatus is required for making the measurements other than that usually found in radio laboratories.

The method may be explained as follows: Consider a completely shielded radio receiver having three stages in the radio frequency amplifier, a detector, and an audio frequency amplifier. Then let

$K_1$  be the gain in the first radio-frequency stage

$K_2$  be the gain in the second radio-frequency stage

$K_3$  be the gain in the third radio-frequency stage

$K_d$  be the detector constant

$K_a$  be the gain in the audio-frequency amplifier

$e$  be the alternating voltage impressed at the input terminals of the receiver.

$V_1$  be the voltage output of the receiver when all the stages are used.

$V_2$  be the voltage output of the receiver when the second stage is omitted.

When all the stages are connected in, assuming the square law of the detector, the output voltage of the receiver is

$$V_1 = (e K_1 K_2 K_3)^2 K_d K_a \quad (1)$$

When the second stage of the radio frequency amplifier is omitted, this becomes

$$V_2 = (e K_1 K_3)^2 K_d K_a \quad (2)$$

The ratio of these two expressions gives, as the gain in the second r. f. stage

$$K_2 = \sqrt{\frac{V_1}{V_2}} \quad (3)$$

In order to obtain values for  $V_1$  and  $V_2$ , a non-inductive



voltage-divider of about 20,000 ohms was connected to the output of the receiver, as shown in Figure 1. The remainder of the circuit of Figure 1 shows a vacuum tube voltmeter having in its output circuit an audio transformer, carborendum crystal rectifier, and a microammeter. This arrangement was adopted on account of its great sensitivity and convenience in operating.

A "datum" indication of the microammeter is selected, as will be explained later, all measurements being taken with this same deflection. Let this deflection correspond to a voltage input to the vacuum tube voltmeter of  $v_o$ , as indicated in Figure 1. The output voltage of the receiver will then be

$$v_o \frac{R}{r} \quad (4)$$

in which  $r$  is that portion of  $R$ , across which the voltage drop must be taken in order that the microammeter regis-

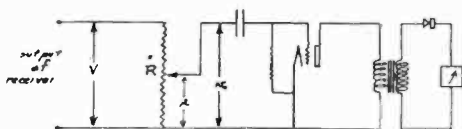

Figure 1

ter the "datum" deflection. By using this arrangement the measurements are made independent of the characteristics of the vacuum tube voltmeter, and associated apparatus, since a completely modulated radio frequency supply is used, the modulation frequency being constant.

Letting  $r_1$  be the value of  $r$  when the stage under question is connected in, and  $r_2$  the value when the stage in question is cut out, equation (3) becomes:

$$K_2 = \sqrt{\frac{r_2}{r_1}} \quad (5)$$

In making the measurements a low power driver was used which supplied radio frequency power completely modulated at 60 cycles per second. The measurements were made in a sheet-iron booth, and the receiver itself was completely shielded, over-all and between stages. Only one wire was led into the booth from the river, the sheet-iron which

formed the booth acting as the return circuit. The driver was located outside the booth, and delivered power to a small coil located in a copper box fastened on the outside of the booth. This coil acted inductively on another small coil, and between the two coils was a sliding copper "door"; by sliding this door the amount of power delivered by the coil connected to the driver to the other coil, connected to the receiver input, was regulated. In making the measurements care must be taken that the detector is not "overloaded."

The "datum" indication is obtained by observing the smallest deflection of the microammeter that can be read accurately when the weakest signal voltage is impressed on the input of the receiver with the stage in question cut out, and the voltage divider set at maximum. To measure the gain of that stage, it is then switched into the receiver, and the voltage divider adjusted until the datum deflection is

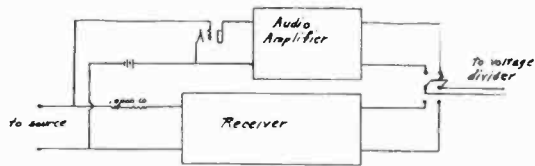

Figure 2

obtained again. Eq. (5) then gives the gain in that stage (where  $r_2=R$ ).

In plotting curves of gain against frequency the datum deflection that is used for each measurement is unimportant; the only requirement is that the detector stage be not overloaded. In order to obtain a check on the method and at the same time determine when overloading of the detector occurs, another vacuum tube voltmeter, followed by an audio frequency amplifier, was connected to the input of the receiver, as shown in Figure 2. On account of the fact that the input voltage required at the set is so small and it is difficult to obtain an amplification in this amplifier of the same order of magnitude as that which the receiver furnishes, a resistance of 10,000 ohms was interposed between the receiver input and the points at which the second vacuum tube voltmeter was connected. In later measurements this resistance was replaced by a small condenser, simulating the capacity of an antenna.

This vacuum tube voltmeter and amplifier serves as a

device for measuring the input voltage. The double-throw switch enables the voltage divider to be connected either to the input measuring system or to the output of the receiver. Assuming a square law in the receiver, and a square law vacuum tube voltmeter at the input, the relation between the settings of the voltage divider when the switch is thrown first in one direction and then in the other, should be linear. Or, using the subscript *i* to indicate input measure-

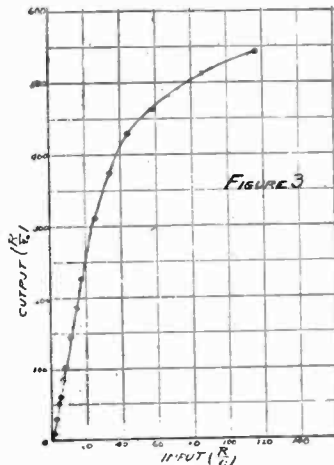

Figure 3

ments and apparatus, and the subscript *o* for the output measurements, other symbols remaining the same:

$$\frac{R}{r_i} v_o = e^2 K_{d1} K_{a1}$$

$$\text{or } e = \sqrt{\frac{\frac{R}{r_i} v_o}{K_{d1} K_{a1}}} \tag{6}$$

Likewise,

$$\frac{R}{r_o} v_o = (e K_1 K_2 K_3)^2 K_d K_a$$

$$\text{or } e = \sqrt{\frac{\frac{R}{r_o} v_o}{(K_1 K_2 K_3)^2 \cdot K_d K_a}} \tag{7}$$

Equating these and reducing:

$$r_o = a \text{ constant } \times r_i \tag{8}$$

Figure 3 illustrates this relation; it is a curve obtained

at constant frequency, the input voltage varying. It is linear for voltages up to the point of overload of the detector in the receiver. The same curve has been plotted in Figure 4, this time taking the square-root of the "input" values. Plotted to logarithmic coordinates, this curve is likewise linear up to the point of overload of the detector, and has a slope very close to 2, as would be expected from the law of the detector. Figure 4 then, is the response curve of the receiver at constant frequency, varying input voltage. Figure 5 is the

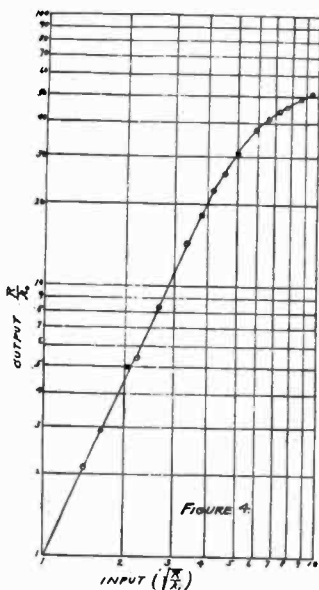

Figure 4

gain-frequency curve of a stage in an experimental receiver.

The same set-up can be used to study the over-all characteristics of radio receivers, at various frequencies, and at constant input voltage. The vacuum tube voltmeter is then used only to indicate the constancy of the input voltage. The over-all gain of the receiver is given by

$$K_T = \frac{\frac{R}{r_o} v_o}{\sqrt{\frac{K}{r_1} v_o} \sqrt{K_{d1} K_{ri}}} = a \text{ constant } \times \frac{\sqrt{r_1}}{r_o} \quad (6)$$

Keeping the input voltage constant, represented by  $r_1$  in eq.

(9), the amplification of the receiver is inversely proportional to  $r_0$ . Such a curve of an experimental receiver is shown in Figure 6.

This method has also been used by the writer for determining the detection coefficients of detectors. In measurements of this kind, as also in obtaining curves like that in

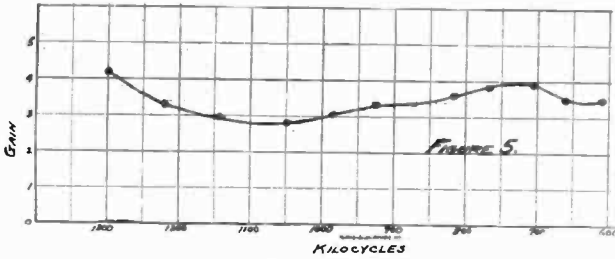

Figure 5

Figures 3, 4 and 6, the actual values obtained are arbitrary, but with a careful set-up conditions can easily be reproduced and the same datum used each time a set of measurements is taken. All the measurements will then be reduced to a common basis, affording an easy means of comparison.

If it is desired the vacuum tube voltmeter at the input may be calibrated, and the amplification of the audio fre-

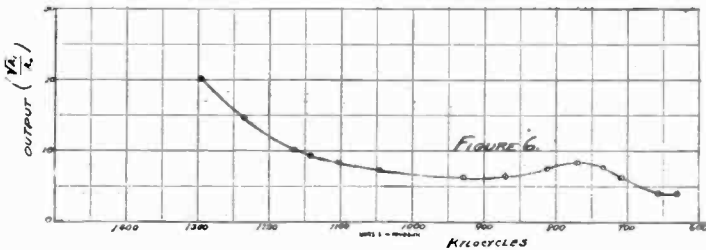

Figure 6

quency amplifiers can be determined. But this will lead to difficulties which this method seeks to avoid.

In conclusion, it may be stated that the only serious difficulty in making these measurements is the avoidance of a "noise level" which, in the present work, was sometimes greater than the original signal strength used to determine the "datum". The noise level was mainly due to vibrations of the building. Its effect on the accuracy of the measure-

ments was appreciable only when using the weakest input voltages. In figure 3, for example, it was difficult to obtain points on the curve below  $R/r_1 =$  about 20 in the daytime, so much of the work was done at night when the shaking of the building was the least.

SUMMARY—A method of measuring radio frequency amplification in radio receivers is presented. It applies accurately only to non-regenerative receivers, to the receivers in which regeneration is not very pronounced. The set-up described in the paper can be used without change for studying the gain-per-stage, the over-all characteristics of a receiver, and detection co-efficients of electron tubes. The method has the advantage that the measurements do not require a knowledge of the actual values of the voltages, and do not require the removal of a stage in question from the receiver. The measurements are made with the stage or the complete receiver under actual operating conditions.

## BOOK REVIEW

**Alternating Current Rectification and Allied Problems,**  
by L. B. W. JOLLEY. JOHN WILEY & SONS, INC., SECOND  
EDITION. 472 + XXII Pages, 340 illustrations. Price \$6.

This volume, of English origin, gives a nearly complete resume of European systems of alternating current rectification and includes details of many American appliances as well. Besides the commonly known types (such as rotary and vibrating mechanical rectifiers, mercury vapor systems, thermionic devices and gas filled tubes) many of the lesser known devices are described as well. To any one who does not follow current literature of European countries many of the latter may appear new and several would seem to offer much promise for further investigation.

The book is hardly complete in the matter of recent American practice, since several of the popular radio rectifiers have been neglected, such as the full wave filamentless tubes, cuprous oxide rectifier plates, magnesium plate rectifiers and the like. The date of the second edition preface (June, 1926) follows the introduction of these devices in this country by a considerable time. On the other hand some details of a type of paste rectifier recently popularized here, following the discoveries of Andre', (as a cartridge type of rectifier for trickle charger work) are included.

In this age of super-power, alternating current has forged ahead, mainly due to the ease of obtaining the necessary high voltages, in spite of many disadvantages that are inherent with the a. c. system. While an outline of the most plausible methods of rectification with the ultimate view of converting large amounts of power to potentials of hundreds of kilovolts is of interest primarily to the power engineer, the methods are of interest to the radio engineer as well. Indeed, it seems that the majority of the systems originated as a solution to radio problems. All types described have been used by radio engineers.

The book is written in a popular style, although the general description of each system and the detailed account of

the outstanding problems are followed by a mathematical study of the theory. In general the formulae given are complete and final and do not involve mathematics higher than algebra and trigonometry. An excellent bibliography appears at the end of each section, comprising some seven hundred items in all, from over seventy periodicals as well as a number of text books. Whenever a particular paper listed in these bibliographies also appears in "Science Abstracts" the file reference to this periodical is also given. The reader might be saved a little time in looking up these references if the tabulation of the particular subject contained therein were a little more specific.

A special section has been included in this edition, to the listing of the sources of power for broadcast receivers and an analysis of the advantages and disadvantages of all methods are discussed. Other special sections include harmonic analysis, wave form measurements, inverters and the use of rectifiers in the field of measurements.

"Alternating Current Rectification" is an excellent reference book and should prove a valuable addition to the library of any radio engineer.

R. R. Batcher.



# DIGEST OF UNITED STATES PATENTS RELATING TO RADIO TELEGRAPHY AND TELEPHONY

Issued April 5, 1927—May 17, 1927

By  
**JOHN B. BRADY**

(Patent Lawyer, Ouray Building, Washington, D. C.)

- 1,623,152—RADIO APPARATUS—A. M. YOUNG, of Brentwood, and N. W. SIMPSON, of Bolton, England. Filed June 12, 1922, issued Apr. 5, 1927. Assigned to Radio Corp. of America.
- 1,623,360—CONDENSER—T. T. RODGERS, M. A. GIBLIN, F. K. MOORE, and G. T. MOORE, of Milwaukee, Wis. Filed Sept. 24, 1924, issued Apr. 5, 1927. Assigned to Radio Corp. of America.
- 1,623,563—ELECTRICAL CONDENSER—G. F. A. STONE, London, England. Filed July 15, 1925, issued Apr. 5, 1927.
- 1,623,628—COMBINED A BATTERY TRICKLE CHARGER AND BY SUPPLY—D. R. LOVEJOY, of New York City. Filed Oct. 16, 1926, issued Apr. 5, 1927. Assigned to Lovejoy Development Corp.
- 1,623,741—VARIABLE ELECTRICAL CONDENSER—L. R. McDONALD, Westmount, Quebec, Canada. Filed Nov. 10, 1922, issued Apr. 5, 1927.
- 1,623,742—VARIABLE ELECTRICAL CONDENSER—L. R. McDONALD, Westmount, Quebec, Canada. Filed Mar. 7, 1924, issued Apr. 5, 1927.
- 1,623,745—TRANSMITTING SYSTEM FOR RADIANT ENERGY—A. F. MURRAY, Boston, Mass. Filed Jan. 14, 1921, issued Apr. 5, 1927. Assigned to John Hays Hammond.
- 1,623,918—RADIO RECEIVING APPARATUS—A. H. GREBE, Hollis, N. Y. Filed Dec. 17, 1924, issued Apr. 5, 1927.
- 1,623,966—RADIO TRANSMISSION SYSTEM—P. S. CARTER, New Brunswick, N. J. Filed June 25, 1923, issued Apr. 12, 1927. Assigned to Radio Corp. of America.
- 1,623,005—METHOD OF RADIO SIGNALING—M. OSNOS and L. KASARNOWSKY, Berlin, Germany. Filed Jan. 12, 1923, issued Apr. 12, 1927. Assigned to Gesellschaft fur Drahtlose Telegraphie.
- 1,624,006—CIRCUIT ARRANGEMENT FOR HIGH FREQUENCY SENDING STATIONS—M. OSNOS, Berlin, Germany. Filed Feb. 12, 1923, issued Apr. 12, 1927. Assigned to Gesellschaft fur Drahtlose Telegraphie.
- 1,624,148—SIGNAL RECEIVING CIRCUITS—E. L. POWELL, Washington, D. C. Filed Mar. 6, 1926, issued Apr. 12, 1927. Assigned to Wired Radio, Inc.
- 1,624,185—WIRELESS RECEIVING CIRCUITS—H. J. ROUND, London, England. Filed May 21, 1923, issued April 12, 1927. Assigned to Radio Corp. of America.
- 1,624,201—RADIO SIGNALING—C. S. AGATE and P. W. WILLANS, Chelmsford, and London, England, respectively. Filed Sept. 28, 1921, issued Apr. 12, 1927.
- 1,624,208—HIGH FREQUENCY SIGNALING—P. M. J. BOUCHEROT, Paris, France. Filed Aug. 29, 1921, issued Apr. 12, 1927.
- 1,624,215—RADIO SIGNALING SYSTEM—G. H. CLARK, Brooklyn, N. Y. Filed June 27, 1922, issued Apr. 12, 1927. Assigned to Radio Corp. of America.
- 1,624,332—ELECTRICAL CONDENSER—P. E. GILLING, East Orange, N. J. Filed Feb. 23, 1925, issued Apr. 12, 1927.

- 1,624,333—ELECTRICAL CONDENSERS—P. E. GILLING, East Orange, N. J. Filed Mar. 13, 1925, issued Apr. 12, 1927.
- 1,624,334—ELECTRICAL CONDENSER—P. E. GILLING, East Orange, N. J. Filed Mar. 13, 1925, issued Apr. 12, 1927.
- 1,624,451—VACUUM TUBE—H. W. WEINHART, Elizabeth, N. J. Filed Apr. 9, 1921, issued Apr. 12, 1927. Assigned to Western Electric Co.
- 1,624,459—SHIELDING AND BALANCING MEANS—W. J. ADAMS and A. HADDOCK, of Irvington, N. Y., and East Orange, N. J. respectively. Filed Dec. 20, 1920, issued Apr. 12, 1927. Assigned to Western Electric Co.
- 1,624,473—HIGH FREQUENCY SIGNALING SYSTEM—L. M. CLEMENT, New York, N. Y. Filed Dec. 8, 1921, issued Apr. 12, 1927. Assigned to Western Electric Co.
- 1,624,537—OSCILLATION GENERATOR—E. H. COLPITTS, East Orange, N. J. Filed Feb. 1, 1918, issued Apr. 12, 1927. Assigned to Western Electric Co.
- 1,624,562—ELECTRON DISCHARGE DEVICE—V. L. RONCI, Brooklyn, N. Y. Filed Dec. 18, 1923, issued Apr. 12, 1927. Assigned to Western Electric Co.
- 1,624,672—COMMUNICATION SYSTEM—H. W. O'NEILL, Elmhurst, N. Y. Filed Dec. 17, 1924, issued Apr. 12, 1927. Assigned to Western Electric Co.
- 1,624,673—METHOD OF AND MEANS FOR RADIO COMMUNICATION—A. E. PAIGE, Philadelphia, Pa. Filed Apr. 19, 1922, issued Apr. 12, 1927.
- 1,624,991—RADIO TELEGRAPH AND TELEPHONE SYSTEM—C. SPEAKER, of Cherrydale, Virginia. Filed Jan. 29, 1921, issued Apr. 19, 1927.
- 1,624,966—AMBULATORY REPEATING SYSTEM—ROBERT W. MORRIS, of Roslyn, New York. Filed Aug. 25, 1923, issued Apr. 19, 1927. Assigned to American Telephone & Telegraph Co.
- 1,625,296—METHOD OF AND MEANS FOR MODULATING SIGNALING CURRENTS—EMORY LEON CHAFFEE, of Belmont, Mass. Filed Aug. 2, 1922, issued Apr. 19, 1927.
- 1,625,445—STATIC ELIMINATOR—J. ASTROM, et al, of Fort Wayne, Indiana. Filed Mar. 16, 1925, issued Apr. 19, 1927.
- 1,625,504—CONVERTER OF ELECTRIC CURRENT—F. G. SIMPSON, of Seattle, Washington. Filed July 6, 1926, issued Apr. 19, 1927.
- 1,625,776—ELECTRON-EMITTING CATHODE AND PROCESS OF PREPARING THE SAME—FREDERICK HOLBORN, of Hoboken, New Jersey. Filed Jan. 14, 1926, issued Apr. 19, 1927. Assigned to Hazeltine Corporation.
- 1,626,464—PORTABLE RADIO APPARATUS—W. M. HEINA, Bronx, New York. Filed Sept. 16, 1926, issued Apr. 26, 1927. Assigned to Heina Radio Corp.
- 1,626,526—CONDENSER—G. A. GILLEN, Jersey City, N. J. Filed May 7, 1924, issued Apr. 26, 1927. Assigned to Gillen, Kimmey Baker Syndicate, Inc.
- 1,626,537—VARIABLE CONDENSER—B. JIROTKA, Berlin, Germany. Filed Apr. 15, 1926, issued Apr. 26, 1927. Assigned to the Firm, Dr. Otto Sprenger.
- 1,625,822—RADIO RECEIVER AND TROUBLE ALARM—R. K. POTTER, of New York. Filed July 15, 1926, issued April 26, 1927. Assigned to American Telephone & Telegraph Co.
- 1,625,823—RADIO RECEIVER AND TROUBLE ALARM—R. K. POTTER, of New York. Filed July 15, 1926, issued Apr. 26, 1927. Assigned to American Telephone & Telegraph Co.
- 1,625,996—ELECTRICAL APPARATUS—L. O. GRONDAHL, of Pittsburgh, and Harry M. Ryder, of Forest Hills Borough, Pennsylvania. Filed Nov. 3, 1923. Assigned to The Union Switch & Signal Company of Swissvale, Pa.
- 1,626,030—SPARK GAP DEVICE—J. H. EASTMAN, Detroit, Michigan. Filed May 17, 1926, issued Apr. 26, 1927.
- 1,626,239—RECEIVING CIRCUIT—L. D. KELLOGG, Deerfield, Illinois. Filed Oct. 6, 1922, issued Apr. 26, 1927. Assigned to Kellogg Switchboard and Supply Co.

- 1,626,356—FIXED CONDENSERS—L. T. RHOADES, Mont Clare, Pa. Filed Apr. 20, 1925, issued Apr. 26, 1927. Assigned to New York Coil Co.
- 1,626,370—RADIO RECEIVER—H. F. WORNER, Philadelphia, Pa. Filed Aug. 21, 1924, issued Apr. 26, 1927.
- 1,626,391—VARIABLE AIR CONDENSER—A. D. CARDWELL, Rockville Center, N. Y. Filed Sept. 26, 1922, issued Apr. 26, 1927. Assigned to The Allen D. Cardwell Mfg. Corp.
- 1,626,449—AUTOMATIC ANTENNA REGULATION—W. W. BROWN, Schenectady, N. Y. Filed Dec. 29, 1925, issued Apr. 26, 1927. Assigned to General Electric Co.
- 1,626,634—ELECTROSTATIC RADIOTUNER—J. SLEPIAN, of Swissvale, Pa. Filed Aug. 3, 1921, issued May 3, 1927. Assigned to Westinghouse Electric & Manufacturing Co.
- 1,626,684—CONDENSER—R. D. MARBURY, of Wilkinsburg, Pa. Filed Oct. 1, 1923, issued May 3, 1927. Assigned to Westinghouse Electric & Manufacturing Co.
- 1,626,685—ACTIVATION BY MEANS OF HYDROGEN FREE, CARBON BEARING GAS—J. W. MARDEN, of East Orange, THOMAS P. THOMAS and J. E. CONLEY, of Bloomfield, N. J. Filed Apr. 10, 1923, issued May 3, 1927. Assigned to Westinghouse Electric & Manufacturing Co.
- 1,626,699—RADIO TRANSMISSION SYSTEM—H. SCHIEFERSTEIN, of Charlottenburg, Germany. Filed Oct. 31, 1921, issued May 3, 1927. Assigned to Westinghouse Electric & Manufacturing Co.
- 1,626,724—FREQUENCY CONTROLLING SYSTEM—C. S. DEMAREST, of Ridgewood, N. J., and M. L. ALMQUIST, of Brooklyn, N. Y. Filed Dec. 31, 1923, issued May 3, 1927. Assigned to American Telephone & Telegraph Co.
- 1,626,803—SELF CONTAINED RADIO RECEIVING UNIT—J. S. FISHBACK, of Indianapolis, Ind. Filed Mar. 27, 1922, issued May 3, 1927.
- 1,626,858—VACUUM TUBE—H. E. METCALF, of San Leandro, Calif. Filed Feb. 28, 1924, issued May 3, 1927. Assigned to The Magnavox Co.
- 1,627,127—ELECTRIC DISCHARGE DEVICE—J. H. THOMPSON, of Hollidays Cove, W. Va. Filed Mar. 18, 1925, issued May 3, 1927.
- 1,627,231—DETECTOR AND METHOD OF CONTROLLING THE SAME—E. L. CHAFFEE, of Belmont, Mass. Filed Mar. 31, 1915, issued May 3, 1927. Assigned to John Hays Hammond, Jr.
- 1,627,411—ELECTRON RELAY—S. RUBEN, of New York, N. Y. Filed Oct. 23, 1920, issued May 3, 1927.
- 1,627,493—ELECTRICAL CONDENSER—W. DUBILIER, of New Rochelle, N. Y. Filed Feb. 28, 1925, issued May 3, 1927. Assigned to Dubilier Condenser Corporation.
- 1,627,707—RADIO SIGNALING SYSTEM—MARIUS LATOUR, of Paris, France. Filed Aug. 19, 1921, issued May 10, 1927. Assigned to Latour Corporation.
- 1,627,592—RADIO APPARATUS AND CURRENT CONTROL DEVICE THEREFOR—P. A. CHAMBERLAIN, of Chicago, Ill. Filed Dec. 4, 1926, issued May 10, 1927. Assigned to Mohawk Corp.
- 1,627,718—RADIO TELEPHONY—P. WARE, of New York, N. Y. Filed Sept. 3, 1921, issued May 10, 1927. Assigned to Ware Radio, Inc.
- Re. 16,606—RADIO RECEIVING APPARATUS—H. F. LOWENSTEIN and E. E. CLEMENT, Washington, D. C. Original filed Aug. 14, 1922; Re-issue Jan. 6, 1927, issued Apr. 26, 1927. Assigned to Edward F. Colladay.
- 1,625,234—RADIO APPARATUS—G. F. WITTGENSTEIN, Zurich, Switzerland. Filed Feb. 26, 1926, issued Apr. 19, 1927.
- 1,625,330—RADIO CONDENSER—A. S. PINKUS, New York City. Filed Apr. 10, 1925, issued April 19, 1927.
- 1,625,409—LIGHT SENSITIVE CELL CONTROL CIRCUIT—T. W. CASE, Auburn, N. Y. Filed Jan. 11, 1923, issued Apr. 19, 1927. Assigned to Case Research Laboratory, Inc.

- 1,627,758—RADIO RECEIVING APPARATUS—MARCEL WALLACE, of New York, N. Y. Filed April 27, 1925, issued May 10, 1927. Assigned to Electro-Laboratories, Inc.
- 1,627,767—TRANSMISSION OF ELECTRIC OSCILLATIONS—L. N. BRILLOUIN & E. M. F. FROMY, of Paris, France. Filed Aug. 10, 1925, issued May 10, 1927.
- 1,627,815—RADIO BATTERY CHARGER—C. T. WEIBLER, of La Grange, Ill. Filed Nov. 24, 1926, issued May 10, 1927. Assigned to All-American Radio Corp.
- 1,628,009—SIGNAL TRANSMISSION SYSTEM—A. H. TAYLOR, of Washington, D. C. Filed Sept. 20, 1926, issued May 10, 1927. Assigned to Wired Radio, Inc.
- 1,628,045—ELECTRONIC DISCHARGE DEVICE—W. F. HENDRY, of Ossining, N. Y. Filed Oct. 8, 1926, issued May 10, 1927. Assigned to Manhattan Electrical Supply Co., Inc.
- 1,628,115—ELECTRIC CIRCUIT CLOSER FOR RELAYS—L. L. CALL, of Detroit, Michigan. Filed Apr. 17, 1922, issued May 10, 1927.
- 1,628,411—SYSTEM OF SECRET WIRELESS TELEPHONY—F. W. KRANZ, of Geneva, Ill. Filed Feb. 1, 1923, issued May 10, 1927.
- 1,628,466—ELECTRON DEVICE AND METHOD OF OPERATING—A. W. HULL, of Schenectady, N. Y. Filed Nov. 15, 1921, issued May 10, 1927. Assigned to General Electric Co.
- 1,628,627—ELECTRICAL STRUCTURE—WM. DUBILIER, of New York, N. Y. Filed June 30, 1923, issued May 10, 1927. Assigned to Dubilier Condenser Corp.
- 1,628,648—RADIO TELEGRAPHIC STATION—J. BETHENOD, of Paris, France. Filed Aug. 2, 1921, issued May 17, 1927.
- 1,628,659—ELECTRICAL CONDENSER—C. S. FRANKLIN, of London, England. Filed June 21, 1921, issued May 17, 1927. Assigned to Radio Corp. of America.
- 1,628,676—RECEIVING ARRANGEMENT FOR WIRELESS TELEGRAPHY—A. MEISSNER, of Berlin, Germany. Filed Sept. 3, 1921, issued May 17, 1927. Assigned to Gesellschaft Fur Drahtlose Telegraphie M. B. H.
- 1,628,982—ELECTRON DISCHARGE DEVICE—R. I. HULSIZER, of East Orange, N. J. Filed May 28, 1921, issued May 17, 1927. Assigned to Western Electric Co.
- 1,628,905—WIRELESS TELEPHONE SYSTEM—A. NYMAN, of Wilkinsburg, Pa. Filed Sept. 2, 1921, issued May 17, 1927. Assigned to Westinghouse Electric & Mfg. Co.
- 1,628,987—THERMIONIC DEVICE AND METHOD OF EVACUATING THE SAME—R. W. KING, of New York, N. Y. Filed Sept. 24, 1920, issued May 17, 1927. Assigned to Western Electric Co.
- 1,628,999—ELECTRON DISCHARGE DEVICE—V. L. RONCI, of Brooklyn, N. Y. Filed Dec. 19, 1924, issued May 17, 1927. Assigned to Western Electric Co., Inc.
- 1,629,001—OSCILLATION GENERATOR—J. C. SCHELLENG, of East Orange, N. J. Filed Sept. 18, 1923, issued May 17, 1927. Assigned to Western Electric Co., Inc.
- 1,629,009—LOW IMPEDANCE ELECTRIC DISCHARGE DEVICE—H. C. SNOOK, of South Orange, N. J. Filed Aug. 7, 1920, issued May 17, 1927. Assigned to Western Electric Co. Inc.
- 1,629,020—CONDENSER—E. B. CRAFT, of Hackensack, N. J. Filed Sept. 6, 1922, issued May 17, 1927. Assigned to Western Electric Co.
- 1,629,337—RADIO FIRE ALARM SYSTEM—H. GARRETT, of Dallas, Texas. Filed Oct. 14, 1925, issued May 17, 1927.
- 1,629,171—ELECTRON DISCHARGE DEVICE—A. MAVROGENIS, of Milwaukee, Wis. Filed Sept. 16, 1926, issued May 17, 1927.

## GEOGRAPHICAL LOCATION OF MEMBERS ELECTED JUNE 1, 1927

	Transferred to Fellow Grade	
Dist. of Columbia,	Washington .....	Hund, August
	Transferred to Member Grade	
Massachusetts,	E. Springfield .....	Laport, E. A.
Canada,	Montreal, c/o Radio La Presse, .....	Spencer, L.
	Elected to Member Grade	
Canada,	Toronto, Hydro Elec. Power Comm. ..	Dalton, F. K.
England,	Liverpool, 76 Old Hall Street, .....	Lyons, C. L.
	Associates Elected	
Alabama,	Pratt City, 58 Vine St. ....	Hassler, W. D.
Arizona,	Jerome, Box 726 .....	Rutherford, R. L.
California,	Fresno, P. O. Box 726 .....	Wells, Frank T.
	Hollywood, 6533 Hollywood Blvd. ....	Drury, Paul O.
	Long Beach, 216 Grand, Apt. A. ....	Lanphere, Merle
	Los Angeles, 1707 So. Flower .....	Baker, Lewis C.
	Los Angeles, 2718 Moss Ave. ....	Kemper, Guy A.
	Los Angeles, 5120 So. Wilton Place ..	Rusthol, H. W.
	Los Angeles, 331 S. Mariposa Ave. ....	Vauchelet, B. F.
	Los Angeles, 5753 8th Ave. ....	Walling, H. S.
	Los Angeles, 1020 Santa Fe Ave. ....	Woods, Edw. J.
	Oakland, 5835 College Ave. ....	Burchard, Bruce M.
	Riverside, 309 Lime St. ....	Chapman, C. W., Jr.
	Riverside, 176 Riverside Drive .....	West, Lloyd E.
	San Francisco, 140 New Montgomery St. ....	Parker, Ray H.
	San Francisco, 1869 Stockton St. ....	Stagnaro, John A.
	Whittier, 410 N. Milton .....	Brown, Wilbur C.
	Whittier, Box 103, .....	Mendeck, Fred C.
Connecticut,	Torrington, 150 Oak Ave. ....	York, P. J.
Florida,	Miami, 56 S. E. First St. ....	Durante, J. A.
	St. Augustine, 10 Sevilla St. ....	McCallum, F. L.
	Tampa, 339 Plant Ave. ....	Moore, Wm. P.
Georgia,	Atlanta, 102 West Peachtree St. ....	Alexander, D. C.
	Atlanta, 963 Ponce de Leon .....	Anderson, L. E.
	Atlanta, 533 Boulevard Place, N. E. ...	Bayliss, V. B.
	Atlanta, 413 6th St., N. E. ....	Bristol, T. R.
	Atlanta, 690 Piedmont Ave., N. E. ....	Cook, J. M.
	Atlanta, 902 Georgia Savings Bank Bldg. ....	Cota, John J.
	Atlanta, Station WSB, Atlanta Journal ..	Daugherty, C. F.
	Atlanta, 1010 E. Shadow Lawn Ave., ...	Dendy, G. R.
	Atlanta, 69 Mangum St., S. W. ....	Foote, James J.
	Atlanta, 123 Spring St., .....	Hill, Arthur M.
	Atlanta, 843 N. Boulevard, .....	Kay, Lambdin
	Atlanta, A. T. & T., Hurt Bldg., .....	Keith, John M.
	Atlanta, 524 Post Office Bldg. ....	Llewellyn, Geo.
	Atlanta, 16 Auburn Ave. ....	Lyon, D. F.
	Atlanta, 8 Peachtree Way .....	MacMillan, R. H.
	Atlanta, 1765 N. Decatur Road .....	Morris, Jas. S.
	Atlanta, 12 Walton St. ....	Mosteller, M. O.
	Atlanta, 902 Flatiron Bldg. ....	Murphy, Brower
	Chambler, 8th & Jackson Sts. ....	Mindenhall, W. W.
	East Point, 423 E. Washington Ave. ....	Jones, J. C.
Illinois,	Chicago, 1662 Clifton Park Ave. ....	Goldman, Stanley
	Chicago, 7526 Robey St. ....	Mooney, Raymond
	Oak Park, 1526 N. Austin Blvd. ....	Witt, Harold A.
Iowa,	Dubuque, care General Delivery .....	Roedell, L. W. F.
	Muscatine, 919 Iowa Ave. ....	Wildman, Thos. S.
Kansas,	Great Bend, 1612 Murphy St. ....	Mitchell, Theo. R.
Kentucky,	Bypro, .....	McGeorge, D. H.
	Louisville, P. O. Box 855 .....	Berry, Robt. C.
Louisiana,	New Orleans, 841 Carondelet St. ....	Andres, Chas. Jr.

Maine,	Belfast, Box 296	Leighley, H. M.
Maryland,	Cumberland, 504 Fifth St.	Sweitzer, Guy H.
Massachusetts,	Arlington, 12 Harvard St.	Pristas, John E.
	Beverly, 132 Dodge St.	Colby, Edw. B.
	Medford, 51 Central Ave.	Wyman, R. C.
Michigan,	Detroit, 5526 3rd St.	Alguire, L. W.
	Detroit, 5711 Wabash Ave.	Cash, Geo. B.
	Detroit, Station WAFD, Addison Hotel	Lathrop, Fred A.
Missouri,	St. Joseph, 1810 Crescent Drive,	Abercrombie, J. B.
	St. Louis, 203 Pine St.	Croxton, G. B.
Nebraska,	Sidney, 307 Central Ave.	Houge, Chas. A.
New Hampshire,	Manchester, 47 Amherst St.	Ryan, M. John
New Jersey	Camden, Victor Talking Mach. Co.	Gray, J. Calvin
	Elizabeth, Box 81 RFD No. 2	Hohner, John
	Fanwood, North Ave.	Hall, C. A.
	Fanwood,	Todd, Harold C.
	Ridgewood, 51 Highwood Ave.	Boyce, W. R. Jr.
New York,	Albany, 140 Grove Ave.	Thomas, J. D.
	Arvene (L. I.), 6603 Blvd.	Gradinger, Archie
	Brooklyn, 1831 East 34th St.	Gruetzke, C. P. E.
	Brooklyn, 21 Vermont Ave.	Kent, C. W., Jr.
	Brooklyn, 2021 East 13th St.	McLaughlin, C. E.
	Brooklyn, 3523 Bedford Ave.	Siegel, Ralph
	Brooklyn, 5007 Sixth Ave.	Slepian, Edward
	Buffalo, 110 Waverly St.	Clark, Chas. W.
	Buffalo, 98 Cayuga St.	Hedtke, Edward
	Hamilton, Box 31, Colgate University	Dowd, Alfred
	Lynbrook (L. I.) 4 Atlantic Ave.	Seidler, A.
	Mount Vernon, 14 North 9th Ave.	Dickely, Fred C.
	New York, 461 East 8th Ave.	Campbell, J. A.
	New York, Radio Inspector, Sub-Trea- sury Bldg.	Cochran, E. C.
	New York, care Postmaster, USS Wor- den	Colvin, Ruel
	New York, 16 Arden St.	Fernandez, Edw.
	New York, 124 West 42nd St.	Heuschkel, Paul J.
	New York, 785 Home St.	Jablon, W. W.
	New York, 113 West 57th St.	LeRoy, Frank S.
	New York, 224 West 13th St.	Taylor, Jay L.
	Ozone Park (L. I.), 8605 95th Ave.	Weilminster, Chas.
	Richmond Hill (L. I.), 9419 127th St.	Dowd, W. A.
	Rochester, 238 S. Goodman St.	Erhart, V. J.
	Rochester, 762 Bay St.	Friedler, D. P.
Ohio,	Cleveland, 2108 East 96th St.	Sherman, K. S.
	Cleveland, Radio Station WHK	Smith, S. E.
Oregon,	Portland, 109 East 42nd	La Salle-Dilley, L.
	Reedsport, Box S. P.	White, F. I.
Pennsylvania,	Oil City, 122 Washington Ave.	Hahn, S. L.
	Philadelphia, 1533 Pine St.	Keyser, Chas. S.
	Philadelphia, 1533 Pine St.	McClair, R.
	Philadelphia, 4223 Osage Ave.	Waltz, W. W.
	Philadelphia, 5010 Catherine St.	Yost, John C.
Texas,	Ft. Worth, 1601 Enderly Place	Abey, Robt. E.
	San Antonio, 1025 South Presa St.	Wall, L. D.
Washington,	Long View, P. O. Box 5, 466 19th Ave.	Trotter, C. A.
	Seattle, 116 Fairview Ave.	Ackerley, James
	Seattle, 703 25th Ave., N. W.	Blom, R. J.
	Seattle, 7708 Latona Ave.	Brandt, O. T. D.
	Seattle, 2049 E. Newton St.	Burleigh, John A.
	Seattle, 903 Telephone Bldg.	Eaden, Neal
	Seattle, 818 East 62nd St.	Flagler, R. H.
	Seattle, 903 Telephone Bldg.	Smith, Oliver C.
West Virginia,	Chester, 325 3rd St.	Faudree, R. F.
Wisconsin,	Milwaukee, 1460 Eighth Ave.	Kazmierowski, J. J.
Canal Zone,	Balboa, Box 35	Young, J. W.
Canada,	Nova Scotia, Halifax, 158 Granville St.	Baldwin, G. H.
	Nova Scotia, Halifax, USS Tampa	O'Day, Arthur C.
	Ontario, Westhill, Station CJYC	Carment, J. M.
China,	HMS Hermes, China Station	Marshall, J. A.
Cuba,	Tuinucu,	Jones, Frank H.
England	Lincs., Skegness, Beam Radio Station	Towers, Robt.
Ireland,	Waterford City, No. 21 Shortcourse	Dunphy, Thos. O.
Mexico,	Mexico City, Jor Juana 119,	Veramendi, M.
	Tampico, Apartado 150	Cordova, F. B.

Porto Rico,	Ensenada, .....	Schell, R. Jr.
S. W. Africa,	Walvis Bay, Radio Station .....	Fitzgibbon, M. B.
Spain,	Madrid, Mejia Lequerica 4 .....	Moya, Miguel

## Juniors Elected

California	Fresno, 1495 N. Van Ness Ave. ....	McKay, W. K.
	San Francisco, 790 Oak St. ....	Sphar, C. H.
Illinois,	Chicago, 7327 Phillips Ave. ....	Armstrong, H. W.
	Chicago, 1631 West 14th St. ....	Cohen, Theo.
	Deerfield, Radio Station WHT .....	Birkenhead, W. D.
	Rock Island, 1615 29½ St. ....	Foley, Jack
Massachusetts,	Boston, Jamaica Plains, 24 Beaufort	
	Rd. ....	Goodrich, R. R.
	Winthrop, 88 Circuit Rd. ....	Colton, H. C.
New York,	Huntington Station (L. I.) .....	Flathman, Edw.
	New York, 100 318 W. 57th St. ....	Backlund, L. R.
	New York, 1075 Home St. ....	Rosenberg, I.
Pennsylvania,	Philadelphia, 5135 N. Fairhill St. ....	Mevius, John C.
	Zelienople, 302 E. New Castle St. ....	Bassler, S. G.
Texas,	Laredo, 216 Matamoros St. ....	Otal, Carlos, Jr.
Washington,	Everett, 2119 McDougal Ave. ....	Sands, L. G.
Canada,	Quebec, Montreal, 6 Delormier Ave. .	Forward, Willis
	Quebec, Montreal, Bank of Montreal ..	Irving, E.
	Ontario, Sarnia, 430 S. Brock St. ....	Hunter, Alex.
	Ontario, Beamsville, RR No. 3 .....	Potter, Robt. C.





*Robison's Manual of*  
**Radio Telegraphy  
and Telephony**

7th EDITION (*Just Revised*)

*Price reduced! (740 pages texts and illustrations)*

THE LAST EDITION selling for \$8.00 had such an excellent sale all over the world that it was quickly exhausted, and this edition, just off the press and thoroughly up to date, now sells for \$5.50 postpaid.

Of the former edition, the official magazine of the American Relay League, *Q S T*, said "it was perhaps the best radio book that ever came to this desk."

This manual first appeared in 1907, the author being Lieutenant (recently Admiral and Commander-in-Chief, U. S. Fleet) S. S. Robison, U. S. Navy.

This and the former edition were revised by Commander S. C. Hooper, U. S. N., late Radio Officer of the United States Fleet.

*Price only \$5.50 postpaid.*

*Address:* SECRETARY-TREASURER  
*U. S. Naval Institute*  
ANNAPOLIS, MD., U. S. A.

---

# Voltage Measurements at Radio Frequencies

**F**OR the measurement of A. C. voltages at high frequency Weston has developed a Thermo-Couple Voltmeter having full scale values ranging from 1 to 25 volts. This voltmeter, known as Model 492, has an accuracy of  $\frac{1}{4}$  of 1% at 600 kilocycles;  $\frac{3}{4}$  of 1% at 1,000 kilocycles and 1.5% at 1,500 kilocycles. This instrument can also be used at higher frequencies up to 3,000 kilocycles with somewhat lower accuracy.

It is a portable type voltmeter enclosed in a hardwood carrying case. Its movement and thermocouple are symmetrically located between two metal shields, but insulated from each other.

Model 492 is an invaluable instrument to the laboratory or research engineer for measuring A. C. voltages at high frequency.

Write us for complete information.

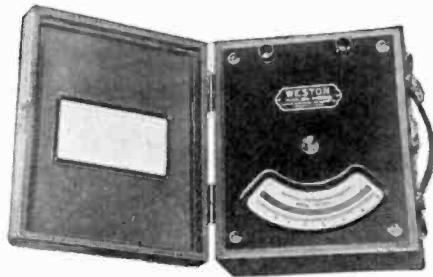

WESTON ELECTRICAL INSTRUMENT CORPORATION  
73 Weston Avenue, Newark, N. J.



STANDARD THE WORLD OVER

**WESTON**

*Pioneers since 1888*



It will be of mutual benefit to mention Proceedings in writing to advertisers



# COSTS

---

◆ CUTTING MANUFACTURING COSTS ◆

---

# COSTS



## COSTS

How to increase volume of output without tying up capital in plants and machinery is an ever-present problem with many manufacturers. Here is an easy solution. Bring your problems to Scovill. Scovill has great factories fully prepared with modern machinery, laboratories, designers and skilled workmen to turn out quantity production of parts or finished products of metal. Scovill can become your factory for all practical purposes almost overnight. Scovill service organizations are located advantageously from coast to coast. To know how Scovill can serve you, get in touch with the nearest Scovill office.

---

## A SCOVILL SERVICE

---

### THESE ARE SCOVILL PRODUCTS

*Made to Order:* Condensers—Variable and Variable Vernier and parts for same, Metal Stampings, Screw Machine Products, Switches, Decorated Metal Radio Panels, Parts from Brass, Steel and Aluminum.

*Carried in Stock:* Butts and Hinges, Continuous Hinges, Machine Screws. *Brass Mill Products:* Sheet, rod, wire, tubing.

**SCOVILL MANUFACTURING COMPANY**  
Waterbury Connecticut

New York, Boston, Chicago, Providence, Philadelphia, Cleveland,  
San Francisco, Los Angeles, Atlanta, Cincinnati, Detroit

*Member, Copper and Brass Research Association*



SILVER-MARSHALL  
652 RESERVOIR B SUPPLY

Uses Vitrohm Resistor 507-64

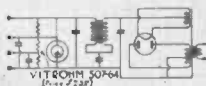

### RAYTHEON A-B-C

350 m.a. CURRENT SUPPLY UNIT

Uses Vitrohm Resistor 507-62  
and Vitrohm Rheostat 507-63

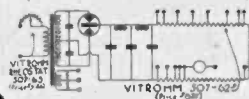

### QRS A-B-C

400 m.a. CURRENT SUPPLY UNIT

Uses Vitrohm Resistor 507-62  
and Vitrohm Rheostat 507-63

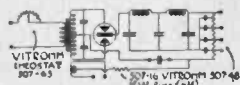
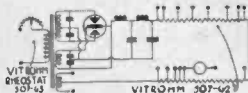

### QRS and RAYTHEON

85 m.a. CURRENT SUPPLY UNIT

Uses Vitrohm Resistors  
507-16 and 507-48

**Vitrohms** are "pre-aged" wire wound on porcelain tubes and protected by fused-on vitreous enamel for the permanent protection of resistance wire and terminals.

Per square inch of surface, Vitrohms have greater watt dissipation than any other resistor.

Send 15c for "How To Use Resistance in Radio." It contains many circuits of interest to all experimenters. Bulletin 507 describing Vitrohms for radio is sent without charge upon request.

Approved by the Raytheon and QRS Laboratories.

**Ward Leonard Electric Company**  
37 41 South Street  
Mount Vernon, N. Y.

# VITROHM RESISTORS

## —in power supply units

35 years of research and experience in the manufacture of resistors is incorporated in Vitrohms for radio.

There are available Vitrohms to give you noiseless, dependable service wherever resistance is indicated in a current or power supply circuit.

Vitrohms do not age or change in resistance value after use. Ten, twenty or thirty years of constant use under all conditions are every-day records of Vitrohms.

It will be of mutual benefit to mention Proceedings in writing to advertisers

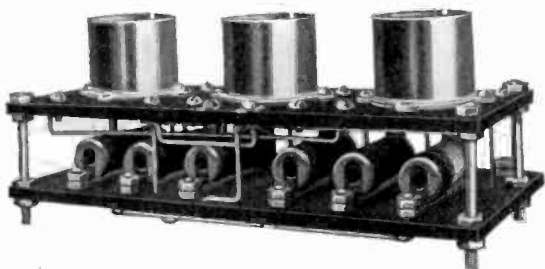

## Resistance coupled amplification

still has charms for the engineer—and rightly. A power tube such as the UX210 does wonders with transformers, but imagine the improvement with resistance coupling.

Resistance coupled amplifier for  
high Mu tubes and power tube . \$30.00

Resistance coupled amplifier for  
201-A's ..... \$20.00

Hi Mu Tubes (Mu 40) ..... \$ 2.25

We supply broadcasting stations with sets of resistances for gain controls in the speech amplifiers.

## Cresradio Corporation

166-32 Jamaica Ave. Jamaica, N. Y.

**CRESCENT  
LAVITE  
RESISTANCES**

It will be of mutual benefit to mention Proceedings in writing to advertisers

# PROFESSIONAL ENGINEERING DIRECTORY

For Consultants in Radio and Allied Engineering Fields

## The J. G. White Engineering Corporation

Engineers—Constructors

Builders of New York Radio Central  
Industrial, Steam Power and  
Gas Plants, Steam and Elec-  
tric Railroads, Transmission  
Systems.

43 Exchange Place New York

## Electrical Testing Laboratories

Electrical, Photometrical,  
Chemical and Mechanical  
Laboratories

### RADIO DEPARTMENT

80th St., and East End Ave.,  
New York, N. Y.

John Minton I. G. Maloff  
JOHN MINTON, Ph. D.  
CONSULTING ENGINEER

for  
Developing — Designing —  
Manufacturing  
of

Radio Receivers, Amplifiers,  
Transformers, Rectifiers, Sound  
Recording and Reproducing ap-  
paratus.

Radio and Electro-Acoustical  
Laboratory

8 CHURCH ST. WHITE PLAINS, N. Y.

## Man Wanted

with experience in exhausting of  
vacuum tubes, to take charge of  
approximately 15 trolley exhaust  
positions, also experienced in  
maintenance and operation of  
pumps. Apply by letter giving  
full details as to age, experience,  
salary desired, and when avail-  
able.

ADDRESS BOX 215

Institute of Radio Engineers

## Free Radio Employment Service

Employers in any line of the  
Radio industry (or in allied in-  
dustries) should call on our Free  
Radio Employment Service when  
additional employees are needed.  
Thoroughly trained, experienced  
men supplied anywhere in the U. S.  
or Canada on 48 hours notice. No  
charge for service. Send post card  
today for our free monthly bulletin.  
Address National Radio Institute,  
Dept. T. R. E., Washington, D. C.

## Vacuum Tube Engineer

with eight years experience in  
research and production of all  
types of receiving tubes, avail-  
able for a new connection. Can  
produce a superior coated fila-  
ment. Thoroughly experienced in  
latest methods of exhaust. Has  
enviable record of cost reduc-  
tions by increasing material and  
labor efficiencies, and successful  
equipment designs.

ADDRESS BOX 360

Institute of Radio Engineers

## Q R V RADIO SERVICE, Inc.

JOHN S. DUNHAM  
J. F. B. MEACHAM

DEVOTED TO SERVICING  
BROADCAST RECEIVERS  
EXCLUSIVELY

1400 BROADWAY, NEW YORK  
WISCONSIN 9780

## J. E. JENKINS & S. E. ADAIR ENGINEERS

Broadcasting Equipment  
General Radio Telephone  
Engineering

1500 N. DEARBORN PARKWAY  
CHICAGO, ILLINOIS

## Four Finishes

Ebony is a lustrous black finish. Walnut Burl, Walnut Grain and Mahogany finishes very closely resemble a polished panel of the natural wood.

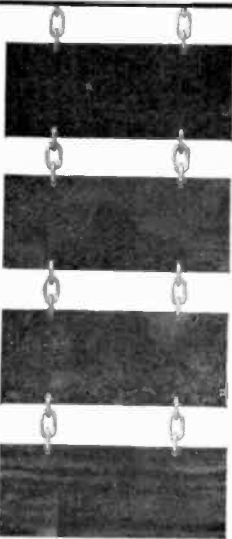
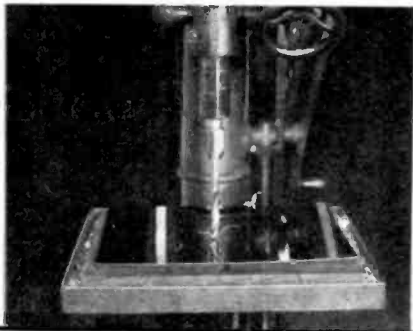

## Cuts *without* Chipping

**A**S the drill sinks into the Micarta panel, it throws up a smooth curl and bores a clean hole without a sign of a chipped edge.

All machining is easy when Micarta is the panel material used. Micarta is smooth, tough, and hard—but not brittle. Sawing, drilling, planing, engraving, or even punching makes a clean cut without shattering the satin-like surface of the Micarta panel.

Workmanship put into Micarta is permanent. Micarta is unaffected by oil, water, or temperature changes. It is not inflammable. It will not shrink, warp, "cold flow" nor crack. Micarta is the permanent panel material.

Westinghouse Electric & Manufacturing Company  
East Pittsburgh, Pennsylvania  
Sole Offices in All Principal Cities of  
the United States and Foreign Countries

# Westinghouse



**MICARTA** The Permanent Panel Material

It will be of mutual benefit to mention Proceedings in writing to advertisers

# CARTER

New  
Complete line of  
Fixed Condensers

*Not affected by climatic conditions*  
*Moisture-proof*  
*Accurate*

**Molded Mica Condensers**  
**By-Pass & Filter Condensers**  
**Buffer Condensers**

This new line of condensers was brought out as soon as we were convinced they were an improvement over existing types.

Greater accuracy has been obtained by new manufacturing methods. Tests have shown that these condensers are not only made accurately but stay accurate after months of use.

We shall be glad to send you complete information, capacities, etc.

IN CANADA: CARTER RADIO CO., LIMITED, TORONTO

Offices in Principal Cities of the World



MEMBER  
**RMA**

It will be of mutual benefit to mention Proceedings in writing to advertisers



# DUDLO

MAGNET WIRE AND WINDINGS

## No Production Delays

*---if you make this  
your coil department*

Radio profits depend largely on adequate deliveries during the rush months. The manufacturer or dealer who finds himself disappointed in deliveries when fall business opens up, also finds it too late to make new connections.

The regular users of Dudlo wire and coils are insured against such disappointments. Enormous volume and large facilities permit Dudlo to absorb the peak demand of the radio trade without delay, confusion or high-pressure production methods.

Not only are Dudlo products of superior quality, but the seasonal demand of any one industry cannot cause any lowering of Dudlo standards of manufacture, supervision or inspection.



**DUDLO MANUFACTURING CORPORATION**

56 Earl Street, Newark, N. J.  
274 Brannan St., San Francisco, Calif.

**FORT WAYNE, IND.**

160 North La Salle St., Chicago, Ill.  
4153 Bingham Ave., St. Louis, Mo.

It will be of mutual benefit to mention Proceedings in writing to advertisers

*Always specify—*  
“ESCO” Maximum miles per watt  
Power supplies for transmission.

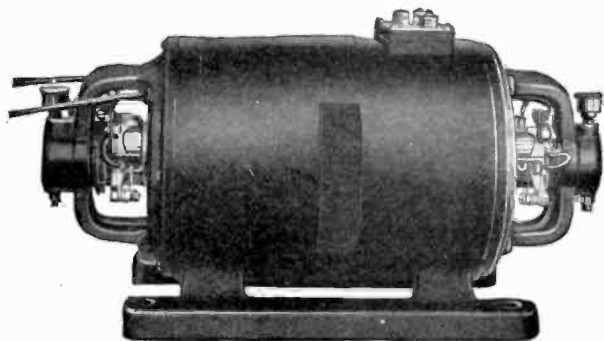

“ESCO” has developed a line of over 100 standard 2-bearing Motor-generators for plate or filament. These include D.C., A.C., single phase and polyphase motors.

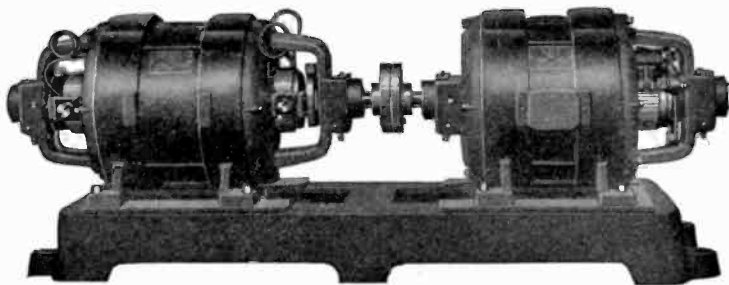

“ESCO” two and three unit sets have become the accepted standards for transmission. The “ESCO” line consists of over 200 combinations. These are covered by Bulletin 237C.

Our engineers are always willing to cooperate in the development of special sets.

“ESCO” is the pioneer in designing, developing and producing Generators, Motor-Generators, Dynamotors and Rotary Converters for all Radio purposes.



HOW CAN “ESCO” SERVE YOU?  
ELECTRIC SPECIALTY COMPANY

TRADE “ESCO” MARK



300 South Street

Stamford, Conn.

It will be of mutual benefit to mention Proceedings in writing to advertisers

XVIII

# *Farrand*

---

# B

---

## ELIMINATOR

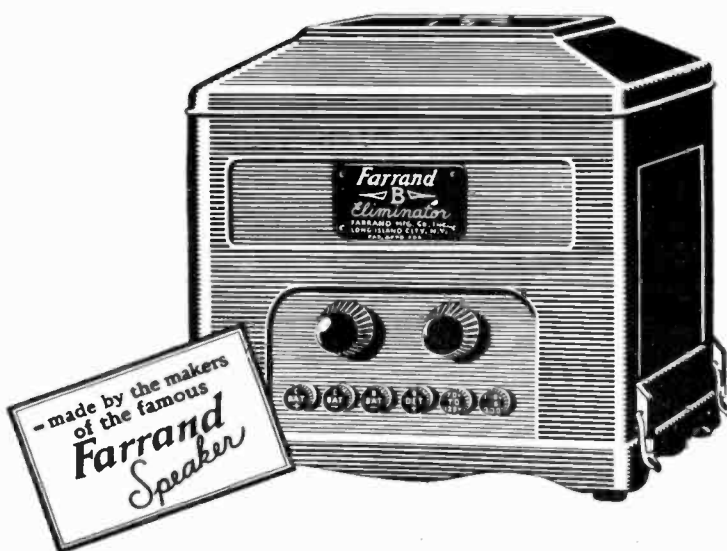

## KNOWN QUALITY

It will be of mutual benefit to mention Proceedings in writing to advertisers

# TOBE

TRADE MARK REG'D U. S. PAT. OFFICE

## B BLOCKS



Are condenser banks of various combinations of values and for different working voltages, for use in the filter-circuits of plate-power supplies for radio-receivers and amplifiers. They are made of TOBE Condensers and the name B-BLOCK is copyrighted.

TOBE B-BLOCKS are standard for home construction of most of the popular B-Power Supplies and Power-Packs. They are furnished on special order to meet any specifications and will be found in leading factory made units. Quotations will be promptly furnished.

**Tobe Deutschmann Co.**  
Cambridge - - - Mass.

*Condensers for all usual working voltages  
TinyTobe Condensers*

*Veritas 2, 5, and 10 watt non-inductive high current Resistors*

**Write us for pamphlet 0-7**

---

# The latest Kolster developments



### Kolster Power Cone Speaker

High-lighted, pencil-striped walnut cabinet, with cathedral grill. Faithful, realistic reproduction, at any degree of volume. Built-in "B" supply for the set. Equipped with 20-foot cable.

Height—42 in. Width—25½ in.  
Depth—19 in.

**The New Model 6H**  
The ultimate set—Kolster Radio 6H. This unusually attractive cabinet of high-lighted stump walnut includes a Kolster 6-tube single control radio and—the new Kolster Power Cone Reproducer with built-in "B" supply for set.

Height—53½ in. Width—27 in.  
Depth—18½ inches



The Kolster Radio Compass, the use of which permits the safe navigation of vessels during thick or foggy weather, is also manufactured by this company.

## FEDERAL-BRANDES, INC.

200 Mt. Pleasant Avenue  
Newark, N. J.

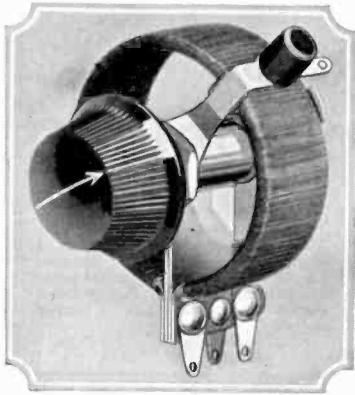

*Greater Efficiency  
and Economy*

*in*

## “B” Eliminator Resistances

**T**HE new Centralab 4th Terminal Potentiometers have two variable contact arms on each unit. Two of these units in series will provide complete voltage regulation for any “B” power supply without additional fixed resistors or variables. One additional unit will provide two “C” bias taps when desired. The economy is apparent in that there are fewer units to buy, and less assembly time to mount them on the panel.

Centralab 4th Terminal Potentiometers are wire wound on a frame of metal and asbestos. They will safely dissipate in excess of 30 watts without break down. This high current carrying capacity makes possible a low total resistance across the “B” supply, giving much better voltage regulation than the high resistances normally used, and sufficient current load on open circuit, to substantially lessen the danger of condenser break down.

Fourth Terminal Potentiometers are wire wound in resistance values up to 6000 ohms. The diameter is 2", depth  $\frac{3}{4}$ ". They are recommended as the best and most economical of available “B” power voltage controls.

Where smaller units must be used because of small panel space, there are other Centralab wire wound potentiometers with diameters of  $1\frac{5}{8}$ " and  $1\frac{3}{8}$ " respectively that can be furnished in resistances up to 20,000 ohms, and variable high resistances up to 500,000 ohms.

*Complete information and circuit data  
will be gladly mailed to those interested.*

**Central Radio Laboratories**

16 Keefe Avenue

Milwaukee, Wisconsin

---

**Centralab**

---

It will be of mutual benefit to mention Proceedings in writing to advertisers

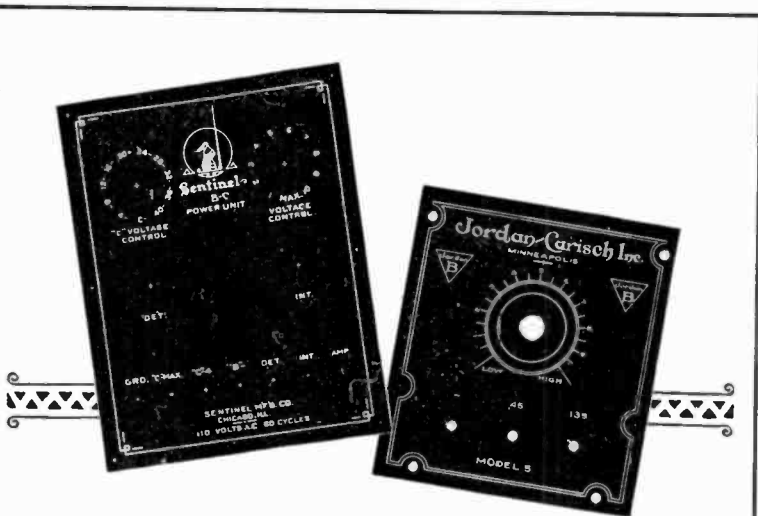

## Veri Chrome Decorated Formica Panels

Formica panels in Black or Wood Finishes with scales printed and terminal identifications marked in gold are very handsome. They give a unit a high-grade appearance and make sales easier.

These are being used on many A, B and C Eliminators on testing instruments of various kinds and, of course, on the radio set itself. Many terminal strips are also being decorated in this way.

*Send your drawings for quotations.*

### The Formica Insulation Company

4646 Spring Grove Avenue

Cincinnati, Ohio

Hear the FOR-  
MICA Orchestra  
Tuesday 9 to 10  
over WLW

**FORMICA**  
Made from Anhydrous Bakelite Resins  
**SHEETS TUBES RODS**

Formica has a  
Complete Ser-  
vice on Insulat-  
ing Material for  
Radio Manufac-  
turers

It will be of mutual benefit to mention Proceedings in writing to advertisers

---

# SM

# UNIPAC

*for Power*

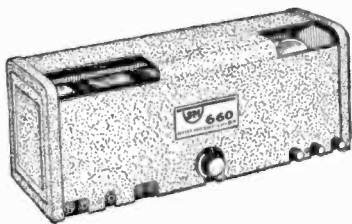

The Silver-Marshall laboratories now offer a series of power packs absolutely without comparison. Type 66-210 Unipac, a push-pull amplifier using two UX-210 tubes, will deliver 4 to 5 watts undistorted power output—from 100 to 300 times more power than a 201-A tube, or from 4 to 17 times more power than average 210 power packs. Type 660-171 Unipac, with two 171 tubes will deliver equal or greater power than average 210 packs at far lower cost!



There is a Unipac for every need, from the most powerful receiving amplifier ever developed down to a lower power 171 power pack. There are models for phonograph amplification, turning any old phonograph in a new electric type actually superior to commercial models costing from five hundred to several thousand dollars. And every Unipac, operating entirely from the light socket, supplies receiver "B" voltage as well.



## SILVER-MARSHALL, Inc.

846 West Jackson Blvd.

Chicago, U. S. A.

It will be of mutual benefit to mention Proceedings in writing to advertisers





## Transformers FOR THE NEW A·C·TUBES

**W**E INVITE INQUIRIES from manufacturers of sets and accessories who are working on the problem of alternating current operation of their new models & *The Thordarson* factory is equipped to make prompt shipments of "Made-to-order" transformers for every radio need & & & &

All manufacturing is done in our own factory - coil winding and impregnating - core stamping - all tool and die work - assembly - enameling - engineering, design and testing - There are no external delays to hold up shipments & & &

*Our price and delivery is right!*

# THORDARSON RADIO

*Supreme in Musical Performance*  
**TRANSFORMERS**

**THORDARSON ELECTRIC MANUFACTURING CO.**  
*Transformer specialists since 1895*  
**WORLD'S OLDEST AND LARGEST EXCLUSIVE TRANSFORMER MAKERS**  
**Chicago, U.S.A.**

---

# Quickly Covers Full Audio Range



Type 413

## Beat Frequency Oscillator Range 15---9,000 Cycles

In the testing of audio frequency devices some form of oscillator is required. Speed in measurement requires that the frequency be varied by means of a single control.

In the Type 413 Oscillator the single control feature is made possible by use of the beat frequency between two high frequency oscillators.

The Type 413 Oscillator is particularly adapted to loudspeaker measurements.

Type 413 Oscillator ..... Price \$210.00

*Write for Complete Laboratory Catalog P*

**General Radio Co., Cambridge, Mass.**

*Manufacturers of Radio and Electrical Laboratory Apparatus*

# GENERAL RADIO

## LABORATORY STANDARDS

---