

VOLUME 12

JUNE, 1924

NUMBER 3

PROCEEDINGS  
*of*  
The Institute of Radio  
Engineers



EDITED BY  
ALFRED N. GOLDSMITH, Ph.D.

PUBLISHED EVERY TWO MONTHS BY  
THE INSTITUTE OF RADIO ENGINEERS  
37 West 39th Street, New York, N. Y.

Subscription \$9.00 per Annum in the United States  
\$9.60 in all other Countries

GENERAL INFORMATION AND SUBSCRIPTION RATES ON PAGE 225

Entered as second-class matter, February 16, 1916, at the Post-Office, at New York, N. Y., under the Act of March 3, 1879.

Acceptance for mailing at special rate of postage provided for in Section 1103, Act of October 3, 1917, authorized October 7, 1918.

# Cunningham

## RADIO TUBES



### THE IDEAL TUBE FOR VACATION TIME

At the seashore—in one of our great national parks or while motoring you will find the Cunningham Dry Battery Detector and Amplifier, Type C-299, the Ideal Tube for your portable receiving set.

The special filament of this tube having a current so low that it may receive its supply from standard No. 6 Dry batteries or even from ordinary flashlight batteries, makes possible this entertaining application of Radio in places far remote.

**Cunningham C-299 Detector and Amplifier Tube**

C-299 3 volts .06 amp. Dry Battery Detector and Amplifier ..... \$5.00

**Other Cunningham Radio Tubes**

C-301A—6 Volts 1-4 amp. Amplifier..... \$5.00

C-300—6 Volts Gas Content Detector..... \$5.00

C-11—1.1 Volts .25 amp. Dry Battery Detector and Amplifier.

Special Base..... \$5.00

C-12—Similar to C-11 with standard base..... \$5.00

**Patent Notice:** Cunningham tubes

are covered by patents dated 2-18-08, 2-18-12, 12-30-13,

10-23-17, 10-23-17 and others issued

and pending. Licensed for amateur,

experimental and entertainment use in

radio communication. Any other use

will be an infringement.

Cunningham 40-page Data Book

fully explaining care and operation of

Radio Tubes now available by sending

10c in stamps to San Francisco office.

*A. J. Cunningham Inc.*

Home Office:

Branch 182 Second St. Branch  
Chicago San Francisco New York

# *Faradon*

**FOR SERVICE**

## **RADIO CONDENSERS**

---

**Constant Capacity  
Extremely Low Losses  
Safety Gap Protection  
High Current Carrying Capacity  
Minimum Volume  
Moisture-Proof Construction  
Long Life  
Quick Deliveries**

These are some of the reasons why radio engineers specify FARADONS.

There are over 200 standard FARADON condensers on which immediate deliveries can be made. Complete new catalog will be sent on request.

**Wireless Specialty Apparatus Company**  
**BOSTON, MASS.**

*Established 1907*



## LOOK ON PAGE 5

of new ROLLER-SMITH Bulletin K-10 and you will find a *new instrument* that will be of interest to every owner of a radio set—transmitting or receiving—and every maker of radio sets.

There is a lot of other interesting information in this little radio instrument manual.

A copy is yours for the asking.

*Send for Bulletin K-10*

## ROLLER-SMITH COMPANY

Electrical Instruments, Meters and Circuit Breakers

MAIN OFFICE:  
2134 Woolworth Bldg., NEW YORK



WORKS:  
Bethlehem, Pennsylvania

*Offices in Principal Cities in U. S. and Canada*

## ACME TRANSFORMERS

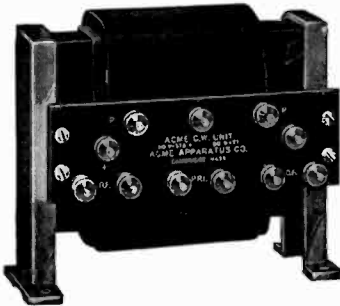

As specialists in the design and construction of Transformers we are prepared to quote prices and delivery on Transformers singly or in quantity.

Our Radio Transformers are well known for their high efficiency and ruggedness.

## ACME APPARATUS COMPANY

200 MASSACHUSETTS AVENUE  
CAMBRIDGE 39, MASS.

TRANSFORMER AND RADIO ENGINEERS AND MANUFACTURERS

*Constant Impedance*  
**AUDIBILITY METER**



**Type 164**

**AUDIBILITY  
METER**

**Price, \$36**

The ear alone cannot be depended upon to estimate the intensity of received signal strength. Some auxiliary standard of reference must be used.

One of the more common methods is to shunt the telephone receivers. As the receivers are shunted, however, a series resistance of such a value should be added to the circuit that the impedance will remain unchanged.

The Type 164 Audibility Meter is so designed that it is direct reading in audibilities, and keeps the total impedance of the circuit practically constant.

Do not guess at your receiving results. Know the real facts.

*Send for Bulletin R*

**GENERAL RADIO CO.**

Manufacturers of

*Radio and Electrical Laboratory  
Apparatus*

Massachusetts Avenue and Windsor St.  
**CAMBRIDGE 39                      MASSACHUSETTS**

## No Washers!

Pacent engineers have solved the problem of spacing condenser plates accurately.

Instead of using washers, which always vary in thickness, the plates themselves are machined into a greatly improved type of spacer. This makes for greater efficiency and increases the rigidity of the condenser assemblage.

One of the reasons why Pacent Variable Condensers are standard in many manufactured sets.

*Write for Catalog D-6*

PACENT ELECTRIC CO., Inc.  
22 Park Place New York, N. Y.

## Pacent RADIO ESSENTIALS

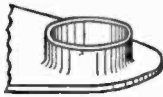
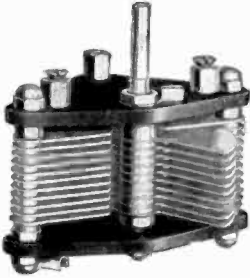

*Corner of plate showing method of spacing in the Pacent condenser*



for use on a 110-volt D.C. line. Equipped with the famous Ward Leonard Vitrohm (Vitreous enamelled) Resistor Units. Literature on request.

## RADIO BATTERY CHARGER

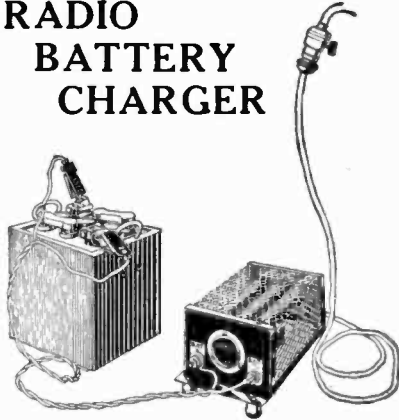

Ward Leonard  Electric Company  
Mount Vernon, New York



# The GREBE TANGENT WHEEL VERNIER



CONDENSER



Grebe Regenerative  
Receivers are licensed  
under Armstrong U.S.  
Pat. No. 1,113,149

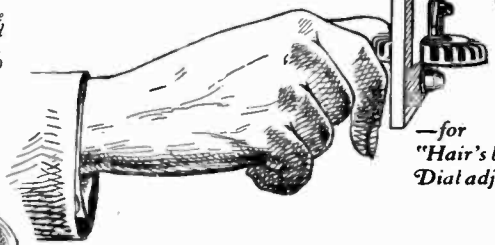

—for  
"Hair's breadth"  
Dial adjustments



## A Device found only on GREBE Receivers

THE man who has once operated a Grebe Receiver reaches instinctively for the Tangent Wheel Verniers on every other receiver he thereafter tunes.

This and other details of Grebe craftsmanship are fully covered by patents granted and pending. Inspect these details at your dealer's today.

"The accomplishment of great things consists in doing small things well."  
—Confucius

Perfection of detail is a big factor in the success of the Grebe Receivers.

*Doctor Wp*

A. H. GREBE & CO., INC.  
Richmond Hill, N.Y.

W

W

## Prolong Tube Life

This Model 301 Filament Voltmeter is invaluable because it prevents many tubes from burning out prematurely. It facilitates exact tuning and enables results to be duplicated exactly. But it is only one of many radio instruments manufactured by Weston and acclaimed everywhere by Radio Engineers. Each instrument is tested and guaranteed to be correct, not only at zero and at full scale deflection, but at every point on the scale as well.

**Weston Electrical Instrument Co.**  
73 Weston Ave. Newark, N. J.  
*Branch Offices in all Principal Cities.*



## Filament Voltmeter

Circular J is an attractive 24-page booklet that explains in detail all Weston Radio Instruments and shows instrument connections for both transmitting and receiving sets. Sent free on request.

*Electrical  
Indicating  
Instrument  
Authorities  
Since 1888*

# WESTON

STANDARD - The World Over

**STANDARD of EXCELLENCE**  
*for* **AUDIO AMPLIFICATION**

**AMERTRAN**  
TRADE MARK REG. U.S. PAT. OFF.

Now made in two types. AmerTran AF-6 (turn ratio 5) is for use in the first stage; AmerTran AF-7 (turn ratio  $3\frac{1}{2}$ ) is the companion transformer for use in further stages of amplification.

Long study and experiment are behind this scientifically balanced combination for perfect reproduction.

**Price, each type, \$7.00**

**American Transformer Co., Newark, N. J.**  
*Designers and builders of radio transformers for over 23 years*



# AMRAD

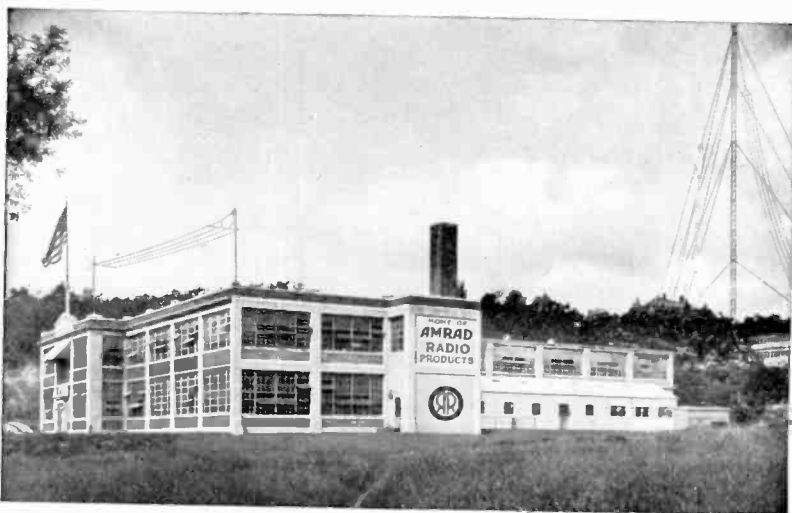

*Main Works of the American Radio and Research Corporation, Medford Hillside, Mass. Home of AMRAD Radio. Showing at right Research and Engineering Laboratories and Broadcast Station WGI—"Where Broadcasting Began"*

## PIONEER ACHIEVEMENTS

For nine years this Corporation has blazed the way in the development of the industry—in the perfection of the design and manufacture of the equipment, and in broadcasting. A few of the Pioneer Achievements are listed below:—

1. First to offer a complete Receiver for the layman, October 1, 1920.
2. First to bring out Radio Frequency Amplification for broadcast reception.
3. The Establishment in 1915 of World's Oldest Broadcast Station Operating Today.
4. First to maintain Two-way Communication by Voice with Europe, November 30, 1923.
5. First to make radio available to all by a plan of Monthly Payments, May 22, 1923.
6. First to develop and market nationally the Period Art Type of radio.
7. The World's Long Distance Receiving Records on Standard Sets.
8. First to develop and use exclusively the Scientific Principle of "Inductance Tuning"
9. First to develop a Rectifier Tube Without a Filament, July 1, 1921.

### AMERICAN RADIO AND RESEARCH CORPORATION

General Offices and Works: MEDFORD HILLSIDE, MASS.  
Offices: BOSTON, NEW YORK, PHILADELPHIA, WASHINGTON, D.C.,  
CHICAGO, KANSAS CITY, MO.

---

### *Radiola Super-Heterodyne*

*It needs NO ANTENNA—no ground—no connections of any kind. Has a handle to lift it by. Tunes in with just two knobs that you turn to marked spots on the dials. Tunes out powerful near stations to get the far ones. A wonderful new achievement in the perfection of its tone—its sensitivity—and its supreme selectivity!*

*Complete with six Radiotrons UV-199 and Radiola Loudspeaker; everything \$286 except batteries . . . . .*



## *Cheer with the Galleries When the Delegates March In!*

No "influence" needed this year for a gallery seat at the big political conventions! Get it all, with a Radiola Super-Heterodyne.

When the delegates march in—their banners streaming; when the bands play and the galleries cheer—be there with the "Super-Het." Hear the pros and cons as they fight their way to a "platform" for you. Hear the speeches for the "favorite sons." The sudden stillness in the audience when the voice of a great speaker rings out. The stamp and whistle and shrill of competitive cheering. Hear the actual nomination of a president.

It used to be all for the delegates' wives and the "big" folks of politics. Now, it's for everybody. Listen in. Get it all. With the *newest* Radiola.

Watch the radio columns of your newspaper for the big convention broadcast schedules

### Radio Corporation of America

*Sales Offices:*

233 Broadway, New York

10 So. La Salle Street, Chicago, Ill.

433 California Street, San Francisco, Cal.



*This symbol of  
quality is your  
protection*

# Radiola

REG. U. S. PAT. OFF.

# PROCEEDINGS OF The Institute of Radio Engineers

Volume 12

JUNE, 1924

Number 3

## CONTENTS

	PAGE
OFFICERS OF THE INSTITUTE OF RADIO ENGINEERS	226
L. W. AUSTIN, "RECEIVING MEASUREMENTS AND ATMOSPHERIC DISTURBANCES AT THE BUREAU OF STANDARDS, WASHINGTON, NOVEMBER AND DECEMBER, 1923"	227
F. KIEBITZ, "ON PROPAGATION PHENOMENA AND DISTURBANCES OF RECEPTION IN RADIO TELEGRAPHY"	233
F. H. KROGER, "THE CAPE COD MARINE SYSTEM OF THE RADIO CORPORATION OF AMERICA"	243
D. C. LITTLE, "KDKA, THE RADIO TELEPHONE BROADCASTING STATION OF THE WESTINGHOUSE ELECTRIC AND MANUFACTURING COMPANY, EAST PITTSBURGH, PENNSYLVANIA"	255
E. V. APPLETON AND MARY TAYLOR, "ON OPTIMUM HETERODYNE RECEPTION"	277
MARIUS LATOUR, "SIGNAL-TO-STATIC INTERFERENCE RATIO IN RADIO TELEPHONY"	295
E. LEON CHAFFEE, "REGENERATION IN COUPLED CIRCUITS"	299
JOHN V. BRADY, "DIGESTS OF UNITED STATES PATENTS RELATING TO RADIO TELEGRAPHY AND TELEPHONY, Issued March 4, 1924-April 29, 1924"	361

## GENERAL INFORMATION

The PROCEEDINGS of the Institute are published every two months and contain the papers and the discussions thereon as presented at the meetings in New York, Washington, Boston, Seattle, San Francisco, or Philadelphia.

Payment of the annual dues by a member entitles him to one copy of each number of the PROCEEDINGS issued during the period of his membership.

Subscriptions to the PROCEEDINGS are received from non-members at the rate of \$1.50 per copy or \$9.00 per year. To foreign countries the rates are \$1.60 per copy or \$9.60 per year. A discount of 25 per cent is allowed to libraries and booksellers.

The right to reprint limited portions or abstracts of the articles, discussions, or editorial notes in the PROCEEDINGS is granted on the express condition that specific reference shall be made to the source of such material. Diagrams and photographs in the PROCEEDINGS may not be reproduced without securing permission to do so from the Institute thru the Editor.

It is understood that the statements and opinions given in the PROCEEDINGS are the views of the individual members to whom they are credited, and are not binding on the membership of the Institute as a whole.

PUBLISHED BY  
THE INSTITUTE OF RADIO ENGINEERS, INC.  
37 WEST 39TH STREET, NEW YORK, N. Y.

EDITED BY  
ALFRED N. GOLDSMITH, Fh.D.

## OFFICERS AND BOARD OF DIRECTION, 1924

Terms expire January 1, 1925; except as otherwise noted

---

	<b>PRESIDENT</b> JOHN H. MORECROFT	
	<b>VICE-PRESIDENT</b> JOHN H. DELLINGER	
<b>TREASURER</b> WARREN F. HUBLEY		<b>SECRETARY</b> ALFRED N. GOLDSMITH
	<b>EDITOR OF PUBLICATIONS</b> ALFRED N. GOLDSMITH	
	<b>MANAGERS</b> (Serving until January 7, 1925)	
MELVILLE EASTHAM DONALD MCNICOL	A. E. REOCH (Serving until January 6, 1926)	LLOYD FSPENSCHIED JOHN V. L. HOGAN
EDWARD BENNETT	(Serving until January 4, 1927)	LOUIS A. HAZELTINE
A. H. GREBE	<b>ADVERTISING MANAGER</b> DE WITT V. WEED, JR.	H. W. NICHOLS

---

### WASHINGTON SECTION

<b>CHAIRMAN</b> COMM. A. HOYT TAYLOR Navy Department, Washington, D. C.	<b>ACTING EXECUTIVE COMMITTEE</b>	<b>SECRETARY-TREASURER</b> C. B. MIRICK, Naval Research Laboratory, Bellevue, Washington, D. C.
--	-----------------------------------	--

### BOSTON SECTION

<b>CHAIRMAN</b> GEORGE W. PIERCE Harvard University, Cambridge, Mass.	<b>SECRETARY-TREASURER</b> MELVILLE EASTHAM 11 Windsor St., Cambridge, Mass.
--	---

### SEATTLE SECTION

<b>CHAIRMAN</b> R. H. MARRIOTT Seattle, Washington	<b>SECRETARY</b> C. E. WILLIAMS Seattle, Washington
<b>TREASURER</b> B. A. ENGHOLM Seattle, Washington	

### SAN FRANCISCO SECTION

<b>CHAIRMAN</b> MAJOR J. F. DILLON, 526 Custom House, San Francisco, Cal.	<b>SECRETARY-TREASURER</b> D. B. MCGOWN, Custom House, San Francisco, Cal.
--	---

---

COPYRIGHT, 1924, BY  
THE INSTITUTE OF RADIO ENGINEERS INC.  
37 WEST 39TH STREET  
NEW YORK, N. Y.

RECEIVING MEASUREMENTS AND ATMOSPHERIC  
DISTURBANCES AT THE BUREAU OF STANDARDS,  
WASHINGTON, NOVEMBER AND DECEMBER, 1923\*

BY

L. W. AUSTIN

(CHIEF RADIO PHYSICAL LABORATORY, BUREAU OF STANDARDS)

*(Communication from the International Union of Scientific Radio  
Telegraphy)*

During December, Nauen showed the lowest average morning strength which has been observed since the present methods of measurement have been used in the laboratory, while the afternoon signals have been of nearly normal strength.

All European stations measured in Washington show weakness in the forenoon at times during November and December. This may be connected with the European sunset, which, in the latitude of Nauen, occurs pretty early in the forenoon, Washington time, during the short days of winter. The corresponding effect in summer occurs in the afternoon, Washington time, and helps to produce the afternoon fading. This effect is much less pronounced in the case of Lafayette than in that of Nauen. This difference does not seem to be entirely due to difference in wave frequency, as St. Assise (UFT) shows less weakening than Nauen tho of nearly the same frequency.

The tables show that Lafayette continues to be approximately twice as strong as last year. Measurements made in Europe also indicate an increase in strength in this station, altho there have been apparently no changes except in frequency (12.8 kc. to 15.9 kc.) to explain the difference.

The atmospheric disturbances were somewhat stronger on an average than in the corresponding months of the year before.

---

\* Received by the Editor, February 7, 1924.

FIELD INTENSITY OF NAUEN AND OF DISTURBANCES  
( $f=23.4$  kc.,  $\lambda=12,800$  m.) IN NOVEMBER, 1923, IN MICROVOLTS  
PER METER

Date	9 A. M.		3 P. M.	
	Signal	Dis- turbance	Signal	Dis- turbance
1	30.0	25	25.7	40
2	15.0	30	19.0	55
3	36.0	25	13.0	85
5	17.0	25	27.0	30
6	**	35	28.0	30
7	**	30	20.5	25
8	47.0	60	51.5	145
9	39.0	40	20.5	100
10	34.0	25	17.0	60
12	15.0	450	21.2	240
13	17.0	35	15.0	140
14	21.2	30	*	120
15	34.0	80	25.7	105
16	**	90	15.0	130
17	30.0	30	21.2	150
19	17.0	50	15.0	130
20	**	50	42.7	150
21	13.0	65	25.7	140
22	25.7	20	30.0	100
23	**	30	13.0	65
24	**	10	12.2	15
26	**	15	20.0	40
27	17.0	10	13.4	50
28	13.0	40	**	35
30	14.0	10	6.0	30
Average	24.1	52.4	20.8	88.4

\*Not heard.

\*\*Not sending.

...Not taken.

FIELD INTENSITY OF LAFAYETTE AND OF DISTURBANCES  
( $f = 15.9$  kc.,  $\lambda = 18,900$  m.) IN NOVEMBER, 1923, IN MICROVOLTS  
PER METER

Date	9 A. M.		3 P. M.	
	Signal	Dis- turbance	Signal	Dis- turbance
1	**	30	150	50
2	140	40	102	60
5	....	....	144	35
6	156	40	168	45
7	**	30	120	35
8	220	100	126	155
10	174	30	120	80
12	120	300	174	250
13	136	30	162	150
14	174	40	126	125
15	156	80	168	100
16	90	100	108	150
17	144	30	156	100
19	150	60	180	150
20	180	40	168	180
21	156	80	120	100
22	**	25	138	125
23	120	35	102	80
24	102	15	150	20
26	**	20	114	45
27	120	15	160	60
28	**	45	90	45
30	**	30	78	35
Average	146	55.2	135.8	94.6

\*Not heard.

\*\*Not sending.

....Not taken.

FIELD INTENSITY OF NAUEN AND OF DISTURBANCES  
( $f = 23.4$  kc.,  $\lambda = 12,800$  m.) IN DECEMBER, 1923, IN MICROVOLTS  
PER METER

Date	9 A. M.		3 P. M.	
	Signal	Dis- turbance	Signal	Dis- turbance
1	7.5	20	19.0	45
5	2.0	40	13.6	60
6	4.0	40	7.0	35
7	2.0	25	5.0	45
10	2.0	15	19.0	25
10	12.8	40	7.0	25
11	6.0	40	14.5	55
13	5.0	15	13.6	40
13	4.0	30	**	40
14	9.5	30	22.0	25
15	13.0	15	7.0	95
17	17.0	15	21.5	30
18	8.5	20	.....	.....
20	.....	.....	**	20
21	5.0	25	18.0	50
22	2.0	25	17.0	40
24	7.0	15	.....	.....
26	**	10	34.0	30
27	2.0	20	25.7	40
28	21.2	10	43.0	20
29	17.0	15	55.7	40
31	6.0	25	21.5	35
Average	7.7	23.4	20.2	39.7

(Signal given as 2 when heard but not measurable.)

\*Not heard.

\*\*Not sending.

.....Not taken.



FIELD INTENSITY OF LAFAYETTE AND OF DISTURBANCES  
( $f=15.9$  kc.,  $\lambda=18,900$  m.) IN DECEMBER, 1923, IN MICROVOLTS  
PER METER

Date	9 A. M.		3 P. M.	
	Signal	Dis- turbance	Signal	Dis- turbance
1	60	25	119	50
5	84	50	108	65
6	102	45	96	35
7	196	30	102	50
8	**	20	138	30
10	125	45	90	25
11	125	50	78	60
12	125	20	102	45
13	**	40	108	45
14	132	35	90	30
15	120	20	222	85
17	**	15	**	40
20	.....	.....	108	25
21	90	30	180	60
22	102	25	102	45
24	**	20	.....	.....
26	**	15	180	35
27	102	20	180	40
28	**	15	212	25
29	163	20	180	50
31	132	30	114	40
Average	118.4	28.5	132	44

\*Not heard.

\*\*Not sending.

..... Not taken.

RATIO OF AVERAGES

Station	Signal	Disturbance	Reception Factor	
	P. M.	P. M.	A. M.	P. M.
	A. M.	A. M.	Signal Dist.	Signal Dist.
NOVEMBER				
Nauen .....	0.87	1.68	0.46	0.24
Lafayette.....	0.93	1.71	2.64	1.43
DECEMBER				
Nauen.....	2.62	1.68	0.33	0.51
Lafayette.....	1.12	1.54	4.15	3.00

SUMMARY: The signal strengths of the Nauen and Lafayette Stations, and the corresponding strength of the atmospheric disturbances in Washington are given for November and December, 1923.

## ON PROPAGATION PHENOMENA AND DISTURBANCES OF RECEPTION IN RADIO TELEGRAPHY\*

BY  
F. KIEBITZ

(COMMUNICATION FROM THE NATIONAL TELEGRAPH ENGINEERING BUREAU,  
BERLIN, GERMANY)

The propagation of electromagnetic waves takes place in accordance with the principles of Huyghens and Fresnel. That is, every point which the wave reaches is to be regarded as the point of origin of elementary wavelets, which combine according to the usual laws governing interference, with due consideration to phase and amplitude.

If the propagation phenomena in radio telegraphy are to be described, as they take place on the separating surface between the earth and the atmosphere, it is first necessary to know how these two media behave electrically. Experiments indicate that the atmosphere behaves practically as an insulator in which, therefore, electric and magnetic forces can exist. The earth, on the other hand, acts as a conductor. This is known because radio frequency alternating currents can be conducted thru the earth, and also because the electric forces and their various components are perpendicular to dry soil. This last effect can be directly observed; and in addition there is an indirect but particularly striking evidence for the vertical position of the electric forces relative to the earth's surface which depends on the following fact: A pair of horizontal antennas stretched in the same line near the surface of the earth and carrying electrical oscillation do not show any lateral radiation effect, whereas the same pair of antennas in free space, and therefore not oscillating in the neighborhood of the ground, act as a Hertzian transmitter or doublet in an exactly opposite fashion to the preceding pair and neither radiate nor receive waves in their own line of direction. This striking effect can be explained by assuming that the electric force is sensibly vertical to the earth's surface, whereas

---

\*Received by the Editor, November 3, 1923. Translated from the German by the Editor.

horizontal components of the electric field at the earth's surface do not have any effect.

If we consider the propagation of waves only over distances for which the earth's curvature may be disregarded, we shall make no great error if we regard the earth's surface as a limiting plane between an insulator and a conductor. Radio frequency alternating currents flow outward radially from the bottom of the antenna of the transmitter (or, to describe the phenomena in another way, radio frequency alternately positive and negative charges flow outward in concentric circles over the earth's surface from the antenna). The radio frequency alternating magnetic and electric fields in the air are inseparably connected with these currents or moving charges.

It is a matter of indifference whether we speak of charges which flow over the earth's surface or of electric fields which move thru the air, or of magnetic fields which grow and decay in the atmosphere, or of currents which flow in the earth's surface. We can employ interchangeably any of these pictures for a description of the same natural phenomena.

In the same way we may describe the excitation of a receiving antenna in various equally valid fashions. For example, we may concentrate attention on the charges which have come to the lowest point of the antenna, or on the currents which flow out of the earth's surface at this point, or on the electric forces which, traveling vertically, strike the antenna, or, finally, on the horizontal magnetic field which cuts the antenna as it moves forward.

Huyghens' principle determines the circular form of the wave front. The *decay* of field intensity with distance must be in agreement with that for an Hertzian oscillator, and therefore, must be proportional to the first power of the distance. As long as we are not forced to consider powerful absorption phenomena in the immediate neighborhood of the transmitter, no other description is possible. A direct quantitative determination of the law of attenuation would be of fundamental significance; but, so far as I know, this has never been carried out. The law connecting amplitude and distance has been obtained only indirectly thru absolute measurements of the field intensity, which latter have even been used for the determination of the effective height of a transmitting antenna and have given values which are in agreement with the conclusions drawn from the geometrical dimensions.

The curvature of the earth must be considered in connec-

tion with the propagation of waves over larger distances. If the distance is small in comparison with the circumference of the earth, we may regard the earth's surface as very approximately spherical. Then, if  $A$  is the distance of the receiver from the transmitter measured on the spherical surface, the energy in spreading out over the arc  $A$  has not traversed a circle of circumference  $2\pi A$  in this plane, but only a circle which is smaller in the ratio  $\frac{\sin \alpha}{\alpha}$  (where  $\alpha$  is the angle between the transmitter and the receiver viewed from the center of the earth), and, therefore, the field is increased in the ratio  $\sqrt{\frac{\alpha}{\sin \alpha}}$ .

When still greater distances have to be considered, and particularly in telegraphing to the opposite hemisphere, this well-known formula is no longer justified because of the curvature of the earth for non-directional transmitters. Only when telegraphing from pole to pole may we regard it as approximately correct, because the Huyghens' elementary wavelets then combine into an enveloping wave front which moves parallel everywhere to their lines of propagation or meridians, and which wavelets continue along meridional paths on the opposite hemisphere because all points reached simultaneously on the paths of the waves are equally far from the poles. On the other hand, the further the transmitter is separated from one pole, the greater will be the difference of phase between the elementary waves which reach the distant receiver; and for a point on the equator, the path to the antipodes along the equator is 34 kilometers (21 miles) longer than that over one pole along the meridian.

If we consider, as an ideal case, that the earth is a perfect conductor and the atmosphere a perfect insulator, the wave which reaches the antipodes is obtained by summation of all the Huyghens elementary wavelets which have nearly equal amplitudes but various path differences of between zero and 34 kilometers (21 miles). Short waves will therefore combine practically to annul each other, because all those in one phase will be nearly exactly as powerful as those in the opposite phase, and therefore short waves are not suitable for communication over long distances.

For this reason, communication over great distances (considering the curvature of the earth) requires waves of the order of magnitude of 10,000 meters in length if audible alternating currents are not to be used for transmission. This fact has become well known thru the experience of those operating high-

power stations, altho the curvature of the earth has not hitherto been given as the explanation for the necessity for long waves. It is perhaps not superfluous to emphasize this point because the desire to operate on short wave lengths is connected with efficiency of radiation from the transmitting antenna.

The above considerations cannot give more than the general order of magnitude of the necessary wave lengths. However attractive it may appear to be to calculate the most useful wave length for communication over the earth's surface between two distant points, it must not be anticipated that the results of a precise calculation will be substantiated by experiments, since the initial assumption that the earth is a uniformly good conductor of electricity is not sufficiently true in reality. The surface of the earth consists of water and land, and the waves have different velocities of propagation over these various surfaces. We can draw this conclusion in part directly from measurements of the stationary waves on wires stretched over the surface of the earth and in part indirectly from the deviations from a true direction or straight line path which occasionally result in directional telegraphy. The outward travel of the waves is more or less retarded by the differences between the non-homogeneous surface of the earth and a perfect conductor, and also because of the differences of path which result from the geometrical shape of the earth which leads to the elementary wavelets arriving at the distant receiver at different times. It is useless, however, to attempt to calculate these time differences because of the irregular distribution of water and land.

It is even more difficult to calculate numerically the changes in amplitude of the waves in traveling over a partially conducting surface, but even if such calculations could be successfully carried out, the influence of the atmosphere on the propagation phenomena would again alter the phenomena. This influence has been experimentally found to change with the weather and even with the amount of sunlight.

The investigations which have been published relative to these effects are so numerous that it is impossible to discuss even the most important of them. Attention has been concentrated properly on Dr. L. W. Austin's formula for the calculation of signal strength at a distance in radio telegraphy. In this formula it is assumed that the absorption depends upon the wave length, and the numerical value of the absorption is empirically determined. Furthermore, the formula is limited to the distant effect during the day and over sea water. It is natural with such

limitations that only roughly approximate formulas can be obtained for the radio signal at distant points, since a generally applicable formula cannot be set up as long as the much simpler task of calculating the state of the weather is not possible.

Unfortunately, it is difficult to obtain information experimentally on radio signals at considerable distances, since such signals are so weak that they can hardly be directly measured by normal physical apparatus capable of giving objective or direct readings. Instead, a number of subjective or indirect methods of observation have been developed which do not always give even the order of magnitude of the signal, much less a quantitatively accurate value. As a result of this, even to-day, after using radio communication for twenty-five years, we are still not able to state whether the day or night values of signal correspond to normal travel of the waves. Partly as a result of the uncertainty relative to these fundamental questions, there have been propounded a great number of theoretically possible explanations which, however, sometimes border on the fantastic.

We have taken pains at the National Telegraph Engineering Bureau to devise receiving arrangements which enable the determination of received signal strength to be objectively carried out, and we have set up as a desirable condition that the transmitting station must not be required to send out special long dashes, but that we shall be able to make objective measurements on the signals of every audible station transmitting normal text. The measuring apparatus consists of a heterodyne receiver, and the signals are sufficiently amplified so that comfortable readable deflections are obtained on a thread electrometer even when Honolulu, the most distant station, is transmitting. The apparatus can be calibrated, and is set up at two locations, one in Berlin and the other 100 kilometers (62 miles) further north in Strelitz. The details of this equipment will be published by Mr. G. Anders. During the year we have succeeded in increasing the reliability of this measuring apparatus and its ease of calibration to such an extent that simultaneous observations on the incoming field strength of American stations agree to within 30 percent.

With these receivers we have concentrated on the signals from the American stations at Rocky Point (Long Island, New York) and Marion, Massachusetts, as a regular proposition, for a considerable time. In carrying out our plans to determine objectively the amplitude of the incoming waves as well as to specify their diurnal and annual variations in more precise fash-

ion than is possible by the subjective methods, our thanks are particularly due to Doctors A. N. Goldsmith and L. W. Austin, whom we have interested in this work. In particular, Dr. Goldsmith has most accommodatingly arranged that all our wishes regarding the procedure at the Rocky Point Station, as required by these researches, have been fully carried out.

These observations have been carried so far that, in the near future, a complete description by Mr. Bauemler will follow. It is already possible to take a definite position relative to certain questions which I have mentioned above.

The received field strengths fluctuate by day and night. The highest values are obtained at night. We have compared these values with those which can be calculated from the distance of the transmitting station, its antenna current, and its antenna height, provided the spherical shape of the earth is neglected and absorption is not considered. The comparison shows that even the night values are generally smaller than these theoretical values. Peak observations, which exceed the theoretical value, frequently occur, but they exceed the theoretical value by less than thirty percent, that is, by less than the possible error of the observations. It is possible to conclude from this that there is no urgent necessity for explaining the large signal values at night by assuming reflections in the upper layers of the atmosphere. It is much more plausible to conclude that the propagation phenomena at night from America to Europe take place with relatively small disturbance over a good conducting ground surface in a homogeneous atmosphere which acts as a perfect insulator.

As a result of the numerous subjective observations, it has been known for a long time that the dependence of transmission on time of the day and season of the year is particularly marked for short wave lengths. The following average values obtained during the past few months have been secured for the 16,400-meter wave of Rocky Point (Long Island, New York, United States). During winter nights, the waves arrive with practically the theoretical or calculated amplitude. During the day in winter time, the amplitude diminishes to one-quarter of the theoretical value. The signal strengths during the summer nights are only slightly below the theoretical value, while the daytime values are greater in the summer than in the winter, the ratio between the average day and night strengths during the summer months being only one-to-two.

Because of the subjective impressions, the differences are



generally given as much larger. The reason for this is actually psychological. Specifically, the atmosphere disturbances make it very difficult to determine the true strength of signals subjectively. These disturbances are particularly strong in the summer, and increase the difficulty of reception to such an extent as to cause the observer to underestimate the intensity of the signals.

Only partial information is available as to the source of the disturbances of radio reception. A portion of these disturbances undoubtedly originate in atmospheric electrical effects, and many useful researches have been carried out to explain the mechanism of the production of the disturbances. It is well known that the normal electric field in the atmosphere, as well as the magnetic field of the earth, is continually varying. Such variations appear with widely different magnitudes, and, for example, cause disturbing currents in the wire lines used for telegraphy and telephony. It is not to be expected that these electrical disturbances will fail to produce some effect on the delicate radio receivers. Actually, they cause severe disturbances in the receivers because the radio receiver must be so much more sensitive than the equivalent arrangements used for wire communication.

It would be natural to attempt to establish a connection between the weather conditions and these atmospheric electrical disturbances. With this in view, we have carried out observations during the last year at the research laboratory at Strelitz not only on disturbances of reception but also on various meteorological and atmospheric electrical factors. However, no relation has been established between the intensity of the disturbances, nor yet the signal strength, and any of the phenomena taking place on the earth's surface (see Wiedenhoff, "Jahrbuch der drahtlosen Telegraphie," volume 18, 1921, part 4). Altho the results have therefore been negative, they have had the beneficial result of stimulating the development of more powerful methods of studying disturbances of reception.

It must also be recognized that many disturbances of reception which have hitherto been ascribed to atmospheric disturbances unquestionably originate in man-made electrical installations. Reception has been repeatedly carried out in cities when, because of war conditions or strikes, all electrical equipment was at rest. Under such circumstances there were very few disturbances of reception.

The types of noise produced by the disturbances in the telephones have also been made the basis of their investigation. There are, for example, very rough disturbances which cause a

crackling sound and are well marked in ink recorder reception. They appear with different intensities in receiving sets connected to antennas which are directional along different lines, and are particularly well suited for objective observation because of their intensity.

We next recorded these disturbances in Berlin and Strelitz, utilizing for this purpose the time signals from Paris and Lyons and taking down the signals on a usable cable siphon recorder. The receivers were therefore tuned to the same wave length and the time signals enabling direct comparison of the records for detecting possible simultaneity of the disturbances. It was found that a large part of the disturbances occurred simultaneously in Berlin and Strelitz. Following this, the same investigations were carried out in Hamburg, and then in Mr. M. Dieckmann's station at Gräfeling near Munich where Messrs. H. G. Möller and Gleissner very kindly undertook to carry out the observations. These investigations showed that even with the receiving stations separated by 600 kilometers (375 miles), a large part of the disturbances coincided. At this point Dr. A. N. Goldsmith courteously participated in these investigations by arranging to have the time signals from Lyons similarly recorded at the Riverhead (Long Island, New York) receiving station of the Radio Corporation of America. The records of the disturbances obtained in New York and Berlin also showed many coincidences, so that it was established that there are disturbances which cover a large portion of the earth's surface. A more complete description of these observations has been published by Mr. M. Bauemler in three articles on "Simultaneous Occurrences of Atmospheric Disturbances" (*"Jahrbuch der drahtlosen Telegraphie und Telephonie,"* volume 19, 1922, part 2; volume 20, 1922, part 6; and volume 23, 1923, part 1).

These researches have therefore established the important fact that there are disturbances of radio reception which cannot originate in the vicinity of the receiver. It is, therefore, necessary to seek their source in distant electrical discharges in the atmosphere or else in still unknown cosmic phenomena or in equally unknown occurrences in the interior of the earth. This last possibility might be somewhat preferred since Mr. Barkhausen has found that iron, placed in a variable magnetic field, is not magnetized or demagnetized smoothly and steadily, but in jumps and finite steps. The earth has a magnetic field of its own which is subject to very appreciable variations. The masses of iron in the crust of the earth must therefore be subject to simi-

lar variations in their magnetization. It is true that we have no exact knowledge of the characteristics of the iron-containing portions of the earth. Yet it may be possible, thru investigations of the electromagnetic disturbances taking place on the surface of the earth and simultaneously over large areas, to discover in the future whether they are caused by the Barkhausen effect in the iron-containing portions of the earth.

Berlin, October, 1923.

**SUMMARY:** The propagation of electromagnetic waves over the earth's surface is studied, particularly for very long distance transmission, for which it is deduced that short waves are inherently unsuitable.

Methods of quantitatively determining the strength of received signals are shown to be necessary; and some of the results obtained by their use in connection with diurnal and seasonal variations of transmission are given.

The simultaneous appearance of disturbances of reception at widely separated points is investigated and found to exist, and it is concluded that the source of such widespread disturbances may be in iron-containing portions of the earth's crust subject to varying magnetic fields and with a stepwise altered magnetization according to the Barkhausen effect.

# THE CAPE COD MARINE SYSTEM OF THE RADIO CORPORATION OF AMERICA\*

By

F. H. KROGER

(RADIO CORPORATION OF AMERICA, NEW YORK)

It is the purpose of this paper to give a general description of the system and equipment employed in the development of a marine coastal station, representing the commercial application of the more recent improvements known to the art of radio telegraphic communication.

Marine radio communication may be divided into the following classes of service (in the order of relative degree of importance of the divisions):

(a) Distress Signals; (b) Navigation Information; (c) Ship Docking and Diversion Orders; (d) Public Radiograms; (e) Press Items, and (f) Medical Service. In explanation of this classification, distress signals include only the SOS calls which are given by the ship in distress, and these affect the shore station only when it may be called upon to relay weak signals, or to call other ships to the aid of the distressed vessels. Navigation information includes time signals, storm warnings, compass bearings, radio beacon signals, and the like, which are generally not handled by commercial shore stations in this country, but are sent out by the government without charge. Ship docking reports are given within a short distance of the harbor for the purpose of arranging pier accommodations. Ship diversion orders are given by the ship owners to the ship for the purpose of altering the ship's destination while en route. In this way, immigrant ships are quickly diverted to less congested ports; cargo ships which leave without exact destination can be ordered into ports offering the best market; or they may be diverted to secure better handling or port facilities when some emergency suddenly alters conditions. This service must be prompt, and therefore, it is most efficient when there is little relaying to do. This requires that the shore station have a long daylight range.

\* Presented before THE INSTITUTE OF RADIO ENGINEERS, New York, November 7, 1923. Received by the Editor, December 6, 1923.

Public radiograms are sent by individuals (and average fourteen words per message). These messages can be allocated as approximately 75 percent relating to business and 25 percent for social purposes. However, this allocation is subject to wide variations depending on the time of year, the class of ship, and the season of travel. The shore station is called upon to handle this traffic with heavy peak loads and yet to give prompt delivery. It might at first appear that the ocean traveler is not concerned so much with time, but the advice of one who has handled thousands of complaints is that the individual is indeed much concerned with hours and even minutes, and that facilities must be provided for the handling of the large files of messages in short periods. Press items are broadcast at scheduled times. Consequently the matter of news selection has been given considerable attention, and the press material is compiled by a Metropolitan daily and edited in the light of experience in this special field, national and local propaganda being deleted. The shore station must be equipped to reach ships which are within a day of the continent of Europe, as the demand for American news is very pressing. A medical service which was established recently provides for a ship obtaining professional medical advice on application to the shore station; this advice is free and originates in the Navy Marine Hospital.

Therefore we have the following requirements for a shore station which shall be capable of handling all classes of commercial service:

- (1) A continuous watch must be maintained on all wave lengths allocated for traffic.
- (2) Provision must be made for receiving calls at the same time that traffic is being accepted.
- (3) The number of channels on each wave length shall be sufficient to take peak loads of traffic without undue delay.
- (4) The daylight transmitting and receiving range shall be at least to mid-ocean.

These requirements may be met by the erection of several stations separated by considerable distances and in fact, this was the solution previous to the war. This method of providing facilities for handling marine traffic has caused an unnecessary amount of interference among the stations themselves and also to other classes of communication. Each station controlled its own affairs and was not amenable to a traffic head, and the result has been that even stations under the same ownership are often found to be causing interference by competing for a ship's traffic. Economic considerations point to a radio central station as a practical solution to the problem of handling

large peak traffic loads and also covering a sufficiently large zone to give the service desired. In addition, it is of course obvious that there will be required small stations in the large harbors which can take care of vessels which are about to dock. Realizing the advantages to be obtained by diminishing interference, and the resulting economic gain in having a centralized system, the Radio Corporation of America decided to proceed with the development of such a system. The Cape Cod, Massachusetts, property was chosen as being suitable, and in the beginning of 1921 the first work was started. The initial step was taken to provide a channel on 136 kilocycles (2,200 meters). It was felt that this must be operated on continuous waves (c. w.) in order to obtain the desired range and not to interfere with other classes of radio traffic. About this time, the one-kilowatt tube was just emerging from the research laboratory of the General Electric Company. In order to obtain data as early as possible on the use of high voltage tube sets, two of these one-kilowatt tubes were used in a circuit oscillating directly into the antenna, with an alternating voltage of 12,000 applied to each anode. The set was installed at the Marion, Massachusetts trans-Atlantic station and the receiving equipment at the trans-Atlantic receiving station at Chatham. The results were quite gratifying, and the engineering department was asked to supply specifications for a somewhat larger transmitter. The next step was to use three of the one-kilowatt tubes, with the additional refinement of providing a constant source of high tension direct current for the plate supply, and to have the tubes generate oscillations in a "tank circuit" coupled to the antenna. By so doing the harmonics which were causing interference when operating the two-kilowatt high voltage alternating current set were eliminated and the frequency of the transmitter was not controlled by the constants of the antenna. This new set was installed and turned over to the Traffic Department in December, 1922, about seven months after the first set was put into operation. The operators at Chatham reported that no one heard the three-kilowatt set and insisted that the shift engineer at Marion give them the two-kilowatt set. Upon investigating the situation, it was found that the two-kilowatt set was radiating a band of wave lengths instead of a pure wave, and that the operators aboard ship had become accustomed to picking up station WCC at Marion without special care in accurately setting their tuners. Therefore instructions were given to try out the new three-kilowatt set for a given length of time in spite of the protests of the Chatham operators. At the

end of two weeks, the new set was being used exclusively and without protest. When the old two-kilowatt set was substituted some time later, while some minor changes were being made in the three-kilowatt set, there was an immediate complaint from the ships. This experience was of great value to the engineers and gave them courage to proceed along the lines taken later with regard to the higher frequency channels. The next step was to provide two channels on the lower frequency, which was done by erecting a second antenna, and using the two-kilowatt transmitter on 130 kilocycles (2,300 meters). Thus, in the course of a year, two transmitting and two receiving equipments were installed and in operation on the lower frequency band allotted for marine service. Six months later a request was made to consider the feasibility of enlarging the system to include the higher frequency band for marine service. Transmission measurements of signals radiated from Marion showed that it was not economical to place the transmitters at Marion, whereas signals sent out from Chatham were efficiently radiated. To operate a transmitter of several kilowatts input to the antenna at 500 kilocycles (600 meters) at the same place that the receiving is done on 136 kilocycles (2,200 meters) involved receiving signals giving a field intensity of less than one microvolt per meter without interference from a transmitter which was giving a field strength at the receiving antenna of the order of 10 volts per meter or an energy ratio of a hundred-trillion-to-one. Field work was immediately started at the Belmar laboratory to determine a method of producing modulated radiation which would be satisfactory for crystal reception and would not cause interference in the 136 kilocycle (2,200 meter) receivers. The fears expressed in general that interrupted continuous waves (i. c. w.) would be too sharp and that they were not efficient for crystal reception caused work to be done on producing a radiation which covered a band of frequencies rather than a single frequency. Such an experimental set was assembled and tests were made using various widths of frequency bands, in connection with a test-receiving station at a distance and with ships picked at random. From our receiving engineers' report it was apparent that with the usual ship receiver using a crystal detector the change of width of frequency band of the transmitter when receiving on stand-by position did not have an appreciable effect on the intensity and sharpness of tuning and when receiving on loose coupling it was only when the broadening was increased beyond 3 percent that the effect began to be noticed. With the

noticed increase in broadness of tuning, also came a decrease in the intensity of the signal. The reports from the ships were not at all coherent until the broadening was increased to 10 percent, when the report was in all cases that the tuning was broad. With 3 percent broadening, the reports varied between "very sharp" to "same as spark station." From this data it was apparent that if the operators used loose coupling, the tuning would be little sharper when receiving i. c. w. than for a good spark station and there would be increased intensity with i. c. w. in that they would receive all the energy on one frequency. The experience with the two- and three-kilowatt sets at Marion on 136 kilocycles (2,200 meters) was considered sufficient evidence that the ship operators would not have difficulty with tuning as soon as they learned of the advantages resulting. Therefore we proceeded to develop a method of modulating the continuous waves which would radiate on one wave length and would give crystal detector reception efficiently. The first step was to find the law of reception efficiency as the ratio of time-on to time-off of energy flow was varied. This variation plotted with audibility as taken by the shunt box method as ordinates and the average power as abscissas showed that when the energy is flowing one-third of the time the audibility is greatest for a given maximum amplitude of energy flow. Since, however, we should consider the quality of note this gives when heterodyning, we find that at this point the note is not musical and not until the energy is on one-half of the time is the note sufficiently musical to make copying easy and to be of value in reading thru interference and static. It was considered advisable to sacrifice plain detector reception to the extent of reducing signal intensity about 20 percent in order to get musical quality of signal when heterodyning. The result is a musical note which is reported as not mellow, but having a quality helpful in reading thru interference. As a result of the experimental work, specifications were written and the equipment installed last summer.

The system which began with one channel on 136 kilocycles (2,200 meters) has now been enlarged to two transmitters on this frequency with a spare set; three corresponding receiving channels; one transmitter for 500 kilocycles (600 meters) with a spare set and two corresponding receiving channels. Equipment has also been provided for increasing to two transmitters on the higher frequency when required, and space provided for the installation of a third as a spare.

In brief the elements of the station are:



**CONTROL SYSTEM**—The complete control of the system is located at Chatham. Here the operators are able to start, stop, and key any one of the transmitters which are at Marion, and the transmitters in the power house at Chatham. The distance from Chatham to Marion is 50 miles (80 km.). One wire is used for the control of each transmitter. The controls are duplicated at each receiving channel, and signaling lamps indicate when the transmitters are in service. The land lines terminate here which give direct service to the Broad Street office in New York City, at a distance of 200 miles (320 km).

**TRANSMITTERS**—The transmitters located at Marion consist of a three-kilowatt set and two five-kilowatt sets, while the transmitters located at Chatham consist of two five-kilowatt sets. The three-kilowatt set is shown in Figure 1 and the general assembly of the five-kilowatt set is shown in Figures 2 and 3.

**ANTENNA SYSTEM**—The antennas located at Marion are two inverted "L" antennas drawn from the two outside end masts supporting the trans-Atlantic antenna. The down lead for each antenna is vertically under the lower end of the flat top terminating at the tuning coil in the field. The energy is fed to the tuning coil by transmission lines which are six hundred and three hundred feet (183 and 92 meters), respectively for the two antennas. The coupling at the antenna coils is conductive and at the transmitter end it is inductive. The antenna at Chatham consists of four "T" antennas supported from a 350-foot (107 meter) tower. The down leads are brought into a common point and then to the tuning coil at the base of the tower. The housing for the outdoor tuning coil is shown in Figure 4. Figure 5 shows the general arrangement of the antenna.

**GROUND SYSTEMS**—The ground system at Marion consists at present of an incomplete overhead distribution system which feeds thru balancing coils to points on underground bus wires which bond together the ground system of the trans-Atlantic set. This is not efficient for the marine wave lengths and will be supplemented as soon as the changes now being made in the trans-Atlantic ground are completed. The ground resistance for one antenna is fourteen ohms and for the other ten ohms. It is expected that this will be decreased to five ohms each. The ground system at Chatham consists of a mesh of buried wires which are fed by an overhead distribution system. On account of the large area available the resistance of this ground is of the order of two to three ohms.

The energy is fed to the tuning coil by a transmission line

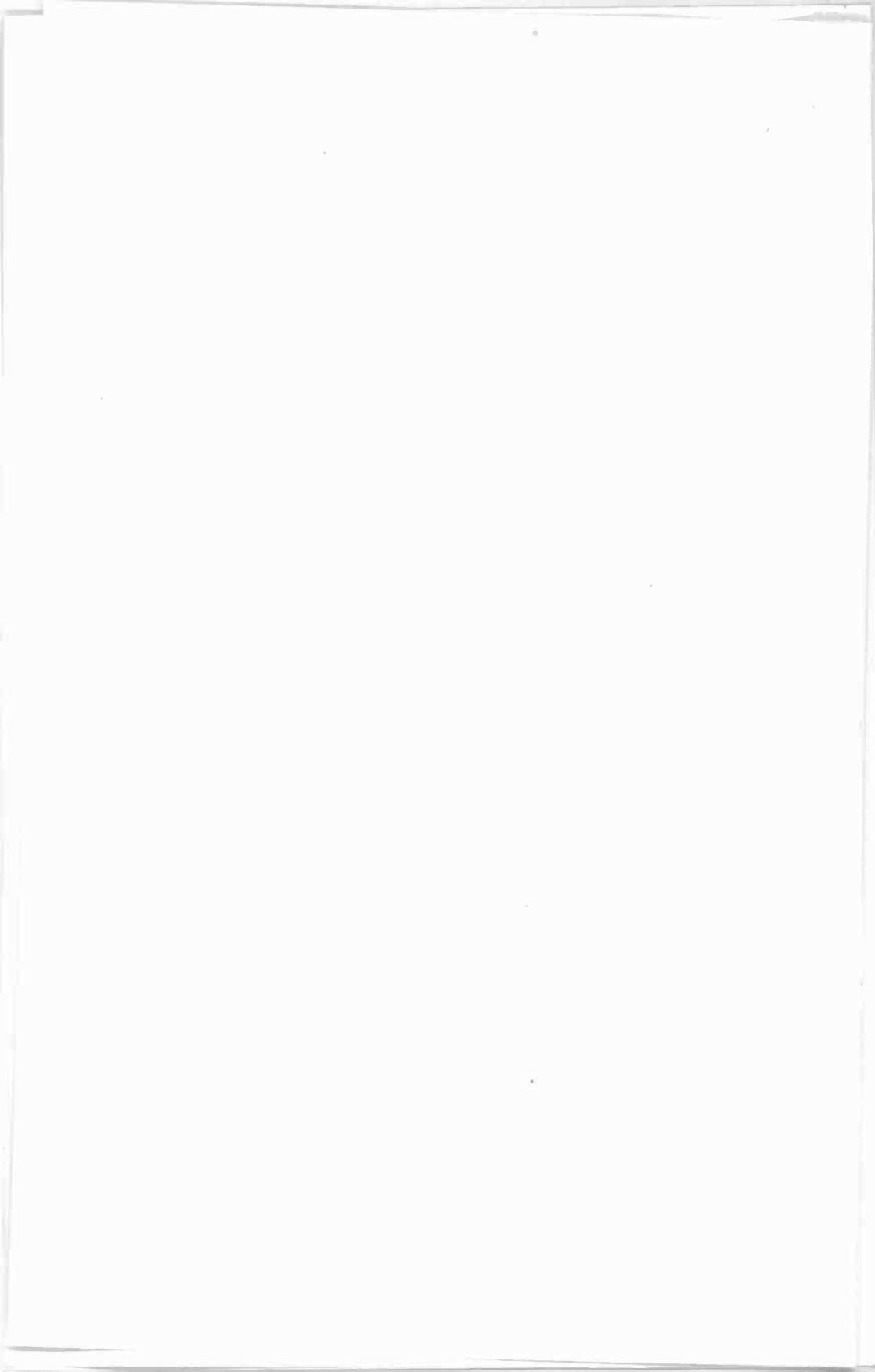

900 feet (277 meters) long, and the coupling is inductive at both ends. The construction of this line is shown in Figures 6 and 7, and the latter figure shows the line leaving the power house where the transmitters are installed. The tuning house at the base of the antenna at Chatham is shown in Figure 8.



FIGURE 4

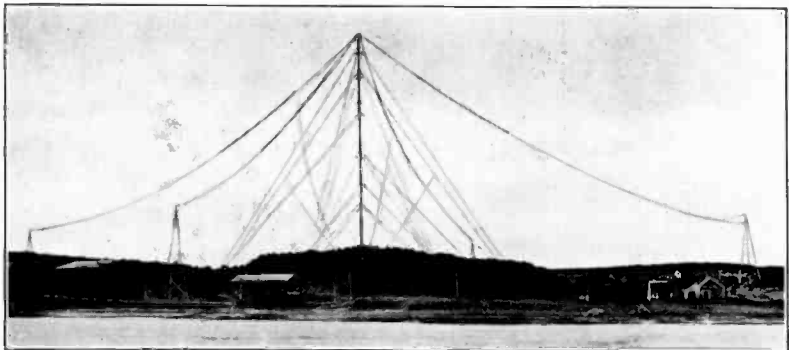

FIGURE 5

RECEIVERS—There are provided three receivers for the lower frequency band and two receivers for the high frequency band. One of the complete receiving units is shown in Figure 9.



FIGURE 6



FIGURE 7



FIGURE 8

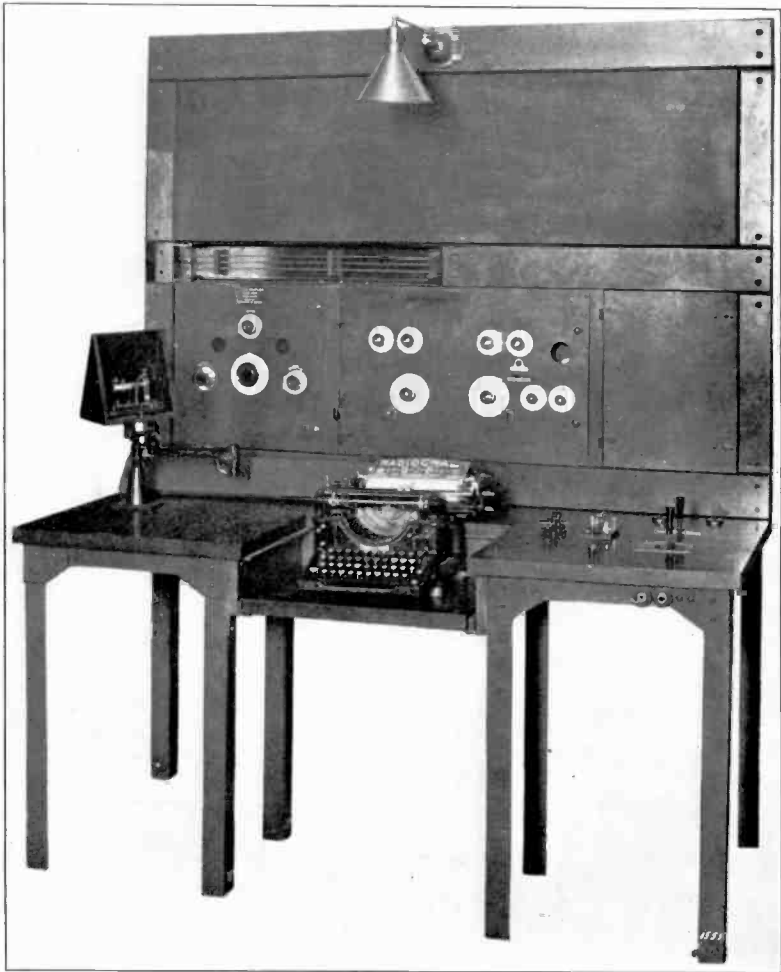

FIGURE 9

**RECEIVER ANTENNAS**—There are two wave antennas, one downleads extending to the south, and the other to the west, which is used on the lower frequency band. The receivers are arranged so as to be used either all on one antenna or distributed between the antennas. The antennas for the higher frequency band consist of a vertical antenna and a loop system.

The results obtained from the Cape Cod system have demonstrated that the application of the recent developments in the art of radio to marine service is not untimely and will bring about an increased over-all efficiency in traffic handling and in the utilization of the limited available wave bands.

**SUMMARY:** This paper gives a general outline of the character of traffic handling which is required in a modern marine radio telegraph communication system. A description of the Cape Cod multiplex marine station of the Radio Corporation of America is given, and the operating problems encountered in supplementing spark transmitting sets with vacuum tube transmitters are outlined.

A brief description, with photographs of the transmitting and receiving equipment, is given; and the advantages made possible by the application of modern radio engineering methods to marine coastal stations are explained.



## KDKA

### THE RADIO TELEPHONE BROADCASTING STATION OF THE WESTINGHOUSE ELECTRIC AND MANUFACTURING COMPANY AT EAST PITTSBURGH, PENNSYLVANIA\*

BY

D. G. LITTLE

(RADIO ENGINEERING DEPARTMENT, WESTINGHOUSE ELECTRIC AND MANUFACTURING COMPANY, EAST PITTSBURGH, PENNSYLVANIA)

The purpose of this paper is to give a brief history of KDKA as the pioneer broadcasting station and to describe the equipment in use at the present time. KDKA was placed in operation on November 4, 1920, and broadcast as the first program the presidential election returns of that date. Semi-weekly programs were put on from that date until December 1st, 1920, when regular evening programs were commenced. The temporary call letters first assigned were 8ZZ. With a power output of only 100 watts, 8ZZ aroused great interest within a radius of 500 miles (800 km.) of Pittsburgh, and radio broadcasting as a public service may be said to have been started. On August 1, 1921, the power was increased to 500 watts and again on October 1, 1921 to 1,000 watts output.

A broadcasting station, in order best to serve the territory it normally covers, must have ample power; the quality both of reproduction and of programs must be of the best; and the service must be reliable. Provision should also be made for considerably increasing the power for emergencies or events of national interest. In order more nearly to approach these conditions, new and improved equipment has been added to KDKA both in the station and the studios. The station apparatus will be described in detail and the studio pick-up arrangement covered in a somewhat more general manner.

KDKA is now provided with three complete transmitting sets, designated as sets numbers one, two, and three.

---

\*Received by the Editor, December 24, 1923. Presented before THE INSTITUTE OF RADIO ENGINEERS, New York, January 2, 1924.



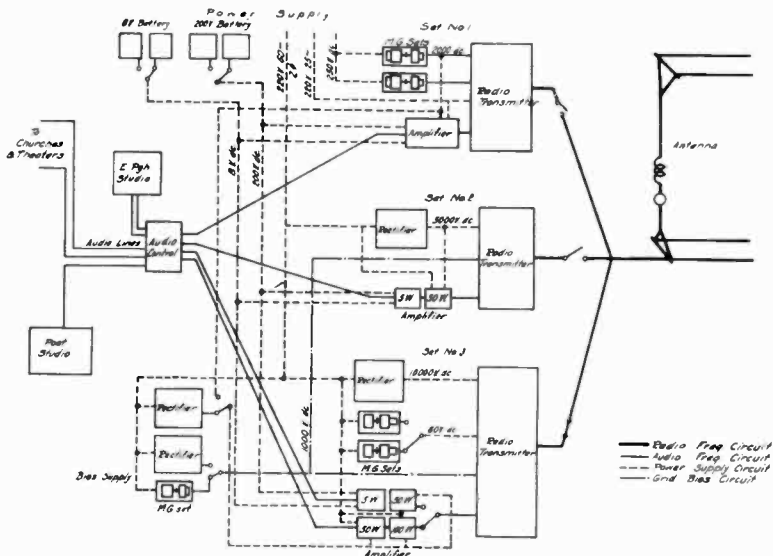

FIGURE 1—Schematic Diagram of K D K A, East Pittsburgh, Pennsylvania

A schematic diagram of the station is shown in Figure 1. It will be seen that each transmitter has its own speech amplifier and power supply apparatus. Set 1 has been fully described

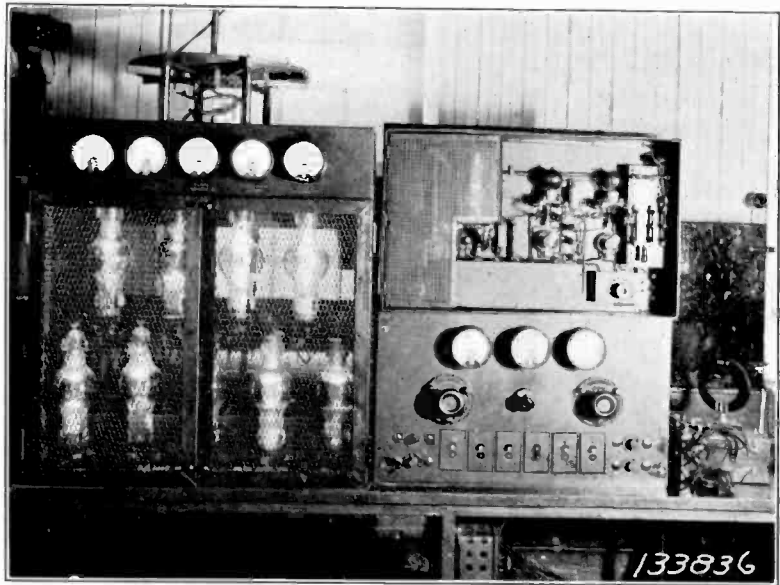

FIGURE 2—Number 1 Transmitter

elsewhere, and the description will not be repeated here.<sup>1</sup> Figure 2, shows this set with its speech amplifier and power control panel. This transmitter was employed on regular programs up to October 1, 1923. Set 2 is shown in Figure 3. A single-phase

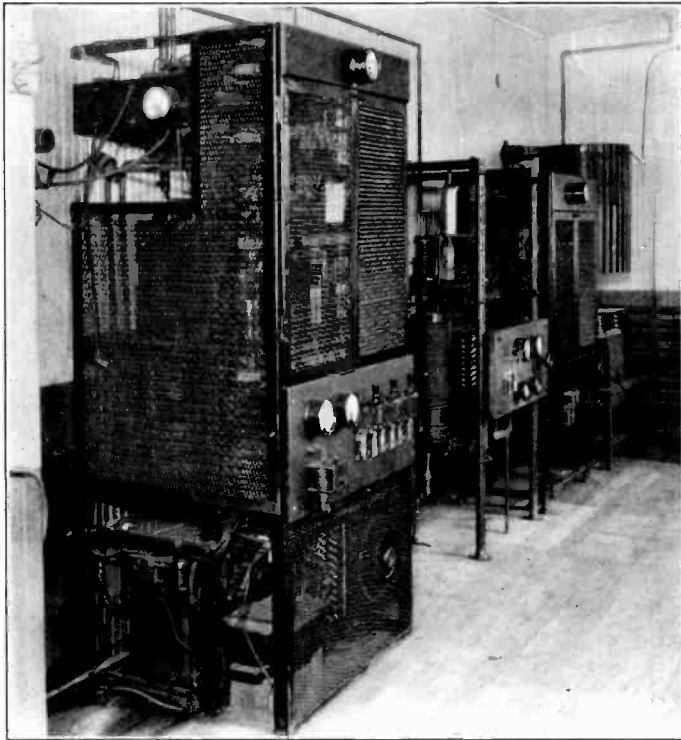

FIGURE 3—Number 2 Transmitter

60-cycle rectifier supplies the plate current at a potential of 5,000 volts to one metal water-cooled oscillator tube and a similar modulator tube. The constant current system of modulation is employed. The oscillator tube is connected to a primary circuit which in turn is loosely coupled to the antenna. This coupling system and also the speech amplifier is of the same design as that employed with the number 3 transmitter which will be described below.

#### NUMBER 3 TRANSMITTER

A general view of number 3 transmitter is given in Figure 4. The three panels at the left are high voltage rectifier and control

<sup>1</sup>“Electric Journal,” June, 1922.

panels while the radio set proper is mounted on the three panels at the right. It will be seen that this equipment is designed along standard switchboard lines, each unit being a separate panel. This construction gives accessibility together with a rugged and permanent design. Metal water-cooled vacuum tubes are employed as rectifiers, modulators, and oscillators in the usual manner, being supported on porcelain pillar insulators behind gray marble panels upon which are mounted the necessary instruments, water indicators, relays, and rheostats.



FIGURE 4—Number 3 Transmitter, General View

### RECTIFIER

The rectifier for furnishing the high voltage direct plate current to the radio set is of the two-phase type. Primary power is 220 volts, 60 cycles, two phase, obtained from the works power plant. Four two-electrode tubes are used, two on each phase, as shown in the diagram Figure 5. The filaments of the rectifier tubes are connected in parallel and heated by 60-cycle power at 15 volts. The four rectifier tubes and associated apparatus have a maximum rated output direct potential of 10,000 volts. The characteristics of a rectifier tube are given in Figure 6. In appearance the rectifier is the same as the three-electrode tube shown under Figure 14 below, except that the grid is omitted.

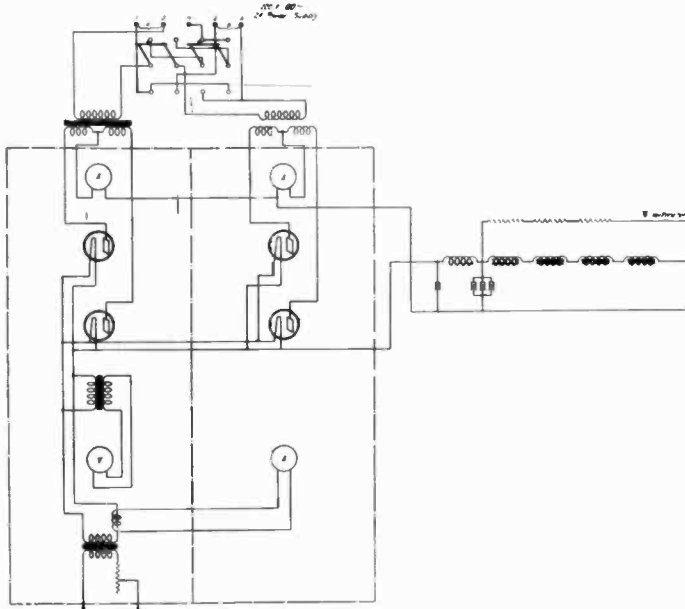

FIGURE 5—Two-phase Rectifier and Filter, circuit diagram

Each rectifier tube requires approximately 20 gallons of water per hour for cooling the plate, the water being fed into and away from the tubes thru  $\frac{1}{4}$  inch (0.6 cm.) inside diameter rubber tubing twenty feet (6 m.) in length placed in the form of a coil, as can be seen in Figure 4. The tubing is connected directly to the works water mains and drainage system. The resistance of these two columns of ordinary city water is approximately two megohms, giving a leakage loss of 5 milliamperes at 10,000 volts or 50 watts. The total leakage loss from rectifier and radio set is thus not over 500 watts, which is less than the power required to operate a circulating and cooling system insulated from ground. This construction as described materially simplifies the equipment.

Figure 7 shows a close-up of the rectifier panels. The instruments on the panels are direct current ammeter for each phase, filament voltmeter, and ammeter reading total filament current. The filament meters are operated thru insulating transformers, as the tube filaments may be at 10,000 volts potential above ground. The primary power supply is stepped up by two transformers the secondaries of which are connected to the rectifier tube plates, as shown in Figure 5. The direct current ammeters for each phase are placed in the return leads to each transformer.

Switches are provided so that the plate transformer primary voltage may be made 110, 154, or 220 volts by connecting to neutral and interphase voltage points for adjusting the plate voltage of the transmitter and thus its power output.

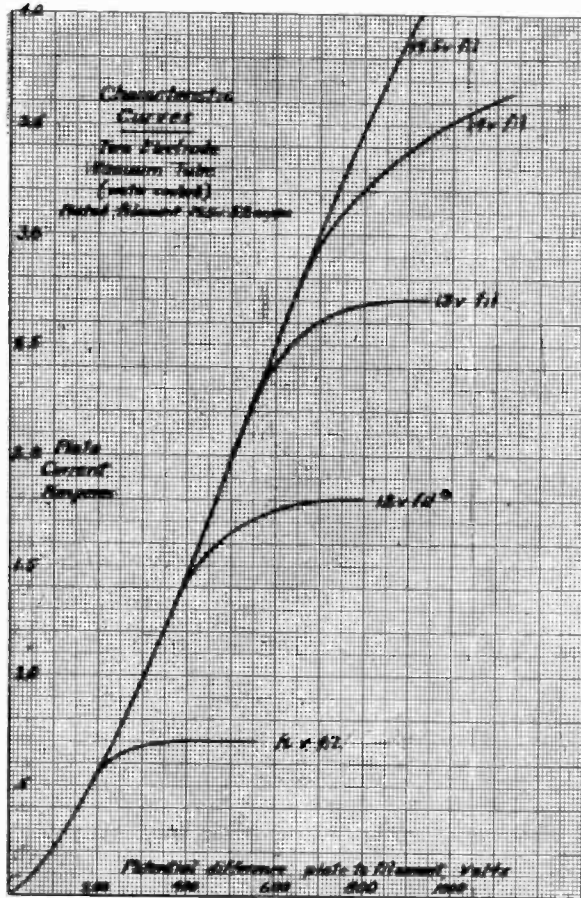

FIGURE 6

### FILTER

A single step filter is employed for reducing the ripple voltage in the output of the rectifier. This consists of a 20-henry inductance connected in series with the positive lead, together with 4-microfarad and 12-microfarad condensers connected from either side of the inductance to the negative line. The constant current choke is composed of four 20-henry inductances in series. Figure 8 shows the filter as installed. This combina.

tion of inductance and capacity leaves a ripple of less than 0.02 of 1 percent with the resonant frequency of the constant current choke coil and 12-microfarad condenser at 5.3 cycles, which is below the audio range.

The filter condensers deserve special mention in that it was necessary to design them for direct current operation. Four-

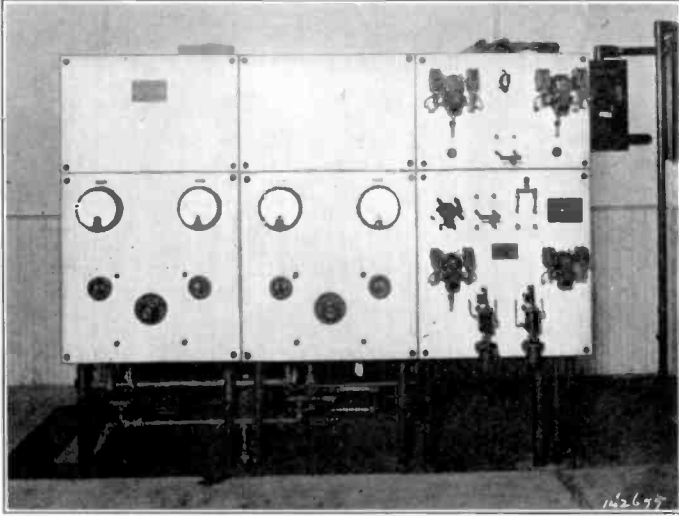

FIGURE 7—Two-phase Rectifier and Control Panels

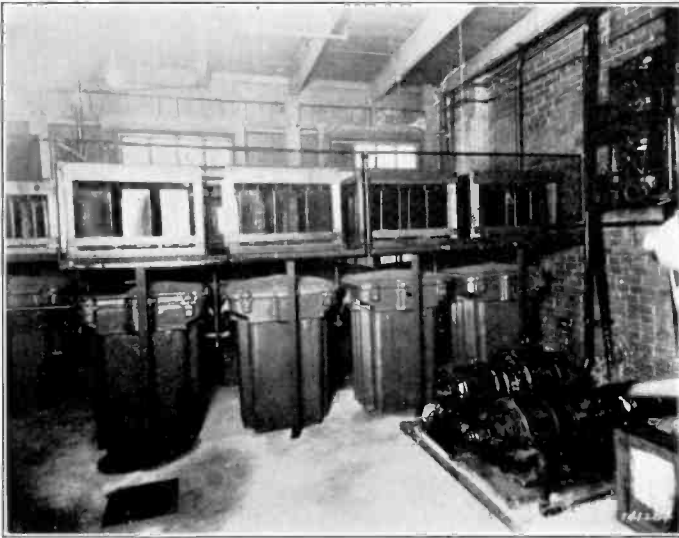

FIGURE 8—Filter Condensers and Choke Coils

microfarad units are employed, each unit consisting of twelve separate 3-microfarad 3,500-volt condensers connected so that there are four sets of three condensers in series across the line. In order to divide the voltage equally across each of the three condensers, resistances of 300,000 ohms are connected across the line and tapped at 100,000- and 200,000-ohm points to the condenser series connections. From the filter the plate current goes to the radio set.

### RADIO SET

Figure 9 shows a close-up view of the radio set panels and Figure 10 the circuit diagram. Four three-electrode vacuum tubes are used, two as modulators and two as oscillators. The filaments of these tubes are connected in series and heated by direct current from either of two duplicate motor generator sets.

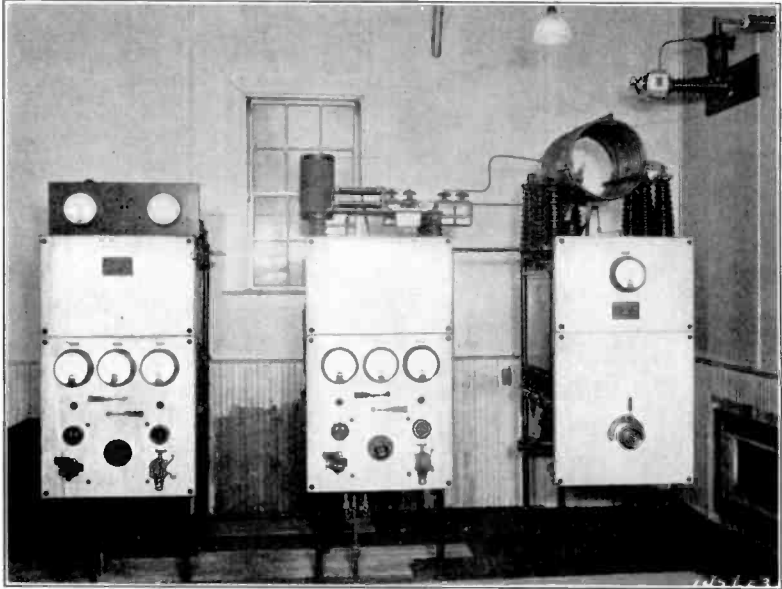

FIGURE 9—Number 3 Transmitter, Radio Panels

The oscillator tubes work into a primary radio frequency circuit, which in turn is loosely coupled inductively to the antenna.

### MODULATOR PANEL

The modulator panel is shown at the left in Figure 9. Because of the low impedance and relatively high static capacity of

the tubes it is necessary to take steps to prevent the occurrence of local or parasitic oscillations. The plate current is fed to the tubes thru a radio frequency choke coil with input at the center of the winding and one tube connected to each end. Radio frequency choke coils are also connected with each grid to a single 20,000-ohm resistor connected in turn to the speech input transformer. This arrangement effectively prevents oscillations taking place between the tubes themselves or in series with the tubes, the plate choke coil, the grid input transformer, and ground. A

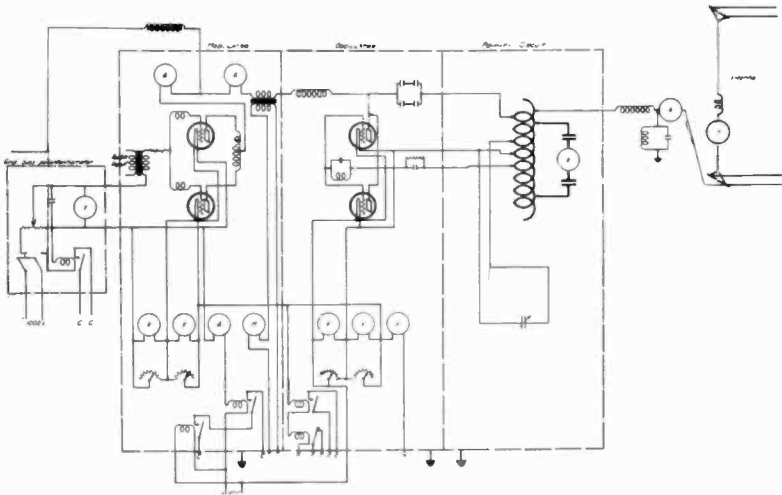

FIGURE 10—Number 13 Transmitter, K D K A, (Circuit diagram)

negative bias of 400 to 800 volts is required and is obtained from a small rectifier described below. Figure 11 shows the potentiometer employed for grid bias adjustment.

The modulator panel mounts filament voltmeters for each tube and rheostats for individual adjustment, modulation meter with its current transformer, and modulator and oscillator plate current meters which are of necessity connected in the positive direct current lead and hence mounted out of reach at the top of the panel. Water circulation indicators and control relays are also included. The modulator tubes each require 20 to 50 gallons of water per hour, depending upon the power used.

Cooling water for all tubes is obtained from a 100-gallon atmospheric pressure tank placed 20 feet (6 m.) above the tubes and supplied thru float valves from two separate water systems.



## OSCILLATOR PANEL

Figure 9 shows the oscillator panel in the center. The two tubes are mounted as before. Grid condenser and leak, plate coupling condenser, and radio frequency choke coil are mounted at the top of the panel as shown. The panel itself mounts fila-

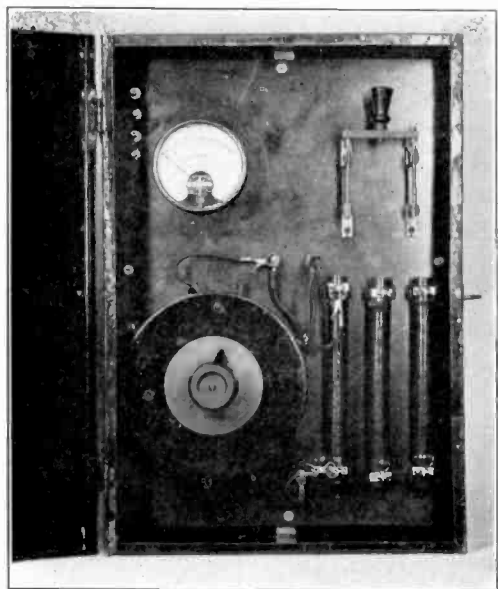

FIGURE 11—Potentiometer for Adjusting Modulator Grid Bias

ment voltmeters for each tube and plate voltmeter, together with water flow indicators and control relays. A choke circuit in series with the tube grids prevents parasitic oscillations. For cooling the oscillator tubes, 15 to 30 gallons of water each per hour is required.

The vacuum tubes employed as modulators and oscillators are of Westinghouse development and design. Figure 12 gives a photograph of a three-electrode tube. With a water circulation of 50 gallons per hour one tube will safely dissipate 6 kilowatts from its plate in addition to the filament energy of 750 watts. This tube is designed for a plate potential of 10,000 volts. At a plate efficiency of 66 percent 10 kilowatts output may be obtained. Figure 13 shows static characteristic curves. The alternating current plate impedance is 2,000 ohms, the amplification constant 13, and the saturation filament emission 8 amperes.

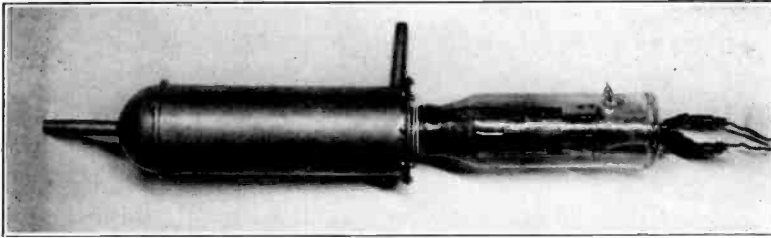

FIGURE 12—Three-Electrode Water-cooled Tube

#### PRIMARY CIRCUIT PANEL

The primary circuit panel is shown at the right in Figure 9. The circuit consists of two 0.001-microfarad oil dielectric condensers connected in series, and an inductance which may be seen above the panel. The condenser series connection provides a point of approximately ground potential for the circulating current ammeter shown mounted on the panel. A variable air condenser of 200 micro-microfarads maximum capacity is connected across two turns of the inductance and provides for vernier tuning of the primary circuit to 920 kilocycles (326 meters). Grid, plate, and ground taps are made from the inductance to the oscillator panel and coupling tap to the antenna.

#### ANTENNA

The radiating system is of the inverted L type, consisting of duplicate antenna and counterpoise shown in Figure 14. The antenna is made up of two round cages 170 feet (52 m.) long, 8 inches (20 cm.) diameter of eight number 14 wires\* each, supported on spreaders 20 feet (6.1 m.) apart at a height of 90 feet (27.5 m.) above the station and 210 feet (64 m.) above the ground. The station end is supported by a steel mast 90 feet (27.5 m.) above the station roof, while the opposite end is attached to a brick smokestack. Separate ropes from each cage run over pulleys and down the sides of the stack with counterweights attached at the lower ends thus giving a uniform tension on the cages at all times. The counterpoise is of the same size and construction placed 110 feet (33.6 m.) below the antenna. A cage type down-lead is connected to the station end of the antenna and is made up of sixteen number 14 copper wires on 3-inch (7.6 cm.) diameter spacers. The down lead runs directly to a small inductance located on the roof of the station, the circuit continuing from a flexible tap on the inductance to the

\*Diameter of number 14 wire = 0.064 in. = 0.163 cm.

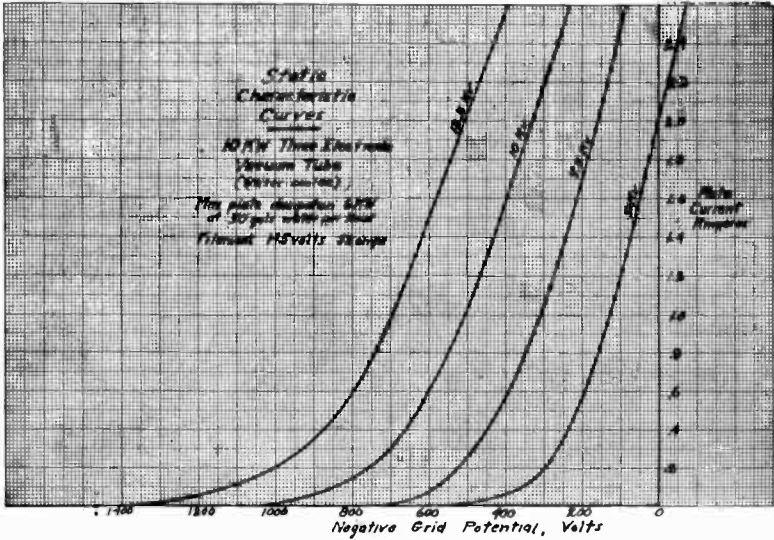

FIGURE 13

antenna ammeter, and thus through a similar cage lead to the counterpoise. It will be noted that the circuit carrying the antenna current does not enter the station. Energy is supplied to the antenna through a coupling lead attached to the station end of the counterpoise. The radiating system is tuned approximately to a frequency of 920 kilocycles (326 meters wave length).

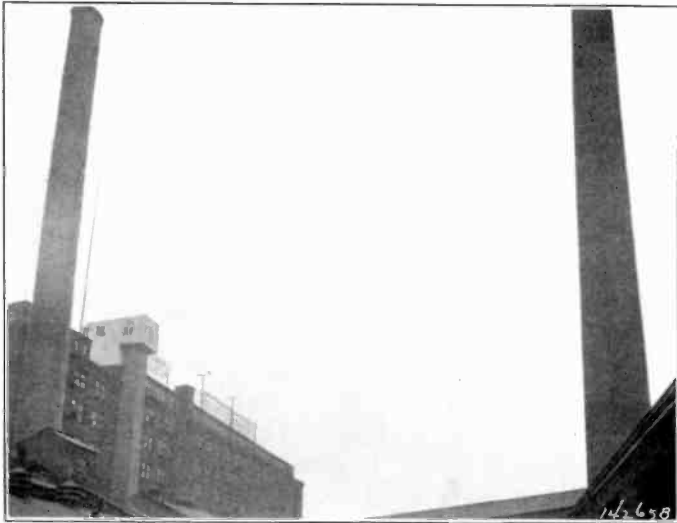

FIGURE 14—Antenna and Counterpoise

The antenna coupling lead is connected to the primary circuits of any of the three transmitters thru inductance coils, the coil for number 3 set being shown at the upper right in Figure 9. The reason for employing an inductance in place of the usual coupling condensers for this purpose is to reduce the harmonics radiated from the coupling lead. The coupling condenser offers less impedance to a harmonic than to the fundamental frequency, whereas the inductance offers a greater impedance, the inductance giving four times the impedance of the condenser at double the fundamental frequency, nine times at triple frequency, and so on. In order still further to reduce the harmonic radiation, a parallel resonant circuit tuned to 920 kilocycles is connected between the coupling lead and ground, thus acting as a shunt to all frequencies except the fundamental of 920 kilocycles. The antenna system at KDKA has a total effective resistance of 16 ohms at 920 kilocycles.

#### FREQUENCY STANDARD

With the large number of broadcasting stations operating at present, having assigned frequencies within ten kilocycles of each other, it is absolutely necessary that the radiated frequencies be correct to within 0.1 of 1 percent with practically no variation from night to night. A frequency standard for station use has been developed which allows this close regulation to be obtained. Figure 15 shows the external appearance and internal construction of the meter and Figure 16 the resonance curve for one of the meters used at KDKA, which is set for a frequency of 920 kilocycles. It will be seen that an adjustment of less than 1 kilocycle in 920 may be obtained. These frequency standards are designed to be adjusted to the frequency assigned to the station where they are to be used and sealed at the Bureau of Standards. All of KDKA's transmitters are provided with vernier tuners and frequency standards to enable precision adjustment.

#### CONTROL

Number 3 transmitter is started and stopped by push buttons located on the attendant's desk, the operator's desk, or the control panel, thru contractors on the control panel shown in Figure 7. The attendant's desk may be seen in Figure 4. The operation of starting number 3 set for a program is as follows:

The station attendant makes an inspection of the set and then presses the water-control button, which by means of an electric-

ally operated valve turns on the cooling water to all tubes. When the water pressure comes up to normal, a green signal lamp is lighted at all control stations. The operator may then start the set by pressing the power button. The plate current cannot

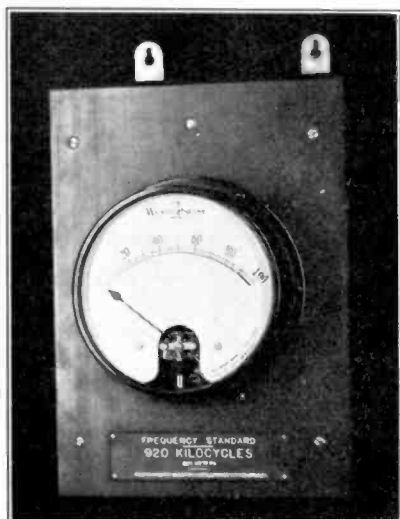

FIGURE 15A—Frequency Standard, interior

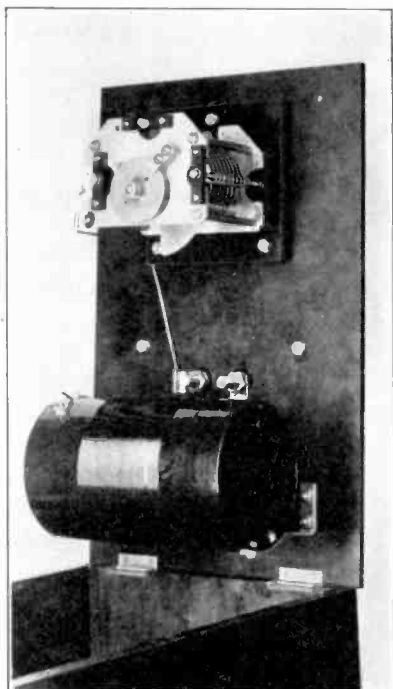

FIGURE 15B—Frequency Standard, exterior

be applied unless the water is on. Pressing of the power button at any control station starts the motor of the filament-heating motor generator set. When the filament generator has built up and the radio set filaments are lighted, a voltage relay closes a contact, which in turn closes contactors on the control panel, turning on the rectifier filaments and primary of the plate transformers. The radio set starts as soon as plate voltage is obtained from the rectifier and filter. When the primary of the plate transformers are connected to the line a red signal light appears at all control stations. The negative lead from the rectifier is connected thru an overload relay on the oscillator panel which opens the control circuit and shuts down the set in case the plate current exceeds a safe value. In case of filament

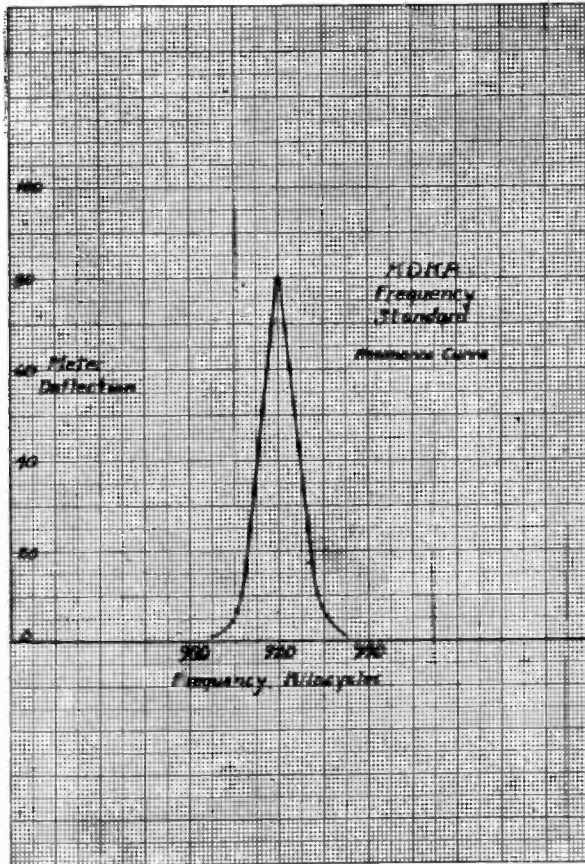

FIGURE 16

failure of one of the radio set tubes, all the filaments cease to burn because of the series connection. To prevent the plate voltage rising to abnormal value, a relay with coil in series with the filaments opens the control circuit and shuts down the rectifier and plate supply. In case the water supply fails, the set is also automatically shut down. The set is normally stopped by pressing the stop button for either water or power at any control station. This interlocked control system protects the vacuum tubes from injury and prevents mistakes on the part of the operators. Figure 17 shows a schematic diagram of the arrangement.

#### GRID BIAS AND AMPLIFIER PLATE VOLTAGE RECTIFIERS

Figure 18 shows two full-wave rectifiers and filters mounted in one frame. One supplies grid bias voltage for sets

2 and 3, and the other power for the 50-watt speech amplifiers described below. Two 0.25-ampere glass rectifier tubes are used in each, the grid bias requiring approximately 1,000 volts direct current and the amplifiers 2,000 volts at the rectifiers. These rectifiers are started automatically by contactors from the control circuits of sets 2 and 3. As auxiliary supply, a small motor generator set is available for grid bias, while the amplifiers may obtain their plate current from the 2,000 volt generators connected with set 1.

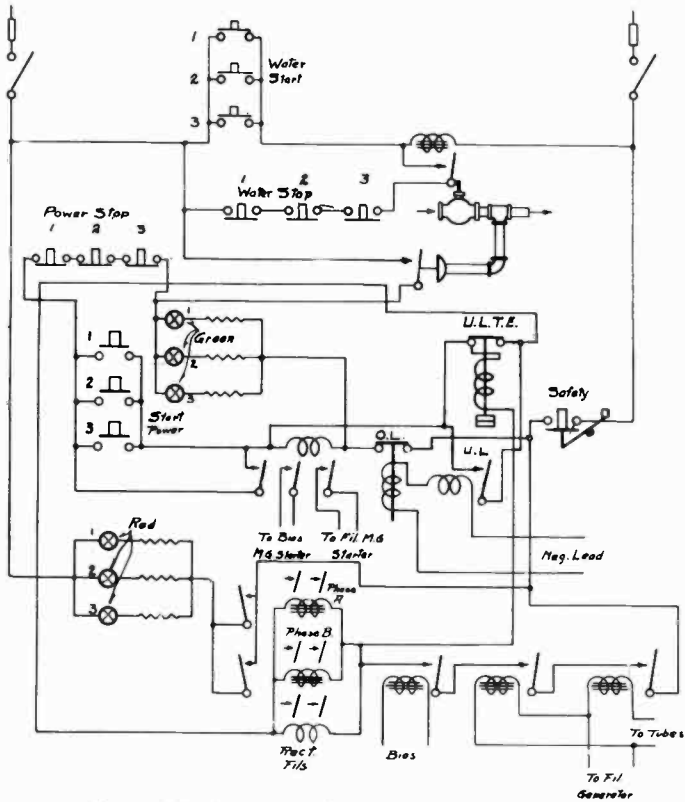

FIGURE 17—Number 3 Transmitter Control System

### AUDIO SYSTEM

Two outside telephone lines, the "Pittsburgh Post" studio line and the East Pittsburgh studio line, terminate at the station operator's desk. The audio frequency circuits are shown by light solid lines in Figure 2. The station operator is in complete control of the station from this desk.

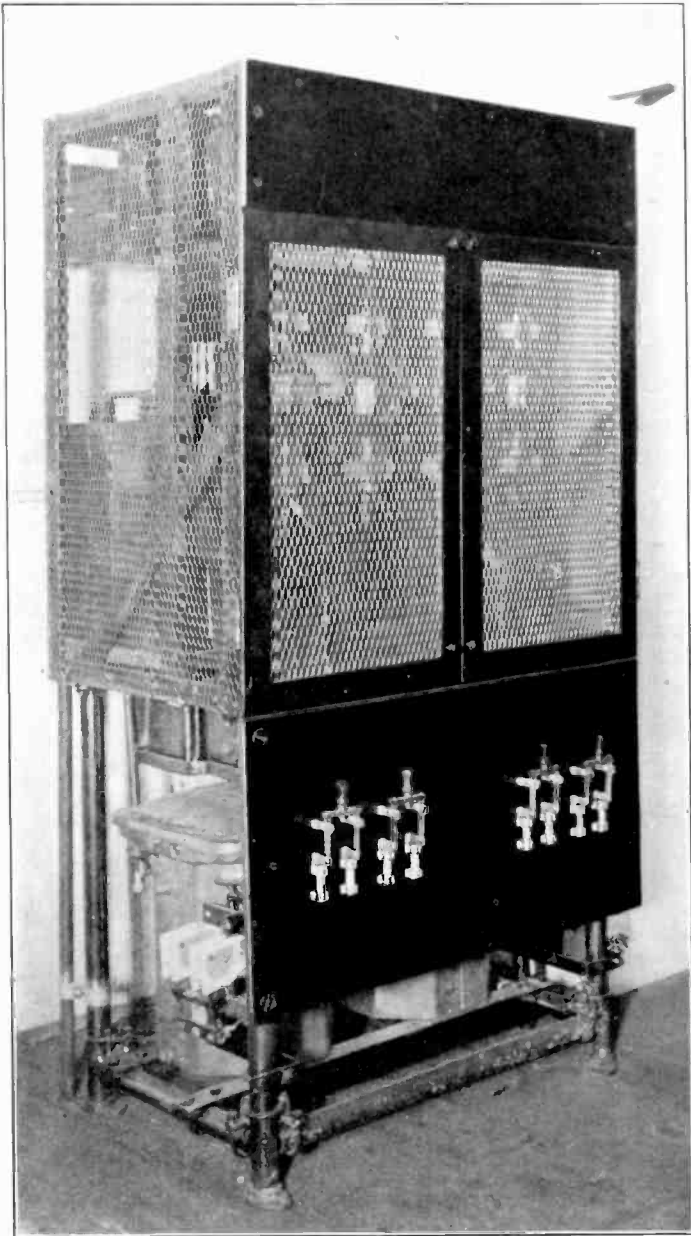

FIGURE 18—Rectifiers, Supplying Modulator Grid Bias and Amplifier Plate Voltages



He may switch any line to any set, start and stop any set, and control the amount of modulation as indicated by the modulation meters at the desk. The operator may also, by means of switches and head receivers, listen in on any line, listen to the output of any amplifier, or by means of a crystal receiving set, listen to the radio output. Centralizing the control in this manner has been found to eliminate mistakes and generally improve the operation of the station.

The audio amplifier for set 2 consists of a 5-watt push-pull stage and a 50-watt push-pull stage, all transformer coupled. The number 3 set has a similar amplifier arrangement and also a 50-watt push-pull first step, and 100-watt push-pull second step which may be used in place of the 5- and 50-watt combination.

Figure 19 gives a photograph of the 50-100-watt amplifier. Storage batteries are provided in duplicate giving voltages of 200 for the 5-watt plates and 12 volts for the 5-watt and 50-watt filaments.

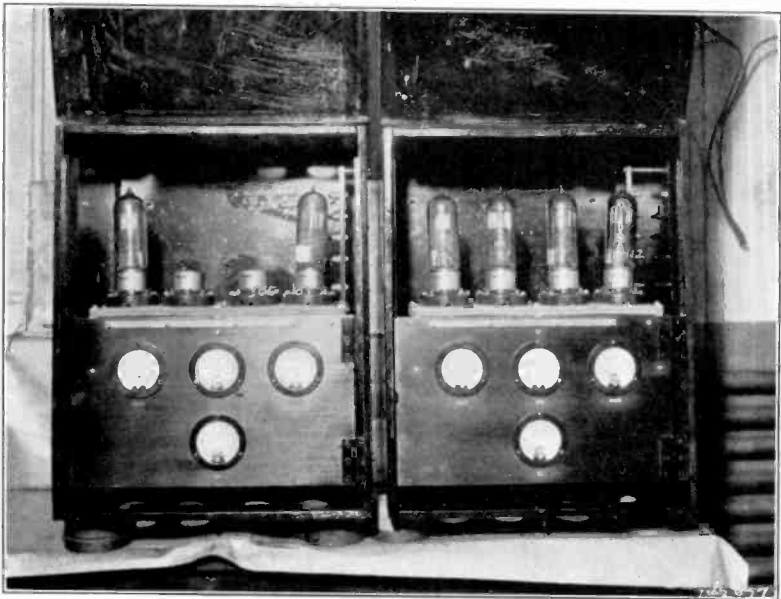

FIGURE 19—50-100-watt Speech Amplifier

#### STUDIO EQUIPMENT

Figure 20 shows the interior of the studio at the "Pittsburgh Post." Double carbon button and condenser type microphones are provided, each with its separate amplifier. Figures 21 and 22

show the three-stage push-pull amplifier employed with the condenser microphone, and Figure 23 the control desk and amplifier for carbon microphones. A ventilated compartment contains



FIGURE 20—"Post" Studio, interior view

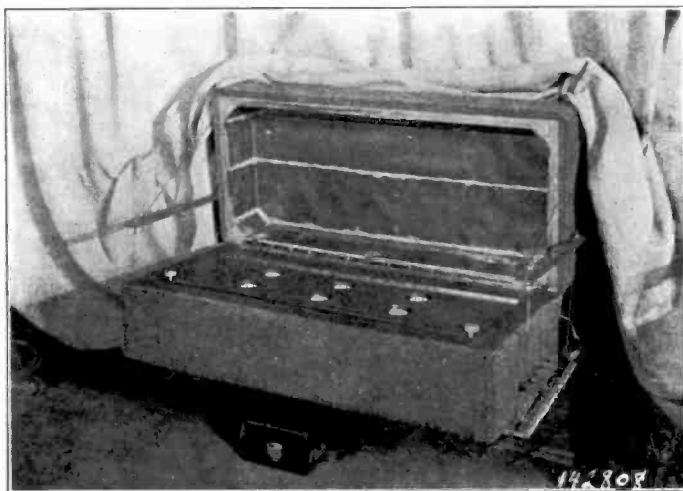

FIGURE 21—Three-stage Push-pull Amplifier, exterior

duplicate 8-volt and 200-volt storage batteries for amplifier plate and filament power.

Figure 24 shows the East Pittsburgh studio where a glow microphone,<sup>2</sup> as well as condenser and double carbon microphones

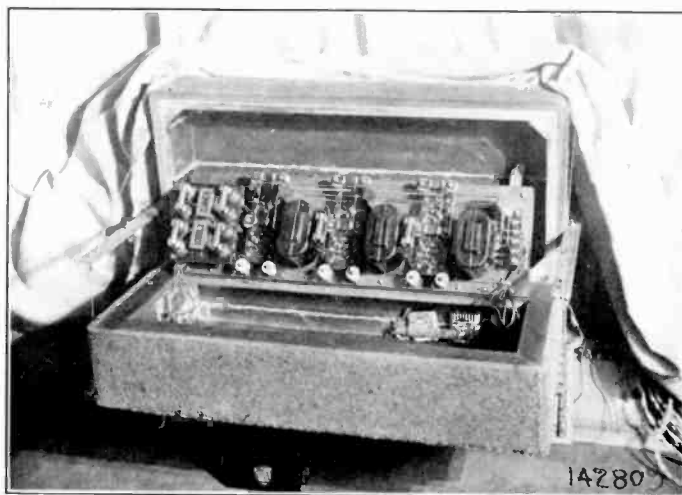

FIGURE 22—Three-stage Push-pull Amplifier, interior

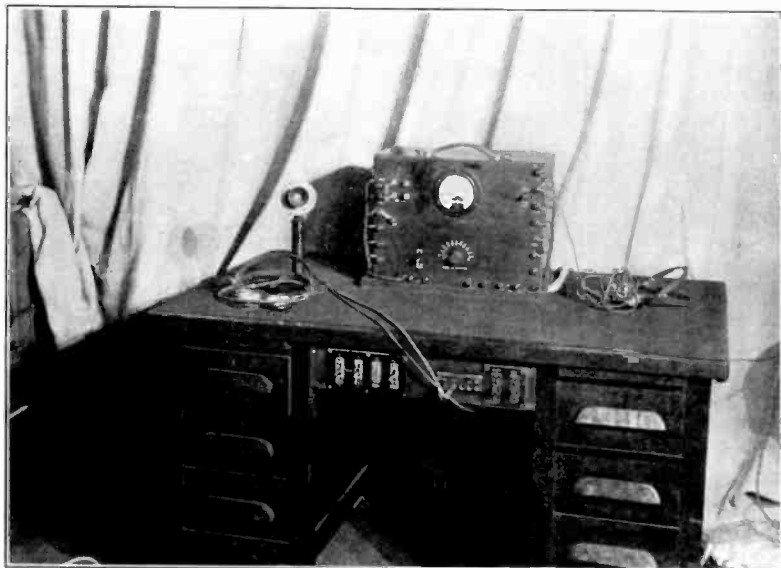

FIGURE 23—"Post" Studio Control Desk and Portable Amplifier

<sup>2</sup> For description, see "Journal of the American Institute of Electrical Engineers," volume XLII, number 3, page 219; March, 1922.

are installed. The studio operator sits at a control desk, upon which are mounted the necessary amplifier change-over switches, signal lights, and modulation meter connecting with the station. There are 200-volt and 8-volt storage batteries with charging apparatus, which are permanently installed in an adjoining room.



FIGURE 24—East Pittsburgh Studio, interior view

#### OUTSIDE PICK-UP APPARATUS

One type of portable amplifier employed at churches, ball parks, and other outside locations is shown on the desk in Figure 23. Double carbon button microphones are generally used, as many as eight being provided in the case of a large church. Figure 25 shows the amplifier and microphone switches at Calvary Church, Pittsburgh. An operator switches in the appropriate microphone for various parts of the service. For semi-permanent installations, such as the Grand Theatre, condenser microphones and suitable amplifiers are employed.

#### CONCLUSION

It is believed that KDKA, as described above, is at the present time second to no broadcasting station in the world. In point of area covered, as shown by letters and telegrams received,

KDKA is regularly heard at night in all parts of the United States, in England, France, and Belgium. Several letters have also been received from South America and the Hawaiian Islands. The daylight range covers that part of the United States east of the Mississippi River.

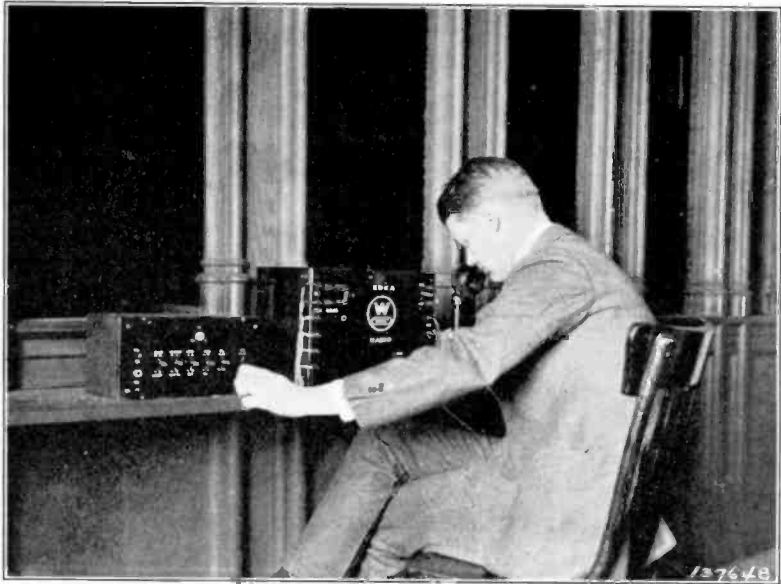

FIGURE 25—Amplifier and Microphone Control Switch at Calvary Church, Pittsburgh

The future of radio broadcasting as a public service depends to a large extent upon the quality of programs and of reproduction, together with the reliability of the transmitting stations. With the equipment described above it is believed that the service rendered by KDKA is a step in the right direction.

**SUMMARY:** The three transmitting sets used at East Pittsburgh are described in detail, together with their auxiliary apparatus.

## ON OPTIMUM HETERODYNE RECEPTION\*

BY

E. V. APPLETON, M.A., D.Sc..

AND

MARY TAYLOR

(CAVENDISH LABORATORY, CAMBRIDGE)

The reception of continuous-wave signals is nowadays carried out almost exclusively by the heterodyne method. In the ordinary applications of this method two oscillations are produced in the receiving assembly, one the result of the continuous-wave signal and the other by means of a local generator of constant frequency. The frequency of the local generator is so adjusted that the difference of local and received frequencies is well within audible range. If the receiving assembly were such that the effects of both local and received electromotive forces were strictly proportional to their magnitudes, that is, if the relations thruout were linear, the two oscillations would produce beats of audio frequency, but these would provoke no telephone response since the carrier wave would still be of radio frequency. It is only when the action of the receiving assembly is non-linear that the two oscillations give rise to a combination tone of frequency  $(n_1 - n_2)$ , equal to the difference of the two component frequencies  $n_1$  and  $n_2$ . This combination tone gives rise to the telephonic signal. It may also be noticed, in passing, that the production of a combination tone of frequency  $(n_1 - n_2)$  is necessarily accompanied by the production of a radio frequency combination tone of frequency  $(n_1 + n_2)$ .

Helmholtz's theory of combination tones is thus directly applicable to our problem with this difference that, whereas in the systems he considered, the non-linearity occurred in the restitution forces, in the heterodyne problems we are considering non-linearity is introduced by the use of resistances which do not obey Ohm's law. Resistances commonly used for this purpose are the contacts of dis-similar crystals or vacuum tube devices.

\*Received by the Editor, November 10, 1923.

In radio practice there are two methods of carrying out this production of combination tones. In one of these the generator producing the local oscillations is distinct from the detector circuit (separate heterodyne). In the other method the local oscillation is generated in the receiver itself and the non-linear properties of the latter are to a certain extent determined by the amplitude of this oscillation (autoheterodyne). Only the former of these methods will be considered here.

The practical advantages accruing from the use of the separate heterodyne method are well known, but to a certain extent practice has outdistanced theory. The chief relation of both practical and theoretical interest is the dependence of the amplitude of the combination tone on the amplitudes and frequencies of the component oscillations. The practical results in this connection were first obtained by E. H. Armstrong<sup>1</sup> whose experimental curves showed that the magnitude of the combination tone reached a maximum value as the electromotive force induced in the receiver from the local generator was increased. The ratio of the maximum amplitude of combination tone (optimum heterodyne) to that obtained when the received and local amplitudes were of equal magnitude (equal heterodyne) was found to depend on the signal strength, being sometimes as high as 55. Armstrong's results were thus at variance with the theoretical treatment due to Liebowitz,<sup>2</sup> whose work suggests that the greatest amplification obtainable by the use of the heterodyne method should be four times that obtained without heterodyne. The theory developed in the present paper shows that Armstrong's results are to be expected if the non-linear theory is properly applied and suggests other results which agree with data obtained experimentally.

The quantitative results of Armstrong<sup>3</sup> were obtained using cumulative grid rectification, but the optimum heterodyne phenomenon is to be found, tho sometimes not so marked, when anode rectification is used. We shall therefore deal with the quantitative aspects of both methods, but, since it happens that both the physical phenomena and the analysis are somewhat simpler in the case of anode rectification, we shall deal with that method first.

<sup>1</sup> PROCEEDINGS OF THE INSTITUTE OF RADIO ENGINEERS, volume 5, page 145, 1917.

<sup>2</sup> PROCEEDINGS OF THE INSTITUTE OF RADIO ENGINEERS, volume 3, page 185, 1915.

<sup>3</sup> Previous citation.

## A—ANODE RECTIFICATION

The most direct method of using the triode for the production of combination tones is that in which the electromotive forces due to the local and received oscillations are impressed between the grid and filament of the tube while the presence of the combination tones is indicated by the response of a telephone receiver  $T$  in the anode circuit. (See Figure 1.)

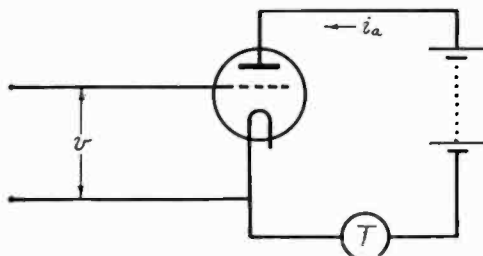

FIGURE 1

Recognizing the fact that combination tones in the telephone are only produced when the relation between the grid potential  $v$  and the anode current  $i_a$  is non-linear, let us assume that the relation between these quantities may be represented by a power series thus:

$$i_a = a_0 + \alpha v + \beta v^2 + \gamma v^3 + \delta v^4 + \dots \quad (1)$$

Let us represent the magnitudes of the local and received oscillatory electromotive forces by  $a \sin \omega_1 t$  and  $b \sin \omega_2 t$ , respectively. Thus if we choose as our origin of time the instant when the two oscillations are in phase we have

$$v = a \sin \omega_1 t + b \sin \omega_2 t \quad (2)$$

To find the amplitude  $A$  of the combination tone of angular frequency  $(\omega_1 - \omega_2)$  we must substitute the expression for  $v$  from (2) in (1), and, after expanding the expression for  $i_a$  as a Fourier series pick out the terms involving  $\sin (\omega_1 - \omega_2) t$  and  $\cos (\omega_1 - \omega_2) t$ . On doing this it is found that only the even terms (e.g.,  $\beta v^2$ ,  $\delta v^4$ ,  $\zeta v^6$ , and so on) of (1) contribute to the expression for  $A$ . Thus if the power series is limited to the first three terms we have

$$A = \beta a b \quad (3)$$

while if it is limited to five terms we have

$$A = \beta a b + \frac{3}{2} \delta a b (a^2 + b^2) \quad (4)$$

and so on.



If the triode is such that its characteristic may be represented by the first three terms of the power series we see from (3) that the stronger we make the local heterodyne oscillation the stronger becomes the combination tone, and thus no optimum effects are to be expected. With normal triodes, however, the electron emission from the filament is limited, and the anode current tends to saturation values as the grid potential is increased. Thus a three-term series is obviously inadequate. If a five-term series is used for  $i_a$  we find, on differentiating (4) with respect to  $a$ , that  $A$  passes thru a maximum value when

$$a^2 = a_o^2 = -\frac{2\beta}{9\delta} - \frac{b^2}{3} \quad (5)$$

For the combination tone to pass thru a maximum value as the magnitude of the local oscillation is increased it is thus seen that  $\beta$  and  $\delta$  must have opposite signs. An examination of the characteristics of typical triodes shows that this condition is normally fulfilled,  $\beta$  being positive and  $\delta$  negative. Thus, in general, we see that for anode rectification there is an optimum value of the combination tone for a particular value of the electromotive force impressed on the receiver by the local oscillator and that this optimum local electromotive force depends on the characteristics of the triode and also, to a certain extent, on the magnitude of the signal electromotive force.

In view of what has just been said with regard to the sign of  $\beta$  and  $\delta$  in (1) we shall, to avoid confusion, rewrite it as follows

$$i_a = a_o + a v + \beta v^2 + \gamma v^3 - \delta v^4 + \dots \quad (1A)$$

The equation (1A) will be used in the remainder of the paper.

The optimum value  $A_o$  of the combination tone may be obtained by substituting for  $a^2$  from (5) in (4), but the results are simpler if an approximation, consistent with the conditions of actual practice, is first made. Thus in a normal case the local oscillation amplitude  $a$  is usually large compared with the signal amplitude  $b$  and thus we may neglect  $b^2$  in comparison with  $a^2$ . From (4) and (5) we find in this way

$$a_o^2 = \frac{2\beta}{9\delta}, \quad (5A)$$

and

$$A_o = b \left( \beta a_o - \frac{3}{2} \delta a_o^3 \right). \quad (6)$$

The practical significance of these results may be stated in words as follows:

(5a) The magnitude of the local oscillation for optimum heterodyne is independent of the strength of the received signal if the latter is small. This is in agreement with Armstrong's experimental data.<sup>4</sup>

(6) The magnitude of the combination tone or signal is directly proportional to the strength of the received signal oscillation when the strength of the local oscillation has been adjusted for optimum heterodyne.

To get an idea of the magnitude of the quantities we are dealing with it is necessary to determine the values of  $\beta$  and  $\delta$  in (1A) for a typical case. To determine these from the ordinary triode characteristics is a laborious matter, and a simpler alternative method has been devised. If we apply a sinusoidal electromotive force between the grid and filament and note the relation between the amplitude  $a$  of the applied electromotive force and the mean anode current  $\bar{i}_a$  we obtain a characteristic from which the values of  $\beta$  and  $\delta$  may be more directly deduced. For from equation (1A) we see that when  $v$  is equal to  $a \sin \omega_1 t$  we have

$$\bar{i}_a = \frac{\beta a^2}{2} - \frac{3}{8} \delta a^4, \quad (7)$$

an expression not involving  $\alpha, \gamma, \epsilon$ , and so on. Such a mean current characteristic illustrating the relation between  $\bar{i}_a$  and  $a$  for a triode is shown in Figure 2, from which it is obvious that  $\beta$  and  $\delta$  as defined in (1A) are of the same sign. On the same diagram is shown an analogous characteristic for a crystal detector in which the mean current  $\bar{i}$  thru the detector is shown as a function of the amplitude of the sinusoidal electromotive force across the detector. The characteristic is seen to be very similar to that of the triode. Both relations were determined experimentally, using low frequency electromotive forces derived from a resistance potentiometer.

The mean current characteristic of the triode is seen to have a point of maximum slope at  $Z$ . The appropriate value of  $a$  for this point may be found from (7) by differentiating twice with respect to  $a$ . Thus  $\frac{d\bar{i}_a}{da}$  is a maximum when

$$a^2 = \frac{2\beta}{9\delta}$$

We note, however, from (5A) that this is the value of  $a$  for

<sup>4</sup>Armstrong, previous citation, Figure 4, page 152. See also Austin and Grimes, "Wash. Acad. Sci.," March 19, 1920.

optimum heterodyne and we thus see that when the received signal is very small the value of the local oscillation amplitude should be adjusted to the value represented by  $OX$ , where the slope of the mean anode current characteristic is a maximum.

In a case where the received signal is not small the more accurate formula must be used, the optimum value of  $a$  being given by (5), and the corresponding amplitude of the combination tone by (4).

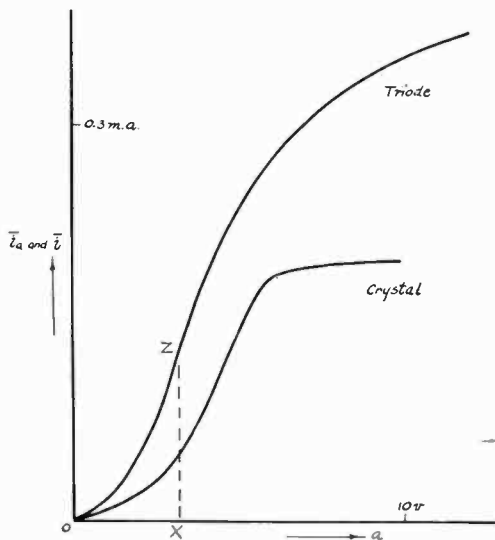

FIGURE 2

It is a simple matter now to state exactly how sensitive heterodyne reception really is. For example, if the signal is small, we see that the current of the combination tone deduced from (5A) and (6) is given by

$$A_o = \frac{2}{3} \beta a_o b,$$

or 
$$A_o = \frac{2\sqrt{2}}{9} \frac{\beta^3}{\delta^3} b \quad (9)$$

On substituting the appropriate values of  $\beta$  and  $\delta$  for the characteristic of Figure 2 (triode) we find that

$$A_o = 6.5 \times 10^{-2} \text{ m.a. per signal volt.}$$

To illustrate the extraordinary sensitivity of the heterodyne method when the local oscillation amplitude is adjusted for

optimum conditions, we may compare the optimum value of the combination tone with that obtained in the case of equal heterodyne when  $a$  is equal to  $b$ . It will be seen later that such a comparison is in effect a true comparison of the sensitivity of a triode receiver for continuous-wave signals and spark (or completely modulated wave) signals, since the signal strength obtained with equal heterodyne is equal to that obtained with spark or modulated wave signals of the same intensity. From (4) we see that the amplitude of the combination tone ( $A_E$ ) for equal heterodyne is given by

$$A_E = \beta b^2 - 3 \delta b^4$$

or, when  $b^2$  is small by

$$A_E = \beta b^2$$

We thus find that

$$\frac{A_o}{A_E} = \frac{2\sqrt{2}}{9} \sqrt{\frac{\beta}{\delta}} \cdot \frac{1}{b}, \quad (11)$$

from which it is seen that the advantages accruing from the use of the optimum heterodyne method are more marked the smaller the received signal.<sup>5</sup> To give definiteness to this statement we have calculated the ratio of the optimum heterodyne signal to that obtained with equal heterodyne (or spark or modulated wave signal) for a triode and various strengths of received signal. These are tabulated below.

$b$ (volt)	$\frac{A_o}{A_E}$	Formula
$\frac{1}{10}$	21	
$\frac{1}{50}$	105	$\frac{A_o}{A_E} = \frac{2\sqrt{2}}{9} \sqrt{\frac{\beta}{\delta}} \cdot \frac{1}{b}$
$\frac{1}{200}$	420	where
$\frac{1}{1000}$	2100	$\beta = 0.0308 \frac{m. a.}{(volts)^2}$
$\frac{1}{5000}$	10200	$\delta = 0.00069 \frac{m. a.}{(volts)^4}$

<sup>5</sup> Compare Armstrong's experimental results, previous citation, Figure 2, page 149.

The amplification obtainable by the use of optimum heterodyne may thus be enormous.

### B—CUMULATIVE GRID RECTIFICATION

As this method of rectification has not previously been the subject of a complete quantitative investigation we propose to deal with the matter fairly thoroly. The main experimental features of this method are that a condenser of small capacity is inserted in the grid circuit of a triode assembly while a high resistance leak is connected in parallel with the grid-filament path. (See Figure 3.) High frequency (radio frequency) potential changes are applied between the points *A* and *B* while the resulting low frequency (audio frequency) effect is detected in the anode circuit. The low-frequency effect may take the form of a diminution of the mean anode current, in which case some form of automatic recorder is used, or it may take the form of the production of combination tones by a telephone inserted in the anode circuit.

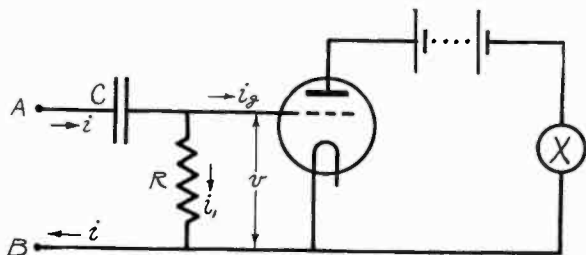

FIGURE 3—Showing Essential Features of Cumulative Grid Rectification Circuit. X is Automatic Recorder or Telephone

Let us denote the high-frequency electromotive force applied between *A* and *B* as *E*, and let the grid potential and grid current be denoted by *v* and *i<sub>g</sub>*, respectively. Let also the current thru the condenser *C* be denoted by *i* and that thru the resistance by *i<sub>1</sub>*. The expression of Kirchoff's laws is therefore

$$v = R i_1 = E - \int \frac{i}{C} dt, \quad (12)$$

and 
$$i = i_1 + i_g \quad (13)$$

Let us assume that the relation between the grid current and grid potential is not linear but may conveniently be expressed in the form of a power series thus

$$i_g = f(v) = a_1 v + \beta_1 v^2 + \gamma_1 v^3 + \dots \quad (14)$$

where *a*<sub>1</sub>, *β*<sub>1</sub>, *γ*<sub>1</sub>, and so on, are constants for the particular

triode, filament temperature, and anode voltage used. It may here be noted that we are neglecting the small and constant current which flows thru the grid circuit and the resistance  $R$ , and which would be represented by a constant term in the expression for  $i_g$ . If, however, we take as the zeros of current and potential those existing in the absence of signals, the expression (14) may be regarded as generally valid.

The result of eliminating  $i$ ,  $i_1$ , and  $i_g$  from (12) and (13) is

$$\frac{dv}{dt} + \frac{f(v)}{C} + \frac{v}{CR} = \frac{dE}{dt}, \quad (15)$$

a differential equation of a generalized Riccati type which represents the action of the grid condenser. The approximate solution of this equation when  $E$  has different forms, representing different types of impressed signal, must be investigated. For examples we shall consider the following cases of practical importance.

(1) The reception of continuous waves without heterodyne. In this case the impressed force between the points  $A$  and  $B$  is sinusoidal and we thus write

$$E = b \sin \omega t \quad (16)$$

(2) The reception of modulated continuous waves. In this case the alternating electromotive force of angular frequency  $\omega$  is modulated with an angular frequency  $p$  and we write

$$E = b(1 + \sin pt) \sin \omega t \quad (17)$$

(3) The reception of continuous waves by the heterodyne method. In this case the impressed electromotive force consists of a received signal of angular frequency  $\omega_2$  and a constant and local oscillation of angular frequency  $\omega_1$ . Thus

$$E = a \sin \omega_1 t + b \sin \omega_2 t \quad (18)$$

We shall consider these three cases in the order mentioned, and, as a first approximation, we shall limit the power series of (14) to the first two terms which are sufficient to enable us to explain the outstanding physical phenomena.

#### RECEPTION OF CONTINUOUS WAVES WITHOUT HETERODYNE

In this case the representative differential equation becomes (See (14), (15), and (16))

$$\frac{dv}{dt} + \left( \frac{1}{RC} + \frac{a_1}{C} \right) v + \frac{\beta_1 v^2}{C} = b \omega \cos \omega t \quad (19)$$

Let us suppose, as is usually the case in practice, that the

term involving  $\beta$  is small, and that, as a first approximation, it may be neglected. Omitting this term the solution of (19) for the steady state is

$$v = \frac{b \omega}{\sqrt{\omega^2 + \frac{q^2}{C^2}}} \cos(\omega t - \phi)$$

where  $\tan \phi = \frac{\omega C}{q}$ , and  $q = \frac{1}{R} + a_1$ .

On substituting this value for  $v$  in the non-linear term involving  $\beta_1$  in (19) the approximate representative equation takes the form

$$\frac{dv}{dt} + \frac{q}{C} v + \frac{\beta_1}{2C} \left( \frac{b^2 \omega^2}{\omega^2 + \frac{q^2}{C^2}} \right) \{1 + \cos 2(\omega t - \phi)\} = b \omega \cos \omega t. \quad (20)$$

The solution of (20) for the steady state consists of three parts

(1) a constant term  $v = -\frac{\beta_1}{2q} \left( \frac{b^2 \omega^2}{\omega^2 + \frac{q^2}{C^2}} \right)$ ,

(2) a term of angular frequency  $\omega$  given by

$$v = \frac{b \omega}{\sqrt{\omega^2 + \frac{q^2}{C^2}}} \cos(\omega t - \phi),$$

and (3) a term of angular frequency  $2\omega$  the magnitude of which is proportional to  $\beta_1$ .

The first of these is of special interest, for it shows that, when a sinusoidal electromotive force is applied to the assembly, the mean grid potential is reduced by an amount proportional to the square of the amplitude of the applied electromotive force. This reduction of mean grid potential produces a diminution of mean anode current by means of which the presence of the high frequency signal is detected or measured.<sup>6</sup>

#### RECEPTION OF COMPLETELY MODULATED WAVES

In this case the representative equation is (See (14), (15), and (17))

$$\frac{dv}{dt} + \frac{q}{C} v + \frac{\beta_1}{C} v^2 = b \left[ \omega \cos \omega t - \frac{\omega - p}{2} \sin(\omega - p)t + \frac{\omega + p}{2} \sin(\omega + p)t \right] \quad (21)$$

<sup>6</sup> Compare Moullin, "Wireless World," volume 10, page 1, 1922.

Since the term involving  $\beta_1$  is small the first approximation to the solution of (21) is given by the solution of

$$\frac{dv}{dt} + \frac{q}{C}v = b \left[ \omega \cos \omega t - \frac{\omega-p}{2} \sin(\omega-p)t + \frac{\omega+p}{2} \sin(\omega+p)t \right]. \quad (21A)$$

For the steady state this solution is

$$v = \frac{b\omega C}{\sqrt{q^2 + C^2\omega^2}} \cos\left(\omega t - \tan^{-1} \frac{\omega C}{q}\right) - \frac{bC(\omega-p)}{2} \frac{\sin\left[(\omega-p)t - \tan^{-1} \frac{C(\omega-p)}{q}\right]}{\sqrt{q^2 + C^2(\omega-p)^2}} + \frac{bC(\omega+p)}{2} \frac{\sin\left[(\omega+p)t - \tan^{-1} \frac{C(\omega+p)}{q}\right]}{\sqrt{q^2 + C^2(\omega+p)^2}} \quad (22)$$

But in actual practice, as will be shown later, we have

$$C\omega \gg q$$

and

$$\omega \gg p$$

Thus (22) may be written approximately

$$v = b \left[ \sin \omega t + \frac{1}{2} \cos(\omega-p)t - \frac{1}{2} \cos(\omega+p)t \right] \quad (23)$$

On substituting for  $v$  from (23) in the term involving  $\beta_1$  in (21) we obtain

$$\begin{aligned} \frac{dv}{dt} + \frac{q}{C}v + \frac{\beta_1}{C}b^2 \left[ \frac{3}{4} - \frac{1}{2} \cos 2\omega t + \frac{1}{8} \cos 2(\omega-p)t + \frac{1}{8} \cos 2(\omega+p)t \right. \\ \left. + \sin pt + \frac{1}{2} \sin(2\omega-p)t - \frac{1}{2} \sin(2\omega+p)t - \frac{1}{4} \cos 2\omega t - \frac{1}{4} \cos 2pt \right] \\ = b \left[ \omega \cos \omega t - \frac{\omega-p}{2} \sin(\omega-p)t + \frac{\omega+p}{2} \sin(\omega+p)t \right] \quad (24) \end{aligned}$$

From this we may see that the variation in the grid potential of signal frequency, which is the point of special interest, is found from the equation

$$\frac{dv}{dt} + \frac{q}{C}v = -\frac{\beta_1 b^2}{C} \sin pt \quad (24A)$$

Its amplitude  $A$  is therefore given by



$$A = \frac{\beta_1 b^2}{\sqrt{q^2 + C^2 p^2}} \quad (25)$$

Thus we see that, due to the action of the grid condenser, a completely modulated wave gives rise to a low-frequency grid potential variation of amplitude given by (25) which, causing corresponding changes of anode current, gives rise to telephonic response. This amplitude is equal to that obtained with equal heterodyne. (See (29) and (29A) later.)

#### RECEPTION OF CONTINUOUS WAVES BY HETERODYNE METHOD

In this case the representative equation becomes (see (14), (15), and (18))

$$\frac{dv}{dt} + \frac{q}{C}v + \frac{\beta_1}{C}v^2 = a\omega_1 \cos \omega_1 t + b\omega_2 \cos \omega_2 t \quad (26)$$

If again we omit the  $\beta_1$  term a first approximation of (26) is given by the solution of

$$\frac{dv}{dt} + \frac{q}{C}v = a\omega_1 \cos \omega_1 t + b\omega_2 \cos \omega_2 t \quad (26A)$$

For the steady state this is

$$v = \frac{a\omega_1}{\sqrt{\omega_1^2 + \frac{q^2}{C^2}}} \cos(\omega_1 t - \phi_1) + \frac{b\omega_2}{\sqrt{\omega_2^2 + \frac{q^2}{C^2}}} \cos(\omega_2 t - \phi_2)$$

$$\text{where } \tan \phi_1 = \frac{C\omega_1}{q} \quad \text{and} \quad \tan \phi_2 = \frac{C\omega_2}{q}$$

We may write this

$$v = r \cos(\omega_1 t - \phi_1) + s \cos(\omega_2 t - \phi_2)$$

$$\text{where } r = \frac{a\omega_1}{\sqrt{\omega_1^2 + \frac{q^2}{C^2}}} \quad \text{and} \quad s = \frac{b\omega_2}{\sqrt{\omega_2^2 + \frac{q^2}{C^2}}}$$

Thus for substitution in the original equation we have

$$v^2 = \frac{1}{2} \left[ r^2 + s^2 + r^2 \cos 2(\omega_1 t - \phi_1) + s^2 \cos 2(\omega_2 t - \phi_2) \right. \\ \left. + 2rs \cos \{(\omega_1 - \omega_2)t + \phi_1 - \phi_2\} + 2rs \cos \{(\omega_1 + \omega_2)t - \phi_1 - \phi_2\} \right]$$

The solution of (26) when the substitution for  $v^2$  has been made will be of the form

$$v = M + r \cos(\omega_1 t - \phi_1) + s \cos(\omega_2 t - \phi_2) + B \cos 2(\omega_1 t - \phi_1') \\ + C \cos 2(\omega_2 t - \phi_2') + D \cos \{(\omega_1 - \omega_2)t + \phi\} \\ + E \cos \{(\omega_1 + \omega_2)t + \psi\} \quad (27)$$

where  $A, B, C, D, b_1', \phi_2', \phi,$  and  $\psi$  are constants depending on the constants of the circuit and on  $a, b, \omega_1,$  and  $\omega_2.$

For practical purposes interest centers in the constant term  $M$  which represents the alteration of mean grid potential, and in the coefficient  $D$  which gives the amplitude of the grid potential variation of the signal angular frequency  $(\omega_1 - \omega_2).$  These are found to be as follows

$$M = -\frac{\beta_1}{2q} (r^2 + s^2) = -\frac{\beta_1}{2q} \left( \frac{a^2 C^2 \omega_1^2}{q^2 + C^2 \omega_1^2} + \frac{b^2 C^2 \omega_2^2}{q^2 + C^2 \omega_2^2} \right) \quad (28)$$

and  $D = \frac{\beta_1 r s}{\sqrt{q^2 + C^2 (\omega_1 - \omega_2)^2}}$

$$= -\beta_1 a b \frac{C^2 \omega_1 \omega_2}{\sqrt{q^2 + C^2 (\omega_1 - \omega_2)^2} \sqrt{q^2 + C^2 \omega_1^2} \sqrt{q^2 + C^2 \omega_2^2}} \quad (29)$$

The presence of the received amplitude  $b$  may therefore be detected as an alteration of mean anode current produced by the alteration of mean grid potential  $M,$  or by an alteration of anode current of angular frequency  $(\omega_1 - \omega_2),$  caused by the low frequency variation of grid potential  $D.$  It is the latter variation of anode current which gives rise to the well-known heterodyne note in the anode circuit telephone.

In considering the physical processes underlying this method of producing combination tones we note that the grid condenser performs two functions. In the first place it hands on the potential changes to the grid, while in the second place it effects a partial insulation of the grid so that the potential across it is sensibly the same as the grid potential itself. So far as the first function is concerned it is advantageous to have the grid condenser as large as possible, but consideration of the second function shows that a very large capacity would tend to smooth out the grid potential low-frequency changes. There must, therefore, be an optimum grid condenser value determined by the frequency of the oscillations ( $2\pi\omega_1$  or  $2\pi\omega_2$ ), by the combination tone frequency ( $2\pi(\omega_1 - \omega_2)$ ) and by the triode and circuit parameters. This value is found by differentiating the expression for  $D$  with respect to  $C,$  the result being that<sup>7</sup>

$$C_{opt}^2 = \frac{\sqrt{2} q^2}{\omega (\omega_1 - \omega_2)}$$

It is of interest to compare this optimum value of  $C$  with the value usually used in practice. As typical practical values we may use

$$q = 1.8 \times 10^{-5} (\text{ohms})^{-1}$$

$$\omega = 10^6 (\text{secs.})^{-1}$$

<sup>7</sup> We have here assumed that  $\omega_1 \neq \omega_2 = \omega.$

and  $\omega_1 - \omega_2 = 2\pi (1,000) (\text{secs.})^{-1}$

The theoretical value of  $C_{opt.}$  is thus 0.003 mfd., which is in close agreement with the value normally used.

We may further note the following useful approximations.<sup>8</sup> Since it is usual to work with the optimum condenser value we have

$$C^2 = \frac{\sqrt{2} q^2}{\omega (\omega_1 - \omega_2)}$$

Also

$$\frac{\omega_1 - \omega_2}{\omega} \ll 1$$

and thus

$$C \omega \gg q$$

and

$$C (\omega_1 - \omega_2) \ll q.$$

Using the above approximations (28) and (29) may be written

$$M = -\frac{1}{2} \frac{\beta_1}{q} (a^2 + b^2), \quad (28A)$$

and

$$D = -\frac{\beta_1}{q} a b. \quad (29A)$$

We thus see that as a first approximation the amplitude of the low-frequency grid potential changes produced by grid condenser action is proportional to the product of the received and local signal amplitudes. If the relation between the grid potential and the anode current is linear, the amplitude of the combination tone produced is also proportional to the same product. This result may be compared with the first approximation made in the case of anode rectification, where a similar result was obtained. (See (3)). A further investigation (the algebra of which is too lengthy to be given here) shows that the parallelism between anode rectification and cumulative rectification is quite complete, in that, if the power series (14) for  $i_o$  contains a  $\delta$  term, an expression of a type similar to (4) is obtained. Thus optimum heterodyne effects are possible with cumulative grid rectification if the power series for  $i_o$  contain a negative  $\delta$  term.

But when the relation between the grid potential and anode current is not linear, as is often the case, optimum heterodyne effects are obtainable which have no parallel in the case of anode rectification, and we now proceed to discuss such cases in greater detail.

Let us assume that the relation between the anode current and grid potential may be written as before

$$i_a = \alpha v + \beta v^2, \quad (1)$$

<sup>8</sup> Some of these approximations have been previously used. See page 13

where the zeros of potential and current are the values obtaining in the absence of local and distant signals. In the presence of such signals the value of  $v$  is given by (27), but so far as the production of combination tones is concerned the important terms are given by<sup>9</sup>

$$v = M + a \sin \omega_1 t + b \sin \omega_2 t + D \cos \{(\omega_1 - \omega_2) t\},$$

where  $M$  and  $D$  are given by (28A) and (29A).

On substituting this value for  $v$  in (1) and collecting terms of the angular frequency  $(\omega_1 - \omega_2)$  the amplitude  $A$  of the combination tone is found to be given by

$$A = ab \left[ \beta - \frac{a\beta_1}{q} + \frac{\beta\beta_1^2}{q^2} (a^2 + b^2) \right]. \quad (30)$$

Thus when the value of  $\beta$  is positive the amplitude of the combination tone of angular frequency  $(\omega_1 - \omega_2)$  passes thru a maximum value as  $a$  the amplitude of the local oscillation is increased. The optimum value of  $a$  is given by

$$a^2 = \frac{1}{3} \left[ \frac{q(a\beta_1 - q\beta)}{\beta\beta_1^2} - b^2 \right]$$

In practice the values of  $b$  are very small compared with those of  $a$ . The optimum value of  $a$  is thus independent of  $b$  and given by

$$a^2 = \frac{1}{3} \left[ \frac{q(a\beta_1 - q\beta)}{\beta\beta_1^2} \right] \quad (31)$$

The value of  $\beta$  is usually positive in practice when low anode potentials are used, so that optimum heterodyne phenomena due to the combined non-linear properties of the grid and anode circuits are obtained. With larger values of anode potential, however, the value of  $\beta$  is sometimes negative in which case the above considerations do not apply. For such conditions the effects of anode rectification and cumulative grid rectification are additive and not in opposition. The study of such cases would most probably be profitable from a practical point of view.

To illustrate the optimum heterodyne phenomena mentioned above the mean-current characteristic representative of grid condenser action in a typical case is shown in Figure 4. This diagram shows the variation of the mean anode current  $i_a$  as a function of the amplitude of a sinusoidal electromotive force ( $E = a \sin \omega_1 t$ ) and may be compared with Figure 2 which is the equivalent characteristic for anode rectification.

<sup>9</sup>The approximations previously mentioned (page 17) have here been used.

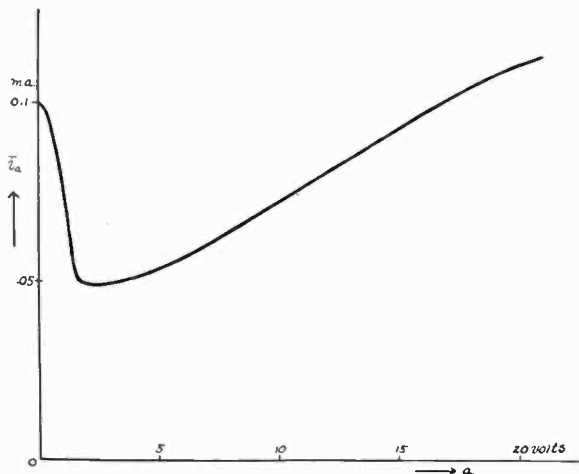

FIGURE 4

In this case the solution of (20) for the appropriate value of  $E$  is

$$v = -\frac{\beta_1 a^2}{2q} + a \cos(\omega_1 t - \phi) + F \cos(2\omega_1 t - \chi), \quad (32)$$

where  $F$  is proportional to  $\omega_1^2$  and  $C\omega_1 \gg q$ . Substituting this expression for  $v$  in (1) the variation of the mean anode current  $\bar{i}_a$  becomes

$$\bar{i}_a = -\frac{\alpha \beta_1}{2q} a^2 + \beta \left[ \frac{\beta_1^2}{4q^2} a^4 + \frac{1}{2} (a^2 + F^2) \right] \quad (33)$$

Here  $F^2$  may be neglected since it is of the order  $\beta_1^4$ . The value of  $\bar{i}_a$  has a turning point when

$$a^2 = \frac{q^2}{\beta \beta_1^2} \left( \frac{\alpha \beta_1}{q} - \beta \right). \quad (34)$$

For real values of  $a$  it is, therefore, necessary that  $\alpha \beta_1 > q \beta$ , and in this case the mean anode current passes thru a minimum for increasing  $a$ ; it is initially diminished.

The value of  $a$  at the turning point depends on the triode characteristics and the value of the grid leak  $R$ . In the actual case represented in Figure 4 the values of the triode parameters were independently found to be

$$a_1 = 0.017 \frac{m. a.}{voltage}; \quad \beta_1 = 0.013 \frac{m. a.}{(volts)^2}$$

$$a = 0.013 \frac{m. a.}{voltage}; \quad \beta = 0.024 \frac{m. a.}{(volts)^2}$$

$$R = 10^6 \text{ ohms, and thus } q = 0.018 \frac{m. a.}{voltage}$$

Substituting these values in (34) theory indicates that the value of  $a$  at the turning point should be 2.02 volts; the experimental value was 2.05 volts.

The slope of the  $(a, \bar{i}_a)$  curve is a maximum when

$$\alpha^2 = \frac{1}{3} \frac{q^2}{\beta \beta_1^2} \left( \frac{\alpha \beta_1}{q} - \beta \right) \quad (35)$$

This is the same value of  $a$  as that given by (31) for the value of the local amplitude when optimum heterodyne effects occur. We thus see that the appropriate value of  $a$  for optimum heterodyne reception may be found by drawing a curve such as that of Figure 4 for the particular triode in question and finding the value of the applied emf. at the point of maximum slope. Zero combination tone effects are obtained if  $a$  has the value given by (34) for the turning point of the curve.

It will be further noticed that for continuous wave reception without heterodyne the maximum anode current response is given by a signal of strength given by (34) and that for a signal very much stronger than this the response might be negligible.

In conclusion we should like to express our gratitude to Dr. B. van der Pol for his kind interest in this work.

**SUMMARY:** The use of the triode for anode rectification and cumulative grid rectification in heterodyne reception is investigated theoretically, and it is shown that:—

(a) The amplitude of the combination tone produced in a radio receiver telephone reaches an optimum value for a certain value of the local oscillation amplitude. In anode rectification this phenomenon is due to the non-linear nature of the grid potential/anode current relation, while in grid condenser action the phenomenon may be due either to the non-uniform grid conductance or to the combined non-linearity of the relations between grid potential and grid and anode currents.

(b) The optimum value of the local oscillation amplitude is independent of the received signal magnitude when the latter is small.

(c) The magnitude of the combination tone is directly proportional to the strength of the signal oscillation when the local oscillation has been adjusted for optimum heterodyne.

(d) The ratio of the optimum value of the combination tone to that produced with equal heterodyne is inversely proportional to the strength of the received signal.

(e) The differential equation representative of grid condenser action is shown to be of a generalized Riccati type.

$$\frac{dv}{dt} + f(v) = \phi(t).$$

Approximate solutions of this are obtained for practical cases. The optimum grid condenser value obtained theoretically in this way is in good agreement with the practical value.



# SIGNAL-TO-STATIC INTERFERENCE RATIO IN RADIO TELEPHONY\*

BY

MARIUS LATOUR

(PARIS, FRANCE)

Having read Dr. J. R. Carson's communication which appeared in the June, 1923, issue of the PROCEEDINGS OF THE INSTITUTE OF RADIO ENGINEERS, I desire to add the following material:

I have previously proposed to carry out radio telephony without carrier transmission and thereby implying homodyne reception<sup>1</sup> But I believe that I have since then found an arrangement which is paramount from the all-important point of view of signal-to-static ratio, and which might advantageously be used in case of shorter waves where homodyne reception is practically impossible, and where the speech frequency represents a relatively much smaller fraction of the wave length spectrum.

The speech voltages occurring at the secondary terminals of a telephone induction coil being of the shape represented by the curve of Figure 1, a radio telephone transmitter antenna is traversed by a radio-frequency current which, whilst having an amplitude which is constantly modulated proportionally to the speech voltages, is of a certain frequency  $f_1$  during positive speech impulses and of a different frequency  $f_2$  during negative speech impulses. These results may be arrived at by means of

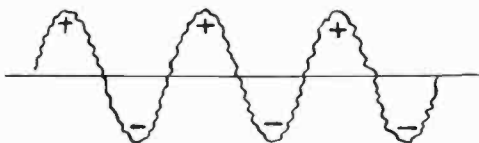

FIGURE 1

the arrangement represented schematically in Figure 2. The primary current variations produced by the action of the micro-

\* Received by the Editor, August 3, 1923.

<sup>1</sup> See my French patent, number 21,853/512,395 of 1916.



phone 1 are amplified by the vacuum tube amplifier 2, which comprises an input transformer 3 and an output transformer 4. The speech voltages thus amplified are used to supply the generating tubes 5 and 6 according to the arrangement of Figure 2, aiming at straight alternating current supply of vacuum tubes.<sup>2</sup> Tubes 5 and 6 work alternately. The waves successively emitted by each tube may be made to have different lengths by different grid or plate circuit settings which we will not here describe.

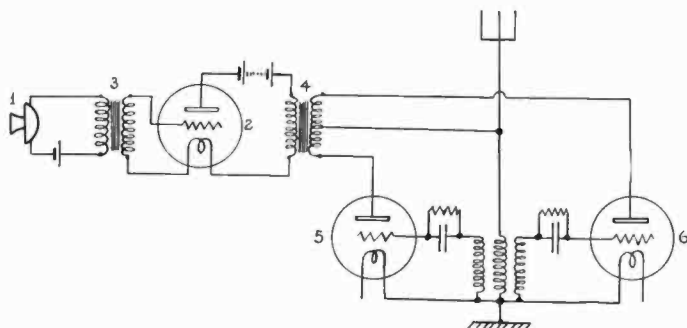

FIGURE 2

Instead of sending the radio-frequency current directly into the antenna, we may, of course, insert a radio-frequency power amplifier between the arrangement of Figure 2 and the antenna.

With the above system of transmission, the reception could be carried out in accordance with the arrangement shown in Figure 3, which is in itself a means of reducing static interference.<sup>3</sup>

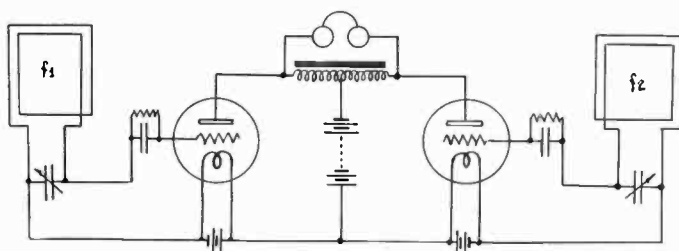

FIGURE 3

It may be seen that, from the point of view of detection of static-provoking shock excitation of the receiving circuits, the two circuits being tuned to different wave-lengths are in opposi-

<sup>2</sup> This is the object of my French patent numbers 502, 601 of 1915

<sup>3</sup> See my French patent, number 526,674.

tion to each other, while, from the point of view of speech reception, the two circuits work alternately but concurrently.

The power supplied to the antenna is not higher than that in carrierless transmission using homodyne reception.

From the point of static, it must be borne in mind that the introduction of a carrier-wave either at the transmitting end or at the receiving end, which is inherent to ordinary radio telephony, is apt to double the intensity of static currents susceptible of having the same frequency as the carrier wave and occurring sometimes in phase and at other times in opposition to the latter.

The method just described of transmitting and receiving without carrier wave does not possess this drawback.

Paris, July 24th, 1923.

**SUMMARY:** Referring to Dr. Carson's paper on "Static-to-Signal Ratio," the author discloses a system of twin side-band radiotelephonic transmission, wherein the carrier component is suppressed, but which differs from other carrierless transmitting systems in that a homodyne receiver is not required. This last peculiarity makes the system particularly suitable for short wave-length transmission and especially so in view of the fact that the disadvantage of broader wave-length spectrum inherent to twin side-band transmission vanishes as the wave-length decreases.



# REGENERATION IN COUPLED CIRCUITS\*

BY

E. LEON CHAFFEE

(ASSOCIATE PROFESSOR OF PHYSICS, HARVARD UNIVERSITY, CAMBRIDGE,  
MASSACHUSETTS)

## PART I

### SINGLE CIRCUIT REGENERATION

It is well known that a vacuum tube, regeneratively connected to a single circuit, acts to reduce the effective resistance of that circuit. At the same time the effective reactance is usually altered. This reduction in effective resistance is often spoken of as due to the introduction of a negative resistance by the tube. This effective negative resistance may or may not be a function of the frequency. When the total effective resistance is equal to or less than zero the circuit oscillates.

The analytical discussion of single-circuit regeneration is given below. There are two cases according to whether the oscillating element is in the plate circuit or in the grid circuit of the tube.

CASE I. OSCILLATING ELEMENT IN PLATE CIRCUIT. In Figure 1, let  $L$ ,  $C$ , and  $R$  be the constants of the oscillatory circuit,  $L_g$  the grid circuit inductance and  $m$  the mutual inductance between  $L$  and  $L_g$ . Let  $R_p = \frac{\partial e_p}{\partial i_p}$  be the plate to filament resistance and  $\mu = -\frac{\partial e_p}{\partial e_g}$  be the amplification factor of the tube. The currents are indicated in Figure 1. Let  $E$  be the effective value of an emf. of frequency  $\frac{\omega}{2\pi}$  induced in  $L$  from an external source. The following complex equations express the conditions in Figure 1. The grid current is assumed to be negligible.

Quantities in Clarendon Type are complex.

\*Received by the Editor, February 15, 1924.

$$\begin{cases} (R + jL\omega) I_1 - \frac{j}{C\omega} I_2 = E \\ \frac{j}{C\omega} I_2 + R_p I_p = \mu E_g = j\mu m \omega I_1 \\ I_1 = I_p + I_2 \end{cases}$$

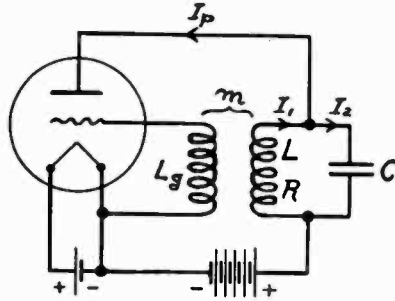

FIGURE 1

The solution of these equations is

$$(1-1) \quad I_1 = \frac{E}{\begin{bmatrix} R + \frac{1}{C^2 \omega^2} - \frac{\mu m}{C} R_p \\ R_p^2 + \frac{1}{C^2 \omega^2} \end{bmatrix} + j \begin{bmatrix} L\omega - \frac{1}{C\omega} \\ R_p^2 + \frac{1}{C^2 \omega^2} \end{bmatrix}}$$

An examination of equation (1-1) shows that the effective or equivalent resistance is decreased, due to the term  $\frac{\mu m}{C}$ , and will be zero if

$$(1-2) \quad \frac{\mu m R_p}{C} = R \left( R_p^2 + \frac{1}{C^2 \omega^2} \right) + \frac{R_p}{C^2 \omega^2}$$

at which point oscillation commences. The effective capacity reactance is increased as shown by the imaginary part of equation (1-1).

Equation (1) and subsequent equations are much more general and hence of greater use if all constants of the circuits are reduced to coefficients and all angular velocities or wave lengths to ratios of angular velocities or wave lengths. By this reduction the equations can be more easily applied to any circuit. To this end the following definitions are made.

Let  $\frac{\omega_o}{2\pi}$  be a particular frequency to which any frequency  $\frac{\omega}{2\pi}$  may be referred in the form of a ratio  $\frac{\omega_o}{\omega}$ . The ratio  $\frac{\omega_o}{\omega} = \frac{\lambda}{\lambda_o}$  will

be denoted by  $\theta$  so that for  $\omega$  in all equations  $\frac{\omega_o}{\theta}$  may be substituted.

If  $\frac{\omega_1}{2\pi}$  and  $\frac{\omega_2}{2\pi}$  represent the natural undamped frequencies of oscillation of two circuits, then  $\frac{\omega_o}{\omega_1}$  will be denoted by  $\theta_1$  and  $\frac{\omega_o}{\omega_2}$  by  $\theta_2$ , respectively. It is then obvious that

$$\theta_1 = \frac{\lambda_1}{\lambda_o} = \frac{\omega_o}{\omega_1} = \omega_o \sqrt{L_1 C_1} \quad \text{and} \quad \theta_2 = \frac{\lambda_2}{\lambda_o} = \frac{\omega_o}{\omega_2} = \omega_o \sqrt{L_2 C_2}$$

The following coefficients are here defined; others will be introduced later when required.

$$\frac{R}{L \omega_o} = \gamma, \quad \frac{R_p}{L \omega_o} = \gamma_p, \quad \sqrt{\frac{m}{L L_p}} = K, \quad \text{or} \quad \frac{m}{\sqrt{L L_p}} = K$$

Using the above ratios and coefficients, equation (1-1) reduces to (1-a)

$$(1-a) \quad I_1 = \frac{\frac{E}{L \omega_o}}{\left[ \gamma - \frac{\mu K \theta_1^2 \sqrt{L_p} - \theta^2}{\gamma_p^2 \theta_1^4 + \theta^2} \gamma_p \right] + \frac{j}{\theta} \left[ 1 - \theta^2 \frac{\gamma_p^2 \theta_1^2 + \mu K \sqrt{L_p}}{\gamma_p^2 \theta_1^4 + \theta^2} \right]}$$

In all practical cases  $\theta^2 \ll \gamma_p^2 \theta_1^4$ , so that (1-a) further reduces to the approximate expression

$$(1-b) \quad I_1 = \frac{\frac{E}{L \omega_o}}{\left[ \gamma - \frac{\mu K \sqrt{L_p}}{\gamma_p \theta_1^2} + \frac{\theta^2}{\gamma_p \theta_1^4} \right] + \frac{j}{\theta} \left[ 1 - \frac{\theta^2}{\theta_1^2} - \frac{\mu K \theta^2}{\gamma_p^2 \theta_1^4} \sqrt{\frac{L_p}{L}} \right]}$$

This expression gives the variation of  $I_1$  as the circuit is tuned by varying  $C$ , the incoming frequency remaining constant, or the variation of  $I_1$  as the incoming wave is varied and the circuit constants remain fixed. In the first case  $\theta_1$  is the variable and  $\theta$  is constant at say the value 1, in which case the incoming wave has wave length  $\lambda_o$ . In the second case,  $\theta$  is varied while  $\theta_1$  remains constant at any chosen value.

Since the arrangement of circuits shown in Figure 1 is seldom used for receiving purposes this equation will not be further investigated.

CASE 2. OSCILLATORY ELEMENT IN GRID CIRCUIT. In this case the oscillatory element is in the grid circuit, a more usual case when the tube is used as a detector or amplifier.

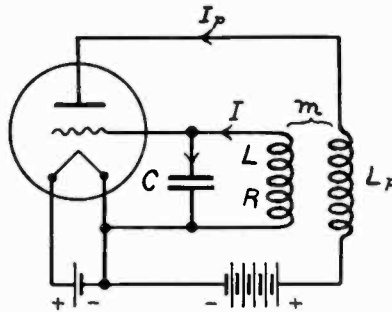

FIGURE 2

Figure 2 gives the connections and the significance of the symbols. The circuit equations for this case are as follows:

$$\begin{cases} \left[ R + j \left( L \omega - \frac{1}{C \omega} \right) \right] I - j m \omega I_p = E \\ -j m \omega I + (R_p + j L_p \omega) I_p = \mu E_g = -\frac{j \mu I}{C \omega} \end{cases}$$

The solution is given in equation (2-1).

$$(2-1) \quad I = \frac{E}{\left[ R - \frac{\mu m}{R_p^2 + L_p^2 \omega^2} R_p \right] + j \left[ \left( L + \frac{\mu m}{R_p^2 + L_p^2 \omega^2} L_p \right) \omega - \frac{1}{C \omega} \right]}$$

In this case, since  $\frac{\mu m}{C}$  is usually greater than  $m^2 \omega^2$ , the effective resistance is reduced and the inductive reactance increased by an increase in  $m$ . The circuit oscillates if the effective resistance is made zero or negative. The condition separating oscillation from non-oscillation is

$$R = \frac{\mu m}{R_p^2 + L_p^2 \omega^2} R_p$$

In this case, as in Case 1, the expression for the current given in (2-1) can be expressed in terms of coefficients as in (2-a) below.

$$(2-a) \quad I = \frac{E}{L \omega_0} \left[ \gamma - \frac{\mu K \theta^2}{\theta_1^2} \frac{\sqrt{L} - K^2}{\gamma_p^2 \theta^2 + 1} \gamma_p \right] + \frac{j}{\theta} \left[ 1 - \frac{\theta^2}{\theta_1^2} + \frac{\mu K \theta^2}{\gamma_p^2 \theta^2 + 1} \frac{\sqrt{L} - K^2}{\gamma_p^2 \theta^2 + 1} \right]$$

If, as is usually the case,  $1 \ll \gamma_p^2 \theta^2$ , then (2-a) becomes

$$(2-b) \quad I = \frac{E}{L \omega_0} \left[ \gamma - \frac{\mu K}{\gamma_p \theta_1^2} \sqrt{\frac{L}{L_p} + \frac{K^2}{\gamma_p \theta_1^2}} \right] + \frac{j}{\theta} \left[ 1 - \frac{\theta^2}{\theta_1^2} + \frac{\mu K}{\gamma_p^2 \theta_1^2} \sqrt{\frac{L}{L_p} - \frac{K^2}{\gamma_p^2 \theta^2}} \right]$$

Referring to equations (1-b) and (2-b) it is evident that the most important resistance-reducing term is not a function of the impressed wave length  $\lambda$ , so that the reduction in resistance for any value of  $\theta_1$  is approximately the same for all wave lengths in the emission spectrum of a broadcasting station. This reduction in resistance has roughly the effect of sharpening the resonance curve dependent upon the amount of regeneration, and it is this sharpening of the resonance curve which causes the distortion of signals so familiar to users of the single circuit arrangements when regeneration is pushed to the limit.

If all of the terms of the equations (1-a) and (2-a) be taken into account it is evident that the effective resistance is somewhat a function of the impressed wave length  $\lambda$ . The effective resistance may have slightly negative values for some wave lengths. For these wave lengths the system gives out power when electromotive forces corresponding to these wave lengths are impressed. Under these conditions the system is not an absorber but an emitter for these wave lengths, while for other wave lengths power is absorbed. The field around the receiving antenna may, as a consequence, be distorted differently for different wave lengths so that a neighboring receiving station might receive a distorted signal as a consequence of the activity of the first receiving station. This effect is, however, extremely small for single-circuit arrangements, but is of more importance when coupled circuits are used, as will be pointed out later.

It is interesting to note that the regeneration terms do not in either Case 1 or 2 depend directly upon  $L$ , but do depend upon  $C$ . In most circuits used for the reception of radio signals, the tuning is accomplished by varying  $C$  and the regeneration adjusted with  $m$ . The maximum signal is obtained when the reactance term is reduced to zero and the effective resistance reduced to as near zero as possible without oscillation. Both  $m$  and  $C$  affect both conditions, so that the final adjustment is obtained by alternate adjustments of  $m$  and  $C$ .



## PART II

### THEORY OF COUPLED CIRCUITS

Before discussing the broader question of regeneration in coupled circuits, a brief review will be made of the familiar theory of forced oscillations in two oscillatory circuits having magnetic coupling. Let the two circuits have constants as shown in Figure 3. The impressed electromotive force  $E$  has a frequency  $\frac{\omega}{2\pi}$ . The complex equations (3) below describe completely the conditions of steady state oscillation of this system.

$$(3) \begin{cases} Z_1 I_1 + j M \omega I_2 = E \\ j M \omega I_1 + Z_2 I_2 = 0 \end{cases}$$

where

$$Z_1 = R_1 + j \left( L_1 \omega - \frac{1}{C_1 \omega} \right) = R_1 + j X_1$$

$$Z_2 = R_2 + j \left( L_2 \omega - \frac{1}{C_2 \omega} \right) = R_2 + j X_2$$

Solving these equations, the complex expressions for  $I_1$  and  $I_2$  become

$$I_1 = \frac{E}{Z_1 + \frac{M^2 \omega^2}{Z_2}} = \frac{E}{Z_{12}} = \frac{E}{R_{12} + j X_{12}}$$

(4-1)

$$= \frac{E}{\left[ R_1 + \frac{M^2 \omega^2 R_2}{Z_2^2} \right] + j \left[ X_1 - \frac{M^2 \omega^2 X_2}{Z_2^2} \right]}$$

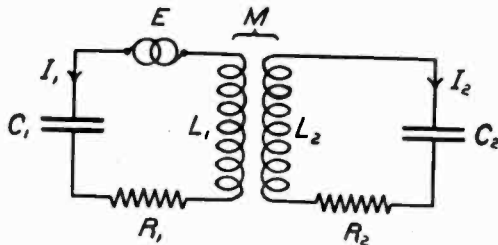

FIGURE 3

where  $Z_{12}$  is the impedance of the primary circuit modified by the presence of the coupled secondary circuit, or, in other words, the impedance of the system as viewed from the primary circuit.

$R_{12}$  and  $X_{12}$  are the resistance and reactance of the system as viewed from the primary circuit.

$$(5-1) \quad I_2 = \frac{-j M \omega E}{Z_1 Z_2 + M^2 \omega^2} = \frac{-j M \omega E}{Z_2 \left( Z_1 + \frac{M^2 \omega^2}{Z_2} \right)} = \frac{-j M \omega E}{Z_2 Z_{12}}$$

Equations (4-1) and (5-1) can be written in the more general form using coefficients.

$$(4-a) \quad I_1 = \frac{\frac{E}{L_1 \omega_0}}{\left[ \gamma_1 + \frac{\tau^2 \gamma_2}{\gamma_2^2 \theta^2 + \left( 1 - \frac{\theta^2}{\theta_2^2} \right)^2} \right] + \frac{j}{\theta} \left[ 1 - \frac{\theta^2}{\theta_1^2} - \frac{\tau^2 \left( 1 - \frac{\theta^2}{\theta_2^2} \right)}{\gamma_2^2 \theta^2 + \left( 1 - \frac{\theta^2}{\theta_2^2} \right)^2} \right]}$$

$$(5-a) \quad I_2 = \frac{\frac{-j \tau \theta E}{\omega_0 \sqrt{L_1 L_2}}}{\left[ \gamma_1 \theta + j \left( 1 - \frac{\theta^2}{\theta_1^2} \right) \right] \left[ \gamma_2 \theta + j \left( 1 - \frac{\theta^2}{\theta_2^2} \right) \right] + \tau^2}$$

where  $\tau = \frac{M}{\sqrt{L_1 L_2}}$ .

It is convenient to make use of another abbreviation, that is

$$1 - \frac{\theta^2}{\theta_1^2} = \beta_1 \quad \text{and} \quad 1 - \frac{\theta^2}{\theta_2^2} = \beta_2$$

Using these abbreviations, (4-a) and (5-a) become

$$(4-b) \quad I_1 = \frac{\frac{E}{L_1 \omega_0}}{\left[ \gamma_1 + \frac{\tau^2 \gamma_2}{\gamma_2^2 \theta^2 + \beta_2^2} \right] + \frac{j}{\theta} \left[ \beta_1 - \frac{\tau^2 \beta_2}{\gamma_2^2 \theta^2 + \beta_2^2} \right]}$$

$$(5-b) \quad I_2 = \frac{\frac{-j \tau \theta E}{\omega_0 \sqrt{L_1 L_2}}}{[\gamma_1 \theta + j \beta_1] [\gamma_2 \theta + j \beta_2] + \tau^2}$$

Equations (4) and (5) give the primary and secondary currents for any adjustments of the primary and secondary circuits and their coupling. If the coupling between the two circuits is fixed, then  $X_1$  and  $X_2$  are the independent variables and the current can be plotted vertically against the variables  $X_1$  and  $X_2$  (or any other quantities upon which  $X_1$  and  $X_2$  depend), as the two horizontal coordinates. There is thus formed a curved surface bounding a space model. For any value of one of the independent variables there is a *certain* value of the other which will make  $I_2$  or  $I_1$  a maximum or a minimum. If, then, one of the

variables is given successive values and the other is each time adjusted to give a maximum or a minimum value of the current, there will then result a ridge (if a maximum is obtained) on the representative surface of equation 4 or 5 lying vertically over the corresponding values of  $X_1$  and  $X_2$  which give the maxima. Such curved surfaces with these ridges are shown in Plate 1 for the secondary current  $I_2$ .

Since, in most practical cases, the value of the secondary current is of greater interest than that of the primary current, the shape of the representative surface for  $I_2$  will be examined more in detail. The expression (5-1) may be written

$$(6-1) \quad I_2 = \frac{-j M \omega E}{Z_1 \left( Z_2 + \frac{M^2 \omega^2}{Z_1} \right)} = \frac{-j M \omega E}{Z_1 Z_{21}}$$

$$I_2 = \frac{-j M \omega E}{Z_1 \left[ \left( R_2 + \frac{M^2 \omega^2 R_1}{R_1^2 + X_1^2} \right) + j \left( X_2 - \frac{M^2 \omega^2 X_1}{R_1^2 + X_1^2} \right) \right]}$$

where  $Z_{21}$  is the impedance of the system as viewed from the secondary circuit. Expression (6-1) can be written in terms of coefficients as follows:

$$(6-a) \quad I_2 = \frac{-j \tau \theta E}{\omega \sigma \sqrt{L_1 L_2} \left[ \gamma_1 \theta + j \beta_1 \right] \left[ \left( \gamma_2 \theta + \frac{\tau^2 \gamma_1 \theta}{\gamma_1^2 \theta^2 + \beta_1^2} \right) + j \left( \beta_2 - \frac{\tau^2 \beta_1}{\gamma_1^2 \theta^2 + \beta_1^2} \right) \right]}$$

It is apparent by inspection of equation (6-1) that if  $X_1$  is set at some value, the value of  $X_2$  which gives a maximum value of  $I_2$  is

$$(7-1) \quad X_2 = \frac{M^2 \omega^2 X_1}{R_2 + X_1^2} \quad \text{or} \quad \left. \begin{array}{l} \text{Adjustment of} \\ \text{secondary react-} \\ \text{ance to give} \\ \text{max. } I_2 \\ \text{max. 1-2 line.} \end{array} \right\}$$

$$(7-a) \quad \beta_2 = \frac{\tau^2 \beta_1}{\gamma_1 \theta + \beta_1^2} \quad \text{or}$$

$$(7-b) \quad 1 - \frac{\theta^2}{\theta_2^2} = \frac{\tau^2 \left( 1 - \frac{\theta^2}{\theta_1^2} \right)}{\gamma_1^2 \theta^2 + \left( 1 - \frac{\theta^2}{\theta_1^2} \right)^2}$$

The relation (7) gives a curve on the horizontal or  $X_1$ - $X_2$  plane of the space model above which may be plotted the maximum values of  $I_2$  obtained by first setting  $X_1$  and then adjusting  $X_2$ . This locus of max. secondary currents is called max. 1-2 line, and its shape is *independent* of the value of the resistance of the secondary circuit. If, now, this value of  $X_2$  be substituted in

(6-1), then as  $X_1$  is varied,  $X_2$  is automatically given the correct value to give a maximum  $I_2$ , and we follow along the ridge of the space model shown in Plate 1. The maximum value of  $I_2$  is then

$$(8-1) \quad \max. I_2 = \frac{-j M \omega E}{(R_1 + j X_1) \left( R_2 + \frac{M^2 \omega^2 R_1}{R_1^2 + X_1^2} \right)}$$

$$(8-a) \quad \max. I_2 = \frac{-j \tau E}{\omega_0 \sqrt{L_1 L_2} \left[ M_1 \theta + j \beta_1 \right] \left[ \gamma_2^2 + \frac{\tau^2 \gamma_1}{\gamma_1^2 \theta + \beta_1^2} \right]}$$

} or { *Height of model over max. 1-2 line.*

Some value of  $X_1$  will give the largest value of  $I_2$  attainable (called the max. max.  $I_2$  represented by the highest peak of the ridge on the space model. If the complex expression (8) be differentiated to find the value of  $X_1$  which gives this max. max.  $I_2$ , the following roots result:

$$(9-1) \quad X_1 = 0$$

$$(9-2) \quad R_1^2 + X_1^2 = \frac{M^2 \omega^2 R_1}{R_2}$$

$$X_1 = \pm \sqrt{\frac{M^2 \omega^2 R_1}{R_2} - R_1^2}$$

$$(9-3) \quad R_1^2 + X_1^2 = -\frac{M^2 \omega^2 R_1}{R_2}$$

} or { *conditions for max. max.  $I_2$*

(gives imaginary value of  $X_1$ )

Root (9-3) gives an imaginary value of  $X_1$ . Roots (9-1) and 9-2) give the same value of max. max.  $I_2$  if

$$(10-1) \quad M^2 \omega^2 = R_1 R_2$$

$$(10-a) \quad \tau^2 = \gamma_1 \gamma_2 \theta^2$$

} *critical coupling*

This latter relation divides the problem into two parts and the coupling which satisfies relation (10) is known as *critical coupling*. For couplings less than critical, root (9-1) gives the max. max. current, the value of which is

$$(11-1) \quad \max. \max. I_2 = \frac{-j M \omega E}{R_1 R_2 + M^2 \omega^2}$$

$$(11-a) \quad \max. \max. I_2 = \frac{j \tau \theta E}{\omega_0 \sqrt{L_1 L_2} \left[ \gamma_1 \gamma_2 \theta^2 + \tau^2 \right]}$$

} or { *max. max.  $I_2$  when  $\tau <$  critical value*

For couplings greater than critical coupling root (9-2) holds, yielding a value for  $I_2$  given by (12)

$$(12-1) \quad \max. \max. I_2 = \frac{-j M \omega E}{2 R_2 \left( R_1 \pm j \sqrt{\frac{M^2 \omega^2 R_1}{R_2} - R_1^2} \right)} \quad \text{or} \quad \left. \begin{array}{l} \max. \\ \max. I_2 \\ \text{when} \\ \tau > \\ \text{critical} \\ \text{value} \end{array} \right\}$$

$$(12-a) \quad \max. \max. I_2 = \frac{-j \tau \theta E}{\omega_0 \sqrt{L_1 L_2}} \quad \left. \begin{array}{l} \max. \\ \max. I_2 \\ \text{when} \\ \tau > \\ \text{critical} \\ \text{value} \end{array} \right\}$$

$$2 \gamma_2 \theta \left( \gamma_1 \theta \pm \sqrt{\frac{\tau^2 \gamma_1}{\gamma_2} - \gamma_1^2 \theta^2} \right)$$

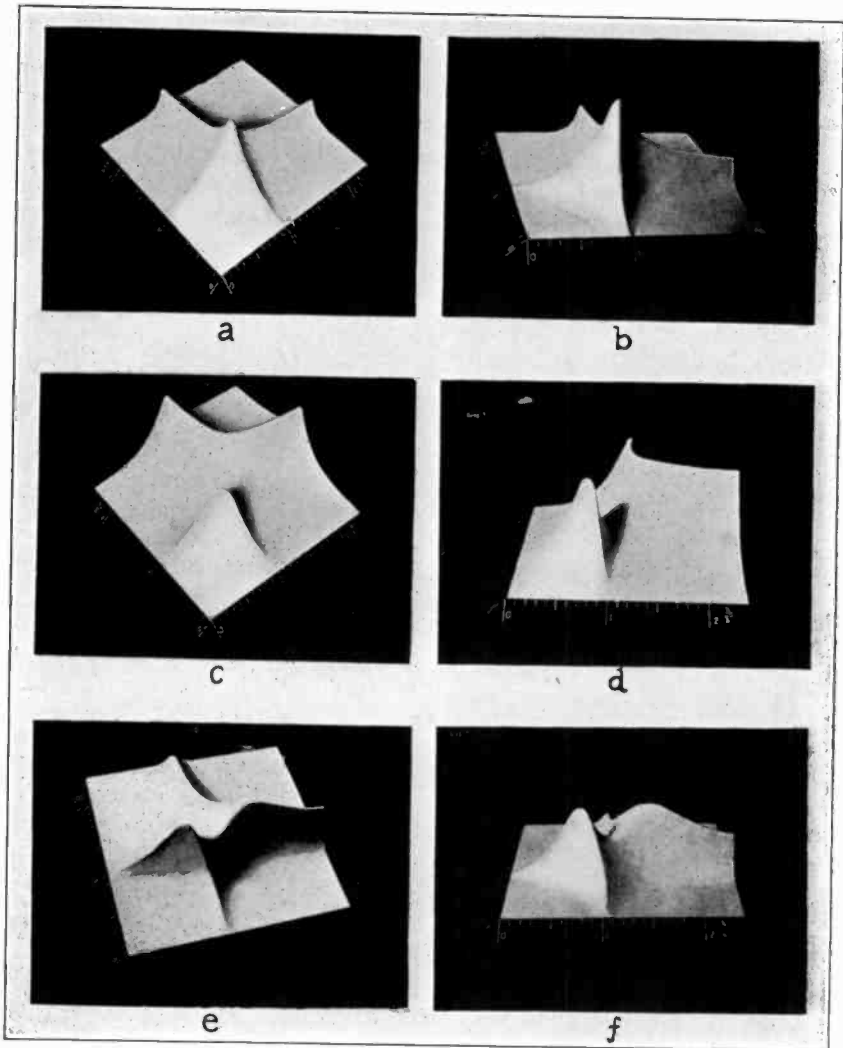

PLATE 1

This expression for  $I_2$  has a numerical value of

$$\begin{aligned}
 (13-1) \quad \max. \max. I_2 &= \frac{E}{2\sqrt{R_1 R_2}} \text{ or } \\
 (13-a) \quad \max. \max. I_2 &= \frac{E}{2\sqrt{\eta_1 \eta_2}} \left. \begin{array}{l} \max. \max. I_2 \\ \text{when } \tau > \text{critical} \\ \text{value. Numerical} \\ \text{value.} \end{array} \right\}
 \end{aligned}$$

In constructing a space model of the secondary current, the ratio of the numerical value of the current to the numerical value of the max. max. current is used. This ratio derived from (5) and (13) is applicable to all cases above critical coupling and including the critical case itself.

$$\begin{aligned}
 (14-1) \quad \frac{I_2}{I_{2mm}} &= \frac{2 M \omega \sqrt{R_1 R_2}}{\sqrt{(R_1^2 + X_1^2)(R_2^2 + X_2^2) + M^4 \omega^4}} \\
 (14-a) \quad \frac{I_2}{I_{2mm}} &= \frac{2 M^2 \omega^2 (R_1 R_2 - X_1 X_2)}{2 M^2 \omega^2 (R_1 R_2 - X_1 X_2)} \text{ or } \left. \begin{array}{l} \\ \\ \end{array} \right\} \tau > \text{critical value} \\
 \frac{I_2}{I_{2mm}} &= \frac{2 \tau \theta \sqrt{\eta_1 \eta_2}}{\sqrt{(\eta_1 \eta_2 \theta^2 - \beta_1 \beta_2 + \tau^2)^2 + (\eta_1 \theta \beta_2 + \eta_2 \theta \beta_1)^2}}
 \end{aligned}$$

The corresponding expression for this ratio for coupling less than critical is obtained from equation (5) and (11), and is

$$\begin{aligned}
 (15-1) \quad \frac{I_2}{I_{2mm}} &= \frac{R_1 R_2 + M^2 \omega^2}{\sqrt{(R_1^2 + X_1^2)(R_2^2 + X_2^2) + M^4 \omega^4}} \text{ or } \\
 (15-a) \quad \frac{I_2}{I_{2mm}} &= \frac{2 M^2 \omega^2 (R_1 R_2 - X_1 X_2)}{2 M^2 \omega^2 (R_1 R_2 - X_1 X_2)} \left. \begin{array}{l} \\ \\ \end{array} \right\} \tau < \text{critical} \\
 \frac{I_2}{I_{2mm}} &= \frac{\eta_1 \eta_2 \theta^2 + \tau^2}{\sqrt{(\eta_1 \eta_2 \theta^2 - \beta_1 \beta_2 + \tau^2)^2 + (\eta_1 \theta \beta_2 + \eta_2 \theta \beta_1)^2}} \text{ value.}
 \end{aligned}$$

In plotting the ratio given in (14) and (15), or any of the other relations, the independent variables  $\beta_1$  and  $\beta_2$  may be used instead of the corresponding quantities  $X_1$  and  $X_2$ . On the other hand, a better physical picture usually obtains if the quantities  $\frac{\omega_1}{\omega}$  and  $\frac{\omega_2}{\omega}$ , or better  $\frac{\theta_1}{\theta} = x$  and  $\frac{\theta_2}{\theta} = y$  are used as coordinates.

In studying the action of coupled circuits without regeneration it is usually simpler altho not necessary to consider that the impressed frequency is  $\frac{\omega_0}{2\pi}$ , making  $\theta = 1$ .

The surfaces shown in Plate 1 to be described below are equations (14) plotted with  $x$  and  $y$  as independent variables.

If the coupling between two coupled circuits is less than critical coupling defined by equation (10), then the space model for the

secondary-current ratio given by equation (15) has a single maximum at values of the independent variables

$$\beta_1=0 \quad \text{or} \quad X_1=0 \quad \text{or} \quad \frac{\theta_1}{\theta} = \frac{\lambda_1}{\lambda} = x=1$$

$$\text{and} \quad \beta_2=0 \quad \text{or} \quad X_2=0 \quad \text{or} \quad \frac{\theta_2}{\theta} = \frac{\lambda_2}{\lambda} = y=1$$

The height of this peak is given by equation (15).

At critical coupling the space model has still a single peak, the height of which is now unity. Plate 1, *a* and *b*, shows a calculated model for critical coupling. The peak has a peculiar shape best shown by contour lines given in Figure 4.

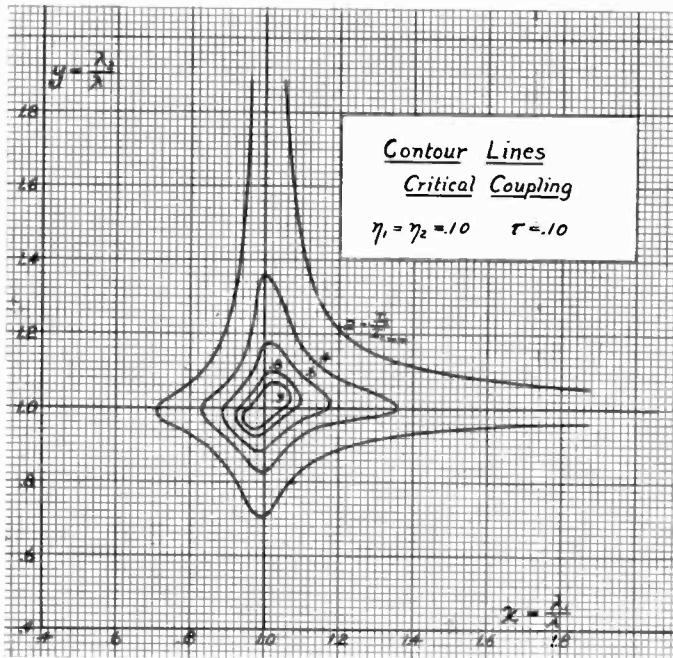

FIGURE 4

If the coupling is greater than critical the space model has in general two ridges, each having a highest point of value unity. Two models calculated from specific values of the coefficients are shown in Plate 1, *c* and *d*, and *e* and *f* (*c* and *d* are two views of the same model and similarly *e* and *f*). As pointed out above, if the secondary circuit is adjusted for a maximum current for successive adjustments of the primary circuit, a locus of points

on the horizontal plane will be found given by equation (7). Such loci are shown by the curve marked Max. 1-2 (meaning primary set first and then secondary circuit adjusted) in Figure 5 where the coordinates are  $\beta_1$  and  $\beta_2$ , and in Figure 6 where the same curve is plotted against  $x$  and  $y$ . It is to be noted that since  $\beta_1$  is a function of  $x^2$  and  $\beta_2$  of  $y^2$ , all curves plotted to  $\beta_1$  and  $\beta_2$  are symmetrical about the origin, but points for  $\beta_1$  and  $\beta_2$  greater than +1 are imaginary.

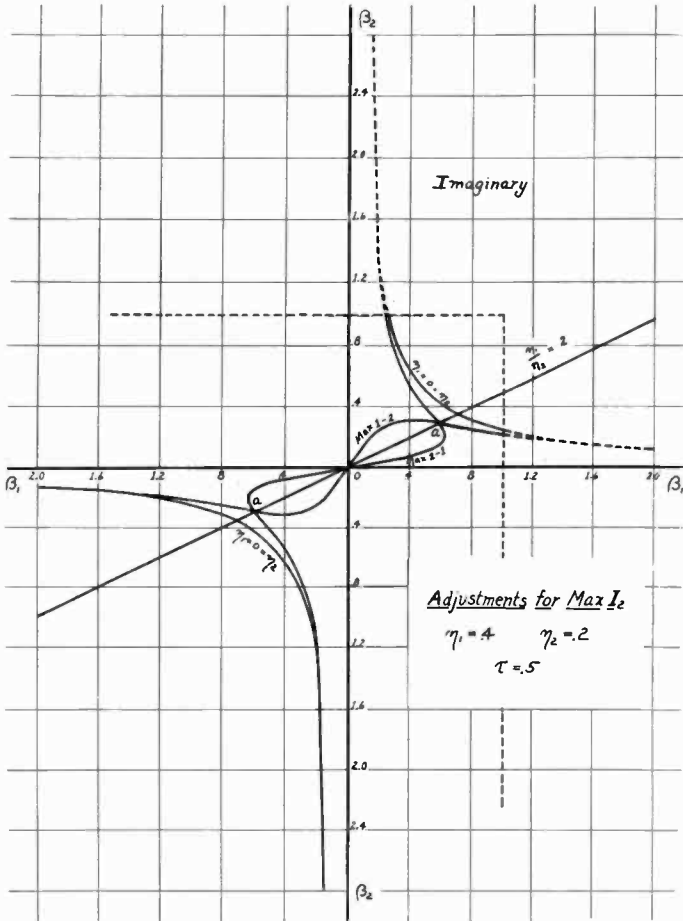

FIGURE 5

It can also be shown that if the reverse order of adjusting the circuits for a maximum is adopted, that is, if the primary circuit is adjusted for a maximum secondary current for every adjust-



ment of the secondary circuit, a new curve will be obtained given by the equation.

$$(16-1) \quad X_1 = \frac{M^2 \omega^2 X_2}{R_2^2 + X_2^2} \quad \text{or} \quad \left\{ \begin{array}{l} \text{Adjustment of} \\ \text{primary circuit} \\ \text{for max. } I_2. \text{ Max.} \\ \text{2-1 line} \end{array} \right.$$

$$(16-a) \quad \beta_1 = \frac{\tau^2 \beta_2}{\gamma_1^2 + \beta_2^2}$$

This locus is shown by the curve Max. 2-1 in Figure 5 and Figure 6. The intersections of Max. 1-2 and Max. 2-1 lines shown at *a*, Figure 6, gives the positions of the max. max. current, the coordinates of which are given by equation 9. (If  $\gamma_1 = 0 = \gamma_2$  curves Max. 1-2 and Max. 2-1 resolve into the curves so marked in the figures. At critical coupling the two intersection points

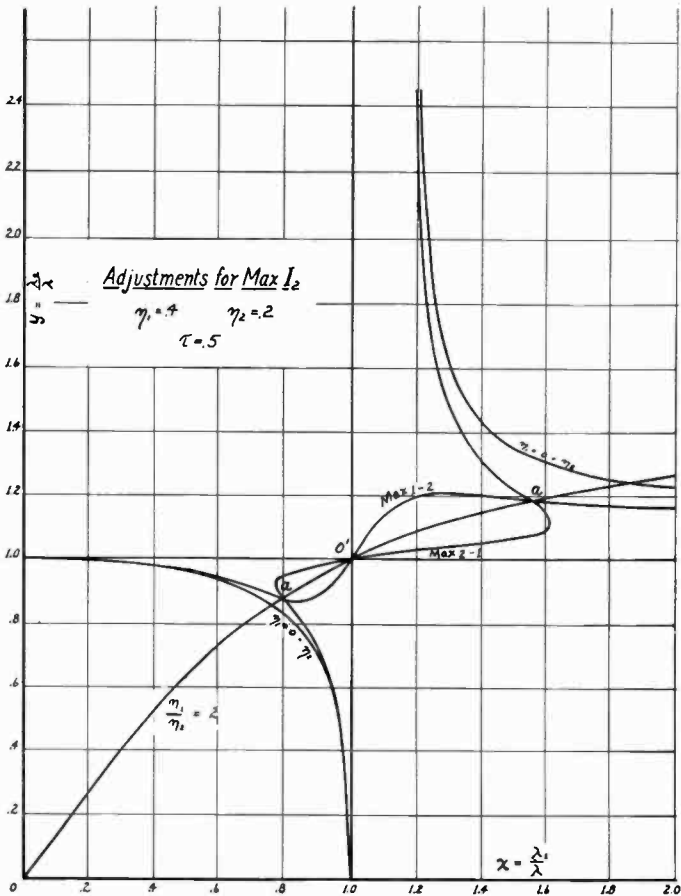

FIGURE 6

*a a* of Figures 6 and 7 merge into a single point at the origin as shown in Figure 7. If  $\gamma_1 = \gamma_2$ , then these curves Max. 1-2 and Max. 2-1 will be similar in shape and symmetrical about the 45° line, but otherwise the two sets will be dissimilar as shown in the figures.

The reason the two sets of curves are different according to the order of adjustment will be apparent if the shape of the saddle between the two peaks (Plate 1, *c, d, e, and f*) is considered. A card with its plane vertical and its lower edge horizontal and parallel to the *y* axis will rest on the surface at one point. If the card is now moved in the *x* direction this point of tangency will travel over the Max. 1-2 line. The Max. 2-1 line can be traced by the card placed at right angles to the *y* axis and moved in the direction of the *y* axis.

For any particular coupling the highest peaks have definite coordinates. If, now, the coupling be changed, the two peaks will move along a curve gotten by eliminating the coupling from the two equations (7) and (9-2), giving

$$\begin{array}{l}
 (17-1) \qquad \qquad \qquad \frac{R_1}{R_2} = \frac{X_1}{X_2} \quad \text{or} \\
 (17-a) \qquad \qquad \qquad \frac{\gamma_1}{\gamma_2} = \frac{\beta_1}{\beta_2}
 \end{array}
 \left. \vphantom{\begin{array}{l} (17-1) \\ (17-a) \end{array}} \right\} \begin{array}{l} \text{locus of peaks} \\ \text{as coupling is} \\ \text{changed} \end{array}$$

This equation is plotted in Figure 6 for the particular value  $\frac{\gamma_1}{\gamma_2} = 2$  and for other values of  $\gamma_1$  in Figure 8. The dotted line in Figure 8 gives the Max.  $I_2$  line for  $\tau = \frac{\gamma_1}{\gamma_2}$  and is hence the limit of the peak loci.

It can be shown that for all values of coupling the ridge along the saddle between the two peaks is directly above the curve of (17) for the appropriate value of  $\frac{\gamma_1}{\gamma_2}$ .

Attention is now called to the fact that if  $\gamma_1$  is equal to  $\gamma_2$  the model is symmetrical with respect to the coordinate axes and the peaks lie over the 45° line, that is, over the line  $\beta_1 = \beta_2$  or  $x = y$ . (See Plate 1, *c* and *d*.) If on the other hand  $\gamma_1$  is not equal to  $\gamma_2$  then the peaks are skewed around as shown in Plate 1, *e* and *f*. In practice the primary circuit may be the antenna circuit and the secondary circuit of the present discussion the secondary circuit of a coupled-circuit receiver. In almost all practical cases the decrement coefficient of the antenna circuit, due to the ground and radiation resistance, is many times that of the secondary circuit. Especially is this true when regeneration is

used in the secondary circuit. It is evident then that the space model of the practical receiver is very much distorted, even more so than represented by the model in Plate 1, *e* and *f*.

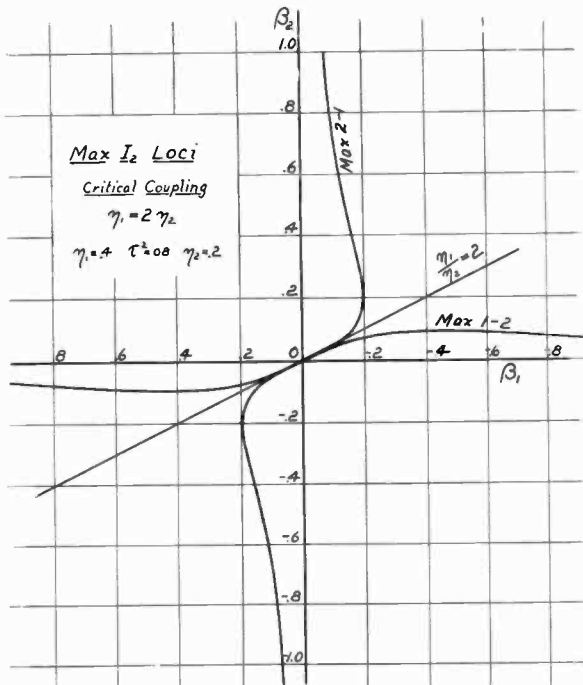

FIGURE 7

It is well now to examine, by means of these space models, the selectivity and tuning relations of a coupled-circuit receiver. If the circuits are adjusted to any point on the  $x y$ -plane and then the natural wave length of say, the primary circuit, is varied while a signal of constant wave length  $y = y_0$  is coming in, the variation in secondary current is given by the cross section of the model along a line thru the original point parallel to the  $x$  axis. Similarly a cross section parallel to the  $y$  axis gives the variation of current when the secondary circuit reactance is varied. If, on the other hand, the two circuits are fixed and the incoming wave length  $y$  is changed, the resulting variation of secondary current can be obtained from equation (14-a) or (15-a) by varying  $\theta$ , remembering that  $\beta_1$  and  $\beta_2$  are both functions of  $\theta$ . If  $\theta$  occurred nowhere in these equations except in  $\beta_1$  and  $\beta_2$ , then since  $\theta$  appears in  $\beta_1$  and  $\beta_2$  symmetrically, the variation in  $I_2$

would be given by allowing  $x$  and  $y$  to vary proportionately, that is by taking a cross section thru the space model along a radial line thru any point determined by the settings of  $\theta_1$  and  $\theta_2$ . The fact that  $\theta$  does occur in other terms of (14-a) and (15-a) makes this method of obtaining the result incorrect. Nevertheless, the terms other than  $\beta_1$  and  $\beta_2$  which contain  $\theta$  are slowly varying terms compared to  $\beta_1$  and  $\beta_2$  so that the cross section obtained as outlined above does, after all, give a result near enough to the correct result to make the method a very useful one. The smaller  $\gamma_1$  and  $\gamma_2$  are, and the less the variation in  $\theta$  necessary to obtain the required resonance curves, the truer is the result obtained by this cross-sectioning method.

In using this method it must be remembered, however, that since the variation in the coordinated  $x$  and  $y$  in this case is *inversely* proportional to  $y$ , the shape of the curve is somewhat distorted from what it would be if plotted in the usual way against  $y$  directly, moving along the radial line toward the origin means an *increase* in  $y$ . If the distance moved is very small the distortion due to this effect is small.

Examining now a specific case, let  $\gamma_1 = 5 \gamma_2$ . The factor of proportionality 5 is much less than is often met in practice. Because

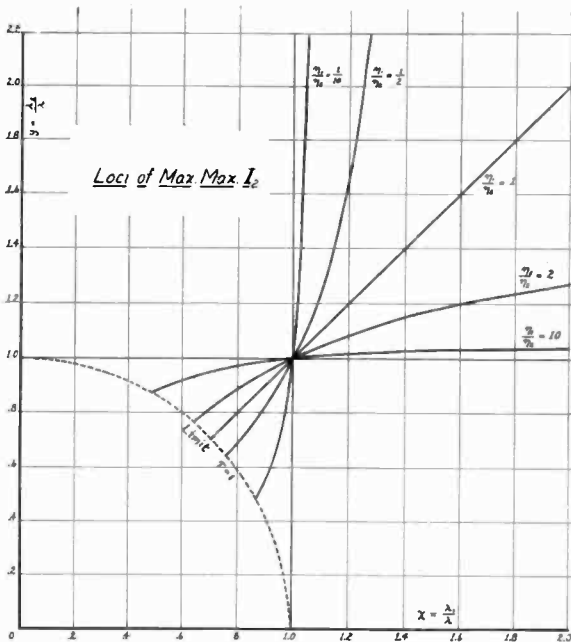

FIGURE 8

of distributed capacity of the coils a stronger signal is often obtained when the coupling is above critical and the adjustments are made for the long wave length maximum. This gives sufficient reason for considering the case shown in Plate 1, *e* and *f*, a practical case. It is evident that the primary circuit is adjusted to a much longer wave length than the resonant value for the incoming wave and that the apparent tuning in the primary circuit is very dull as shown by the section *pp* parallel to the *x* axis of the space model shown in Figure 9. The tuning in the secondary circuit is sharp as indicated by the section *ss*. The selectivity against interference from other stations, is, however, relatively low as indicated by the diagonal section along the line *oo*. The corresponding sections *p'p'* and *s's'* through the other peak of the space model are also shown in Figure 9.

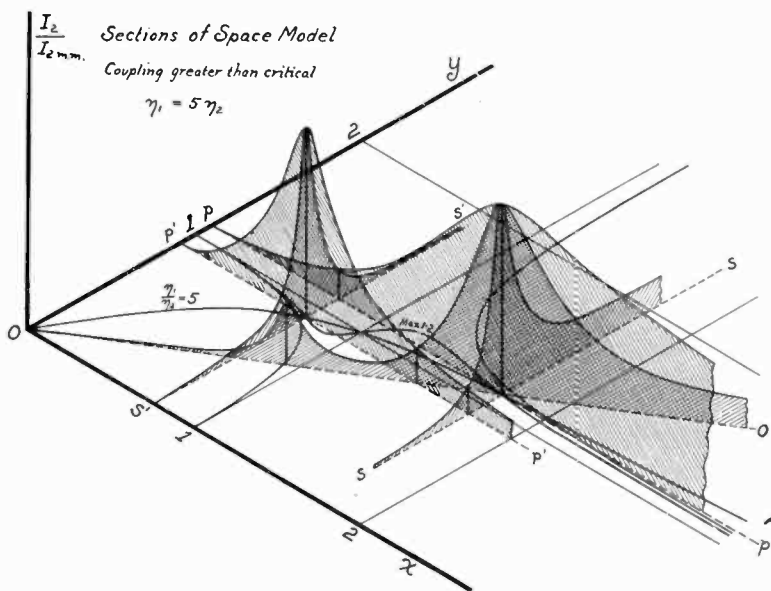

FIGURE 9

Figure 10 is a sectional drawing of the special case when  $\gamma_1$  is equal to  $\gamma_2$ . As pointed out above, the space model under these conditions is symmetrical as shown in *c* and *d* of Plate 1 and the two max. max. current peaks lie over the  $45^\circ$  line of the *x-y* plane.

The above discussion indicates the manner in which the space model can be used to advantage to study the equivalent resonance curve, and the selectivity and tuning relations under different conditions of the circuits. Enough has been given to show

*Sections of Space Model*

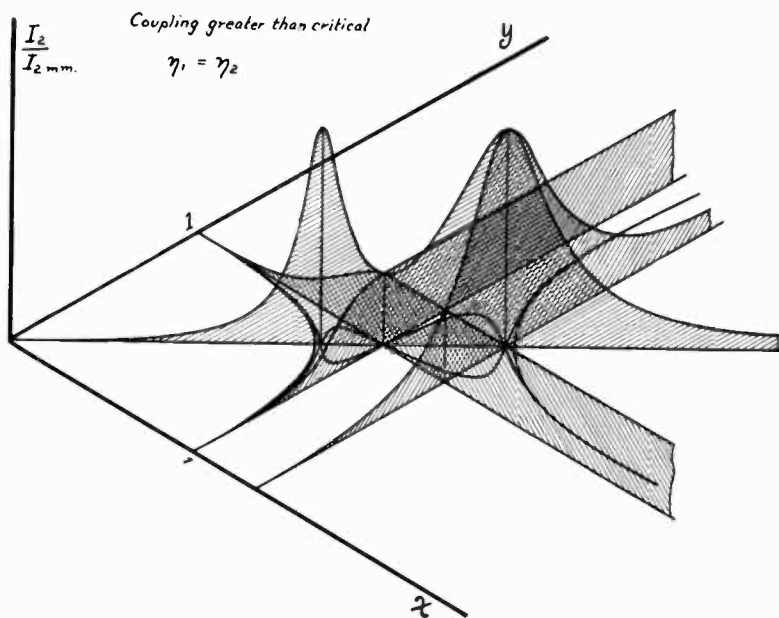

FIGURE 10

that the ratio of values of the decrement coefficients as well as their absolute values is important.

Referring now to the case of critical coupling, there is only one main maximum, but if the circuits are not in resonance, there are two values of the incoming wave length which will give maxima. This is shown by the section  $oo'$  and  $oo''$  in Figure 11, which shows cross sections of the space model for critical coupling when  $\gamma_1 > \gamma_2$ . Again, it is interesting to note that the equivalent resonance curve at critical coupling when the incoming wave is varied, is broad at the top as shown in Figure 12, whereas the curve obtained for a fixed  $y$  thru the point  $x = 1$  and  $y = 1$  as either  $y_1$  or  $y_2$  is varied, is sharper. (See Figure 4.) This broadness of resonance with a flat top is of advantage when receiving a radio telephone having a long carrier wave because of the broad spectrum which must be received.

The reason for the broader shape of the critical coupling resonance curve as  $y$  is varied is easily seen when it is remembered that for all couplings above zero, coupled circuits have two free periods of oscillation and there are two branches to the equi-coupling curves similar to that shown in Figure 6. A cross section along the  $45^\circ$  line thru these branches obtained by varying  $y$  gives two

peaks of current. For couplings above critical the two current peaks can be resolved, but at and below critical coupling the peaks are so close that they merge and cannot be resolved. The resultant resonance curve is, therefore, a sum of two curves very close together and hence is, necessarily, broader than a single resonance curve.

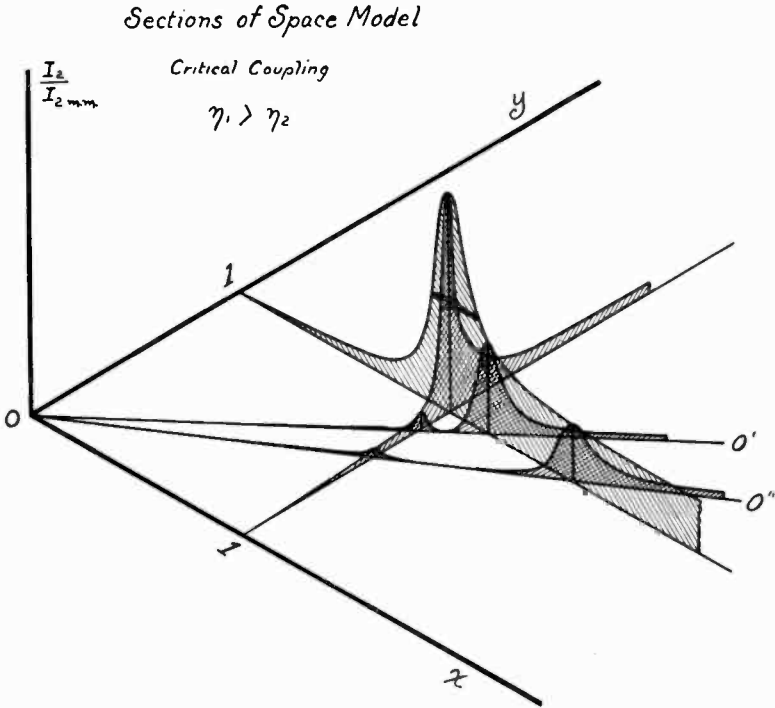

FIGURE 11

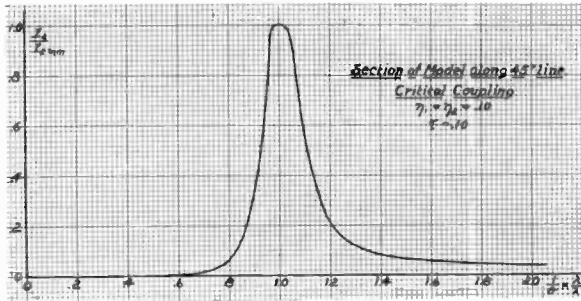

FIGURE 12

In the further development of radio communication it is conceivable that it will be desirable to receive more complex radio spectra such, for instance, as two waves with considerable separation. Such a spectrum can be received by making the two peaks of coupled circuits coincide with the two waves, but this can be done efficiently only when the two maxima occur on the  $45^\circ$  line of the model, as shown in Figure 10, and this is possible only when the ratio of resistance to inductance for the two circuits is the same. Since, as has been pointed out, the resistance of the antenna circuit is usually much greater than that of the secondary circuit, the reception of a two-wave spectrum necessitates the reduction of the primary circuit resistance by some method such as regeneration in that circuit.

### PART III

#### REGENERATION IN COUPLED CIRCUITS

The familiar theory of coupled circuits presented above has been given as a necessary foundation to the following theory of regeneration in coupled circuits. The author apologizes for the seemingly necessary repetition, but it is hoped that possibly the method of presentation may be of interest.

The theory of regeneration in coupled circuits is necessarily complex and a complete solution will not be attempted. Any one who has operated a double circuit regenerative receiver knows the complexity of adjustments and the interdependence of every adjustment on every other, so it is believed that a discussion of the theory of the case may enlighten the operations.

The only case considered in this paper is that in which regeneration takes place in one of two coupled circuits having constants shown in Figure 13. The circuit having regeneration is denoted by subscripts 2 and is termed the secondary circuit altho this terminology is entirely arbitrary. The emf. may be induced in either circuit. The equations for this case are readily deduced and are as follows:

$$(18) \quad \begin{cases} Z_1 I_1 + j M \omega I_2 = E_1 \\ j M \omega I_1 + Z_2 I_2 - j M \omega I_p = E_2 \\ j \left( \frac{\mu}{C_2 \omega} - m \omega \right) I_2 + Z_p I_p = 0 \end{cases}$$

where

$$\begin{aligned} Z_1 &= R_1 + j \left( L_1 \omega - \frac{1}{C_1 \omega} \right) \\ Z_2 &= R_2 + j \left( L_2 \omega - \frac{1}{C_2 \omega} \right) \\ Z_p &= R_p + j L_p \omega \end{aligned}$$



$M$  is the mutual inductance between  $L_1$  and  $L_2$ ,  $m$  the mutual inductance between  $L_2$  and  $L_p$ , and  $\mu$  is the amplification factor of the tube.  $E_1$  and  $E_2$  are emfs. of frequency  $\frac{\omega}{2\pi}$  introduced into the first and second circuits, respectively. In most of the following discussion it is simpler to consider the impressed frequency of the emf.  $E_1$  and  $E_2$  to be equal to the reference frequency  $\frac{\omega_0}{2\pi}$ , except in those discussions where the impressed frequency is assumed to vary for the purpose of obtaining the shape of the resonance curve of the system. The equations will be developed, however, without this limitation and they are expressed in terms of any frequency  $\frac{\omega}{2\pi}$ .

The solution of equation (18) is given below

$$(19) \quad I_1 = \frac{E_1 \left( Z_2 - \frac{\mu m}{C_2} \frac{m^2 \omega^2}{Z_p} \right) - j M \omega E_2}{Z_1 \left( Z_2 - \frac{\mu m}{C_2} \frac{m^2 \omega^2}{Z_p} \right) + M^2 \omega^2}$$

$$(20) \quad I_2 = \frac{E_2 Z_1 - j M \omega E_1}{Z_1 \left( Z_2 - \frac{\mu m}{C_2} \frac{m^2 \omega^2}{Z_p} \right) + M^2 \omega^2}$$

It is apparent on examination of equations (19) and (20) that the coupling  $m$  effects only  $Z_2$ , and hence regeneration in a circuit affects *only* the impedance of that circuit and not the impedance of any circuit coupled to it.<sup>1</sup> The equivalent impedance of the second circuit or the circuit in which the regeneration is established is

$$(21) \quad \bar{Z}_2 = Z_2 - \frac{\mu m}{C_2} \frac{m^2 \omega^2}{Z_p} \quad \text{or} \quad \begin{array}{l} \text{Equivalent im-} \\ \text{pedance of regen-} \\ \text{erated circuit} \end{array}$$

$$(22) \quad \bar{Z}_2 = \left[ R_2 - \frac{\mu m}{C_2} \frac{m^2 \omega^2}{Z_p^2} R_p \right] + j \left[ X_2 + \frac{\mu m}{C_2} \frac{m^2 \omega^2}{Z_p^2} X_p \right] \quad \text{or}$$

$$(23) \quad \bar{Z}_2 = [R_2 - H R_p] + j [X_2 + H X_p] \quad \text{or}$$

$$(24) \quad \bar{Z}_2 = \bar{R}_2 + j \bar{X}_2$$

<sup>1</sup> Several statements have appeared in the literature which claim that regeneration in the secondary circuit of two coupled circuits reduces the resistance of the primary or antenna circuit. Such statements are incorrect.

In equation 23 the quantity  $\frac{\mu m}{C_2} - m^2 \omega^2$  has been replaced by the abbreviation  $H$ , which will be called the *coefficient of regeneration*.  $H$  has no dimensions and is nearly independent of frequency, particularly if  $C_2$  and  $L_p$  are small. Expressed in terms of coefficients,  $H$  has the value

$$(25-1) \quad H = \frac{\frac{\mu m}{C_2} - m^2 \omega^2}{Z_p^2} \quad \text{or} \quad \left. \begin{array}{l} \\ \end{array} \right\} \begin{array}{l} \text{coefficient of regenera-} \\ \text{tion} \end{array}$$

$$(25-a) \quad H = \frac{L_2}{L_p} \cdot k \left( \frac{\mu}{y^2} \sqrt{\frac{L_2}{L_p} - k} \right) \left( \frac{1}{\gamma p^2 \theta^2 + 1} \right)$$

where  $y = \frac{\lambda_2}{\lambda_0}$  as before, and  $k = \frac{m}{\sqrt{L_p L_2}}$  is the coefficient of coupling between  $L_p$  and  $L_2$ .

Examination of equation (25) shows that regeneration gives  $H$  a positive value unless  $m^2 \omega^2 > \frac{\mu m}{C_2}$ , which is seldom the case. Since  $H$  depends upon  $m$ , the effect of  $m$  or  $k$  is to alter the values of resistance and reactance of the *regenerated circuit only*. The resistance  $R_2$  is changed to an effective or equivalent value  $\bar{R}_2$  and the reactance  $X_2$  to an effective value  $\bar{X}_2$ . The change in the reactance can be attributed to an apparent change in  $L_2$  as developed in the following equations.

$$(26-1) \quad \bar{X}_2 = X_2 + H X_p$$

$$(26-2) \quad = (L_2 + H L_p) \omega - \frac{1}{C_2 \omega}$$

$$(26-3) \quad = L_2 \omega - \frac{1}{C_2 \omega} \quad \text{where } \bar{L}_2 \text{ is the equivalent inductance.}$$

Regeneration increases the apparent inductance to  $L_2 + H L_p$ . In practice the actual change is small.

The following quantities may now be defined in terms of  $\bar{L}_2$ .

$$(27) \quad \bar{\omega}_2 = \frac{1}{\sqrt{\bar{L}_2 C_2}}$$

$$(28) \quad \bar{\lambda}_2 = \frac{2 \pi V}{\bar{\omega}_2} \quad V = \text{velocity of light.}$$

$$(29) \quad \bar{\beta}_2 = 1 - \left( \frac{\lambda_2}{\bar{\lambda}_2} \right)^2 = 1 - \frac{\theta^2}{\theta_2^2}$$

$$(30) \quad \bar{\tau} = \frac{M}{\sqrt{L_1 \bar{L}_2}}$$

$$(31) \quad \bar{K} = \frac{m}{\sqrt{L_p \bar{L}_2}}$$

Then it follows that since

$$(32) \quad \bar{R}_2 = R_2 - H R_p, \text{ then}$$

$$(33) \quad \bar{\gamma}^2 = \frac{\bar{R}_2}{\bar{L}_2 \omega_o} = \gamma_p^2 \frac{\bar{L}_2}{L_2} - H \frac{L_p}{L_2} \gamma_p$$

The expression for  $H$  can be given in terms of equivalent values

$$(25-b) \quad H = \frac{\bar{L}_2}{L_p} \cdot \frac{\bar{K} \left( \frac{\mu}{\gamma_p^2} \sqrt{\bar{L}_2} - \bar{K} \right)}{\gamma_p^2 \theta^2 + 1}$$

In discussing the conditions of oscillation and maximum regeneration it is easiest to assume first that  $E_2$  is zero. This case is the most practical, for  $E_1$  may then be considered to be the signal emf. induced in the antenna circuit represented by the primary circuit of Figure 13, and the secondary circuit of the same figure is the usual closed secondary circuit with regenerative detector or amplifier. Equations (19) and (20) then reduce to

$$(34) \quad I_1 = \frac{E_1 \bar{Z}_2}{Z_1 \bar{Z}_2 + M^2 \omega^2} = \frac{E_1 [(R_2 - H R_p) + j(X_2 + H X_p)]}{Z_1 [(R_2 - H R_p) + j(X_2 + H X_p)] + M^2 \omega^2}$$

$$= \frac{E_1}{Z_1 + \frac{M^2 \omega^2}{\bar{Z}_2}} = \frac{E_1}{\bar{Z}_{12}}$$

where  $\bar{Z}_{12}$  is the equivalent impedance of the system looking from the primary circuit.

$$(35) \quad I_2 = -\frac{j M \omega E_1}{Z_1 \bar{Z}_2 + M^2 \omega^2} = -\frac{j M \omega E_1}{Z_1 [(R_2 - H R_p) + j(X_2 + H X_p)] + M^2 \omega^2}$$

$$= \frac{-j M \omega E_1}{\bar{Z}_2 \left( Z_1 + \frac{M^2 \omega^2}{\bar{Z}_2} \right)} = \frac{-j M \omega E_1}{Z_2 \bar{Z}_{12}} = \frac{-j M \omega E_1}{Z_1 \left( \bar{Z}_2 + \frac{M^2 \omega^2}{Z_1} \right)} = \frac{-j M \omega E_1}{Z_1 \bar{Z}_{21}}$$

where  $\bar{Z}_{21}$  is the equivalent impedance of the system looking from the secondary circuit.

If now  $H R_p$  is made equal to or greater than  $R_2$ , then  $R_2$  will become zero or negative. If the regenerated circuit is not coupled to the first circuit (that is if  $M=0$ ) the second circuit will oscillate as soon as  $R_2$  becomes zero or negative. This condition that  $R_2=0$  is the same as the condition of oscillation of the simple

circuit of Case 2, Part I. When, however, the two circuits are coupled,  $\bar{R}_2$  may be negative without oscillations taking place, because of the additional losses introduced by the primary circuit. There is then presented the peculiar condition of two coupled circuits, the effective resistance of one of which may be negative. It was this interesting condition which partially induced the present investigation in order to determine how the usual relations of coupled circuits with positive resistances given in the second part of this paper would be altered.

**CASE 1. SPECIAL CARE OF CONSTANT REGENERATIVE EFFECT.**  
 Referring to equation (25) it is evident that the regeneration coefficient  $H$  is a function of both  $\theta_2$  and  $\theta$ , that is,  $H$  varies with the setting of the secondary condenser and the incoming wave length, altho the variation with the latter is slight. The first case to be considered assumes  $H$  is constant. Under this assumption the resistance of the secondary circuit is altered to a constant value  $\bar{R}_2$ , which may be negative and  $L_2$  is slightly altered to a new equivalent value  $\bar{L}_2$ . All quantities will be expressed and plotted in terms of the equivalent values. This case applies to two circuits, one having a constant negative resistance obtained in any way, and also to the practical case of coupled circuits having a regenerative secondary circuit when the tuning is done by varying  $L_2$  so that  $m$  does not change.

To investigate further, the same procedure used in the theory of coupled circuits with positive resistances may be followed. The secondary current given by equation (35) is expanded below in terms of equivalent values and is similar to equation (6) for coupled circuits with positive resistances.

$$(36-1) \quad I_2 = \frac{-j M \omega E_1}{Z_1 \left[ \left( \bar{R}_2 + \frac{M^2 \omega^2 R_1}{X_1^2} \right) + j \left( \bar{X}_2 - \frac{M^2 \omega^2 X_1}{R_1^2 + X_1^2} \right) \right]} \quad \text{or}$$

$$(36-a) \quad I_2 = \frac{-\frac{j \tau \theta E_1}{\omega_0 \sqrt{L_1 L_2}}}{[\gamma_1 \theta + j \beta_1] \left[ \gamma_2 \theta + \frac{\tau^2 \gamma_1 \theta}{\gamma_1^2 \theta^2 + \beta_1^2} \right] + j \left( \beta_2 - \frac{\tau^2 \beta_1}{\gamma_1^2 \theta^2 + \beta_1^2} \right)}$$

Now referring to equation (36-1) and following the same procedure as before, if  $X_1$  has some value and  $\bar{X}_2$  is varied until a maximum of  $I_2$  is obtained, the value of  $\bar{X}_2$  is

$$(37-1) \quad \bar{X}_2 = \frac{M^2 \omega^2 X_1}{R_1^2 + X_1^2} \quad \text{or} \quad \bar{X}_2 \text{ to give max. } I_2 \text{ equation of max. 1-2 line}$$

$$(37-a) \quad \bar{\beta}_2 = \frac{\tau^2 \beta_1}{\gamma_1^2 \theta^2 + \beta_1^2} \quad \beta_2 \text{ to give max. } I_2, \text{ equation of max. 1-2 line}$$

Equation (37) corresponds to equation (7) and is *independent* of the value of  $R_2$ , whether negative or positive.

The value of the max.  $I_2$  is

$$\begin{aligned}
 (38-1) \quad \max. I_2 &= \frac{-j M \omega E_1}{(R_1 + j X_1) \left( \bar{R}_2 + \frac{M^2 \omega^2 R_1}{R_1^2 + X_1^2} \right)} \quad \text{or} \\
 (38-a) \quad \max. I_2 &= \frac{-j \bar{\theta} E_1}{\omega_o \sqrt{L_1} \bar{I}_2} \quad \left[ \bar{\gamma}_1^2 \theta + \frac{\bar{\gamma}_1^2 \theta}{\gamma_1^2 \theta^2 + \beta_1^2} \right]
 \end{aligned}
 \left. \vphantom{\begin{aligned} (38-1) \\ (38-a) \end{aligned}} \right\} \begin{array}{l} \text{Obtained} \\ \text{by adjusting} \\ X_1 \\ \text{then } \bar{X}_2 \end{array}$$

This expression evidently gives a finite value of  $I_2$  even if  $\bar{R}_2$  is negative, but less in absolute value than  $\frac{M^2 \omega^2 R_1}{R_1^2 + X_1^2}$ . The conditions under which  $I_2$  shall have its greatest value can now be found, as was done in the simple theory of coupled circuits, by differentiating equation (38-1), remembering it is a complex expression. The roots thus found for  $X_1$  are similar to equation (9) in Part II.

$$(39-1) \quad X_1 = 0$$

$$(39-2) \quad R_1^2 + X_1^2 = \frac{M^2 \omega^2 R_1}{\bar{R}_2} \quad \text{Imaginary value of } X_1 \text{ if } \bar{R}_2 \text{ is negative.}$$

$$(39-3) \quad R_1^2 + X_1^2 = -\frac{M^2 \omega^2 R_1}{\bar{R}_2} \quad \text{Value of } X_1 \text{ to give max. max. } I_2.$$

Expression (39-2), which in Part II gave the value of  $X_1$  for the max. max.  $I_2$ , now, when  $\bar{R}_2$  is negative, gives an imaginary value. Therefore root (39-3) must now be used.

Examining more closely the conditions given in (39) it is evident that (39-3) gives in general for any value of  $\omega$  two values of  $X_1$  for which the denominator of equation (38) is zero. At these two values of  $X_1$  the current  $I_2$  (and also  $I_1$ ) becomes infinite or oscillation begins at frequency  $\frac{\omega}{2\pi}$ . Values of  $X_1$  (with corresponding values of  $X_2$ , since the discussion assumes that adjustments are such that equation (37) holds) between these two points give finite values of  $I_2$  of frequency  $\frac{\omega}{2\pi}$ . Since the only adjustments under considerations lie on the Max. 1-2 line shown in Figures 5 and 6 for  $\theta = 1$ , this line included between the boundary points of oscillation at frequency  $\frac{\omega}{2\pi}$  ( $\frac{\omega_o}{2\pi}$  for Figures 5 and 6,

since  $\theta$  equals unity for these figures), is the locus of max.  $I_2$  just as in the second part of this paper when the secondary resistance was positive. It should be noted that the shape of the Max. 1-2 line is independent of whether  $\bar{R}_2$  is positive or negative and that the *same* two values of  $X_1$  satisfy equation (9-2) that satisfy (39-3) if the negative  $\bar{R}_2$  has the same numerical value that the positive  $R_2$  had in Part II.

As was demonstrated in Part II, the Max. 2-1 line (adjustment of primary circuit to max  $I_2$  for various settings of secondary circuit) passes thru the points of max. max.  $I_2$ , which have in this case of negative resistance been shown to be the boundary points between oscillation and non-oscillation. The portion of this Max. 2-1 line between these two points is in this case the locus of max.  $I_2$  of frequency  $\frac{\omega}{2\pi} \left( \frac{\omega_o}{2\pi} \text{ if } \theta = 1 \right)$  where the order of adjustment of the two circuits is as indicated, that is, first secondary then primary.

For points on the Max. 1-2 line outside the region between the boundary points of oscillation,  $\bar{R}_2 + \frac{M^2 \omega^2 R_1}{R_1^2 + X_1^2}$  (see equation (36)) is negative and  $\bar{X}_2 - \frac{M^2 \omega^2 X_1}{R_1^2 + X_1^2} = 0$ . This condition cannot exist because if the first expressions were negative, a larger amount of power would be supplied to the system than would be dissipated, an obvious impossibility. What actually happens is first an increase in magnitude of the oscillation. The vacuum tube then operates over such an extent of its characteristics that the average values of  $\mu$  and  $R_p$  are altered. This alteration in  $\mu$  and  $R_p$  is, in each case, in the direction of reducing the negativity of  $\bar{R}_2 + \frac{M^2 \omega^2 R_1}{R_1^2 + X_1^2}$ . Equilibrium is established when this expression again becomes zero. Of course harmonics are introduced which complicate matters, but to a first approximation in the qualitative discussion they may be neglected. The variations in  $\mu$  and  $R_p$  will also alter the value of  $\bar{X}_2$ , but to the first approximation, equation (37) may still be considered true and the oscillation at frequency  $\frac{\omega}{2\pi} \left( \frac{\omega_o}{2\pi} \text{ if } \theta = 1 \text{ as in Figures 5 and 6} \right)$  will then take place over the portions of the Max. 1-2 line outside the boundary points.

If equations (37) and (39-3), both of which hold for these two points of boundary between oscillation and non-oscillations, are solved simultaneously there results

$$\begin{array}{l}
 (40-1) \quad \frac{R_1}{R_2} = -\frac{\lambda_1}{\bar{X}_2} \text{ or} \\
 (40-a) \quad \frac{\gamma_1}{\gamma_2} = -\frac{\beta_1}{\bar{\beta}_2}
 \end{array}
 \left. \vphantom{\begin{array}{l} (40-1) \\ (40-a) \end{array}} \right\} \begin{array}{l} \text{Locus of points where oscilla-} \\ \text{tion begins at frequency } \frac{\omega_0}{2\pi} \\ \text{as coupling } M \text{ is varied.} \end{array}$$

Equation (40) is evidently the same as (17) in Part II which is the equation of the straight lines in Figure 5 and Figure 7, and the curved lines in Figure 6 and Figure 8. Attention is again called to the fact that the figures are all drawn for the case that  $\theta = 1$ . The boundary points given by equation (39-3) are therefore, as in Part II, found to be the points of intersection of the Max. 1-2 line, the Max. 2-1 line and the appropriate radial line. These points of intersection which now mark the boundary between oscillation and non-oscillation were in Part II the points of max. max.  $I_2$ , the current in the present case increasing toward infinity instead of to a finite max. max. value.

If, now,

$$\begin{array}{l}
 (41-1) \quad M^2 \omega^2 = -R_1 \bar{R}_2 \text{ or} \\
 (41-a) \quad \bar{\tau}^2 = -\gamma_1 \bar{\gamma}_2 \theta^2
 \end{array}
 \left. \vphantom{\begin{array}{l} (41-1) \\ (41-a) \end{array}} \right\} \text{Critical coupling.}$$

a relation which gave critical coupling in Part II, the boundary points just discussed come together at  $X_1 = 0$  and  $\bar{X}_2 = 0$ . Relation (41) marks then a sort of critical coupling for negative resistance in one circuit, for then the region of no oscillation at frequency  $\frac{\omega}{2\pi}$  has shrunk to a point and become a point of max. max.

$I_2$ , that is, infinite  $I_2$ . This adjustment should be the condition for maximum signal with greatest selectivity. A little analysis shows that under this condition the line Max. 1-2 and the locus of equation (40) are tangent at the origin as shown in Figure 7, which is drawn for the case  $\theta = 1$ .

It is, therefore, evident from the above discussion that when two circuits are coupled and one, say the secondary, has regeneration so that its effective resistance is negative but less in absolute value than  $\frac{M^2 \omega^2 R_1}{R^2_1 + X_1^2}$ , and if the new equivalent reactance determines the new natural wave length  $\bar{\lambda}_2$  which will be slightly different from  $\lambda_2$ , and if now all equations be plotted to  $x = \frac{\gamma_1}{\theta}$  and  $y = \frac{\bar{\theta}_2}{\theta}$  or to  $\beta_1$  and  $\bar{\beta}_2$ , then the locus Max. 1-2 (shown for  $\theta = 1$  in Figure 5), which marks the maximum value of  $I_2$  in simple coupled circuits when  $X_1$  and then  $X_2$  are adjusted, also marks the maximum value of current of frequency  $\frac{\omega}{2\pi}$  when the second-

ary resistance is negative. As this locus curve is traversed, there are two values of  $X_1$  marking a range outside of which the system oscillates at frequency  $\frac{\omega}{2\pi}$ . Between the two values of  $X_1$  the points on curve Max. 1-2 give max.  $I_2$  unless the tube starts oscillating at some other frequency, a possibility which will be shortly explained.

Referring to Figure 6, for which  $\theta = 1$  and which may now be used for the case of negative resistance  $\bar{R}_2$ , oscillation at frequency  $\frac{\omega_o}{2\pi}$  takes place if the adjustments are such as to correspond to points on the locus Max. 1-2 outside the region between the intersections of the Max. 1-2 and the Max. 2-1 lines. Over the portions of the Max. 1-2 and the Max. 2-1 lines between these points of intersection, the current  $I_2$  will be a maximum when the adjustments are made in the proper order. It is evident that maximum regeneration at frequency  $\frac{\omega_o}{2\pi}$  will occur at the points of intersection of the Max. 1-2 and Max. 2-1 lines, that is, at points  $a-a$ .

It is apparent that if  $M$  is varied, the points of intersection (points of max. max.  $I_2$ ) travel along the  $\frac{\gamma_1}{\gamma_2}$  line. If, however,  $M$  is fixed and  $\bar{R}_2$  varied, the points  $a-a$  travel along the Max. 1-2 line which is itself unchanged in shape. If  $\bar{R}_2$  is positive, the points  $a-a$  represent points of max. max.  $I_2$ . As  $\bar{R}_2$  approaches zero the points recede from the origin  $O'$  along the Max. 1-2 line until when  $\bar{R}_2 = 0$  the points are at  $x = 0$  and  $x = \infty$ . As  $\bar{R}_2$  becomes a larger negative quantity, the points  $a-a$  approach  $O'$  along the same Max. 1-2 line, this time marking points where oscillation at frequency  $\frac{\omega_o}{2\pi}$  begins, or points of maximum regeneration. At these points  $I_2$  is theoretically infinite.

The boundary line on the  $x-y$  plane separating the region of non-oscillation from that where oscillation at *some* frequency takes place can now be deduced. It must be remembered that whereas frequency  $\frac{\omega}{2\pi}$  has signified an impressed frequency, it may now signify a frequency of oscillation of the circuit, for a current of frequency  $\frac{\omega}{2\pi}$  can exist with zero impressed emf. of that frequency provided the equivalent resistance and reactance for that frequency are both zero. It is then possible to have an im-



pressed emf. of one frequency  $\frac{\omega}{2\pi}$  different from  $\left|\frac{\omega_0}{2\pi}\right|$  and yet have the system oscillate in another frequency  $\frac{\omega}{2\pi}$  different from the above two frequencies and also different from either frequency  $\frac{\omega_1}{2\pi}$  and  $\frac{\omega_2}{2\pi}$ . It therefore becomes necessary to keep in mind five frequencies.

Referring to equations (34) and (35), oscillation will take place if

$$(42) \quad Z_1 \bar{Z}_2 + M^2 \omega^2 = 0 \quad \text{General condition of oscillation}$$

where now  $\frac{\omega}{2\pi}$  is any frequency instead of the specific frequency of the emf.  $E_1$ .

Expanding (42) we get

$$(43) \quad \left\{ \begin{aligned} (R_1 + j X_1)(\bar{R}_2 + j \bar{X}_2) + M^2 \omega^2 = 0 & \quad \text{or} \\ (R_1 \bar{R}_2 - X_1 \bar{X}_2 + M^2 \omega^2) + j(X_1 \bar{R}_2 + \bar{X}_2 R_1) = 0 \end{aligned} \right\} \text{General condition of oscillation.}$$

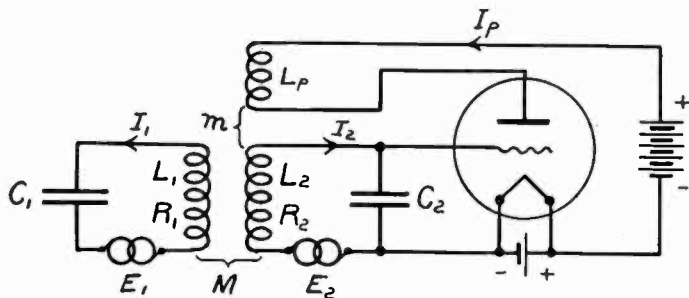

FIGURE 13

The condition of oscillation, therefore, reduces to the double condition that both the real and imaginary parts of (43) must vanish, or

$$(44) \quad \left\{ \begin{aligned} R_1 \bar{R}_2 - X_1 \bar{X}_2 + M^2 \omega^2 = 0 \\ X_1 \bar{R}_2 + \bar{X}_2 R_1 = 0 \end{aligned} \right\} \text{General condition of oscillation.}$$

These equations when solved give expressions previously deduced, that is,

$$(45-1) \quad \bar{R}_2 + \frac{M^2 \omega^2 R_1}{R_1^2 + X_1^2} = \bar{R}_{21} = 0 \quad \text{same as (39-3)}$$

$$(46-1) \quad \bar{X}_2 - \frac{M^2 \omega^2 X_1}{R_1^2 + X_1^2} = \bar{X}_{21} = 0$$

General condition of oscillation.

Using the usual notation, equations (45) and (46) may be written as follows:

$$\left. \begin{aligned}
 (45-a) \quad \bar{\gamma}_2 &= - \frac{\bar{\tau}^2 \gamma_1}{\gamma_1^2 \theta^2 + \left[ 1 - \frac{\theta^2}{\theta_1^2} \right]^2} \\
 (46-a) \quad \left[ 1 - \frac{\theta^2}{\theta_2^2} \right] &= \frac{\bar{\tau}^2 \left[ 1 - \frac{\theta^2}{\theta_1^2} \right]}{\gamma_1^2 \theta^2 + \left[ 1 - \frac{\theta^2}{\theta_1^2} \right]^2}
 \end{aligned} \right\} \begin{array}{l} \text{General condi-} \\ \text{tion of oscilla-} \\ \text{tion.} \end{array}$$

If  $\theta$ , the only function containing  $\omega$ , is eliminated from these two equations, the resulting expression gives the locus of points on the  $\theta_1 - \theta_2$  plane where equation (42) is true and hence gives the boundary between oscillation and non-oscillation irrespective of the frequency. The elimination yields the expression

$$(47) \quad \left[ \gamma_1 \gamma_2 (\gamma_1 + \gamma_2) \bar{\theta}_2^2 + \bar{\gamma}_2 + \bar{\tau}^2 \gamma_1 \right] \theta_1^4 + \left[ \bar{\gamma}_2^2 (\gamma_1 + \bar{\gamma}_2) \bar{\theta}_2^2 - 2 \bar{\gamma}_2 (1 - \bar{\tau}^2) \right] \theta_1^2 \bar{\theta}_2^2 + \left[ \frac{\bar{\gamma}_2^2 (\gamma_1 + \bar{\tau}^2 \gamma_2)}{\gamma_1} \right] \bar{\theta}_2^4 = 0 \quad \begin{array}{l} \text{Boundary equa-} \\ \text{tion for special} \\ \text{case.} \end{array}$$

This equation is plotted in Figure 14 for  $\tau = 0.5$ ,  $\gamma_1 = .4$ , and various values of  $\bar{\gamma}_2$ . Considering any one curve, no frequency  $\frac{\omega}{2\pi}$  can make the effective resistance  $\bar{R}_{21}$  of the system and the effective reactance  $\bar{X}_{21}$  simultaneously vanish for points inside the boundary. The effective resistance of the system viewed from the secondary circuit for points inside the boundary is positive and the system does not oscillate. For each point on the boundary the effective resistance and reactance expressed by equations (45) and (46) vanish for some frequency. For each point outside the boundary,  $\bar{R}_{21}$  is negative for some frequencies, one of which makes the reactance  $\bar{X}_{21}$  vanish. The system, therefore, oscillates at this frequency, but this condition of negative resistance cannot persist for the current would rise to an infinite value and still have the supply of power greater than the dissipation. The oscillations increase in amplitude until the values of  $\mu$  and  $R_p$  are no longer constant over the cycle and until the average values of these factors have altered to an extent to reduce the effective resistance  $\bar{R}_{21}$  for the frequency of oscillation to zero. The stable condition is reached when the altered values of  $\mu$  and  $R_p$  make  $\bar{R}_{21}$  and  $\bar{X}_{21}$  vanish. The changes in the tube factors do not alter the reactance term nearly as much as they do the resistance term, so that the frequency under these conditions is not

much different from the frequency which makes the original effective reactance (equation 46) vanish.

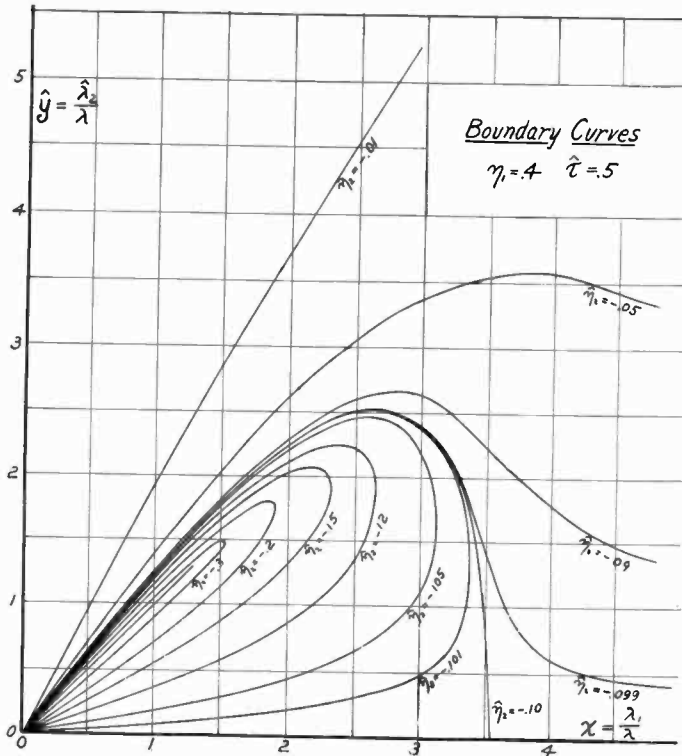

FIGURE 14

Referring to Figure 15, the heavy full line curve marked *boundary* is equation (47) plotted for values of  $\eta_1$ ,  $\eta_2$  and  $\bar{\tau}$  given on the figure. This curve represents the boundary between oscillation for points outside and non-oscillation for points within. The coordinates are as indicated, that is, the ratio between the natural wave lengths  $\lambda_1$  and  $\lambda_2$  of the respective circuits, to the reference wave length  $\lambda_0$ .

The curves marked Max. 1-2 are equation (46) plotted for various values of  $\theta$  and mark the loci along which  $\bar{X}_{21}$  vanishes for the several values of  $\theta$ , that is, for different wave lengths. For instance, the Max. 1-2 line for  $\theta = 1$  is a line over which  $\bar{X}_{21}$  for  $\lambda = \bar{\lambda}_0$  is zero, and is the Max. 1-2 line of previous figures over which, when  $\bar{R}_2$  was positive, the maximum secondary current was obtained under an impressed emf. of wave length  $\lambda_0$ , and when the order of adjustment of the circuits was first primary

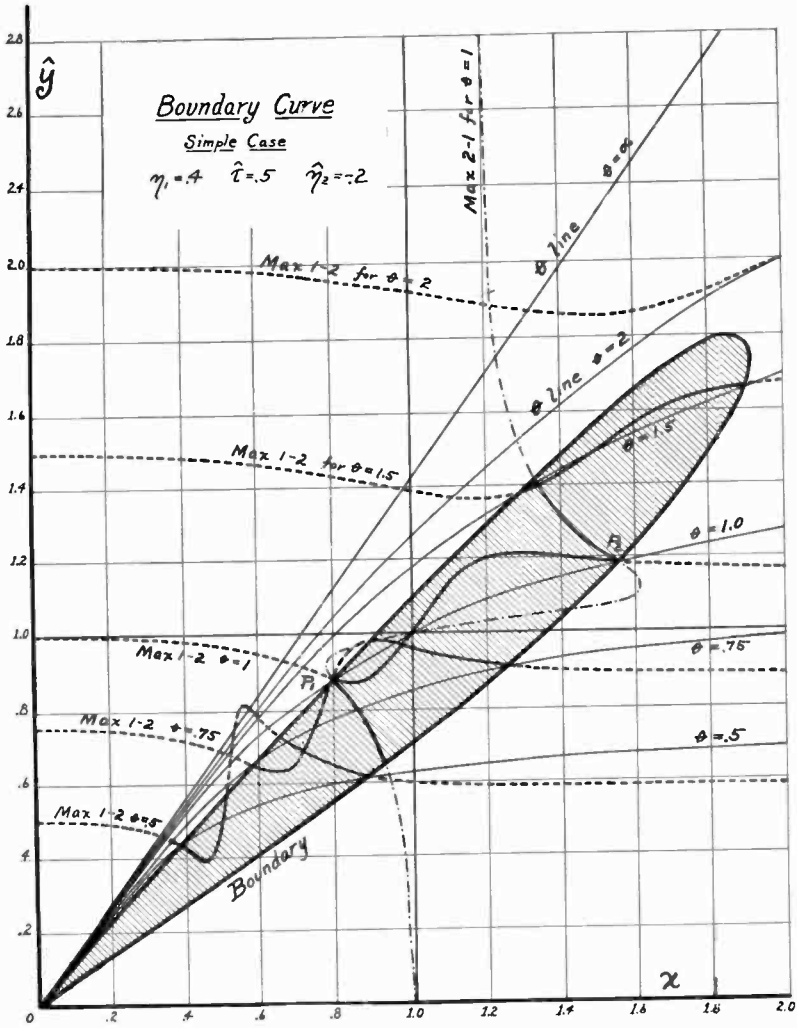

FIGURE 15

and then secondary. Since, in the case represented in Figure 15,  $R_{21}$  is positive within the boundary, that portion of the Max. 1-2 line for  $\theta = 1$  inside this boundary now marks the locus of maximum secondary current when an emf. of wave length  $\lambda_0$  is impressed. The curve outside the boundary approximately gives the line over which the system oscillates with wave length  $\lambda_0$ . The other curves for other values of  $\theta$  give the analogous curves when  $\lambda = \theta \lambda_0$ . Inside the boundary the curves give the loci of maximum secondary current under an impressed emf. of wave length

$\lambda = \theta \lambda_o$ , and outside the boundary the curves give the approximate loci of oscillation at wave length  $\lambda = \theta \lambda_o$ . When a portion of one of the Max. 1-2 lines which is outside the boundary crosses another Max. 1-2 line, there is a condition for which the same adjustments of the circuits satisfy  $\bar{X}_{21} = 0$  for the two wave lengths. In this case the oscillation will take place at the longer wave length because then the resistances are less.

If  $\bar{\tau}$  be eliminated from equations (45) and (46), then the equation given below results.

$$(48) \quad \theta^2 = \frac{\bar{r}_1 + \bar{r}_2}{\frac{\bar{r}_1}{\theta_2^2} + \frac{\bar{r}_2}{\theta_1^2}} \quad \begin{array}{l} \text{Locus of max. regen-} \\ \text{eration points as } \bar{\tau} \text{ is} \\ \text{varied.} \end{array}$$

If  $\theta$  equals unity, this equation reduces to equation (40) and gives the locus of the boundary points of oscillation at wave length  $\lambda_o$  as the coupling is varied. For any other value of  $\theta$  the equation gives the locus of points where oscillation begins for wave length  $\theta \lambda_o$  for all values of  $\bar{\tau}$ .

If the constants of the circuits are as assumed in Figure 15, it is evident that maximum regeneration for wave length  $\lambda_o$  occurs at *two* points where the Max. 1-2 line for  $\theta = 1$  cuts the boundary curve.

Figure 16 is similar to Figure 15 except that it is calculated for critical coupling, the numerical value of which for the constants given is  $\sqrt{.08}$ . In this case the two points of maximum regeneration of Figure 15 have approached and have fused to a single point.

It is now interesting to examine the value of the primary and secondary currents for any impressed frequency  $\frac{\omega}{2\pi}$  when the circuits are adjusted to any point of the diagram either inside or outside the boundary curve. The expressions for the primary current taken from equation (34) are

$$(49-1) \quad I_1 = \frac{E_1}{Z_{12}}$$

$$(49-2) \quad I_1 = \frac{E_1}{\sqrt{R_{12}^2 + \bar{X}_{12}^2}} = \frac{\frac{E_1}{L_1 \omega_o}}{\sqrt{\left(\frac{R_{12}}{L_1 \omega_o}\right)^2 + \left(\frac{X_{12}}{L_1 \omega_o}\right)^2}} \quad \left. \begin{array}{l} \text{Numerical} \\ \text{value of} \\ \text{primary} \\ \text{current.} \end{array} \right\}$$

$$(49-a) \quad I_1 = \frac{E_1}{L_1 \omega_0} \sqrt{\left[ \eta_1 + \frac{\bar{\eta}_2}{\eta_2^2 \theta^2 + \left| 1 - \frac{\theta^2}{\theta_2^2} \right|^2} \right]^2 + \frac{1}{\theta} \left[ 1 - \frac{\theta^2}{\theta_1^2} - \frac{\bar{\eta}_2 \left| 1 - \frac{\theta^2}{\theta_2^2} \right|}{\eta_2^2 \theta^2 + \left| 1 - \frac{\theta^2}{\theta_2^2} \right|^2} \right]^2}$$

The expression for the secondary current for any frequency  $\frac{\omega}{2\pi}$  is from equations (35) and (36)

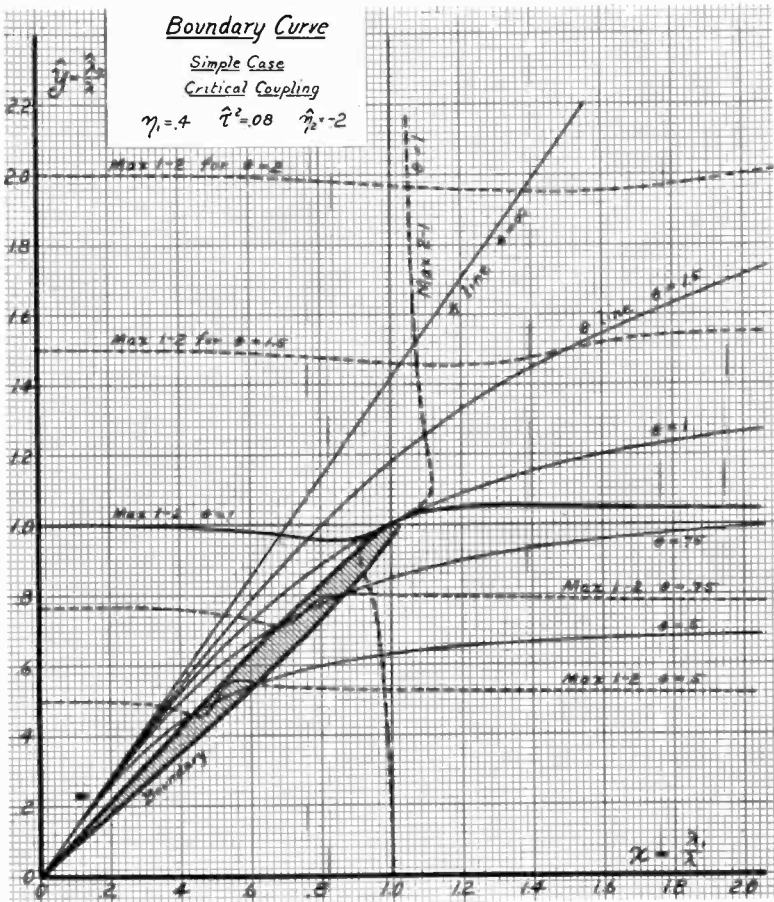

FIGURE 16

$$(50-1) \quad I_2 = -\frac{j M \omega E_1}{Z_1 Z_{21}}$$

$$(50-2) \quad I_2 = \frac{j M \omega E_1}{\sqrt{R_1^2 + X_1^2} \sqrt{R_{21}^2 + X_{21}^2}} \text{ or}$$

$$(50-a) \quad I_2 = \frac{\bar{\tau} E}{\omega_o \sqrt{L_1 \bar{L}_2} \sqrt{\left(\theta \frac{R_1}{L_1 \omega_o}\right)^2 + \left(\frac{X_1}{L_1 \omega_o}\right)^2} \sqrt{\left(\frac{R_{21}}{L_2 \omega_o}\right)^2 + \left(\frac{X_{21}}{L_2 \omega_o}\right)^2}} \text{ or}$$

Numerical value of secondary current

$$I_2 = \frac{E \bar{\tau}}{\omega_o \sqrt{L_1 L_2} \sqrt{\gamma_1^2 \theta^2 + \left[1 - \frac{\theta^2}{\theta_1^2}\right]^2} \sqrt{\left[\bar{\gamma}_2 + \frac{\bar{\tau}^2 \gamma_1}{\gamma_1^2 \theta^2 + \left[1 - \frac{\theta^2}{\theta_1^2}\right]^2}\right]^2 + \frac{1}{\theta} \left[1 - \frac{\theta^2}{\theta_2^2} - \frac{\bar{\tau}^2 \left[1 - \frac{\theta^2}{\theta_1^2}\right]}{\gamma_1^2 \theta^2 + \left[1 - \frac{\theta^2}{\theta_1^2}\right]^2}\right]^2}}$$

Expressions (49) and (50) are functions of the settings  $\frac{\lambda_1}{\lambda_o}$  and  $\frac{\lambda_2}{\lambda_o}$  of the two circuits and also functions of  $\theta = \frac{\lambda}{\lambda_o}$ . The shape of the resonance curve produced by varying  $\lambda$  when the two circuits are set at certain values of  $\frac{\lambda_1}{\lambda_o}$  and  $\frac{\lambda_2}{\lambda_o}$  can be obtained from equations (49) and (50) by varying  $\theta$ . This method, of course, gives the exact shape of the resonance curves and is slightly different as already explained from the approximate method described in Part II of taking a cross section thru the space model which has been plotted against  $x$  and  $y$ . As an example the resonance curve is calculated for the point  $P_1$  of Figure 15. At  $P_1$  as well as at  $P_2$  the system is on the verge of oscillating at wave length  $\lambda_o$ , and hence the system is in a sensitive adjustment for receiving the single wave length  $\lambda_o$ . If the received message is from a radio telephone station the radiated energy consists of a band of wave lengths grouped around the carrier wave  $\lambda_o$ , and it is of interest to obtain the equivalent resonance curve of the system to determine how efficiently the whole radio-telephone spectrum will be received.

Figure 17 is a plot against  $\theta$  of the components  $\frac{\bar{R}_{12}}{L_1 \omega_o}$  and

$\frac{\bar{X}_{12}}{L_1 \omega_0}$  (see equation (49-2)) of the equivalent impedance of the system of point  $P_1$ , Figure 15, as viewed from the primary circuit. For some impressed wave lengths, the system offers a negative resistance to the impressed electromotive force. Under these conditions the wave of wave length  $\lambda$  for which the resistance is negative suffers no absorption in the system; but on the contrary energy is emitted from the system of that wave length, but only when  $\lambda$  is impressed. If the primary circuit is the antenna of a double-circuit receiving system and a wave of length  $\lambda$  is im-

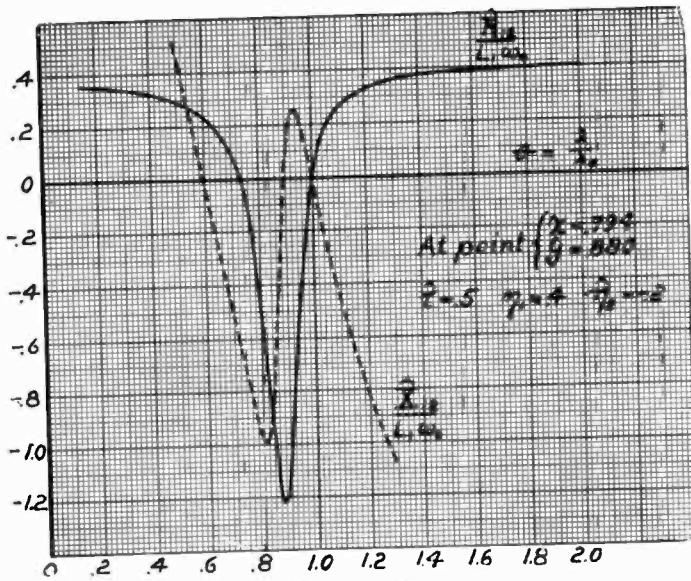

FIGURE 17

pressed for which the resistance is negative, energy will be emitted from the antenna, the phase of the emitted energy being determined by the values of  $\bar{X}_{12}$  and  $\bar{R}_{12}$ . Obviously in some directions around the antenna the direct and emitted wave will reinforce while in other directions the two will tend to cancel. This opens up an interesting field of investigation to determine the effect of one receiving antenna on the distortion of the message received by a neighboring system.

Figure 18 gives plots of  $\frac{\bar{R}_{21}}{L_2 \omega_0}$  and  $\frac{\bar{X}_{21}}{L_2 \omega_0}$  (see equation (50-a)).

Figure 19 is a plot of the secondary current calculated from equation (50-a).



The secondary current curve of Figure 19 is, of course, an approximate cross section of the space model along a radial line thru the point  $P_1$ . Distances along the radial line are, however, not proportional to  $\theta$ , but the relation between distance and  $\theta$  is

$$(51) \quad \text{distance} = \frac{\sqrt{\left(\frac{\lambda_1}{\lambda_0}\right)^2 + \left(\frac{\lambda}{\lambda_0}\right)^2}}{\theta}$$

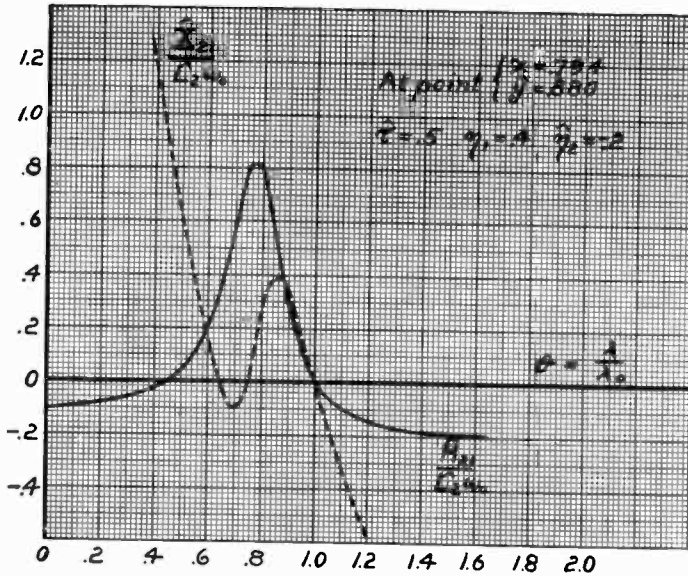

FIGURE 18

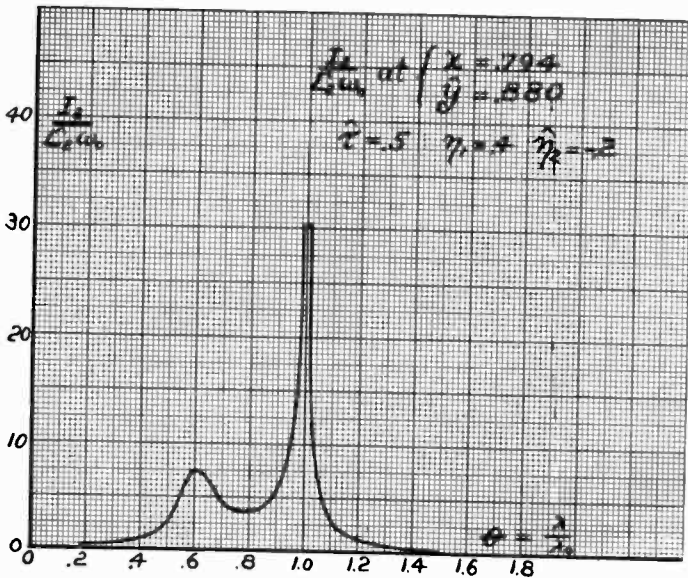

FIGURE 19

To give a better picture of the cross section of the model Figure 15 is replotted in Figure 20, and along the radial lines the current curves for  $I_2$  are plotted as sections of the space model.

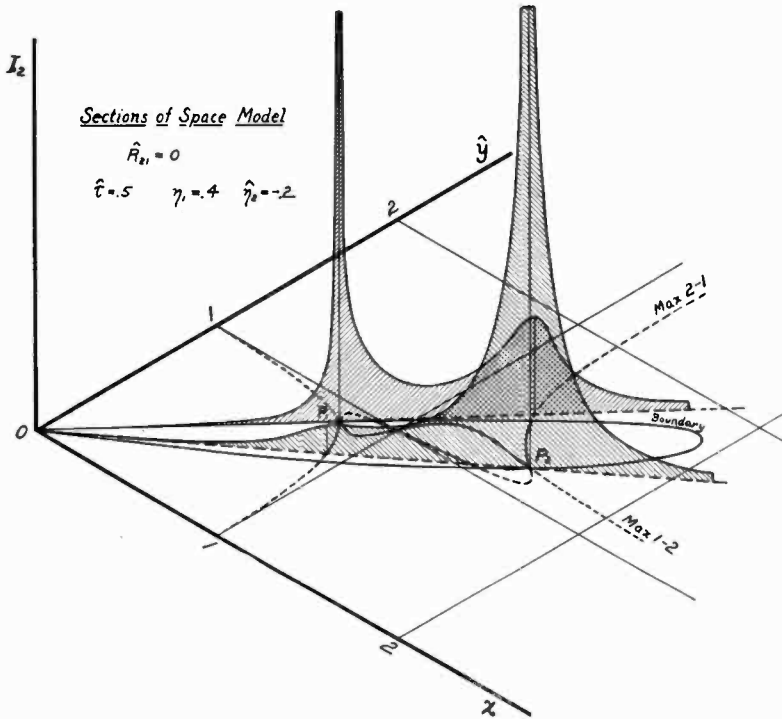

FIGURE 20

Figure 21 shows the values of  $\frac{\bar{R}_{12}}{L_1 \omega_0}$  and  $\frac{\bar{X}_{12}}{L_1 \omega_0}$  for the point  $\frac{\lambda_1}{\lambda_0} = 1$  and  $\frac{\lambda_2}{\lambda_0} = 1$  on the diagram, Figure 16. This case is for critical coupling and the resistance touches zero in a very small region about the point  $\theta = 1$ .

**CASE 2. COMPLETE CASE OF VARYING REGENERATIVE EFFECT.** All of the calculation hitherto considered assumes that the regeneration remains constant as  $\frac{\lambda_2}{\lambda_0}$  is varied, that is,  $H$  defined in equation (25) is assumed constant for any given value of  $K$ . This would be true if the tuning of the secondary circuit were accomplished by varying  $L_2$  without changing  $m$ . It should also be remembered that for the sake of simplicity all equations and graphs have been expressed in terms of equivalent values of

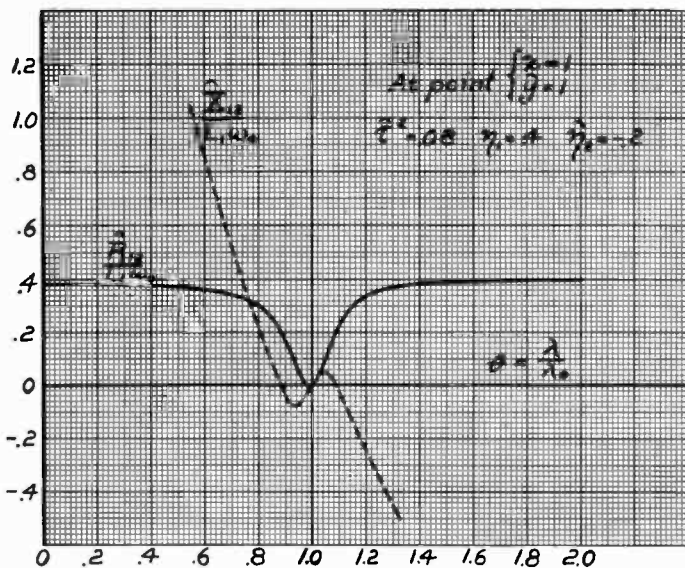

FIGURE 21

$\bar{L}_2, \bar{\lambda}_2$ , etc., which differ slightly from the actual values of  $L_2, \lambda_2$ , and so on, because of the effect of regeneration on these quantities.

In practice, tuning is usually accomplished by varying  $C_2$ . The equations for the ideal case of constant  $H$  may be extended to apply to the actual case of practice provided the following assumptions are made which are necessary for simplification.

Assumption 1  $\gamma_p^2 \theta^2 \gg 1$   
 (52) Assumption 2  $\mu K \sqrt{\frac{L_2}{L_p}} \cdot \frac{\theta^2}{\theta_2^2} \gg K^2$  see equation (25-b)

In actual cases these assumptions cause errors of less than one per cent.

These assumptions lead to the following reduction of equation (25-a).

(53) 
$$\bar{h} = \frac{L_2}{L_p} \frac{K \mu \sqrt{\frac{L_2}{L_p}}}{\gamma_1^2 \gamma_2^2 \theta^2} = \frac{L_2}{L_p} \cdot \frac{s}{\theta_2^2}$$
 *Approximate value of H*

(54) where  $s = \frac{K \mu \sqrt{\frac{L_2}{L_p}}}{\gamma_p^2}$

The general conditions of oscillation shown by equations (45-1) and (46-1), now however expressed in terms of actual values instead of equivalent values, are

(45-2)  $\bar{R}_{21} = 0$   
 (46-2)  $\bar{X}_{21} = 0$  } *Conditions of oscillation*



the particular value which  $\theta$  has at any one point determining the frequency at which the circuits oscillate at that point.

Equation (58) is so complex that it gives little idea of the shape of the curve. Three cases are plotted in Figures 22, 23, and 24 for constants given on the plots.

$$(59) \quad I_1 = \frac{E_1}{L_1 \omega_0} \frac{\sqrt{\left\{ \gamma_1 + \left[ \gamma_2 - \frac{S \gamma_p}{\theta^2} \right]^2 + \left[ 1 + \frac{S - \theta^2}{\theta^2} \right]^2 \right\}^2 + \frac{1}{\theta^2} \left[ 1 - \frac{\theta^2}{\theta_1^2} - \frac{\tau^2 \left[ 1 + \frac{S - \theta^2}{\theta_2^2} \right]^2 + \left[ \gamma_2 \theta - \frac{S \gamma_p}{\theta^2} \right]^2 + \left[ 1 + \frac{S - \theta^2}{\theta_1^2} \right]^2 \right]^2}}{2}$$

$$(60) \quad I_2 = \frac{E_1 \tau}{\omega_0 \sqrt{L_1 L_2}} \frac{\sqrt{\left\{ \sqrt{\gamma_1^2 \theta^2 + \left( 1 - \frac{\theta^2}{\theta_1^2} \right)^2} \left[ \gamma_2 - \frac{S \gamma_p}{\theta^2} + \gamma_1^2 \theta^2 + \left( -\frac{\theta^2}{\theta_1^2} \right)^2 \right]^2 + \frac{\tau^2 \gamma_1}{\theta^2} \left[ 1 + \frac{1}{\theta^2} \left( 1 - \frac{\theta^2}{\theta_2^2} + \frac{S}{\theta_2^2} - \frac{\tau^2 \left( 1 - \frac{\theta^2}{\theta_1^2} \right)}{\gamma_1^2 \theta^2 + \left( 1 - \frac{\theta^2}{\theta_1^2} \right)} \right)^2 \right]^2}}{2}$$

Equation (56-1) is the equivalent reactance and corresponds to equation (46-1) of the approximate solution. This equation gives, in the region of non-oscillation, a family of loci of maximum secondary current, each curve being for a constant value of  $\theta$ . In the region of oscillation each curve gives approximately the locus of oscillation at the particular constant frequency given by the value of  $\theta$  for that curve. These lines are shown in Figures 22 and 24.

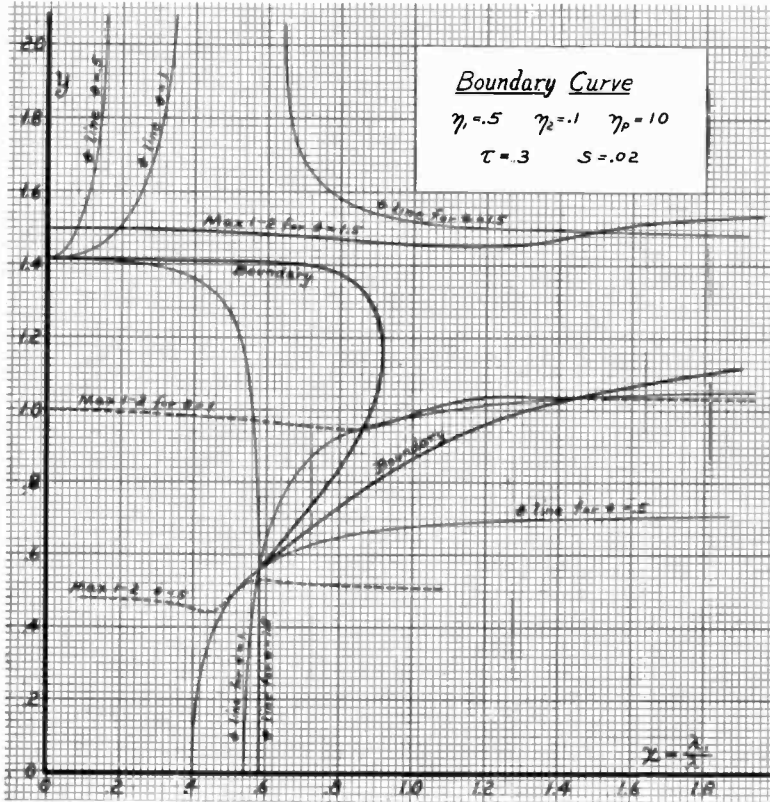

FIGURE 22

Equation (57), which corresponds to equation (48) of the special case solution, is the locus of points of intersection of equation (56-a) and the boundary curve (58) as  $\tau$  is varied, or in other words, gives the curves over which move the boundary points of oscillation at  $\lambda = \theta\lambda_0$  as  $\tau$  varies. They are indicated in Figures 22 and 24 as  $\theta$  lines.

The numerical values of the primary and secondary currents for this complete case are complex. They are given below in terms of co-efficients with the simplification afforded by approximations (52).

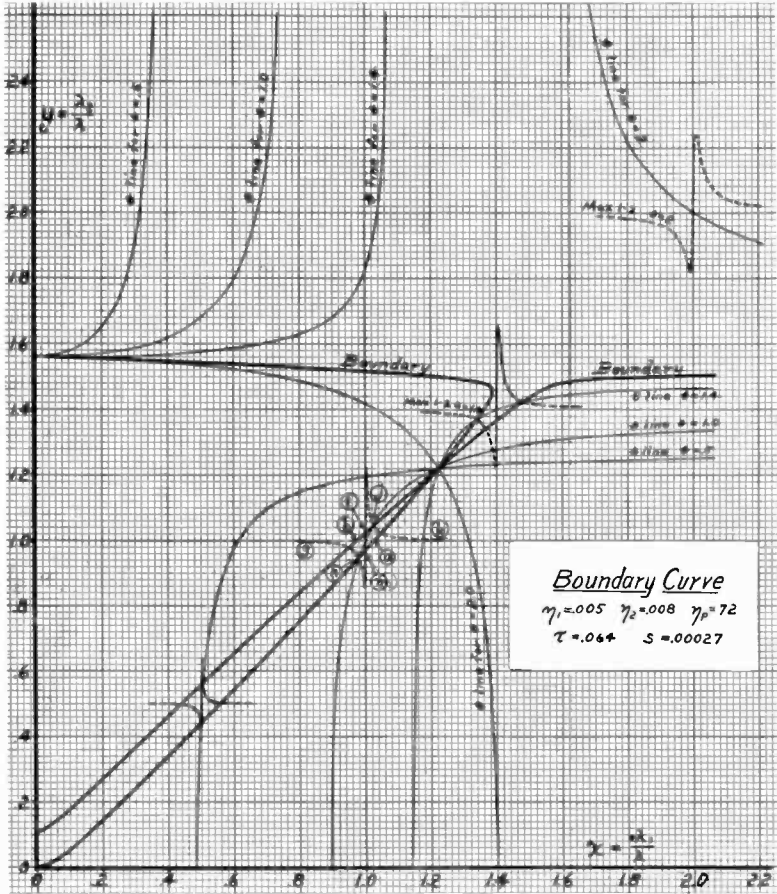

FIGURE 23

Experimental boundary curves are shown in Figures 25, 26, and 27. Figure 25 shows the effect on the boundary curve of varying the coupling between the primary and secondary circuits, other coefficients remaining constant. It is evident that the closer the coupling the broader is the region of non-oscillation. Figure 26 illustrates the effect of changing the amount of regeneration, the arbitrary numbers on the curves being small for the greater regenerative coupling. The boundary curves

move away from the origin on the  $45^\circ$  line as the regenerative coupling is increased. Figure 27 shows the effect of adding 10 ohms to the primary circuit. A locus of constant oscillation frequency outside the boundary and the maximum-current line inside the boundary are also shown in this figure.

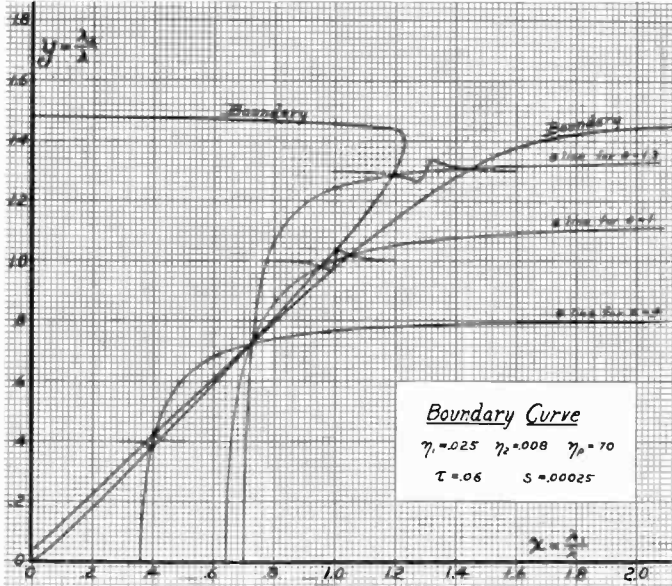

FIGURE 24

The theoretical curves of Figure 22 were calculated for unusually large values of coupling and resistances of the circuits in order to open up the curves to show better their characteristics. The curves of Figure 23 were calculated for the measured constants of the experimental arrangement and should be similar to the curve for no added resistance of Figure 27. The curve of Figure 24 is for a larger value of  $\gamma_1$  and should be similar to the other boundary curve of Figure 27. The values for  $\gamma_1$  and  $\gamma_2$ , used in calculating Figure 23, are probably not correct, because the radio frequency resistances of the coils were not measured but estimated from the audio frequency resistances. The agreement of theory and experiment is, however, sufficiently close to confirm the theory.

The curves of Figures 22, 23, and 24, will now be described more in detail. In Figure 22 the boundary curve (equation 58), instead of giving a closed figure extending to the origin as in the



simple case (Figures 15 and 16) is now an open curve usually coming down to a sharp point at its lowest part. The region above the curve and within the conical shaped part is the region of non-oscillation; the part of the diagram below the boundary curve is the region of oscillation. The intercept on the  $y$  axis is the setting for which the secondary circuit as a single circuit starts to oscillate. The boundary curve does not extend to the origin because, as the secondary condenser is decreased, the regenerative tendency rapidly increases, so that for values of the secondary condenser below a certain value, (that is, for the lower extremity or tip of the boundary curve), the system oscillates no matter what the primary circuit setting is.

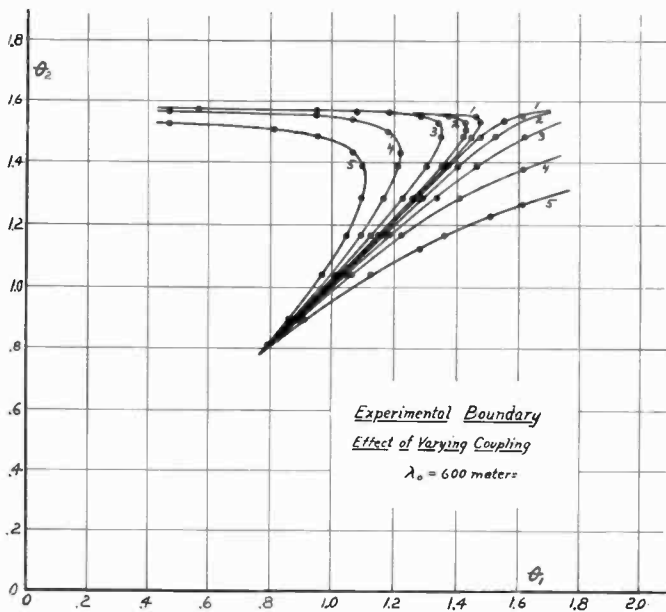

FIGURE 25

The Max. 1-2 lines (equation 56-a) are, as in Case 1, the loci over which  $X_{21}$  is zero for various values of  $\theta$  indicated on the curves. These lines in the region of non-oscillation mark the loci of maximum secondary current when the order of adjustment is first primary and then secondary. They are the max. 1-2 lines of previous figures. In the region of oscillation these curves give approximately the loci of oscillation at wave length  $\theta\lambda_0$ . The points where these Max. 1-2 lines intersect the boundary curve are points of maximum regeneration at wave length  $\theta\lambda_0$  and hence

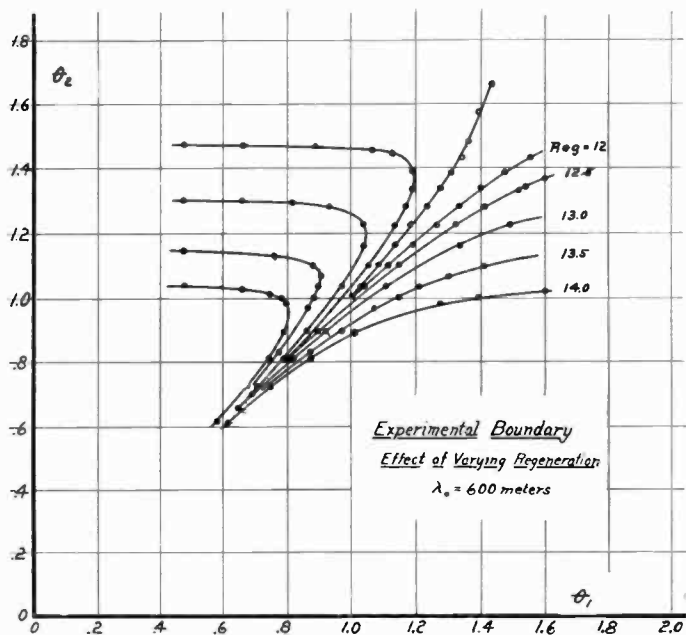

FIGURE 26

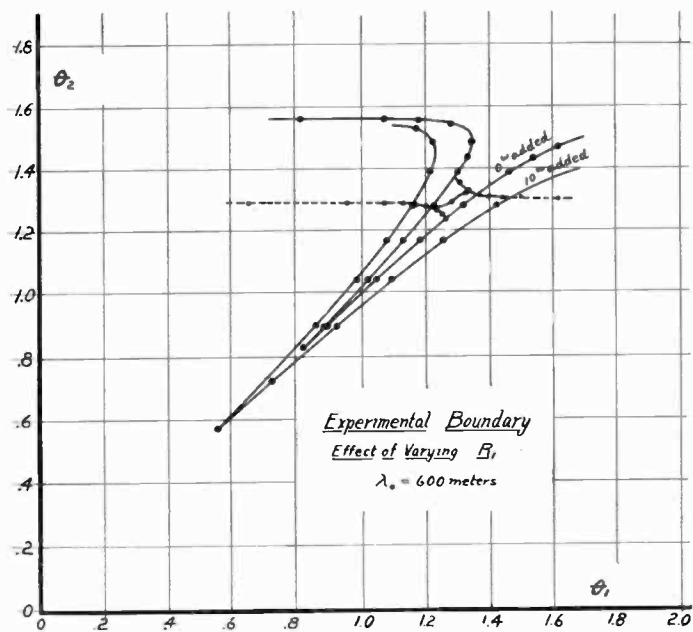

FIGURE 27

are points of maximum signal strength for that wave length. The  $\theta$ -line for the same value of  $\theta$  passes thru these two points of intersection and is the locus over which these two maximum-regeneration points move as the coupling  $\tau$  is varied. When the Max. 1-2 lines do not intersect the boundary curve there is but one point of intersection of the corresponding  $\theta$ -line and Max. 1-2 line. The branches of the  $\theta$ -lines extending upward and above the oscillation region mean nothing and are not included in all of the other figures.

The boundary equation (58) has in some cases as, for example, in the case of Figure 22, imaginary roots for  $\theta_1$  for all values of  $\theta_2$  below the tip. This is, however, not always so, as shown by the cases of Figures 23 and 24, where values of  $\theta_2$  below the tip give real values of  $\theta_1$ . The boundary equation then encloses a narrow region below the tip which might be supposed to be a region of non-oscillation, but which really is an overlapping of two regions of oscillation, and therefore is a region where the system may oscillate at either one of two frequencies. It is in this region that one gets the familiar click in telephones placed in the plate circuit of a tube generating oscillations in one circuit (the secondary circuit in this case) when another loosely-coupled circuit (the primary circuit) is tuned through the resonant point. For instance, assume that  $\theta_2$  is unity and that  $\theta_1$  is increased by changing the primary condenser. The coordinate point then moves to the right along the  $\theta_2=1$  line of Figure 23. For values of  $\theta_1$  between 0 and 1.03 (point *a*), the point is in one region of oscillation, and the frequency of oscillation is given by the value of  $\theta$  from equation (56-a). This value of  $\theta$  is given by the upper branch of Figure 28, which is equation (56-a) plotted for  $\theta_2=1$ . On passing the point *a* ( $\theta_1=1.03$ ) of Figure 23, the representative point passes off one region of oscillation into the second region of oscillation, namely, the right hand region. This change is accompanied by a sudden alteration of frequency of oscillation given by the drop  $\theta$  from *c* to *d* of Figure 28. As the representative point passes further to the right the value of  $\theta$  is given by the lower branch of Figure 28 from *d* on toward the right. If now  $\theta_1$  be decreased, the representative point returns in the second region of oscillation along the  $\theta_2=1$  line to point *b* of Figure 23, where an abrupt change of frequency takes place on leaving the second region of oscillation. The variation of  $\theta$  during this decrease in  $\theta_1$  is represented by path *def* of Figure 28.

The enclosed region *cd**ef* of Figure 28 represents the hysteresis so familiar to experimenters. Sometimes the resonance of two

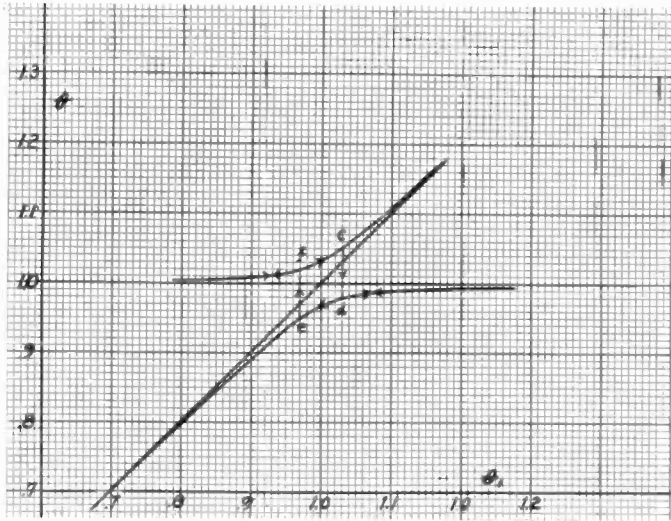

FIGURE 28

circuits is determined by obtaining the average of the values of the condenser settings which give the two clicks. This method is approximate, but gives accurate results if the hysteresis is not great. The hysteresis is reduced by narrowing the region of double oscillation, which in turn can be done by reducing the coupling.

The same sort of hysteresis or abrupt changes in frequency are obtained if the primary condenser is held fixed and the secondary condenser varied. The break points now occur at points *l* and *n* of Figure 23. Figure 29, which is equation (56-a) plotted for  $\theta_1 = 1$ , gives the changes in  $\theta$ . The path traversed in Figure 29 is *optrsrqpo*.

If, as the primary condenser is increased, the secondary condenser is always adjusted to maintain  $\theta$  constant at say the value unity, which is to say the system is kept in tune to the incoming wave length  $\theta \lambda_0$ , the representative point moves to the right along curve *gh* of Figure 23. At point *h* an abrupt change of oscillation frequency takes place. No value of  $\theta_1$  and  $\theta_2$  between points *h* and *j* will make  $\theta$  equal to unity. For values of  $\theta_1$  greater than that for point *j* the curve *jk* is traversed which lies in the second region of oscillation.

As was pointed out above, there are usually *two* points of intersection of the Max. 1-2 line for  $\theta = 1$  with the boundary curve. An experimental determination of the boundary line with the included portions of the Max. 1-2 and Max. 2-1 lines is shown in

Figure 30. Two cases are shown for two values of coupling between the primary and secondary circuits, the outer boundary being for the greater coupling. The abscissas and ordinates are

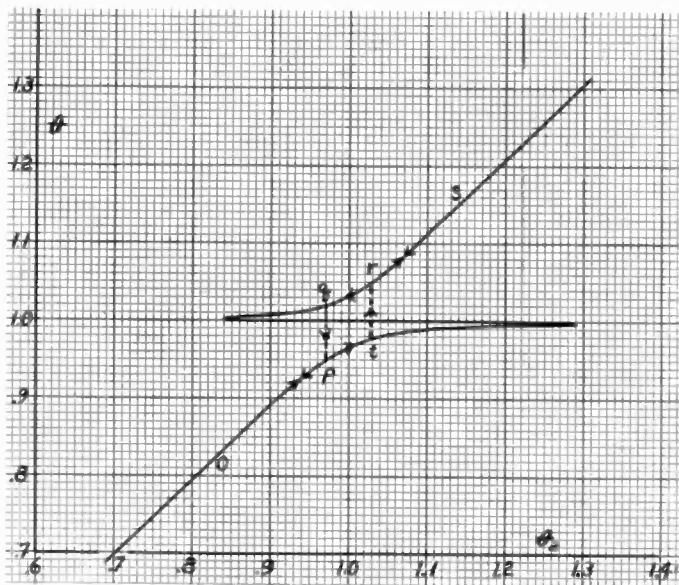

FIGURE 29

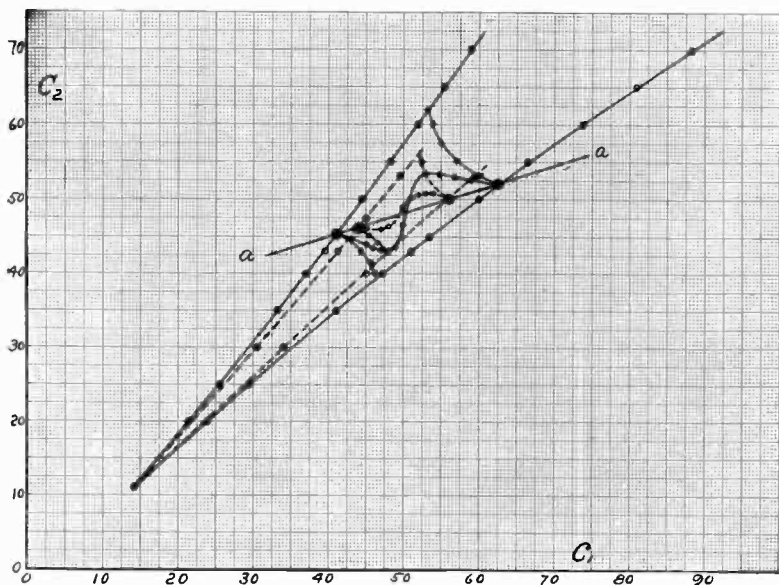

FIGURE 30

respectively  $C_1$  and  $C_2$ . The points of maximum signal strength are shown by large circles.

In tuning a receiving circuit to obtain maximum selectivity there should be but one maximum signal point or one point of intersection of the Max. 1-2 line for  $\theta = 1$  with the boundary line. This condition is true when the Max. 1-2 line passes thru the tip of the point and has *no* other intersection with the boundary line.

The tip of the point of the boundary line is usually coincident with the common intersection point of all the  $\theta$  lines. The coordinates of this point can be obtained from equation (57) and are

$$(61) \quad \begin{cases} x' = \sqrt{\frac{s(\gamma_p + \gamma_2)}{\gamma_1 + \gamma_2}} = \theta_1' \\ y' = \sqrt{\frac{s(\gamma_p - \gamma_1)}{\gamma_1 + \gamma_2}} = \theta_2' \end{cases} \quad \begin{array}{l} \text{Intersection of } \theta \\ \text{line, tip of point.} \end{array}$$

In dealing with the boundary  $\theta$  must be taken as unity, so that  $x' = \theta_1'$  and  $y' = \theta_2'$ . The position of the tip of the point is dependent upon  $s$  and is *independent* of coupling until the coupling becomes very weak, when the tip suddenly draws away from the point determined by (61), and the boundary line may lose its point and show merely a dip as in Figure 31. An experimentally obtained plot of the position of the tip of the point as indicated by the value of  $C_2$  for various couplings is shown in Figure 32. Plots are given for two values of  $s$  or regenerative couplings. The constancy of position of the tip is clearly shown by one curve. For the other curve the regenerative coupling was much reduced, so that the tip of the point is off the plot, but the rising portion touches the axis at  $C_2$  equal to 82, which value is the largest capacity for which the secondary circuit will oscillate alone, and corresponds to the horizontal portion of the boundary line.

Altho the tip of the point may leave the point given by (61), a substitution of (61) in the boundary equation (58) shows that these coordinates satisfy the equation and point (61) must always lie on the boundary curve. In cases similar to that of Figure 36, this point is an isolated portion of the boundary reduced to a single point.

Returning now to Figure 30, it is observed that the max. max. points lie on a line  $aa$ , which corresponds to a certain value of  $\bar{\gamma}_2$  (equivalent). The slope of this line  $aa$  shows that  $|\bar{\gamma}_2| < \gamma_1$ . If the regeneration is increased,  $\bar{\gamma}_2$  becomes more negative, and when  $-\bar{\gamma}_2 = \gamma_1$ , the line  $aa$  or its equivalent on the  $x y$  plane be-

comes a 45° line, and the region of no oscillation shrinks practically to a line. Since,

$$(62) \quad \bar{\gamma}_2 = \gamma_2 - \frac{s \gamma_{1p}}{\theta_2^2}, \text{ Equivalent } \gamma_2$$

the value of  $\bar{\gamma}_2$  varies with position on the diagram, so that for only one setting of the secondary circuit with a given value of  $s$  does  $\bar{\gamma}_1 = -\bar{\gamma}_2$ . At only one point, therefore, can the region of no oscillation shrink to zero width, and that is practically at the tip of the point. Above the tip  $|\bar{\gamma}_2| < \gamma_1$ . below the tip  $|\bar{\gamma}_2| > \gamma_1$ .

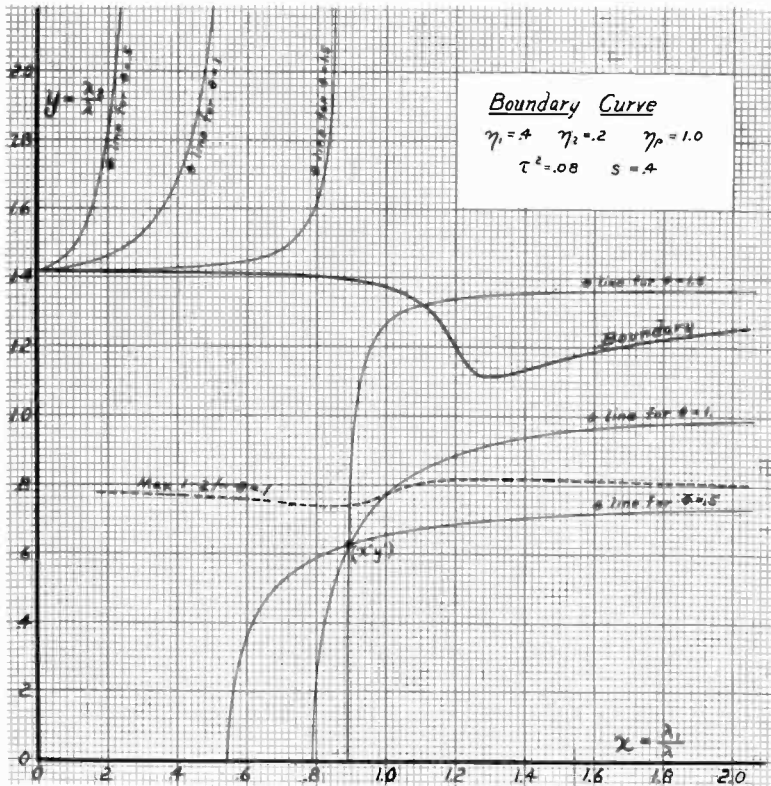

FIGURE 31

These statements are essentially true, but subject to a slight correction as will now be pointed out. The value of  $\theta_2$  for the tip of the point is given by equation (61). If this be substituted in (62) the value of  $\bar{\gamma}_2$  at the tip of the point is

$$(63) \quad \bar{\gamma}_2 = -\gamma_1 \cdot \frac{\gamma_{1p} + \gamma_2}{\gamma_{1p} - \gamma_1} \quad \text{Value of } \bar{\gamma}_2 \text{ at tip.}$$

Since  $\gamma_2$  and  $\gamma_1$  are usually very small compared to  $\gamma_p$ , then  $\bar{\gamma}_2$  is to all intents and purposes equal to  $-\gamma_1$  at the tip.

The tip of the point can be made to fall practically, but not quite at point  $\theta_1=1, \theta_2=1$ , by making  $s$  have the value

$$(64) \quad s = \frac{\gamma_1 + \gamma_2}{\gamma_p} \quad \text{Approximately correct value of } s \text{ for tuning.}$$

This is the best value of  $s$  for tuning to an incoming wave  $\lambda = \lambda_0$ , since it makes  $-\bar{\gamma}_2$  practically equal to  $\gamma_1$ . The Max. 1-2 line for  $\theta=1$  may, however, have more than one point of intersection with the boundary. Since the width of the boundary curve and the shape of the Max. 1-2 line both depend upon the value of  $\lambda$ , the coupling must now be adjusted so that there is but one point of intersection of the Max. 1-2 line and the boundary, and hence one point of maximum signal strength. This is then the condition of critical coupling.

Analytically the condition of critical coupling can be found by solving for the coordinates of the intersections of the Max. 1-2 line for  $\theta=1$ , and the boundary line and determining the condition that there be but one point. This can be done by making  $\theta=1$  in equations (55-a) and (56-a) and eliminating  $\theta_2$ . The values of  $\theta_1$  for the two points of intersection are given by the following equation

$$(65) \quad 1 - \frac{1}{\theta_1^2} = \frac{\tau^2 s \gamma_p \pm \sqrt{s^2 \gamma_p^2 \tau^4 + 4 \gamma_1 \tau^2 (1-s) [s \gamma_p - \gamma_2 (1-s)] - 4 \gamma_1^2 [s \gamma_p - (1-s)]^2}}{2[s \gamma_p - \gamma_2 (1-s)]}$$

If the radical is zero, there will be but one point of intersection. The condition that the radical is zero and hence the condition of critical coupling is

$$(66) \quad \tau^2 = \frac{-2 \gamma_1}{s^2 \gamma_p^2} [s \gamma_p - \gamma_2 (1-s)] [1-s - \sqrt{s^2 \gamma_p^2 + (1-s)^2}] \quad \text{Critical coupling}$$

If, as is usually the case,  $s^2 n_p^2$  and  $s$  are negligible compared with unity, then critical coupling may be approximately expressed as follows:

$$(67) \quad \tau^2 = -\frac{2 \gamma_1}{s \gamma_p^2} [\gamma_2 - s \gamma_p] = -\frac{2 \gamma_1 \bar{\gamma}_2}{s \gamma_p^2} \quad \text{Approximate critical coupling}$$

where  $\bar{\gamma}_2$  is the equivalent  $\gamma_j$  of the secondary circuit. Equation (67) gives the value that  $\tau$  must have to give a single point of tuning when  $\bar{\gamma}_2$  is negative, that is, when  $s \gamma_p > \gamma_2$ . If  $\gamma_2 = s \gamma_p$  then  $\bar{\gamma}_2 = 0$  and  $\tau = 0$ . As  $s \gamma_p$  is increased, the numerator increases more rapidly than the denominator and  $\tau$  increases, but if  $s$  is made very large, the limit of  $\tau$  is seen to be  $\sqrt{\frac{2 \gamma_1}{\gamma_p}}$ , so that for a



regenerative circuit  $\tau$  must always lie between zero and  $\sqrt{\frac{2\eta_1}{\eta_p}}$ .

If, now, the value of  $s$  from (64) is substituted in equation (67), the value of critical coupling is given as

$$(68) \quad \tau^2 = \frac{2\eta_1^2}{\eta_p(\eta_1 + \eta_2)} \quad \text{Critical coupling.}$$

Referring now to Figure 32, the value of critical coupling given

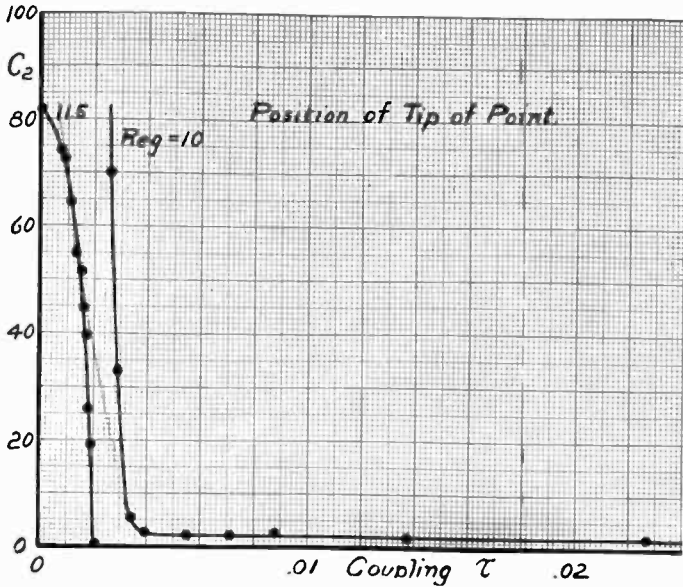

FIGURE 32

by equation (68) is approximately that value when the tip of the point draws away from point (61), or where the curve in Figure 32 starts to rise.

In actual practice it is not always necessary to tune to the very tip of the point, but a slightly closer coupling may be used if the converging portion of the boundary curve is very narrow. Then the two points of maximum regeneration lie so close together that they practically merge into one with slightly broader tuning.

Using the above considerations, a few practical directions for tuning a coupled-circuit receiving system can be given. The value of  $s$ , which is determined by the tickler adjustment, must first be set at the correct value given by (64). To find this value approximately, set the coupling at a fairly large value, which is surely above critical coupling, and set the tickler so that the tip

of the point is near or a little below the wave of the signal being received. The tickler adjustment for this condition represents an upper limit for  $s$ . The coupling may now be reduced to the point where a further reduction necessitates a great reduction of the tickler to prevent the system from oscillating. This value of coupling is approximately that given by (68) and represents an upper limit. The values of the tickler and coupling adjustments found above are approximately the theoretically correct values to use, altho practically they represent upper limits and just as good results can be obtained if both are slightly less.

For the next part of the tuning process, increase the coupling a bit and reduce the tickler slightly. Set the primary circuit as near as possible to the incoming wave. Now vary the secondary condenser about the resonant value. The tube will cease to oscillate in a narrow range of secondary capacity somewhere in which the signal should be a maximum. If the range is too wide the coupling should be decreased or the tickler increased. If the position of the maximum signal is not exactly in the center of the non-oscillation range, the primary setting should be slightly altered until, by cut-and-try process, the peak is exactly in the center between the points of oscillation. Now the range may be decreased and the signal increased in strength by decreasing the coupling until the tube nearly oscillates. The final value of the coupling should be about or a little less than the value found above. By following the above procedure the loudest signal with the least distortion and maximum selectivity will be obtained.

A question of considerable interest is the relative selectivity of a coupled-circuit and a single-circuit receiving system. It is well known that the former is much more selective than the latter. An expression can be obtained for the ratio of currents in the tuned circuits connected to the grids of the detecting tubes for the two systems, when the coupled circuit system is set at critical coupling and regenerated to the point of oscillating, and the single circuit is also regenerated to the point of oscillating. Instead of using the complex case for the coupled circuit system, the special solution of Case 1, Part III, which is expressed in terms of equivalent values, is used. This special solution, which is much simpler, is just as applicable as the complete solution, because we are to consider the effects of varying  $\theta$ , in which case the regeneration remains essentially constant.

The expression for the ratio of currents in the coupled-and single-circuit systems, respectively, when each is set to give the

strongest signal, can be obtained by dividing equation (50-b) by equation (2-b), remembering, however, that in equation (50-b),  $\theta_1$  and  $\bar{\theta}_2$  are to be set at unity and  $\bar{\tau}$  is to have the critical value given by equation (41-a); and further remembering that in equation (2-b),  $k$  is to be adjusted so that the equivalent resistance is zero and that the reactance term stated in equivalent values reduces to  $\frac{1-\theta^2}{\theta^2}$ . The result of this division is

$$(69) \quad \frac{I \text{ coupled}}{I \text{ single}} = \sqrt{\frac{\bar{L}_1}{L_2}} \cdot \frac{\sqrt{-\gamma_1 \bar{\gamma}_2 \theta^2} \sqrt{\gamma_1^2 \theta^2 + (1-\theta^2)^2}}{\sqrt{\bar{\gamma}_2^2 \theta^2 (1-\theta^2)^2 + [\gamma_1^2 \theta^2 + \gamma_1 \bar{\gamma}_2 \theta^2 + (1-\theta^2)^2]^2}}$$

It should be remarked in reducing this equation in order to make the comparison of the two systems more just, the primary circuit of the coupled system is assumed to be the antenna circuit of the single-circuit system.

The ratios of voltages impressed on the grids of the detector tubes in the two cases is  $\frac{I_2 L_2}{I L}$ . This ratio, which is the square root of the ratio of signal strengths in the two systems, is denoted by  $G$ , the value of which is given in equation (70).

$$(70) \quad G = \sqrt{\frac{\bar{I}_2}{L_1}} \frac{\sqrt{-\gamma_1 \bar{\gamma}_2 \theta^2} \sqrt{\gamma_1^2 \theta^2 + (1-\theta^2)^2}}{\sqrt{\bar{\gamma}_2^2 \theta^2 (1-\theta^2)^2 + [\gamma_1^2 \theta^2 + \gamma_1 \bar{\gamma}_2 \theta^2 + (1-\theta^2)^2]^2}}$$

(Square root of ratio of signals strengths in coupled and single circuits)

Equation (70) is further simplified by dropping out  $\theta$ , except in the terms of form  $(1-\theta^2)$  on the ground that, for instance,  $\gamma_1 \theta$  is more nearly constant in practice than  $\gamma_1$ , because of the variation of resistance with frequency.

The maximum value of  $G$ , called  $G_{max}$ , is obtained when  $\theta$  is equal to unity, and is given below:

$$(71) \quad G_{max} = \frac{\sqrt{-\gamma_1 \bar{\gamma}_2}}{\gamma_1 + \bar{\gamma}_2}$$

The ratio of  $G$  to  $G_{max}$  is probably a better measure of relative selectivity. This ratio is plotted in Figure 33 for  $\gamma_1 = .10$ , and several values of  $\bar{\gamma}_2$  from 0 to  $-.10$ , and in Figure 34 for  $\gamma_2 = .05$  and several values of  $\bar{\gamma}_2$  from 0 to  $-.05$ . The values of coupling for the several curves is different in each case, it being determined by equation (41-a). The gain in selectivity through the use of coupled circuits is clearly shown by these figures, in fact, theoretically the selectivity approaches infinity as  $-\bar{\gamma}_2$  approaches  $\gamma_1$ .

The values of  $G_{max} \times \sqrt{\frac{L_1}{L_2}}$  for the two values of  $\bar{\gamma}_1$  are plotted in Figure 35, which indicates that the coupled system can give a stronger signal than the single circuit when properly tuned.

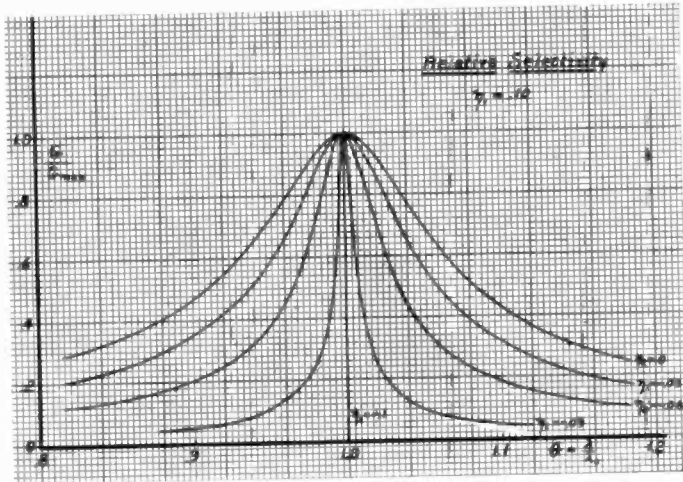

FIGURE 33

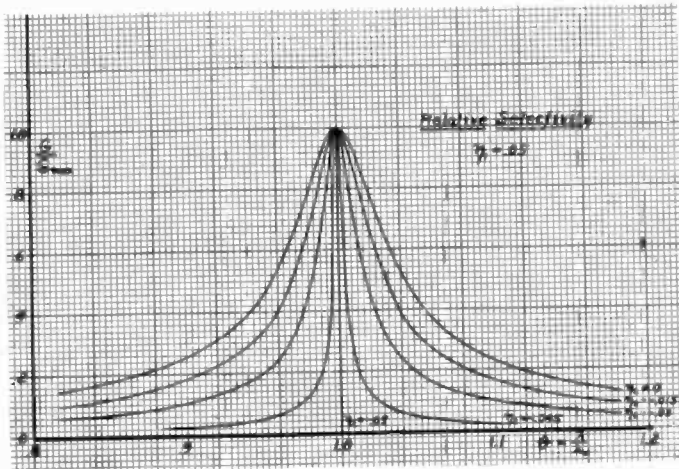

FIGURE 34

Undoubtedly instability reduces somewhat the tremendous theoretical superiority of coupled circuits, both as regards selectivity and signal strength.

Cruft Laboratory, Harvard University,  
Cambridge, Mass.

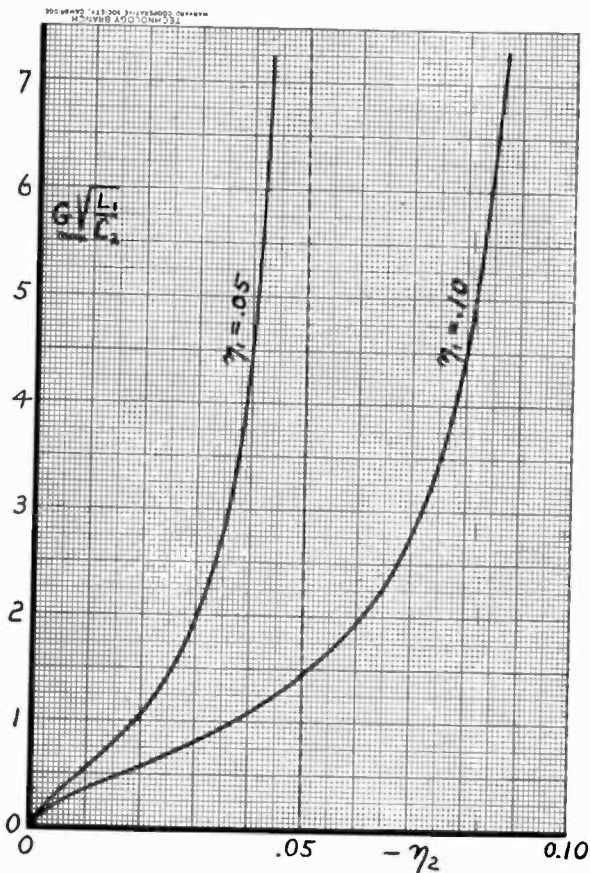

FIGURE 35

**SUMMARY:** 1—The simple theory of regeneration in a single oscillatory circuit is developed, both when the oscillatory element is in the plate circuit and in the grid circuit of the regenerating tube.

2—The theory of couple circuits having positive resistances is reviewed and illustrated by means of space models for the secondary current. The use of sections of the model for determining graphically and for visualizing the variations of secondary current as the primary or secondary circuits are changed or as the impressed wave length is varied, is given.

The positions of the two peaks of max. max. secondary current, when the coupling is greater than critical, is shown to depend upon the relative values of  $\frac{R}{L\omega_0} = \eta_i$  for the two circuits. When the ratio of  $\frac{\eta_1}{\eta_2}$  is unity, the two peaks are symmetrically located on the space model with respect to the primary and secondary axes, otherwise the space model is unsymmetrical.

3—The theory of regeneration in coupled circuits is developed. It is shown that regeneration in the secondary circuit affects only the impedance of that circuit and may make the equivalent resistance of that circuit zero or negative.

The first case taken up assumes the regeneration to be constant, so that the theory for this case is the theory for coupled circuits, one of which has a negative resistance. The boundary equation between oscillation and non-oscillation is derived and plotted.

The second case discussed is the practical case in which the degree of

regeneration depends upon the size of the secondary condenser. The boundary equation is derived for this case and the curves for several numerical examples plotted. The conditions defining critical coupling and conditions of best tuning of coupled circuits are discussed.

Expressions are derived giving the relative selectivity of coupled circuits and a single circuit receiver, and curves are plotted giving the results in two numerical examples.

## NOMENCLATURE

Clarendon Type denotes complex quantities.

Ordinary Type denotes numerical quantities.

— over a symbol denotes equivalent value.

Equations reduced to forms containing coefficients are indicated by a letter following the equation number, that is, 1-a is the coefficient form for 1-1.

Subscript  $_p$  denotes quantities pertaining to the plate circuit of a vacuum tube.

Subscript  $_g$  denotes quantities pertaining to the grid circuit of a vacuum tube.

$j$  complex operator numerically equal to  $\sqrt{-1}$ .

$\mu = -\frac{\partial e_p}{\partial e_v}$  amplification factor of vacuum tube.

$R_p = \frac{\partial e_p}{\partial i_p}$  resistance from plate to filament of a vacuum tube.

$R_p$  may represent the total resistance of the plate circuit, that which is exterior to the tube usually being negligible.

$I$  root-mean-square value of sinusoidal alternating current.

$E$  root-mean-square value of a sinusoidal alternating emf.

$R$  resistance.

$L$  inductance.

$C$  capacity.

$Z$  impedance.

$m$  regenerative mutual inductance.

$k$  regenerative coefficient of coupling.

$M$  mutual inductance between primary and secondary of coupled circuits having inductance  $L_1$  and  $L_2$ , respectively.

$\tau = \frac{M}{\sqrt{L_1 L_2}}$  coefficient of coupling between primary and secondary circuits.

$\omega$  angular velocity.

$\frac{\omega}{2\pi}$  any frequency, either that of impressed emf. or of oscillation.

$\lambda$  wave length corresponding to  $\omega$ .

$\frac{\omega_o}{2\pi}$  a particular reference frequency.

$\lambda_o$  wave length corresponding to  $\omega_o$ .

$\frac{\omega_1}{2\pi} = \frac{1}{2\pi\sqrt{L_1 C_1}}$  the undamped frequency of free oscillation of circuit having inductance  $L_1$  and capacity  $C_1$  (primary circuit).

$\lambda_1$  wave length corresponding to  $\omega_1$ .

$\frac{\omega_2}{2\pi} = \frac{1}{2\pi\sqrt{L_2 C_2}}$  } corresponding quantities for secondary circuit, corresponding to  $\frac{\omega_1}{2\pi}$  and  $\lambda_1$ .

$$\theta = \frac{\omega_o}{\omega} = \frac{\lambda}{\lambda_o}$$

$$\theta_1 = \frac{\omega_o}{\omega_1} = \frac{\lambda_1}{\lambda_o}$$

$$\theta_2 = \frac{\omega_o}{\omega_2} = \frac{\lambda_2}{\lambda_o}$$

$$x = \frac{\theta}{\theta_1}$$

$$y = \frac{\theta}{\theta_2}$$

$$X \text{ reactance} = L \omega - \frac{1}{C \omega}$$

$$\beta_1 = \left(1 - \frac{\omega_1^2}{\omega^2}\right) = \left(1 - \frac{\lambda^2}{\lambda_1^2}\right) = \left(1 - \frac{\theta^2}{\theta_1^2}\right) = \left(1 - \frac{1}{x^2}\right)$$

$$\beta_2 = \left(1 - \frac{\omega_2^2}{\omega^2}\right) = \left(1 - \frac{\lambda^2}{\lambda_2^2}\right) = \left(1 - \frac{\theta^2}{\theta_2^2}\right) = \left(1 - \frac{1}{y^2}\right)$$

$\gamma = \frac{R}{L \omega_o}$  decrement coefficient at frequency  $\frac{\omega_o}{2\pi}$  for circuit denoted by subscripts attached to  $\gamma$ ,  $R$ , and  $L$ .

$\gamma_p = \frac{R_p}{L_p \omega_o}$  decrement coefficient for plate circuit of vacuum tube.

$$s = \frac{k \mu \sqrt{L_2}}{\gamma_p^2 \sqrt{L_p}}$$

$H = \frac{\frac{\mu m}{C_2} - m^2 \omega^2}{Z_p^2} = \frac{L_2}{L_p} \cdot \frac{k \left(\frac{\mu}{y^2 \sqrt{L_p}} \sqrt{L_2} - k\right)}{\gamma_p^2 \theta^2 + 1}$  coefficient of regeneration.

$$h = \frac{L_2}{L_p} \cdot \frac{k \mu \sqrt{L_2}}{y^2 \gamma_p^2 \theta^2} = \frac{L_2}{L_p} \cdot \frac{s}{\theta^2}$$

$\bar{L}_2 = L_2 + H L_p$  equivalent inductance of regenerated circuit.

$\bar{R}_2 = R_2 - H R_p$  equivalent resistance of regenerated circuit.

$$\bar{\omega}_2 = \frac{1}{\sqrt{L_2 C_2}}$$

$$\bar{\lambda}_2 = \frac{2\pi V}{\bar{\omega}_2} \quad V = \text{velocity of light.}$$

$$\bar{\beta}_2 = 1 - \frac{1}{\left(\frac{\bar{\lambda}_2}{\lambda}\right)^2} = 1 - \frac{\theta^2}{\theta_2^2}$$

$$\bar{\tau} = \frac{M}{\sqrt{L_1 L_2}}$$

$$k = \frac{m}{\sqrt{L_p L_2}}$$

$$\eta_2 = \frac{\bar{R}_2}{L_2 \bar{\omega}_2}$$

$Z_{12}$  impedance of coupled circuits looking from primary circuit

$Z_{21}$  impedance of coupled circuits looking from secondary circuit.

$G$  relative selectivity of coupled and single circuit receivers.



DIGESTS OF UNITED STATES PATENTS RELATING TO  
 RADIO TELEGRAPHY AND TELEPHONY\*  
 ISSUED MARCH 4, 1924—APRIL 29, 1924

BY

JOHN B. BRADY

(PATENT LAWYER, OURAY BUILDING, WASHINGTON, D. C.)

1,485,485—H. G. Cordes, filed September 29, 1919, issued March 4, 1924.

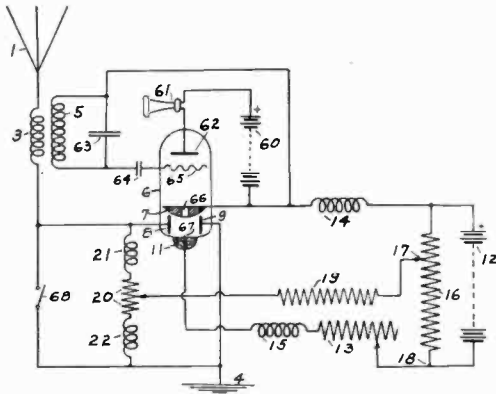

NUMBER 1,485,485—Radio Signaling

RADIO SIGNALING system where a circuit arrangement is provided at the receiving station for reducing the effect of undesirable signals of comparatively short duration and great intensity such as are produced by static disturbances from effecting the receiving circuit. This object is attained by placing a signal sifter in series with the receiving antenna circuit so that signals tending to produce current exceeding a predetermined amplitude cannot pass thru the sifter or are made to pass thru the sifter with increased difficulty as the intensity of the undesirable signal increases. The presence of the sifter in the antenna circuit introduces only a small additional resistance into the circuit for currents of comparatively small amplitude which are produced by the desired signals.

\*Received by the Editor, May 15, 1924.

1,485,524—H. H. Pickron, filed March 9, 1923, issued March 4, 1924. Assigned one-half to W. E. Copp, of Rock Island, Illinois.

**CRYSTAL DETECTOR FOR RADIO INSTRUMENTS** enclosed in a casing with the mineral supported at one end and a helical telescopic spring located in the other end and adapted for engagement with the mineral.

1,485,773—L. Espenschied, filed September 12, 1921, issued March 4, 1924. Assigned to American Telephone and Telegraph Company.

**RADIO CALLING OR SIGNALING** from a radio transmitter to remote receiving stations. In brief, the invention consists in using what may be termed the "carrier-off" method, that is, the transmitting station transmits a carrier wave continuously on which a message may from time to time be impressed. When it is desired to call a station, the transmission is suppressed and, as a result, certain operations take place at the receiving station giving some audible or visible signal suitable for calling the attention of the attendant.

1,485,776—J. K. M. Harrison, filed January 3, 1920, issued March 4, 1924.

**MARINE SIGNALING APPARATUS** for giving a signal as a marking buoy. A galvanic battery is provided with pole elements exposed to the sea water as electrolyte. The energy derived from this battery is utilized for energizing the circuits of a radio transmitter which may be of the buzzer excitation type.

1,486,049—G. B. Spring, filed October 21, 1922, issued March 4, 1924.

**RADIO TELEGRAPH AND TELEPHONE INSTRUMENT**, consisting of a headset for a radio receiver where the receiver caps are provided with metallic ear pieces contacting with the ears of the operator with connections to the radio receiver whereby the human body may be utilized as the antenna.

1,486,134—H. Gerdien, filed November 30, 1921, issued March 11, 1924. Assigned to Siemens and Halske, Aktiengesellschaft.

**MEANS FOR TRANSMITTING SIGNALS FOR RADIO TELEGRAPHY**, comprising a signal modulation circuit which includes an iron core coil device connected in the antenna circuit. Radio frequency

energy is delivered to the antenna thru a coil disposed on the iron core in inductive relation to the antenna coil. A direct current coil is wound on the same core and supplied with low potential direct current. A separate source of direct current is also provided with a circuit arrangement for connecting it to the direct current coil for quickly raising the saturation of the core to the desired point before the low potential direct current supply is connected to the coil whereby the time constant of the system is greatly increased and signals more sharply defined.

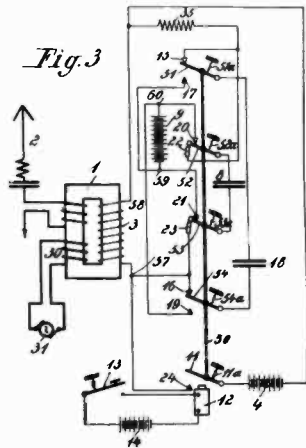

NUMBER 1,486,134—Means for Transmitting Signals for Radio Telegraphy

1,486,237—J. A. Fleming, filed November 6, 1919, issued March 11, 1924. Assigned to the Radio Corporation of America, New York.

THERMIONIC DEVICE which consists of vacuum bulb, a filament, a pair of collecting plates and a pair of potential plates, the four plates being arranged substantially symmetrical to and closely surrounding the filament. When the filament is rendered incandescent, negative electricity escapes from the filament and passes across the vacuum space into the plate *C* and then returns by the external circuit passing thru the instrument *F* to the positive terminal of the filament. This current is called the thermionic current. If now the plates *D*, which are called potential plates, are connected to some source of high or low frequency alternating or even direct potential this variation of potential will cause a sudden and marked diminution in the thermionic current, which

can be observed in the instrument  $F$  or can be utilized to actuate a relay.

1,486,432—B. Hodgson and S. R. Mullard, filed August 22, 1921, issued March 11, 1924.

**SUPPORT FOR FILAMENTS IN THERMIONIC VALVES AND OTHER TUBES**, wherein a spring is interposed between the filament and a point on the glass envelope whereby the spring maintains a uniform tension on the filament during abnormal heating of the envelope.

1,486,505—K. W. Wagner, filed June 28, 1923, issued March 11, 1924. Assigned to Radio Corporation of America.

**STABILIZING OSCILLATION GENERATORS**, wherein a plurality of load circuits are connected with the generator and arranged to maintain the frequency delivered to a work circuit at a constant value.

1,486,506—K. W. Wagner, filed June 28, 1923, issued March 11, 1924. Assigned to Radio Corporation of America.

**STABILIZING OSCILLATION GENERATORS**, functioning at a particular working frequency. A primary load which is substantially independent of the working frequency is connected to the generator with a filter for excluding secondary or undesired frequencies connected between the generator and the load. A supplemental stabilizing load consisting of an oscillation circuit excluding the working frequency but imposing an increased supplemental load on the generator at nearby frequencies is also connected to the generator whereby the operating condition of the generator tends to remain constant.

1,486,221—E. Berry, filed March 5, 1921, issued March 11, 1924. Assigned to Radio Corporation of America.

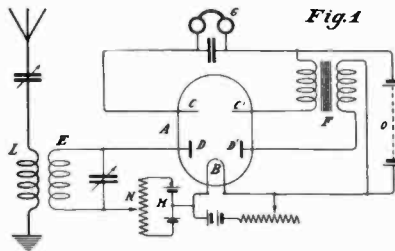

NUMBER 1,486,221—Means for Controlling the Flow of Electrons in Electric Discharge Devices

MEANS FOR CONTROLLING THE FLOW OF ELECTRONS IN ELECTRIC DISCHARGE DEVICES, comprising a tube having a cathode, a pair of anodes, and two plate electrodes located either within or without the vessel and arranged one on each side of the path between the cathode and the anodes so as to apply a potential to the path of the electrons which are thereby caused to fall on the two anodes alternately. The receiving circuit is connected to the electrodes and the detector is connected between the anodes.

1, 486,885—J. H. Hammond, Jr., filed July 30, 1915, issued March 18, 1924.

RADIODYNAMIC DUPLEX SYSTEM, wherein electromagnetic waves having contrasting characteristics are transmitted for operating a distant control apparatus.

1,486,886—J. H. Hammond, Jr., filed June 3, 1914, issued March 18, 1924.

SYSTEM FOR TELEDYNAMICALLY CONTROLLING MOVING BODIES at the same time that a visible signal carried by such body may also be controlled by radiant energy.

1,486,887—J. H. Hammond, Jr., filed July 13, 1914, issued March 18, 1924.

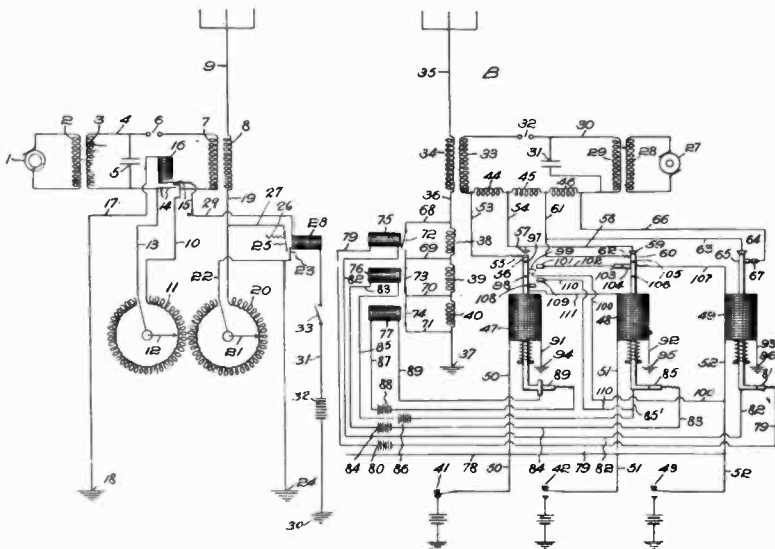

NUMBER 1,486,887—Electric-Radiant Siren

**ELECTRO-RADIANT SIREN**, where signals are transmitted over a varying range of wave lengths. The transmitter contains a pair of variable inductance devices which may be continuously operated to maintain the primary and secondary circuits in resonance over a varying scale of frequencies.

1,487,012—H. Chireix, filed August 29, 1921, issued March 18, 1924.

**CALLING ARRANGEMENT FOR SIGNALING**, actuating a call indicator in a receiving station in response to a plurality of operations that follow each other in a predetermined cycle. A mechanical system is provided at the receiver including two isochronous pendulums. One of the pendulums is accelerated by the predetermined order of calling signals and then the differential movement of the two pendulums causes an indicating device to be actuated.

1,487,096—L. F. Fuller, filed June 16, 1919, issued March 18, 1924. Assigned to Federal Telegraph Company of San Francisco.

**ELECTRICAL CONDENSER** of the stack type having a round edge metallic shield at each end thereof. The end plates serve as flux distribution shields increasing the voltage at which corona will form.

1,487,115—J. L. McQuarrie, filed September 15, 1921, issued March 18, 1924. Assigned to Western Electric Company.

**INTELLIGENCE SYSTEM** for translating electrical effects into mechanical movements, whereby persons who are afflicted by being blind and deaf may read. By the use of the apparatus of this system a person who is both blind and deaf may read print in a convenient and simple manner and with considerable rapidity thru the sense of touch. For accomplishing this, a signal receiving device consisting of a series of electromagnetically actuated levers is arranged so that the free ends of the levers come just beneath the finger tips when the hand is placed on the device thru which the levers pass. The levers are selectively controlled thru the action of selenium cells or other light sensitive means. If a letter of the alphabet, for instance, is interposed between the selenium cell and a source of light, electrical conditions will be set up in circuits containing the selenium cells whereby electromagnets will be operated to actuate its associated lever to con-

vey to a person who is both blind and deaf, a signal distinctive of a particular character thru the sense of touch.

1,487,298—J. H. Vennes, filed September 5, 1919, issued March 18, 1924. Assigned to Western Electric Company.

METHOD OF AND APPARATUS FOR VIBRATION of electron tubes while connected in a circuit for observing any imperfections in the tube arising out of non-rigid mounting of the electrodes.

1,487,308—H. H. Beverage, filed January 20, 1921, issued March 18, 1924. Assigned to General Electric Company.

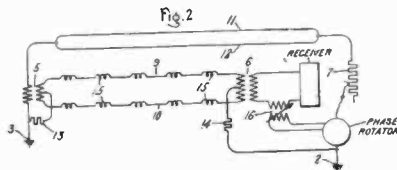

NUMBER 1,487,308—Radio Receiving System

RADIO RECEIVING SYSTEM, where the receiving apparatus may be at a distant point from the receiving antenna. The receiving antenna is a long horizontal uni-directional type with a transmission line for conveying signaling currents from a selected point in the antenna to a distant receiving station. A circuit arrangement is provided for eliminating in the receiving apparatus the effect of currents received upon the transmission line due to the exposure of said line to effect of ether waves.

1,487,339—E. W. Kellogg, filed January 20, 1921, issued March 18, 1924. Assigned to General Electric Company.

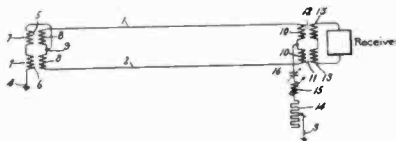

NUMBER 1,487,339—Radio Signaling System

RADIO SIGNALING SYSTEM having an antenna for receiving signals from a desired direction to the substantial exclusion of signals coming from other directions. A long horizontal receiving antenna is employed and the received energy conveyed along a transmission line to a distant receiving station located along

the length of the antenna, from a point in the antenna where the signaling currents received are strongest.

1,487,353—H. J. Nolte, filed September 8, 1921, issued March 18, 1924. Assigned to General Electric Company.

**ELECTRON-DISCHARGE APPARATUS**, wherein a water cooling system is provided for maintaining the anode at a fairly low temperature. The anode projects into a cooling tank thru which cooling fluid is continuously circulated thru a long spiral heat radiating coil.

1,487,451—J. F. Farrington, filed October 16, 1922, issued March 18, 1924. Assigned to Western Electric Company, Incorporated.

**CIRCUITS FOR ELECTRIC DISCHARGE DEVICES**, wherein the cathodes are heated by alternating current. According to the present invention, the disturbances which arise in the output circuit of an electro discharge device in consequence of the alternating current used for heating its cathode may be neutralized by opposing thereto like disturbances produced in the output circuit of a similar discharge device.

1,487,617—D. C. Stoppenbach, filed August 17, 1920, issued March 18, 1924. Assigned to General Electric Company.

**ELECTRICAL APPARATUS** or condenser built up of alternate sheets of conducting and insulating material. Resilient plates of metal are provided on each end of the stack, which plates are tightly clamped together, uniformly pressing the condenser elements together thruout their area.

1,488,006—R. A. Heising, filed September 29, 1919, issued March 25, 1924. Assigned to Western Electric Company, Incorporated.

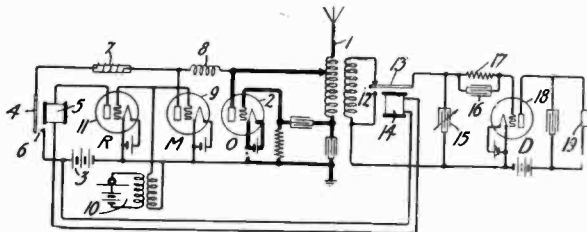

NUMBER 1,488,006—Radio Transmission System



**RADIO TRANSMISSION SYSTEM**, in which two-way communication may be attained at each station over a single antenna. A circuit is provided for preventing the production of side tone in the receiver at the radio station by energy from the local transmitter. According to this invention, a normally operative receiving set and a normally inoperative transmitting set are connected to the same antenna. Voice or sound operated relays serve, when energized, to render the receiving set inoperative and to render the transmitting set operative. A feature of the invention consists in the provision of a normally oscillating oscillator which serves both for production of oscillations for the transmitter and as a detector. This considerably simplifies the necessary apparatus and makes the control of the system quick acting.

1,488,114—J. H. Hammond, Jr., filed August 24, 1912, issued March 25, 1924.

**RADIO TELEGRAPHY AND TELEPHONY**, in which the amplitude or frequency or both of the transmitting energy may be periodically varied. A rotary condenser may be interposed in the antenna circuit and driven at a rate where the periodicity of the circuit is varied at a rate above the limits of audibility. The variation is secured in such manner that the time intensity curves shall be peaked and not flattened, whereby a true sinusoidal wave form may be produced at the receiver.

1,488,337—H. Gernsback, filed May 14, 1921, issued March 25, 1924.

**ELECTRIC VALVE** containing a filament heated to red or white incandescence in contact with the wall of a highly exhausted glass bulb. A remarkably high current is produced between the filament and an outside external electrode. The electronic flow is made to pass between the filament and the outside element, altho these two elements are not in metallic contact. Under the heat of the filament the wall of the glass vessel becomes a conductor which allows the electronic charges to pass. The tube is shown as applied to receiving circuits functioning as a rectifier.

1,488,489—J. C. Gabriel, filed December 23, 1920, issued April 1, 1924. Assigned to Western Electric Company, of New York.

**WAVE MODULATING** at a radio transmission station. The invention consists in the provision of means for connecting a signaling wave device to a modulating device in two ways, each of which produce modulation and which together cooperate to modulate

more effectively. The signal-controlling device operates directly thereon thru the agency of an intermediate variable impedance device or system of variable impedance devices such as several discharge tubes arranged to rectify several phases of alternating current and impress the combined rectified current on the modulating device. As a result of the uni-directional conductivity of the variable impedance tubes, the current is variably rectified in accordance with the signals and the resulting waves into which the rectified current is translated are correspondingly modulated in amplitude. Due to the direct action of the signal-controlling device arranged in parallel with respect to the modulator, a further modulation of variation in amplitude of the waves results.

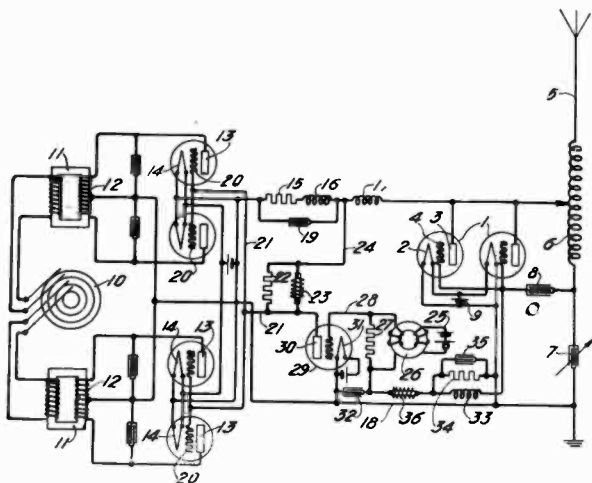

NUMBER 1,488,489—Wave Modulating

1,488,613—G. W. Pickard, filed February 28, 1919, issued April 1, 1924. Assigned to Wireless Specialty Apparatus Company.

VACUOUS ELECTRICAL APPARATUS of the electron tube class wherein desired vacuous condition is preserved without dependance upon a continuously operating vacuum pump. The invention has particular reference to high power transmitting tubes where steel containers are employed in lieu of glass and vacuum maintained despite inherent joints and seals. The metallic container which houses the tube electrodes in a vacuum is itself disposed within an outer vacuous container.

1,488,791—C. Kinsely, filed March 29, 1920, issued April 1, 1924.

SPACE-TELEGRAPH RECEIVING SYSTEM for avoiding the effects

of static disturbances. A pair of loop receivers which may be differently affected by static disturbances are employed connected to Hall relays. The energies thus separately received in a plurality of wave receiving elements are separately utilized to control the operation of a signal indicator circuit so that the indicator in said circuit is actuated only at times when all of said wave-receiving elements are energized. The effects of the strays in several receiving elements are seldom synchronous enough to produce any effect on the indicator.

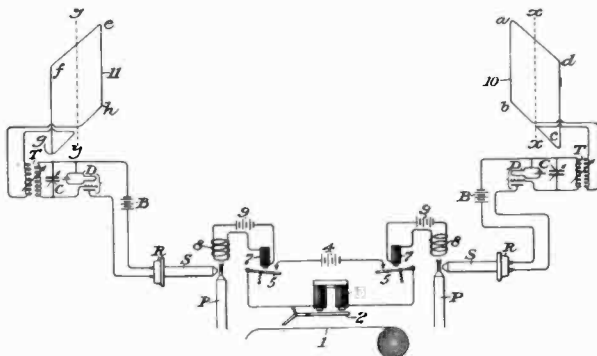

NUMBER 1,488,791—Space-Telegraph Receiving System

1,489,158—W. Schäffer, filed August 18, 1922, issued April 1, 1924. Assigned to Gesellschaft für drahtlose Telegraphie, m.b.h.

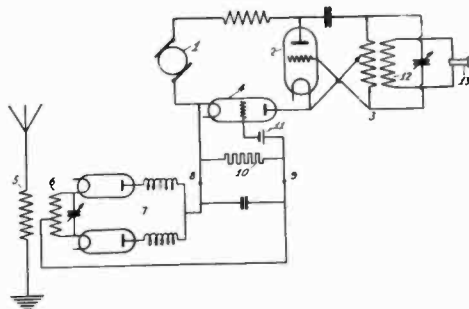

NUMBER 1,489,158—Arrangement for the Audible Receiving of Undamped Oscillations

ARRANGEMENT FOR THE AUDIBLE RECEIVING OF UNDAMPED OSCILLATIONS, wherein the received energy is used for producing and controlling energy of a different frequency from the received frequency. The frequency thus produced may therefore be kept

so low that it is audible in a telephone so as to make possible the direct hearing of inaudible incoming radio frequency. An audio frequency generator is provided at the receiving station consisting of an electron tube having a grid for controlling the oscillations in the generator circuit. The receiving circuit causes direct current potential to be impressed on the grid in proportion to the received energy to thereby control the effect of the low frequency generator upon a signal indicator.

1,489,031—J. H. Hammond, Jr., filed March 25, 1914, issued April 1, 1924.

**RADIODYNAMIC SYSTEM AND METHOD FOR AVOIDING WAVE INTERFERENCE** in dynamic control systems. The system contemplates a transmitter of a plurality of differently characterized or contrasting impulses to the first of which only the receiving circuit is responsive and upon receipt of which the electrical constants are automatically changed so that the circuit becomes responsive to the next succeeding transmitted energy upon receipt of which a desired control may be effected. Interference from undesired sources will therefore not affect a control, because the particular combination of frequencies to set a control could probably not be determined by hostile stations.

1,489,228—L. A. Hazeltine, filed December 28, 1920, issued April 1, 1924. Assigned to Hazeltine Corporation of New Jersey.

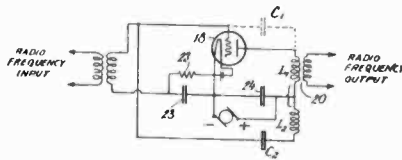

NUMBER 1,489,228—Method and Means for Neutralizing Capacity Coupling in Audions

**METHOD AND MEANS FOR NEUTRALIZING CAPACITY COUPLING IN AUDIONS**, comprising a coil connected between the grid and filament electrode and an auxiliary coil and neutralizing capacity connected in series between the plate electrode and the filament. The auxiliary coil is coupled electromagnetically with the first coil with a coefficient of coupling substantially equal to unity and having a ratio of turns thereto equal to the ratio of the

coupling capacity to the neutralizing capacity, said ratio differing from unity.

1,489,287—A. H. Taylor, filed May 29, 1923, issued April 8, 1924.

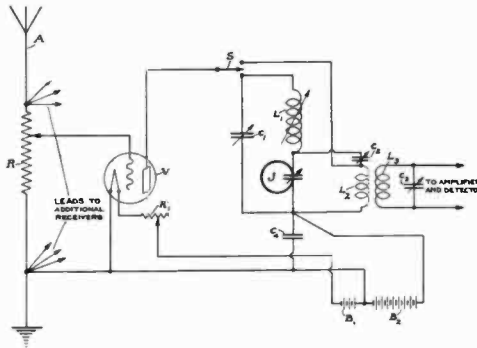

NUMBER 1,489,287—Receiver of High-Frequency Electrical Signals

**RECEIVER OF HIGH-FREQUENCY ELECTRICAL SIGNALS**, wherein a multiplicity of separate signal channels may be established on the same antenna. A rejector circuit is interposed between each receiver and the connections with the antenna for eliminating undesired reactions of one receiver upon another.

1,490,165—L. Espenschied, filed September 30, 1919, issued April 15, 1924. Assigned to American Telephone and Telegraph Company.

**BALANCED ANTENNA SYSTEM** for directive reception so arranged that it will produce a maximum effect upon the receiving apparatus in response to oscillations received in a given direction, but will produce practically no effect upon the receiving apparatus in response to radiations received from the local sending antenna. Another feature in the invention relates to a directive receiving antenna so arranged that its direction of maximum absorbing effect may be rotated at will, without affecting its faculty of producing substantially no effect upon the receiving apparatus in response to radiations transmitted from the local sending antenna.

1,490,198—Q. A. Brackett, filed January 24, 1921, issued April 15, 1924. Assigned to Westinghouse Electric and Manufacturing Company.

**SYSTEM OF CONTROL** for radio signal transmission where a non-radiating absorbing circuit is provided for the signaling

energy between the signal characters. A magnetic core is provided which interlinks inductances connected in the antenna and absorbing circuits. The magnetic characteristics of the core are then changed for producing signals whereby said radiating and absorbing circuits may be selectively rendered effective or non-effective.

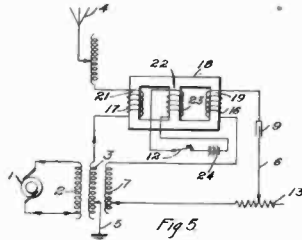

NUMBER 1,490,198—System of Control

1,490,958—R. Bown, filed November 23, 1921, issued April 22, 1924. Assigned to American Telephone and Telegraph Company.

**FREQUENCY CONTROL SYSTEM**, in which a plurality of radio stations are divided into groups of intercommunicating stations, each group having assigned to it a definite frequency range which shall not interfere with the frequency range assigned to any other group. The frequency used in the various groups for signaling is controlled by generating at a master station a fundamental frequency, transmitting said frequency to the stations of the various groups, generating at said station energy to be used for signaling, and controlling by the fundamental frequency of the locally generated energy without controlling the amplitude of the energy.

1,491,288—G. H. Clark, filed May 2, 1919, issued April 22, 1924.

**RADIO SIGNALING APPARATUS**, including a wave changer system for arc transmitter. A loading coil and a fine adjustment coil are connected in the antenna circuit with switch arms adapted to make contact with said coils. Means are shown for connecting said arms to cause simultaneous movement to provide coarse and fine adjustment.

1,491,341—A. H. Eaves, filed August 14, 1918, issued April 22, 1924. Assigned to Western Electric Company.

CONDENSER made up of a number of fixed condenser units of various capacities with a switching device whereby the total capacity between a pair of line terminals may be varied in the terms of the smallest capacity.

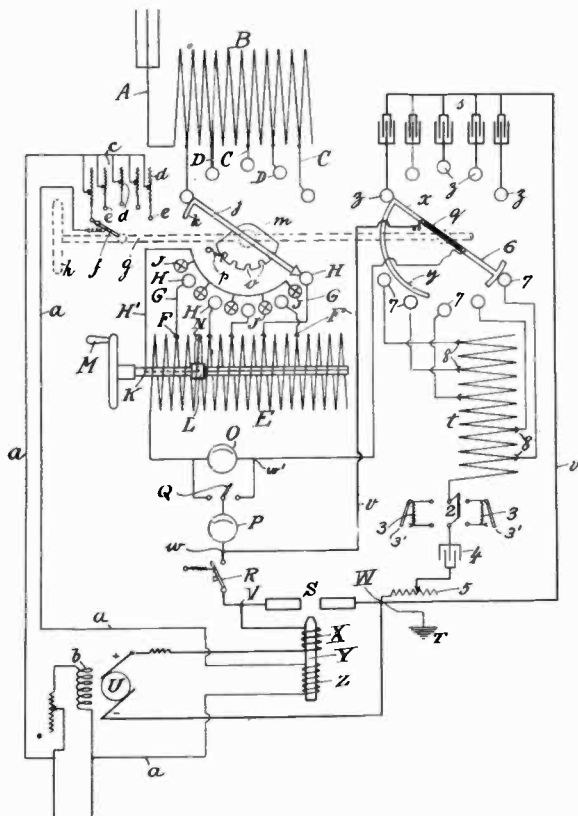

NUMBER 1,491,288—Radio Signaling Apparatus

1,491,362—H. E. Shreeve, filed February 20, 1918, issued April 22, 1924. Assigned to Western Electric Company.

VACUUM TUBE shell for surrounding the base of a tube. The shell consists of a collar, a plate of insulating material fitted in the outer end of said collar and terminal connections carried by said plate for each of the tube electrodes. The plate is positioned within the collar perpendicular to the axis of the collar.

1,491,372—E. W. F. Alexanderson, filed October 28, 1921, issued April 22, 1924. Assigned to General Electric Company.

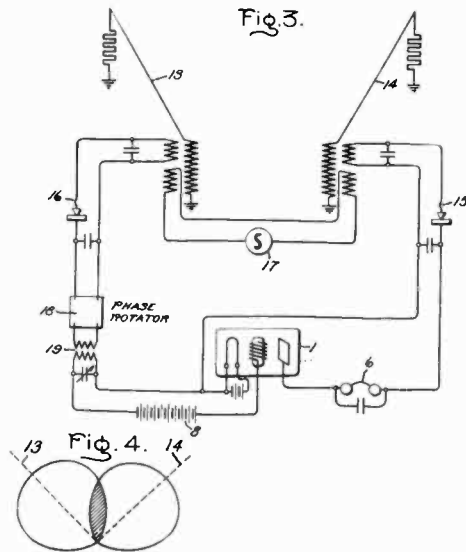

NUMBER 1,491,372—Radio Receiving System

**RADIO RECEIVING SYSTEM** having a high degree of selectivity. The receiver includes a detector and two circuits associated with said detector upon which received signaling current may be impressed. A circuit is connected to one of these circuits for integrating the phase of the signaling currents flowing therein. An indicator is associated with one of said circuits and separate means associated with the other circuits for causing said indicator to respond only to currents which are in phase with the signaling current. The receiver will then respond only to currents which are in phase with the signaling currents.

1,491,387—P. R. Fortin, filed February 12, 1921, issued April 22, 1924. General Electric Company.

**ELECTRON-DISCHARGE APPARATUS**, of high power wherein a cooling fluid is circulated around the exterior of the plate electrode of the tube maintaining the electrode at a proper working temperature. The plate electrode is a cylindrical cup-shaped member making a tight joint with the glass envelope of the electron tube.

1,491,405—A. W. Hull, filed March 1, 1921, issued April 22, 1924. Assigned to General Electric Company.

**SIGNAL-RECEIVING SYSTEM** for the reception of continuous wave signals. A tube circuit is shown in which the potential



of the grid electrode is varied periodically between suitable positive and negative values at a frequency somewhat different from that of the signaling currents to be detected so that the resistance of the signaling circuit will be varied between maximum and minimum values to vary at an audible frequency. By tuning the circuit between cathode and the controlling grid, oscillations will be produced in that circuit and the potential of the grid will automatically be caused to vary periodically at the frequency of the oscillations produced.

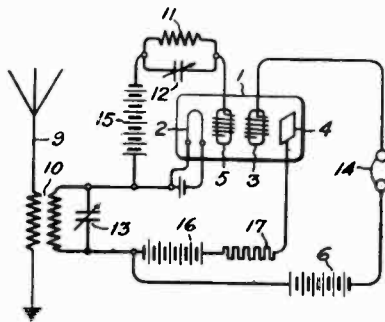

NUMBER 1,491,405—Signal-Receiving System

1,491,450—W. C. White, filed February 4, 1920, issued April 22, 1924. Assigned to General Electric Company.

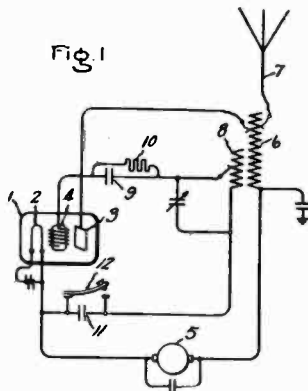

NUMBER 1,491,450—High-Frequency Signaling System

**HIGH-FREQUENCY SIGNALING SYSTEM**, consisting of an electron tube transmitter wherein signals are produced by a keying circuit connected in the grid of the electron tube. The keying

circuit operates to charge the grid to a value sufficiently negative by an accumulation of electrons from the cathode to prevent the production of oscillations so that signaling characters may be produced.

1,491,543—A. Meissner, filed May 3, 1922, issued April 22, 1924.

**METHOD OF AND APPARATUS FOR ELIMINATING DISTURBING EFFECTS**, by employing two receiving systems each tuned to substantially the same frequency with circuits for modulating the signaling energies of the received effects at different frequencies adapted to produce beats of different frequencies with the signal frequency. A circuit is provided for opposing the differentiated received effects and detecting the resultant of the combined effects.

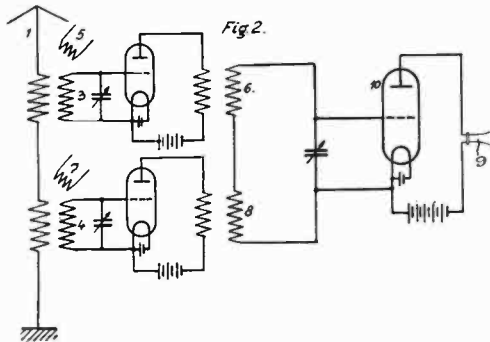

NUMBER 1,491,543—Method of and Apparatus  
for Eliminating Disturbing  
Effects

1,491,772—J. H. Hammond, Jr., filed May 9, 1912, issued April 22, 1924.

**SELECTIVE WAVE TRANSMISSION SYSTEM**, wherein wave groups are transmitted at a distinctive rate obtained by means of interrupters or variations of wave amplitude. The transmission system includes a circuit inductively connected to the transmission circuit including a source of periodic impulses of a predetermined frequency. These impulses are varied at a frequency different from the first frequency. Another circuit is provided wherein periodic impulses of a still different frequency are produced. At the receiver a plurality of circuits are used tuned to respond to the several frequencies for operating a control by conjoint action of all frequencies.

1,491,772—J. H. Hammond, Jr., filed April 26, 1912, issued April 22, 1924.

METHOD OF AND SYSTEM FOR SELECTING WAVE TRANSMISSION, for control systems wherein the transmitting station is provided with circuits for emitting a plurality of co-existing series of waves in groups having different group frequencies. The wave groups are emitted in sets having rates different from the wave group frequencies.

1,491,773—J. H. Hammond, Jr., filed May 9, 1912, issued April 22, 1924.

METHOD OF AND SYSTEM FOR SELECTIVE WAVE TRANSMISSION, wherein selectivity in transmission is secured by employing distinctive wave lengths and distinctive wave-group frequencies. A still higher degree of selectivity is secured by transmitting and receiving these waves and wave-groups at a third distinctive rate, which may be obtained by means of interrupters, variations of wave amplitude or in other ways.

1,491,774—J. H. Hammond, Jr., filed May 13, 1912, issued April 22, 1924.

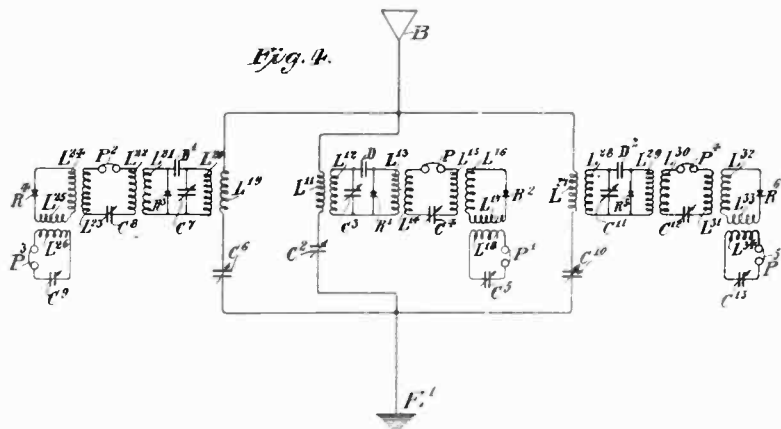

NUMBER 1,491,774—Multiplex Radio Telephony and Telegraphy

MULTIPLEX RADIO TELEPHONY AND TELEGRAPHY, where selectivity is secured by employing distinctive wave lengths and wave-group frequencies or periodic amplitude variations. A still higher degree of selectivity is obtained by using a combination of radio-frequency waves and at least one series of wave groups

or periodic amplitude variations for the transmission of telephone conversations, and a combination of high-frequency waves and at least two series of wave groups or periodic amplitude variations for the transmission of telegraph signals.

1,491,775—J. H. Hammond, Jr., filed September 29, 1916, issued April 22, 1924.

METHOD OF AND SYSTEM FOR TRANSMITTING AND RECEIVING ELECTRO-RADIANT ENERGY, for securing secrecy in radio communication. The transmitting circuit shown includes a plurality of rotary spark gaps and a shunted tone circuit whereby a plurality of effective tone signaling frequencies are secured which are selectively received at the receiving circuit to operate any desired control circuit.

1,492,000—H. J. Round, filed August 26, 1920, issued April 29, 1924. Assigned to Radio Corporation of America, New York.

THERMIONIC DEVICE FOR RADIO TELEGRAPHY AND TELEPHONY, in which the anode is situated at a distance from the cathode and is constructed of a pair of independent grid-like devices in close parallel planes. One anode is closer to the cathode than is the other anode. The grid is interposed between the anodes and the positive battery applied to the anode structure.

1,492,321—H. J. J. M. de R. de Bellescize, filed August 29, 1921, issued April 29, 1924.

RADIO SIGNALING SYSTEM, comprising an electron tube apparatus wherein the energy from the detector circuit is delivered to two differential low frequency circuits differently tuned. The two circuits have high time constants with respect to the oscillation frequency and the time constants of the radio frequency receiving circuit.

LIST OF RADIO TRADE MARKS PUBLISHED BY PATENT OFFICE  
PRIOR TO REGISTRATION

(The numbers given are serial numbers of pending applications)

187,947—"LYTTON RADIO DUPLEX" for radio receiving sets, in ornamental design. Walter Lytton, Incorporated, Chicago, Illinois. Claims use since February 12, 1923. Published March 18, 1924.

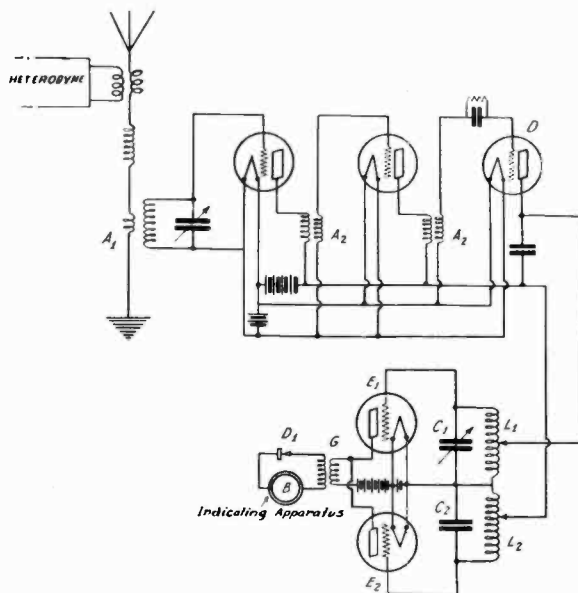

NUMBER 1,492,321—Radio Signaling System

- 188,673—"SUPERTRAN F M C" for audio frequency transformers. Ford Mica Company, Incorporated, New York. Claims use since October 3, 1923. Published March 18, 1924.
- 188,897—"RADIO-POWER" for filament heating transformers and parts thereof. The Eagle Carburetor Company, Cleveland, Ohio. Claims use since October 1, 1923. Published March 18, 1924.
- 188,954—"DUO-REFLEX" for parts for radio receiving sets. Electrical Research Laboratories, Chicago, Illinois. Claims use since April 1, 1923. Published March 18, 1924.
- 188,955—"ERLADYNE" for parts for radio receiving sets. Electrical Research Laboratories, Chicago, Illinois. Claims use since April 1, 1923. Published March 18, 1924.
- 188,956—"ERLAFLEX" for parts for radio receiving sets. Electrical Research Laboratories, Chicago, Illinois. Claims use since April 1, 1923. Published March 18, 1924.
- 188, 957—"TRIPLEX" for parts for radio receiving sets. Electrical Research Laboratories, Chicago, Illinois. Claims use since April 1, 1923. Published March 18, 1924.

- 188,970—"PEARLCO" for radio receiving sets. Pearl Radio Corporation, Philadelphia, Pennsylvania. Claims use since March 1, 1922. Published March 18, 1924.
- 188,972—"RADIONOGRAPH," in ornamental design for radio receiving sets. Radionograph Corporation of America, New York. Claims use since about August 20, 1923. Published March 18, 1924.
- 188,974—"SEC-TRON" for radio receiving sets. The Sec Tron Company, Cleveland, Ohio. Claims use since May, 1923. Published March 18, 1924.
- 189,371—Ornamental design of a sound amplifying device for Loud Speakers. Multiple Electric Products Company, New York. Claims use since April 1, 1923. Published March 18, 1924.
- 163,098—"RADIOPERA" for radio apparatus. Lyon and Healy, Incorporated, Chicago, Illinois. Claims use since about April 1, 1922. Published April 8, 1924.
- 172,607—"M P M—MILLION POINT MINERAL" for crystal detectors. Million Point Mineral Company, Needles, California. Claims use since October 30, 1920. Published April 8, 1924.
- 172,769—"WORLD WIDE WIRELESS" in ornamental design for radio apparatus. Radio Corporation of America, New York, New York. Claims use since July, 1921. Published April 8, 1924.
- 185,289—"DI-LO" in ornamental design for radio receiving apparatus. Fallkill Radio and Electrical Corporation, Poughkeepsie, New York. Claims use since July 1, 1923. Published April 8, 1924.
- 188,345—"CROSS COUNTRY" for radio receiving sets. United Profit-Sharing Corporation. Claims use since October 1, 1923. Published April 8, 1924.
- 190,273—"RADIO-MASTER—THE VOICE OF THE WORLD" in ornamental design for radio receiving sets and amplifiers. Henry T. Schiff, Bay City, Michigan. Claims use since October 1, 1923. Published April 8, 1924.
- 190,274—"VITRODYNE" in ornamental design for radio receiving sets and amplifiers. Henry T. Schiff, Bay City, Michigan. Claims use since October, 1922. Published April 8, 1924.

- 190,321—"VITARADIO" for radio receiving sets. Vitanola Talking Machine Company, Chicago, Illinois. Claims use since December, 1922. Published April 8, 1924.
- 191,082—"MORRADYNE" for radio receiving sets. Morrison Radio-Phone Company, Incorporated. Claims use since January 5, 1921. Published April 8, 1924.
- 187,654—"THORITE" for loud speakers. Winkler-Reichmann Company, Chicago, Illinois. Claims use since July 29, 1923. Published April 15, 1924.
- 189,062—"UNI-TUNE" for radio receiving sets. Nassau Radio Company, Incorporated, Brooklyn, New York. Claims use since November 22, 1923. Published April 15, 1924.
- 189,652—"A-B-ALLEN-BRADLEY" in ornamental design for radio apparatus. Allen Bradley Company, Milwaukee, Wisconsin. Claims use since October 1, 1923. Published April 15, 1924.
- 190,248—"PYRATEK" for crystal detectors. The Erisman Laboratories, New York, New York. Claims use since December 20, 1923. Published March 18, 1924.
- 190,297—"PHUSIFORMER" for intervalve coupling transformers. F. R. Hoyt, New York City, assigned to The Wilson Company of New York. Claims use since about November 1, 1923. Published March 18, 1924.
- 190,686—"HOM-E-OLA" for radio receiving sets. Hoffman-Corr Mfg. Company, New York. Claims use since December 14, 1923. Published March 18, 1924.
- 190,726—"SUPERTRON" for radio receiving apparatus. Victor Radio Mfg. Company, New York. Claims use since about June 1, 1923. Published March 18, 1924.
- 191,126—"INDUCTON" for radio receiving sets and parts. Radio Accessories Company, of New York. Claims use since about October 1, 1922. Published March 18, 1924.
- 191,215—"O. H. VOLTRON" for vacuum tubes. Otto Herschekowitz of Newark, New Jersey. Claims use since November 26, 1923. Published March 18, 1924.
- 181,886—"HOME-BUILT" for radio receiving coils. G. O. Wilkinson, Philadelphia, Pennsylvania. Claims use since December 20, 1922. Published March 25, 1924. (Not subject to opposition.)

- 188,601—Ornamental design for radio apparatus. Mercury Radio Products Company, Little Falls, New Jersey. Claims use since April, 1922. Published March 18, 1924.
- 191,613—"NEUTROSTAGE" for stage of tuned radio frequency amplification with neutralization of capacity coupling in radio receiving apparatus. Claims use since February 25, 1923. Freed-Eisemann Radio Corporation. Published April 1, 1924.
- 191,909—"MASTERTONE" for electron tubes. H. G. Porell Company, Boston, Massachusetts. Claims use since December 18, 1923. Published April 1, 1924.
- 190,380—"K-Q" in ornamental design for radio apparatus. King Sewing Machine Company, Buffalo, New York. Claims use since October 19, 1923. Published April 15, 1924.
- 190,699—"CATS-EYE" for detectors. Stream-O-Light Lamp Company, Columbus, Ohio. Claims use since March 1, 1920. Published April 15, 1924.
- 190,709—"RESISTRON" for grid leaks. Temple Instrument Company, Camden, New Jersey. Claims use since September 15, 1923. Published April 15, 1924.
- 191,362—"ALKADYNE" for radio apparatus, in ornamental design. The Connecticut Telephone and Electric Company, Incorporated, Meriden, Connecticut. Claims use since January 4, 1924. Published April 15, 1924.
- 191,640—"VOCELESTE" for radio apparatus. The Radio Products Company, Cleveland, Ohio. Claims use since September, 1923. Published April 15, 1924.
- 192,703—"KANT-BLO" for vacuum tubes. Harry B. Kanter, New York City. Claims use since January 24, 1924. Published April 15, 1924.
- 182,891—"REDDEN'S" for radio apparatus. (Not subject to opposition.) A. H. Redden, Irvington, New Jersey. Claims use since February 1, 1922. Published April 15, 1924.
- 192,903—"DURATRAN" for radio transformers. Dubilier Condenser and Radio Corporation, New York. Claims use since about April 28, 1923. Published April 29, 1924.
- 193,360—"POLYDYNE" for radio apparatus. Service Radio Corporation, New York. Claims use since February 20, 1924. Published April 29, 1924.



- 193,361—"POLYMER" for radio apparatus. Service Radio Corporation, New York. Claims use since February 20, 1924. Published April 29, 1924.
- 193,362—"POLYDON" for radio apparatus. Service Radio Corporation, New York. Claims use since February 20, 1924. Published April 29, 1924.
- 193,363—"POLYFORMER" for radio apparatus. Service Radio Corporation, New York. Claims use since February 20, 1924. Published April 29, 1924.



# Not claims *but proven facts*

Under test, Radion Panels show the lowest phase angle difference, the lowest di-electric constant and the highest resistivity.

Radion Panels are absolutely impervious to moisture, gases and most acids. And this is true for both sides of the panel.

No other panel is as easy to work. Radion Panels do not chip under the saw or drill.

The beauty of Mahoganite Radion Panels cannot be surpassed, while the soft sheen of the black panels is equally attractive.

Dials, V. T. Sockets, Condenser ends, Insulators, and Knobs are also made of Radion.

It will pay you to test Radion for yourself. Any co-operation which we can give in such a test will be furnished gladly.

**American Hard Rubber Co.**  
11 Mercer Street                      New York

# RADION

**Panels, Dials, Knobs, Sockets**

# Enjoy a RADIO SUMMER

**R**ADIO will play a wonderful part in your summer pleasures. At home or vacationing—seashore—north woods or mountain nook, radio will be a friendly, convenient companion.

Broadcasting stations are increasing their sending power. The bugaboo of summer static is no longer feared, and so remarkable has been the improvement and simplification of receiving sets that you will find their cost much lower than you might expect.

Give thought *now* to summer radio. Replace your worn out batteries with Burgess 'A,' 'B' and 'C's, which are recognized by expert and amateur alike as the best obtainable.



## BURGESS BATTERIES

*"Ask Any Radio Engineer"*

### BURGESS BATTERY COMPANY

ENGINEERS - DRY BATTERIES - MANUFACTURERS  
FLASHLIGHT - RADIO - IGNITION - TELEPHONE  
GENERAL SALES OFFICE: HARRIS TRUST BLDG., CHICAGO  
LABORATORIES AND WORKS: MADISON, WISCONSIN

### SAFETY DEMANDS

## BRACH RADIO VACUUM PROTECTOR

*Built to Protect—Not to Meet a Price*

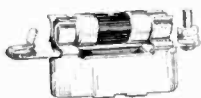

The First Choice of Leading Engineers  
Endorsed by National Board of Fire Underwriters



L. S. BRACH MFG. CO.

NEWARK, N. J.



## MAGNET WIRE & WINDINGS

### FOR RADIO

WRITE TODAY FOR PRICES AND SAMPLES

DUDLO MANUFACTURING CO., FORT WAYNE, IND.

Pacific Coast Representative

A. S. Lindstrom, 111 New Montgomery St., San Francisco, Cal.

---

# Brandes

*The name to know in Radio*



**T**HE *Table-Talker* is made and guaranteed by the makers of the famous Brandes *Matched Tone* Headsets—for sixteen years the standard of clear reception.

It is a *real* loudspeaker. Its tone is clear. Its volume is sufficient to fill the largest room in any home.

You will find it worthy of *your* approval and indorsement.

C. BRANDES, Inc.  
237 Lafayette St., N. Y. C.

Brandes *Matched Tone*  
*Table-Talker* . . . . . \$10  
Brandes *Matched Tone*  
Superior Headset . . . . . \$6  
Brandes Navy Type Headset . . \$8

*Matched Tone*  
Radio Headsets

# MURDOCK

## *Radio*

Standard Since 1904

*Announcing*

**Murdock  
Hazeltine Neutrodyne\***

*Receiver Type CS-32*

\*Registered U. S. Patent Office  
Licensed by Independent Radio Mfrs., Inc.  
under Hazeltine Patents

Circulars and Prices  
on Request

**WM. J. MURDOCK CO.**  
CHELSEA 50, MASS.

*Sales Offices:*

CHICAGO

SAN FRANCISCO

# CROSLEY

Announcing — The New Models — each a leader in its line



Crosley Trirdyn 3R3, \$65.00



Crosley Trirdyn 3R3 Special, \$75.00



Crosley 51, \$18.50



Crosley 51-P Portable, \$25.00



Crosley 52, \$30.00



Crosley 51-A, \$14.00



Crosley 50, \$14.50



Crosley 50-A, \$18.00

## Guaranteed Satisfaction at a Reasonable Price

**CROSLEY 50**—A new one-tube Armstrong Regenerative Receiver. We believe this to be the most efficient one-tube receiver ever put on the market. Uses any standard storage battery or dry cell vacuum tube. **Price \$14.50.**

**CROSLEY 50-A**—A new two-stage Audio Frequency Amplifier to match the new Model 50 Receiver. When used in connection with the Crosley Model 50 Receiver, it gives the equivalent of a three-tube regenerative receiver. **Price \$18.00.**

**CROSLEY 51**—In twenty-four days this receiver became the biggest selling radio receiving set in the world and it holds that position to-day. Will bring in local stations on the loud speaker at all times and distant stations under favorable conditions. **Price \$18.50.**

**CROSLEY 51-A**—A new one-stage Audio Frequency Amplifier to match the Model 51 Receiver. Combined they give the equivalent of a three-tube receiver. **Price \$14.00.**

**CROSLEY 52**—A new three-tube Armstrong Regenerative Receiver. Provides loud speaker volume on distant stations under practically all conditions. **Price \$30.00.**

**CROSLEY 51-P**—This is our new portable set. It is the Crosley Model 51 two-tube receiver mounted in a leatherette covered carrying case, space for batteries and all self-contained. **Price \$25.00.**

**CROSLEY TRIRDYN 3R3**—This three-tube receiver gives the efficiency and volume of a five-tube receiver. We believe it is the most efficient receiver on the market at any price for bringing in long distance stations. **Price \$65.00.**

**CROSLEY TRIRDYN 3R3 SPECIAL**—This receiver is exactly the same as the Trirdyn 3R3, except the solid mahogany cabinet is larger to contain "A" and "B" Batteries required when standard dry cell tubes are used. **Price \$75.00.**

Write for descriptive circular

For Sale by Good Dealers Everywhere

**THE CROSLEY RADIO CORPORATION**

Powel Crosley, Jr., President

661 Alfred Street

Cincinnati, Ohio

Licensed under Armstrong  
U S Patent No. 1,113,149

Crosley Owns and Operates  
Broadcasting Station W L W

**CROSLEY**  
Better—Cost Less  
Radio Products

# PROFESSIONAL ENGINEERING DIRECTORY

For Consultants in Radio and Allied Engineering Fields

## MONTAGUE FERRY

38 So. Dearborn St., Chicago

*Radio Apparatus  
Design*

## The J. G. White Engineering Corporation

Engineers—Constructors

*Builders of New York Radio Central*

Industrial, Steam Power and Gas  
Plants, Steam and Electric Rail-  
roads. Transmission Systems.

43 Exchange Place New York

## Electrical Testing Laboratories

Electrical, Photometrical,  
Chemical and Mechanical  
Laboratories

## RADIO DEPARTMENT

80th Street and East End Ave.  
New York, N. Y.

Your Card here will be seen  
by over 2,500 Institute of  
Radio Engineers members.

Rate: Per single issue . . . . \$ 5.00

Rate: Per year (six issues) 25.00

ARISTOS **"COPPERWELD"** WIRE

TRADE MARK REG. U. S. PAT. OFF.

(Made by the Molten Welding Process)

**ADOPTED AND USED BY THE LARGEST  
RADIO COMPANIES IN THE WORLD**

**For aerials, Copperweld has advantages over  
solid copper or bronze**

Radio frequency currents, because of "skin effect," flow along the exterior of wires. The smooth exterior thickness of copper on Copperweld Wire gives it practically the same high electrical conductivity as a solid copper wire (see Letter Circular No. 62, U. S. Bureau of Standards).

Greater strength is given by its steel core. No. 14 Copperweld Antenna Wire has *50% greater strength* than No. 14 hard-drawn copper or 7-No. 22 stranded copper wires. It stays up under severe loads when copper and stranded copper wires sag and break.

For ANTENNA, No. 14 Bare Copperweld Antenna Wire  
For LEAD-IN, No. 17 Rubber Insulated Copperweld Wire  
For GROUND Wire, same as Lead-In Wire  
For GROUNDING to earth, Copperweld Ground Rods,  $\frac{1}{2}$ " diam.

*Larger sizes for commercial stations*

## Copperweld Steel Company

(Formerly named Copper Clad Steel Company)

New York

San Francisco

Chicago

Mills and Main Office, Braddock P. O., Rankin, Pa.



THE DeForest name has been in the forefront of radio research for twenty-three years. DeForest invented the three-electrode vacuum tube which makes present-day radio possible. The sets and parts made to-day by the DeForest Company are worthy of the DeForest name.



\*Reg. U. S. Pat. Off.



**GENERAL INSTRUMENT CORPORATION**  
**Low Loss**  
**Grounded Rotor Condenser**

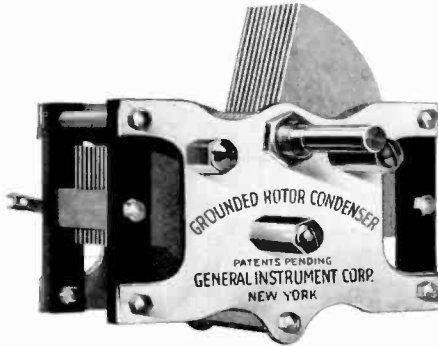

Patent Pending, Serial No. 698912

Type	Plates	Minimum Capacity in M-Mfd.	Maximum Capacity in M-Mfd.
46A.....	13	6	300
46D.....	21	9	500
46F.....	41	15	1000
46T (Transmitting)	45	18	500

**Readings**

The equivalent series resistance at 1,000 Cycles at Maximum Capacity setting is 20.5 Ohms; the Phase Angle difference less than  $\frac{3}{4}$  of a minute. The Power Factor at 1,000 Cycles is approximately .0064%.

These readings refer to Type 46D (21 Plate) .0005 MFD.

The accuracy of this Condenser makes it suitable for Bridge Measurement Work.

*Curves Furnished Upon Request*

These Condensers with a single plate a slow motion



can also be furnished vernier or with gear attachment

**General Instrument Corporation**

423 Broome Street

New York City

# Announcing:



## M4

Requiring no battery

Price \$25.00

THE efficiency, the appearance and the price of this new instrument clearly reflect the research and production facilities of The Magnavox Company, largest builders of radio reproducing equipment in the world.

Its exquisite tone quality results from the perfection of the Magnavox semi-dynamic operating principle incorporating: first, a new magnetically balanced armature; second, an improved type of diaphragm supported by hollow rubber gaskets; and third, an extremely high resistance winding which makes M4 unusually sensitive.

Beautifully finished in dark enamel with gold high lighting, the graceful appearance of Magnavox M4 suggests its use in the most dignified surroundings.

*Magnavox M4 and other Magnavox Radio  
Products can be had of good dealers everywhere.*

**THE MAGNAVOX COMPANY**  
OAKLAND, CALIF.

New York Office: 350 WEST 31st STREET  
Canadian Distributors: Perkins Electric Limited  
Toronto, Montreal, Winnipeg

## ALPHABETICAL INDEX TO ADVERTISEMENTS

<b>A</b>	
Acme Apparatus Company - - - - -	II
American Hard Rubber Company - - - - -	IX
American Radio and Research Corporation - - - - -	VII
American Transformer Company - - - - -	VI
<b>B</b>	
Brandes, C., Inc. - - - - -	XI
Brach, L. S. Manufacturing Company - - - - -	X
Burgess Battery Company - - - - -	X
<b>C</b>	
Copperweld Steel Company - - - - -	XIV
Crosley Radio Corporation - - - - -	XIII
Cunningham, E. T., Inc. - - - - -	Inside Front Cover
<b>D</b>	
DeForest Radio Tel. & Tel. Company - - - - -	XV
Dubilier Condenser & Radio Corp. - - - - -	Back Cover
Dudlo Manufacturing Company - - - - -	X
<b>E</b>	
Electrical Testing Laboratories - - - - -	XIV
<b>F</b>	
Ferry, Montague - - - - -	XIV
<b>G</b>	
General Instrument Corporation - - - - -	XVI
General Radio Company - - - - -	III
Grebe, A. H. & Company - - - - -	V
<b>M</b>	
Magnavox Company - - - - -	XVII
Murdock, Wm. J. Company - - - - -	XII
<b>N</b>	
National Carbon Company - - - - -	Inside Back Cover
<b>P</b>	
Pacent Electric Company - - - - -	IV
<b>R</b>	
Radio Corporation of America - - - - -	VIII
Roller-Smith Company - - - - -	II
<b>W</b>	
Ward Leonard Electric Company - - - - -	IV
Weston Electrical Instrument Company - - - - -	VI
White, J. G. Engineering Corporation - - - - -	XIV
Wireless Specialty Apparatus Company - - - - -	I

When writing the advertisers please mention THE PROCEEDINGS OF THE  
INSTITUTE OF RADIO ENGINEERS.

# EVEREADY

## Radio Batteries

—they last longer



EVEREADY "B" BATTERY  
No. 766  
In the new metal case

Thirty years of Dry Cell experience and a large research organization are back of EVEREADY Radio Batteries.

There is an EVEREADY Battery for every radio need.

Dry Cell "A" Batteries—

Storage "A" Batteries—

"B" Batteries for all sets—from the smallest portable to the largest permanent installation.

"C" Batteries for improving quality of reception and increasing "B" Battery life.

Manufactured and Guaranteed by

## National Carbon Company

New York—San Francisco

Headquarters for Radio Battery Information

CANADIAN NATIONAL CARBON CO., Limited.

Factory and Offices: Toronto, Ontario

# DUBILIER CONDENSERS

The Standard for High-Frequency Engineering

Fifteen years of specialized research and manufacturing experience lie behind Dubilier Condensers. As a result Dubilier Condensers are now used by practically every broadcasting, commercial and government station in the world, and in millions of radio receiving sets.

Dubilier research has kept steady pace with progress in high-frequency engineering. As new problems arise the high-frequency engineer may confidently turn to the Dubilier organization for condensers of the type that he requires.

Dubilier condensers are of many types, sizes and capacities. They range from the smallest condenser used in the home radio receiver to units as large as 3,500 KVA.

The Dubilier research organization will be pleased to design condensers for special engineering purposes.

Dubilier Condenser and Radio Corp.  
48-50 West Fourth Street, New York



Dubilier 3,500 KVA  
Condenser, 50,000 V.-  
70 amp.

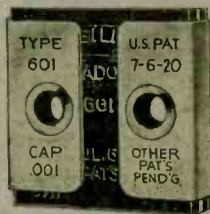

Dubilier Micadon for  
Radio Reception

