

VOLUME 11

AUGUST, 1923

NUMBER 4

PROCEEDINGS
of
The Institute of Radio
Engineers



EDITED BY
ALFRED N. GOLDSMITH, Ph.D.

PUBLISHED EVERY TWO MONTHS BY
THE INSTITUTE OF RADIO ENGINEERS
THE COLLEGE OF THE CITY OF NEW YORK
140th Street and Convent Avenue, New York, N. Y.

Subscription \$9.00 per Annum in the United States
\$9.60 in all other Countries

GENERAL INFORMATION AND SUBSCRIPTION RATES ON PAGE 331

Entered as second-class matter, February 16, 1916, at the Post-Office, at New York, N. Y., under the Act of March 3, 1879.

Acceptance for mailing at special rate of postage provided for in Section 1103, Act of October 3, 1917, authorized October 7, 1918.

27 APRIL 1976

~~CO133~~ LOT 15/2000 411

JN J BOTKIN

Faradon

FOR SERVICE

RADIO CONDENSERS

**Constant Capacity
Extremely Low Losses
Safety Gap Protection
High Current Carrying Capacity
Minimum Volume
Moisture-Proof Construction
Long Life
Quick Deliveries**

These are some of the reasons why radio engineers specify FARADONS.

There are over 150 standard FARADON condensers on which immediate deliveries can be made. Complete specification list and price list will be sent on request.

Wireless Specialty Apparatus Company
BOSTON, MASS.

Established 1907



RADIO APPARATUS

for

Indication



A complete line of 3 1/2" A. C. and D. C. Ammeters, Voltmeters and Thermal Ammeters for all radio applications.

Reception



Single and double telephone receiver Head Sets for both crystal and tube sets.

Amplification



The "Universal" Loud Speaker. An ideal outfit for home use at a low price.

Bulletins Nos. K-10, K-20 and K-810 describing the above will be sent on request.

ROLLER-SMITH COMPANY

Electrical Instruments, Meters and Circuit Breakers

MAIN OFFICE:
2134 Woolworth Bldg., NEW YORK



WORKS:
Bethlehem, Pennsylvania

Offices in Principal Cities in U. S. and Canada

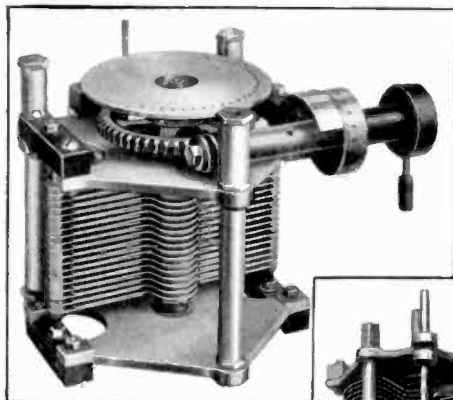

Type 222
Precision
Condenser

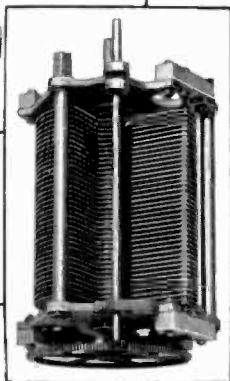

Type 246
Variable Air
Condenser

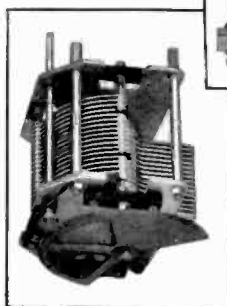

Type 239
Variable Air
Condenser

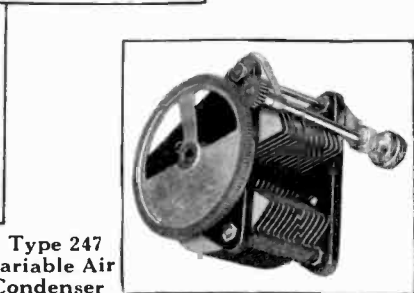

Type 247
Variable Air
Condenser

Condensers

for every need—
each the best in its
field. From

\$3.25 to \$90.00

The General Radio Co. was the first in this country to supply low loss condensers commercially. For over 8 years it has maintained a research laboratory for the study of dielectric losses.

Bulletin Recovering apparatus made by the General Radio Co. sent on request.

GENERAL RADIO COMPANY

Manufacturers of Electrical and Radio Laboratory Apparatus

Massachusetts Ave. and Windsor St. Cambridge, Mass.

5368

CONVENIENT COMBINATION PLUG CONNECTIONS



PACENT MULTIJACK

Three perfect jacks
in one moulded unit.
Cat No. 52. \$1.50
Price

THE Pacent Multijack is just one of a number of Pacent Essentials affording dependable combination plug connections. The Pacent Twinadapter permits connecting two plugs to one jack and the Pacent Duojack is directly attachable to any pair of binding posts and provides two plug connections. The new No. 40 Pacent plugs at 50 cents afford a perfect combination with these devices. Bulletins D-8 will be sent upon request.

PACENT ELECTRIC CO., Inc.
22 Park Place New York, N. Y.

Sales Offices:
Chicago, Philadelphia, St. Louis, Minneapolis,
Washington, D. C., San Francisco and Jacksonville

Pacent

RADIO ESSENTIALS

ACME TRANSFORMERS

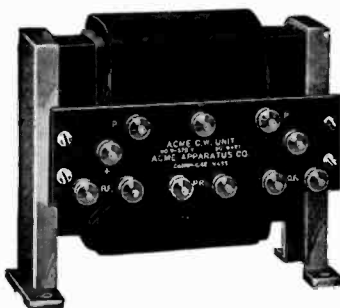

As specialists in the design and construction of Transformers we are prepared to quote prices and delivery on Transformers singly or in quantity.

Our Radio Transformers are well known for their high efficiency and ruggedness.

ACME APPARATUS COMPANY

200 MASSACHUSETTS AVENUE
CAMBRIDGE 39, MASS.

TRANSFORMER AND RADIO ENGINEERS AND MANUFACTURERS

Clear Away the Noises

with the

Dubilier By-Pass Condenser

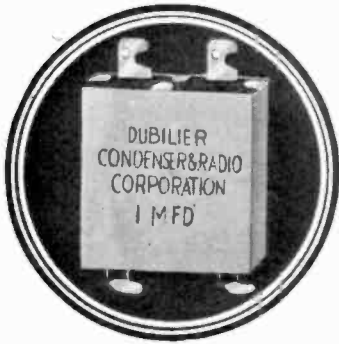

.1 mfd	\$.70
.25 mfd75
.5 mfd90
1 mfd	1.25
2 mfd	1.75
3 mfd	3.75
4 mfd	3.75

THE "B" battery is responsible for much poor reception. Its voltage is not constant, because of internal chemical action. Its internal resistance increases with age, so that the radio frequency currents are partially blocked.

To clear up the music and speech from the broadcasting station, to overcome these "B" battery defects, use a Dubilier condenser of 1 mfd (or larger) across the "B" battery terminals or as a by-pass. Note the purity of tone, the increase in signal strength.

DUBILIER CONDENSER & RADIO CORP.
48-50 WEST FOURTH STREET, NEW YORK

DUBILIER DEVICES

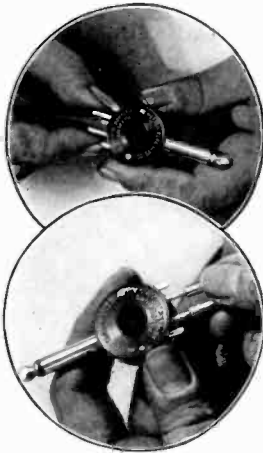
W**W**

The Handy Plug

A New Weston Product

When you are in a hurry—just shove the terminals into a Weston plug—instant contact.

Or to disconnect with equal speed—press the triggers and pull out your terminals—no tools required—no broken fingernails.

The Weston plug works in a fraction of a second.

A unique design typical of Weston workmanship.

Try one and see if this plug is not infinitely superior to any plug you have ever used.

Sent postpaid for \$1.00

Weston Electrical Instrument Co.
72 Weston Ave. Newark, N. J.

Makers of the World's Standard Electrical Instruments

Electrical
Indicating
Instrument
Authorities
Since 1888

WESTON

STANDARD - The World Over

The AMERTRAN

Price \$7

A Super Audio Frequency Amplifying
Transformer Without Distortion

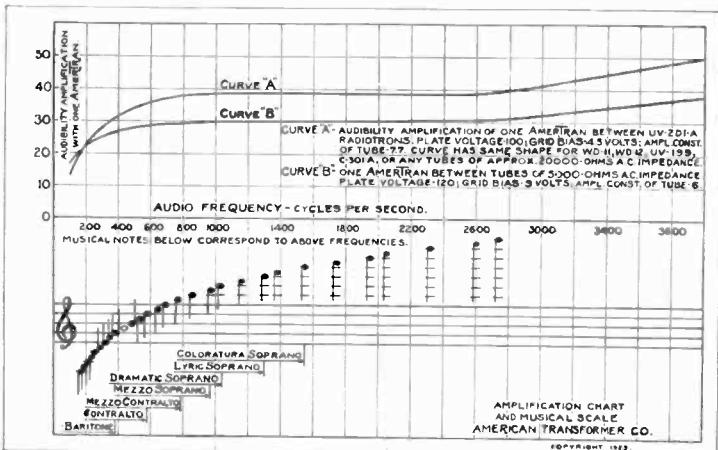

American Transformer Company

Newark, N. J.

AMRAD

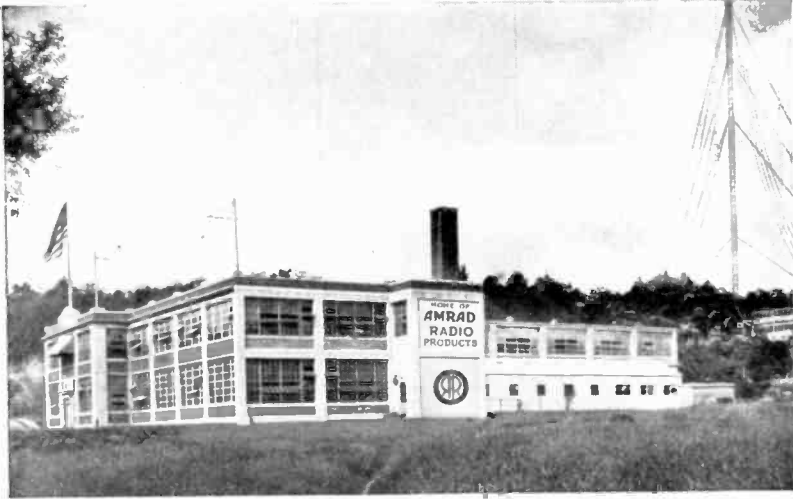

Main Factory of the American Radio and Research Corporation, Medford Hillside, Mass. Home of Amrad Radio. Showing at extreme right Research and Engineering Laboratories and Broadcasting Station WGI, erected June 1915, the World's Oldest Broadcasting Station operating to-day

Exclusive Developments

For eight years this Corporation has specialized in the development of Radio. Among results—



BASKETBALL VARIOMETER
Remarkably low Dielectric losses and distributed capacity.

The AMRAD "S" Tube—a Rectifier with NO FILAMENT TO BURN OUT.

The AMRAD BASKETBALL Variometer—a radical improvement over the conventional moulded type.



The S-TUBE
Rectifies 300 to 750 volts A.C. Resulting D.C. has minimum wave ripple with ordinary filter.

AMERICAN RADIO AND RESEARCH CORPORATION

MEDFORD HILLSIDE, MASS.

(4 Miles North of Boston)

New York

Chicago

*One Half
Actual Size*



Radiotron UV-199
The little tube of big
performance \$6.50

*One Half
Actual Size*



**Radiotron
UV-201-A**
The
super-
amplifier
tube
\$6.50

Radiotrons

To Get Distance—and Get it Clearly

**Radiotron
WD-12**

*The standard
base dry cell
tube \$6.50*

**Radiotron
WD-11**

*The ideal dry
battery detector
\$6.50*

**Radiotron
UV-200**

*The long dis-
tance detector
\$5.00*

**At the Nearest
R C A Dealer**



*This symbol of qual-
ity is your protection*

For quality of reception and length of service, every man wants a **RADIOTRON**. Experienced amateurs and broadcast listeners know the sensitivity and dependable performance of these tubes. UV-199 for portable sets because it operates on flashlight batteries—WD-11 and WD-12, the dry cell tubes, for use everywhere—especially on farms and at the summer bungalow—UV-200 and UV-201-A for use with a storage battery. There is a Radiotron for every need.

Look for the RCA trade mark, and the name **RADIOTRON**. Each is a guarantee of satisfaction.

Radio Corporation of America

*Sales Department, Suite 2092
233 Broadway, New York*

District Sales Offices

*10 So. La Salle St., Chicago, Ill.
433 California St., San Francisco, Cal.*

PROCEEDINGS OF The Institute of Radio Engineers

Volume 11

AUGUST, 1923

Number 4

CONTENTS

	PAGE
OFFICERS OF THE INSTITUTE OF RADIO ENGINEERS	332
L. W. AUSTIN, "RECEIVING MEASUREMENTS AND ATMOSPHERIC DISTURBANCES AT THE UNITED STATES NAVAL RADIO RESEARCH LABORATORY, BUREAU OF STANDARDS, WASHINGTON, March and April, 1923"	333
W. R. G. BAKER, "DESCRIPTION OF THE GENERAL ELECTRIC COMPANY'S BROADCASTING STATION AT SCHENECTADY, NEW YORK"	339
ROBERT H. MARRIOTT, "INTERFERENCE"	375
E. O. HULBURT, "ON SUPER-REGENERATION"	391
L. W. AUSTIN, "LOOP UNI-DIRECTIONAL RECEIVING CIRCUITS FOR THE DETERMINATION OF THE DIRECTION OF ATMOSPHERIC DISTURBANCES"	395
J. B. DEMPSTER AND E. O. HULBURT, "STANDARDS OF CAPACITY PARTICULARLY FOR RADIO FREQUENCY CURRENTS"	399
D. C. PRINCE, "VACUUM TUBES AS POWER OSCILLATORS, PART II"	405
JOHN B. BRADY, "DIGESTS OF UNITED STATES PATENTS RELATING TO RADIO TELEGRAPHY AND TELEPHONY; Issued April 24, 1923-June 19, 1923"	437

GENERAL INFORMATION

The PROCEEDINGS of the Institute are published every two months and contain the papers and the discussions thereon as presented at the meetings in New York, Washington, Boston, Seattle, San Francisco, or Philadelphia.

Payment of the annual dues by a member entitles him to one copy of each number of the PROCEEDINGS issued during the period of his membership.

Subscriptions to the PROCEEDINGS are received from non-members at the rate of \$1.50 per copy or \$9.00 per year. To foreign countries the rates are \$1.60 per copy or \$9.60 per year. A discount of 25 per cent is allowed to libraries and booksellers.

The right to reprint limited portions or abstracts of the articles, discussions, or editorial notes in the PROCEEDINGS is granted on the express condition that specific reference shall be made to the source of such material. Diagrams and photographs in the PROCEEDINGS may not be reproduced without securing permission to do so from the Institute thru the Editor.

It is understood that the statements and opinions given in the PROCEEDINGS are the views of the individual members to whom they are credited, and are not binding on the membership of the Institute as a whole.

PUBLISHED BY
THE INSTITUTE OF RADIO ENGINEERS, INC.
THE COLLEGE OF THE CITY OF NEW YORK

EDITED BY
ALFRED N. GOLDSMITH, Ph.D.

OFFICERS AND BOARD OF DIRECTION, 1923

Terms expire January 1, 1924; except as otherwise noted.

PRESIDENT

IRVING LANGMUIR

VICE-PRESIDENT

JOHN H. MORECROFT

TREASURER

WARREN F. HUBLEY

SECRETARY

ALFRED N. GOLDSMITH

EDITOR OF PUBLICATIONS

ALFRED N. GOLDSMITH

MANAGERS

(Serving until January 2, 1924)

EDWIN H. COLPITTS

LOYD ESPENSCHIED

JOHN V. L. HOGAN

GEORGE H. LEWIS

DONALD McNICOL

(Serving until January 7, 1925)

MELVILLE EASTHAM

JOHN H. MORECROFT

(Serving until January 6, 1926)

EDWARD BENNETT

LOUIS A. HAZELTINE

ADVERTISING MANAGER

DE WITT V. WEED, JR.

WASHINGTON SECTION

ACTING EXECUTIVE COMMITTEE

ACTING CHAIRMAN

COMM. A. HOYT TAYLOR

Navy Department,
Washington, D. C.

LOUIS W. AUSTIN

Navy Department,
Washington, D. C.

CAPTAIN GUY HILL

War Department,
Washington, D. C.

BOSTON SECTION

CHAIRMAN

GEORGE W. PIERCE
Harvard University,
Cambridge, Mass.

SECRETARY-TREASURER

MELVILLE EASTHAM
11 Windsor St.,
Cambridge, Mass.

SEATTLE SECTION

CHAIRMAN

J. R. TOLMIE
University of Washington
Seattle, Washington

SECRETARY

ALBERT KALIN
University of Washington
Seattle, Washington

TREASURER

ARCHIE BOLSTAD
SEATTLE, WASHINGTON

SAN FRANCISCO SECTION

CHAIRMAN

MAJOR J. F. DILLON,
526 Custom House,
San Francisco, Cal.

SECRETARY-TREASURER

D. B. MCGOWN,
Custom House,
San Francisco, Cal.

COPYRIGHT, 1923, BY
THE INSTITUTE OF RADIO ENGINEERS INC.
THE COLLEGE OF THE CITY OF NEW YORK
NEW YORK, N. Y.

RECEIVING MEASUREMENTS AND ATMOSPHERIC
DISTURBANCES AT THE UNITED STATES NAVAL
RADIO RESEARCH LABORATORY, BUREAU OF STAND-
ARDS, WASHINGTON, MARCH AND APRIL, 1923*

BY

L. W. AUSTIN

(United States Naval Radio Research Laboratory, Washington, D.C.)

*(Communication from the International Union for Scientific Radio
Telegraphy)*

The April observations indicate the approach of summer conditions by the strengthening of the atmospheric disturbances and by the beginning of the summer fading which has appeared a full month earlier than last year. The belief that the extreme fading of the European stations in Washington is largely local has been strengthened by the frequent observation of the simultaneous weakening of the signals from Radio Central, Long Island. During the portions of the year when European fading is not prominent, the signals from Radio Central show remarkable uniformity in Washington, seldom varying more than ten percent.

In March and April, Lafayette has unfortunately been sending very little during the forenoon (Washington time).

The calculated A.M. intensities (all daylight between stations), assuming 480 amperes for Lafayette and 380 amperes for Nauen, are:

$$\begin{aligned} E \text{ (Lafayette)} &= 31.5 \cdot 10^{-6} \text{ volts/meter and} \\ E \text{ (Nauen)} &= 15.3 \cdot 10^{-6} \text{ volts/meter} \end{aligned}$$

*Received by the Editor, June 4, 1923.

RATIO OF AVERAGES

λ (meters)	Signal	Disturbance	A. M.	P. M.
	P. M.	P. M.	Signal	Signal
	A. M.	A. M.	Disturbance	Disturbance
	MARCH			
23,400	1.09	1.85	3.06	1.86
12,500	0.89	1.80	2.36	1.16
	APRIL			
23,400	2.0	0.158
12,500	0.42	2.42	0.56	0.099

FIELD INTENSITY OF NAUEN AND OF DISTURBANCES
 ($\lambda=12,500$ m.) IN MARCH, 1923, IN MICROVOLTS PER METER

Date	10 A. M.		3 P. M.	
	Signal	Dis- turbances	Signal	Dis- turbances
1	21.0	5.0	38.5	23
2	39.8	6.0	28.5	5
3	40.6	5.6	34.7	8
5	37.2	4.5	25.2	10
6	20.0	8.8	28.5	12
7	37.0	10.0	17.0	26
8	13.8	8.0	32.0	15
9	31.0	3.0	28.7	12
10	28.7	25.0
12	23.1	10.0	37.1	16
13	15.4	25.0	28.0	30
14	24.5	8.0	*	15
15	26.7	52.0	10.0	155
16	21.9	25.0	30.9	43
17	32.0	10.0
19	38.5	13.0	43.0	12
20	38.5	10.0	25.5	10
21	39.0	9.0	51.5	25
22	36.3	7.3	34.1	19
23	42.0	12.0	32.0	13
24	36.3	42.0
26	72.8	13.0	18.5	52
27	51.5	8.0	32.0	23
28	*	8.0	43.0	16
29	*	6.0	36.3	14
30	55.7	6.0
31	*	52.0	15.0	48
Average	34.3	14.5	30.5	26.2

* = not heard.
 = not taken.

FIELD INTENSITY OF LAFAYETTE AND OF DISTURBANCES
 ($\lambda = 23,400$ m.) IN MARCH, 1923, IN MICROVOLTS PER METER

Date	10 A. .M.		3 P. .M.	
	Signal	Dis- turbances	Signal	Dis- turbances
1	*	10	125	52
2	*	12	120	10
3	*	12	*	16
5	*	10	90	18
6	70	13	95	28
7	90	20	70	42
8	*	16	85	32
9	*	8	105	15
10	*	53
12	*	21	95	28
13	*	95	50	56
14	*	21	100	22
15	*	100	29	268
16	*	43	50	86
17	*	19	70	35
19	*	23	140	18
20	*	19	100	16
21	*	16	85	46
22	*	12	100	36
23	85	23	85	26
24	*	73
26	*	22	85	100
27	*	19	85	45
28	*	15	100	25
29	*	10	95	26
30	*	6
31	*	95
Average	81.7	26.6	89	47.6

* = not heard.

..... = not taken.

FIELD INTENSITY OF NAUEN AND OF DISTURBANCES
 ($\lambda=12,500$ m.) IN APRIL, 1923, IN MICROVOLTS PER METER

Date	10 A. M.		3 P. M.	
	Signal	Dis- turbances	Signal	Dis- turbances
2	*	8	*	48
3	30.4	50	43.0	62
4	55.7	52	2.0	350
5	23.1	52	*	95
6	40.5	68	9.0	150
7	43.0	32	17.5	100
9	25.5	29	*	69
10	32.8	80	*	120
11	32.5	150	*	180
12	31.6	55	*	210
13	38.5	240	*	340
14	27.0	50	17.5	69
16	40.5	25	20.0	40
17	17.6	62	5.0	190
18	19.2	18	21.0	100
19	*	26	13.2	89
20	35.5	30	13.6	98
21	13.6	40	*	96
23	24.3	150	*	350
24	36.2	150	4.1	250
25	34.0	45	24.0	70
26	51.5	40	7.7	185
27	53.5	55	11.0	390
28	55.5	25	15.9	95
30	55.5	40	15.0	50
Average	35.5	62.9	15.0	152

* = not heard.

... = not taken.

FIELD INTENSITY OF LAFAYETTE AND OF DISTURBANCES
($\lambda=23,400$ m.) IN APRIL, 1923, IN MICROVOLTS PER METER

Date	10 A. M.		3 P. M.	
	Signal	Dis- turbances	Signal	Dis- turbances
2	*	15	110.0	85
3	*	100
4	*	120	15.0	580
5	*	98	40.0	240
6	*	280	26.1	210
7	*	70	50.0	180
9	*	60	29.0	160
10	*	185	2.0	200
11	*	240	20.5	360
12	*	120	25.0	390
13	*	290	2.0	500
14	*	80	92.5	60
16	*	52	25.7	190
17	*	125	19.0	280
18	*	28	50.0	175
19	*	44	50.0	120
20	*	65	24.4	145
21	*	85	30.8	188
23	*	340	32.5	430
24	*	260	50.0	420
25	*	80	75.0	130
26	*	82	50.0	300
27	*	100	29.1
28	*	55	*	180
30	*	70	*	80
Average	0	121.8	38.5	243.6

* = not heard.

..... = not taken.

SUMMARY: Field intensities of the signals from the Lafayette and Nauen stations, together with the simultaneous strengths of the atmospheric disturbances at Washington are given for March and April, 1923.

DESCRIPTION OF THE GENERAL ELECTRIC COMPANY'S BROADCASTING STATION AT SCHENECTADY, NEW YORK*

BY

W. R. G. BAKER

(GENERAL ELECTRIC COMPANY, SCHENECTADY, NEW YORK)

Radio telephone broadcasting transmitters differ in many respects from the commercial type of radio telephone equipment. The general requirements of radio telephone transmitters, used for purposes other than broadcasting, are ordinarily determined by commercial traffic conditions. In this case, the limits of both the electrical and mechanical design are rather definitely fixed by economic and operating conditions. On the other hand the economics of a broadcasting station are indefinite at present, and the method of operating is determined by factors far removed from those governing commercial traffic.

It is logical to expect that broadcasting stations would be somewhat similar to the best class of commercial equipments. There is, however, one very important exception and that is the fact that the broadcasting transmitter has been subjected to numerous refinements which, due to both economic and operating considerations, could not be incorporated in the commercial transmitter. In general, the commercial radio telephone transmitter is required to transmit only the band of voice frequencies necessary to handle commercial telephony. Transmitters for broadcasting purposes must, however, transmit frequencies over a considerable band from the deepest tone of orchestral instruments and organs to the high note of the piccolo flute. The commercial transmitter is required to operate both as a telephone and telegraph set over a considerable range of wave lengths. The control equipment is designed to permit the operating personnel to handle commercial traffic with the minimum amount of switching.

In order to indicate the general similarity between a commercial and a broadcasting telephone transmitter, attention is

* Received by the Editor, January 31, 1923. Presented before THE INSTITUTE OF RADIO ENGINEERS, New York, February 7, 1923.



FIGURE 1—1 Kilowatt Commercial Radio Telephone Transmitter

called to Figure 1 which shows the Model AT-702 transmitter built by the General Electric Company for the Radio Corporation of America. This transmitter is designed to provide communication by continuous-wave telegraphy, interrupted continuous-wave telegraphy, and telephony. In this equipment four 250 watt radiotrons (UV-204) shown in Figure 2 are used as oscillators when transmitting continuous waves or interrupted continuous waves. For telephony, two UV-204 radiotrons are

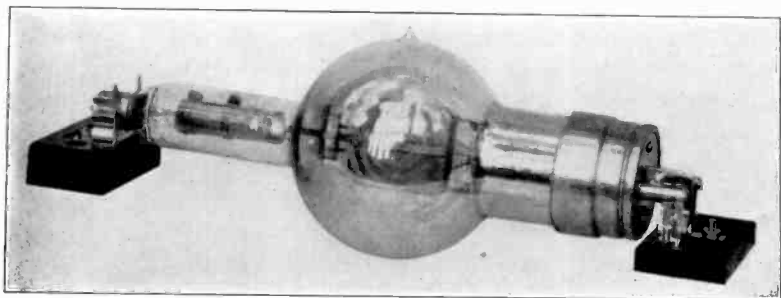

FIGURE 2—Radiotron Type UV-204

utilized as oscillators, two as modulators and a 50-watt radiotron (UV-203) shown in Figure 3 is employed as a speech amplifier. The set has a normal wave length range of from 300 to 800 meters. Provision, however, is made so that the wave length range may be modified to cover the band of 600 to 2,000 meters, in which case telephony is available up to 1,000 meters and continuous and interrupted wave telegraphy thruout the entire range of wave lengths. On the metal panel forming the front of the unit are mounted various instruments and controls, which are required to handle commercial traffic expeditiously.

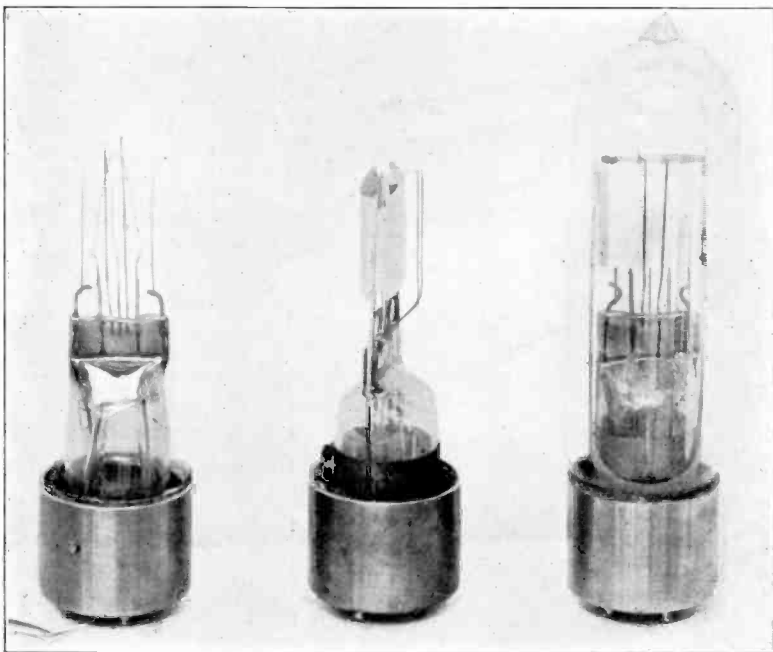

FIGURE 3—Radiotron Type UV-203

The operator's control and the extension station equipment are shown in Figures 4 and 5. The operator's control unit contains switching equipment for starting and stopping the motor-generator. The three-position control switch permits the selection of "Remote," "Local" or "Interphone" operation. With the "Local" position, the operator has complete control of the transmitter. When in the "Remote" position, the "Send-Receive" control is transferred to the subscriber's control unit. When in the "Interphone" position, wire telephony is available between the operator and the extension station.

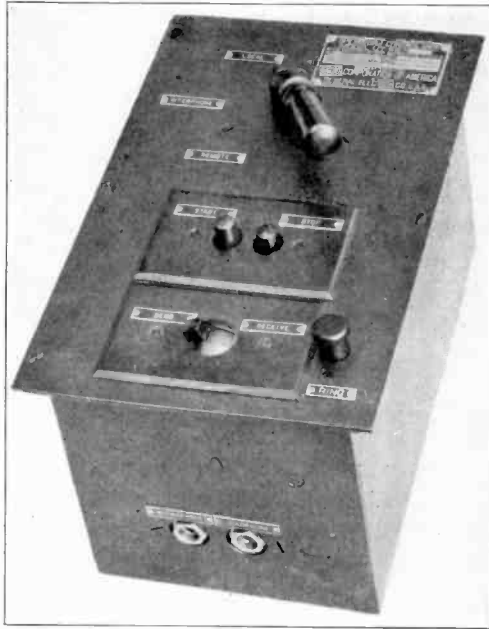

FIGURE 4—Operator's Control Unit for Radio Telephone Transmitter



FIGURE 5—Extension Station Equipment for Radio Telephone Transmitter

The power equipment illustrated in Figure 6 is a three-unit motor-generator set, consisting of a motor, a double-current self-excited generator, and a high voltage direct current generator.

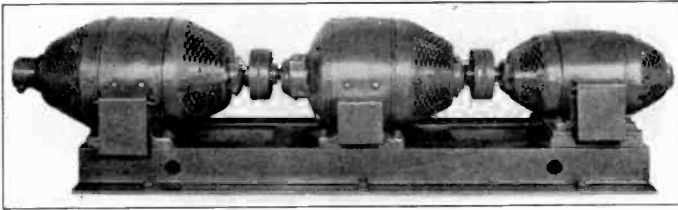

FIGURE 6—2,000 Volt Direct Current Motor Generator Set for Radio Telephone Transmitter

It is evident that a commercial telephone transmitter such as just described must contain the fundamental elements of a broadcasting transmitter. The service requirements, however, are entirely different, hence it would be expected that the detail design of the equipments would vary considerably. Among other requirements, a broadcasting transmitter must deliver radio frequency power at a constant frequency. In addition it must operate at a load point sufficiently high to permit reasonable efficiency without introducing an undue amount of distortion. Such a transmitter unit is shown in Figure 7. In this equipment, the frequency is determined by a tank circuit which in turn is coupled to the antenna circuit. The tube equipment consists of four UV-204 and one UV-203 radiotrons. Two of the UV-204 tubes are employed as oscillators, two as modulators, while the UV-203 is used as a speech amplifier. The control equipment is comparatively simple as only telephony is required and the wave length range is from 300 to 600 meters.

The amplifiers used with this equipment are shown in Figures 8 and 9. Three types are used depending upon the pick-up device employed and the selection to be reproduced. Since this equipment is, in general, quite similar to that used at "WGY"* it will be considered in connection with that station.

The control cabinet, Figure 10, provided with this equipment permits the operating personnel to select either one of two transmitting equipments thus preventing an interruption in case of trouble. In addition, the entire amplifier equipment may be replaced by an emergency group by simply throwing a switch.

The most interesting type of broadcasting stations are those

* Call of the General Electric Company's broadcasting station at Schenectady, New York.



FIGURE 7—1 Kilowatt Broadcasting Radio Telephone Transmitter

in which continued research and development are carried on, one of which is WGY operated by the General Electric Company at Schenectady, N. Y. It is obvious that a discussion of all the problems incident to the design and operation of a broadcasting station of this type is beyond the scope of this paper. It seems advisable, therefore, to consider the entire equipment in a general way indicating the various features deserving special attention.

The general requirements for the highest grade broadcasting stations are as follows:

1. The station must be ready to operate at all times. This means that the director of broadcasting may at any time handle a special program if he so desires.

2. Continuity of service is absolutely necessary. In other words, the equipment must be designed and operated in a manner that will prevent an interruption during a program.

3. The quality of transmission must be of the highest order.
4. The transmitter frequency must be maintained constant.

The requirements of a broadcasting station may be summarized by stating that the best possible service must be available at all times.

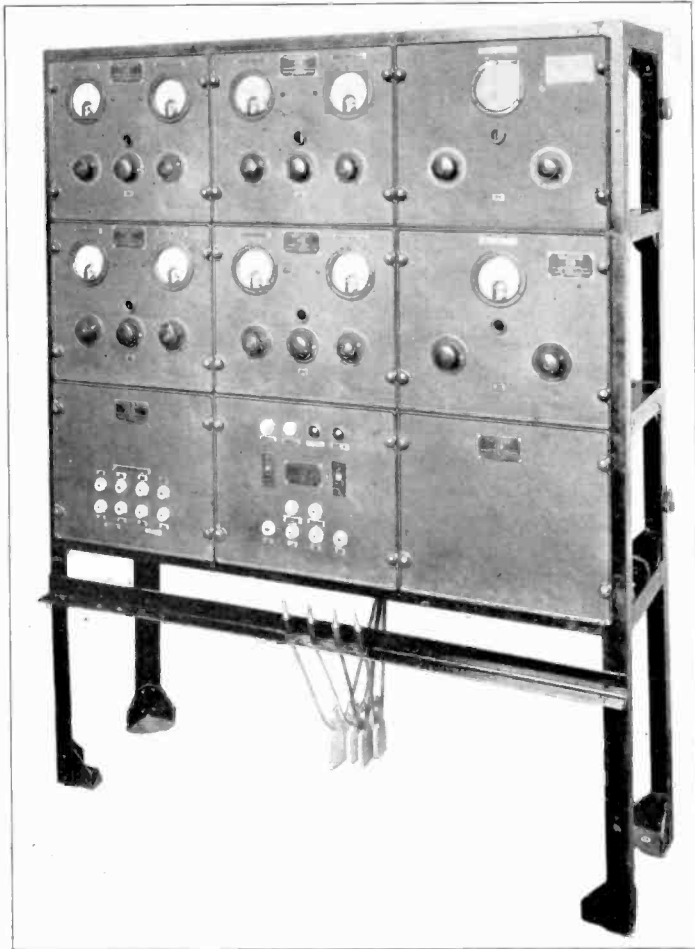

FIGURE 8—Amplifiers for Broadcasting Station Transmitter

In considering station WGY, it is convenient to divide the equipment into three parts.

1. Power Plant.
2. Control Equipment.
3. Studio.

POWER PLANT

The power plant includes all equipment necessary for the generation, modulation, and radiation of the radio frequency power. This apparatus is located in what is called the power

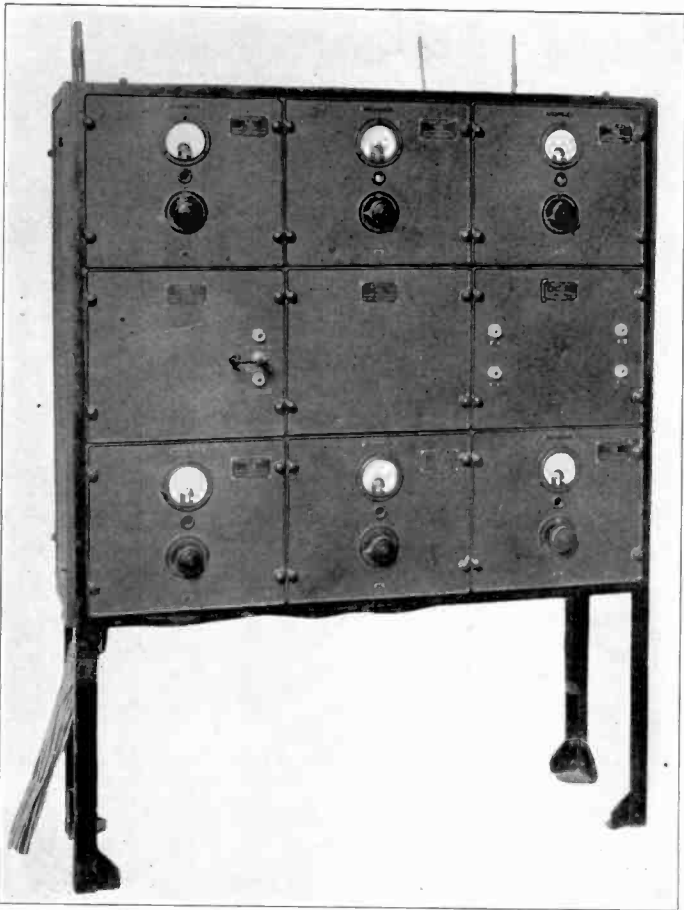

FIGURE 9—Amplifiers for Broadcasting Station Transmitter

house and consists in general of the following equipment, which is provided in duplicate:

- (a) High voltage direct current supply consisting of one or more batteries of kenotron rectifiers.
- (b) Radio frequency generator utilizing one or more radiotrons as oscillators.
- (c) Modulator unit consisting of one or more radiotrons as modulators.

CONTROL EQUIPMENT

The control room contains all amplifying and switching equipment.

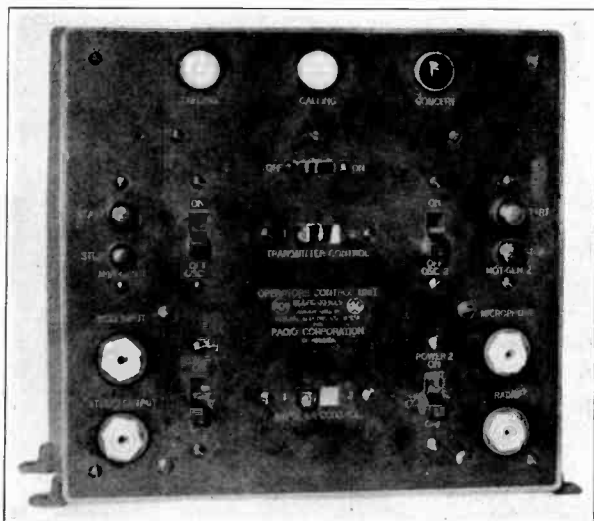

FIGURE 10—Operator's Control Cabinet for Broadcasting Station Transmitter

STUDIO

The studio consists of the usual room prepared and furnished especially for broadcasting service.

In Figure 11 is shown the general arrangement of the equipment used at WGY. In order to provide suitable space for the main and auxiliary studios it was necessary to locate this portion of the station 3,000 feet from the power house. While it is not absolutely necessary to locate the control room in close proximity to the studio it was found more convenient to do so in this particular instance.

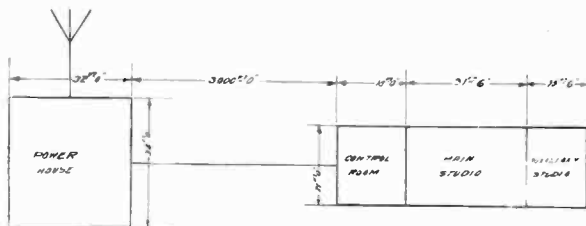

FIGURE 11—Layout of "WGY"

THE POWER HOUSE

ANTENNA

The power house is located in the building shown in Figure 12. This figure also gives some idea of the antenna employed at

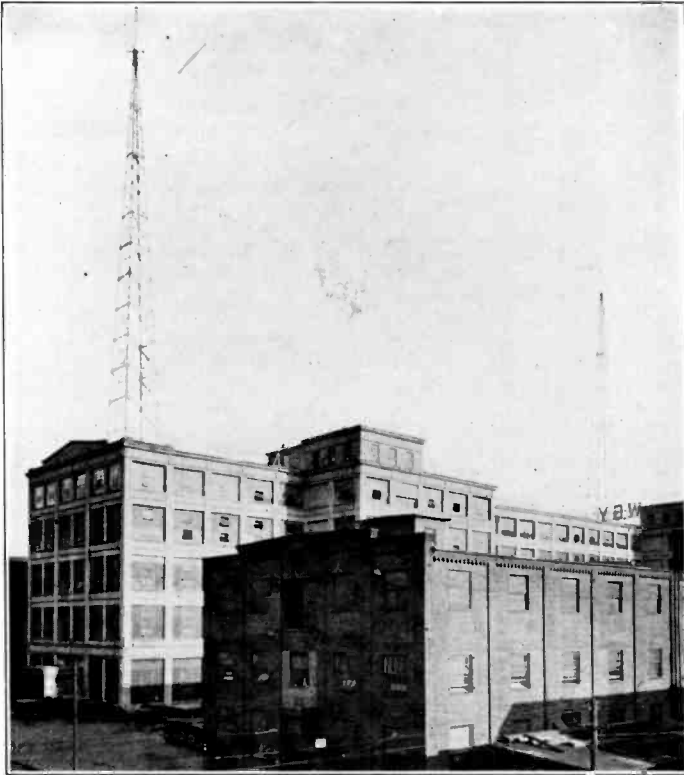

FIGURE 12—"WGY" Broadcasting Towers

WGY, which is of the multiple tuned type having two tuning points. An extensive counterpoise system is utilized and can be seen in Figure 13, which also shows the outdoor tuning coil. The second multiple tuning coil is located in the power house and serves to transfer power to the antenna. The towers are 185 feet (56 m.) high and placed 352 feet (107 m.) apart. The length of the flat top portion of the antenna system is approximately 200 feet (61 m.).

RECTIFIER EQUIPMENT

The direct current supply for the plate circuits of the tube equipment used for the generation and modulation of the radio

frequency power is obtained from a battery of kenotron rectifiers. The present equipment with its filter is capable of delivering power at 12,000 volts with a ripple of less than one-tenth of one percent. The schematic circuit diagram is shown in Figure 14 and the actual construction is indicated in Figure 15.



FIGURE 13—Counterpoise and Outdoor Tuning Coil at "WGY"

In this rectifier the delta connected primary is supplied from a 3-phase, 220-volt generator. The high tension windings of the transformer are connected to form two Y's, 180 degrees out of phase. Each Y with its kenotrons is thus a half wave rectifier delivering voltage waves E_1 and E_2 with the odd multiples of the triple harmonic component in the two Y's 180 degrees out of phase and the even components in phase. If the neutral points of the two Y's are connected thru a reactance and the load is connected as shown, the odd multiples of the triple harmonic component will not appear in the rectified voltage wave whereas the even harmonic components will appear. The voltage across the reactor or interphase transformer is the sum of the absolute values of the odd multiple of the triple harmonic frequency

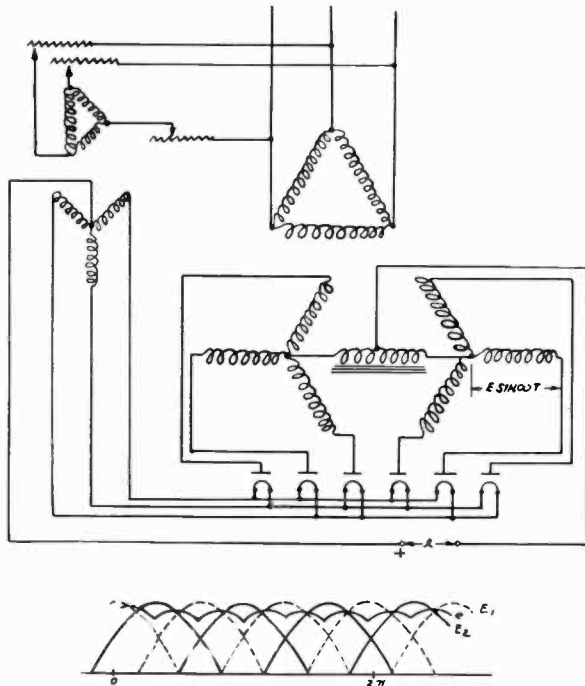

FIGURE 14—Schematic Circuit Diagram of Rectifier at "WGY"

voltage due to each Y. The current due to this voltage is inter-phase transformer magnetizing current, and circulates thru the kenotrons and transformer windings without appearing in the load.

The current waves drawn thru each kenotron are nearly square, lasting for one-third of the cycle. Since there are two high tension windings per phase passing current in opposite directions, the primary current wave is symmetrical and contains no even harmonics. The direct current component of current delivered by each of the two Y's is one-half of the total direct current, so that each tube is required to pass only one-half the maximum value of current required per tube in the ordinary three-phase full-wave rectifier. The tube equipment consists of six UV-218 kenotrons, one of which is shown in Figure 16.

OSCILLATOR AND MODULATOR UNITS

The oscillator circuit is shown schematically in Figure 17. This utilizes a tank circuit loosely coupled to the antenna so that the frequency is determined chiefly by the constants of the

tank or dummy circuit. The oscillator utilizes one UV-208 tube (Figure 18), operating at reduced output. The complete oscillator and modulator assembly is shown in Figure 19.

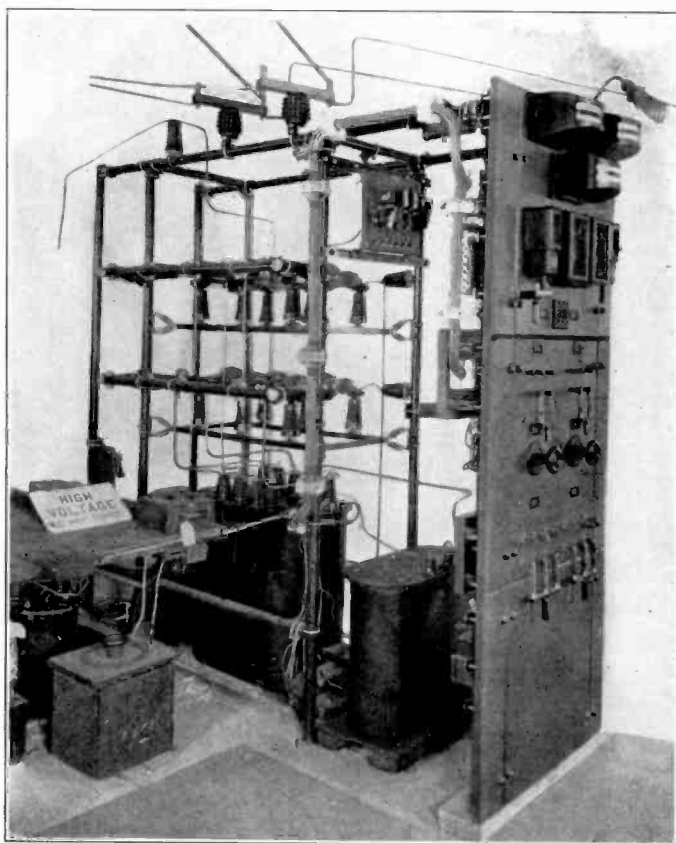

FIGURE 15—Kenotron Rectifier

The modulator employs five UV-206 tubes (Figure 20). The modulating system is that commonly known as the plate method of modulation. The modulation unit also includes an amplifier known as the 4th stage of amplification. This amplifier consists of two units:—a push-pull and a reactance coupled amplifier. Either unit may be used, depending upon operating conditions. Both units use UV-204 tubes at a plate potential of 2,000 volts.

In addition to the apparatus mentioned, the power house contains the necessary generators and batteries together with an oscillograph, power controls, and auxiliary switches.

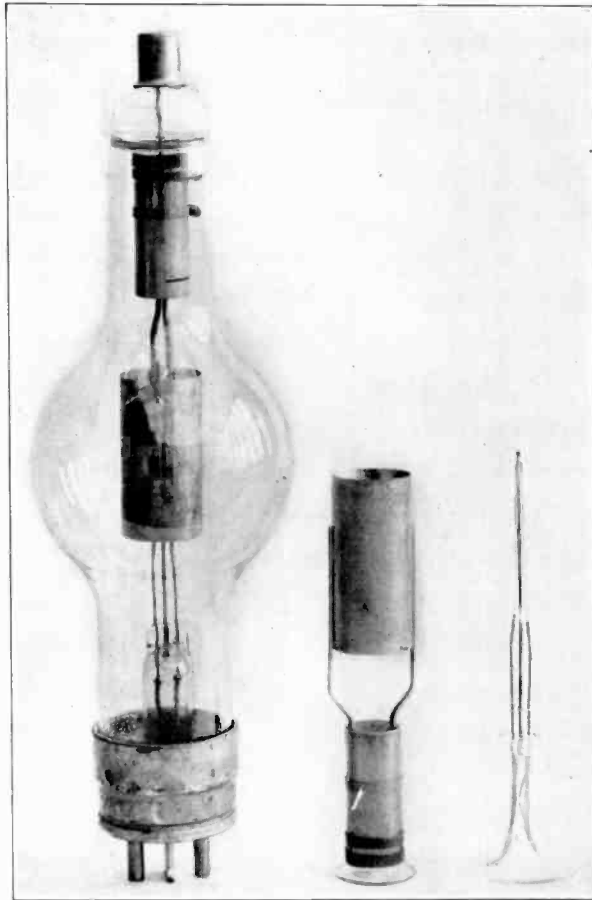

FIGURE 16—Type UV-218 Kenotron (View Showing Electrodes)

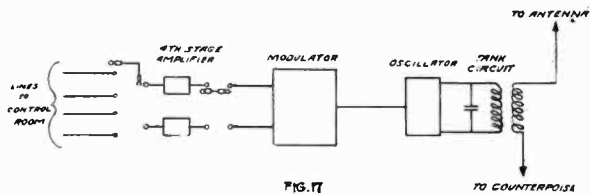

FIGURE 17—Schematic Diagram of Power House Circuits

CONTROL ROOM

In order to understand the function of the control room attention is called to Figure 21 which shows the amplification system. Numbers 1 to 10 indicate first-stage or microphone amplifiers. The microphone circuits from both the main and auxiliary studios

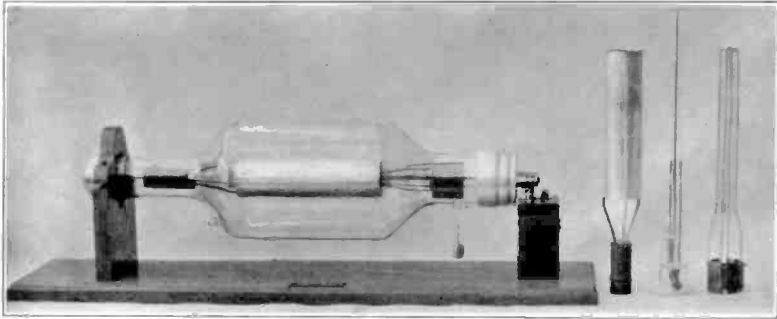

FIGURE 18—Radiotron Model UV-208

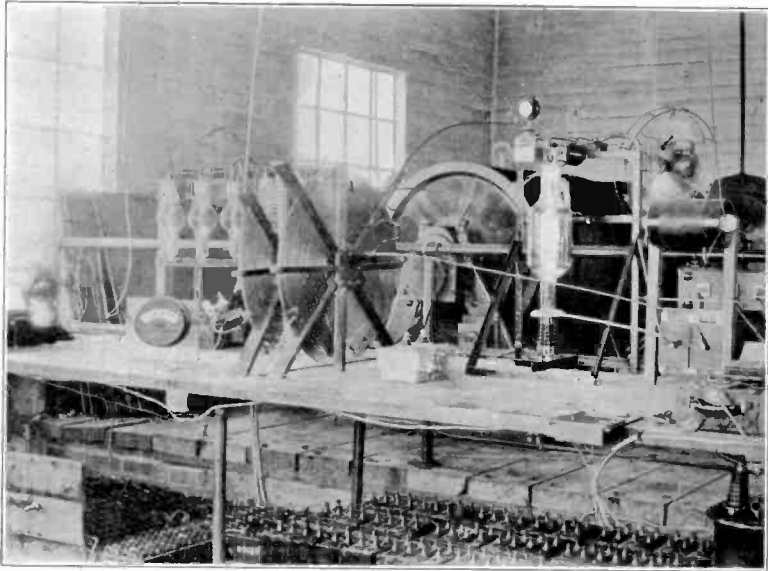

FIGURE 19—Oscillator and Modulator Assembly at "WGY"

terminate in jacks. Four different types of first-stage amplifiers are provided and are selected according to the pick-up device used. In all cases UV-202 tubes (Figure 22) are used operating at a plate potential of from 350 to 400 volts depending upon the type of circuit. The circuits for first-stage amplifiers are shown in Figures 23 to 26, inclusive. Each first-stage amplifier has its own output control, filament control, and listening-in jack. An assembly of one group of amplifiers is shown in Figure 27. Certain amplifiers are assigned to various classes of service, for example, each studio has its own announcing amplifier. In addition some of these amplifiers are used exclusively for broadcasting from places other than the studio.

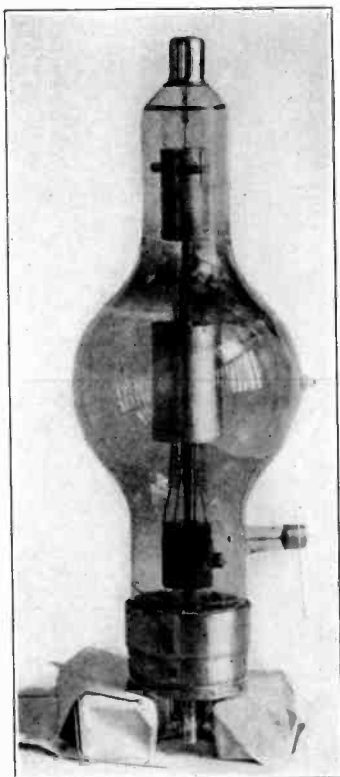

FIGURE 20—Model UV-206 Radiotron

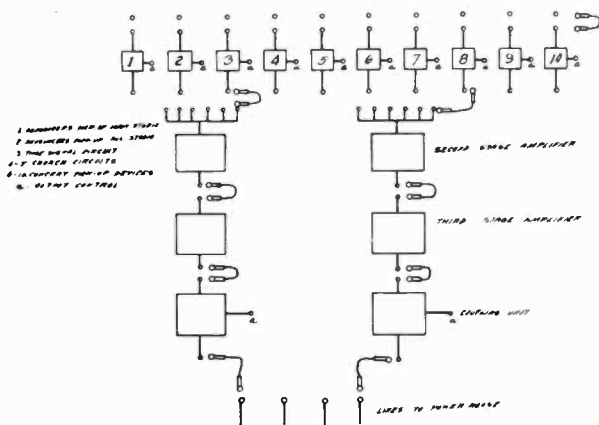

FIGURE 21—Schematic Diagram of Control Room Circuits

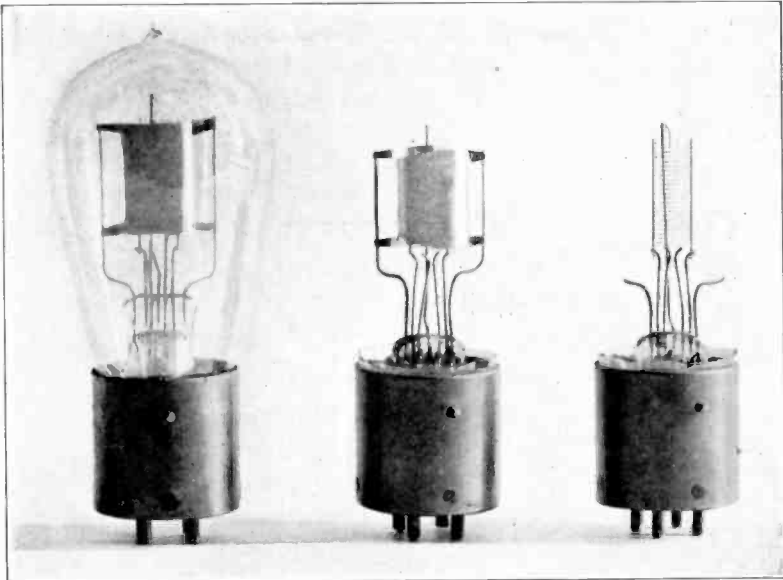

FIGURE 22—5 Watt Transmitting Radiotron Type UV-202

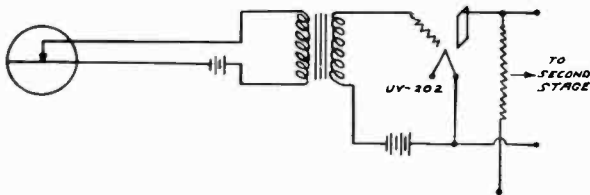

FIGURE 23—Microphone and First Stage Amplifier (Single Button)

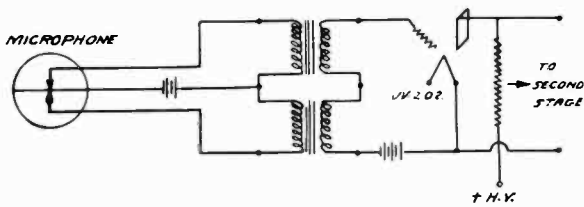

FIGURE 24—Microphone and First Stage Amplifier (Double Button)

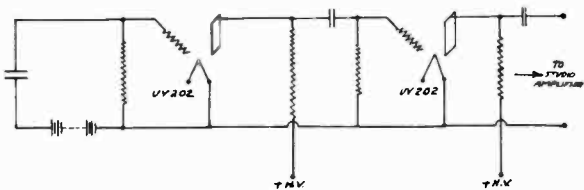

FIGURE 25—Condenser Transmitter and Associated Circuits

The output circuits of the first-stage amplifiers may be plugged into either one of two second-stage amplifiers. The input circuit of the second stage units includes a number of jacks connected in multiple, thus permitting a number of first-stage amplifiers to be plugged into one second-stage unit. The out-

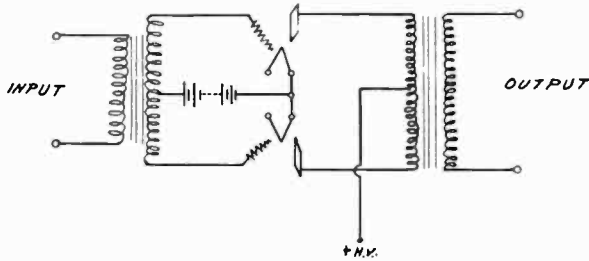

FIGURE 26—Push-Pull Amplifier

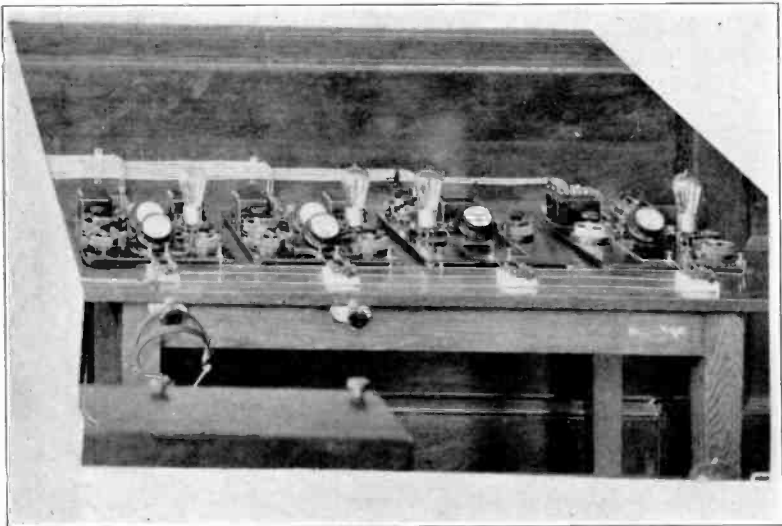

FIGURE 27—Control Room Amplifiers at "WGY"

put of the second-stage amplifier may be plugged into either of two third-stage amplifiers. Both second and third-stage units use one UV-203 tube operated at a plate potential of 600 volts. The circuit diagram of a second-stage amplifier is shown in Figure 28 and that of a third-stage amplifier in Figure 29. Both types of amplifiers use one UV-203 tube operating at a plate potential of 600 volts. Figure 30 shows the assembly of a group of second and third-stage amplifiers with their control equipment.

The output of the third-stage amplifier is plugged into either of two filter units indicated in Figure 21 as coupling units. The lines to the power house may be plugged into the particular coupling unit in use.

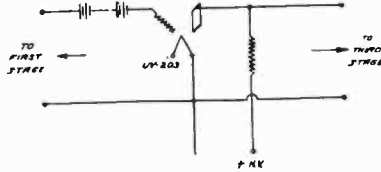

FIGURE 28—Second Stage Amplifier

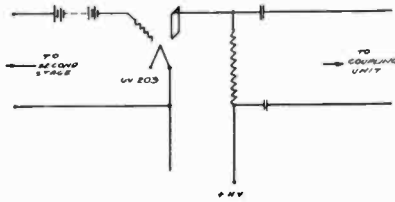

FIGURE 29—Third Stage Amplifier

The input and output jacks of all amplifying equipments are located on the control board shown in Figure 31. The lamps at the top of this switchboard are part of the signaling system.

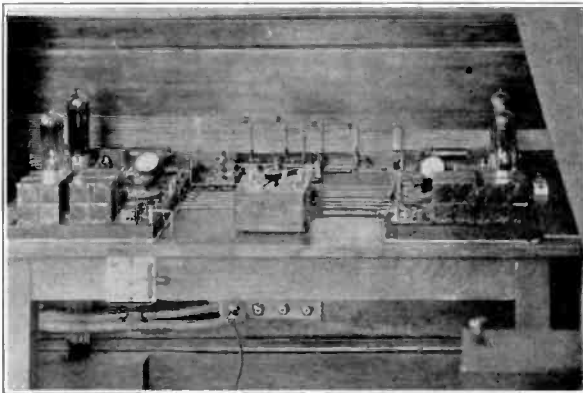

FIGURE 30—Second and Third Stage Amplifiers at "WGY"

Power for the filaments of all amplifiers is obtained from storage batteries. The plate supply may be obtained either from a direct current generator or storage batteries. All power supplies are in duplicate usually by providing both a battery and a generator. The battery equipment is illustrated in Figure 32.

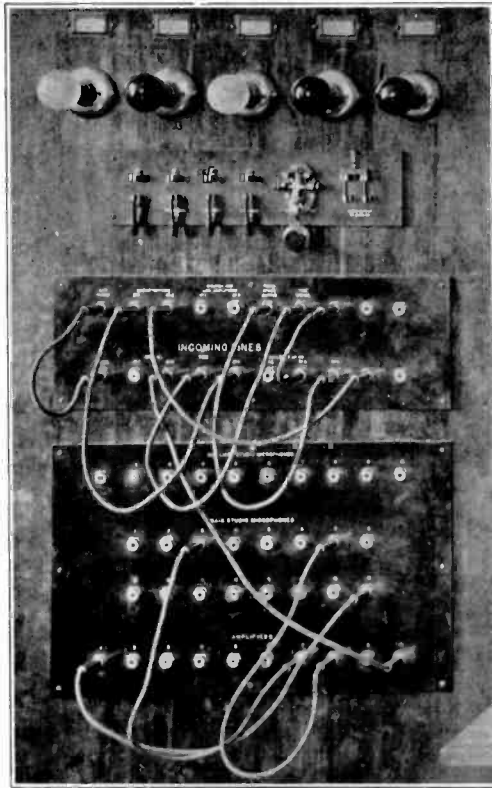

FIGURE 31—Control Board at "WGY"

PICK-UP DEVICES

The pick-up device is one of the most important units of a station since it is depended upon faithfully to transform the efforts of the artist into a form of energy that can be used by the balance of the equipment. This unit is now receiving, and will in the future receive, an increasing amount of attention. While there are a considerable number of pick-up devices in use they may, in general, be divided into four classes:

1. Carbon transmitters,
2. Magnetic transmitters,
3. Condenser transmitters,
4. Special types.

Two types of microphones in the first class are available and are known as single and double-button microphones (Figure 33). Both types have been used considerably at WGY with very fair results.

The magnetic type of pick-up device as used at WGY not only eliminates some disadvantages of the carbon type but provides a means whereby individual control of certain instruments may be readily accomplished. This is particularly true in the case of the piano. Figure 34 shows the mounting of two pick-up devices on the piano. In this device, the vibrations of the

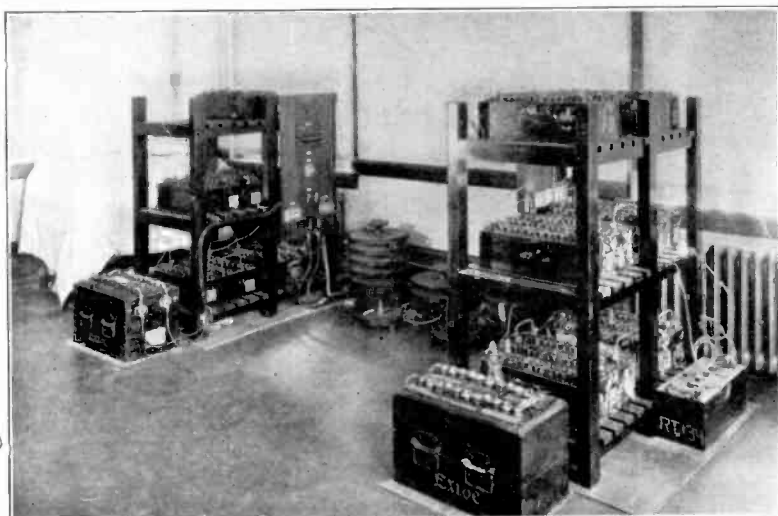

FIGURE 32—Battery Racks Control Room Broadcasting Station, "WGY"



FIGURE 33—Double Button Microphone

sounding board are transmitted to a rotatable coil. This coil which is placed in a strong magnetic field has induced in it potentials which are impressed on the grid of a special first-stage amplifier.



FIGURE 34—Piano Pick-up Device, "WGY" Broadcasting Station

When this device is used, individual control of a vocal selection and the accompaniment is readily accomplished since the vocal selection would be taken care of by a condenser transmitter or carbon microphone.

A modification of the magnetic transmitter as used for the piano has been applied to phonograph reproduction (Figure 35). This transmitter together with a suitable filter has proved quite satisfactory.

One type of condenser transmitter is shown in Figure 36. This pick-up device is probably one of the best types for use in the studio, but is somewhat more difficult to apply outside of the station. The general system employed is either to mount the



FIGURE 35—Phonograph Pick-up Device, "WGY" Broadcasting Station

microphone on a cabinet containing at least the first amplifier or to locate the unit near the end of the studio so that the amplifiers may be located in the control room. The condenser microphone requires from one to two additional stages of amplification and operates with a potential of 500 volts between plates.

A new type of pick-up device called the Pallophotophone has been used for several types of service.

This device (Figure 37) is dependent for its operation upon the variation of a beam of light. This light is made to fluctuate on and off a light-sensitive cell, the increase or decrease of light

causing a corresponding change in the flow of current thru the circuit in which the cell is connected. Amplification is obtained in the ordinary way by means of tubes.

The two main features upon which the remarkable quality obtained with the device depends are: (1) the special design of the vibrating system, which is extremely light and responds to vibrations even above the audible range, the amplitude of the mirror movement being many times that of the diafram upon which the sound waves impinge, and (2) the absence of that lag in the operation of the special light cell used, which is so pronounced in the ordinary selenium cell.

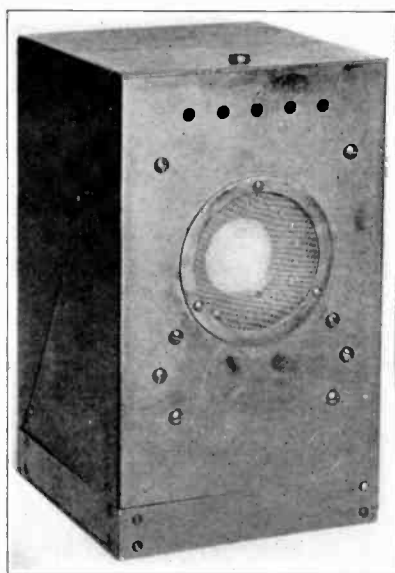

FIGURE 36—Condenser Transmitter

This device as used in the studio is mounted upon a light pedestal that can be easily moved from place to place, all the main controls (Figure 38) being housed in a suitable cabinet and located in the control room.

The Pallophotophone may be used to record and reproduce the voice or music (Figure 39). In this case a sensitized film is made to pass at a uniform speed behind a narrow opening, across which the beam of light before mentioned is made to vibrate. In this way a sort of oscillograph record is photographed upon the film.

In order to reproduce speech or music, light is made to pass

thru the narrow slot or opening, with which the record was made, onto the light sensitive cell and the photographed record is passed back of the opening at the same speed at which the record was taken. The variations of light passing thru the opening will correspond to the vibrations produced by the original sound waves, and in this way the reproduction will be the same as if a person talked or sang directly into the device.

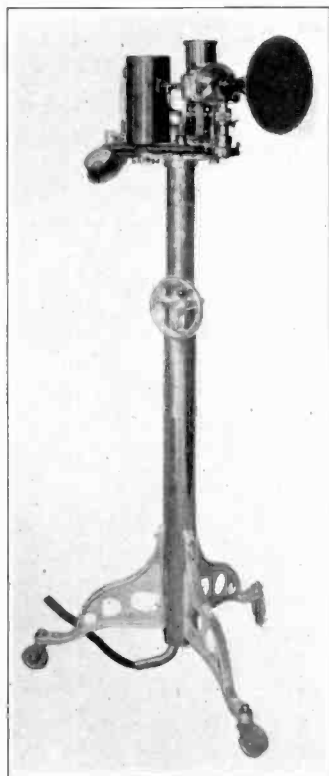

FIGURE 37—Pallophotophone
Pick-up Device

In using the reproducer in broadcasting, the electrical impulses are not again converted into sound but are impressed directly on the amplifying system. In this way the distortion that would otherwise be present is eliminated.

TIME SIGNAL RECEIVER

The receiving equipment necessary in order to re-radiate the government time signals is located in the control room. This

apparatus is shown in Figure 40 and consists of a trap circuit, tuning unit, and amplifiers.

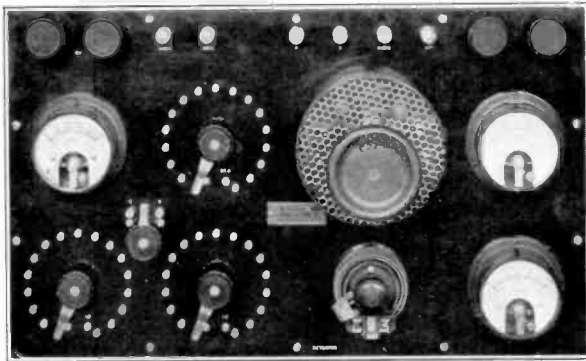

FIGURE 38—Pallophotophone Control Cabinet

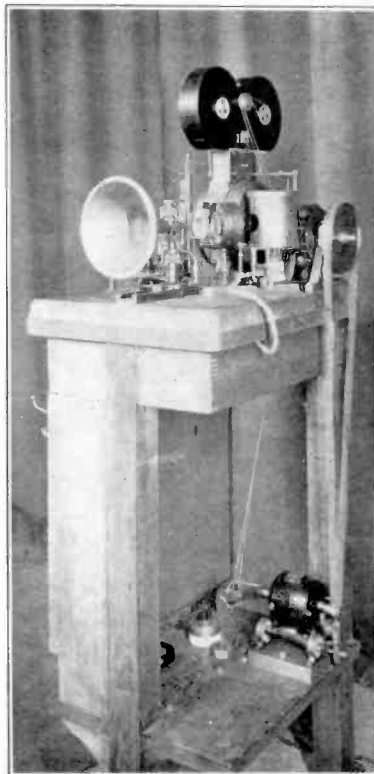

FIGURE 39—Pallophotophone Recorder

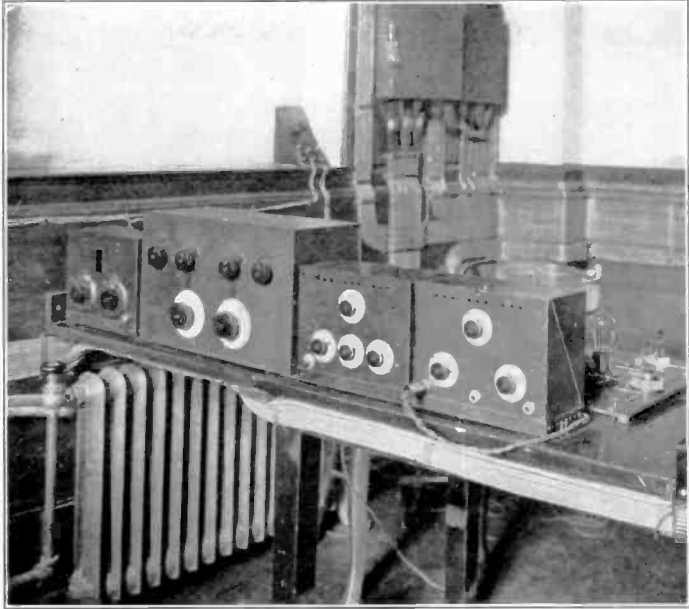

FIGURE 40—Time Signal Receiver at "WGY"

THE STUDIO

A general view of the main studio is shown in Figure 41.



FIGURE 41—Main Studio at "WGY"

All microphone and control circuits are carried in lead-covered cables laid behind the wall draperies. Connection boxes are arranged near the floor for the microphone outlets. Figure 32 shows the announcer's microphone and control box.



FIGURE 42—Announcer's Microphone and Control Box

The auxiliary studio is of somewhat similar arrangement and differs mainly in that it is considerably smaller. This studio is used chiefly for readings and lectures.

The problem of broadcasting from churches and other places outside of the regular studio has received considerable attention. This is especially necessary when, as in the case of Sunday services, a different church service is broadcast every Sunday. A typical arrangement of pick-up devices is shown in Figure 43 and illustrates the refinement required in order to transmit every part of the service. These pick-ups are controlled by a specially designed unit shown in Figure 44. This control box contains amplifier

equipment sufficient to compensate for line losses, and so on. Figure 45 illustrates schematically how this equipment is linked with the control room at WGY. With this equipment an operator located at the church switches the various pick-up devices in and out of the circuit according to the requirements of the church service.

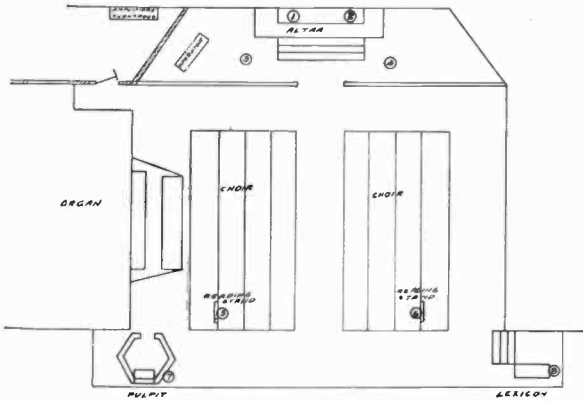

FIGURE 43—Typical Microphone Arrangement for Church Service

When it is required to broadcast from a remote point, it is frequently necessary to add additional amplifiers at this point.

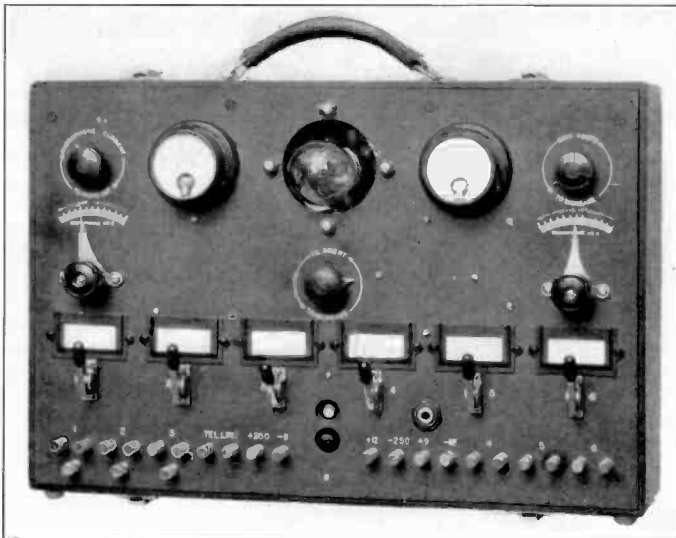

FIGURE 44—Control Equipment Used at Churches

This, of course, depends upon the electrical characteristic of the lines between the control room and the remote point. Great care is taken in not only obtaining high quality circuits, but in determining the amount of amplification necessary to maintain the speech always above the interference level.

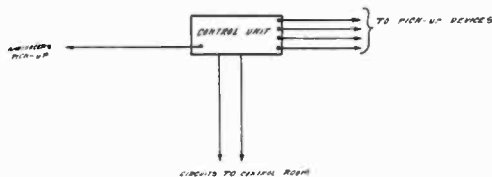

FIGURE 45—Schematic Diagram of Circuits for Broadcasting From Churches

STUDIO OPERATION

A great portion of the success of any broadcasting station depends upon the operation of the studio. The proper placing of the artist and the relation of the various instruments of the orchestra, band or chorus, affects the transmission very materially. Even for the radio play, where a number of pick-up devices may be used or where different pick-up devices are used for the various instruments, the broadcasting may be ruined by improper placement of performers. In cases where a separate pick-up device is used for some instrument such as the piano and where the soloist has an individual pick-up, the location is somewhat simplified, since the relative intensities may be regulated by the individual controls associated with each pick-up device.

The acoustic properties of the studio also have a decided effect on the placement of the pick-up device, especially for music. Obviously the best method of determining the proper location of the microphone is by actually testing with the artist. This not only assures satisfactory operation during the performance but permits a gradual education of the studio manager in locating the artist and microphone to obtain the best results.

Probably the ideal condition would obtain if the pick-up device could be definitely located and the control equipment used to obtain the desired effect. This could be accomplished if, for example, each instrument in an orchestra had a separate pick-up device. In general the individual pick-up idea has worked out very satisfactorily for a limited class of broadcasting. In this class are the radio show, the musical comedy, and similar performances. The radio show in particular requires the use

of individual pick-up devices. For instance, some casts contain from twelve to fifteen performers, each of whom may act their part. The use of individual microphones together with a knowledge of the play and the general characteristics of each performer permits a selection and grouping of pick-up devices which gives the most realistic results. This, however, does not stop with the performers but includes the various stage effects, such as wind, the ringing of a door or telephone bell, the slamming of a door, the scratching of a match, and so on. These effects are very important in order to assist the imagination of the radio theater-goer.

Obviously the operation of the studio is one of the most important features of a broadcasting station, and is probably destined to be the most important part. While the entire broadcasting equipment may be the best possible, unless the output of the studio is entirely correct, the desired effect on the listener is not obtained.

The grouping for one scene of a play, "The Wolf," is shown in Figure 46 and the grouping for a harp selection in Figure 47.

OPERATION

In order to understand the duties of the operating personnel and the functioning of the signaling system, it is desirable to trace the operation of the station during the transmission of a program.

The station is manned one-half hour before the program is to start and all clocks checked from a master clock. The two power men on duty measure the insulation of the tie lines to the control room, check all batteries, and operate the entire equipment into an artificial antenna. The senior power man then throws a switch which operates signal lights in the control room and studio indicating to the studio and control men that the power house is ready, but that the power is not on the antenna. So far as the power house is concerned, the set is in operation, and the two operators begin to perform their regular duties. The senior power man supervises the operation of the power equipment, monitors the radio output, and watches the modulation indicators in various parts of the circuit. By means of signal lights he informs the control room whether the modulation should be increased or decreased. In case of emergency he communicates with the control room over the inter-communicating system. The junior power man takes all readings and records them in the log at the beginning of each selection. In case the selection is a



FIGURE 46—Pick-up Grouping for Scene of a Play



FIGURE 47—Pick-up Grouping for a Harp Selection

long one, the readings are recorded every ten minutes. This finished the picture insofar as the power house is concerned. These men must keep the station running until directed by the control operator to shut down.

Coming back to the control, we find that the operators have checked all batteries, amplifiers, and pick-up devices, and have connected in those required for the program.

In the studio, we find the announcer and his assistant arranging a group of artists. All artists not performing remain in the reception room where a loud-speaking reproducer permits them to hear the other numbers of the concert.

Assume that the artists are placed and the control room has received a signal to this effect. The senior control man throws a key which, operating contactors in the power house, transfers the set from the artificial to the regular antenna. The radiation from the antenna operates a green signal light in the control room and studio. The announcer throws a small key to "Announce" which, thru contactors, connects the announce microphone and its set of amplifiers, and also lights red warning signals in the studio and control room. While the announcement is being made, the control man has grouped the amplifiers and pick-up devices for the first selection. After the announcement has been made, the announcer throws his key to the "concert" position, automatically disconnecting the announce microphone and connecting in the proper concert amplifiers and pick-up devices.

In the control room, the senior operator controls the grouping of the amplifiers and monitors the radio output. The assistant operator takes all readings for each selection and records them in the log and also checks the output of the amplifiers. A third operator keeps a six-hundred meter log and answers telephone calls. This operator also has control of a 1-kilowatt commercial transmitter adjusted for telegraph operation on 300 or 600 meters. This transmitting equipment is quite similar to the commercial transmitter previously described.

In case the pick-up device has been located incorrectly and the control men cannot compensate by any adjustment of the amplifying equipment, a small electric sign is lighted in the studio. This sign is located where it is not visible to the artist and indicates whether the location is wrong with respect to the soloist or the accompanist. It also indicates the general nature of the trouble. If possible, the studio manager then makes the necessary correction in location.

QUALITY

It has been indicated that a broadcasting station is good to just the extent that the output of the pick-up device represents the efforts of the artist. This assumes that the balance of the equipment when actuated by the output of the pick-up device does not introduce distortion. The distorting effects may be due to either the acceptance or suppression of a particular frequency or band of frequencies. For example, a unit might amplify some frequencies considerably better than others thus resulting in accentuating those particular frequencies. Distortion may also result from overloading some unit with the result that while faithful reproduction occurs, so long as an impulse does not exceed a certain amplitude, all impulses having amplitudes in excess of this limiting value are decreased correspondingly.

While these are but a few of the means whereby distortion may be introduced, they indicate the care required to obtain the high quality transmission necessary for a broadcasting equipment. The over-all frequency characteristic of WGY is shown in Figure 48. The dotted line represents the condition that

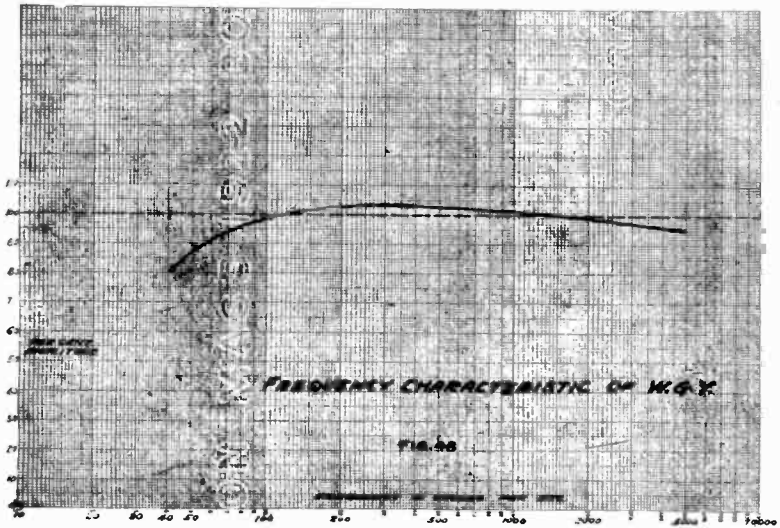

FIGURE 48—Over-all Frequency Characteristic of Transmitter at "WGY"

should exist for theoretically perfect transmission. The solid line indicates the actual frequency characteristic obtained. This characteristic was obtained by substituting a source of power for the pick-up device, hence any distortion due to the pick-up

is not considered. It should be noted that the essential frequency band (100 to 5,000 cycles) approximates very closely the ideal characteristic.

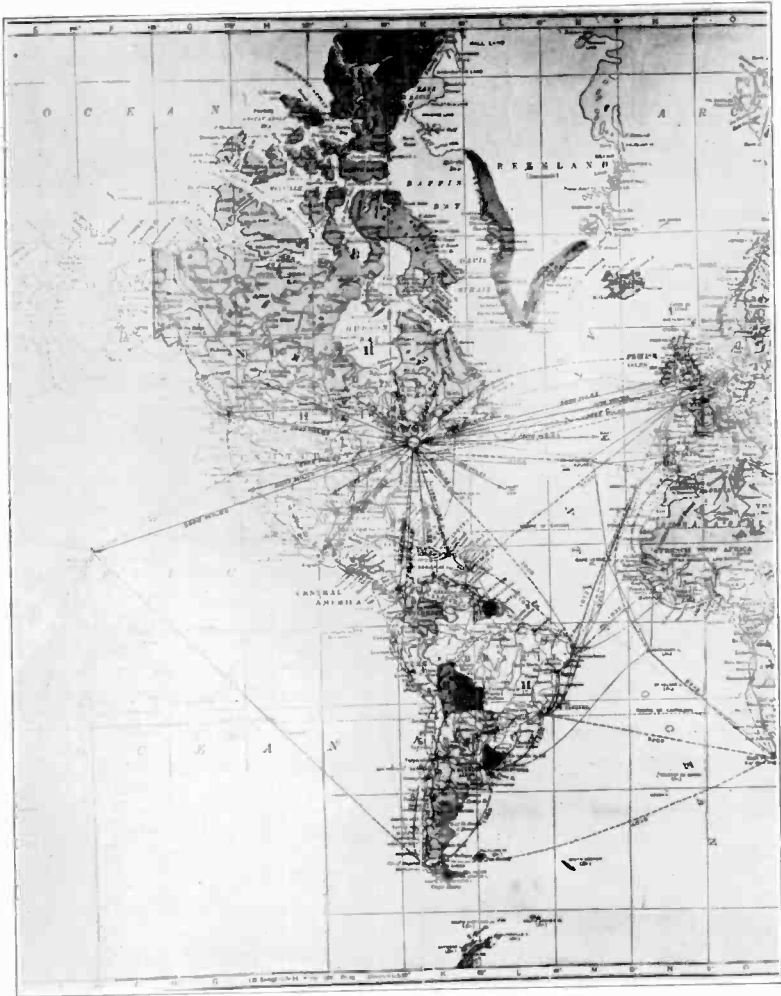

FIGURE 49—Record Ranges of Broadcasting Transmitter at "WGY"

RANGE

Probably the most indefinite factor of a broadcasting station is the range. Not only is the range affected by the usual conditions incident to radio transmission, but in broadcasting it is further complicated by the lack of a common basis of agreement for defining the term. In commercial work the range generally

indicates the distance over which commercial traffic can be handled satisfactorily. With broadcasting, the reception of even a small portion of a concert, or just sufficient information whereby the station may be identified, immediately establishes a new record.

It is nevertheless interesting to observe the distances that have been obtained. In Figure 49 is shown a map indicating some of the distant points from which reports of WGY have been received. In each case the report of the reception gave sufficient information to prove definitely that the writer had received an appreciable part of at least one program.

CONCLUSION

The preceding describes in a general way the present-day broadcasting equipment. That great improvements will be made is, of course, obvious. It must be remembered, however, that a considerable investment has already been made in transmitting stations. In addition, the thousands of receiving stations purchased primarily for broadcasting reception necessitate a very careful consideration of the economics of the entire situation before any changes in wave length or method of transmission can be justified if such changes would tend to make this receiving equipment obsolete.

SUMMARY: After a consideration of the points of similarity and of difference of commercial and broadcasting radio telephone transmitters, there are described the pick-up devices, amplifying equipment, transmitters, and control systems of a modern broadcasting station. The factors entering into the operation and performance of such a station are considered.

INTERFERENCE*

BY

ROBERT H. MARRIOTT

(RADIO AIDE, UNITED STATES NAVY YARD, BREMERTON, WASHINGTON)

Interference is an important problem in the theory and practice of radio, and recently it has become a larger and different problem.

Before radio left its shell of laboratory walls, interference was chiefly a theory. For when the experimental transmitter such as the Hertzian oscillator transmitter and the corresponding receiving loop were in the same room, there was usually but one transmitter operating, and the receiver was directional and too insensitive to be disturbed by other electromagnetic fields. But that was more than twenty-five years ago, and radio has changed so greatly now that a condition of lack of interference is chiefly a theory.

When radio first came out of the laboratory, interference was often an encouragement to those who struggled to make stations work. Their coherers responded to static and local electromagnetic fields, producing innumerable combinations of dots that were mistaken for messages. The recognition of this condition caused the coherer sets to be very thoroly screened by iron cases and was one of the causes of the change to the telephone receiver and detector method of reception.

In 1901, there was unintentional and intentional interference between radio stations in New York harbor. This was when the Marconi Company, the American Wireless Telephone and Telegraph Company, and the De Forest Company all tried to report the International Yacht Races at the same time. That was probably the first marked case of radio interference and the first radio interference fight in this country. It was an object lesson that proved the need for avoiding radio interference and interference fights, and caused experiments and development in tuning and in "etheric diplomacy."

*Received by the Editor, January 6, 1923. Presented before the Seattle Section of THE INSTITUTE OF RADIO ENGINEERS, January 6, 1923, and before THE INSTITUTE OF RADIO ENGINEERS, New York, May 2, 1923.

¹"United States Radio Development," page 192, PROCEEDINGS OF THE INSTITUTE OF RADIO ENGINEERS, volume 5, number 3.

Thru the "Era of Development of Demand for Radio Service"¹ ending in about 1911, interference between radio stations grew. Detectors were developed by listening to interference, and transmitter and receiver tuning was developed to avoid interference, and, as a further result, a portion of the law, effective in 1912 (with regulations), was made to prevent interference by regulating radio station wave lengths, decrements, classes of service, locations, and powers.

The uppermost thought at that time was to prevent interference with SOS calls first, and then to prevent interference with commercial and government telegrams. The result was that nearly all wave lengths were given up to commercial and government telegrams. It was soon recognized that the amateur wanted to play with radio, and he was given the 200 meter wave.

Since then it has been shown that the amateur's wave length is something more than a wholesome sport device that keeps him at home after dark. The amateur went in for a large quantity of audion receivers before the commercial companies and government and proved the worth of the audion. One of the amateurs, Mr. Edwin H. Armstrong worked with his audion bulbs and brought out the regenerative circuit, which started the greater strides in radio. The war came and showed that the amateur is a self-educated military radio force available for the army and navy. And he has shown that he has a self-acquired training that is useful to commercial companies. All of which has brought up the importance of amateur radio in comparison with government and commercial radio.

The audion and the regenerative audion developed into radio telephone broadcasting. The broadcasting was what the public wanted and they put in receivers to get it. They put in so many receivers that the number of government, commercial, and amateur receivers became small in comparison.

To-day when the question is asked as to whether radio stations interfere with others or not, the first thought is whether they interfere with broadcasting receivers, because broadcasting receivers have, by their great numbers, become so important a group of radio receivers.

Freedom from interference with distress calls must be considered as of the highest value. The value of commercial messages is proportionate to the price of the messages. The value of government messages probably can be determined. The value of amateur and broadcast receiving probably may be arrived at by estimating how much the owners have invested

and are investing in radio apparatus. The demand for interference-preventing devices and regulations should be proportionate to the values mentioned.

The government, commercial companies, and amateurs are organizations equipped to say what actually is the value of their receiving. If the value of broadcast receiving can be estimated, the relative value of the other kinds of receiving should be determinable automatically.

An accurate estimate of the public's investment in broadcast receiving apparatus is not possible. But if we wait for accurate estimates, we may endure some years of unnecessary lack of development and interference while we wait. Even if figures could be obtained from manufacturers and retailers, it soon becomes apparent that there are a large number of temporary manufacturers who never advertise, and there are many home-made sets. Odd machine shops mention the drilling of numerous large sheets of bakelite, cabinet makers tell of specially elaborate boxes made for radio sets, and there are stories of expensive receivers that have been built without buying much but vacuum tubes from the radio dealer.

Suppose as a convenient method of calculation that a city of 200,000 population is taken as a basis, and that the running expenses of the radio retailers are estimated by estimating their rents, cost of help, advertising, lost goods, bad accounts, and so on. One radio store may be found that has an expense of \$40 per day, one with a \$35 expense, another with a \$25 expense, another with a \$20 expense. Then there may be anything from department stores to laundry offices that are handling radio goods at an extra expense of from \$3 to \$15 per day. All of those found may total up to \$200 per day. If the retailers get one-third of the sale price, the several stores must sell \$600 worth of radio apparatus per day to pay their expenses, and the broadcast listeners of that city must be spending over \$500 of that per day for apparatus to get broadcast signals.

If it seems strange that the public of a city of 200,000 should spend \$500 per day for broadcast receiving, compare that sum with what they spend for printed broadcasts. They probably spend five times that amount for newspapers.

For convenience in figuring, and to be conservative, suppose that 200,000 people in 100 square miles (250 sq. km.), pay \$360 per day for their equipment to receive radio broadcast messages. That amounts to \$15 per hour or 25 cents per minute. Broadcast material is not available, and the broadcast listeners are not

near their instruments, except during a few hours per day, therefore the cost per minute is higher than 25 cents during certain hours and less at other times. In sparsely settled country, the value per minute may be relatively higher because the receivers may have to be more expensive to receive from longer distance or the broadcast time may be shorter or broadcast may supply the only rapid news service. On this basis, a price table may be made for different densities of population and different times of the broadcaster's day. The following chart is an example:

VALUE OF TIME TO BROADCAST LISTENERS
VALUE PER MINTUE FROM

Persons in 100 Square Mile Area	7	5	10	11	12	1	7	8	12	1
	to 10 P. M.	to 7 P. M.	to 11 P. M.	P. M. to 12	to 1 A. M.	to 7 A. M.	to 8 A. M.	A. M. to Noon	to 1 P. M.	to 5 P. M.
	\$	\$	\$	\$	\$	\$	\$	\$	\$	\$
5,000,000	25.00	15.00	10.00	5.00	1.00	0	0.25	3.00	5.00	3.00
1,000,000	5.00	3.00	2.00	1.00	0.15	0	0.05	0.50	1.00	0.50
500,000	2.50	1.50	1.00	0.50	0.10	0	0.25	0.50	0.25
200,000	1.00	0.60	0.40	0.20	0.05	0	0.10	0.20	0.10
100,000	0.50	0.30	0.20	0.10	0	0.15	0.10	0.05
50,000	0.25	0.15	0.10	0.05	0	0.05
25,000	0.15	0.10	0.05	0
10,000	0.05	0.03	0.01	0
5,000	0.05	0.01	0

Such a table is useful in considering radio problems of the present time, for example:

A telegram-handling radio station doing a business of \$25 per day or 2 cents per minute cannot be expected to survive if it interferes during the period when the broadcast listeners' time is worth many times that amount.

OBSERVED AND REPORTED INTERFERENCE

To find out what is interfering with the public, it is necessary to communicate more or less directly with the public. This was done particularly in Seattle, Washington, by making observations and inquiries, by giving out typewritten questionnaires, and thru the printed columns and radiophone broadcasts of the Seattle "Post-Intelligencer."

On Sunday, November 12, 1922, the Seattle "Post-Intelligencer," which has a Sunday circulation of about 140,000, printed an article which was preceded and followed for several days by broadcasting. The wording of the article and broadcasts was about as follows:

“What Interferes With Receiving The Post-Intelligencer Broadcast

“The Post-Intelligencer and R. H. Marriott, Naval Radio Aide are trying to find out what are the worst sources of interference with the receiving of the Post-Intelligencer broadcasts. The purpose is to find ways of reducing or eliminating these interferences.

“Following is a list of interferences which have been noted. Please put a number “one” beside the interference that bothers you most and a number “two” beside the next worst interference, and so on thru the list. Also please write any additional interferences or remarks, and your name and address on a piece of paper and attach it to the marked clipping and mail them to the Radio Editor of the Post-Intelligencer. The address of the place where you receive the broadcasts is the one which will aid us in finding the zones of different kinds of interferences.”

Sources of Interference

- Seattle Radio Station, KPE.
- Navy Radio Station at Seattle, NVL.
- Navy Spark Station at Keyport.
- Navy Arc Station at Keyport.
- Station at
- Amateur Spark Station at
- Amateur C. W. Station at
- Broadcast Station at
- Leaky insulators on high voltage power line.
- Hum from light circuits.
- Electric Elevators.
- Street Cars.
- Milwaukee Electric Trains.
- Telephone Ringing Circuits.
- Wire Telegraph Lines.
- Factory Motors.
- Regenerative receivers belonging to neighbors.
- Annunciator systems.
- Neighbors tuning, or connecting and disconnecting their receivers.
- Switching lights on and off.
- Static.

These reports or copies of them will be turned over to Mr. Marriott. Mr. Marriott as Naval Radio Aide, a director of THE INSTITUTE OF RADIO ENGINEERS, and a member of several engineering and scientific societies, is in a position to co-operate with you thru the “Post-Intelligencer” for the reduction of interference.

As some interference can be reduced or eliminated at the receiver, it will be desirable for you to include a brief statement or sketch of the kind of receiver and antenna you have and how loudly you get the Post-Intelligencer.”

Seattle radio station KPE apparently took first place as a producer of interference for broadcast listeners and amateurs.

It is located at Pier Number 1, not far from the center of population of Seattle, and is a spark station operated by the Port Warden's office of the city of Seattle. The caustic remarks and more or less specific statements about that station indicated the new condition which may be anticipated because of universal public receiving.

There was a tendency to question the need for such a station, and the wisdom of its location and choice of wave length. There were some specific statements to the effect that the station transmitted unnecessarily, and specific statements that the station frequently called NVL, the Naval station five blocks away, and frequently worked with that station altho both stations have wire telephone connections.

NVL, the Naval spark station located in the L. C. Smith Building, and also near the center of the Seattle population, was not complained of quite so much, yet KPE and NVL were spoken of in much the same terms.

Another indication of the trend of the situation is that it seems the broadcast listeners at first blamed nearly all of their interference on the amateurs, and particularly the interference from KPE and NVL. But now the amateurs have largely changed to continuous wave operation, and have apparently more or less advised the public as to where the actual interference comes from.

With these two stations as they are, and broadcasting as it is, they probably will always interfere with amateurs and broadcast listeners if either of these two stations work any time between 10:30 A.M. and 1:00 A.M., and will cause a maximum of irritation by working between 5:30 P.M. and 11:00 P.M.

The Naval spark station at Keyport, about ten miles (16 km.) from the western waterfront of Seattle, is farther away from all parts of Seattle and operates on longer wave lengths. Only one person mentioned interference from this station. He was an amateur living in the part of Seattle nearest to Keyport.

The Navy arc station at Keyport produced harmonics. These harmonics, when summed up in the usual types of receivers, produce what is called "mush."² In special receivers built

² "Mush" in Ohio means a mixture of corn meal and water. "Mush" in the Northwest may mean any kind of breakfast food, usually rolled oats. "Mush" in Alaska means something like "move-along." Some people say "Mush" to dogs when they mean "Sit down" or "Lie down." Ohio mush mixed and fried in Pennsylvania with pork scraps produces what is called "Scrapel." "Scrapel" may be a better name than "mush" for scrambled harmonics.—R. H. M.

Mr. Marriott's search for a sufficiently expressive term for harmonic emissions is significant of the seriousness of the problem.—EDITOR.

for finding them, each harmonic "whistles" or "squeals" like any other continuous wave beat.

The Keyport arc harmonics damaged the quality of local broadcast receiving in some parts of Seattle and interfered materially with long distance broadcast and amateur receiving.

From November 22, 1922 to November 28th, an experimental harmonic reducing circuit was put into operation at Keyport while handling the regular station traffic. A special schedule, sending "V's" was operated on Sunday, November 26th, from 10:30 A.M. to 11:00 A.M., and from 2:30 P.M. to 3:00 P.M. The public was advised of this thru the columns and broadcasts of the "Post-Intelligencer," and volunteer observers were notified by mail asking all to report. The reports were to the effect that the harmonics did not interfere, altho some harmonics could be found with sensitive receivers. These reports agreed with our findings at three observing stations on three kinds of antennas, nine miles (14 km.) from Keyport.

To avoid the crowded arrangement at Keyport, an upper floor was built, and the experimental apparatus more substantially rebuilt and operated on regular traffic from December 5th to 13th. This apparently reduced the harmonics still further.

Another experimental arrangement was put into operation on the night of December 14th. This arrangement apparently gives still greater efficiency and practically eliminates twenty-five or more of the objectionable harmonics. Apparently the Keyport station no longer interfered with the reception of any wave lengths below 1,000 meters when the receiving station was located nine miles (14 km.) or more from Keyport. We are now working on a revision of this circuit. It is possible that the harmonics may be eliminated above 1,000 meters, leaving only the 5,400 meter fundamental.

When changes are made in experimental harmonic reducers, another ordinary arc is used at Keyport and this brings in reports of harmonic interference. Lack of space and limited appropriations may make it necessary to use this ordinary arc at times when the arc equipped with harmonic reducing circuits requires repairs.

Obtaining information thru the printed and spoken broadcasts of the "Post-Intelligencer" indicated how far-reaching such broadcasts are. A man living about seven hundred miles (1,120 km.) from Seattle, in the United States, reported that receiving

local broadcasts was interfered with and long distance broadcasts eliminated when an arc station in his vicinity was operated.

The amateur spark stations have been changing to continuous waves stations. The amateurs get together. They form clubs and quarrel, and form new clubs. There must have been fifteen such clubs in a series in Seattle in the last seven years. But they keep on getting together and their average performance creates co-operation which differs from that of any other class of radio users.

The continuous wave and interrupted continuous wave amateur stations seem to be a decided improvement over the spark stations. However, some of them produce energy on such wave lengths as 400 meters and interfere with broadcast listeners. And dot-dash c. w. (continuous wave), or modulated c. w. or i. c. w. is not c. w.; it is between the spark set and c. w. set in effect, so far as tuning out is concerned. Also the use of partially rectified alternating current for the plate circuit seems to have been the cause of some interference. And the amateur wave length is so close to the broadcasting wave length that a great deal of interference results, especially when the amateur is a close neighbor.

A 5-watt c. w. telephone and telegraph station, about 600 feet (180 m.) from a broadcast receiving station spoiled all broadcast receiving. It came in more loudly with broadcast receiver set to 400 meters than when adjusted to 200 meters.

The broadcast stations in Seattle apparently were well enough scheduled as to time, so that they seldom interfered with one another. They do, of course, prevent receiving distant broadcast stations if such local stations are nearby and on nearly the same wave length.

They, too, were reported for producing harmonics on 180 to 200 meters, which interfered with amateur receiving. It may be mentioned that we had difficulty in some cases in finding harmonics from the Keyport arc station because they were drowned out or broken up by the fundamental and harmonics from a broadcasting station.

Leaking insulators on high voltage power lines produce interference. Fifty to one-hundred-thousand volt overhead wires are not uncommon in this country. Altho the annual rain fall near Seattle is only about thirty-four inches (86 cm.), most of the rain falls slowly and continuously, especially during the winter. The high voltage discharges over the wet insulators in a mild or violent manner depending on the amount of water on them, the

voltage, and the size and quality of the insulators. Similar buzzes or crashing sounds can be heard in the broadcast receivers. When a 60,000 volt line is within two hundred feet (60 m.), it may sometimes render unintelligible a broadcast from a 50-watt station located ten miles (16 km.) away.

The operators of high tension lines use lighting arresters which they charge at certain times each day. One company charges its arresters at about 9:00 P.M., producing three long loud crashes that wipe out part of what is sometimes the best broadcast reception of the day.

The hum from electric light circuits is annoying in many cases where the house wiring is not in iron conduit, and particularly where the two sides of the light circuit do not run along together, and thus make a "loop transmitter" with 60-cycle induction. In some cases, the radio receivers or antenna are placed more closely than necessary to the wiring of other circuits.

In one case it was noted that street car circuit interference was very bad when the cars were within a few hundred feet (a hundred meters), and objectionable when they were within a half mile (0.8 km.).

Telephone ringing produces interference in many cases. Switching lights on and off produces clicks. Wire telegraph lines and annunciator systems produce interference at some locations. Motors and generators sometimes create interference.

Neighbors tuning, or connecting and disconnecting receivers have an effect, but usually it is only apparent as a slight change in strength or quality of the received broadcast. X-ray equipments occasionally produce interference over a distance of from a few hundred feet (about 100 meters) to a mile (1.6 km.) or more.

Regenerative receivers belonging to neighbors are usually close-by transmitters that cause a great deal of interference. Sometimes, when they are of the so-called three circuit type (three separate windings), they do not transmit so much. When they use a radio frequency amplifier ahead of the regenerative circuits, they may not transmit interference. In some cases, when the neighbors use one or two radio frequency amplifiers and not the usual regenerative arrangement, the radio amplifiers regenerate and transmit some interference. Careful receiving operators, who use the receiver in a regenerating condition just long enough to pick up the whistle of the broadcasting station they are after, sometimes cause considerable interference if they fail to get that station on the first trial.

Static in the vicinity of Seattle is much milder than in other

parts of the United States. Thunder storms are not so frequent as in other parts of the country. For local broadcasts, static seems to have been a minor interference in Seattle during the summer of 1922. For receiving long distance broadcasts, it interfered quite decidedly at times.

SUGGESTIONS FOR REDUCING INTERFERENCE

Now that a suggested method for measuring the interference to broadcast listeners has been proposed, using the dollar as the unit for measurement, and since various sorts of interference have been outlined, the next step would seem to be to suggest ways and means for reducing the interference. Some reduction has been made while the material for this paper was being gathered, particularly in connection with the arc harmonics from Keyport. This reduction of arc harmonics may be some compensation to the public, and indirectly to the "Post-Intelligencer," for their help in gathering data on the subject.

Human beings have to do with the production of all the interference noted above, except static. Static is not affected by a dollar argument,—it is non-human.

Static, and such interference as fellow humans cannot be persuaded to discontinue, can be decreased and sometimes eliminated at the receiver. Screening, directional antennas, and tuning may be used as fortifications against such interference.

Putting all building circuits in continuous and well grounded iron conduit screens off a large part of the interference from these circuits. Putting all of the receiving apparatus, except the antenna and control handles, in a grounded sheet or screen metal box decreases local disturbances.

An ordinary antenna in combination with a rotatable loop antenna may be used to reduce or eliminate interference from any one direction. This arrangement has been occasionally described in print. It is especially fully discussed by Mr. G. W. Pickard and others in a recent paper.³ While this paper describes static chiefly on long waves and in connection with its elimination, thereby finding the direction of the static source, it is usable for short waves in cutting out undesired stations and other interferences. The loop alone is useful in cutting out interference. However, to use the loop, usually requires more amplifiers than for an ordinary antenna. For accurate directional work using both antenna and loop, a very small ordinary antenna serves

³ "Static Elimination by Directional Reception," by G. W. Pickard, PROCEEDINGS OF THE INSTITUTE OF RADIO ENGINEERS, volume 8, number 5.

best to balance the loop. However, a large ordinary antenna can be used by employing loose coupling when balancing. The balanced arrangement decreases the interference and makes the signals about twice as strong as with the loop alone. By increasing the coupling, the signals can be made about as strong as by using the ordinary antenna alone or even stronger, and the disturbance is usually somewhat weaker than with the antenna alone. If the disturbance is from a source in about the same direction as the source of the desired broadcast, the directional arrangement is of little value. The short waves used at present and lack of space for revolving loops make uni-directional arrangements more or less impractical. However, it is quite possible that longer waves will be used and that future houses will be designed to accommodate larger radio equipment. Using the loop alone in local broadcasts apparently often gives a pleasant reduction of interference. The loop does not pick up so much interference from sources at right angles to it.

Using the ordinary antenna, combined with the loop tuned to over 1,000 meters, for uni-directional effects, at two points simultaneously (Astoria and Bremerton), the triangulation results obtained in 1920 indicated Mt. Rainier as the chief static center in this section. One year's daily observations at Bremerton and observations at a point east of Ketchikan, Alaska, also indicated Mt. Rainier as the chief static center for this locality.

Tuning in the receiving instrument reduces some kinds of interference. Tuning arrangements are repeatedly described in publications. Thus, Mr. Frank Conrad has recently described tuning in a somewhat different manner using a simple single coil and regenerative feed back.⁴

Some of the interference of human origin can be corrected by simply notifying the management of whatever organization is operating the interfering device. The management may not know about it or may not want to make a change without specific complaints on which to base the action. And the actual operator may not be in a position either to correct the situation or tell the management about it. For example, the charging of the lighting arresters by the power company at 9:00 P.M. might be changed to 6:00 A.M. if somebody wrote to the General Manager of the power company.

Harmonics and poor transmission from broadcast stations will probably be eliminated by those broadcasters who find that

⁴ "Radio Receiving Equipment," by Frank Conrad, PROCEEDINGS OF THE INSTITUTE OF RADIO ENGINEERS, volume 10, number 6.

they are succeeding. They will eliminate their weak points to become more successful. Therefore the solution seems to be to encourage the broadcasters that have the natural attributes for success. For example, the newspapers should be one industry that is naturally fitted to succeed because newspapers always have been broadcasters of printed words. They know what the public wants and have facilities to get what the public wants. And their oral broadcasting can augment their printed broadcast and vice versa.

Some of the interference from radio stations can also be corrected by notifying the management. For example, one of the rumors encountered when asking for data on the interference situation, was to the effect that one influential man was having operators copy the traffic sent by the Seattle radio station. If he does that, and the copies and logs show any amount of obviously unnecessary sending on the part of that station, then turning copies over to the mayor or council with an explanation of the obviously unnecessary interference should produce results. It would be beneficial also if such observers would supply the local Radio Inspector of the Department of Commerce with a copy. If the law is not being violated, the Radio Inspector cannot do anything now, for it appears that a great amount of unnecessary interference can exist under the present law and regulations. But if the Department of Commerce has evidence showing the existence of such unnecessary interference, the Department will know what kind of laws to ask from Congress. Furthermore, if the observer were to send a copy of his records and a letter asking for better radio laws to his Senator and Representative, it should help in causing Congress to pay attention to the subject. The more letters and reports of radio interference sent to Congressmen, the sooner they will act. And changes in laws and regulations seem to be of primary importance to reduce interference.

Reports of interference by the Navy may be sent to the Secretary of the Navy at Washington or the Commandant of the Naval District in which the interfering station is located. Interference by a commercial station can be reported to the manager of the operating company. Interference by amateurs can be reported to the amateur or the local amateur club. In all cases, copies should help if sent to the local radio inspector or the Department of Commerce at Washington and to Congressmen at Washington.

By deciding on a standard measure of value for the use of

the ether, and by providing working charts for zones of population, kinds of service, wave length, and time, it should be possible to make laws and regulations that can be used with the charts to prevent interference.

It appears that telegram handling stations could:

- (a) Schedule a considerable portion of their traffic for the time between 1:00 A.M. and 7:00 A.M.
- (b) Use stations that are not near a large center of population.
- (c) Put their overland business on the wires.
- (d) Employ operators who get traffic thru without repeating.
- (e) Change spark sets to continuous wave sets.
- (f) Eliminate harmonics.

If these things are feasible, they should be required by a new law.

The new law should provide for many things; for example: that a receiving station be a receiving station and not a transmitter of continuous waves as it is when the tickler regenerates into the antenna. And very careful law-making attention is apparently necessary in considering the amateur and broadcast listener.

The amateur and the broadcast listener are neighbors, neighbors in wave lengths and in their homes. When the amateur transmits, he is an undesirable neighbor. One solution would be for somebody to move, but apparently there is no neighborhood that is not occupied by broadcast listeners or amateurs (or soon there will be no such neighborhood).

For one or the other to move to another neighborhood of wave lengths has objectionable features, but it seems to be the most practical thing to do.

There are those who suggest that the amateur should keep still all of the time or at least during broadcast periods. That will not do because amateur operating has proved its value, and the most practical time for the amateur to work is between dark and a healthy bed time hour, which period is also the most practical time for the greatest number of broadcast receivers to listen.

The amateur has proved his worth to the government and to commercial radio, and therefore it seems that the government and commercial interests should give up an ample wave length range into which broadcasting can move.

It seems that quite a number of longer wave lengths should be set apart for broadcasting, so that it will be possible to listen

to a distant station when local stations are working and so that different kinds of broadcasting can be picked up on different wave lengths. Also provision probably should be made for the possibility that one central high power station may broadcast excellent programs which will be picked up, relayed, and re-broadcasted at numerous points.

December 27, 1922.

SUMMARY: A brief history of the development of interference with radio receiving is outlined. The present change in the interference problems caused by the number of broadcast listeners is discussed. The suggestion is made that each kind of radio service be given a value in dollars and cents as a basis for eliminating interference. Estimates are made, and a charge submitted showing the per minute value of freedom from interference, to broadcast listeners, according to the population and time of day. Various sorts of interference to broadcast listeners are listed and described. Suggestions are offered for eliminating or reducing interference.

DISCUSSION

John R. Tolmie: I believe it is argued abroad by manufacturers of quenched gap transmitters that such transmitters when well constructed compare favorably with, or are superior to, tube transmitters. Is it known whether they are advancing such an argument in this country?

Robert H. Marriott: So far as I know, the foreign quenched gap manufacturers are not prominently represented in this country at present. On what do they base their claims?

John R. Tolmie: Part of their argument is that the tube transmitters cause about as much interference as do quenched gap transmitters.

Albert Kalin: Makers of tube transmitters want to get the most out of them at smallest cost, and in doing this they produce arrangements that transmit harmonics and other interferences.

T. M. Libby: Cannot the tube transmitter produce good efficiency without using grid bias and couplings that result in such interference?

Albert Kalin: They can approach a theoretical 50 percent efficiency, but they want a higher efficiency and endeavor to get it by producing sharp pulses in the plate circuit.

Robert H. Marriott: It seems that efficiency as a whole should be based more on lack of interference than it is at present.

John R. Tolmie: Beat receivers cause a great deal of the interference.

Howard F. Mason: So many listeners listening for long distance cause a lot of interference. Broadcasting stations have experimental licenses to be used for testing, and they use those licenses to call up each other over long distances. Then, too, broadcast listeners make their receivers oscillate to pick up those broadcasting stations so that they can listen in and hear what the broadcasting stations say to each other.

ON SUPER-REGENERATION*

BY

E. O. HULBURT

(UNIVERSITY OF IOWA, IOWA CITY, IOWA)

The Armstrong super-regenerative circuit consists of the usual regenerative system, obtained by coupling the plate and grid circuits, with the addition of a local variation of relatively low frequency which is impressed either directly or indirectly on the grid. The explanation of the action of this system, set forth clearly by Armstrong,¹ may be given briefly as follows: In the absence of the low frequency variation the circuit would oscillate spontaneously at a radio frequency which is tuned to be either exactly or closely that of the incoming signal. The low frequency variation, however, introduces periodically a negative and a positive resistance into the radio oscillatory circuit and is found either to prevent the radio frequency oscillation entirely or to reduce it to a negligible value. In the presence of a signal the radio oscillation begins when the resistance arrives at a negative value, and during the interval that the resistance is negative builds up rapidly by regenerative action until a relatively great amplitude is attained. It is only prevented from reaching amplitudes sufficient to defeat the action of the circuit by the reversal of sign of the resistance. During the interval that the resistance is positive the radio frequency oscillation is reduced rapidly to zero, and then when the resistance becomes negative once more the amplifying action is repeated.

It has been pointed out by others that the expressions "negative resistance" and "positive resistance" do not perhaps afford a clear idea of the action in the circuit altho their general meaning is unquestionably correct. A more precise description of the action might be obtained by considering that the effect of the low frequency variation is to shift periodically the operating value of the grid potential so that the characteristics of the tube change periodically, at one moment the characteristics being such that the circuit is free to oscillate, corresponding to the negative resistance case, and at another moment being such as to prevent oscillation, corresponding to the positive resistance case.

A simple mathematical analysis brings out some essential

* Received by the Editor, February 21, 1923.

¹ PROCEEDINGS OF THE INSTITUTE OF RADIO ENGINEERS, volume 10, page 244, 1922.

features of the super-regenerative action.

Let f be the frequency of the signal and of the radio frequency regenerative circuit, and let F be the frequency of the low frequency variation. For simplicity we shall assume that the variable resistance drops sharply to a finite negative value and remains there for an interval of time $1/\beta F$, where β is a number greater than 2. This assumption, of course, is not a statement of the actual case, for in reality the resistance both descends to the negative region and ascends therefrom as a continuous function. However, by the introduction of the multiplying factor β , the rather complicated action which really takes place may be represented in the theoretical way just mentioned. We denote by e_1 , the grid voltage caused by the signal at the beginning of the time interval $1/\beta F$. Because of regenerative action, the grid voltage will increase rapidly according to an exponential law, which is the usual expression for this type of cumulative action. We may then write

$$e = e_1 \varepsilon^{kft},$$

where e is the value of the grid voltage at the time t and k is the constant of regeneration. k also contains the factor 2π resulting from defining f as a frequency. The average value E_1 of e over the interval $1/\beta F$ is given by

$$E_1 = \beta F \int_0^{\frac{1}{\beta F}} e_1 \varepsilon^{kft} dt = e_1 \frac{\beta F}{kf} \left(\varepsilon^{\frac{kf}{\beta F}} - 1 \right). \quad (1)$$

For a second signal which produces a grid voltage e_2 , and which differs from the signal corresponding to e_1 only in intensity, the average value E_2 of the amplified grid voltage is such that

$$E_2 = e_2 \frac{\beta F}{kf} \left(\varepsilon^{\frac{kf}{\beta F}} - 1 \right).$$

Then

$$\frac{E_1}{E_2} = \frac{e_1}{e_2}.$$

This shows that the amplification produces no distortion. This is in agreement with observation, for it is known that the super-regenerative system amplifies radio telephone signals without distortion.

The influence of the frequency of the resistance variation also appears from equation (1). Suppose that the same signal is amplified by super-regeneration using resistance variation frequencies F' and F'' , which give rise to amplified average grid voltages E' and E'' , respectively. Then, if other factors are considered constant in the two cases,

$$\frac{E'}{E''} = \frac{F' \frac{\varepsilon^{\frac{kf}{\beta F'}} - 1}{\beta F'}}{F'' \frac{\varepsilon^{\frac{kf}{\beta F''}} - 1}{\beta F''}}.$$

Since $k f / \beta F$ is a quantity much greater than unity, for if it were not the super-regenerative circuit would not amplify, this expression reduces approximately to

$$\frac{E'}{E''} = \frac{F'}{F''} \varepsilon^{\frac{k f}{\beta} \left(\frac{1}{F'} - \frac{1}{F''} \right)}. \quad (2)$$

In the usual detector action the rectified component of the plate current corresponding to an impressed grid voltage is, to a first approximation, directly proportional to the square of the impressed grid voltage. The intensity of the sound heard in the telephones is directly proportional to the square of the rectified plate current. Therefore, the intensity of the sound is directly proportional to the fourth power of the impressed grid voltage. Denoting the sound intensity by I' and I'' for the two cases under consideration we have from (2)

$$\frac{I'}{I''} = \left\{ \frac{F'}{F''} \varepsilon^{\frac{k f}{\beta} \left(\frac{1}{F'} - \frac{1}{F''} \right)} \right\}^4.$$

From this we may expect the intensity of the signal heard in the telephones to increase very rapidly as the frequency of the resistance variation is decreased. A similar argument may be followed out in the case of the signal frequency, and the conclusion reached that, other things being equal, the intensity of the signal heard in the telephones increases in a marked manner as the signal frequency is increased. These conclusions are in accord with qualitative observation.

In spite of the numerous simplifications and variations of Armstrong's super-regenerative circuits which have been published (see, for example, recent numbers of "QST"), the author ventures to draw attention to the circuits of Figures 1 and 2. These systems were found very useful for a laboratory or class demonstration, being simple to assemble and operate and appearing to retain the amplification and selectivity characteristic of the more elaborate super-regenerative systems. The circuit of Figure 1 was the usual radio frequency regenerative receiver circuit with the addition of the low frequency circuit $L_4 C_4$. The air condensers C_2 , C_3 , and C_4 were each variable from 20 to 1,000 $\mu\mu\text{f}$. The cylindrical coils L_2 and L_3 , 17 cm. (6.7 inches) in diameter, each consisted of 22 turns of wire. L_2 was a honey-comb coil of 1,250 turns and of inductance about 0.1 henry. This arrangement was effective in receiving outside signals. The circuit of Figure 2 was a simple oscillatory circuit with the low frequency circuit $L_3 C_3$ introduced into the filament connection. C_2 and C_3 were air condensers variable from 20 to 1,000 $\mu\mu\text{f}$, and the coils L_1 and L_2 were each of 15 turns of wire on a cylindrical

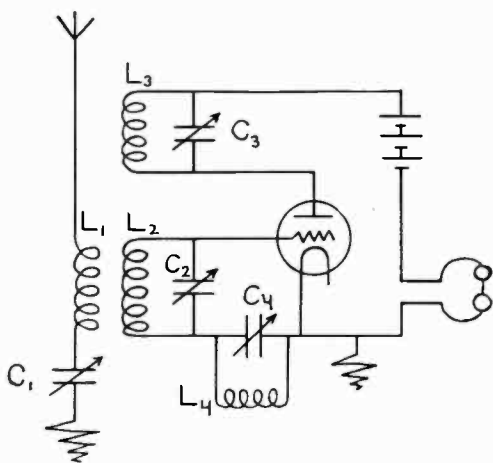

FIGURE 1

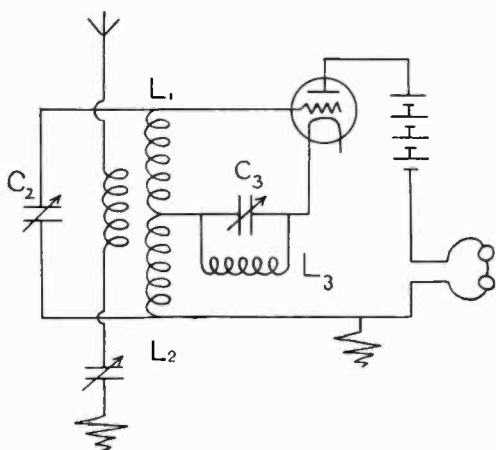

FIGURE 2

form 17 cm. (6.7 inches) in diameter. L_3 was the honeycomb coil of Figure 1. This circuit was interesting rather for its simplicity than for its usefulness as a receiver of signals.

Physical Laboratory,
University of Iowa,
February, 1923

SUMMARY: A simple mathematical analysis of super-regeneration yields conclusions, in accordance with observation, that the super-regenerative system amplifies without distortion and that the amplification increases with increase of signal frequency and with decrease of variation frequency.

Two single tube super-regenerative circuits, interesting because of their simplicity, are described.

LOOP UNI-DIRECTIONAL RECEIVING CIRCUITS FOR THE DETERMINATION OF THE DIRECTION OF ATMOSPHERIC DISTURBANCES*

BY

L. W. AUSTIN

(UNITED STATES NAVAL RADIO RESEARCH LABORATORY, WASHINGTON, D. C.)

(*Communication from the International Union of Scientific Radio
Telegraphy*)

(*American Section*)

The swinging frame or loop of 15 turns, 30 ft. (9.15 m.) long, 8 ft. (2.44 m.) high and 4.5 inches (11.9 cm.) spacing is shown in Figure 1, while the circuits used are shown in Figure 2. The

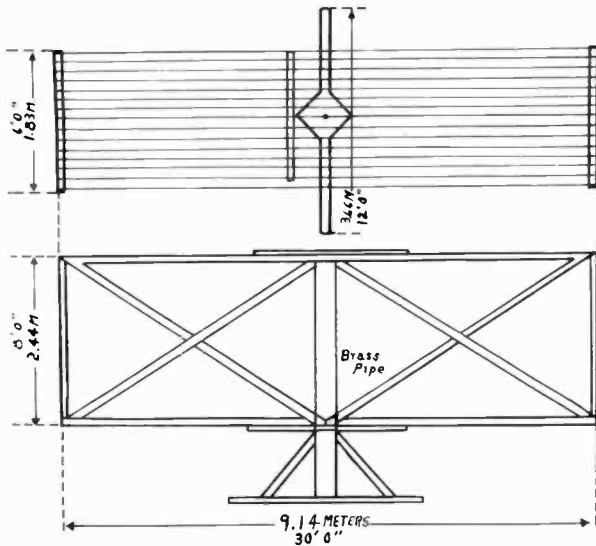

FIGURE 1

parallel tuned circuit in the antenna simplifies the tuning of long waves on the small antenna and also seems to give a better balance than is obtainable with series tuning. The resistance R_1 ,

*Received by the Editor, March 30, 1923.

5,000 to 50,000 ohms, serves to reduce signal strength on the antenna to approximately that of the loop, while R_2 , 200 to 1,000 ohms, broadens the tune and enables the coupling to be changed without a too rapid shift of phase, thus rendering a complete balance easy. The balancing antenna used at different stations

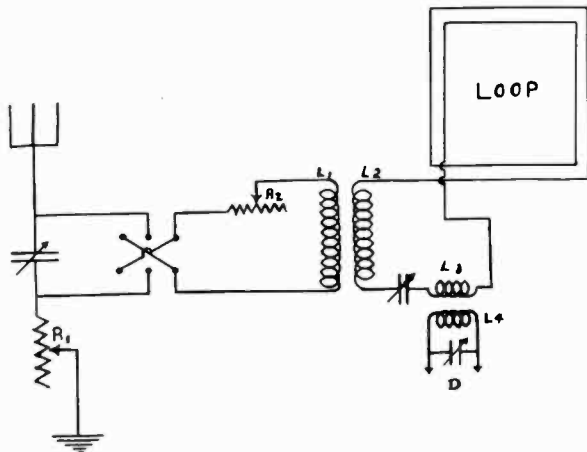

FIGURE 2

varied considerably in size. A single wire 100 ft. (30.4 m.) long and 30 to 50 ft. (9.15 to 15.5 m.) high was found to be satisfactory. The arrangement of coupling between the antenna and loop, as shown in Figure 2, renders the loop uni-directional. With the switch S in one position, signals are received from one side while those from the opposite are cut off, while with the switch reversed, signals are received only from the opposite side. Similar uni-directional combinations can be made between an antenna and a pair of underwater or underground wires, or in fact, between any ordinary antenna and any type of directional collector.

For the determination of static direction, the loop is turned and the coupling $L_1 L_2$ adjusted so that when the switch S is thrown in one direction the static is a maximum, while with the switch in the opposite direction, it is a minimum. The absolute direction in which the signals are strengthened and weakened with the switch in a certain direction is best determined by observations on a station in a known direction. When this is determined, it is advisable to place a mark on one side of the loop corresponding to a mark on the switch, to indicate the signals from this side of the loop are strengthened with the switch in the marked position. When the general direction of the static

has been determined as described, the loop is turned approximately at right angles to the indicated direction of the static. Then the switch *S* is rapidly reversed, the loop at the same time being moved slowly until the position is obtained where the sound of the static on the telephones is of the same intensity with the switch in its two positions. For exact readings the position of the loop expressed in degrees should be observed at which a difference in the intensity of the static is just detectable on each side of the zone of equality. In the mean position between these two points, the loop is exactly at right angles to the static. This method of determining static direction is far more accurate than that of the simple unbalanced loop (radio compass). In fact, good readings can be obtained by the balanced method when no difference at all in intensity can be observed with the simple loop.

If a loop of the size described is not found practicable, a smaller one can be used provided the number of turns is increased so that the product (area of loop) \times (number of turns) remains practically constant.

SUMMARY: A balanced loop and vertical antenna method of determining the direction of incoming atmospheric disturbances is described.

STANDARDS OF CAPACITY PARTICULARLY FOR RADIO FREQUENCY CURRENTS*

BY

J. B. DEMPSTER AND E. O. HULBURT

(DEPARTMENT OF PHYSICS, UNIVERSITY OF IOWA, IOWA CITY)

An investigation has been made of condensers which may be used for currents of radio frequency (as well as of other frequencies), and the capacity of which may be calculated with precision from the dimensions. In 1906, the late Lord Rayleigh¹ suggested a method of making and using a condenser which would enable all errors due to end and lead-wire capacities to be avoided. The principle was essentially that of the variable condenser of Maxwell² and required an adjustable condenser so constructed that altho its total capacity was unknown the increase in capacity was accurately known.

In the present instance, Rayleigh's suggestion has been adopted with some slight modification for measurements with radio frequency currents. A condenser of two coaxial cylinders was made according to the diagram of Figure 1. The two end pieces *A* consisted of cylindrical cups of brass about 7 cm. (2.76 in.) in length, each with an interior cup of brass held rigidly and accurately centered in the external cup by means of the insulating ring *b* and post *d* of hard rubber. The brass collars *a* and discs *c* served to keep the cylinders circular in cross section. The ends *A* fitted on to the section *B* which consisted of an interior and exterior cylinder of brass. The cylinders were held in place only by the ends *A*. The mean inner radius of the outer cylinder was 4.9232 cm. (1.93 in.) and the mean outer radius of the inner cylinder was 4.1326 cm. (1.63 in.). Connection was made to the inner cylinder by means of a brass rod *e* insulated from the outer cylinder. The capacity of the condenser with section *B* in place was measured in arbitrary units on the scale of a variable air condenser. Section *B* was then removed, the ends *A* were fitted together and the capacity of the condenser, which was composed

*Received by the Editor, May 28, 1923.

¹"Philosophical Magazine," 12, 97, 1906.

²"Electricity and Magnetism," section 127

only of the ends *A*, was recorded on the variable condenser. The difference in the two readings was exactly the capacity of section *B* given by the formula.

$$C = \frac{k l}{2 \log_e \frac{r_2}{r_1}},$$

where r_2 and r_1 are the radii of the external and internal cylinders, respectively, k is the dielectric constant of the medium, and l is the length of the section. In the present case k was unity, for air was between the condenser plates. Three sections were made to be placed at *B*, their lengths being 31.560, 15.780, and 7.890 cm. (12.4, 6.2, and 3.1 in.), so that the respective capacities were 100, 50, and 25 micromicrofarads. Any of these, either alone or in combination with the others, could be fitted between the ends *A*.

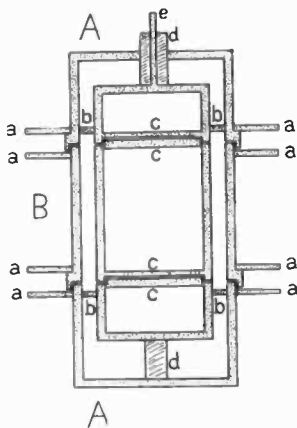

FIGURE 1

No standard condensers were at hand with which these could be compared. Measurements of the capacities by means of resonant circuits supplied with undamped radio frequency current showed that the 100 $\mu\mu\text{f}$. section was equal to four times the 25 $\mu\mu\text{f}$. section and to twice the 50 $\mu\mu\text{f}$. section within the error of observation which was less than 0.2 $\mu\mu\text{f}$. Currents of frequencies corresponding to wave-lengths of 600 meters and 300 meters gave the same results. This was considered to be a decisive and complete verification that the absolute values of the capacities of the sections were what they were designed to be and that the condensers could be used with confidence with alternating current measurements. A photograph of the standard condenser is shown in Figure 2.

Lord Rayleigh recorded no measurements with this type of condenser. We should perhaps remark that a condenser of the form of that of Figure 1, in which the section *B* was insulated from the ends *A* was used by Rosa and Dorsey³ in their determination of the ratio of the electrical units. Such a condenser, however, was of the guard type due to Lord Kelvin, and, therefore, was quite different from the one used here. It would be unsuited to measurements with alternating currents.

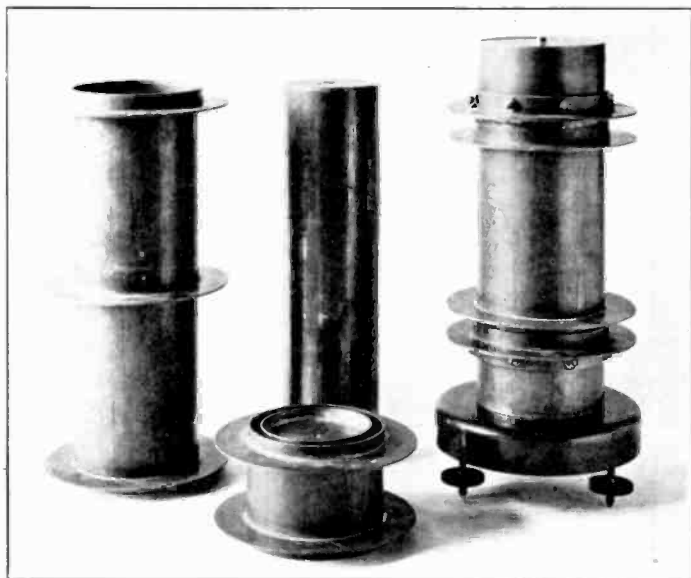

FIGURE 2

A semi-circular plate variable air condenser of forty-three plates was accurately calibrated and was used thereafter as a secondary standard. The dial of this condenser had 100 scale divisions and was turned by a worm-screw which had a head graduated into 100 parts. Measurements showed that each of these parts corresponded to a capacity change of $0.0676 \mu\text{f}$. This condenser was calibrated by means of the circuit of Figure 3. C_1 was the standard condenser of Figure 1, C_2 was the secondary standard, and C_3 was a variable air condenser. Current of frequency about 10^6 was induced in the circuit by coupling *L* loosely to an electron tube continuous wave generator. The central section *B* was removed from C_1 so that its capacity was formed

³"Bulletin of the Bureau of Standards," 3, 433, 1907.

only by two end sections *A*, condenser *C*₂ was set at a specified reading and the circuit was tuned to resonance by *C*₃. Section *B* was inserted into *C*₁, and *C*₂ was reduced until resonance again occurred. The difference in the two readings of *C*₂ was equal to the capacity of section *B*. In this manner the secondary standard was calibrated step by step thruout its range. The calibration curve obtained in this way gave only the capacity corresponding to the difference in two scale readings. To fix the absolute value of the capacity corresponding to a scale reading a single direct comparison of the primary and secondary standards was carried out by the method of substitution.

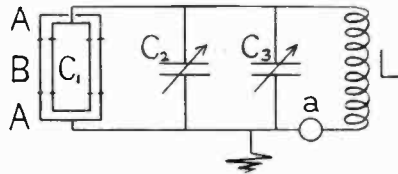

FIGURE 3

The resonance indicating instrument *a*, Figure 3, consisted of a thermo-couple of resistance 4.5 ohms and a d'Arsonval galvanometer. The galvanometer had a resistance of 121.5 ohms and a sensibility of 6×10^{-8} amperes per millimeter deflection at a scale distance of one meter. A marine type of suspension was used, the period being about one second. This system was quick in action and well adapted to measurements of resonance. Resonance points could be determined with an accuracy of about 0.5 $\mu\text{mf.}$, as may be seen from a typical resonance curve, curve 1, Figure 4. The curve was obtained by plotting the variable capacity in micromicrofarads as abscissas against the current thru the thermo-couple in milliamperes as ordinates. In order to increase the sharpness of the resonance curve, and thereby the accuracy of the capacity measurement, advantage was taken of the fact that the thermo-couple galvanometer system is one in which the deflections are proportional to the square of the current, that is, $i^2 = ar$ where *i* is the current, *r* the deflection, and *a* a factor of proportionality. The derivative, or sensibility, $d i / d r = 2 i / a$, and is seen to increase in direct proportion to the current *i*. Therefore, by increasing the coupling between *L* and the generating circuit to produce a stronger current, a sharper resonance curve was obtained. When stronger currents were used the galvanometer moved off the scale. To avoid this the

suspending fiber of the galvanometer was twisted slightly to depress the zero point. Curve 2, Figure 4, illustrates the resonance curve in this case, the sharpness of the curve being such as to enable the determination of the resonance point to within $0.2 \mu\mu\text{f.}$, or less. Of course there are many methods of determining resonance which are more sensitive than the one just described. These methods are for the most part more difficult of control and do not lend themselves to rapid observations.

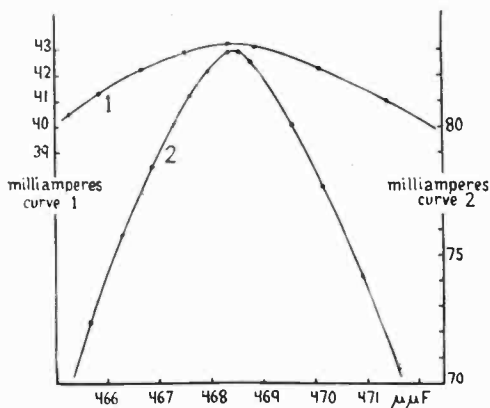

FIGURE 4

It was found that thin metallic discs and small metallic spheres suspended in the air could not in general be used as standards, for their calculated capacities (from the lengths of the radii) and observed capacities were not in agreement, due to unavoidable modification of the electric field caused by the connecting wire. In the case of small spheres the calculated capacities were 4.18 , 7.07 , and $8.35 \mu\mu\text{f.}$ and the measured values were 2.2 , 4.2 , and $5.0 \mu\mu\text{f.}$, respectively, after the observed capacities of the lead-wires had been subtracted. In the case of discs, the calculated capacities were 8.85 , 17.7 , and $35.4 \mu\mu\text{f.}$ When the lead-wire was connected to the centre and normal to the plane of the disc, the observed capacities were 5.7 , 13.4 , and $32.2 \mu\mu\text{f.}$, respectively. If the wire were attached to the edge of the disc the measured capacities became 5.9 , 13.6 , and $32.8 \mu\mu\text{f.}$, respectively.

The capacities of small parallel plate variable condensers were found to be in close agreement with the values calculated from the dimensions and the distance apart of the plates, using the usual formula for the capacity of a parallel plate condenser

with the edge effect correction. Figure 5 shows a photograph of one of these condensers. Thick brass plates were used, circular in shape, and beveled until the edges were thin.

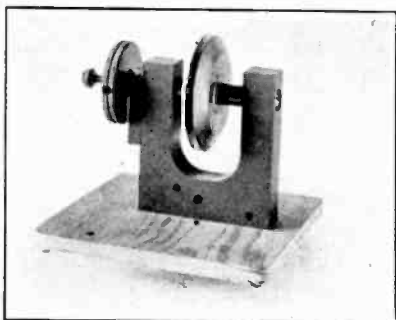

FIGURE 5

We take pleasure in thanking Mr. E. G. Linder for valuable help in making the observations.

Physical Laboratory,
University of Iowa,
May, 1923

SUMMARY: Standards of capacity for use with radio frequency currents, made according to a suggestion of the former Lord Rayleigh, are described. A simple method of increasing the sensitivity of the thermo-couple galvanometer system for indicating resonance is mentioned. Metallic discs and small spheres were found to be erratic standards, because of unavoidable effects of the connecting wires. The measured capacities of small parallel plate condensers were in agreement with the capacities calculated from the dimensions.

VACUUM TUBES AS POWER OSCILLATORS

By

D. C. PRINCE

(RESEARCH LABORATORY, GENERAL ELECTRIC COMPANY, SCHENECTADY, N. Y.)

PART II

CHAPTER IV

PARTIALLY TUNED PLATE CIRCUIT

Altho circuit design where but one tuning is involved has been dealt with in principle, a somewhat more complicated circuit than that used as an example may be analyzed because it throws light not only on the procedure with more complicated circuits, but also on the provision made to avoid parasitic oscillations by providing a partially tuned circuit in addition to the fully tuned circuit which furnishes the main determination of frequency.

ANALYSIS OF SEMI-TUNED PLATE OSCILLATOR

The circuit shown in Figure 31 is useful because of the filtering effect of the plate circuit in reducing harmonic radiation. Before discussing the filter action, the oscillating properties require study.

Figure 32 is a vector diagram corresponding to this circuit diagram. To understand this diagram, assume the antenna current I_{L_2} flowing in the antenna loading coil L_2 . This current induces in the primary inductance L_1 the voltage $I_{L_2} X_M$, due to the coupling. The voltage $I_{L_2} X_M$ has two components, e_r at right angles to $I_{L_1} X_{L_1}$ and e_x parallel with $I_{L_1} X_{L_1}$. The former is the power component due to the antenna resistance. The latter represents a wattless interchange between primary and secondary circuits. $I_{L_1} X_{L_1}$ is the self-induced voltage in L_1 . Both $I_{L_1} X_{L_1}$ and $I_{L_2} X_M$ are induced in L_1 , so that their sum is impressed upon C_1 and current in C_1 produces the voltage $I_{C_1} X_{C_1}$. The capacity current I_{C_1} leads its voltage 90° while the current in L_1 lags 90° behind its self-induced voltage.

*Received by the Editor, March 15, 1923. Continued from PROCEEDINGS OF THE INSTITUTE OF RADIO ENGINEERS, volume 11, number 3, June, 1923.

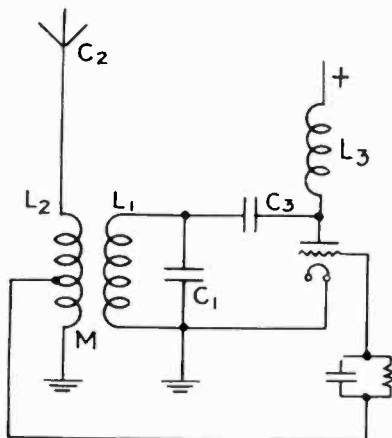

FIGURE 31—Connections of Partially Tuned Plate Circuit

Since the grid is connected to the antenna coil L_2 , the grid potential will be at right angles to I_{L_2} and the plate potential E_p may be made 180° out of phase by proper choice of C_3 , giving voltage $I X_{C_3}$.

It is apparent that, as drawn, $I_{L_1} X_{L_1}$ and $I_{C_1} X_{C_1}$ are not equal. In other words the primary circuit is not in tune. How-

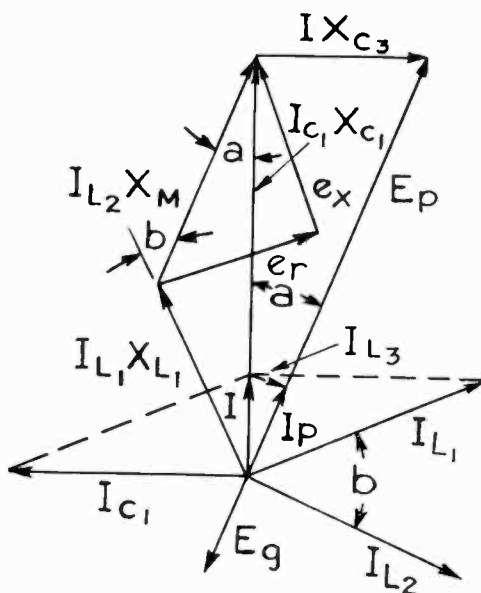

FIGURE 32—Vector Relations in Partially Tuned Plate circuit

ever, it is also apparent that an increase in $I_{L_1} X_{L_1}$ must be at the expense of the e_x component of $I_{L_2} X_M$, since e_r represents the energy transfer which must be maintained. The angle "b" is determined by the ratio between these two, so that the more nearly tuned the primary circuit the greater the angle "b." If the primary were entirely tuned, "b" would be 90° and it would become entirely impossible to correct this angle by any drop across C_3 .

In the other direction, if $X_{C_1}/X_{L_1}=4$, any second harmonic component in the plate current will be in resonance and a large second harmonic wave may be radiated. If this ratio be greater than 4, a second harmonic current in the antenna will be amplified and continuous second harmonic oscillations might even be built up, provided the wave length were just twice the natural wave length of the antenna. It therefore seems desirable to keep the tuning point of the primary circuit between the fundamental and second harmonic.

Having avoided accentuating harmonics by not making the ratio X_{C_1}/X_{L_1} too large and the dephasing of the grid by not making this ratio too near unity, the amount of harmonic radiation, for any value of C_1 say, can be determined by plotting out the plate current and making an harmonic analysis of it. This current is then assumed to pass thru C_3 to the primary circuit, and the portion of it which finds its way into the antenna may be calculated directly.

Once C_1 has been made large enough to keep harmonic radiation within required limits, the whole circuit may be calculated exactly by making a quantitative determination from the vector diagram, bearing in mind the values for E_p and E_g from the tube characteristic and that these voltages must be displaced 180° in phase. A sample calculation is attached in which this procedure has been followed.

The coupling required by this circuit is normally quite close, so that it might be expected to be doubly periodic. When a coupled circuit is doubly periodic, the two periods are necessarily further apart than the natural periods of the separate circuits. These periods may, therefore, be well separated. Also the antenna will respond only feebly to oscillations of the higher frequency and, since the grid is driven from the antenna coil, it is easy so to proportion the circuits that the higher frequency oscillation will not be sustained. The greater the separation of tuning points between primary and secondary, the less is the tendency toward double frequency oscillation.

APPENDIX TO CHAPTER IV

CALCULATION OF A PARTIALLY TUNED PLATE CIRCUIT

This circuit is to feed 20 kilowatts at 2,500 meters into a multiple tuned antenna having two downleads. Full power requires 46.5 amperes per downlead. The tube requires alternating potentials of 9,400 volts on the plate and 2,300 volts on the grid. No requirements have to be met regarding harmonics, so the primary volt-amperes will be made equal to approximately 4π times the watts. This results in a value of 0.004 mfd. for C_1 .

Tabulating these figures gives:

$$\begin{array}{ll} \lambda = 2,500 \text{ meters} & 2\pi f = 753,000 \text{ radians/sec.} \\ C_1 = 0.004 \text{ mfd.} & \frac{1}{2\pi f C_1} = 332 \text{ ohms} \\ E_p = 9,400 \text{ volts} & \\ E_g = 2,300 \text{ volts} & I_{L_2} = 46.5 \text{ amperes} \\ & \text{Power} = 20 \text{ KW.} \end{array}$$

The potential across C_1 will be very nearly E_p , so let this value be used. Then

$$I_{C_1} = \frac{9,400}{332} = 28.3 \text{ amperes}$$

which may also be taken as the value of I_{L_1} in this case.

Knowing the primary current and power transferred thru the coupling, e_r is given by

$$e_r = \frac{20,000}{28.3} = 707 \text{ volts}$$

Now I_{C_1} , X_{C_1} is to be built up of the three vectors I_{L_1} , X_{L_1} , e_r and e_x , and as e_r is only 707 volts and I_{C_1} , X_{C_1} is 9,400, we may take I_{L_1} , X_{L_1} and e_r to be each equal to 4,700 volts without incurring any error of appreciable magnitude. We then have

$$X_{L_1} = \frac{X_{C_1}}{2} = 166 \text{ ohms}$$

$$L_1 = \frac{166}{753,000} = 221 \text{ micro-henrys}$$

$$X_M = \frac{4,700 \text{ volts}}{46.5 \text{ amps.}} = 101 \text{ ohms}$$

$$M = \frac{101}{753,000} = 134 \text{ micro-henrys}$$

The angle "a" is now readily calculated and from it the value of the plate blocking condenser may be determined.

$$a = \sin^{-1} \frac{707}{9,400} = \sin^{-1} 0.0752 = 4.33^\circ$$

$$I X_{C_3} = 9,400 \sin a = 707 \text{ volts}$$

$$I = \frac{20,000}{9,400} = 2.13 \text{ amperes}$$

$$X_{C_3} = \frac{707}{2.13} = 332 \text{ ohms}$$

$$C_3 = \frac{1}{332 \times 753,000} = 0.004 \text{ mfd.}$$

In order that unity power factor current may be taken by the tube, the plate choke must draw a reactive current equal and opposite to that taken thru the plate blocking condenser. This is given by:

$$I_{L_3} = I \sin a = 2.13 \times 0.0752 = 0.16 \text{ ampere}$$

$$X_{L_3} = \frac{9,400}{0.16} = 58,700 \text{ ohms}$$

$$L_3 = \frac{58,700}{753,000} = 78 \text{ milli-henrys}$$

Grid excitation is supplied from the antenna circuit. When the antenna coil is on hand, it should not be a difficult matter to pick a point on it giving 2,300 volts which is the potential required, remembering that part of the voltage in this coil is induced by the primary current.

At 20 kilowatts, the antenna voltage is 30,900 volts, and the voltage induced in the antenna coil by the primary is

$$I_{L_1} X_M = 28.3 \times 101 = 2,860 \text{ volts}$$

These two voltages are practically in phase, so:

$$I_{L_2} X_{L_2} = 30,900 - 2,860 = 28,040 \text{ volts}$$

$$X_{L_2} = \frac{28,040}{46.5} = 603 \text{ ohms}$$

$$L_2 = \frac{603}{753,000} = 802 \text{ micro-henrys}$$

CHAPTER V

PRIMARY GRID COUPLING APPLIED TO DOUBLY PERIODIC CIRCUITS

DOUBLY PERIODIC CIRCUIT

The possibility of double periodicity has been mentioned in

the preceding section, altho the phenomenon has not been elaborated.

When a vacuum tube is used as a source of oscillations, it may furnish power at any of the frequencies for which the circuit to which it is attached is resonant, provided the grid and plate voltages have components in the proper phase and the losses are not too high. A coupled circuit in the general case has three resonant frequencies.

The analysis of a circuit of this type is given in Pierce, "Electric Oscillations and Electric Waves," Chapter XI, pages 156 to 159. Referring to Figure 33, the "apparent complex impedance of the primary circuit" is given by:

$$Z_1' = R_1 + \frac{M^2 \omega^2}{Z_2^2} R_2 + j \left\{ X_1 - \frac{M^2 \omega^2}{Z_2^2} X_2 \right\} \quad (1)$$

$$= R_1' + j X_1' \quad (2)$$

$$R_1' = R_1 + \frac{M^2 \omega^2}{Z_2^2} R_2 \quad (3)$$

$$X_1' = X_1 - \frac{M^2 \omega^2}{Z_2^2} X_2 \quad (4)$$

where R_1 and R_2 are primary and secondary resistances.

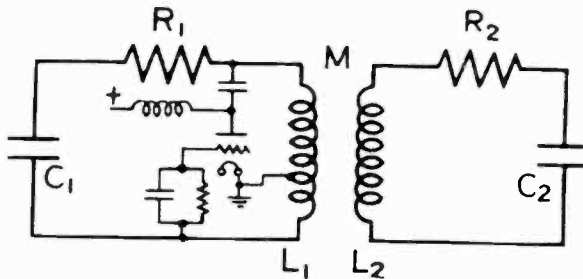

FIGURE 33—A Doubly Periodic Circuit

Z_1 and Z_2 are primary and secondary impedances consisting of inductances L_1 and L_2 and capacities C_1 and C_2 .

M is the mutual inductance.

ω is angular velocity of the vectors representing the currents.

Let it be assumed that the frequencies at which the oscillator will tend to run are those for which Z_1' has no reactive component, or that:

$$X_1 - \frac{M^2 \omega^2}{Z_2^2} X_2 = 0. \quad (5)$$

If it be attempted to solve this equation by substituting in

the values for X_1 , X_2 , Z_2 , and so on, a mass of algebraic expressions results which is practically impossible of solution and interpretation. It can, however, be solved graphically and, for the case in which the resonant points are close together, can readily be solved by the aid of a simple approximation.

Let it be assumed that both circuits are tuned by themselves to correspond to an angular velocity (ω_o) and that the three wave lengths are expressed as variations from this of ($\Delta \omega$). Also let:

$$\left. \begin{aligned} M\omega &= M\omega_o = M_o \text{ (a constant)} \\ X_1 &= 2 L_1 (\Delta \omega) \\ X_2 &= 2 L_2 (\Delta \omega) \end{aligned} \right\} (6)$$

Then
$$2 L_1 (\Delta \omega) - \frac{M_o^2 \cdot 2 L_2 (\Delta \omega)}{4 L_2^2 (\Delta \omega)^2 + R_2^2} = 0$$

Or
$$8 L_1 L_2^2 (\Delta \omega)^3 + \{2 L_1 R_2^2 - 2 L_2 M_o^2\} (\Delta \omega) = 0$$

The three roots of this equation are:

$$(\Delta \omega) = 0 \text{ and } (\Delta \omega) = \pm \frac{1}{2} \sqrt{\frac{M_o^2}{L_1 L_2} - \frac{R_2^2}{L_2^2}} \quad (7)$$

Two of these roots may be imaginary, in which case there will be only one wave length. The necessary condition is:

$$M_o < R_2 \sqrt{\frac{L_1}{L_2}} \quad (8)$$

Using the approximations outlined above, the apparent reactance and resistance of a proposed set have been calculated using:

$$R_2 = 0.5 \text{ ohms}$$

$$M_o = 1.46 \text{ ohms}$$

$$L_1 = 0.000,443 \text{ henry}$$

$$L_2 = 0.001,430 \text{ henry}$$

$$R_1 = 0$$

$$\omega_o = 115,000$$

Desired output 200 kilowatts.

The values obtained have been plotted in Figure 34. A_1 , A_2 , and A_3 are the three points on which the oscillator might run.

By having the primary tune at a slightly different frequency from the secondary, it is possible to shift the resonant points to three other values, such as B_1 , B_2 , and B_3 .

POWER DELIVERED AT "SIDE" FREQUENCIES

Let M_s be the coupling in ohms used in attempting to run on

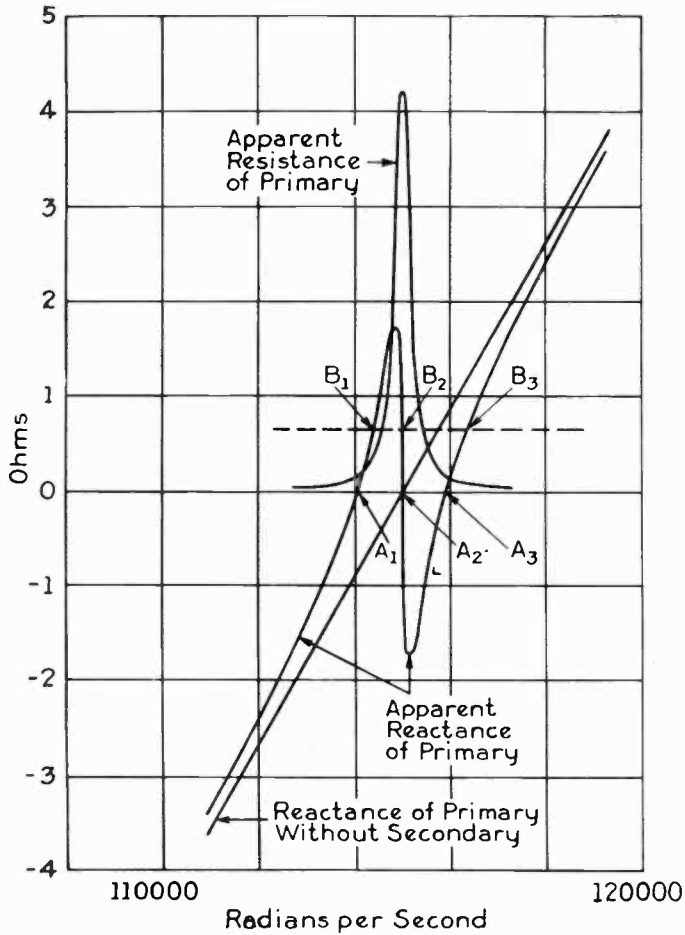

FIGURE 34—Apparent Resistance and Reactance of a Primary Circuit Coupled to a Secondary

$R_1 = 0$	$L_1 = 0.000,443$ henry
$R_2 = 0.5$ ohm	$L_2 = 0.001,430$ henry
$M_c = 1.46$ ohms	$\omega_c = 115,000$ radian/sec.

the “side” frequencies with the two circuits tuned alike. Then, if M_c is the coupling required to get the power across on the “center” frequency, they are connected by the equation

$$M_c^2 = \frac{4 L_2^2 (\Delta \omega)^2 + R_2^2}{R_2^2} M_c^2 \quad (9)$$

Now the expression for the side frequencies may be written

$$(\Delta \omega)^2 = \frac{M_c^2}{4 L_1 L_2} - \frac{R_2^2}{4 L_2^2}$$

and substitution of the value of $(\Delta \omega)^2$ as given by the latter equation into the former results in

$$M_s = \sqrt{\frac{R_2^2 (M_c^2 - 1)}{R_2^2 - \frac{L_2}{L_1}}} \quad (10)$$

Substitution of the values for the proposed set result in an imaginary value for M_s , showing that special means will be required to get the power across.

The criterion of double periodicity with its resulting limitations upon energy transfer may be more conveniently expressed than by the relation

$$M_o \leq R_2 \sqrt{\frac{L_1}{L_2}}$$

The two circuits being adjusted to the same period $X_1 = X_2 = 0$, and energy transferred from one circuit to the other will be at unity power factor. Using the equality

$$I_2 = \frac{E_m}{R_2} = \frac{I_1 M_o}{R_2} = I_1 \sqrt{\frac{L_1}{L_2}},$$

volt-amperes primary are $I_1^2 \omega L_1$. The energy component is assumed not to affect the total appreciably. Secondary volt-amperes are from the above

$$I_2^2 \omega L_2 = I_1^2 \frac{L_1}{L_2} \omega L_2 = I_1^2 \omega L_1 \quad (11)$$

That is, if the secondary volt-amperes are equal to or less than the primary, then the circuit is singly periodic. If they should be more, provided the frequency remained unchanged, the circuit is trebly periodic.

The maximum power which can be delivered to the secondary of a singly periodic coupled circuit is

$$\frac{E_m^2}{R_2} = \frac{(I_1 M_o)^2}{R_2} = \frac{I_1^2 R_2^2 \frac{L_1}{L_2}}{R_2} = I_1^2 R_2 \frac{L_1}{L_2}$$

The power consumed in the primary is $I_1^2 R_1$, therefore the efficiency of transfer is

$$\frac{I_1^2 R_2 \frac{L_1}{L_2}}{I_1^2 R_1 + I_1^2 R_2 \frac{L_1}{L_2}} = \frac{R_2 L_1}{R_1 L_2 + R_2 L_1}$$

or, rearranging,

$$\text{Efficiency} = \frac{R_2}{\frac{R_2}{\omega L_2} + \frac{R_1}{\omega L_1}} \quad (12)$$

That is, efficiency is equal to the power factor of the secondary divided by the sum of the primary and secondary power factors for the case where primary and secondary volt-amperes are equal. If the coupling is less, the efficiency of transfer will also be less.

The foregoing argument does not exclude the possibility of practical operation with a poly-periodic circuit as will be shown.

PRIMARY GRID COUPLED CIRCUIT

It has been demonstrated that, in the case of coupled circuits one of which is driven by a thermionic valve, Figure 33, there is a critical condition determined by the relation that the volt-amperes in both circuits are equal. If there are more volt-amperes in the driving circuit, the system will always oscillate at one frequency. If there are more volt-amperes in the driven circuit, there will be two frequencies at which the system may oscillate. In the interests of efficiency and economy of apparatus, it is not desirable to circulate as many volt-amperes in the tube tank circuit as in the antenna, so that the doubly periodic circuit should be used.

If a thermionic valve be attached to the primary, oscillations will take place at frequencies, such that X_1' is zero, for the case where grid and plate voltages are displaced 180° , or nearly zero, if the 180° relation is not exact, that is:

$$X_1 = \frac{M^2 \omega^2}{Z_2^2} X_2$$

as given by equation (5). This equation (5) is most easily solved graphically and, provided $M\omega > R_2\sqrt{L_1}/L_2$, may have three roots two of which represent stable operating points. Figure 35 shows the general nature of the curves of X_1 and $\frac{M^2 \omega^2}{Z_2^2} X_2$. On this figure are also plotted the corresponding values of $\frac{M^2 \omega^2}{Z_2^2} R_2$.

Since R_2 is constant, the variation in the apparent primary resistance due to R_2 represents a variation in secondary current. The higher the apparent resistance, the higher the secondary or antenna current. X_1' is also plotted and the three frequencies at which it is zero are indicated by f_0 , f_1 , and f_2 .

That f_0 is unstable, appears from the following reasoning

Suppose the frequency to increase a small amount from f_0 ; then that part of the apparent primary reactance due to the secondary becomes capacitive. This equivalent capacity in series with C_1 gives an equivalent value smaller than C_1 . The circuit, therefore, has a resonant point still higher and the frequency continues to increase. On the other hand, if the frequency momentarily falls below f_0 , that part of the apparent primary reactance due to the secondary circuit is inductive. This inductance added to L_1 gives a circuit resonant at a still lower frequency. The frequency, therefore, always tends to depart from f_0 in the direction of the initial impulse. Corresponding reasoning will show that f_1 and f_2 are stable frequencies.

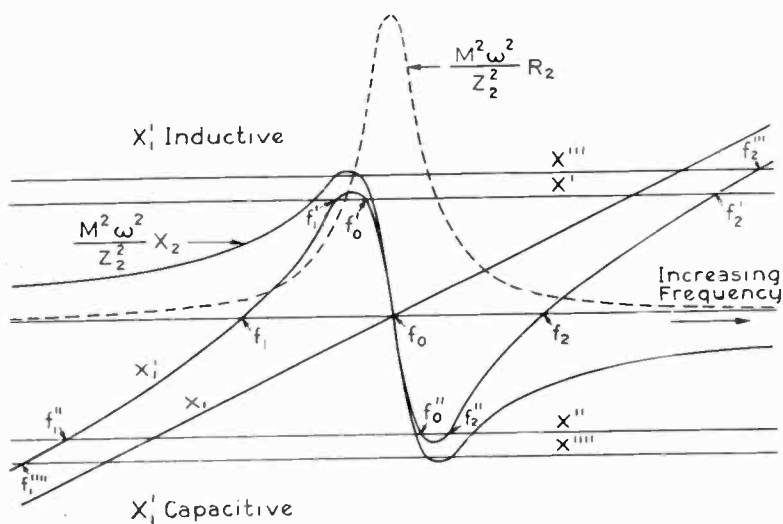

FIGURE 35—Apparent Primary Impedance of Coupled Circuits

It follows that stable frequencies lie on both sides of the zone included between the two maxima of the apparent reactance curve. The stable points may be brought separately as close to the maxima as desired by tuning primary and secondary to different natural periods, the effect being to displace the axis and give resonant points at f_0' , f_1' , and f_2' . The closer the resonant point is to one of the apparent reactance maxima, the greater will be the apparent resistance, and hence secondary current, so that it is desirable to secure resonance near these points.

The frequencies corresponding to the maxima of the total apparent reactance curve are functions of coupling, while those of apparent primary reactance due to the secondary are not.

The latter points are easily determinable and, for fairly close coupling, may be used in an approximate calculation to determine coupling.

To solve for the maxima of apparent primary reactance due to the secondary, the second term of equation (4) is amplified.

$$X_2' = \frac{M^2 \omega^2 \left(L_2 \omega - \frac{1}{C_2 \omega} \right)}{R_2^2 + \left(L_2 \omega - \frac{1}{C_2 \omega} \right)^2} \quad (13)$$

For maxima:

$$\frac{dX_2'}{d\omega} = \frac{d}{d\omega} \left[\frac{M^2 \omega^2 \left(L_2 \omega - \frac{1}{C_2 \omega} \right)}{R_2^2 + \left(L_2 \omega - \frac{1}{C_2 \omega} \right)^2} \right] = 0. \quad (14)$$

The solution of (14) is somewhat involved, but may be greatly simplified under the conditions usually encountered. With a fairly efficient circuit, the two maxima will occur near enough to f_o , so that the mutual inductance in ohms may be taken as constant. That is,

$$M \omega = M_o \quad (15)$$

For such a narrow range, the change in capacity reactance with a given change in frequency is equal to the change in inductive reactance, so that the change in inductive reactance may be substituted for the change in capacity reactance. That is,

$$L_2 \omega_o = + \frac{1}{C \omega'} - \frac{1}{C (\omega_o + \omega')} \quad (16)$$

where $\omega_o + \omega' = \omega$ so that ω_o is the departure from reference frequency. (14) may now be rewritten

$$\frac{dX_2'}{d\omega_o} = \frac{d}{d\omega_o} \left[\frac{2 M_o L_2 \omega_o}{R_2^2 + (2 L_2 \omega_o)^2} \right] = 0 \quad (17)$$

Dropping constants $2 M_o L_2$ in the numerator:

$$(R_2^2 + 4 L_2^2 \omega_o^2)^{-1} - 8 L_2^2 \omega_o^2 (R_2^2 + 4 L_2^2 \omega_o^2)^{-2} = 0 \quad (18)$$

$$R_2^2 = 4 L_2^2 \omega_o^2 \quad (19)$$

$$R_2 = 2 L_2 \omega_o \quad (20)$$

$$\omega_o = \frac{R_2}{2 L_2} \quad (21)$$

To allow a safe margin for stability, a slightly larger value of ω_o should be used, say:

$$\omega_o = \frac{3 R_2}{4 L_2} \quad (22)$$

or $X_2 = 2 L_2 \omega_o = 1.5 R_2$ (23)

Now, if we refer again to (3)

$$(3) \quad R_1' = R_1 + \frac{M^2 \omega^2}{Z_2^2} R_2$$

R_2 is the resistance of the secondary or antenna circuit. R_1 is the resistance of the primary or tank circuit. Primary current is selected to give proper tube performance and is otherwise a minimum. Primary loss is therefore known, and

$$R_1' = \frac{\text{Primary Loss} + \text{Antenna Loss}}{(\text{Primary Current})^2} \quad (24)$$

We can thus solve directly for $M \omega$ and M , since ω is the required angular velocity. Knowing $M^2 \omega^2$, we may solve for X_1 in (4), and all quantities are known.

Where the secondary or antenna system is multiple tuned, and the coupling is to only one of the inductances used in tuning the capacity, an exact solution is quite involved. However, under ordinary conditions, the amount of energy and wattless interchange between the circuits is small enough not to change the current distribution among the various inductances. If this condition exists, the coupling obtained above is merely multiplied by the ratio of total current to the current in that part of the circuit to which the primary is coupled.

OPERATION OF COUPLED DOUBLY PERIODIC OSCILLATOR

Referring again to Figure 35, it is apparent that when the circuit is adjusted to give good output on one of the stable frequencies, the apparent primary resistance and hence secondary current is very low for the other. If the oscillations are started by closing the direct current supply switch, they will naturally start at the frequency presenting the minimum resistance. This is automatically the wrong frequency. Once started at the proper frequency, the oscillations are stable, unless seriously disturbed, and may be reduced in amplitude to a small value and returned without any tendency to change.

However, if there is a tendency for the frequency to change with load, because of the method of connecting the tube to the circuit, stability may be momentarily destroyed, whereupon a permanent change in frequency will occur. In any case, means must be employed to cause oscillations to start at the correct frequency.

Suppose oscillations are being generated at frequency f_2'' , the driving tube being connected to form a Hartley circuit, and suppose further that a slight decrease in frequency takes place. The apparent resistance is increased. This increase of resistance in a Hartley circuit causes the frequency to fall further so that there is an element of instability when a Hartley connection is used to drive a coupled system and the circuits are tuned separately to frequencies below the frequency of oscillation.

If, on the other hand, the circuits are tuned above the frequency of oscillation f_1' with a Hartley driver, an increase in frequency increases the apparent resistance which causes the driver to tend toward lower frequency so that the condition is inherently stable.

With a Colpitts driving circuit, conditions are exactly reversed, the stable condition being obtained with the circuits separately tuned to a frequency below that to be generated.

The reason that the Hartley and Colpitt's circuits have tendencies toward change in frequency is that when the grid excitation is, for any reason, displaced in phase, the tubes pass wattless current, so that the coupled circuits no longer operate on the zero reactive current axis. This has been explained in Chapter III.

It is apparent that, if the relative tuning of the circuits is changed to correspond to the X axis at X''' , there is but one point of zero reactive energy f_2''' at which oscillations must take place. At this frequency the apparent secondary resistance is very low, hence secondary current is low. Once oscillations have started, the tuning may be changed to move the axis to X'' . During this change oscillations are continuously stable and persist at f_2'' with large secondary current. This then gives one method of starting a close coupled circuit at a useful frequency. This method is not altogether desirable for signaling because, altho secondary current is controlled over a wide range with stability, the "idle" wave has a different frequency from the sending wave, which is objectionable on interference grounds.

GRID KEYING

It has already been pointed out that the amplitude of oscillations may be very much reduced by weakening input without changing tuning or stability. Once started, therefore, signaling may be accomplished by varying the strength of oscillations maintaining the minimum oscillation by the main tube bank or by an auxiliary source.

It is useful to examine some possible ways of accomplishing this result. It has been suggested that the value of grid leak resistance might be increased to reduce the amplitude of oscillations. Without entering into any extended discussion of the oscillating characteristics of a tube under these conditions it is apparent that oscillations will take place, for the commencement of oscillations takes place when there is no charge on the grid condenser and the grid resistance is, therefore, immaterial. The amplitude of oscillations will be small, because plate current is somewhat proportional to grid current, and grid current is kept small by high leak resistance. Since the oscillation amplitude is small, the grid bias must be small, as there would otherwise be no grid current to maintain the bias. An approximate determination of tube loss can be made by assuming no oscillations at all, that is the limiting case. The plate potential is then the direct potential and the grid is at ground. This condition eliminates all low impedance tubes which are destroyed quickly by full impressed plate voltage with grid at ground potential. There are probably no high voltage oscillator tubes made which can stand full plate voltage with grounded grid for any considerable time.

It should be possible to reduce oscillation amplitude by external bias. This means is subject to the objection that an external bias circuit is not self-starting and oscillations reduced to a low value might cease altogether, due to some small change in impressed voltage.

AUXILIARY OSCILLATOR KEYING

One advantage of an auxiliary source of oscillations is that such a source may be used both for starting and keying, the main power bank being completely shut down when the key is up. If the auxiliary source be a vacuum tube oscillator, it must have a separate oscillating circuit of its own. This circuit is tuned to the frequency to be obtained and is coupled loosely for two reasons. First, it is necessary that the coupling be loose enough to give but one frequency possibility as driven from the auxiliary source. Secondly, when the main set is in operation, current in the auxiliary must not increase to such an extent as to do it damage. The coupling may be so adjusted that, when the main set comes into operation, it will feed back just enough energy to the auxiliary circuit to remove the load from the driving tube of that circuit. Let us examine the requirements for this condition.

Let I_a = amplitude of current in the auxiliary circuit while used as driver, and

I_b = corresponding current in that part of the main circuit to which auxiliary is coupled.

I_a' = current amplitude in the auxiliary circuit while it is being driven by the main circuit.

I_b' = corresponding amplitude in that part of the main circuit to which the auxiliary is coupled.

Z_a = impedance of auxiliary circuit.

Z_b = impedance of main circuit in terms of that portion to which the auxiliary circuit is coupled.

Z_a'
 Z_b' = corresponding apparent impedances.

M_a = mutual inductance between auxiliary and main circuit.

From Pierce, page 160, equations 31 and 32, for the auxiliary driving

$$I_a = \frac{E}{Z_a'} \quad (25)$$

$$I_b = \frac{M_a \omega E}{Z_b Z_a'} \quad (26)$$

Dividing (25) by (26)

$$\frac{I_a}{I_b} = \frac{Z_b}{M_a \omega} \quad I_a = \frac{I_b Z_b}{M_a \omega} \quad (27)$$

For main circuit driving

$$I_b' = \frac{E}{Z_b'} \quad (28)$$

$$I_a' = \frac{M_a \omega E}{Z_a Z_b'} \quad (29)$$

Dividing (28) by (29)

$$\frac{I_b'}{I_a'} = \frac{Z_a}{M_a \omega} \quad (30)$$

Since we wish $I_a = I_a'$

$$I_a = \frac{I_b' M_a \omega}{Z_a} \quad (31)$$

It is desired to have the entire circuit, as driven from the auxiliary source, oscillate at one frequency only. To meet this requirement

$$M_a \omega < R_b \sqrt{\frac{L_a}{L_b}} \quad (32)$$

With this condition fulfilled, the oscillations may take place at the resonant frequency of both circuits so that

$$Z_a = R_a, \quad Z_b = R_b \quad (33)$$

From (27), (31), and (33):

$$\frac{I_b R_b}{M_a \omega} = \frac{I_b' M_a \omega}{R_a} \quad (34)$$

$$M_a \omega = \sqrt{\frac{I_b R_b R_a}{I_b'}} \quad (35)$$

(35) subject to the limitation (32) gives the coupling between main and auxiliary circuits with which the main circuit current may vary from I_b to I_b' and just unload the oscillator supplying the auxiliary circuit assuming zero regulation. In practice the current would rise slightly, but not enough to damage the circuit or apparatus.

The power expended by the auxiliary oscillator will be the sum of the $I^2 R$ losses in both circuits and can be readily calculated from the relations given. It is not certain just what criteria control the minimum value of I_b . Its value must be large enough to secure quick and reliable starting of the main circuit oscillations at the proper frequency.

USE OF PLATE CURRENT FOR KEYING

For moderate power telegraph sets, say 5 kw. to 20 kw., it would be desirable to have a method of maintaining small amplitude oscillations with stability and without excessive loss. With this in mind let us examine the effect of resistance in the filament ground lead bridged by a condenser. Such a resistance will give a grid bias proportional to plate current, because the filament will be above ground by the $i r$ drop. Under suitable conditions this should give stability and self-starting characteristics.

To find out what the required conditions are, we shall investigate the requirements for a 20 kw. water cooled tube, type UV-207, using the characteristic given in Figure 36. With a fair degree of accuracy the plate current, for negative grid potentials, may be obtained from the formula.

$$i = 0.29 \times 10^{-3} \left(E_g + \frac{1}{\mu} E_p \right)^{3/2}$$

where 0.29×10^{-3} is a constant obtained by substitution in a number of points on the characteristics. μ is about 35. In an oscillating circuit, there are two components of both grid and plate volts, one component being a constant and the other alter-

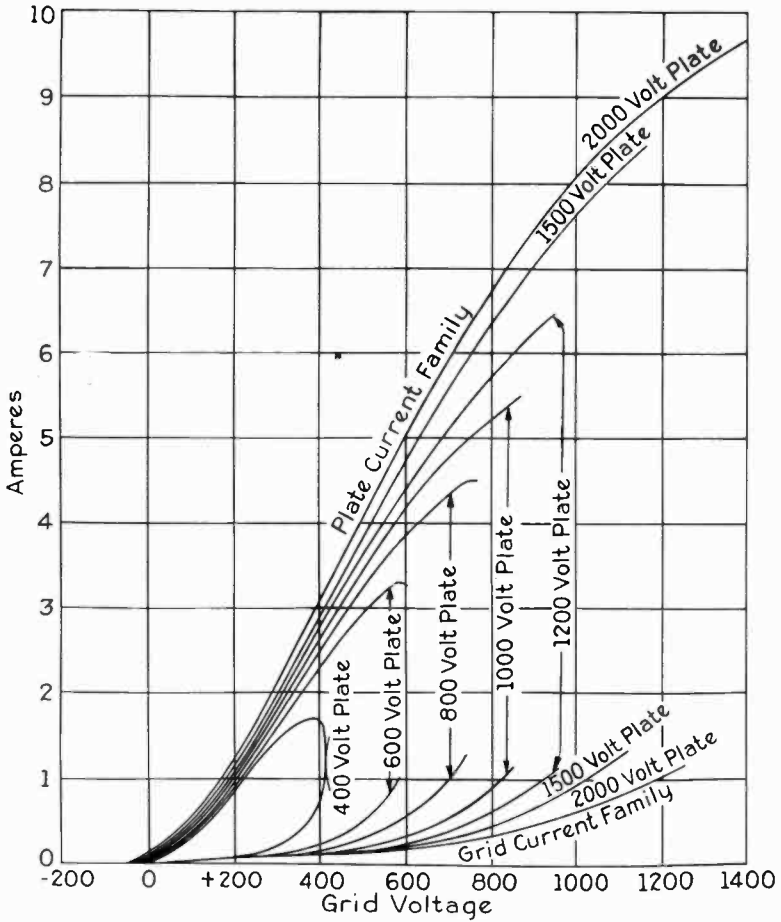

FIGURE 36—Characteristics of Water-Cooled Radiotron Number 109 at 52 Amperes Filament. Taken by Oscillograph

nating. The alternating components are proportional and are related by the circuit coupling. If ΔE_o and ΔE_p are the alternating components:

$$\begin{aligned}
 i + \Delta i &= 0.29 \times 10^{-3} \left[E_o + \frac{1}{\mu} E_p - \Delta E_o + \frac{1}{\mu} \Delta E_p \right]^{3/2} \\
 &= 0.29 \times 10^{-3} \left[E_o + \frac{1}{\mu} E_p - \left(C - \frac{1}{\mu} \right) \Delta E_p \right]^{3/2}
 \end{aligned}$$

For our purposes, C is determined by the full load adjustment and is 0.25. E_p is determined by the impressed potential and is 15,000, therefore:

$$i + \Delta i = 0.29 \times 10^{-3} \left[E_o + \frac{15,000}{35} - \left(0.25 - \frac{1}{35} \right) \Delta E_p \right]^{3/2}$$

Now, $\frac{\Delta E_p}{\Delta i} = r_o$ is the equivalent resistance of the tube which is apparently negative, so that oscillations will be set up, provided $r_o < r$, the equivalent shunt resistance of the load circuit. That is, an equivalent circuit may be drawn as in Figure 37. "r" is the resistance which, if placed in multiple with resistanceless capacity C and inductance L , would give the circuit impedance. A certain circulating current in L and C sets up a potential across r and r_o . The energy absorbed by "r" is

$$W_r = \frac{E^2}{r}$$

The energy given up by r_o is

$$W_{r_o} = \frac{E^2}{r_o}$$

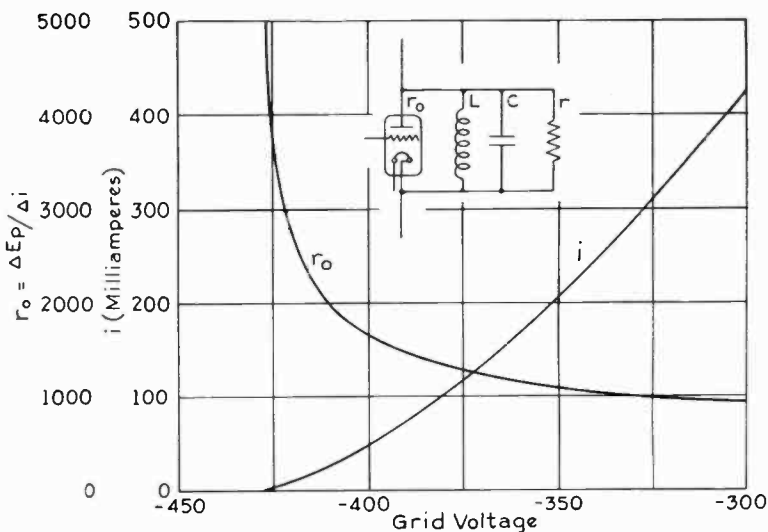

FIGURE 37—Negative Resistance of a UV-207 Radiotron

Therefore, if r_o is smaller, there is a net surplus which is stored by increased amplitude of the oscillations in L and C . By applying a series of values to E_o , the corresponding values of $\frac{\Delta E_p}{\Delta i}$ can be obtained and a curve plotted, giving this slope which is a measure of the negative resistance. Figure 37 shows a curve

obtained in this way. Since the normal load corresponds to about 3,500 ohms, these figures indicate that stable low amplitude oscillations should be obtainable at a little over 0.005 amperes representing an input of 75 watts. The accuracy of the flow equation is hardly sufficient to prove that as low an amplitude as this can be maintained. However, it is apparent that low amplitude oscillations can be obtained with small loss by a bias method.

To maintain a current of 0.005 requires a grid bias of 425 volts or a resistance of 85,000 ohms in the filament ground lead.

ELIMINATION OF ONE FREQUENCY BY GRID PHASING

If the coupling is such as to give two oscillating frequencies, which are fairly well separated, the undesired frequency may be discriminated against by the adjustments of the circuit. One way of accomplishing this result is as follows: Referring to Figure 38: the grid circuit is inductively coupled to the primary or plate circuit and is tuned to resonate at a frequency between the operating points of the main coupled circuit. For the lower frequency, then, the grid excitation is shown in Figure 39-A, these phases being correct for oscillation. At the resonant frequency of the grid circuit, the vectors are as shown in Figure 39-B. Grid and plate voltages are in quadrature and oscillations are not maintained. At the second resonant point of the main circuit, the vectors are as shown in Figure 39-C. Here the grid excitation actually opposes any oscillations at that frequency.

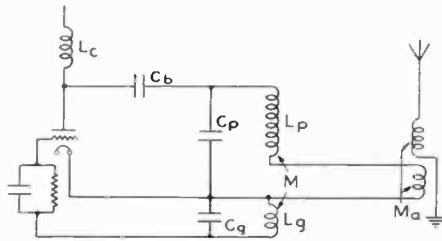
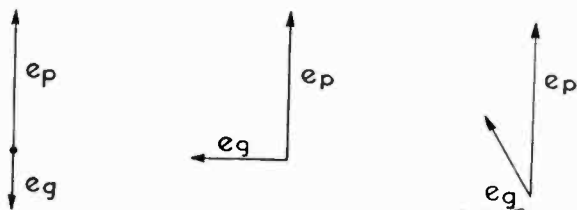

FIGURE 38—Circuit for Use in Eliminating Frequencies by Grid Phasing

With such an arrangement, altho the main circuit is doubly periodic, oscillations at the undesired frequency are opposed. It is necessary to have the grid coupling loose enough so as not to give rise to still further undesirable resonant points.

SIMULTANEOUS OPERATION AT TWO FREQUENCIES

The foregoing discussion regarding change of amplitude in



FIGURES 39-A, 39-B, 39-C. Plate and Grid Voltage Relations for Circuit Shown in Figure 38

coupled circuits is incomplete in one very important respect. A three-element vacuum tube is not limited essentially to oscillations at one frequency. On the contrary, in an unsaturated state, it can maintain simultaneously oscillations of a great many frequencies. The largest factor tending to prevent a multiplicity of frequencies is the grid bias. Since the grid is biased so that it can interrupt all currents for a considerable portion of a cycle, a predominant oscillation can maintain itself by properly synchronized pulses of current. Other frequencies in an incipient state die out during the period when no current flows and are thus unable to gain headway.

Even tho a circuit be oscillating steadily at one frequency and small amplitude, a circuit readjustment intended to increase output may render the bias momentarily insufficient to prevent the start of other oscillations. If such oscillations meet with little energy absorption they will, once started, displace the useful frequency. The likelihood of this occurrence is a time function of the change in amplitude. No quantitative derivation of this function is yet available.

APPENDIX TO CHAPTER V

CALCULATION OF A PRIMARY GRID COUPLED CIRCUIT

The circuit which is to be used is that shown in Figure 38, in which one of the resonant frequencies is discriminated against by causing the grid voltage to have the wrong phase for oscillations at the undesired frequency. It is to deliver 200 kw. at 16,400 meters, using 10 tubes operating at 15,000 volts direct current. The antenna characteristics are those given in Figure 42.

The tube characteristics as given in Figure 40 and 41 for 25 kw. output are

- Tube loss = 6.6 kw. per tube.
- Alternating plate volts = 9,400.
- Alternating grid volts = 2,350.

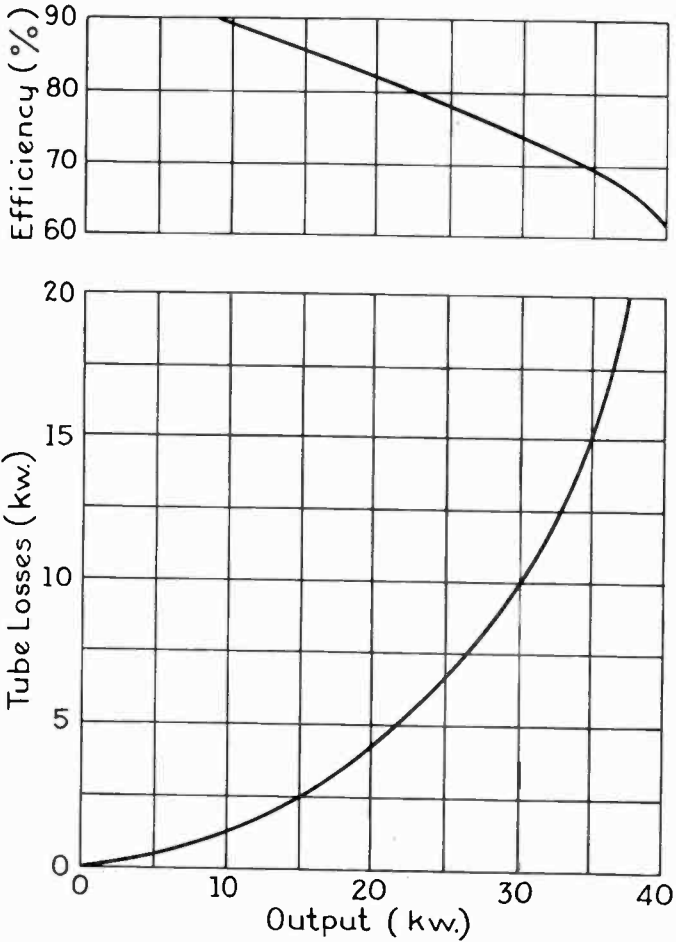

FIGURE 40—Calculated Efficiency and Losses for Best Operating Conditions of Water-Cooled Raciotron Number 109 at 15,000 volts d. c. (See Figure 36)

Estimated grid loss 8 percent of plate loss by the method of Chapter I. 25 kw. are used as a basis to allow for primary and other losses, to give a net 20 kw. per tube to the antenna.

PRIMARY CIRCUIT

Since a loose coupling to the antenna is contemplated, the volt amperes which must be stored in the primary circuit are 4π times the watts, or 2,510 kva. At 9,400 volts this represents a circulating current of 267 amperes, and the apparent resistance of this circuit, due to the secondary or antenna circuit, must be

$\frac{200,000}{267^2} = 2.81$ ohms. The reactance of the condenser C_p is $\frac{9,400}{267} = 35.2$ ohms. The apparent reactance due to the secondary, added to the primary inductive reactance, must equal this amount.

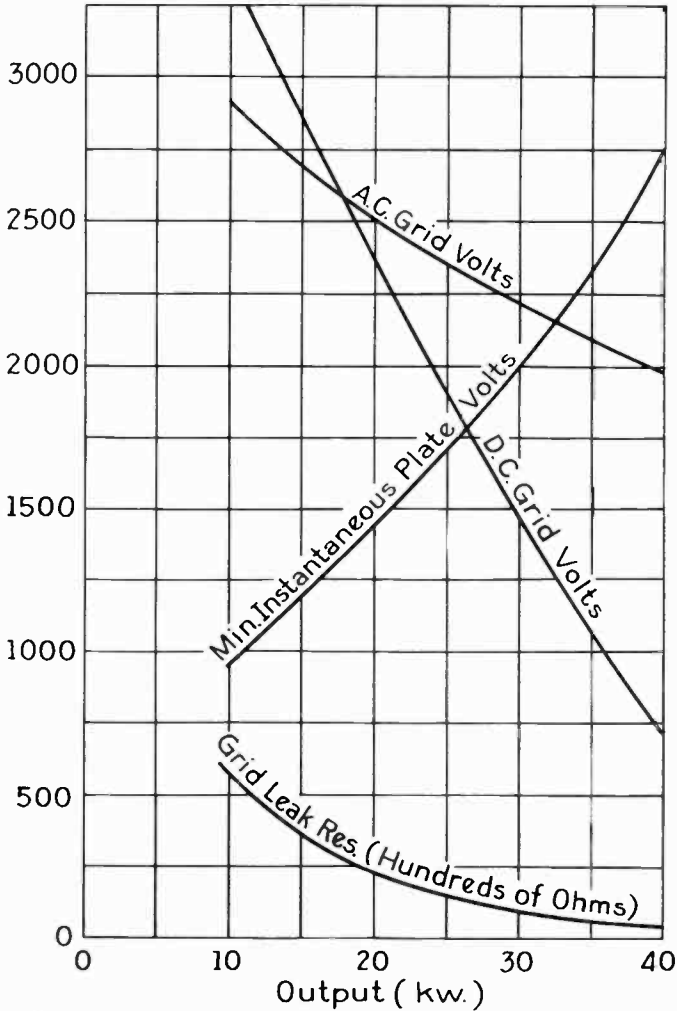

FIGURE 41—Calculated Optimum Operating Conditions of Water-Cooled Raxiotron Number 109 at 15,000 volts d. c. (See Figure 36)

ANTENNA CIRCUIT

The antenna characteristics are given in Figure 42. The primary reactance for various amounts of primary mistuning is also plotted. The circuit is certainly doubly periodic, for the antenna current is $\sqrt{\frac{200,000}{0.5}} = 633$ amperes, so that antenna kva. are $633^2 \times 164.2 = 65,600$ kva., as compared with 2,510 in the primary. The minimum coupling which would give 2.81 ohms effective resistance in the primary is seen to be between 5 and 10 ohms, but since the circuit is doubly periodic, enough additional coupling must be provided to separate the resonant points by an amount sufficient to allow the grid circuit to discriminate against one of the resultant frequencies. We will assume 20 ohms coupling. Referring to Figure 42, this gives 2.81 ohms apparent primary resistance at 99.61 percent frequency. The corresponding effective antenna reactance in the primary circuit is 7.25 ohms and the primary is mistuned 10 percent. The primary inductive reactance must be $35.2 - 7.25 = 27.95$ ohms. The second resonant frequency is found by extending the primary reactance and 20 ohm coupling curves to the right until they again cross. This occurs at slightly over 110 percent frequency, and this frequency must be discriminated against by the grid circuit. The grid circuit will be adjusted to resonate at 109 percent and will thus eliminate the 110 percent frequency point.

GRID CIRCUIT

The vector diagram from which the grid excitation is calculated is shown in Figure 43. Starting in the primary circuit with E_{C_p} the total drop in the inductance L_p is equal to E_{C_p} and may be divided into components $I_{L_p} X_{L_p}$, due to the self-induction of L_p in L_p and $I_2 X_{M_a}$ due to the mutual effect of the antenna. $I_2 X_{M_a}$ may be further sub-divided into E_r in phase with I_{L_p} and E_x in quadrature with I_{L_p} and therefore in phase with $I_{L_p} X_{L_p}$. The drop in the plate blocking condenser E_{C_b} gives the plate voltage E_p , lagging behind E_{C_b} , by an angle "b."

In the grid circuit E_{C_g} must be 180° removed from E_p and $I_{L_g} X_{M_g}$ is 90° removed from I_{L_p} . The drop in the grid coil due to its own current is $I_{L_g} X_{L_g}$ and 180° removed from this is the effect of the grid circuit on the primary, an amount which is so small that it may be neglected in the calculations and which will be automatically taken care of in the final adjustments of the set.

The angle "a" is obtained from the ratio of apparent resist-

l

a



enna)

pled Circuit

when coupled to

15'

The shunt resistance of the primary oscillating circuit may be calculated from the voltage and power

$$R = \frac{9,400^2}{200,000} = 442 \text{ ohms}$$

If a plate blocking condenser of 0.2 mfd. be assumed, its impedance is 43.5 ohms and

$$b = \tan^{-1} \frac{43.5}{442} = \tan^{-1} 0.0985 = 5^\circ 40'$$

If the grid circuit tunes at 109 percent frequency, there will be no component of grid voltage in the proper phase to produce oscillations at 110 percent and over. Assuming tuning at 109 percent frequency the grid circuit voltage diagram may be calculated by trigonometry for the value of EC_g is known and is 2,350 volts from the second paragraph in this appendix. The angle at the origin is $a+b=10^\circ 15'$ $I_{L_g} X_{L_g} = EC_g \times \frac{1}{1.09^2} = 1,980$ volts.

With these two sides and angle the remaining side $I_{L_p} X_M$ is calculated by trigonometry to be 369 volts and the angle $c=1^\circ 55'$. We thus have the voltage diagram complete, altho the currents and reactances have not yet been determined.

The source of power in this circuit is the voltage $I_{L_p} X_M$. The current is normal to $I_{L_g} X_{L_g}$. The power factor is

$$\sin d = \sin (a+b+c) = \sin 12^\circ 10' = 0.211$$

The total power in the grid circuit is:

$W_g = 10 \times 6,600 \times 0.08 = 5,280$ watts. (See second paragraph of this Appendix, and hence:

$$I_{L_g} = \frac{5,280}{369 \times 0.211} = 67.8 \text{ amperes.}$$

This represents a circulating wattless power of 159,000 volt-amperes which is not apt to affect materially the primary where 2,510,000 volt-amperes are circulating. The length of the vector $I_{L_g} X_M$ is given by:

$$\begin{aligned} I_{L_g} X_M &= I_{L_p} X_M \cdot \frac{I_{L_g}}{I_{L_p}} \\ &= 369 \times \frac{67.8}{267} = 94 \text{ volts} \end{aligned}$$

an insignificant figure as previously stated which will be corrected in tuning the primary circuit.

It will be noticed that the circulating volt-amperes in the grid circuit are much higher than are required for any energy storage effect. Two ways are available of decreasing it. First,

$I_{L_p} X_M$ may be increased. This means that the natural frequency of the grid circuit must be further removed from its operating frequency which, in turn, requires a larger coupling between the tank and antenna circuit to insure against oscillations at the wrong frequency. Secondly, the power factor of energy transfer to the grid circuit may be increased. This requires that the angle $(a+b)$ be increased. "a" is fixed by the choice of primary kva., and the equivalent antenna resistance, but "b" may be increased by increasing the impedance of the plate blocking condenser. The first remedy is open to the objection that high power mutual inductances are difficult to build and should be kept as small as possible for this reason. Also the less the coupling the fewer the harmonics which will be transferred to the antenna. The second remedy is also far from desirable since it may lead to unexpected complications of a parasitic nature. Hence there are three factors in this circuit—grid circuit volt-amperes, coupling between primary and antenna, and phase displacement due to plate blocking condenser—which must be balanced by the judgment of the designer of the set.

PLATE CIRCUIT

The value of the plate blocking condenser has already been assumed to be 0.2 mfd. or 43.5 ohms. This results in the angle "b" being $5^\circ 40'$. Now the input current to the oscillating circuit is $\frac{200,000}{9,400} = 21.3$ amperes in phase with E_{C_p} , so that to bring the plate current into phase with E_p requires a current in L_c :

$$I_{L_c} = 21.3 \times \sin 5^\circ 40' = 2.1 \text{ amperes}$$

As the potential across it is 9,400 volts, its impedance is 4,480 ohms.

TABULATION OF CONSTANTS

From the preceding calculations the values of all the capacities and inductances may be obtained and arranged in tabular form.

In giving these figures no allowance has been made for the fact that the operating frequency is 99.615 percent of the antenna frequency instead of 100 percent. This discrepancy will be taken care of when the circuit is actually adjusted. The error involved is less than the accuracy with which the various coils and condensers can be measured, and final adjustment must be made by tuning the various circuits separately with a small oscillator and wavemeter.

Unit	Volts	Am- peres	Impe- dance	Value
L_c	9,400	2.1 (a.c.)	4,480	39 milli-henrys
C_b			43.5	0.2 mfd.
C_p	9,400	267	35.2	0.247 mfd.
L_p		267	27.95	243 micro-henrys
M	369	267	1.38	12 micro-henrys
M_a			20	174 micro-henrys
C_o	2,350	67.8	34.7	0.251 mfd.
L_o	1,980	67.8	29.2	254 micro-henrys

RECAPITULATION OF CRITERIA

C_p has such a value that 4π times output watts will correspond to a current required to give the proper plate voltage.

M_a is assumed by inspection of Figure 42 and must be large enough to give reasonable separation of resonant points and transmit the required power.

C_b is arbitrarily assumed. The test of its choice is whether L_c is found to have a reasonable value and whether proper grid phasing can be obtained.

L_p follows from the choice of M_a .

L_c must take as many volt-amperes lagging as C_b takes leading.

The directions of grid circuit voltage vectors are fixed because E_{C_o} must be 180° from E_p , and $I_{L_p} X_M$ must be 90° from I_{L_p} . If the circuit is to tune at 109 percent frequency

$$I_{L_o} X_{L_o} / E_{C_o} = \frac{1}{1.09^2}.$$

The grid requirements set the length of E_{C_o} and the circuit losses determine what the remaining constants must be.

(To be concluded)

SUMMARY: Chapter IV. The general method of designing any but the simplest of circuits is to draw a vector diagram and then calculate circuit constants that will give vectors of the proper lengths and directions. This method has been exemplified by designing a circuit in which the grid is tuned and contains the load. The plate circuit is magnetically coupled and is partially tuned to act as an harmonic by-pass. A numerical example of the method is given.

Chapter V.—The criteria for double periodicity of two coupled circuits are first developed and it is shown that for a singly periodic circuit the secondary volt-amperes cannot exceed the primary. The maximum power which can be transferred to the secondary is limited by this requirement. A greater amount of energy can be transferred by a closer coupling, which results in making the circuit doubly periodic, and tuning the circuits individually to

other than the desired frequency. High power will then be delivered on only one of the stable frequencies. The method of designing a circuit to deliver energy under such conditions is developed. Such a circuit always tends to oscillate at the frequency giving least load. It is shown that grid keying cannot be used without other modifications of the circuit. Signaling can be carried on by changing plate voltage, by maintaining a residual oscillation from an auxiliary source, by inserting resistance in the high voltage direct current circuit between filament and ground, or by discriminating against one of the stable frequencies by grid phasing. A doubly periodic circuit may even operate at both frequencies simultaneously unless proper conditions are maintained.

DIGESTS OF UNITED STATES PATENTS RELATING TO
RADIO TELEGRAPHY AND TELEPHONY*

ISSUED APRIL 24, 1923—JUNE 19, 1923

BY

JOHN B. BRADY

(PATENT LAWYER, OURAY BUILDING, WASHINGTON, D. C.)

1,452,610—M. Klosner, filed September 2, 1920, issued April 24, 1923.

ELECTRICAL CONDENSER having a set of stationary plates and a set of adjacent turnably adjustable plates contained in an air-tight casing. A weight is connected to the adjustable plates for normally maintaining the sets of plates in non-interleaved relation. The condenser is mounted with the adjustable plates on a horizontal axis thru the center of the casing with the stationary plates supported in the upper portion of the casing.

1,452,849—H. J. Round, filed December 13, 1921, issued April 24, 1923. Assigned to Radio Corporation of America.

RADIO TRANSMITTING STATION, in which the antenna system is situated at a distance from the generator, as in the case of a multiple transmitting station employing a plurality of transmitters operating simultaneously on different wave lengths. In this invention the antenna loading inductances or a portion thereof is replaced by a trunk cable extending from the foot of the antenna to the generator or power house. This cable is shielded from the earth by a system of wires which surround the cable in the form of a cage. This cage may be electrically connected with the counterpoise.

1,452,925—W. H. Nottage and T. D. Parkin, filed December 18, 1920, issued April 24, 1923. Assigned to Radio Corporation of America.

RADIO TELEGRAPH CALLING DEVICE having a balance wheel relay at the receiver. The relay consists of a spring-controlled bal-

*Received by the Editor, July 3, 1923.

ance wheel operated by an electromagnet the circuit of which is interrupted by the oscillations of the wheel. The relay may be unaffected by ordinary received signals, yet when a train of impulses at predetermined intervals is incident upon the receiver, the oscillations of the relay are increased by the impulses sufficiently to enable it to actuate a bell or other signal or operate in some way an electric circuit for the control of apparatus. In order to operate the control circuit the calling signals must be transmitted in impulses at regular intervals corresponding to the natural oscillation period of the balance wheel of the oscillator.

1,452,957—E. H. Colpitts, filed August 23, 1916, issued April 24, 1923. Assigned to Western Electric Company.

HIGH FREQUENCY SIGNALING circuit for two-way telephonic communication where a repeater radio station is arranged to receive signals at one frequency and re-transmit the energy at a different frequency. The arrangement of the circuits is such that useless local circulation of power at the repeater station causing "singing" is prevented.

1,452,960—W. T. Ditcham, filed December 18, 1920, issued April 24, 1923. Assigned to Radio Corporation of America.

RADIO TRANSMITTER control circuit for producing signals without interrupting the oscillation generator. A primary and a secondary circuit are employed in the transmitter and a portion of one of the windings is extended to transfer energy from the primary circuit to the secondary circuit. A key is provided for short-circuiting the extended portion of the inductance for producing the signals. The extended portion of the inductance is relatively small compared to the remaining inductance in its circuit whereby the generator will oscillate at substantially the same frequency as before, but no direct effect will be imparted to the radiating antenna system.

1,453,267—J. L. Bradford, filed November 29, 1918, issued May 1, 1923. Assigned to De Forest Radio Telephone and Telegraph Company.

ELECTRON-EMITTING CATHODE AND METHOD OF MAKING THE SAME. A filament electrode is described in this patent, which discards the idea of coatings on filaments. The new filament is formed in a homogeneous mass by mixing together a

base material containing tungsten, an oxide and a chloride of metals of the alkali earth group, and then amalgamating the mixture into a solid bar from which the filaments may be swaged or drawn. The object of manufacturing the electron filament material is to secure a more constant and uniform electron-emitting body having greater physical strength and more stability than coated filaments now employed.

1,454,085—E. A. Sperry, filed January 27, 1917, issued May 8, 1923.

ELECTRIC INDICATOR FOR VIBRATIONS OF THE AIR which makes use of a long spindling slender gas flame which is acted upon by vibrations of air changing its characteristics. A plurality of conductors are arranged adjacent to the flame, one being nearer the base of the jet than the others and thereby unequally heated. Any change in the flame causes increase in the unequal heating and changes the conductivity of the conductors which are electrically connected to employ usefully the change in current to actuate an indicator.

1,454,307—A. L. Anderson, filed December 23, 1919, issued May 8, 1923. Assigned to Augustus Taylor.

RADIO TELEGRAPHY using the arc as a transmitter. The invention provides a uni-wave arc signaling circuit. A radiating antenna circuit and a non-radiating circuit or absorbing circuit shunted about the arc generator are provided. Two circuits containing resistance and a key are independently coupled with each of the above circuits and one closed when the other is opened for producing the signals. The closed circuit will always contain a substantial amount of resistance.

1,454,328—A. Meissner, filed September 3, 1921, issued May 8, 1923.

RECEIVING ARRANGEMENT FOR RADIO TELEGRAPHY, wherein a tube having a common filament, two grids and two plates is employed, and a circuit provided whereby the received oscillations are impressed on one of the grids and an audio frequency oscillating current impressed on the other grid. The incoming energy is rectified and amplified and enables the local alternating current source to actuate a translating device.

1,454,532—W. E. Beatty, filed August 1, 1917, issued May 8, 1923. Assigned to Western Electric Company.

METHOD AND MEANS FOR SECRET SIGNALING for rendering radio telephonic conversation unrecognizable by the usual receiving apparatus. At the transmitter, the frequency of the carrier wave is varied gradually over a pre-determined range. At the receiver the received waves are detected by combination with a series of similar frequencies and the resultant signals combined to operate a reproducing circuit.

1,454,592—H. R. C. Van De Velde, et al, filed January 7, 1921, issued May 8, 1923. Assigned to Radio Corporation of America.

RADIO DIRECTION-FINDING MEANS FOR AND METHOD OF PILOTING AIRCRAFT, wherein the pilot of the aircraft flies the machine in a direct line to a radio beacon station located on the aerodrome which he desires to find. The direction finder includes a pair of coils disposed at right angles with each other, one being supported on a wing or plane of the aircraft and the other being supported on the fuselage of the machine. A radiogoniometer is connected with the loop circuits. The search coil of the instrument is mounted to rotate with control wires secured to the rudder bar in such manner that when the rudder is moved in a clockwise direction the search coil is rotated in a counter-clockwise direction always to maintain the circuits in proper relation for the reception of a particular transmitting station.

1,454,598—W. T. Ditcham, filed December 18, 1920, issued May 8, 1923. Assigned to Radio Corporation of America.

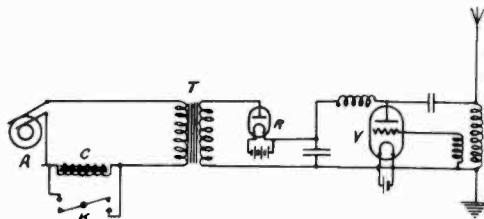

NUMBER 1,454,598—Radio Transmitter

RADIO TRANSMITTER having an oscillating valve circuit supplied from a source of alternating current with a rectifier interposed between the source of supply and the oscillating valve. An impedance is connected in the supply circuit with a key for short-circuiting the impedance and making telegraph signals. The impedance is of such value that, when it is not short-cir-

cited during space intervals between signals, the valve will continue to oscillate substantially at the same frequency as it normally oscillates during signal periods, but will generate only a small current compared to its normal working current. The purpose of the invention is to eliminate key clicks usually heard when keying the valve transmitter.

1,454,624—C. C. Chapman, filed April 27, 1920, issued May 8, 1923. Assigned to Augustus Taylor.

RADIO TELEGRAPHY SIGNALING SYSTEM employing the arc generator with a circuit arrangement for signaling by a single frequency eliminating the presence of the compensating wave. An oscillatory absorbing circuit is arranged to be connected with the arc generator with an interrupter for alternately completing the absorbing circuit or the antenna circuit at an audio frequency. The radiating signals have a group frequency within the range of audibility so that the groups may be received and detected by a receiver which would respond to radio frequency continuous waves.

1,454,629—H. F. Elliott, filed June 6, 1921, issued May 8, 1923. Assigned to Augustus Taylor.

RADIO TELEGRAPHY SIGNALING SYSTEM employing an arc generator for efficiently transmitting with a single wave. An absorbing circuit is employed connected to simulate the characteristics of the antenna circuit between signals. A plurality of "sector secondary circuits" are inductively coupled with the inductances in both the antenna circuit and the absorbing circuit. A key is placed in each of the segments in the sector circuits whereby all of the circuits may be closed or opened simultaneously to change the electrical constants of the oscillatory circuits alternately for producing the signals. A connection is taken from the central point of the sector circuits to ground for discharging the current induced in the sector circuits.

1,454,630—H. F. Elliott, filed June 6, 1921, issued May 8, 1923. Assigned to Augustus Taylor.

RADIO TELEGRAPHY signaling system employing an arc circuit for signaling with a uni-wave. An oscillatory circuit is shunted around the arc generator circuit with a transformer coupling the oscillatory circuit with the antenna circuit. A keying circuit including inductances and resistances is coupled

thru said inductances with the inductance in the antenna circuit and the inductance in the oscillatory circuit. The antenna and the local oscillating circuits are tuned to the same frequency, and by varying the electrical constants of one circuit or the other, the arc is caused to oscillate on one circuit to the practical neglect of the other. The residual current which usually exists in the antenna circuit is reduced by employing the coupling between the local oscillatory circuit and the antenna circuit.

1,454,652—H. Pratt, filed November 22, 1921, issued May 8, 1923. Assigned to Augustus Taylor.

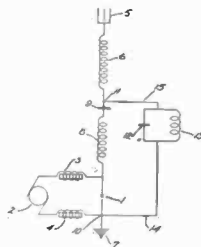

NUMBER 1,454,652—
Radio Frequency
Transmission System

RADIO FREQUENCY TRANSMISSION SYSTEM utilizing an arc generator connected in an antenna circuit. An additional circuit is connected across the antenna load circuit which has a maximum impedance for the working wave, but which serves to by-pass or absorb currents of all frequencies except that required for transmission, and thereby the additional circuit tends to suppress the radiation of harmonics.

1,454,997—G. Greco, et al, filed April 18, 1922, issued May 15, 1923.

CRYSTAL DETECTOR formed within a dustproof dome-shaped casing which incloses the crystal and a contact wire which is bent over and placed in contact with a sensitive point on the crystal. The construction is intended to eliminate the necessity for constantly readjusting the setting of the detector to maintain a sensitive point.

1,455,099—W. R. G. Baker, filed January 5, 1922, issued May 15, 1923. Assigned to General Electric Company.

RADIO FREQUENCY SIGNALING SYSTEM employing a tube

transmitter. The invention relates to a circuit arrangement for generating oscillations in the grid circuits of the tubes independently of any coupling with the plate circuits. A series condenser is connected in the grid circuit and shunted by a resistance for maintaining the average potential of the grids negative with respect to the cathodes. The tubes are supplied from alternating current and an interrupter provided which cuts off the power supply to a rectifier, periodically causing the production of oscillations in the transmitter tube circuits.

1,455,141—P. D. Lowell and Francis W. Dunmore, filed March 27, 1922, issued May 15, 1923.

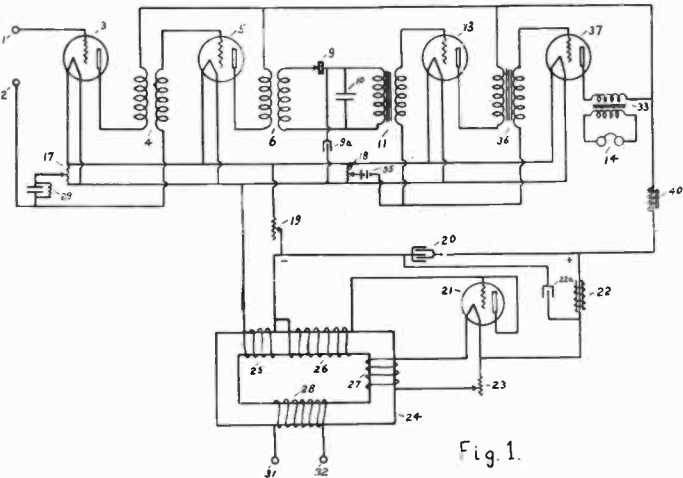

FIG. 1.
NUMBER 1,455,141—Radio Receiving Apparatus

RADIO RECEIVING APPARATUS, comprising an electron tube receiver wherein the filament and plate circuits are supplied from the house lighting circuit, dispensing with the primary and secondary batteries which have been a continuous source of inconvenience in the past. Means are provided for eliminating the alternating current hum from the receiving circuits.

1,455,458—J. S. E. Townsend, filed October 15, 1916, issued May 15, 1923.

MEANS FOR DETECTING SMALL ELECTRIC CURRENTS particularly adapted for wave meters. An evacuated bulb having its filament connected in series with a choke coil and a battery of sufficient strength to heat the filament to a temperature slightly

above or below the point of incandescence is employed in a series of circuit arrangements. The lamp is in a sensitive condition to show visually any small change of temperature due to the passage thru the filament of small additional current. Therefore when any radio frequency at a proper resonant period is superimposed on the circuit, the lamp becomes a quantitative indicator of relative amounts of energy picked up at different frequencies.

1,455,767—J. Slepian, filed December 31, 1921, issued May 15, 1923. Assigned to Westinghouse Electric and Manufacturing Company.

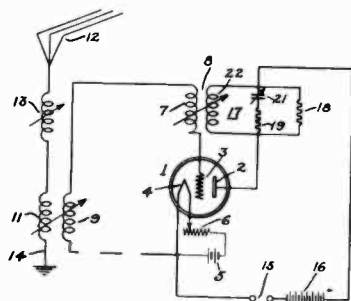

NUMBER 1,455,767—Radio Receiving System

RADIO RECEIVING SYSTEM, using a regenerative feed-back circuit adjusted to a point where an increase in the amplitude of the oscillations causes a more than proportional increase in the feed-back power, tending to maintain the oscillations continuously. The unbalanced condition of the system, which is effective following the application of the signal impulses, is made stable a pre-determined time interval thereafter by means of thermally responsive elements having a time lag in their response. The maximum amplitude attained by the oscillations at the end of said time lag is dependent upon the intensity of the impulses tending to unbalance the system. The thermally responsive elements are connected in shunt with the coupling coil in the plate circuit of the tube and have a high negative temperature coefficient and a definite time lag.

1,455,768—J. Slepian, filed January 20, 1922, issued May 15, 1923. Assigned to Westinghouse Electric and Manufacturing Company.

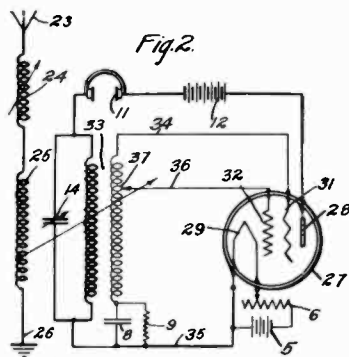

NUMBER 1,455,768—Radio Receiving System

RADIO RECEIVING SYSTEM of the regenerative feed-back type having a provision for causing the circuit to oscillate intermittently, the oscillatory current being controlled by the intensity of the received signals. A circuit for securing intermittent oscillations at the receiver by this method is shown in the accompanying cut.

1,455,781—W. Dubilier, filed December 7, 1921, issued May 22, 1923. Assigned to Dubilier Condenser and Radio Corporation.

ELECTRICAL CONDENSER in which a plurality of condenser sections are employed and connected in parallel thru a light fusible conductor so that should any of the sections become inoperative by short-circuit, they will be automatically disconnected from the circuit by destruction of the fuse elements.

1,455,795—L. Logan, filed December 20, 1920, issued May 22, 1923.

MEANS FOR CONTROLLING A PRODUCTION PROCESS utilizing radiant energy in the form of light waves. Light is directed upon a light-sensitive cell, and the amount thereof controlled by a mechanical movement which is desired to reproduce by a reverse process at a receiver. Many applications of the invention are listed in the specification such as the accurate measurement of an object, the determination of dimensions of optical glass, the control of liquid level in a tank by light reflection, and rotary shaft movements.

1,455,845—N. Lea, filed May 2, 1921, issued May 22, 1923.

Fig. 3.

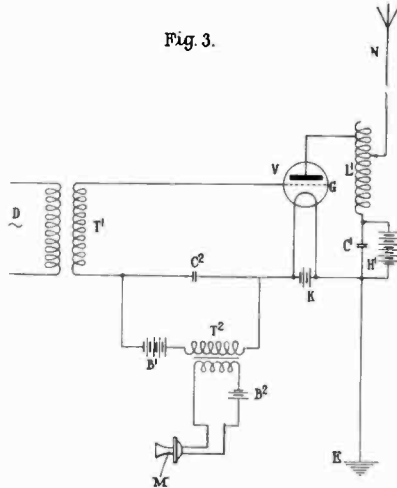

NUMBER 1 455,845—Modulated Signaling System Particularly Applicable to Radio Signaling

MODULATED SIGNALING SYSTEM PARTICULARLY APPLICABLE TO RADIO SIGNALING, in which an electron tube circuit is provided having a source of radio frequency oscillations connected in the grid circuit and a microphone for modulating the source also connected in the grid circuit. The grid potential is fixed at a negative value of greater magnitude than that sufficient to reduce the anode current approximately to zero.

1,455, 896—L. B. Turner, filed February 9, 1921, issued May 22, 1923.

RADIO TELEGRAPH RECEIVER arranged for high speed signaling. The patent points out that receivers are limited in operating speed by the slowness with which oscillations die away during the space interval immediately following the signal. By this invention the receiving circuit is "curbed" by connecting a relay in a portion of the output receiver circuit which automatically increases the decrement of the oscillatory circuit when the amplitude of the received current reaches the operative value. The circuit retains the increased decrements a substantial time during the space interval following the signal.

1,456,505—W. A. Knoop, et al, filed May 12, 1919, issued May 29, 1923. Assigned to Western Electric Company.

ELECTRIC DISCHARGE DEVICE in which the frame for the

electrodes of the tube is imbedded in the glass press of the tube, which frame supports the electrodes and also serves to provide electrical connections between the electrodes and the terminal points on the tube. A block of insulating material serves to support the frame wires at the upper extremity thereof.

1,456,528—H. D. Arnold, filed May 10, 1915, issued May 29, 1923. Assigned to Western Electric Company.

ELECTRIC DISCHARGE DEVICE designed so that the electrodes do not retain an amount of occluded gases to vary the vacuum in the tube during the life of the tube. The plate electrode is composed of a narrow strip of metal which is folded back and forth on itself to provide a ribbon plate electrode free from occluded gases, which might be contained in a solid plate electrode and which later manifest themselves during the operating life of the tube.

1,456,504—W. G. Houskeeper, filed April 13, 1920, issued May 29, 1923. Assigned to Western Electric Company, Incorporated.

ELECTRODE SUPPORTING DEVICE which avoids the necessity of wires being imbedded in the glass frame within the tube. The wires which support the electrodes are twisted over a glass frame and are then secured to the electrodes, avoiding the necessity for imbedding the support wires in the glass.

1,456,595—C. A. Hoxie, filed April 13, 1918, issued May 29, 1923. Assigned to General Electric Company.

RECORDING APPARATUS of the photographic type in which the incoming signals produce movement of a diafram which in turn vibrates a mirror reflecting light on a sensitive film which is developed to provide a record of the received signals.

1,456,867—F. Conrad, filed May 15, 1919, issued May 29, 1923. Assigned to Westinghouse Electric and Manufacturing Company.

APPARATUS FOR THE RECEIPT OF RADIO IMPULSES for radio control purposes. The receiving circuit is rendered highly selective by dynamically interlinking the receiving relay with the antenna thru two local circuits, one of which is tuned to resonate to the radio frequency and the other of which is tuned to resonate to the spark or group frequency of the transmitter.

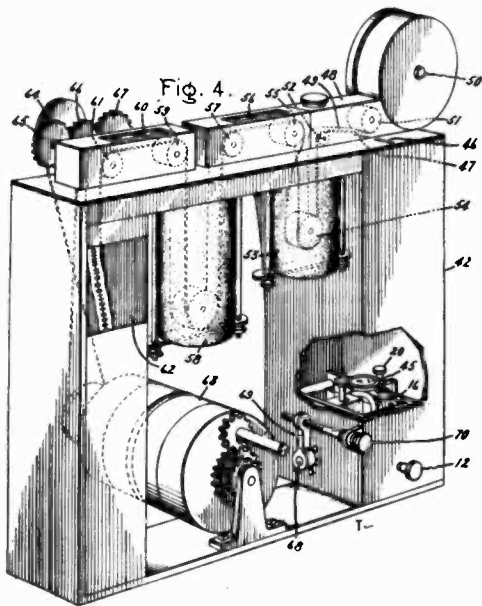

NUMBER 1,456,595—Recording Apparatus

1,457,069—L. Levy, filed September 27, 1919, issued May 29, 1923.

RECEIVING SYSTEM FOR ELECTRIC WAVES, highly selective to a particular signaling frequency and substantially unresponsive to interfering signals and atmospherics. The antenna circuit is provided with a succession of frequency-selective circuits and a selective amplifier and detector employed. A succession of acoustical frequency circuits are then provided for translating the signal into a pre-determined audible frequency.

1,457,447—J. Mills, filed December 22, 1921, issued June 5, 1923. Assigned to Western Electric Company, Incorporated.

RADIO RECEIVING CIRCUITS employing successive detection circuits and two independently rotatable directive loops connected in series and tuned to different frequencies. The circuit arrangement enables duplex operation where one loop may receive from a local transmitter with an impedance varying element operated simultaneously with the rotation of the loop and the other loop may operate on a distant station.

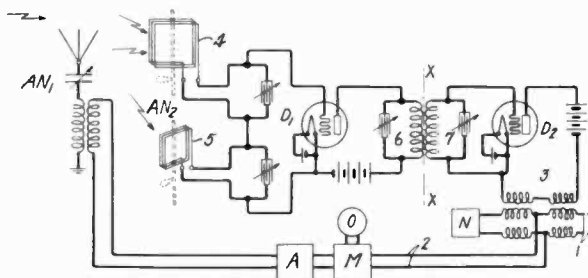

NUMBER 1,457,447—Radio Receiving Circuits

1,458,153—F. H. Shaw, filed August 20, 1919, issued June 12, 1923.

VACUUM TUBE BASE AND RECEPTACLE comprising a cylindrical shell forming the base of an electron tube inturred at one end to form a locking flange, and provided with an insulating closure molded into sealing relation with the other end of the shell. The shell is supported in the insulating material and the leads from the electrodes are carried thru the insulated material to contacts molded in the insulated closure. The tube base is supported in a socket provided with binding posts making connections with the contacts.

1,458,165—W. W. Coblentz, filed September 22, 1920, issued June 12, 1923.

SYSTEM OF ELECTRICAL CONTROL employing light rays of different coloring. A Wheatstone bridge circuit is employed at the receiver having photo-sensitive cells connected in the arms thereof with a relay circuit connected across the bridge, whereby light rays focused upon the photo-sensitive cells cause a change in the electrical conductivity of the cells, causing the relay to be operated.

1,458,466—A. Crossley, filed July 7, 1919, issued June 12, 1923.

ANTENNA SELECTOR SWITCH for combining different characteristics of antennas at a radio receiving station. The switch is illustrated in combination with four groups of ground wires extending in opposite directions. Each group of wires includes three conductors of different lengths. The ends of the conductors are connected to contact points on a switch panel. A pair of switch blades are arranged to be independently moved over the contacts to select different wires. The blades are con-

nected with the radio receiving apparatus so that different conductors may be readily chosen to secure the best radio receiving results.

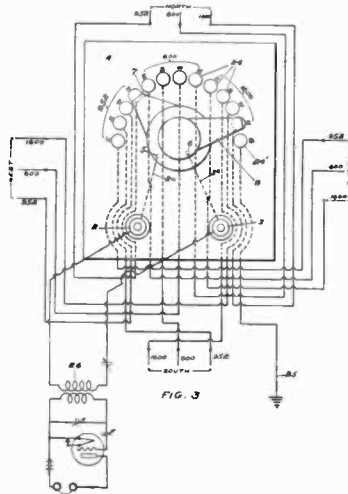

NUMBER 1,458,466—Antenna Selector Switch

1,458,949—H. W. Nichols, filed January 7, 1922, issued June 19, 1923. Assigned to Western Electric Company, Incorporated.

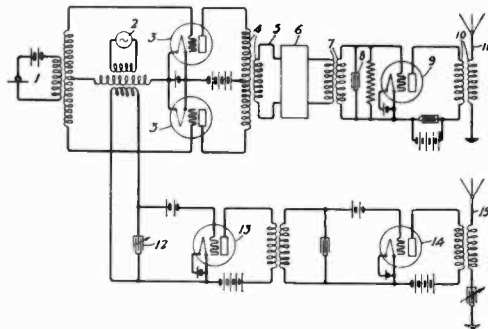

NUMBER 1,458,949—Carrier Radio Telephone System

CARRIER RADIO TELEPHONE SYSTEM, in which one side band component of the modulated wave is radiated and the carrier wave separately radiated. At the distant receiver these frequencies are combined to translate the signal. The object of the

invention is to provide a system where the capacity of the amplifiers required for a given amount of useful power radiated is less than 50 percent for a given power output of that in systems transmitting the carrier and both side band components.

1,459,308—D. G. McCaa, filed April 6, 1920, issued June 19, 1923. One-third assigned to Federal Telegraph Company of San Francisco.

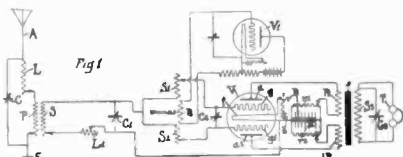

NUMBER 1,459,308—Signaling Apparatus

SIGNALING APPARATUS, intended for the substantial elimination of static disturbances at the receiver. The secondary circuit is divided at the receiver by means of inductances S^1 and S^2 so that received signals simultaneously operate the grids of tube or tubes V . Primary windings P^1 and P^2 are connected in the respective plate circuits and differentially act upon the translating circuit S^3 . The current changes in the primaries P^1 and P^2 are therefore equal, and since these primaries oppose each other in their inductive effects upon the secondary S^3 , there is no response by the telephone T on receipt of undesired signals or disturbances. In order to receive the desired signals a primary P^3 is arranged to superimpose oscillations from oscillating circuit V^1 on the receiving circuit differing in frequency a selected amount from the signal frequency to produce beats which cumulatively affect the signal translating circuit.

1,459,400—C. D. Hocker, filed November 17, 1916, issued June 19, 1923. Assigned to Western Electric Company, Incorporated.

ELECTRON-EMITTING CATHODE AND PROCESS OF MAKING THE SAME, to improve the characteristics of cathodes in the following particulars:

1. To make the thermionically active coating adhere more firmly to the electrode or filament by mechanically binding the active coating materials to the filament.

2. To increase the electron emission at any given temperature.
3. To lengthen the life of the filament at any given temperature.

A noble metal such as gold, silver or platinum is used to bind mechanically a metal of the alkaline earth group to the filament. Barium, strontium, and calcium may be used in the coating with the substance containing a noble metal and the coatings baked on the filament.

1,459,412—A. McL. Nicolson, filed April 16, 1915, issued June 19, 1923. Assigned to Western Electric Company.

THERMIONIC TRANSLATING DEVICE having a cathode comprising an insulated tube such as quartz tube, the surface of which is coated with a thermionically active coating, with a heating element within the tube for rendering the surface thermionically active. The area of the cathode is increased and the output of the tube accordingly increased.

1,459,417—P. Schwerin, filed November 1, 1916, issued June 19, 1923. Assigned to Western Electric Company, Incorporated.

ELECTRON DISCHARGE DEVICE for operating at high power. The plate electrode of the tube is continuously cooled to prevent excessive heating due to electronic bombardment from the cathode. The plate electrode is constructed in the form of a conduit having an inlet and an outlet for the flow of cooling medium therethru. The power with this type of tube may be increased, for it is not limited by the normal melting point of the anode or that temperature at which the anode would normally throw off occluded gasses if it were not water cooled.

1,450,080—L. A. Hazeltine, filed August 7, 1919, issued May 22, 1923.

METHOD AND ELECTRIC CIRCUIT ARRANGEMENT FOR NEUTRALIZING CAPACITY COUPLING, which consists in winding an additional coil over the secondary coil of the tuning system in such position that the additional coil forms a capacity shield between the primary circuit and the secondary circuit. The auxiliary coil and the secondary coil are connected with terminals of unlike polarity together, the auxiliary coil being interposed in the electrostatic field created between the coupling coils to neutralize capacity coupling.

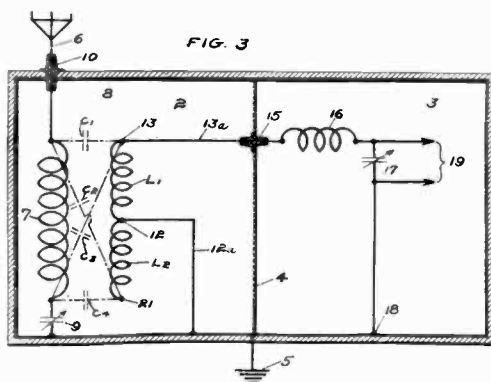

NUMBER 1,450,080—Method and Electric Circuit Arrangement for Neutralizing Capacity Coupling

LIST OF RADIO TRADE MARKS PUBLISHED BY PATENT OFFICE PRIOR TO REGISTRATION

The numbers given are serial numbers of pending applications:

- 153,200—"REMLER" for radio apparatus. E. T. Cunningham, San Francisco, California. Claims use since February, 1919. Published June 26, 1923.
- 167,229—"DE FOREST," a facsimile of Lee De Forest's signature. De Forest Radio Telephone and Telegraph Company, Jersey City, New Jersey. Claims use since 1913. Published June 26, 1923.
- 175,091—"LYRADION" for radio receiving apparatus. Lyradion Manufacturing Company, Mishawaka, Indiana. Claims use since about March, 1922. Published June 26, 1923.
- 175,472—"HIS DADDY'S CHOICE" for radio transmitting and receiving sets. De Forest Radio Telephone and Telegraph Company, Jersey City, New Jersey. Claims use since December 15, 1922. Published June 26, 1923.
- 177,790—"LYRADION" for combined phonographs and radio receiving apparatus. Lyradion Manufacturing Company, Mishawaka, Indiana. Claims use since in or about March, 1922. Published June 26, 1923.
- 178,957—"CUNNINGHAM," in facsimile of signature of Elmer T. Cunningham, for radio receiving apparatus. E. T. Cun-

- ningham, San Francisco, California. Claims use since October, 1920. Published June 26, 1923.
- 178,783—"TUNUP" in ornamental design for radio receiving apparatus. U. S. Tool Company, Inc., Newark, New Jersey. Claims use since January 11, 1923. Published June 26, 1923.
- 179,337—"ADAPTAPHONE" for device for attaching telephone receiver to sound amplifier. The Teagle Company, Cleveland, Ohio. Claims use since March 23, 1922. Published June 26, 1923.
- 179,380—"THE RADIO CONSTRUCTOR" for radio magazine. S. Newman and Company, New York City. Claims use since December, 1922. Published June 26, 1923.
- 179,971—"TEMPHONE" for telephone instruments. S. F. Stein, Williamsport, Pennsylvania. Claims use since September 27, 1922. Published June 26, 1923.
- 169,727—"RADIO CORPORATION OF AMERICA, WORLD-WIDE WIRELESS" in ornamental design for radio receiving, detecting, amplifying, and transmitting apparatus, and parts thereof. Radio Corporation of America, New York City. Claims use since April 19, 1922. Published June 26, 1923.
- 177,552—"LISTEN-IN" for radio record books. E. Fleming and Company, Cambridge, Massachusetts. Claims use since March 8, 1923. Published May 22, 1923.
- 164,317—"VENUS" for radio receiving sets. Horne Manufacturing Company, Jersey City, New Jersey. Claims use since April 15, 1922. Published May 29, 1923.
- 171,544—"THROATYPE" for loud speaker. Master Radio Corporation, Los Angeles, California. Claims use since August 10, 1922. Published May 29, 1923.
- 175,437—"POSACO RADIO" in ornamental design, for radio equipment. C. D. Rotter Company, Stamford, Connecticut. Claims use since July 6, 1922. Published May 29, 1923.
- 175,739—"RUSONITE" for detectors. Rusonite Products Corporation, New York City. Claims use since April 1, 1922. Published May 29, 1923.
- 175,549—"FISCHER-RADIO" in ornamental design, for variocouplers and variometers. G. H. Fischer Company. Glen-

- dale, New York. Claims use since January 15, 1922. Published May 29, 1923.
- 175,865—"AMSCO PRODUCTS" in ornamental design for radio apparatus. Charles Hardy doing business as Advanced Metal Stamping Company, New York City. Claims use since April 25, 1922. Published May 29, 1923.
- 176,400—"SODION" for radio apparatus. The Connecticut Telephone and Electric Company, Meriden, Connecticut. Claims use since about February 14, 1923. Published May 29, 1923.
- 176,635—"BLUE STREAK" for telephone receivers for use with radio apparatus. Marinette Electric Corporation, Marinette, Wisconsin. Claims use since May 1, 1922. Published May 29, 1923.
- 176,676—"NEUTRODYNE" for radio receiving sets. Louis A. Hazeltine, Hoboken, New Jersey. Claims use since February 23, 1923. Published May 29, 1923.
- 178,281—"AMPLICITE" crystals for detectors. Radio Mineral Company, Newark, New Jersey. Claims use since February 15, 1923. Published May 29, 1923.
- 109,000—"BANNARD" for radio receiving apparatus. Triangle Electric Trading Company, New York City. Claims use since 1916. Published May 29, 1923.
- 164,617—"WAV-OM-ETER" for radio sets and parts thereof. Washington Radio Corporation, Washington, D. C. Claims use since May 15, 1922. Published June 5, 1923.
- 167,482—"MURDOCK RADIO" in ornamental design, for radio receiving apparatus. William J. Murdock Company, Chelsea, Massachusetts. Claims use since on or about July 1, 1921. Published June 5, 1923.
- 172,494—Crystal in ornamental design for crystal detectors. Edward Reese, doing business as Standard Crystal Company, Newark, New Jersey. Claims use since on or about April 15, 1922. Published June 5, 1923.
- 175,740—"S L" in ornamental design for radio apparatus and parts thereof. The Sayre-Level Radio Company, Philadelphia, Pennsylvania. Claims use since on or about June 1, 1921. Published June 5, 1923.

- 177,241—"MICRO VERN" for dials for radio apparatus. Pacent Electric Company, New York City. Claims use since December 5, 1922. Published June 5, 1923.
- 176,021—"AMPLION" for telephone receivers. Edward Alfred Graham, doing business as Alfred Graham and Company, London, England. Claims use since September, 1920. Published June 5, 1923.
- 178,333—"DU-TEC" for crystal detectors. Dublier Condenser and Radio Company, New York City. Claims use since October 1, 1922. Published June 5, 1923.
- 169,097—"ROGERS RECEIVING RADIOMETER" for radio receiving apparatus. Bertram C. Rogers, Pittsburgh, Pennsylvania. Claims use since January 15, 1922. Published June 5, 1923.
- 169,089—"BURGESS BATTERY" in ornamental design for "B" Batteries. Burgess Battery Company, Madison, Wisconsin. Claims use since March, 1917. Published June 5, 1923.
- 168,894—"K E CO" in ornamental design for printing telegraph and radio apparatus. Kleinschmidt Electric Company, Long Island City, New York. Claims use since November 17, 1913. Published June 12, 1923.
- 177,218—"HERALD" in ornamental design for radio receiving apparatus. Etna Radio Company, Incorporated, New York City. Claims use since November 1, 1922. Published June 19, 1923.
- 169,020—"SIGNAL" for radio apparatus. Signal Electric Manufacturing Company, Menominee, Michigan. Claims use since September 1, 1919. Published May 29, 1923.

EFFICIENCY

*The goal of all worth while
manufacturers*

Leading manufacturers of radio sets are constantly striving for efficiency, because an efficient set is a satisfactory set. Intelligent design of parts, arrangement and the use of an effective insulation are three factors which assist most in reaching this goal.

RADION

is a special grade of insulation made particularly for radio use.

Radion shows the lowest phase angle difference, lowest di-electric constant and highest resistivity. In short, there are less losses where Radion is used than in any other material. It also has supreme moisture, gas and acid repelling properties.

For the convenience of manufacturers Radion is made in 18 stock sizes. Special sizes will be cut on order, however, without additional expense. Panels are made in two colors—black and mahoganite, exquisitely finished, and are the easiest to machine and engrave.

Radion is also moulded in Dials, V. T. Sockets, Condenser Ends and other parts—both in stock designs and according to individual specifications.

Manufacturers who want the utmost in efficiency will do well to ask our cooperation in the solution of insulation problems. It will gladly be given.

American Hard Rubber Co.
11 MERCER STREET NEW YORK

Manufacturers and Moulders of

RADION

Panels and Parts

"The Supreme Insulation"

ARISTOS **"COPPERWELD"** WIRE

TRADE MARK REG. U. S. PAT. OFF.

(Made by the Molten Welding Process)

**ADOPTED AND USED BY THE LARGEST
RADIO COMPANIES IN THE WORLD**

**For aerials, Copperweld has advantages over
solid copper or bronze**

Radio frequency currents, because of "skin effect," flow along the exterior of wires. The smooth exterior thickness of copper on Copperweld Wire gives it practically the same high electrical conductivity as a solid copper wire (see Letter Circular No. 62, U. S. Bureau of Standards).

Greater strength is given by its steel core. No. 14 Copperweld Antenna Wire has *50% greater strength* than No. 14 hard-drawn copper or 7-No. 22 stranded copper wires. It stays up under severe loads when copper and stranded copper wires sag and break.

For ANTENNA, No. 14 Bare Copperweld Antenna Wire
For LEAD-IN, No. 17 Rubber Insulated Copperweld Wire
For GROUND Wire, same as Lead-In Wire
For GROUNDING to earth, Copperweld Ground Rods, $\frac{1}{2}$ " diam.

Larger sizes for commercial stations

Copper Clad Steel Company
New York San Francisco Chicago
Mills and Main Office, Braddock P. O., Rankin, Pa.

350 to 400 vs 200 to 600

The new allocation of wave lengths comes very fortunately for the manufacturer at the season when the demand is slackening. This provides a breathing space for him to study his products to determine whether they still are effective under the new conditions.

The Laboratories offers facilities for experimentation of this kind.

Electrical Testing Laboratories

80th Street and East End Avenue, New York, N. Y.



Brandes

The phrase "it's just as good as Brandes" was never true. There is no radio headset, for amateur or expert, equal in all respects to Brandes—the standard for fifteen years.

And now with a production of one complete headset every ten seconds it is possible to effect such savings that new prices are announced effective August 1. The Brandes standard will, of course, be rigidly maintained.

NEW PRICES

Superior
\$6.00

Navy Type
\$8.00

Made in Canada and England by
Canadian Brandes, Limited, Toronto and London
C. BRANDES, Inc., 237 Lafayette St., N. Y. C.

Matched Tone
TRADE MARK REG. U.S. PAT. OFF.
Radio Headsets

Burgess, the *Radio* Battery

Specified by radio engineers—designed and built by wireless specialists—and recommended by the leading manufacturers of radio equipment.

Burgess Radio Batteries, the result of years of careful experiments, are built under exacting manufacturing standards which must meet the requirements of strict laboratory formulas and tests—a supervision that insures their perfect operation.

For professional or amateur radio use, where noiselessness, long life, high capacity and uninterrupted, dependable service are essential, Burgess has no superior. All progressive jobbers and dealers handle Burgess Radio Batteries.



Burgess Battery Company

DRY BATTERIES
 Engineers—Manufacturers
 Flashlight—Radio—Ignition—Telephone. General Sales Office: Harris Trust Bldg., Chicago. Laboratories and Works: Madison, Wis. Branches, New York, Boston, Washington, Kansas City, St. Paul, New Orleans. In Canada:

General Offices and Works:
 Niagara Falls, Ont.
 Winnipeg, Toronto,
 Montreal, St. John

BRACH VACUUM LIGHTNING ARRESTER



For 17 Years a Leader in the Field of Protective Apparatus



L. S. BRACH MFG. CO.

NEWARK, N. J.

DUDLO MAGNET WIRE and WINDINGS

have been developed especially to meet the exacting requirements of radio apparatus construction. With our large, modern plant and large force of workers skilled in the handling of fine wire, we are able to give you the utmost satisfaction in taking care of your wire and coil requirements.

WRITE TODAY FOR PRICES AND SAMPLES

DUDLO MANUFACTURING CO., FORT WAYNE, IND.

Pacific Coast Representative

A. S. Lindstrom, 111 New Montgomery St., San Francisco, Cal.

MURDOCK

REAL RADIO RECEIVERS

Have Been Standard
Since 1904

TYPE No. 56

2000 — OHM — \$5.00

3000 — OHM — 5.50

BUY THEM FROM
YOUR DEALER

WM. J. MURDOCK CO.
CHELSEA, MASS.

NOVO "B" BATTERIES FOR RADIO

22½ - 45 & 105 VOLTS



**NOISELESS
DEPENDABLE
GUARANTEED**

ASK YOUR DEALER

NOVO MANUFACTURING CO.

424-438 W. 33RD ST.
NEW YORK

531 SO. DEARBORN ST., CHICAGO.

Selective Advertising

Advertising in the I.R.E. PROCEEDINGS insures representation with high class radio manufacturers exclusively and presents your message to readers who are either amateurs in radio or have adopted it as a profession. No wasted circulation and rates reasonable. Full information furnished upon request.

D. V. WEED, Jr.

Advertising Manager

**The Institute of Radio
Engineers, Inc.**

**The College of the
City of New York**

NEW YORK, N. Y.



for use on a 110-volt D.C. line. Equipped with the famous Ward Leonard Vitrohm (Vitreous enamelled) Resistor Units. Literature on request.

RADIO BATTERY CHARGER

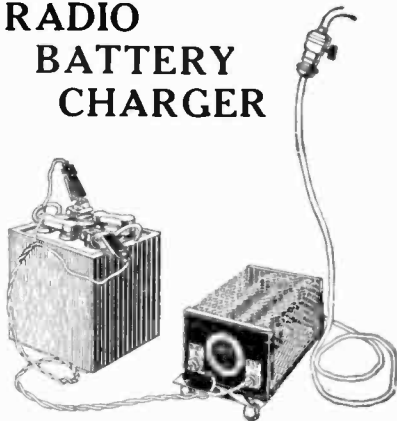

Ward Leonard Electric Company

Mount
Vernon,
New York



Tuned Radio Amplifier

Many Radio Frequency Amplifiers have been constructed, using Resistance, Impedance or Transformer coupling, but these types are inherently limited both as to degree of Amplification and wave-length range. The Grebe Type RORN Tuned Radio Amplifier is unlimited as to wave-length range, and gives the greatest possible Amplification that can be obtained from a Vacuum Tube.

It has been clearly demonstrated that all of the fixed-coupled types of amplification circuits are inherently limited, either as to amplification or wave-length range, or both.

The resistance coupled type responds almost equally well to any of the useful frequencies, but is only efficient on wave-lengths above 2,000 meters. Impedance coupling gives somewhat greater amplification than either of these, but its efficient operation is confined to a very narrow band of wave-lengths.

The Type RORN Unit has none of the defects common to the coupled type of amplifiers. With a single tube it gives greater amplification over its entire wave-length range than can be obtained with two stages of transformer-coupled type.

The RORN Unit may be used with any of the standard regenerative receivers now on the market, and is particularly adapted for use with the Grebe Receivers.

Write for Bulletin

A. H. GREBE & CO., Inc.

General Offices and Factory

72 Van Wyck Blvd.

Richmond Hill, N. Y.

Western Branch: 451 East 3rd St., Los Angeles, Cal.



**ANY GOOD
RECEIVING SET**

THE man who purchases a Magnavox for its *clearness* of reproduction, finds additional advantages in its use which contribute greatly to his enjoyment of Radio.

For instance, due to its extreme sensitivity, the Magnavox can reproduce distant signals which to ordinary reproducers would be indistinguishable.

Two Units R3 Magnavox Reproducer and 2 stage Power Amplifier . . . \$90.00

R2 Magnavox Reproducer with 18-inch curvex horn: the utmost in amplifying power . . . \$60.00

R3 Magnavox Reproducer with 14-inch curvex horn: ideal for homes, etc. \$35.00

**Model C Magnavox Power Amplifier for your Magnavox Reproducer 2 stage \$55.00
3 stage 75.00**

Magnavox Products can be had from good dealers everywhere. Write for new booklet.

THE MAGNAVOX CO.
Oakland, Cal.
New York: 370 Seventh Avenue

MAGNAVOX PRODUCTS

8-R **No Radio Receiving Set is complete without them**

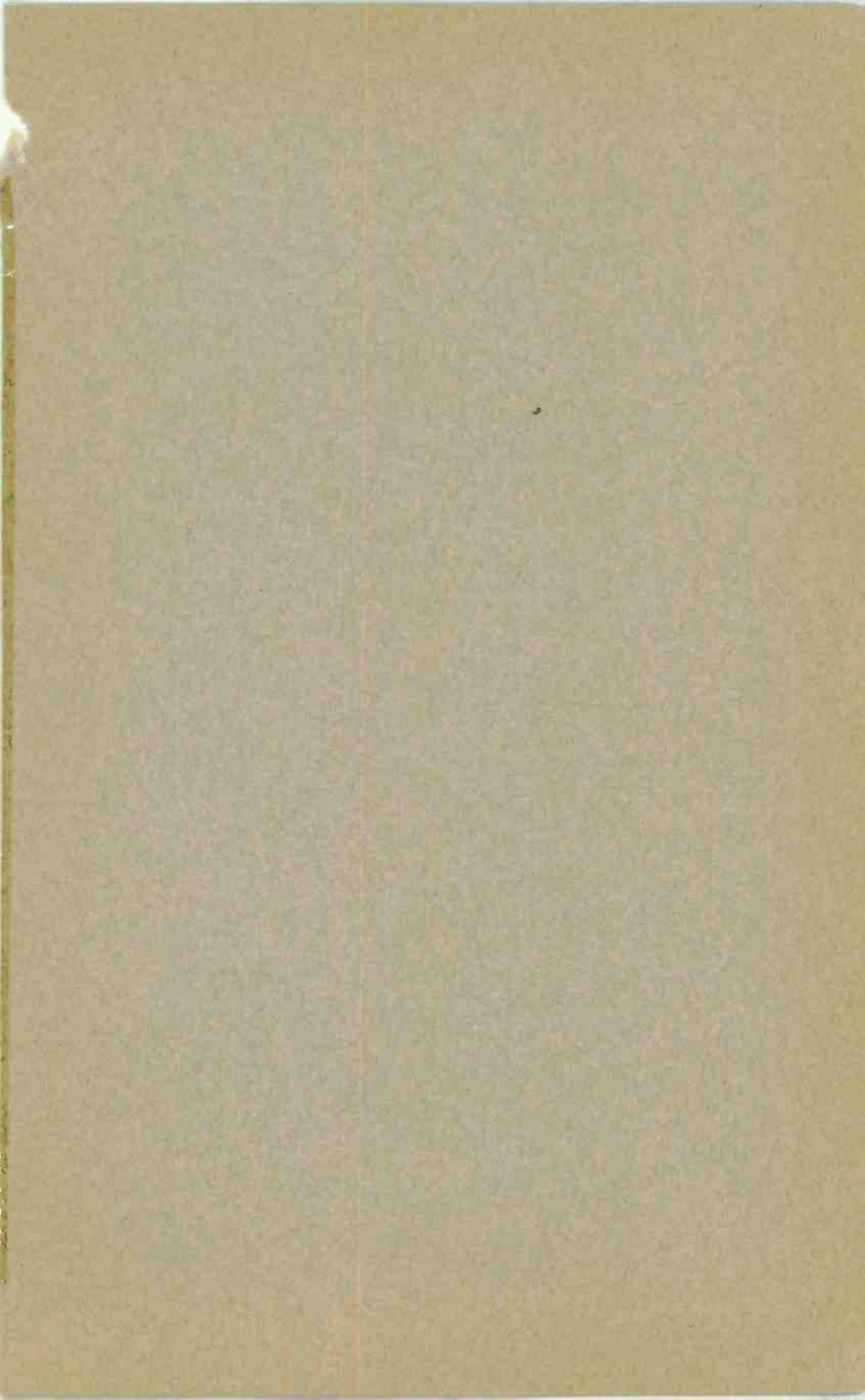

THE DeForest name has been in the forefront of radio research for twenty-three years. DeForest invented the three-electrode vacuum tube which makes present-day radio possible. The sets and parts made to-day by the DeForest Company are worthy of the DeForest name.



*Reg. U. S. Pat. Off.

