

VOLUME 11

JUNE, 1923

NUMBER 3

PROCEEDINGS  
*of*  
The Institute of Radio  
Engineers



EDITED BY

ALFRED N. GOLDSMITH, Ph.D.

PUBLISHED EVERY TWO MONTHS BY  
THE INSTITUTE OF RADIO ENGINEERS  
THE COLLEGE OF THE CITY OF NEW YORK  
140th Street and Convent Avenue, New York, N. Y

Subscription \$9.00 per Annum in the United States  
\$9.60 in all other Countries

GENERAL INFORMATION AND SUBSCRIPTION RATES ON PAGE 185

Entered as second-class matter, February 16, 1916, at the Post-Office, at New York, N. Y., under the Act of March 3, 1879.

Acceptance for mailing at special rate of postage provided for in Section 1103, Act of October 3, 1917, authorized October 7, 1918.

27 APRIL 1976  
C0133 LOT 15/2000-1A  
JN J BOTW

# *Faradon*

**FOR SERVICE**

## RADIO CONDENSERS

---

**Constant Capacity**  
**Extremely Low Losses**  
**Safety Gap Protection**  
**High Current Carrying Capacity**  
**Minimum Volume**  
**Moisture-Proof Construction**  
**Long Life**  
**Quick Deliveries**

These are the reasons why one radio engineer said that he "would not dare" let his sets go out with any condensers but FARADONS.

There are over 100 standard FARADON condensers on which immediate deliveries can be made. Complete specification list and price list will be sent on request.

**Wireless Specialty Apparatus Company**  
**BOSTON, MASS.**

*Established 1907*



## Send for These Bulletins

Every person interested in Radio should have these.

No. K-10. 3½" ammeters, milli-ammeters, voltmeters, milli-voltmeters and thermal ammeters for all receiving and transmitting sets.

No. K-20. Telephone receivers and Loud Speakers.

No. K-810. Medium and large size ammeters, milli-ammeters, voltmeters, milli-voltmeters and current squared meters for all receiving and transmitting sets.

*Distributors, write for attractive proposition*

# ROLLER-SMITH COMPANY

Electrical Instruments, Meters and Circuit Breakers

MAIN OFFICE:  
2134 Woolworth Bldg., NEW YORK



WORKS:  
Bethlehem, Pennsylvania

*Offices in Principal Cities in U. S. and Canada*

## ACME TRANSFORMERS

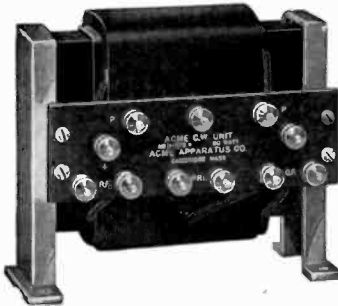

As specialists in the design and construction of Transformers we are prepared to quote prices and delivery on Transformers singly or in quantity.

Our Radio Transformers are well known for their high efficiency and ruggedness.

## ACME APPARATUS COMPANY

200 MASSACHUSETTS AVENUE  
CAMBRIDGE 39, MASS.

TRANSFORMER AND RADIO ENGINEERS AND MANUFACTURERS

# There's a Demand Today for **RADIO STANDARDIZATION**

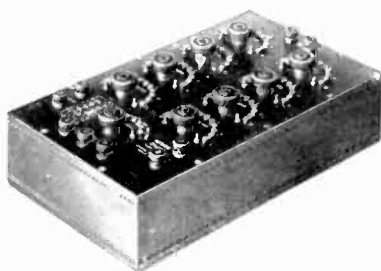

To measure accurately Resistance, Inductance and Capacitance use a General Radio Company's

Type 193

## **Decade Bridge**

Comparatively simple, extremely accurate and—like all General Radio Company instruments—guaranteed.

This bridge has three resistance arms, two of which consist of four dial decades, with a range of 0.1 to 1111 ohms. The Aryton-Perry Method of winding produces units the resistances of which are nearly independent of frequency.

Mounted in a polished walnut cabinet, fitted with a copper shield to protect against outside electrostatic fields.

**Price \$125**

For use with this bridge—

Standards of Inductance  
Standards of Capacitance  
Standards of Resistance

*All fully described in Bulletin 405R—sent free on request*

## **GENERAL RADIO CO.**

Manufacturers of

*Radio and Electrical Laboratory  
Apparatus*

Massachusetts Avenue and Windsor St.  
**CAMBRIDGE 39 MASSACHUSETTS**

*Standardize on General Radio Equipment Throughout*

5292

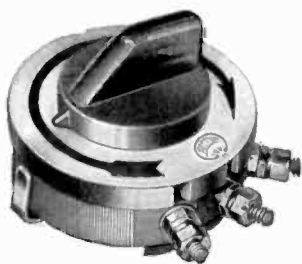

Complete  
with Dial . . . \$1.00

## The New PACENT RHEOSTAT

**E**FFICIENT, foolproof, economical. Two units. Assembled with single set screw. Simple to mount. Once mounted, no parts can loosen up. Pointer cannot turn beyond its range. Silvered dial furnished with every Rheostat can be used as template and makes it unnecessary to engrave panel. *Furnished in resistances of 6-10-20-30 ohms.*

Pacenet Potentiometer, same design (375 ohms) Cat. No. 88.....\$1.25

**PACENT ELECTRIC CO., Inc.**

22 Park Place, New York, N. Y.

*Sales Offices: Philadelphia, Chicago, St. Louis, Minneapolis, San Francisco, Washington, D. C., Jacksonville.*

**Don't Improvise—"PACENTIZE"**

# Pacenet

## RADIO ESSENTIALS

Radio Testing Laboratory

## **GREGG & COMPANY**

*Engineers*

Offer a fully equipped radio laboratory to manufacturers and consulting engineers interested in unbiased reports based on scientifically sound measuring methods. Our personnel includes radio engineers of long experience, assuring reports of great practical value.

165 Broadway

New York

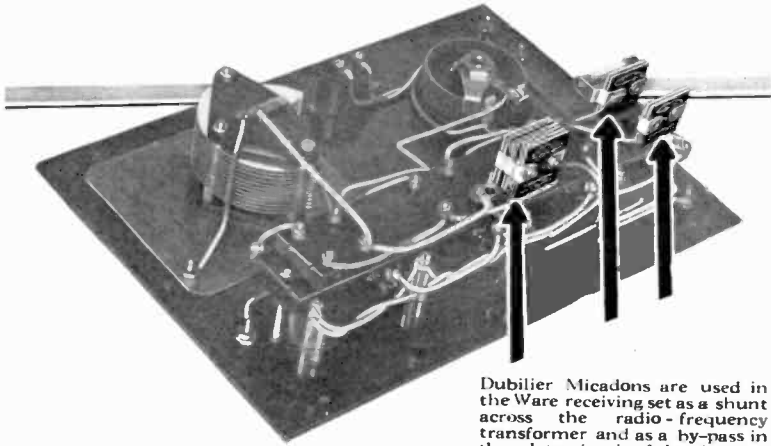

Dubilier Micadons are used in the Ware receiving set as a shunt across the radio-frequency transformer and as a by-pass in the plate-circuit of the detector tube.

## —and in Ware Receiving Sets

**O**NLY an infinitesimal amount of energy is received by any set. Losses must be avoided in amplifying it before detection. Hence the condensers in the circuit must be permanent in capacity. They must deliver all the energy stored up.

Because Dubilier Micadons alone meet this requirement they are exclusively used in the well-known efficient Ware radio sets and in other sets made by reputable manufacturers.

Unless a set is equipped with Dubilier Micadons the broadcasting station is not received at its best.

Price 35 cents to \$1.50 each, depending on the capacity.

Correspondence with designers and manufacturers of radio sets is invited

### DUBILIER CONDENSER AND RADIO CORP.

48-50 West Fourth St., New York

#### *Branch Offices in the Following Cities*

Los Angeles, Cal.  
St. Louis, Mo.

Atlanta, Ga.  
Huntington, W. Va.  
Washington, D. C.

Chicago, Ill.  
Pittsburgh, Pa.

Distributed in Canada by Canadian General Electric Company, Ltd., Toronto

# The AMERTRAN

Price \$7

A Super Audio Frequency Amplifying Transformer Without Distortion

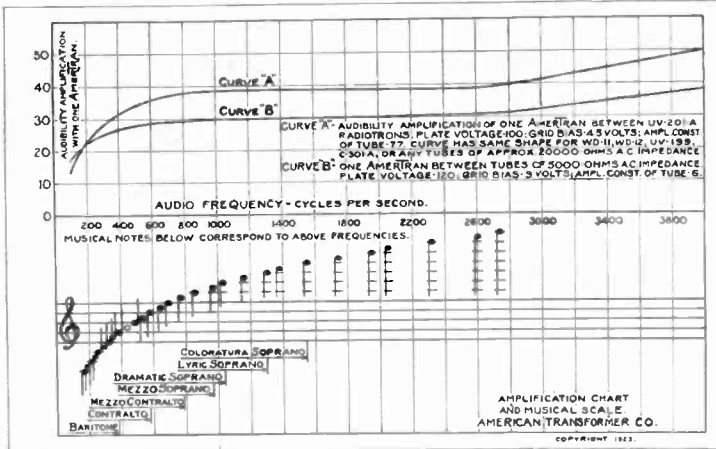

American Transformer Company

Newark, N. J.

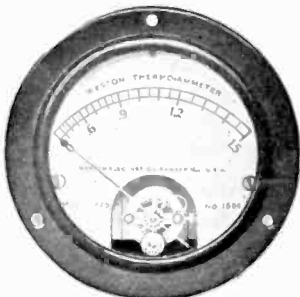

Model 425  
Thermo-Ammeter

## FOR RADIO WORK

### WESTON

Instruments offer a wide choice both in the size of the instruments and in their ranges and cover every need of the advanced experimenter and the commercial station.

*Write for information relating to the instruments you are interested in*

**Weston Electrical Instrument Co.**  
73 Weston Avenue Newark, N. J.

Electrical  
Indicating  
Instrument  
Authorities  
Since 1888

# WESTON

STANDARD - The World Over



# AMRAD

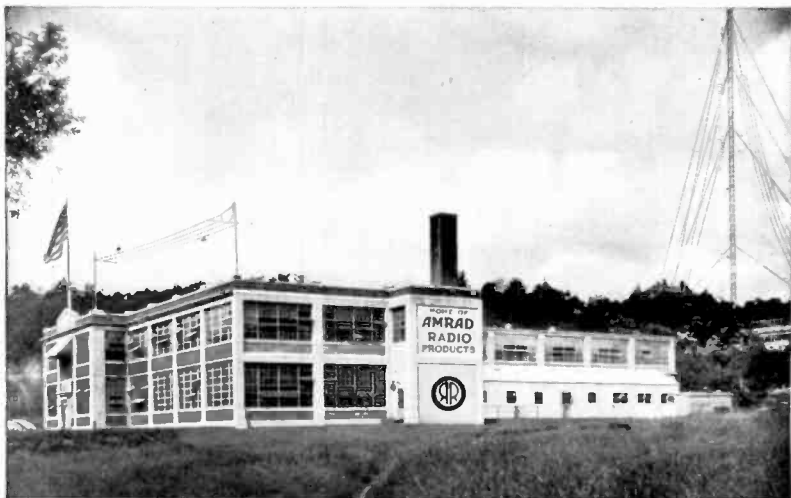

*Main Factory of the American Radio and Research Corporation, Medford Hillside, Mass. Home of Amrad Radio. Showing at extreme right Research and Engineering Laboratories and Broadcasting Station WGI, erected June 1915, the World's Oldest Broadcasting Station operating to-day*

## Reliable Radio Products

This Corporation has already manufactured for the U. S. Government alone over three-quarters of a million dollars' worth of Radio Equipment during the late War—winning an enviable reputation for precise production methods and quality workmanship. This same exactness of manufacture, preceded by organized research and planned engineering, is now employed in the building of Amrad Radio Products for the use of the Layman Public.

Among the contributions of this Corporation to the Radio Art is its development of a Vacuum Tube without a Filament—the AMRAD "S" TUBE.

### AMERICAN RADIO AND RESEARCH CORPORATION

MEDFORD HILLSIDE, MASS.

(4 Miles North of Boston)

New York

Chicago

---

# A NEW Radiotron!

**S**MALL in size, small in current consumption—drawing but .06 amperes. Yet it is an exceptional detector, and amplifier for either audio-frequency or radio-frequency. Operates on a flashlight battery, for lightweight portable receivers. Or gives remarkably long service with ordinary No. 6 dry cells.

*UV-199 has a new tungsten filament that combines the advantages of the coated and old tungsten filaments—and does away with the disadvantages of each! It is the achievement of seven years of research.*



*Actual Size*

UV-199

A tube scarcely three - and - a - half inches high! Operates on flashlight battery.



*This symbol of quality is your protection*

**Radio**  **Corporation**  
of America

*Sales Office: Suite 2065  
233 Broadway  
New York, N. Y.*

*District Offices:  
10 South LaSalle Street, Chicago, Ill.  
433 California Street, San Francisco, Cal.*

# PROCEEDINGS OF The Institute of Radio Engineers

Volume 11

JUNE, 1923

Number 3

## CONTENTS

	PAGE
OFFICERS OF THE INSTITUTE OF RADIO ENGINEERS	186
L. W. AUSTIN, "RECEIVING MEASUREMENTS AND ATMOSPHERIC DISTURBANCES AT THE UNITED STATES NAVAL RADIO RESEARCH LABORATORY, BUREAU OF STANDARDS, WASHINGTON, JANUARY and FEBRUARY, 1923"	187
H. W. NICHOLS AND LLOYD ESPENSCHIED, "RADIO EXTENSION OF THE TELEPHONE SYSTEM TO SHIPS AT SEA"	193
Discussion on the above paper	240
FRANCIS W. DUNMORE, "CONTINUOUS-WAVE RADIO TRANSMISSION ON A WAVE LENGTH OF 100 METERS, USING A SPECIAL TYPE OF ANTENNA"	243
VALERIAN BASHENOFF, "PROGRESS IN RADIO ENGINEERING IN RUSSIA, 1918-1922"	257
JOHN R. CARSON, "SIGNAL-TO-STATIC-INTERFERENCE RADIO IN RADIO TELEPHONY"	271
D. C. PRINCE, "VACUUM TUBES AS POWER OSCILLATORS, PART I"	275
JOHN B. BRADY, "DIGESTS OF UNITED STATES PATENTS RELATING TO RADIO TELEGRAPHY AND TELEPHONY; ISSUED FEBRUARY 27, 1923-APRIL 17, 1923"	315

## GENERAL INFORMATION

The PROCEEDINGS of the Institute are published every two months and contain the papers and the discussions thereon as presented at the meetings in New York, Washington, Boston, Seattle, San Francisco, or Philadelphia.

Payment of the annual dues by a member entitles him to one copy of each number of the PROCEEDINGS issued during the period of his membership.

Subscriptions to the PROCEEDINGS are received from non-members at the rate of \$1.50 per copy or \$9.00 per year. To foreign countries the rates are \$1.60 per copy or \$9.60 per year. A discount of 25 per cent is allowed to libraries and booksellers.

The right to reprint limited portions or abstracts of the articles, discussions, or editorial notes in the PROCEEDINGS is granted on the express condition that specific reference shall be made to the source of such material. Diagrams and photographs in the PROCEEDINGS may not be reproduced without securing permission to do so from the Institute thru the Editor.

It is understood that the statements and opinions given in the PROCEEDINGS are the views of the individual members to whom they are credited, and are not binding on the membership of the Institute as a whole.

PUBLISHED BY

THE INSTITUTE OF RADIO ENGINEERS, INC.  
THE COLLEGE OF THE CITY OF NEW YORK

EDITED BY

ALFRED N. GOLDSMITH, Ph.D.

# OFFICERS AND BOARD OF DIRECTION, 1923

Terms expire January 1, 1924; except as otherwise noted.

## PRESIDENT

IRVING LANGMUIR

## VICE-PRESIDENT

JOHN H. MORECROFT

## TREASURER

WARREN F. HUBLEY

## SECRETARY

ALFRED N. GOLDSMITH

## EDITOR OF PUBLICATIONS

ALFRED N. GOLDSMITH

## MANAGERS

(Serving until January 2, 1924)

EDWIN H. COLPITTS  
LLOYD ESPENSCHIED

JOHN V. L. HOGAN  
GEORGE H. LEWIS

## DONALD McNICOL

(Serving until January 7, 1925)

MELVILLE EASTHAM

JOHN H. MORECROFT

(Serving until January 6, 1926)

EDWARD BENNETT

LOUIS A. HAZELTINE

## ADVERTISING MANAGER

DE WITT V. WEED, JR.

## WASHINGTON SECTION

### ACTING EXECUTIVE COMMITTEE

#### ACTING CHAIRMAN

COMM. A. HOYT TAYLOR  
Navy Department,  
Washington, D. C.

LOUIS W. AUSTIN  
Navy Department,  
Washington, D. C.

CAPTAIN GUY HILL  
War Department,  
Washington, D. C.

## BOSTON SECTION

#### CHAIRMAN

GEORGE W. PIERCE  
Harvard University,  
Cambridge, Mass.

#### SECRETARY-TREASURER

MELVILLE EASTHAM  
11 Windsor St.,  
Cambridge, Mass.

## SEATTLE SECTION

#### CHAIRMAN

ALBERT KALIN  
Seattle, Washington

#### SECRETARY

C. E. WILLIAMS  
8326 13th Avenue  
Seattle, Washington

#### TREASURER

HOWARD F. MASON, 3335 33D AVENUE, SOUTH,  
SEATTLE, WASHINGTON

## SAN FRANCISCO SECTION

#### CHAIRMAN

MAJOR J. F. DILLON.  
526 Custom House,  
San Francisco, Cal.

#### SECRETARY-TREASURER

D. B. MCGOWN,  
Custom House  
San Francisco, Cal.

COPYRIGHT, 1923, BY  
THE INSTITUTE OF RADIO ENGINEERS INC.  
THE COLLEGE OF THE CITY OF NEW YORK  
NEW YORK, N. Y.

RECEIVING MEASUREMENTS AND ATMOSPHERIC  
DISTURBANCES AT THE UNITED STATES NAVAL  
RADIO RESEARCH LABORATORY, BUREAU OF STAND-  
ARDS, WASHINGTON, JANUARY AND FEBRUARY, 1923\*

BY

L. W. AUSTIN

(UNITED STATES NAVAL RADIO RESEARCH LABORATORY, WASHINGTON, D. C.)

(*Communication from the International Union for Scientific Radio  
Telegraphy*)

The observations for January and February show the continuation of winter conditions. The afternoon signals and disturbances are, in general, slightly stronger than those of the forenoon, and the disturbances are uniformly weak. Lafayette was not heard during the forenoon in January, but has been measured a number of times in February.

The calculated signal intensities, assuming 480 amperes at Lafayette and 380 amperes at Nauen are:

$$E (\text{Lafayette}) = 31.5 \cdot 10^{-6} \text{ volts/meter}$$

$$E (\text{Nauen}) = 15.31 \cdot 10^{-6} \text{ volts/meter}$$

RATIO OF AVERAGES

	Signal	Disturbance	A. M.	P. M.
	P. M.	P. M.	Signal	Signal
	A. M.	A. M.	Disturbance	Disturbance
JANUARY				
$\lambda = 23,400 \text{ m.}$	.....	1.32	.....	3.86
$\lambda = 12,500 \text{ m.}$	1.33	1.24	2.37	2.53
FEBRUARY				
$\lambda = 23,400 \text{ m.}$	1.15	1.65	6.85	4.94
$\lambda = 12,500 \text{ m.}$	1.24	1.82	3.76	2.58

\*Received by the Editor, March 30, 1923.

FIELD INTENSITY OF LAFAYETTE AND OF DISTURBANCES  
 ( $\lambda = 23,400$  m.) IN JANUARY, 1923, IN MICRO-VOLTS PER METER

Date	10 A. M.		3 P. M.	
	Signal	Dis- turbances	Signal	Dis- turbances
2	*	10	90.0	42
3	*	35	100.0	60
4	*	28	95.0	35
5	*	12	100.0	21
6	*	16	165.0	15
8	*	28	105.0	15
9	*	6	125.0	15
10	*	10	125.0	20
11	*	14	85.0	25
12	*	18	100.0	15
13	*	33	....	..
15	*	20	85.0	25
16	*	15	....	..
17	*	8.4	75.0	20
18	*	20	105.0	16
19	*	8	110.0	50
20	*	15	55.0	10
22	*	28	....	..
23	*	40	75.0	40
24	*	10	90.0	40
25	*	23	75.0	15
26	*	28	115.0	21
27	*	19	100.0	40
29	*	21	100.0	16
30	*	15	90.0	10
31	*	18	100.0	18
Average	*	19.2	98.5	25.4

\*Not heard.

.... Not taken.

FIELD INTENSITY OF LAFAYETTE AND OF DISTURBANCES  
 ( $\lambda = 23,400$  m.) IN FEBRUARY, 1923, IN MICRO-VOLTS PER METER

Date	10 A. M.		3 P. M.	
	Signal	Dis- turbances	Signal	Dis- turbances
1	*	10	95.0	16
2	*	15	80.0	19
3	*	19	*	25
5	*	8	90.0	18
6	70.0	12	100.0	10
7	*	8	95.0	15
8	*	..	90.0	16
9	*	10	80.0	15
10	*	18	*	9.3
12	95.0	32	90.0	20
13	*	8	*	16
14	80.0	10	95.0	21
15	75.0	17	75.0	18
16	85.0	11	80.0	12
17	100.0	8	105.0	12
19	*	6	*	15
20	*	4	*	18
21	95.0	4	90.0	10
23	80.0	12	100.0	9
24	70.0	10	....	..
26	65.0	6	120.0	80
27	90.0	22	125.0	50
28	90.0	16	120.0	16
Average	82.9	12.1	95.8	20

\*Not heard.

... Not taken.

FIELD INTENSITY OF NAUEN AND OF DISTURBANCES  
 ( $\lambda = 12,500$  m.) IN JANUARY, 1923, IN MICRO-VOLTS PER METER

Date	10 A. M.		3 P. M.	
	Signal	Dis- turbances	Signal	Dis- turbances
2	9.0	8	26.5	19
3	25.2	15	18.5	20
4	27.8	12	17.0	15
5	*	6	19.0	10
6	17.0	8	25.0	8
8	21.5	16	34.0	8
9	*	4	43.0	8
10	22.8	6	34.0	10
11	30.0	8	38.5	12
12	13.0	18	43.0	6
13	25.0	15	.....	..
15	25.7	4	22.8	10
16	17.0	8	.....	..
17	25.0	5.2	30.0	10
18	13.6	6	34.0	8
19	25.7	8	18.0	18
20	10.5	5	14.0	4
22	21.5	16	.....	..
23	*	15	28.0	22
24	32.5	6	25.0	23
25	22.1	12	43.0	6
26	17.5	10	43.0	8
27	19.2	8	39.5	22
29	35.5	10	27.0	8
30	26.0	8	32.5	4
31	29.0	6	25.0	10
Average	22.3	9.4	29.6	11.7

\*Not heard.  
 .....Not taken.



FIELD INTENSITY OF NAUEN AND OF DISTURBANCES  
( $\lambda = 12,500$  m.) IN FEBRUARY, 1923, IN MICRO-VOLTS PER METER

Date	10 A. M.		3 P. M.	
	Signal	Dis- turbances	Signal	Dis- turbances
1	5.4	4	14.5	8
2	17.5	6	22.9	6
3	12.0	15	21.5	18
5	14.0	3	25.0	10
6	17.5	6	22.9	4
7	43.0	4	27.0	8
8	35.5	5	32.5	9
9	27.0	6	47.0	8
10	30.0	10	33.3	5.6
12	17.0	15	30.8	8
13	17.5	4	43.0	8
14	19.2	4	34.8	10
15	*	6	17.0	9
16	22.1	5	20.5	6
17	13.8	3	22.8	4
19	17.0	3.1	22.1	8
20	25.8	2	22.8	6
21	24.0	1.2	23.5	4
23	25.2	6	22.8	3
24	20.0	6	....	..
26	19.0	3	22.1	62
27	*	6.3	22.8	10
Average	21.1	5.6	26.3	10.2

\*Not heard.

....Not taken.

SUMMARY: Field intensities of the signals from the Lafayette and Nauen stations, together with the simultaneous strength of the atmospheric disturbances are given for January and February, 1923.



# RADIO EXTENSION OF THE TELEPHONE SYSTEM TO SHIPS AT SEA\*

BY

H. W. NICHOLS

(WESTERN ELECTRIC COMPANY, NEW YORK)

AND

LLOYD ESPENSCHIED

(AMERICAN TELEPHONE AND TELEGRAPH COMPANY, NEW YORK)

In 1919, the American Telephone and Telegraph Company and the Western Electric Company initiated a development program which had for its object the development of a radio telephone system capable of enabling the service of the Bell Telephone System to be extended to include vessels at sea. The program involved extensive development work in the laboratory and field, the establishment of shore and ship stations, and the putting of the system into practical operation, altho on a limited and experimental scale.

It is the purpose of this paper to describe the results of this development work from the standpoint of the complete system, with emphasis upon the general transmission and operating features rather than upon the details of the apparatus developed to perform the necessary functions. The development divides itself, naturally, into two parts: first, the determination of the system-design and the establishment of the necessary stations, and, second, the study of the transmission and operating characteristics of the system.

## PART I

### RADIO SYSTEM-DESIGN AND ESTABLISHMENT OF STATIONS

#### GENERAL PLANS

The fundamental condition laid down at the beginning of this work was the very general one that there should be developed a system by which any telephone subscriber of the Bell System

\*Presented before THE INSTITUTE OF RADIO ENGINEERS, New York, January 3, 1923. Received by the Editor, January 4, 1923.

could carry on a conversation with a telephone station located on a ship, and that, from the point of view of the speakers, the operation should be similar to the carrying on of an ordinary toll call between land wire subscribers. This, of course, involves the development of a satisfactory two-way radio telephone system for ship use. Furthermore, it was desired to be able to carry on three simultaneous and independent conversations between three ships and one land station, since a final commercial system will involve the establishment of several circuits simultaneously. These 2-way transmissions were to be obtained without employing an excessively large frequency band.

A rough study of the problem resulted in a decision to locate the experimental land stations about 200 or 250 miles (320 or 400 km.) apart and to try for reliable commercial transmission to ships at a distance of approximately 200 miles (320 km.).

The transmission problems involved in this work, which were different from those in wire telephone engineering, were:

- (a) A much greater variability in the transmission equivalent to be expected in the radio link;
- (b) A much greater and more variable interference, both natural and artificial;
- (c) A lack of secrecy in the sense of a wire system;
- (d) Greater possibilities of cross-talk between channels because of the use of a single medium;
- (e) More complication in the matter of signaling and in the setting up of the telephone circuit.

The apparatus problems were, of course, entirely different from those of wire transmission and will not be considered in detail in this paper.

An engineering project of this kind divides itself naturally into two phases; that of the development in the laboratory of systems and apparatus which are technically suitable for the work and, second, the providing in the field of a model system, incorporating the knowledge obtained in the laboratory as a means for enabling the system to be tried out. A preliminary survey of the purely technical problems convinced us that the more important ones were the development of two-way radio telephone apparatus and of multi-channel systems which would operate from a single transmitting station without interference between channels; the design of transmitting apparatus which would satisfy the requirements and which could be built with the vacuum tubes available, and the development of a type of

receiving system which would provide sufficient selectivity to allow an economical use of the frequency range and at the same time fit in with the two-way system most likely to be adopted. It was decided that during the laboratory development work preparations should be made in the field for providing the necessary experimental stations. This field work as it developed included the location of station sites, the actual construction of the station buildings and the antennas, the equipping of the stations with the apparatus as developed in the laboratory and as further developed in the station, the equipment of the ships, and, finally, the operation and tests of the overall system.

### SYSTEM DESIGN CONSIDERATIONS

In the beginning it was thought that to cover the required 200 miles (320 km.) range about one or one and one-half kilowatts in the antenna would be necessary. It was not known what wave lengths would be made available for this work by the Department of Commerce. To produce this amount of power in the antenna there were available Western Electric 250 watt tubes which it was decided to employ. The question then arose as to the particular type of transmission systems most suitable for the work. The points of importance in solving this problem are as follows:

The greatest economy both in power and in wave length range may be secured by transmitting only one side band of the modulated wave. Moreover, this method has the great advantage that variations in the transmission characteristics of the medium do not cause as great fluctuations in the received signal. This is because the received signal is proportional to the product of the carrier and side bands and if the carrier is supplied locally instead of being transmitted, it is not affected by transmission factors. The use of such a system, however, or of one in which only the carrier is suppressed, throws upon the receiving set the burden of maintaining a constant oscillator frequency not only complicating it but also making reception impossible for the great majority of ships which are equipped with only straight detectors. This would defeat general inter-communication in emergency. Further, it practically restricts the transmitting set to one in which the power tubes are used as amplifiers, and it was known that some difficulty might be experienced in operating a number of 250 watt tubes in parallel if it should be necessary to transmit at wave lengths as low as 300 meters. For these reasons and after some development work it was decided that the proper

system to use in the first experiment was one in which modulation is carried on by the constant current method which requires about an equal number of modulator tubes and power tubes and sends out all components of the modulated wave.

The simultaneous transmission of three channels from the land station may be accomplished in several ways. It is possible, for example, to carry on such multi-channel operation from one antenna, which is multi-tuned, or from three separate antennas. The antenna power may be supplied by one system of tubes carrying all three conversations or the power tube system may be split into three parts. Also, using a single antenna simply tuned it would be possible to transmit the three channels from one system of tubes by a system of double modulation which had been installed by the Western Electric Company on United States battleships two or three years earlier. The difficulties which are likely to arise in these various schemes are as follows: The use of multi-tuned antennas involves loss of power in the circuits used to give the antenna three degrees of freedom. The use of a single system of power tubes for three channels requires that the tube system be capable of handling a large overload at times without impairment of quality, since it is possible that the peaks of three channels may occur simultaneously. It was expected that under conditions of this kind there would be inter-modulation of the channels due to the modulating action in the plate circuits of the power tubes. The use of three separate antennas located very close to one another and tuned to frequencies differing by three or four percent, might lead to such close coupling of the three channels that cross-talk and modulation of one channel by another would result, the latter by plate modulation of one set of tubes by the currents induced in its antenna. The use of the double modulation system—alho requiring but one radiated carrier—is open to the objection of overloading and cross modulating of channels and also to the objection that the receiving apparatus aboard ship must be more complicated. An analysis of these and other proposed methods of operation resulted in the decision to employ at that time three separate but closely adjacent antennas and three separate transmitting sets using the constant current modulation system. This choice was made because of conditions peculiar to this particular problem and to the vacuum tubes then available. Of course improvements can be made in the system at the present time as a result of the information obtained in the development using the very much larger vacuum tubes now available.

These decisions, therefore, determined the general type of system to be used, namely, one in which many of the known advantages of single side band transmission were sacrificed in order to secure simple apparatus, to make use of then existing power tubes, and to enable the transmission to be received generally.

The problem of securing the two-way operation necessary aboard ship and for combined radio and wire operation may be attacked in several ways. In general, there are three methods available:

- (1) In which the east and west channels are established alternately and not simultaneously, by switching. The push-button scheme is a familiar example, although unsuitable for tying in with the wire telephone system. Another arrangement is the use of voice-operated relays to throw the terminal apparatus into the sending or receiving condition, depending upon the direction of transmission.
- (2) The use of the principle of balance to separate the outgoing from the received transmission. The radio receiving antenna circuit is balanced with respect to the transmitting antenna circuit.
- (3) Employment of different frequencies for the two transmissions, relying upon frequency-selecting circuits for effecting separation. The first two methods allow of operation on the same or on different carrier frequencies.

All of these fundamental methods were considered in their several possible embodiments, and compared from the standpoint of the conditions to be met in the radio system itself and in linking it with a public service telephone system. The system finally adopted employed different frequencies for sending and receiving and secured discrimination by frequency selection supplemented at the land station by a moderate degree of spatial separation and balance. By using sharply selective receiving circuits, a moderate frequency difference between east and west channels sufficed to give the necessary degree of separation.

#### PRELIMINARY TESTS

By the time these decisions had been made there was available for experimental purposes a plot of land near Cliffwood, New Jersey. It was decided to construct a model of the proposed antenna system on this plot and to operate small transmitting

sets to determine the cross-talk and other important conditions. The antenna system decided upon consisted of three poles arranged in the form of an equilateral triangle supporting three antennas—one from the middle of each span to the transmitting shack at the center of the triangle. The dimensions of this model system were 50 meters (164 ft.) by 10 meters (33 ft.) high. Three experimental transmitting sets of small power were set up under the antenna system and studies were made of the interference produce between channels when all three channels were in use. Three receiving sets of the general form proposed were built and taken to a location near Elberon, New Jersey, about 16 miles (26 km.) from Cliffwood, at which place it was decided to locate the three-channel receiving station to co-operate with the New Jersey transmitting station a mile (1.6 km.) away.

In November, 1919 the first test of a three-channel system was held between Cliffwood and Elberon with the result that the receiving sets resolved conversations on carriers of frequencies of 725, 750, and 775 kilocycles without any cross-talk altho the received volume was so large as to be audible all over the room. This is a frequency difference between channels of approximately three percent. A change in frequency to 747, 759, and 777 kilocycles resulted in a barely perceptible cross-talk on the middle channel, with no cross-talk on the others. These results indicated that the loop receivers which had been developed were sufficiently sensitive and selective to carry out the proposed three-channel work; and, altho a great deal of development work was done later on the receiving sets, the general principles were retained. It was found that some reliance must be placed upon the directional properties of the loop antennas, and considerable care was used to secure very sharp directional selectivity. This was done by compensating for the vertical antenna effect of the loop by a balanced connection to ground.

During the whole course of this ship-to-shore work very little trouble was experienced thru interference by continuous wave stations, even when their frequencies came within two or three percent of those to be received. We did have, however, much difficulty due to interference from spark stations, since they inherently occupy a wide frequency range.

#### PROVISION OF STATIONS AND DEVELOPMENT OF APPARATUS

During the time the model system was being constructed at Cliffwood, land had been purchased at West Deal, Monmouth County, New Jersey, for the permanent transmitting station.



It contains about sixty-three acres in the general form of a square bisected by a small brook flowing east. The center of this site is 1.1 miles (1.8 km.) south of the Elberon receiving station.

In the spring of 1919, six 165 foot (30 m.) self-supporting steel towers had been ordered, three of which were intended for the Deal Beach station and three for the Green Harbor station to be built near that town in Massachusetts. Following preliminary work at Cliffwood it was decided to erect these steel towers in the form of an equilateral triangle five hundred feet on a side. This work was completed by December, 1919.

In the meantime, complete building plans had been made and contracts awarded for building the permanent transmitting station. On account of severe weather conditions and strikes, the construction of the building was delayed, so that in order to carry on experimental work a small frame building was constructed under the antenna system. It was decided to build in this temporary building a rough transmitting set which could be used as a model in the final design of the four sets to be located in the permanent building. This method of handling the work turned out to be much better than attempting to design the whole transmitting set on paper, because with these rather short wave lengths some troubles were experienced by the setting up of very short wave oscillations in the wiring of the set. Some experimental work was necessary to obtain the proper layout of circuits connecting the various parts of the apparatus.

At about this time antenna studies were made to determine the proper form to give to antenna suitable for three-channel operation without excessive cross-talk and this study indicated that by the use of series inductance and capacity the antennas could be stiffened enough to prevent excessive coupling effects and still pass the required frequency band.

The experimental transmitter was completed in February 1920 and in the middle of that month speech was transmitted from Deal Beach to New York and sent from there over wire lines for test purposes.

The spring was spent in study and improvement of the transmitter circuits, and in April the design and construction of the final model, of which set four were to be built, began. This transmitter was completed by May and later, in June, was sent to Green Harbor, Massachusetts, in order that the latter station might be available for test purposes.

Work now began on the four final transmitters for the Deal Beach Station. These sets were manufactured in the New York

shop from working drawings made from the experimental model.

The final transmitting apparatus being well on the way, tests of the model transmitting set were made prior to its removal to Green Harbor, to determine the transmission characteristics and the distances which it might be expected to cover. In order to do this a systematic program of broadcasting music and speech from Deal Beach Station began in May, 1920. Amateurs and others were requested to co-operate with us in the study of "fading" and other transmission phenomena. As a result of these tests many hundreds of letters were received, which showed that audible radio signals were often received at a distance of one thousand miles (1,600 km.), altho a great deal of fading was to be expected, in overland transmission at least, even at moderate distances. These tests were carried on at wave lengths in the neighborhood of 400 meters.

While this work was going on, a two-way telephone set for use aboard ships was developed, and in the spring of 1920 one of these sets was installed aboard the steamship "Ontario" of the Merchants and Miners Transportation Company. Experimental communication with this ship, by means of the model transmitters at both Deal Beach and Green Harbor stations, showed that commercial operation, at least for one channel, could be maintained.

By the fall of 1920, the construction work on the four transmitting and receiving channels was completed and early in December a demonstration of simultaneous three-channel operation from this station to ships was carried out with entirely satisfactory results.

#### DESCRIPTION OF THE EXPERIMENTAL RADIO STATIONS

The system as developed at Deal Beach consists of four transmitting sets, operating into four separate, altho naturally coupled, antennas, one set and antenna being intended primarily for 600 meter calling and for emergency. The receiving station co-operating with Deal Beach is located about a mile (1.6 km.) north of that station and contains four receiving sets receiving energy from four loop antennas. The transmitting sets are capable of putting about one kilowatt of modulated radio frequency power into each antenna and are controlled from a telephone switchboard into which run trunk lines from New York City. A ten-pair telephone cable connects Deal Beach and Elberon and another telephone switchboard at Elberon permits the transfer of received signals back to the wire line. The radio

station operates, therefore, generally as a telephone repeater arranged for two-way operation with two repeaters. At the ship stations, because of the small amount of space involved, transmitting and receiving are carried on the same antenna at different frequencies in the two directions. Because of the better receiving conditions on the shore the proper transmission balance was obtained by making the output of the ship transmitting set about one-quarter that of the land station.

The general principle of operation of one channel of the wire-to-radio repeater will be described from the schematic circuit diagram of Figure 1, which shows, in the dotted blocks, one channel of the transmitting station, a ship station, and one receiving set. At the transmitter station the master oscillator, very carefully shielded to maintain constant frequency, operates into a two-stage amplifier, the last stage being fifty watt tubes, and from there into a bank of six radio frequency power tubes, each with a rating of 250 watts plate dissipation. Speech to modulate this radio frequency output enters from a telephone line and is applied to a speech amplifier the output of which operates into a bank of 250 watt modulator tubes in parallel. Thus both the radio frequency and the speech frequency currents are brought up to the high power level before modulation takes place. The six radio frequency and six speech frequency tubes have their plate circuits connected together and operate as a constant current modulation system. Thus current of the frequency  $F_1$ , generated by the master oscillator and amplified and modulated, is radiated from the antenna. The notation  $F_1 \pm S_1$  indicates the radiation of the carrier and two side bands from this antenna. The incoming speech  $S_1$ , as it comes from the telephone line, passes thru the hybrid coil and to the balancing network shown. This balancing network has an impedance characteristic similar to that of the incoming line, and the combination of hybrid coil and network is similar to that used in telephone repeater practice to secure two-way operation. The object of this arrangement is, of course, to prevent signals, coming in from the receiving station, operating upon the transmitter of the outgoing channel. If the balancing network is an exact picture of the incoming line and if the hybrid coil is properly made, incoming signals for transmission west on the telephone line will produce no voltage at the terminals of the transmitting amplifier.

At the receiving station the incoming wave is impressed upon a loop antenna and the receiving set. The resulting detected

output is then amplified as indicated and returns to the hybrid coil, passing out on the telephone line without producing a voltage on the speech amplifier of the transmitting set if the hybrid coil balance coil is perfect.

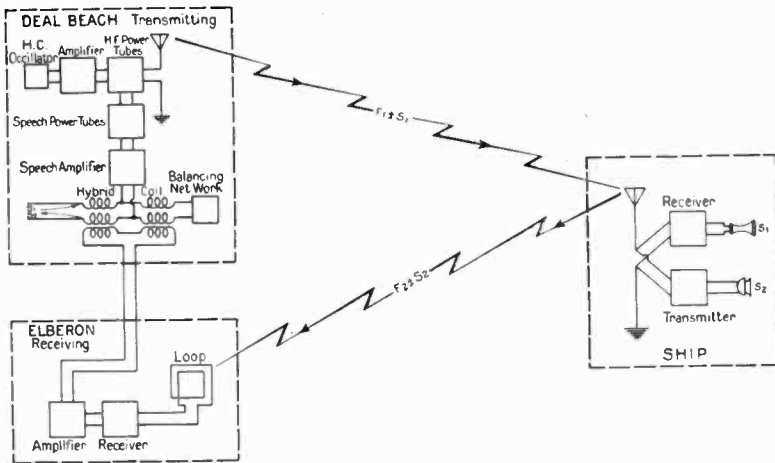

FIGURE 1—Two-way Radio-Wire System

On the ship, this physical separation of transmitting and receiving set is, of course, not practical, and, as indicated before, transmission and reception take place upon one antenna so arranged that the receiving circuit offers a high impedance to currents of the outgoing frequency and low impedance to the incoming signal. Actually, the outgoing signal is not entirely excluded from the ship's receiver and there is present a side tone of about the magnitude of the incoming signal. This is by no means an undesirable condition and is the one which holds approximately in an ordinary telephone subscriber's instrument. The presence of side tone assures the speaker that his system is functioning properly.

Figure 2 shows a general view of the outside of the transmitting station at Deal Beach. The three steel towers form an equilateral triangle of sides five hundred feet (150 m.) and each is one hundred and sixty-five feet (50 m.) high. Steel cables to support the antennas are strung between these towers and also three cables extending inward support a fourth antenna which rises directly from the building in the middle of the triangle. One antenna goes to the middle of each of the first mentioned

steel cables, so that there are a total of four transmitting antennas. One of these is intended for use at six hundred meters. The building is thirty by ninety feet (9.1 by 27.3 m.) and two stories high. The southern half comprises the operating room which rises two full stories. The other part of the building is taken up by an office, shop, power room, living and dining room and kitchen, and by six bedrooms.

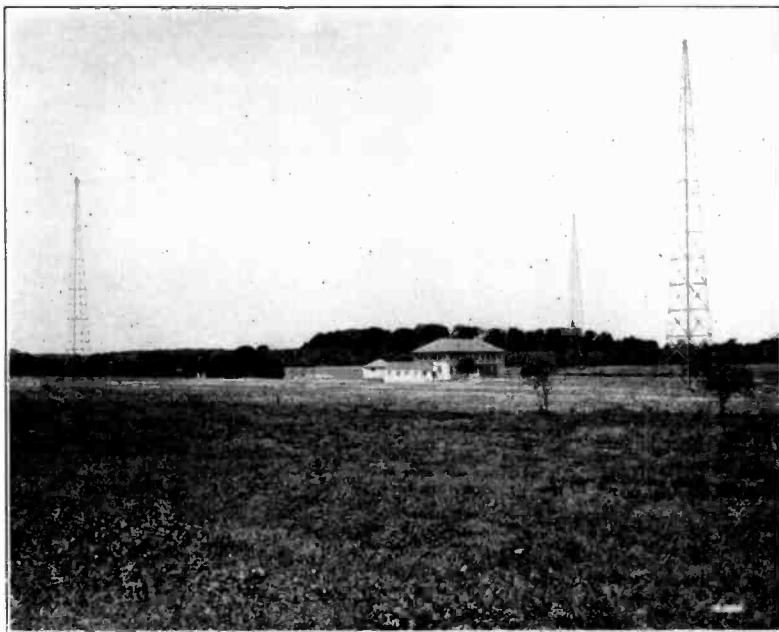

FIGURE 2

Figure 3 is a view of the operating room showing the four transmitting units at the back; the power switchboard for supplying the plate circuits of the tube at the right; the telephone switchboard for the four speech or telegraph channels in the center; and on the gallery above the transmitting units, the coupling coils, loading inductances, and so on, between the sets and the antennas. The motor generator sets capable of supplying as much as five kilowatts at eighteen hundred volts to each of the transmitting sets are located in an adjoining room and controlled from the operating room.

Figure 4 shows the interior of one of the transmitting units. In the shielded box at the upper right hand corner is the master oscillator which sets the frequency to be used for that particular

channel. Next to the left are two more shielded compartments, each of which contains an amplifier. The last one comprises fifty watt tubes. In the larger unshielded compartment are located, above, the six radio frequency power amplifiers. The reason for introducing two amplifiers between the master oscilla-

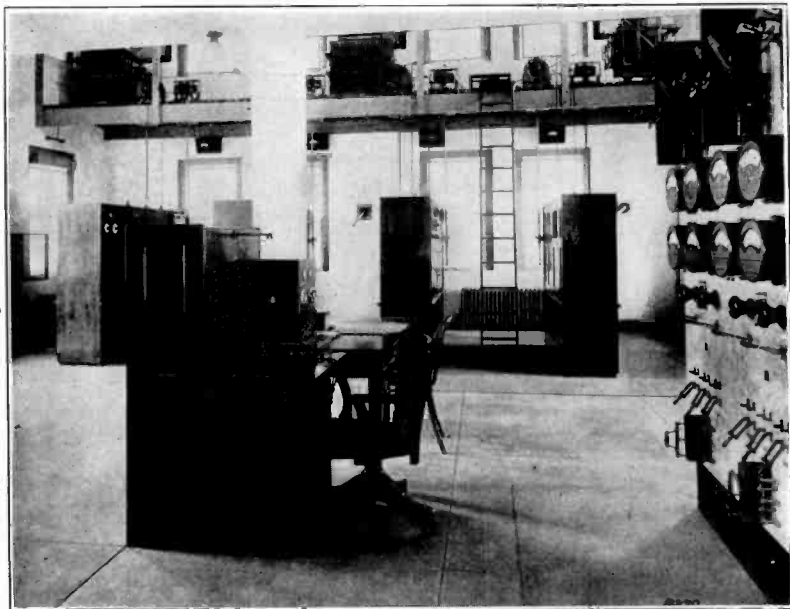

FIGURE 3

tor and the power tubes is to prevent any reaction from the antenna circuit back to the master oscillator. By taking this precaution the frequency of the master oscillator never varies more than fifty cycles in eight hundred thousand. The lower set of shielded compartments, at the right, contains the audio frequency telephone amplifiers which supply currents to the six modulator power tubes shown in the lower part of the open compartment. These two sets of six tubes each are connected together to secure constant current modulation. The output of these twelve tubes is led to terminals on the output of the transmitter unit at the left. To secure cooling in hot weather, a fan is installed below the power tube compartment. In the extreme left compartment are shown choke coils in the power circuits, and at the extreme left on the outside are circuit breakers and two handles for operating the tuning and coupling apparatus in the gallery above.

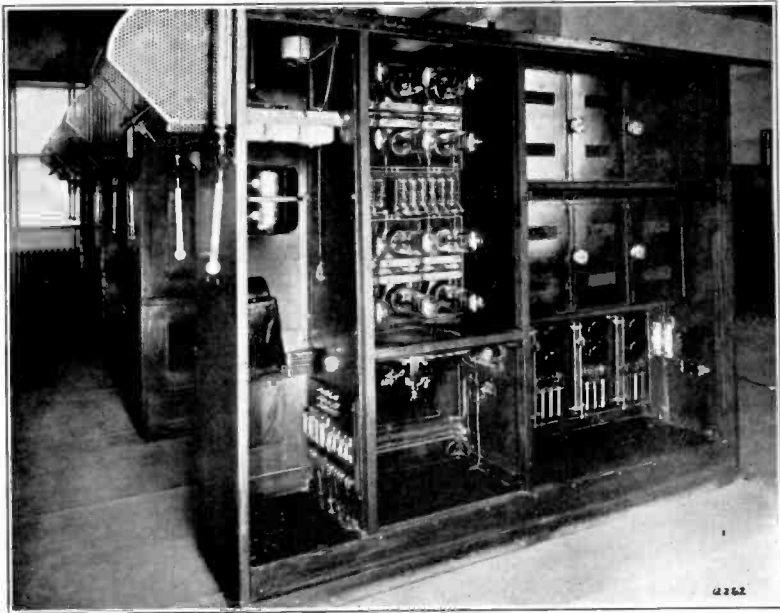

FIGURE 4

Figure 5 shows one set of radio frequency apparatus in this gallery. The two inductometers at the left are for coupling and tuning, and the large condenser at the right, the plates of which consist of brass frames covered with copper window screen, is inserted in series with the antenna. This capacity together with the inductance immediately above it, stiffens the antenna circuit and increases the frequency selectivity to prevent radio frequency interaction between the several antennas.

The telephone switchboard shown in Figure 6 is a special type of P. B. X. (private branch exchange), constructed to provide the necessary shielding and to include telegraph oscillator, phantom coils, and other special apparatus. This switchboard provides for four channel telephone or telegraph operation and for the control and monitoring of all channels. In the operation of the system one operator, located at this switchboard, has complete control of the entire transmitting plant. The operating board was especially built for the experiments, and altho not the final form contains features which are of interest in that they illustrate well the technique involved in combined wire and radio operation.

The four vertical rows of jacks correspond to the four two-way

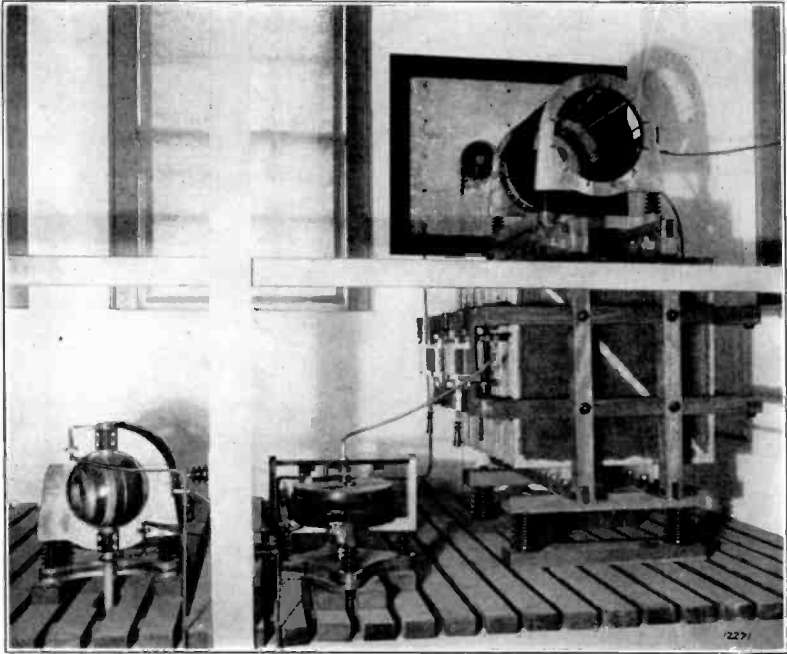

FIGURE 5

radio channels. At the top of each row will be seen the dials for controlling amplification. On the apron are telegraph keys, telephone keys, and operating cords. The cord circuits, by being plugged into the jacks, interconnect any one of the New York toll circuits with any one of the four radio circuits. The cord circuits contain the switching keys seen in front, by means of which the radio station operator is enabled to split the circuit and talk either way, connect the circuit thru and bridge on it and talk or monitor. This cord circuit is shown in Figure 7 in relation to the rest of the wire-radio junction circuit. It will be seen to be of a four-wire instead of the more usual two-wire type and to comprise in reality two circuits, one for east-bound and the other for west-bound transmission. This arrangement was used in order to obtain flexibility in the experiments. It enables the circuits to be continued inland as four-wire circuits and permits of the switching operations being carried out with a minimum effect upon the 2-way balance of the transmission system.

The receiving station at Elberon is located on a rented plot of ground and was not built in permanent form, since we did not regard this location as entirely suitable for receiving from the



Atlantic. Reception is carried on the four channels by means of four loop antennas operating into four receiving sets. A telephone switchboard similar to that at Deal Beach provides for the connection to the wire system. Of course, two telephone switchboards are not necessary but one was installed at each station in order that we might determine by operating tests whether the control of the system should be from the transmitting or the receiving station.

The receiving sets as finally developed were extremely selective and pass only a band of speech width with a large attenuation outside this band. They will be described in another paper.

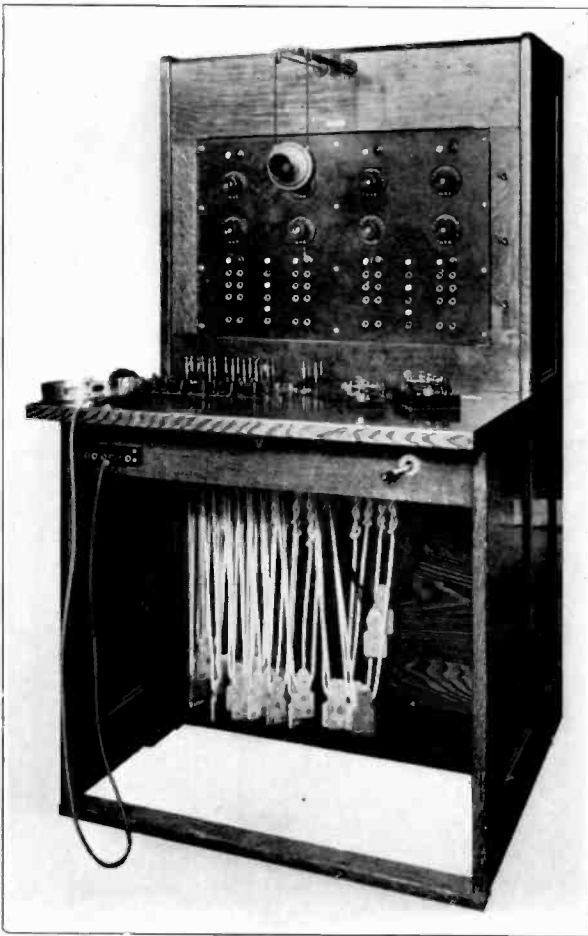

FIGURE 6

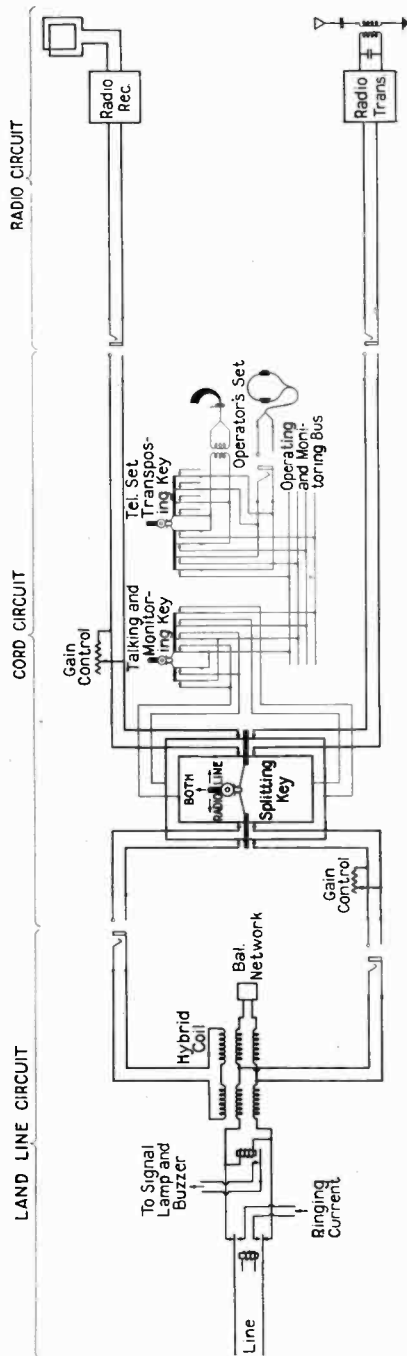

FIGURE 7—Land Radio Station Operating Circuits

Figure 8 shows a front view of one of the experimental transmitters used aboard ship. The lower half consists of power control apparatus. Three 250 watt tubes are used of which one is

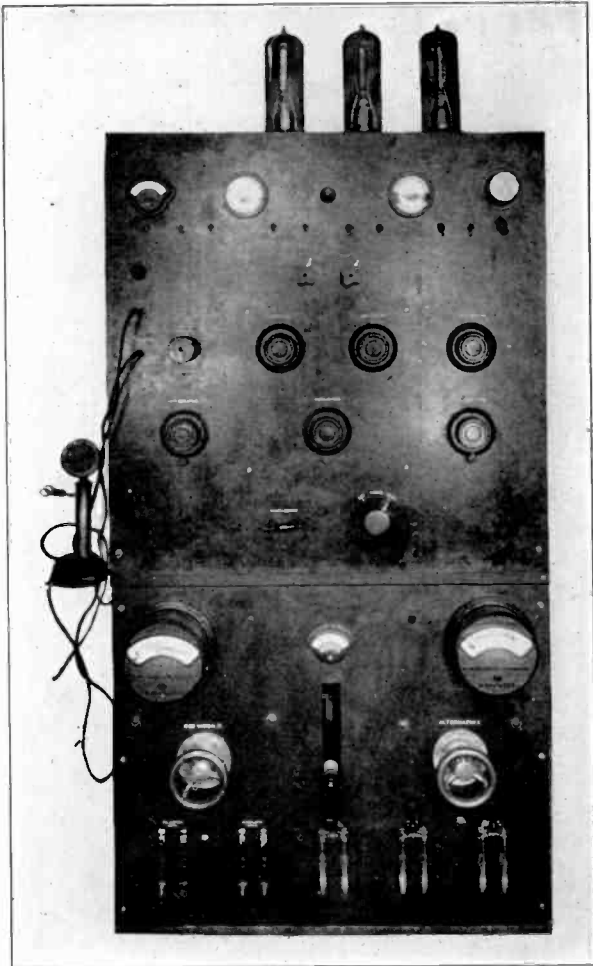

FIGURE 8

a master oscillator, one a power amplifier and one a modulator. The large capacity tube was used as a master oscillator and only a very small part of its output applied to the second power tube. This was done in order to prevent reaction of the antenna system upon the oscillator.

Apparatus of this type was installed on the "Ontario" and "Gloucester" of the Merchants and Miners Line, and operated

in conjunction with Deal Beach and Green Harbor. Later another electrically similar set was built by the General Electric Company and was installed and operated by the Radio Corporation on the steamship "America." This installation is illustrated in Figure 9.

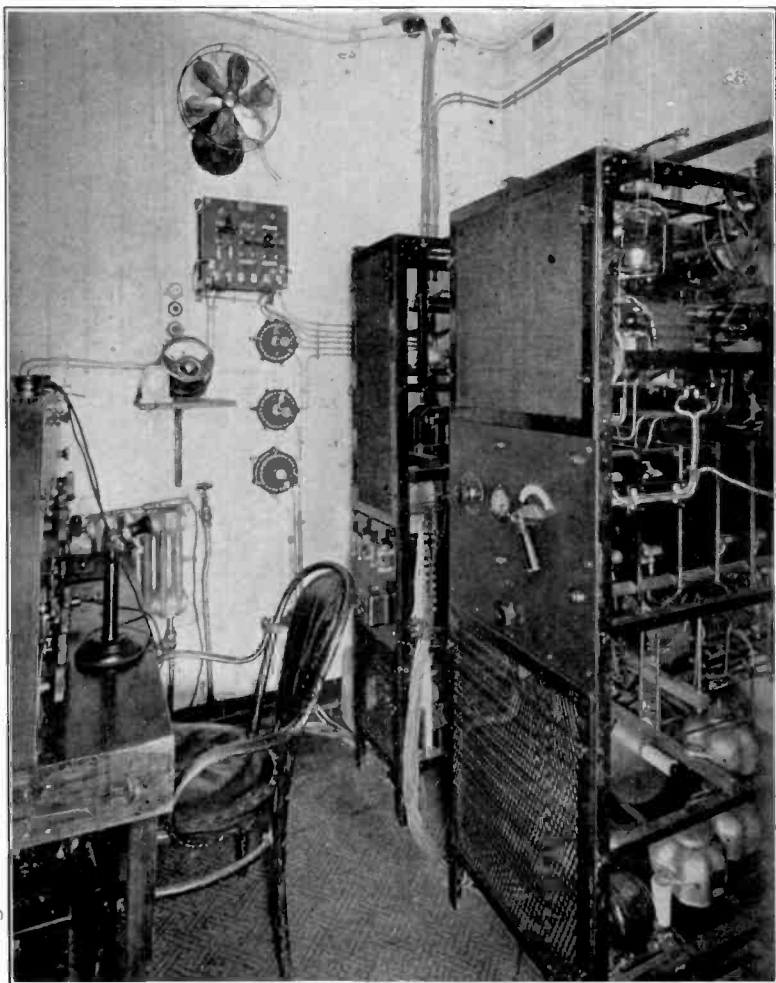

FIGURE 9—Duplex Radio Set Installed by the General Electric Company on the S. S. *America*

## PART II

### OPERATION OF THE COMBINED RADIO AND WIRE SYSTEM

The development work as described in Part I had resulted in establishing an experimental ship-to-shore radio telephone plant of some proportions. This will be seen by reference to the accompanying map of Figure 10 which gives a picture of the field setting, as it were, of the experimental operations. The experimental plant included:



FIGURE 10

Two operating shore stations—Deal Beach, New Jersey, and Green Harbor, Massachusetts.

A field experimental station at Cliffwood, New Jersey.

Two ship installations, on the S. S. "Gloucester" and the S. S. "Ontario."

The vessels operated between Boston and Philadelphia or

Baltimore and took any of several courses, two representative ones of which are as plotted in the figure.

Let us now consider this plant from the communication standpoint and look into its characteristics, first as an electric transmission system, and then as a message handling facility.

Each of the two land stations was tied into its nearest center by wire circuits, Deal Beach to New York and Green Harbor to Boston. We will take for our example the New York-Deal Beach-Ship circuit pictured in Figure 11 and shown diagrammatically in Figure 12. This is a combination of wire-radio toll circuit,

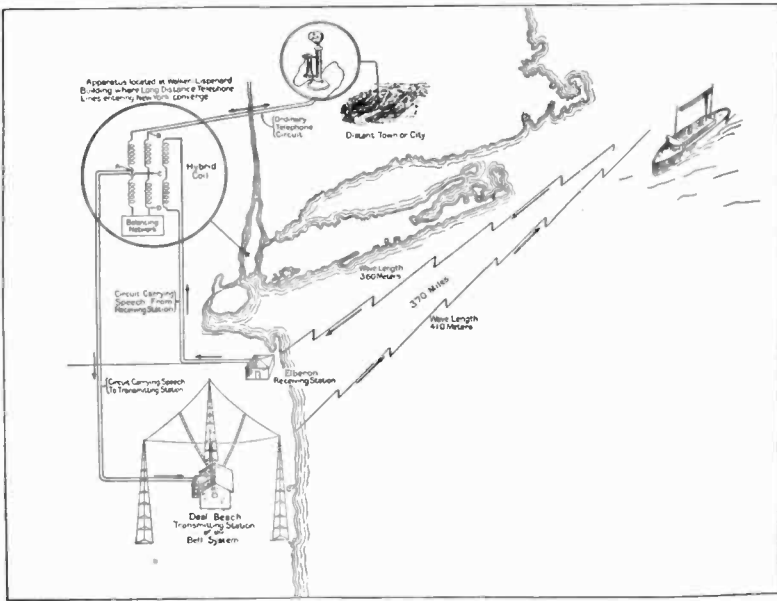

FIGURE 11

one end of which terminates on a vessel of variable position and the other end of which is capable of being extended either over a local circuit to a New York subscriber or over a long distance circuit to reach subscribers at more distant inland points.

This communication circuit must fulfill two general requirements. In the first place it must be so constituted electrically as to preserve the feeble voice currents launched upon it by one subscriber so that they be rendered to another person with sufficient volume and fidelity of wave shape to be readily intelligible. This requires that the circuit be properly engineered as an electrical transmission network. Secondly, given a circuit

capable of talking, it is necessary that this circuit be flexible in use so that it can be put at the disposal of any land line subscriber for connection to a ship at sea, at any time the ship is within range. This requires that the proper switching facilities be provided and brings in operating and traffic problems.

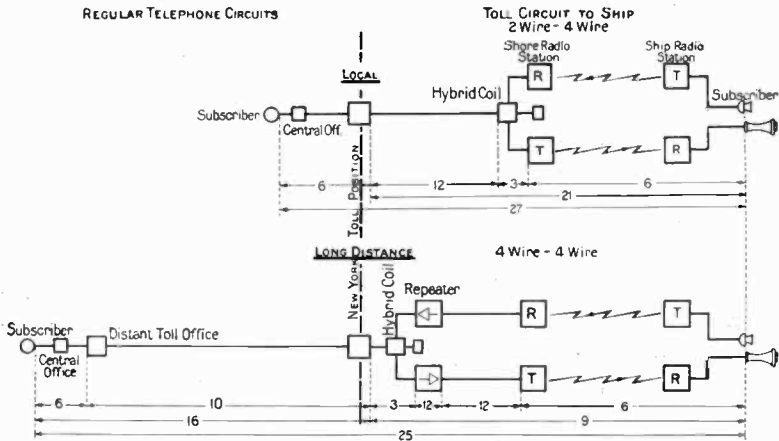

FIGURE 12—Combined Wire and Radio Circuits

### THE RADIO-WIRE TRANSMISSION CIRCUIT

Two types of circuits were used in the experiments in operating between New York and the vessel, as shown schematically in Figure 12. The radio link is the same for both. Different frequencies are used for transmitting in the two directions so that in the radio link we have the equivalent of two circuits, one for transmitting east and the other for transmitting west. This is the same as the four-wire telephone circuit. In the thru circuit first shown, the radio four-wire circuit is brought into a two-wire circuit at the land radio station, making a regular two-wire telephone circuit from the radio station to the New York toll terminal. This circuit was used in the tests for calls local in New York. In the arrangement of the second circuit of Figure 12, each of the one-way radio channels is extended back to the New York toll office by its own wire line and there joined into a two-wire circuit, making the wire-radio toll line from New York to the ship a four-wire system. This arrangement forms a high grade circuit and is the one used in the experiments for connecting with long distance lines.

Taking the four-wire circuit, the path of the voice currents may be traced thru from one end to the other as follows: The

currents which are initiated by the land subscriber, for example, upon arrival at the New York toll office divide in the hybrid coil between the east-bound and the west-bound circuits. The currents are prevented from being propagated over the west-bound branch because of the unilateral nature of the repeater. The currents of the east branch are amplified in the repeater of this circuit in order to make up for the attenuation suffered in the cable circuit, and upon arrival at Deal Beach are amplified to power proportions, modulated upon the radio carrier and radiated into space. Upon being received at the ship end of the radio circuit they are sharply selected in respect to frequency, are again amplified, and delivered to the listener. When the ship subscriber talks, the voice currents are amplified, pass directly into the radio transmitter, are transmitted over the radio link in the usual way, received at the shore station, amplified and sent out over the wire circuit to New York. Here they pass in the reverse direction thru the hybrid coil and divided between the two-wire circuit on the one hand and the balancing network on the other, thus getting back into a regular two-wire telephone circuit.

#### INTERCONNECTION BETWEEN RADIO AND WIRE CIRCUITS

It will be well to recall at this point just what it is that makes possible automatic repetition or thru transmission between the wire and radio circuits.

There is both an outgoing and an incoming radio channel. The automatic repetition from the wire to the outgoing radio channel is made possible thru ability to control the transmitter wave power by the voice currents set up at the distant end of the telephone line. It will be recalled that in the early radio telephone art, before the vacuum tube, modulation was effected by the microphone transmitter which required that the talker be present at the radio station. It is, therefore, the electric-control type of modulator such as the vacuum tube, as distinguished from the air-wave control modulator, which permits of the talker being at the far end of a wire circuit. Conversely in the receiving channel, it is the fact that the detecting action yields telephone currents directly, ready for propagation over a wire circuit, that enables the radio channel to be extended to a distant listener.

Thus it is the thermionic tube modulator and detector which have made possible the radio-wire transfer. It is the thermionic tube as a reliable high-quality amplifier, however, that makes the transfer practical; for it is the amplifier which enables the weak voice currents received at the radio station from a land



line subscriber to be boosted to power proportions and thus control the considerable radio frequency power required for transmission; and, again, it is the amplifier which enables the extremely weak currents received from the radio link to be so augmented that upon being placed upon a wire circuit, and perhaps being further amplified en route, they may be heard in the regular telephone at the other end.

The other important feature of the radio-wire inter-connection is the junction of the four-wire and the two-wire circuits by means of the hybrid coil and balancing network as shown in Figure 11. The windings of such a coil are so designed as to establish a sort of Wheatstone bridge circuit. This bridge circuit accomplishes the joining of the regular two-wire telephone circuit with the sending radio channel on the one hand and the receiving radio channel on the other, while still maintaining an electrical separation between the two radio channels. It is really, therefore, the connecting link between the two-wire type of circuit of the telephone plant and the four-wire circuit of the radio link. The hybrid coil type of circuit, is taken from the telephone repeater and carrier current art.<sup>1</sup> The radio receiving circuit corresponds to the generator branch of the Wheatstone bridge, and radio transmitting circuit to the detector branch. The two-wire telephone line corresponds to the "X" arm of the bridge and the balancing artificial line to the "Y" arm. The ratio arms are in effect formed by the windings of the hybrid coil.

#### SPEECH RECEIVED FROM SHIP RE-TRANSMITTED FROM SHORE STATION

Now this junction circuit always has some unbalance because it is obviously impossible to maintain a perfect symmetry between the telephone line and the balancing network. Especially is this true where the telephone line is a type not designed for repeater operation and is switched at its terminal to any of a number of lines of different impedances, as was the case with the circuit used in the tests.

This unbalance between the line and its balancing network will be seen to permit some of the speech-current received over the radio link to get across into the transmitting circuit, to modulate the shore station carrier and to get out into the ether

<sup>1</sup> "Telephonic Repeaters," B. Gherardi and F. B. Jewett, "Journal of American Institute of Electrical Engineers," pages 1255-1395, November, 1919.

"Carrier Current Telephony and Telegraphy," E. H. Colpitts and O. B. Blackwell, "Journal of American Institute of Electrical Engineers," pages 205-300, February, 1921.

again on the transmitting wave length. As a matter of fact during the experiments the unbalance was sometimes such as to permit of fairly strong transmission around back thru the shore transmitter, so that incoming speech was repeated out thru the shore station transmitter in amplified form. This enabled listeners in the vicinity of New York to hear the conversation originating on the ship almost as well as that originating on land, and they naturally thought that they were picking up the ship's radio transmission directly, whereas they were actually overhearing the re-transmission of the shore-station's reception.

#### THE THRU CIRCUIT AS A REPEATERED TELEPHONE CIRCUIT

This re-transmission makes all the more evident the true role of the shore station, namely, that of a large telephone repeater, repeating between two sections of line, the one a land line and the other a "space" line, and functioning also to convert between the voice frequencies of one section and the radio frequencies of the other. As such, we can consider the over-all circuit from a transmission standpoint much as we do long distance repeatered telephone circuits.

Now one of the most important transmission considerations in such a long distance circuit is that of how the amplification is applied in relation to the losses in the circuit. This question of amplification is particularly important in the case of combination radio-wire systems, because the radio circuit possesses inherently large transmission losses and requires correspondingly large amplification. The necessary large amplification is supplied at both ends of the radio link, partly in the transmitting station where the voice currents are amplified up to power proportions and partly at the receiving end where the amplification is likewise large altho at small power. In the radio telephone circuits which were operated in the experimental work the power in the sending antenna to that in the receiving antenna is in the ratio of roughly  $10^{10}$ . This required amplification which was distributed somewhere near equally between the sending and the receiving ends. It has been found convenient to express such transmission losses in terms of a power ratio using  $10^{0.1}$  as a unit.<sup>2</sup> Thus the above antenna-to-antenna power ratio would correspond to 100 of such units.

<sup>2</sup>The unit used in this paper is one which has been found convenient in expressing the transmission loss or gain of a circuit. One unit is taken as that power ratio which is equal to  $10^{0.1}$ . Thus, if the attenuation or amplification of a circuit is one unit the power at the two ends are in ratio of  $10^0$ ; if ten units, in the ratio of  $10^{(10 \times 0.1)}$  or 10; twenty units would therefore have a power ratio of 100, and so on. The advantage of using a power ratio instead

## CIRCUIT TRANSMISSION EQUIVALENTS

It is necessary that the amplification of such a circuit be sufficient to offset very closely the loss, in order that the net loss be small. Actually, in the tests, the radio portion of the circuit was worked with a net transmission loss of about six units meaning that at least 95 percent of the radio over-all circuit losses were wiped out. This means that if a change of say 10 percent occurs in the amplification, or in the ether loss as by fading or movement of the vessel, the circuit equivalent will be greatly affected—changed by about 200 percent. The difficulty of maintaining the ship circuit stable will therefore be appreciated.

Figure 12 shows the transmission loss (of six units) obtained for the radio link during the tests and also the other losses which are in the wire portion of the combination system. The distribution of losses in the first circuit will be noted to be approximately as follows:

- 6 units in the radio link.
- 3 units in the hybrid coil—balancing network.
- 12 units in the wire circuit to New York.
- 6 units from the New York central office to the subscriber.

This makes a total loss between subscribers of 27 units which is satisfactory for a good talk under fairly quiet conditions. This equivalent was usually realizable under the conditions of the test and the majority of the calls put thru from local stations in New York with the ship 100-200 miles (160-320 km.) out were successful despite occasional spark interference in the radio circuit.

The transmission loss is, however, too high in such a circuit to enable it to be extended inland over long distance wire circuits. If this is attempted, two limitations come into play. In the first place, the volume of the talk becomes too weak. If the call were extended over a toll circuit having a 10-unit equivalent, for example, the over-all equivalent would become something like 37 unit, which is excessive. This could be overcome to some extent by a cord circuit repeater at New York. A second limita-

of a current ratio is that it is independent of the impedances of the two portions of the circuit considered. The advantage of expressing the power ratio as an exponent is that on account of the exponential nature of attenuation it enables the net transmission efficiency of a system to be readily derived by algebraically summing up the individual losses and gains. This unit has been selected as more suitable for general use in expressing transmission efficiencies than the 800 cycle "mile of standard cable" which has sometimes been used. The ratio between these two units is as follows: 1 mile of standard cable equals 0.95 units as used in this paper.  $\frac{P_1}{P_2} = 10^{0.1} = \frac{1}{0.95} \epsilon^{2(0.100)}$  units.

tion which existed in the experimental set-up resided in the unbalance between the line and the balancing network at the radio station. This unbalance permitted currents received over the radio link to be fed back thru the radio transmitter of the land station, as described above. These fed-back currents overload the radio transmitter if they are large compared with the currents being supplied to the radio transmitter from the shore subscriber. In other words, if there is sufficient amplification in the shore transmitter to enable very weak voice currents arriving over a line of high equivalent to load the transmitter fully, then the transmitter is likely to be overloaded by currents which get thru the hybrid coil from the associated radio receiver. For these reasons, the two-wire-four-wire circuit of Figure 12 is not good enough for extension over long distance circuits.

The four-wire type of circuit which is suitable for long distance land line connections is shown in the second diagram with representative transmission equivalents. A brief comparison of the two-wire and the four-wire circuits will make it evident why the four-wire circuit gives the better equivalent. It enables the land line loss between the radio station and the toll center to be more or less wiped out, thus in effect placing the radio station electrically at the toll center. Another way to express the situation is this: regard the hybrid coil unbalance as the limiting factor, then assume that, while holding to a given unbalance, the four-wire circuit (the loss in which can be largely wiped out by one-way amplifiers) is extended inland. The length of the remaining two-wire line back to the land subscriber is thereby decreased and the ratio of the current received at the radio station over the line as compared with that transmitted across the hybrid coil thru unbalance is increased. It will be observed that with the circuit conditions as illustrated, the overall equivalent between, say, a Chicago subscriber and a ship, including a 10-unit toll circuit loss, is approximately 25 units, which should give a good talk.

#### POWER LEVELS AND INTERFERENCE

It is necessary that the magnitude of stray currents be so kept down in comparison to the transmission currents thruout the system as to obviate noise interference with telephone conversation. This requirement is particularly difficult of realization in the radio link because of static and, especially in the vicinity of New York, interference from spark telegraph stations. It is, of course, this interference, caused by the presence in the ether,

on the wave length band being used, of extraneous wave components, which sets the actual range limit of the radio link. Actually it was found that in transmitting on about 400 meters in the vicinity of New York the receiving field strength could not be permitted to go on the average below about 200 microvolts per meter, and even then the spark situation is so bad in the present art as to give periods of prohibitive interference. In less congested zones along the coast to the north, probably lower field strengths could be permitted.

### TRANSMISSION VARIATIONS IN RADIO CIRCUIT

One of the outstanding transmission characteristics of a ship-to-shore radio telephone system is the variation which the attenuation of the radio link undergoes as a result of the movement of the vessel. In order to determine the magnitude of these variations, a series of measurements were made of the telephone transmission over the radio circuit as the vessel proceeded on her course.

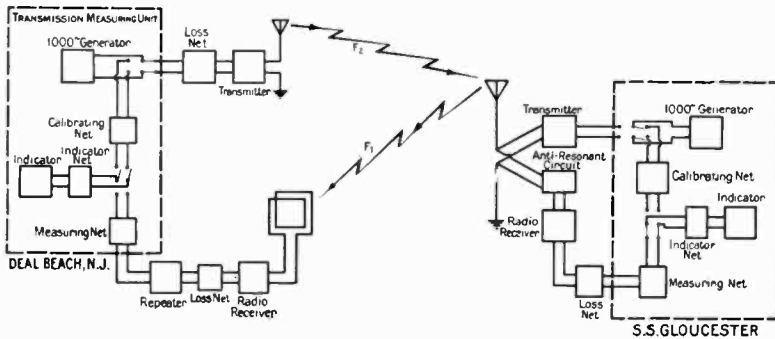

FIGURE 13—Measurements of Telephone Transmission of Radio Circuits

The method of making these measurements is shown schematically in Figure 13. Take for example the case of measuring a one-way circuit as distinguished from a circuit looped back. A 1,000-cycle current of predetermined power of the order of one milliwatt is impressed upon the input circuit of the radio transmitter. This tone is received in the output of the distant radio receiver. There it is passed to the measuring apparatus where it is amplified, rectified, and made to operate an indicating instrument. The receiving end measuring apparatus is then switched to a local source of 1,000-cycle current giving the same power as was applied to the transmitter at the sending end. The proportion of this power which enters the measuring apparatus

is then varied by a variable network calibrated in power ratio loss (it was actually in miles of standard cable), until the indicator reading is the same as that obtained from the radio receiver. The setting of the variable network then indicates the transmission loss of the circuit. The method is similar to that developed for measuring the transmission loss of telephone circuits.

These measurements were used for the purpose of enabling the radio link to be worked to a constant transmission equivalent—in this case, of about six units. The procedure for so doing was as follows: When the vessel was first picked up, the receiving amplifications in both east and west channels were adjusted until the measurements showed a transmission equivalent of 6 units. Then as the vessel proceeded on her course the transmission equivalent was measured at intervals of an hour or less and the receiving amplification readjusted to hold the desired six-unit equivalent. In this way, the talking efficiency of the radio link, was kept constant.

The total amplification change which had been made from the beginning of a run up to any one time gives a measure of the change which has occurred in the transmission loss of the radio circuit. By plotting this change in relation to the time of day and in turn to the varying distance between the two stations, an interesting curve results which shows the manner in which the progress of the vessel affects the transmission of the radio circuit. In Figure 14, the time of day is plotted horizontally, distance is plotted vertically on the right and amplification vertically on the left. The zero amplification reference is the amplification in the circuit which gives a six-unit equivalent at the time the vessel is first picked up.

Curve A shows the manner in which the distance between shore-station and ship varied with time of day as on her south-bound course the ship approached the shore station from the northeast and drew away again to the south. The vessel in this case was on her inshore course along the coast as shown in Figure 10 above. Curve B shows the manner in which the receiving amplification on shore had to be changed with time of day to keep the ship-to-shore transmission constant, first decreased as the ship came closer and then increased as she drew away again to the south. Curve C is for reception on ship and shows the manner in which the ships receiving amplification had to be varied to keep the shore-to-ship transmission constant. Altho these are not measurements of any absolute quantity such as field-strength, they are practical measurements of actual talking circuits and

as such include the effect thereon of apparatus adjustments as well as the "other" conditions and therefore are of value in determining the conditions to be met in maintaining the over-all system in operation. The difference between curves B and C,

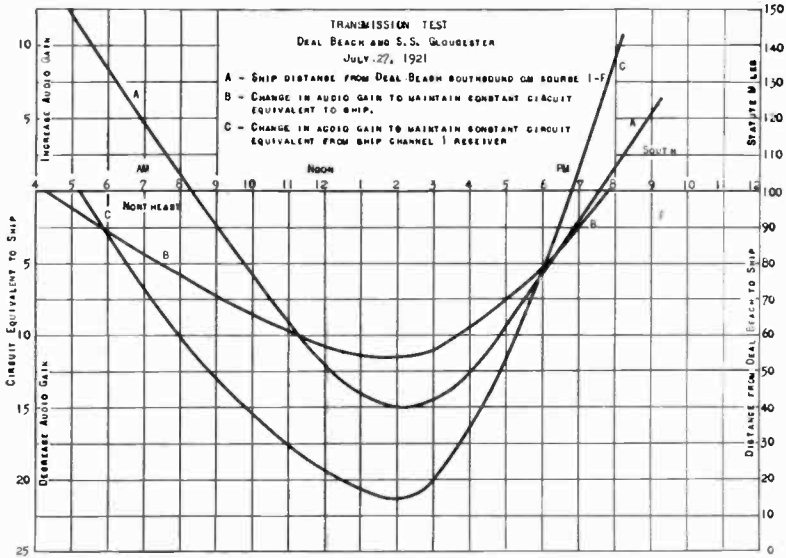

FIGURE 14

for example, are in part the result of the difference in adjustment given to the detector tubes of the two circuits. The load on the detectors was kept practically constant by adjustable radio-frequency amplification so that any overloading was approximately constant thruout the measurements and had the effect of minimizing the variation of circuit equivalents with distance.

The curves of Figures 15 and 16 are obtained by taking the data of Figure 14 and plotting the variation of amplification with separation between stations. The minimum point is arbitrarily chosen. These curves show up rather strikingly the fact that the transmission to the south is much poorer than that to the northeast of Deal Beach. This result agrees with experience since greater difficulty is usually encountered in communicating with a vessel when the line of transmission is along the coast than when it is straight out to sea. The larger transmission loss may be due to shore absorption or, possibly, to refraction of waves by the electrical discontinuity represented by the coast line. This high attenuation effect was observed rather uniformly in all of the measurements, and would itself form an interest-

ing subject of investigation, using more absolute methods of measurement.

TRANSMISSION TEST  
 DEAL BEACH AND S. S. GLOUCESTER  
 JULY 27, 1921  
 SOUTHBOUND ON COURSE I-F

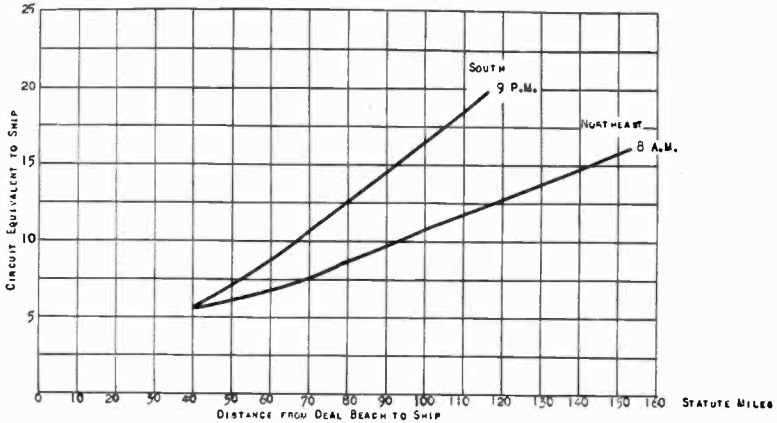

FIGURE 15

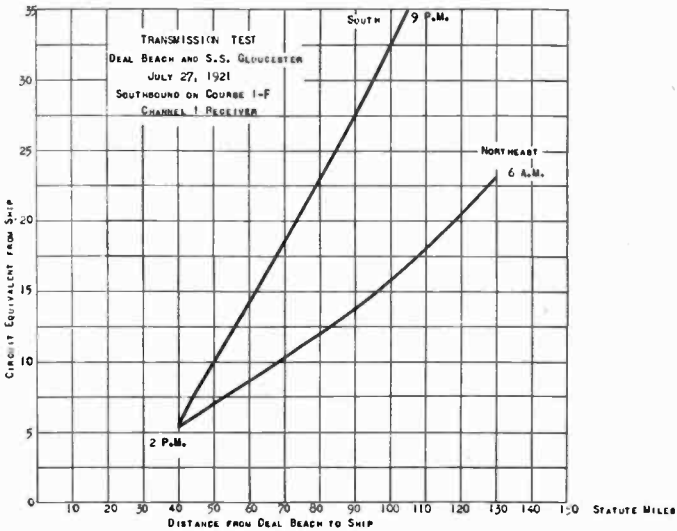

FIGURE 16

Figure 17 shows the circuit-equivalent-distance characteristic for the off-shore course taken by the vessel. The curve is generally similar to that for the near-in course.



The rate at which the transmission of the circuit varies with change in distance is an important matter in operation, since it determines the frequency with which the amplification in the circuit must be readjusted to keep the equivalent constant. In accordance with the Austin-Cohen formula, the equivalent

TRANSMISSION TEST  
 DEAL BEACH AND S.S. GLOUCESTER  
 JULY 20, 1921  
 SOUTHBOUND ON COURSE 3  
 CHANNEL 1 RECEIVER

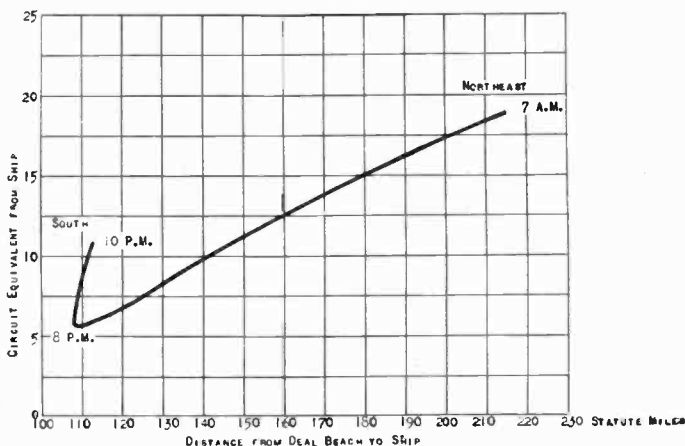

FIGURE 17

should vary at the rate of about 0.25 units per statute mile (1.6 km.) with the vessel 100 miles (160 km.) out, assuming a square law detector. In the worst case found, the circuit equivalent varied at the rate of 0.5 unit per statute mile. This was one of the cases where the vessel was well south and close in shore and, of course, represents very poor transmission. It means that with the vessel traveling as slowly as ten miles (16 km.) per hour, a transmission change of about five units per hour will occur. In telephone practice it is desirable to keep the transmission equivalent constant to within two or three units, so that this condition would require re-adjusting the amplification as often as every half hour.

These curves show the necessity for so designing the receiving set as to be able readily to obtain a wide variation in amplification in order to accommodate the changes in transmission efficiency. Under the conditions of the test, it was found that a variation of 40 units amplification is necessary in order to carry

the vessel from a range of 40 up to 200 statute miles (64 to 320 km.). In order to gain such control, it is desirable to switch stages of amplification into and out of the circuits and to obtain closer adjustment by means of networks of variable loss.

When we speak of holding the circuit to a constant transmission equivalent thruout a wide variation in the position of the ship, we do not mean that the circuit for 200 miles (320 km.), for example, is as good as that for 40 miles (64 km.). The field strength received over the longer circuit is, of course, very much weaker than that received over the shorter one, and is subject to correspondingly more interference. For a transmitting power of about one kilowatt used in the tests, it was found that the circuit was rather consistently good up to 100 miles (160 km.) or so. During summer daylight condition, it was only fairly good at around 150 miles (240 km.), and at 200 miles (320 km.) was subject to so much interference that its insurance against interruption in service was small. Under more favorable conditions, particularly as at night in the winter time, connections could be established over very much greater distances, but not reliably.

#### FIELD STRENGTH MEASUREMENTS

The circuit transmission measurements described above were supplemented during the latter end of the experiments by measurements of a more fundamental nature, namely, of the received field strength. These measurements represent the application to the ship-to-shore development program of what was really another investigation—that of the development of methods and apparatus for measuring field strengths at these relatively short wave lengths as well as for longer wave lengths. The method and means employed will not be described, since they will be the subject of another paper to be given before THE INSTITUTE OF RADIO ENGINEERS shortly by the engineers immediately responsible for this development. Field strength measurements will be discussed, therefore, only insofar as the results obtained apply to the ship-to-shore type of system.

The first measurements which were made are given in Figure 18. Time did not permit of checking the results, but they are approximately correct. They show the variation in the strength of field received from the S.S. "Gloucester" during the same trip as the circuit measurements of Figure 14 were taken. The fact that the transmission is considerably better to the northeast from Deal Beach than when the vessel is south is rather strikingly in evidence. The dash-line curve is for the Austin-Cohen formula

and shows that the field strength versus distance relation checks that formula for these relatively short wave lengths when the path of transmission is practically entirely over sea. The absorption

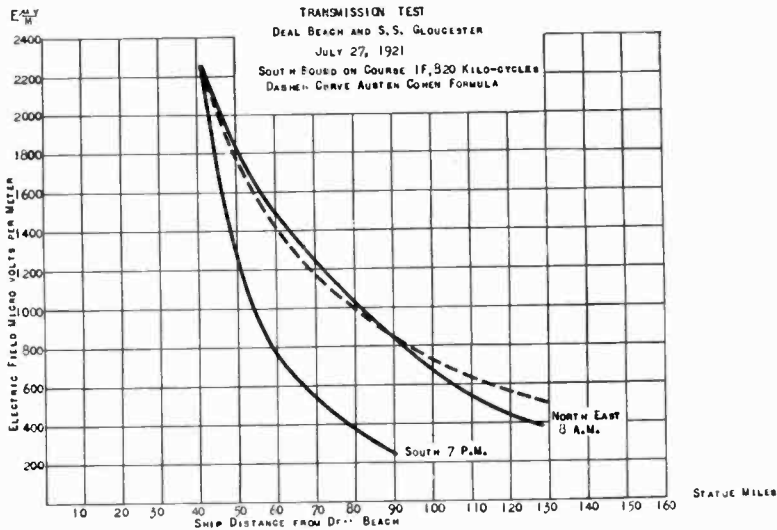
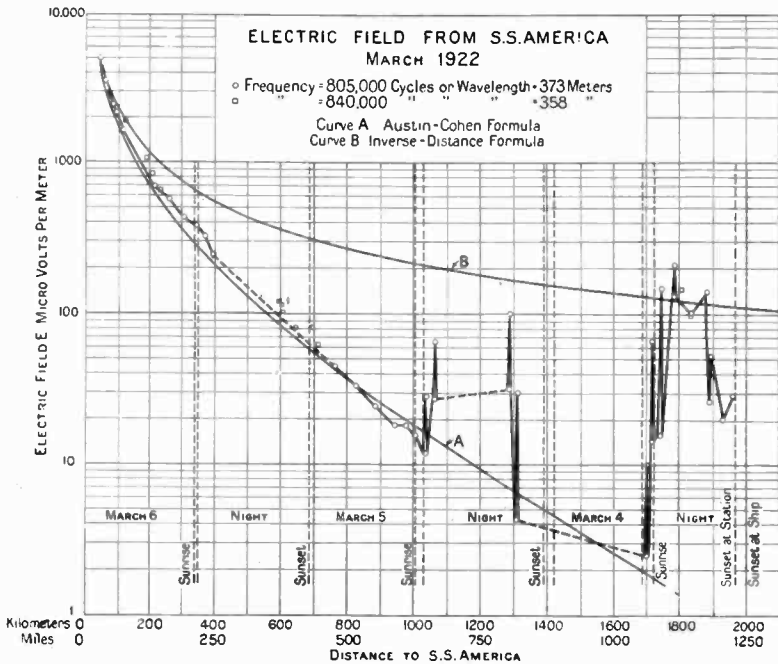
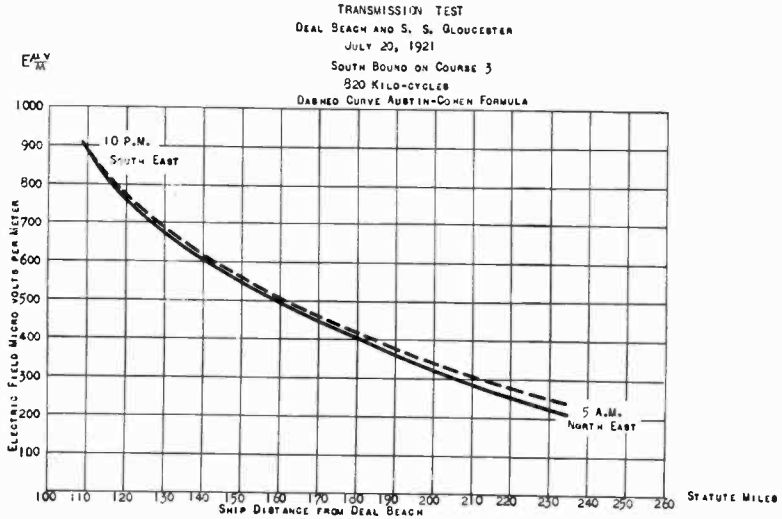

FIGURE 18

coefficient is obviously greater when the path of transmission has a relatively large component skirting along the coast line. The curve shows also that the vessel was picked up and the circuit "made" on this day at a field strength of about 400 microvolts per meter, then increased as the vessel came nearer and passed the land station to a value of 2,200, and that the circuit was "broken" at about 200 microvolts. The results of another measurement made on the off-shore course of the vessel are given in Figure 19. A larger proportion of this curve is for straight-out-to-sea transmission where the attenuation law is seen to be normal.

In the field strength measurements made during the ship-to-shore development, those of the S.S. "America" en route across the Atlantic are especially illuminating. The results are given in Figure 20. The vessel was in-bound so that the curve develops from the right to the left, altho the effect is just the same as if it developed in the reverse direction with the vessel out-bound as was shown by another set of measurements which gave generally similar results. The actual measurement results are indicated by the points and by the connecting heavy line curve. The light curve A is a plot of the Austin-Cohen formula,

the absorption term of which is for daylight transmission over water. The light curve B is a plot of the simple inverse-with-distance law without any absorption term.



This curve shows up the following important factors:

(1) The enormous variation between day and night in the received field strength which occurs at distances of the order of 1,000 miles (1,600 km.) using wave lengths of 350 to 400 meters as now employed in broadcast transmission. The curve shows night to day variations of the order of 100:1 or a power ratio of 10,000:1. This means, for example, that it would require 10,000 times more power to "get thru" as well during the day as during the best times at night. These enormous day to night fluctuations are now familiar to broadcast listeners. This curve shows the impossibility of giving continuous ship-to-shore telephone service at these relatively short wave lengths for distances as great as 1,000 miles (1,600 km.). For such distances much longer wave lengths will be required, as well as more sending power.

(2) The wide fluctuations which occur thruout the night period. Altho smaller than the day to night fluctuations, their effect upon transmission is still very large. The fluctuations during the third night out, for example, are as much as 10:1 in field strength or 100:1 in power, or about 20 of the power ratio units we have used above. In view of the rapidity with which these fluctuations occur—within a very few minutes—it is practically impossible to maintain a circuit under these conditions satisfactory for regular telephone service.

(3) The most interesting thing to observe is that the fluctuations tend to fall within the two curves A and B. The day transmission is a pretty definite proposition, following closely the Austin-Cohen formula. The night transmission appears in the nature of a "bob-up" from the day condition but seems to be limited in the extent of its "come-back" by the loss imposed by the simple inverse-with-distance law. The fact that the difference between curves A and B is entirely one of absorption suggests that the very large and rapid night fluctuations, which are now so well known to broadcast listeners, may be explained in large part if not in whole, by variations in atmospheric absorption.

#### OCCASIONAL LONG DISTANCE TRANSMISSIONS

Many of the long distance records which have been made on short waves and low power can be accounted for simply on this basis—that the absorption which ordinarily obtains during daylight has been temporarily wiped out. The way in which it is pos-

sible for the range to "open up" tremendously under exceptionally favorable conditions will be seen from this: Referring to Figure 20, assume that the normal daylight range between S.S. "America" and New York was 250 miles (400 km.) as fixed by a limit taken as 200 micro-volts per meter. Then, at night, this same field strength may be delivered over a distance of about 700 miles (1,100 km.) if the absorption is wiped out in accordance with curve B.

Furthermore, so favorable is the simple spreading-out law at such distances, that the field strength is only halved in going another 700 miles to 1,400 miles (2,200 km.) and only halved again in doubling this distance to 2,800 miles (4,500 km), and so on. In other words under no-absorption conditions, by increasing the receiving radio frequency amplification by a current ratio of only  $\frac{1}{2} \times \frac{1}{2} = \frac{1}{4}$ , or about 12 power ratio units, the range of transmission may be increased from the reliable daylight range of 250 miles (400 km.) to a possible night range of ten times this distance. It is therefore seen that many if not all of the long distance transmissions which have been realized for short periods of time probably can be explained simply on the basis of there having occurred an exceptional clearing up of absorption at a time of unusually favorable interference conditions.

#### SETTING UP AND OPERATING COMBINED RADIO-WIRE CIRCUITS

The operating problems presented by the combination wire-radio telephone system are more difficult than these involved in the operation of either a straight telephone toll line on the one hand or the ordinary radio-telegraph circuit on the other. In regular long distance telephone circuits we have a fixed type of system which is maintained continually in good talking condition and the operators turn the terminals over to the use of the subscribers themselves. On the other hand in a radio telegraph circuit operating between land and vessel the circuit is kept entirely in the hands of skilled operators who have access to the apparatus and who handle the traffic directly between themselves. In no case before have we had the requirement of taking a radio link of varying length, building it up as occasion requires with wire circuits and, upon call, putting the combined system at the disposal of people experienced only in the use of the regular telephone. The technical difficulties of the combination system, together with the necessity of coming as close as possible to meeting telephone standards in the quality of talk given, greatly reduce the length of the radio link which can be used for a service

as compared with those distances which can be spanned for short periods of time under the most favorable conditions. The effect which the requirement of reliability has in reducing the range of transmission will be appreciated from the discussion of field strength measurements.

There are various ways in which the combination circuit can be set up and operated and it will take further experience before the most satisfactory arrangement is determined upon. In order to explain the operation generally, however, we will describe how the circuit was actually set up during the tests. Take the case of a call originating on the vessel; then the procedure is as illustrated in Figure 21, namely:

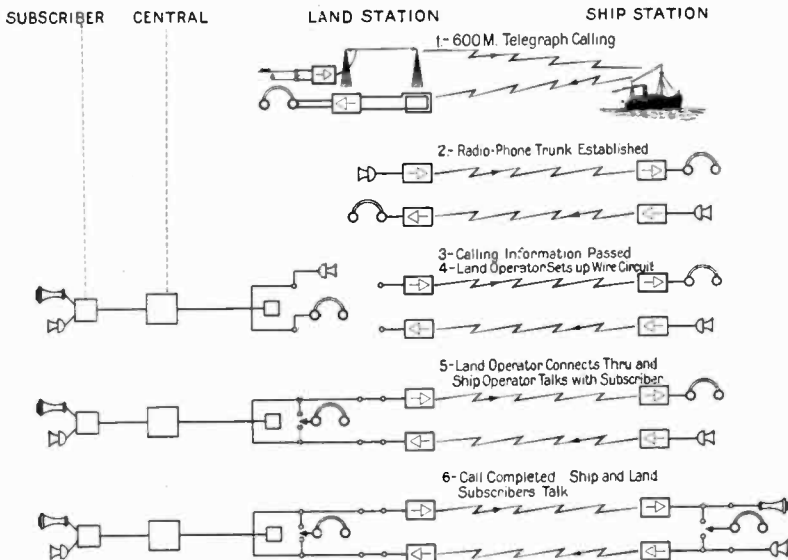

FIGURE 21—SETTING UP A TELEPHONE CONNECTION

1 When the ship comes within range she calls the land station by telegraph on 600 meters, and informs the land station of her message business.

2. The land station then assigns a pair of telephone channels to which both stations switch over and the circuit tested out for talking. In case of important long distance land line connection, this test may involve circuit transmission measurements.

3. The ship operator then passes to the land operator

by voice (or by tone modulation telegraph) the information as to the connection desired.

4. The land operator then tells the ship operator to stand by while he switches to the wire circuit and passes the call to the telephone central, who in the case of a local call is a local operator (actually, for this case, she was the operator on the New York Cortlandt Official board of the American Telephone and Telegraph Company); or in the case of a long distance call is a toll operator.

5. The land line connection is made in the usual way and the shore station radio operator greets the land line subscribers.

6. The shore station operator then joins together the land line and the radio link thus connecting the land subscriber with the ship operator, who proceeds to tell the subscriber that this is the steamship so and so and that Mr. Blank wishes to talk with him. While this is going on, the land operator is monitoring on the circuit and makes such final adjustments of the amplification as may be necessary.

7. The ship operator then summons the ship subscriber and the latter takes up the conversation.

The handling of calls originated by the land line subscriber presents a more difficult operating problem because of the uncertainty as to the radio link—it not being known whether it can be established and, if so, as to how long a wait will be involved in getting the connection. During the tests, most of the calls originated in the New York area. For these cases the land subscriber was connected to the Deal Beach station and there the call was put thru directly to the ship in case the radio telephone circuit was available. When not available, information as to the call was recorded by the radio operator and the telephone circuit released for the time being. The call was then completed by first setting up the radio link and then calling back the initiating subscriber. It is obvious that the giving of commercial service will involve: first, the ascertaining of whether or not the vessel is within range; second, the “lining up” of the radio link preparatory to the thru connection; and third, the building up of the land line connection back to the calling subscriber and the making of the thru connection. Many detailed variations are possible in the procedure and the determination of the best operating methods will have to await upon experience obtained in actually giving service.



In order to become familiar with the problems involved in maintaining the ship-to-shore system in operation, a series of operating tests were carried out for a period of about three months, starting in January, 1921, and operating between Deal Beach station and the S.S. "Gloucester." In accordance with a

Date	1/9/21	Station	K Q G	No.	4
Time <del>land</del> received	3:50 P.M.				
	FROM				
Place	NEWARK, N.J.				
Tel. No.	7522 WAVERLY				
Person	E. E. FREY				
	TO				
Place	S. S. GLOUCESTER				
Tel. No.	K Q G				
Person	M. E. FULTZ				
Time Passed					
Time land subscriber connected to ship operator	3:55 P.M.				
Time circuit completed	3:55 P.M.				
Time disconnected	3:58 P.M.				
Reports	QUALITY FAIR VOLUME WEAK				
Connection failed due to					

Date	1/9/21	Station	2 X J 4	No.	4 (12)
Time filed <del>on-connection</del>	3:48 P.M.				
	FROM				
Place	NEWARK, N.J.				
Tel. No.	7522 WAVERLY				
Person	E. E. FREY				
	TO				
Place	S. S. GLOUCESTER				
Tel. No.	K Q G				
Person	M. E. FULTZ				
Time Passed	3:50 P.M.				
Time land subscriber connected to ship operator	3:55 P.M.				
Time circuit completed	3:55 P.M.				
Time disconnected	3:58 P.M.				
Reports	FAIR QUALITY				
Connection failed due to					

FIGURE 22

pre-arranged schedule (unknown to the engineer-operators), calls were entered by a considerable number of Bell System engineers in the vicinity of New York, and calls were initiated from the vessels also by the opening of sealed envelopes carrying instructions to call one or more parties on shore. Figure 22 is a facsimile of the message form or "ticket" used in the operating tests. The table below gives a representative record sheet recording the calls which were made on a particular day and also the time which elapsed in putting each one thru. These data, of course, are not especially representative of what can be done with a system after it is operating smoothly in commercial service, but are interesting in giving a general idea of the way the system worked and in showing that calls were successfully put thru in a reasonably short time. In the aggregate a large number of calls were made, and as a result the system was put to a fairly severe operating test. It was found, as was to be expected, that the time required to put thru the radio connections to the vessels is large in comparison with the connecting time on the wire lines, and will require that precaution be taken in the operating routine to minimize the time during which wire circuits are held up pending connection with the radio link. (The wire circuits used in the tests appeared in New York on a busy P.B.X.

(private branch exchange) and did not receive the operating attention that they would in regular service.) But even tho the radio holding time was larger than the usual wire time, it is in itself rather surprisingly good considering the difficulties which attended this maiden operation of telephone circuits to ships and the operating results must be regarded as full of promise for the extension of telephone service to the highways of the sea.

#### TESTS OF THREE-CHANNEL OPERATION

Of course, any comprehensive ship-to-shore radio telephone system must be capable of establishing a number of telephone connections from a common land station to a number of ships. The Deal Beach experiments, therefore, had as one of their objectives the trying out of multi-channel operation. These tests were conducted during the fall of 1920 and thru January 1921, with the S.S. "Gloucester" and the S.S. "Ontario." A third boat was simulated by a small-power experimental set installed at the Cliffwood, New Jersey, experimental station. The three channel operation is illustrated diagrammatically in Figure 23, which also shows the scheme of frequencies. The three channels transmitting from Deal Beach were grouped in one frequency range, spaced 30,000 cycles apart. The frequencies transmitted from the ship and received at Deal Beach were grouped in another frequency range removed 30,000 cycles from the first and having frequency intervals likewise of 30,000 cycles. Transmitting and receiving channels differing by 90,000 cycles were paired in the manner indicated to form two-way circuits. While it is possible to squeeze channels together more closely than this, it was not desired in the experiments to go to the limit of frequency squeezing, particularly because of the severe selectivity requirements imposed upon vessel equipment. These frequencies represented a fair balance between technical perfection on the one hand and practically realizable conditions on the other. It will be seen that the set-up was really a four-channel system, with the fourth channel used on 600 meters for calling purposes. Under these conditions three conversations were carried on successfully from the single land station, two to actual ships and one to a "dummy" ship at the Cliffwood experimental station.

#### EQUIPPING OF S.S. "AMERICA"

The primary development work of the ship-to-shore system was carried out, as described above, in conjunction with coastal

**DAILY RECORD SHEET—SHIP TO SHORE RADIO SERVICE**  
*System Test*

April 6, 1921

		DESTINATION	TOTAL TIME IN CONTACT	DELETED	INTERRUPTIONS	CANCELLED	COMPLETE IN-FACTORY	REMARKS
		From ship	No. - Min.					
TELEPHONE CALLS								
	1	N.Y.C.	41				✓	Good.
	2	N.Y.C.	37				✓	Good.
	3	N.Y.C.	14				✓	Pair. Weak arc QRM.
	4	N.Y.C.	14				✓	Pair. (weak) bad arc QRM.
	5	Newark	3 - 55	P. (2:14 P.M. 3:11) out.			✓	Good. (weak RN, spk.)
	6	Long Beach	3 - 01	P. (11:55 A.M. Out till 1 P.M. (2:14 P.M. 3:11) out.			✓	Good, but weak.
	7	Albany Park	2 - 40	P. (2:15 P.M. Don't ans.			✓	Pair. RT from QRM.
	8	Newark	2 - 22	P. (2:15 P.M. Answer, Party out.			✓	Good, but weak.
	9	Albany Park	1 -	P. (3:00 P.M. Out of Blag.			✓	Good. Suite relay.
	10	Albany Park	1 -				✓	Good. Spk QRM.
	11	Newark	40				✓	Good. Weak QRM. J EM.
	12	Newark	57				✓	Good. Weak QRM. J EM.
	13	Altonhurst, NJ	40				✓	Good. (Bad spare QRM)
	14	Albany Park	29				✓	
	15				3:47 P.M. Out till 5 P.P.		✓	
TELEGRAMS								
	1	N.Y.C.	21				✓	Good. Ship has spare QRM.
	2	N.Y.C.	45				✓	Good.
	3	N.Y.C.	53				✓	Pair.
	4	N.Y.C.	47				✓	Pair.
	5	N.Y.C.	19				✓	Good.
	6	N.Y.C.	11				✓	Good.
	7	N.Y.C.	12				✓	Good. Mr. Marfield tries out transmitters.
	8	N.Y.C.	18				✓	Good.
	9	Spring Lake	20				✓	Good.
	10	N.Y.C.	2 - 09	P. (2:15 P.M. Not in.			✓	Good.
	11	N.Y.C.	3 -	P. (2:30 P.P. Will Call.			✓	Good.
	12	N.Y.C.	3 -				✓	Good.
	13	N.Y.C.	26				✓	Good.
	14	N.Y.C.	16				✓	Good.
	15	N.Y.C.	8				✓	Pair.
	16	N.Y.C.	6				✓	Pair.
	17	N.Y.C.	25				✓	Pair.
	18				10:46 A.M. J.M. don't ans.		✓	
	19						✓	
	20				3:02 P.M. Not there today.		✓	
	21				E. 3:50-3:51 P.M. Out off.		✓	
	22						✓	
SUMMARY								
From ship	1							
To ship	1							
To ship	2							
			TOTAL TIME TO TRANSMIT	DELAY TO TELEPHONE SERVICE				
			NO. OF WORDS	TOTAL TIME TO TRANSMIT				
			114	8				
			17	1				
			0	0				
			0	0				
			31	28				
			29	28				
			3	3				
			0	0				
			1	1				
			3	3				
			0	0				
			1	1				
			0	0				
			26	26				
			0	0				
			3	3				
			0	0				
			0	0				
			177	177				

vessels. Such vessels were chosen because the rapidity of their turn-round gave much more frequent test periods than could be obtained by means of vessels pursuing a longer route. It remained, however, to equip a trans-oceanic vessel and connect her into the telephone system.

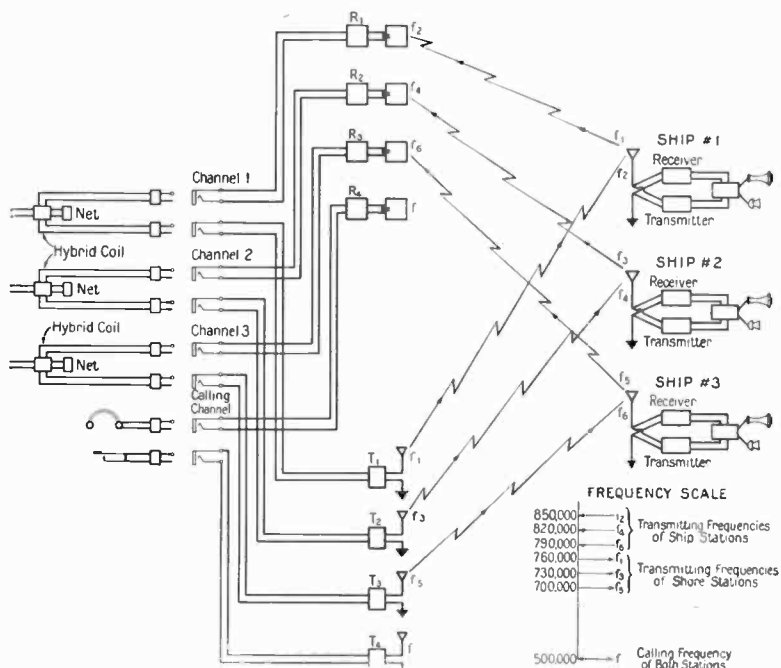

FIGURE 23

In 1921, the development tests of ship-to-shore telephony were extended to include the General Electric Company and the Radio Corporation of America. The engineers of these companies built a ship set similar to that developed in the work described above, but of a more commercial design, and installed in on the S.S. "America" in January, 1922.<sup>3</sup> During the succeeding few months, tests were made between the S.S. "America" and the shore, and on a number of these trips connections were put up to various interested parties around New York when the ship was within about 300 miles (480 km.) of the Deal Beach station. Of course, the "America" was carried out much farther than this at night, but the circuits were not sufficiently reliable

<sup>3</sup>See article "Duplex Radio Telephone Transmitter," by Baker and Byrnes, "General Electric Review," August, 1922.

to be used in connection with the land lines, as will be appreciated from the field strength measurements given above.

A photograph of a portion of the installation on the S.S. "America" is reproduced in Figure 9 above. The talking tests made with the "America" were the occasion of much interest on the part of the listeners-in, and several of the demonstrations were the subject of newspaper accounts and need not be described. The more technical phases of the tests with the S.S. "America" are (a) the field strength measurements, and (b) the simultaneous telegraph tests discussed below.

#### SIMULTANEOUS TELEPHONE AND TELEGRAPH OPERATION BETWEEN SHIP AND SHORE

During the experiments with the Steamships "Gloucester" and "Ontario," the radio telephone transmissions were carried on alternately with the conduct of the regular radio telegraph service of the vessels. Simultaneous operation was impossible because the vessels were equipped with spark transmitters. While this arrangement of having to switch between either telephone and telegraph operation is permissible for small vessels where the communication load is light, it is, of course, not satisfactory for large trans-oceanic vessels where the message business may be such as to require practically continuous operation on the part of both services.

Recognizing, therefore, that one of the problems attending the successful application of radio telephony to large vessels is that of simultaneous telephone and telegraph operation, tests of such transmission were conducted in co-operation with the Radio Corporation of America from the S.S. "America." These were made during February and March of 1922. On the land end, the two radio circuits terminated at different stations, the telegraph end at the Bush Terminal, New York City station of the Radio Corporation, and the telephone at our Deal Beach, New Jersey, station. The telegraph transmitter was of the continuous wave tube type manufactured by the General Electric Company. The telephone and telegraph sets used individual antennas on the ship.

Altho certain apparatus difficulties were experienced aboard the vessel because of the short notice at which the tests were made, nevertheless the tests were successful and demonstrated that a telephone set can be made to operate simultaneously with a suitable C. W. (continuous wave) telegraph transmitter. The final solution of this problem of simultaneous operation, how-

ever, will undoubtedly require further work in co-ordinating the two types of systems, in order to permit them to be operated on wave lengths relatively close together. During the tests, the wave lengths were widely different, the telegraph operating on about 2,100 meters and the telephone on about 375 meters. The work done at Deal Beach in the development of multiplex telephone operation, where three telephone channels were operated in the vicinity of 400 meters and a fourth channel was operated for telegraphy at 600 meters, demonstrates that it should be feasible to operate telephone and telegraph channels simultaneously on closely adjacent wave length bands. However, in determining wave length allocations, these limiting factors will have to be considered: first, the greater susceptibility of the telephone to interfering noises, such as beat tones, and second the fact that the telephone requires two bands, one for each direction of transmission, and that these bands are required to be spaced a little apart in frequency. It is obvious that by controlling both types of channels from the same station they can be better co-ordinated in respect to frequency and general service use than if operated from separate stations, so that combined telephone-telegraph shore stations present interesting possibilities for the future.

Another method of operation which makes for wave length conservation is that of superimposing the telephone and telegraph channel on the same carrier wave after the general manner of compositing long distance telephone lines with telegraph. This can be done by combining the two channels on one circuit as is done in wire practice and then modulating the combined channels upon the radio carrier. At the receiving end both channels can be detected simultaneously and then the channels separated by composite sets or filters. This method is mentioned to show the ultimate possibilities of combined operation and is not put forward as one which is sufficiently practical, all things considered, for use in the art of the immediate future.

#### RADIO LINKED WITH TRANSCONTINENTAL LINE AND CATALINA ISLAND

The ship-shore radio link was on several occasions connected with very long distance circuits in order to demonstrate the extreme conditions under which combined radio and wire operation are possible.

Perhaps the most interesting case is that in which the ship was linked up with the transcontinental telephone line and con-

needed thru to Catalina Island in the Pacific thus bringing together the two oceans. The circuit arrangements for one of these demonstrations are given schematically in Figure 24.

TRANSCONTINENTAL LINE WITH RADIO EXTENSIONS



FIGURE 24

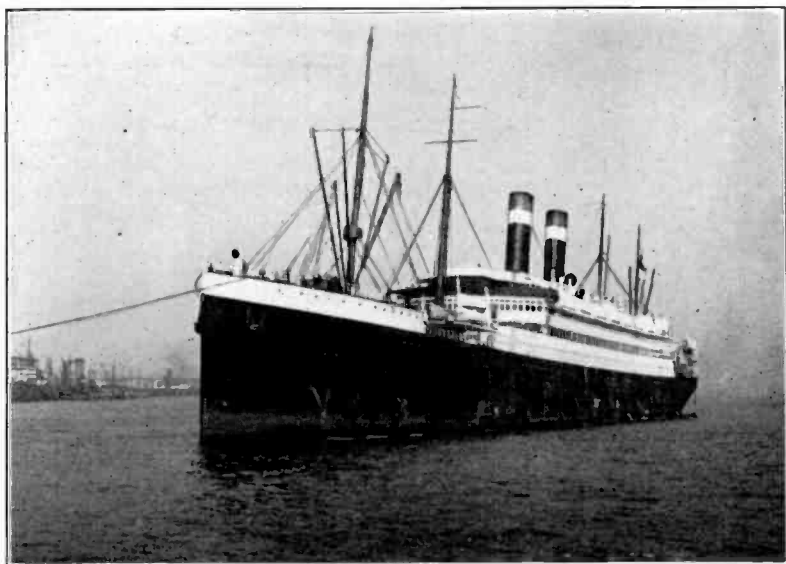

FIGURE 25

Both the Deal Beach and Green Harbor shore stations were used, since it was desired to reach the ship anywhere on her course from Boston to the Delaware capes. The demonstration was,

therefore, also an example of connecting the ship into the land telephone system thru either of two shore stations. As a matter of fact, at one time the vessel could be reached thru both stations. It happened that the vessel was coming up the coast. The night before the demonstration the ship was communicated with thru the Deal Beach station and connected thru to Catalina Island for a rehearsal. For the demonstration of the following morning, connection was made thru Green Harbor. During both the rehearsal and the demonstration the operator on the vessel talked successfully, altho with some difficulty, with the Catalina Island operator, while New York listened in. This demonstration was made for General J. J. Carty on February 14, 1921. An earlier demonstration of a similar nature, although not involving Green Harbor, was made for the delegates of the Preliminary International Communications Conference on October 21, 1920.

#### CONCLUSIONS

The result of this development may be summed up as follows:

(1) It has realized a radio-telephone system capable of giving two-way transmission and meeting the requirements imposed by joint radio-wire operation.

(2) It has demonstrated the actual use of this radio-telephone system in a wire-radio toll circuit as a means for extending the telephone service of the country to include vessels at sea.

(3) The experiments have demonstrated also the practicability of multi-channel operation from a common land station whereby a number of land subscribers may be connected simultaneously to a number of different vessels.

(4) The transmission and operating tests show the difficulties attending the establishment and maintenance of the radio-telephone link to a moving vessel and the necessity for careful adjustment of the transmission conditions of the circuit and for a diligent maintenance of these adjustments during operation.

(5) In the experiments in multi-channel operation and in simultaneous telephone and telegraph transmission from the same vessel, a beginning has been made in one of the most important problems concerned with the early application of radio telephony to the marine service, namely, that of the co-ordination between radio-telegraph and radio-telephone transmission. It is obvious that the general development of the art of selective transmission, as well as the



entrance of radio telephony, calls for the use of purer carrier waves and of a minimum transmission band in radio telegraphy.

(6) As regards the important question of wave lengths, the development has shown that the relatively short waves employed in the experiments are satisfactory up to several hundred miles but that for longer distances longer wave lengths will be required. The difficulty of obtaining for the marine service a wave length range sufficiently wide for permitting the handling of any considerable traffic is obvious. The band which can be allocated to this service will naturally be limited by the requirements of other services; and the intensiveness with which this band can be worked by closing up the frequency spacing between channels is limited by the consideration of intercommunication between different types of systems and by apparatus expense.

In general it may be said that the present development has contributed to the communication art the means whereby the universal land line telephone system may be extended to ships at sea. The actual giving of such service must await the working out of the economic problems involved and the necessary business and organization arrangements between the communication companies and the steamship companies.

**SUMMARY:** The paper describes the development of a two-way radio-telephone system and its use in extending the Bell Telephone System to connect with ships at sea. The electrical considerations and the experimental work involved in determining the system-design of the radio link are discussed. Two land stations were established, one of them a permanent three-channel station on the New Jersey coast. Two coastal vessels and finally one trans-Atlantic liner were equipped. These installations are briefly described in the paper.

The operation of the combined radio and wire system is explained, particularly in respect to the transmission characteristics of the over-all system and the effect thereupon of the movement of the vessel and of variations in atmospheric conditions. Measurements of the variations in the field strength received from field vessels at sea show why it is possible to receive over very long distances at favorable times at night and not during the day. The method of establishing combined radio-telephone-wire circuits to ships is described and representative results are given of the considerable telephone traffic which was handled over the system experimentally during a period of trial operation. Tests of multi-channel telephone operation to several ships thru the Deal Beach shore station, and also tests of simultaneous telegraph and telephone operation from the same vessel are described. Connection of a vessel thru the transcontinental telephone line to the Catalina Island radio-telephone system, whereby the vessel in the Atlantic talked with an island in the Pacific, is briefly described, and finally the outstanding conclusions of the entire development work are given.

## DISCUSSION

A. A. Oswald (by letter): The functioning of the shore station as a repeater connecting the wire and the radio circuits has been described at some length. It may be of interest to consider repeating action of this general kind when applied between two radio circuits, as distinguished from the case of a land wire-radio link.

From time to time, various radio repeater systems have been proposed, in general, analogous to either the 21-type or 22-type repeaters used in long distance wire telephone circuits. The 21-type repeater is one which operates in two directions and employs a single amplifying element. The 22-type repeater operates in two directions and requires two amplifying elements. Each type has certain advantages. The establishment of a number of radio stations for the ship-to-shore experiments afforded an opportunity to test one radio repeater system of each type.

A test was conducted in which the Green Harbor station functioned as a 21-type radio repeater element between the S. S. *Gloucester* and the S. S. *Ontario*. At the shore station, Figure 1, the radio receiver was tuned to 820,000 cycles and the transmitter was adjusted to 730,000 cycles. The shore station transmitter and receiver were then connected together. Both ship transmitters were tuned to 820,000 cycles and both receivers to 730,000 cycles. Thus Green Harbor received both ships on the same frequency and re-transmitted the received signals to both ships.

Altho satisfactory telephone communication was established between the two ship stations, several disadvantages were observed which are inherent to the 21-type repeater. The carrier frequency of the terminal transmitters must be identical to prevent a beat note in the receiving element of the repeater. Carrier noise from both terminal transmitters is simultaneously received at the repeater and re-transmitted, thereby materially increasing the noise level in both terminal receivers. Amplification at the repeater is limited by the strongest incoming signal, since the adjustment must avoid overloading the transmitter. Amplification at the repeater is also limited by the electrical relation between the receiver and transmitter, which must be such that an oscillatory or singing condition is not established. If the four-wire termination is replaced by a two-wire termination, such as would be required if connections were made to the regular ship

---

\*Received by the Editor, March 16, 1923.

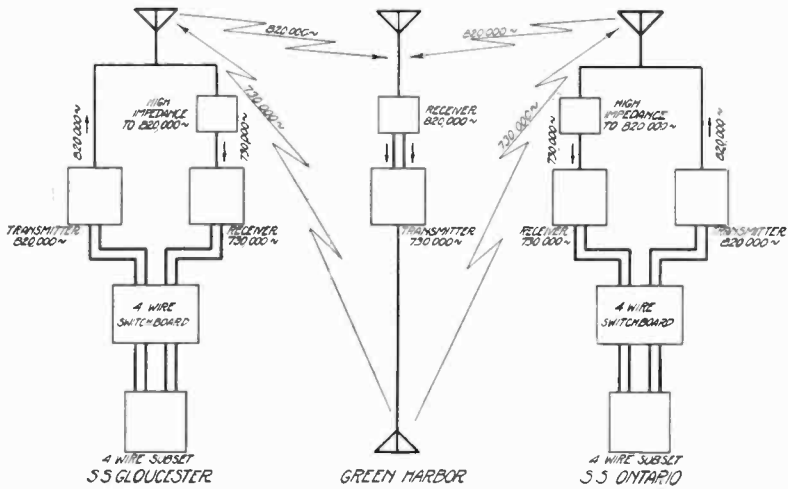

FIGURE 1—21-Type Radio Repeater

telephone system, a careful adjustment of amplification is necessary at all points in the system in order to avoid undesired and destructive oscillations. Obviously a similar condition arises when two or more repeaters are introduced in the radio circuit.

A similar test of a 22-type radio repeater was conducted at the Deal Beach Three Channel Station. In this case, four frequencies were employed and the repeater had two separate transmitters and receivers. Two complete channels at Deal were used to form the repeater element between the S. S. Gloucester and a five-watt transmitter at Cliffwood, N. J. (Figure 2).

The principal disadvantages of the 22-type repeater are the cost of two transmitters and two receivers as against half this equipment for the 21-type, and the use of four frequency bands as against two bands for the 21-type. On the other hand, it was found that the 22-type radio repeater not only eliminated the undesirable features of the 21-type, but also had marked advantages. Since the terminal transmitters operate at widely different frequencies an audible beat note is not produced in the receiver units of the repeater. Carrier noise is confined to one channel. The amplification in the east and west circuits is not limited by the repeater units except in the matter of overloading. Two or more radio repeaters may be introduced in the radio circuit without additional difficulties. Two-wire terminations are subject to the usual hybrid-coil limitations and do not involve any new considerations except precautions to avoid overloading the radio transmitter. Free oscillations or singing will only occur

around the complete radio circuit when the wire terminals are unbalanced.

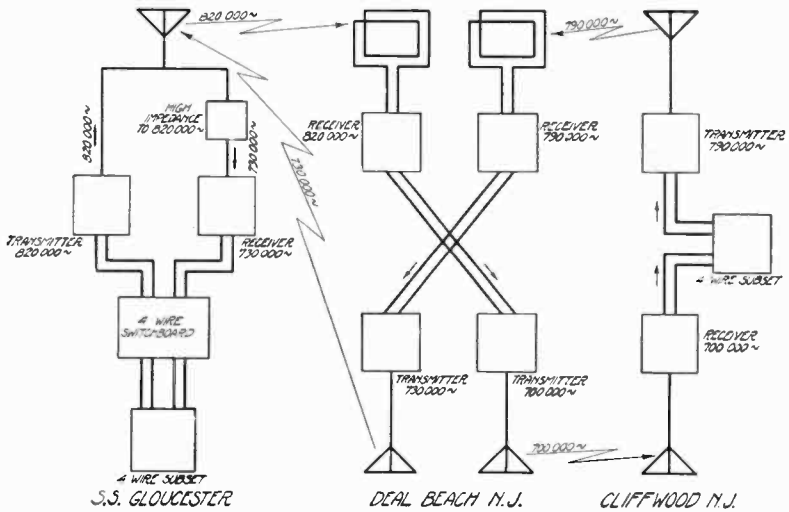

FIGURE 2—22-Type Radio Repeater

It will be noted that in both these experiments the incoming radio frequency signal was demodulated at the receiver and the resulting speech currents were then applied to the repeater transmitter. Reduction of the signal frequencies to corresponding frequencies in the speech range was convenient, and in general has several advantages. However, under some conditions it may be desirable and, moreover, it is feasible to employ direct frequency conversion from the incoming to the outgoing frequency band.

# CONTINUOUS-WAVE RADIO TRANSMISSION ON A WAVE LENGTH OF 100 METERS, USING A SPECIAL TYPE OF ANTENNA\*

By

FRANCIS W. DUNMORE

(ASSOCIATE PHYSICIST, BUREAU OF STANDARDS, WASHINGTON, D. C.)

## INTRODUCTION

The use of short wave lengths, of the order of 100 meters, for radio transmission, has numerous advantages. However, comparatively few investigations have been made of transmission on 100 meters, with either damped waves, or continuous waves, or radio telephony. This paper describes a method of continuous-wave transmission on a wave length of 100 meters, using a special type of antenna. This investigation was undertaken at the request of the Office of the Chief of Air Service, United States Army. The Office of the Chief of Air Service, and the Office of the Chief Signal Officer, United States Army, have given their consent to making public the results of this investigation.

In the investigation here described, communication was carried on using continuous waves, interrupted continuous waves and radio telephony. An electron tube generating set, rated at about 200 watts, was used. The antenna was especially designed for use on a wave length of about 100 meters. Most of the tests here described were conducted on a wave length of 105 meters. A special type of receiving set, suitable for 100 meters, was developed for this work. This paper gives sufficiently detailed information so that anyone having suitable radio experience can construct and operate similar apparatus, and continue in this line of investigation.

The use of short wave lengths is advantageous in that it reduces interference in several different ways. At the present time, very few stations transmit on waves having such short wave lengths as 100 meters. For communication by radio

---

\*Received by the Editor, April 2, 1923. Published by permission of the Director of the Bureau of Standards, of the United States Department of Commerce.

telephony, a much narrower band of wave lengths in meters is required when transmitting on 100 meters than when transmitting on longer wave lengths such as 300 meters or above.

The use of short waves such as 100 meters also reduces, in two ways, the difficulties in reception due to strays or "atmospherics." It has been observed that more serious strays are encountered in reception with an antenna of large dimensions than with an antenna of comparatively small dimensions. For reception on 100 meters, a small antenna can be used. It has been found suitable to use a loop antenna (single-turn coil antenna) about 10 feet (3.2 m.) on a side, for reception on 100 meters, and with such a small antenna difficulties due to strays are reduced. Furthermore, even if a large antenna is used, it has been observed that strays are usually not so serious when a receiving set is tuned to 100 meters as when it is tuned to longer wave lengths. An interesting application of the use of a wave length of approximately 100 meters has recently been reported to have been made by the Westinghouse Electric and Manufacturing Company. The report states that Cleveland, Ohio, is located in a so-called "dead spot" with respect to 360-meter broadcasts from KDKA in Pittsburgh, Pennsylvania. It was found that this dead spot did not exist when wave lengths of 100 meters were used. Broadcasts of KDKA were made simultaneously on approximately 360 and 100 meters. The 100-meter signals were received clearly in Cleveland, and were re-broadcast on 360 meters from a broadcasting station in Cleveland. The local listeners in Cleveland were therefore enabled to hear KDKA on their 360-meter receiving sets.

The antenna here described has a directional characteristic somewhat like the combination of a coil antenna and a vertical antenna and can be directed to transmit the strongest signals in a certain general direction. The antenna described is, however, not so markedly directive that it is not suitable for broadcasting in all directions over moderate distances.

#### GENERATING SET

The circuit of the generating set used, as well as the antenna, is shown in Figure 1. There is a tuned-plate primary circuit, with a coupled antenna circuit. Four Western Electric Type G-tubes, rated at 50 watts each, were used in parallel. The tubes were found to operate more satisfactorily by connecting in the grid circuit an inductively wound resistance of 3,200 ohms shunted by a 0.002 microfarad condenser. A 50-ohm resistance

was connected in the high-voltage supply circuit, and helped to stabilize the operation of the tubes. For operation at 105 meters, it was found that the primary or plate coil *B* (Figures 1 and 3) should consist of two turns of heavy copper strip two inches (5.08 cm.) wide. This coil, shunted by a mica transmitting condenser having a capacity of 0.002 microfarad, gave a natural wave length of the primary circuit of about 105 meters.

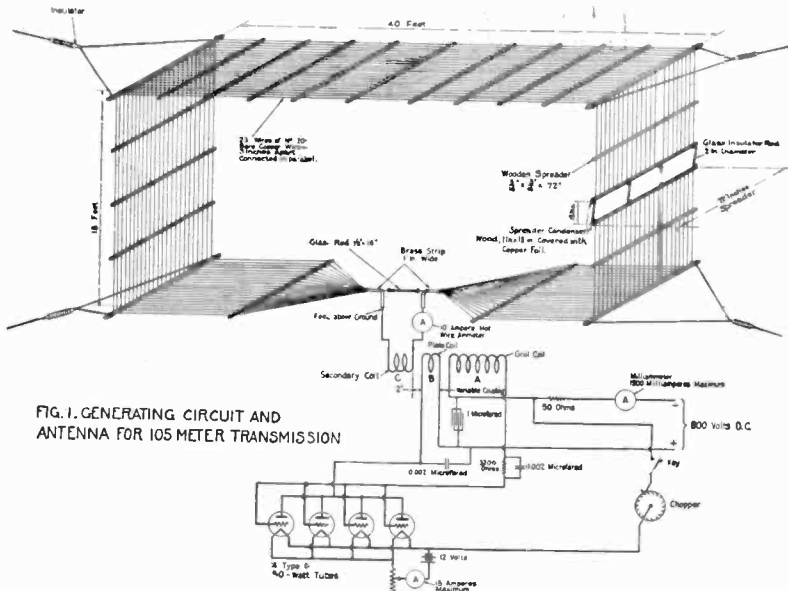

FIG. 1. GENERATING CIRCUIT AND ANTENNA FOR 105 METER TRANSMISSION

FIGURE 1—Generating Circuit and Antenna for 105-meter Transmission

For the grid coil *A*, a helix of 14 turns was used, as shown in Figure 2. The helix was made of half-inch (1.27 cm.) copper strip, had a diameter of ten inches (25.4 cm.) and a spacing between adjacent turns of five-sixteenths of an inch (0.079 cm.) A tap at five and one-half turns from the center gave best reception. The coupling between this coil and the plate coil *B* was rather critical.

The generating circuit was coupled to the antenna by a secondary coupling coil *C*, which is shown in Figure 4. This coil consisted of three turns of brass strip, one inch (2.54 cm.) wide, and was connected in series with the antenna.

Figure 5 shows the generating set as assembled in an experimental setup, including the grid coil *A*, the plate coil *B*, and the secondary coupling coil *C*.

While the generating set described above was arranged espe-

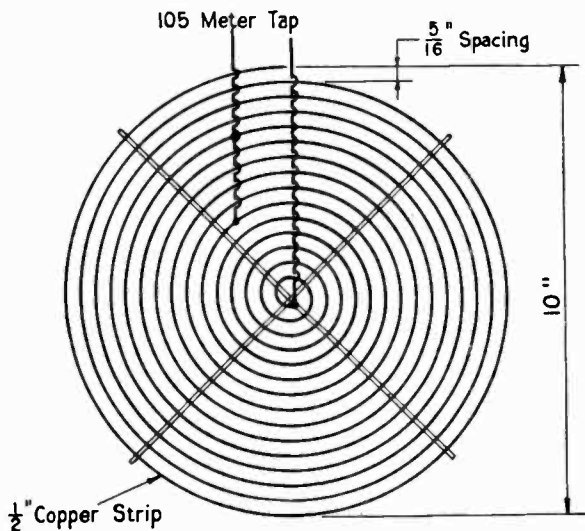

FIGURE 2—Grid Coil for Transmitting Set

cially for use with the antenna here described, the same generating set can be satisfactorily used with a **T, L**, fan, or other usual type of elevated antenna.

In conducting communication on interrupted continuous waves, a chopper was used, which was connected in the lead from the filament to the radio-frequency circuit, as shown in Figure 1.

It is important to keep the frequency of the generating set

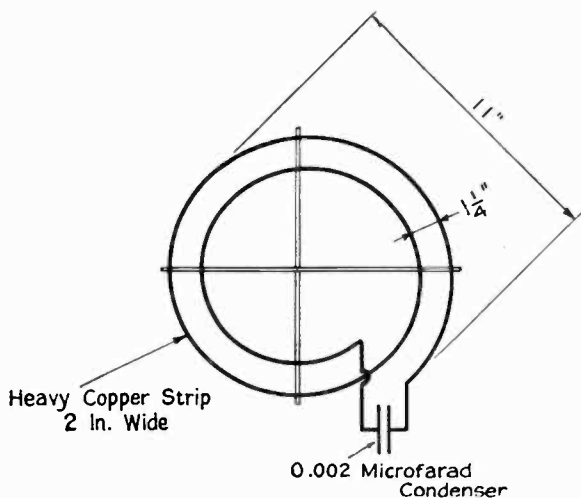

FIGURE 3—Plate Coil for Transmitting Set



constant, since slight changes of frequency will require frequent adjustments of tuning at the receiving station, and a small change of frequency of the transmitting set may cause the receiving station to lose the transmitting station. During opera-

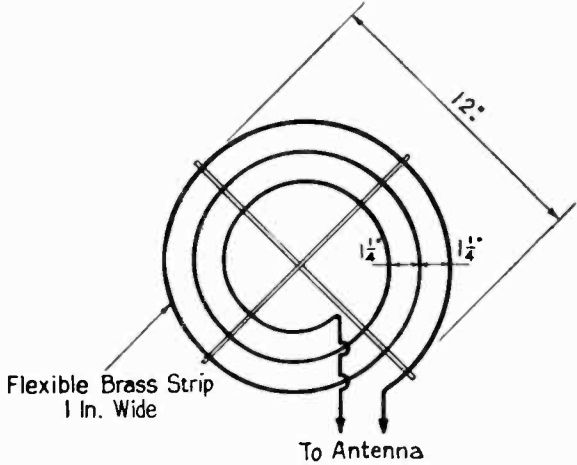

FIGURE 4—Secondary Coupling Coil

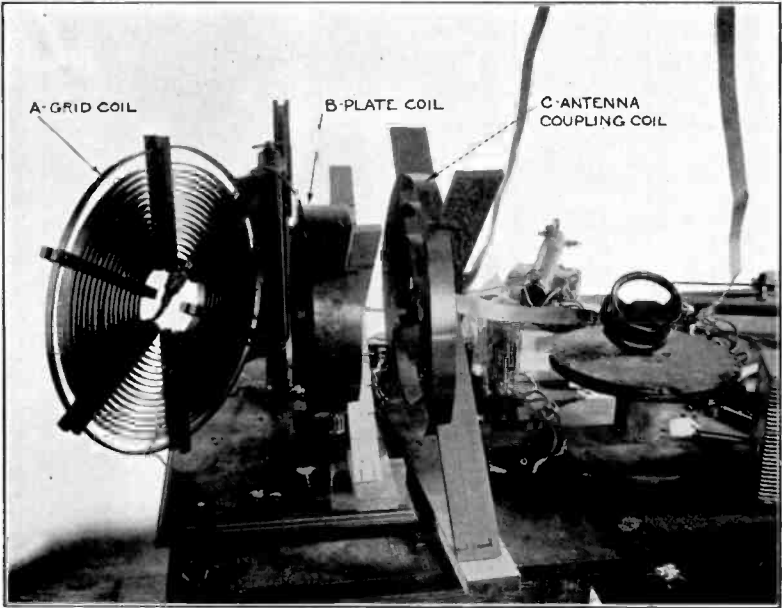

FIGURE 5—Assembled Generating Set

tion, the operator should not get near the helix of the transmitting set, or other parts of the circuit carrying radio-frequency current.

#### ANTENNA

The antenna used was especially constructed with a view to reducing ohmic resistance and to obtain the maximum radiation on the wave length used. It had both localized and distributed capacity, and is shown in Figure 1. The antenna as erected and the small operating building containing the generating set is shown in Figure 6. It consisted of 23 number 20 Brown and Sharpe gauge bare copper wires\* connected in parallel and spaced three inches (7.62 cm.) apart, which formed a rectangle 18 feet

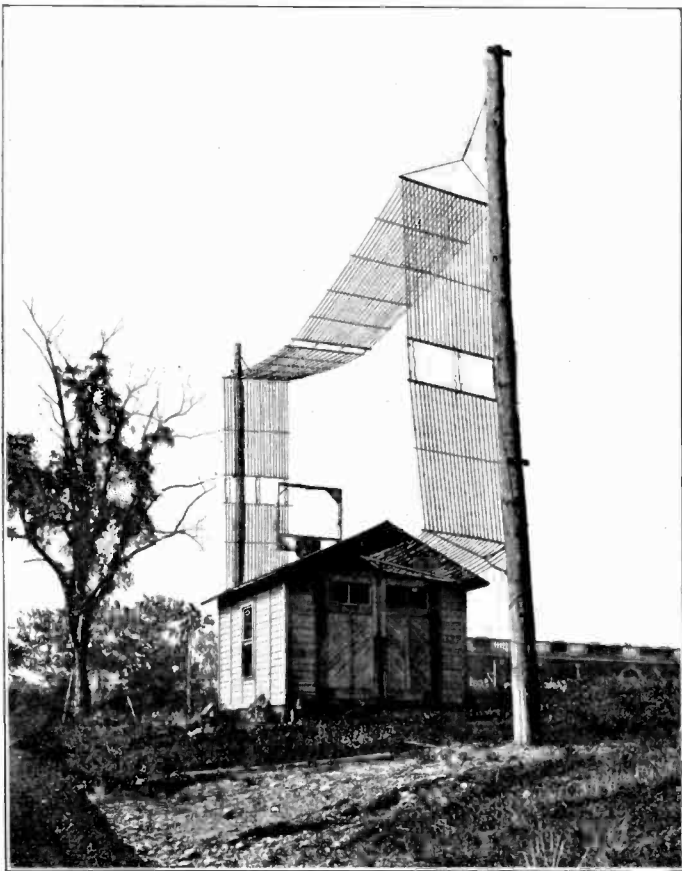

FIGURE 6—Special Type of Antenna for Transmission on 105 Meters, Consisting of 23 Turns in Parallel

(5.5 m) high and 40 feet (12.2 m.) long. The antenna was supported from two poles. Light wooden spreaders six feet (1.85 m.) long were placed about every four feet (1.2 m.) in order to keep the wires separated. The generating set is coupled to the antenna at the middle of the lower side of the antenna, by means of the secondary coupling coil *C* shown in Figure 4. The 23 wires did not form a complete circuit, but had a gap of about 18 inches (0.46 m.) Different locations of this gap were tried. The two spreaders at the gap on which the wires terminated were held together by glass rods bent so as to have hooks on each end. The two spreaders at the gap were covered with copper foil connected to all of the wires, and a condenser having long narrow plates widely separated from one another was thus formed by spreaders. The capacity of this gap condenser was small, but was of the proper value to give a natural wave length of 105 meters to the antenna as constructed.

Figure 6 shows three such condenser gaps which were constructed for experimental purposes. During any particular test, two of these three condensers were short circuited by jumper wires shown in the photograph, so that there was only one condenser in the antenna at a time.

One advantage of this type of antenna is that it can be made very rigid, so that its natural wave length will vary very little even when fairly strong winds are blowing. This is an important advantage since with the ordinary **T** or other form of elevated antenna, considerable variations in the transmitted wave length are often caused by wind blowing the antenna around and thus varying its capacity. Another advantage in this particular type of construction is the fact that a number of parallel wires spaced have a lower radio-frequency resistance than when bunched together even tho each wire is insulated.

#### RECEIVING SET

A special receiving set suitable for wave lengths from about 75 to 175 meters was developed for use during tests made at Washington. The circuit diagram of this set is shown in Figure 7, and the assembled receiving set is shown in Figure 8.

This set was designed for use with a single-turn coil antenna. It consists essentially of one stage of radio-frequency amplification employing a tuned plate circuit, a detector, and two stages of audio-frequency amplification. The plate circuit tuning element

\*Diameter of number 20 Brown and Sharpe gauge wire = 0.0312 inch = 0.081 cm.

G (Figure 7) in the plate circuit of the first tube is made by winding 125 turns of number 38 double-silk covered wire\* in a single layer on one end of a piece of square insulating tubing  $3\frac{3}{4}$  inches (9.5 cm.) long, having an inside diameter of one-half inch (1.27 cm.) and an outside diameter of five-eighths of an inch (1.59 cm.).

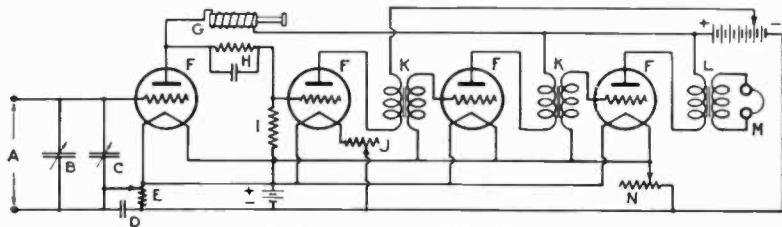

FIG. 7. RECEIVING SET FOR 75 TO 175 METERS

- |   |  |
|---|--|
| A. TERMINALS FOR CONNECTION TO COIL ANTENNA | H. 2 MEGOHM GRID LEAK, 0.0002 MICROFARAD CONDENSER |
| B. 0.0006 MICROFARAD TUNING CONDENSER       | I. 1 MEGOHM GRID LEAK                              |
| C. TWO PLATE VERNIER CONDENSER              | J. DETECTOR TUBE FILAMENT RHEOSTAT                 |
| D. 0.002 MICROFARAD CONDENSER               | K. AUDIO FREQUENCY TRANSFORMERS                    |
| E. 300 OHM STABILIZING RESISTANCE           | L. TELEPHONE TRANSFORMER                           |
| F. RECEIVING TUBES                          | M. TELEPHONE RECEIVERS                             |
| G. PLATE TUNING DEVICE                      | N. FILAMENT RHEOSTAT                               |

FIGURE 7—Circuit Diagram of Receiving Set for 75 to 175 Meters

For tuning, a movable iron core is used, which consists of laminations 0.001 inch (0.0025 cm.) thick built up into a core seven-sixteenths of an inch (1.34 cm.) square and two inches (5.08 cm.) long.

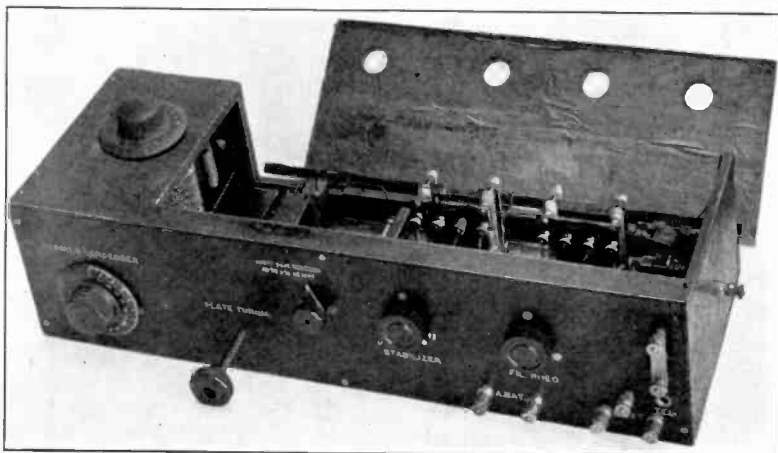

FIGURE 8—Assembled Regenerative Receiving Set for 75 to 175 Meters, for use with Coil Antenna

\*Diameter of number 38 wire = 0.0039 inch = 0.010 cm.

## TRANSMISSION TESTS

Numerous tests have been made with this type of transmitting set in connection with the type of antenna described.

In May and June, 1922, transmission tests were conducted from Washington, D. C., to Pittsburgh, Pennsylvania, to determine the variations of signal intensity from daylight to darkness on a wave length of 105 meters. In November, 1922, tests were conducted at McCook Field, Dayton, Ohio, with the type of generating set and antenna above described located on the ground and a receiving set located on an airplane, to determine the directional characteristics of this type of transmitting antenna.

### TESTS AT WASHINGTON—RECEPTION ON GROUND

The tests in May and June were conducted with station 8XK at East Pittsburgh, Pennsylvania, which is operated by Frank Conrad, of the Westinghouse Electric and Manufacturing Company. Communication was conducted, using unmodulated continuous waves, interrupted continuous waves, and radio telephony. Two-way communication was usually maintained during both daylight and darkness.

The receiving set at Pittsburgh employed an electron tube detector and one stage of audio-frequency amplification. When the transmitting set at Washington was putting about 4.8 amperes at 105 meters into the antenna, the signal received at Pittsburgh had an audibility which varied somewhat, but on the average was about 100. One important purpose of these tests was to investigate the phenomena of transmission over land on a wave length of 105 meters, with special reference to variations of signal intensity from daylight to darkness. On two different days tests were conducted from 12 o'clock noon to 9:00 p. m., and both continuous wave and interrupted continuous wave signals were transmitted every fifteen minutes for a period of five minutes. It was found that the received signals transmitted during daylight on 105 meters were nearly as strong as those transmitted at night. On one day, the signals received at Pittsburgh had an audibility of 170 at 3:30 p. m., when the sun was shining brightly at Pittsburgh, while previously that day during cloudy weather the audibility had been 100. The general audibility observed during all the tests on 105 meters probably did not vary any more than would occur in ordinary commercial transmission on such wave lengths as 600 meters. The observed audibility of the received signal for interrupted continuous waves

was, roughly, about one-half that of the received signal for unmodulated continuous waves. The fading often observed during radio communication on 200 meters, especially at night, was notably absent during these tests on 100 meters.

The May and June tests would indicate that in transmission on 100 meters serious fading does not occur, and that the usual marked difference in transmission between daylight and darkness is absent, altho these particular tests were not sufficiently extensive to be conclusive on these points.

The plane of the antenna at Washington made an angle of about 45 degrees with respect to the line of direction to Pittsburgh, so that the signals observed at Pittsburgh do not represent the best transmission of which the transmitting set is capable over a distance of 200 miles (320 km.). Experiments were made using the antenna with the condenser gap in the middle of the top side, and also with the condenser in the middle of each of the vertical sides. With the condenser in the top side, the antenna had a radiation characteristic very similar to that of the usual form of coil antenna, except that complete extinction of the signal was not obtained. With the condenser gap in a vertical side, a somewhat uni-directional characteristic was obtained, the best transmission being in the direction of the open side. Altho the tests were not conclusive, maximum distance range was obtained when the condenser was in a vertical side.

#### TESTS AT DAYTON—RECEPTION ON AIRPLANE

In November, 1922, tests were conducted at McCook Field, Dayton, Ohio, for the purpose of determining the directional characteristic of this type of transmitting antenna, and further to test the performance of the 100-meter transmitting set. The Engineering Division of the Air Service, United States Army, conducts experimental work at McCook Field, and these tests were made in co-operation with representatives of the Air Service. All the Dayton tests were made, using interrupted continuous waves. Signals were sent from the transmitting set and antenna located at McCook Field, and received on an airplane in flight.

In the apparatus as installed at McCook Field, a 40-volt "C" battery was used in place of the grid leak shown in Figure 1. Three 50-watt power tubes were used. An ammeter indicated an antenna current of 5 amperes with continuous waves and 2.5 amperes with interrupted continuous waves.

For reception on the airplane a 60-foot (18.3 m.) trailing wire

was used with a  $7\frac{1}{2}$  lb. (3.4 kg.) weight. This short wire and heavy weight caused the antenna to maintain an approximately vertical position and gave the antenna a receiving characteristic which was only slightly directional. For receiving at Dayton, a Signal Corps Type SCR-69 set was used, the coils being rewound for 100 meters. This set is of the direct-connected non-regenerative type consisting of a detector and two stages of audio-frequency amplification.

Tests were first made with the condenser gap in the center of the top horizontal section of the antenna. The airplane made a circle of three miles (4.8 km.) radius around the transmitting antenna, at an altitude of 2,000 feet (610 m.). It was noted that the signals were very strong along the plane of the antenna and very weak at right angles to the plane of the antenna. The effect was similar to transmission from a coil antenna combined with an ordinary elevated antenna, that is, a figure-of-eight characteristic without sharp minimum was obtained. When flying over the antenna at right angles to its plane and about 800 feet (240 m.) above it, two dead zones were noted, one just before being directly over it, and the other just after passing over it.

The antenna was then connected with the condenser gap in the center of one of the vertical sides. A second flight similar to the one mentioned above was made. The transmission characteristic seemed to be similar to the figure produced by the print of a shoe, the antenna being located at the instep. The signals were, on the whole, louder than in the first test in which the condenser was in the horizontal side of the antenna. Maximum radiation took place from the end of the antenna in which the condenser was placed.

Figure 9 shows the course taken in a third flight in order to determine the range in the general direction of maximum radiation. An altitude of 4,000 feet (1,220 m.) was held during this flight. It was found that as the airplane flew in a direction forming an angle of about 40 degrees with respect to the plane of the transmitting antenna, that the signal was lost at 11 miles (17.6 km.). The airplane then continued for a couple of miles and made a turn flying at right angles to the plane of the transmitting antenna in order to cross the plane of maximum radiation. For a distance of one and one-half miles (2.4 km.) on each side of the plane of the coil, the signals could be clearly heard. This was at a distance of 13 miles (20.8 km.). This distance, over which the signals could be heard, increased as the source was approached.

At 14 miles (22.4 km.) a similar region over which signals could be heard was found.

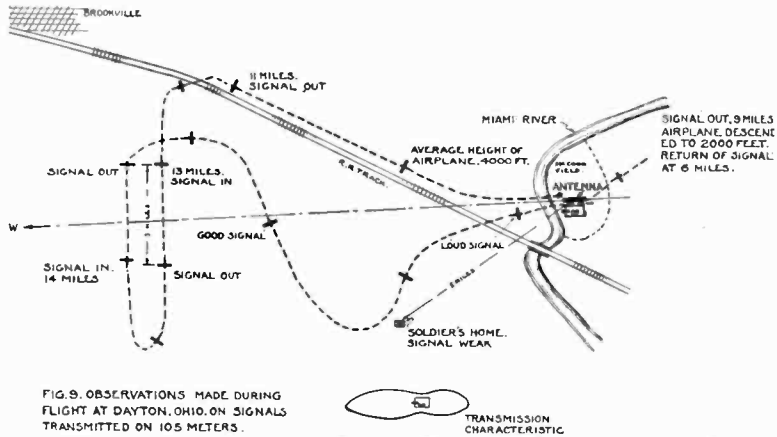

FIGURE 9—Observations Made During Flights at Dayton, Ohio, on Signals Transmitted on 105 Meters

A flight was next made in the opposite direction at a similar angle with respect to the plane of the antenna. The signal was lost at nine miles (14.4 km.). The altitude was then decreased to 2,000 feet (610 m.) and a return course taken. The signal was not picked up again, at this altitude, until the airplane was within six miles (9.6 km.) of the transmitting station. The fact of greater signal strength at greater heights has been noted by Franklin<sup>1</sup> and others, when using wave lengths of three meters, with a reflecting arrangement. The tests described by Franklin were made near the sea, and at an altitude of 100 feet (30.5 m.) the signal strength was about seven times what it was at sea level.

The short-distance range obtained in these tests at Dayton were probably due to the fact that a receiving set of comparatively low sensitivity was used. In the previous tests made between Washington and Pittsburgh, a receiving set of considerably greater sensitivity was used, and much greater distances were covered.

### CONCLUSION

The investigations which have been described show that it is entirely practical to get good daylight communication over a distance of 200 miles (320 km.), using the generating set and the

<sup>1</sup>C. S. Franklin, "Short-wave Directional Wireless Telegraphy," "Wireless World and Radio Review," volume 10, pages 219-225, May 10, 1922.



special type of antenna described. The use of the method described appears to have particular advantages for daylight communication.

The type of antenna here described has been found to have the same general kind of directional characteristic as the more usual type of receiving coil antenna used in conjunction with an ordinary elevated antenna.

**ACKNOWLEDGMENT**—Assistance in the course of this investigation has been rendered by Mr. Francis H. Engel. The author also wishes to acknowledge his indebtedness to Mr. Frank Conrad and his associates for their co-operation and assistance in conducting the transmission tests between Washington and Pittsburgh.

Department of Commerce,  
Washington, D. C.

March 5, 1923

**SUMMARY:** The paper describes a method and apparatus for continuous-wave transmission on a wave length of 105 meters. An electron tube generating set was used which employed four 50-watt tubes in a tuned-plate primary circuit, coupled to the antenna circuit. The antenna was rectangular in shape, 18 feet (5.5 m.) high by 40 feet (12.4 m.) long, and consisted of 23 wires connected in parallel. The generating set was coupled in on the lower side, and a gap which constituted a condenser was inserted in one of the other sides. The primary circuit and the secondary circuit separately each had a natural wave length of about 105 meters. A special receiving set was developed for this short-wave work. In transmission tests conducted between Washington and Pittsburgh, good signals were received in Pittsburgh during daylight, with 4.8 amperes in the transmitting antenna. Comparatively little variation in transmission was noted from daylight to night, and fading was not so serious as might be expected for somewhat longer wave lengths. The method described would, therefore, seem to have particular advantages for daylight communication. Tests were made at Dayton, Ohio, in transmitting with this set from the ground to an airplane in flight, and directional characteristics of the antenna were determined with the condenser gap in the top side of the antenna, and also in one of the vertical sides.



## PROGRESS IN RADIO ENGINEERING IN RUSSIA 1918-1922\*

BY

VALERIAN BASHENOFF

(MEMBER AND SECRETARY OF THE INSTITUTE OF RUSSIAN RADIO  
ENGINEERS, MOSCOW, RUSSIA)

1. During the period of the blockade, Russian radio engineers were almost entirely cut off from the remainder of the civilized world. Only on rare occasions were they able to learn of progress in radio engineering in foreign countries thru intercepted radio telegrams or a casual number of an engineering journal or newspaper. Consequently until 1921 it was necessary for them to utilize to the utmost in their engineering activities all the creative ability along theoretical and experimental directions which was available in Russia under the existing circumstances. The purpose of this paper is to convey to the West European and American scientific world some information relative to the technical progress in radio communication which was carried out. It should be mentioned that during the period from 1918 to 1921 all radio engineering work in Russia was necessarily carried out by Russian scientists and engineers, with complete isolation from scientific work done abroad, and under very difficult circumstances and disturbed conditions of the industrial enterprises in Russia. Most of the material of this paper comes from the proceedings of meetings of the Institute of Russian Radio Engineers and from the data of the Russian Patent Committee for Research. Everything dealing with the field of military radio engineering has been omitted from this paper.

All scientists and engineers in Russia who are working in the field of radio engineering have associated themselves in a private scientific and engineering society (The Institute of Russian Radio Engineers), which was founded in March 31, 1918, by thirty-four such scientists and engineers. This society, chronologically considered, is the third organization of this sort in the history of the world. It now has approximately two hundred members. The

---

\* Received by Editor, September 22, 1922. Translated from the German by the Editor.

headquarters are in Moscow, and sections have been formed in the following cities: Petrograd, Nijni-Novgorod, Kieff, and Odessa. The Institute of Radio Engineers is also the parent organization of the Radio Engineering Society of Turkestan. Since 1919, the President of the Institute of Russian Radio Engineers has been Professor M. W. Schuleikin, of the Moscow Institute of Technology, and the author has been the Secretary since 1919.

The individual activities of the members of the Institute will be described below. As indicative of the activity of the Institute it may be stated that regular meetings are held in Moscow and Petrograd weekly.

The radio laboratories of Russia, in order to co-operate better in their common scientific activities, have formed a "Radio Association" which was a portion of the scientific-technical division of the Superior Industrial Council of Russia. The Institute of Russian Radio Engineers is an affiliated organization of the "Radio Association." There has, therefore, existed in Russia since June, 1921, an organization which thruout this country has almost the same tasks as the International Union for Scientific Radio Telegraphy (U. S. R. I.). The President of the "Radio Association" is Professor A. A. Petrowski at Petrograd, the Vice-President, Professor M. W. Schuleikin, of Moscow, and the author is the Honorary Secretary.

2. It is correct to state that the electron relay during recent years has been the most important subject for research in all foreign radio engineering. In 1917 it was called to our attention in the form of three-electrode tubes in the French amplifiers, and aroused no slight interest among Russian radio engineers. Engineer M. A. Bontsch-Bruewitsch was the first to build up an organization in Russia for the production of these tubes for receivers and amplifiers in military and long distance radio stations, this work being carried out in the shops of the radio station at Twer, where he was then stationed. After the establishment of the Radio Laboratories of the People's Commissariat of Posts and Telegraphs at Nijni-Novgorod, Mr. Bontsch-Bruewitsch transferred his activities to the new location and busied himself with a quantity production of tubes (type P. R. I. tubes for receiver and amplifier uses). Mr. Bontsch-Bruewitsch originated a whole series of constructional improvements which have been patented in Russia and which include a spring suspension arrangement to avoid mechanical shocks to the tubes, and grids with two external terminals by means of which the

grid can be brought to incandescence during the evacuation process. The scientific work of this engineer in the production of very great quantities of these tubes is of special interest (see the Russian journal, "Radio Engineering," number 7, August, 1919). When we became acquainted in 1921 with the theoretical results, in the same field, of the German and English scientists, we found that their fundamental notions were in good accord with the conclusions reached by Mr. Bontsch-Bruewitsch as early as 1919, altho he had reached his results from quite a different point of view (see "Theory of the Triode" by Professor Bontsch-Bruewitsch, Russian journal "Radio Telegraphy and Telephony," number 10, 1921). The first samples of these tubes were used in the Russian radio stations in 1919, and until 1922 the shops of the Radio Laboratory at Nijni-Novgorod were the only source of receiving tubes for all the Russian Stations. At the end of 1921, Professor M. M. Bogoslawski organized the quantity production of tubes in his shops at the First Polytechnic Institute at Petrograd. He used as a model for these tubes the French triodes, but with small improvements in construction. Professor Tschernischoff organized the production of receiving tubes of somewhat different type from those of Professor Bogoslawski at the radio laboratory of the Polytechnic Institute at Petrograd. Since the beginning of 1922 the National Shops at Odessa have been delivering amplifier tubes of special construction. In the field of the manufacture of transmitting tubes for large outputs, the good work done by Professor Bontsch-Bruewitsch and Professor A. A. Tschernischoff deserves notice. The former has produced transmitting tubes for large outputs with water-cooled anodes at the laboratory at Nijni-Novgorod. These tubes have the following original construction. They consist of a copper tube into which four mutually perpendicular contact fins are soldered, thus producing chambers. In each chamber a filament as well as a grid are fastened on a glass rod. This arrangement permits excellent cooling of the anode and raises the output which can be obtained from the tubes. Tubes of this sort for each output were used by Professor Bontsch-Bruewitsch in the radio-telephone station at Moscow and have given excellent results. He succeeded, by the end of 1922, in producing 2-kilowatt tubes using a new construction, without water-cooled anodes.

Professor A. A. Tschernischoff had begun the manufacture of high-powered transmitting tubes and rectifiers in 1918 at the radio laboratory of the Polytechnic Institute in Petrograd.

In these, to heat the cathode, a discharge is caused to pass by means of a definite constant electromotive force between an auxiliary cathode and the main cathode. The anode consists of a platinum vessel which is placed around a glass tube. Water is circulated steadily in this glass tube. This water circulation reaches the points of greatest development of heat. By making the metallic walls sufficiently thin, excellent cooling is obtained and it becomes possible to increase the output of transmitting tubes. At the beginning of this research, the investigator had to solve a great number of technical problems which took considerable time. The chief problem was to maintain a high vacuum ( $10^{-6}$ — $10^{-8}$  mm.). It was not until 1921 that such vacuum was obtained thru special devices. One device which deserves particular notice is a new type of mercury condensation pump built according to the ideas of Professor A. A. Tschernischoff and Miss J. K. Schmidt. The most characteristic feature of this pump is the condensation of the mercury vapor on a water-cooled metallic wall which is connected to the other glass portions of the pump by a platinum cylinder with thin walls.

3. The best results in the utilization of tubes of small and large output in Russia have been obtained in two forms of radio telephone transmitter, one of which was discovered by Mr. A. T. Ugloff and the other by Professor Bontsch-Bruewitsch. Mr. Ugloff worked out his circuit in a practical way at the Second Military Radio Depot of the town of Kasan, and described the results at a meeting of the Institute of Russian Radio Engineers on February 8, 1919. He had aimed at obtaining speech modulation of radio frequency without the use of a microphone capable of withstanding high power. The result was obtained by the use of a cascade amplifier which amplifies the modulated radio frequency current produced in the first oscillatory circuits by an attached microphone. It was characteristic of this amplifier arrangement that it was very sensitive to alterations in the microphone resistance. The investigator had at his disposal only low-power tubes of French manufacture intended for amplifier and receiver purposes. In order to increase the total antenna power he added more tubes in each step; in fact the number of tubes in each step could be made eight or ten times greater than that in the preceding. These tubes had a filament voltage of six volts and 300 to 320 volts in the plate circuit. In most of his experiments he used only three tubes in the first stage, 12 in the second and 84 in the third. Experiments in radio telephony using this system were carried out in

July, 1920, between the Volga Steamer *Radisheff* and the Radio Station of the Second Military Depot at Kasan, and lead to the result that satisfactory two-way communication was possible between the steamer and the station at Kasan over the entire distance from Kasan to Zarizen. From this point on, the radio telephonic communication was only one-way, the station at Kasan being unable to hear the steamer altho the steamer could hear Kasan as far as Astrachan, 1,100 km. (690 miles) in a straight line from Kasan. In order to establish communication over this distance, continuous waves were used by the steamer which were well received at Kasan. The same circuit using 35 French tubes permitted complete reception in Kasan with a six-step amplifier (model 1 constructed by A. W. Dikaroff) at a distance of 500 km. or 300 miles, with a low antenna on the steamer. Even better results were obtained with this radio-telephone set on the steamer *Dekabrist* in 1921.

Mr. A. T. Ugloff, of the Military Radio Engineering Laboratories, installed receiving stations on moving trains in 1918, and, in 1920, obtained good results in transmission from moving trains. One of the fellow-workers of Mr. Ugloff, Mr. S. W. Witkewitsch, built a radio telephone set for airplanes using the same circuit and obtained good results.

Professor Bontsch-Bruewitsch constructed high power radio telephone stations in quite a different way. He used in his circuit high power tubes of the construction mentioned above, and record ranges were obtained in tests during 1920. One of his tubes operating on low-plate voltage was used for producing continuous oscillations. These were modulated by means of a second tube placed in parallel with the first. The modulated oscillations were then amplified by a tube and transferred to the grids of six tubes in parallel which fed the antenna circuit. The maximum antenna current, using 3,000 volts in the plate circuit, was 30 amperes. This corresponded to an output of 5 kw. in the antenna of the old station at Moscow with a mast height of 120 meters (394 ft.). Long distances were covered by this transmitter. The most distant stations which received the speech with three-step audio frequency amplifiers of French origin were Irkutsk (4,600 km. or 2,880 miles), Tschita (4,700 km. or 2,940 miles) and, using a simple detector receiver, Obdorsk (200 km. or 125 miles). This speech was obtained with good intensity in Christiania and Berlin. In the later case, Dr. A. Esau received the radio telephone messages from Moscow on a small loop antenna at Geltow. Since August, 1921, the inventor has perfected a new circuit for radio tele-

phone modulation which has been described in number 10 of the journal "Radio Telegraphy and Telephony." This circuit can be used in any desired arrangement where vacuum tubes serve as modulators. It permits any desired increase of sensitiveness of the modulator, gives large outputs, and is very stable against disturbances. In this modulator circuit a microphone is connected thru a transformer to the grid circuit of a simple receiving tube. Thus the variations of potential on the grid of a second tube never exceed a certain value even for the largest fluctuations in potential of the grid of the first tube, and even if such large fluctuations result from small resistance changes in the microphone. In the autumn of 1922, the first Russian broadcasting station was established at Moscow at the Central Radio Telegraphic Station. This station was built on the Bontsch-Bruewitsch system, and has an antenna 150 m. (490 feet), antenna resistance 5.5 ohms, antenna power 5.5 kilowatts, and a range of 2,000 km. (1,250 miles).

A further considerable contribution to the field of vacuum tube technique was a radio-frequency cathode tube oscillograph produced by Professor A. A. Tschernischoff and Miss J. K. Schmidt. In their oscillograph, as with the Braun tube, cathode rays are used which are influenced by electric and magnetic fields. The difference between the Braun tube and their oscillograph is that in the Braun tube the cathode rays fall on a fluorescent surface, whereas in their arrangement they fall directly on a photographic plate in their path, thus acting on the sensitive film. For clear pictures of currents having a frequency of approximately 1,000,000 oscillations per second, voltages of 60,000 are required, which make it necessary to have a very high vacuum in the oscillograph. This has been obtained thru the use of three Langmuir pumps in parallel. In connection with this oscillograph, very high constant voltages are obtained by vacuum connected as kenotrons.

Mr. L. S. Termen has produced a musical instrument utilizing vacuum tubes which produce tones of desired pitch by utilizing the difference frequencies arising from two systems of definitely chosen pitch. Using this instrument, the discoverer has given highly successful concerts in Moscow and Petrograd. Engineer Guroff, of the Petrograd radio shop of the Naval Supply Service, has produced a musical instrument of similar type. Messrs. S. N. Rjewkin and B. A. Wredenski, of the Military Radio Laboratories, have investigated the phenomena of interrupted production of oscillations, and have produced a tube oscillator, built



according to a method which the first of them had applied at the beginning of 1920. The method involves the insertion of a condenser in the grid circuit with a high resistance in parallel. Satisfactory regularity of the oscillations was observed, which were produced in separate groups. Between these groups there were shorter or longer pauses. This apparatus has been applied to measurements of capacities and high resistances, to wave meters for radio stations, and to the investigation of other physical phenomena, such as photo-electric effects, in the radio laboratories of the National Industrial Trust. Mr. A. A. Grigoriowa, engineer, has carried on a lengthy research on tube oscillations by self-excitation and on amplifiers using double grid tubes. Messrs. S. N. Rjewkin, N. N. Lutzenko, and B. A. Wredenski worked out a method of feeding the antenna, the plate, and filament circuits of cathode tubes with three-phase current, at the military radio engineering laboratories. In this system the transmitting tube acts also as a rectifier for high voltages. Mr. A. L. Mintz has worked out a new type of tube electrometer (voltmeter) for wire and radio telephony measurements.

In view of the increased use of cathode tubes of large output, it has become necessary to produce very high voltage rectifiers with correspondingly large outputs. This problem was solved in two ways. Professor W. P. Wologdin worked out a good construction of a very satisfactorily operative mercury arc rectifier. In the fall of 1919 at the radio laboratory at Nijni-Novogod, Professor M. A. Bontsch-Bruewitsch produced a kenotron rectifier for direct current at voltages from 6,000 to 15,000 and up to 0.5 ampere or more.

4. In the construction of radio frequency alternators, the following progress has been made in Russia. A radio frequency alternator was produced by Professor W. P. Wologdin, and is of the uni-polar type, as are, for example, those of Alexanderson, Count von Arco, and others. The first model was produced by Professor Wologdin in 1912. The rotor of his machine consists of a number of sheets of equal resistance, and the stator is water-cooled. A considerable number of small machines have been built according to his plans; and these were followed by an alternator giving 50 kilowatts output, which gave good results in May, 1922. A 150-kilowatt alternator is in construction in his laboratory at this time, and the calculations for a 500-kilowatt machine have been completed in the designing division. It is noteworthy that the designer has been able to secure the necessary iron for the radio frequency alternator, with a thickness of

0.03-0.05 mm. (0.002 inches) in the Ural steel works. Machines of such types will be used in the various Russian high-power stations in the future.

5. The principle of operation of the radio frequency alternators designed by Mr. S. M. Eisenstein involves the utilization of the stator periphery in the production of marked distortion of the wave form of the generated voltage. Furthermore, when in a single circuit there exist several non-sinusoidal electromotive forces in series, displaced from each other by 120 degrees (ordinary three-phase system), all components with the exception of the third harmonic disappear. Using a special stator winding, the frequency can be multiplied 1.5 times. This permits of an alternator which produces the desired frequency for antenna excitation at comparatively low speed.

Professor M. W. Schuleikin has produced a type of static frequency converter which he called a "harmonic resonance transformer;" and such a transformer was built in the radio shops of the Naval Supply Service and tried out in practice. Professor Wologdin has described the construction of a static frequency transformer which in its simple form consists of two inductances in series, one of constant value and one of variable value, with a capacity in parallel with them.

The Poulsen arc converter has been widely used in Russia during the last four years for radio telegraphy. The Moscow "Feeble Current Trust," "Glaw-Elektro" has built a large number of such converters, under the engineering direction of Mr. Eisenstein. It should be stated that the chief constructional features of this type are almost the same as in the arcs which were received in Russia in 1917 from foreign factories. In 1919 a high power station was established in Moscow (Shabolovka) using a Poulsen arc of 100 kilowatts power in its primary circuit, which worked with the high power stations in Rome, England, and various other points.

The antenna is supported by two wooden masts which consists of four main beams, and are 150 meters (490 feet) in height. For a still larger trans-Atlantic station, not far from Moscow, there will be used wooden masts consisting of six poles, each 200 meters (645 feet) in height. The third mast of the Shabolovka Station is a metal lattice work tower 150 meters (490 feet) high, and built to be self-supporting in accordance with a very original design of Mr. Schustow, a Russian engineer.

Professor A. A. Tschernischoff worked out a new type of arc converter with a device for automatic regulation and which also

permits of external adjustment of the arc. In the radio division of the National Experimental Electrical Engineering Institute, Mr. S. J. Turligin, engineer, has designed and constructed a model of a converter working in a steam and gas jet. He has also built the magnetic circuits out of iron dust and obtained good results.

6. In addition to ordinary open antennas, coil antennas have been widely used in Russia. In December, 1914, they were demonstrated by Mr. Eisenstein and were also used for special receiving arrangements by the author in the spring of 1915. The latter arrangements were used in Russia until 1921, but only for uni-directional reception. In December, 1920, they were used for practical communication at the central receiving station of Lubertzy, near Moscow. The antennas at this central receiving station are arranged in accordance with the author's methods for a number of duplex receptions. As was shown by the first trials, there is no disturbance of reception when the large transmitters at Moscow (Hodijnka and Shabolovka) are operating at full power. Experiments at this station in July, 1921, have shown that, with a mast 60 meters (200 feet) high, good reception could be carried on simultaneously from Paris, England, Nauen, Rome, and Tashkent, and that the operation of the high-power transmitter 20 to 25 kilometers (13 to 16 miles) away caused no marked disturbance. As a result, the traffic-carrying capacity of the principal radio telegraph stations of Moscow was increased six to seven times (because of the simultaneous reception of five messages while both of the high power stations were operating at the same time). In addition to increasing the amount of traffic which could be handled, this method of the author also lead to a great improvement in reception because of the reduction of atmospheric disturbances. In all the tests at this radio station on July 2, 1921, reception was entirely possible at a time when the receiving station 15 kilometers (9 miles) away, and using an ordinary open antenna on a mast 120 meters (400 feet) high, had been shut down for an hour because of a thunder storm. In the log of the latter station it was noted by the operators that they had observed heavy atmospheric disturbances, which, however, had not been noticed at Lubertzy.

Professor A. A. Petrowski has developed a triple sighting system for locating mobile radio stations using a number of loop receivers. This system can also be employed for the location of aircraft during flight.

Professor M. W. Schuleikin and A. L. Mintz have produced

a calculating device which, designed according to Professor Schuleikin's ideas, facilitates the calculation of all the antenna constants. Thus, by two settings of the calculator, there can be obtained with sufficient accuracy for antennas of any common form, the values of the effective height, effective resistance, and values of inductance and capacity which must be connected into the antenna to tune it to any wave length.

A valuable contribution was made to the design of transmitting antennas in December, 1921, by Professor M. W. Schuleikin and J. G. Kliatzkin. They have improved Alexanderson's antenna system. Using a single mast, there is obtained theoretically the same or even greater range than with the Alexanderson system employing a number of masts. It is hoped that these theoretical conclusions will be speedily tried out experimentally.

The author and Mr. J. F. Plebanski applied in July, 1918, for a patent on a certain type of directional transmitter using a closed antenna system. Tests in the fall of the same year showed that radio telegrams from Ribinski to Sergiew-Posad, 200 kilometers (125 miles) from Moscow could be received there, while these signals could not be received at the station at Jaroslavl, 80 kilometers (50 miles) from Ribinski.

Engineer K. S. Tschetirkin proposed in March, 1919, to construct an operating radio central. According to the ideas of the author, the transmitting keys and the telephone receivers were to be placed in the central operating room, where, with the help of amplifiers and connecting wires, the transmitters could be controlled and the receiving signals recorded. Such arrangements have great advantages in the concentration of the entire activities of various transmitting and receiving stations with resulting increase in traffic handled. Tests at the station at Lubertz have shown that the signals can be carried with very slight loss in readability of 25 kilometers (16 miles) from the station to the Hotel Metropol in Moscow, where operators write down the messages.

7. Messrs. A. W. Dikareff and A. T. Ugloff in Kasan have worked out various new types of six-step amplifiers and external heterodyne oscillators, and have undertaken the manufacture of this apparatus on a large scale. Their equipment has been used widely in the Russian radio stations. In January, 1920, Mr. Ugloff used a multi-step amplifier for the amplification of speech drawn from wire lines. Such a loud-speaking telephone system has been used with great success in various parts of Mos-

cow for propaganda purposes. Engineer R. W. Lwowitsch in the radio factory at Odessa has produced a direct indicating wave meter, with constant capacity and variable inductance of the variometer type and various other pieces of apparatus. Mr. Mintz has developed a method for receiving on open transmitting antennas as an emergency proposition. The engineers at the National Experimental Electro-technical Institute at Moscow have constructed an apparatus conceived by the author for measuring the decrement of received electromagnetic waves. This has been produced in two forms, the first of which uses a double coil antenna without any telephone shunts, and the second uses a simple coil antenna with variable shunts across the telephones.

Professor Petrowski and W. F. Mitkewitsch and Messrs P. P. Schilowski and O. A. Pawlinow have devised a form of tone signal radio station, the tone of which is definitely fixed by resonance to a low frequency, and the receiving system of which is based on a new optical arrangement. The same investigators have indicated a number of possibilities in the application of this system. Mr. S. J. Trojanski has carried on researches relative to the resistance of antennas and receivers as well as measurements on the magnetic fields in Poulsen arcs. His work has been practically applied in the design calculations of large Poulsen arc transmitters. Engineer N. N. Ziklinski has produced an apparatus for capacity measurements. The novelty to this apparatus consists in the use of two branches which enable the balancing of the entire system by the use of portions of a normal double condenser of variable capacity which is connected in both branches. Mr. A. F. Schorin had given methods of constructing special radio apparatus for the determination of geographical location using electromagnetic waves as early as 1918. The circuits are enclosed in a small cabinet which contains a receiver, amplifier, relay, and a chronograph with three pens which is driven by a small electric motor. Using Mr. Schorin's apparatus, the time signals from the radio station at Nauen were recorded, and by employing further amplification the time signals of the other large West European and Russian radio stations were also recorded.

In the field of high speed telegraphy, an invention made by Mr. A. F. Schorin at the end of 1917 has found wide application in Russia. At that time the German press messages from the station at Nauen were recorded on an ordinary Morse inker in the General Staff Headquarters in Petrograd, 30 kilometers (19

miles) from the receiving station where the signals has been received.

At the beginning of 1919, Mr. A. F. Schorin undertook some researches between the stations at Detskoe Selo and Moscow. Signals from Nauen and Paris had been recorded in Moscow at fairly high speeds with Wheatstone recorders. Similar investigations were carried out, using Hughes apparatus. By the end of 1921, the inventor had worked out all details of a process which was suitable for use with the apparatus of Hughes, Wheatstone, Beaudot, and Siemens. Successful tests of high-speed operation were carried on between Moscow and Nijni-Novgorod in 1922.

Mr. W. N. Tejeh presented a paper in 1919 before a meeting of the Russian Institute of Radio Engineers relative to the employment of small output relays for wire telephony and telegraphy. Mr. A. T. Ugloff employed vacuum tubes for the amplification of wire line telephone signals at the Military Radio Depot in Kasan, and also carried out multiplex telephony along iron wires over distances up to 600 kilometers (375 miles). Since the end of 1920 much work has been done in Russia in multiplex telephony on wires, using vacuum tubes. As is well known, the methods used involve the transmission of electromagnetic waves along the conductors. In this way it becomes possible to send several conversations over one wire. In the recent researches in 1921 in the Moscow Radio Laboratory of the Feeble-Current Organization ("Trust"), Messrs. P. W. Schmakow and G. A. Kuprianow carried out simultaneous conversations on a two-channel artificial cable circuit which was the equivalent of 250 kilometers (156 miles) of open wire, having a diameter of 4 millimeters (0.16 inch). Thus six conversations were transmitted at radio frequency and two at audio frequency. To prevent inductive disturbances, several electrical filters were used which transmitted frequencies up to 4,500 cycles without disturbing speech. Professor W. J. Romanow is working in the same field employing, however, only audio frequencies for the simultaneous transmission of several conversations. Professor Tschernischoff, W. D. Teikowjen, and Professor W. J. Kowalenkoff have developed methods for multiplex telephony along the high tension lines of the Moscow power plants, for example, for connecting the newly erected power plants at Schatursk and Moscow over the high tension lines.

Professor W. J. Kowalenkoff has also carefully worked out with much inventive skill a number of methods of using vacuum tubes on wire lines, in particular in connection with telephony. Mr.

A. J. Kowalenkoff built a successfully operated radio telephone set for airplanes in flight in 1921. The first tube sets for this apparatus were constructed and tested by Mr. L. J. Sapelkoff in the Odessa Aerodrome in 1917.

8. In the field of radio television, various plans have been tried out in Russia but without practical success in any case. Mr. A. M. Kokurin, a student at the Technical High School in Moscow, applied in 1920 for a patent for the radio transmission of photographs. This inventor utilizes two antennas at his transmitting station, one of which sends the synchronizing signals while the other sends the actual pictures. Synchronization of the luminous points at the transmitting and receiving stations is obtained thru a successive shifting mechanism which is connected to the two antennas. Synchronization is carried out at a different wave length from the picture transmission. Other experiments in radio television have been carried out by Mr. L. S. Termen and Professor Kowalenkoff in Petrograd and Professor Bontsch-Bruewitsch in the laboratory at Nijni-Novgorod.

Mr. G. A. Solotowski, engineer, made public in 1921 all the details of a method for guiding ships thru narrow channels by means of submerged cables carrying electric currents. His methods were to send alternating currents thru a cable on the bottom of a channel and to provide the ship with a loop direction finder.

In the above brief description, it has been attempted to show the work which the Russian radio engineers have been carrying on during the last four years. Many of these investigations have been published in the journals "Radio Telegraphy and Telephony" and "Radio Engineering," and have thus become widely known in Russia. The latter periodical was succeeded in 1921 by the journal "Communication Engineering." The fact that since 1917 there have uninterruptedly appeared in Russia two periodicals in the field of radio engineering, one of scientific nature and one of popular type, and this during a time when all other technical periodicals suspended publication, is an indication of the great interest which the field of radio communication has excited in Russia. The organization and conduct of these journals, published in Nijni-Novgorod, are under the direction of Professor W. K. Lebedinski. It is owing to his vigorous work and conscientiousness, as well as his interest in the entire field, that during the last five difficult years in which Russian scientists have been completely isolated from the remainder of the world, there has ap-

peared an important journal containing information of value to all the Russian radio engineers.

Valerian Bashenoff,  
Gegarinsky perenlok 23, lodg. 28,  
Moscow, Russia.

**SUMMARY:** The organization of the radio engineers of Russia and the relationship of the Institute of Russian Radio Engineers to other scientific organizations is described. The work of the Russian engineers since 1917 in a number of fields is summarized, with particular reference to vacuum tube amplifiers, low and high power transmitting tubes, portable stations, oscillograph measurements, radio frequency alternators and frequency multipliers, high power Poulsen arcs, directional reception, radio direction finding, radio centralized operation, broadcasting, precision measurements, high speed telegraphy, multiplex telephony along wires (guided radio), and pilot cables.



# SIGNAL-TO-STATIC-INTERFERENCE RATIO IN RADIO TELEPHONY\*

BY

JOHN R. CARSON

(DEPARTMENT OF DEVELOPMENT AND RESEARCH, AMERICAN TELEPHONE AND TELEGRAPH COMPANY, NEW YORK)

A criterion of fundamental importance in radio transmission is the ratio of the energy levels of the signal and of interference. The object of this note is to discuss the signal-to-*static*-interference<sup>1</sup> ratio in two systems of radio transmission described in a recent issue of these PROCEEDINGS.<sup>2</sup> The first system is known as single side-band transmission and is characterized by the transmission of only one side-band, the other side-band and the unmodulated carrier being suppressed. In the second system, both side-bands are transmitted, either with or without the carrier; both cases will be discussed.

In the propositions stated and discussed below, comparison is made on the basis of equal total energy transmitted or radiated from the sending stations.

I. *The signal-to-static-interference ratio in double side-band transmission with carrier suppression is equal to that in single side-band transmission, if and only if, in the double side-band system (1) over-all transmission is effected without appreciable phase distortion of the component frequencies, and (2) a local demodulating carrier or homodyne wave is provided at the receiving station which is exactly synchronous as regards both phase and frequency with the original carrier. Neither of these requirements is imposed on the single-side-band system.*

Both the requirements imposed on double side-band transmission in the foregoing proposition are necessitated by the fact that the equality of ratio presupposes that the two side-bands,

\* Received by the Editor, May 4, 1923.

<sup>1</sup> The word *static* is used in a generic sense to cover random and irregular interference, such as atmospherics, as distinguished from the interference from another station.

<sup>2</sup> "Relations of Carrier and Side Bands in Radio Transmission," R. V. L. Hartley, PROCEEDINGS OF THE INSTITUTE OF RADIO ENGINEERS, February, 1923. This paper should be consulted for a description of the systems of transmission dealt with in the present paper.

after demodulation, come into exact phase. Under these circumstances the low frequency energy in double side-band transmission is twice that in single side-band transmission on the basis of the same transmitted energy. The mean interference energy, however, in the former system is twice that in the latter owing to the fact that the receiving system must receive a frequency band of double width.<sup>3</sup> Consequently the ratio is the same in the two cases.

The foregoing statement may be explained as follows. In the *radio frequency* receiving circuits, the signal energy is the same in the two systems of transmission. The interference energy, however, in double side-band transmission is twice that in single side-band transmission on account of the necessity of receiving a frequency band of double width in the former case. Consequently the possibility of obtaining equality of signal-to-interference ratio in the *audio frequency* circuits depends on *demodulating the radio-frequency signal in double side-band transmission with double efficiency* as compared with the interference. At first glance this might seem impossible; however, an examination of the problem shows that this can be accomplished provided the corresponding frequencies in the two-side-bands and the local and original carrier are so related in phase that the corresponding frequencies coalesce into a single frequency of double amplitude in the audio frequency side of the demodulator. This result, however, depends strictly on the requirements stated in proposition I. With phase or frequency fluctuation of the local carrier, the signal and interference are demodulated, on the average, with the same efficiency, giving a signal-to-interference ratio in double side-band transmission just  $\frac{1}{2}$  that of single side-band transmission.<sup>4</sup>

A brief consideration, however, will serve to show that the requirements imposed on double side-band transmission with carrier suppression for equality of signal-to-interference ratio are unrealizable in present-day practice and that consequently the inferences to be drawn from the preceding proposition as regards the possibilities of double side-band transmission are erroneous in their practical implications. As regards the first requirement,

<sup>3</sup>This statement can be established in a very general way without any assumptions regarding the impulsive character of static. A theoretical investigation of the problem will be published shortly.

<sup>4</sup>To guard against possible misunderstanding on the part of the reader, it should be clearly understood that the requirements stated above have to do with energy relations. It is not implied that any such severe requirements are imposed on double side-band transmission in order to have satisfactory transmission of signal.

over-all transmission without appreciable phase distortion, no data are at hand to estimate the magnitude of this effect. Some rough calculations of wave transmission over sea water make it appear probable that the phase distortion would be small. On the other hand, it would seem probable that the over-all phase distortion, including that occurring in the terminal apparatus might be appreciable in long distance transmission. However, it is theoretically possible to introduce phase-correcting circuits at the receiving station, so that the first requirement, theoretically at least, can be satisfied.

As regards the second requirement, phase and frequency synchronism of the demodulating carrier, the case is different. The only known means of securing this synchronism is by transmitting some of the original carrier.<sup>5</sup> This, however, requires that some of the total transmitted power, in the case of double side-band transmission be assigned to the unmodulated carrier. This is not necessary in single side-band telephone transmission where, as discussed in the Hartley paper, phase distortion introduces no loss in signal energy and inappreciable loss in quality. In fact, an asynchronous homodyne can be employed.<sup>6</sup>

In view of these considerations the following propositions, rather than proposition I, correctly represent the actual possibilities of double vs. single side-band transmission.

II. *The signal-to-interference ratio in double side-band transmission with carrier suppressed is one-half the corresponding ratio in single side-band transmission, when account is taken of the phase and frequency variations from synchronism of the local carrier or homodyne wave.*

III, *The signal-to-interference ratio in double side-band transmission with carrier transmitted is  $1/(1+c)$  times the corresponding ratio in single side-band transmission, where  $c$  is the ratio of the unmodulated carrier energy to the side-band energy in the former system.*

In the case considered in proposition II, account is taken of the fact that the local demodulating carrier or homodyne is inevitably subject to asynchronous variations, that is, departures as regards phase or frequency from the original carrier. This produces on the average a reduction of demodulated signal energy

<sup>5</sup> Whether energy is transmitted at the original carrier frequency or at some other frequency from which the carrier is derivable is immaterial to the present argument. The essential point is that energy must be transmitted in addition to the energy of the side-bands.

<sup>6</sup> As stated by Hartley, the case is different in *telegraph* transmission. The conclusions of this paper, as indicated by its title, are limited to telephonic transmission.

to  $\frac{1}{2}$  that obtaining when exact phase and frequency synchronism exists. Aside from this loss of energy, it seems probable that this system of transmission is inferior in radio-telephony owing to the fluctuations of energy level as the local homodyne swings into and out of phase.

The case considered in proposition III, where the required synchronism in double side-band transmission is secured by carrier transmission, is the one of most practical importance. In practice, since the carrier should be fairly large compared with the side-bands a conservative figure for  $c$  is 2, which gives a relative signal-to-static-interference ratio of 3-to-1 in single versus double side-band transmission. It seems probable that this figure is rather low and that 4-to-1 would more correctly represent the condition actually obtaining in practice.

To summarize, in addition to the very important gain in economy of the frequency range, single side-band transmission enjoys the added advantage of a very substantial gain in the signal-to-static-interference ratio. It is interesting to note that this gain is made possible not only by the narrower transmission band required, but by the fact that it is possible to employ an asynchronous homodyne wave.

Department of Development and Research,  
American Telephone and Telegraph Company,  
May 1, 1923.

**SUMMARY:** Several general propositions are stated relative to the signal-to-static ratio, in single and double side band transmission, indicating a superiority in practice for the former system.

# VACUUM TUBES AS POWER OSCILLATORS\*

## PART I

BY

D. C. PRINCE

(RESEARCH LABORATORY, GENERAL ELECTRIC COMPANY, SCHENECTADY,  
NEW YORK)

### FOREWORD

The following discussion is an attempt to reduce power oscillator design to an engineering basis comparable with that upon which the design of motors and transformers now rests. In doing so, explanations are offered for many of the auxiliary disturbing phenomena.

By their nature, electron and high frequency phenomena cannot be directly measured and observed, so that the auxiliary phenomena especially must be explained by setting up hypotheses and then trying experiments which would be expected to produce certain results if the hypotheses are correct. Since an indefinite number of other hypotheses might produce the same result, it must be frankly admitted that some of the points raised border on speculation. In publishing this paper, it is the author's hope that evidence in confirmation or rebuttal may be brought out with a view to removing the subject as far as possible from the realm of uncertainty.

An attempt has been made to treat subjects which have had little or no discussion in the past, rather than to cover all uses of vacuum tubes. With the exception of Chapter VI, the discussion is limited to free oscillating circuits. In Chapter VI the forced circuit is touched upon merely to show how the same general methods of analysis may be used to determine the effect of the driven circuit upon the efficiency and output. These phases are most important in the free oscillator and have not been exhaustively treated in discussions of the forced oscillator.

The tests upon which this paper is based were made by Mr. F. B. Vogdes and Mr. A. Schmidt, Jr. The paper in its final form was prepared by Mr. Vogdes and edited by Mr. E. W. Kellogg. I wish to thank these men for their able assistance.

\*Received by the Editor, March 15, 1923.

## CONTENTS

### CHAPTER I

An exact method is developed whereby the performance of a vacuum tube as an oscillation generator can be determined, together with the required voltages which must be impressed upon the different members to secure such results. Starting and blocking are discussed.

### CHAPTER II

An approximate method is developed whereby the effect of varying factors, such as space charge, voltage, and so on, can be more readily determined than by the laborious exact method of Chapter I.

### CHAPTER III

Based on the conditions required for the tube as developed in Chapter I, the design of a single tuned circuit is developed. Criteria are established for selecting the value of inductances and capacities thruout the circuit. Conditions for intermittent oscillation are discussed.

### CHAPTER IV—*Chapters IV and V will appear in the August PROCEEDINGS*

The design of a partially tuned plate circuit is developed. The procedure is characteristic of the methods which may be used in a large variety of circuits which depend upon one inductance and capacity to establish the frequency, but which have other inductances and capacities coupled to the main circuit.

### CHAPTER V

The operation of vacuum tubes in doubly periodic circuits is developed. The criterion for double periodicity is simply derived. Methods of controlling oscillations in doubly periodic circuits are suggested.

### CHAPTER VI—*Chapters VI, VII, and the Appendix will appear in the October PROCEEDINGS*

The influence of the receiving circuit on the efficiency and output of a vacuum tube power amplifier is discussed.

### CHAPTER VII

The methods of Chapter I are applied to circuits in which

the plate voltages are not sinusoidal. It is shown that efficiencies and outputs may be considerably increased by circuit arrangements which give special wave form.

#### APPENDIX

A brief comparison is given showing the correspondence between theory and observation affecting emission, space charge, and amplification constant. The division of primary and secondary electrons between grid and plate is discussed.

### CHAPTER I

#### VACUUM TUBES AS POWER OSCILLATORS

The purpose of this discussion is to develop the process of calculating the performance of a power oscillator from its characteristic curves. The first part will be restricted to sinusoidal wave forms found in simple circuits. The fundamental relations are as follows: Referring to Figure 1, let:

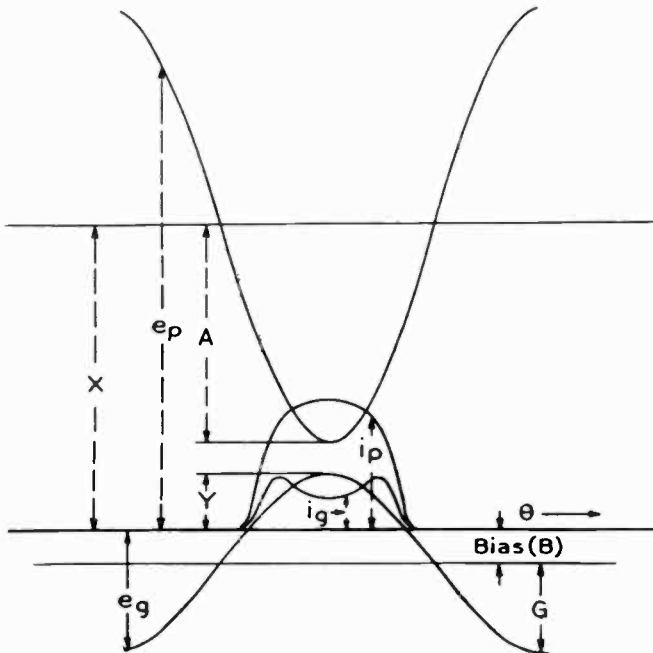

FIGURE 1—Potential and Current Relations for a Piotron Oscillator

$X$  = Direct current impressed plate potential in relation to filament.

$e_p$  = Instantaneous plate potential in relation to filament.

$i_p$  = Instantaneous current to plate.

$e_g$  = Instantaneous potential, grid to filament.

$i_g$  = Instantaneous grid current.

Then

$X i_p$  = Instantaneous input to plate.

$e_p i_p$  = Instantaneous plate loss.

$e_g i_g$  = Instantaneous grid loss.

$$e_p i_p + e_g i_g = \text{Total instantaneous tube loss} \quad (1)$$

$$(X - e_p) i_p - e_g i_g = \text{Instantaneous net output} \quad (2)$$

$$\frac{(X - e_p) i_p - e_g i_g}{X i_p} = \text{Instantaneous efficiency} \quad (3)$$

The foregoing instantaneous values must be integrated over a complete cycle to secure average values:

$$\int_0^{2\pi} X i_p d\theta = \text{average input} \quad (4)$$

$$\int_0^{2\pi} (X - e_p) i_p - e_g i_g d\theta = \text{average output} \quad (5)$$

$$\frac{\int_0^{2\pi} (X - e_p) i_p - e_g i_g d\theta}{\int_0^{2\pi} X i_p d\theta} = \text{average efficiency} \quad (6)$$

The foregoing relations are quite independent of tube characteristics, frequencies, and wave shapes. Tube characteristics cannot readily be expressed by equations of the characteristic curves because they are divided into zones which follow different physical laws. For amplification purposes, operation is usually restricted to a small part of one zone where one law holds, but the amplitude of sustained oscillations is determined by the passage from one zone to an adjoining one. This will be clear by reference to an actual set of static characteristic curves. Figure 2 is such a set of curves taken from a General Electric Company one-kilowatt tube. Below 10 volts, the current is approximately proportional to the  $5/2$  power of the voltage. The exponent drops gradually to  $3/2$  above 10 volts, then becomes unity about 250 volts, and later becomes negative. However, by making use of the characteristic curves directly, integration may be accomplished by steps. That is, a series of points in the cycle may be selected, and inputs and outputs so obtained may be averaged over a cycle.



No measurable lag exists in the movement of electrons, so that frequency is unimportant except as it affects the circuits associated with the tube.

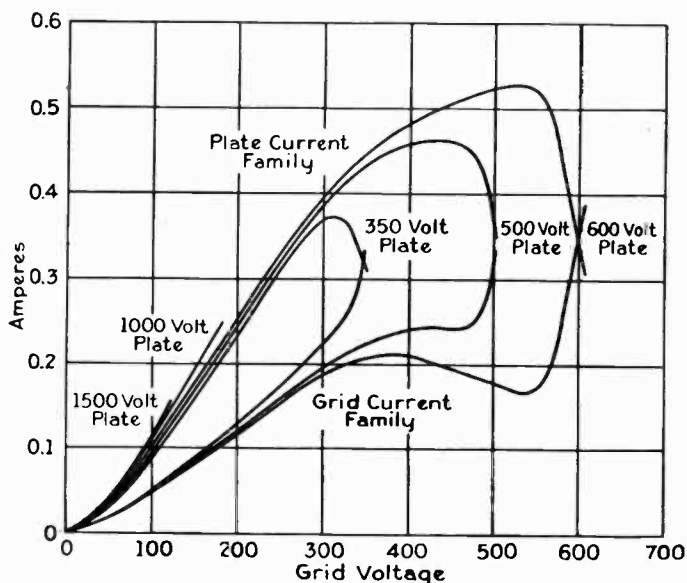

FIGURE 2—Characteristics of UV-206 Photron Number 7,621

In performing step by step integration, the five variables,  $X$ ,  $e_p$ ,  $e_g$ ,  $i_p$ ,  $i_g$ , must be determined. The procedure is as follows:

$X$  is the direct impressed voltage for which the tube is designed—in this case 10,000.

$e_p$  cannot be defined in general terms. In an oscillator of reasonably low losses, the induced voltages may be assumed sinusoidal with very slight error. The wave form is, therefore, known, but not the amplitude. Let “ $A$ ” denote the amplitude. The sinusoidal term of  $e_p$  is superimposed upon the impressed direct potential.

$e_g$  is induced by the same flux as  $e_p$ , and is, therefore, of the same shape. From equation (5), positive output is obtained by having  $e_p$  a minimum while  $i_p$  is maximum. That is,  $e_p$  and  $i_p$  are  $180^\circ$  out of phase. But  $i_p$  and  $e_g$  are in phase. (See characteristics, Figure 2), therefore  $e_p$  and  $e_g$  must be  $180^\circ$  out of phase. Amplitude and axis of  $e_g$  are unknown. Let “ $G$ ” and “ $B$ ” represent these values.

$i_p$  and  $i_g$  are read directly from the characteristic, if  $e_p$  and  $e_g$  are known.

The general three-element tube equation is

$$i = f\left(e_g + \frac{e_p}{\mu}\right) \quad (7)$$

from which it appears that

$$e_g = -\frac{e_p}{\mu} \text{ for } i_p = 0. \quad (8)$$

Let  $e_p = X - A \cos \theta$  (9)

and  $e_g = -B + G \cos \theta$  (10)

then if  $\theta_1 =$  Angle at which  $i_p = 0$

$$-B + G \cos \theta_1 = -\frac{X - A \cos \theta}{\mu} \quad (11)$$

For angles greater than  $\theta_1$  the inputs and outputs are both zero, so that integration need not be carried beyond this point. Equation (11) contains  $A$ ,  $B$ , and  $G$ , which may be considered the independent variables.

Let "Y" be the distance which the grid swings above the zero axis.

Then  $B = G - Y$  and (11) may be written

$$\frac{X - A \cos \theta_1}{\mu} = -Y + G (1 - \cos \theta) \quad (12)$$

Now  $X - A$  is the minimum voltage between plate and filament and  $Y$  is the maximum positive grid potential. Inspection of the characteristics (Figure 2) shows that if  $Y > 0.8 (X - A)$ , the condition is approached where  $i_p$  decreases and  $i_g$  increases. This represents a potential reduction both in output and efficiency so that operation should not be carried beyond this point. Another way of stating this proposition is that, when an oscillator is started, the oscillations continue to increase in amplitude until the circuit losses balance the output. This point has been estimated by inspection to occur when the maximum grid voltage is 80 per cent of the minimum plate voltage. That this assumption does not involve any great error may be seen from the following considerations. Referring to calculated point (Table II), an increase of 2 per cent in plate induced voltage would be 185 volts. The corresponding increase in grid volts would be 18. The resulting minimum plate and maximum grid voltages are then 565 and 618, respectively. For this condition the grid receives most of the emission current and the plate practically none (see characteristic, Figure 2). The output would, therefore, be greatly reduced and the tube would be unable to sustain the in-

creased loss involved in the wider amplitude of oscillation. Since the output is reduced for an increase of less than 2 per cent in the alternating current plate voltage and is obviously reduced for any reduction in plate voltage, it appears that the assumed values are very near to the point of stable operation. A selection of  $A$  then determines  $Y$  and an added selection of  $\theta_1$  determines  $G$ . We have then two independent variables,  $A$  and  $\theta_1$ , to which a series of values may be assigned and the performance of the tube investigated.

To facilitate this work the form shown in Table I has been prepared with the instructions for filling in each line. Table II is a sample calculation of one operating point using this form. Lines  $A$  to  $K$  inclusive are used only once for a given pair of values of maximum grid and minimum plate volts. Lines  $L$  to  $S$  must be filled in separately for each operating point.

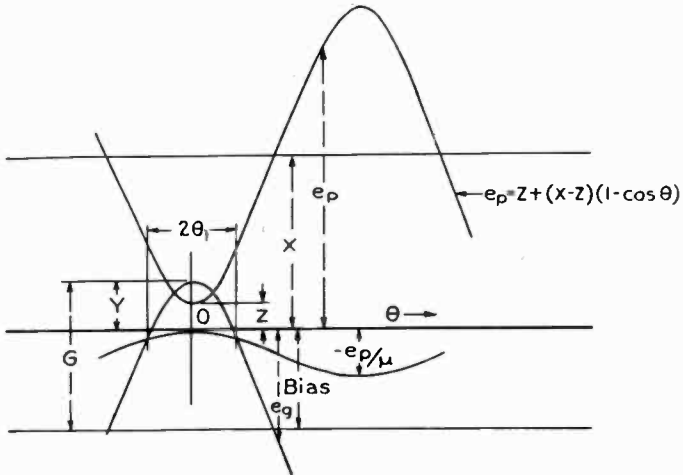

FIGURE 3

The nomenclature has reference to Figure 3. With the one-kilowatt tube for which characteristics are given, the plate and grid current families are so compact that they can be combined into one and extrapolated with reasonable accuracy. This was done in Figure 4, to permit calculation of points using minimum plate voltages as high as 1,000. The momentary tube losses represented by a plate potential of 1,000 and grid potential of 800 are so high that no static characteristic readings could be taken in that region. The ideal

method of taking characteristics is with an oscillograph, since this permits momentary currents and voltages to be recorded without damage to the tube.

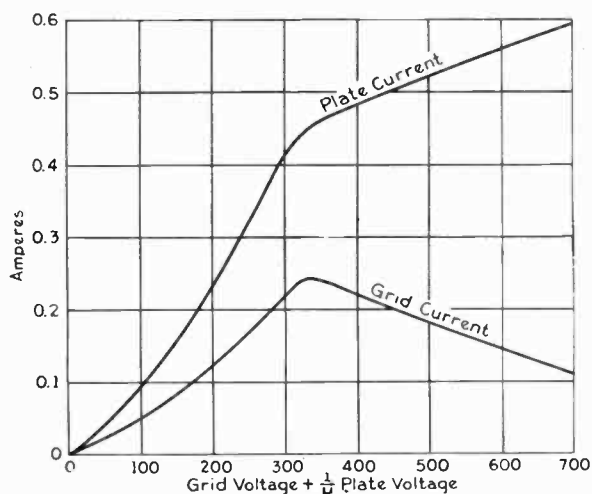

FIGURE 4—Extrapolated Characteristics of Plotron UV-206, Number 7,621

Figure 5 shows the result of calculating points for three values of minimum plate potential with varying  $\theta_1$ . Since  $\theta_1$  of itself is of no interest, the values have been plotted against output instead. The output of the tube is limited by heating of the plate which in this case may safely dissipate 350 watts. Outputs of 1,080, 1,195, and 1,215 may thus be obtained within the capacity of the tube by the adjustments indicated. It would appear that the efficiency curves and loss curves should cross at the same outputs. The reason that they do not is that grid leak bias losses are included in efficiency determinations, altho they do not contribute toward tube heating.

It is apparent that for still higher minimum plate voltage, the watts output at 350 watts loss would ultimately be less than that for 1,000 volts minimum plate. The optimum conditions for maximum output are, therefore, in this neighborhood, altho considerable latitude is permitted without loss of output. Since these values are not functions of frequency, they form the basis for the design of practically any oscillating circuit in which these tubes are operated at 10,000 volts.

The performance of other tubes or of the same tube at other supply voltages and filament currents are similarly obtained.

TABLE I

KEY FOR OSCILLATOR CALCULATIONS

Tube . . . . .  
 Amplification Constant ( $\mu$ ) . . . . .  
 Maximum Grid Volts ( $Y$ ) . . . . .  
 D. C. Plate Volts ( $X$ ) . . . . .  
 Characteristics . . . . .  
 Minimum Plate Volts ( $Z$ ) . . . . .

		a	b	c	d	e	f	g	h	i	j
		Plate Voltage									
$\theta$		0°	10°	20°	30°	40°	50°	60°	70°	80°	90°
A	$1 - \cos \theta$	0	0.0152	0.0603	0.1340	0.2340	0.3572	0.5000	0.6580	0.8264	1.0000
B	$(X - Z)(1 - \cos \theta)$	( $(X - Z) \times$ Line "A")									
C	$e_p$	( $Z +$ Line "B")									
D	$e_p / \mu$	(Line "C" $\div \mu$ )									
		Grid Voltage									
Operating Angle ( $\theta_1$ )		(Insert only the Values Required)									
F	$Y + e_p / \mu$	( $Y +$ Line "D")									
G	$1 - \cos \theta$	0	0.0152	0.0603	0.1340	0.2340	0.3572	0.5000	0.6580	0.8264	1.0000
H	Max. Swing of $e_o$ ( $G$ )	(Line "F" $\div$ Line "G")									
J	A. C. Component of $E_s$	(Line "H" $\div \sqrt{2}$ )									
K	Bias	(Line "H" $- Y$ )									
		Calculation of an Operating Point									
$\theta_1 =$		(Pick One of the Values Required)									
$\theta =$		0°	10°	20°	30°	40°	50°	60°	70°	80°	90°
L	$1 - \cos \theta$	0	0.0152	0.0603	0.1340	0.2340	0.3572	0.5000	0.6580	0.8264	1.0000
M	$G \times (1 - \cos \theta)$	(Take value of $G$ in corresponding to $\theta_1$ )									
N	$e_o$	( $Y -$ Line "M")									
O	$e_o + e_p / \mu$	(Line "N" $+ $ Line "D")									
P	$i_p$	(From Characteristic Curves)									
Q	$i_o$	(From Characteristic Curves)									
R	Loss-plate	(Line "P" $\times$ Line "C")									
S	Loss-grid	(Line "Q" $\times$ Line "N")									
		Av. Plate Current = $\frac{P_a + 2P_b + 2P_c + 2P_d, \text{ etc.}}{36} = \dots$ Av. Grid Current = $\frac{Q_a + 2Q_b + 2Q_c + 2Q_d, \text{ etc.}}{36} = \dots$ Av. Plate Loss = $\frac{R_a + 2R_b + 2R_c + 2R_d, \text{ etc.}}{36} = \dots$ Av. Grid Loss = $\frac{S_a + 2S_b + 2S_c + 2S_d, \text{ etc.}}{36} = \dots$ Electron Loss = Sum of last two losses = $\dots$ Grid Leak Loss = Bias $\times$ Av. Grid Current = $\dots$ Total loss (not including Filament) = Sum of last two = $\dots$ Input (not including Filament) = $X \times$ Av. plate current = $\dots$ Output = Input - Total loss = $\dots$ Efficiency (not including Filament) = $\frac{\text{Output}}{\text{Input}} = \dots$									

TABLE II

SAMPLE OSCILLATOR CALCULATIONS

Tube UV-206  
 $X = 10,000$   
 $Y = 600$   
 $Z = 750$

Tube UV-206  
 $\mu = 250$   
 Max. Grid Volts 600

D. C. Plate Volts, 10,000  
 Characteristics, Figure 4  
 Min. Plate Volts 750

Plate Voltage

$\theta$	0°	10°	20°	30°	40°	50°	60°	70°	80°	90°
$(1 - \cos \theta)$	0	0.0152	0.0603	0.1340	0.2340	0.3572	0.5000	0.6580	0.8264	1.000
$(X - Z)(1 - \cos \theta)$	0	140	555	1,240	2,170	3,330	4,625	6,080	7,650	9,250
$e_p$	750	890	1,305	1,990	2,920	4,080	5,375	6,830	8,400	10,000
$e_p / \mu$	3	4	5	8	12	16	22	28	34	40

Grid Voltage

$\theta_1$	0°	10°	20°	30°	40°	50°	60°	70°	80°	90°
$Y + e_p / \mu$	603	604	605	608	612	616	622	628	634	640
$1 - \cos \theta_1$	0	0.0152	0.0603	0.1340	0.2340	0.3572	0.5000	0.6580	0.8264	1.000
$G$	$\infty$	39,800	10,000	4,530	2,610	1,710	1,240	960	768	640
A. C. Component of $E_s$	$\infty$	28,200	7,070	3,200	1,845	1,210	877	679	543	453
Bias	$\infty$	39,200	9,400	3,930	2,010	1,210	640	360	168	40

1st Operating Point

$\theta_1 = 70^\circ$

$\theta$	0°	10°	20°	30°	40°	50°	60°	70°	80°	90°	Sum.	Av.
$1 - \cos \theta$	0	0.0152	0.0603	0.1340	0.2340	0.3572	0.5000	0.6580	0.8264	1.000		
$G(1 - \cos \theta)$												
$e_o$	600	586	543	471	374	256	120	-28				
$e_o + e_p / \mu$	603	590	549	479	386	272	142	0				
$i_p$	560	555	540	510	470	330	120	0			5,610	156
$i_o$	140	145	160	190	230	170	60	0			2,050	57
Loss-plate	420	494	705	1,020	1,375	1,345	645	0			11,590	322
Loss-grid	84	85	87	90	86	44	7	0			902	25

Electron Loss = 347  
 Grid Leak Loss = 20  
 Total Loss (not including Filament) = 367

Input (not including Filament) =  $10,000 \times 0.1560 = 1560$   
 Output = 1183  
 EFF. (not including Filament) = 76.5 percent.



It is apparent from Figure 5 that the adjustment which will give the greatest output is not necessarily best for a lesser output. An envelope can be drawn so as to include the points of minimum loss for any particular output. Such information can be plotted up and used as a basis for selecting the proper circuit constants for any set of conditions. This has been done in

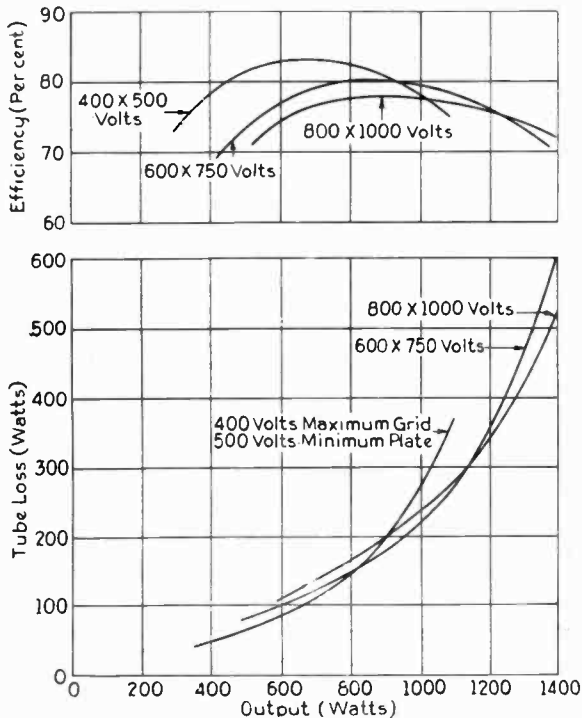

FIGURE 5—Calculated Efficiency and Loss in a UV-206 Tube at 10,000 Volts Direct Current

Figures 6 and 7. The corresponding loss-efficiency curves for 15,000 volts are shown in Figure 8. Having decided upon the desired power, the circuit constants may be taken from Figures 6 or 7, and the loss and efficiency from the other curves.

#### STARTING PROPERTIES

With a tube of known performance, it is not ordinarily necessary to make an investigation to determine whether oscillations will start automatically. In special cases, however, it may be desirable to verify this point. Suppose it is necessary to determine whether oscillations will be self-starting for the point

calculated above. Immediately after closing the switch, the plate potential is the full direct impressed voltage or 10,000 volts. The grid is at zero. Figure 9 shows this portion of the characteristic. Any transient disturbance such as the closing of the switch will start a small circulating current in the oscillator circuit. This will induce voltages which will be divided between plate and grid in the fixed ratio determined by the connections to the oscillating circuit. For the point under consideration  $\Delta e_g = -0.104 \Delta e_p$ .

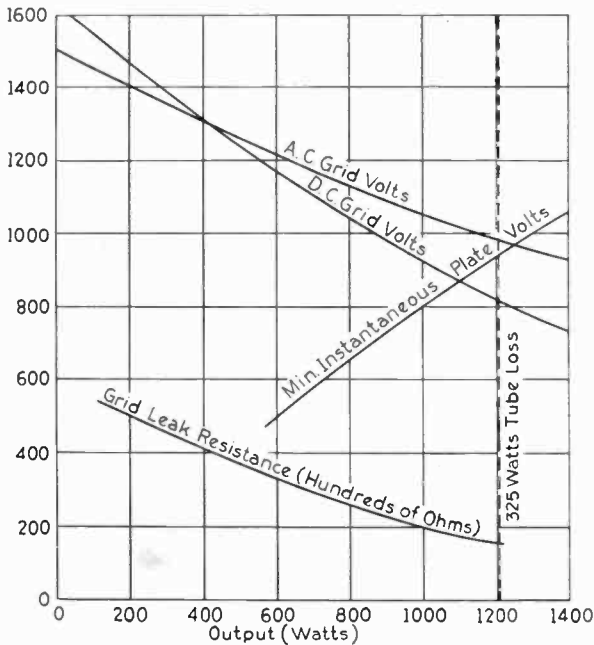

FIGURE 6—Calculated Optimum Operating Conditions for a UV-206 Tube at 10,000 Volts Direct Current

Values of plate current can be plotted against induced plate voltage maintaining the relation  $\Delta e_g = -0.104 \Delta e_p$ . To do this a series of plate voltages are assumed such as 10,000, 9,900, 9,800, 9,700, etc. The difference between these values and 10,000 are equivalent to induced voltages in an oscillating circuit and the grid voltages are  $-0.104$  times these values. Figure 10 represents the resultant derived characteristic. By drawing a second axis  $X'$  thru the current value at zero volts and referring currents to the new axis, any point on the curve represents volts and amperes, alternating current instantaneous output. Over a



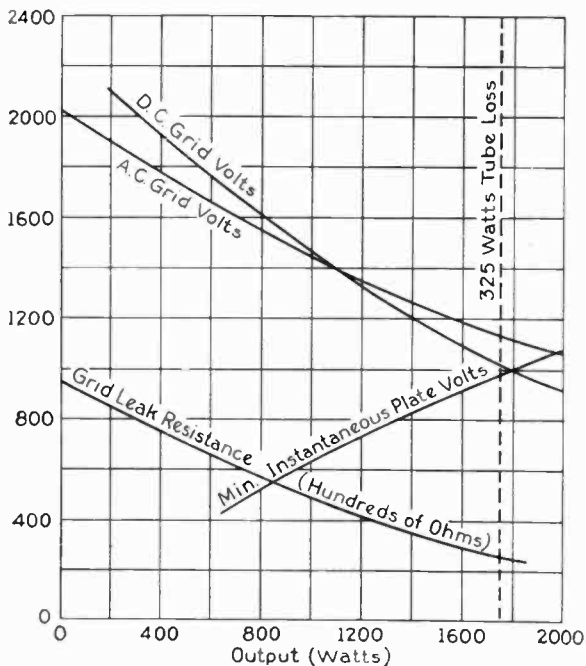

FIGURE 7—Calculated Optimum Operating Conditions for a UV-206 Tube at 15,000 Volts Direct Current

short distance from the origin the curve may be considered a straight line, the reciprocal of the slope of which is the ohmic resistance which would just use up the energy output of the tube. If the equivalent resistance of the circuit is greater than this amount, oscillations will start and increase until a stable point is reached. The energy consumed is  $W_L = \frac{(\Delta e_p)^2}{r}$ . If "r" is increased, less energy is consumed and the surplus is stored in the form of oscillating energy in the circuit until increased amplitude of oscillation fails to yield a sufficient increase in output to support the increase in losses. The equivalent resistance is the resistance of a multiple tuned circuit which is inversely proportional to the ohmic resistance in the parts of the circuit. In the case under investigation full load corresponds to a resistance of 35,800 ohms. The oscillations would be self-starting with 8,700 ohms, so that starting is certain. The range between 8,700 and 35,800 is a zone within which continuous operation will overheat the tube, and so is not useful, except that it represents a margin of safety as far as self-starting is concerned. For lower

impressed voltage, this margin becomes progressively narrower until a point is reached where oscillations will not be self-starting, but will be maintained if once started. This point must be borne in mind when adjustments are being attempted at reduced voltages. A circuit in perfect adjustment will often fail to start at all on half voltage altho it will oscillate well if the full voltage is thrown on and then reduced.

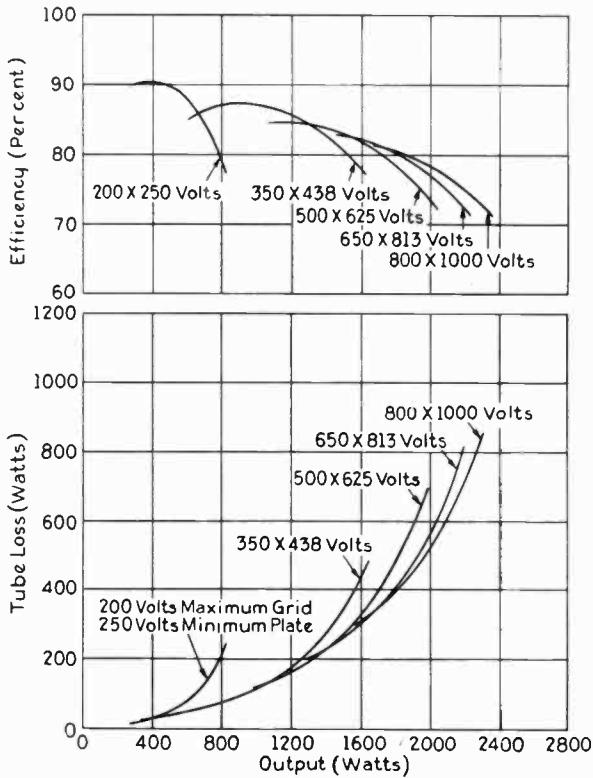

FIGURE 8—Calculated Efficiency and Loss in a UV-206 Tube at 15,000 Volts Direct Current

No conclusions can be drawn from Figure 10 as to the stable oscillations of the circuit at full amplitude. As soon as oscillations have commenced the grid begins to bias itself negatively, so that the axes of this graph are no longer maintained.

#### BLOCKING

Certain tubes, even tho well designed, are subject to a phenomenon technically known as blocking. The visible evidences

of this phenomenon are cessation of oscillation accompanied by a sudden increase of plate current to a value larger than that which can be obtained with full voltage and zero potential on the grid. A high power tube is usually destroyed by blocking, since the energy dissipated in the heating of the plate is enormous.

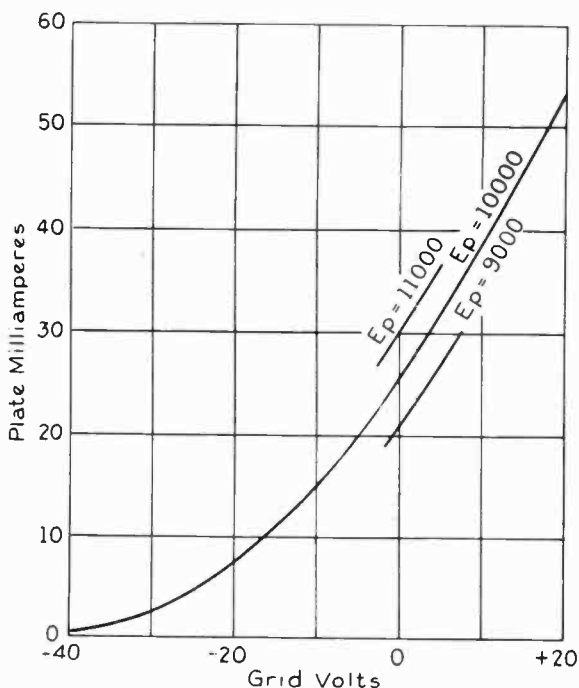

FIGURE 9—Characteristics of a UV-206 Tube

The General Electric Company's one-kilowatt tube, which has been used as an example, is practically immune from blocking, but the nature of the phenomenon can be studied by arbitrarily extrapolating the composite characteristic (Figure 4). Figure 11 could conceivably apply for a plate voltage of 2,000. After the grid voltage passes 1,000, the grid current reverses. If the average current is in the reverse direction, the drop in the grid leak is reversed so that the axis about which the grid swings is positive. Now since current flows from the grid terminal when positive voltage is applied to it, there is the equivalent of negative resistance of a value  $e_g/i_g$  between grid and filament,  $i_g$  being negative. If the grid leak have a value of say 18,000 ohms, the drop in the grid leak will be 1,250 volts for a current of

-70 ma. and this drop will maintain the grid at 1,250 volts. A condition of equilibrium is established at "A," but it is unstable, since -80 ma. will give a drop of 1,440 volts across the resistance, which is sufficient to cause the flow of -130 ma. -130 ma. would give a resistance drop and hence the grid a potential of over 2,000 volts, but at this point the current would again reverse so that stability is established at "B." By drawing a tangent from the origin thru "C," the minimum resistance is found for which stable equilibrium can be established with the grid at a positive potential. For lesser values of biasing resistance, blocking cannot take place.

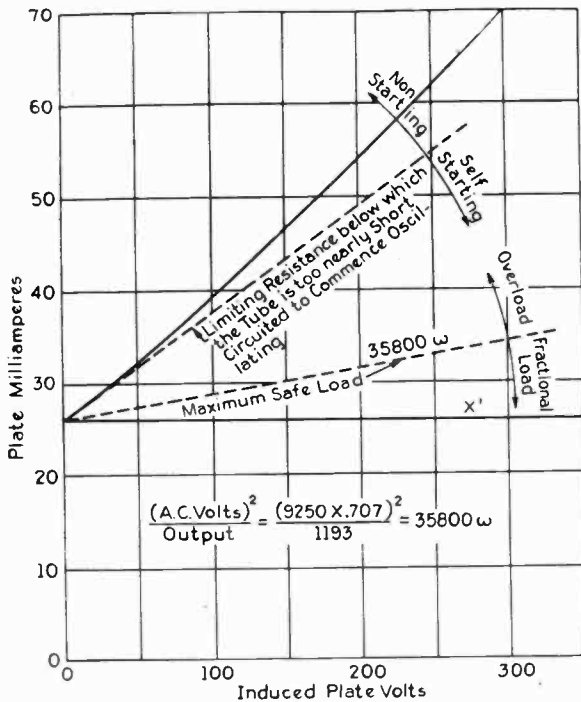

FIGURE 10—Oscillator Starting Characteristics at 10,000 Volts Direct Current

It will be noted that three simultaneous events are necessary to give blocking: the minimum plate voltage must be high; the maximum grid voltage must be high; and the grid leak resistance must be high. This situation is obtained if the output of the oscillator is forced by decreasing the effective resistance of the plate circuit. This reduces the amplitude of os-

illation and increases the minimum plate potential. The operator, in trying to restore the oscillation amplitude, raises the grid excitation, which carries the grid beyond the potential at which grid current begins to decrease. This reduces the average current, which, in turn, reduces the negative bias, allowing the grid to swing into a still more positive zone until blocking results.

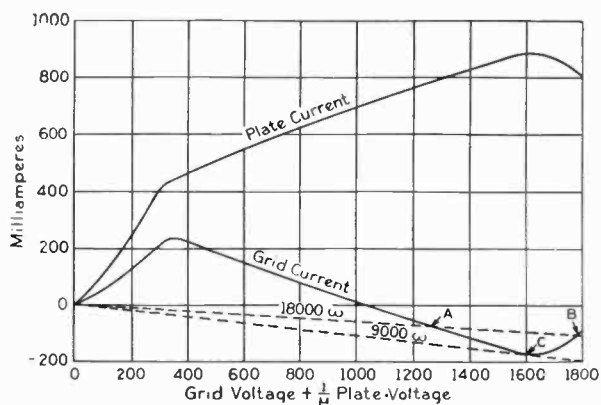

FIGURE 11—Characteristic Curve Showing Blocking Condition

By reasonable care in circuit design, blocking may be entirely avoided. Take, for instance, the point already calculated. The circuit adjustment was such that the full plate swing of 9,250 volts gave a corresponding grid swing of 960 volts. Since the plate supply is 10,000 volts, the minimum plate voltage is 750. Thus, before the grid approaches a potential at which its current becomes negative, the plate potential is too low for blocking to take place.

## CHAPTER II

### APPROXIMATE THEORETICAL PLIOTRON PERFORMANCE WITH SINE WAVES OF PLATE AND GRID POTENTIAL

For some qualitative analysis, vacuum tube oscillator performance may be approximated by substituting a portion of a sine wave for the actual current wave obtained in the foregoing exact method. Such a wave may be integrated mathematically instead of by the laborious step-by-step method. Referring to Figure 12:

Let  $E$  = Direct potential impressed upon the circuit.

$e_p$  = Filament to plate potential.

$a$  = Fraction of total potential not consumed by space charge.

$i_p$  = Plate current.

$I$  = Maximum value of plate current.

$c$  = Such a value that  $(1+c)I$  gives the maximum plate current referred to the axis about which it is sinusoidal.

$\theta_1$  and  $\theta_2$  = Points at which plate current curve intercepts the zero axis.

$e_p = E(1 - a \sin \theta) = E f_1 \theta$ .

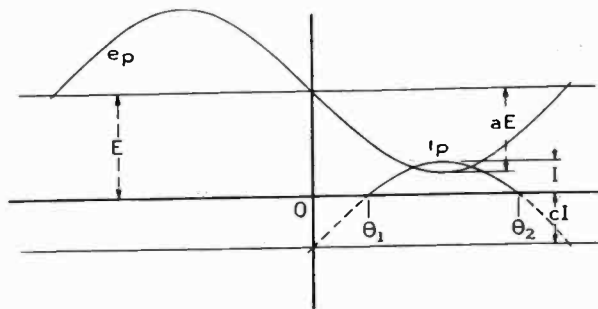

FIGURE 12

Since the oscillating circuit is highly tuned, it responds only to impulses of fundamental frequency and hence the voltage is a pure sine wave. For full load operation, maximum current must flow when the tube drop is a minimum, so that the plate potential does not swing lower than  $(1-a)E$ , which corresponds to the space charge loss.

$$i_p = I \left( -c + (1+c) \sin \theta \right) = I f_2 \theta$$

The fundamental law is, of course,

$$i_p = K \left( E_g + \frac{1}{\mu} E_p \right)^{3/2}$$

but with the grid potential  $180^\circ$  out of phase with plate potential, the actual resultant expression approaches closely  $i_p = K E_g$ . If we wish  $i_p = K' \sin \theta + K''$ , the expression for  $E_g$  may be modified so that this result will be obtained. With this approximation, it is not necessary to use step-by-step integration.

The input of the oscillator is given by the expression

$$\begin{aligned} W &= E i_p = E I \left( -c + (1+c) \sin \theta \right) \\ &= E I f_2 \theta \end{aligned} \tag{1}$$

The tube loss is equal to the instantaneous product of current and drop across the tube, that is,

$$\begin{aligned} \text{Loss} &= EI(1 - a \sin \theta) \left( -c + (1 + c \sin \theta) \right) \\ &= EI f_1 \theta f_2 \theta \end{aligned} \quad (2)$$

$$\text{Output} = (1) - (2) = EI f_2 \theta (1 - f_1 \theta) \quad (3)$$

$$\begin{aligned} \text{Efficiency} &= (3)/(1) = \frac{EI f_2 \theta (1 - f_1 \theta)}{EI f_2 \theta} \\ &= 1 - f_1 \theta = a \sin \theta \end{aligned} \quad (4)$$

To determine average efficiency the instantaneous efficiency must be weighted in proportion to the input.

$$\text{Average Efficiency} = \frac{\int_{\theta_1}^{\theta_2} EI f_2 \theta (a \sin \theta) d\theta}{\int_{\theta_1}^{\theta_2} EI f_2 \theta d\theta} \quad (5)$$

$$= \frac{\int_{\theta_1}^{\theta_2} a \sin \theta [-c + (1 + c) \sin \theta] d\theta}{\int_{\theta_1}^{\theta_2} [-c + (1 + c) \sin \theta] d\theta} \quad (6)$$

$$= \frac{a \int_{\theta_1}^{\theta_2} [-c \sin \theta + (1 + c) \sin^2 \theta] d\theta}{\int_{\theta_1}^{\theta_2} [-c + (1 + c) \sin \theta] d\theta} \quad (7)$$

$$= \frac{a \left[ c \cos \theta + \frac{(1+c)}{2} \theta - \frac{(1+c)}{4} \sin 2\theta \right]_{\theta_1}^{\theta_2}}{\left[ -c\theta - (1+c) \cos \theta \right]_{\theta_1}^{\theta_2}} \quad (8)$$

Since the thermionic valve has uni-directional conductivity, there can be no current reversal. The expression is, therefore, meaningless unless  $\theta_1$  and  $\theta_2$  are chosen to include that portion of the cycle during which current flows. During the remainder of the cycle there is neither input nor output, so that integration between these limits gives the complete result.

With the origin as shown, the following relations between the limits and constants exist:

$$\begin{aligned} \frac{c}{1+c} &= \sin \theta_1 & \cos \theta_2 &= -\cos \theta_1 \\ \bar{\theta}_2 &= \pi - \theta_1 & \sin 2\theta_2 &= -\sin 2\theta_1 \end{aligned}$$

The complete expression can then be written:

$$\text{Efficiency} = \frac{a \left[ \frac{1+c}{2} (\pi - 2\theta_1) - 2c \cos \theta_1 + \frac{1+c}{2} \sin 2\theta_1 \right]}{-c (\pi - 2\theta_1) + 2(1+c) \cos \theta_1} \quad (9)$$

The value "I" has been selected as a constant, because the maximum emission of any tube is a constant, depending upon filament rating. The expression for output (3) can, therefore, be evaluated to show the variation in output accompanying variations in efficiency. Equation (3) solved gives the numerator in equation (9) for  $E I = 1$ .

In Figure 13 efficiency and output as a percentage of the maximum are plotted for "a" = 1.

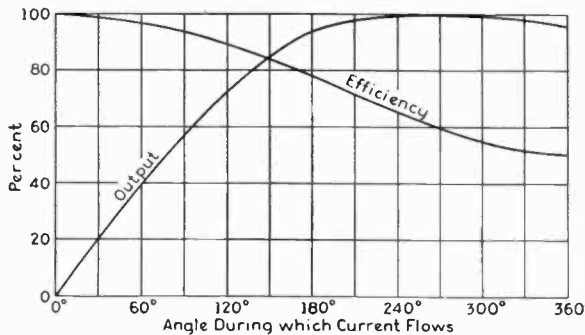

FIGURE 13—Theoretical Efficiency of Plotron Oscillators. Variation with angle during which plate current flows, neglecting space charge and assuming current wave proportional, above cut-off value, to sine grid potential. Maximum plate current constant

In Figure 14, curves are plotted for various values of "a," showing efficiency, output, and loss for current flowing for different fractions of the cycle.

In order that conclusions may be drawn, the output and loss curves have been plotted to scales inversely proportional to  $(1-a)$ , taking the maximum output for  $(1-a) = 5$  percent, as 200 for convenience. If the curves are considered as applying to one tube, the space charge in percent will be inversely proportional to the voltage applied, "I" remaining constant, therefore

$$\text{Output} = E I f_2 \theta (1 - f_1 \theta)$$

and where  $E \propto \frac{1}{1-a}$

$$\text{Output} = \frac{K'' I}{1-a} f_2 \theta (1 - f_1 \theta)$$



The curves as plotted, therefore, represent the conditions encountered when impressed voltage is varied.

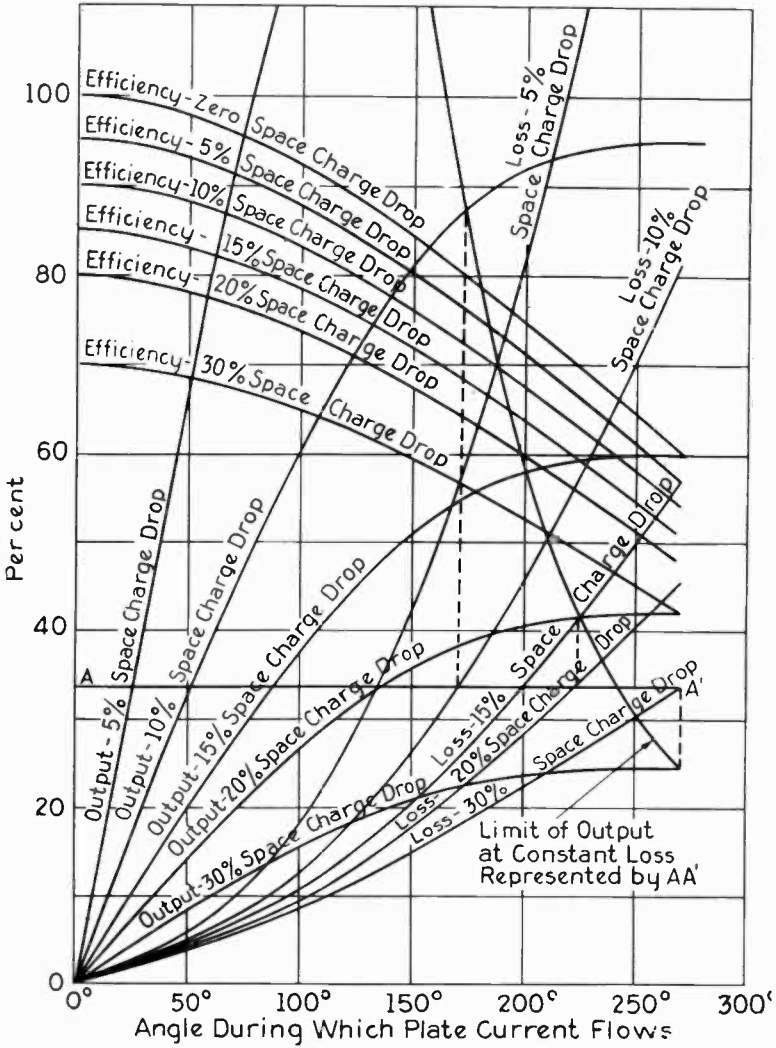

FIGURE 14—Theoretical Pliotron Oscillation Characteristics (Absolute Space Charge Constant, Impressed Voltage Variable)

Since the tube output is limited by heating, the effect of voltage variation on tube output can be deduced directly. Any line, say "AA'" is drawn, representing maximum dissipation for a given tube. The intersections of this line with the loss curves are the angles during which current can be passed at different

voltages. The same abscissas extended to the output curves determine the variation in output at constant heating.

Assuming 1,000 volts space charge drop, the variation of output with voltage is plotted in Figure 15. The scale of outputs is based on the maximum possible output of the tube on 20,000 volts, neglecting heating. It will be observed that the curve shows a slight tendency to saturate, but that output at constant heating is still increasing almost in proportion to voltage when space charge is reduced to 5 percent of the impressed voltage.

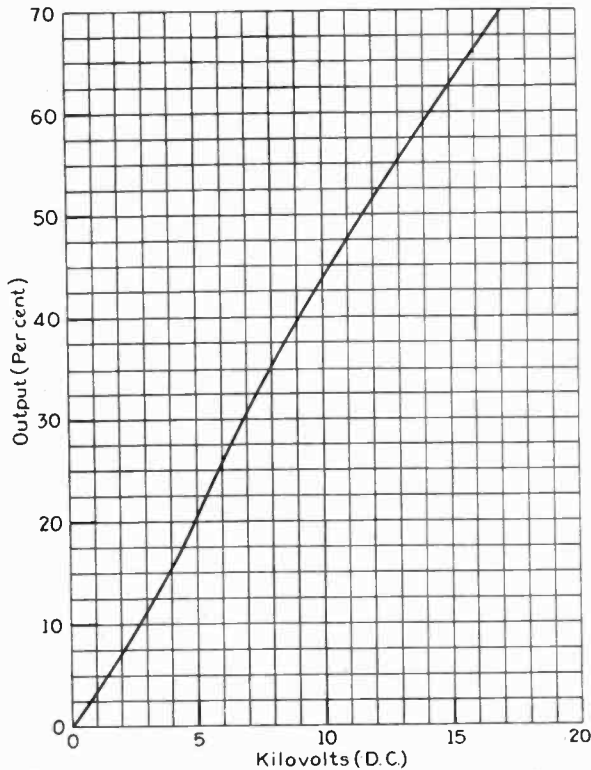

FIGURE 15—Theoretical Pliotron Characteristics. Variation of Output with voltage, maximum current and loss constant

For convenience in determining the currents indicated by a direct current meter in the plate circuit under the foregoing conditions, Figure 16 has been prepared. Curve "A" applies to currents of the form assumed in the foregoing calculations of oscillator efficiency, while curve "B" gives the corresponding

figure for tubes operated as rectifiers without smoothing devices.

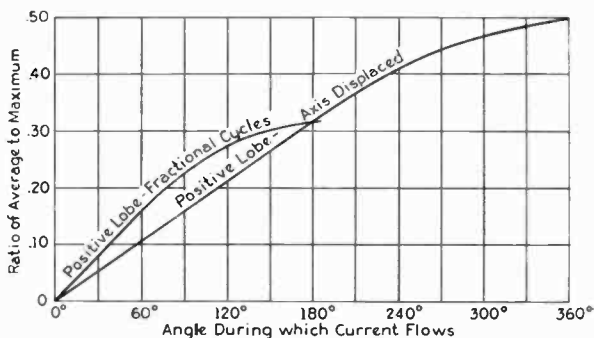

FIGURE 16—Ratio of Average to Maximum for Sine Waves

In order to obtain an idea of the grid swing required to secure various efficiencies where sinusoidal excitation is used, conditions have been assumed as shown in Figure 17. It has been assumed that, for oscillators, the grid potential will swing positive as the plate swings negative until the two approximately meet.

Let  $e_p =$  plate potential  $= E (1 - a \cos \theta)$

$e_g =$  grid potential  $= E (-b + g \cos \theta)$

$E =$  direct potential impressed.

$1 - a =$  ratio of space charge drop to  $E$ .

$b =$  ratio of grid bias to  $E$ .

$g =$  ratio of maximum grid swing to  $E$ .

$d =$  ratio of current cut-off point to  $E$ .

$E d = \frac{e_p}{\mu} =$  grid potential necessary to reduce current to zero.

Since all values are expressed as ratios to  $E$ , the  $E$  will be assumed as unity in the following relations:

$1 - a =$  maximum plus grid swing

$b + 1 - a = g$ .

$2 \theta_1 =$  angle during which current flows. The grid swings positive from the point where current begins to flow by a distance.

$$M = (1 - a) + d_1 = 1 - a + \frac{e_{p1}}{\mu}$$

$$= 1 - a + \frac{1 - a \cos \theta_1}{\mu}$$

$g \cos \theta_1 = g - M$

$$\text{Or } g = \frac{\left[ \frac{1 + \mu}{\mu} - a \left( \frac{1}{\mu} \cos \theta_1 + 1 \right) \right]}{1 - \cos \theta_1}$$

$$b = g - (1 - a)$$

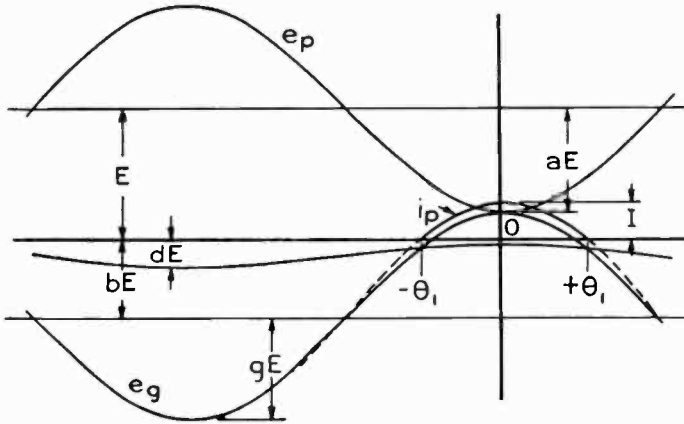

FIGURE 17

The curves in Figure 18 show variations in “ $g$ ” with  $2\theta_1$ , the angle during which current flows, for  $a=0.95$  and  $\mu=10$  and  $\mu=100$ . For small values of  $\theta_1$ , “ $g$ ” approaches infinity, so that if high efficiency is to be obtained with sine excitation, the potential, from grid to filament may be equal to, or even greater than those from plate to filament.

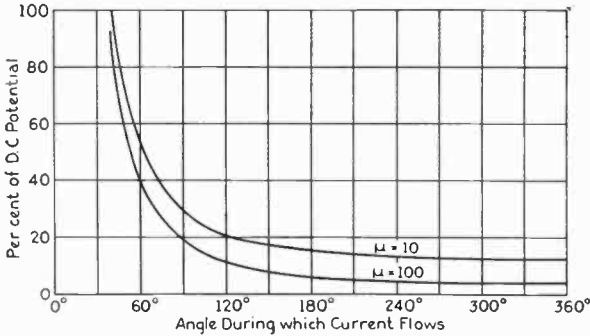

FIGURE 18—Theoretical Plotron Characteristics. Maximum Grid Potential as a Function of Direct Potential Impressed on Plate. Grid Excitation Sinusoidal. Space Charge 5 percent. Maximum Plus Grid Potential equals Minimum Plate Potential

## CHAPTER III

### CIRCUIT DESIGN

The design of vacuum tube oscillator circuits hinges on two points:

1. An oscillating circuit must be supplied in which there is sufficient energy stored to carry the circuit by its fly-wheel effect over those parts of the cycle during which the input to the circuit is not equal to the losses.
2. The voltages applied to the tube must be in amplitude and phase of proper value as determined in Chapter I.

### STORED ENERGY

Consider a circuit having an inductance " $L$ " and a capacity " $C$ " and oscillating at a frequency " $f$ " and voltage " $V$ " with " $W$ " watts loss. At a point in the cycle when the current is zero, the instantaneous voltage will be  $\sqrt{2} V$ ; all the energy is stored in the condenser and its amount is  $C V^2$ . The r.m.s. current in this circuit is  $2\pi f C V$ , and the joules lost per cycle are  $W/f$ . Dividing energy stored by joules lost per cycle gives:

$$\frac{\text{Energy stored}}{\text{Energy lost per cycle}} = \frac{C V^2}{W/f} = \frac{f C V^2}{W} = \frac{2\pi f C V^2}{2\pi W} = \frac{VI}{2\pi W}$$

which shows that the ratio of energy stored to energy dissipated per cycle is  $\frac{1}{2\pi}$  times the ratio of reactive power to watts. Circuits having less than twice as much energy stored in them as they dissipate per cycle tend to be erratic in operation. Circuits having more than this amount of energy stored in them may have disproportionate resistance loss. Unless, therefore, there is some other determining factor, circulating volt-amperes should approximate  $4\pi$  times the power. Another way of saying this is that power factor should not be over 8 percent, or that decrement should not exceed 0.25. This circulating energy has the same effect as the flywheel of a single acting engine and must be coupled closely to the plate.

After assurance is obtained that circulating energy is adequate, oscillator design in general is only a matter of determining proper voltages and phase relations. For the tube which has already been used as an example, the rated output is 1 kilowatt at 10,000 volts direct current. The characteristic voltages from Figure 6 are:

Minimum plate 800 volts, from which r.m.s. value	
of alternating current potential is . . . . .	6,500
R.M.S. Grid Volts. . . . .	1,050 volts
Grid Bias . . . . .	920 volts
Grid Leak Resistance . . . . .	20,000 ohms
Loss in tube (Figure 5) . . . . .	220 watts
Efficiency . . . . .	79.5 percent

Suppose we wish to design a simple Hartley circuit to meet these conditions. The circuit is shown in Figure 19. In this figure:

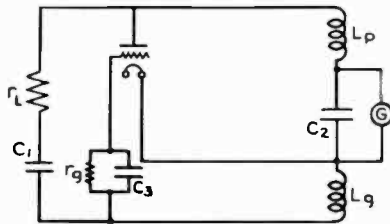

FIGURE 19—Hartley Circuit

- $L_p$  = plate inductance.
- $L_g$  = grid inductance.
- $C_1$  = tuning condenser.
- $C_2$  = direct current blocking condenser.
- $C_3$  = grid blocking condenser
- $r_g$  = grid leak resistance.
- $r_l$  = load resistance.
- $G$  = direct current energy source.

To meet the tube requirements

$$L_p/L_g = \frac{6500}{1050}, \quad r_g = 20,000 \text{ ohms.}$$

Suppose the desired frequency to be  $10^6$  cycles, and that a maximum of energy is to be delivered to  $r_l$ . With an output of 1 kilowatt, circulating kilovolt-amperes should be  $4\pi$  or 12.5 kilovolt-amperes.

$$X_{L_p} = \frac{E_p^2}{V_a} = \frac{6500^2}{12500} = 3,380 \text{ ohms, at } 10^6 \text{ cycles. } L_p = 0.538 \text{ milli-henry.}$$

$$X_{L_g} = X_{L_p} \times \frac{1050}{6500} = 545 \text{ ohms, at } 10^6 \text{ cycles. } L_g = 0.087 \text{ milli-henry.}$$

$$X_{C_1} = X_{L_p} + X_{L_g} = 3,925 \text{ ohms, at } 10^6 \text{ cycles. } C_1 = 4.06 \times 10^{-5} \text{ mfd.}$$

$$\text{Circulating current is } \frac{12500}{6500} = 1.925 \text{ amperes.}$$

$$\text{The total resistance of the circuit is } \frac{1000}{1.925^2} = 270 \text{ ohms.}$$

From this, if we measure the radio frequency resistance of

$L_p$ ,  $L_g$ ,  $C_1$ , and connecting wires,  $r_1$  can be obtained. Suppose the inductances have power factors of 1 percent, and that the condensers and leads have negligible loss

$$r_1 = 270 - 39.3 = 230.7 \text{ ohms.}$$

There is an almost infinite variety of circuit arrangements containing but one tuning which are solved by the same method as indicated above. The voltages may be obtained by self-induction, drop across capacities or mutual effects and, so long as the plate and grid voltages are obtained in the proper phase and the circuit is not overloaded, correct operation should be obtained.  $C_2$  and  $C_3$  are not critical.

If the experimenter does not secure the results expected, there are two causes more usually encountered than others: The tube may not correspond to the characteristics, or the circuit constants may not be as they seem. The most frequent tube variation is emission. If this is low, performance will not be obtained. If emission is high, tube life may be extended by lowering the filament current. Output and efficiency can both be increased at the expense of life by overburning the filament.

A three-element tube is ready to function at almost any frequency. At high frequencies, inductances may perform as capacities if their natural frequencies are exceeded. Condenser leads may have more inductive impedance than the capacity impedance of the condensers to which they are attached. Circuits may oscillate by parts, and so on. At high frequencies, skin effects increase resistance and surrounding objects may affect resistance, inductance, or capacity. All such parasitic phenomena must be considered or eliminated before the true performance is obtained.

#### GRID PHASE ANGLE CORRECTIONS

A discussion of circuit design is not complete without a treatment of the phenomena which make pliotron oscillators run at a frequency other than the natural resonant frequency of the circuits. The factors entering into the selection of plate blocking condensers and chokes also deserve some detailed analysis.

A Hartley circuit normally operates at a frequency lower than that determined by the relation

$$f = \frac{1}{2\pi\sqrt{LC}}$$

The reason for this is apparent from Figures 20-A, B, and can be calculated quantitatively.

Figure 20-A is a composite circuit and voltage diagram.  $OA$  is the plate voltage vector; the plate is connected at  $A$ , the filament at  $O$ , and the plate inductance between these points.  $OB$  is the inductive drop in the grid coil,  $BC$  the resistance drop, so that  $OC$  is the grid voltage vector with the grid connected at  $C$ .  $CA$  is the condenser drop. Since resistance in the plate coil does not affect the grid phase angle, it is left out of the diagram, altho its effect is obvious.

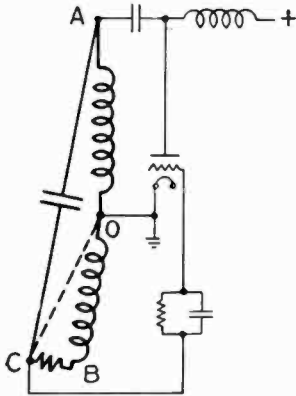

FIGURE 20-A

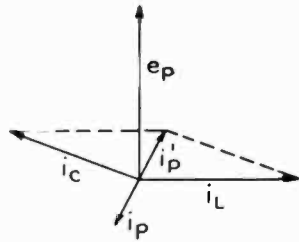

FIGURE 20-B

The plate current is in phase with the grid voltage and is shown as  $i_p$  in Figure 20-B. In this figure,  $i_c$  is the current thru the circuit  $OBCA$ , and  $i_L$  is the current thru inductance  $OA$ . According to Kirchoff's law, the vector sum of the currents at any point, such as  $O$ , must be zero. Therefore, the sum of  $i_c$  and  $i_L$  must equal  $i_p'$ , which is  $i_p$  reversed. Now, since  $i_p$  has a component leading  $e_p$  which adds to the corresponding component of  $i_c$ , the value of  $i_L$  must be increased, which can be accomplished either by reducing the inductance of the plate coil or lowering the frequency. It follows that a simple Hartley circuit will always operate below the resonant point and that the amount of frequency drop can be calculated by applying numerical values to the vectors shown in Figure 20-B.

By the same reasoning the operation of a Colpitts' circuit can be analyzed as in Figures 21-A, B.

As before, Figure 21-A is the voltage and circuit diagram, with plate at  $A$ , filament at  $O$ , and grid at  $C$ . In this case the component of plate current is in phase with  $i_L$  so that it must be balanced by an increased current in the plate condenser. This requires either a larger plate condenser or a higher frequency



so that a Colpitts' circuit always operates above the resonant point by an amount which can be calculated by applying numerical values to the vectors.

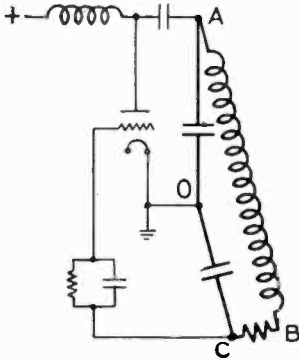

FIGURE 21-A

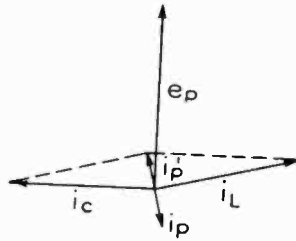

FIGURE 21-B

The diagrams Figures 22-A, B show the effect of the plate blocking condenser and line choke on the operation of a Hartley circuit. In Figure 22-A,  $O A B$  and  $C$  have the same significance as in Figure 20-A.  $A D$  is the alternating current component of the drop across the blocking condenser. The plate is now at-

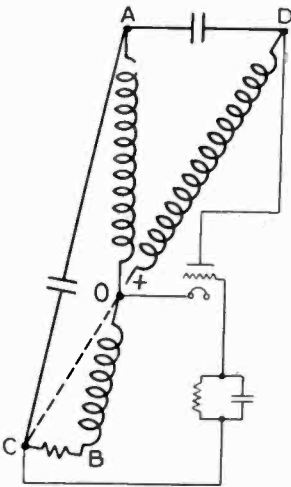

FIGURE 22-A

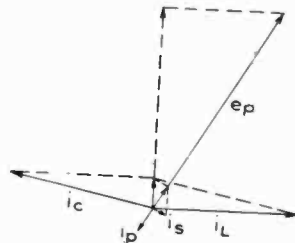

FIGURE 22-B

tached to  $D$  instead of to  $A$ .  $O D$  is the alternating component of drop across the line choke. The direct current is introduced

between  $O$  and  $D$ , but does not appear in the diagram, which represents only alternating vectors. Figure 22-B is similar to 20-B, except for the added current in the choke  $OD$ , which is designated  $i_s$  and the change in  $e_p$ , which must now be in the direction  $OD$  instead of  $OA$ .

It is apparent that proper proportioning of blocking condenser and choke may bring the plate voltage back into line with the grid voltage and plate current. Best efficiency is obtained by having plate voltage and current exactly  $180^\circ$  out of phase, as will be apparent by reference to Chapter I. If the  $180^\circ$  relation is not maintained, the step integration must be carried over the entire duration of current flow and, since maximum current will no longer correspond to minimum voltage, the integrated product is necessarily larger. The line choke and blocking condenser should, therefore, be included in the circuit design.

To do this the circuit  $OBCA$  is calculated as tho choke and blocking condenser were not present. This circuit may be equivalent either to a pure resistance or to a resistance and reactance in series. Let it be proportioned so that it will be equivalent to a resistance. The angle  $COA$  can then be calculated and its supplement  $AOD$ . Since the equivalent resistance between  $A$  and  $O$  is known, the capacity reactance  $AD$  is selected so that  $AD/OA = \tan^{-1}(180^\circ - AOC)$ . The circuit voltage is impressed at  $D$  and the circuit  $DAO$  will draw some leading current, the amount being easily ascertainable. It is then only necessary to choose the choke  $DO$  of such a value that it will draw the same amount of lagging current.

The procedure in arriving at the proper values of blocking condenser and line choke will be clearer if a numerical example is carried through.

In the first place it is necessary to secure the proper grid excitation ratio.

Let 
$$\frac{E_p}{E_g} = \frac{OA}{OC} = 4.$$

Since  $OD$  is the plate voltage, it may be necessary to make a second approximation if  $OD$  is seriously different from  $OA$ .

Let  $OA = 100$  ohms inductance. 10 ohms resistance.

$OB = 25$  ohms inductance.

$BC = 2.5$  ohms resistance.

$CA = 125$  ohms capacity.

Then Angle  $OAC = \sin^{-1} \frac{2.5}{100} = 1^\circ 27'$

If 100 volts be impressed across  $OA$

$$i_L = 1, \quad \text{Watts in } OA = i_L^2 \times 10 = 10.$$

$$i_c = 1, \quad \text{Watts in } BC = i_c^2 \times 2.5 = \frac{2.5}{12.5}.$$

Equivalent resistance  $\frac{E^2}{W} = \frac{100^2}{12.5} = 800$  ohms. We may adjust to have this circuit operate at the resonant point so that its reactance is zero.

By the sine rule:

$$\frac{OA}{\sin C} = \frac{OC}{\sin A} = \frac{AC}{\sin O}$$

$$\frac{100}{\sin C} = \frac{0.25}{0.025}, \quad \sin C = 0.1, \quad C = 5^\circ 45'$$

$$\text{Angle } AOD = A + C = 6^\circ 55'$$

$$AD = AO \tan AOD$$

$$= 800 \times 0.1 = 80 \text{ ohms capacitance.}$$

The total impedance  $DAO$  is, therefore, 804 ohms, so that the grid voltage ratio is nearly correct. If we impress 100 volts between  $D$  and  $O$ , the current is

$$\frac{100}{804} = 0.124 \text{ amperes}$$

And the wattless volt-ampere component is

$$0.124^2 \times 80 = 1.23 \text{ volt-amperes.}$$

In order to correct for these leading volt-amperes, the choke should draw the same amount lagging

$$DO = \frac{100^2}{1.23} = 8,130 \text{ ohms.}$$

If the impedance of the plate blocking condenser had been high, the assumed ratio between grid and plate voltages would not have been obtained. It would then have been necessary to assume an initial value somewhat larger than desired for the final result, proceeding by a series of approximations. However, it is not likely that a high impedance blocking condenser would be desirable for other reasons. A high impedance blocking condenser corresponds to a low impedance choke which would allow radio frequency currents to flow in higher loss circuits and possibly damage power generating apparatus.

Proportioning the plate blocking condenser and line choke is not the only method of bringing plate voltage and current into the  $180^\circ$  relation. The angle  $OAC$  may be compensated

for by dephasing the grid in such a way as to cause the oscillations to occur at the natural resonant frequency and the plate current and voltage to be properly related.

Figures 23-A and 23-B are two methods by which a Hartley circuit may be restored to operation at the natural resonant frequency with proper phase relations, while Figures 23-C and 23-D are the two equivalent methods for the Colpitts' circuit.

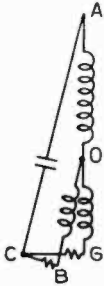

FIGURE 23-A

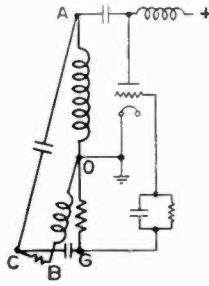

FIGURE 23-B

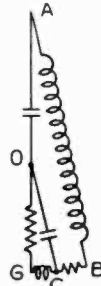

FIGURE 23-C

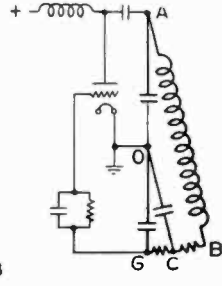

FIGURE 23-D

In Figure 23-A, the phasing is accomplished by connecting resistance  $C G$  and inductance  $G O$  in series. The grid is attached at  $G$ . The same result is accomplished in Figure 23-B by a resistance from  $O$  to  $G$  and a condenser from  $G$  to  $C$ . The elements are reversed in 23-C and 23-D to produce lag instead of lead.

Altho grid phasing may correct the various angles, it is probable that adjustments of choke and blocking condenser are to be preferred since these devices are normally present and so do not constitute added complication.

#### GRID BIAS CONDENSER

It will be noted that no criteria have yet been developed governing the choice of grid blocking condenser. Since the function of this condenser is to pass the alternating current component of grid excitation without serious drop while forcing the direct component to flow thru the grid leak or biasing resistance, its value is not critical. Its value should be large enough so that the grid plate capacity is small by comparison. The values of tube capacity are normally so small that this requirement causes no concern. The individual pulses of direct current should cause no considerable change in the bias, but this also causes small concern.

## INTERMITTENT OSCILLATION

Trouble may be encountered due to excessive capacity of the grid leak condenser. Since the reason for this is not apparent at first glance, it will be developed in more detail. The evidence of trouble is a falling off in input and output and the radiation of an interrupted wave.

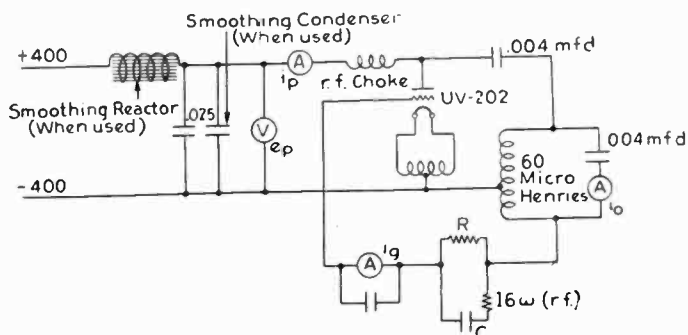

FIGURE 24—Circuit Used in Taking Films Shown in Figures 26, 27, 28

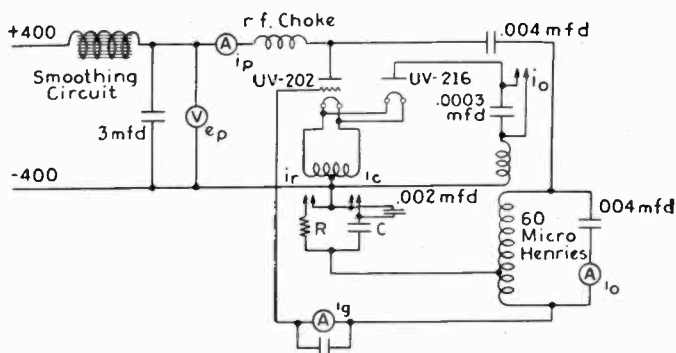

FIGURE 25—Circuit Used in Taking Film Shown in Figure 29

Oscillogram (Figure 26) shows the result of a very large grid condenser. This film was taken with the circuit shown in Figure 24. The oscillations alternately build up and die out, the period being quite long. By reducing the condenser, the period is changed as shown in Figure 27. The phenomenon exists even when considerable care is used in smoothing out the impressed voltage by means of a filter, as shown in Figure 26. That the phenomenon is not due to resonance is indicated by the irregularities shown in Figure 28. In the foregoing oscillograms, plate current is used as a measure of oscillations. Figure 29 shows that

the actual oscillation amplitude follows the same general form. This was taken with the circuit shown in Figure 25.

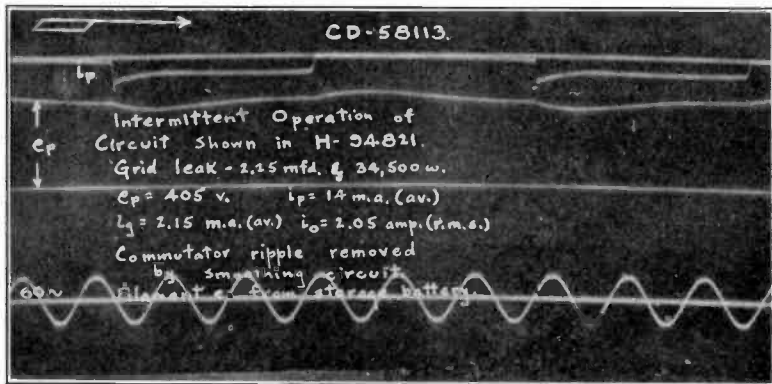

FIGURE 26

The explanation of this phenomenon is arrived at as follows: Referring to Figure 30, let the ratio of alternating current plate and grid volts, and other adjustments be constant. If we then assume a constant bias in volts, the tube output for any amplitude of oscillations can be calculated directly by the method developed in the first chapter. Several such curves are plotted.

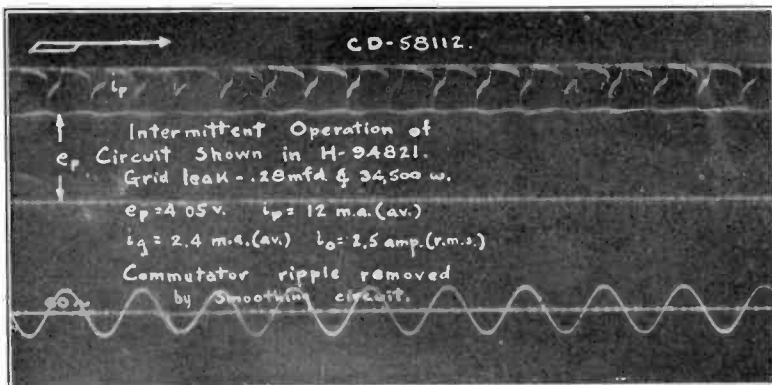

FIGURE 27

The resistance loss in the circuit is a square curve and is also plotted. An intersection between tube output and circuit loss represents a point of equilibrium. If a decrease in oscillation amplitude causes the tube output to become higher than the losses, the point is stable. If the reverse is the case, it is unstable. By de-

termining the grid current for various points on the curves of output at constant bias, the corresponding leak resistances can be determined. These points may be joined by curves representing output variation with change in oscillation amplitude at constant leak resistance.

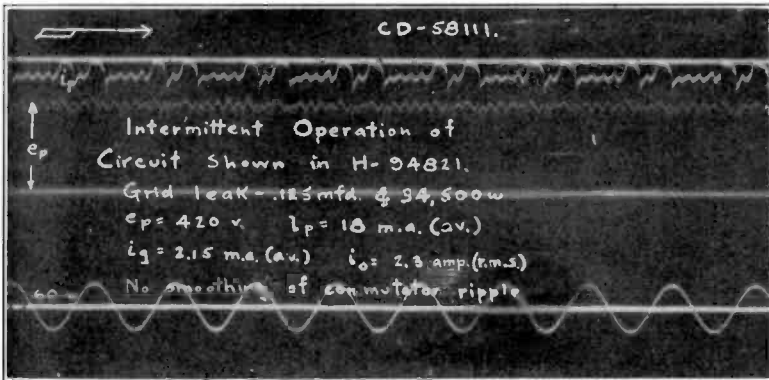

FIGURE 28

There is a value of bias such that the bias curve and the loss curve are tangent as at *C*. A greater bias cannot be used as there are no intersections and hence no points of equilibrium.

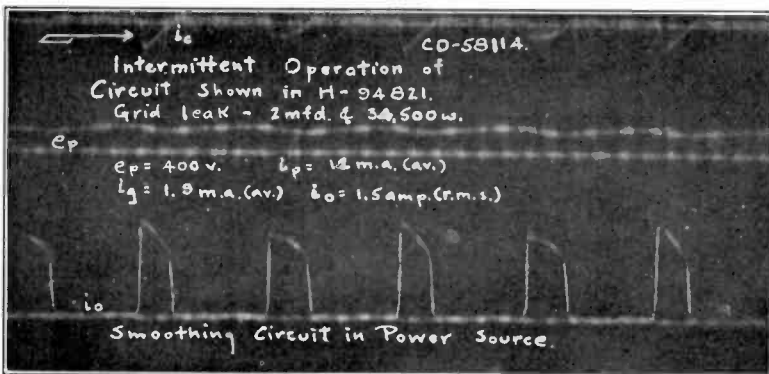

FIGURE 29

Thru any point as *A* or *B* on the loss curve two lines can be drawn, one representing the direction of output variations at constant bias and the other the output variation at constant leak resistance. If a fixed bias is being used, the equilibrium test must be applied to the fixed bias line. If resistance bias is being used,

the test is applied with reference to the constant resistance line. The grid blocking condenser tends to hold constant bias, therefore with a large condenser, operation as far as equilibrium, is concerned, approaches a constant bias line.

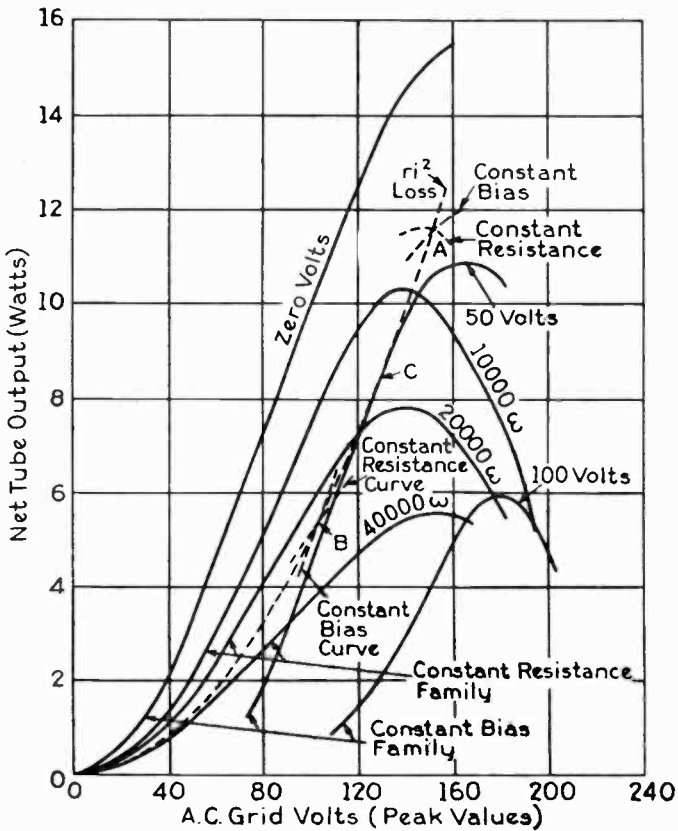

FIGURE 30—Curves Showing Grid Circuit Stability of a UV-202 Tube Assuming Alternating Current Plate Volts are 1.7 Alternating Current Grid Volts and Direct Current Plate Volts are 350

For a small grid condenser, the constant resistance line is more nearly the criterion of stability. It is apparent that in the region from *C*, in the direction of point *A*, stable operation is obtained with either constant resistance or constant bias. In the direction *B*, constant bias operation is unstable, while constant resistance operation is still stable.

Best operation, especially for a highly efficient tube, is very likely to fall in the *CB* zone so that stability requires a grid condenser small enough to cause the slope of the resultant curve for the rate of amplitude variation likely to take place to be less



than the slope of the loss curve. The condition is also frequently observed in regenerative receiver sets.

Having established a condition of either instability or a very narrow margin of stability, equilibrium may be disturbed by a large number of causes, including generator ripple, line regulation, keying, and the like. The cycle followed is somewhat as follows: Assuming the 20,000-ohm value of grid leak, the tube starting with zero bias will build up both oscillations and grid bias until equilibrium is reached at 7.3 watts output and approximately 50 volts bias. If the grid condenser is small, the operation will be stable. If the condenser is large, any momentary disturbance will shift the operating point up or down on the 50-volt bias line, the condenser tending to hold the bias constant over a brief interval. If it shifts down, the tube output becomes less than the circuit losses, and the oscillations die out. The grid condenser then discharges thru the leak until the bias is low enough for oscillations to start again. The cycle is then repeated.

*(To be continued)*

**SUMMARY—Chapter I.** The performance of an oscillating pliotron is determined by ascertaining at intervals of a few degrees the instantaneous plate loss, grid loss, input, and so on. These values are then averaged over the cycle to determine tube output and efficiency. By performing this operation with a variety of plate and grid voltages, the optimum conditions for a given output are obtained. In this way a combination of plate and grid voltages and grid bias is obtained which is independent of frequency and can be used for the design of any free oscillating circuit where sinusoidal plate and grid voltages are obtained 180 degrees out of phase. It is shown that the conditions of starting of oscillations can be obtained by assuming zero grid bias and determining the circuit resistance which will just absorb the tube output for small amplitude oscillations. The phenomenon of "blocking" is shown to be due to secondary electron emission from the grid. By knowing under what conditions this secondary emission takes place the circuit may be so designed that all will not occur simultaneously.

**Chapter II.** For qualitative investigations of vacuum tube performance the plate circuit is assumed to be a portion of a sine wave. This permits mathematical integration to be substituted for the step-by-step integration of the first chapter. By using the mathematical form a qualitative investigation of the effects of space charge, variations in plate voltage and other factors can be made. Where a bird's-eye-view is required this method gives much quicker results than the exact method.

**Chapter III.** In this chapter it is shown how simple circuits may be designed from data determined by the methods of Chapter I. A resonant circuit is selected in which a circulating current will build up a voltage equal to or greater than that required for grid plus plate excitation without absorbing more than tube output in resistance loss. The circulating voltamperes should not be less than  $4\pi$  times the watts. Having met these requirements, the plate, filament, and grid are attached either to the inductance or capacity in such a way as to give the proper voltage division. Some phase displacement of grid excitation from 180 degrees may occur. Connections are given by which the grid phase can be corrected to exactly 180 degrees. The proper selection of chokes and blocking condenser may correct such displacement. Too large a grid condenser may cause intermittent oscillation. The mechanics of this phenomenon are described in detail because of its occurrence in regenerative receivers.



DIGESTS OF UNITED STATES PATENTS RELATING TO  
RADIO TELEGRAPHY AND TELEPHONY\*

ISSUED FEBRUARY 27, 1923—APRIL 17, 1923

By

JOHN B. BRADY

(PATENT LAWYER, OURAY BUILDING, WASHINGTON, D. C.)

1,446,650—B. Macpherson, filed October 22, 1919, issued February 27, 1923. Assigned to Wireless Specialty Apparatus Company.

ELECTRICAL CONDENSER, comprising alternate sheets of foil and dielectric with pressure plates upon opposite ends of the stack and resilient strips, or bands of insulating material extending around the pressure plates whereby the band may be placed under tension to maintain the alternate sheets of the condenser in intimate contact.

1,446,752—B. W. Kendall, filed December 29, 1916, issued February 27, 1923. Assigned to Western Electric Company, Incorporated.

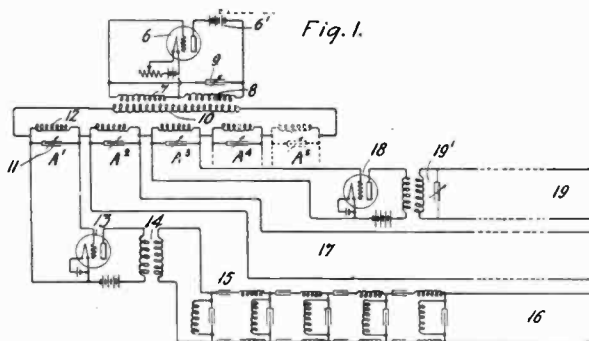

NUMBER 1,446,752—Generator and the Generation of Multiple Frequencies

GENERATOR AND THE GENERATION OF MULTIPLE FREQUENCIES, by distortion of the wave form of the fundamental

\*Received by the Editor, May 10, 1923.

frequency and by selecting the overtones or multiple frequencies present in the distorted wave for various uses, such as carrier waves in multiplex signaling. An electron tube generator is employed and continuously overloaded to produce a distorted wave comprising the desired harmonics which are selected and amplified for delivery to separate signaling channels.

1,446,890—L. Espenschied, filed June 7, 1918, issued February 27, 1923. Assigned to American Telephone and Telegraph Company.

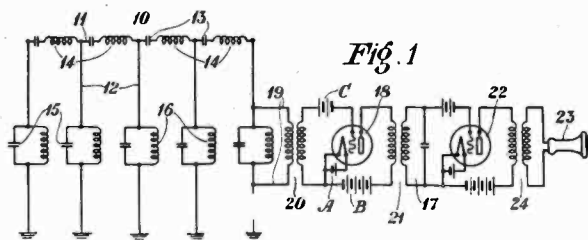

NUMBER 1,446,890—Radio Receiving Apparatus

**RADIO RECEIVING APPARATUS** arranged for eliminating or minimizing the effects of static disturbances. The invention proposes to avoid such disturbance by changing or diverting the disturbing energy into a plurality of frequencies other than that of the energy to be transmitted or into a band or frequencies of considerable extent so that, even tho the frequency being transmitted falls within its scope, only a small proportion of the disturbance reaches the translating or indicating devices of the system. This is accomplished by employing a wave filter form of antenna as illustrated in the cut.

1,447,165—F. A. Kolster, filed January 30, 1919, issued February 27, 1923.

**RADIO METHOD AND APPARATUS**, in which a closed loop circuit and an antenna circuit are used for reception of transmitted energy from a signaling station and arranged to combine the received currents to produce a uni-lateral characteristic for observing the direction of the transmitting station.

1,447,204—L. Espenschied, filed September 30, 1919, issued March 6, 1923. Assigned to American Telephone and Telegraph Company.

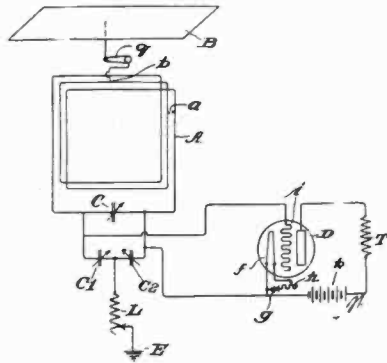

NUMBER 1,447,165—Radio Method and Apparatus

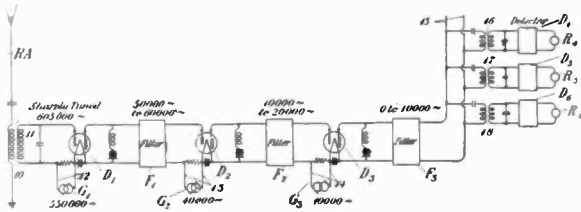

Fig. 5

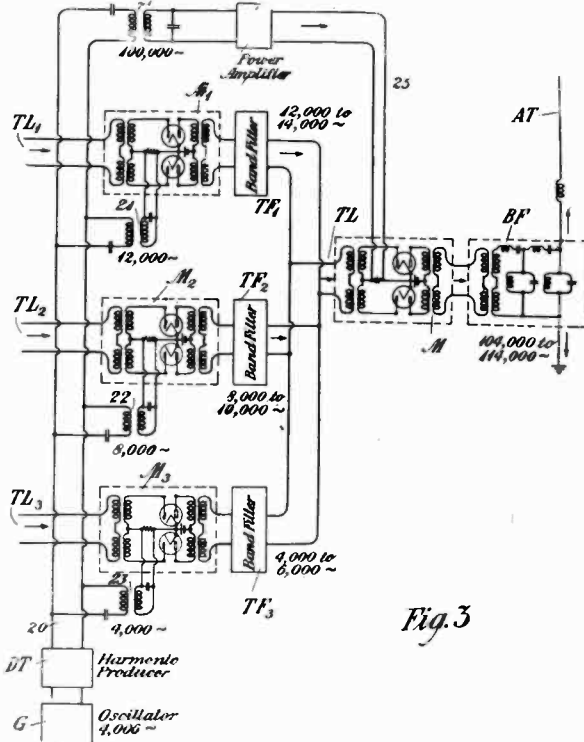

Fig. 3

NUMBER 1,447,204—Plural Modulation and Demodulation Circuits

**PLURAL MODULATION AND DEMODULATION CIRCUITS**, for use in multiplex radio systems. It is proposed to generate at the sending station a fundamental frequency and produce harmonics of this fundamental frequency. The lower harmonics are then used as carriers for the first step of modulation and a higher harmonic is used as the carrier for the second step of modulation. At the receiving station either of two things may be done: A fundamental frequency may be independently generated at the receiving station and harmonics may be produced from this fundamental, one of the higher harmonics being used for the first step of frequency translation and lower harmonics used for the final step of frequency translation. By this scheme all of the channels at each station are definitely tied together, since they are related to a fundamental frequency, and it is a matter of relatively simple adjustment to maintain the fundamental frequency at the sending and receiving station the same. An alternative expedient is to detect from the received band of frequencies the fundamental frequency generated at the sending station and produce from this frequency harmonics which may be used in the steps of demodulation, as above described. This expedient not only definitely ties together the frequencies of the various channels at the sending and receiving station, but also rigidly relates the frequencies of corresponding channels at the two stations.

1,447,481—H. Morris-Airey and George Shearing, filed August 22, 1921.

**THERMIONIC VALVE** construction in which the leads entering the glass envelope of the tube are formed by lead seals. These conductors are formed between the external contacts of the tube and the interior electrodes by running the lead thru a glass tube in a molten condition, which when hardened becomes an effective seal and serves as a connection.

1,447,773—L. Espenschied and Ralph Bown, filed September 15, 1921, issued March 6, 1923. Assigned to American Telephone and Telegraph Company.

**RADIO TRANSMISSION CONTROL SYSTEM**, which maintains a uniform transmission level by varying the amplification of the receiver to compensate for transmission variations. The regulation at the receiver is automatic. A current limit relay operates at the receiver to actuate a motor driving a contact arm which cuts in or out resistance in the amplifier circuit to maintain the

volume of received signal constant irrespective of fluctuation in the transmission current.

1,447,779—J. H. Hammond, Jr., filed December 27, 1910, issued March 6, 1923.

SYSTEM OF ETHER WAVE CONTROL, comprising a transmitting station arranged to emit waves of constant amplitude with a signaling device for increasing the amplitude of said waves. At the receiver the apparatus is arranged to be unresponsive to currents set up by the waves of constant amplitude, but responsive to the waves of increased amplitude. The energy received from these latter waves operates the observing device.

1,447,793—M. Latour, filed August 19, 1921, issued March 6, 1923.

RADIO RECEIVING SYSTEM, in which the sensitiveness of reception is improved by adjusting the magnetization of the telephones to a selected point. A pair of rectifiers are used in the receiving circuit for improving rectification and increasing sensitiveness in heterodyne reception.

1,448,575—G. H. Stevenson, filed December 21, 1920, issued March 13, 1923. Assigned to Western Electric Company, Incorporated.

WAVE METER AND SIMILAR ELECTRICAL DEVICE, in which the change in capacity by movement of the control key, normally used to connect the buzzer in the wave meter circuit, is compensated for by substituting an equivalent capacity in the circuit upon operation of the key.

1,449,148—W. F. Gehrig, filed March 9, 1922, issued March 20, 1923. Assigned to Essex Specialty Company, Incorporated.

DETECTOR of the crystal type in which the cat-whisker is adjusted to a sensitive point on the crystal from a support consisting of a split spherical ball bearing. The invention resides in this split spherical bearing, by which the cat-whisker may be readily adjusted to any desired position.

1,449,253—M. S. Strock, filed September 23, 1921, issued March 20, 1923.

UNI-DIRECTIONAL RECEIVING SYSTEM employing a coil antenna and a ground variable inductor coupled therewith, as absorb-

ing means for the transmitted energy. The electron tube detector of the receiving apparatus is connected to this collecting system, the filament electrode being connected to the inductor and the grid being connected to the loop.

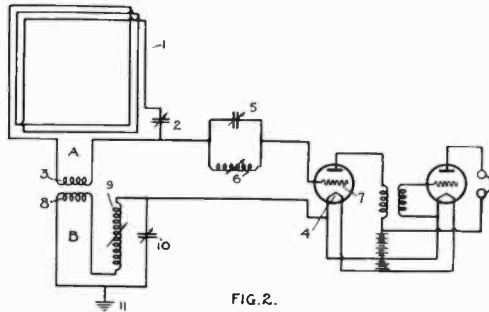

FIG. 2.

NUMBER 1,449,253—Uni-directional Receiving System

1,449,372—H. D. Arnold, filed December 1, 1915, issued March 27, 1923. Assigned to Western Electric Company, Incorporated.

Fig. 1.

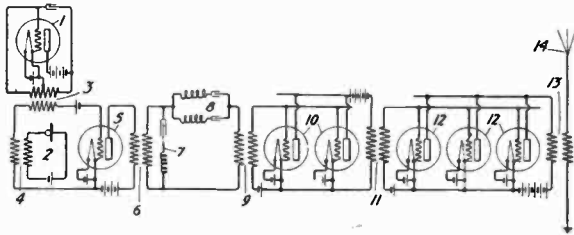
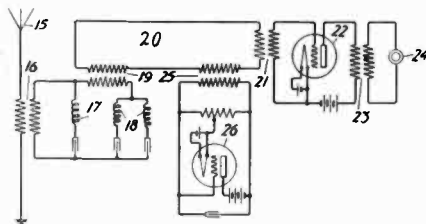

Fig. 2.



NUMBER 1,449,372—System of Telephony



SYSTEM OF TELEPHONY, arranged to increase the efficiency of telephonic communication by modulating a radio frequency oscillation and eliminating from the antenna, or other sending circuit, constant amplitude oscillations of the carrier-wave frequency, which, in present practice, are impressed upon it. Further objects of the inventions are to improve the quality of speech received and to make possible the secret transmission and reception of messages. These objects are accomplished by providing an arrangement of circuits whereby current is suitably modulated and is supplied to the antenna only when the characteristics of the radio frequency current to be impressed on the antenna are changing in accordance with the wave form of the signal to be transmitted, and by providing at the receiving station a small auxiliary generator which shall furnish a wave of the frequency of the unmodulated carrier wave.

1,449,382—J. R. Carson, filed December 1, 1915, issued March 27, 1923. Assigned to American Telephone and Telegraph Company.

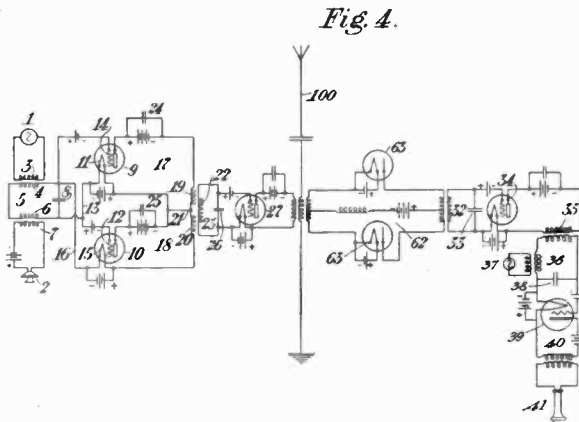

NUMBER 1,449,382—Method and Means for Signaling with Radio Frequency Waves

METHOD AND MEANS FOR SIGNALING WITH RADIO FREQUENCY WAVES in duplex operation and without transmission of energy, except during the time when signals are actually being transmitted. The system contemplates the generation of an audio frequency signaling wave and an undamped radio frequency carrier wave. The carrier is modulated in accordance with the signal wave to produce a modulated wave. the ampli-

tude of which is directly proportional to the modulating wave. The transmission of energy is automatically prevented in the absence of the signal wave.

1,449,722. W. R. G. Baker, filed September 17, 1921, issued March 27, 1923. Assigned to General Electric Company.

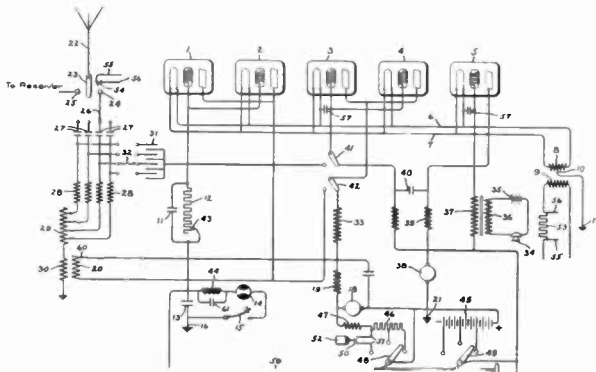

NUMBER 1,449,722—Radio Frequency Signaling System

**RADIO FREQUENCY SIGNALING SYSTEM**, which may be interchangeably used in the transmission of speech-modulated radio frequency waves as are used in radio telephony, interrupted continuous waves for radio telegraphy, or continuous waves for radio telegraphy. An electron tube transmitter circuit is provided with a switching arrangement whereby the tubes used as modulators in radio telephone transmission may be used as oscillators in circuit with the other oscillators when the set is used for telegraphy.

1,449,911—R. H. Ranger, filed November 12, 1921, issued March 27, 1923. Assigned to Radio Corporation of America.

**METHOD AND MEANS OF RECEIVING SIGNALS**, consisting in receiving the transmitted signals at a plurality of stations and comparing the signals received at the same station to eliminate errors and effects of static interference.

1,450,038—G. Hill, filed April 28, 1920, issued March 27, 1923.

**COMBINED WAVE CHANGER AND WAVE METER**, involving a method of having the indicating pointer of the wavemeter which indicates the wave length on the various scales so combined with the wave changer that as the handle of the wave changer is

operated, the pointer for the wavemeter is operated and picks out or selects the proper scale.

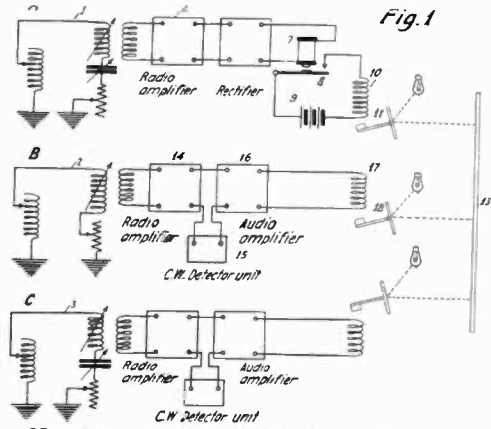

NUMBER 1,449,911—Method and Means of Receiving Signals

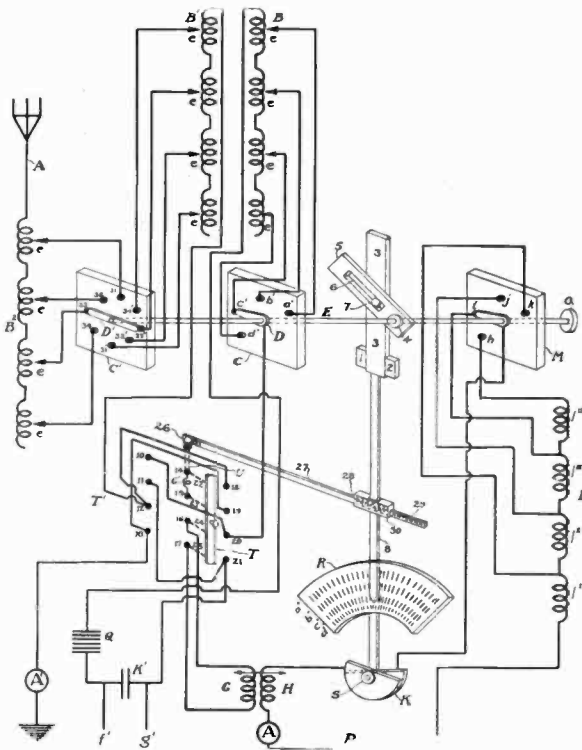

NUMBER 1,450,038—Combined Wave Changer and Wave Meter

1,450,061—W. W. Coblenz, filed August 6, 1920, issued March 27, 1923.

**OPTICAL METHOD FOR PRODUCING PULSATING ELECTRIC CURRENT**, for signaling by light rays. The method consists in successively exposing a light sensitive body to light rays which are colored to effect alternate photo-positive and photo-negative action by the body whereby the current passing therethru is modulated accordingly.

1,450,265—J. Slepian, filed April 18, 1919, issued April 3, 1923.  
Assigned to Westinghouse Electric and Manufacturing Company.

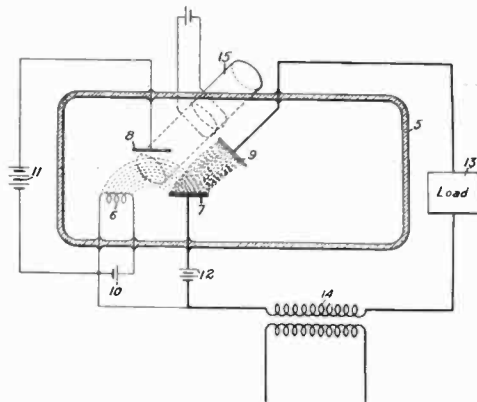

NUMBER 1,450,265—Hot Cathode Tube

**HOT CATHODE TUBE** for rectification, in which a relatively small incandescing filament may be operated at moderate temperatures to produce a small number of electrons and these electrons may be caused to impinge upon an adjacent electrode with high velocity by subjecting them to the influence of a high voltage electrostatic field. As a result, there is produced a profuse emission of electrons from the adjacent electrode by the joint action of reflection and secondary emission, it being well known that the impact of a high-velocity electron upon another body may set free a large number of low-velocity electrons therefrom. The adjacent electrode, which is thus caused to be the seat of a profuse electron emission, may now be employed as a cathode in an auxiliary circuit, and a relatively large amount of current may be offered passage in one direction because of the large number of electrons available.

1,450,413—H. W. Edmundson, filed March 10, 1919, issued April 3, 1923. Assigned to General Electric Company.

VACUUM ELECTRIC DISCHARGE DEVICE, in which a shield is provided to block the discharge of electrons from the cathode in the direction of the leading-in conductors in the tube. The patentee does away with the continued electron bombardment in the direction of the glass press in the tube containing the leading-in wires, as the tendency of depositing a conductive film between the leading-in wires, impairs the efficiency of the tube. The shield prevents bombardment in the direction of the press.

1,450,749—G. W. Pierce, filed March 11, 1914, issued April 3, 1923. Assigned to Peter Cooper Hewitt; the Farmers Loan and Trust Company of New York, executors of said Peter Cooper Hewitt.

APPARATUS FOR AND METHOD OF CONTROLLING ELECTRIC CURRENTS, comprising a mercury vapor circuit. The invention is illustrated in connection with a radio receiving circuit wherein the mercury vapor tube is rendered particularly sensitive to received signals.

1,451,426—L. J. Lesh, filed April 9, 1918, issued April 10, 1923. Assigned to Emil J. Simon.

SPARK GAP APPARATUS employing quench gap units supported in separate resilient holders, whereby each unit is removable whereupon the holder closes the circuit originally occupied by the gap. Each quench gap unit is provided with heat dissipating ribs.

1,451,427—L. J. Lesh, filed June 5, 1918, issued April 10, 1923. Assigned to Emil J. Simon.

SPARK GAP APPARATUS, comprising individual quench gap units which are arranged radially about a support. The spark gap units are each independently removable from the radial frame and are positioned somewhat like the spokes of a wheel. A selector switch is provided for connecting the desired number of units in the transmitter circuit.

1,452,032—J. F. Farrington, filed April 30, 1918, issued April 17, 1923. Assigned to Western Electric Company, Incorporated.

OSCILLATION GENERATOR FOR SIGNALING SYSTEMS, wherein

the oscillator is connected with an antenna system, which includes an inductance and capacity, by a particular connection of the input circuit of the tube and the antenna system. The input circuit of the tube is connected across the capacity and a variable connection is provided between one terminal of the input circuit and the inductance in the antenna system.

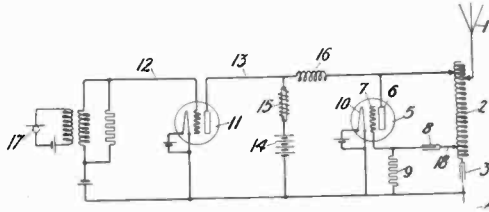

NUMBER 1,452,032—Oscillation Generator for Signaling Systems

1,452,064—V. Bush, filed November 22, 1918, issued April 17, 1923. American Radio and Research Corporation.

RADIO TRANSMITTER of the impact excitation type in which a series of uni-directional pulses are produced. The primary and secondary circuits are closely coupled and detuned. The spark gap comprises a series of relatively high sparking length gaps with a capacity, resistance, reactance or impedance connected across a portion of the gap such that the primary circuit has a high resistance to the resurgence of current thru the gap at radio frequency and oscillations after the first impacts are damped out.

1,452,339—R. A. Heising, filed May 28, 1918, issued April 17, 1923. Assigned to Western Electric Company, Incorporated.

ELECTRICAL DISCHARGE DEVICE, including an electron tube circuit in which the leak path between the cathode and the grid consists of a highly inductive reactance. This leak path is also shown as comprising an inductance in series with a parallel arrangement of capacity and resistance.

*This patent should be considered with previous digests.*

1,443,469—J. Guthrie and John W. Simmons, filed August 4, 1922, issued January 30, 1923. Assigned to Simmons Manufacturing Company.

RHEOSTAT particularly adapted for electron tube filament

control wherein fine adjustment may be desirable. The rheostat comprises a series of resistance disks supported in a container. A plunger operates to vary the pressure on the disks according to predetermined ratio, thereby varying the conductivity of the pile.

LIST OF RADIO TRADE MARKS PUBLISHED BY PATENT OFFICE  
PRIOR TO REGISTRATION

*The numbers given are serial numbers of pending applications:*

- 170,633—"3YQ, FEDERAL RADIO, CAMDEN, N. J." in ornamental design, for radio receiving apparatus. Federal Institute of Radio Telegraphy, Camden, New Jersey. Claims use since on or about April 1, 1922. Published February 27, 1923.
- 165,755—"CAT'S WHISKERS" with design of cat's face, for radio receiving apparatus. A. J. Meyer Mfg. Co., Inc., West Hoboken, New Jersey. Claims use since on or about May 20, 1922. Published March 6, 1923.
- 172,357—"RW" in ornamental design, for radio receiving sets. R-W Mfg. Co., Chicago, Illinois. Claims use since October 14, 1922. Published March 6, 1923.
- 168,529—"THE CLARION," MARFIELD RADIO MFG. CO., for radio receiving apparatus. Maurice W. Hirshfield, New York. Claims use since July 1, 1922. Published March 27, 1923.
- 169,825—"RADIO WAVES," monthly magazine. Radio Waves Publishing Co., Portland, Oregon. Claims use since March 20, 1922. Published March 27, 1923.
- 171,433—"MOR-TONE" for mica condensers. Radio Supply & Service Corp., New York, N. Y. Claims use since June 16, 1922. Published March 27, 1923.
- 172,983—"FRECO" for radio receiving apparatus. Fallkill Radio & Electrical Co., Poughkeepsie, New York. Claims use since June 15, 1922. Published March 27, 1923.
- 174,548—"JEWELL" for radio receiving sets. Frederic Wommer, Minneapolis, Minnesota. Claims use since September 16, 1922. Published March 27, 1923.
- 174,260—"RFL" for radio receiving apparatus. Radio Fre-

- quency Laboratories, Inc., Boonton, New Jersey. Claims use since December 20, 1922. Published March 27, 1923.
- 174,253—"RED SEAL" for radio receiving apparatus. Manhattan Electrical Supply Co., Inc., New York, N. Y. Claims use since November 20, 1922. Published March 27, 1923.
- 174,947—"RADETEC" for crystal detectors. Orrin W. Towner doing business as "Two Laboratories, Kansas City, Missouri." Claims use since October 23, 1922. Published March 27, 1923.
- 162,985—"G-L ORIGINAL GARBE-LAHMEYER," in ornamental design, for radio receiving apparatus. Deutsche Elektrizitäts-Werke Zu Aachen-Garbe, Lahmeyer & Co.—Atkien-gesellschaft, Aachen, Germany. Claims use since about November 23, 1921. Published April 3, 1923.
- 168,786—Ornamental design for crystal detectors. The Radiola Wireless Corporation, New York, N. Y. Claims use since March 1, 1922. Published April 3, 1923.
- 173,576—"RADIO-FOUR WAY SWITCH PLUG," in ornamental design, for telephone plugs. Louis De F. Munger, doing business as Four Way Company, Springfield, Massachusetts. Claims use since October 16, 1922. Published April 3, 1923.
- 173,960—"DIODE" for Vacuum tubes. Electrad Corporation of America, New York, N. Y. Claims use since December 10, 1922. Published April 3, 1923.
- 174,388—"EURACO," for radio apparatus. Robert E. Goll, doing business as European Radio Company, New York, N. Y. Claims use since November 1, 1921. Published April 3, 1923.
- 162,091—"UNION-RADIO-CORPORATION" in ornamental design for Radio Apparatus. Union Radio Corporation, New York, N. Y. Claims use since March 24, 1922. Published April 24, 1923.
- 168,729—"RADIO-MERCHANDISING," for radio magazine, Radio Publishing Corporation, New York, N. Y. Claims use since June 1, 1922. Published April 24, 1923.
- 174,201—"ESTRU" radio apparatus, in ornamental design. Dalton Whittier, Ture Company, Chicago, Illinois. Claims use since May 11, 1922. Published April 24, 1923.
- 174,657—"KASKADE," for Radio Receiving Outfits. David



Grimes, doing business as Grimes Radio Engr. Co., New York, N. Y. Claims use since December 22, 1922. Published April 24, 1923.

174,859—"REGENOFLEX" for Radio Receiving Sets. Radio Corporation of America. Claims use since January 17, 1923. Published April 24, 1923.

176,634—"LITTLE TATTLER" for Radio Receiving Sets. Marinette Electric Corporation, Marinette, Wisconsin. Claims use since November 1, 1922. Published April 24, 1923.

167,334—"GENERAL RADIO Co.," for radio receiving sets. General Radio Company, Cambridge, Massachusetts. Claims use since January, 1916. Published April 24, 1923.

175,289—"AMERTRAN," in ornamental design for transformers. American Transformer Co., Newark, New Jersey. Claims use since June 1, 1922. Published April 24, 1923.



---

# It will pay you to test RADION

Radion is a *special* grade of hard rubber made particularly for radio use. It has unusual insulation values at radio frequencies. Tests by competent authorities have proved it supreme amongst radio insulations.

## Among Other Desirable Properties:

Radion shows the lowest phase angle difference, lowest di-electric constant and highest resistivity. It also has superior moisture, gas and acid repelling properties.

Radion panels—made in 18 stock sizes and two colors, black and mahoganite—are the easiest to machine and engrave. They also have an incomparable finish.

Dials, V. T. Sockets, Antennae insulators, phone caps, knobs, condenser ends and other parts are moulded from Radion—both in stock designs and according to individual specifications.

It will pay you to test Radion. We shall be pleased to cooperate. Write today telling us your problems.

**American Hard Rubber Co.**  
11 MERCER STREET NEW YORK

*Manufacturers and Moulders of*

# **RADION**

## **Panels and Parts**

*“The Supreme Insulation”*

---

ARISTOS **"COPPERWELD"** WIRE

TRADE MARK REG. U. S. PAT. OFF.

(Made by the Molten Welding Process)

**ADOPTED AND USED BY THE LARGEST  
RADIO COMPANIES IN THE WORLD**

**For aerials, Copperweld has advantages over  
solid copper or bronze**

Radio frequency currents, because of "skin effect," flow along the exterior of wires. The smooth exterior thickness of copper on Copperweld Wire gives it practically the same high electrical conductivity as a solid copper wire (see Letter Circular No. 62, U. S. Bureau of Standards).

Greater strength is given by its steel core. No. 14 Copperweld Antenna Wire has *50% greater strength* than No. 14 hard-drawn copper or 7-No. 22 stranded copper wires. It stays up under severe loads when copper and stranded copper wires sag and break.

For ANTENNA, No. 14 Bare Copperweld Antenna Wire  
For LEAD-IN, No. 17 Rubber Insulated Copperweld Wire  
For GROUND Wire, same as Lead-In Wire  
For GROUNDING to earth, Copperweld Ground Rods,  $\frac{1}{2}$ " diam.

*Larger sizes for commercial stations*

**Copper Clad Steel Company**

New York

Chicago

Mills and Main Office, Braddock P. O., Rankin, Pa.

**350 to 400 vs 200 to 600**

The new allocation of wave lengths comes very fortunately for the manufacturer at the season when the demand is slackening. This provides a breathing space for him to study his products to determine whether they still are effective under the new conditions.

The Laboratories offers facilities for experimentation of this kind.

**Electrical Testing Laboratories**

80th Street and East End Avenue, New York, N. Y.

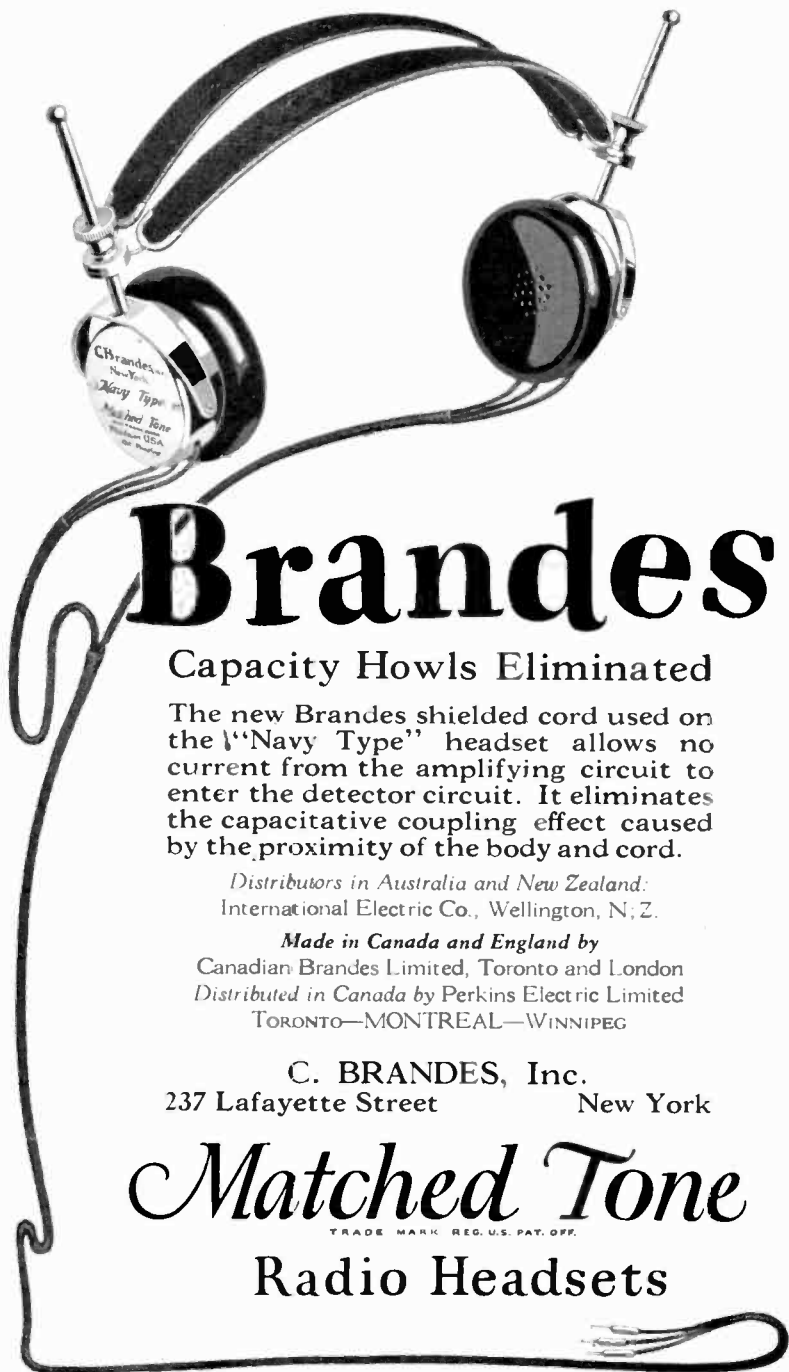

# Brandes

## Capacity Howls Eliminated

The new Brandes shielded cord used on the "Navy Type" headset allows no current from the amplifying circuit to enter the detector circuit. It eliminates the capacitive coupling effect caused by the proximity of the body and cord.

*Distributors in Australia and New Zealand:*  
International Electric Co., Wellington, N. Z.

*Made in Canada and England by*  
Canadian Brandes Limited, Toronto and London  
*Distributed in Canada by Perkins Electric Limited*  
TORONTO—MONTREAL—WINNIPEG

C. BRANDES, Inc.  
237 Lafayette Street New York

## *Matched Tone*

TRADE MARK REG. U.S. PAT. OFF.

## Radio Headsets

# Burgess, the *Radio Battery*

*Specified by radio engineers—designed and built by wireless specialists—and recommended by the leading manufacturers of radio equipment.*

Burgess Radio Batteries, the result of years of careful experiments, are built under exacting manufacturing standards which must meet the requirements of strict laboratory formulas and tests—a supervision that insures their perfect operation.

For professional or amateur radio use, where noiselessness, long life, high capacity and uninterrupted, dependable service are essential, Burgess has no superior. All progressive jobbers and dealers handle Burgess Radio Batteries.



**Burgess Battery Company**  
 DRY BATTERIES  
 Engineers—Manufacturers  
 Flashlight—Radio—Ignition—Telephone. General  
 Sales Office: Harris Trust  
 Bldg., Chicago. Laboratories  
 and Works: Madison,  
 Wis. Branches: New York,  
 Boston, Washington, Kansas  
 City, St. Paul, New  
 Orleans. In Canada:  
**BURGESS BATTERIES, Ltd.**  
 Winnipeg, Toronto,  
 Montreal

# BRACH VACUUM LIGHTNING ARRESTER



For 17 Years a Leader  
 in the Field of  
 Protective Apparatus



L. S. BRACH MFG. CO.

NEWARK, N. J.

# DUDLO MAGNET WIRE and WINDINGS

have been developed especially to meet the exacting requirements of radio apparatus construction. With our large, modern plant and large force of workers skilled in the handling of fine wire, we are able to give you the utmost satisfaction in taking care of your wire and coil requirements.

WRITE TODAY FOR PRICES AND SAMPLES

**DUDLO MANUFACTURING CO., FORT WAYNE, IND.**

Pacific Coast Representative

A. S. Lindstrom, 111 New Montgomery St., San Francisco, Cal.

# MURDOCK

## REAL

### RADIO RECEIVERS

Have Been Standard  
Since 1904

TYPE No. 56

2000 — OHM — \$5.00

3000 — OHM — 5.50

BUY THEM FROM  
YOUR DEALER

WM. J. MURDOCK CO.  
CHELSEA, MASS.

# NOVO "B" BATTERIES FOR RADIO

22½ - 45 & 105 VOLTS



**NOISELESS  
DEPENDABLE  
GUARANTEED**

**ASK YOUR DEALER**

**NOVO MANUFACTURING CO.**

424-438 W. 33<sup>RD</sup> ST.  
NEW YORK

531 SO DEARBORN ST., CHICAGO.

## Selective Advertising

Advertising in the I.R.E. PROCEEDINGS insures representation with high class radio manufacturers exclusively and presents your message to readers who are either amateurs in radio or have adopted it as a profession. No wasted circulation and rates reasonable. Full information furnished upon request.

**D. V. WEED, Jr.**  
*Advertising Manager*

**The Institute of Radio  
Engineers, Inc.**  
**The College of the  
City of New York**  
NEW YORK, N. Y.



for use on a 110-volt D.C. line. Equipped with the famous Ward Leonard Vitrohm (Vitreous enamelled) Resistor Units. Literature on request.

## RADIO BATTERY CHARGER

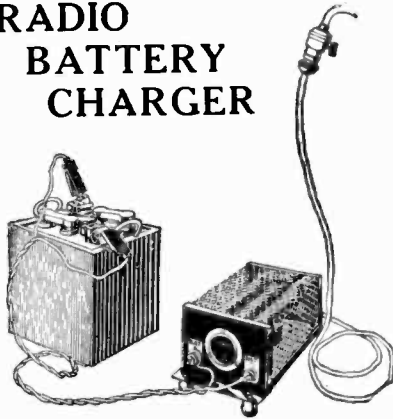

**Ward Leonard Electric Company**  
Mount  
Vernon,  
New York



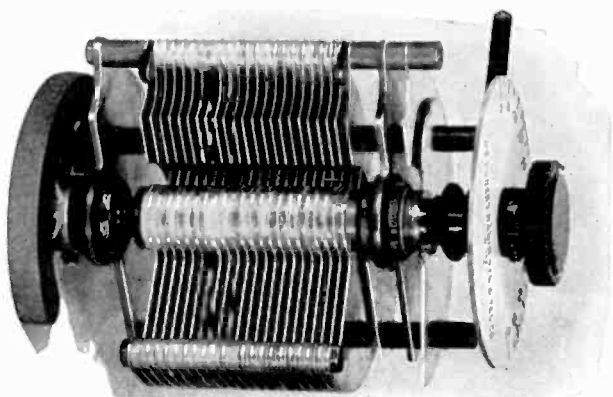

## Available Once More! De Forest Vernier Variables

These condensers are perfection. Movable plates are heavier than those found in any other condenser on the market. Heavy, adjustable, lock-nut bearings that cannot stick. A single, separately controlled vernier plate permits you to "get on the peak" and have 20% louder signals. Accurately made, securely fastened counterweight balances movable plates and permits operation in any position—vertical, horizontal or at any angle. Supplied with the Bakelite knob and white dial which are found on all precision, laboratory equipment.

There is nothing like these condensers on the

market—use them in that 100% efficient set you contemplate building. Built of finest obtainable materials, carefully adjusted and individually tested at 500 volts, they are the condensers you would order if you had some made to order.

CV-1503 has a maximum capacity of .0015 mfd. and is designed for use in the primary circuit, either in series or shunt with inductance. CV-1003 has maximum capacity of .001 mfd., which is correct for the secondary circuit in shunt to inductance. Used with DeForest Honeycomb Duo-lateral Coils they provide tuning equipment unsurpassed for selectivity, sharpness and all-round efficiency.

DE FOREST RADIO TEL. & TEL. CO.  
JERSEY, CITY, N. J.



\*Reg. U. S. Pat. Off.





*These two devices have revolutionized Radio:*

## The Magnavox Reproducer and the Magnavox Power Amplifier

**T**HE efficiency of Magnavox Radio apparatus is best realized by comparison with other instruments constructed on less modern scientific principles. When operated in accordance with instructions, satisfactory results are assured.

**Magnavox R3 Reproducer and 2 stage Power Amplifier, as illustrated . . . \$90.00**

**R2 Magnavox Reproducer with 18-inch curvex horn: the utmost in amplifying power; requires only .6 of an ampere for field . . . \$60.00**

**R3 Magnavox Reproducer with 14-inch curvex horn: ideal for homes, etc. \$35.00**

**Model C Magnavox Power Amplifier** insures getting the largest possible power input for your Magnavox Reproducer . . . 2 stage \$55.00  
3 stage 75.00

*Magnavox Products can be had from good dealers everywhere. Write for new booklet.*

**THE MAGNAVOX CO.**  
Oakland, Cal.  
New York: 370 Seventh Ave.

# MAGNAVOX PRODUCTS

*No Radio Receiving Set is complete without them*

6-R





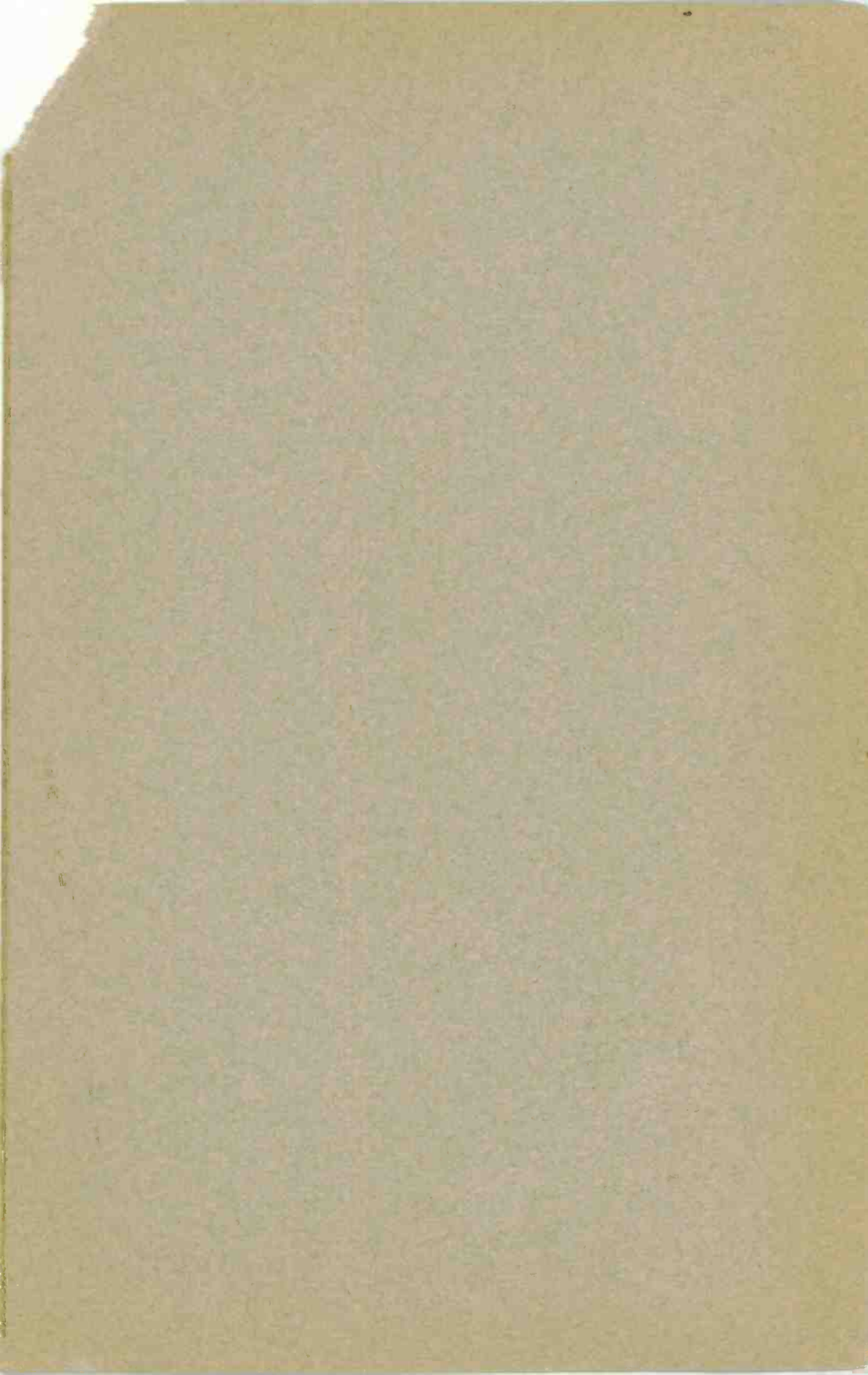

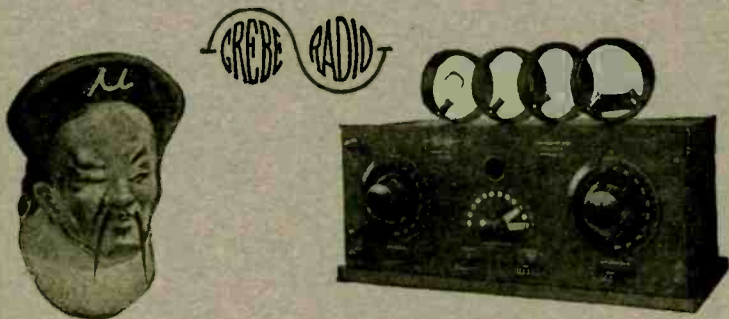

## Tuned Radio Amplifier

Many Radio Frequency Amplifiers have been constructed, using Resistance, Impedance or Transformer coupling, but these types are inherently limited both as to degree of Amplification and wave-length range. The Grebe Type RORN Tuned Radio Amplifier is unlimited as to wave-length range, and gives the greatest possible Amplification that can be obtained from a Vacuum Tube.

It has been clearly demonstrated that all of the fixed-coupled types of amplification circuits are inherently limited, either as to amplification or wave-length range, or both.

The resistance coupled type responds almost equally well to any of the useful frequencies, but is only efficient on wave-lengths above 2,000 meters. Impedance coupling gives somewhat greater amplification than either of these, but its efficient operation is confined to a very narrow band of wave-lengths.

The Type RORN Unit has none of the defects common to the coupled type of amplifiers. With a single tube it gives greater amplification over its entire wave-length range than can be obtained with two stages of transformer-coupled type.

The RORN Unit may be used with any of the standard regenerative receivers now on the market, and is particularly adapted for use with the Grebe Receivers.

*Write for Bulletin*

**A. H. GREBE & CO., Inc.**

*General Offices and Factory*

72 Van Wyck Blvd.

Richmond Hill, N. Y.

*Western Branch: 451 East 3rd St., Los Angeles, Cal.*