

VOLUME 2

DECEMBER, 1914

NUMBER 4

PROCEEDINGS
of
THE INSTITUTE OF RADIO
ENGINEERS

(INCORPORATED)

OFFICERS, PAST PRESIDENTS, AND COMMITTEES
OF THE INSTITUTE

THE "HYTONE" RADIO TELEGRAPH
TRANSMITTER

MELVILLE EASTHAM

RADIO TRAFFIC

DAVID SARNOFF

THE RESISTANCE OF THE SPARK AND ITS EFFECT
ON THE OSCILLATIONS OF ELECTRICAL
OSCILLATORS

JOHN STONE STONE

INDEX TO VOLUME 2 OF THE PROCEEDINGS



EDITED BY
ALFRED N. GOLDSMITH, Ph.D.

PUBLISHED QUARTERLY BY
THE INSTITUTE OF RADIO ENGINEERS
SEVENTY-ONE BROADWAY
NEW YORK

GENERAL INFORMATION

The right to reprint limited portions or abstracts of the articles, discussions, or editorial notes in the Proceedings is granted on the express condition that specific reference shall be made to the source of such material. Diagrams and photographs in the Proceedings may not be reproduced without securing permission to do so from the Institute thru the Editor.

Manuscripts and letters bearing on the Proceedings should be sent to Alfred N. Goldsmith, Editor of Publications, The College of the City of New York, New York.

Requests for additional copies of the Proceedings and communications dealing with Institute matters in general should be addressed to the Secretary, The Institute of Radio Engineers, 71 Broadway, New York.

The Proceedings of the Institute are published quarterly and contain the papers and the discussions thereon as presented at the meetings in New York, Washington or Boston.

Payment of the annual dues by a member entitles him to one copy of each number of the Proceedings issued during the period of his membership. Members may purchase, when available, copies of the Proceedings issued prior to their election at 75 cents each.

Subscriptions to the Proceedings are received from non-members at the rate of \$1.00 per copy or \$4.00 per year. To foreign countries the rates are \$1.25 per copy or \$5.00 per year. A discount of 25 per cent. is allowed to libraries and booksellers. The English distributing agency is "The Electrician Printing and Publishing Company," Fleet Street, London, E. C.

Members presenting papers before the Institute are entitled to ten copies of the paper and of the discussion.

It is understood that the statements and opinions given in the Proceedings are the views of the individual members to whom they are credited, and are not binding on the membership of the Institute as a whole.

COPYRIGHT, 1914, BY

THE INSTITUTE OF RADIO ENGINEERS, INC.

SEVENTY-ONE BROADWAY

NEW YORK, N. Y.

In each issue of the Proceedings, a list of "Positions Available and Positions Wanted" is published. Radio companies and individuals interested may gratuitously avail themselves of this service by communicating with the Secretary. The names of the applicants or companies will not appear except by request, and all such communications will be considered strictly confidential.

CONTENTS

	PAGE
OFFICERS AND PAST PRESIDENTS OF THE INSTITUTE	249
COMMITTEES OF THE INSTITUTE	250
MELVILLE EASTHAM, "THE 'HYTONE' RADIO TELEGRAPH TRANS- MITTER"	253
Discussion on the above paper	270
DAVID SARNOFF, "RADIO TRAFFIC"	273
Discussion on the above paper	288
JOHN STONE STONE, "THE RESISTANCE OF THE SPARK AND ITS EFFECT ON THE OSCILLATIONS OF ELECTRICAL OSCILLATORS"	307
Discussion on the above paper	325
INDEX TO VOLUME 2 OF THE PROCEEDINGS, 1914	329

Following the Index at the end of this number are the title page, page of general information, and table of contents page for the entire Volume 2 (1914) of the Proceedings. These last may be suitably placed at the beginning of the volume for binding.

OFFICERS AND BOARD OF DIRECTION, 1914
(Term expires January 6, 1915)

PRESIDENT

LOU S W. AUSTIN

VICE-PRESIDENT

JOHN STONE STONE

TREASURER

JOHN HAYS HAMMOND, JR.

SECRETARY

EMIL J. SIMON

MANAGERS

JOHN L. HOGAN, JR.
GUY HILL

ROBERT H. MARRIOTT
ROY A. WEAGANT

EDITOR OF PUBLICATIONS

ALFRED N. GOLDSMITH

ASSOCIATE EDITORS

JOHN STONE STONE

GEORGE H. CLARK

ADVERTISING MANAGER

ARTHUR A. HEBERT

ASSISTANT TREASURER

THOS. T. TRAPNELL

ASSISTANT SECRETARY

RALPH H. LANGLEY

**SECRETARY-TREASURER,
WASHINGTON SECTION**

CHARLES J. PANNILL

GENERAL COUNSEL

HAROLD R. ZEAMANS

PAST-PRESIDENTS

SOCIETY OF WIRELESS TELEGRAPH ENGINEERS

JOHN STONE STONE, 1907-8

LEE DE FOREST, 1909-10

FRITZ LOWENSTEIN, 1911-12

THE WIRELESS INSTITUTE

ROBERT H. MARRIOTT, 1909-10-11-12

THE INSTITUTE OF RADIO ENGINEERS

ROBERT H. MARRIOTT, 1912

GREENLEAF W. PICKARD, 1913

STANDING COMMITTEES

1914

COMMITTEE ON PAPERS

ALFRED N. GOLDSMITH, <i>Chairman</i>	College of the City of New York, New York
ARTHUR E. KENNELLY	Cambridge, Mass.
JOHN STONE STONE	New York
LOUIS W. AUSTIN, <i>Ex-officio</i>	Washington, D. C.

COMMITTEE ON STANDARDIZATION

JOHN STONE STONE, <i>Chairman</i>	National Arts Club, New York
GUY HILL, <i>Secretary</i>	Navy Yard, New York
ARTHUR E. KENNELLY	Cambridge, Mass.
ERNEST R. CRAM	Washington, D. C.
GREENLEAF W. PICKARD	Boston, Mass.
FREDERICK A. KOLSTER	Washington, D. C.
GEORGE W. PIERCE	Cambridge, Mass.
EMIL E. MAYER	Tuckerton, N. J.
LOUIS W. AUSTIN, <i>Ex-officio</i>	Washington, D. C.

COMMITTEE ON PUBLICITY

ROBERT H. MARRIOTT, <i>Chairman</i>	Custom House, New York
JOHN L. HOGAN, JR.	New York
ROY A. WEAGANT	New York
V. FORD GREAVES	Washington, D. C.
LOUIS W. AUSTIN, <i>Ex-officio</i>	Washington, D. C.

SPECIAL COMMITTEES

COMMITTEE ON INCREASE OF MEMBERSHIP

JOHN HAYS HAMMOND, JR., <i>Chairman</i>	Gloucester, Mass.
THOMAS E. CLARK	Detroit, Mich.
GEORGE S. DAVIS	New Orleans, La.
CHARLES P. EDWARDS	Ottawa, Canada
CYRIL F. ELWELL	London, England
V. FORD GREAVES	Washington, D. C.
OSCAR C. ROOS	Manila, P. I.
ROY E. THOMPSON	Seattle, Wash.
ROBERT B. WOOLVERTON	San Francisco, Cal.
FRANCIS J. BEHR, Capt. U. S. A.	Gloucester, Mass.
STANFORD C. HOOPER, LIEUT. U. S. N.	Flagship "Wyoming"
LOUIS W. AUSTIN, <i>Ex-officio</i>	Washington, D. C.

COMMITTEE ON FINANCE

JOHN HAYS HAMMOND, Jr., <i>Chairman</i>	Gloucester, Mass.
JOHN STONE STONE	New York
ROBERT H. MARRIOTT	New York
ALFRED N. GOLDSMITH	New York
HAROLD R. ZEAMANS	New York
LOUIS W. AUSTIN, <i>Ex-officio</i>	Washington, D. C.

COMMITTEE ON SPECIFICATIONS FOR STEAMSHIP RADIO EQUIPMENT

ROBERT H. MARRIOTT, <i>Chairman</i> , Custom House	New York
GEORGE S. DAVIS	New Orleans, La.
LEE DEFOREST	New York
LEONARD F. FULLER	San Francisco, Cal.
GUY HILL	New York
JOHN L. HOGAN, JR.	New York
FRITZ LOWENSTEIN	New York
EMIL E. MAYER	Tuckerton, N. J.
RICHARD PFUND	New York
GREENLEAF W. PICKARD	Boston, Mass.
EMIL J. SIMON	New York
FRED. G. SIMPSON	Seattle, Wash.
ROY A. WEAGANT	New York
LOUIS W. AUSTIN, <i>Ex-officio</i>	Washington, D. C.

COMMITTEE FOR ORGANIZATION OF BOSTON SECTION

ARTHUR E. KENNELLY, <i>Chairman</i>	Cambridge, Mass.
MELVILLE EASTHAM, <i>Secretary</i>	Cambridge, Mass.
SEWELL CABOT	Brookline, Mass.
GREENLEAF W. PICKARD	Boston, Mass.
GEORGE W. PIERCE	Cambridge, Mass.
LOUIS W. AUSTIN, <i>Ex-officio</i>	Washington, D. C.

EDITING COMMITTEE

(To act during any absence of the Editor)

JOHN L. HOGAN, JR., <i>Chairman</i>	New York
LLOYD ESPENSCHIED	New York
ARTHUR A. HEBERT	New York
LOUIS W. AUSTIN, <i>Ex-officio</i>	Washington, D. C.

THE "HYTONE" RADIO TELEGRAPH TRANSMITTER.*

By

MELVILLE EASTHAM

In this paper a description of some of the radio transmitting sets manufactured by the Clapp-Eastham Company will be given, and also a description of some other apparatus and instruments used in connection with them. The method used in these transmitting sets is to charge a condenser by a low frequency alternating voltage about 30,000 times per second; the discharges being divided, by means of a rotary sectored gap, into definite groups recurring at a rate of about 1,200 per second. The group frequency determines the tone in the receiver. The tone due to the frequency of the supply circuit is not very prominent, particularly with weak signals; and the spark frequency, due to its very high frequency is not noticeable in the telephones.

The supply circuit may be of any commercial frequency; but where direct current only is available, a rotary converter is used to obtain alternating current. A closed core transformer, with high magnetic leakage, raises the potential to several thousand volts, and its design is such as to give approximately constant current with a somewhat flat topped electromotive force wave in the secondary.

The glass condenser which it charges is discharged across a rotary quenched gap and thru the primary of an inductive coupler, the secondary of which is connected between the aerial and ground, as usual. The coupling of the oscillating circuits varies, of course, with the radiation resistance of the secondary circuit or antenna; but is somewhat higher than is the case for the usual stationary quenched gap set because of the very short gap used, and the cooling effect of the rotation of the copper electrodes.

THE TRANSFORMER.

The transformer is designed to be used directly on the line, and the primary (A) is tapped at different points to allow the

* Delivered before The Institute of Radio Engineers, New York, June 3, 1914.

power to be varied by varying the inductance. It is shown in Figure 1. The closed core (B) has the secondary (C) wound on the leg opposite the primary, and a plug of magnetic material (D) is placed as shown, to increase the leakage. The core is worked at a magnetic flux density of about 12,000 lines per square millimeter.; so that the leakage across the leakage plug will cause the secondary discharges to occur more regularly, this effect being due to the flat topped current wave caused by working the transformer iron near saturation.

The other sketch "B," Figure 2, shows another design of transformer, to allow the magnetic leakage to be easily and continuously varied.

As the transformer voltage is low (about 4,000 volts in a 5 kilowatt set), there is no difficulty in properly insulating the transformer without sacrificing mechanical strength. The end turns on the secondary are spaced and well insulated, thus protecting them against the sudden drop of potential at the transformer terminals which occurs when the condenser discharge begins. This decrease of potential does not penetrate far into the windings because of its short duration, and consequently it produces a high potential across the outer turns.

METHOD OF OPERATION.

Figure 3 shows the way in which the discharges occur during one cycle of the supply circuit; the discharge frequency shown, being at a rate of about 4,000 per second, this value being assumed for the sake of clearness. The full line is the voltage curve obtained with the gap open, and the dotted line shows the voltage at which a spark will occur across the gap. It will be seen that the voltage rises from 0 to the point at which discharges begin in such a way that several sparks occur before the rotation of the gap has opened the circuit.

The first spark in the next group, which occurs when the gap surfaces approach each other again, is somewhat higher in potential than the succeeding ones, because the voltage across the condenser and the gap rises during the time between groups. This discharge was experimentally removed from each group of radiated waves by connecting a spark gap across the secondary of the oscillation transformer set, this gap being just long enough to allow only those wave trains to spark across which were of higher potential than most of the others. The adjustment is easily made by watching the effects produced in a rotating vacuum tube; and it is found that about 6 per cent of the total

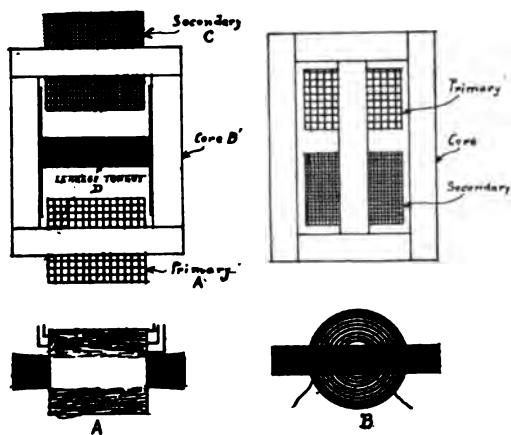

FIGURE 1

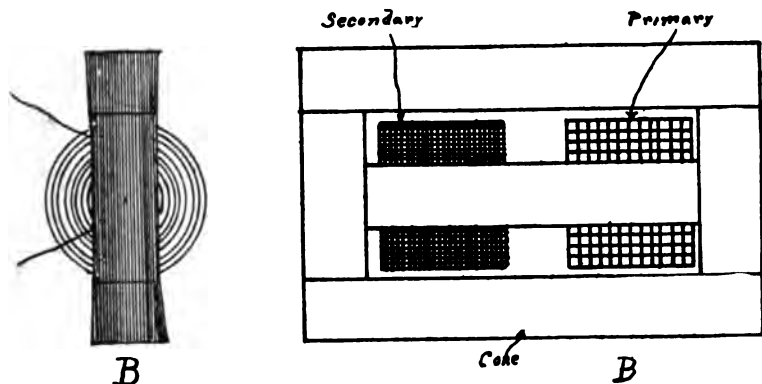

FIGURE 2

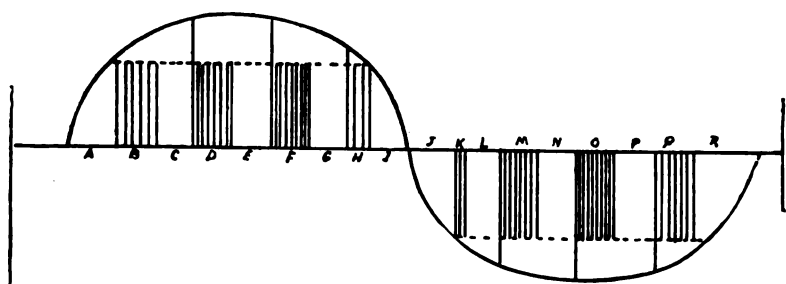

FIGURE 3

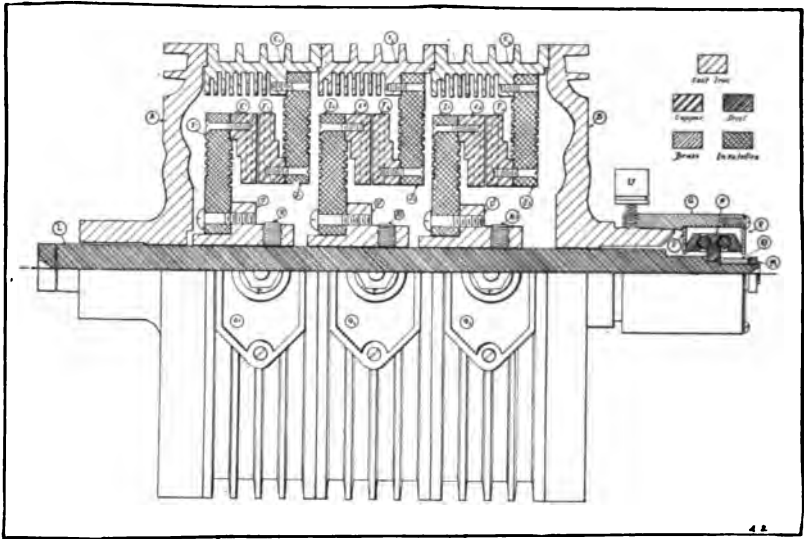

FIGURE 4

radiated energy is in the first spark, which is not so well quenched as the succeeding sparks. As the secondary electromotive force wave is not perfectly flat topped, more sparks per group will occur near the peak of the wave than at either end; and of course there is a time, when the voltage is passing thru zero, when no sparks occur. The groups average about thirty sparks each, the maximum number per group being about 45.

THE SPARK GAP.

The spark gap is of the rotary quenched type, several units being used in series, the number depending on the power rating of the set. The construction of a "Type K" gap is shown in the photographs and drawing, the latter giving constructional details of one rated at 3 kilowatt (Figure 4).

A small motor ($\frac{1}{8}$ horse power) is direct connected to the shaft "L," which rotates inside of the cast iron housing "A C B." Bakelite discs "I" are screwed at their centre to hubs "D" and at the outside to copper rings "E." Opposite each copper ring "E" are two copper half rings "F," supported on bakelite pieces "J."

The gaps are connected in series, and terminals are brought out from each thru insulating bushings. The air tight casing is made up of two ends "A," and "B," and three sections "C," so accurately fitted together that gaskets are unnecessary. Both

inside and outside of the casings are ribbed, to give additional heat radiating surface; and the rotary copper "E" has milled radial grooves next to the disc "I" which grooves act as centrifugal fan blades. The heat losses in the gap are not sufficient to require a fan to keep the gap casing cool. A double thrust ball bearing "N" is mounted in a nut "G," so that the distance between the rotary and stationary electrodes may be adjusted. The coupling, not shown in the photograph has a safety stop to prevent running the two electrodes together. The 5 kilowatt gap is similar, five units being used instead of the three shown in the drawing. These gaps are made very accurately, as a spark length at each gap of only about 0.003 inch (0.075 mm.) is used, and it is desirable to have the sparking distances constant and alike. The sparking surfaces of the copper on both stationary and rotary elements are milled with 36 radial slots, so that when rotated at 1,800 R. P. M., the tone corresponds to that of a 540 cycle alternator. It is necessary that the width of the sparking segments be so proportioned that sparks occur during not more than one-half of the total time, as otherwise the telephone diafram is retarded on its excursion away from the magnet, thereby resulting in a decreased sound intensity. This retardation may occur when a "tone circuit" is used instead of the segmented gap, and the same effect would be produced by exciting a radio frequency alternator with a sinusoidal alternating current for tone purposes.

The photographs show the construction of the parts of the gap, the left half being that of one complete rotary element with its insulating disc and hub. The right half shows a stationary unit with the insulating disc and copper electrodes in place (Figure 5). The next drawing shows a 1 kilowatt gap of somewhat similar construction (Figure 6). The two stationary elements are of different outside diameters, so that they may both be placed in position with the back of "B" removed.

TRANSMITTING SETS.

A 5 kilowatt switchboard set, for use on a 120 volt 60 cycle circuit, is shown in Figure 7. In the upper panel are the ammeter, voltmeter, wattmeter, main switch, circuit breaker, gap motor switch, and a switch to short circuit the ammeter and current terminals of the watt meter while sending. The four point switch is connected to taps on the primary of the transformer, for varying the power input.

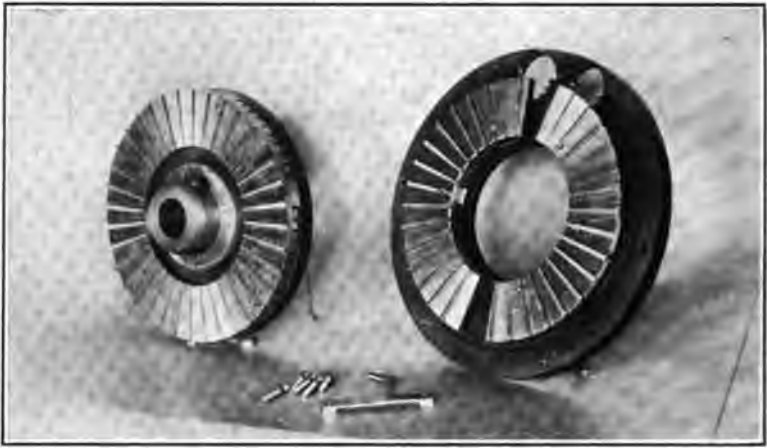

FIGURE 5

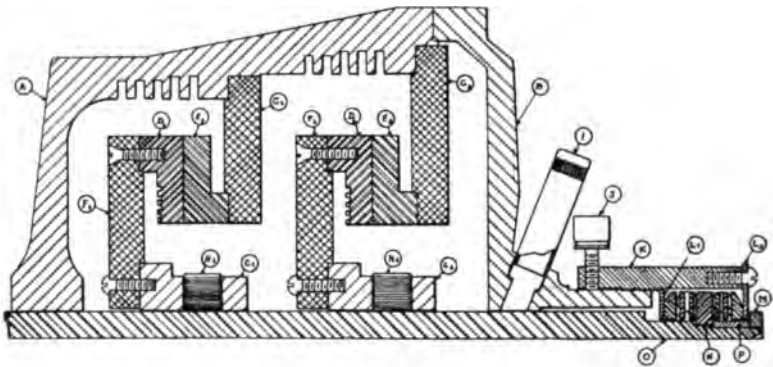

FIGURE 6

The lower panel has the radiation meter, oscillation transformer, and clips for short circuiting series inductances in the aerial and gap circuits. The oscillation transformer (Figure 8) has its secondary of edgewise wound copper fastened to the switchboard, while the primary is hinged, at the right side, for variation of the coupling. A sliding contact on the primary allows it to be adjusted by means of the insulating handle, when the current is on.

The gap and motor can be seen, with the condenser case underneath. The condenser is made up of thin glass plates, covered with tinfoil, and impregnated in a non-hygroscopic wax which reduces leakage.

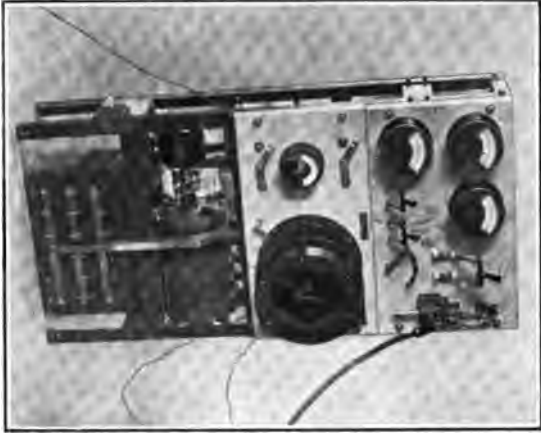

FIGURE 7

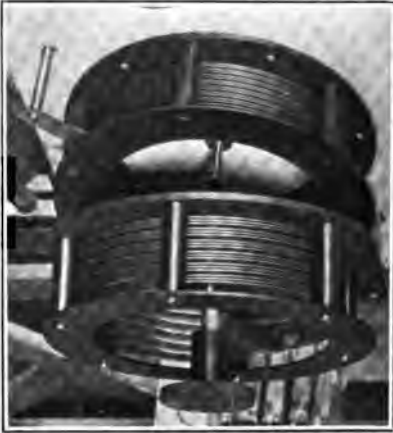

FIGURE 8

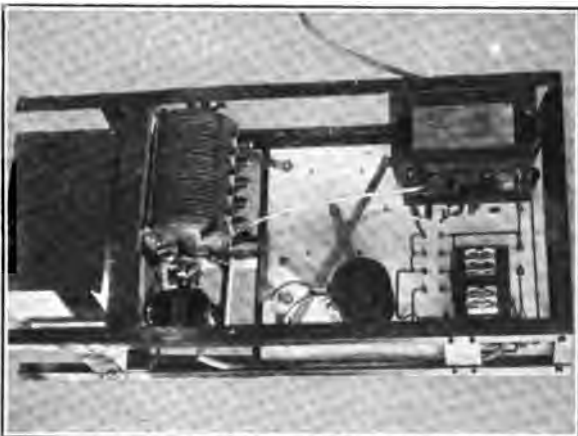

FIGURE 9

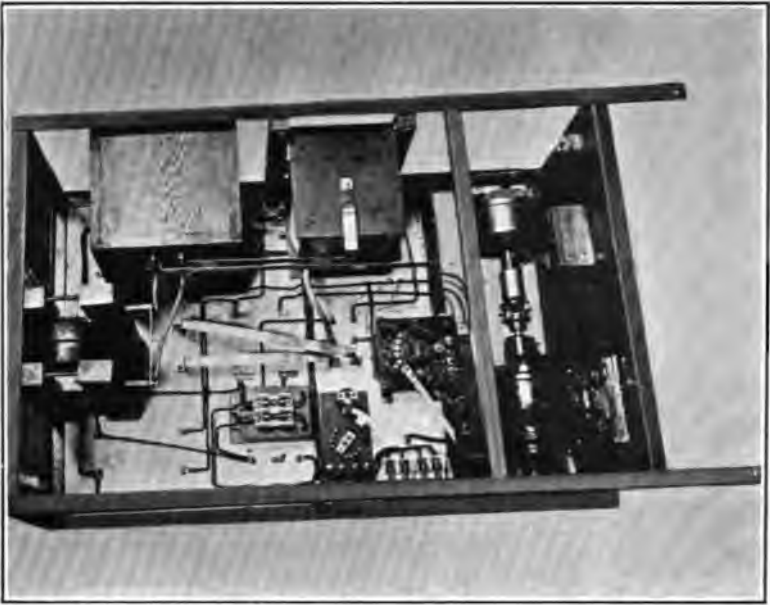

FIGURE 11

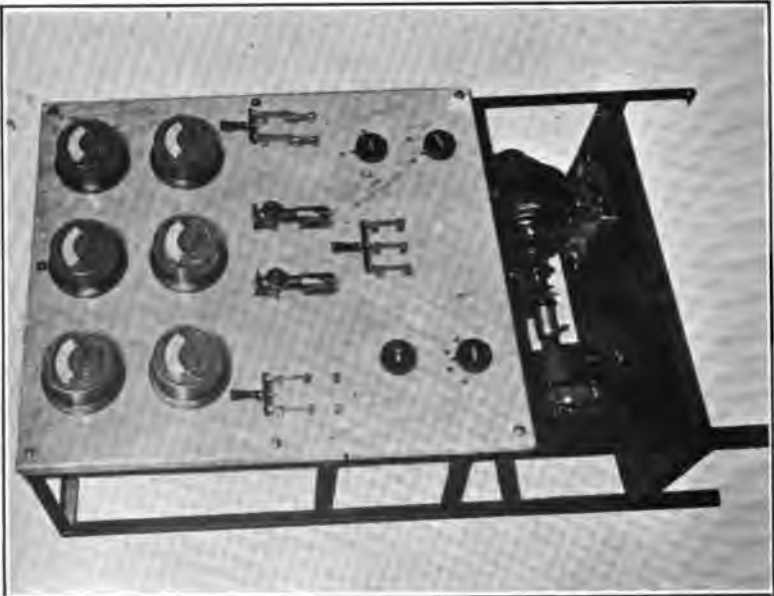

FIGURE 10

The next photograph of the back of the set (Figure 9) shows the transformer, protective condenser and load coils. One inch by 0.125 inch (2.54 cm. by 0.32 cm.) copper strip is used for the oscillating circuit connections, and the high tension circuit is insulated from the marble by Bakelite bushings.

Figures 10 and 11 show a 1 kilowatt set for use on 110 volt direct current, a rotary converter for changing it to alternating current as well as for driving the spark gap. The meters are D. C. ammeter, D. C. voltmeter, A. C. ammeter, A. C. voltmeter, A. C. watt meter, and radiation meter. The four round handles are for the starting box, the power variation switch, the antenna switch, and the primary of the oscillation transformer. This set is supposed to be placed within reach of the operator, to avoid extra complications and wiring. A double throw switch throws the set from the D. C. line to a 90 volt battery, giving about 0.6 kilowatt for emergency service. The efficiency of these sets, from A. C. supply to a 10 ohm phantom antenna is usually about 58 or 60 per cent, one set having shown 67 per cent.

In Figure 12 is shown a relay key for use on high power sets, where a hand key is not desirable. The large silver contacts cool the spark so rapidly that there is very little difficulty in breaking heavy currents, particularly as the armature gives a hammer blow to open the circuit quickly.

The next Figure 13 shows a sectional view of the relay, in which "D" is the core, "F" the winding, "I" the armature, "N" the moving contact, and "L" "L" the two stationary contacts. The moving contact slowly rotates and so keeps the stationary contacts from wearing unevenly.

A portable set of $\frac{1}{4}$ kilowatt capacity is shown in Figure 14. It is for sending and receiving, to be operated in connection with a small A. C. generator, not shown. A similar set designed to operate on a 24 volt storage battery with an independent interrupter, is shown in Figure 15.

Altho we believe the closed core transformer is better adapted to radio work, we build some open core transformers, the one shown in Figure 16 being of 3 kilowatt capacity at 120 cycles. It is shown on top of its case. The next one is 10 kilowatt capacity, of similar construction, but larger. (Figure 17.)

The next drawing, Figure 18 gives the constructional details of the 3 kilowatt open core transformer, one-half showing a front view, while the other half is a sectional view from the top. This construction allows any secondary coil to be removed without disturbing the others; as the primary slides out in a unit.

It is arranged to have a large surface for heat radiation. These resonance transformers, in common with most others of the open core type, have an $I^2 R$ loss about four times that of a closed core transformer of the same output.



FIGURE 12

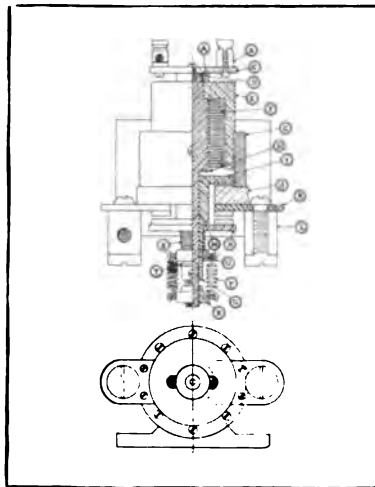

FIGURE 13

Instead of using an alternating current for charging the condenser, a high voltage direct current can be used with extremely satisfactory results. Either a segmented disc or a "tone circuit" across the gap may be used for telegraph work, or a smooth gap

for telephone work. The telephone results are limited in power by the available transmitters, this being the principal difficulty in most telephone methods.



FIGURE 14

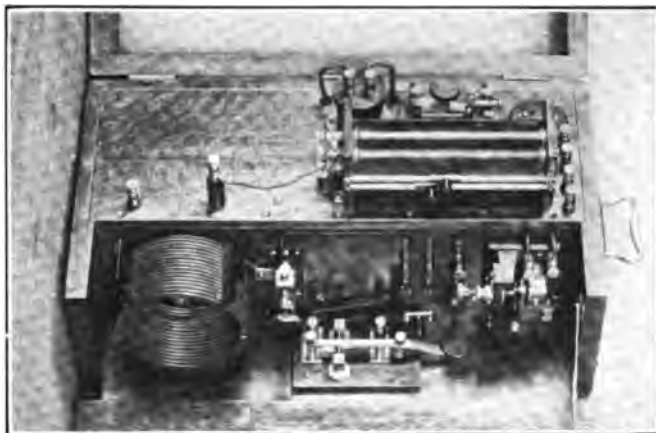

FIGURE 15

SUSTAINED WAVES.

The experimental work on direct current transmitters developed some very interesting, as well as practical, results. It was found that by using a very high coupling (about 65 per cent), and a well cooled rotary gap, single impulses could be produced in the gap circuit which would transmit their energy to the oscillating circuit with a very good efficiency. These

impacts occur so rapidly that the antenna receives new energy before its energy absorption has practically damped out its oscillations, and so there is a sustained wave. After the first impulse, the reaction of the secondary on the primary produces an oscillating voltage across the gap, and when that voltage, plus the condenser voltage, reaches a sufficiently high point, a second impulse will occur. Because of the secondary reaction, the impulse will always occur at that part of the secondary oscillation at which its tendency will be to increase the amplitude of the oscillating current. This is the same effect Dr. Chaffee has shown in his admirable oscillograms when working with his rectifying gap. The rate at which these impacts occur depends upon the supply of current to the condenser, the length of gap, and the damping of the oscillating circuit; but it is usually about one fifth the oscillation frequency. Altho the primary circuit does not oscillate, it is necessary approximately to adjust its natural period to that of the secondary, so that it will transfer its energy during a half oscillation of the secondary. Without changing the primary adjustment, the wave length may be varied over a range of about 50 per cent with no material variation in the radiated energy; and the coupling also is not critical.

Large inductances are placed in the supply leads to assist in maintaining a constant current, and to stop any tendency to arc when the discharges occur, but they have no effect on the impact frequency.

For telegraph work a tone circuit is preferable to a sectored gap, as the former allows a continuous current to flow from the generator thru the steadying inductance, while the latter interrupts the supply current at each tone impulse.

A wave meter coupled to the primary circuit does not show any one prominent frequency, as it is set into oscillation whenever its frequency is a multiple of the impact frequency. This fact gives a simple method, suggested by Dr. Chaffee for determining the rate at which the impacts occur.

The efficiency of this arrangement, from generator to a 10 ohm phantom antenna, at 600 meters, is about 65 per cent, and I believe it can be raised to a still higher value.

AUDIBILITY METER.

During the earlier work with high spark frequencies, we used a resistance shunt across the telephone receivers for measuring audibility, the instrument having resistance steps varying in a constant ratio for convenience in quick adjustment. This was



FIGURE 16

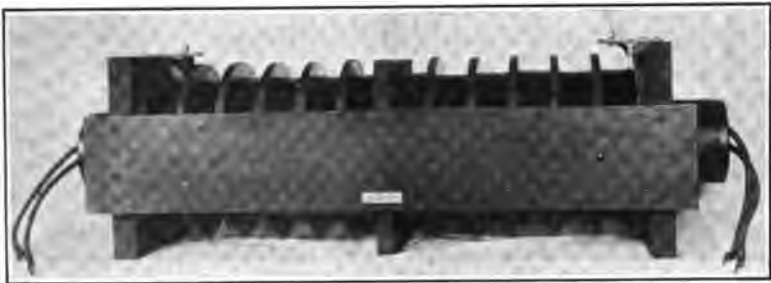

FIGURE 17

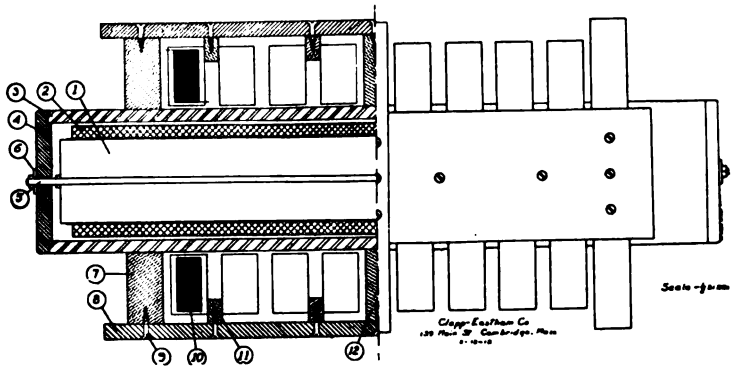

FIGURE 18

found to be very inaccurate, however, as every variation of the spark frequency (as well as of the tone frequency) varied the ratio of the currents in the telephones and shunt. We found that we could get more reliable results from a small iron core telephone transformer, the coupling of which could be varied from a maximum to zero. The primary was connected to the detector and the secondary to the telephones, and, using a

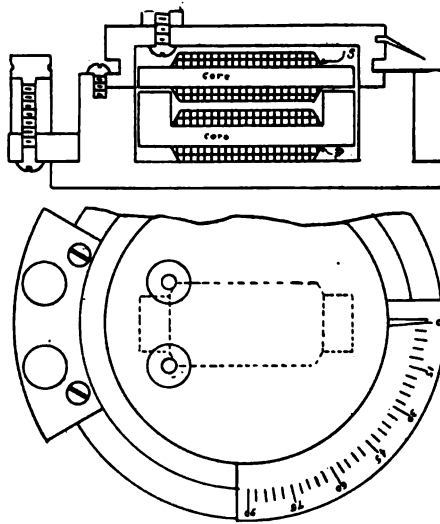

FIGURE 19

winding of proper inductance and a resistance low compared to the telephones, the losses are very slight. The instrument is calibrated with two sensitive alternating current meters, one in the primary, the other in the secondary in series with the telephones. If the transformer is properly designed, the ratio of currents at any certain coupling will be practically constant, even with large frequency variations. This may be roughly proved by testing it on a telephone conversation when it will be found not to produce distortion.

Figure 19 shows one type of construction used in which the primary "P" is wound on the lower stationary core, and the secondary, "S," on a similar core, which can be rotated thru 90 degrees, a pointer indicating the audibility. The inductance and resistance of the telephone may be varied over quite a range without affecting the accuracy of calibration within the audible limits (which latter are not very close). By proper design, this

could probably be given an audibility scale of constant ratios, tho the experimental instruments had irregular intensity calibration curves.

RADIO FREQUENCY WATTMETERS.

During the development of these transmitting sets, it was thought desirable to have a more satisfactory method of measuring the radio frequency energy than that provided by the use of an absorbing phantom circuit and hot wire meter, and therefore a number of experimental wattmeters for radio frequencies were built, the construction of which may be of interest to some of the readers. The first wattmeter tried (shown in Figure 20) was of the electrostatic type, as used by several English and German experimenters, at lower frequencies. The moving vane was connected to the high potential side of the helix, and the two stationary sets of vanes across a resistance in the ground circuit. This instrument was unreliable, because of the low torque resulting from the necessity for high insulation. The same difficulty was found in the next instrument which was built like a "string electrometer" and so the later instruments were all made on the electro-dynamometer plan. In this type, the current in the ground lead is conducted thru the stationary coils, and the moving coil is connected in series with a high non-inductive resistance between the ground and the aerial. It was at first thought necessary to reduce the inductance of the potential circuit to the lowest possible value; and the moving coil was made like the movement of a Duddell Oscillograph, using two parallel phosphor bronze galvanometer suspension ribbons with a mirror at their center. The photograph of Figure 21 shows an instrument built this way, but the sensitiveness was not great enough, so that others were built with longer wires. This change resulted in considerable improvement, giving fair results with high power factors, and at radio frequencies. The instrument is shown in Figure 22. The power factor in an antenna is only a few per cent; and consequently greater sensitiveness was required, so that moving coils were made having six or eight round turns about 1 inch (2.5 cm.) in diameter, wound astatically on a mica frame. Some difficulty was experienced with electrostatic charges which collected on the mica and exerted a torque comparable to that produced by the winding, but this was eliminated by using very thin wood frames. As the mutual induction between the moving and stationary coils introduces some complications, an instrument of the torsion head type was built, which was the most successful of all. This instrument.

shown in the photograph of Figure 23, had eight turns in the stationary core wound with thirty strands of Number 29 double-enamelled wire,* and would carry seven amperes. The



FIGURE 20



FIGURE 21



FIGURE 22



FIGURE 23

* Diameter of wire, 0.0113 inch (0.287 mm.)

moving coil had six and one-half active turns, and was suspended on a phosphor bronze strip about 4 inches long. With seven amperes in the current coils about 2 milliamperes was required to give a full scale deflection of 300 degrees at unity power factor. As the potential circuit was capable of carrying 80 milliamperes without a serious temperature rise, full scale deflection could be obtained on a circuit having a power factor of 1.5 per cent. The difficulty at low power factors, however, was in the inductance, and to a smaller extent the capacity, of the series resistance in the potential circuits. These effects could probably be compensated for, or at least a correcting factor used in the readings. The range of the instrument can be greatly increased by the use of air core current transformers, which can be constructed with a current ratio which is constant over large ranges of frequency variation, and with small phase angle error. By the use of proper transformers, potential and current may also be measured on the same instrument.

SUMMARY: A transmitting radiotelegraphic set using a very short, rapidly rotating, quenching gap is described. It is shown that by using properly sectored sparking surfaces the partial discharges can be regularly spaced, and a higher note obtained in the receiver than corresponds to the frequency of the alternating current supplied. The construction of the set is given in detail. The generation of sustained radio frequency energy by similar means is explained.

An audibility meter, which is a modified audio frequency telephone transformer with variable and measurable coupling between primary and secondary, is discussed. The author also outlines the development of a radio frequency wattmeter. The successful instrument, which is of the electro-dynamometer type, is shown.

DISCUSSION

E. E. Mayer: I think Mr. Eastham is to be congratulated on the development of the Hytone Sets described. The figures given for the efficiency have impressed me very much, as an over-all efficiency of 65 per cent for a set of 5 kilowatt is very high; particularly if we consider that a rotary converter of that size dealing with commercial frequencies would not have a very much higher efficiency.

The watt-meter for high frequency measurements described by Mr. Eastham has been of extraordinary interest to me, as it seems to be a very promising beginning of a method of simplifying measurements of high frequency energy, and seems to indicate a way of studying a number of problems which are not very clear at the present time.

But it may be permitted to call the attention to a number of facts which make these measurements very difficult, and show that extreme care is required in order to give reliable results.

1. If the current coil is inserted near the ground and the voltage coil is connected to taps on the top of the helix or somewhere in the antenna, the watt-meter will not under all circumstances measure the total energy for that section. There is a certain loss by radiation in the helix and there is also some distributed capacity in the leads and in the helix itself. Furthermore, in case there are higher harmonics of any magnitude at all in the antenna, there is a possibility that the energy of these harmonics will not be measured, because by chance the moving coil might just tap a node of voltage of one of these higher harmonics. As the higher harmonics do not contribute anything to the useful radiation, this is not very serious; but what Mr. Eastham calls the "apparent power factor" might be changed considerably.

2. Besides this effect, it seems to me that the measured voltage and at the same time the measured energy entirely depend upon the way the lead to the moving coil is conducted. We have to remember that the variable magnetic flux interlinked with the closed circuit formed by the ground, loading coil, leads, and the moving coil of the watt-meter is not very well defined. The emf., therefore, is also quite arbitrary. The conditions are entirely different from those in what are known as *quasi-stationary* alternating current problems. As there is nearly no radiation at commercial frequencies, it is only necessary in a measurement of this kind to conduct the leads so that there is no outside magnetic field connected to the measuring loop.

But near an antenna the problem is very much more complicated. A thoro theoretical investigation would be necessary to get an idea as to how we should conduct the leads in order to obtain exact results.

But there cannot be any doubt that an instrument of this kind would be very valuable for comparative tests; e. g., in order to compare the efficiency of radiation of antennas of different kinds, the amount of Joulean losses in the ground connection, and also the distribution of the electro-magnetic field. The efforts of Mr. Eastham deserve the highest credit, and I think that very many members of the profession besides myself would appreciate it if Mr. Eastham would develop his radio frequency wattmeter to the point of commercial usefulness.

RADIO TRAFFIC.*

BY

DAVID SARNOFF.

With the continuous advance in the state of the art, radio communication has come to embrace a number of subjects other than those of engineering. Traffic regulation is perhaps one of the most important factors. The Traffic Department of a large company is responsible for:

1. The procuring of traffic.
2. The movement of traffic.
3. The procuring of all contracts for wireless equipments.
4. The economical and efficient operation of ship and shore stations.

In order to procure a profitable volume of traffic it is necessary for a company to be so organized as to make the service easily accessible to everyone who may have occasion to utilize the system of radio telegraphy; but in practice it is required to go beyond this; it is necessary to bring to the attention of the public the value of radio service and its many advantages when viewed from a purely commercial standpoint. This, of course, is accomplished by usual business methods.

The landline telegraph offices all over the United States act as collectors and distributors of messages and transmit and receive them to and from the radio coast stations.

In the early years of its existence the Marconi Company found that most of the complaints arising from non-delivery of radiograms were due to improper routing. The landline telegraph clerks and operators were unfamiliar with the method of routing wireless messages, and while their tariff books gave them general information as to the names of the various vessels equipped with radio apparatus and their routes and ranges, it was insufficient to enable the landline employees to determine with accuracy the particular coast station with which a vessel was in range at the time the message was filed for transmission. This objectionable feature was eliminated by the Marconi Company thru the

* Delivered before The Institute of Radio Engineers, New York, September 2nd, 1914.

publication of a monthly list, giving full information of vessels carrying radio equipments. This list is carefully prepared and shows the various coast stations with which arriving and departing vessels communicate and the times when communication with each coast station may be expected. These lists are furnished regularly to the landline telegraph offices thruout the country, and have greatly increased the volume of radio traffic originating on land.

In connection with this paper, one of my friends said: "If I were you, one of the first things I would explain is what happens when a man on shore concludes that he wishes to send a wireless message; how he does it, and what is the *modus operandi*." I feel that an answer to this gentleman's suggestion might be of some interest to us all. Suppose then we consider the case of a person who wishes to send a radio message to another on board a ship. All that it is necessary for the sender to do is to take the telegram to any Western Union telegraph office and make known his wishes. The clerk in charge of the telegraph office then refers to the list of proposed sailings which, as explained, has been furnished by the Marconi Company, and ascertains therefrom the coast station with which that particular ship is in communication at the time. The message is then "routed" by landline thru that coast station, and when it reaches there, it is transmitted by radio to the vessel.

The operator on board the ship delivers the message to the addressee and obtains a duly signed receipt, which is pasted on the back of the station's message copy, thus forming complete evidence of the receipt and delivery of the radiogram, and serving as the necessary document in case of future complaint or reference.

It now becomes necessary to account to the various companies engaged in the handling of this message for the tolls in connection with its transmission and reception. In attempting an explanation of the method of accounting adopted and pursued in the various countries thruout the world, it must first be stated that the charges on a radiogram are divided into three classes: namely, ship tax, coast tax, and the landline forwarding charges. The ship tax is the charge the ship makes for transmitting or receiving the message; the coast tax is the charge the shore station makes for transmitting or receiving the message; the landline forwarding charge is the amount charged by the connecting landline telegraph company for transmitting and delivering the message.

Referring again to our example, the coast station, after having transmitted the message to the ship, enters all particulars of the telegram on a standard abstract form. These abstracts are forwarded to the auditing department of the company at stated periods, and from the information given therein, invoices for the full radio tolls are rendered against the telegraph company with which the message originated.

The company or administration controlling the radio installation on the ship station is credited with the shipboard tolls and the remainder of the charge is credited to the coast station. Similarly, messages which are received at coast stations from ships at sea are entered on another abstract form, from which the auditing department debits the company (or administration controlling the ship station) with the coastal tolls, plus the landline forwarding charge, and the landline telegraph company is credited with its proportion of the tolls.

The London Convention prohibits the acceptance and transmission of "collect" radio messages, and as cases may occur where the sender of a radiogram may wish to pay for a reply, provision is made for this in the way of a "reply-paid service." The sender of a telegram may, therefore, pay for as many words as he desires, in excess of the ten word minimum, which is applied to all radiograms, and the letters "R. P." together with the number of words are signaled to the receiving radio station, which furnishes the addressee with a reply-paid voucher when delivering the received message. This voucher may be returned to the radio station or any landline telegraph office as payment for the transmission of a reply.

Should the person to whom the "R. P." voucher is issued desire to send a greater number of words than is provided for in the voucher, additional tolls are collected at the sending station. On the other hand, if the reply-paid voucher is not utilized, or a less number of words transmitted than were provided for, either the difference in amount or the total amount, as the case may be, is held in reserve by the company and a refund of tolls may be obtained upon written application to the head office.

In accordance with the provision of Article 42 of the London Radio Telegraphic Convention, liquidation of accounts is effected directly between the companies operating the ship and shore stations, but in the event that a ship station is controlled by a company with which no special arrangement has been made, recourse may be had to the privilege of liquidating the accounts thru government channels; provided, however, that the ship or

coastal station flies the flag of a country that has ratified the Radio Telegraphic Convention. In the case of a non-contracting country, communication may be denied in instances where special traffic arrangements are not in effect, except, of course, in cases of distress, at which time no distinction is made.

In this connection, it might be interesting to mention that notwithstanding the fact that the United States Government had ratified the Berlin and London Conventions, the Mexican Government, which is also a country adhering to these conventions, refused to permit its coast stations to communicate with ships flying the American flag until a guarantee of \$1,000 (Mexican) had been deposited by the Marconi Company with the Director General of Telegraphs at Mexico City.

The Government of Mexico gave as its reason that the ship stations of the United States did not appear in the list of "Radio Telegraph Stations of the World," issued by the Berne Bureau. This, however, is an isolated case, and even with countries which have not ratified the International Convention—and they are few—communication has never been denied. Cuba may be used as an example in this connection.

In brief, then, we have the answer to what happens to a radio message when one finally decides to file it for transmission. The circumstances incidental to its delivery appear simple on the surface, but it must be remembered that a great deal of effort and energy has been expended by the various companies and organizations which have made possible a successful radio telegraph business.

A difficulty which seemed insurmountable for a long time and which was successfully overcome eventually by the Marconi organization, was the method of accounting and charging for radio messages. The Berlin Convention of 1906 stipulated that radiograms should be counted and charged for on a word rate basis, pure and simple, but for a long time the landline companies in the United States absolutely refused to consider radio messages in a class different from their ordinary domestic telegrams—that is, a fixed charge for ten word minimum. To accept and forward radiograms over the land wires on a message basis, and to forward them by radio on a word rate basis, would have caused endless confusion in accounting. It was, therefore, necessary to have all the Marconi companies agree to handle radio messages on a message basis thruout, until such time as the American Marconi Company could prevail upon the United States landline telegraph companies to accept its point

of view. This was successfully accomplished in 1912, and at the present time the Western Union and Postal Telegraph companies handle Marconi radiograms on a word rate basis, thereby simplifying to the greatest extent the method of accounting and also executing the letter and spirit of the London and Berlin Radio Telegraphic Conventions.

From the very first it was realized by the parent Marconi Company that when radio equipments were installed on merchant vessels a thoroly practical means of regulating traffic was needed, in order to make radio communication successful. It is significant to note that the system originally adopted by the Marconi companies, which was modeled after the international landline telegraph and cable methods, is, with few exceptions, still in vogue; and, in fact, so reliable has it proven that the London Convention practically adopted it and stipulated that radio traffic should be so handled.

It has been my good fortune in my radio activities, both in the traffic and inspection service, to come in close contact with the various representatives of the Department of Commerce, and to these gentlemen, personally, as well as to the Department, must be given due credit for the very important part that has been played in promoting and advancing harmonious work. I feel that regulation in radio is both necessary and desirable, and feeling thus I find an excuse in presuming to pass judgment upon some of the present regulations.

With the increased number of ship and shore stations, with the present government regulation of wave lengths and with the constant increase in the volume of traffic, it is most desirable so to regulate the transmission of radiograms that they may be accurately received with maximum efficiency during a minimum of time. To accomplish this result, three factors must be given constant consideration:

1. Efficient operating, which among other qualifications, calls for a competent telegraphist.
2. Efficient apparatus.
3. System and brevity in transmission and the elimination of all superfluous words and symbols.

Mr. V. Ford Greaves, Radio Engineer of the Department of Commerce, in his paper on the "Radio Operator Problem,"* adequately and capably covers his subject. I had the pleasure of reading the paper and heartily agree that the operator is a

* Published in Proceedings of the Institute of Radio Engineers, Volume 2, Number 3, September, 1914.

very important factor in the art of radio communication, and as such should receive careful consideration and study. The importance of the human element in radio communication cannot be overestimated.

It seems to be an open question as to which of the following combinations is preferable: An older, and within reasonable limits less efficient type of equipment, in the hands of a skilled radio operator, or a modern and more efficient set in the hands of a poor operator. My own observations and experiences in connection with the problem inclines me to favor the skilled operator. However, I fully appreciate the necessity and desirability of having the ideal combination, namely, the good operator and the good set.

In his paper, Mr. Greaves states that "so far as safety at sea depends upon the radio operator, speed is not particularly important, altho it may be desirable under certain circumstances." I cannot quite agree with this. Speed in radio work, when speed can be utilized, is perhaps more desirable and more important than in any other means of communication, for, nearly all commercial ship and shore stations operate on the same wave length; and it is necessary, particularly in congested waters, to await an opportunity to "come in." As a radio operator with a number of years' experience, I recall those painful moments of waiting. The desirability of speed holds good not only in ordinary commercial work, but also in cases of distress; for example, in the wreck of the Empress of Ireland there were only six or seven minutes available in which to communicate. During this time the operator gave the Father Point station full particulars of the collision and received from that station the assurance that assistance would come to him in time.

We all know the number of deplorable cases, existing to-day, where radio operators require considerably more than six or seven minutes to dispatch a single message, even when static and other interferences are absent. As a general rule, an operator who is capable of telegraphing with speed will employ his ability when it is possible to do so; and as it is admitted that under certain conditions speed is not only desirable, but imperative, it must follow that an operator should have speed. This applies not only to commercial operators, but to all operators engaged in radio work. It must be considered, however, that speed alone does not constitute the "good" radio operator. Speed *and* stability and judgment, from the most effective combination. In

an address delivered before the New York Electrical Society, Mr. Marconi summed the matter up in these words:

“Wireless telegraphy, like aviation, is as yet a comparatively undeveloped art, therefore personal skill and practical ability on the part of the operators are of the greatest importance in overcoming the difficulties of the moment.”

An amusing feature of the present radio laws and regulations was recently brought to light when it was found that a vessel not required by law to carry radio apparatus, but which was voluntarily equipped, sailed with a skilled operator in charge; who, however, did not have a license. Had the vessel sailed without an operator, the law would have been fully complied with, but because the vessel sailed with an unlicensed operator on board, the owners became liable for a violation of the law. It would have been an interesting sequel had that operator been the means of saving the lives of several hundred people on some vessel in distress.

I do not, of course, mean to imply that licenses for radio operators are unnecessary; I simply cite an instance where the regulations might have defeated the very purpose for which they were designed.

In this connection it should be noted that any radio company which guarantees to furnish operators and equipments to comply fully with the requirements of the law must at all times be on the “*qui vive*” to see that all operators are in possession of the proper licenses before they are assigned for duty at any radio station. Companies furnishing operators endeavor to employ only those holding first grade licenses, for unforeseen circumstances may arise and make it imperative to transfer an operator from a cargo ship to a passenger ship requiring a first grade operator.

I have drawn up an ordinary commercial message, showing every letter and symbol as it should be transmitted in accordance with the provisions of the London Convention. I have also drawn up this message in a form which I personally recommend for its transmission. In my opinion this conveys all the necessary information and has the advantages of brevity.

International Regulations for Handling Radio Traffic

Calling	KA	WSE	WSE	WSE	de	KSH	KSH	KSH
Answering	KA	KSH	KSH	KSH	de	WSE	K	

Order of Transmission

P Nr 1 15 Radio 25th 5:30 P. M.

S.S. Kroonland.

The Honorable Judge Gordon,
Hotel Astor, New York.

— . . . —
Kroonland expected reach Quarantine early Tuesday morning.

— . . . —
Lincoln.

Suggested Method for Handling Radio Traffic

Calling WSE KSH

Answering K

Order of Transmission

P 1 RF 15

Kroonland.

The Honorable Judge Gordon,
Hotel Astor, New York.

— . . . —
Kroonland expected reach Quarantine early Tuesday morning.

— . . . —
Lincoln.

Before the change from the old Marconi system of working to the present method, the following data was not transmitted:

1. The word "Radio."
2. The date. (Provided the date of transmission was the same as the date on which the message was filed.)
3. The time filed in figures. (Code only was used.)

The word "Radio" is printed on every message blank, and as every message sent by radio is a radio message, there seems to be no need for the transmission of the word in the check of the message.

If no date is transmitted with a message, it would mean that the radiogram is sent the same day it is filed; and as this is the average case, it is preferable to indicate the date only where a message is transmitted on a date subsequent to that on which it was filed.

Figures are more liable to error in transmission and reception than letters; it also takes more time to transmit figures; therefore, if it is necessary to transmit the time filed, a code should be adopted and used. I give the code time previously used by the Marconi Companies. (See Figure 1.)

The hours from one o'clock A. M. to twelve o'clock noon are denoted by the first twelve letters of the alphabet (J being omitted), and the hours from one o'clock P. M. to twelve o'clock

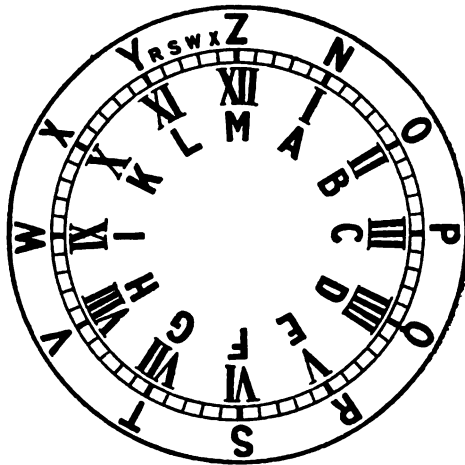

FIGURE 1

midnight are denoted by the other letters of the alphabet (U being omitted).

In order to denote the four intermediate minutes in every complete period of five minutes, the letters RSWX are employed, R denoting the first, S the second, W the third, and X the fourth minute after each hour or after each complete period of five minutes.

On the North Atlantic, where the volume of traffic is perhaps heaviest, it is no uncommon occurrence to have as many as ten or fifteen of the larger trans-oceanic liners within the radius of a single coast station. Practically speaking, nearly every commercial ship and shore station transmits on the 600 meter wave length, therefore in this case it is possible for only two stations to work at the same time. Unfortunately, too, we have not yet seen the last of that most hated and most despicable enemy of all radio operators, which comes down to us from the realms above in the shape of "static."

During heavy static conditions it is often necessary for the transmitting station to repeat each word a number of times and the advantages of brevity under such circumstances certainly needs no elaboration. Every word and every symbol saved means a saving of time and energy, as well as an increased pos-

sibility for disposing of radio traffic. Further, Article 6 of the London Convention stipulates that,

“The exchange of superfluous signals and words is prohibited.”

I desire also to call particular attention to several service Regulations of the London Convention, governing Radio Traffic.

Article 16 reads:

“The coastal rate and the shipboard rate shall be fixed in accordance with the tariff per word, pure and simple, on the basis of an equitable remuneration for the radio work, with an optional minimum rate per radiotelegram.

“The optional minimum rate per radiotelegram shall not be higher than the coastal rate or shipboard rate for a radiotelegram of ten words.”

The provision of an optional minimum has seriously restricted the exchange of radiotelegraphic traffic. A number of steamships, notably those flying Belgian, Dutch and German flags, insist upon a ten word minimum shipboard rate, whereas a number of coast stations and ships of other nationalities do not apply any minimum.

At the time the Marconi Company arranged with the Western Union Telegraph Company for the establishment of word rates on the landlines in the United States, it was the desire of the Marconi Company that its ship and shore stations should not apply a minimum charge; but owing to the insistence of those foreign ship stations which apply a ten word minimum in all instances, the Marconi Company and the Western Union Telegraph Company were compelled to set up the minimum, altho in doing so both companies felt that the principle was wrong.

The application of the ten word minimum has to a large extent withheld the exchange of radiotelegrams, particularly those originating in one country to be forwarded to ships at sea through the medium of coast stations located in another country. Owing to the lack of uniformity in the system of counting and charging for wireless messages, the cable companies have been unable to arrange for the prepayment of the radio charges on radiotelegrams which have to be cabled to a foreign coast station for transmission. As an example, I cite a message originating in New York City for transmission to a passenger on board a German ship thru a British coast station. The cable company does not apply any minimum, nor does the British coast station; but the German ship does. This means that in a message contain-

ing less than ten words, the cable company would have to collect its own tolls, the British coast station tolls, both without minimum, and the ship tolls with a ten word minimum. It can be readily seen how necessary it is to have the minimum universally abolished as long as radiotelegrams have to be counted and charged for on a word rate basis.

Another matter which needs correction is the regulation adopted at the London Convention (Article 42), which provides that the coastal and shipboard charges shall not enter into the accounts provided for by the International Telegraph Regulations, but shall be charged directly between the radio management to which the office of origin is subject and the radio management to which the coastal station of destination is subject. It is quite evident that this regulation was framed without giving due consideration to messages originating in one country and intended for transmission by way of a coast station in another country. The provision lacks the element of applicability to extra-European messages, and it is within this class that messages between points in the United States and Europe, etc., come.

If the optional minimum is abolished, and provision is made for settlement of coastal and shipboard charges on foreign radiotelegrams thru the International Telegraph accounts, facilities for the exchange of radiotelegrams will be greatly improved and the accounting simplified.

Article 19, Paragraph 2, of the Service Regulations of the London Convention, provides that:

“The counting of words by the office of origin shall be conclusive in the case of radiograms intended for ships and that of the shipboard station of origin shall be conclusive in the case of radiograms proceeding from ships, both for purposes of transmission and of the international accounts. However, when the radiogram is worded wholly or in part, either in one of the languages of the country of destination, in the case of radiograms proceeding from ships, or in one of the languages of the country to which the ship is subject, in the case of radiograms intended for ships, and contains combinations or alterations of words contrary to the usage of such language, the bureau or shipboard station of destination, as the case may be, shall have the right to recover from the addressee the amount of charge not collected. In case of refusal to pay, the radiogram may be withheld.”

This regulation is not in accordance with any known telegraph or cable practice. The number of words, or the “check,” as it is

called, should be agreed upon by both the sending and receiving stations. In case of a difference of opinion, the sender, and not the receiver of a message, should pay the additional amount required.

In the case of a radiogram originating on shipboard and transmitted to a coastal station for delivery on land, a "collect" service message must be forwarded over the landlines, requesting the addressee to pay the additional amount where the difference in the check requires additional payment. In such cases, who is to pay for this "service"? The London Convention makes no provision.

Article 33 deals with cases where communication between a ship and shore station is unreliable and where uncertainty exists. Paragraph 2 provides that:

"If in the opinion of the receiving station the radiogram, altho imperfectly received, is nevertheless capable of transmission, said station shall enter the words 'reception doubtful' at the end of the preamble and let the radiogram follow. In such case, the management of the radio service of the country to which the coastal station is subject shall claim the charges in conformity with Article 42 of the present regulations. If, however, the shipboard station subsequently transmits the radiogram to another coastal station of the same management, the latter can claim only the rates applicable to a single transmission."

In my opinion, a telegraph operator should not give "O. K." for a message unless he is absolutely certain that he has received it entirely and correctly. An "O. K." or "R" should end all doubt on the part of the transmitting operator as to whether or not the reception is complete and accurate. Then no doubt could exist and there would be no possibility of a person receiving the same message from two different stations.

The regulation referred to may also impose a financial loss upon the radio company controlling the two coastal stations. For example: a message from the steamship "Momus," bound north, addressed to Brown, Paris, is transmitted via the Marconi Station at Tampa, Fla., the cable charge from Tampa to Paris being thirty-four cents per word. If the reception of this message is doubtful and the receiving station has not given an "O. K." to the sending operator, the probabilities are that the message will be sent again, thru another coastal station, and the Marconi Company will be out of pocket thirty-four cents for each word, covering additional cable charges to Paris.

A difficulty often arises in connection with "Call Letters" assigned by the different countries adhering to the International Radiotelegraphic Convention when a foreign vessel is being fitted with radio apparatus in an American port, or an American vessel in a foreign port. Application for call letters must be made to the government whose flag the vessel flies, and where the time is short, money must be spent on cable tolls in order to procure this information before the sailing of the vessel. Some governments even refuse to assign temporary call letters until the radio apparatus on board the vessel is inspected and a license issued. Since the government issuing the call letters also issues the license, it is obviously impossible to comply with this regulation.

A simple solution would be for each government to furnish its national representative with call letters for a limited number of vessels, and in the case of installation of radio apparatus in a foreign port on a vessel not previously equipped, application for call letters could be made to the representative of the country whose flag the vessel flies. The necessary formalities could be executed later.

I should very much like to have an opinion on the wave length limitations as provided for by the international regulations. Personally, I believe that the present wave length ranges provided for commercial work are insufficient; that they are not conducive to the highest radiating efficiency, and are productive of unnecessary interference; more so, perhaps, than was the case before the adoption of the regulations. It helps very little to stipulate that the logarithmic decrement of the emitted waves shall not exceed two-tenths per complete oscillation and at the same time limit the wave length range so as to bring about a condition where 600 meters is adopted as the normal wave length by nearly all commercial ship and shore stations.

At the present time we have an excellent example of the control of radio stations and radio operation on the part of the government authorities in case of war, disaster or other public peril; and in view of this it seems only reasonable that during times of peace the greatest facilities should be afforded for efficient and harmonious commercial working.

If it were possible to take full advantage of the available antenna space on vessels, the receiving and transmitting range would of course be increased; but if full advantage were taken of the distance between the masts on a good many of the trans-oceanic liners, the natural period of the antenna would probably be very nearly 600 meters, and adding to this the necessary

inductance in the secondary of the oscillation transformer, the wave length would be brought above the present prescribed limits.

It must also be remembered that working too near the fundamental of the antenna causes high damping, and in this respect the regulations provide that the logarithmic decrement shall not exceed two-tenths; therefore, it seems obvious that the best general efficiency cannot be obtained on a good many vessels with the present regulations.

On the average coastwise vessel the use of wave lengths above 1,600 meters is impractical, and in so far as the 300 meter wave length is concerned, its inefficiency seems to be so generally admitted that I need hardly discuss it. One of the United States radio inspectors recently told me that he went on board a vessel lying in port at New York to test the 300 meter wave length, and to ascertain just how many people would answer his calls. He called ship and shore stations on 300 meters for nearly two hours without a response; and on the following day when he inquired of those he called as to the reason for their not answering, he was informed that his 300 meter wave signals were not heard. This, of course, would show that the average operator uses the 300 meter wave length so seldom that radio stations do not tune for this wave length.

Where two coast stations are situated close together both may be transmitting simultaneously and vessels may be receiving at the same time; provided, however, that wave lengths of sufficient dissimilarity are used. This is the case at New Orleans, where the United Fruit station transmits its messages during schedule hours on a wave length of 1,800 meters and the Marconi station at New Orleans works with nearby vessels on the 600 meter wave length without interference.

To do this and live up to the letter of the law it is necessary for the vessel receiving the longer wave to transmit its replies on the longer wave also, for Article 4 of the Service Regulations of the London Convention states that:

“Communication between a coastal station and a station on shipboard shall be exchanged on the part of both by means of the same wave length.”

Such regulations make it necessary for both coast stations at New Orleans to adopt the 600 meter wave length, the result being a loss in efficiency and delay in the disposition of the traffic.

It detracts from the general efficiency and from the rapid movement of traffic to have all commercial radio stations use 600 meters as the normal wave length, which unfortunately is the case at the present time. Perhaps in designing new apparatus for use on shipboard, due advantage will be taken of the privilege afforded by the present regulations in that wave lengths between 300 and 600 meters may also be utilized. This will probably help a little, but not as much as if the present limits were modified to permit the use of all wave lengths below 1,000 meters for commercial ship and shore communication. If such extension were granted, however, I would recommend that a single wave length be used for general calling and in case of distress. Possibly the 600 meter wave length would be found the most convenient for this purpose.

SUMMARY: The functions of the traffic department of a radio company, namely: procuring and moving traffic, procuring equipment contracts, and operating ship and shore stations economically and efficiently, are described. In connection with the work of the Marconi Company, the coöperation between the Western Union and Postal Telegraph Companies and the radio company is treated in detail. The complete routine procedure for the transmission of a radiogram is given fully. Various matters coming under the provisions of the Berlin and London Conventions are discussed, e. g.: cases in which public traffic need not be accepted, methods of accounting and charging for radiograms, and the use of a word basis *versus* a fixed charge minimum. The importance of speedy transmitting is emphasized, and a new shortened message form proposed. Proper methods of prepaying messages, the rapid assigning of call letters, and revision of the present wave length regulations are considered.

DISCUSSION.

Robert H. Marriott: In order that the advance in the science and art of radio communication shall be a well balanced one, it is desirable that we should have papers and discussions dealing with the various phases of the subject and written from different points of view. We are fortunate in obtaining Mr. Sarnoff's paper on the traffic phase of the subject, and his opinions on the other phases relative to the traffic point of view.

PROCURING TRAFFIC ON SHIPBOARD.

On many vessels, for example trans-Atlantic English vessels, the operators do not receive or deliver the messages directly. This is done by stewards, inquiry office men, or others; who also handle the money received and get whatever benefit there may be in charges for money exchanges. The passenger receives the benefit of the operator's knowledge of traffic only in a second-hand way. It seems to me that it would be better for the traffic and the operator if he had full charge of the receipt and delivery of all messages. The traffic should also be improved in volume and efficiency, and receipts should be increased if the operator were given a commission. This is an incentive and recompense for getting traffic and handling it quickly and correctly.

SLOW OPERATORS AND SHORTENED MESSAGE FORMS.

If the salary or other recompense received by operators were such that radio operating became a profession worth following by men of ability and judgment, the messages would probably be handled more rapidly and with less confusion. Highly skilled men have been able to handle a brief form of message similar to that proposed by Mr. Sarnoff to great advantage, but greater detail in the information supplied on the message form for the purpose of checking is probably necessary for a large percentage of the present operators. Mr. Sarnoff is a very skillful operator, but others probably could not satisfactorily handle his brief form of message.

DISCREPANCIES IN CHECKING MESSAGES.

Confusion in the number of words as shown in the check may easily arise. For example, a French operator is handed a message by an American. The message contains the word "all right," but it is spelt "alright." The Frenchman counts "alright" as one word, but if he passes the message to an English or American operator it will be counted as two words. It might

possibly be well to forward the message and collect for the correct number of words from the office of origin without wasting time, with radio or wire line service messages.

MESSAGE REPETITION.

Some of the older and more experienced operators are accustomed to hold messages if they are not sure that these messages have been properly received, and they later repeat the same messages to the same station, including, however, in the preamble, the words "prevent duplication."

WAVE LENGTH REGULATION.

I believe that Mr. Sarnoff's criticisms as to the limitation of wave lengths to between 300 and 600 meters for commercial vessels is agreed with by practically all persons connected with commercial radio service. If armies and navies deserve any special privileges in the nature of reserved wave lengths, their reservation should probably start in the neighborhood of 800 or 1,000 meters; and commercial vessels and stations should probably have a monopoly of all wave lengths between 300 and 800 or 1,000 meters. Furthermore, commercial vessels should be permitted to use an antenna which stretches practically the entire distance between the masts of the ship, instead of being forced to shorten their antennae by the requirements of a compulsory use of so short a wave as 300 meters.

Just why armies and navies should be allowed to use any wave length they desire and should have a complete monopoly on certain wave lengths during times of peace is a question which I have not heard satisfactorily answered. Indeed, it would probably improve naval radio service if in times of peace there were no restrictions on commercial wave lengths, for it would thus become necessary for the navy operators to become skillful in changing their wave lengths so as to work thru interference. Of course, in times of war the armies and navies will take whatever wave lengths they desire so far as the enemy will let them. According to the present reports, the warring nations are using such wave lengths as best suit their purpose, and in some cases are sending long dashes to prevent working of the enemy. English commercial vessels before entering the Mersey river are required to lower their antenna to the deck, and are not allowed to raise it again until they leave the Mersey outward bound. In addition, in some cases the steamship company or the captain of the ship does not permit the operator to send at all until the ship is

very close to an English or American port, and then the operator is sometimes permitted only to use the small power emergency set. As to the warring navies, they apparently use any calls or symbols which may suit their purpose.

Mr. Sarnoff mentions the case of a radio inspector who told him that he had spent two hours in the port of New York unsuccessfully calling ship and shore stations on 300 meters. I presume that I am the inspector to whom he referred. However, my procedure was slightly different. I sent the call "MA" on 300 meters for 4 hours from a vessel lying in the Bush Terminal docks; having previously arranged for certain stations to notify me if I apparently caused any interference. I was not notified, and the stations afterward told me that there were no evidences of interference. The receiving tuners on the vessels and shore stations in the vicinity were probably set at a longer wave length, partly because they wanted to receive at 600 meters and partly because they could not efficiently tune to a wave length of 300 meters. This last is the case mainly because a large proportion of the tuners have no condenser in series with the primary circuit.

COMMERCIAL SERVICE ON VARIOUS WAVE LENGTHS.

The insistence of the Marconi Company in adjusting all their transmitters to a wave length of 600 meters has made the two-tenths decrement regulation little more than a joke, and also has probably materially interfered with their own traffic. There is no doubt that this company could use successfully a number of wave lengths between 300 and 600 meters. On referring to my paper on "Radio Range Variation," Volume 2, number 1, page 46 of the PROCEEDINGS OF THE INSTITUTE OF RADIO ENGINEERS, it will be found that I furnished the natural periods of about 102 vessels equipped with antennae occupying the entire span between the masts. These were mostly United States coastwise ships. From the data given, it will be seen that the natural wave lengths vary from 210 to 550 meters, the average being 370 meters; and that with ample coupling inductance in series with these antennae the circuit wave lengths varied from 280 to about 600 meters. It is clear that these vessels could use without difficulty the wide range of wave lengths between 280 and 600 meters. The larger vessels should use the longer wave lengths and the smaller vessels should use the shorter wave lengths. Short wave lengths can be used with considerable practical success as is shown by the fact that the vessel having the greatest number of long range messages to its credit had a natural antenna

wave length of 250 meters and was tuned to 300 meters, actually radiating at 230 and 360 meters. It is true that this exceptional work was largely due to the skill and judgment of the operator, but it showed that short waves may be very successfully used.

Yesterday, I conducted a test on one of the vessels operated by the American Marconi Company, the antenna of which had a natural wave length of 400 meters. I found that when the coupling coil was used in the antenna circuit without any series loading coil the open circuit wave length was 492 meters, so that all the Marconi Company would have to do on this vessel to obtain a wave length of 492 meters would be simply to use the coupling coil and nothing else in the antenna. To obtain a 600 meter wave, an extra loading inductance can, of course, be readily inserted. The simple use of the coupling coil just mentioned would probably in every case give the vessels of the Marconi Company a range from about 300 meters to less than 600 meters in addition to the regular 600 meter connection. Certain companies other than the American Marconi Company provide a series condenser in the open circuit of the receiving tuner by means of which they can take advantage of the short wave lengths.

In a recent paper before The Institute of Radio Engineers on "Radio Steamship Specifications" (PROCEEDINGS OF THE INSTITUTE OF RADIO ENGINEERS, Volume 2, number 2), I described automatically operated tuners which would enable signals to be heard regardless of the wave length at which they were being sent without continual tuning on the part of the operator.

If Mr. Sarnoff deems it proper, I should like to have him describe the proposed methods for handling the trans-Atlantic traffic.

V. Ford Greaves: I have been particularly interested by Mr. Sarnoff's paper and it has proven very instructive. The subject covers a field in which I am endeavoring to specialize. With your permission I will ask Mr. Sarnoff a few questions and discuss certain of his statements.

I should like to ask Mr. Sarnoff to state the date of the correspondence in which the Mexican Government refused credit on radiograms, giving as a reason that the vessels of the United States did not appear in the "International List of Radiotelegraph Stations of the World." I believe it was 2 or 3 years ago.

Supplement No. 8 of January 19th to the Berne publication completed the list of United States stations, both ship and land, with the exception of a dozen or so recent installations. The Bureau of Navigation is making every effort to keep the official list of stations as up to date as possible so far as United States stations are concerned.

Mr. Sarnoff does not agree with my contention that "so far as safety at sea is concerned, operating speed is not particularly important but may be desirable in some cases." This contention is based on the assumption that a certain wave length might be isolated exclusively for distress purposes and additional operators detailed to "listen in" constantly on this wave length, thus avoiding the interference caused by commercial communication and thereby reducing the necessity for operating speed except in extreme cases such as the "Empress of Ireland" mentioned. Furthermore, in cases of distress messages the law requires that all commercial communication cease, thus eliminating interference and the necessity for speed on this account.

I cannot refrain from making a few remarks concerning Mr. Sarnoff's reference to the case of the unlicensed operator. The law is clear and specific in the case and every effort should have been made to procure a properly licensed operator.

In the event of a licensed operator not being available, the law provides that the courts or the Secretary of Commerce may remit the penalty incurred if circumstances warrant. This precludes the possibility of the law being made ridiculous by an exceptional circumstance.

In the particular case under discussion the operator employed had twice failed in his examination for first-grade license, but procured one about a month later at another examining office. A careful review of his examination papers showed that he barely passed in his final trial.

He was, however, entitled to a second-grade license by his first examination which would have properly qualified him for the particular ship had he accepted the license.

The law makes still another provision for such emergency cases. The operator could have procured a "temporary permit" from the Collector of Customs thru the Radio Inspector, even by telephone if necessary.

Surely Mr. Sarnoff does not complain of delays or inconvenience in the assignment of call letters by the United States Government. Temporary call letters are often assigned by telegraph.

In regard to the regulation of wave length, some of the United States delegates to the London Radio Convention drew up and informally submitted a plan about as follows:

(a) The adoption of an international calling and "listening" wave length of 600 meters and prohibiting the use of any wave length between 500 and 700 meters for any other purpose except distress; (b) that stations calling on the standard wave length and receiving acknowledgment should shift to some other wave length according to a signal; (c) the range of wave lengths to be divided between the governments and private interests as follows:

Amateur	below 200 meters	
Commercial	200 to 500 meters	
Government	700 to 800	"
Commercial	800 to 900	"
Government	900 to 1,100	"
Commercial	1,100 to 1,400	"
Government	1,400 to 1,600	"
Commercial	1,600 to 1,800	"

and so on alternating every 200 meters.

This suggestion met with overwhelming opposition on the part of the foreign delegates, but it seems to be the ideal solution of the problem (with modifications perhaps) so far as the United States is concerned and no doubt the matter will again be considered at the International Radio Convention to be held in Washington in 1917.

Such an agreement would call for efficient wave changing switches for all stations and would necessitate a series of signals so that operators could quickly agree upon wave lengths. There is no reason why two stations communicating should use the same wave length. Even with the present wave length limitations advantage could be taken of shifting to other wave lengths.

A regulation would also have to be made requiring all stations to interrupt any traffic at intervals to "listen in" on the standard wave length.

The American delegates formally proposed that the lower wave length limit be 700 meters but were overruled.

George S. Davis: Mr. Sarnoff's paper deals with a very interesting, important and vital subject to most of the radio engineers and the commercial companies. It is perhaps the most important subject with which we must deal. Mr. Greaves and Mr. Sarnoff both spoke of speed in operating. Speed is

very desirable and essential, but we must have speed with accuracy, and with both of these we must have an operator who understands how to operate his set and is able to repair it in case of emergency. As far as our own traffic is concerned, we require speed and accuracy as well as the ability of the operator to handle his messages accurately and to take care of his set; and our operators are not promoted to high salaried positions until they are able to handle both their apparatus and traffic with proper speed and to copy on the typewriter. Another point which Mr. Sarnoff brought out was the question of wave lengths, and the necessity for finding some way of relieving the congestion of traffic. Under present conditions all ships are sending on a wave length of 600 meters, and that means that a ship in the locality of Cape Hatteras is always hours behind in getting traffic thru or in sending of messages. In the case of the 300 meter wave, when it can be used, it improves conditions. But it is never used, for it would mean a great deal of trouble to change from the 600 to the 300 meter wave; and it is asking too much of the commercial companies practically to discard most of their apparatus. The radio apparatus now being designed for ships is so made that the operator can change his wave length by merely shifting a switch. Under the present conditions, it causes the operator to lose about 20 minutes in order to make a change from 300 to 600 or 1,800 meters wave length, and these 20 minutes may often occasion a loss of 6 or 8 hours in disposing of traffic; which loss may well prove serious. It seems to me to be unreasonable to assign two wave lengths and to require operators to set the apparatus so as to tune sharply. For this reason, it seems desirable that the commercial companies should be allowed a much wider range of wave lengths than they have at present. We know that the Navy Department of our country, and the Navy Departments of some of the European countries have wave lengths ranging from 300 to 4,000, or 5,000 meters; and pay no attention to the rights that commercial companies have. If it is proper to regulate the commercial companies by forcing them to use a certain wave length, it should also be proper for the government to use a wave length which will not interfere with the commercial workers. The companies should have some rights in the matter; because it is due to them that the development of the art has been so marked. At the London Convention it was required that ships use 600 meters, or if they failed in that to use 1,800 meters. But in the case of small ships, it has never been quite clear to me how they are

going to do anything on long waves. Take, for instance, the small ship "Monroe." The antenna on this ship would not produce very good results at 1,800 meters. On the other hand, a small ship like this should work on the shorter wave length to good advantage. Not until the time of the production of automatic transmitting and receiving apparatus will we eliminate the otherwise unavoidable congestion of traffic. The operator is now and always will be an important factor in the management of traffic, in the care of his sets, and in promptness in fulfilling his duties. It appears to be a little unreasonable to expect commercial operators to carry on all their business quickly and properly on the same wave length. For instance, our ships are sometimes out as far as 500 miles and messages filed on Wednesday are not transmitted until Thursday or Friday; and when we seek an explanation, the operator informs us that he has been calling Cape Hatteras steadily, but could get no response as many other ships were on the same wave length, and the shore stations could not separate and read their signals. On the other hand, some stations will handle the same ships almost twice the distance mentioned because of the absence of interference from other ships using the same wave length.

John L. Hogan, Jr.: It seems that all of us are in fairly close agreement as to what is desirable in radio service, but it is unfortunate that the opinions of the people who handle radio work commercially should be so different from those of most of the delegates to the radio conventions. As regards the ideal operator, accuracy and speed, which are two things that have been much praised so far, seem to me to be very necessary; but I must also insist that the operator should be able to send clear-cut, "clean" Morse. We have hundreds of operators scattered around the country who can send at high speed but not all of them can at the same time send with any considerable clearness. Personally, I do not believe that many operators can copy Continental or Morse code when sent by hand at the rate of say 42 to 50 words per minute. But with machine sending, which is clean-cut, matters are different. In some recent tests by the Marconi Company, using an automatic transmitter, one of our Brooklyn operators copied messages sent at the rate of 32, then 35, and finally 42 words per minute.

Mr. Sarnoff's statement that the radio companies endeavor to hire only those operators who have a first-grade license is, of course, correct. The commercial companies had hoped that the

system of licensing now in vogue would be of considerable assistance to them in supplying them with a grade of men on whom they could depend. It has been found, I believe, that even a first-grade license is too lenient in its requirements, and that many operators who can secure first-grade licenses are not of the type on whom one can place any marked responsibility. The Department of Commerce realized this fact from the beginning, and it has recently brought out a new (salmon-colored) license certificate, the requirements for which are somewhat higher than for the first grade. I have not met many operators having an extra first-grade license, and I believe one reason for this is the requirement of 4 years of sea service. This has prevented some of our best men from securing the license. Some have been operators for far more than the required number of years, and in responsible positions on shore, but not at sea.

We cannot, as Mr. Sarnoff has said, be too emphatic in insisting on brevity when the operators are calling or transmitting. I know it has been the practice of the land stations to handle traffic on condensed forms when the ship transmitting was within 100 miles. The results are satisfactory, and I believe the Department of Commerce overlooks the slight irregularity involved in the interests of all concerned.

The International Convention does place a considerable burden on the companies in not prescribing more definitely what is to be done in the matter of the disagreement in checks. In spite of the regulation that the ship's operator shall have the final voice in the matter as to the number of words in the message, he generally is forced to yield in cases of dispute by the land operator, who usually has more authority. It is occasionally impossible to get any agreement.

As regards doubtful transmission, I feel that messages which have not been received with positive correctness should not be O. K.'d, and that no delivery should be made unless the message as received is known to be accurate.

Wave length regulation is of great importance. The use of a single wave length, say 600 meters, for calling purposes has been considered to be an ideal thing by engineers for many years. There should be provision for promptly changing the wave length so soon as the call had been answered. The change of wave length should be considerable, for we all know that 600 meters may be in practice anything between 500 and 700 meters. The range used should be, roughly, from 400 to 1,200 meters, for while it is true that occasional good work can be done on

wave lengths as short as 300 meters, the range of most ships would be sadly cut down if they were compelled to use this wave for all messages.

The requirement that a ship shall work with the nearest shore station seems in part necessary if all ships are to work on a wave length of 600 meters. However, if the range of available wave lengths is markedly lengthened, as it should be, the ships can work with any one of a number of well-chosen shore stations without causing interference and with considerable reduction of needless payments for land-wire transmission.

Emil J. Simon: Mr. Hogan has brought out a very good point: namely the requirement by law that a ship station shall work with the nearest land station. This causes a needless expense to the steamship company, particularly if it owns its land station as in the case of the United Fruit Company. If the shore station is in range and is their own, it is certainly desirable that they shall work with it in preference to working with a nearer station of another company. Needless transferring of the message with attendant expense is thus avoided, for if the ship is compelled to work with the nearer station it must pay tolls to it. It seems, therefore, that this is an unfair regulation.

V. Ford Greaves: In the matter of licenses, the Department of Commerce in drawing up the requirements is in the position of a public agent, and must meet the demands of the public. I am sure every effort has been made to give satisfaction to both public and operators. There are many operators trying to obtain extra first-grade licenses who complain that the time of service requirements are too high; but these requirements have just been changed and the new forms will be published shortly. We shall require 18 months' satisfactory commercial service at sea at least 2 years previous to the date of filing of the application.

John L. Hogan, Jr.: In reply to Mr. Greaves, my remarks as to licenses were not intended as a criticism of the Department of Commerce. The Department of Commerce has been of considerable assistance in eliminating the undesirable type of man. I am glad to learn that the extra first-grade license requirements have been changed in the manner described by Mr. Greaves.

David Sarnoff: Referring to the points raised by Mr. Marriott, I would say that so far as his suggestion that operators be permitted to deal with the public direct is concerned, I do

not agree as to the practicability of this. It is to the advantage of the radio operator, shipping company and the public to have the passengers file the messages with the pursers or other authorized persons on shipboard. This eliminates undesirable interference with the working of the operator, and affords him a greater opportunity for attending to his business. Most of the radio cabins are small, and do not permit of comfortable accommodations for passengers who may wish to come in to the radio station and file their messages. Further, it is but human that passengers on shipboard should wish to remain awhile, ask many questions and thereby prevent the operator from listening for faint signals. On trans-oceanic liners, the shipping companies absolutely forbid any unauthorized persons to visit the radio cabin without authority from the commander of the vessel. On American coastwise vessels, however, operators deal directly with the public. We can all appreciate that a radio station on shipboard is a very attractive place for sociability, and will attract many visitors of both sexes.

Mr. Marriott suggests that it would be well to pay operators a commission on radio business, and thereby possibly increase the traffic. The American Marconi Company pays its operators 25 per cent. commission of the ship tax on all messages obtained by them.

Mr. Marriott stated that he made a test recently on one of the vessels operated by the American Marconi Company the antenna of which has a natural period of 400 meters. He claims that by using only the inductance of the secondary of the oscillation transformer and omitting entirely the loading coil, the open circuit period was 492 meters, but he failed to say what was the decrement of the emitted wave. I do not know the particular vessel on which this test was made, but as I have pointed out in my paper, working too near the fundamental of the antenna causes high damping. I believe that the average set as used on coastwise vessels, when adjusted in the manner described by Mr. Marriott, would probably exceed the two-tenths decrement requirement, thereby incurring the displeasure of the gentlemen of the Department of Commerce, which, of course, the Marconi Company would not wish to do. In this connection, I might also say that Dr. Austin of the Bureau of Standards has pointed out that a ship antenna has the lowest radiation resistance when loaded to about 2.5 times its natural period. I have stated in my paper that wave lengths between 300 and 600 meters may be employed in certain cases to good

advantage and I have no doubt that in the design of apparatus for future use, this matter will be given consideration by the various radio companies, but this measure in itself is not by any means sufficient to relieve the present congestion.

Mr. Marriott also stated that the failure of the Marconi Company to take advantage of the wave lengths between 300 and 600 meters has rendered the two-tenths decrement regulation, provided for by the International Radio Telegraph Convention, a "practical joke." I do not know why Mr. Marriott should address this particular charge to the Marconi Company when all other companies, in so far as I know, are not using intermediate wave lengths between 300 and 600 meters. However, I heartily agree that the decrement regulation, when considered in conjunction with the wave length regulations, is a "practical joke"; but it was caused by the people who made the laws and not by the Marconi Company.

Referring to the questions of Mr. Greaves, I do not know the exact date of the Mexican correspondence. However, I have it on file at my office and will be pleased to forward him copies.

In regard to the unlicensed operator mentioned by Mr. Greaves, I repeat what I have already stated in my paper; that is, that I am not averse to the licensing of radio operators, and in fact, believe it to be advantageous from every point of view. The particular case, however, is worthy of mention, for the reason that the operator was a skilled telegrapher, and failed in his examination only because of his limited technical knowledge. It is true that technical knowledge is quite essential but the point remains nevertheless that had this operator not boarded the ship, the vessel would have cleared without violating any of the radio laws. Yet because of his having sailed with the vessel, the owners did become liable for violating of the law. Unquestionably this is a singular case, and is interesting because possible good work in the way of assistance in a case of distress might have been prevented by the law which is primarily designed for securing such assistance. I am aware that provision is made by the Department of Commerce for emergency cases in the way of temporary permits, and that other authorities are vested in local radio inspectors; but unfortunately some steamship owners wait until the last moment before they request the services of an operator. This is particularly true in the case of small freighters and oil tankers the sailings of which are more or less indefinite. This happens to be the condition in the particular case under discussion; and rather than fail to provide

radio service for this vessel, it was thought best to utilize a good telegrapher who for some reason or other did not possess a license.

I wish to state to Mr. Greaves that my remarks relative to the assignment of call letters certainly do not apply to the Department of Commerce at Washington, which has at all times been very quick to assign these letters, often utilizing the telegraph for imparting this information so that no time would be lost. I refer particularly to the Canadian and Belgian Governments, which have actually refused to assign call letters to vessels equipped in this country and flying their flags until descriptions of the apparatus installed were forwarded to their government offices. This, of course, cannot be done by telegraph, for they provide official documents of considerable length for the purpose. Therefore it has been found necessary to assign temporary call letters, and this is an inconvenience that can so easily be obviated, that I thought it worthy of mention.

Mr. Davis has given us some very practical views in regard to radio operators and radio communication generally. While it is true that an ideal operator is a man who possesses sound knowledge of the apparatus, is capable of effecting repairs in case of emergency, and is also a good telegrapher, I do not feel that I should wish to place technical knowledge on the part of the operator above his ability to telegraph. Our experience has been that the combination of a good operator and a good technical man is a rarity. Generally speaking, it seems that a radio operator is either a good technical man, and an unskilled telegrapher, or else a good telegrapher and deficient in his knowledge of the apparatus and his ability to effect repairs. Occasionally, it is true, an ideal combination is found but where this is so, the man does not remain an operator. The radio companies usually provide him with a better position.

I still maintain that speed is a very necessary and very desirable qualification of a radio operator, for the simple reason that there is no other means of communication where the telegraphing ability of an operator is so important to the general working of the entire system. As I have pointed out, the wave length regulation, interference, static and the many other elements which make radio communication difficult, require a speedy disposition of traffic, and as others must wait before an operator finishes with his transmission, it is obvious that the sooner he concludes, the greater the opportunity for others to work. Mr. Davis has told us that failure on the part of an

operator to transmit or receive his business during a period of 5 minutes or so, when work is being done on schedule hours, often means that the operator may not have an opportunity to send or receive his messages perhaps for 8 or 10 hours. Added to this is the fact that vessels are continually getting out of range, and poor operating ability often results in a total loss of the message.

Mr. Hogan has told us, and he is quite correct, that a great many operators send at what seems to them to be a tremendous speed but forget to send Morse properly or to space properly. We do not, of course, disassociate speed from ability to send clean Morse and space properly. Those who send quickly but inaccurately are not telegraphing; they are simply manipulating the key. Perhaps it would help us to understand better what is meant by speed when I say that I do not mean that a man must send faster than the average operator is able to receive. I should say that an operator transmitting at the rate of from 20 to 25 words per minute (5 letters to a word), sending properly without nervous effort, and without repetition, is operating at a most desirable speed, and one which will be most suitable to the average radio receiving operator.

Mr. Simon has raised the question as to whether a ship station should have to work with the nearest coast station, and he calls attention to the fact that very often this may result in a financial loss to the shipping company, or the radio company controlling the installation on a vessel which may come within this regulation. Of course, this rule works both ways, for it is an entirely reciprocal arrangement; and while it may be true that a United Fruit Company boat, for example, is required to transmit its messages to the nearest radio coast station which may be a Marconi station, it is also true that a ship fitted with Marconi apparatus is required to transmit to the nearest coast station which may be controlled by the United Fruit Company. Also, with the present wave length regulation, it is indeed highly desirable that a ship should work with the nearest coast station, and thereby avoid adding to the already considerable amount of interference. It is obvious, of course, that a ship working with the nearest coast station furnishes that coast station with strong signals, and therefore traffic can be dispatched with greater ease and speed, thus avoiding the necessity for repetition and consequent loss of time.

Before I conclude, I should like to comply with Mr. Marriott's request and say a few words regarding the proposed Marconi

trans-Atlantic stations. Owing to the present unfortunate European situation, the British Government has appropriated for its use the high powered stations at Clifden in Ireland, Towyn and Carnavern in Wales; and it is therefore not possible for the American Marconi Company to open to the public its stations at Belmar and New Brunswick, N. J. The traffic arrangements proposed, however, are briefly the following:

We have opened a large office at 42 Broad Street, which will be the head office of the Marconi Telegraph Cable Company. Messages intended for Europe will be received at this office, and from there transmitted over the wire to Belmar, N. J. There are two wires running between the Broad Street office and Belmar, and each of the wires is duplexed. There are also four wires running between Belmar and New Brunswick, N. J., which stations are separated by a distance of approximately 30 miles. In the case of a message filed at Broad Street, for transmission abroad, the operator at Broad Street will transmit the message over the wire to the Belmar station, which in turn will punch the transmitting tape either by hand, or possibly by means of the Kleinschmidt perforator. The perforated slip will then be put thru an automatic Wheatstone transmitter which will operate the main relays at Brunswick over the 30-mile wire. The main relay will break the transformer current, and effect the actual radio transmission. In the case of messages received from Europe, Belmar will act as the receiving station. Messages will be received directly, either on the dictaphone or the telegraphone; probably the former. As the wax cylinders become filled with signals, they will be sent out to an adjoining room, put on another machine, and the operator will transcribe the message making a copy directly on the typewriter. This copy will be handed to the land-wire operator for transmission to the Broad Street station, and thence delivered to the point of destination.

In answer to a question from Mr. Hogan, I wish to state that the Creed-Bille system may prove of very material use in our trans-Atlantic scheme. I know that the Marconi engineers considered its use very seriously, and that tests have been and are being conducted with this type of apparatus.

In conclusion, I wish to thank Mr. George De Sousa, Traffic Manager of the Marconi Wireless Telegraph Company of America most heartily for the very kind assistance he has given me in the preparation of this paper.

Robert H. Marriott: In answer to Mr. Sarnoff's contentions regarding the direct handling and delivering of messages and the payment of commissions on the basis of business handled, I considered the entire radio traffic as a whole. The remarks apply more particularly to vessels not under the United States flag.

It will be remembered that I described a case where an antenna, the natural wave length of which was 400 meters, was to be used at 492 meters with the coupling coil only in the antenna. It was objected that the decrement would be too high. I will say that I have had no particular difficulty in obtaining two-tenths decrement for such arrangements as I described.

In connection with the use of short wave lengths, it is to be noted that I have not advocated the use of short waves exclusively. What is proposed is the use of all wave lengths from short to long, and each for the purpose to which it is most adaptable. For example, two Savannah Line vessels, a few miles apart off Cape Hatteras, could easily communicate with each other using short waves and without interfering with Cape Hatteras, which latter might be at the same time communicating with a distant vessel on long wave lengths. This use of short waves at diminished power should certainly prove effective in carrying on short range work without producing interference.

Alfred N. Goldsmith: Feeling that a number of matters referred to in Mr. Sarnoff's highly interesting paper were of such importance that a more detailed account of them might be desirable, I have written Mr. Sarnoff in connection with several of these points and am placing certain of his answers and my comments thereon before the Institute.

It will be remembered that Mr. Sarnoff referred to the action of the Mexican Government in demanding a cash deposit from the Marconi Company before permitting any of its shore stations to work with the Marconi stations. According to Mr. DeSousa, the following is the case. Speaking for the Marconi Company he says:

"Up to the present time we have not received a refund of the \$1,000 (Mexican money), which we deposited with the Mexican Government on October 9, 1913. We have been endeavoring to get a refund from the Mexican Government ever since the Berlin and London Conventions were ratified by the United States. On December 12, 1913, the Director of Telegraphs, Mexico City, stated that the Mexican Government had not

received, up to that time, from the Navy Department at Washington, the 'indispensable' data required to settle the radio telegraph account, and that it was not possible to return the deposit until such information had been received.

"The remarks of the Mexican Director General of Telegraphs were conveyed to the United States Naval Radio Service, and on February 28, 1914, the Superintendent of Radio Service notified us that the Department of State of the United States had suitably informed the Embassy at Mexico City in regard to the matter on January 13, 1914."

It will be noted that the radio companies insist on a word rate basis for the payment of messages and favor the abolition of a minimum length of message payment. The reasons given by Mr. Sarnoff for this attitude are as follows:

The advantages of the word rate basis as opposed to the minimum length of message system are:

- A. It facilitates the exchange of international telegrams, which is now impossible.

In this connection it should be noted that the United States land line telegraph companies make no charge for the address and signature; simply charging for the text of the message, which is on the basis of a 10-word minimum. That is, this is the system for their ordinary domestic messages. In the case of radio traffic, however, they are required, in accordance with the provision of the International Convention, to charge for all words in a message, including the name, address, and signature on a word rate basis with an optional minimum not exceeding 10 words.

The cable companies apply no minimum and this is also the case with the European telegraph companies or government administrations which control the telegraph business. So that in the case of a person wishing to send a radio message from some point in the United States to a vessel communicating with a foreign coast station the procedure would be rather complicated.

- B. It simplifies accounting.
- C. It affords great uniformity in the method of handling radio messages.

In the paper are shown some of the difficulties that arise in the handling and account of radio messages when some radio companies apply a 10-word minimum, other radio companies apply no minimum, the cable company applies no minimum, and the land line companies do apply a minimum on radio messages, but in a different manner from that in which they apply them to their domestic messages.

D. The public pays only for as many words as it actually uses.

It is of interest to know what the ship tariff on messages is and what portion of this tax goes to the ship station and what portion goes to the shore station. Generally speaking, vessels of the United States apply a ship tax of 4 cents per word, and vessels of other nationalities, 8 cents per word. The division of tolls on a message is 40 per cent. to the ship station and 60 per cent. to the coast station.

I have often been told that a good telegrapher is generally a poor technical man, and vice versa. Mr. Sarnoff has also mentioned this fact. I therefore asked him whether he thought it was because of insufficient or improper training of the operator and could be remedied in the future; or whether he believed that, in general, skill as a telegrapher was incompatible with thorough technical knowledge. I suggested further that if these characteristics were really mutually exclusive, it might be necessary to amend the existing law so as to include one good technical man on board each boat and one able telegrapher. In answer to my query, Mr. Sarnoff has stated that he believes lack of training to be the factor more responsible for the deficiencies of many radio operators. He certainly believes, in view of existing improvements, that a remedy is possible. He would secure this in two ways: by training thoroughly able telegraphers in the technical side of radio operation, and by making apparatus more sturdy and simple in operation. This being possible, he does not regard the revision of the law described above as necessary

THE RESISTANCE OF THE SPARK AND ITS EFFECT
ON THE OSCILLATIONS OF ELECTRICAL
OSCILLATORS.*

By

JOHN STONE STONE.

*(Vice-President of The Institute of Radio Engineers, and Past
President of the Society of Wireless Telegraph Engineers.)*

The working theory of the electrical oscillation circuit of today is still that of the oscillatory discharge of a condenser thru a coil first given by Professor William Thompson, the late Lord Kelvin, in a classical paper entitled "On Transient Electric Currents," which he contributed to the *Philosophical Magazine* in 1853.† It is, of course, much to the credit of any working theory that it should so successfully stand the test of time. In this connection, however, we must not lose sight of some facts which have a bearing on this point. In the first place, there was practically no industrial use of oscillation circuits prior to the advent of radiotelegraphy, and tho radiotelegraphy began to assume the aspects of an industry some ten years or more ago, it has only become at all common to make quantitative measurements of the high frequency currents in the aerial and in the closed oscillation circuit of radiotelegraphic apparatus within the latter half of that period. Furthermore, while it has been a comparatively easy matter, with the aid of Braun cathode ray tubes, to make oscillagrams of the phenomena taking place in electrical oscillation circuits, of relatively low natural frequency, and thus to compare the nature of the oscillations taking place in these low frequency oscillators with the predications of the mathematical theory of Thompson, it has been quite impossible to make such explicit comparisons or tests of the applicability of this mathematical theory to such extremely high frequency oscillation circuits as are commonly employed in radio spark telegraphy. This difficulty in producing oscillagrams of the

* Presented before The Institute of Radio Engineers, New York, May 13, 1914.

† *Phil. Mag.*, 1853, Ser. 4, Vol. V., page 393.

oscillations taking place in a very high frequency oscillation circuit, does not, however, as we shall see presently, prevent us from otherwise making the desired comparison between the requirements of the working mathematical theory and the salient characteristics of the actual oscillations which take place in such circuits; and tho this comparison is less direct, it is perhaps none the less conclusive.

The Thompson theory states that if a condenser of capacity C be charged to a voltage V and be then discharged thru a coil having a resistance R and an inductance L, the discharge will be oscillatory in character, provided $\frac{R^2}{4L^2}$ is less than $\frac{1}{CL}$ and that the oscillatory current flowing at any time t after the close of the circuit may be expressed as:—

$$i = Q_0 \frac{\omega^2 + \alpha^2}{\omega} e^{-\alpha t} \sin \omega t$$

Where

$$Q_0 = CV.$$

$$\alpha = \frac{R}{2L}$$

and

$$\omega^2 = \frac{1}{CL} - \alpha^2 = \omega_1^2 - \alpha^2$$

In the foregoing Q_0 is, of course, the initial charge of the condenser and ω_1 or $\frac{1}{\sqrt{CL}}$ is the *free* periodicity of the circuit formed

by the condenser and the coil, or the periodicity to which that circuit would respond resonantly if isolated from other circuits and acted upon by a constant electro-motive force of that periodicity.

The periodicity ω is the *natural* periodicity of the circuit; and is the periodicity of the electrical oscillations which, according to the theory, result in it when its electrical equilibrium, so to speak, is in any way abruptly disturbed and it is thereafter left to itself.

Figure 1 illustrates the decrescent train of oscillations predicated by this theory, to which I shall hereafter refer as the logarithmic decrement theory, and it has been demonstrated by means of oscillagrams that this theory represents, with a very fair degree of accuracy, the oscillations which take place in oscillation circuits of relatively low natural periodicity, where the resistance of the spark is nil or is completely inferior to, and

therefore masked by, the conductor resistance of the circuit. But in the case of the extremely high frequency oscillators of radio-telegraphy, and in fact in any oscillator in which the spark resistance is the major dissipative resistance of the circuit, we should not expect this theory to be in close accord with the actual phenomena; and empirical evidence shows quite conclusively that the logarithmic decrement theory does not represent the phenomena, even qualitatively, when the spark resistance is the dominant resistance.

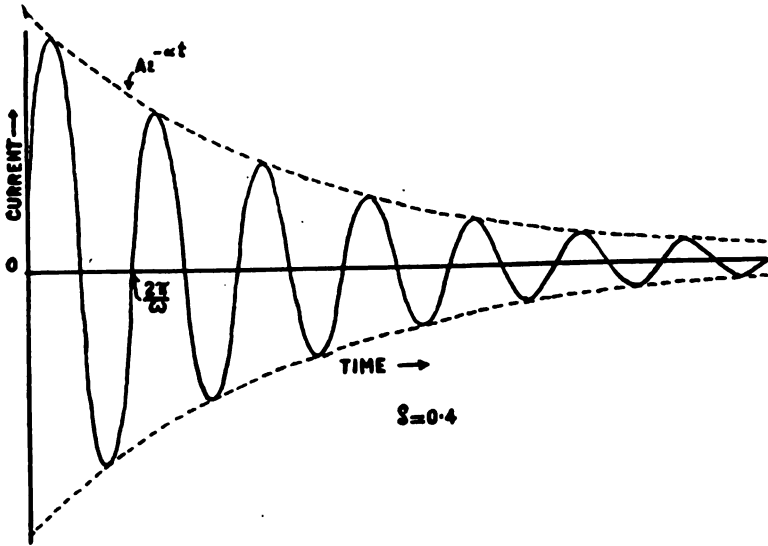

FIGURE 1

I have, at least by implication, distinguished between the laws governing the oscillations which take place in high and low frequency electrical oscillation circuits, and the fact is that the difference between a high frequency oscillation circuit and a low frequency oscillation circuit is one of kind and not merely one of degree or of the relative dimensions of the electrical constants, as is sometimes assumed.

A high frequency oscillator is not merely the replica of a low frequency oscillator on a smaller scale, as to its resistance, inductance and capacity. The low frequency oscillator is essentially one in which the initial resistance of the spark, if there be a spark, is small compared to the conductor resistance of the oscillator, while a high frequency oscillator is essentially of a kind in which the initial resistance of the spark is large compared to the conductor resistance of the oscillator or at least is compar-

able thereto. This distinction may perhaps be most easily apprehended by considering a numerical example in which a relatively low frequency oscillator is compared with a high frequency oscillator.

Let the low frequency oscillator be one whose periodicity ω_a is 6.28×10^3 , a periodicity which corresponds to a frequency of 1,000, and let the free periodicity ω_h of the high frequency oscillator be 6.28×10^6 , a periodicity which corresponds to a frequency of 1,000,000. Further, let the inductance L_a and capacity C_a of the low frequency oscillator be 1,000 times as great as the inductance L_h and capacity C_h respectively, of the high frequency circuit. If the energy of the oscillation is to be the same in the two circuits we must have,

$$C_a V_a^2 = C_h V_h^2$$

where V_a and V_h are respectively the initial voltage of the charge in the low and high frequency circuit condensers. From this we see that $V_h = 31.6 V_a$ or that the voltage of the initial charge of the condenser of the high frequency circuit must be 31.6 times as great as that of the initial charge of the condenser in the low frequency circuit in order that the energy of the dischargers be the same in the case of the two oscillators. Thus we see that if the initial voltage in the case of the condenser of the low frequency circuit be 1,000 volts, a voltage at which there is practically no spark on closing the circuit, the initial voltage in the case of the condenser of the high frequency circuit must be 31,600 volts, which corresponds to the spark gap of about 1 cm. between ball electrodes of 2 cm. diam. Considering now the conductor resistance of the two oscillators, it is not to be expected that the conductor resistance of the inductance coils in the two circuits will be in the same proportions as the inductances of the circuits, but the least proportion which can fairly be assumed between them is that they are proportional to the square root of the inductances. In the case of the low frequency oscillator in question, therefore, the spark gap is almost infinitesimal, and the spark resistance is at a minimum, while in the corresponding high frequency oscillator the spark is so large as to give rise to the rapid dissipation of the energy of the oscillations and the conductor resistance of the oscillator is less, and in practice would be considerably less, than $\frac{1}{30}$ th of that of the low frequency oscillator.

More space has been given to this elementary consideration of the inherent difference in kind between high and low frequency

oscillators than might perhaps seem necessary except that the existence of such a distinction between the two classes of oscillators does not seem to have been elsewhere clearly stated, and because a failure to make this distinction has led many to assume that the verification of the logarithmic decrement theory for low frequency oscillators implies its applicability to high frequency oscillators, a proposition which we shall see is not, at least in the majority of instances, at all justified.

Even tho the rapidity of the oscillations in high frequency oscillators seems to place an insuperable difficulty in the way of any one attempting to make clear and quantitative oscillagrams of these oscillations, nevertheless quantitative measurements may be made of the amplitudes of the individual oscillations of such circuits; and by a comparison of these, the law of the decay of the oscillations in such circuits can be determined. These measurements entail the use of a Braun cathode ray tube and do not differ materially in procedure from that by which the oscillagrams of the low frequency oscillations are secured; except that in the case of the measurement of the high frequency

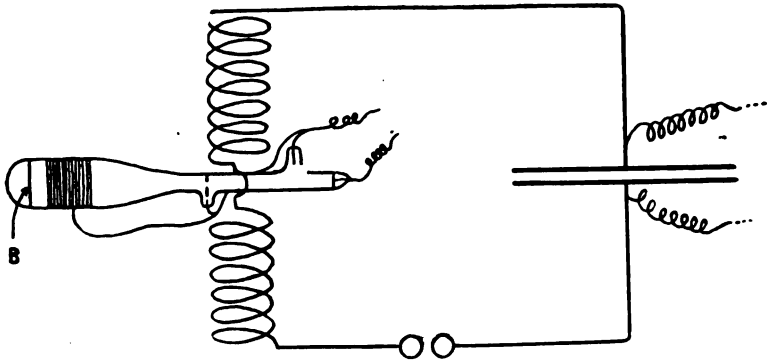

FIGURE 2

circuit no attempt is made to expand vertically the luminous horizontal band produced by the cathode ray and thus secure the familiar wavy decrescent line of the oscillagram. In these measurements of high frequency circuits the neck of the Braun tube passes thru the portion of the oscillator coil at which the oscillatory magnetic field is a maximum (see Figure 2). The cathode ray playing on the screen B of the tube is deflected to the left by the oscillations in one direction and to the right by the oscillations in the opposite direction, and makes, upon a juxtaposed photographic plate, a record which is of the character

shown in Figure 3. Since the cathode ray in oscillating to left and right moves most slowly near the end of each swing as does the bob of a swinging pendulum, it excites greater phosphorescence in the screen B at points corresponding to the ends of the



FIGURE 3

swings, and this it is that produces the bright spots in the band of light on the photographic plate. Measurements of the distances of the bright spots from the central point permit of the plotting of such a curve as that of Figure 4, which shows the

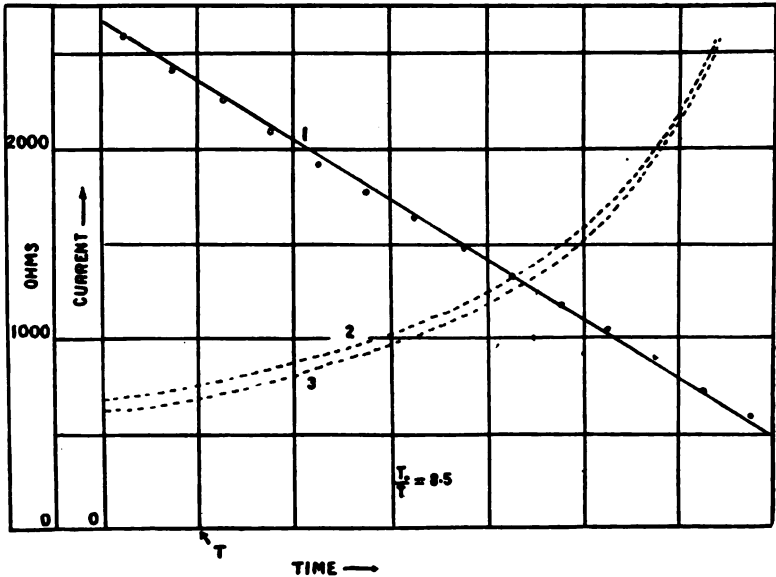

FIGURE 4

way in which the successive oscillations diminish in amplitude with time. Figures 4 and 5 are drawn from data given by Dr. Zenneck in his works* because his data are more complete and conclusive on the points which it is desirable to bring out here than that derivable from any of my own observations.

* § 218 (a) Chapt. IX, Vol. I, "Electromagnetische Schwingungen und Drahtlose Telegraphie."—Also § 11 (b) Chapt. I, "Leitfaden der Drahtlose Telegraphie."

By this method of measurement no information is gained as to the frequency of the oscillations, nor as to the law of decay of the oscillations at or near the point of their final disappearance. These defects are not of much practical importance, however, as the frequency may be more accurately investigated thru the use of a very loosely coupled resonant secondary having no spark gap to introduce indeterminate aberrations than by any

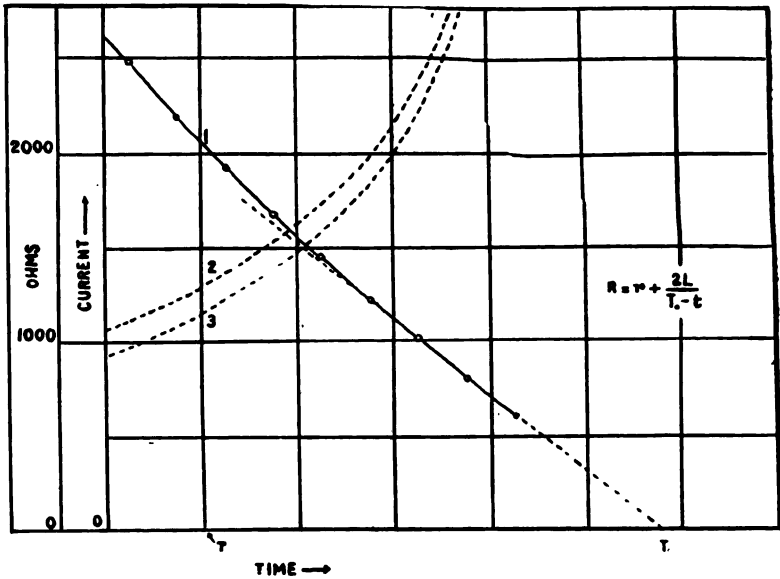

FIGURE 5

oscillogram, while the question of the end of the train of oscillations is of only minor importance since by the time the amplitude of the oscillations has reached one-fifth its initial value, the energy of the remaining oscillations represents only 4 per cent. of the total energy of the train.

When we investigate thus the rate of decay of oscillations in a high frequency oscillation circuit in which the conductor resistance is negligible compared to that due to the spark, we find that the decay or subsidence of the oscillations is a linear function of the time, as shown in Figure 6, and not an exponential function as shown in Figure 1.

The observations of the amplitudes in curve 1 of Figure 4 lie almost exactly on a straight line, while the observations of amplitude in curve 1 of Figure 5 lie on a line which is approximately a straight line but which shows a slight curvature during

the first two oscillations of the current. The explanation of the deviation from the strictly linear subsidence in the case of Figure 5 is that tho these observations were made with the same coil and condenser as those of Figure 4, there was added to the oscillation circuit in the case of the test of Figure 5 a conductor resistance of 80 ohms.

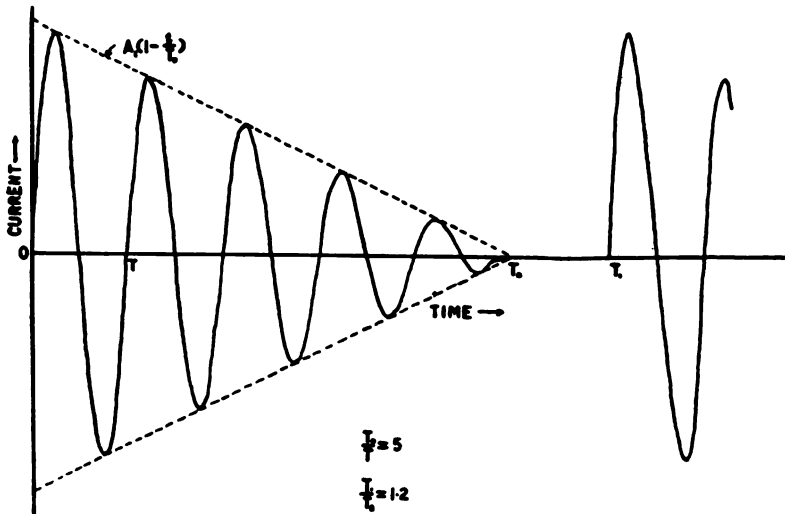

FIGURE 6

From these and similar observations on circuits in which the spark resistance is preponderant, it is evident that the amplitude of the oscillations may be represented analytically by the expression $A_1 - B_1 t$, where A_1 is the initial amplitude and (minus B_1) is the *constant rate of subsidence* or decay of the oscillations with time; and that this expression may be substituted for the exponential factor $e^{-\alpha t}$ of the logarithmic decrement theory in dealing with such circuits. To secure a consistent mathematical theory of the oscillations of circuits in this class, it is however necessary to reconcile this mode of subsidence with the circuital equation of the electrical oscillator, and for this purpose we will write the expression for the current i at any instant of time t after the disruption of the dielectric at the spark gap, as

$$i = (A_1 - B_1 t) \sin \omega' t, \quad (2)$$

in which we make no assumption as to A_1 , B_1 or ω' except that they are not functions of t or i .

The circuital equation of the oscillator which we must use is:—

$$L \frac{di}{dt} + \frac{1}{C} \int i dt + Ri = 0 \quad (3)$$

If we substitute the value of i for (2) in this equation we get,

$$\left(L \omega' - \frac{1}{C \omega'} \right) (A_1 - B_1 t) \cos \omega' t + \left\{ R (A_1 - B_1 t) - B_1 \left(L + \frac{1}{C \omega'^2} \right) \right\} \sin \omega' t = 0 \quad (4)$$

For all values of t which makes $\sin \omega' t$ vanish we have

$$L \omega' = \frac{1}{C \omega'},$$

from which it follows that

$$\omega'^2 = \frac{1}{CL} = \omega_1^2 \quad (5)$$

the physical significance of which is that the natural periodicity of oscillation of these circuits is the same as the free periodicity and is independent of the resistance of the circuits. This is a point of deviation from the logarithmic decrement theory in which

the periodicity of the natural oscillations is $\omega = \sqrt{\frac{1}{CL} - \frac{R^2}{4L^2}}$

while the free or resonant periodicity is $\omega_1 = \frac{1}{\sqrt{CL}}$.

For values of t which make $\cos \omega' t$ vanish we have from equation (4)

$$R (A_1 - B_1 t) = B_1 \left(L + \frac{1}{C \omega'^2} \right) \quad (6)$$

Substituting (5) in (6) we have

$$R = \frac{2 B_1 L}{A_1 - B_1 t} \quad (7)$$

the physical significance of which is that the resistance of the spark is inversely proportional to the *amplitude* of the oscillatory current.

It remains to determine the constants A_1 and B_1 .

In the first place, it is evident that $B_1 = \frac{A_1}{T_0}$, where T_0 is the time from the beginning of the oscillations till they cease altogether. The expression for the current may therefore be written:

$$i = A_1 \left(1 - \frac{t}{T_0} \right) \sin \omega_1 t \quad (8)$$

A_1 may be determined either by the condition that $\int i dt = Q_0$, which means that the total flow of electricity thru the circuit during an oscillation train must equal the initial charge Q_0 in the condenser, or it can be determined by the condition

$$\int_0^{T_0} i^2 R dt = \frac{1}{2} C V_0^2,$$

the significance of which is that the total energy dissipated in an oscillation train must equal the energy of the initial charge of the condenser.

These two methods give consistent results by which $A_1 = Q_0 \omega_1$, provided that $\frac{2 T_0}{T}$ is an integer. The physical interpretation of this condition is that the oscillation train comes to an end at a time when the oscillating current would normally be zero. The condition of maximum deviation from this is when the oscillation train is assumed to come to an end at a time when the oscillatory current would otherwise be at a maximum. It may be shown that in that event A_1 would be slightly greater than $Q_0 \omega_1$, but this difference will always be small even when the damping is large or when the ratio $\frac{T_0}{T}$, which is equal to the number of complete oscillations in an oscillation train, is not very large.

The complete expression for the current may therefore be written,

$$i = Q_0 \omega_1 \left(1 - \frac{t}{T_0} \right) \sin \omega_1 t \quad (9)$$

or if we call R_0 the initial resistance at $t = 0$ we have $T_0 = \frac{2L}{R_0}$ so that the most explicit form of the expression for the current is,

$$i = \frac{Q_0}{\sqrt{CL}} \left(1 - \frac{R_0 t}{2L} \right) \sin \frac{t}{\sqrt{CL}} \quad (10)$$

It is extremely simple. $\frac{Q_0}{\sqrt{CL}}$ represents the initial amplitude, $\left(1 - \frac{R_0 t}{2L} \right)$ represents the subsidence of the amplitudes and $\frac{1}{\sqrt{CL}}$ represents the natural periodicity of the circuit.

Each of these factors is different from and more easy to compute than the corresponding factor in the logarithmic decrement theory but these are not the more important points of distinction between the new and the old theories.

In the first place, in the circuits to which the logarithmic decrement theory applies, the ratio of the amplitudes of consecutive oscillations is a constant. Thus if I_n and I_{n+1} represent the amplitudes of the two successive oscillations of period T , then

$$\frac{I_{n+1}}{I_n} = \varepsilon^{-\alpha T} \quad (11)$$

which is the constant known as the *damping*, while αT is known as the *logarithmic decrement per cycle*. In the circuits to which the new linear theory applies it is not the ratio $\frac{I_n}{I_{n+1}}$ that remains constant but the difference $I_n - I_{n+1}$, and we have

$$I_n - I_{n+1} = A_1 \frac{T}{T_0}, \quad (12)$$

which is also a constant, and in which $\frac{T}{T_0}$ is the reciprocal of the number of complete oscillations in a train. The ratio $\frac{T}{T_0}$ is evidently the true *damping* in the case of circuits to which the new linear theory applies and corresponds to the quantity $\varepsilon - \alpha T$ of circuits to which the logarithmic decrement theory applies.

It is interesting to note that while in the logarithmic decrement theory no oscillations can occur unless the resistance is less than $2\sqrt{\frac{L}{C}}$, it is easy to see that in the case of circuits in which the linear subsidence prevails, oscillations will occur as long as

$$R_0 < \frac{2}{\pi} \sqrt{\frac{L}{C}} \quad (13)$$

The distinction between the theory which is likely to be of most practical importance, however, results from the fact that while under the logarithmic decrement theory the oscillations continually diminish in amplitude with the lapse of time, they theoretically never reach zero, while in the new theory they reach zero mathematically as well as physically after the very definite time T_0 , or after the very definite number of half oscillations $\frac{2T_0}{T}$.

This does away with the chief difficulty to be met with in applying the comparatively simple mathematics of ordinary undamped alternating currents or currents of constant amplitude to the damped oscillations of the circuits to which the linear subsidence theory applies. It enables us to express in a comparatively simple and elementary way the usual succession of oscillation trains with definite spark frequency as the sum of a number of simple alternating currents, each of constant amplitude, and does away with the difficulties which arise in the case of the logarithmic decrement and which are of purely mathematical origin, due to the overlapping of the purely fictitious tail of each train of oscillations by the equally fictitious tail of every other train. Thus it may be shown that if we designate the time interval between these successive sparks or the reciprocal of the spark or group frequency by T_1 , then

$$i = \sin \omega_1 t \sum_1^{\infty} a_m \sin \frac{m \pi}{T_1} t \quad (14)$$

where
$$a_m = 2 \frac{A_1}{m \pi} \left(1 - \frac{T_1}{m \pi T_0} \sin \frac{m \pi T_0}{T_1} \right)$$

m taking successively the positive integer values.

The determination of the alternating current which will be induced in a very loosely coupled secondary or wave meter, becomes extremely simple, and the interpretation of the reading of an alternating current instrument in either the primary or secondary circuit becomes correspondingly simple.

The computation of the above series is perhaps a bit troublesome when $\frac{T_1}{T_0}$ is not an integer and when T_1 is large compared

to T_0 . But this need lead to no particular difficulty in interpreting the readings of instruments in the primary circuit, because so long as the wave trains do not overlap or $T_0 < T_1$, readings of the instrument will, other things being equal, be proportional

to the spark frequency $\frac{1}{T_1}$. It therefore becomes possible to

conduct all computations on the basis of a ratio of $\frac{T_0}{T_1} = 1$ and

to correct by multiplying the current or voltage reading of the

instrument by the actual ratio $\frac{T_1}{T_0}$.

When $\frac{T_1}{T_0} = 1$ in the sine series for i we have,

$$i = \frac{2A_1}{\pi} \sin \omega_1 t \sum_1^{\infty} \frac{1}{m} \sin \frac{m\pi}{T_1} t \quad (15)$$

and the series is rapidly convergent.

Returning now to a consideration of Figures 4 and 5, curve 1 shows the manner of subsidence of the oscillations with time, curve 2 shows the total resistance of the circuit at any time, and curve 3 the spark resistance calculated by the expression

$\frac{2L}{T_0 - t}$ which we see is the equivalent of the expression (7) if we

remember that $\frac{A_1}{B_1} = T_0$.

Inspection of these curves leads to the conclusion that the departure from the linear law of subsidence is inappreciable when the conductor resistance is 10 per cent. or less of the total initial resistance of the circuit. Curves 2 and 3 are drawn as smooth curves in spite of the fact that there is nothing in the determination of expression (7) to justify this, since the expression (7) for R is determined only for values of t which make

$\cos \omega_1 t = 0$, or $t = \frac{m\pi}{2\omega_1}$ where m is any integer. But tho I have

given no analytical support to this tacit assumption that the resistance undergoes no cyclical changes in each oscillation in the circuits with which we are dealing, there are nevertheless very substantial grounds for the proposition that when the conditions are such as to give the linear subsidence of amplitudes,

the spark resistance is given by the expression $R = \frac{2L}{T_0 - t}$ and

suffers only immaterial cyclical variations.

It has long been known that if a steady unidirectional current i pass across an air gap between two metallic or graphite carbon electrodes, the relation between the current and the voltage across the gap is given very closely by an expression of the form,

$$V = a + \frac{b}{i} \quad (16)$$

where a and b are constants over a certain range in the values of the current.

If we call $\frac{V}{i}$ the resistance of the gap (and for the use we are going to make of this ratio we are justified in doing so), then the resistance of the gap is

$$\rho \equiv \frac{V}{i} = \frac{a}{i} + \frac{b}{i^2} \quad (17)$$

If, therefore, we vary the current flowing across the gap in question with extreme slowness, measuring the while the voltage across the gap, and compute the values of the resistance ρ for a

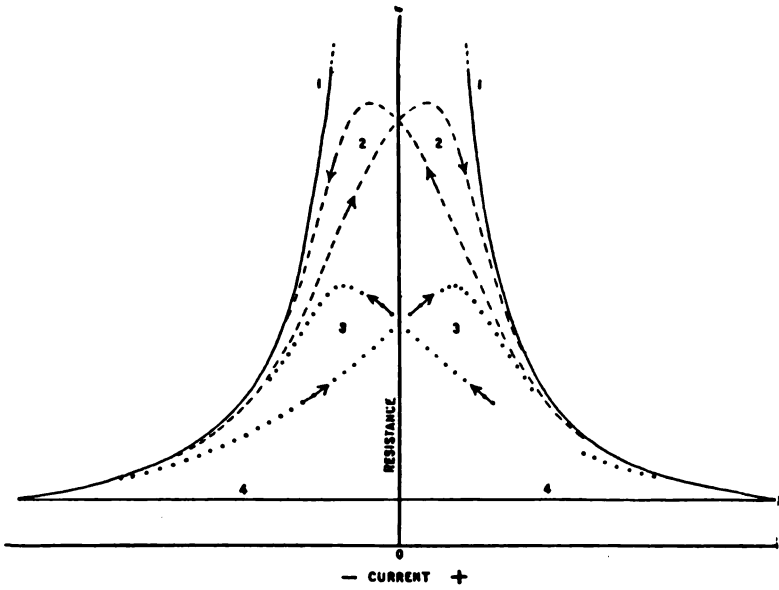

FIGURE 7

sufficient number of different values of the current, we should find that this resistance varied with the current after the manner shown in curve 1 of Figure 7; the resistance increasing indefinitely as the current diminishes and becoming infinite when the current becomes zero. Similarly if an alternating current of extraordinarily low frequency were to be passed across the gap, then the relation between the current and the voltage across the gap would be illustrated by the curves 5 and 1 respectively of Figure 8, from which it will be seen that the voltage increases indefinitely as the current approaches zero and becomes infinite at or very near the time the current vanishes. This may be called the static theory of the resistance voltage and current at

the gap, because it represents the conditions after the resistance of the gap has reached a steady state for each value of the current flowing, but when the changes of current strength take place with

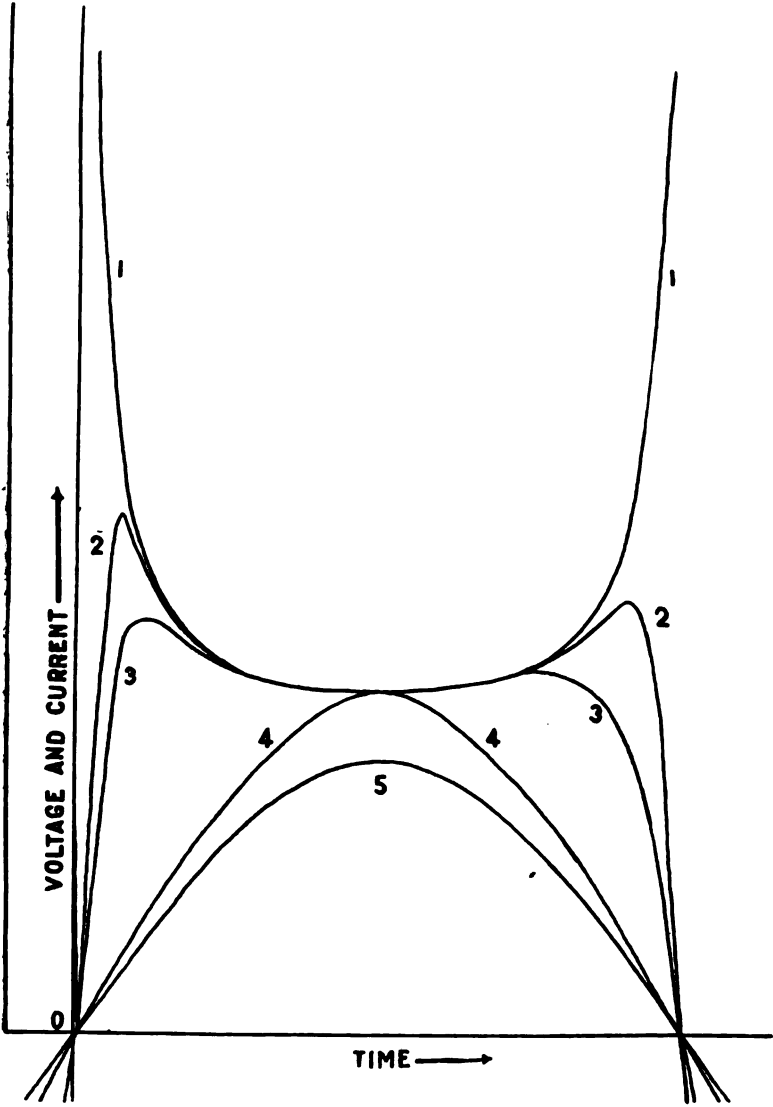

FIGURE 8

considerable rapidity, a very different set of phenomena are observed. The resistance of the gap is then seen to depend not only on the current flowing at the instant, but also upon the current which has been flowing during an appreciable interval of

time preceding it. In other words, the resistance of the gap shows a species of hysteresis or lagging behind the current variations. Thus if the simple harmonic current of curve 5, Figure 8 be of a moderate frequency, say 100 cycles per second, then the voltage at the terminus of the gap will no longer correspond to curve 1 of that figure, but will be of the character of curve 2 Figure 8. In that case the resistance variation with current will be that shown by curve 2 of Figure 7. If now the frequency of the simple harmonic alternating current of curve 5 of Figure 8 be doubled, the voltage across the gap would be that shown by curve 3, Figure 8; and in that case the resistance variation with current will be that shown by curve 3, Figure 7. It is easy to see that as the frequency of the current of curve 5 of Figure 8 is continually increased, the voltage curves will continually approach the simple harmonic curve 4 of that figure, and the corresponding resistance curves of Figure 7 will continually approach the constant value indicated by the line 4 in Figure 7. In other words, the resistance, owing to its marked hysteresis, will not have time to execute a cyclic change during a cycle of a high frequency oscillation and will only have time to follow the changes in the amplitude of the oscillations.

The above considerations apply to quenching gaps, but not to gaps in hydrogen or hydro-carbon gases or in flames or to gaps equipped with powerful magnetic blow-out fields.

It will be seen that the linear subsidence theory is as extreme in one direction as the logarithmic decrement theory is extreme in the other direction, the one theory requiring that the effects of the conductor resistance shall be very small compared to that of the spark resistance and applying particularly to certain high frequency circuits, while the other requires that the effects of the spark resistance shall be very small or negligible compared to the conductor resistance, and applying particularly to certain low frequency circuits. A great many oscillation circuits, and probably the majority of oscillation circuits, are intermediate between the two classes mentioned, and I hope soon to present a paper giving the theory of such circuits in some detail.

Before closing it may be well to consider briefly the effects of dielectric hysteresis, since when this is present in the condensers, it reproduces a virtual resistance in the circuit which in a manner determines the damping of the oscillations.

In the absence of dielectric hysteresis, if we have a voltage $E \sin \omega t$ across the terminals of a condenser of capacity C , the current which flows through the condenser will be $EC \omega \cos \omega t$,

and the ratio of the current to the voltage across the condenser, which, for lack of a better term, we may call the instantaneous value of the admittance of the condenser, will be $C \omega \cot \omega t$. But if, owing to dielectric hysteresis, the current through the condenser lags by an angle θ , then the instantaneous value of the admittance becomes

$$\frac{I}{E} (\cos \theta \cot \omega t + \sin \theta)$$

where I is the amplitude of the current.

From this we see that the condenser acts like a condenser of air dielectric of capacity $\frac{I}{E \omega} \cos \theta$ in parallel with a conductance of value $\frac{I}{E} \sin \theta$.

In other words, the condenser having a definite hysteretic angle of lag is the equivalent of a condenser without hysteresis *shunted* by a resistance which is very nearly inversely proportional to the frequency of the current.

A quantitative study of this subject is to be found in Dr. Austin's admirable paper read before The Institute of Radio Engineers last year, and appearing in the Proceedings of the Institute for April, 1913. Suffice it therefore to say here that as the hysteretic conductance of the condenser is directly proportional to the capacity of the condenser and very nearly so to the periodicity of the oscillations, while the product of the capacity by the periodicity remains the same in high and low frequency circuits considered as two classes, this hysteretic conductance will be the same for the class of high as for the class of low frequency circuits. As this hysteretic conductance $\frac{I}{E} \sin \theta$ is in parallel with a condenser conductance $\frac{I}{E} \cos \theta$, its relative importance is therefore the same in low and high frequency circuits.

The corresponding resistance or impedance function of the hysteretic condenser is

$$Z = \frac{E}{I} \frac{1}{\sin \theta + j \cos \theta} = \frac{E}{I} (\sin \theta - j \cos \theta)$$

where $j = \sqrt{-1}$.

This shows that the hysteresis may be represented by a hysteretic resistance $\frac{E}{I} \sin \theta$ which is very nearly inversely proportional to the periodicity in series with the condenser of capacity $\frac{E}{I \omega \cos \theta}$.

Therefore, if dielectric hysteresis is a pure hysteresis, we may represent it either by a conductance in parallel with the condenser, or by a resistance in series with the condenser. But from the above consideration of the subject the values of the capacity of the condenser will be very slightly different from each other in the two cases. This fact has not heretofore been recognized so far as I am aware, and this difference in capacity will in general be so small that it is questionable whether it could easily be observed with any of our present means; since $\cos \theta$ will always be very nearly unity in all workable condensers, and $\sin \theta$ will be an extremely small quantity.

It will, in general, be permissible to take I as equal to $EC\omega$. Then we have, for the apparent capacity C' in parallel with an apparent hysteretic conductance S' , $C' = C \cos \theta$ and $S' = C\omega \sin \theta$.

Correspondingly for this apparent capacity C'' in series with an hysteretic resistance R'' , we have

$$C'' = \frac{C}{\cos \theta} \text{ and } R'' = \frac{\sin \theta}{C\omega}.$$

SUMMARY: The author shows that the Kelvin theory of oscillating circuits (the logarithmic decrement theory) is applicable only when the spark resistance is small, and not when it is predominant in the circuit. In homologous circuits at audio and radio frequencies, the condenser potential difference will be much higher in the radio frequency circuit, and spark phenomena will control the law of current amplitude decrease. Braun tube oscillograms of radio frequency circuits with predominant spark resistance show a linear and not logarithmic decay of the current amplitude. For circuits having a linear decrement, the values of current and circuit resistance at the end of any time are derived. The new expressions, which are simple, are compared with those of the logarithmic decrement theory. The summational current effect for a number of wave trains, in the case of circuits having a linear decrement, is obtained and discussed. In studying leakage in condensers, it is shown that the effect of dielectric hysteresis in condensers is equivalent in effect to either a conductance in parallel with the condenser or a resistance in series with it. A new feature, namely the difference in the capacity value of the condenser in the two cases mentioned, is considered.

DISCUSSION.

Louis W. Austin: The most important theoretical deduction from Mr. Stone's interesting paper seems to be the lack of dependence on the periodicity of the resistance. This has a marked bearing on the calculation of quenching gap circuits.

Among circuits containing non-quenching gaps there will probably be few cases where Mr. Stone's present calculations would apply, except possibly that of a circuit made up of compressed air condensers and a single turn of inductance. In cases where a number of turns of inductance are used, and the spark is of moderate length and carries considerable current, the spark resistance usually would not amount to more than half of the total resistance. And in the case where the circuit is coupled to an antenna, the portion of the effective resistance due to the spark would be considerably less than this.

We shall look forward with great interest to the paper promised by Mr. Stone in which he will discuss the effects of both types of resistance.

Lee de Forest: When I was on the Continent in 1908, I was surprised to observe a general ignorance among European radio engineers of the genuine nature of the work of Mr. Stone in the theoretical and mathematical aspects of radio science.

His sterling contributions to the theory of natural and forced oscillations in "sonorous circuits"; his all-important discovery and masterful analysis of the now universally understood "Resistance Equivalent of Radiation"; his lucid graphical analysis of impedance, reactance and conductance of the most complicated "branch circuits"—all these matters which were for the first time explained in his manifold patent specifications, were quite unknown or unappreciated abroad.

Of late, however, a changed attitude is observed in occasional foreign reprints of some of Mr. Stone's important papers; something more nearly approaching justice to his brilliant work; and a greater willingness to accord to him the place among the few genuine leaders in radio thought which he so genuinely merits.

The Institute of Radio Engineers should take justifiable pride in having presented to it a paper of such obvious importance—a completely novel representation of phenomena with which all radio engineers have long considered themselves perfectly acquainted and yet which as Mr. Stone has so clearly shown,

have been consistently misunderstood and mis-analyzed, for these many years.

For our work, and in our peculiar fields, at least, this paper should rank in importance with the classic paper of Lord Kelvin which, for spark circuits, it must now supplant.

It is to me gratifying that the new theory is such a simple one, so easily applicable. It now seems (in light of Mr. Stone's lucid explanations) quite incredible that all previous writers on such subjects have persisted in applying to spark-damped oscillations a complicated and erroneous theory, one which so obviously fails to explain the numberless photographic records of decaying wave-trains in spark circuits.

Alfred N. Goldsmith: One of Mr. Stone's statements requires slight modification. The equation for a linearly damped current is

$$i = (A_1 - B_1 t) \sin \omega' t.$$

It is stated by the author that A_1 is the initial amplitude. Strictly speaking, this is not correct, since at time zero, $i = 0$. Consequently, a finite time will have elapsed before the first current maximum, or initial amplitude is attained. A first approximation to this time is obviously $\frac{T}{4}$ where T is the time of a complete oscillation. The value of $\sin \omega' t$ at that time is unity and

$$i = \left(A_1 - B_1 \frac{T}{4} \right)$$

It will be seen, therefore, that the initial current amplitude is slightly less than A_1 , and the difference will be proportional to the linear decrement of the circuit. To a first approximation, the same statement may be made for logarithmically damped circuits, except that the term "logarithmic decrement" must be substituted for linear decrement.

If a closer approximation to the initial amplitude is desired, it becomes necessary to equate the first derivative of i with respect to t to zero, and solve the trigonometrical (transcendental) equation obtained. The physical explanation of the discrepancy between the first approximation and the exact value of the initial amplitude is found in the fact that the curve of current decay is not tangent to the line

$$i = (A_1 - B_1 t)$$

at the points of maximum current amplitude. The maxima of

current always come slightly earlier than the points of tangency. Similar statements hold for the logarithmic decrement case.

It is interesting that the full possibilities of the Braun tube oscillograph are beginning to be realized. The excellent use which has been made of it by Zenneck and Rukop (*Physikalische Zeitschrift*, 14, page 226, 1913, and *Annalen der Physik*, 44, page 97, 1914), and by Chaffee (*Proceedings of the American Academy of Arts and Sciences*, 47, Number 9, page 267, 1911) shows its possibilities. Indeed, Chaffee showed conclusively by its use that the currents thru a copper-aluminum gap (in moist hydrogen) placed in an oscillating circuit had a linear and not a logarithmic decrement. It is to be hoped that this powerful instrument of research will be widely employed in the future by radio engineers.

The theory of circuits of linear decrement is arousing much interest at present. A number of important papers on this subject have appeared. Among these may be mentioned that by B. Macku (*Annalen der Physik*, 24, page 941, 1911) and a paper by E. Taege on the effect produced in ordinary circuits coupled loosely to linearly damped circuits (*Strom und Stromeffekt im Resonanzkreise bei der Annahme geradlinigen Amplitudenabfalls im Primärsystem*, *Verh. der Deutschen Physik. Gesellschaft*, 15, Number 16, page 753, 1913).

In connection with dielectric hysteresis in condensers, the discussion by Messrs. L. Israel and A. Kuhn in *PROCEEDINGS OF THE INSTITUTE OF RADIO ENGINEERS*, Volume 1, Part 2, page 41, is of interest. The values of the equivalent hysteretic conductance or resistance mentioned by Mr. Stone are there derived by another method.

We shall await with much interest Mr. Stone's promised paper dealing with cases intermediate between those of the logarithmically and linearly damped circuits.

INDEX TO VOLUME 2

1914

All references to any individual, company, or radio station are fully listed in this index. Answers to points brought out in the Discussions will be listed under the name of the questioner. In general, all topics are listed under the noun referred to. The numbers correspond to pages in the text. The following abbreviations are used: R. F.—radio frequency; A. F.—audio frequency; L. V.—low voltage; H. V.—high voltage.

- A** **BRAHAM, M.**, 60
 Absorption, atmospheric, 92
 —, sustained wave, 54, 58
 —, selective, 97
 Age, of operators, 204-206, 211
 Air, dielectric strength of, 145
 Alexanderson, E. F. W., 69, 95, 100, 107, 137-157, 159, 160, 163, 164
 Alternator, Alexanderson, 95
 —, Goldschmidt, 69-82
 —, Stone, 100
 Amesbury (measurements by Pickard), 41
 Amplifier, Audion, 15-36
 —, carbon, 34
 Antenna, artificial, 131, 178, 261
 —, insulation, 82
 Anti-coherer, 61, 63
 Arc (characteristic), 319
 Arlington (station), 34, 53, 66, 226
 Atmospherics, 38, 49 *et seq.*, 180
 Audibility Meter, 264, 266
 Audion, 15-36
 —, frequency multiplication with, 32
 Austin, Louis W., 54, 131-133, 157, 298, 323, 325
- B** **BELMAR** (station), 302
 Berlin Convention, 276
 Berne Bureau, 276, 292
 Bjerknes, V., 237, 238
 Blue cathode discharge (in audion), 20, 34
 Bonus salary system, 47
 Braun tube oscillograph, 264, 307, 311, 327
 Bureau of Navigation (United States), 196, 199-201, 228
 Bureau of Standards (United States), 226, 231, 298
 Bush Terminal, Brooklyn (station), 290, 295
- C** **CALL LETTERS**, 285, 292
 Cape Cod (station), 213
 Cape Hatteras (station), 294, 295, 303
 Capacity, apparent, 323, 324, 327
 Carborundum, 66
 Carnavern (station), 302
 Cathode discharge, in audion, 20, 34
 Chaffee, E. Leon, 264, 327
 Chamberlain, E. T., 211
 Checking messages, 283, 284, 288, 296
 Clapp-Eastham Co., 253
 Clark, George H., 34, 36, 58, 226
 Clearance (in alternators), 75
 Clifden (station), 302
 Code (Continental vs. Morse), 197, 201, 211, 213, 215
 Code (indicating time), 281
 Cohen, Louis, 68, 237-240, 242, 243
 Colorado (stations), 43
 Committees of the Institute, 6, 114, 192, 250
 "Compensation Wave," 97
 Condenser, compressed air, 160
 —, in antenna, 131-133
 Corona, 153, 156, 161
 Creed-Bille system, 302
 Cuban Government, 276
 Curtis, Austin, 55, 56
- D** **DAMPING**, of audion, 19
 Davis, George S., 293-295, 300
 Decrement, of antenna, 133
 —, linear, 312 *et seq.*, 326, 327
 —, logarithmic, 237-240, 308, 317
 —, spark, 161, 312
 de Forest, Lee, 15-36, 54, 55, 63, 97, 107, 325
 de Sousa, George, 302
 Denver (station), 41
 Department of Commerce (United States), 207, 213, 215, 277, 297-300

Dielectric fatigue, 159, 162
——— hysteresis, 137-157
——— testing, 158
Duddell oscillograph, 267
Dust storms (effect on signals), 50

EASTHAM, Melville, 253-269, 270
Eccles, W. H., 238, 242
Edison, Thomas A., 17, 168
Efficiency, 162, 171, 264
Eiffel Tower (station), 66
Eilvese (station), 82, 92, 93, 98, 108
Eisenstein, S., 217
Electrostatic, shields, 143, 151, 164
———, voltmeter, 158, 159
"Empress of Ireland" accident, 212,
278, 292
Elster and Geitel, 17
Energy, in antenna, 173, 181
Engine, gasolene, 169
———, oil, 169
———, steam, 82, 169
Examinations, operators', 202, 203

FATHER POINT (station), 212, 278
Fatigue, in dielectrics, 159, 162
Federal Telegraph Co., 28, 98, 163
Fessenden, Reginald, 69, 95
Fleming valve, 17, 30
Fortescue, 163
Frequency multiplication, with audion,
32, 35

GAP, rotary quenching, 256, 257
Goldschmidt, Rudolph, 69-92,
105
Goldsmith, Alfred N., 32, 160-162, 183,
184, 303-305, 326, 327
Greaves, V. Ford, 195-210, 211, 214,
277, 291-293, 297, 299, 300
Group purchasing of sets, 166

HALLBORG, H. E., 157, 162
Hanover, see Eilvese
Hepburn, A. J., 202
Heterodyne, receiver, 54, 105, 236
High speed reception (Telegraphone-
audion), 28
——— (photographic),
83
——— transmission, 79, 80, 302
High voltage transformer, 137-141
Hill, Guy, 163, 178, 183, 226, 235
Hills, Stanley M., 163
Hinners, Frank, 225
Hogan, John L., Jr., 34, 53, 58, 135,
162, 181, 184, 214, 235, 295-297, 301
Honolulu (station), 34, 99
——— "daylight fading" at, 25
Hysteresis, dielectric, 137-157, 323,
324, 327
———, in air, 151
———, in iron, 141
"Hytone" apparatus, 253-269, 270

INSULATION, breakdown, r.f., 160
———, h.v., 138, 163, 168
———, 176, 178, 185
———, losses, 144-151
Interchangeability of parts, 167
Interference prevention, 91, 93
Iron losses, 141, 159
Israel, Lester L., 33, 67, 163, 217-234
327

KANSAS CITY (station), 45, 48
Kelvin voltmeter, 159
———, Lord, 214, 307, 308
Kennelly, A. E., 56
Key, relay, 261
Kiebitz, F., 56
Kleinschmidt perforator, 302
Kolster, Frederick A., 68, 202, 241-244
Kuhn, Alfred, 327

LAMINATIONS (for r.f.), 74
Landline traffic, 273, 274
Langley, Ralph H., 159
Leakage, adjustable magnetic, 254
Latitude tests (Paris-Arlington), 66
Le Blanc, F. and Kerschbaum, 62
Le Quesne, Chas. A., Jr., 32, 34
Licenses, operators', 203, 207, 215, 27.
292, 296
Licenses, operators', temporary, 292,
299
London Convention, 275, 277, 294, 282-
284, 286, 293
Los Angeles (station), 28

MACKU, B., 327
Majorana, audion circuits, 32
Makower, A. J., 238, 242
Manhattan Beach (station), 37, 41, 45
Marconi Company, 209, 210, 213, 273-
287, 290, 291, 295, 299
Marconi, Guglielmo, 279
Marconi Telegraph Cable Co., 302
Marriott, Robert H., 37-53, 64, 66, 93,
157, 163, 165-178, 180, 288-291, 298,
301, 303
Mayer, Emil E., 69-92, 105, 106, 270
Members, new, 8-13, 116-126
Membership increase, 139
Mexican Government, 276, 291, 299,
303
Moisture, effect on signals, 40, 49, 58
"Monroe" (ship station), 295
Moonlight, effect on signals, 39

NAME PLATES, 168
National Electric Signaling Co.
235
New Brunswick (station), 302
New London (station), 235
New Orleans (station), 283

OFFICERS OF THE INSTITUTE,
 5, 113, 191, 249
 "Omnigraph," 199, 211, 213
 Operating speed, 196, 212
 Operator, 195-210, 278
 ———, age of, 204-206, 211
 ———, examinations of, 202, 203
 ———, promotion of, 209
 ———, salary of, 209
 Osborne, H. S., 160
 Overlapping of wave trains, 226-228,
 235

PARKHURST, A. F., 180
 Peek, F. W., Jr., 153
 Photographic receiver, 83
 Pickard, Greenleaf W., 41
 Pierce, George W., 65
 Pole pitch, in alternators, 73, 95
 Postal Telegraph Co., 277
 Poulsen arc, 97
 ——— tikker, 19, 87
 Power factor of antenna, 269, 270
 ——— of insulators, 147
 Promotion of operators, 209
 Pupin, Michael I., 104-106

RADIO TELEPHONY, 92, 96, 233,
 236, 262
 Range variation, 37-58
 Rating, 171
 Reception, high speed, 28, 83
 ———, automatically tuned, 175
 Reflection alternator, 72
 Refraction of waves, 56, 57
 Regulation (speed of radio alternators),
 85
 Resistance of spark, 307-326
 Ruhmer, Ernst, 217
 Rukop, H., 327
 Ryan, Harris J., 160

SALARIES OF OPERATORS, 209
 Salts (fused salt detector), 59-63
 San Juan, P. R. (station), 211
 San Francisco (station), 28, 55, 98
 Sarnoff, David, 212-214, 273-287, 291-
 305
 Secondary, E. M. F. in, 256
 ———, short-circuited, 68
 Seibt, Georg, 219
 Shield, electrostatic, 143, 151, 164
 Simon, Emil J., 66, 183, 217-234, 297,
 301
 Siren effect, in audion, 22, 31
 Slip rings (in radio alternators), 75
 Solar ionization, effect on signals, 51, 53
 Spares (parts of sets), 167
 Spark, resistance of, 307-326
 Specifications, minimum, 186
 ———, steamship radio, 165-178
 ———, United States Navy, 166

Speed in operating, 79, 80, 196, 212,
 278, 288, 292, 295, 300
 Speed regulation, in radio alternators,
 85
 Sphar, C. F., 31
 Static, see Atmospherics
 Stone, John Stone, 30, 53-55, 63-65, 99-
 104, 133, 179, 180, 183, 235, 241, 243,
 307-326
 Storage battery, Edison, 168-170, 180,
 182-184
 ———, lead, 170, 179
 Sustained wave absorption, 54, 58
 ——— generation, 263
 Switchboards, 174, 257-260

TAEGE, E., 327
 Telegraphone, with audion, 27
 Telephony, see Radio Telephony
 Temperature effect of signals, 38, 47, 55
 Tesla, Nikola, 69
 Tikker, 87, 231
 Tissot, C., 59-63
 Tolls, 274, 282, 304, 305
 Towyn (station), 302
 Traffic, radio, 273-287
 Tone wheel, Goldschmidt, 87
 Transformer, h.v., 137-141, 253, 254,
 261
 Trans-Atlantic work, 302
 Transmitter, three phase, 217-234
 ———, portable, 261
 Tuckerton (station), 69-92, 93, 108
 Tuning antenna, 135

UNITED FRUIT CO., 180, 181,
 184, 209, 210, 214, 286, 297, 301
 United States Navy, 166, 183, 209, 221,
 231, 294
 United Wireless Co., 37

WARD, GEORGE G., 213
 Ward, Leonard, 82, 84
 Wattmeter, r. f., 267-269
 Wave, compensation, 97
 ———, length of ships, 38, 52
 ——— regulation, 286, 287, 289,
 290, 293, 294, 296, 298, 299, 303
 Weagant, Roy A., 32
 Weinberger, Julius, 56, 64, 65
 Western Union Telegraph Co., 274,
 277, 282
 Wheatstone transmitter, 302
 Wien, Max, 160
 Wind effect on signals, 50
 "Wired wireless," 24
 Woolverton, R. B., 211

ZENNECK, J., 327