

# IRE TRANSACTIONS



## ON BROADCASTING

Volume PGBC-7

AUGUST, 1961

Number 3

### TABLE OF CONTENTS

N.A.B. Engineering Achievement Award .....	1
Scan Converter for Broadcast Use .....	Albert W. Malang 2
Minimizing The Effects of Vidicon Lag With a Long Video Delay Line .....	William L. Hughes 7
Improved Video Recording System .....	Frank Gillette 10
Recent Advances in Vidicons .....	Martin Rome 11
An Improved Loudness Indicator .....	Jarrett L. Hathaway 18
The International Broadcasting System of the Voice of America .....	G. Jacobs and E. T. Martin 24
FCC Laboratory Observations of Precision Frequency Control of TV Stations .....	E. W. Chapin 35
The CBS NetALERT — A System for Network Signaling .....	A. A. Goldberg, A. Kaiser, G. D. Pollack, and D. Vorhes 43

PUBLISHED BY THE  
PROFESSIONAL GROUP ON BROADCASTING

## IRE PROFESSIONAL GROUP ON BROADCASTING

The Professional Group on Broadcasting is an organization, within the framework of the IRE, of members with principal professional interest in Broadcasting. All members of the IRE are eligible for membership in the Group and will receive all Group publications upon payment of prescribed fee.

Annual Fee: \$2.00

### Administrative Committee

R. F. GUY, *Chairman*

W. L. HUGHES, *Vice Chairman*

F. J. BIAS, *Secretary-Treasurer*

E. W. ALLEN

R. S. KIRBY

R. J. ROCKWELL

J. L. BERRYHILL

L. LOONEY

J. G. ROUNTREE

G. E. HAGERTY

O. L. PRESTHOLDT

J. W. WENTWORTH

H. T. HEAD

R. M. MORRIS

J. W. WRIGHT

*Ex Officio*

C. H. OWEN

### IRE TRANSACTIONS®

on Broadcasting

Published by The Institute of Radio Engineers, Inc., for the Professional Group on Broadcasting at 1 East 79 Street, New York 21, N. Y. Responsibility for the contents rests upon the authors, and not upon the IRE, the Group or its members. Individual copies of this issue and all available back issues may be purchased at the following prices: IRE members (one copy) \$2.25, libraries and colleges \$3.25, all others \$4.50.

---

COPYRIGHT ©1961 — THE INSTITUTE OF RADIO ENGINEERS, INC.

All rights, including translation, are reserved by the IRE. Requests for republication privileges should be addressed to the Institute of Radio Engineers, 1 East 79 Street, New York 21, N. Y.

PRINTED IN THE U.S.A.

EDITORS PAGE -----

For those of you who attended the recent N.A.B. convention, the picture below will be a familiar scene, and one in which the P.G.B. can be justly proud. Mr. Prose Walker is presenting the Engineering Achievement Award of the National Association of Broadcasters to Ray Guy, the new chairman of P.G.B. recently retired from N.B.C. For the benefit of the uninformed, Ray has enjoyed his quiet and peaceful retirement by casually rocking on the front porch. This rocking has had a few minor interruptions, such as taking charge of the installation of an F.M. station for his church, putting in a several months stint in Saigon for the I.C.A., and at the moment ye editor is writing this scratch sheet, I am looking at a letter from Ray written from Morocco where he is doing more work for the Government.



Don't forget ----- The Fall Symposium ----- Willard Hotel, Washington, D.C. -----  
October 6 & 7. These dates facilitate attendance at the annual picnic of the F.C.C. Bar  
Association in Washington on October 9.

There will be a lot of interesting papers, and all your old Broadcasting type friends  
will be there. See you then - - - - -

EDITOR



## SCAN CONVERTER FOR BROADCAST USE

Albert W. Malang  
Chief Video Facilities Engineer  
American Broadcasting Company

Television Broadcasting as it exists today draws from many sources to assemble a program. Then by a judicious choice of editing and transitional processes, the completed program becomes an integrated continuum. Very frequently program material must be obtained from outside sources, not under the direct control of the broadcaster, yet the broadcaster retains responsibility for the quality of the finished program.

For many years, the preponderant part of outside source material entered the broadcaster's plant as film. With the advent of Vidicon film chains a remarkably good job could be done even under conditions so adverse as to almost defy imagination. In the recent past, however, more and more programming has been from sources other than film and the broadcaster's own studios, and the problems have been growing to great seriousness.

Careful analysis of the situation a few years ago indicated that the root of the problem lay in the fact that considerable programming was arriving as electrical signals rather than discrete picture images, and the broadcaster was losing control of the thing he is most stringently held accountable for. The requirements imposed upon the broadcaster by the FCC are dictated by the vast complex of visual and aural communication, both cable and radiation, which are the U. S. TV Networks today.<sup>1</sup>

Part of the problem arises from the rather large scale use of TV Magnetic Tape Recording, and this particular facet has received much attention by many groups.<sup>2</sup> Part of the problem arises from the growing volume of foreign material, and unfortunately a single International Standard for TV does not exist.<sup>3</sup>

Part also arises from the fact that Network Programming is national in character and frequently interesting program material originates at locations other than network plants, and for a variety of reasons it is not possible to store the material or change its location. In these instances, it would be desirable to retain the picture information, yet completely reconstitute the electrical signal. The work done on Standards Conversion suggested that this was within the realm of possibility yet preliminary analysis indicated some formidable problems.

In 1958 the problems had achieved sufficient proportions that a project to determine a solution was initiated. Preliminary tests with a vidicon

were undertaken and the system criteria established. Comparative tests using an Image Orthicon as the readout device were not promising, hence this approach was abandoned. A survey of the then available electrical storage tubes was also undertaken, and carried to the point where a system was tested using an adaptation of a racar conversion system. When the system performance was evaluated, this approach did not seem to offer an immediate solution. The unavailability of an Emitron chain prevented exploring that avenue, although reports of European work in similar areas did yield data for evaluation.

It was, therefore, decided to pursue actively a Vidicon system, and a prototype was assembled.

The actual device that performs the task assigned at ABC is composed of two basic sections, readin and readout, optically coupled.

The readin section of the equip was fabricated from a display kinescope device which was originally purchased for kinescope recording purposes. To this was added an entirely new video channel, and vertical sweep modulation equipment.

The readout section was assembled from a standard broadcast vidicon film chain. The actual storage media is the vidicon tube and the display kinescope is lens coupled to the vidicon.

The block diagram of the equipment is almost elemental. The incoming composite signal enters the video amplifier where immediately synchronizing signal is separated to feed the deflection equipment. Then the video signal is amplified, frequency corrected, clamped, and applied to the kinescope. The deflection section converts the synchronizing signal into appropriate line and field rate deflection currents for the yoke. In addition, there is a high frequency oscillator section operating at about 21mc which feeds a second yoke to provide a small additional vertical deflection. This technique, usually called "spot wobble," is used to blend the raster lines to each other so that the display appears to be full frames rather than a scanned interlaced raster.

This image is coupled to the vidicon faceplate through a carefully selected lens, whose performance at very short imaging distances was checked and found usable.

The vidicon camera contains only the vidicon

tube, yoke, and preamplifier. The remainder of the equipment for signal processing and deflection is rack mounted. The video channel has clamping, blanking insertion, aperture correction and gamma correction.

The performance of the unit is somewhat difficult to assign specific numbers to, since in all cases the output is a function of the input, and to date it has been necessary to adjust the parameters for different sources. However, some subjective judgment of performance can be made from comparison photos of input and output.

The success of this unit in making possible stable pictures from unstable sources, and in addition permitting some very interesting special effects, has spurred even greater interest in this device for regularly scheduled use. It would, therefore, be of interest to see what the possibilities are for future evolution.

First, and foremost, is the need for better optics. Lenses, even excellent ones, have a serious corner resolution deterioration problem, particularly at large apertures. Also few lenses are designed for the short distances used by this device.

Secondly, a vidicon tube specifically designed for this type of service is needed. One of the most interesting facets of this project was an improvement of signal to noise observed in one experimental tube. The output signal to noise was actually better than the input when visually observed on a monitor.

The full possibilities of highlight aperture correction and vertical aperture correction are yet to be explored. And certainly we have yet to exhaust the possibilities of different kinescopes.

As technology advances, the day may well arrive when the optical portion of this system will be discarded, and direct electrical storage becomes a practicality.

Certainly the need is great, for a scan converter permits far reaching system simplification, makes possible program effects not otherwise achievable, and last but by no means least, restores control of the electrical signal characteristics to the broadcaster.

#### References

1. NAB Engineering Handbook  
A. Prose Walker
2. Integration of Videotape & Live Television  
A. W. Malang and M. C. Worster  
NAB April 1960
3. Videotape Problems with Various International Systems  
J. R. Popkin-Clurman  
AIEE Convention June 1960  
Standards Conversion of TV Signals  
V. K. Zworkin and E. G. Ramberg  
Electronics January 1952

TYPICAL SYSTEM PERFORMANCE

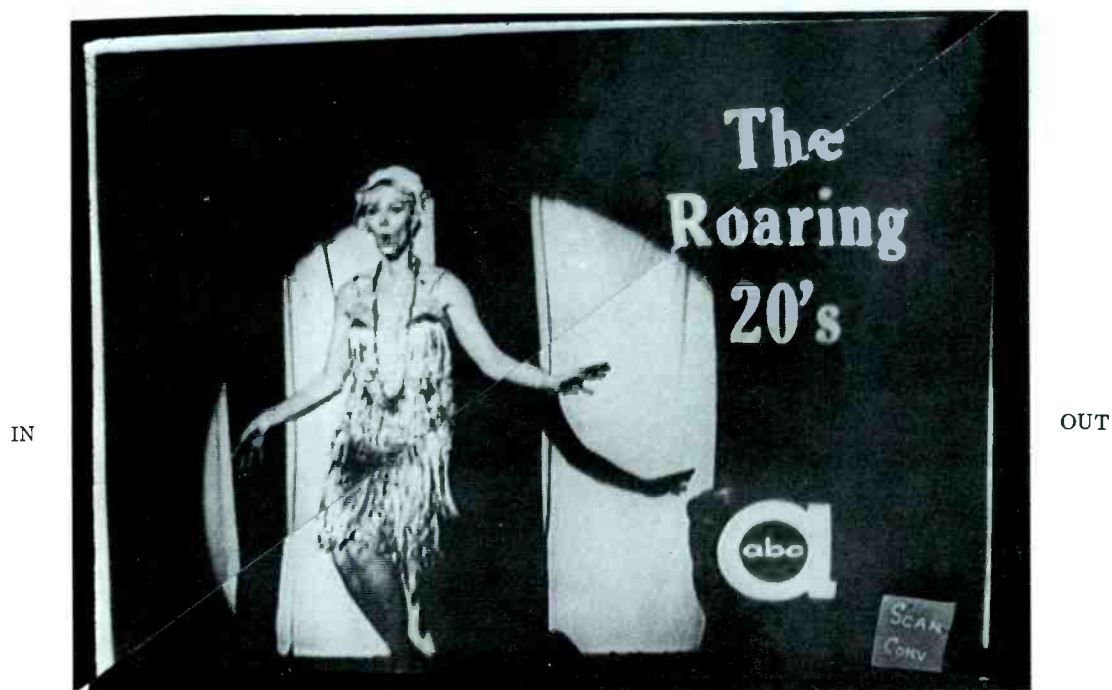
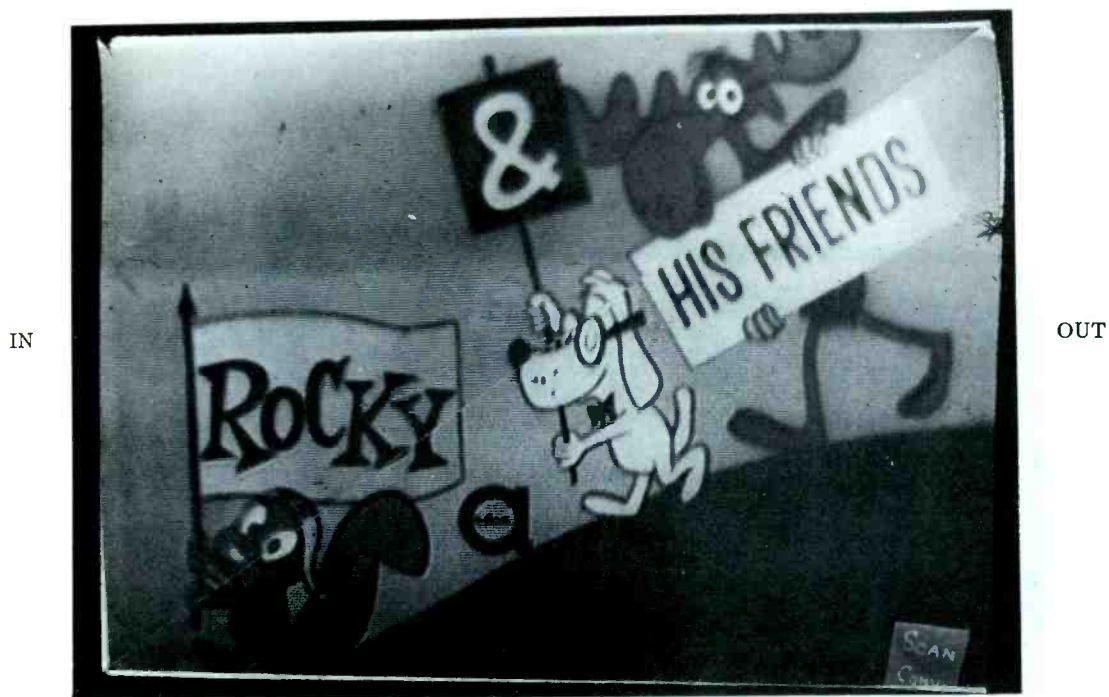

Fig. 1.

SYSTEM PERFORMANCE

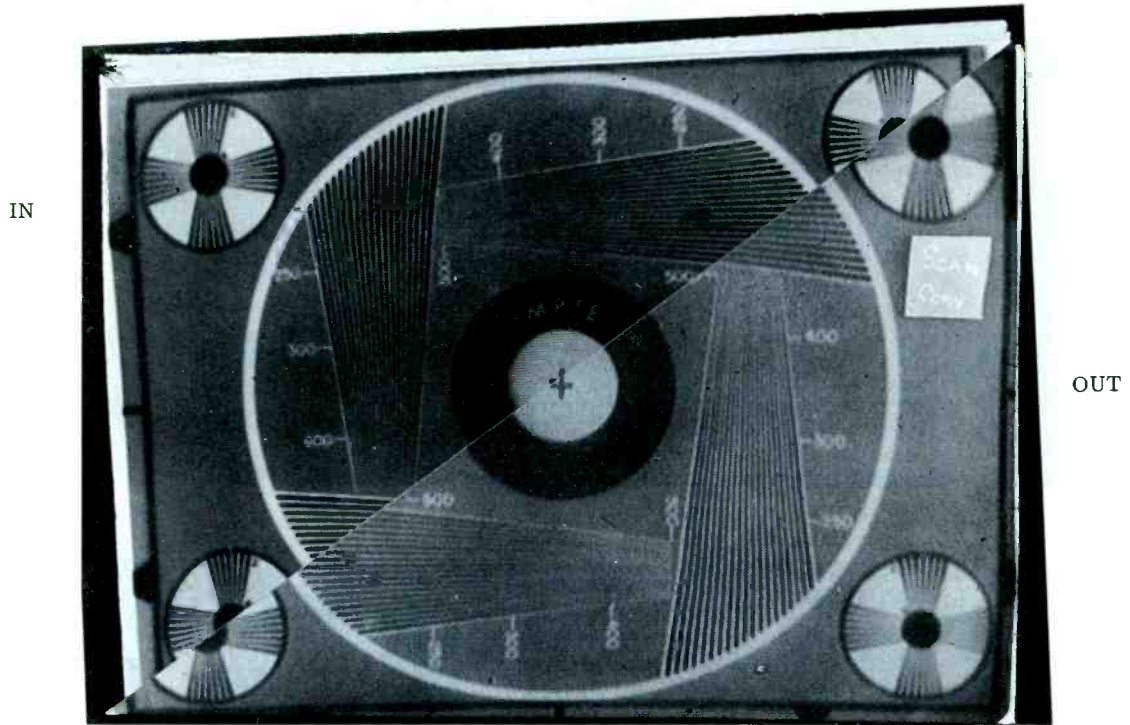
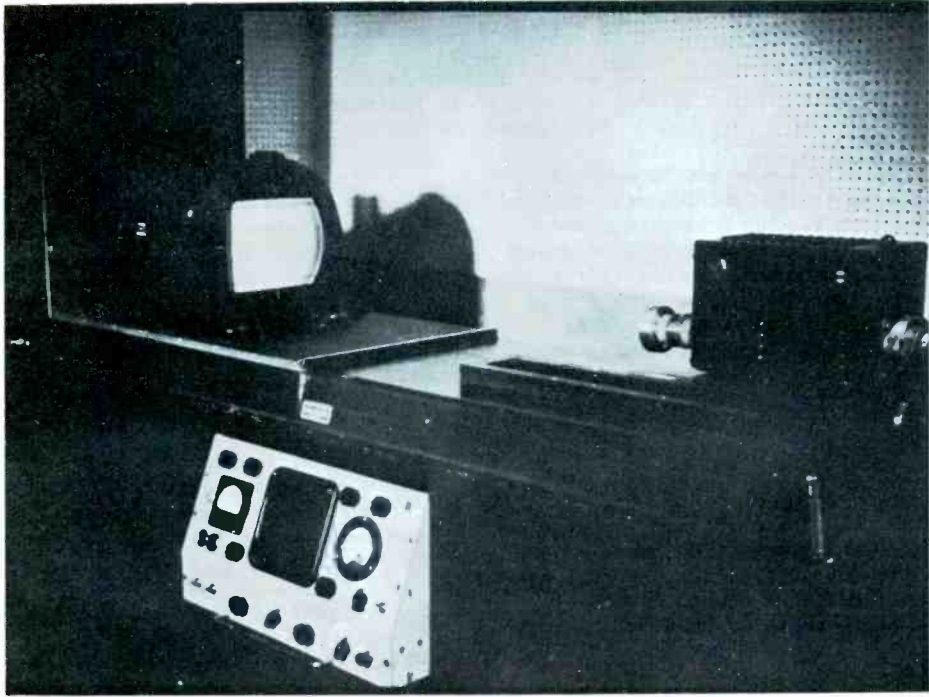
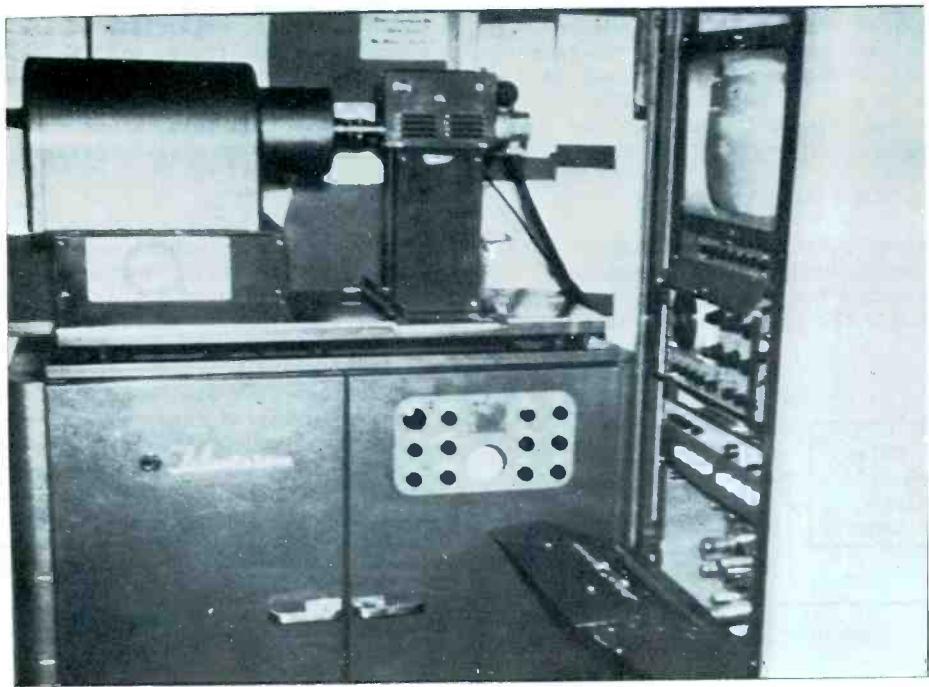

Fig. 2.





PROTOTYPE SYSTEM



OPERATIONAL SYSTEM

Fig. 3.

MINIMIZING THE EFFECTS OF VIDICON LAG  
WITH A LONG VIDEO DELAY LINE

Wm. L. Hughes, Head  
School of Electrical Engineering  
Stillwater, Oklahoma

A common complaint among people who utilize vidicon cameras is the "stickiness" or "lag" effect which is encountered when these tubes are used at low light levels. This paper discusses a method of minimizing this effect using a wide band video delay line with a time length equal to 262 television lines. This technique is an outgrowth of an extensive color television systems research program carried on at Iowa State University for the last several years.

SIMPLIFIED ANALYTICAL EXPRESSION OF PROBLEM

To understand the basic problem, suppose we have a vidicon camera for which there is an undesirable lag characteristic. Let us, for the moment suppose that the signal output of the camera tube is represented by equation 1.

Signal Output

$$= F_0 + kF_1 + k^2F_2 + k^3F_3 + \dots(1)$$

In equation 1,  $F_0$  represents the signal of the present field,  $F_1$ , represents the signal of the first field back,  $F_2$  represents the signal of the second field back and so on. The constant  $k$  represents the percentage of signal that remains after the target has been scanned once. This number can run between 0.1 and 0.4 for modern vidicons.

IDEALIZED CORRECTION SCHEME

The simplified discussion just completed does not consider the question of interlace. Ignoring this problem for the moment, however, let us now consider the block diagram of Figure 1.

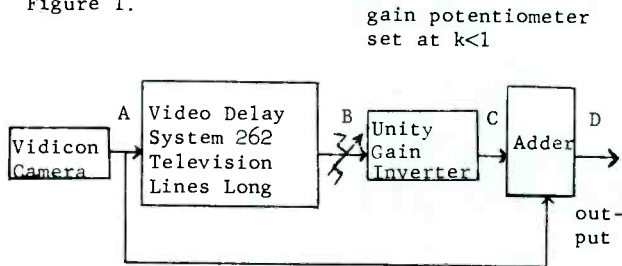

Figure 1

In this system, the output of the vidicon camera is fed to video delay system which is 262 television lines long. This is 16,651.5 microseconds on color standards. The signal at point A, then, is identical to that of equation 1. If we assume the gain of the delay line is unity, however, the signal at point B is given by equation 2.

$$\text{Signal at B} = F_1 + kF_2 + k^2F_3 + \dots(2)$$

This signal is passed through a potentiometer which allows a fraction  $k$  of the signal to go through a unity gain inverter. The output of the inverter at point C can then be written as in equation 3.

$$\text{Signal at C} = -kF_1 - k^2F_2 - k^3F_3 \dots(3)$$

When the signal at C is added to the signal at A in the adder, the results is the signal at D which is simply  $F_0$ , the current field.

Now let us consider what this means in an interlaced conventional television system in which the picture being televised has fast motion. First, regardless of the motion, the cancelled stuck fields will be in registration error by one line. However, in reasonably fast motion, the resolution capability of the human eye is less than this, so we can expect that the overall smear will be greatly reduced.

EXPERIMENTAL SYSTEM

In the experimental verification of this system, one is first confronted with the problem of obtaining a wide band delay line 16,651.5 microseconds long plus or minus 0.1 microsecond. An extensive color television systems research program at Iowa State University which had been in progress for some years also called for such a line and a study program was undertaken to determine the best way to obtain it. Three schemes were considered and were explored experimentally to some extent. The first scheme attempted was to put a television picture on a barrier grid storage tube and then read it off on the next field. This scheme could have been made to work, but it had some difficult problems. First, it was difficult to completely destroy

the residual field in one sweep which meant that the barrier grid tube had some sticking characteristics of its own. Second, two barrier grid tubes would have been required since it would be necessary to read one and write on the other simultaneously. Third, the resolution was poor, the signal was noisy, and it was difficult to do a good job of preserving gray scale. The second scheme attempted was to design a system using fused quartz acoustical delay lines. The problems here were that the fused quartz lines were expensive and had an extremely high temperature coefficient of delay (70 parts per million per degree centigrade). This would have required temperature control to an accuracy of 0.1 degree centigrade. This was not at all impossible but it was expensive. The third scheme attempted, and the one finally used, involved a torsional wire delay line driven by magnetostrictive transducers. This line had a temperature coefficient of delay of 2 parts per million per degree centigrade which allowed the line to be used without temperature control. Further, it was manually adjustable to plus or minus two microseconds. The line had a bandwidth of about 600 kilocycles. This certainly would not be high enough for transmission of a high quality television picture. It was adequate, as it turned out experimentally, to successfully cancel the stuck fields. Wider bandwidth lines are currently under development by the Ferranti Electric Company and the General Electric Company. The first line was made by Ferranti.

A picture of the delay line system is shown in Figure 2. The line is driven by a

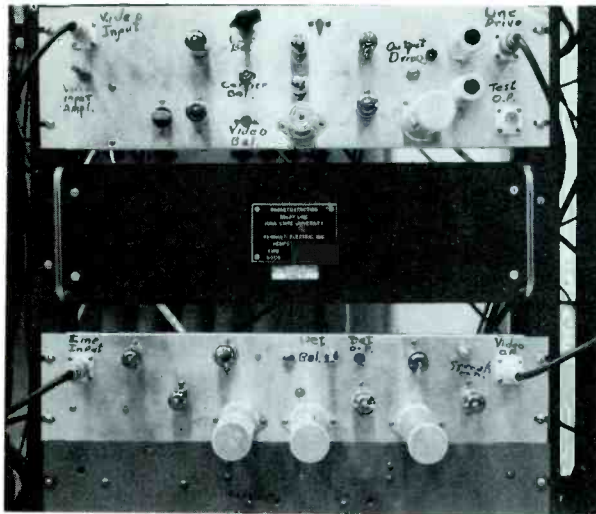

Figure 2

simple carrier system which operates at an 800 kilocycle carrier frequency. A unit currently under development will operate at a carrier frequency of 1.2 megacycles. The whole system takes up about 15 inches of standard rack space and commercially would cost about \$1500. Figure 3 shows the delay line itself and Figure 4 gives an interior view of the delay line.

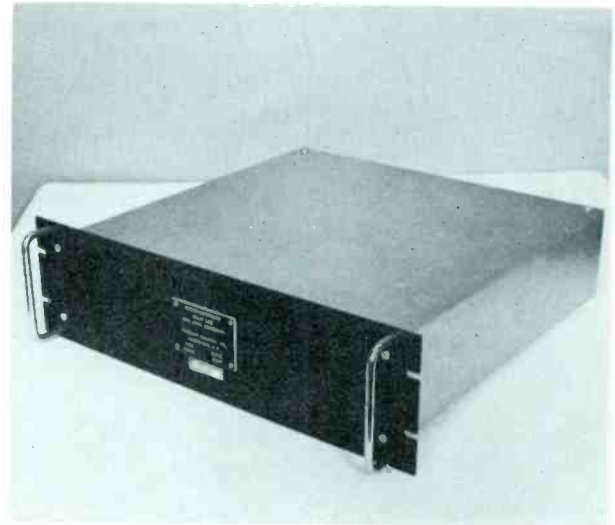

Figure 3

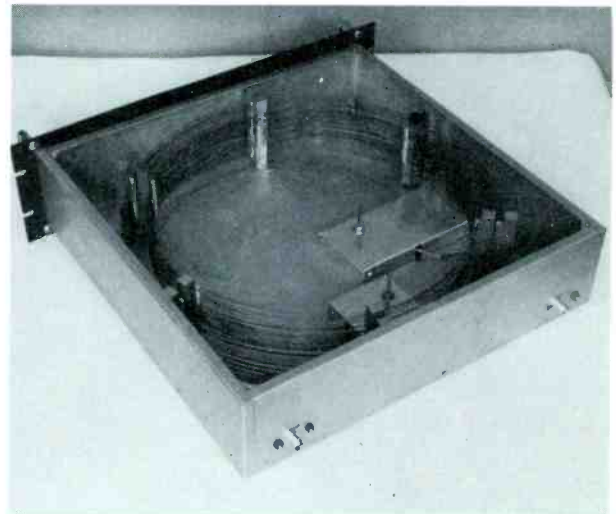

Figure 4

When this delay system was used with a vidicon camera operating at low light levels, the sharpening of edges in reasonably fast motion was quite striking. The major difficulty with the system was that the delay system was slightly noisy. This noise is caused by the low carrier frequency and is not fundamental to

the system. Moving the carrier from 800 kilocycles to 1.2 megacycles is expected to correct this situation. It is expected that considerable improvement can be made in pictures from live vidicon cameras operating at low light levels using this technique.

## IMPROVED VIDEO RECORDING SYSTEM

Frank Gillette  
General Precision, Inc.  
Pleasantville, N. Y.

### Abstract

Uniform terminology and a method of graphical representation are established. Factors affecting exposure uniformity are described by reviewing fundamental relations between the film exposure cycle and the television scan. Practical arrangements for recording television pictures on motion-picture film are described and analyzed. Effects of phosphor persistence are considered, and a detailed analysis of persistence effects in single-field recording is offered.

## RECENT ADVANCES IN VIDICONS

Martin Rome  
Machlett Laboratories  
Springdale, Connecticut

The last few years have seen the introduction of many new vidicon types. Sensitivity, lag, response, resolution, and miniaturization of the new tubes are reviewed. In addition a brief discussion on the variation of gamma with dark current and light level of broadcast vidicons is included.

### The New Vidicons

#### Introduction

Tube Registration. In recent years there has been considerable advancement made in the field of vidicons. If the number of tubes is to serve as an indication of advancement--a rather dubious criterion, I think--then there has indeed been much progress made. There are more than 20 vidicon types registered with EIA and at least an equal number of tubes with private labels by both American and foreign manufacturers. In addition, there are many experimental and developmental types still in the laboratory stage. No attempt will be made to cover this latter group if indeed such were possible. The rate of vidicon type registration is, to some extent, indicative of industry activity. Figure 1 shows the number of registrations by year; the rapid rise in rate in the past few years is apparent. Hopefully, the current standardization activity by the cognizant engineering committee of the Joint Electron Devices Engineering Council (JEDEC) will help reduce the rate without impeding technological advancement.

Mechanical Front-End Configuration. There are three configurations of front-end design. These are shown in their historical sequence (reading from left to right) in Figure 2. It will be noted that the lists of representative tubes under each configuration contain some duplication. In the case represented by the EEV P820 actual alternate designs for the given tube type are available from the one manufacturer. For registered types, duplication generally means that the type is supplied by different manufacturers.

#### Tube Characteristics

Sensitivity. Perhaps the most striking improvement in vidicons for closed-circuit applications has been the increase in sensitivity. Figure 3 shows the substantial rise in sensitivity

in recent years. The curves are from the registration data for representative tube types released during the years noted. The uppermost curve is an average of data for the 7735A, a new industrial-type registered by RCA, the Resistron 255, and the EMI 10667.<sup>1</sup> Dark current is constant at .02  $\mu$ a throughout. The luminous response at .<sup>2</sup> foot-candles faceplate illumination is 50, 80, 150, and 250  $\mu$ a per lumen, respectively, for the four curves. It should also be noted that the greater uniformity of photoconductor thickness in recent tubes permits higher dark currents with a consequent increase in effective sensitivity.

Lag. Image retention, or lag, the principal limitation to increased live pickup use of the vidicon, when carried to an extreme, has found novel application in broadcasting. Vidicons of the storage type characterized by long image persistence include: the GEC 1326, the 7351 registered by Machlett Laboratories, the 7383 registered by Westinghouse and the EMI 10667L. The storage characteristics of these tubes are different; the 7383 (the Permachon) operates in a regenerative mode of storage maintaining almost constant signal level for long periods of time. The other three tube types utilize an extension of the usual photoconductive lag; as in conventional tubes, read and erase occur simultaneously. Adequate, continuously read signals are possible from a fraction of a second to several seconds after the termination of scene exposure. These tubes have found application in weather-radar broadcasting in which the radar PPI display is televised with image retention between radar scans.<sup>2</sup>

Spectral Response. Most vidicon types have spectral sensitivity responses approximating the S-18 standardized curve which peaks around 450  $m\mu$ . A camera tube with such a response operating under Tungsten-lamp illumination approximates the response curve of the human eye. There are available vidicons with sensitivities in other spectral regions. Figure 4 shows the normalized spectral responses of several representative tubes. The Resistron 255IR response extends out to 2000  $m\mu$ , considerably beyond the limit of present photo-emissive surfaces. The 7351 curve is red sensitive, peaking around 600  $m\mu$ . Peaking near 400  $m\mu$  is the ML-522B with sensitivity extending into the ultraviolet. All curves were obtained at constant signal output, a condition specification made necessary by the non-linear nature of the vidicon.

TABLE I

TUBE TYPE	DARK CURRENT ( $\mu\text{a}$ )	RADIANT RESPONSE (a) ( $\mu\text{a}/\text{lm}$ )	AT WAVELENGTH ( $\text{m}\mu$ )	LUMINOUS RESPONSE (b) at .1 ft-c FACEPLATE ILLUMINATION ( $\mu\text{a}/\text{lu}$ )
ML-522B	.002	0.44 (c)	405 (peak)	115
7735A	.02	.10	450 (peak)	425
	.20	.38 (c)	450 (peak)	1000
7351	.02	.08	600 (peak)	770
	.08	.27 (c)	640 (peak)	1300
Resistron 255IR	.02	.005	800	
	.02	.001	1600	
	.08	.030	800	
	.08	.007	1600	

(a) .02  $\mu\text{a}$  signal current; (b) 2870°K Color temperature Tungsten-lamp; (c) .08  $\mu\text{a}$  signal current.

Radiant and luminous responses for some of the vidicon types mentioned are given in Table 1.

The ML-522B, operating at a very low dark current, has the highest peak-radiant-response but because of the high proportion of red and near-infrared radiation of the 2870°K Tungsten lamp, the luminous response is relatively low. For the same reason, the 7351, with a peak-radiant response lower than the 7735A, by virtue of its red response has the highest luminous sensitivity. The infrared-sensitive Resistron 255IR, despite its relatively low radiant response in the regions of interest is able to detect images through up to a half millimeter of germanium and to image objects hotter than 200°C.

Resolution. Improvements in resolution have been finding wider application in the last year or two. The improvement is primarily in tube usage rather than design.<sup>3</sup> By increasing the G3 uni-potential of the vidicon with a commensurate increase in the magnetic focus field (to maintain one loop) and increasing the deflection power, an appreciable improvement in aperture response is possible. The enhancement is seen in Figure 5 which shows the horizontal-square-wave aperture response improvement as a function of the focus field for several TV line numbers. The curves follow down to 30 gauss which is generally lower than normally encountered in conventional systems. The practical application of the high-resolution mode of operation has been made possible by the improvement in yokes since beam-landing error tends to be greatly exaggerated with increasing G3 voltage.<sup>4</sup> Although the same techniques are applicable to vidicons of earlier vintage the use of finer mesh in most newer tubes has minimized the drawback of mesh-in-focus.

Reduced Weight and Size. With the advent of increased emphasis on space application there have been recent developments directed towards smaller ruggedized tubes requiring less power. The 7263A, registered by RCA, and the 7226A, registered by GEC, are about an inch shorter than the conventional tube and ruggedized. Both have lowered

heater-power requirement; 0.6 watts for the former and 1 watt for the latter. Another approach to reduce the size and power requirements of the vidicon camera has been the electrostatic deflection and focus tubes.<sup>5</sup> These include the 7522 registered by GEC and the Westinghouse WX 4306. The rated center resolution for the two tubes is 500 and 450 TV lines, respectively; both tube types are rated at 300 TV lines corner resolution. A ruggedized version of the 7522, the GEC 1343 and an electrostatic version of the 7383, the Westinghouse WX 4606, have recently been introduced. A historically earlier approach to reduced size is the 1/2" diameter magnetically focused and deflected vidicon. A new Grundig small TV-camera using the 1/2" Resistron 135 is 35 mm in diameter and 9" long, without lens and cable connector.

Miscellaneous. Tubes with low operating dark currents suitable for slow scan operation include the 7290 registered by Westinghouse and the Machlett ML-522B. An electrostatic focus and deflection version of the former, the Westinghouse WX 4384 has recently been announced. A self-aligning gun requiring no alignment coils is used in the 7038A and the 7291A, registered by Machlett Laboratories.

#### The Vidicon Transfer Characteristic

The transfer characteristic of a vidicon is the relationship between the illumination on the tube and the corresponding signal-output current. This relationship is generally written as

$$i = k_1 I_v^{\gamma_v} \quad (1)$$

where  $i$  is the signal current,  $k_1$  is a constant,  $I_v$  is the illumination on the faceplate of the vidicon and  $\gamma_v$  is the exponent commonly referred to as the vidicon gamma. A similar relationship for a cathode-ray-tube is

$$I_c = k_2 i^{\delta_c} \quad (2)$$

where  $I_c$  is the cathode-ray-tube brightness,  $k_2$  is a constant, and  $\gamma_c$  is the cathode ray tube gamma. Combining (1) and (2),

$$I_c = K I_v^{\gamma} \gamma_c \quad (3)$$

which indicates that for cameras and receivers with no gamma correction the cathode-ray-tube brightness is directly proportional to the incident vidicon-faceplate illumination only when the gammas are reciprocals.

The gamma of the vidicon, particularly at the dark currents used for film pickup operation, is not constant for all faceplate illuminations. In practice a constant gamma is not always desirable; quite frequently a characteristic approaching that of the knee of the image orthicon is preferred for the accommodation of a highlight without suppressing the blacks. Shown in Figure 6 are the transfer characteristics for a broadcast vidicon, the 7291A, at dark currents of .005 and .01  $\mu$ a. The gamma, shown as the broken-line curve, decreases substantially with increasing light level. Surprisingly, the function of gamma with faceplate illumination is practically identical for both dark currents noted.

However, when considering the relation of gamma with signal current there is a decided difference. Figure 7 is a plot of this function for the same tube-type averaged over many tubes and shows that gamma varies differently with signal current for the two dark currents. This is contrary to an observation reported by Murch.<sup>6</sup> An additional consideration is the gamma for different colors. Figure 10 shows the transfer characteristic (illumination expressed in percent) for 703 m $\mu$  (red) and 452  $\mu$  (blue). The spectral half-widths are 12 and 10 m $\mu$ , respectively. There is very little difference between the gammas for these widely separated wavelengths (.63 to .48 for the red and .61 to .45 for the blue), although both curves show the same decrease in gamma with illumination as was found for white light.<sup>1</sup>

## Conclusion

The advances made in the vidicons, although primarily in industrial and special-purpose types, has been significant. No attempt has been made in this review to cover all the new tube types. It is hoped that some of the more recent tubes touched upon here may serve to suggest new applications in the field of broadcasting. The brief section on gamma, it is believed, points up the necessity for considering the variation of this characteristic with light-level and dark current.

## Acknowledgment

I would like to express my appreciation to the companies, and specifically the people, who have so graciously furnished much of the information: R.G. Neuhauser of RCA, Herman Albertine of GEC, Dr. Walter Heimann of PTW, in Germany, and Mr. J. Sharpe of EMI, and Copthorne Macdonald of Westinghouse. Also, I would like to thank Mr. H. Jordan of these laboratories for his aid with the data presented here.

## References

- (1) H. G. Lubszynski, S. Taylor, J. Wardley, "Some Aspects of Vidicon Performance," Brit. Inst. of Rad. Eng. vol. 20, pp. 323-334, May, 1960.
- (2) W. C. Crusinberry, "Weather Radar Broadcasting" Broadcast Engineering October, 1960.
- (3) L. L. Pourciau, M. Altman, C. A. Washburn, "A High-Resolution Television System," Journ. S.M.P.T.E. vol. 69 pp. 105-108 (1960).
- (4) J. Castleberry and B. H. Vine "An Improved Vidicon Focusing-Deflecting Unit," Journ. S.M.P.T.E. vol. 68 pp. 226-228, (1959).
- (5) H. Albertine, Jr., "Electrostatic Focus and Deflection Vidicon," P.G.E.D. Meeting of IRE Washington, D.C., October 1959.
- (6) L. J. Murch, "Standardized Gray-Scale Characteristic for Vidicon Telecine," Journ. S.M.P.T.E. vol. 68, 740-743 (1959).
- (7) I. J. P. James, "A Vidicon Camera for Industrial Colour Television," Brit. Inst. of Rad. Eng. vol. 19 p. 182, March, 1959.



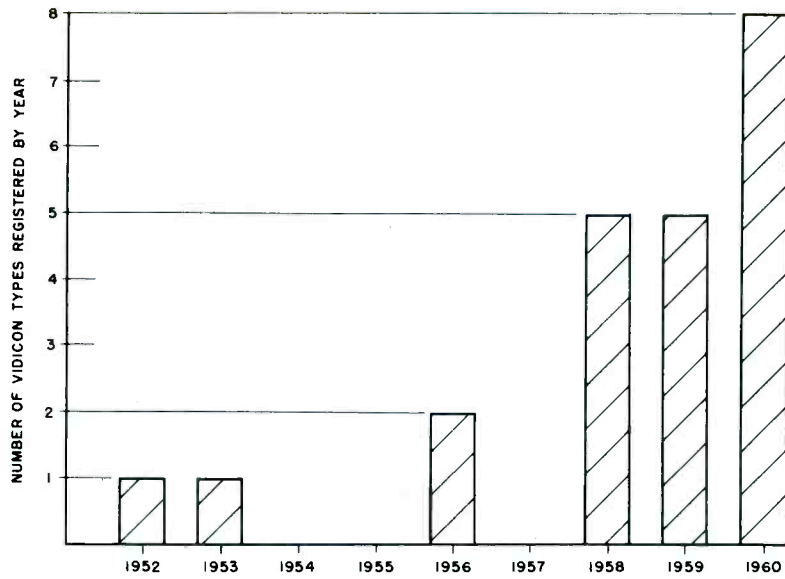

Fig. 1. The number of vidicon tube-types registered by year from 1952 through 1960.

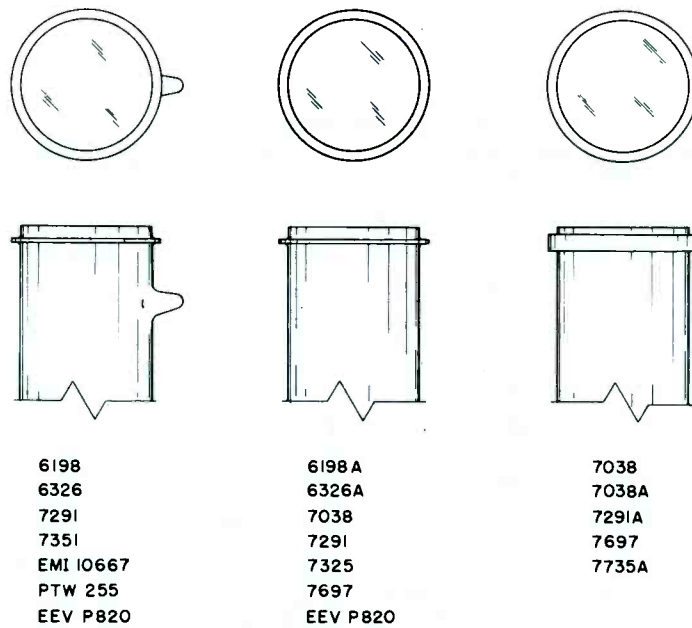

Fig. 2. The three front-end vidicon configurations. The lists of tube-types representative of each configuration contain duplications.

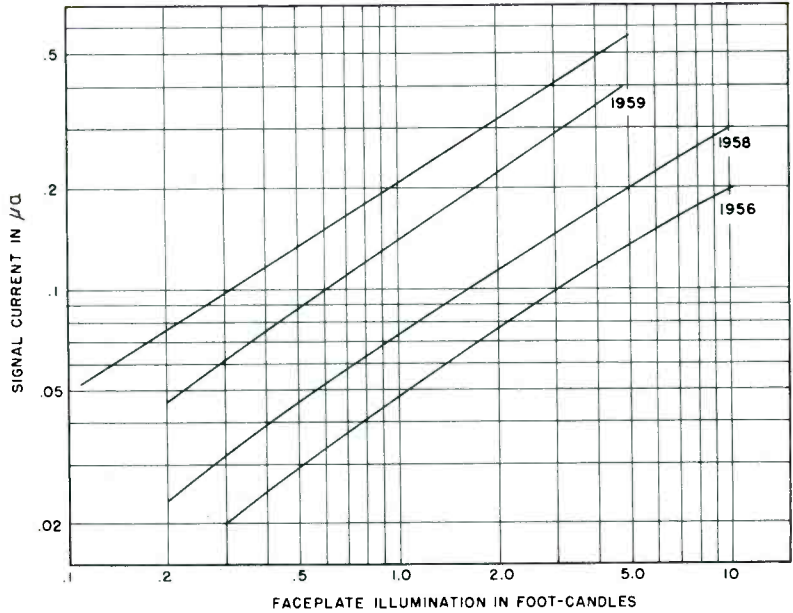

Fig. 3. The log-log plot of signal current as a function of faceplate illumination (transfer characteristic) demonstrating the increase in sensitivity in recent years. The curves are for representative tube-types registered during the year noted; the uppermost curve is an average of most recent industrial-type vidicons. Dark current is constant at 0.02  $\mu\text{a}$  throughout.

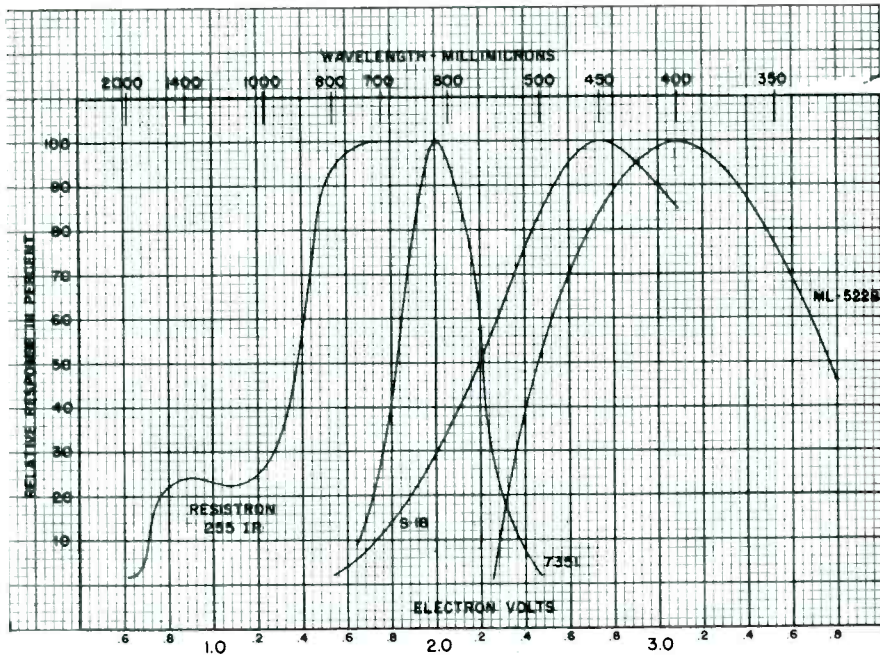

Fig. 4. Normalized spectral response curves for infrared, red, and blue-ultraviolet vidicons and standardized S-18 distribution. All data taken at constant-signal-output.

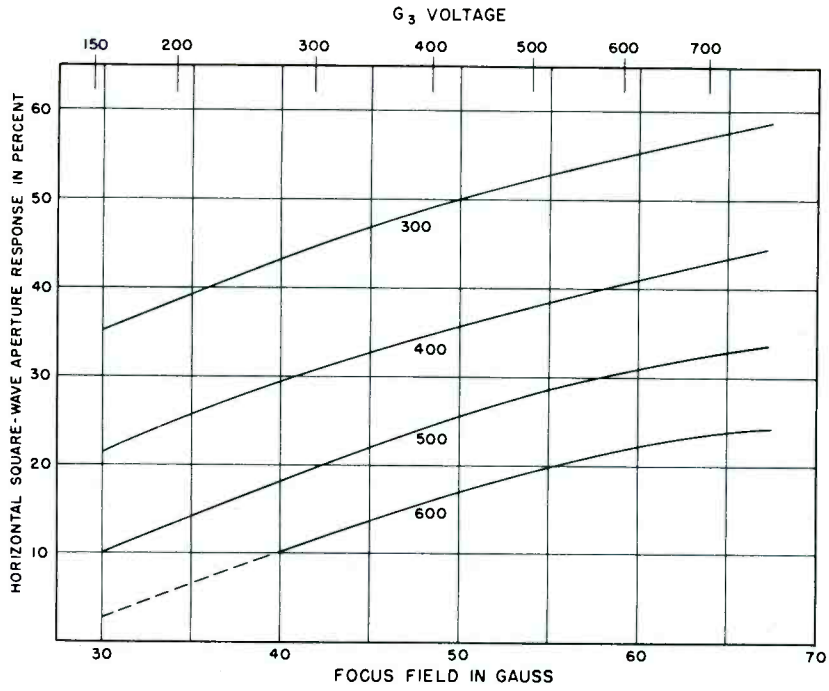

Fig. 5. Horizontal-square-wave aperture response in per cent as a function of magnetic focus field in Gauss for 300, 400, 500, and 600-TV line numbers.  $G_3$  voltage adjusted to maintain one of loop of focus. Raster area is 1/2 inch X 3/8 inch.

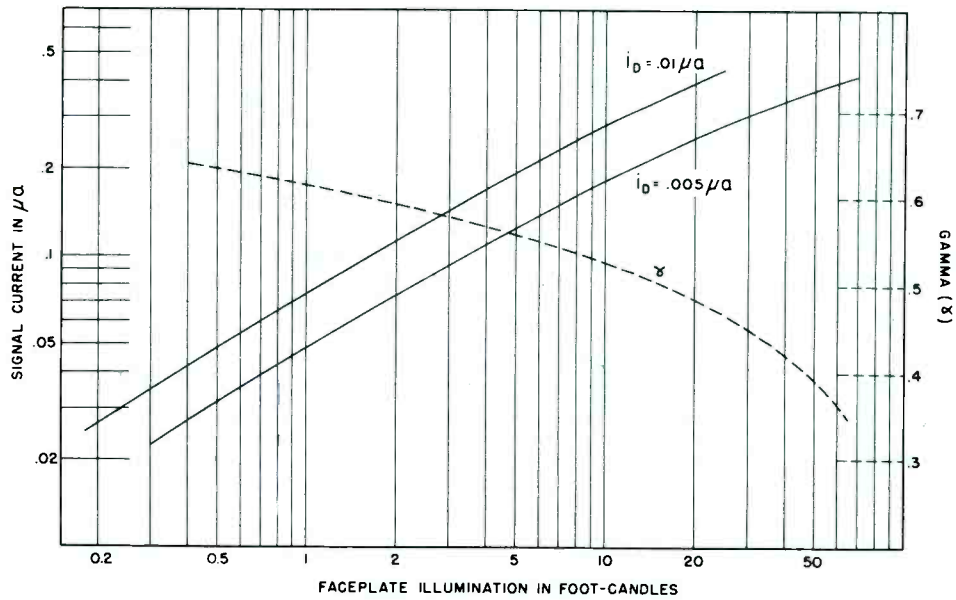

Fig. 6. Transfer characteristic of the 7291A vidicon at dark currents of 0.005 and 0.01  $\mu a$ . Gamma as a function of faceplate illumination in foot-candles.

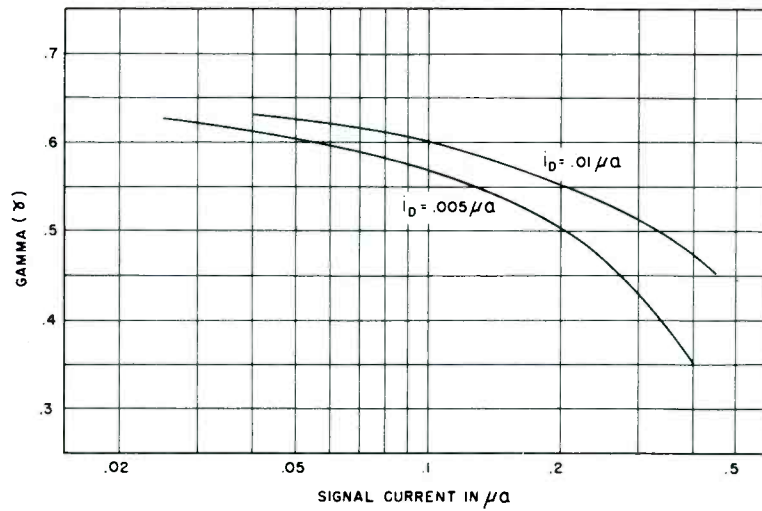

Fig. 7. Gamma of the 7291A vidicon as a function of signal current in  $\mu a$  for dark currents of 0.005 and 0.01  $\mu a$ .

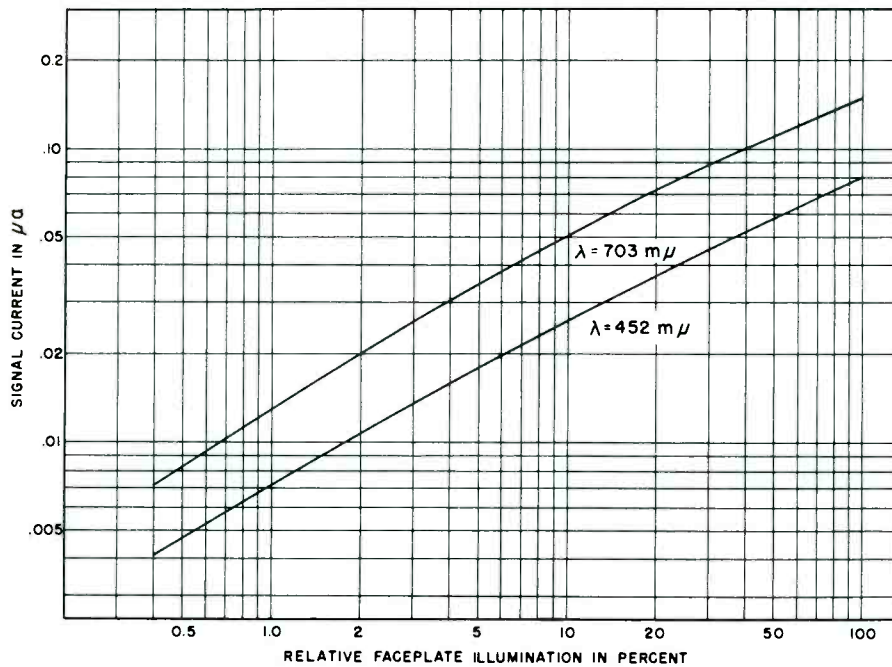

Fig. 8. Transfer characteristic of the 7291A vidicon for red (703  $m\mu$ ) and blue (452  $m\mu$ ) light. Illumination is given in per cent.

"AN IMPROVED LOUDNESS INDICATOR"  
by Jarrett L. Hathaway  
National Broadcasting Company  
New York, New York

Summary - The standard type VU meter has for many years been employed almost exclusively by broadcasters in the United States as a program level indicator. A new unit which should give better indication of peak loudness has now been developed and is being evaluated. This unit operates within the range of time constants specified by the FCC for transmitter aural modulation meters. A field test is now in progress, with a number of the new indicators in various studios throughout the country.

There is a well-known saying to the effect that everybody talks about the weather but nobody does anything about it. That's almost the way it has been in broadcasting with the volume indicator. Sound control engineers have generally felt that the present standard VU meter is somewhat deficient as an indicator of loudness but on the other hand, they have found it a reliable, convenient and inexpensive instrument representing a tremendous improvement over the units it replaced back in the late 1930's. Actually, some of those old volume indicators or VI's as they were called had as much as a 40% overshoot, followed by half a dozen or so oscillations before reaching steady state. Furthermore, their decibel scales were extremely cramped at the lower readings. The standard VU meter is basically power-actuated and has excellent ballistic characteristics. It does not read narrow program peaks like an ordinary oscilloscope. For sound level indicating, this ability of neglecting high amplitude short duration peaks is generally an advantage, although in the VU meter it may be overdone.

For medium frequency notes, the human ear requires 40 milliseconds of sustained acoustical energy to produce a full loudness sensation. This physiological characteristic has been known for a long time, and was taken into consideration in one of the requirements included in the FCC Rules and Regulations. These have for many years specified that an approved transmitting station aural monitor must be equipped with a meter which reaches 90% of full value on peaks lasting 40 to 90 milliseconds. In addition to this characteristic, they have specified that the meter must have a fall time of 500 to 800 milliseconds, to a point which is 10% above zero. This latter specification is needed for visual reasons, since the eye would have difficulty in

following a meter which met the 40 to 90 millisecond requirement unless the fall time were much greater. Although the standard VU meter is definitely superior to the old style volume indicators and also to ordinary oscilloscopes for indicating sound level, it has been found deficient in the metering of repeated short bursts, such as those existing in a "shouting" or "staccato" type of commercial announcement. That is the type which has generated so many potent complaints against the broadcaster's sound level control - complaints which have probably exceeded in number and severity those against any other technical imperfection in both radio and television broadcasting.

A rudimentary illustration of the VU meter deficiency in metering short repeated peaks may be obtained with apparatus as diagrammed in FIGURE 1. Here an audio oscillator supplies a medium frequency tone to an indicating meter over one of two paths - an adjustable attenuator in one and a chopper in the other, operable at about 4 per second with "on" times of 50 milliseconds. The oscillator is first adjusted so that when the chopper is stopped at an "on" position, the VU meter reads 100. When the chopper then operates, making and breaking the oscillator feed, the VU meter is found to read almost 9db below the 100 mark. Next, with the chopper in operation the oscillator level is increased so that it again produces a reading of 100. Then the selector switch is thrown to the attenuator side, and the attenuator is adjusted for a meter reading of 100. Under these conditions, FOR BOTH SWITCH POSITIONS the standard VU METER READS 100, but the loudspeaker connected across it, according to all of the listeners tested, sounds much louder ON THE INTERRUPTED SIGNAL than on steady state.

The subjective loudness test vs meter indication may also be conducted with a meter having characteristics within the range specified by the FCC for transmitter aural monitors. With such an instrument, when the tone is interrupted as on the VU meter test, the reading falls a little less than 3db as compared to 9 for the VU meter. When the oscillator level and attenuator are re-adjusted for readings of 100 on each of the switch positions, test listeners agree that LOUDNESS IS THE SAME ON THE INTERRUPTED SIGNAL as on the steady state.

Another factor which should be consid-

ered in the development of an improved loudness indicator is that if the reading is to be truly indicative of loudness the instrument must be compensated in frequency response to a degree dependent on the frequency response all the way through the eventual listener's loudspeaker system. It should also be compensated for the reproduction level of the home loudspeaker. Since it is impossible to include all factors for all cases it was considered advisable to provide a very mild roll-off of sensitivity at both the extreme high and low frequencies where the sensitivity of ears and apparatus is relatively low.

After conducting tests a year or so ago, we decided to develop a simplified arrangement having time constants for improved indication of loudness peaks and also having rolled-off sensitivity at the frequency extremes. The object was to develop a practical loudness indicator which would aid the control engineers in regulating program levels. A dc microammeter with appropriate calibration was needed, so for convenience a standard VU meter was used. This was a rather obvious choice, since all studios were already equipped with these meters. We made up a package of electronic hardware assembled on a 4" square bakelite board, which in turn could be mounted right on the VU meter terminals. A photo of the overall assembly is shown on FIGURE 2. The 13 or 26 volt dc supply which normally lights the VU meter bulbs can also serve as power for the units' transistor amplifier.

The schematic of the final unit is shown on FIGURE 3. The isolation transformer as used has an input at all significant frequencies of 7000 ohms or greater. The adjustable attenuator permits use of the loudness indicator on circuits which normally operate from +2 to +16 VU. An equalizer network follows the 3300 ohms isolation resistor, and provides a 3db roll-off at 100 and at 8000 cps. The emitter output transistor feeds a peak-to-peak type rectifier which in turn charges a capacitor to 90% in less than 20 milliseconds. This does not mean that the meter rises to full reading in this short a time, since mechanical inertia limits the rate of rise. The dc meter, not shown on this diagram, is driven by voltage across the capacitor. When signal is removed, the capacitor is discharged to the 10% value in about 800 milliseconds. Following a short program peak, during the very early stage of the lengthy discharge, the needle continues to rise from the pre-existing voltage across the capacitor. In this way, the mechanical ballistics of the meter are overridden by the electrical charge and discharge times and the meter is forced to indicate short peaks more accurately - especially so when they are repeated at short intervals. Amplitude linearity of the complete

unit, which is very necessary for matching the VU meter calibration, is achieved through application of a slight forward bias on the diodes through the 22,000 ohm resistor.

The present method of adjusting the new unit for a given circuit is to set it for 3db lower sensitivity than a standard VU meter on 1000 cps tone. With this adjustment the "shouting" commercials read a little higher than on the VU meter while most of the remainder of the program reads slightly lower. Thus, the differences of meter readings and the changes of gain which the control engineer makes are such that average level programming is about the same as if a VU meter were used. However, the more sustaining types of program material are raised 2 or 3db above usual level, while the "shouting" commercials are adjusted to 2 or 3db below their usual level.

Since ours is an operating company rather than a research organization, it was decided to try out the new loudness indicator in Operations rather than undertake comprehensive controlled laboratory testing. Therefore, we had 20 units manufactured and after bench checking, placed them in "on-the-air" service at strategic studio locations around the country. Operating personnel were furnished questionnaires to indicate their reactions to the new units as compared to the tried and true VU meters which many of these men had utilized for 20 years or so. Psychologically this of course represented a rough comparison for the new units, but that was what we wanted. The FIGURE 4 shows a returned questionnaire, as filled in by a control engineer of many years experience in this field, who was very favorably disposed toward the loudness indicator. FIGURE 5 is a questionnaire from one of those with quite the reverse feeling. FIGURE 6 is a tabulation of all reports received. In determining worth of the new loudness indicator these results should be qualified in that a large percentage of the unfavorable ones come from transmission room personnel rather than from program control men. Reasons for this are: 1) the transmission men's need for standardization in checking peaks, and 2) the new problems which are created in connection with the taking of frequency response runs. This summation shows that the meter reads higher on such material as "shouting announcements," which should result in a level reduction by the control engineers. It will be noted also that the new meter usually does not read higher on average program material. It further shows that most of the men believe that the new meter gives a better indication of loudness, the item which we believe should be the most important single factor in the control of programs. Even despite and including the unfavorable reports from transmission men, it should be noted that roughly two-thirds of our operating men like

the new loudness indicator and feel that it aids them in doing a better job. One of the replies was favorable to the new indicator because of the calmer action of the needle; another reported that the needle movement was less erratic and caused less eye strain. However, others did not like the slow meter fall because it prevented indication of the valleys of program level.

The new loudness indicator should not be used for system measurements, mainly because of its frequency response roll-off. For tone measurements a switch could of course be arranged to connect the VU meter with proper attention directly to the circuit and so by-pass the transistor amplifier and rectifier. We haven't done this in our studios so far and in fact we haven't yet decided to go 100% to the use of the new loudness indicators. We are still investigating the factors involved in making a complete change-over. Before this big step we must have the test units in use for a much longer period of time

and we would also like to be standardized with the other broadcasters and the Telephone Company. In general, our present thoughts are that the new loudness indicator seems to be better for monitoring and controlling purposes and is probably well worth the added cost of converting. If our field test continues to look as favorable as it does at present, we hope that the other broadcasters will become interested in testing meters of this type. So far, the indications are that the new program loudness indicator represents a definite step toward an improvement for the listener at home. It is a step in the direction he has been asking us to take ever since the beginning of radio - one which will help to iron out some of his undesirable loudspeaker volume changes.

The author appreciates the encouragement and help received in pursuit of this development from Andrew Hammerschmidt, Theodore Kuron, George Nixon, and William Trevarthen.

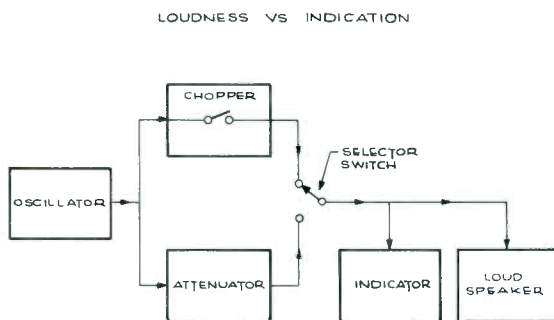

Fig. 1. Subjective loudness testing.

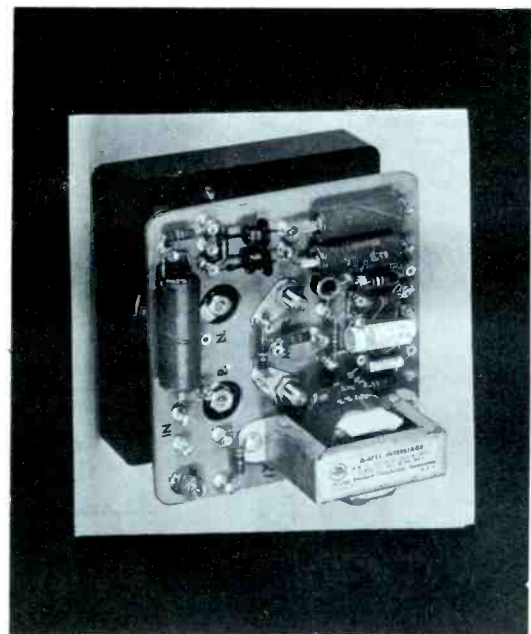

Fig. 2. Photo of over-all assembly.

EXPERIMENTAL LOUDNESS INDICATOR

The present Volume Indicator (VU Meter) has been in use for a number of years and has performed reasonably well as an indicator of musical sound levels. However, for broadcast transmission purposes it is not an entirely reliable indicator of sound loudness, particularly for certain types of voice. The Loudness Indicator under test is intended to perform both functions. It is a form of quasi-peak meter and has been adjusted so that the pointer will rise rapidly but fall or decay slowly. Thus the program peaks may be more accurately portrayed, with less time devoted to the indication of short duration minimum levels. Your direct answers to the questions below plus general comments will be helpful in determining the ultimate characteristics of an improved instrument.

SCHEMATIC DIAGRAM  
LOUDNESS INDICATOR

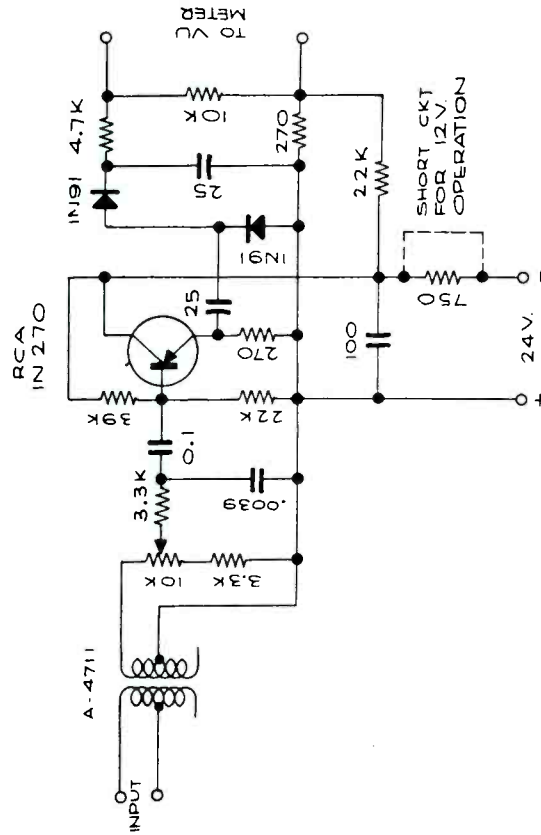

Fig. 3. Loudness indicator schematic.

1. Are the indications of the experimental meter usually higher than the present VU meter on music? YES  NO
2. Are the indications of the experimental meter usually higher than the present VU meter on staccato speech? YES  NO
3. Do the indications of the experimental meter seem to correlate better with the loudness of the sound? YES  NO
4. Is level control facilitated and do you believe it to be better when using the experimental meter? YES  NO

General Comments:

THIS NEW METER IS A DECIDED IMPROVEMENT IN COMPARISON TO THE STANDARD VU-METER. SUGGEST IT BE ADOPTED AS THE STANDARD IN AUDIO CONTROL OPERATIONS IN THE INDUSTRY.

Location: CITY NEW YORK N.Y. Studio SH-4J - RADIO CITY  
 Date 27 JANUARY 61 Name E.R. CARWAL

Please return to: Mr George M Nixon, Director, Engineering Development  
 Room 612M, NBC New York.

Fig. 4. Favorable questionnaire.



EXPERIMENTAL LOUDNESS INDICATOR

The present Volume Indicator (VU Meter) has been in use for a number of years and has performed reasonably well as an indicator of musical sound levels. However, for broadcast transmission purposes it is not an entirely reliable indicator of sound loudness, particularly for certain types of voice. The Loudness Indicator under test is intended to perform both functions. It is a form of quasi-peak meter and has been adjusted so that the pointer will rise rapidly but fall or decay slowly. Thus the program peaks may be more accurately portrayed, with less time devoted to the indication of short duration minimum levels. Your direct answers to the questions below plus general comments will be helpful in determining the ultimate characteristics of an improved instrument.

- |   |   |     |   |     |    |
|---|---|-----|---|-----|----|
| 1. Are the indications of the experimental meter usually higher than the present VU meter on music?           | <table border="0"> <tr><td>YES</td><td>X</td></tr> <tr><td>NO</td><td></td></tr> </table> | YES | X | NO  |    |
| YES   | X   |     |   |     |    |
| NO  |   |     |   |     |    |
| 2. Are the indications of the experimental meter usually higher than the present VU meter on staccato speech? | <table border="0"> <tr><td>YES</td><td>X</td></tr> <tr><td>NO</td><td></td></tr> </table> | YES | X | NO  |    |
| YES   | X   |     |   |     |    |
| NO  |   |     |   |     |    |
| 3. Do the indications of the experimental meter seem to correlate better with the loudness of the sound?      | <table border="0"> <tr><td>X</td><td></td></tr> <tr><td>YES</td><td>NO</td></tr> </table> | X   |   | YES | NO |
| X   |   |     |   |     |    |
| YES   | NO  |     |   |     |    |
| 4. Is level control facilitated and do you believe it to be better when using the experimental meter?         | <table border="0"> <tr><td></td><td>?</td></tr> <tr><td>YES</td><td>NO</td></tr> </table> |     | ? | YES | NO |
|   | ?   |     |   |     |    |
| YES   | NO  |     |   |     |    |

General Comments:

Better for speech but not as good as VU for  
 \_\_\_\_\_  
 music because of slow meter fall.  
 \_\_\_\_\_  
 \_\_\_\_\_

Location: City New York Studio Radio City  
 Date 1/25/61 Name H.B.

Please return to: Mr George M Nixen, Director, Engineering Development  
 Room 612W, NBC New York.

Fig. 5. Unfavorable questionnaire.

EXPERIMENTAL LOUDNESS INDICATOR

1. Are the indications usually higher than VU meter on music?
2. Are the indications usually higher than VU meter on staccato speech?
3. Do the indications correlate better with the loudness?
4. Is level control facilitated?

	1		2		3		4		<u>Favorable</u>	<u>Unfavorable</u>	<u>Questionable</u>
	<u>Yes</u>	<u>No</u>	<u>Yes</u>	<u>No</u>	<u>Yes</u>	<u>No</u>	<u>Yes</u>	<u>No</u>			
NEW YORK	4	13	9	8	12	5	10	7	10	7	1
PHILADELPHIA	0	1	0	1	1	0	1	0	1	0	0
CHICAGO	0	4	4	0	3	0	3	0	3	0	1
HOLLYWOOD-BURBANK	5	14	16	3	15	2	10	7	11	3	3
<u>SUMMARY</u>	9	32	29	12	31	7	24	14	25	10	5

Fig. 6. Tabulation of results.

## THE INTERNATIONAL BROADCASTING SYSTEM OF THE VOICE OF AMERICA

George Jacobs, Chief, Frequency Division  
Office of the Engineering Manager  
Broadcasting Service  
U. S. Information Agency  
Washington 25, D.C.

and

Edgar T. Martin, Engineering Manager  
Broadcasting Service  
U. S. Information Agency  
Washington 25, D.C.

### Abstract

The Voice of America, the international broadcasting service of the U. S. Information Agency, speaks for America in thirty-five different languages to a worldwide audience. The technical facilities that make this possible literally encircle the globe. Thirty shortwave transmitters at seven locations in the continental United States range in power from 25 to 200 kilowatts. Overseas, the VOA has nine relay stations with forty-seven transmitters ranging in power from 35 to 1,000 kilowatts. This presentation discusses the development of this technical system from its war-time inception. Highlighted in the discussion are the problems encountered in the development of the system, the techniques designed to counteract these obstacles, and future plans for strengthening the signal of the Voice of America.

### Introduction

Within three months after the Japanese attack on Pearl Harbor, the Voice of America went on the air for the first time with the mission of combating enemy propaganda and explaining why the United States was in the war and what we were fighting for.

The first broadcast, on February 24, 1942, was in the German language. This broadcast heralded the beginning of a new era in the United States' foreign relations and established the pattern for the current world wide operations of the Voice of America, and its parent organization, the U. S. Information Agency. America's story is told overseas by the U.S.I.A. through radio, television, press, publications, motion pictures and other cultural activities.

Today, the Voice of America, speaking for the United States as the international radio service of the U. S. Information Agency, provides millions of listeners in many parts of the world with objective newscasts, up-to-the-minute facts about U.S. policies, and information concerning the life and culture of the American people. The Voice does this in thirty-five different languages, for a total program time of nearly a hundred hours a day.

Edward R. Murrow, recently appointed Director of the U. S. Information Agency, has reaffirmed that the creed established in that first Voice broadcast of nearly twenty years ago -- to tell the truth -- will continue to be the guiding principle of the Voice of America's operations.

This paper deals with the technical side of the Voice of America, and will discuss the development of the present far-flung network from its war-time inception. Highlighted in the discussion will be some of the problems encountered, how they were solved, and future plans for strengthening VOA's signal.

Before Pearl Harbor, the United States was far behind other major powers in the field of international broadcasting. By early 1942, the Axis was blaring forth its propaganda to the world from approximately seventy-five high power broadcast transmitters. In the United States, the international broadcasting effort consisted of about a dozen shortwave transmitters operated on a commercial basis by five privately owned broadcasting organizations. These transmitters formed the nucleus of VOA's technical network when it began broadcasting in 1942.

Since that time, and at a cost of approximately fifty-three million dollars, VOA's transmitting network has been developed into an integrated system that literally encircles the globe. Thirty shortwave transmitters, located at seven plants in the continental United States, range in power from 25 to 200 kilowatts. Overseas, VOA has nine transmitting plants with a total of forty-seven broadcasting transmitters, ranging in power from 35 to 100 kilowatts shortwave and 50 to 1,000 kilowatts on medium and long wave.

### Problems

The main technical problems that confront international broadcasting from the United States can be stated as follows:

1. The problem of overcoming the deteriorating propagation effects encountered on the transmission paths from the

United States, passing through, or near, the northern auroral zone, to the important target areas of eastern Europe and Asia. Figure 1 shows how the shielding effect of the auroral zone prevents direct transmission from the United States to many important areas of the world on the consistent basis necessary to attract and maintain a listening audience.

2. The problem of overcoming the vast distances between the United States and the target areas in order to reach listeners with a competitively strong signal in the broadcast bands that are popular in the listener's area.
3. The problem of overcoming Communist jamming, which since 1948 has attempted to prevent reception of VOA broadcasts in the languages of the Soviet Union, the European satellites, and, more recently, China.

#### Development of the System

Operational experience gained during the war years clearly indicated that effective world-wide broadcasting requires a carefully developed integrated network or system of facilities, specifically designed to deliver a strong technically competitive broadcast to a listener in any selected area of the world on either the short-, medium- or long-wave broadcasting bands -- which ever are popular in the specific area and lie within range of most of the available receivers.

Long-range forward planning is essential in the development of such a system. It cannot be developed piecemeal, but must take into account all the interrelated elements of the system. In the case of international broadcasting, the system begins at the microphone and ends in the receiver of the listener. In the technical development of the VOA, the "systems concept" -- that of considering the performance of the system as a whole -- has been of paramount importance.

#### Relay Stations

The development of the VOA facilities system centers upon the use of overseas relay stations, at locations where it is possible to take maximum advantage of favorable radio propagation conditions, to overcome the problems facing direct short-wave broadcasting from the United States.

While the transmission paths passing through the auroral zones are heavily distorted and absorbed, paths that do not pass near the auroral zones are not affected by this phenomenon. In Figure 1, for example, the circuit from New York to Tangier, North Africa, does not pass near the auroral zones, and it is therefore possible to maintain a reliable program service from the

United States to Tangier by short wave.

The effects of the auroral zone on circuits from Tangier are indicated in Figure 2. It can be seen, by comparison with Figure 1, that the very areas that are shielded from the United States can be reached without difficulty from Tangier. Therefore, programs transmitted from New York to Tangier can be simultaneously relayed from Tangier directly into European or Near and Middle Eastern target areas -- areas that cannot be reached effectively directly from the United States. By the use of appropriately located relay stations in this manner, the auroral zones can be by-passed, and a technically effective transmission can be delivered to target areas that are normally shielded from direct transmission from the United States.

Auroral zone by-passes to other areas of the world can be achieved by locating relay stations in, for example, Hawaii and the Philippine Islands. Both the fundamental problems of distance and auroral zone absorption can be solved by this relay station concept. By placing relay stations in appropriate locations, short-wave transmissions can be received at the relay stations directly from the United States with the least possible effects from the auroral zone absorption. After receiving the transmission, the signal can be boosted in strength and simultaneously relayed directly into a selected target area on the broadcasting bands that are popular in the area and lie within the range of most of the available receivers.

Based upon this concept, VOA relay stations have been established at various appropriate locations throughout the world. Each station is a complete self-contained installation with its own diesel power plant, small studio complement, receiving station for program reception, high-power short-, medium- and long-wave transmitting facilities, and point-to-point radio Teletype communications facilities.

The relay stations are integrated into a single system so that they can be fed programs directly from the United States, or between each other.

The overseas relay system of the VOA consists of the following:

1. Tangier, Morocco: This station was designed primarily as VOA's main gateway to Europe, North Africa and the Near and Middle East. At Tangier, the major facilities consist of ten shortwave transmitters ranging in power from 35 to 100 kilowatts. Twenty-nine rhombic antennas are available for beaming programs to Tangier's target areas. Figure 3 and 4 are interior and exterior shots of the Tangier Relay Station.

2. Munich, Germany: This location is near enough to the Central European target areas so that medium- and long-wave broadcast bands can be used, as well as shortwave. The station consists of four shortwave transmitters ranging in power from 75 to 100 kilowatts, and several lower power transmitters. A 300 kilowatt medium-wave transmitter operates on a frequency of 1,196 kc and a 1,000 kilowatt long-wave transmitter operates on a frequency of 173 kc. Twenty-six shortwave antennas are available for coverage of Europe, the Eurasian areas of the Soviet Union, Near and Middle East, and parts of Africa. The medium-wave antenna is a 4-element array providing four separate patterns each beamed towards a desired European target area. The antenna system is designed for sky-wave radiation out to about 500 miles from Munich. The long-wave antenna consists of a single top-loaded tower over 900 feet high. It has been designed for omnidirectional radiation for Central European coverage.
3. Thessaloniki, Greece: This relay station was engineered to take advantage of its nearness to the Balkan target areas. The station consists of four 35 kilowatt shortwave transmitters, and a 50 kilowatt medium-wave transmitter operating on a frequency of 791 kc. Twelve shortwave antennas are available for coverage of the Balkans, the western Soviet Union, east Europe, the Near and Middle East, and parts of Africa. The medium-wave antenna consists of a 2-element directional array providing a reversible cardioid pattern with one beam centered to give sky-wave coverage of the Balkans and the other to give coverage of Greece.
4. Rhodes, Greece: VOA's station at Rhodes is used primarily for covering adjacent areas of the eastern Mediterranean. A 150 kilowatt medium-wave transmitter beams broadcasts to this area for nine hours a day on a frequency of 1,259 kc. Two 35 kilowatt shortwave transmitters reinforce the medium-wave coverage. The Rhodes' station is rather unique in that the transmitting facilities are housed aboard a vessel, the U.S. Coast Guard's Courier. The Courier does not, however, broadcast from the high seas. The vessel operates as a fixed installation, either from an anchorage in Rhodes harbor, or from within the national waters of Greece, with the approval of the Greek Government.
5. Philippine Islands: VOA maintains transmitting facilities near Manila and San Fernando on the island of Luzon. These facilities consist of six shortwave transmitters ranging in power from 35 to 100 kilowatts, a 50 kilowatt medium-wave transmitter operating on 920 kc., and a 1,000 kilowatt medium-wave transmitter operating on 1140 kc. Twenty rhombic antennas are available for beaming short-wave broadcasts over an arc extending from Korea to India. The 50 kilowatt medium-wave transmitter uses a six-tower array for sky-wave coverage of the Philippines and adjacent areas of Southeast Asia, while the megawatt transmitter uses a four-tower array which produces three separate beams directed towards Southeast Asia, and parts of China. This antenna system increases the effective sky-wave radiation up to 3,500 kilowatts in certain directions.
6. Okinawa: VOA's Okinawa installation completes Far Eastern coverage by beaming short and medium-wave broadcasts to northern and central Asiatic areas. This station consists of three shortwave transmitters ranging in power from 35 to 100 kilowatts, and a 1,000 kilowatt medium-wave transmitter operating on 1180 kc. Six rhombic antennas direct shortwave transmission to Siberia, the Far East, China and Central Asia. The medium-wave antenna consists of a six-element array producing two beams directed towards China, Manchuria, Korea, and the Soviet Far East.
7. Colombo, Ceylon: This installation, operated for VOA by Radio Ceylon, in accordance with an agreement between the governments of the U.S. and Ceylon, is intended primarily for coverage of India and Pakistan. The station consists of three 35 kilowatt shortwave transmitters. A large number of curtain arrays are available for beaming broadcasts to India, Pakistan and adjacent areas.
8. Woofferton, England: Six 50 kilowatt shortwave transmitters, operated for VOA by the British Broadcasting Corporation, on a contractual basis, beam Voice broadcasts to Europe, Africa and the Near and Middle East. Twenty-six high-gain curtain antennas are available for directing these transmissions to their targets.
9. Honolulu, Hawaii: This station, located in the nation's newest state, serves as an auroral by-pass to the Far East and Southeast Asia. It consists of two 100 kilowatt shortwave transmitters and seven rhombic transmitting antennas.  
The overseas system of the VOA, consisting of forty-seven high-power transmitters, has made auroral zone by-passing possible and has reduced the distance factor from transmitter to target area to values that are optimum for the effective delivery of

broadcasts on short, medium- or long-wave, whichever is popular in the selected target areas.

#### "Feeder" Link

The overseas stations of the VOA have just been described. They are the link in the over-all system directed towards the selected target area. The link from the United States to the overseas stations is referred to as the "feeder" link in the over-all system. It consists of thirty high-power shortwave transmitters located at seven plants in the continental United States. These high-power transmitters employ high-gain directive transmitting antennas for the dual purpose of feeding program transmissions from the studios of the VOA to the overseas relay stations for simultaneous relay into selected target areas and also as a supplemental means of direct target area coverage during periods of favorable propagation conditions. The following facilities are used for this purpose:

1. Bound Brook, New Jersey: Six 50 kilowatt shortwave transmitters and seventeen high-gain antennas beamed towards Europe, North Africa and South America.
2. Brentwood, New York: Three 50 kilowatt shortwave transmitters and nineteen high-gain antennas beamed towards Europe and South America.
3. Schenectady, New York: Three shortwave transmitters ranging in power from 25 to 100 kilowatts and eight high-gain antennas beamed towards Europe and South America.
4. Wayne, New Jersey: Two 50 kilowatt shortwave transmitters and four high-gain antennas beamed on Europe.
5. Bethany, Ohio: Six shortwave transmitters capable of operation at powers between 50 and 140 kilowatt and 22 high-gain antennas beamed on Europe, Africa, and South America.
6. Delano, California: Five shortwave transmitters ranging in power from 50 to 200 kilowatts and 22 high-gain antennas beamed towards Southeast Asia, the Far East, Siberia, and South America.
7. Dixon, California: Five shortwave transmitters ranging in power from 50 to 200 kilowatts and 20 high-gain antennas beamed towards Hawaii, Australia, Southeast Asia, the Far East, and South America.

#### Washington Headquarters

For the most part, VOA programs originate from its Washington headquarters plant. The Washington facilities, which take up nearly 100,000 square feet in the Health, Education and Welfare Building

on Independence Avenue, include eighteen studios, equipment to make forty different disc or tape recordings simultaneously, ten tape-editing booths, a recording control center, the Master Control, engineering offices, editorial offices, music and transcription libraries, and various other services which are required to keep VOA in operation twenty-four hours a day.

VOA's Master Control is one of the largest and most flexible in the world. It feeds programs originating in VOA studios, through special telephone circuits, to the shortwave transmitters in the United States. The Control Console (see Figure 5) is capable of selecting program material from one hundred sources and of handling twenty-six programs simultaneously.

This rounds out the systems concept of the VOA world-wide international broadcasting network. VOA broadcasts originating in studios located in Washington, D. C., are fed through appropriate control equipment and landline circuits to any one of thirty feeder transmitters located at seven plants in the United States. These programs are then broadcast over the high-power shortwave "feeder" transmitters, employing high-gain directional-antenna systems, to any one of forty-seven high-power transmitters located at nine overseas relay points throughout the world. The circuits to the relay stations by-pass the auroral zone of exceptionally heavy r-f absorption. The relay stations, located at optimum distances from the selected target areas, boost the level of the signal received from the "feeder" transmitters and simultaneously relay the broadcast directly into the target area on either the short, medium-, or long-wave broadcasting band, whichever is popular for broadcasting in the target area itself. Often secondary target-area coverage is also obtained directly from the transmitters located in the continental USA during periods of favorable propagation conditions.

Figure 6 shows pictorially how VOA broadcasts originating in the Washington, D.C., studios are transmitted to overseas listeners. Figure 7 shows the areas of the world that VOA broadcasts now reach.

#### Jamming

Communist jamming of VOA Russian-language broadcasts was first observed in February 1948. Since that time, jamming has continued and it is believed that approximately 2,000 radio transmitters are presently being used to jam Russian, European-satellite and Chinese language transmissions of the VOA and other broadcasters.

Jamming consists mainly of irritating sounds like buzz saws, sirens, white noise, etc., placed on the same frequency as the VOA transmissions for the purpose of making reception of the program difficult, if not impossible. Although intentional interference of radio transmissions violates

certain international radio agreements, these transgressions continue.

The VOA early realized that the most effective way to combat or nullify the effectiveness of jamming was to adopt a dynamic versatile approach requiring a wide range of latitude in engineering, operating, and program techniques. Such an approach is necessary because there is no single "magical" solution to this problem -- a technique that is successful today may be blotted out by increased jamming tomorrow.

Concurrent with the development of the system itself, certain techniques have been devised taking the form of electronic devices such as heterodyne filters, speech clippers, exalted carrier-type receivers, etc., the use of high-power transmitters and high-gain antennas, the advantageous use of favorable propagation conditions when these exist, the transmitting of the same program simultaneously from various relay stations located at different geographical locations, broadcasting on an around-the-clock basis, increasing the number of broadcasts in the English language, which are not jammed, as well as continuous study of the problem. These have permitted various degrees of, and in some cases complete, penetration of the jamming barrage.

That many broadcasts can be heard in spite of jamming is clear from reports of monitoring stations located on the rim of Communist territory, from systematic questioning of visitors to and escapees from the Soviet orbit, from letters written by Soviet bloc listeners, and from violent attacks on the Voice by Communist dignitaries and by the press and radio of the Soviet Union. Nevertheless, jamming is effective and represents a major problem for the Voice of America.

#### Future Plans

The growth and competition in shortwave broadcasting continues at a dynamic pace. Shortwave broadcasting throughout the world increased 13% during 1960, with about 140 countries engaged in this medium of mass communication. VOA's greatest competition, from the standpoint of the number of hours devoted each day to shortwave programming, comes from Radio Moscow, Radio Peking and the UAR's "Voice of the Arabs", with each of these devoting more time to shortwave programming than VOA.

Many newly emerging countries and developing nations began, or increased, shortwave broadcasting during the past year or two. For these countries, shortwave radio provides an effective, simple and relatively inexpensive means of mass communication. Even the Soviet Union depends to a great extent on shortwave radio for keeping people in its hinterlands informed.

The increased availability at steadily lowering costs of transistorized radio receivers has also played an important part in the recent upsurge in the popularity of shortwave broadcasting.

Independent of power lines and capable of operating for months on a few cheap batteries, radio can now penetrate into rural and underdeveloped areas, opening up vast new potential audiences, both for the Voice of America and its competitors.

VOA has developed a long-range facilities planning program for meeting the growing world competition in shortwave broadcasting. Basically, this plan calls for eliminating coverage deficiencies which exist presently, and for boosting signal strengths in the more important target areas where competition is greatest.

The Congress has recently appropriated funds for two major steps in this program. These consist, first, of a new domestic plant which is now under construction in Greenville, N.C. This plant will provide VOA relay stations in Europe and the Mediterranean area with a more reliable and higher quality signal, and will also improve the capability of direct broadcasting to some areas of Europe, Africa and Latin America. The principal transmitters will consist of six 500 kilowatt shortwave, six 250 kilowatt shortwave, and six 50 kilowatt shortwave. This new installation, being built at a cost of nearly twenty-four million dollars, will be the world's most powerful shortwave broadcasting station when it comes on the air during early 1963 (see Figure 8). When in operation, it will permit VOA to discontinue use of fourteen obsolete shortwave transmitters at other domestic plants, some of which have been in service for more than twenty-five years.

The other new technical facility approved by Congress is an African relay station now under construction near Monrovia, Liberia. This station, being built at a cost of approximately thirteen million dollars, will provide VOA, for the first time, with competitive shortwave coverage of the entire African continent. The six 250 kilowatt and two 50 kilowatt shortwave transmitters planned for the Liberian installation are expected to go into operation during mid-1963. The new station will partially fill the coverage gap that will be caused when VOA's Tangier station ceases operation on December 31, 1963, when the present agreement with the Moroccan Government terminates. It will also improve VOA's coverage capability in parts of the Middle East and Europe during critical periods of low sunspot activity.

#### Science and Research

Research has played an important part in the development of the VOA broadcast system. The VOA has established, during the development of this system, a research program utilizing the services of leading research organizations at various colleges and universities, other government departments and agencies, and commercial research organizations having experience in developing research activities along the lines most important to the technical development of the VOA. In general, this research program has explored the

broad field of electronics, communications, and radio propagation. VOA's research program has played a very significant role in the early development of ionospheric scatter communications, advancing the state of knowledge concerning auroral and other anomolous types of radio propagation, developing high-power transmitters, high speed, self calibrating modulation monitors, peak audic clippers and other devices which have benefitted both the VOA and the communication field in general.

VOA is keenly aware of the necessity for keeping abreast of technical improvements in the science of broadcasting and communications. The engineering staff maintains very fruitful informal contact with the profession. To focus attention on scientific research and development, VOA has organized a Science Advisory Group drawn from a cross-section of the academic world, industry and government. This group is chaired by Henry Loomis, VOA's Director. It serves both as a forum for review of technical plans and as a source of technical ideas and information. Through the Science Advisory Group, VOA has available to it for consultative purposes, some of America's engineering and scientific leaders in the field of communication.

VOA is actively participating in governmental long-range planning for space communications. It has urged that international radio and television broadcasting be considered as a high priority goal for this country's space communications program.

VOA also participates actively in the Inter-departmental Radio Advisory Committee (IRAC) and other government and international groups concerned with telecommunications planning.

#### Engineering Personnel

The Office of the Engineering Manager, VOA's engineering headquarters in Washington, is made up of approximately one hundred **various types of** engineers, communication specialists, technicians and supporting clerical personnel. Of this number, more than **one-third** hold degrees in the various fields of engineering or associated sciences, or are registered Professional Engineers. Overseas, VOA employs approximately six hundred and twenty-five communication specialists and technicians, of whom eighty-six are American (see Figure 9).

#### Effectiveness

The question may certainly be asked whether all this is effective; does the VOA actually reach its target areas, especially in those countries under Communist domination? To determine the technical effectiveness of the VOA world-wide broadcasting system, monitoring stations have been set up to act as "ears" for the VOA. At these monitoring stations all VOA language broadcasts to the particular area are monitored under reception conditions that are typical for the average listener in the area. Reception information amassed at these technical monitoring stations during 1960, amounting to over a million individual monitoring observations, indicated that on languages that are not jammed, such as English, Arabic, Hindi, Urdu, etc., over 90% of all the programs monitored were reported as being received satisfactorily. On the Soviet and satellite VOA language transmissions, which are being jammed by the Communists, the percentage of satisfactory reception is, as one would expect, somewhat lower. Indications are, however, that fairly good reception of the VOA is possible over large areas under Communist domination.

Possibly one of the most tangible proofs that the Communists regard the VOA as a threat to their designs is the magnitude of the Soviet Union's effort to jam the broadcasts beamed to the Communist-dominated areas of the world.

Scientific surveys, letters from listeners, efforts by the Communist press and radio to discredit the broadcasts, and reports from correspondents and travelers, all provide convincing evidence that the VOA's world-wide international broadcasting system has been successful in overcoming the natural and man-made obstacles and is getting through, to an appreciable degree, with its message from America.

The Voice of America's Washington studios are located in Health, Education and Welfare Building, on Independence Avenue. Free public tours are conducted at 11 A.M. and 3 P.M., Monday through Friday, and visitors are cordially invited.

The Voice of America, broadcasting through its technical facilities, seeks only to be the radio mirror, without distortion, of America and the American people.



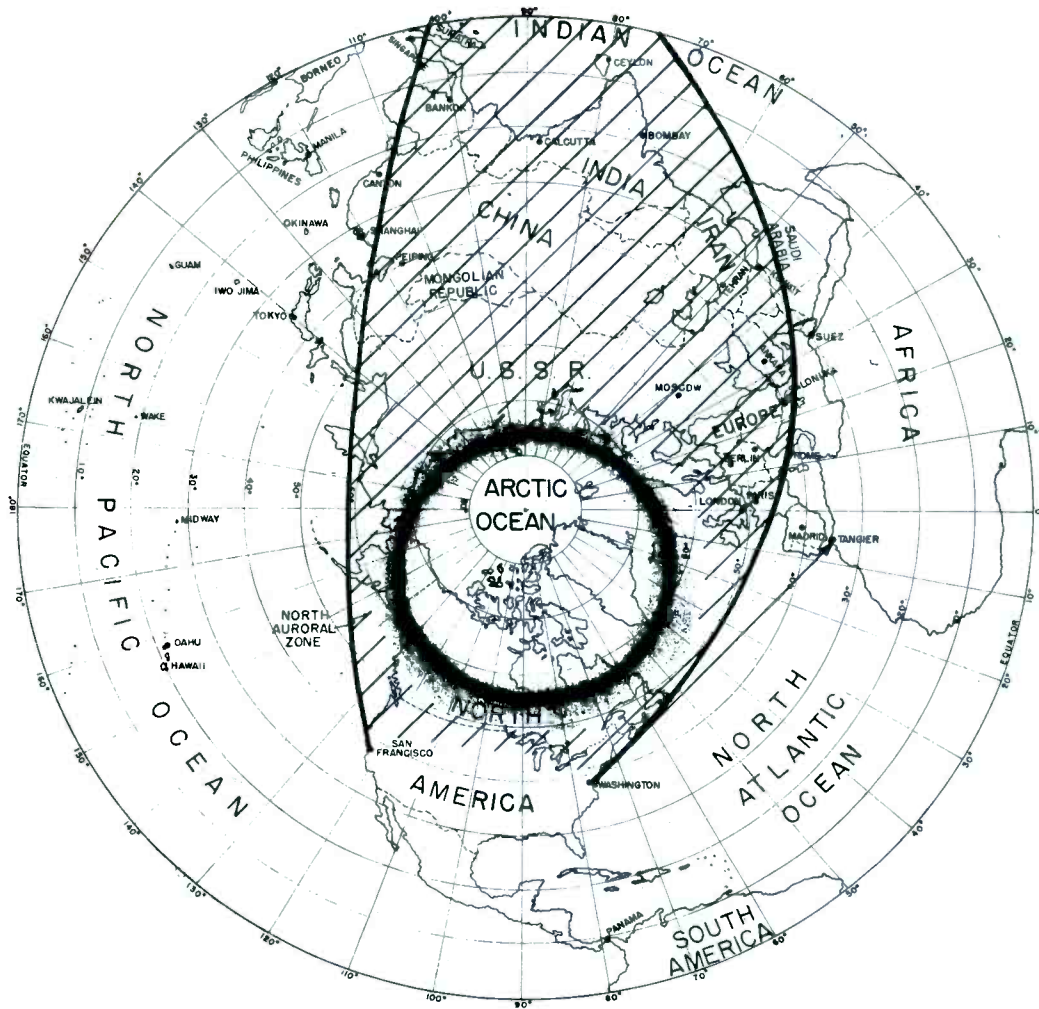

Fig. 1. An arctic projection indicating the approximate location of the northern auroral zone. Cross-hatched area shows parts of the world that cannot be reached effectively from short-wave transmitters in the United States due to the shielding effect of the auroral zone. Note, however, that circuits from New York to Tangier and from San Francisco to Manila are not shielded by this zone.

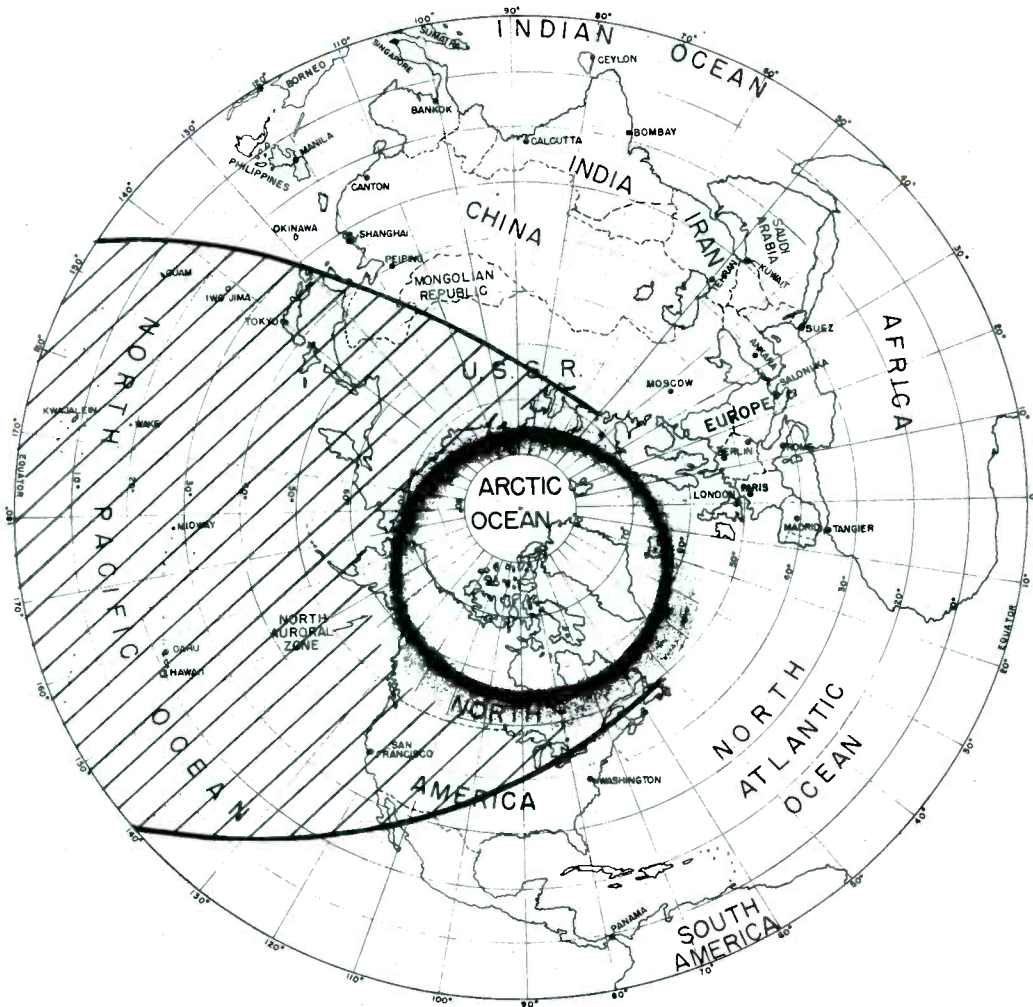

Fig. 2. The same map projection as Fig. 1 with the cross-hatched area indicating the auroral zone shielding effect upon short-wave transmission from Tangier. Note that Asiatic and European areas shielded from direct coverage from the United States (see Fig. 1) can be covered from Tangier.

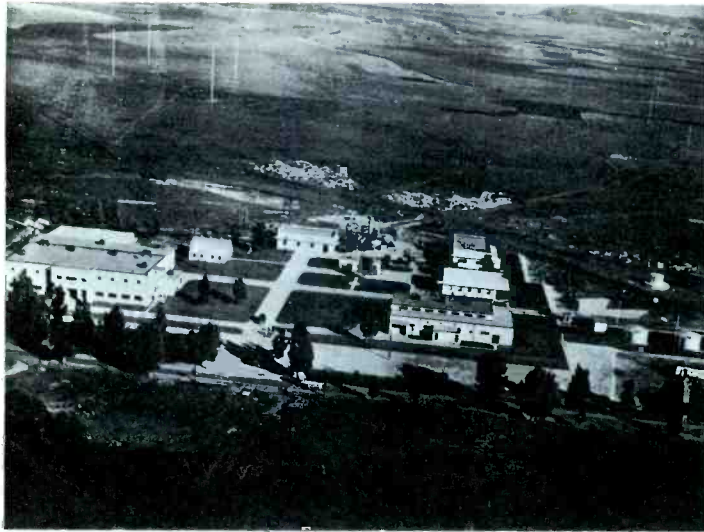

Fig. 3. Aerial view of VOA's Tangier relay station. Transmitter buildings on left house ten short-wave transmitters. Self-contained diesel-generating plant is contained in buildings on right. Antennas in background beam VOA broadcasts to Europe, North Africa and the Near and Middle East.



Fig. 4. Interior view of VOA's Tangier relay station showing 100-kw transmitters (upper level) and 35-kw transmitters (lower level).

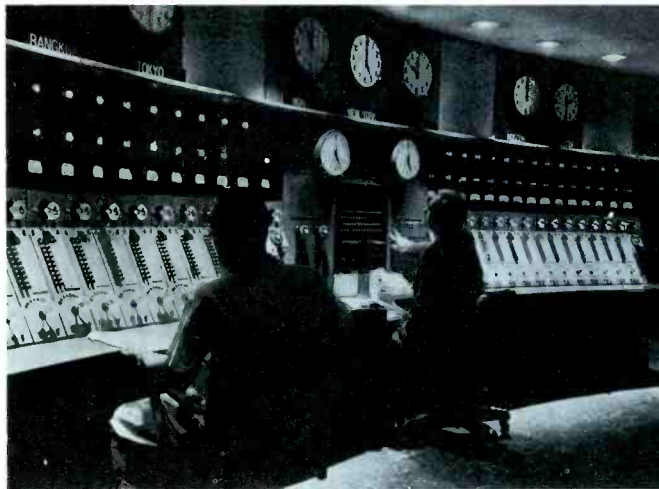

Fig. 5. The Voice of America's master control console is largest and most flexible in the world. Especially designed and built for the Voice facilities in Washington, D.C., it can select programs from 100 different sources and transmit 26 programs simultaneously.

Master control is manned at all times by two radio technicians who preset the board in advance for each 15-minute program change. Here two technicians check the volume control while monitoring the programs which are being transmitted.

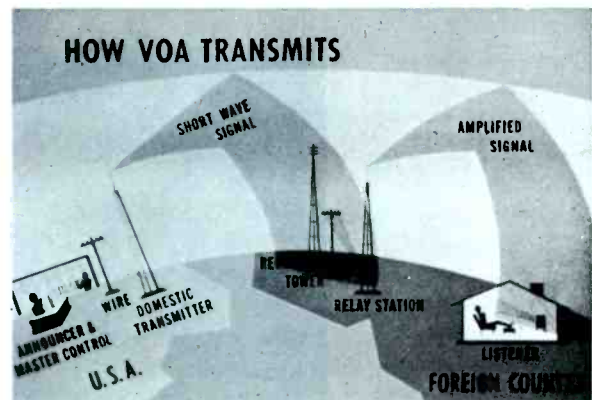

Fig. 6. Programs in thirty-five languages originate in VOA's Washington studios, and are carried by land-line to high-power shortwave transmitters located on the east and west coasts of the United States. Overseas relay stations pick up the broadcasts and strengthen the signal, transmitting the program to the intended audiences on long, medium and shortwave.

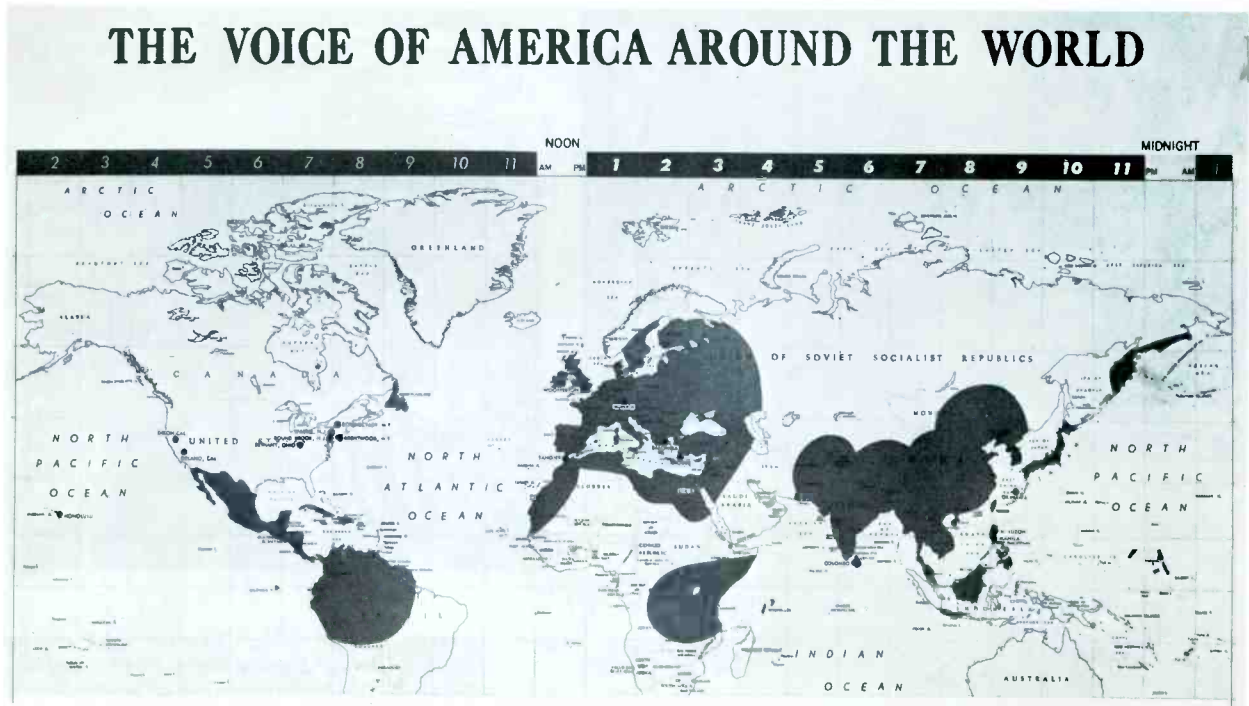

Fig. 7. The Voice of America, broadcasting around the clock, beams programs to a potential audience of more than 500 million people. VOA's present coverage areas are shown shaded in the above map.

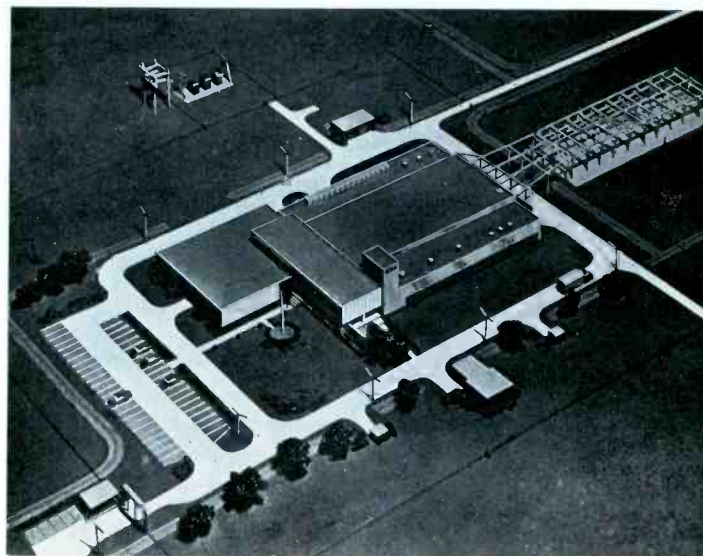

Fig. 8. Plan model of one of the transmitting plants now under construction for VOA near Greenville, N. C. The 24 million dollar project will include two such transmitting plants and a receiving center. When completed, during early 1963, the installation is expected to be the largest broadcasting station in the world.

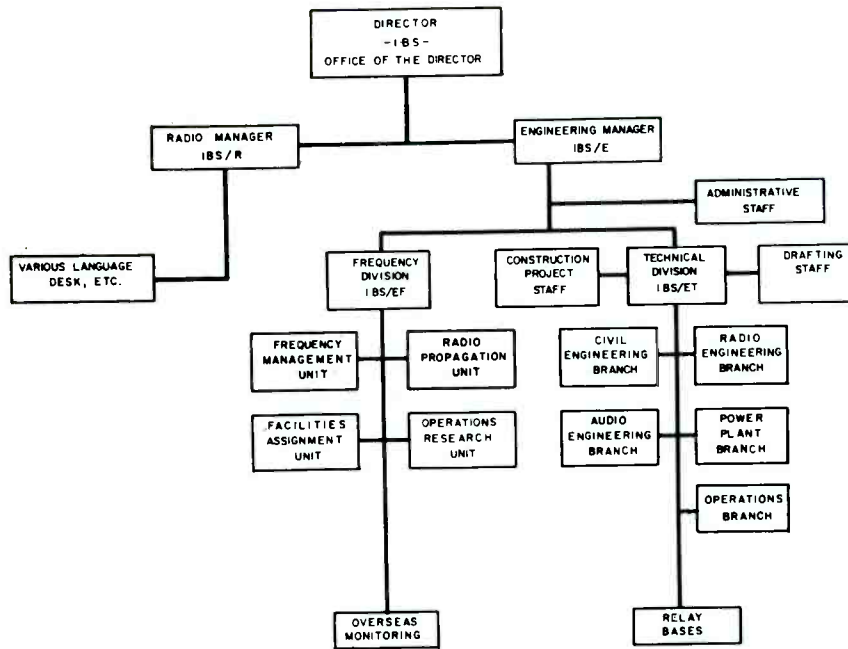

Fig. 9. Headquarters for VOA's engineering staff is in Washington, D. C. The organization chart shown above illustrates the many functions performed by the 100-man engineering staff.

## FCC LABORATORY OBSERVATIONS OF PRECISION FREQUENCY CONTROL OF TV STATIONS

E. W. Chapin  
Chief, Laboratory Division  
Federal Communications Commission

Summary - Observations on the use of both high and low-frequency precision offset for interference reduction have not indicated any severe problems due to propagation, at least for Channel 4. Arrangements are being made for further observations on high VHF channels.

A few years ago numerous observations were made at the FCC Laboratory at Laurel, Maryland, on the use of both high-frequency and low-frequency precision offset for the reduction of interference caused by co-channel operation of TV stations. As used herein low-frequency precision offset refers to offsets less than 1 KC and high-frequency offset to offsets near 10 or 20 KC. The original observations were mostly based on simulated visual presentations obtained by adding an appropriate video-frequency continuous-wave signals to the demodulated received desired TV signal. A few control tests were made with radio frequency signals, but extended tests were impractical by that method with the techniques then in use. These tests have been reported as given in the references. In addition Laboratory personnel also viewed tests on high-frequency precision offset at the RCA Laboratories at Princeton, New Jersey.

The results of these tests led to a desire for further actual radio frequency tests with more flexible and stable methods of adjusting the various parameters, and for a method to permit evaluation of propagation effects over appreciable periods. It was especially important to investigate the propagation effects, with regard to low-frequency precision offset, since low-frequency offset requires frequency stability considerably greater than for high-frequency precision offset.

Intermediate between the original tests and tests to be described later, recordings were made of the frequency difference between a local precision stabilized oscillator frequently checked against WWV and the received video carrier of WNBC-TV, New York. These recordings indicated a stability of the received signal of the order of one cycle over short periods, except during those periods involving aircraft reflections and the case of the lower part of the fading cycle. This latter condition is probably of little importance as under this condition little interference would be produced because of the weak undesired signal. The day to day stability was also of the order of 1 cycle except for occasional changes due to tube replacement or adjustments. Figure 1 shows a typical recording. Difficulty in evaluating these recordings in terms of effects on the received picture interference led to further tests permitting direct picture observations.

During the period of the above frequency measurements and during those tests hereafter described, WRCA-TV, (Now WNBC-TV) New York, N. Y., Channel 4 (not offset) and WRC-TV Washington, D. C. Channel 4 (offset - 10 KC) were using highly stable crystal control for their own test purposes.

The signals of the New York station were received at Laurel, on a 5-element Yagi antenna with its back toward Washington. In addition a separate antenna was used for nulling out as much of the remaining Washington signal as possible. This signal was then fed through a receiver and converted to 1 mc. This receiver employed a specially stabilized high frequency oscillator as well as a crystal controlled second heterodyne oscillator. Another receiver converted the signal to 500 KC, at which frequency a crystal filter some 50 cycles wide removed most of the remaining modulation and WRC-TV signals. The 500 KC signal was then converted back up to Channel 4 by use of the same oscillators as used for reducing the frequency. Consequently, the final frequency was unaffected by the several conversion oscillators.

In order to permit observation of low-frequency precision offset, one of the conversion oscillators involved in returning the 500 KC to Channel 4 was arranged to permit its frequency to be precisely deviated from the value used in down conversion. This same arrangement also permitted a high-frequency offset different from that provided by the stations themselves. Provision was made for modulating the reconstituted carrier with video modulation from a Laboratory color video source or with video modulation demodulated from local TV stations.

The signals from the Washington station were picked up on a separate antenna and both signals fed through variable attenuators to the inputs of various TV sets. With the above equipment set-up we could use the reconstituted New York signal for interference at various levels to the signals received from the Washington station. The interfering signal could also be obtained from a local source if desired. The test system has been described in some length as it may prove useful to others in similar investigation. Figures 2, 3, 4, 5, and 6 are diagrams of the equipment arrangement.

During the spring and summer of 1960 observations were made on numerous days when color program material or material employing color sync standards were available. (Employment of color sync standards is requisite since the field rate must be constant to obtain the benefits of precision offset, and the optimum

particular values of offset are related to the field rate). During a very large part of the observation time no difficulty with use of precision offset could be traced to propagation. During times when fading due to aircraft was noted there was deterioration of the signal, but the added deterioration due to loss of favorable offset was impossible to evaluate. At a very small percentage of time deterioration of undetermined cause was noted. At the present time further observations are underway on Channel 4. The foregoing observations included both high and low-frequency precision offset.

It is highly desirable that similar observations be made on the high band VHF television signals, since propagation effects on the received frequency might be expected to be some three times worse. Preliminary arrangements are underway for such observations at Laurel. These tests will require percentage stabilizations of the frequency of some high band VHF stations even better than that required for the Channel 4 tests.

Stability of the system used in the tests permitted more critical examination of interference at particular offset values. For low-frequency precision offset there is a freedom from gross structural interference at the odd 30 cycle points. Flicker is present. However, it was noted that this flicker was a function of the television receiver characteristics, apparently being affected by both AGC and viewing tube phosphor persistence. While flicker was very bad on the monochrome sets used, it was much less on the color sets employed. At these flicker 30 cycle points the interference at points on adjacent lines tends to be averaged on alternate fields.

It was noted that certain types of receiver AGC appeared to markedly improve even the worst offset conditions, and it would therefore seem that the design of some present receivers may better the performance even with present non-precise offset. See Part III of Reference 5. Therefore, the improvement obtained by going to precision offset may be somewhat reduced.

The design of the receiver used is also of great importance because sync stability becomes a real problem when the ratio of the desired signal to the undesired signal becomes less than some 20 db. Even if sync is not apparently

affected it may result in minor vertical instability which may destroy the improvement due to precision offset. On the other hand, receiver design may permit values less than 20 db.

Because of receiver variations it is necessary that careful consideration be given to existing and currently produced receivers when evaluating the improvement to be gained by various types of precision offset.

#### References

1. RCA Laboratories Division. "A Study of Co-Channel and Adjacent-Channel Interference of Television Signals, Part I," RCA Review, Vol. XI, p. 99. March, 1950.
2. "A Study of Beat Pattern Effects as They Relate to the Several Color Television Systems." March 23, 1950. This paper was presented in evidence in hearings before the Federal Communications Commission, Docket No. 8763, et.al. in 3 parts, designated as Exhibits 389, 391, and 465.
3. "Interference to Color and Monochrome TV Receivers by Oscillator Radiation and other CW Signals," W. K. Roberts, L. C. Middlekamp, and E. W. Chapin, Transaction of IRE on Broadcast and Television Receivers, July, 1954, PGBTR.
4. W. L. Behrend, "Reduction of Co-Channel Television Interference by Precise Frequency Control of Television Picture Carriers", I. R. E. Transactions on Broadcast Transmission Systems. PGBTS-7, February, 1957, p. 6.
5. Co-Channel Television Interference and Its Reduction. E. W. Chapin, L. C. Middlekamp, and W. K. Roberts, June, 1958 Transactions on Broadcast Transmission Systems, PGBTS.
6. Reduction of Co-Channel Television Interference by Very Precise offset carrier Frequency. L. C. Middlekamp, December 1958, IRE Transactions on Broadcast Transmission Systems, PGBTS.
7. Engineering Aspects of Television Allocations, TASO Panel 6, Report of March 16, 1959.

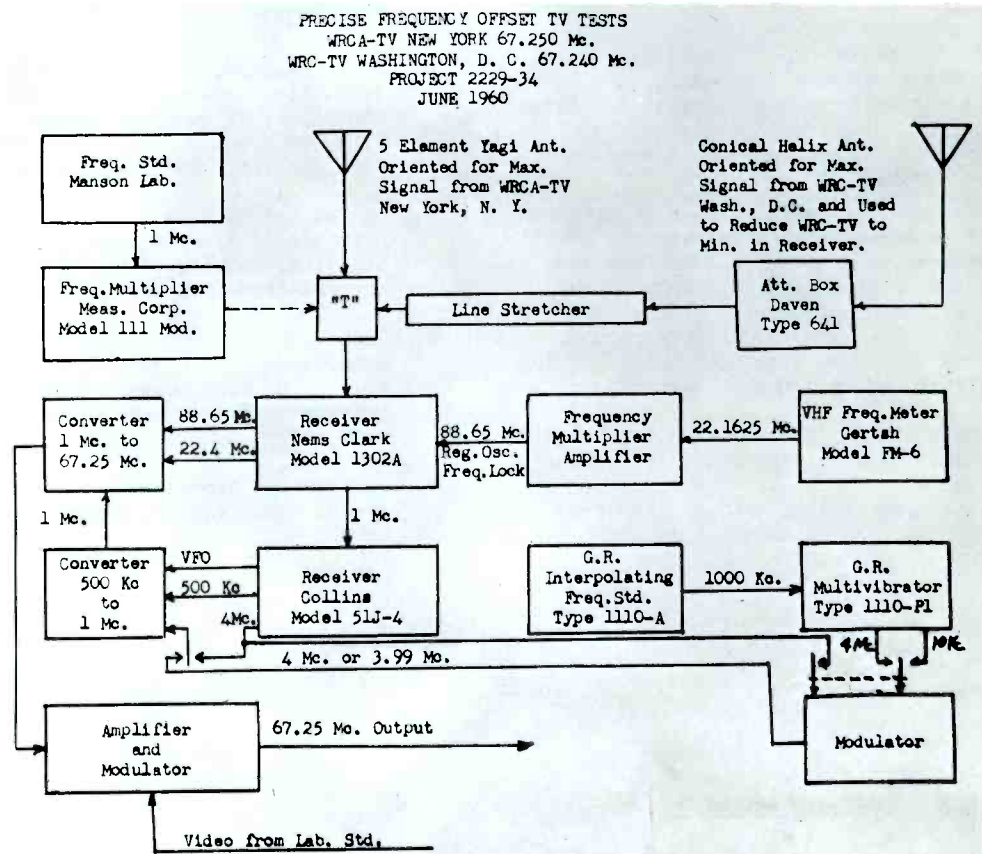
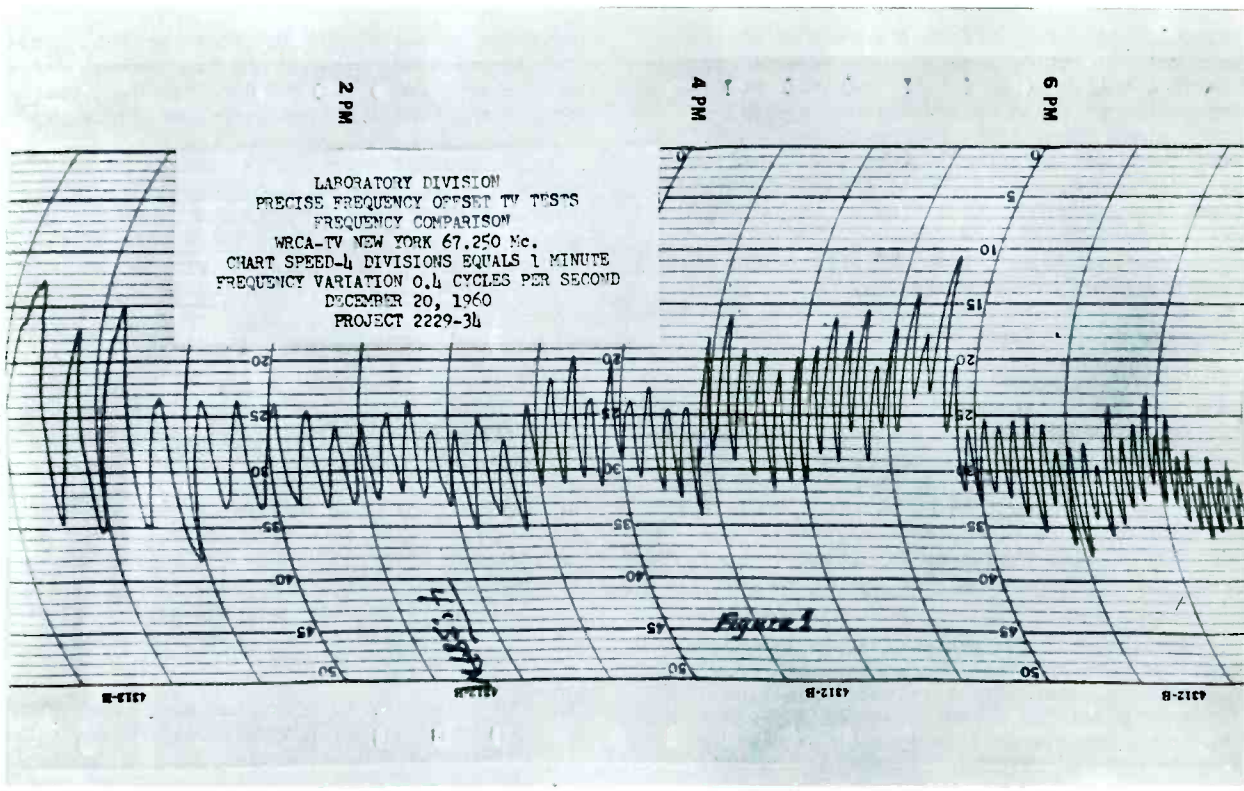

Figure 2



PRECISE FREQUENCY OFFSET TV TESTS  
 WRCA-TV NEW YORK 67.250 Mc.  
 WRC-TV WASHINGTON, D. C. 67.240 Mc.  
 PROJECT 2229-34  
 JUNE 1960

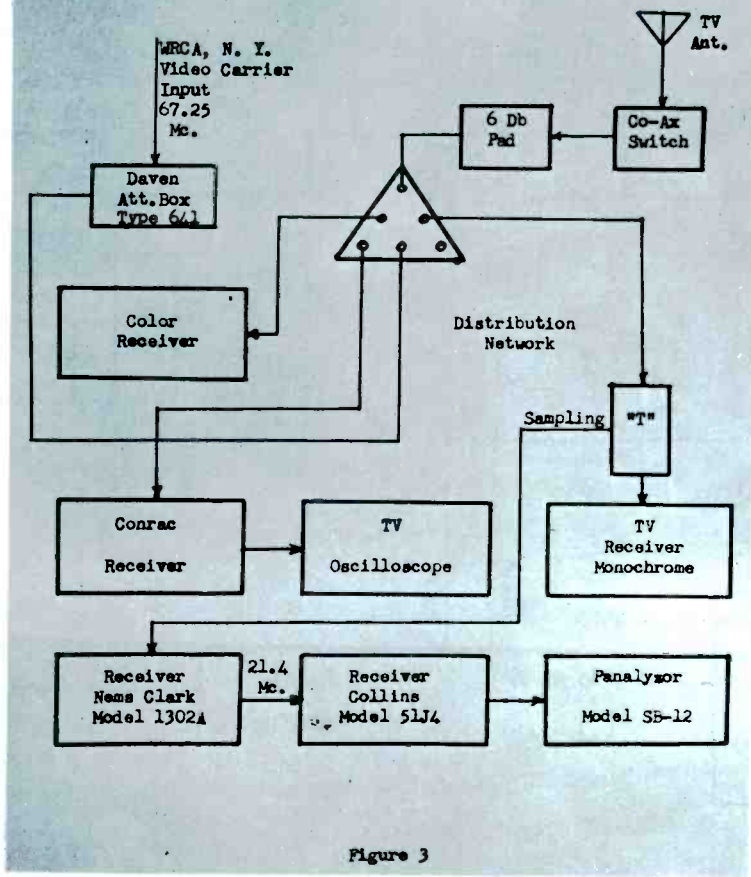
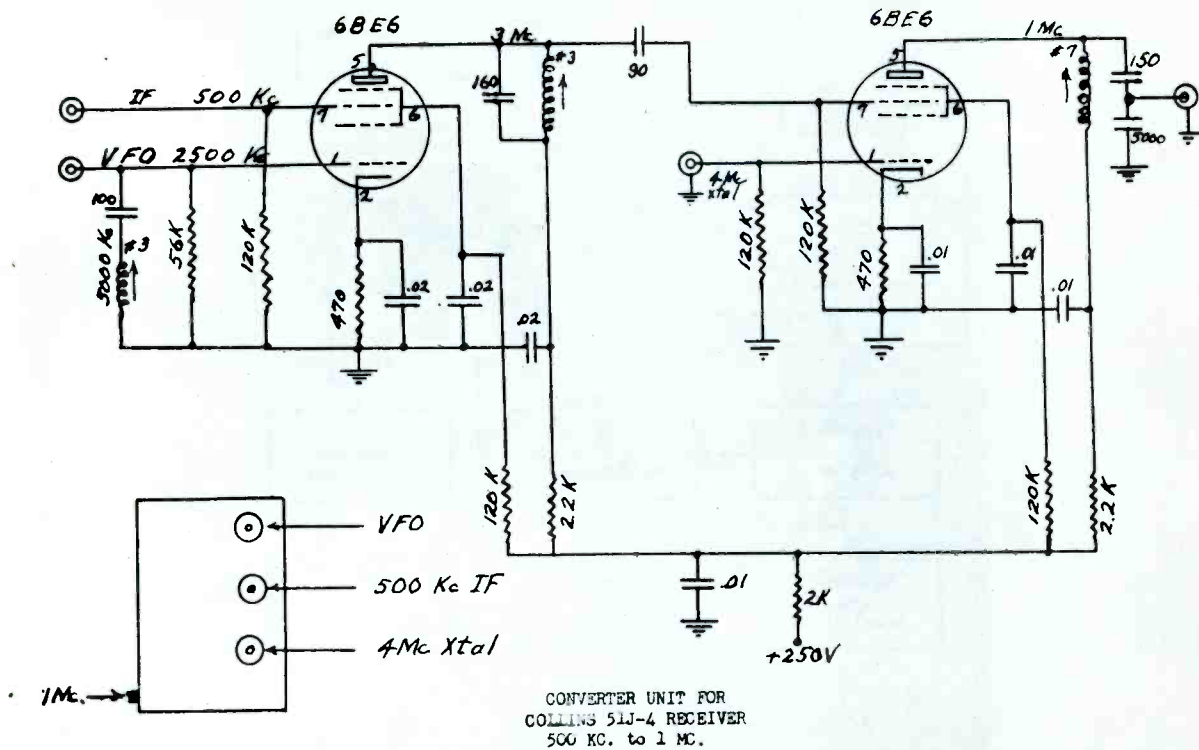

Figure 3

LABORATORY DIVISION  
 CO-CHANNEL INTERFERENCE  
 PROJECT 2229-34  
 JUNE 1960



CONVERTER UNIT FOR  
 COLLINS 51J-4 RECEIVER  
 500 KC. to 1 MC.

Figure 4

LABORATORY DIVISION  
 CO-CHANNEL INTERFERENCE  
 PROJECT 2229-34  
 JUNE 1960

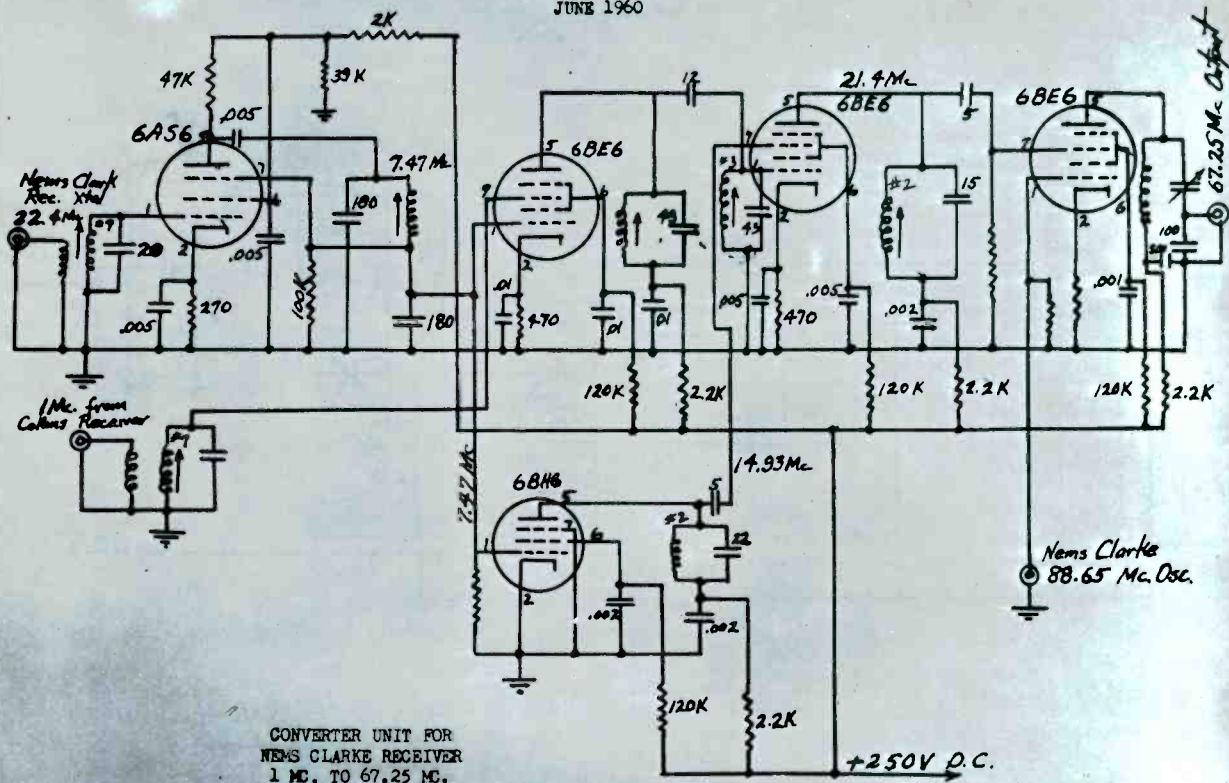

CONVERTER UNIT FOR  
 NEMES CLARKE RECEIVER  
 1 MC. TO 67.25 MC.

Figure 5

LABORATORY DIVISION  
PROJECT NO. 2229-34  
JUNE 1960

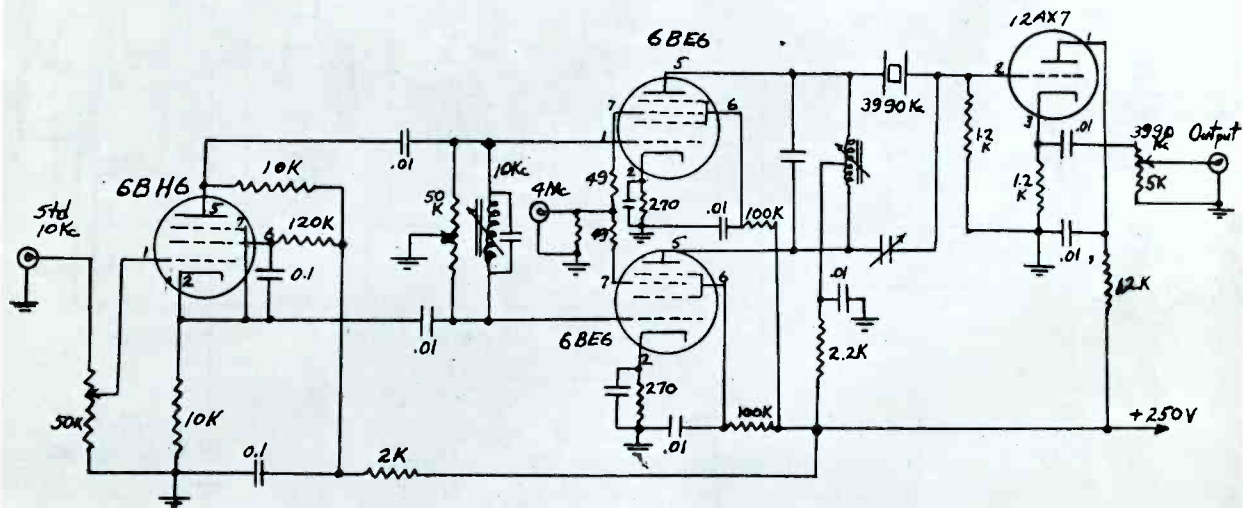

CO-CHANNEL INTERFERENCE  
PRECISION LOW FREQUENCY CARRIER OFFSET  
MODULATOR

Figure 6

# THE CBS NetALERT<sup>®</sup> - A SYSTEM FOR NETWORK SIGNALING

A. A. Goldberg, A. Kaiser, G. D. Pollack  
CBS Laboratories  
Stamford, Conn.

and  
D. Vorhes  
CBS Radio  
New York, N. Y.

Divisions of Columbia Broadcasting System, Inc.

## Introduction

Network radio broadcasting has changed considerably compared to the pre-television era. Fifteen years ago, the public looked toward radio for a complete repertoire of music, drama, comedy, and news. The affiliate stations were on the network most of the time and bulletins or special programs were automatically received. Any communications from network headquarters to the stations could be handled during station breaks. Now, however, the stations are off the network most of the time, and there is no simple way to alert these stations to receive urgent news bulletins or national emergency announcements.

Under certain conditions, hundreds of telephone calls must be placed to alert all 210 CBS Radio affiliated stations. Alerting is particularly difficult at night when the maximum number of calls would have to be made to the homes of station managers.

The CBS NetALERT System, developed and produced by CBS Laboratories, enables all CBS Radio affiliates to be automatically alerted. The CBS NetALERT System provides nine different alert signals, transmitted over the network's regular telephone lines at a fraction of the normal program level. Signals identifying extremely important or emergency news alerts are simultaneously transmitted to the station executive's home.

The nine different alert signals are each composed of from one to nine virtually inaudible pulses; each less than 1/30th of a second. These signals are received by a logic filter which recognizes and accepts only the particular alert code being transmitted.

NetALERT transmitters are now being installed in the outgoing program lines at major network points. When installation of the system is

completed, NetALERT signals will be capable of being sent to the entire network, to those stations in any single time zone, or to those in any combination of time zones, as the situation may require.

## Statement of the Problem

### Telephone Lines

Two types of telephone lines are used on the network; class B lines and class C lines. Ninety-five percent of the stations are served by B lines which have a guaranteed frequency response of 100 to 4900 cps. The balance of the stations are served by C lines with a frequency response of 200 to 3500 cps. Experience has shown that the upper response of the C line is not dependable above 3500 cps. NetALERT must operate on both class B and C lines.

### Unobtrusiveness

Any signals superimposed on the normal program must be unobtrusive. The signal need not be completely inaudible, although this would represent the ultimate in unobtrusiveness.

Subjective tests were conducted to determine the audibility of 1000 to 3500 cps signals of varying duration. A jury agreed that burst durations of 20 milliseconds or less sounded like a click, whereas longer durations conveyed the actual tone. Burst durations greater than 50 milliseconds were considered objectionable. These tests were carried out against a silent background and at full level.

When the tests were made in the presence of music and speech, the jury agreed that a 30-millisecond burst at a level of -20 db with respect to program, was unobtrusive. In fact, the signal could be completely masked by rhythmic music.

During all of these tests, the program was muted during the duration of the burst. When the burst amplitude was reduced to zero, all that remained was a short duration "hole" in the program. Depending on the program content, this "hole" was inaudible or sounded like a click. Shaping of the rise-time and decay-time minimized this click.

### Reliability

Two types of system reliability are desired: (1) The transmitted signal should always be received; (2) No signal should ever be received in the absence of a transmitted signal (false alarm). Both types of reliability are important. In the case of the first, if a program cue alert should not be received, the network would suffer embarrassment. If a national defense alert should not be received, the results could be very serious. Similarly, in the case of the second, false alerts could cause important inconveniences.

Unobtrusiveness and reliability are conflicting requirements. As the signal pulse width and level are reduced, audibility decreases but the signal becomes increasingly difficult to separate from the program. It was decided that the signal width should not exceed 30 milliseconds and the signal level should not exceed -20 db with respect to the program. Since the signal frequency must be less than 3500 cps, a circuit had to be developed that would discriminate against program, despite the higher level, and act only when a signal was received.

### Accessories

Optional accessories include:

1. Remote indicator
2. Executive alarm
3. Notch filter

The Remote Indicator, which is connected via a multiconductor cable to the receiver, provides means for the alert to be indicated on the desk of the station executive. It must be compact and pleasingly styled.

During "very special programs" or "national emergency" alerts, means must be provided to sound an alarm in the home of the station executive. This is done via telephone company service. A small accessory box, known as an Executive Alarm, feeds the telephone company lines.

Whenever one section of the network tapes a program originating from another part of the network, it may be desirable to eliminate the NetALERT signals during playback. Here a notch filter tuned to the NetALERT signal frequency would be inserted in the program line from the tape player.

### Types of Alert Signals

Six different alerts and three spares are desired and are assigned the following functions:

- Alert No. 1 - Station cue
- Alert No. 2 - Network cue
- Alert No. 3 - Voice closed-circuit
- Alert No. 4 - Exclusive bulletin
- Alert No. 5 - Spare
- Alert No. 6 - Spare
- Alert No. 7 - Spare
- Alert No. 8 - Very special program
- Alert No. 9 - National emergency

For Alerts Nos. 1 and 2, the receiver will automatically reset to zero after four seconds. For Alerts 3 to 9, the receiver will maintain the alert until reset by the network. Alerts Nos. 8 and 9 actuate the executive alarm.

Two different modes of operation were considered: (1) Alerts could be sent by employing a unique signal for each alert and having the correct number indicated immediately; or (2) Alerts could be sent by transmitting an appropriate number of similar signals sequentially. The second approach, requiring less expensive apparatus, would achieve a system of excellent performance and reliability and was selected for the NetALERT system.

### NetALERT System

#### Basic Theory of Operation

While actual frequencies and burst durations may not be divulged, it can be stated that the frequencies are contained in the spectrum between 1000 and 3500 cps, and that the total burst duration does not exceed 30 milliseconds.

Referring to Figure 1, the program line at the CBS Radio Central Control passes through the NetALERT transmitter. When an alert is dialed, each closure of the dial contacts causes switch S1 to go through one cycle. The cycle consists of the outgoing line departing the incoming program line, dwelling first on the F1 signal for

duration  $D_1$ , next on the F2 signal for duration  $D_2$ , and finally returning to the incoming program line. For example, if Alert No. 4 is dialed, the cycle is repeated four times. At the radio station, the NetALERT receiver is bridged across the network program line. An audio amplifier with a bandpass of 200 to 6000 cps amplifies the signal which then divides into two paths; namely, an F1 analysis channel and an F2 analysis channel.

In the F1 channel, a clipper circuit is set to clip not the sinusoidal alert signals but only the program which is at a 20 db greater level. The clipped program is then analyzed for a pure F1 signal in the absence of any other signal. It accomplishes this in the following manner: The outputs of an F1 bandpass detector and an F1 band-reject detector are summed. When the desired signal conditions exist, the combined detector output is a negative pulse that is used to trigger a one-shot multivibrator. The multivibrator output is a square positive pulse of approximately  $D_1 + D_2$  duration which allows a thyatron to fire upon receipt of a coincident signal from the F2 channel.

The F2 channel contains a tuned amplifier peaked at F2. When the F2 alert signal is received, it is amplified and fires the thyatron when the coincident gating pulse is simultaneously present.

The thyatron fires once for each received alert signal. Current passes through a stepping relay containing a multiplicity of contacts as well as a disk which presents a numeral to the viewer. Means are available for the NetALERT transmitter to reset the receiver to zero.

#### NetALERT Transmitter

Figure 2 is a simplified diagram of the NetALERT transmitter. Four program lines are shown entering the transmitter and four lines leaving at respective indicated impedance and signal levels. These lines are designated "Line 3", "Line 4", etc., to correspond with numbers used at Central Control of the CBS Radio Network. In addition, two internal lines are provided, one being driven by an F1 oscillator, the other by an F2 oscillator.

During a program period, switches W in Figure 2, which are transistor single-pole switches, are maintained in a "closed" condition by the application of positive control voltages applied to the bases of these transistors. Thus, program enters and leaves the transmitter. Switches X and Y are identical line switches maintained in an "open" condition during program periods by applying negative voltages to the respective transistor bases. Therefore, no NetALERT signals will appear across the outgoing program lines.

At the instant a NetALERT pulse is dialed in the Control Unit (described below), all W switches are opened and the X switches are closed. This causes a 1.6-volt rms, F1 signal to appear across the 560 $\Omega$  termination and 0.11-volt rms across each

program line when properly terminated by 150 $\Omega$ . This signal attenuation is the result of using two 1 K bridging resistors in series with the signal lines to prevent line loading and crosstalk. The X switches are held closed for a period of  $D_1$  whereupon they are opened, and simultaneously the Y switches are closed for a period  $D_2$ . During this period, a 0.11-volt rms, F2 signal is placed on the program lines. When the Y switches are opened, a total duration  $D_1 + D_2$  after the start of the NetALERT pulse period, the W switches are closed and the program resumes. This full sequence of events occurs once for each NetALERT pulse transmitted.

Push-pull power amplifiers are required to raise the outputs of the NetALERT signal oscillators from 1 milliwatt to approximately the required 10 milliwatts.

Switches Z are transistors wired in shunt with the NetALERT signal lines. During program periods, these are kept closed to provide a short circuit across the 560 $\Omega$  resistor. In this way, the common impedance "seen" by the four program lines via the 1 K bridging resistors is zero and program crosstalk is held to less than -60 db. The Z switches are open for the full  $D_1 + D_2$  period necessary to send a NetALERT pulse.

Figure 3 is a symbolic diagram of the transmitter logic and control circuits. Three one-shot transistor multivibrators are shown, designated I, II, and III. Upon the momentary closing of the telephone dial switch, an 18-volt positive pulse is applied to multivibrators I and II to initiate their respective quasi-stable cycles. The natural quasi-stable period of multivibrator I is in excess of duration  $D_1 + D_2$ , that of multivibrator II is exactly duration  $D_1$ . The output of I opens the W and Z switches, that of II closes the X switches. When II returns to its stable state after duration  $D_1$ , it furnishes a positive pulse to III, thereby initiating its quasi-stable period of  $D_2$  during which the Y switches are closed. On the return of III to a stable state, a negative trigger is supplied to I for the purpose of returning it to its stable state, approximately 5 ms before the end of its natural quasi-stable period. Thus, a full cycle of NetALERT pulse is timed, and all switches have been returned to their normal program condition.

The 2 K and 100 K resistors and the .05 mf capacitor in the dial-triggering circuit are incorporated to prevent spurious triggering of the system as a result of telephone dial contact bounce.

The transmitter has been packaged in two parts: The control unit and the transmitter proper.

Control Unit. This unit may be rack mounted and contains the telephone dial assembly, manual switches, indicator lights, and power for the low-voltage ac control relays located in the transmitter. It also contains thermally operated switches and an electromagnetic relay.

Transmitter: This unit may be installed up to 50 feet away from the Control Unit. Plug-in modules contain the transistor line switches and the F1, F2 power amplifiers. Semi-conductor circuitry is used throughout. The F1 and F2 generators are stable tuning fork oscillators that are on continuously.

#### NetALERT Receiver

Each affiliate of the CBS Radio Network will have a NetALERT receiver bridged across the incoming program line. Line impedances can be either 150 or 600 ohms; balanced or unbalanced. Line level is not critical and can be between -20 and 0 VU. The receiver is energized continuously from the 117 volt, 60 cycle line. A total of 7 tubes (including power supply rectifier) plus three germanium diodes are used.

Only key CBS Radio Network Central Controls can send alerts. As mentioned previously, alerts Nos. 1 and 2 reset to zero automatically after four seconds. This is coded into the circuitry of the receiver. Alert No. 3 and higher can be reset only by Central Control. This is accomplished by their sending one NetALERT pulse after a minimum wait of 15 seconds. Each receiver is programmed to return to zero upon receipt of this delayed pulse.

To supplement the indication of the alert number on the front panel of the receiver, it was decided to attract additional attention to the higher alerts by means of an alarm system. A flashing red panel light plus a repeating chime calls the attention of the radio station personnel that an Alert No. 3 or higher has been received. An alarm reset push-button is provided on the receiver to shut off the alarm.

Three receptacles on the rear of the receiver can be used by the radio station to operate supplementary devices such as remote indicators and executive alarms.

#### Remote Indicator

The remote indicator provides a means for numerical indication of the alert at a remote point, especially on the desk in an executive's office within the radio station.

Referring to Figure 4, a cable (up to 250 feet long) plugs into one of the three receptacles in the rear of the NetALERT receiver. The face of the indicator displays an illuminated numeral that will duplicate the numeral displayed on the front panel of the receiver.

#### Executive Alarm

The purpose of the executive alarm is to indicate at an executive's home if an Alert No. 8 or 9 has

been received at the radio station. The alarm will continue even after the alert on the station's NetALERT receiver has been reset to zero. It can be turned off only after: (1) The receiver has been reset to zero, and (2) The executive alarm reset button has been operated at the station.

The executive alarm is housed in a small cabinet and is plugged into the NetALERT receiver. A leased telephone company line is attached to the executive alarm, and the alarm bell furnished by the telephone company in the executive's home will ring continuously for Alert No. 8 and intermittently for Alert No. 9.

A red light on the top of the indicator glows brightly when an Alert No. 3 or higher is indicated. An optional push-button is provided for turning off the NetALERT receiver and indicator alarms.

#### Notch Filter

A notch filter tuned to F1 has been provided for use in a tape recorder playback line to prevent the NetALERT receivers from being triggered during a delayed broadcast. The input and output impedances of the notch filter are 600 ohms, and the frequency response is shown in Figure 5. The insertion loss is less than 0.5 db. Listening tests have proven that the filter causes no noticeable deterioration of program quality.

#### Conclusions

The CBS Radio NetALERT system is in the process of being field tested. Receivers installed in Los Angeles and Boise, Idaho, indicate good system reliability. It is expected that by August of 1961, NetALERT will be in operation throughout the entire CBS Radio Network. The American public can look forward to better radio service and prompt dissemination of the important news that shapes our lives.

#### Acknowledgements

We would like to acknowledge important participation of B. B. Bauer, Vice President of CBS Laboratories, who had the overall charge of this development program; and of A. Mosser and J. Wistrand of CBS Laboratories, as well as H. Korke and A. Peck of CBS Radio, who made numerous technical suggestions and assisted with the establishment of operational requirements. Encouragement and support of Dr. Peter C. Goldmark, Director of Research of CBS Laboratories, and Arthur Hull Hayes, President of CBS Radio, is gratefully acknowledged.



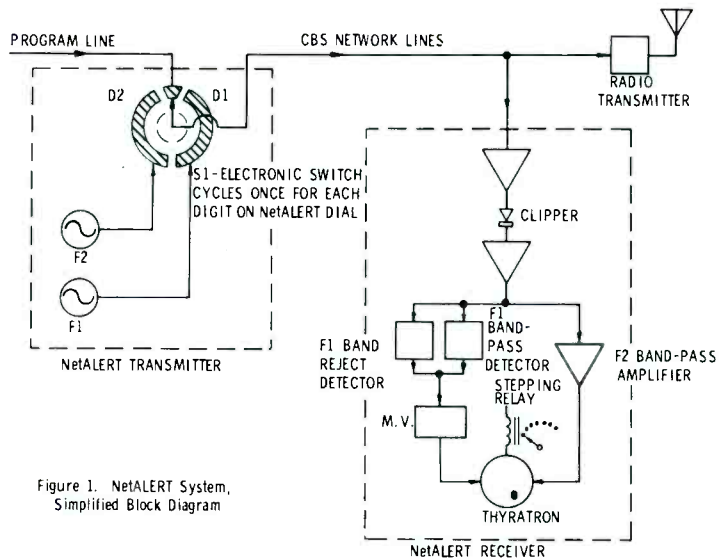

Figure 1. NetALERT System, Simplified Block Diagram

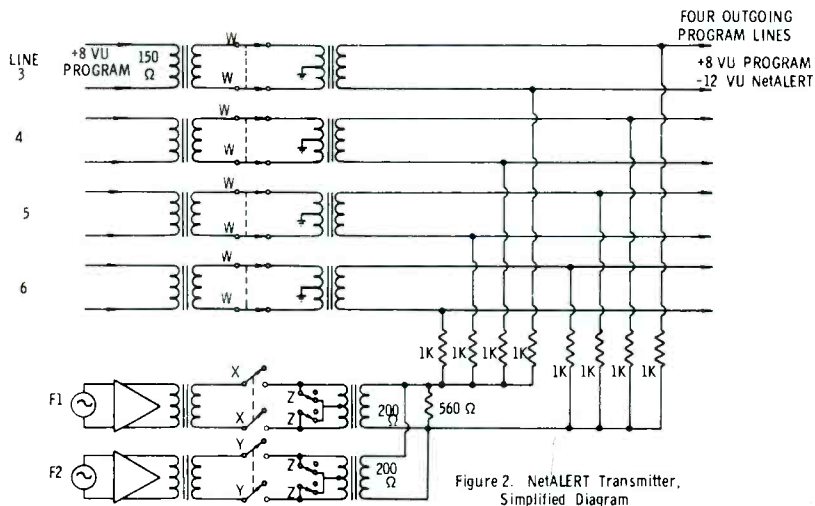

Figure 2. NetALERT Transmitter, Simplified Diagram

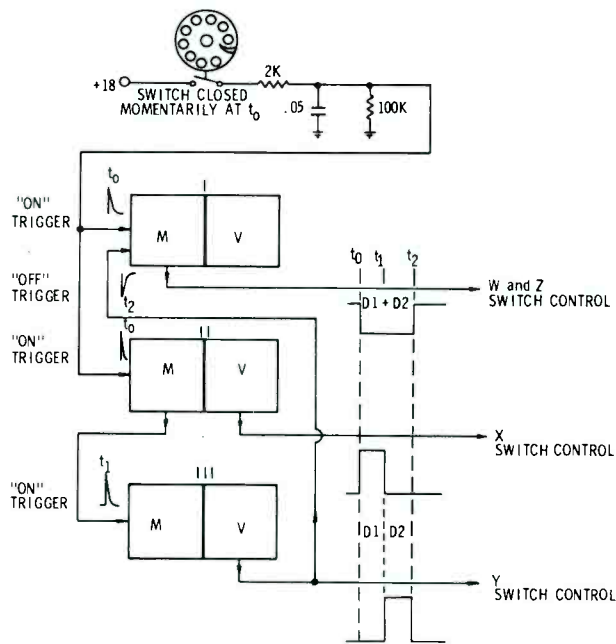

Figure 3. Transmitter Logic Diagram