

IEEE spectrum

articles

- 33 Spectral lines** **The closed-loop society**
 Donald Christiansen *Linear extrapolations seldom aid today's forecasters in probing the characteristics of tomorrows' technology-based society*

Applications

- 34 Technology forecasting** **TV look-ahead**
 Raymond Wilmotte *'Compatible evolution' is the byword as large screens, higher resolution, and video disks enhance 'everyman's entertainment'*

- 80 New product applications**
Instruments, solid-state devices, and other products now available that give the engineer greater scope for design and application are described

- 84 Spectrum's hardware review**
A listing of new products and manufacturers, about which readers may obtain information

- 87 Applications literature**
Brochures, manuals, and applications handbooks selected by the editors

Large systems

- 54 Energy** **How Bell pinches power**
 Hubert L. Kertz *Both design and good fortune play a role in conserving electricity, gasoline, and building fuels for the Bell System*

- 59 Communications** **The co-op in the sky**
 Bruce B. Lusignan, James G. Potter, James M. Janky *The Public Service Satellite Consortium aims to access member-users to a low-cost telecommunications network*

- 66 Satellites** **Europe's 'NASA' gets off the ground**
 Roy Gibson, Werner J. Kleen *The new Paris-based European Space Agency has ten member countries, a \$500 million annual budget, and a wide range of future programs*

- 71 Industry applications** **Electronics prints this magazine**
 Howard Falk *SPECTRUM exploits computers, photographic processing, and electronic equipment to produce each month's copy*

Retrospective

- 40 Innovation** **The marriage that almost was**
 Michael F. Wolff *Western Union has always been ridiculed for rejecting the telephone. But what actually happened wasn't so ridiculous after all*

Perspective

- 76 Transportation** **Transpo head speaks out**
 Gordon D. Friedlander *The new Secretary of Transportation addresses major issues affecting U.S. surface and air mobility*

departments

6 Meetings	86 Regional news	99 IEEE Standards
14 Calendar	23 Inside IEEE	99 Special publications
20 Focal points	26 Forum	100 IEEE Press books
21 News from Washington	88 Scanning the Issues	100 Educational aids
22 Energy report	89 IEEE tables of contents	101 Book reviews
85 News from Industry	94 Future special issues	103 People

the cover

Alexander Graham Bell's centennial Double-pole telephone receiver. Photo by the Smithsonian Institution. Superimposed is the Bell patent. See article, p. 40.

STAFF

Editor: Donald Christiansen

Managing Editors: Ronald K. Jurgen, Howard Falk; Senior Editor: Gordon D. Friedlander; Associate Editors: Peter Allan, Marce Eleccion, Gadi Eyalan, Don Mennie, Ellis Rubinstein (Copy); News Editor: Evelyn Tucker; Contributing Editors: Nilo Lindgren, Alexander A. McKenzie, Michael F. Wolff; Editorial Assistants: Stella Grazda, Barbara Gail Music, Lynnette Peace; Production Manager: Ruth M. Edmiston

Art Director: Herbert Taylor; Associate Art Director: Janet Mannheimer; Technical Graphic Artist: Morris Khan; Art Assistant: T. Dale Goodwin

Business Manager: Carl Maier

Advertising Director: William R. Saunders; Research Manager: Henrik Prins; Advertising Production: Carl Maier (manager); Ines L. Auditore (assistant manager)

EDITORIAL BOARD

Chairman: Donald Christiansen

Norman Abramson, Robert Adler, E. M. Aupperle, F. E. Borgnis, Charles Concordia, S. H. Durrani, J. M. Early, C. A. Falcone, J. M. Fluke, Jr., R. D. Grundy, Craig Harkins, A. A. J. Hoffmann, G. M. Hopper, Werner J. Kleen, Eugene Mittelman, Shigebumi Saito, R. L. Schoenfeld, Harold Sobol, F. E. Terman, C. F. Walker, W. H. Ware

bird (bird) *n.* 1. Any member of the class Aves, which include warm-blooded, egg-laying feathered vertebrates with forelimbs modified to form wings. 2. A bird hunted as game. 3. *For sport.* *slang* A rocket or guided missile. 4. A target, a clay pigeon. *slang* 5. The feather-tipped object used in playing bird minton. 6. A shuttlecock. *slang* 6. *slang* One who is odd or remarkable. 7. *British slang* A young woman. 8. *slang* A decisive sound of disapproval or derision. Used chiefly in the expression *give someone the bird* — *for the birds* *slang* Objectionable or worthless. — *into* *birded* *birding* *birds* 1. To observe and identify birds in their natural surroundings. 2. To trap, shoot, or catch birds. [*Middle English* *bird*, *brȳd*, young bird. Old English *brȳd*.]

a thousand words

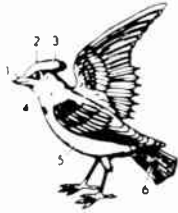

a picture

Get the picture with CVI Compressed Video

Transmit still TV images
over ordinary telephone lines.

Standard Features

- Simple Operation
- 25 or 50 second picture transmission
- Picture viewing during transmission & reception
- Use standard TV cameras, monitors, & video accessories
- "Dial up" or dedicated circuits
- Compact transmit terminal
- Non-fading image display

Options

- Multiple image storage
- Hard Copy
- Frame Freezing
- Video Pre-Processing
- Color
- Computer Interconnect

Get the picture

cv*i*

Colorado Video, Incorporated
P. O. Box 928
Boulder, Colorado 80302 U.S.A.
Phone (303) 444-3972
TWX 910-940-3248

Pioneers in Compressed Video

IEEE PUBLICATIONS BOARD

J. J. Suran, *Chairman*

E. K. Gannett, *Staff Secretary*

R. W. Lucky

Lawrence Rabiner

T. S. Saad

A. C. Schell

C. R. Spitzer

Glen Wade

J. N. Warfield

P. L. Bargellini

J. J. Baruch

J. L. Blackburn

Donald Christiansen

R. M. Emberson

Harlow Freitag

R. C. Hansen

J. C. Herman

Consultants

Hiroshi Inose, V. P. Kodali, R. P. Wellinger, B. M. Zambotti

PUBLISHING SERVICES

Elwood K. Gannett, *Director, Publishing Services*

Patricia Penick, *Administrative Assistant to the Director*

H. James Carter, *Manager, Editorial Services*

Elizabeth Braham, *Manager, Information Services*

Lawrence Liebman, *Manager, Printing Services*

W. Reed Crone, *Managing Editor*

Proceedings of the IEEE and IEEE Press

IEEE SPECTRUM is published monthly by The Institute of Electrical and Electronics Engineers, Inc. Headquarters address: 345 East 47 Street, New York, N.Y. 10017. Cable address: ITRIPLEE. Telephone: 212-644-7555. Published at 20th and Northampton Sts., Easton, Pa. 18042. Change of address must be received by the first of a month to be effective for the following month's issue. Please use the change of address form below. Annual subscription: for IEEE members, first subscription, \$3.00 included in dues. Single copies, \$4.00. Nonmember subscriptions and additional member subscriptions available in either microfiche or printed form. Prices obtainable on request. Editorial correspondence should be addressed to IEEE Spectrum at IEEE Headquarters. Advertising correspondence should be addressed to IEEE Advertising Department, at IEEE Headquarters. Telephone: 212-644-7760.

Responsibility for the contents of papers published rests upon the authors, and not the IEEE or its members. All republication rights, including translations, are reserved by the IEEE. Abstracting is permitted with mention of source. For republication permission write to Editor, IEEE Spectrum, at IEEE Headquarters. Copyright © 1976 by The Institute of Electrical and Electronics Engineers, Inc. Printed in U.S.A. Second-class postage paid at New York, N.Y., and at additional mailing offices. IEEE spectrum is a registered trademark owned by The Institute of Electrical and Electronics Engineers, Inc.

BPA

SUBSCRIPTIONS, orders, address changes: IEEE Service Center, 445 Hoes Lane, Piscataway, N.J. 08854. Telephone: 201-981-0060. Other Publications: IEEE also publishes more than 30 specialized publications (see SPECTRUM, Jan. 1976, pp. 101-102).

IEEE DEPARTMENTS: IEEE Headquarters: 345 East 47 Street, New York, N.Y. 10017. IEEE Service Center (for orders, subscriptions, address changes): 445 Hoes Lane, Piscataway, N.J. 08854. Telephones: Headquarters, 212-644 + extension; Information 7900, General Manager 7910, Controller 7748, Educational Services 7860, Publishing Services 7560, Region/Section Services 7750, Technical Services 7890, Service Center, 201-981-0060. Washington Office/Professional Services, 202-785-0017.

MOVING?

PLEASE NOTIFY
US 4 WEEKS
IN ADVANCE

Name (Please Print) _____

Address _____

City _____ State/Country _____ Zip _____

MAIL TO: IEEE SERVICE CENTER

CODING DEPARTMENT

445 HOES LANE, PISCATAWAY, N. J. 08854

ATTACH
LABEL
HERE

- This notice of address change will apply to all publications to which you subscribe.
- List new address above.
- If you have a question about your subscription place label here and clip this form to your letter.

Circle No. 2 on Reader Service Card



spectral lines



The closed-loop society

Not so many years ago, the forecasts of the great majority of those in the business of telling society where it might expect to find itself five, ten, and more years hence were based largely on trend extrapolation. There was good reason for this. First, World War II had left the industrialized nations with clear-cut needs. Winners and losers alike were in dire need of many basic, material necessities that had been unavailable or were destroyed during the war. And individual and corporate profits resulting from the war were available, as energy in a tank circuit, to provide the impetus for producing and consuming the wanted goods. Population was expanding and thus reinforced the image of an insatiable marketplace. Materials to produce consumer goods seemed in plentiful supply, as did energy to produce and utilize such products.

Against such background, the trend extrapolators could scarcely go wrong. Why, then, a mere 30 years later, is advanced society in its present state?

One answer is that society has not been generally treated as the closed-loop system that it is, complete with feedback paths that forge major redirections. Thus, key changes in its value systems and society's consequent demands upon itself are overlooked.

The most important of these feedback paths are perhaps those that are not activated until a particular output reaches some threshold level. A case worth considering involves the shift in balance from a goods-producing society to a services-oriented society.

The service orientation did not happen overnight. It has been paced by the development of technology itself. Indeed, "service" in the sense of maintenance has been a necessary function since the day the wheel was invented. An important characteristic of servicing is related to the life-cycle "age" of the product. In the early days of radio, those who serviced sets were as knowledgeable about their operation as those who designed and built them; it was only later that a certain number of "tube changers" moved into the ranks of the radio servicemen. Today, consumer products are serviced "by the book," by replacing whole modules.

In the case of sophisticated equipment such as computers, "service" may be construed to encompass a variety of functions: programming at various levels, applications support, and the like. So we see that part of the reason for the increasing number of workers in the service segment is the greater sophistication and versatility of the hardware that technology has wrought. It is not, as some antitechnologists would like to believe, entirely because equipment breaks down.

In a recent paper presented to the National Symposium on Energy and Materials, Joseph Coates, of the U.S. Congress' Office of Technology Assessment, commenting on the service orientation of the economy, noted the ironic fact that, in a world that is increasingly dependent on tech-

nology, fewer members of the work force have direct contact with technology—rather, the fundamental commodity of advanced society is information. Coates observes: "The lack of immediate contact with wagon wheels, cisterns, nails and hammer, with farm equipment and the plow, machinery, wire, pipe, water, construction and concrete, results in the largest portion of our society's being fundamentally ignorant of the bases of our society."

Coates believes a technologically naive, if well educated, populace such as he projects could engender a movement toward "magical solutions," like exorcism and casting out of devils, under crisis conditions. A more commonly attempted "magical solution" identified by Coates is the search for scapegoats. (May one assume he had in mind technology?)

Coates' observation suggests a trigger point that could activate a feedback path such as we mentioned earlier. Unfortunately, triggering only "magical" feedback seems capable of turning off the whole system. We would propose, instead, the exploitation of an alternate feedback path. It might be activated when one or more groups of citizens, most of whom are well educated and many of whom are employed in the service, support, or information segment, become disenchanted with a particular output of society (pollution, for example) and motivated to do something about it.

Such a group has emerged in the form of a rather sophisticated school of humanist-environmentalists whose members embrace "soft" technology—by which is meant technology that is not detrimental to society or to the environment (*Spectral lines*, *IEEE Spectrum*, Feb. 1975, p. 29). In many cases this means, initially at least, going back to basics—to the hammer, cistern, and plow of which Coates speaks. Yet the "soft" technologists seem amenable to moving up the scale of complexity, provided doing so does not seriously harm the environment or commit them to connect to a "system" that leaves them vulnerable to faults over which they have no control.

Feedback stemming from actions by groups such as this could help close a communications gap between engineers and a large segment of society that is engaged in "servicing" technology at a level two or three times removed from technology itself. What might the result be? Surely, in some cases, the mere reinvention of the wheel. But in others, perhaps, the development of "old," abandoned technology whose time is suddenly right. Or a modest influence in changing the way in which a complex, sophisticated technology is being applied—in society's best interests. And, not least, "exorcism" of any influence of those "magical" solutions attempted by the emotionally illiterate.

We'll discuss other little-used feedback paths in the technosocietal system in future issues.

Donald Christiansen, Editor

Technology forecasting

TV look-ahead

'Compatible evolution' is the byword as large screens, higher resolution, and video disks enhance 'everyman's entertainment'

More than two decades have passed since the original National Television System Committee (NTSC) standards for U.S. 525-line commercial color television were implemented. The electronic distribution of information and entertainment has undergone several technological revolutions in this relatively brief span, and still more innovation is forecast for the immediate future. Remarkably, the original standards have stood the test of time well, providing a continuity of purpose and function between yesterday's vacuum tube and today's integrated circuit. But with domestic color TV sales nearing saturation, the pressure is on for receiver manufacturers to develop a brand-new market for home TV systems. The possibilities here include (but are not limited to) video disks, large flat-screen displays, higher-resolution TV (more scanning lines), and narrowband transmission allowing many more channels than are presently available.

My examination of commercial television technology was funded and encouraged by the Federal Communications Commission and resulted in the three-volume "Technological boundaries of television" published late in 1974. Based on that report, this discussion also includes this author's further inquiries since completing the original assignment.

Measuring percentages toward perfection

While NTSC standards are not perfect, they are not too far from perfect, at least in regard to picture sharpness for the screen sizes ordinarily used. For larger screens, it may be desirable to have more scan lines. But controversy surrounds this point. Some experts believe 525 lines can be effective for large screens.

A "perfect" picture is one that appears to the viewer to be as sharp as he would see it in real life. Viewed at a distance equal to five times the screen height, a station monitor's sharpness is, according to an Eastman Kodak estimate, about 82 percent perfect in this sense. This expression of quality as a percentage of perfection can be gauged from measurements with film. Eastman Kodak has measured the sharpness of its Super 8 film at 70 percent and receives sufficient complaints from professional photographers to consider it only marginally acceptable. Sixteen-mm film measures 85 percent, which is about the same as television viewed at a distance of five times the screen height. Kodachrome measures 98 percent and appreciation is expressed about its sharpness.

There are other factors besides sharpness, however, that affect picture quality. Television images suffer from ghosts, snow, interference, and distortions of var-

ious kinds. An informal discussion among experts came up with the suggestion that a nice (but impractical) combination of the good points of U.S. and European standards would be a 6-6-6 arrangement—60-per-second field rate, 600 scan lines, 6-MHz video bandwidth corresponding to a total bandwidth of about 8 MHz (possibly less with some sophistication). Somewhat more resolution than represented by 6-6-6 could probably be squeezed out of existing technology without requiring the development of new components. The percentage of perfect sharpness can be expected to be better than 82 percent for a 6-6-6 monitor.

Judging from this comparison, it does not seem likely that a strong demand will develop to improve on the NTSC's standards unless it is to produce a very large flat screen display. Even for this purpose, it would seem a horrendous problem to modify the NTSC standards in any significant manner, but it does not seem impossible that such changes might evolve in connection with wide-band cable, pay TV, broadcasting from satellites, or opening a new band.

The immediate attitude of designers regarding higher-quality TV is that every part of the system would become much more difficult to design, on the premise that no fundamentally new technology over that currently applied would be available. Since the number of picture elements increases as the square of the number of scan lines (for the number of picture elements should increase equally along both the horizontal and vertical axes), the complexity of each of the major components can be expected to increase at a rate somewhere between the square and the third power of the number of lines, affecting the cost proportionately. These projected conditions present strong obstacles to change. They are based, however, on the assumption of an essentially unchanged technology, and that assumption is clearly false.

There is no indication that the plateau of technical innovation has been reached in electronics. On the contrary, one can see innovations emerging in two key television areas—radical reduction in bandwidth and a significant improvement in the design of television cameras with the discovery of charge coupled devices (CCDs) and charge injection devices (CIDs). But change, however imminent it may seem, always requires much time for practical implementation and wide economic distribution.

An important goal for any high-quality television system is compatibility, meaning that while special sets would be required to produce high-quality display sets designed to NTSC standards could receive the high-quality signals and display them with NTSC quality. While the best method of obtaining this result

Raymond Wilmotte Consultant

is not known, it can probably be achieved at moderate cost.

Bandwidth reduction

Probably the most important of recent TV technology advances is that the bandwidth required for television can be drastically reduced while picture quality remains good. One technique recently developed for this purpose is pseudo-random scan. It is well known that the bandwidth of television can be reduced by slow-scan. Slow-scan, however, with the usual sequence of scanning is suitable only for stationary images. Surprisingly, if the picture elements are illuminated in well-organized randomness, the results can be remarkably good even with moving objects. Sidney Deustch of Brooklyn Polytechnic Institute contributed considerably to this idea. But more recently it has reached practical application in the development of a pseudo-random scanning sequence that is compatible with NTSC. The inventor is Robert Stone of General Electric; he calls it Sampledot (Fig. 1).

In one sixtieth of a second, Sampledot covers about 3 percent of the total screen while NTSC covers 50 percent. The whole screen is covered by Sampledot in nearly half a second and by NTSC in one thirtieth of a second. The ratio 15:1 would lead one to expect a similar reduction in bandwidth, but time is lost between the illumination of one picture element and the next so that the bandwidth reduction in the two General Electric Sampledot units now commercially available is 4:1 and 10:1 respectively.

The main visible deficiency of Sampledot is not in representing moving objects, but in a characteristic background pattern that is barely visible at a viewing distance of about ten times the picture height. The pattern is due to the fact that the phosphor of an illuminated element does not glow for the full half second. The result is that the fast phosphor produces more of this background pattern than does the slow phosphor. Robert Stone refers to these background patterns as "artifacts." The picture elements are illuminated in a sequence that gives the appearance of randomness within a small segment of a TV picture. The whole TV

picture is divided into these segments—64 or 96 of them. The pseudo-random pattern in each segment consists of one picture element in each of the 16 horizontal lines contained in a segment. This pattern is repeated from segment to segment in one thirtieth of a second. The process is carried out 16 times with different random patterns for about half a second (actually 0.533 second) covering all the elements of the picture.

Three varieties of Sampledot have been constructed thus far—fast phosphor, slow phosphor, and a type requiring a memory. This last type is still in the laboratory. It is expected to eliminate the deficiencies of the other two types and in addition reduce the bandwidth by another 50 percent.

There is nothing sacred in the frame time of half a second used by Sampledot. Undoubtedly it will be found that different applications will require different frame times to achieve the best compromise between quality and bandwidth-savings. What Sampledot has clearly proven is that a frame time of a thirtieth of a second is unnecessarily short for high-quality performance. This is because the eye-brain complex does not appreciate high resolution for moving objects.

Another important effort relating to bandwidth conservation involves the use of pulse code modulation (PCM) to reduce redundancy. It has been under serious study for a number of years by the Bell Laboratories, Comsat, and others. The telephone company, because of its interest in Picturephone, has been working on channel conservation using digital signals for its long-distance transmission. To obtain a good picture free from "contour" distortion (due to the quantization the digits introduce in representing an analog signal), it was found that each picture element ("pel" or "pixel") required 8 bits of information for black and

[1] These black-and-white monitors compare television transmission quality between the standard NTSC system at 30 frames/second (left), and Sampledot at 1,875 frames/second (right). The image source is a carefully photographed standard slide available from the Society of Motion Picture and Television Engineers (SMPTE). The background pattern, characteristic of TV transmission via Sampledot, is faintly visible in the right-hand display.

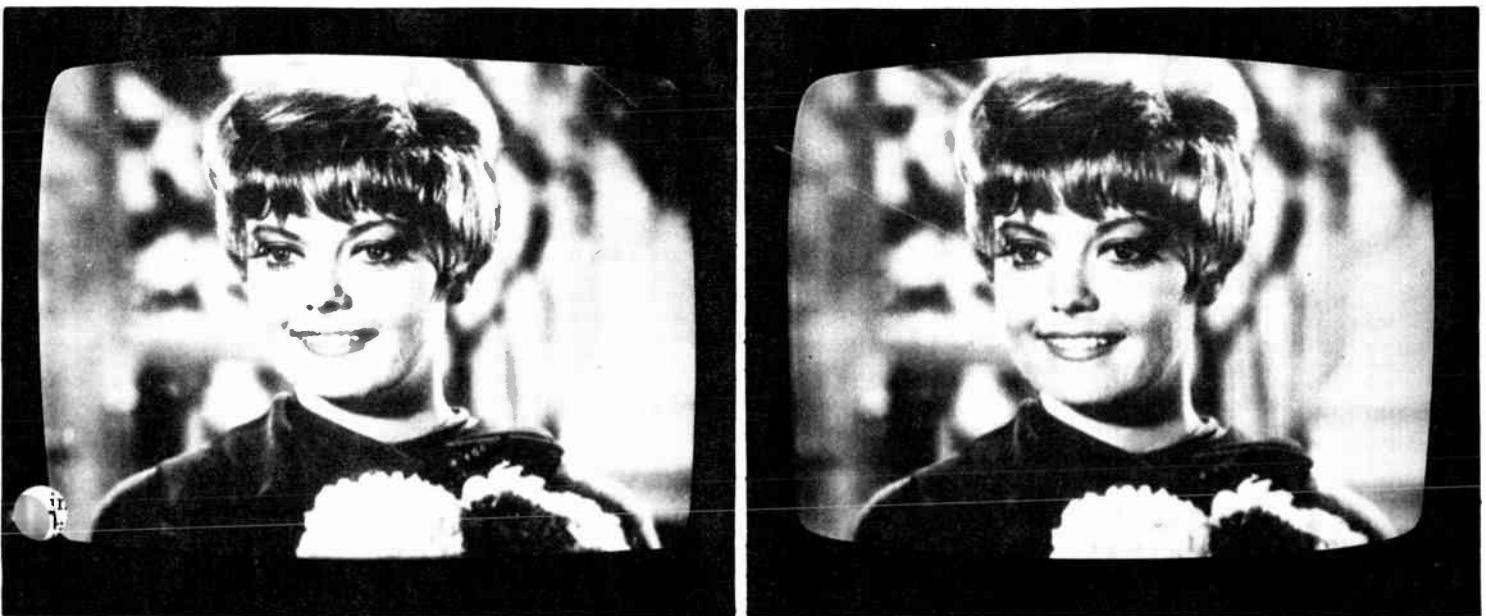

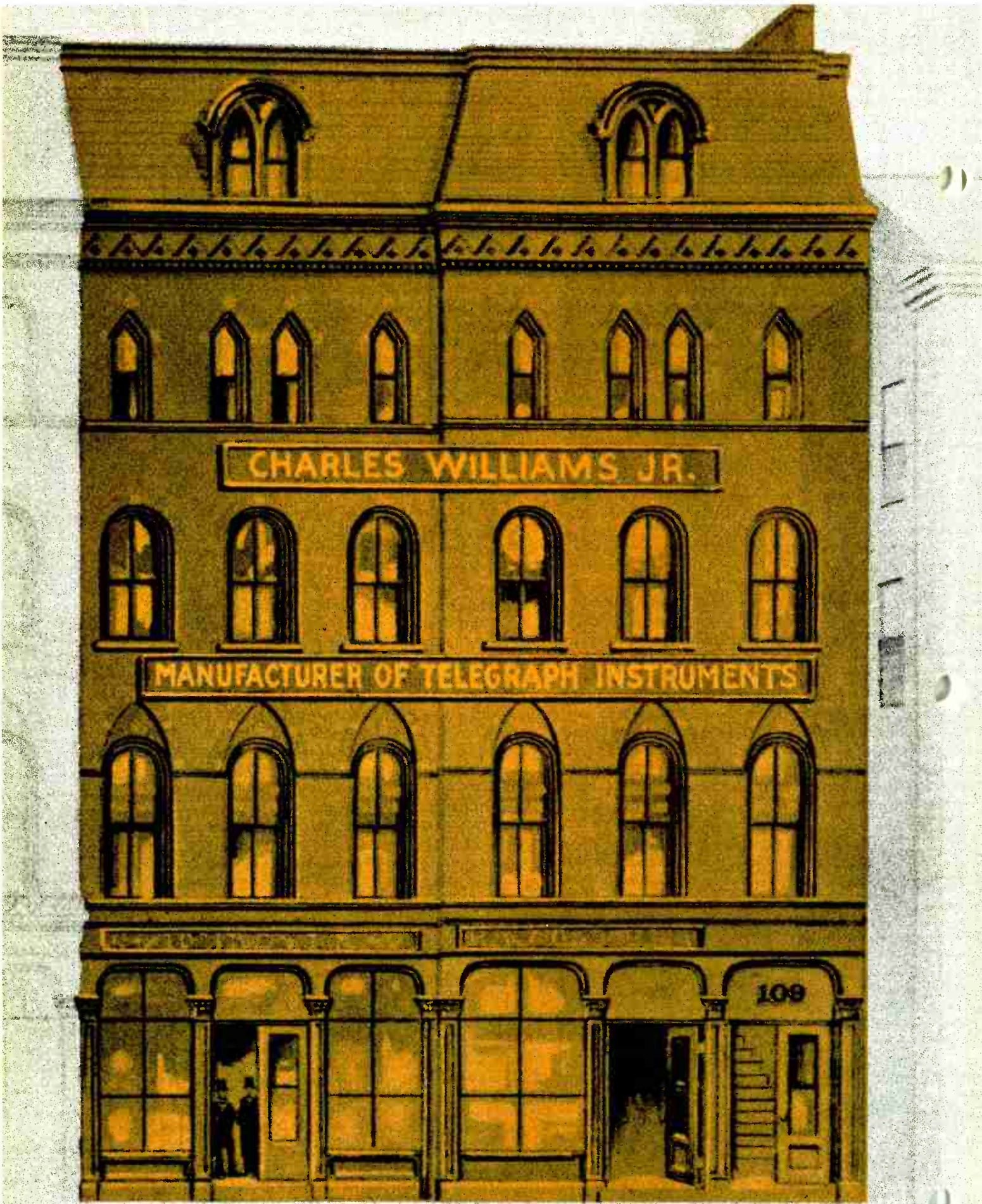

The marriage that almost was

Western Union has always been ridiculed for rejecting the telephone. But what actually happened wasn't so ridiculous after all

The birth of the telephone—one hundred years ago this month—is a fascinating story of the genius and persistence of one man. In addition, it is an instructive demonstration of how an industrial giant, in this case the Western Union Telegraph Co., can miss its chance to foster an industry-creating breakthrough—something that has happened again and again in electronics and other fields.

Between 1875 and 1879, Western Union's chiefs engaged in an intricate minuet with Alexander Graham Bell and his associates. On more than one occasion, the telegraph colossus came excruciatingly close to absorbing the small group of entrepreneurs. That the absorption was finally avoided was probably the result of a technological gamble

that simply didn't pay off, as well as a clash of personalities that may have been the reason the gamble was taken in the first place.

The clash occurred between William Orton, the president of Western Union, and Gardiner Hubbard, Bell's father-in-law and principal backer. The roots of the clash go back to before either man had even heard of Bell. They go back to at least 1868 when the first of several bills designed to break Western Union's telegraph monopoly was introduced in the U.S. Congress on behalf of Hubbard, a Boston patent lawyer-turned-promoter, who was among the many then fearful of Western Union's growing power. In those years, the telegraph was the nation's great growth industry and Western Union its largest and most powerful corporation. Formed in 1866 by consolidating the leading telegraph companies, it would, by 1873, transmit 90 percent of the telegraph business over more than 150 000 miles of wire. As one U.S. Senator warned, the power of the telegraph could scarcely be overestimated, for all urgent business and social correspondence was carried out via telegraph and "it is the means of influencing public opinion through the press, of acting upon the markets of the country, and of seriously affecting the interests of the people."

Attacking the telegraph monopoly

Hubbard had achieved considerable financial success from such ventures as bringing the street

railway and illuminating gas to Cambridge, Mass. Long intrigued by telegraphy, he decided to do something about what he called "this monopoly with its inflated capital which serves its stockholders better than the public and whose rates are exorbitant and prohibiting of many kinds of business." Between 1868 and 1874, he lobbied unceasingly, shuttling back and forth between homes in Boston and Washington, for a private "postal telegraph company" to be chartered by Congress but with Hubbard and some of his friends among the incorporators. As Hubbard envisioned it, the company would build telegraph lines along the nation's rail and post roads and contract with the Post Office Department to send telegrams on its wires at rates roughly half those being charged by Western Union. Hubbard claimed that such a system was the only way rates could ever be brought down "since the statistics prove that telegraphic management in private hands *does not* result in either economy or efficiency of service to the public." He also attacked Western Union as resisting technological innovation, remarking prophetically, in 1874, that "the day for new inventions has not passed . . . the potentialities of the telegraph are boundless; no man dare say what the future will bring forth."

It was William Orton who led Western Union's campaign to defeat the bills induced by the company's enemies. Orton was a formidable adversary. He originally had studied to be a teacher, writing his college thesis on the magnetic telegraph and building a model to illustrate it. After teaching for a few years, he went into the printing and publishing business, which led, in 1862, to an appointment as New York City Collector of Internal Revenue and, in 1865, Commissioner of Inter-

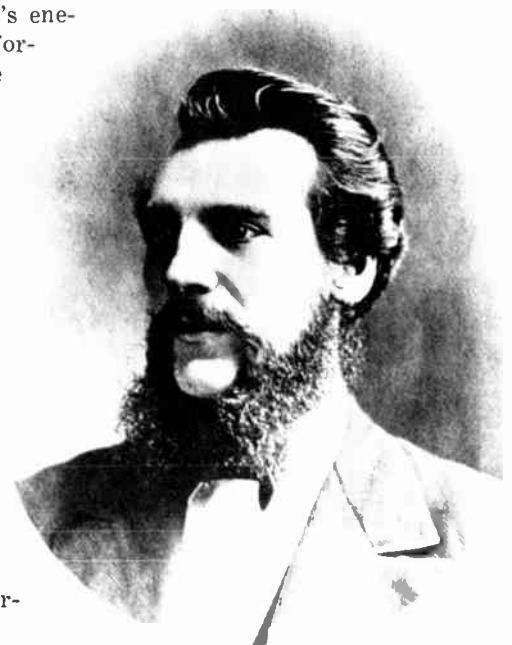

Alexander Graham Bell, 1876

◆◆◆ **The place: the attic of Charles Williams' "shop," 109 Court Street, Boston, Mass. Time: shortly after dawn, July 14, 1875. As Thomas Watson later put it: "The speaking telephone was born at that moment."**

Michael F. Wolff Contributing Editor

nal Revenue. In the fall of 1865, he accepted the presidency of a leading private telegraph company, only to discover that its financial condition was so desperate that it required a merger with Western Union to save it. But the whole industry was in chaos then and Western Union was apparently not much better off. When Orton moved up to the Western Union presidency in 1867, he found himself in what his obituary, writer later called "an onerous position which might well have appalled a less resolute and courageous man." Orton had to suspend dividends for several years, pouring the money thus saved into reconstructing and extending lines and building new offices. He also established "the previously unknown office of electrician" and pushed for technological innovations such

as the duplex and quadruplex telegraph, which would greatly extend the existing information-carrying capability. On the political front, he fought hard and skillfully against Hubbard and his other rivals, objecting to having Government compete with private enterprise, casting doubts on the ability of the Post Office to run the system, and so on. There were acrimonious exchanges between him and Hubbard brought on by such charges as Hubbard's suggestion that Western Union's unique opportunity to get news of world commodity prices before anyone else presented a "temptation so strong few would have the strength to resist."

Orton's feelings were probably summed up very well when he wrote his chief Washington lobbyist in 1870 that Hubbard "vibrates from one end of the capitol to the other and between one committee and another so regularly that he may by and by be looked upon as a part of the Congressional clock-work. . . . I am inclined to believe that a little of Sheridan's Indian policy would be good for him, and if not scalped he should doubt-

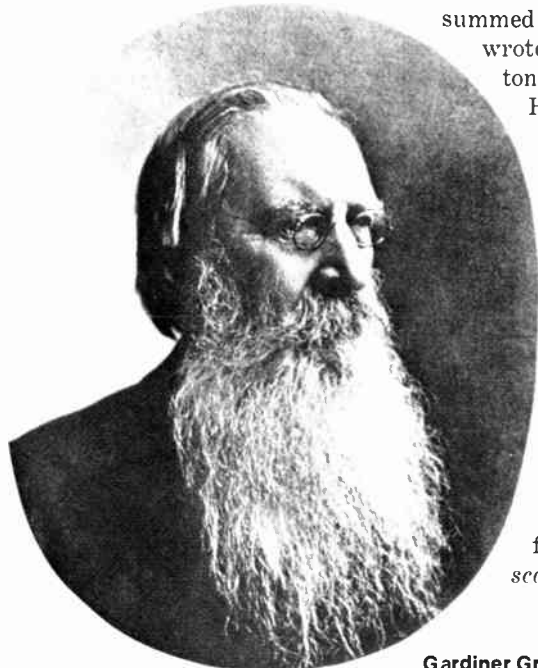

Gardiner Greene Hubbard

HOW BELL MADE PHONE A SUCCESS

Inventor Tells Fascinating Story of Its Birth—Emperor of Brazil Aided Him—Noted Japanese Among the First Users



(Copyright by Underwood & Underwood, N. Y.)
ALEXANDER GRAHAM BELL, INVENTOR OF TELEPHONE.

Cover page of a published reminiscence by Bell.

less have his head shaved at the earliest opportunity."

In the end, Orton managed to enlist enough Congressional support to defeat Hubbard's bill as well as those of others who were attacking Western Union. Hubbard lost because of weaknesses in his quite complex bill, but also because the proposed scheme aroused considerable suspicion in Congress as it called for the Government to assume all the financial risks while Hubbard and his friends would enjoy substantial profits if his postal corporation succeeded. Thus, in the spring of 1874, the promoter of what one Congressman called "a swindling scheme" gave up his efforts and returned to Boston ready for new ventures. As it turned out, he didn't have long to wait, for in October Alexander Graham Bell came to tea.

Hubbard had met Bell two years earlier at a Boston school for deaf children. The 25-year-old Bell was then pioneering in the teaching of speech to the deaf and Hubbard, whose 15-year-old daughter Mabel had been deaf since the age of five, was the school's president. Bell had been on the trail of what would turn out to be the telephone since 1866. In that year, he discovered that in his speech experiments with tuning forks he had unknowingly repeated Helmholtz's experiments for determining the musical tones of vowels. This led to one of the great "mistakes" of modern technology. Bell got hold of Helmholtz's book and, being unable to read the German text, concluded wrongly, from the diagrams, that Helmholtz had transmitted vowel sounds by electricity. Obviously, if vowel sounds could be sent, then so could consonants, and hence ordinary speech. Years later, long after he had learned of his error, Bell would admit that if he had been able to read German he might never have commenced his experiments.

When he first met Gardiner Hubbard at the deaf children's school in 1872 Bell had been in the U.S. only one year and was just getting introduced to the stimulation of the nation's intellectual and scientific center. Caught up in the excitement over telegraphy, he began working on a scheme he called the harmonic telegraph for transmitting several messages simultaneously over a single wire. The following year, he began teaching speech at Boston University and conducting some of the experiments that, by the summer of 1874, would lead to his basic conception of the telephone. He also took on Mabel Hubbard as a private pupil. Although she didn't like him at first, their relationship deepened until the fall of 1874, when he first paid a social call at the elegant Hubbard home on Brattle Street in Cambridge.

Gardiner Hubbard later recalled what happened on that visit: "He [Bell] had been playing upon the piano, and, I think, stopped, and . . . asked if we knew that if he sung to the piano a corresponding note would reply. He said that was not only true but that if a telegraph wire was connected with the note of a piano and a sounding board or musical instrument at a distance and a current of electricity carried over it, the sound could be transmitted by telegraph, and that it could be adapted by using the different notes to represent a dot and a dash for a telegraph. When I asked him what would be the value of it, he replied that he thought it would be of great value, as all the different notes could be sent over the same wire, so that one wire could do the work of thirty or forty. I told him I had been interested many years in the postal telegraph and telegraphy in general, and that if he had an invention of that kind I should have no objection to furnishing the funds to take out a patent, as one of my oldest friends in Washington had great skill in that matter and considerable experience in telegraph patents."

Soon afterwards, the seeds of the Bell Telephone Company were planted when Hubbard and Thomas Sanders agreed to support Bell's harmonic telegraph experiments in return for a share in the patent rights. Sanders was a well-to-do businessman who had furnished money for some of Bell's previous experiments in return for Bell's help in caring for his deaf-mute son George.

A meeting with President Orton

Around the same time, in 1874, Bell learned that, during the summer, a Chicago electrician named Elisha Gray had transmitted musical tones "that were distinctly audible at the receiving point over an unbroken circuit of 2400 miles." In its report on the gadget, which Gray called a telephone, *The New York Times* for July 10 quoted a Western Union official as saying "that in time the operators will transmit their own voices over the wires and talk with one another instead of telegraphing."

News of Gray's invention naturally disturbed Bell and, spurred on by Hubbard and Sanders, he put aside his telephone ideas and concentrated on his harmonic telegraph. With the help of a young machinist named Thomas A. Watson, Bell pursued his work in the grimy three-story electrical shop of Charles Williams, where, only six years earlier, a country boy named Thomas Edison had been tinkering with his own scheme for a multiple telegraph.

By February 1875, Bell and Watson had been able to make their device work, and, on February 19, Bell and Sanders entrained for Washington to show it to their patent attorneys. They no sooner had set up their equipment at Hubbard's Washington home when Bell was startled to learn that he would be meeting shortly with none other than President Orton of Western Union.

Bell described what transpired to his parents in a letter of March 5.

One of the first things I did on reaching Washington was to set up my apparatus so as to make four stations, A, B, C, D. My wish was to illustrate

that a message could be sent from B to C at the same time that a message passed from A to D.

I had four cells of a battery, but no acids. In order to have plenty of battery power, that the thing might work well enough, I wished [sic] six cells and a mixture of bi-chromate of potash with some acid (I forget what).

There was only one electrician in town, and I went to him for everything, unfortunately giving my name.

He sent me down two cells of Lockwood's battery, and I was surprised that the young man who brought them came right into the parlor and stared about, to see what kind of instruments I had got.

Still further was I surprised to find that the two cells he brought would not work.

The young man came back with the bi-chromate solution for the other cells, but I had my suspicions aroused and did not use the solution.

To add to my distress Mr. Hubbard informed me that Mr. Orton (the president of the Western Union Telegraph Company) would be round in half an hour to see my instruments.

"The Western Union" is probably the largest corporate body that has ever existed.

It controls more miles of telegraph wire than there are in the whole of Europe! It was, therefore, important to have my instruments in good shape. I did my best by getting nitric acid and sulphuric acid to get the cells I had in working order. I sawed a large carbon in two, borrowed a couple of stop-basins and had the whole in working order just half a minute before Mr. Orton made his appearance. The instruments, by good luck, never worked better. Mr. Orton was very much interested, and said he would like to see me again, but had to go to New York that night.

Two days afterwards I was in the Capitol seeing the Senate, when a gentleman came up and tapped me on the shoulder. It was Mr. Orton. He told me that the Western Union would be glad to give me every facility in perfecting my instruments, and he gave me a hearty invitation to take my apparatus to New York, and I should have the assistance of their best electricians.

They have a special experimental room, and have at instant command thousands of cells of battery, and thousands of miles of real line wire to test with.

Mr. Orton said further, that he wished me distinctly to understand that Western Union had no interest in Mr. Gray or his invention.

Orton might have been telling the truth. That fall, Hubbard had had more than one conversation

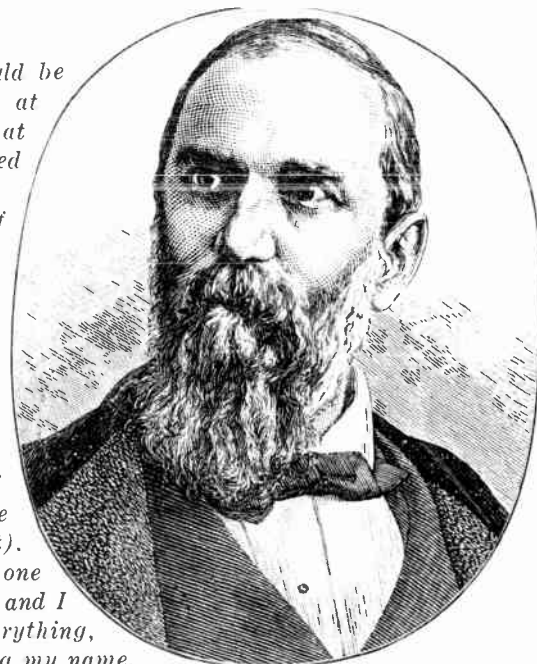

William Orton

with Orton about Gray's invention and later testified that Orton considered it "a very curious invention . . . but that he did not see that it could be of any practical value, though of great theoretical interest." Only a few months earlier, Orton had announced to the world "a discovery that may be called the solution of all difficulties in the future of telegraphic service." This was the quadplex telegraph, which had been developed by Thomas Edison under patents controlled by Western Union. The benefits of the invention were, coincidentally, reported in *The New York Times* of July 10, 1874, directly above the news of Gray's invention. "In one instant it will quadruple the usefulness of the 175 000 miles of wire owned by the Western Union Telegraph Company. It is a new process of multiple transmission by which two messages can be sent simultaneously in the same direction over the same wire and either message can be dropped at any way station on the circuit."

But so far as Bell's invention went, why Orton should have been interested in it was explained in that same letter:

There are two rival telegraph companies . . . The Western Union and the "Pacific Line."

The Western Union have hitherto enjoyed a monopoly. But last year a man invented a method of sending four messages simultaneously along the same wire, and the Pacific Telegraph Company bought his patent for seven hundred and fifty thousand dollars (\$750 000).

The result has been that the Pacific Company has been able to reduce their prices so as to compete successfully with the Western Union.

Now my invention comes out as a means by which thirty or forty messages may be sent simultaneously, and by which intermediate stations may communicate with one another. If the Western Union take it up it would enable them to recover lost ground. At all events it is evidently a good time to bring out the invention. I visited the Western Union telegraph headquarters in New York on my way here. I have made arrangements to spend Saturday and Sunday every week in New York at the West. Un. Building.

I am to have the assistance of Mr. Prescott . . . , so now I feel that all is plain sailing if I can prove priority.

On February 27, Bell, Hubbard, and Sanders formalized their earlier agreement to share equally in Bell's telegraphic inventions, including "any further improvements he may make in perfecting said inventions of improvements." This simple agreement, notes Robert Bruce, author of the recent biography *Alexander Graham Bell and the Conquest of Solitude*, marked the beginning of what eventually became the largest single business enterprise in history.

Orton drops his mask

In mid-March, Bell visited the Western Union headquarters offices in New York City where, as

The birth of the telephone

In 1913, Alexander Graham Bell's assistant, Thomas Watson, addressed the newly organized Telephone Pioneers of America at its annual meeting in Chicago on the "birth and babyhood" of the telephone. When he came to speak of that spring evening in 1875 (see text), Watson related how Bell said, "Watson, I want to tell you of another idea I have, which I think will surprise you." I listened, I suspect, somewhat languidly, for I must have been working that day about sixteen hours with only a short nutritive interval, and Bell had already given me during the weeks we had worked together, more new ideas on a great variety of subjects, including visible speech, elocution and flying machines, than my brain could assimilate, but when he went on to say that he had an idea by which he believed it would be possible to talk by telegraph, my nervous system got such a shock that the tired feeling vanished. I have never forgotten his exact words; they have run in my mind ever since like a mathematical formula. 'If,' he said, 'I could make a current of electricity vary in intensity precisely as the air varies in density during the production of a sound, I should be able to transmit speech telegraphically.' He then sketched for me an instrument that he thought would do this, and we discussed the possibility of constructing one. I did not make it; it was altogether too costly and the chances of its working too uncertain, to impress his financial backers—Mr. Gardiner G. Hubbard and Mr. Thomas Sanders—who were insisting that the wisest thing

for Bell to do was to perfect the harmonic telegraph; then he would have money and leisure enough to build air castles like the telephone.

"During the winter and spring of 1875, . . . when I was not working for Bell I was thinking of his ideas. All through my recollection of that period runs that nightmare—the harmonic telegraph, the ill working of which got on my conscience, for I blamed my lack of mechanical skill for the poor operation of an invention apparently so simple. Try our best, we could not make that thing work right, and Bell came as near to being discouraged as I ever knew him to be.

But this spring of 1875 was the dark hour just before the dawn."

On June 2, 1875, the two young men were sweating over a modification of the harmonic telegraph in the attic of Williams' shop. In Watson's words: "I had charge of the transmitters as usual, setting them squealing one after the other, while Bell was retuning the receiver springs one by one, pressing them against his ear . . . One of the transmitter springs I was attending to stopped vibrating and I plucked it to start it again. It didn't start and I kept on plucking it, when suddenly I heard a shout from Bell in the next room, and then out he came with a rush, demanding, 'What did you do then? Don't change anything! Let me see?' I showed him. It was very simple. The make-and-break points of the transmitter spring I was trying to start had become welded together, so that when I snapped

he related it, "Mr. Orton and Mr. Prescott both devoted a large portion of their time in discussing with me the whole plan from its theoretical point of view." Then came a series of tests which, as Bell put it, "went like clock work. The signals," he later wrote, "though feeble, came sharply and concisely through the 200 miles of line wire."

Despite the successful tests, the mood changed dramatically when Bell returned the same afternoon. This is revealed by Bruce, who quotes a subsequent letter to Bell's parents informing them that Orton casually pumped him further on his work and then announced that "that ingenious workman," Elisha Gray, had just visited Orton with apparatus next to which Bell's was "crude." Orton, reports Bruce, then proceeded to point out what a great power Western Union was, and reminded Bell that inventors were apt to overestimate the value of their work. The interview was capped by Orton asking whether Gardiner Hubbard was involved with Bell "in this matter." When the presumably shaken young inventor replied in the affirmative, he was told, "The Western Union will never take up a scheme which will benefit Mr. Hubbard." After that, a "perfectly gentlemanly and polite" William Orton drove Bell to his hotel, promising him all the help Western Union could give but stressing once more that Hubbard could not be involved as he had done too much to injure the company.

According to Bruce, Hubbard (who was in New York that day) immediately offered to withdraw, but Bell would not hear of it. Then, at Hubbard's suggestion, Bell threatened to take his instruments to the rival Atlantic and Pacific Telegraph Company. This seems to have caused Orton to back down to the extent of saying that while Western Union would not help develop something that would benefit Hubbard, neither would personal feelings keep the company from buying a desirable invention. Orton also emphasized that while he would back Gray if Bell went to his rivals, no such arrangement existed at the moment, nor was any contemplated.

This attempted "squeeze" seems to have been the last direct contact between Orton and the tiny Bell group until the famous offer—which I shall discuss shortly—of the telephone patents to Western Union two years later.

From New York, Bell returned to Boston "thoroughly worn out . . . beginning to realize the cares and anxieties of being an inventor." He postponed his classes and returned to telegraphy, but his heart does not seem to have been in it. Technical difficulties were encountered, but perhaps, too, his traumatic encounter with Orton in New York unconsciously held him back, making him a trifle less interested in building a multiple telegraph and perhaps more ready to concentrate on his long-simmering ideas for transmitting speech. He had discussed these ideas with Joseph Henry at the Smithsonian Institution while in Washington, D.C., and the world-renowned scientist had advised him that he had "the germ of a great invention" and that he should work at it himself rather than permit others to perfect it.

A few months after his Washington trip, there came an evening that may well have marked the psychological turning point for Bell. As described in the editorial box (left), Bell, that evening, turned to Watson saying, "I want to tell you of another idea I have, which I think will surprise you." The other idea was, of course, "to transmit speech telegraphically," and the realization of that goal took place shortly afterward, on June 2, 1875, a date Watson always remembered as marking the birth of "the speaking telephone."

The months following the exhilarating discovery of June 2 were turbulent ones for Bell. He became engaged to Mabel Hubbard, for one thing. And for another, he kept at his telephone research despite the skepticism of his father-in-law, who would have preferred that he devote his efforts to the multiple telegraph. Finally, on February 14, 1876, his application for the telephone patent was filed in Washington. By an amazing coincidence—one that was to cause Bell no end of grief in the years to come—the filing was followed within only a few hours by the filing of a caveat (a warning only of intent to invent) by none other than Elisha Gray, covering "the art of transmitting vocal sounds or conversations telegraphically through an electric circuit."

the spring the circuit had remained unbroken while that strip of magnetized steel by its vibration over the pole of its magnet, was generating that marvelous conception of Bell's—a current of electricity that varied in intensity precisely as the air was varying in density within hearing distance of that spring. That undulatory current had passed through the connecting wire to the distant receiver which, fortunately, was a mechanism that could transform that current back into an extremely faint echo of the sound of the vibrating spring that had generated it, but what was still more fortunate, the right man had that mechanism at his ear during that fleeting moment, and instantly recognized the transcendent importance of that faint . . . The shout I heard and his excited rush . . . my room were the result of that recognition. The speaking telephone was born at that moment."



Thomas A. Watson, 1874

The Telephone.

THE proprietors of the Telephone, the invention of Alexander Graham Bell, for which patents have been issued by the United States and Great Britain, are now prepared to furnish Telephones for the transmission of articulate speech through instruments not more than twenty miles apart. Conversation can be easily carried on after slight practice and with the occasional repetition of a word or sentence. On first listening to the Telephone, though the sound is perfectly audible, the articulation seems to be indistinct; but after a few trials the ear becomes accustomed to the peculiar sound and finds little difficulty in understanding the words.

The Telephone should be set in a quiet place, where there is no noise which would interrupt ordinary conversation.

The advantages of the Telephone over the Telegraph for local business are

1st. That no skilled operator is required, but direct communication may be had by speech without the intervention of a third person.

2d. That the communication is much more rapid, the average number of words transmitted a minute by Morse Sounder being from fifteen to twenty, by Telephone from one to two hundred.

3d. That no expense is required either for its operation, maintenance, or repair. It needs no battery, and has no complicated machinery. It is unsurpassed for economy and simplicity.

The Terms for leasing two Telephones for social purposes connecting a dwelling-house with any other building will be \$20 a year, for business purposes \$40 a year, payable semiannually in advance, with the cost of expressage from Boston, New York, Cincinnati, Chicago, St. Louis, or San Francisco. The instruments will be kept in good working order by the lessors, free of expense, except from injuries resulting from great carelessness.

Several Telephones can be placed on the same line at an additional rental of \$10 for each instrument; but the use of more than two on the same line where privacy is required is not advised. Any person within ordinary hearing distance can hear the voice calling through the Telephone. If a louder call is required one can be furnished for \$5.

Telegraph lines will be constructed by the proprietors if desired. The price will vary from \$100 to \$150 a mile; any good mechanic can construct a line; No. 9 wire costs 8½ cents a pound, 320 pounds to the mile; 34 insulators at 25 cents each; the price of poles and setting varies in every locality; stringing wire \$5 per mile; sundries \$10 per mile.

Parties leasing the Telephones incur no expense beyond the annual rental and the repair of the line wire. On the following pages are extracts from the Press and other sources relating to the Telephone.

GARDINER G. HUBBARD.

CAMBRIDGE, MASS., MAY, 1877.

For further information and orders address

THOS. A. WATSON, 109 COURT ST., BOSTON.

The first telephone advertisement.

Nevertheless, on March 7 (a remarkably short time since his application, which attests to the originality and importance of his invention), Bell's patent was granted. Mabel Hubbard would write her fiancé that he had triumphed over "the colossal power" of Western Union and of William Orton whom she described as "almost the most powerful man in this country and willing to spare no expense, honest or dishonest, to conquer you."

After this, "matters began to move more rapidly," recalled Watson, "and during the summer of 1876 the telephone was talking so well that one didn't have to ask the other man to say it over again more than three or four times before one could understand quite well, if the sentences were simple." In June, the whole world learned of the invention through its successful demonstration at the Centennial Exhibition in Philadelphia; in the fall, Bell and Watson laid the multiple telegraph aside forever; in January 1877, Bell received a second telephone patent (for an "Improvement in Electric Telegraphy"); in April, a line was connected between Williams' shop and home, and Bell could write Mabel, proudly, "The first telephone line has now been erected and the telephone is in practical use."

Western Union says no

Despite his successes during these months, Bell's financial affairs were precarious. Desperately anxious to get married, he went on the lecture circuit with his telephone. Although the profits were disappointing, they were apparently sufficient

to forestall the remedy Mrs. Hubbard seems to have been pushing—the outright sale of the telephones rather than the leasing of them, which her husband preferred. As Watson circumspcctly explained: "Some of the ladies deeply interested in the immediate outcome were strenuously advocating at this critical juncture making and selling the telephones at once in the largest possible quantities—imperfect as they were. Fortunately for the future of the business the returns from the lectures that began at this very time alleviated this danger."

Mrs. Hubbard's concern was understandable. She was anxious for Mabel to be married, and she also enjoyed a standard of luxury that earlier correspondence suggests was quite important to her. During the 1872 debate over his telegraph bill, Gardiner Hubbard had written his wife, "The thought of one day giving you an abundance of the good things of this world keeps up my courage." Consequently, there must have been considerable anxiety over Hubbard's affairs, for by July 1877 he was describing them as "entirely deranged by the adverse circumstances of the past few years." Most of the money for the fledgling Bell enterprise was coming from the merchant Thomas Sanders, who, by March 1878, would have sunk almost his whole fortune of \$110 000 into the venture.

Nevertheless, somewhere along the way, Hubbard conceived a solution to his financial difficulties that would have been far more drastic than the selling of individual telephones. His solution was the now legendary offer of the Bell patents to Western Union for \$100 000.

Strangely enough, although this offer is mentioned in almost every book on Bell and the industry, there seems to be almost no evidence of it. We don't know when the offer was made, or precisely why it was rejected. Bell biographer Robert Bruce places it during the late fall or winter of 1876–77, but adds that there is no mention of it in Bell's private correspondence, which is surprising when one considers Bell's volubility concerning so many other events. Two scholars who examined the Western Union Company's "President's Letter Books" for that period found no mention of it, nor has any mention of it been found in Hubbard's surviving letters to Bell. (In 1928, Bell's secretary, Catherine MacKenzie, wrote in her biography of Bell that he used to say *he* had made the patent offer in person but had been shown out when it was learned Hubbard was a backer. However, continues her account skeptically, "No evidence to support or to disprove this has been available to the writer.") Indeed, the only evidence that it even occurred is the following gleeful recollection, in 1913, by Watson:

"At about this time Professor Bell's financial problems had begun to press hard for solution. We were very much disappointed because the president of the Western Union Telegraph Company had refused, somewhat contemptuously, Mr. Hubbard's offer to sell him all the Bell patents for the exorbitant sum of \$100 000. It was an especially hard blow to me, for while the negotiations were pending I had had visions of a sumptuous office in the Western Union Building in New York which

November 15, 1876

I was expecting to occupy as Superintendent of the Telephone Department of the great telegraph company. However, we recovered even from that fiasco. Two years later the Western Union would gladly have bought those patents for \$25 000 000."

Despite the lack of documentation, this incident is invariably used as a prime example of technological myopia, cropping up frequently in surveys of forecasting boners. This may well be due to the existence of a "report" that has appeared in the engineering literature on several occasions during the past two decades at least. This document—always good for laughs and, consequently, adorning the walls of many an office—reads as follows:

For further reading

For readers who wish to probe beneath a surface this article could only skim, the writer recommends starting with two excellent, heavily documented books on which he relied considerably: Robert V. Bruce's *Bell: Alexander Graham Bell and the Conquest of Solitude* (Little, Brown and Co., 1973) and Matthew Josephson's *Edison* (McGraw-Hill, 1959). Then, for the early years of the telegraph industry, including the Hubbard-Orton controversy, the reader might consult Lester G. Lindley's doctoral dissertation (Rice University, 1971) *The Constitution Faces Technology: The Relationship of the National Government to the Telegraph, 1866-1884*. Another relevant dissertation is Rosario J. Tosiello's *The Birth and Early Years of the Bell Telephone System, 1876-1880* (Boston University, 1971). Five earlier books particularly worth reviewing, although hard to find, are: *Edison—His Life and Inventions* (F. Dyer, T. Martin, and W. Meadowcroft, Harper & Bros., 1929); *Menlo Park Reminiscences* (F. Jehl, Edison Institute, Dearborn, Mich., 1937); *Alexander Graham Bell*, by his long-time secretary Catherine MacKenzie (Houghton-Mifflin, 1928); *Beginnings of Telephony* (F. Rhodes, Harper & Bros., 1929); and Thomas Watson's autobiography *Exploring Life* (D. Appleton and Co., 1926). As for actual source material, the thousands of pages of testimony from the 20-odd years of telephone litigation that relate directly to Bell were edited and published in two works available in the Bell Collection at the Library of Congress, and the AT&T Historical Collection. These are *The Bell Telephone*, published by the company in 1908, and *Proofs by and about Alexander Graham Bell*, by the company's chief counsel James Storrow. Much of Bell's correspondence cited in this article is here, along with his detailed deposition explaining the conception of the telephone. *The Narrative History of the Litigation on the Bell Patents, 1878-1896* by Charles Swan (Storrow's assistant) is a must for anyone who would explore that legal thicket, while the *Journal of the Telegraph*, *Scientific American*, and *Frank Leslie's Illustrated Weekly* from that period provide informative as well as colorful accounts of the technical progress as it occurred. Finally, a comprehensive chapter on Theodore Vail and the growth of AT&T under his leadership is provided in Robert Sobel's *The Entrepreneurs* (Weybright and Talley, 1974).

Chauncey M. Depew, Esq.
President, Western Union Telegraph Co.
New York City

Dear Mr. Depew:

This committee was formed at your request to consider the purchase of U.S. Patent 174,465 by the Western Union Company. Mr. Gardiner G. Hubbard and Mr. A. G. Bell, the inventor, have demonstrated their device, which they call the "Telephone," for us, and discussed their plans for its use.

The "Telephone" purports to transmit the speaking voice over telegraph wires. We found that the voice is very weak and indistinct, and grows even weaker when long wires are used between the sender and receiver. Technically, we do not see that this device will ever be capable of sending recognizable speech over a distance of several miles.

Messrs. Hubbard and Bell want to install one of their "Telephone" devices in virtually every home and business establishment in the city. This idea is idiotic on the face of it. Furthermore, why would any person want to use this ungainly and impractical device when he can send a messenger to the local telegraph office and have a clear written message sent to any large city in the United States?

The electricians of our own company have developed all the significant improvements in the telegraph art to date, and we see no reason why a group of outsiders, with extravagant and impractical ideas, should be entertained, when they have not the slightest idea of the true practical problems involved. Mr. G. G. Hubbard's fanciful predictions, while they sound very rosy, are based upon wild-eyed imagination and a lack of understanding of the technical and economic facts of the situation, and a posture of ignoring the obvious technical limitations of his device, which is hardly more than a toy, or a laboratory curiosity. Mr. A. G. Bell, the inventor, is a teacher of the hard-of-hearing, and this "Telephone" may be of some value for his work, but it has too many shortcomings to be seriously considered as a means of communication.

In view of these facts, we feel that Mr. G. G. Hubbard's request for \$100,000 for the sale of this patent is utterly unreasonable, since the device is inherently of no value to us. We do not recommend the purchase.

Yours truly,

(Name Deleted)
for the committee

Unfortunately, this report is suspect on several counts. First, it is misaddressed. Chauncey Depew was never president of Western Union Telegraph (he became a member of the board of directors in 1881). Second, it is unsigned and the original was apparently not on corporate stationery. Finally, its tone seems far too shrill and exaggerated for a report to top management. For various reasons, Bell's invention may well have been considered a toy in the commercial sense, but it is hard to believe an examining committee would have considered it

“wild-eyed” and “idiotic on the face of it.”

How did such a document originate? One can speculate along three lines: It could have been a joke. Or it could have been an honest attempt to recreate years later what such a committee might have reported. Or it might have grown out of a confused reminiscence by someone who was aware that Chauncey Depew was offered—and refused, to his everlasting regret—a share in the Bell patents.

Depew's \$200 million chat

The Depew story is fascinating not only in itself but for the additional light it sheds on the Orton-Hubbard relationship. In his autobiography and in a subsequent interview with *The New York Herald Tribune* of August 1, 1926, which appeared under the headline “Chauncey Depew confesses three big mistakes in long career,” Depew called the telephone his third mistake, and “the greatest money error I ever made.”

In 1876, Depew was attorney for the New York Central Railroad (he subsequently became president and board chairman) and in this capacity was in almost daily contact with Hubbard, who was then an officer of the Congressional Commission for the Improvement of the Mails and the Telegraph. Depew related that Hubbard came to him one day:

He thought he could put a promising investment in my path. He explained that his son-in-law, Bell, while a curious person in many respects was nevertheless a great inventor and that he had at last perfected what he was pleased to call the “talking telegraph.”

Money was needed. If I would invest \$10 000 in the company they were forming they would give me a paid-up one-sixth of the whole enterprise, and Hubbard was sure I would make money by it. I asked him to let me think it over awhile, and when he had left I put on my hat and posted right down to see my friend, William Orton, then president of the Western Union Telegraph Company.

On hearing my story, friend Orton laid his hand on my shoulder to make his words the more emphatic, I suppose, and told me in all good faith and complete sincerity to drop the matter at once. He said in the first place the invention was a toy, that Bell could not perfect anything so that it might have commercial possibilities, and that above all, if there was any merit to the thing, the Western Union owned the Gray patents and would simply step in, superseding Bell, and take the whole thing away from him. That cooled me off to an amazing extent. I felt I was out of the deal when I left Orton's office.

However, that same afternoon Hubbard dropped in again to find out if I had made a decision. I told

him what Orton had said, and that I had better drop out of the matter. Hubbard was most vehement then in his deprecation of any chances the Western Union might have to win a patent suit with the so-called Gray patents, which, he said, he knew all about. He told me more of Bell's work and his prospects, and by the time he got through I seemed to be weaned away from Orton and back to Hubbard's side again. So I asked Hubbard to come in and see me the next day, and went home that night actually resolved to risk the \$10 000 in Bell's device on the strength of Hubbard's arguments.

Scarcely had we arisen from the evening meal that day when my friend Orton, of the Western Union, dropped in. He said: “After you left my office I began to worry for fear you would be foolish enough to let Bell have that \$10 000. I know you will lose it if you risk it in that invention, and I do not believe you can afford such a loss. I want to explain further to you why Bell could not succeed with his device, even if it worked. We would come along and take it away from him, and you would be out of pocket the \$10 000.” And so on these lines I chatted it out with Orton—that's the most expensive chat I have had yet!

Next day I told Hubbard I had decided after all not to invest any money with Bell, and, although we argued some more, I stuck to this last decision, and Hubbard went away.

A few months after the above interview appeared, William Langdon, the historical librarian for the American Telephone and Telegraph Co., interviewed Depew, and elicited the fact that he did not know about Hubbard's offer of the Bell patents to Orton.

This led Langdon to speculate that Orton had already declined to buy the telephone when the Depew offer was made, and that this was the basis for Hubbard's antagonism.

“On the other hand,” wrote Langdon, “I wonder if by the time Mr. Depew came to him Mr. Orton was not already finding reason to suspect that the Bell Telephone had a value and that he might have made a mistake in not buying it. At the same time I have no doubt that his judgment was still that the Gray patent was superior and would prevail if it came to a contest in our courts. It might well be that the simplest way for Mr. Orton to look out for his Company's interest was to prevent the Bell people from getting any money rather than to let the matter get into the courts.”

This begins to suggest why there was very likely much more behind Orton's rejection of Hubbard's offer than the naive myopia many people have perceived. After all, Orton was nobody's fool. Depew considered him “the best informed and most accomplished electrical expert in the country.”



Thomas Alva Edison

Scientific American credited him with "a ready appreciation of inventors' work" and with being "quick to advocate the adoption and use of new and improved devices calculated to add to the extension and efficiency of the telegraph system or the convenience of the public."

Edison enters the race

Perhaps the best example of Orton's understanding—and the one that makes the Depew "report" so incredible—is that he had been far-sighted enough to put young Thomas Edison on Bell's heels early in 1875, soon after he had learned what Bell and Gray were doing with the multiple telegraph. In fact, this writer strongly suspects that Orton's whole attitude toward the telephone can be understood as resulting from a subtle combination of his dislike for Hubbard and his great confidence in Edison and the other inventors in Western Union's "stable." Ironically, this confidence came tantalizingly close to being totally justified.

Edison had left Williams' shop in Boston early in 1869 and arrived in New York City that summer. He was broke and in debt, but full of ambition. Within two years, his reputation as an "ingenious" inventor had been established and he had landed a contract to build stock tickers for Western Union.

During the next four years, Edison enjoyed a turbulent and sometimes bitter relationship with Western Union and its president that space limitations unfortunately prevent describing here. But two inventions came out of the relationship that are directly relevant to this story. The first of these was the quadruplex, hailed by Orton as "the solution of all difficulties in the future of telegraphic science." This established Edison as an inventor who "never fails in anything he seriously undertakes."

As a result of this success, some months after visiting Bell in Washington in February 1875, Orton engaged Edison to look into the "acoustical telegraph" that Bell and Gray were pursuing. However, Orton may have been after bigger game, for in July he furnished Edison with a German report on a primitive "telephone" that had been made with sausage skin and wood in 1860 by one Philipp Reis. Edison's researches led him to file a caveat on January 14, 1876, which included an apparatus for analyzing sound waves. The apparatus, shown in the accompanying drawing, employed a solenoid connected via a plunger to the base of a resonating metal chamber that acted as a diaphragm. According to Edison's

Scientific American Record
 Filed January 14, 1876.

1 month before Bell or Gray

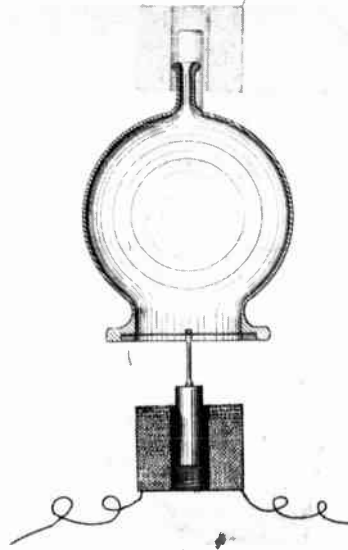

Edison's Magnetophone.

This drawing from among Edison's laboratory papers claims to show the first telephone on record because it illustrates one of the devices included in a telegraphy caveat Edison filed one month before Bell filed his telephone patent application. Although Edison considered himself to be the first person to use the "magnetophone" in acoustic telegraphy, he readily admitted that it had never occurred to him to cause a human voice to vibrate the diaphragm. For this he always gave full credit to Bell.

biographers, he did not try the effect of sound waves produced by the human voice on this apparatus until a few months later when he learned of Bell's telephone demonstration. He went back to his device and found, incredibly, that it was capable of transmitting speech, although apparently crudely. Although Edison always admitted having been after a harmonic telegraph and not a telephone, and that he was "as much astonished as anyone" when he heard of Bell's discovery, we will never know if it was, in fact, Edison's deafness that caused him to put aside his device and not try the effect of sound produced by a human voice, thereby missing the opportunity to become the inventor of the telephone!

It could not have been long after March 1876 that Orton put Edison on a retainer of \$500 a month, in Edison's words, to "take hold of Bell's telephone and make it commercial." According to Edison, attempts to introduce the telephone commercially "failed on account of its faintness and the extraneous

sounds which came in on its wires. . . ."

Orton's confidence in Edison was not misplaced. During the next year he worked with his well-known intensity to raise the telephone volume. One of the weaknesses of Bell's first telephone was that it was actually two receivers, one at each end of the line, and only one person could talk at a time. Edison apparently recognized the need for a separate transmitter, and, by April 1877, had filed a patent for a transmitter he called "more perfect than Bell's." Edison's transmitter embodied two important innovations. Whereas Bell used a vibrating diaphragm to energize a magnet coil and diaphragm at the receiving end, Edison introduced a variable-resistance circuit using graphite-impregnated electrodes and an induction coil. This greatly extended the transmission range and the volume.

A few months later, Edison discovered that a button of pure carbon attached to a metal disk caused an even greater increase in the volume. In short, he had built a microphone, and the carbon transmitter patent he filed in February 1878 proved an enormous asset to Western Union in the furious telephone war in which it was by then engaged with the newly formed Bell Telephone Company.

The great telephone war

The Bell Company had been formally organized in July 1877 (two days before the long-awaited

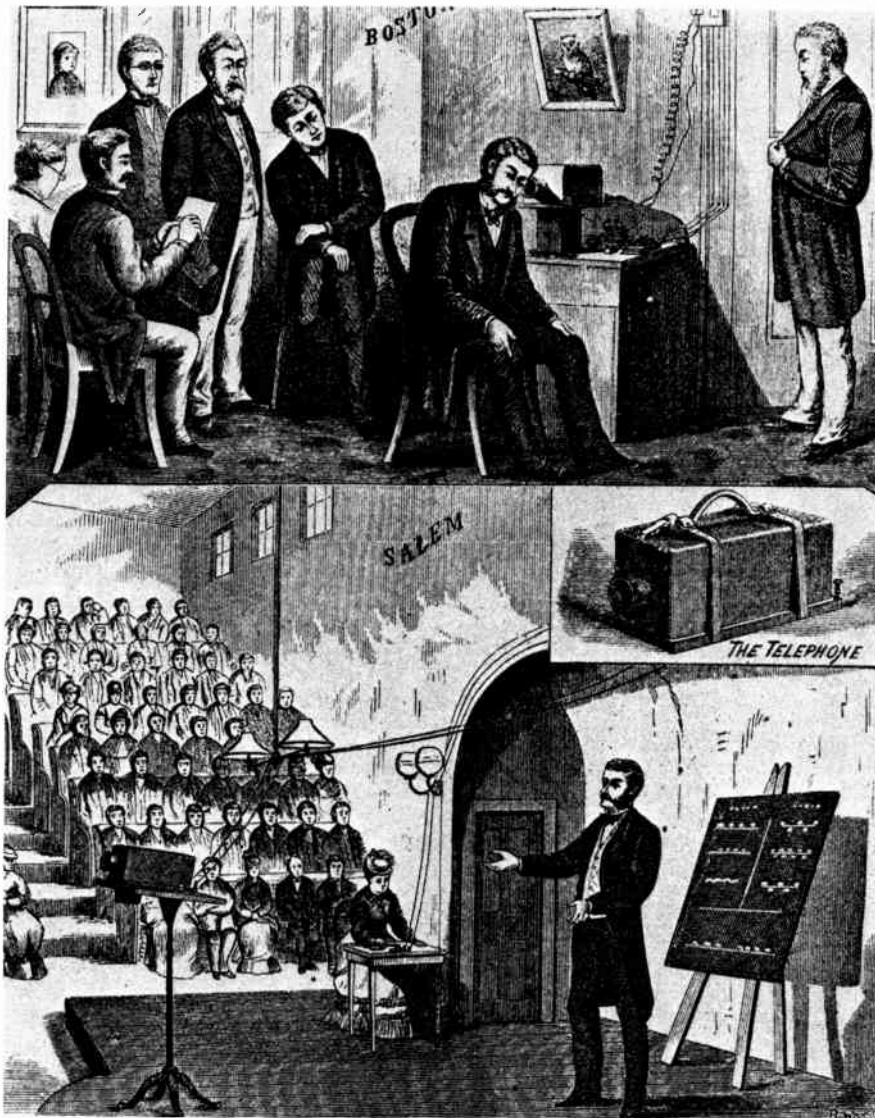

This woodcut, reproduced from the *Scientific American* of March 31, 1877, shows Bell lecturing to an audience at Salem, Mass. At the same time, Bell's telephone, shown placed before his audience, is connected up to his laboratory, 14 miles away in Boston.

wedding of Alex and Mabel), and by fall it had placed nearly 1000 telephones in operation. By then, whatever doubts Orton may have actually had about the commercial value of the new invention were clearly gone. In August, he ordered Western Union's top expert and Edison's first partner, Franklin Pope, to make "a full and careful investigation of the subject of telephony with a view to acquiring such patents as would enable the Western Union to use the telephone in connection with its business."

Pope reportedly was given all possible assistance, including every publication that could be found from the past 50 years on electricity and acoustics and the services of a scientific translator familiar with eight languages. After a few months of investigation, Pope concluded that Elisha Gray's patents would control the use of the telephone, and he recommended their acquisition.

Emboldened by Edison's progress with his transmitter, Orton apparently heeded Pope's advice. In December 1877, he organized the American Speak-

ing Telephone Company, which picked up the important patents and claims of Edison, Gray, and others, and entered direct and bitter competition with the tiny Bell interests. The giant corporation (it was capitalized at the then-astronomical sum of \$40 million) opened its own telephone exchanges, cut rates (and, it was alleged, Bell wires), and rented its own telephones, which it claimed used Gray's receiver and Edison's transmitter. Edison summarized the battle with wry brevity: "... the fight was on, the Western Union pirating the Bell receiver and the Boston company pirating the Western Union transmitter."

The beleaguered Bell Company fought back on two fronts — technological and legal. Tom Watson (by now superintending all telephone manufacturing and development work) hired the immigrant Emile Berliner, who had filed a caveat for a variable-pressure transmitter just 13 days before Edison's first transmitter application. This enabled the Bell Co. to file an interference against Edison's transmitter, thereby tying his patent application up in litigation that was not settled in his favor until 1892!

Meanwhile, in March 1878 Western Union had filed a block of interferences against Bell's patents on behalf of Gray and several other inventors. These were the first of more than 600 suits to be fought in courts high and low over the next 18 years—and were to cause Bell considerable anguish, even though his claim was always upheld.

The most important of these suits came in September 1878, when the Bell Company retaliated by seeking an injunction against a Western Union agent, Peter Dowd, who was renting Western Union telephones in Massachusetts. Western Union based its defense on the work of Gray, whom the company claimed as the principal inventor. When the case was settled by consent, in the fall of 1879, it would establish the fact that the Bell Company's most powerful opponent no longer disputed the Bell patents.

Western Union hangs up

Since this consent agreement marks the end of the conflict, I will turn now to a brief summary of

the rocky path that led to it.

During 1877 and 1878, both parties realized competition would benefit no one and that some sort of settlement should be reached if at all possible. Feelers were put out, and on February 8, 1878, one of Edison's associates wrote him from Chicago that "it seems quite well understood here that the Bell party will come into the Western Union camp and I think it is the sensible thing for them to do. The way to make money in the telephone field is to join forces and present a solid front. There will be enough of the spoils to satisfy all if the basis of agreement is equitable."

For some reason, quite possibly the old personal antagonism between Hubbard and Orton, this particular merger fell apart within the next two weeks. But in April, the personal factor was eliminated forever. On a Sunday evening, after a ride in New York's Central Park, 52-year-old William Orton suffered a fatal stroke. In a special memorial edition, the *Journal of the Telegraph* reported that he had been about to go on a three-month vacation and that at times he "appeared to suffer from excessive weariness and occasionally complained of severe headaches." Adding that the company had never been stronger or with such an apparently brilliant future before it, the editors also claimed that Orton "was much interested in the telephone and believed that while as yet crude and imperfect it would ultimately be perfected so as to be of much greater practical value commercially than had as yet been demonstrated."

Some indication of the strain Orton must have been under is provided by a letter his Washington lobbyist sent Edison on April 22: "Orton was a giant among pigmies on Broadway and Dey St. . . . when he was Orton he was a kind hearted man and if he had not been worn down by the hungry stockholders he would have been a different man."

With Orton gone, a settlement would undoubtedly be easier. Testimony on the Dowd case began in January 1879 and negotiations looking toward a possible settlement were begun as early as April. Western Union's chief counsel, George Gifford, was apparently convinced of the validity of Bell's patent and his strategy was to try and convince the Bell Company that although it controlled the principle of telephony, Western Union controlled the instruments by which it was commercially feasible; hence, he reasoned, the patents should be combined and a company formed in which each side would own 50 percent. A clue to Western Union's interest in settling is provided in a letter from Orton's successor, Norvin Green, to Edison on December 26, 1878: "I am quite satisfied there never has been a dollar of profit to any proprietor operating the telephone; and unless the competition is speedily reconciled and better prices obtained, there never will be."

The Bell Company refused Gifford's proposal, but the principals continued negotiating directly. This resulted in the famous agreement of November 10, 1879, by which Western Union admitted the validity of the Bell patents, agreed to retire from the telephone field, and assigned all its telephone patents to the Bell Company. In return, the Bell

Company agreed to pay Western Union 20 percent of all royalties received from telephone rentals over the next 17 years and to keep out of the public telegraph message business.

Why such a drastic settlement, particularly when Western Union might well have hung on for years while it looked for ways to buy out the Bell Company or otherwise throttle it? The answer does not lie in a failure to recognize the importance of the telephone. Rather, it seems to lie in a fear of the predatory actions of Jay Gould, a figure who loomed much larger in the events of the period than this article has had space to explain. Gould was a man of whom Edison said, "His conscience seemed to be atrophied, but that may be due to the fact that he was contending with men who never had any to be atrophied." In May 1879, Gould had launched one of his periodic attacks on Western Union. This time, he organized a competing telegraph company and, at the same time, began buying telephone exchanges and making motions in support of the Bell Company in its fight against Western Union. Western Union's stock plummeted, and the decision to settle with Bell was probably based on a desire to ensure the security of its telegraph monopoly. Moreover, Western Union did receive a very handsome price. As the annual report for 1880 said: "The effect of the settlement was the termination of expensive and hazardous litigation, securing to this Company protection from competition and a valuable franchise, and establishing the value of assets held by the Gold and Stock Telegraph Company [Western Union's telephone subsidiary] at least one and one half millions greater than they were before the settlement was made." Indeed, over the next 17 years Western Union received nearly \$7 million in royalties from the Bell Company. But ironically, while Western Union's settlement was probably sound business strategy at the time, within a year Gould gained control of the company anyway.

There is a further irony to the story. The old instinct for eliminating competition never died completely, and the year 1908 saw the consummation, if only briefly and incompletely, of the marriage that almost was. One of Gardiner Hubbard's master strokes, before he lost the helm of a near-bankrupt Bell Company early in 1879, was to hire the brilliant Theodore Vail as general manager. Vail played a key role in the Western Union fight and, later, in laying the foundations for the AT&T we know today. In 1908, aiming to make AT&T the only significant force in communications in the U.S., he engineered the purchase of enough Western Union shares to gain working control of the company. But five years later, antitrust pressure forced him to unload, thus ending forever his dream of a single company. ♦

This writer wishes to acknowledge particularly the valuable assistance of Lewis S. Gum, of AT&T, and Arthur R. Abel, of the Edison National Historic Site, in making accessible to him a wealth of archival material. In particular, all illustrations with the exception of those showing Edison and his telephone device were supplied by the AT&T Photo Center. The two involving Edison were supplied by: U.S. Department of the Interior, National Park Service, Edison National Historic Site.

This display makes oscilloscope timing measurements easier, faster and more accurate.

Main sweep has two intensified zones.

Two intensified zones on the main sweep correspond to the two expanded, delayed sweeps shown below. They are quickly and independently positioned to provide a visual approximation of the Δ time measurement.

Two expanded sweeps.

Both intensified zones are expanded at a faster rate for better resolution and are swept alternately with the main sweep trace for a complete, powerful measurement display. Δ time accuracy is enhanced by superimposing one trace over the other, yet they can be vertically separated for independent analysis.

Sweep rates displayed digitally.

Digital crt readout displays both sweep rates for measurement ease and convenient photographic documentation. To the left is the main sweep rate and to the right is the sweep rate for the two alternate (or delayed) sweeps.

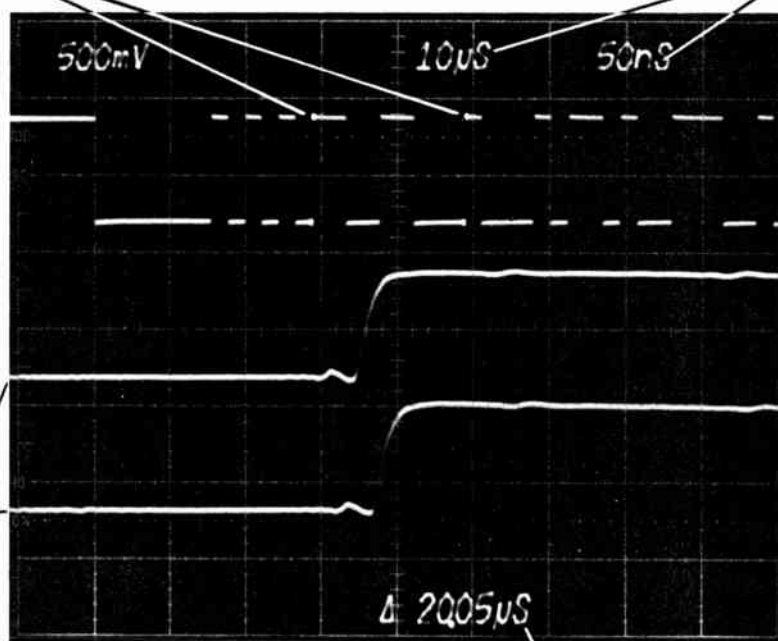

Time difference is computed and displayed digitally.

The time difference (Δ time) between each of delayed sweeps (or intensified zones) is digitally computed and displayed directly on the crt for swift and convenient measurement. When similar points on each of the alternate delayed traces are aligned, the Δ time readout gives you a highly accurate measurement of the time between the points.

CRT display, photographed on a 7904 oscilloscope, shown full size.

Fill out and mail to: Tektronix, Inc., P.O. Box 500, Beaverton, OR 97077

Please send me

- The new 7B80-Series brochure
- Δ time measurement application notes.
- A catalog of 7000-Series oscilloscope mainframes and plug-ins.

Please have a Tektronix Field Engineer contact me about a demonstration.

Name _____ Position _____
 Company _____ Mail Sta _____
 Address _____
 City _____ State _____ Zip _____
 Phone () _____

Only these new plug-in time bases make it possible.

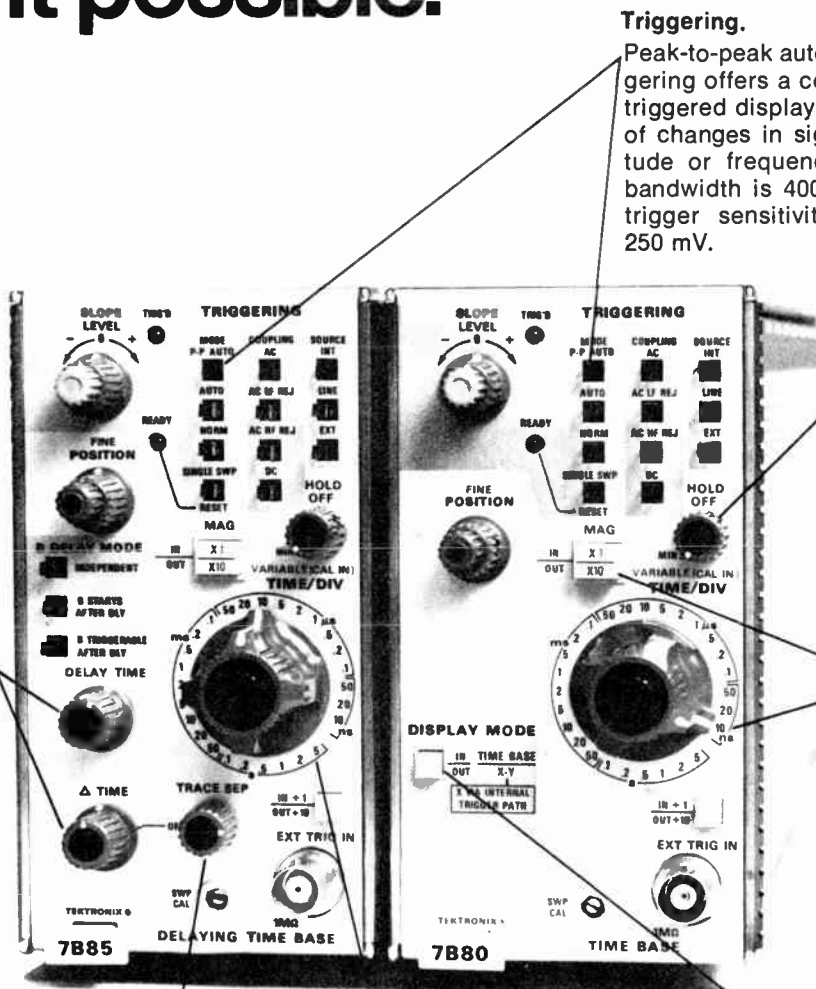

Triggering.
Peak-to-peak automatic triggering offers a continuously triggered display regardless of changes in signal amplitude or frequency. Trigger bandwidth is 400 MHz with trigger sensitivity at least 250 mV.

Trigger holdoff adjustable.
Variable trigger hold-off allows you to obtain stable displays on complex signals like digital data trains.

Controls position both intensified zones.

DELAY TIME positions the first intensified zone. Δ TIME positions the second intensified zone relative to the first. The Δ delay time value — the time between the two intensified zones — is presented digitally on the crt.

7B80 sweep rates.
The alternate (delayed) sweeps can be set to any rate up to 1 ns/division on the 7B80. Naturally, other 7000 Series time bases with different performance features can be used with the 7B85 to make Δ time delay measurements.

Alternate traces can be separated.
TRACE SEPARATION activates the Δ delay time mode and permits the two delayed traces to be vertically positioned with respect to each other for your most convenient display.

7B85 sweep rates.
Sweep rate for the main sweep can be set from 1 ns/division to 5 s/division.

Optional X-Y mode.
For phase relationship measurements, an optional X-Y mode routes the X (horizontal) signal from an oscilloscope vertical amplifier to the horizontal sweep unit without changing input probes.

Here's how to get more information

Your nearby Tektronix Field Engineer will be happy to show you how these new time bases combine with a 7000-Series oscilloscope mainframe and other 7000-Series plug-in instrumentation to fit your measurement needs. Just call your local Tektronix Field Office or send the coupon to Tektronix, Inc., P.O. Box 500, Beaverton, OR 97077. In Europe, Tektronix Limited, P.O. Box 36, St. Peter Port, Guernsey, Channel Islands.



TEKTRONIX®

committed to
technical excellence

The 7000 Series...more than an oscilloscope

On Reader Service Card, Circle No. 27 for Technical Data—No. 28 for Demonstration.

Energy

How Bell pinches power

Both design and good fortune play a role in conserving electricity, gasoline, and building fuels for the Bell System

Five million barrels of oil, enough energy to meet all the needs of 80 000 families for a year, are the savings from two years of intensified energy conservation by the Bell System. Comprised of the American Telephone and Telegraph Company, 23 operating telephone companies, Western Electric, and Bell Laboratories, this organization handles nearly five million calls a day, over a network linking 143 million telephones in the U.S. With its 28 000 buildings, its 180 000 motor vehicles (the world's largest private fleet), and its nearly one million employees, the Bell System also consumes large amounts of energy. Just an example: In 1973 Bell vehicles covered nearly 2.6 billion kilometers, devouring 600 million liters of gasoline. Nevertheless, the system is not an energy-intensive industry. In fact, in 1973, the Bell System contributed 2 percent to the U.S. gross national product while consuming only one tenth of 1 percent of the nation's energy.

Even before the 1973 Arab oil embargo raised the United States "energy consciousness," the Bell System had been saving large amounts of energy thanks to its large-scale introduction of energy-lean solid-state technology. But as a result of the embargo and the na-

tion's desire for energy self-sufficiency, a comprehensive energy-conservation program was developed that was designed neither to impair telecommunications services nor to affect negatively employee welfare and morale. This program covered the following major areas:

- Electric power for the operation of switching and transmission equipment for the U.S. nationwide telecommunications network.
- Electric power and fuel for building systems—basically, thermal, lighting, and computer operations.
- Transportation fuels for the vehicle fleet.
- Electric power and fuel for the manufacture of cable, wire, printed wiring products, and various telecommunications equipment such as telephones, data sets, and teletypewriters.

More solid state

Since the early 1960s, nearly two billion transistors, diodes, and integrated circuits have gone into use in the Bell System, and enormous savings of power have been achieved through the installation of these devices—compared with the power that would have been

Hubert L. Kertz

American Telephone and Telegraph

Useful terminology

Barrel of oil equivalent (BOE): The amount of energy contained in a 159-liter barrel of crude oil (about 6.1×10^9 joules). This unit is used as a common denomination for various fuels. **Beam lead:** An electrical connection established through use of a new method for batch-processed, self-sealing contacts. This type of contact is used in connection with high-performance silicon devices used in communications. The beam lead replaces an earlier, more costly and failure-prone connection method, whereby each lead of a silicon device (which, incidentally, had to be sealed in an expensive vacuum can) had to be separately connected to the leads of the can header. The header, in turn, had to be connected to the rest of the circuit. **Call store:** A memory that records and temporarily retains information while it is used by the switching system. **Degree-day:** The number of degrees of the mean temperature of the day below (or above) a given value. (In the U.S. 18.3 °C has been designated as the value below which heating is required.) **Dry-bulb temperature:** The temperature that is measured when not taking into account the humidity of the medium where it is measured (air, in this article). (The thermometer bulb remains dry during the measurement.)

Enthalpy cycle: Thermodynamically, *enthalpy* is the total heat content of the matter under discussion. In the context of this article, *enthalpy cycle* denotes a cycle for air conditioning that takes into account the total heat content of air; that is, the amount of heat included in the air itself as well as in the water vapor in it. **Ferreed switch:** A switching device in which reed contacts are combined with one or more metal parts with remanent magnetism, whose magnetization can be changed by current pulses in associated coils. **Hydronic system:** Water-fed system for heating and/or cooling. **Reed-relay translator:** An encoding/decoding circuit for processing calls at relay logic. **Remreed switch:** A miniature switching device consisting of two overlapping magnetic reeds, made of semipermanent magnetic alloy, which can be selectively magnetized by control current pulses in associated coils. The reed contact is sealed in a glass envelope. In contrast to ferreeds, which require external magnetic plates to provide the latching function, remreeds employ the remnant magnetism in the reeds themselves after a control pulse, for this function. The new remreed switching system employed at Bell System is thus not only more compact than its older ferreed counterpart, but also more efficient, the magnetic field being closer to the contact gap. **Wet-bulb temperature:** A temperature reading that is arrived at by letting the moisture of a wet gauze, which surrounds a thermometer bulb, evaporate as the thermometer is spun in air. The evaporation has a cooling effect, the extent of which depends on the humidity of the surrounding air.

I. Energy conservation and other impacts of modifications in switching systems memory, electronic switching networks, power systems, and other communication areas within the Bell System.

Area of Modification	Action Taken	Energy-Related					Other Benefits
		Direct Reduction in Energy Use, %	Indirect Energy Saving in	Improved Reliability	Less Space Needed	Less Material Needed	
Electronic switching systems memory	Replacement of ferrite sheets by ferrite core, as memory elements for call stores (see box on p. 54 and Fig. 1)	75	Manufacturing (due to size reduction), repairs, trouble diagnosis	X	X	X	Simplified installation, cost reduction, increased operating speed Reduced need for conventional, discrete circuit elements, reduced assembly time for core arrays
	Extensive use of silicon integrated circuits (ICs) in access systems for driving ferrite cores						
	Extensive use of silicon ICs for logic and switching		Manufacturing (due to size reduction), repairs, trouble diagnosis	X	X	X	
Electronic switching networks (for interconnecting customer lines, trunks to other offices, and service circuits such as dial pulse receivers and ringing circuits)	Replacement of "ferreed" switches, wire-spring relays, reed relay translators, and discrete semiconductor logic devices by "remreed" switches, diodes, pnpn transistors, and silicon ICs (see box on p. 54 for terminology)	40	Building, wiring, and testing of a remreed switching network	X	X		All-electronic control scheme, modern interconnection techniques, shorter wiring time, wiring less error-prone (completed in factory)
Carrier systems, voice-frequency (VF) amplifiers, multifrequency (MF) signaling units, and other units	Replacement of vacuum tubes by hybrid integrated networks (HINs, Fig. 2)	50-60	Cooling systems for buildings due to lower amount of heat generated by the HINs				
Some communications equipment	Replacement of filament lamps by light-emitting diodes (LEDs)	78	Cooling systems for buildings due to lower amount of heat generated by LEDs				Longer life (ten times that of filament lamps)
Power systems	140-volt dc power system was developed for replacing 24- or 48-volt battery plants	27	Cooling systems for buildings due to lower energy losses in transmission (due to lower current)		X	X	

required to perform the same functions with vacuum tubes.

New systems are continuing to evolve, and most of these second-generation, solid-state systems provide further reductions in the amount of energy required for each operational function performed. Two examples of this are electronic switching systems memories and electronic switching networks. Also, new electronic components, such as hybrid integrated networks (HINs) and light-emitting diodes (LEDs), are being introduced into presently installed existing systems to reduce the electric energy required to perform the same functions as their predecessors.

In addition, Bell Laboratories has developed a 140-volt dc power system for switching and transmission

equipment to reduce the loss of energy experienced in the existing low-voltage (24- or 48-volt) distribution systems. (Since energy losses in distributing power are proportional to the square of the current, and increasing the voltages reduces distribution currents, energy savings are significant. These savings also reduce the amount of cooling needed to maintain the optimum environment for basic switching and transmission equipment.) The energy savings, as well as other benefits obtained by carrying out these modifications, are summarized in Table I.

In buildings, immediate energy cuts

The immediate action items affecting the conservation program in buildings consist of:

- An extensive delamping program.
- Reduction of domestic hot water temperature.
- Reduction in heating and cooling of occupied areas as well as of unattended buildings.
- Development of computer programs to identify areas of high energy use.
- Revised design and operation of buildings (resulting

The ENERGY system at the Bell System for data collection, analysis, and energy reports employs a time-sharing computer. The system accepts energy-consumption data (purchases, in the case of gasoline and fuel oil) by type of fuel and use, such as transportation, buildings, and manufacturing, and converts the fuel data into "barrels of oil equivalent" (BOE, see box on p. 54). To permit true measurement of the effectiveness of business growth and climatic variations, energy-demand indicators such as total number of company telephones, total area of floor space, total distance traveled by motor vehicle fleet, and heating and cooling degree-days (see box on p. 54), are also entered into the data base. Ready accessibility to all of this information facilitates analysis of trends in energy use.

Input data from the operating telephone companies, Bell Laboratories, and Western Electric:

Energy sources (type, usage, and cost)		Energy demand indicators
Electricity	Propane	Total number of company telephones
Gasoline	Diesel oil	Total area of floor space
Natural gas	Hot water	Total distance traveled by motor vehicles
Fuel oil	Chilled water	Degree-days
Steam		Other

Data processing:

1. Classification:

Building energy	Motor vehicle fuels	Manufacturing energy
Telephone power		
House-service electricity		
Building fuels		
Emergency fuels		
2. Conversion into barrels of oil equivalent (BOE)
3. Analysis of energy trends

Major output reports covering individual companies and the entire Bell System:

Total energy consumption	Total cost	Fuel usage
Gasoline	Gasoline	Natural gas
Electricity	Electricity	Fuel oils
Building fuels	Building fuels	Steam
		Propane
		Emergency fuel

Building energy per unit area	Manufacturing energy	Total energy per in-service telephone	Other
kWh per unit area			
Building fuels per unit area			

from the previous item).

For example, elevators have been reprogrammed to shut down when not required during nonrush hours. Also, the testing interval of emergency power-generating equipment has been reduced to cut down fuel consumption, without jeopardizing the integrity of the telephone network.

A significant user of power in buildings is ventilation equipment for air-conditioned spaces. Many local codes and ordinances require that, in typical office buildings, at least 10 percent of the total circulated air be outdoor air. Telephone central offices, which are classified as office buildings in many localities, thus have been compelled to provide this minimum of outside air for lightly occupied, and even some unattended, buildings. This requirement is expensive and wasteful, especially when the high circulation rates required by electronic equipment are considered. For those areas where the 10-percent requirement is too great, efforts are underway to obtain code variances to reduce the percent of intake. Scheduled ventilation is also considered for reduction in energy consumption. Under this scheme, during nonoccupancy conditions, the amount of outside air is limited to the quantity required for pressurization only.

For cooling, the need to maintain a practical duct distribution system size generally results in the use of high-velocity air-conditioning systems for telephone equipment loads of 215 watts/m² and above. To maxi-

[1] Among modifications at the Bell System—which are intended, among other things, to reduce energy consumption—a new "call store" with 32 000-word capacity is organized to include logic circuitry and word-access and bit-access circuitry, all employing silicon integrated circuits having beam leads (see box on p. 54). The memory itself consists of an array of small ferrite cores.

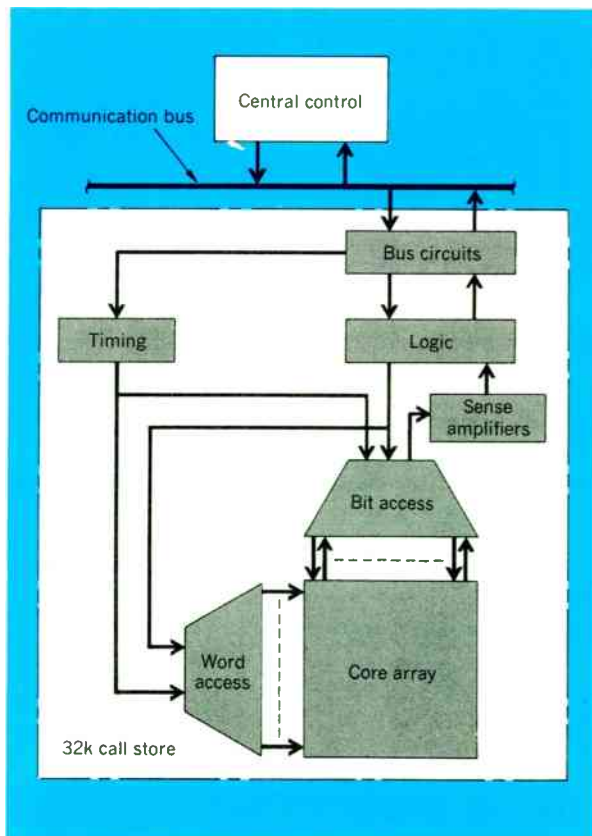

mize efficiency and minimize the ceiling congestion due to cabling and ductwork, Bell engineers have adapted new modular cooling system (MCS) technology to provide more effective cooling of transmission and switching equipment. Using chilled water, greater heat removal is provided by the MCS at the point of application than is provided by a conventional air-conditioning system. Also, the energy savings to be realized are significant because MCS concentrates the cooling on the specific piece of high-heat-dissipating apparatus. The MCS consists of a process cooler (chilled-water fan coil), an air-distribution plenum ceiling, and a modular raised floor. The versatility of this equipment also minimizes the cost of rearranging the cooling system because of changes in office layout and growth.

Another major consideration in favor of MCS is that less building space is required for mechanical equipment rooms. Unlike conventional cooling systems that must be installed all at one time, the cost of process coolers can be deferred until they are needed.

A wasteful consumption of energy often results from

[2] One example of many hybrid integrated networks (HINs) available in the Bell System to replace an estimated 12 million vacuum tubes, with a total energy saving of 250 million kWh, is that replacing the 408A pentode and the 427A regulator in the N1 repeaters. The HIN regulator uses a regulator diode to set the voltage and two varistors for temperature compensation. The 408A pentodes serve two functions in the repeater—amplification and oscillation. The solid-state replacements thus required two different designs—amplifier and oscillator HINs. Both designs use cascode junction field-effect transistor circuits, but the oscillator requires an extra resistor-capacitor circuit to provide proper operation. The amplifier and oscillator HINs have straps across the pins corresponding to the tube filaments to provide continuity in the thermistor-controlled, series heater circuit.

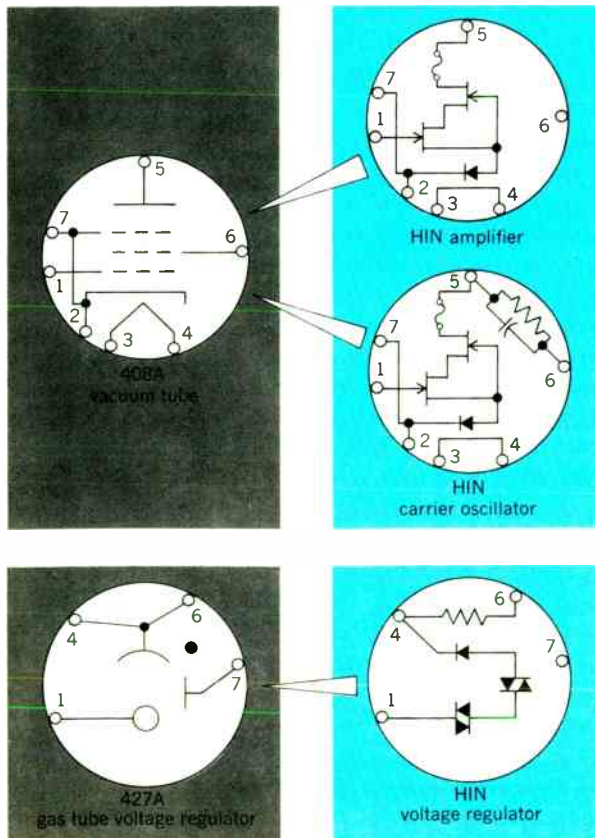

having simultaneous heating and cooling requirements in different zones in the same building. In an effort to conserve otherwise rejected energy and transfer it to where it is needed, the Bell System is increasingly using electric-driven, centrifugal heat pump systems. In these systems, a chilled-water loop, via a chiller (evaporator), conditions the air-conditioning system to cool high-heat-releasing areas. Perimeter heating is accomplished via a water loop from the condenser. Rather than dissipate the extracted heat from the cooling load to the atmosphere via the cooling towers, the “reclaimed” heat is transferred by the heat pump from the condenser circuit to the perimeter hot-water loop. Automatic controls maintain optimum performance of the chiller. As the heat pump system can be used year round, the need for boilers for hydronic systems (for definitions of this and other unfamiliar terms see the box on p. 54) can be reduced or eliminated. An additional advantage of the heat pump system is the reduction in the products of combustion being introduced to the atmosphere.

The sun and outside air are harnessed

While it is recognized that the concept of solar heating is quite old, its application to commercial buildings is relatively new. For future building designs in the Bell System, solar energy looks promising. The winter of 1974 saw the completion of a solar heating plant in Massachusetts for a telephone central office that has reduced the amount of oil required for the auxiliary burner by 50 percent. And solar energy is harnessed for cooling, as well as for heating, in a building currently under construction for New York Telephone on Long Island.

In addition to using solar energy, the Bell System is now in the process of modifying existing air-conditioning systems to operate in the total heat mode, or *enthalpy cycle*, using outside air as a cooling source whenever it is cold enough. However, the *dry-bulb temperature* of the outside air alone does not satisfy the environmental conditions required in buildings. Although outside air will handle the sensible heat load, it cannot care for the latent heat load, which depends on the humidity.

The enthalpy sensors employed in the total heat-mode air-conditioning scheme (known also as the “airside economizer” scheme) measure *wet-bulb*, as well as *dry-bulb temperature*, and through pneumatic or electrostatic controllers indicate the enthalpy state of the outside air—that is, its total energy content, including that contributed by water vapor in the air. Similar devices installed in the return air stream (from air-conditioned areas) in conjunction with the instrumentation monitoring outside conditions pilot a controller to select the environment having the lowest total heat content.

In looking to the future for effecting energy conservation in building systems, many considerations were given to the design and engineering criteria for buildings both under construction and being planned. Value engineering has taken on an important aspect in building rearrangements and construction projects. As an ongoing requirement, architects and engineers are required to submit alternate proposals on building designs and office rearrangements. The recommended design and alternate proposals are submitted with fact

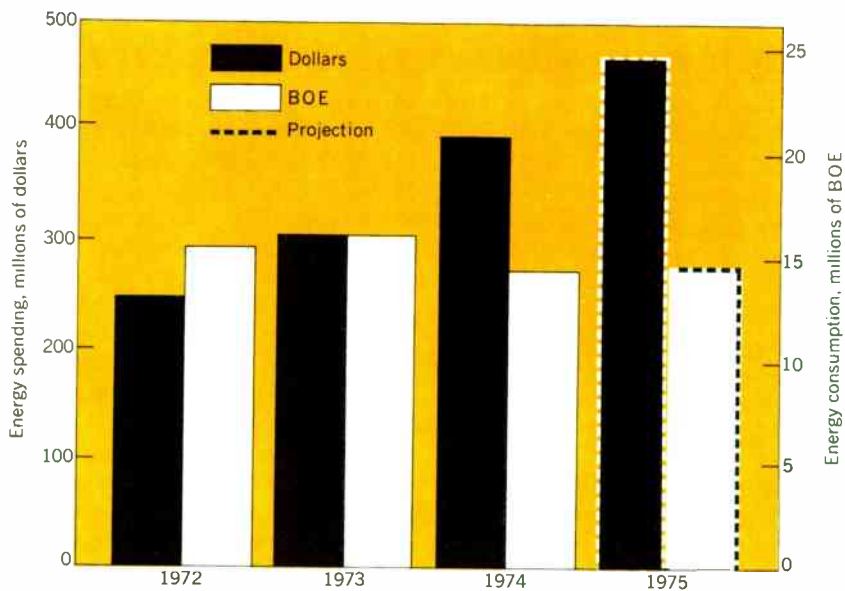

[3] In spite of reduced total energy consumption in the Bell system in 1974, as compared with 1973, the energy spending increased dramatically in 1974 as a result of increased electricity, gasoline, and building fuels costs. A similar increase in energy expenditure is estimated for 1975 in spite of steady energy consumption that year (the complete data were not available at press time). (The above results reflect growths in the volume of business: 9.1 percent in 1973 over 1972, 7.4 percent in 1974 over 1973, and 5.3 percent in the first nine months of 1975, over the similar period in 1974.) The energy consumption unit is barrels of oil equivalent (BOE).

sheets detailing first cost and yearly operational cost estimates. The design that renders minimum energy usage consistent with initial construction costs is selected.

Goal for vehicles—maximum fuel economy

When the energy crisis struck, instructions were issued by the American Telephone and Telegraph Company (AT&T) to the operating telephone companies, detailing ways whereby gasoline could be saved. In particular, these instructions covered areas such as purchase of efficient vehicles, driver training, and proper maintenance. Work was begun almost immediately by AT&T and Bell Laboratories, with the cooperation of automobile and truck manufacturers, to find specific ways to structure and operate the fleet for maximum fuel economy. The result of this work was specific recommendations as to engine size, transmission, rear axle, tires, weight, and optional equipment to be specified for the purchase of new vehicles.

Another list of recommendations on the maintenance of vehicles already in the fleet covered tune-ups, air filters, carburetor adjustments, spark plugs, lubrication, and tires. Each of these was to be cost-effective as well as to conserve fuel. In addition, to aid the operating companies in determining the most efficient fleet size, AT&T and Bell Laboratories developed a time-shared computer program capable of calculating the fleet size that minimizes the cost of operation and meets given vehicle-availability criteria. The program may also be used to evaluate the characteristics of an existing fleet. For each type of analysis, the program computes the cost and various availability factors. In another computer program, aimed at reducing maintenance costs and fuel consumption, data from thousands of transactions now recorded in company garages are gathered and inputted. All operating expenses are recorded to provide the management with information on budget and gasoline control, and on repair analysis.

As a direct result of programs undertaken in the Bell System to conserve fuel and reduce the motor vehicle fleet's costs, in 1974, the Bell System cut down fuel consumption by more than 4 percent over that of 1973,

in spite of a 2-percent increase in the size of the fleet, and increased procurement for additions and replacements of less efficient motor vehicles due to emission-control features.

Complementing conservation efforts in buildings and motor vehicles are efforts related to savings in manufacturing energy. For example, in Western Electric, the manufacturing and supply arm of the Bell System, process heat in production areas is recycled for space heating use in administrative areas. Also, many of the processes themselves have been modified to be more energy efficient. A case in point is the reduction of temperature in 26 pulp machines during nonoperating hours at the cable shop at the Hawthorne Works in Chicago, Ill., an action that saved the company 1.3 million kWh per year.

A final word: Regardless of the energy supply situation, an overwhelming causative factor that dictates the conservation of energy is its cost, the worm in the apple of the energy conservation program. In 1974, the Bell System used nearly 10 percent less energy than in 1973, even though the volume of business increased 7.4 percent. And at the end of nine months of 1975, the consumption was only 1 percent above the System's goal of "zero energy growth," in spite of 5.3-percent growth in business. However, even with this conservation, the Bell System experienced a 28-percent increase in overall energy costs in 1974 (Fig. 3), and it is expected that final data will indicate a similar increase in energy expenditure for 1975, due to increases in electricity costs as well as in the price of gasoline and that of building fuels. ♦

Hubert L. Kertz (F) retired in 1975 as vice president of AT&T's Construction Plans Department, and recently became president of American Bell International, an AT&T subsidiary. Under his direction, the energy conservation program described in this article was begun. A licensed professional engineer, Mr. Kertz spent his entire career with the Bell System, beginning in 1926 with Pacific Telephone and Telegraph Co. He received both the A.B. and E.E. degrees in electrical engineering from Stanford University.

The co-op in the sky

The Public Service Satellite Consortium aims to access 'small' member-users to a low-cost space telecommunications network

After a decade of experimentation, satellite communication systems for public service uses are on the threshold of "hard" application—not only in the United States but around the globe. Three projects have demonstrated—or are about to demonstrate—the feasibility of public service telecommunications systems:

- In the United States, at a cost of less than \$4600 per receiver station, a 119-station experimental satellite network recently carried a variety of health and educational services into schools and hospitals located in communities, from Appalachia to Alaska, that have been too remote to benefit from network broadcasting.
- In India, 2500 communities, separated by language, culture, and geography, are presently benefiting from an ambitious program of social services beamed from a single Government facility. Here, the system installation costs have been estimated to be less, by a factor of at least three, than would have been possible either with earth-bound communication facilities or with traditional satellite systems.
- In Japan, technical breakthroughs resulting in improved cost/performance of high-powered satellites will soon make possible the world's first national satellite broadcasting system.

These developments have demonstrated that the burden of performance in a satellite communications network can now be transferred from earth stations to the satellite itself. The resultant decrease in both the cost and complexity of the receiver stations puts satellite broadcasting into the budgetary grasp of the small, independent user and opens the door to a huge range of social services or projects. For example, medical students in many dispersed geographical locations can participate in televised instruction from a major medical center. Consultations can be conducted between physicians at distant hospitals, and those doctors would have the technology at hand to exchange such data as EKGs, medical histories, and laboratory reports for diagnostic purposes.

Lecture or audio/visual materials originating at one learning center can be made available to many geographically dispersed schools, libraries, hospitals, industrial plants, offices, and other environments in which learning can take place. Schools geographically separate, but educationally related, can, through satel-

lite interconnection, become functional units in special systems that would enable them to share resources and instructional materials designed to meet their common needs. Students viewing televised courses offered by a regional open-university system can interact with the instructor by using two-way voice or data communications.

Libraries and computerized data bases across the country can be linked for instant access and transfer of information. The satellite can be used as a catalyst to unify presently uncoordinated state and interstate

An 11-meter (36-ft) parabolic antenna—the kind necessary for a ground terminal receiving transmissions from present-day, low-powered 4/6-GHz transponders built into commercial satellites—dwarfs a 3-meter (10-ft) antenna—the kind that suffices for receiving high-powered 2.5-GHz transmissions. While the cost of a ground station employing an 11-meter antenna might run as high as \$65 000 (a figure that would be prohibitive for small users), the cost of a station using a 3-meter antenna is likely to be under \$10 000.

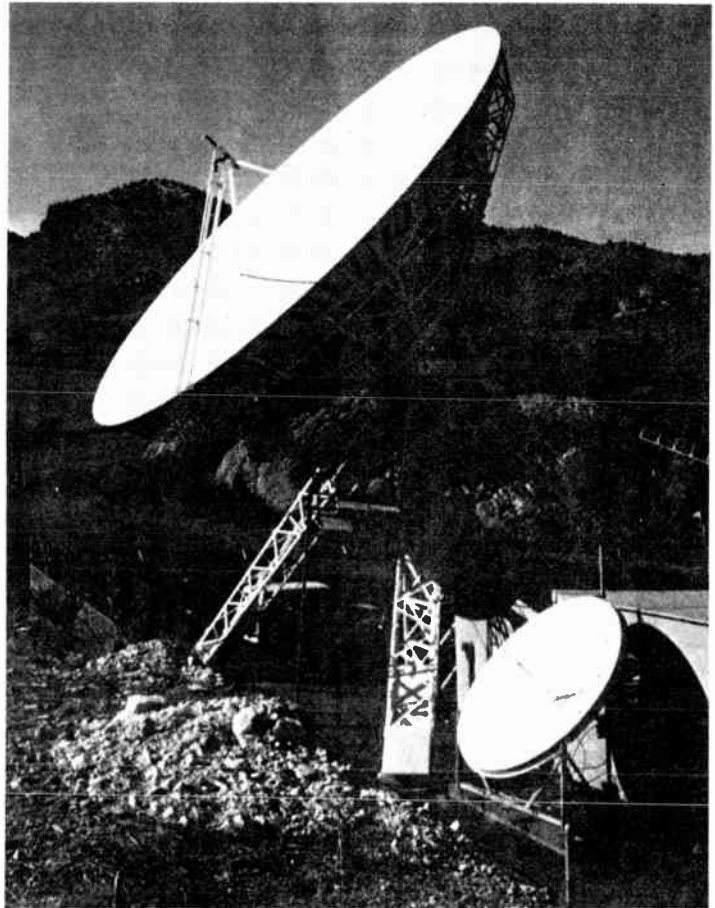

Bruce B. Lusignan

Communication Satellite Planning Center

James G. Potter

Public Service Satellite Consortium

James M. Janky

Communication Satellite Planning Center

Perspective: the difficulties of applying the communications satellite to public education

There is little doubt that the communications satellite can be a mechanism for providing significant benefits and needed services to many people in the world. In education, a communications satellite can be used to multiply the effectiveness of skilled teachers, to reach people living in remote areas, and to keep in touch with migrant populations. It can be the basis for numerous educational applications, from individualized instruction to library information retrieval; from teleconferences to instructional broadcasts on a group basis; from remote computing to class management. From an educational point of view, communications satellites have the potential to reach and affect everyone.

In spite of the optimism that permeates discussions of the use of satellites for education and the potential benefits that can be derived through their use, considerable care must be exercised in developing their applications. History has shown that human and social problems, as well as benefits, are often a consequence of technological advances. There is no reason to believe that the application of satellites to education will be exempt from unanticipated social problems. The challenge is to develop and apply satellites to help solve the existing problems of education, without creating new problems of greater consequence. What follows is only a short sketch of the parameters of this challenge; a more detailed discussion of communications satellite applications to education will appear in the May issue of the *IEEE Transactions on Education*.

Education and cultural change

An assumption, often made, is that a satellite is only an extension of existing communications links that will allow us merely to expand what we already are doing. This is shortsighted, especially in education. Our experiences with technology have been primarily *intracultural*. Projectors, recorders, radio, and even broadcast television have limited coverage. The education that has been transmitted has been confined to relatively small areas, to populations that tend to be rather homogeneous. Broadcasting from space, however, can cover large areas of the world, and can encompass peoples of many different nations, languages, and cultures. Satellites, for the first time, allow direct *intercultural* education. This is what is new; and this is what no one yet knows how to do well.

Institutional problems

The amount and diversity of activity and the precision necessary to establish and operate a widespread satellite-based

educational system will tax the capabilities of any organization. The successful accomplishment of the numerous technical and educational tasks requires the cooperation and administration of a large number of specialists dispersed over a wide geographic region, often in remote areas, if the program is to succeed.

If a satellite is to be shared by several countries, a number of political problems will arise. For instance, a country will have to decide whether it will allow material that has been produced by, and broadcast from, another nation to reach its people. Furthermore, a country will have to be willing to establish a national educational and communications system that is based on a satellite facility over which it does not have full control. It will be difficult for most countries to decide to participate in such a system, particularly if the satellite broadcasts can be received directly in the home, rather than having to be received and retransmitted by Government-controlled ground stations.

The introduction and successful exploitation of an advanced technology also require a serious commitment to educational improvement from the educational and political hierarchies in the region. This will not be easy to obtain for an operational system that encompasses large numbers of people. Education by satellite is a major change in the current educational pattern. The educational community, however, has been characterized by a strong resistance to change. Technological progress, on the other hand, has been more rapid and is accelerating. It is clear that satellites can accommodate education, but will education accept satellites?

Financing satellite activities

An educational satellite system incorporates course materials, video and audio programs, ground and satellite hardware, maintenance activities, supporting services, staff training, and other activities. Each has an associated cost. It is clear that no single organization, including the Federal government, can pay all of these costs on a continuing basis.

The revenues of public elementary and secondary schools are shared by the various levels of government, with over 50 percent provided by local communities. The decision to purchase educational technology hardware and course material, therefore, is, not unexpectedly, often made at the local level. This probably will continue to be so, particularly for the purchase of the ground terminals and the communications cost to participate in satellite programming. Since no local unit is large enough to amortize the cost of a major effort in satellites,

communications systems for administration, health, law enforcement, highways, conservation, and public safety.

These manifold possibilities, now available to public service agencies (both governmental and private), herald a new era in satellite communications. But that era may not commence until the "small" user—be it a rural school system, a hospital, a local library, etc.—can afford access to a system. If properly organized, small users can own their own key to this potentially rich world of modern telecommunications, and it is to this end that the Public Service Satellite Consortium (PSSC) has been formed.

What is the PSSC?

In March 1975, the Public Service Satellite Consortium came into being. PSSC's formation was the result of a series of meetings of educators, health care specialists, and communications experts excited by experiments conducted on NASA's Applications Technology Satellite-VI (ATS-6), the most powerful communica-

tions satellite launched to date (see *Spectrum*, Jan., pp. 91-93).

Over 45 nonprofit organizations have become members since March of last year. Some of the present members, such as the Public Broadcasting Service (PBS), National Public Radio, and the State of Alaska, plan to use satellite communications as soon as possible. Others, such as the Medical University of South Carolina and the Catholic Television Network, are interested in the prospect of reduced distribution costs and national program interchange but will conduct further studies before investing heavily in satellite communications.

The Public Service Satellite Consortium has been formed to permit these and its other members to render their respective public services more effectively and at less cost. The utility of a consortium lies in its ability to aggregate a large number of small, diverse users into a market group that can then share the risks and take advantage of economies of scale in planning, procurement, and operations. Thus, the PSSC is in-

and since there is a variety of decision-making structures, it is a high-risk venture for any commercial concern to expend the large amount of money necessary either to develop a major system or to produce high-quality, fully validated materials.

Aggregation and diversity

Technology is most economical when large audiences are involved; when the same materials can be used by many people; when the equipment is used almost continually; when the capital expenditures and initial investments can be distributed over a large base of users. This is particularly true of technologies, such as satellites, that require large initial investments.

The aggregation of needs and the creation of instructional material to meet the norm, rather than deviations from the norm, can conflict with the need for diversity, a concept particularly important when dealing with several national or cultural groups. Since individual needs, desires, and aspirations vary widely, one must insure that in meeting the common needs, the needs and rights of individuals and of special groups are recognized, protected, and fulfilled. Diversity is especially necessary in education, since education shapes a person's values and ideas, and is a primary means for passing a culture and heritage from one generation to the next.

For the adoption of technology, aggregation can promote efficiency, lead to lower overall operating costs, create widespread use of an innovation, and assure that certain minimum standards of education are met. Aggregation, however, also may promote uniformity, reduce the number of alternatives, make the system less responsive to local needs and desires, and negate the accountability of the schools to parents and to the local community.

In one sense, the basic difficulty in applying satellites to education is how to develop and apply techniques that can be highly effective, but which are economical only when applied on a mass basis, to insure that there is enough flexibility and variety so that education can be responsive to local needs and desires.

The task is to apply satellites to education in order to improve the quality of education, reduce its cost, increase the availability of educational opportunity, and create possibilities for additional choice, yet do so without creating new problems that outweigh existing ones. This is the challenge that confronts those who are making decisions about applying satellites to education.

*Lawrence P. Grayson
National Institute of Education
Washington, D.C.*

tended to be an operating company, a co-op of public service organizations and agencies who know that, now or in the future, they will need advanced telecommunications service. The fundamental job of the Consortium is to move valid services from an experimental status to regular operation.

It will assist the members with several major functions, beginning with aids to help them formulate precise, realistic statements of their requirements as they exist today and as they can be projected into the future. Additionally, the Consortium will provide coordination services and technical support for appropriate experiments; prepare and analyze alternatives in terms of technology, financing, and organization to help individual members implement working plans to satisfy their requirements; and maintain an active policy and administrative structure in order to coordinate responsibly the joint activities of its members.

Regulatory matters are especially critical, even at this early juncture. The PSSC will be following developments very closely as the U.S. prepares for the

World Administrative Radio Conferences of 1977 and 1979, attempting to protect the options of the public-service community as these proceedings result in policy positions and then in specific regulatory decisions. A comparable effort will be undertaken as the FCC deliberates on other issues affecting public-service telecommunications.

The Consortium will perform a brokerage function on behalf of its members by integrating their composite traffic requirements and by assisting in negotiations with applicable suppliers for satellite capacity, communications apparatus, and insurance. Pools of interest will be aggregated on a national basis so that the more users there are, the lower the cost of service will be for each member.

The preliminary thinking of the membership is that the Consortium should not be involved in programming, thereby preventing any activity in the production, marketing, or censorship of programmatic materials. Criteria for selecting appropriate materials rest strictly with the members involved. As a general rule, the Consortium will not own or operate any of the ground receiver stations but may provide technical assistance to its members in such areas as procurement, installation, and maintenance.

The first step taken by the PSSC was to appoint H. Rex Lee (a former FCC commissioner) as chairman of the Interim Board. After a lengthy search, John P. Witherspoon, who had served previously as the first principal executive for television of the Corporation for Public Broadcasting, was appointed president of the PSSC on October 1, 1975.

Funding to support the first year's activities is being provided by a \$475 000 grant from the U.S. National Aeronautics and Space Administration and the Department of Health, Education, and Welfare, as well as from membership dues. In subsequent years, increasing support is expected from members for services rendered and from private foundations. Under the terms of the founding grant, the Consortium will become responsible for the transmission facilities in Denver, and nearby Morrison, Colo., which were major elements of health and education experiments on ATS-6. The core technical staff that served as operations manager of those experiments is now under contract to the Consortium.

The next two to three years will be a period of intense experimentation for most members. The Consortium has filed proposals with NASA to participate on ATS-6 (which is scheduled to return from India in 1976) and on the U.S./Canadian Communications Technology Satellite (CTS). The PSSC is working closely with NASA to be sure that the experiments of public-service users are as well coordinated as possible. Procedures are being developed that encourage one category of users to experiment on ATS-6, another to experiment on CTS, and a third to begin on commercial satellites. The intention is to recommend courses of action that are likely to lead smoothly to operational service if the early experimentation is successful.

What technologies are immediately available?

Today, there is a surplus of satellite capacity, resulting in part from a decision by the competing carriers to fly satellites having virtually identical performance characteristics. Commercial satellite transponders all

operate at 4/6 GHz, have 5 watts of output power, and provide continental U.S. coverage. The in-orbit capacity of each system ranges from 24 to 48 transponders. This surplus of capacity has created a buyer's market for public broadcasting as it contemplates a move to satellites. Unfortunately, none of the commercial satellites presently available have higher-powered transponders that operate at frequencies that would permit use of lower-cost earth stations. An immediate need by any member of the Consortium to move to operational satellite service can only be accommodated using lower-powered transponders, which necessarily increases the cost of the earth stations—in effect, putting them out of the grasp of many PSSC members.

PSSC members using the ATS-6 satellite will have available to them two high-powered transponders operating at 2.5 GHz. Those utilizing CTS (which was launched in January) have one transponder operating at 12/14 GHz. Both satellites, therefore, are attractive because they provide high-power transmissions so that prospective PSSC users, like the Federation of Rocky Mountain States and Stanford University, can employ inexpensive ground terminals.

However, ATS-6 and CTS are experimental, limited-life, and limited-coverage satellites that are to spawn no NASA offspring. Consequently, they cannot answer PSSC's long-term needs. Until such time as the Consortium's members can generate enough traffic to warrant the huge costs of a dedicated satellite system—something far off into the future—they will have to depend on commercial, common-carrier satellites. And, as currently constituted, these do not suit most members' needs.

Drawbacks in the present systems

Further, to broaden substantially the base of domestic satellite communications, the entry fee for individual users must be reduced. Unless the users are highly clustered where they can share an earth station, it is imperative to locate the station at the point of use, which is extremely difficult to do with present satellite systems.

The likelihood of being able to locate a satellite earth station at the point of use varies inversely with

the level of local interference from other services that share the spectrum. Local interference from terrestrial microwave systems is very severe at 4/6 GHz (the commercial satellite band) in most urban areas of the U.S. It is much lower at 2.5 GHz, 12 GHz, and 14 GHz because these bands are not as heavily utilized at the present time. Nevertheless, to date no commercial satellite operator has been willing to broadcast in these bands, and this represents a severe constraint to many Consortium members, particularly in the health community, who want to transmit from the point of use, but who find the density of local interference at 6 GHz in many parts of the U.S. prohibitive.

If the Consortium is at all successful, the number of terminals in its network will far exceed the size of any existing domestic satellite network. Consequently, it is necessary to examine critically the capabilities of the satellite transponders tailored to today's networks and to consider placing more of the performance burden on the satellite and less on the ground.

Making do; then pressing for improvement

Until the commercial carriers can be convinced that it would be financially advantageous to provide high-powered transponders at less crowded frequency bands, PSSC members must make do with what exists. The less wealthy Consortium members have therefore decided to work only with ATS-6 and CTS, but three members have proceeded with negotiations toward the leasing of commercial satellite time.

The largest single user of transponder time, at least in the intermediate future, will be the Public Broadcasting Service (PBS), which is proposing to use satellites to network three television channels to 170 public television licensees. National Public Radio (NPR) is planning to network six stereo channels to 150 additional stations. The Ford Foundation, the Corporation for Public Broadcasting, PBS, and NPR have formed a Satellite Working Group to coordinate planning for the transition from terrestrial to satellite distribution on commercial satellites; and their work is in an advanced stage.

The State of Alaska hopes to be the third "operational" member, and has been negotiating with AT&T

NASA's Applications Technology Satellite-VI deploying after launch. ATS-6 has become the prototype of a new kind of communications satellite in that it bears much of the cost of its telecommunications system rather than leaving the prime financial burden on its ground stations.

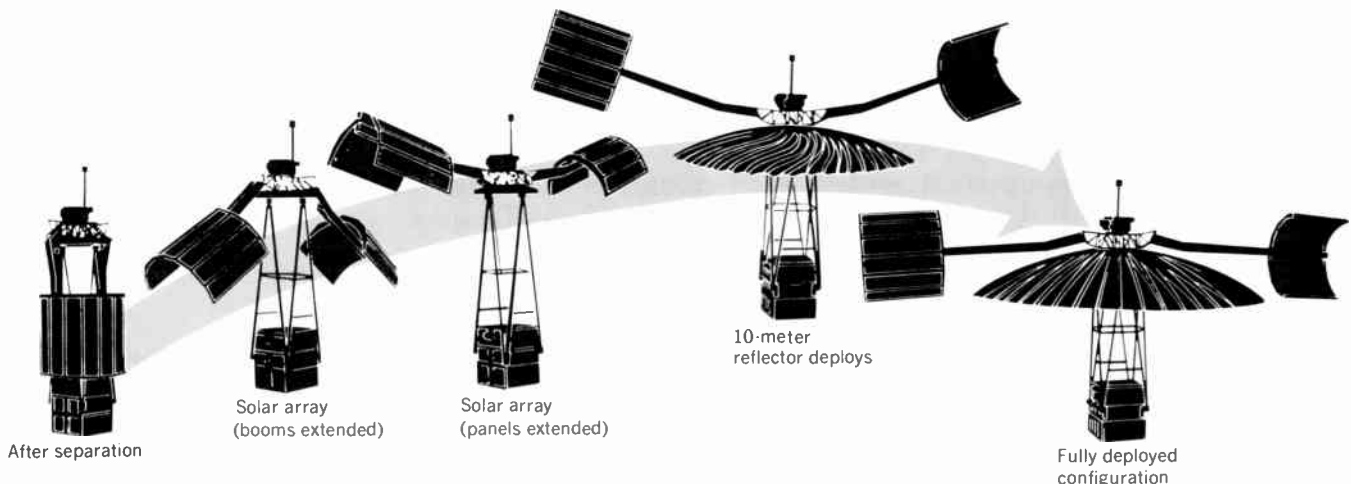

and RCA to provide interstate and intrastate television, voice, and data service in Alaska. Both Alaska and public broadcasting have joined the Consortium to assist in planned expansions of their systems.

But this is by no means the end of the story of PSSC's activities. The Consortium hopes to be able to influence the future direction of commercial satellite systems. In the *Second Report and Order* of the Federal Communications Commission, which authorized the establishment of commercial domestic satellite facilities in 1972, the potential of satellite technology for providing "a better means of serving certain of the existing markets and developing new markets not now being served" was recognized and encouraged.

To date, the domestic satellite carriers have not displayed a strong interest in the commercial possibilities of public service telecommunications. Consequently, the PSSC faces a series of difficult questions that must be answered in order to attract private investment.

What does the PSSC need?

The Consortium must decide: (1) What satellite configuration would be most compatible with the needs of the membership? (2) How might satellite carriers be induced to provide such capacity? (3) In the interim period when only experimental satellites or low-powered commercial satellites are available, what course of action is most appropriate for each individual member of the Consortium? And (4) what common needs of the membership are most appropriate for consideration by the group as a whole?

The Consortium is by no means limited to the sole use of communications satellites as a distribution mechanism. Even if the cost of satellite distribution continues to decline, it probably will be more economical to use a mixture of satellite and terrestrial facilities to reach highly clustered users for some time to come. The further development of Instructional Television Fixed Service (ITFS) and cable television probably will contribute more to the growth of new markets in urban areas than the introduction of inexpensive satellite earth stations. It is very much to the advantage of the Consortium to encourage the development of local subconsortia, no matter what satellites happen to be available. If public broadcasting proceeds to implement its present plan to create a nationwide distribution network using low-powered 4/6-GHz transponders, the Consortium will encourage maximum use of the system components for other public-service purposes.

To achieve the very high reliability required to meet the operational needs of users such as public broadcasting, satellite carriers have concluded that it is necessary to have in-orbit backup and a ground spare. The required initial capital investment for a three-satellite system, which is the standard of the industry, is of the order of \$70 to \$90 million. (The box at the right provides a costs breakdown for three body-stabilized satellites similar to versions developed by RCA for its domestic system and by General Electric for the Japanese Broadcast Satellite.)

A lease arrangement for satellite capacity from a common carrier is the most feasible means for the Consortium to pursue its operational objectives at the present time. Generally speaking, there are potential economies of scale in communication satellites—that

Satellite lease costs

The capital cost of a satellite system consisting of two in-orbit satellites, a ground spare, and insurance to cover the risk incurred from launch through in-orbit checkout is estimated to be \$89.4 million. For purposes of discussion, body-stabilized satellites similar to versions developed by General Electric and RCA are assumed. A nonrecurring charge of \$10 million is assumed to cover the modifications required by the Consortium for three higher-powered transponders on each spacecraft.

The cost breakdown is as follows:

Three satellites	\$36.0 M
Two launches (Thor-Delta 3914)	28.0 M
Hardware for possible third launch	9.0 M
Development cost	10.0 M
Subtotal	\$83.0 M
Insurance for two launches	6.4 M
Total	\$89.4 M

The authors have learned from private conversations with NASA headquarters that the launch cost of a Thor-Delta 3914 (\$14.0 million) is the sum of \$9.0 million to the supplier of the vehicle and \$5.0 million to NASA for launch services. The hardware for a third launch (but not launch services) must be purchased in advance in order to be able to react quickly in the event of catastrophe.

The cost of insurance is estimated to be 10 percent of the value of the in-orbit investment, exclusive of non-recurring costs. This rule-of-thumb is commonly used in the industry.

Annual revenue requirements are calculated on the basis of a return on capital investment of 21 percent over seven years. The required payback factor is 28.5 percent, leading to required annual revenue of \$25.5 million. To this total is added the estimated marginal cost of telemetry, command, and control, which is assumed to be \$2.0 million annually.

The annual tariff paid by the Consortium for six in-orbit transponders (three on each satellite) is assumed to be based on its relative utilization of satellite capacity. Sufficient power and weight are available to the communications subsystem on a General Electric satellite to use 17 20-watt transponders at the beginning of life and 12 20-watt transponders at the end of life. Spacecraft vendors typically place more transponders on a spacecraft than could be powered at the end of life, recognizing that some fraction of the transponders may eventually fail.

To determine the proportion of the satellite capacity consumed if the Consortium wished to use only three 20-watt transponders on each satellite, one would have to know precisely how the remaining capacity was utilized. For concreteness, the tariff paid by the Consortium will be calculated under the assumption that there are 14 identical 20-watt transponders on each spacecraft, or 28 transponders in orbit. Assume there is 50-percent utilization of the 22 transponders not used by the Consortium. Then the Consortium would utilize 35.3 percent of the satellite capacity subscribed for, and should pay the carrier \$9.71 million annually for satellite service.

Assume that the six transponders leased by the Consortium are utilized 40 percent of the time over the course of a year. Then the per-hour cost of transponder time would be approximately \$463. Assume that the Consortium applied a 20-percent margin to allow for possible underutilization of transponder time by the membership. Then the price to a member of one hour of transponder time would be approximately \$556.

B.B.L., J.G.P., and J.M.J

is, the more transponders on a satellite, the lower the per-transponder cost should be. The Consortium will be negotiating with common carriers to determine the feasibility of using a portion of the available capacity of a large-satellite system to provide higher-powered transponders to serve emerging markets that require lower-cost earth stations. If the satellite were large enough, sufficient capacity would remain to allow the carrier to serve established markets in the manner deemed most appropriate. Conceivably, both the Consortium and the common carrier could benefit financially from such an arrangement.

The ability of satellite manufacturers to accommodate a wide range of technical requirements on a single spacecraft has increased dramatically in the past five

years. For example, unsolicited proposals by five satellite manufacturers to the Iranian Government indicated an ability to supply a mix of transponder power levels from 5 watts to 100 watts at any of the available frequency bands. This new flexibility is due in part to the normal process of technological evolution and in part to a recent awareness by satellite vendors of the potential market for lower-cost earth stations.

Perhaps the most significant developments are the coming of age of body-stabilized satellites and the concomitant increase in payload of the economical Thor-Delta family of launch vehicles. Until recently, all commercial spacecraft used spin stabilization, a proven design in which the body of the satellite spins and the antenna system is despun. Body-stabilized designs (in which the satellite remains oriented toward the earth while one or more internal momentum wheels spin at high speed) are rapidly increasing in reliability and offer significant advantages, such as extendable solar arrays that can be oriented to the sun continuously for maximum electrical conversion of solar energy and a more flexible design that offers numerous capacity-to-weight tradeoffs. This is not to say that spinners are being excluded from consideration. A final decision on the satellite configuration should be based on a detailed understanding of user requirements, available capacity, cost, and system reliability.

Once the common requirements of the membership are understood, the Consortium will attempt to reach accord with a carrier prepared to invest in public-service telecommunications. A combination of improved technology, thoughtful experimentation by Consortium members that clarifies the desirability and cost-effectiveness of new applications of telecommunications, and better organization between member institutions will reduce the risks involved.

What will a future system cost?

Approximately how much will it cost the user to employ the eventual system, and what can he expect for his money? Answers to these questions can only be tentative at this early stage in the life of the Consortium. Much depends on related initiatives by the communications industry and the needs of the membership, which will continue to grow.

The Public Broadcasting Service, which has immediate service requirements, is planning to use low-powered transponders that operate at 4/6 GHz to network their video broadcasts to receiving stations having 10-meter antennas and gallium-arsenide field effect transistor (GaAs FET) receivers. The capital cost of such a station, uninstalled and equipped to receive one video channel, is approximately \$65 000, which is too costly for most PSSC members. To locate such stations at the point of use, PBS will have to demonstrate to the FCC that the facility will neither cause nor suffer from harmful interference. Because the 4-GHz band is already crowded, it is likely that a substantial percentage of the 170 stations contemplated will have to be installed in some "quiet" location far from the PBS studio. The cost of the terrestrial tail, when required, probably will substantially exceed the cost of the satellite receiver. (In addition to the cost of a microwave relay, the user generally must procure an appropriate site and then provide access, utilities, and an equipment shelter.)

PSSC's charter members

As of January 7, 1975, there were 45 members of the Public Service Satellite Consortium. Included on the membership roster are public service agencies, professional societies, universities, states, and a variety of subconsortiums located throughout the United States. Among the initial users of satellite communications systems will be the Public Broadcasting Service and National Public Radio, both in Washington, D.C., and the State of Alaska. PSSC members from academia include: Brigham Young University, Provo, Utah; Coast Community College District, Costa Mesa, Calif.; the Indiana University Medical Educational Resources Program, Indianapolis, Ind.; the Medical University of South Carolina, Charleston, S.C.; Miami-Dade Community College District, Miami, Fla.; San Diego State University, San Diego, Calif.; the Southern California Consortium for Community College Television, Downey, Calif.; Stanford University, Stanford, Calif.; the University of California at Berkeley, Calif.; the University of Hawaii, Honolulu, Hawaii; the University of Mid-America, Lincoln, Neb.; the University of Southern California, Los Angeles, Calif.; and the University of Wisconsin, Stevens Point, Wis.

Other members include: the Alabama ETV Commission, Birmingham, Ala.; the Aloha System Project, Honolulu, Hawaii; the American Academy of Orthopaedic Surgeons, Chicago, Ill.; the American College of Physicians, Philadelphia, Pa.; the American Library Association, Washington, D.C.; the Aspen Institute, Palo Alto, Calif.; the California Instructional Television Consortium, Rohnart Park, Calif.; the Catholic Television Network, San Francisco, Calif.; the Committee on Institutional Cooperation, Evanston, Ill.; Community Television of Southern California, Los Angeles Calif.; the Corporation for Public Broadcasting, Washington, D.C.; the Department of Education, San Diego, Calif.; the Federation of Rocky Mountain States, Denver, Colo.; the Indiana Higher Education Telecommunication System, Indianapolis, Ind.; the Joint Council on Educational Telecommunications, Washington, D.C.; and the Kansas Public Television Commission, Topeka, Kans.

The remaining members are: the Maryland Center for Public Broadcasting, Owings Mill, Md.; the Mississippi Authority for ETV, Jackson, Miss.; the Mountain States Health Corporation, Boise, Idaho; the National Education Association, Washington, D.C.; the North Dakota Educational Broadcast Council, Fargo, N. Dak.; the Public Interest Satellite Association, New York, N.Y.; the Rocky Mountain Corporation for Public Broadcasting, Albuquerque, N. Mex.; SALINET, Denver, Colo.; the South Carolina Educational Television Network, Columbia, S.C.; the Southern Educational Communications Association, Columbia, S.C.; the United Methodist Board of Discipleship, Nashville, Tenn.; the United States Catholic Conference, New York, N.Y.; and the Virginia Public Telecommunications Council, Richmond, Va.

If 20-watt transponders (rather than the present 5-watt transponders) were used at 2.5/14 GHz in conjunction with a satellite antenna complex designed to provide contiguous U.S. coverage with spot beams for Alaska, Hawaii, and Puerto Rico, the cost of a receiver station designed to meet the quality and reliability standards of PBS would drop from \$65 000 to approximately \$30 000 (PBS would require a 4.6-meter antenna and redundant GaAs FET receivers). Members of the Consortium who plan to use the receiving station to feed a closed-circuit distribution system require less performance. The capital cost for such users would be of the order of \$10 000. (These users could employ 3.6-meter antennas and nonredundant GaAs FET receivers.) The cost of installation, whether performed by the member or by an outside contractor, is estimated to be at least 50 percent of the capital cost of the station, and may be higher, depending on individual requirements. But related procurements worldwide for similar components could result in lower prices for Consortium members, despite inflation.

Commercial entities are now prohibited from using the down-link band extending from 2.5 GHz to 2.69 GHz and would prefer to have more bandwidth. The satellite band at 12/14 GHz is attractive to both commercial and noncommercial users. Unfortunately, preliminary indications are that receive-only stations for Consortium users will cost at least twice as much at 12 GHz due to the higher system margins required to cope with the severe rain attenuation at this frequency.

What would be the total cost to a Consortium member? Obviously, the answer depends on what services the member requires and how many members share the cost. As indicated in the box on p. 63, the price for an hour of transponder time for national distribution could be approximately \$556. This cost assumes that the Consortium transponders are used only 33 percent of the time. The Consortium tariff structure could be set to increase average use by offering lower rates during the off-peak hours. The capital cost of a receiving station, installed in a turnkey fashion, should be under \$20 000.

The station cost on an annualized basis, including interest and other recurring costs (exclusive of person-

nel), should be less than \$4000 per year, a figure which probably is within reach of Consortium members.

Down to earth

Distribution, however, is only one element of the telecommunications process. Programming, utilization, evaluation, and administration add substantially to the total cost. Most important, the increased use of telecommunications will require organizational adjustments in many cases. Hence, Consortium members intend to examine the implications of satellite distribution carefully before making firm commitments.

The favorable experience with the health and education experiments on the ATS-6 has demonstrated that satellites can provide a new range of services in the public interest. But the complexity of the technical, economic, and organizational tasks now facing the Consortium can hardly be overstated. John Witherpoon, the president of the Consortium, expressed his view of the challenges ahead at the first annual meeting in November 1975:

"It will not help much to depend on guesses or to rely on the fact that we are clearly on the side of the good, the true, and the beautiful. Success begins with a hard-nosed look at ourselves We're in a tough business, combining exotic and rapidly changing technology, difficult economic questions, and some regulatory and political issues that will challenge the statesmanship, technical expertise, and simple clout of all concerned." ♦

Bruce B. Lusignan (F) is the director of the Communication Satellite Planning Center at Stanford University, Stanford, Calif., and an associate professor of electrical engineering at the university. He has managed multidisciplinary research and system engineering courses for more than twelve years at Stanford. His research interests focus on the application of communications satellites to economic growth with special emphasis on technical system optimization and interaction between economic, business, and political factors. He also conducts policy research in applications of television in education, work, social values, and world energy resources. Dr. Lusignan received the B.S.E.E., M.S.E.E., and Ph.D. degrees, all at Stanford University.

James G. Potter (M) is director of planning and analysis at the Public Service Satellite Consortium. Prior to this assignment, he was associate director of engineering at the Federation of Rocky Mountain States in Denver, Colo., where he was responsible for the planning, implementation, and operation of a 4/6-GHz earth station used in the Satellite Technology Demonstration on NASA's ATS-6 satellite, and for the PSSC's engineering planning. Dr. Potter possesses an A.B. degree in physics from the University of Michigan in Ann Arbor and an M.S. and Ph.D. in EE from Stanford University.

James M. Janky (M) works at the Communication Satellite Planning Center at Stanford, where he concentrates on satellite systems design for Iran, Alaska, Indonesia, and for the Public Service Satellite Consortium. Formerly an assistant director of the Broadcast and Engineering Component in the Federation of Rocky Mountain States, where he was responsible for the communications equipment at remote sites, network control center system design, and hardware for the limited digital response system, Dr. Janky holds a B.E.E. from the University of Detroit, Detroit, Mich., and M.S.E.E. and Ph.D. degrees from Stanford University.

For further reading

To provide the reader with background information on various aspects of their article, the authors recommend three papers. For further information on optimization procedures for satellite systems planning, see: Mitchell, W. C., "The use of satellites in meeting the telecommunications needs of developing nations," Communications Satellite Planning Center, Stanford University, Technical Report No. 1, June 1975. For information on regulatory aspects of communications satellites, see: Russell, S. P., "Techno-economics of U.S. domestic satellite orbit-spectrum utilization," Communications Satellite Planning Center, Stanford University, Oct. 1975. And for a summary of all the experiments made on ATS-6, see: Whalen, A., *et al.*, "ATS-6 technical aspects of the Health/Education Telecommunications Experiment," *IEEE Trans. on Aerospace and Electronic Systems*, vol. AES-11, no. 6, Nov. 1975.

Satellites

Europe's 'NASA' gets off the ground

The new Paris-based European Space Agency has ten member countries, a \$500 million annual budget, and a wide range of future programs

Until May 31 of last year, European satellite and launcher activities were under the umbrellas of the European Space Research Organization (ESRO) and the European Organization for the Development and Construction of Space Vehicle Launchers (ELDO), respectively. On that date, these two agencies were integrated into a single new agency, the European Space Agency, or ESA. Its chartered purpose is "to provide for and to promote, for exclusively peaceful purposes, cooperation among European States in [scientific] space research and technology and their space applications . . ." ESA is also charged with the formulation and implementation of a long-term European space policy that would coordinate European space programs with national programs.

Outlined here are ESA's facilities and staff for fulfilling its charge as well as a discussion of its ongoing satellite programs.

People, places, and programs

Prior to the formation of ESA, both ESRO and ELDO had been active for more than ten years. As a result, ESA inherited facilities and ongoing satellite programs as well as a staff of trained and experienced personnel.

At ESA headquarters in Paris, approximately 250 persons are employed. At ESA's research and technology center (ESTEC) in the Netherlands at Noordwijk, an additional 900 employees work in project teams on administrative tasks and in extensive laboratories, workshops, and integration facilities. Another 250 people are employed at the space operations center (ESOC) in Darmstadt, Germany, and in ESA tracking stations at Redu, Belgium, and Fairbanks, Alaska. New ground stations are under construction near Madrid and in Germany, where most of the remaining employees are located. ESA also has a small establishment at Frascati, near Rome, which contains the Space Documentation Service. Through a network of terminals throughout Europe, the Frascati facility provides a computerized documentation and data recovery system.

Eight scientific satellites have thus far been launched successfully in the European program. The most recent (August 1975) was COS-B, a satellite for the study of cosmic rays. It carries a single payload serving as a remotely controlled astronomical laborato-

ry designed to study radiation emitted from known and assumed sources of gamma rays. The payload was assembled from experimental units supplied by six institutes in four European countries. The cylindrically shaped satellite weighs 278 kg, including the payload, and was launched by a Delta 2913 vehicle. Its eccentric orbit has an apogee of 98 000 km and a perigee of 2000 km. The period of orbit is 1.54 days, with a maximum eclipse of 1.6 hours. An operational life of two years is foreseen so that 24 targets can each be studied for about one month.

In the near future, a number of new satellites are to join COS-B in space. Four of ESA's planned launches are to be used in scientific satellite programs as opposed to application programs. One of these is the so-called GEOS program.

GEOS: launch, 1977

The GEOS satellite will be devoted to magnetospheric research. Its payload contains 16 electric- and magnetic-field sensors and 26 particle analyzers distributed over a total of seven scientific experiments. All field sensors and two of the particle detectors had to be displaced from the satellite and are mounted on booms extending outward from the satellite that vary in length between 1 and 20 meters.

With the GEOS payload, it will be possible to measure particle fluxes from the lowest energies (nearly 0 eV) up to the MeV range and to record electric and magnetic fields from dc up to 77 kHz. In particular, the mutual interaction between fields and particles will be studied. In this context, it is intended to inject waves into the plasma from an antenna (20 meters long) on the satellite and to look for the response in both particle and field domains. Final analysis of the data will be carried out in a cooperative effort between satellite experimenters and scientists from auroral observatories throughout the world.

Together with its apogee boost motor, the GEOS satellite weighs 560 kg. It is three-axis stabilized and is equipped with a hydrazine propulsion system for attitude control and to enable it to be shifted along its geostationary orbit to positions of major scientific interest.

GEOS will transmit data at various rates. In its fastest and normal mode, data will be transmitted at a rate 10 to 100 times faster than that of previous ESRO satellites (100 000 b/s). A special ground station is under construction at Darmstadt to process the data received. Some processing will be in real time. It is from the Darmstadt station that the satellite will be operated during its two-year lifetime.

Roy Gibson European Space Agency
Werner J. Kleen
Technical University of Munich

GEOS will have many "firsts." It will be the first purely scientific geostationary satellite. It will be the first European satellite with UHF S-band transmission. It will be the first European spacecraft with a hydrazine orbit and attitude propulsion system. It will be the first to be superclean in the magnetic, electric, and electromagnetic regimes. And it will play a major role in the International Magnetospheric Program.

IUE: launch, end of 1976

ESA is also participating in the International Ultraviolet Explorer (IUE) project with the U.S. National Aeronautics and Space Administration (NASA) and the British Scientific Research Council (BSRC). ESA's contribution comprises the deployable solar-cell array for the spacecraft and the design, construction, and operation of a ground station near Madrid for use by European astronomers. The available observing time will be shared by NASA, the BSRC, and ESA in the ratios 4:1:1.

ISEE: launch, autumn 1977

A third ESA project involves the International Sun Earth Explorer (ISEE), formerly known as the International Magnetospheric Explorer. This is a joint project of NASA and ESA and will use a three-spacecraft system to study magnetospheric problems. ESA is providing the satellite known as ISEE-B to be launched in tandem with NASA's ISEE-A.

EXOSAT: development, 1976

A fourth ESA scientific satellite is to be the European X-Ray Observatory Satellite (EXOSAT). Its scientific mission will be the measurement of the position, structural features, and spectral and temporal charac-

teristics of cosmic X-ray sources in the range from approximately 0.1 keV to 20 keV.

METEOSAT: operational, mid-1977

In addition to the scientific satellite programs just described, ESA plans a number of application satellites. For years, the European space program consisted entirely of scientific satellites and, even under ESA, the scientific program is mandatory for all member states. Today, however, ESA's budgeted allocation for scientific satellites is small in comparison with its expenditure on application satellites.

One of these application satellites is named METEOSAT. It is to carry out a program for the collection, processing, and dissemination of meteorological data by means of a geostationary satellite and associated ground facilities. Its principal mission objectives are:

1. Imaging of the earth's surface and cloud system simultaneously at visible and infrared wavelengths, every half hour, and transmission to earth of the raw data.
2. Dissemination of the processed data in suitable formats from the METEOSAT ground facilities via the satellite to the data users' stations.
3. Collection by the satellite and relay to the ground of data from drifting or fixed sea- or land-based sensor platforms (interrogated or self-timed) or from a polar orbiting satellite.

The METEOSAT system, which is Europe's contribution to the Global Atmospheric Research Program and to the World Weather Watch of the World Meteorological Organization, is designed to meet the requirements of European meteorologists. The system is expected to be operational by mid-1977, or at least in

Artist's concept of AEROSAT, which will be used in the implementation of a worldwide operational system of air traffic control in the mid-1980s.

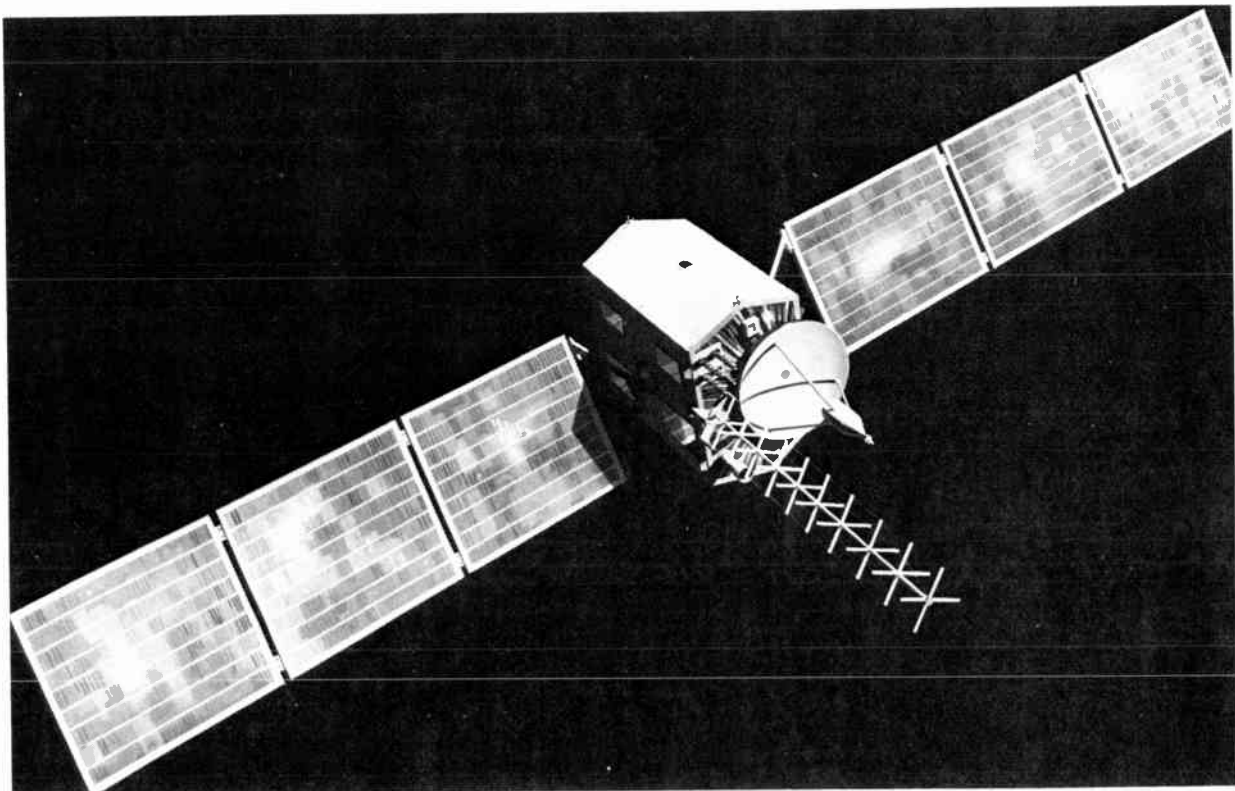

time for the First Global GARP Experiment (FGGE), presently scheduled for mid-1978 to mid-1979. In the framework of FGGE, METEOSAT will form part of a larger system of five geostationary meteorological satellites with compatible performance characteristics (two provided by the U.S. and one each provided by Europe, Japan, and the U.S.S.R.).

The weight of the METEOSAT satellite will be nearly 700 kg at launch including an ejectable apogee boost motor and launcher attachment fittings. The satellite is cylindrical (2.1 meters in diameter and 3.2

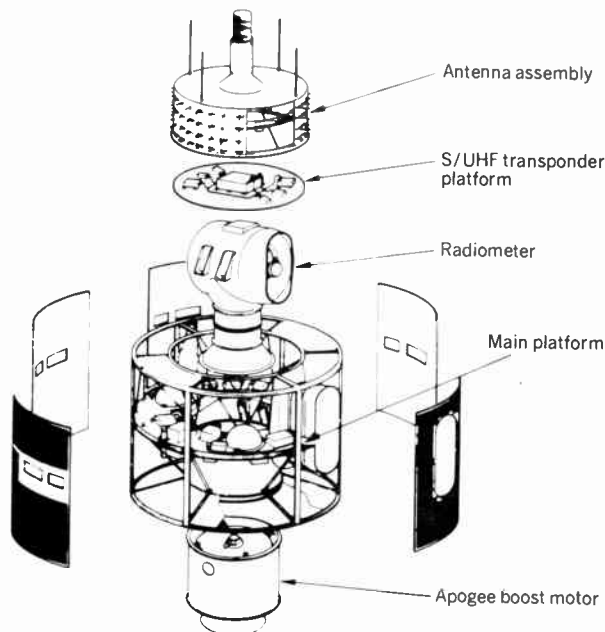

The METEOSAT is an applications satellite for the collection, processing, and dissemination of meteorological data. It is scheduled for launch in 1977.

Overall configuration for the manned space laboratory SPACELAB (A) and cross sections (B).

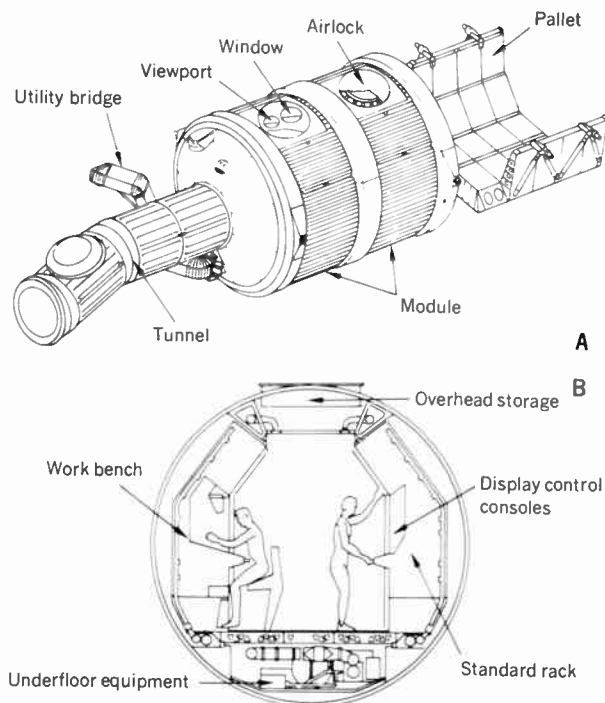

meters high) and is spin stabilized at 100 r/min. Planned lifetime is three years.

ECS/OTS: operational, 1980

The aim of the European Communication Satellites (ECS) program is to provide, by 1980, an operational satellite system designed to meet the needs of the member administrations of the Conférence Européenne des Postes et Télécommunications and of the European Broadcasting Union. The system will be capable of routing via space a large part of the continually increasing volume of intra-European telephone, telegraph, and telex traffic, and of relaying Eurovision programs (for which a satellite system offers certain technical and operational advantages).

Traffic forecasts show that the operational satellite system must be able to carry the equivalent of about 5000 telephone circuits in 1980, for traffic between points more than the economic minimum of 800 km apart, rising to about 20 000 telephone circuits in 1990. The basic European Broadcast Union requirement for TV channels is for the permanent allocation of two wide-band repeaters capable of transmitting high-quality television.

There will be at least one large earth station handling telephone traffic and TV transmission in each country requiring the services. A number of earth stations handling TV transmission exclusively are envisioned for countries such as in North Africa and the Middle East, requiring this service only.

The Orbital Test Satellite (OTS) in the ECS program is due to be launched in mid-1977. It will enable the future users of ECS to prepare for the operational phase. OTS is designed particularly to do the following:

1. Demonstrate the performance and the reliability in orbit of all on-board equipment—payload, spacecraft systems, and subsystems—by means of a configuration similar to that of the operational vehicle.
2. Fulfill, from an experimental communications system point of view, the objectives required by the ECS mission such as experiments on propagation, frequency reuse, transmission impairments, time division multiple access, etc.
3. Provide an experimental and preoperational traffic capacity of 2000 to 5000 telephone circuits and one or two TV channels.

OTS will operate at frequencies in the range from 11 to 14 GHz. It will give experimenters the possibility of testing, simultaneously, wide-band digital transmissions between large stations and narrow-band signals between small stations. Propagation measurements at up- and down-link frequencies will also be possible.

The OTS satellite will have six SHF telecommunication antennas—one Spotbeam, three Eurobeam "A," and two Eurobeam "B"—whose coverage will include not only the whole of Western Europe but also the Middle East, North Africa, the Azores, the Canary Islands, Madeira, and Iceland.

The modular concept of OTS with a service module providing all the support functions and a communications module carrying mainly the payload, enables the satellite to be adapted easily and economically to different missions. Various payloads can be carried without costly redesign to the service module. And the communications module can be adapted to carry alter-

native payloads without major redesign. Further flexibility is provided by the fact that the satellite structure is designed to accommodate a heavier weight than is needed for OTS and thus has significant growth capability for future requirements.

MAROTS: launch, end of 1977

The first example of using the OTS service module for a different mission without redesign is an ESA satellite for maritime communications. Called MAROTS, it is being built for launch toward the end of 1977. The nine European countries participating in this program among them own about 36 percent of the world's shipping tonnage. The characteristics of MAROTS will be in accordance with the guidelines of the Intergovernmental Maritime Consultative Organization.

AEROSAT: launch, 1979

The AEROSAT program will provide for system experimentation and evaluation preparatory to implementation in the mid-1980s of a worldwide operational system of air traffic control by satellite. It will enable the International Civil Aviation Organization to specify the functions and timing of an operational system. The program is being carried out within the framework of a memorandum of understanding signed by the U.S. Federal Aviation Administration, by the Government of Canada, and by ESA on behalf of nine of its member states.

The program is divided into two parts:

1. The Space Segment of the program includes the development, production, launching, and operation of the satellites. It is being undertaken jointly by ESA, Canada, and Comsat General. A joint space program office has already been set up to direct this segment. The three parties are contributing to this segment of the program in the ratios of 47, 6, and 47 percent, respectively. Invitations to tender for the satellite and control-facility contracts are due to be issued in early 1976. These contracts will be open to qualified industrial consortia on both sides of the Atlantic (see box on this page for those firms in the European industrial consortia).
2. The Coordinated Segment of the program includes the Aeronautical Satellite Communication Centers, the Aeronautical Services Earth Terminals, and the avionics. It is being undertaken separately by the parties to the memorandum of understanding.

The satellites will be launched into geostationary orbit, the first in November 1979 and the second a few months later. Both will be located initially over the Atlantic Ocean, separated by about 25 degrees in longitude. Their design lifetimes will be seven years.

Some effort will be spent on additional applications such as earth resources, geodesy, direct broadcasting, and specialized communications such as data transmission.

SPACELAB: launch, 1980

SPACELAB is Europe's contribution to NASA's advanced space transportation system or space shuttle. The SPACELAB concept involves two basic elements: a pressurized module and an unpressurized pallet. The former provides a shirt-sleeve environmental laboratory and the latter acts as an observing platform that permits direct exposure of instruments to space. ESA,

on behalf of the participating European countries, is responsible for the design, development, manufacture, and delivery of one flight unit to NASA. An engineering model, two sets of ground-support equipment, and initial spares are included in the delivery. Additionally, within the program, ESA will provide sustaining engineering through the first two SPACELABs and the associated integration activities.

As an integral part of the space shuttle system, SPACELAB is a reusable spacecraft that is carried to and from orbit in the cargo bay of the orbiter and remains there throughout the flight. The duration of such flights is nominally fixed at seven days, though extensions up to 30 days are envisioned. The SPACELAB/orbiter combination will perform as a short-stay space station with a crew, or payload specialists, of up to four persons working in SPACELAB and spending their off-duty time in the orbiter. SPACELAB's dimensions cannot exceed those of the orbiter's cargo bay (18.3 meters long and 4.5 meters in diameter). The all-up weight of SPACELAB and payload may not exceed the permissible landing weight of 14 500 kg. The intention is, depending on the configuration flown, that between 5500 and 9000 kg of this total will be accounted for by users' experimental equipment.

One of the main objectives of SPACELAB is to provide the facilities that will enable experimenters to conduct their orbital experiments *in situ*. Considerable mission flexibility is ensured by the modular design approach adopted.

The experimenters who will make use of SPACELAB will be drawn from three main fields. There will be those whose interest lies in the disciplines of pure science: the astronomers, astrophysicists, and earth scientists. Others will be active in the applied sciences, such as telecommunications, meteorology, and medicine. Still others will take advantage of the unique opportunities offered by the zero-*g* environment where absolute vacuum is permanently "on tap" to develop new methods of processing and manufacture.

ARIANE launcher: 1979 and 1980

So far, all ESRO-ESA satellites have been launched by U.S. launch vehicles either as part of a cooperative program with NASA or against payment. In the ministerial discussions leading to the formation of ESA, it was agreed that the development of a European heavy launcher was necessary in order to complete ESA's in-

European industrial consortia

There are three permanent European industrial consortia: COSMOS, MESH, and STAR. COSMOS consists of ETCA (Belgium), GEC-Marconi (UK), MBB (Germany), SAT (France), Selenia (Italy), Siemens (Germany), and SNIAS (France). MESH consists of Aeritalia (Italy), ERNO (Germany), Fokker VFW (Netherlands), HSD (UK), Matra (France), and SAAB-Scania (Sweden). STAR consists of AEG Telefunken (Germany), BAC (UK), CGE-Fiar (Italy), Contraves (Switzerland), Dornier (Germany), L.M. Ericsson (Sweden), Montedel (Italy), SABCA (Belgium), and Thomson-CSF (France). CIFAS, a temporary consortium, consists of AEG-Telefunken (Germany), MBB (Germany), SAT (France), SNIAS (France), and Thomson-CSF (France).

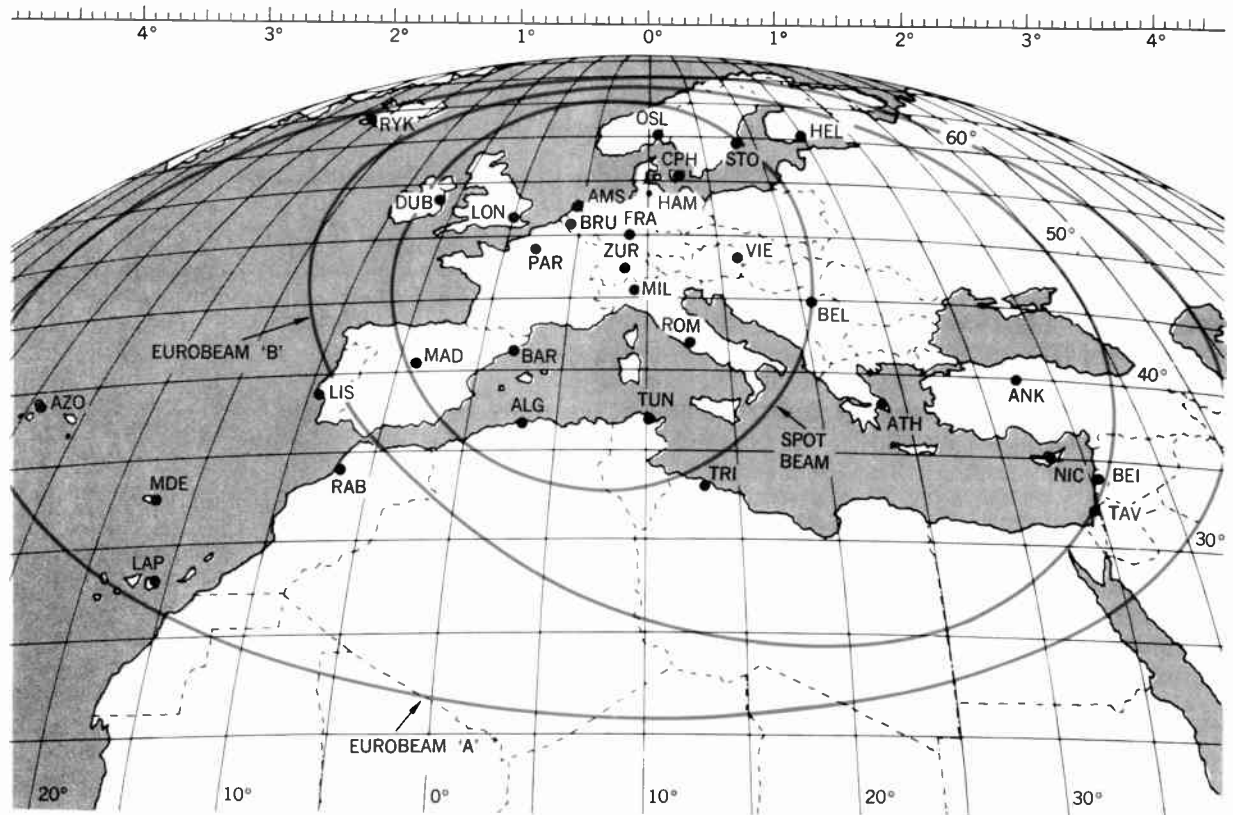

The Orbital Test Satellite will have six SHF telecommunication antennas whose coverage will include not only the whole of Western Europe but also the Middle East, North Africa, the Azores, the Canary Islands, Madeira, and Iceland.

ventory. Therefore, the French Ariane launcher program was Europeanized and entrusted to ESA.

Ariane is designed to place satellites of about 800 kg in geostationary orbit—i.e., 1500 kg including apogee boost motor in transfer orbit—in the 1980s. Ariane is a three-stage vehicle, 47.6 meters high and weighing 202 tonnes at lift-off. It will be launched from the French Guiana Space Center at Kourou. Four qualification launches are scheduled for 1979 and 1980.

Basic technology program

ESA has a program of basic technology as part of its obligatory program funded by all member states. But expenditure in this field is limited. In the future, the objective will be to ensure that this program is sensibly integrated with national technology programs.

Finances and the future

In 1975, ESA member states voted the equivalent of about 350 million U.S. dollars for the agency's programs. In 1976, this funding must increase to over \$500 million simply by reason of the normal progress of the approved programs. The \$500 million is likely to be a maximum for some time, although the amount must be updated annually to take account of inflation.

About two thirds of the budget is devoted to optional programs and one third to the obligatory program comprising scientific and basic activities. The percentage contributions of individual member states to the obligatory program in 1976 are: Belgium, 3.89; Denmark, 2.26; France, 21.20; Germany, 25.25; Italy, 13.23; Netherlands, 5.24; Spain, 4.44; Sweden, 4.46; Switzerland, 3.56; and United Kingdom, 16.47.

The 1980s will mark not only Europe's first manned space activities—in the reusable SPACELAB—and the availability of a European heavy launcher, but also Europe's ability to offer for the first time, in highly competitive markets such as telecommunications, operational applications satellite systems. What the role of ESA should be in assisting European industry to win such contracts in nonmember states has still to be determined. What is not in question is that it is largely thanks to a cooperative European effort, now represented by ESA, that Europe has an advanced space industry well able to compete in the field of commercial space applications. The new ESA hardware under development and due to be launched between now and 1980 will increase still further Europe's technological skills and experience. ♦

Roy Gibson became director general of ESA in April 1975. He was formerly acting director general, ESRO, and director of administration, ESRO. Earlier in his career, he was head of administration and later deputy director of ESTEC in Noordwijk, Holland, and, from 1958 through 1967, was with the United Kingdom Atomic Energy Authority.

Werner J. Kleen (F), Dr.phil.nat and Dr.habil of the University of Heidelberg, worked from 1932 until 1974 at Telefunken, Berlin; CSF, Paris; Institute National de Electronica, Madrid; and Siemens AG, Munich. His work has been mainly in the area of electron tubes and physical research. From 1968 until 1971, he was director of ESTEC in Noordwijk. An honorary professor at the Technical University of Munich, Dr. Kleen is a member of *Spectrum's* editorial board.

Industry applications

Electronics prints this magazine

SPECTRUM exploits computers, photographic processing, and electronic equipment to produce each month's copy

From the technical expert's mind to the pages of *IEEE Spectrum*, the information we publish moves through a complex sequence of transformations, most of which are guided and carried out by the members of our editorial staff. However, once an edited and reviewed manuscript has found its way to the printer, computers and electronic equipment take on the central role of converting it into typeset columns and pages.

Processing steps from marked *Spectrum* manuscripts to finished typeset pages are diagrammed on the next three pages. The equipment for implementing these steps, typical of state-of-the-art systems now used for magazine composition, is owned and operated by the Mack Printing Company, Easton, Pa.

Until a few years ago, copies of *Spectrum* were produced using metal-cast "monotype," which was mounted on letterpress equipment to print the magazine. By the mid-1960s, *Spectrum's* printer had installed phototypesetting equipment that spewed out photographic prints of typeset text. The present-day system is a computer-based implementation of this phototypesetting approach.

Motivating the shift from monotype to phototypesetting was the lure of lower composition costs. In comparison with a monotype casting machine that could set two lines of type per minute, a single APS-4 phototypesetter produces 500-600 lines per minute. Although the cost of installing a phototypesetting machine is high (purchase price of an APS-4 is about \$150 000), its output equals that of hundreds of monotype casting machines—and this is the basic capability that accounts for its acceptance. We can think of all of the other equipment and procedures shown on the following pages as devoted to the care and feeding of the phototypesetter.

The phototypesetter needs input data and control instructions, in digital form, recorded on magnetic tapes. The computer that produces these tapes records on them exactly which text words are to be included in each phototypeset printed line, and specifies exactly how words are to be hyphenated when they must run over to the next line. Because of the complexities of correctly spacing (justifying) and hyphenating words to make up equal-length lines of type, a large computer—Mack Printing uses a 2050A Honeywell computer—is called upon to perform these tasks.

In order to convert a typewritten manuscript into appropriate input to the system, it must be put into computer-readable form. An optical character reader

(OCR) performs most of this conversion task by scanning typewritten pages at its input and outputting digital code for storage on magnetic disks. In the Mack Printing system, a Honeywell 1602 real-time minicomputer system operates four Honeywell 4720 series disk storage units, each capable of storing about 12 million print characters, and the OCR is a Compuscan 170 machine.

Since OCR performance depends on cleanly typed material and the use of a special typewriter character-set, *Spectrum's* typed manuscripts are retyped when they reach the printer. A CRT editing terminal, the Hendrix 5200, is used to correct any errors that may have been introduced during input processing. When the Hendrix operator releases the input material, it is recorded on a magnetic tape and taken to the 2050A computer. After processing here, a magnetic drive-tape is taken to the APS-4 phototypesetter where typeset galleys are produced. Xerox copies of these galleys are returned to *Spectrum's* offices, where the editorial staff reads and corrects them as necessary.

At about the same time that an edited *Spectrum* manuscript arrives at the printer for input typing, finished drawings, photographs, and other "artwork" pertaining to that manuscript are also sent to the printer to be photographed. The sizes of these photographs are specified at *Spectrum*, so that, with the galley text, they can be pasted together to form the pages of the magazine. Proofs of these photographs, at the specified sizes, are then returned to *Spectrum*.

With these artwork proofs and the corrected galley copies in hand, *Spectrum's* Production Manager, Ruth Edmiston, pastes up a dummy layout that shows the printer exactly how all the text and art elements should come together to form completed pages.

When this material arrives at the printer, the Hendrix terminal operator inserts all galley text changes into the disk-stored galley data. New, corrected phototypeset galley proofs are then produced, and the printer's pasteup department prepares complete pages, using *Spectrum's* dummy layouts as guides. Xerox copies of these completed pages are then sent to *Spectrum* for release. If necessary, further changes are then made in the pasteup, by cutting out and moving paragraphs.

When given an editorial release, the completed pasteup is photographed and large lithographic plates with as many as 16 pages on each plate are prepared for the printing press. To check for correct use of color and any other last-minute problems, the printer supplies full-color copies of these plates for final *Spectrum* editorial approval. Then the presses roll.

Howard Falk Managing Editor

H1
B1

Why has EFI been a slow starter?

In 1974, you could not purchase a U.S.-manufactured automobile on which EFI was standard equipment. In 1975, you could get EFI as standard equipment on the Cadillac Seville and on the limited-edition Chevrolet Cosworth Vega, ^{and} for '60, you could get EFI as an option on a few other Cadillac models. ^{and} Yet, in 1975, ^{as had been the case for many years prior to 1975, in} EFI was standard on many automobiles ^{as well as} built in Europe ^{and} on some built in Japan.

Why have U.S. automobile manufacturers been less receptive to EFI than their counterparts in other countries? The answer to this question lies not only in the automobile manufacturers' decisions as to how they want to spend their money but also in whether or

CENTER FIRST CHARACTER ON THIS LINE
1 !why has EFI been a slow starter?/w
2 !///In 1974, you could not purchase a U.S.-manufactured
3 EFI was standard equipment. In 1975, you could get EFI - sti
4 the Cadillac Seville and on the limited-edition Chevro. os
5 \$600, as an option on a few other Cadillac models. Yet, in 19
6 years prior to that—EFI was standard on many automobiles pro
7 as on some built in Japan.
8 Why have U.S. automobile manufacturers been less recep
9 counterparts in other countries? The answer to this question
10 manufacturers' decisions as to how they want to spend their m



Input documents. At the printer, the manuscript is retyped—standard Olivetti typewriters are used, but they are equipped with characters shaped so they can be accurately “read” by automatic equipment. Corrections to the retyped manuscripts are made on-the-spot by added typing. One, two, or three squares (indicating that the preceding character, word, or line is in error) are followed by the correct information. Here, the single square corrects a misplaced *h*. After proof-reading, corrections are typed between the lines and bracketed by triangles.

Edited manuscripts. *Spectrum* manuscript marked with typeface specifications is sent to the printer. Here H1 is a “macro” code that instructs the phototypesetter to set 12-point Helvetica medium characters. B1 is a similar code calling for 9-point Century characters set in lines 18½ picas wide.

IEEE Spectrum's flow chart

Here are the main stages in the process that transforms Spectrum manuscripts into printed copy

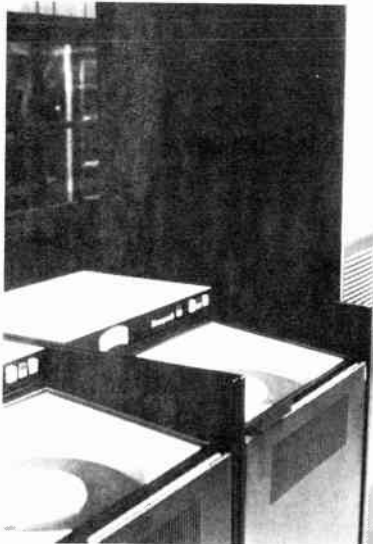

Minicomputer and disk storage. The Honeywell 316 minicomputer routes data from the OCR. The data are stored on Honeywell 4720-series disks, there to await further processing.



CRT editing terminal. Using the Hendrix 5200 terminal, a skilled operator inserts corrections into the stored data. Complex specifications covering type style (font), size, and spacing (leading, measure) are given as simple “macro” codes. For each such code, the 2050A computer produces specifications for driving the phototypesetter.

Now—an amazing new journal with a circulation of **ONE.**

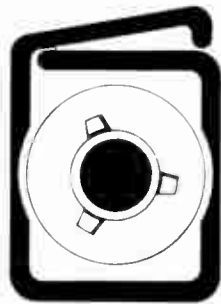

And that ONE is you.

It's called the ANNALS OF THE IEEE.

But please don't let the title mislead you, because the ANNALS introduces a very exciting innovation in technical journal publishing.

Technically, the ANNALS is a modified *Selective Dissemination of Information (SDI)* service. In actuality, however, it functions as a journal—but a journal with a BIG difference.

Based on the wide-ranging contents of the IEEE's 36 technical periodicals, the ANNALS permits you to . . .

... pick and choose and order (in advance or after original publication) only those theoretical and/or applications papers of

direct interest to you, no matter in which IEEE periodical they appear.

And these are full-size reprints—not microforms—of the complete papers, including all illustrations.

Just think of the real benefits that an ANNALS subscription offers . . .

- *You receive only papers on subjects that really interest you.
- *You greatly reduce the possibility of missing an IEEE paper that is important to you.
- *You save costly time spent in searching periodicals.
- *You save valuable space needed to store full issues of periodicals that might contain only one or two items you plan to read "some day."

Considering the great number of subject-interest terms from which ANNALS subscribers may choose, we think you'll agree with the headline above. In all probability, there will be no two subscribers receiving exactly the same "journal" each month.

Subscriptions to ANNALS OF THE IEEE are available only to IEEE members at this time. If you are an IEEE member and would like to know more about the ANNALS, simply fill out the coupon below, enclose in an envelope, and mail it to the IEEE. A packet of informative literature, including a Tentative Reader Interest Profile, will be sent to you immediately.



THE INSTITUTE OF
ELECTRICAL AND
ELECTRONICS
ENGINEERS, INC.

Mail entire coupon to:

IEEE Service Center
Annals of the IEEE
445 Hoes Lane
Piscataway, N.J. 08854



Please type or print all information requested.

IEEE Member No. _____

IEEE periodicals besides Spectrum being received regularly _____

Primary job function, eg., teaching, R&D, management, etc. _____

Principal professional area of interest, e.g., aerospace, power, etc. _____

SHIPPING LABEL—please type or print. AN-A

Name	Address	City	State/Country	Zip

Transportation

Transpo head speaks out

The new Secretary of Transportation addresses major issues affecting U.S. surface and air mobility

Last January, President Ford nominated William T. Coleman, a prominent Philadelphia attorney, to be the fourth Secretary of Transportation since the establishment of the Department of Transportation (DOT) in 1967—and the second Black ever to hold Cabinet rank in U.S. history.

Mr. Coleman's career in government started with his appointment as law clerk to the late U.S. Supreme Court Associate Justice Felix Frankfurter. In Pennsylvania, he served as special counsel, specializing in labor relations, for the Southwestern Pennsylvania Transportation Authority (SEPTA). He is a former director of Pan American Airways, Inc., and has held similar posts in major industrial firms.

Mr. Coleman was graduated from Harvard Law School at the top of his class. A former classmate and close personal friend, Secretary of Commerce-designate Elliott L. Richardson, recalls those days with the comment: "Brother, he was sharp!" *Spectrum* shared that impression after interviewing the Secretary in his vast office at the new Transportation Department headquarters near l'Enfant Plaza. Despite the impressive surroundings, Mr. Coleman took an 80-percent "cut" in salary when he left his position as senior partner of a prominent Philadelphia law firm. He accepted the Cabinet post because "we live in troubled times, and I feel the people who believe in the business system should be in Washington working on it."

As *Spectrum* readers may recall, last July's issue contained an in-depth interview with a fellow Pennsylvanian, Governor Milton J. Shapp (pp. 60-64), on wide-ranging issues concerning ground transportation. Governor Shapp portrayed the U.S. mainline, suburban commuter, and urban mass-transit systems as in a sorry state. He further decried the lack of progress in rail electrification in the U.S. Our interview with the "top man" of DOT confirms the bleakness of the U.S. rail landscape. Secretary Coleman was most gracious in his acceptance of *Spectrum's* request for an interview and accorded us a generous amount of time in his crowded daily schedule for a free-wheeling "Q and A" format that pursued a broad scope of issues.

Of subsidies and loan guarantees

***Spectrum:* Mr. Secretary, I have heard you feel that railroads should receive Federal subsidies to improve their equipment and you're asking for Federal taxes that would make railroads more competitive with waterways and barge transport. What would be the mechanics for implementing this scheme?**

Coleman: I have never said that the railroads should get Federal subsidies, if by that you mean a gift of Federal monies. We have proposed, with respect to ConRail [the Eastern railway consolidation scheme], that the Federal government should lend \$1 billion to ConRail and should also invest, by way of equity, up to an additional \$1.1 billion. Furthermore, we proposed in the Rail Revitalization Act that there should be loan guarantees available to railroads for rehabilitation purposes.

I feel that when you're dealing with freight movements—and that's basically the type of railroad operation we're talking about—they should be handled by the private sector, and this should not be accomplished by outright gifts of Federal monies. In other words, the people should make the investment; but they'll be repaid their capital investment, plus interest.

With respect to water barges, they *do* compete with the railroads in carrying bulk goods such as shipments of grain. The Federal government spends between \$500 and \$800 million annually in developing, repairing, and maintaining the waterways. The barges have the right to use the waterways, but they pay nothing whatever for the maintenance of these facilities. Therefore, I think that since they compete with the railroads and thus divert some of the rail business, it's only fair that they pay a user charge the same way the public pays a fee when it uses the highways, pays a gasoline tax, or pays a toll to cross a bridge. I don't think it's right for people who are making money in the private sector to get a "free ride" if they are using Government facilities.

***Spectrum:* Your mention of ConRail is interesting. A few months ago, I interviewed Governor Shapp and he took a rather dim view of the ConRail scheme. He said: "Here we have five or six railways in the Northeast and in the Midwest that are bankrupt," and this proposal to merge these railways into one superentity would be a very unwieldy and unworkable scheme. What are your views on that subject?**

Coleman: I've always had great respect for Governor Shapp; I've known him for a long time, and I know he's done a lot of thinking about these railroad problems. On the other hand, we were faced with a situation where Congress hesitated to reorganize—and there should be reorganization to ensure that there is a proper degree of competition. In the USRA [United States Railway Association], the proposal is that ConRail will be the principal railroad in the region; however, something like 3200 km (2000 mi) of existing track will be sold off to the Chessie [Chesapeake & Ohio], which means there will be competition to ConRail. And, indeed, there is a further provision in the plan in which

Gordon D. Friedlander Senior Editor

the Norfolk & Western—if it wants to buy in—would also get the right to enter the service territory. Therefore, you will have this necessary competition.

Actually, our calculations show that, if there is less competition, ConRail would tend to make more money. So the public, Congress, and USRA are willing to give up some of the money that could otherwise be made, in favor of competition. I think that the USRA plan is an important one and needs to be given an opportunity to succeed.

Spectrum: Recently, I saw an appraisal of why U.S. railways are in such poor shape vis-à-vis the European railroads. Following World War II—although many European systems were almost completely demolished during that conflict—these rail lines were rebuilt and rehabilitated very quickly. Most people overseas couldn't afford the luxury of private automobiles, so they had to use the railroads as a viable means of transportation mobility. As we didn't have that problem in the U.S., we concentrated on the private automobile to the disadvantage of the railroads. Do you agree that this is a fair appraisal?

Coleman: Yes. After the second World War—and perhaps even before in the first instance—two significant events occurred. By 1940, U.S. railroads probably made the decision that they should get out of the passenger-carrying business; thus they instituted policies that would discourage passenger use of trains. And, wherever possible, they would cite passenger revenue losses as reasons for abandoning the service. From 1945 on, the railroads permitted the equipment and rolling stock to dilapidate; they let roadbed maintenance deteriorate. And, at the same time—certainly by 1956—when the interstate highway program began, Federal dollars were redirected toward highway construction, which, in turn, had the effect of making the trucking industry much more efficient and permitted trucks to compete with the railroads in such a way that they took over a large portion of railway business. Also, as we mentioned earlier, the water barges drained away a good chunk of rail freight revenues. So, I would say that, today, the railroads carry not more than 30 percent of the freight that they are potentially capable of carrying.

Spectrum: If I heard you correctly, you said you did not favor direct subsidies to the railroads, yet you seem, by implication, to favor subsidies to interstate highways and to the trucking industries. Why wouldn't you support a direct Government subsidy to railroads as is done overseas?

Coleman: I don't favor a subsidy to trucks; I was describing what happened. We presently have an ongoing study as to whether the big trucks are paying their fair

share of the upkeep of the highways. A study made five years ago indicated that they were not and we are trying to update that study. If the present analysis shows what I think it will—mainly that the big trucks are not paying their fair share—then there should be an additional diesel fuel tax levied on them.

My feeling on subsidies is that no private company should be given an outright subsidy unless there are other public policies that you are trying to promote. For example, when you are dealing with intracity buses, then you might grant a subsidy because (1) you tend to be dealing more with the movement of poor people within the city, and (2) you want to have an active policy that will discourage the middle-class person from driving his car into town. He will opt for coming in by bus.

Since that is the travel mode by which you want them to come into the city, you may have to peg the fare lower than what it would normally be. Therefore, you recognize there is a public purpose and need for

which the subsidy will pay the difference. But when you're dealing with freight, I just don't think a subsidy is justified. For example, I do not think it would be fair that, when somebody wants to buy an automobile, part of the cost of shipping that car from Detroit to Philadelphia should be paid by the general public. I think that the freight charges should be sufficient to cover the cost of that shipment.

Spectrum: Do you find any inconsistency in your philosophy with the fact that the Government did bail out the Lockheed Corporation and Penn Central?

Coleman: That's true, but I think it's time to reexamine the public policy. Lockheed was a different situation, because there you were dealing with a question of national defense. Although I'm not familiar with all of the details, I understand that a good case was made at the time as to why Lockheed, which is so heavily involved in military work, should be given a guarantee. The grant wasn't a subsidy—what the Government did was to guarantee a loan. And my understanding is that the loan, so far, has been paid on time and the Government hasn't lost any money.

Metroliners and the "Northeast Corridor"

Spectrum: Some of the critics of our so-called "advanced passenger trains," such as the Metroliners, say that we have "tomorrow's trains running on yesterday's tracks." I came down on the Metroliner this morning and, over some stretches, I think one needs a seat belt for safety; the roadbed is that bad. Also, the Metroliners' schedules, I think, are noticeably slipping.



William T. Coleman

The ConRail challenge

ConRail, the Eastern railway consolidation scheme, became an organizational fact of life last November because Congress failed to reject a plan submitted in September by the United States Railway Association (USRA). The ConRail scheme creates a 17-state Federally financed rail system to consolidate seven bankrupt rail systems—including the huge Penn Central combo.

Now, however, Congress is confronted with passing an implementation bill to grant ConRail a \$2.5 billion "startup" fund, called for in the USRA report. That's where the crunch may start . . .

With ConRail targeted to start its operations by the end of this month, some fast legislative action is imperative, because the Senate must pass on the funding action. Similar movement in the House may even be lagging behind that in the upper chamber.

Meanwhile, creditors of the bankrupt systems are claiming that the railroads' assets are grossly undervalued, thereby heralding lengthy litigations. Furthermore, Pennsylvania and New Jersey have fears for commuter-line survival. And the First National City Bank claims it foresees far greater than anticipated ConRail expenses. Also, the opposition of the truck and highway lobbies is an unknown factor at this time.

Finally, USRA is asking for amendments to the House bill for additional money to repair dilapidated tracks and roadbeds so that trains can be operated at speeds that will make them competitive with other modes of transportation.

Coleman: I agree. We are presently considering a program in which we want to upgrade the roadbeds in the Northeast and to put additional trains into service. We are thinking seriously of recommending—first to the President, and then to Congress—a proposal by which we would improve the tracks so that we could have trains running at 120 mi/h (200 km/h) between Boston and Washington. If that is to be done, we are talking about spending \$2 billion. But we want to implement this program in such a way that we can eventually upgrade the tracks to permit trains to run at maximum speeds of 150 mi/h (240 km/h). If we do that, we are talking about the expenditure of another \$3.5 billion.

***Spectrum:* Concerning the Northeast Corridor project, I've heard over the years that we would eventually have trains that would cover the Boston–New York–Washington run on schedules that would be roughly competitive with air travel. Yet nothing, to my knowledge, has been done to implement this scheme other than the Metroliner service—which still takes three hours for the run between New York and Washington.**

Coleman: And that is true, but that's just what I'm talking about—that we are thinking about the other leg, New York–Boston, to close the gap. My ex-partner in law, Richardson Dilworth [a former mayor of Philadelphia] is the chairman of that study group, so I am fairly familiar with the proposal. As I understand it, in the early 1960s, this high-speed service could have been achieved for something less than \$1 billion. But under President Kennedy, that item was knocked out of the budget appropriations because he felt that we should not spend that much. Mr. Kennedy had other priorities and so, as in the case of many individual

projects, you have to consider the overall national needs and commitment priorities.

Coleman on urban mass transit

***Spectrum:* How much money will the Federal government request, over the next five years, for urban mass transit systems?**

Coleman: We've already asked for \$11.8 billion, which is for a six-year program. I don't think we will increase that figure. However, bear in mind that, under the provisions of the 1973 Highway Bill, the Government has the prerogative to determine which highway should or should not be built; that money could be transferred for mass transportation. Further, it's my understanding that there is between \$8 and \$12 billion allocated to highways in places where the highways will never be built. Thus, all of that money could be available for urban mass transportation.

***Spectrum:* Well, let me ask you this, Mr. Coleman: the cost of intracity systems is escalating so wildly—for example, the initial estimate for the Washington Metro, I believe, was \$3 billion at the outset; now it's up to \$4.5 billion . . .**

Coleman: It started at \$1.5 billion and now it's up to about \$4.5 billion . . .

***Spectrum:* Yes, and it will probably be \$6 billion by the time of completion . . .**

Coleman: I hope not, if we can keep it down!

***Spectrum:* And it's projected, or estimated, that such a system for Los Angeles, in itself, would cost \$12 billion. So aren't we talking about relatively small appropriations, nationwide, considering the tremendous job that would have to be done?**

Coleman: Yes, there is a tremendous job that must be done; but I feel that there is a limited amount of money available. Furthermore, we want to make it

“The people who believe in the business system should be in Washington working on it.”

clear that certain communities will have to solve their transportation problems by means other than subways and rapid-transit systems, so I would say that Los Angeles should develop an alternative rapid-transit system independently. We'll be able to do that in this country if we can get the local communities and governments to face up to these problems in instances where some of the money now being spent on highways should be transferred to other modes.

I feel that, as of now, \$11.8 billion is a substantial amount of money. Remember, we have to come to grips with inflationary cost escalation. In this context, I have issued a policy statement that when we make a grant, *that is to be the limit of our obligation*. If indicators signal cost overruns on a project, then the local communities involved will have to make up the difference in funding.

I decided on this course because, when I came into this office, I was disturbed by a lot of these plans in which there was a built-in automatic cost-escalation clause. It seems logical to me that if I were a highway

“Certain communities will have to solve their transportation problems by means other than subways . . .”

builder, or I was constructing a subway, and if I knew that there was a provision in these grants that the Government would escalate the sum of money by 10 percent annually, I would obviously not be interested in keeping the cost down. Therefore, I have tried to develop guidelines saying that if you come in and tell me what your true estimate is, we will give you 80 percent of that; but if it costs more, then you're going to have to put up the money yourself.

Railways vs. highways

Spectrum: Getting back once again to mainline railways, I notice on the Amtrak route map of the U.S. that there are “blind spots”—and very significant ones. For example, there is no Amtrak passenger service, except for the Montreal run into Vermont, north of Boston. New Hampshire and Maine are just out of the picture; there are no rail passenger services whatever. Also, some major cities are completely bypassed. Are there any plans to reestablish passenger service in upper New England, and other “bypasses” on the Amtrak map?

Coleman: We have the Amtrak bill and, as we indicated, over the next four years, Amtrak will have \$1 billion for new capital equipment; also, we would underwrite Amtrak's losses up to \$450 million per year. But obviously highways must be transporting people; the Federal government has spent in excess of \$58 billion—and the states have spent ten times that much—since 1956 on building these highways. So we must admit that in some places highways are taking the place of the train.

The intercity bus is a very efficient mode of moving people. Thus I'd like to see the problem solved by having high-speed trains between Washington and Boston, and then build a terminal at Boston so that passengers could walk across a platform and board a bus line that would serve upper New England.

You have to realize that on the Metroliner, under Amtrak, the Government has subsidized about 60 percent of that service—and you pay a fair amount of money for that ride as a taxpayer. I don't think it's good policy to be spending that kind of money throughout the U.S. Every time somebody gets on a train, for all intents and purposes, the Government pays at least 50 percent for that ride.

Coleman on air carriers

Spectrum: Could I turn to air-carrier transportation, Mr. Secretary? For some time now, Pan Am has been complaining rather bitterly that it is at a considerable competitive disadvantage because it has no domestic routes—with the exception of the New York–San Francisco run, which will only carry passengers who are bound for overseas des-

tinations. Do you think Pan Am is justified in its desire to have domestic routes, and should they be granted?

Coleman: As you know, at one time, I was on the Pan Am board, so I used to make this argument a lot. I guess when I say “yes, they're justified,” you have to weight the bias in my judgment. But aside from that, we are now trying to get a determination made as to just how the international air-carrier business should be handled; that is to say, whether we should have one or two major airlines like Pan Am and TWA (which basically are the U.S. carriers doing the bulk of the international business) with fewer domestic routes, or whether we should give Pan Am some domestic routes and, at the same time, give some domestic carriers a share of the international routes.

If I had to come down with the decision, I think I would say we should have one or two major U.S. carriers because they could compete better with the foreign carriers. You know, at one time, it was said that if there weren't three or four carriers flying the route between New York and London, there wouldn't be

“The quality of human ingenuity is such that when you do have the available technology, you have to use it.”

enough competition. But my understanding is that every day across the Atlantic, there are about 29 different carriers on this service, so there is plenty of competition.

Spectrum: As a final question: how do you feel about SSTs? Do you see a future for them in the U.S. as air carriers?

Coleman: I'd prefer not to answer that because we are presently considering the application of the Anglo-French *Concorde*, and, until that is resolved, I don't think I can publicly indicate my feelings. My general feeling is that, throughout history, man has made great strides forward and great developments—and when there is something developed involving advanced technology, unless there are extreme environmental effects or safety risks, history just doesn't permit us to stand still. We have to move forward.

In the case of the *Concorde*, some individuals say, “Why do you really have to go to Europe in three hours? What's wrong with seven or eight hours?” To which I would reply: “You know, Columbus came over here in about 40 days,” and I remember when I first flew to Europe; it took a long time. We made two or three stops en route. Then we got the four-engine turboprop plane, and, finally, the jet. Now the time will be further reduced by the supersonic planes. I just think that the quality of human ingenuity is such that when you do have the available technology, you *have* to use it. On the other hand, the environmentalists have alerted us to the special problems created by the SSTs. We have to examine these to make sure we're not doing irreparable damage to ourselves and future generations.

Spectrum: Thank you, Mr. Secretary. ◆

New product applications

Monolithic A/D converters offer high accuracy; quad op amp slews at 1.2 V/ μ s

The CMOS A/D converters combine all linear and digital circuits on a single chip. The 8700 series also comprises the first IC-type converters to use an integrating principle. All three models—the 8-, 10-, and 12-bit models—use an integrating conversion technique called incremental charge balancing to achieve high linearity and monotonic performance.

The manufacturer specifies both maximum nonlinearity and relative error at $\pm 1/2$ LSB. Typical temperature drifts are less than 10 ppm/ $^{\circ}$ C in zero offset and less than 30 μ V/ $^{\circ}$ C in gain over the -40 to $+85^{\circ}$ C temperature range.

Another feature is latched parallel binary outputs, which make the converters logically compatible with processors like micro- and minicomputers. They can be used to store measurement data or to ease operations such as sampling and multiplexed transmission.

The series offers direct compatibility with CMOS logic, low-power TTL, and TTL-compatible MOS. The units operate from stable dual supplies over ± 3.5 to ± 7 volts.

An unlimited range of input signal voltage can be converted. The series is designed for current input, allowing the user to scale the analog signal and a reference voltage with resistors. Virtually any stable negative voltage can be used as a reference. Zero offset is adjustable with a simple trimming circuit.

The conversion logic offers resolutions of 256 divisions of full-scale voltage in the 8700 (8-bit), 1024 divisions in the 8701 (10-bit), and 4096 divisions in the 8702 (12-bit). The start-conversion line can be clocked; set HIGH by external logic; or, for free-running operation, tied to $+5$ volts. Conversion cycle times are: 8700, 1.25 ms; 8701, 5 ms; and 8702, 20 ms. Free-running conversion times are 800, 200, and 50 per second, respectively.

The incremental charge-balancing design differs from conventional integrating con-

verter designs in that the charge on the capacitor is continuously compared with a reference rather than measured at the end of the cycle.

The converter itself requires only about 15 mW in active operation. It typically draws 1.4 mA from the positive supply and 1.6 mA from the negative supply.

In quantities of 100 or more, prices for the series are: 8700, \$16; 8701, \$22.50; and 8702, \$29.50.

Circle No. 40 on Reader Service Card

The model 836 quad operational amplifier provides a wide-band, low-cost replacement for four model-741 amplifiers. The 836 is more than twice as fast, giving the designer a bandwidth large enough to cover the audio-frequency range.

Features include a typical slew rate of 1.2 V/ μ s, as compared with 0.5 for standard 741- and 124-type quads. This raises small-signal bandwidth (unity gain frequency) to 1.5 MHz and power bandwidth to 20 kHz.

Class AB output operation eliminates the crossover distortion problem of conventional class B operation. At maximum output voltage, the output remains symmetrical about ground and typically swings within 1 volt of either supply.

Input common-mode voltage range is -15 to $+13.5$ volts. Because this range includes the negative supply, fewer external components are required for biasing in single-supply applications. Typical supply current at ± 15 volts is only 700 μ A per amplifier, resulting in a total dissipation of 84 mW per package, or 21 mW per amplifier.

The op amp consists of four internally compensated operational amplifiers with differential inputs. The amplifiers share a common bias network and supply inputs. The quad operates on single supplies from 3 to 30 volts or on split supplies from ± 1.5 to ± 15 volts. Outputs are short-circuit protected.

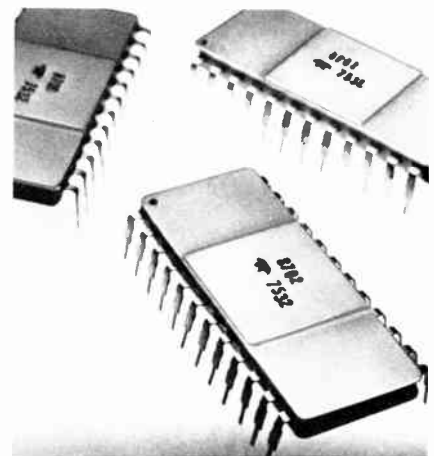

The 8700 series of monolithic 8-, 10-, and 12-bit CMOS A/D converters incorporate all linear and digital circuits on the same chip. They can be used without any external components.

Three versions are available: the 836C in a 14-pin ceramic or plastic DIP for 0 to 70° C operation, and the 836B in a ceramic DIP for -55 to $+125^{\circ}$ C operation.

Key specifications of the 836C include: 8-mV maximum input offset voltage, 100-nA maximum bias current, 150- μ V/ maximum power-supply rejection, 70-dB minimum common-mode rejection, and 25 000 minimum voltage gain.

The 836B has similar specifications, as well as a minimum slew rate of 0.8V/ μ s over the military temperature range. Typical slew rate is the same as the 836C, 1.2 V/ μ s.

Prices at distributors for quantities of 25 to 99 are \$4.05 (836CJ), \$4.45 (836CL), and \$13.00 (836BL).

Further information on the 8700 series converters and the model 836 op amp is available from Teledyne Semiconductor, 1300 Terra Bella Ave., Mountain View, Calif. 94041.

Circle No. 41 on Reader Service Card

Thick-film resistor compositions provide TCRs of less than 100 ppm/ $^{\circ}$ C

The 1600 series of "Birox" resistor compositions provides applications for thick-film resistor compositions in hybrid microcircuits, resistor networks, and attenuators. The series is compatible with platinum/silver and palladium/silver conductors.

The compositions offer temperature coefficients of resistance (TCRs) of less than 100 ppm/ $^{\circ}$ C at temperatures of -55 to $+125^{\circ}$ C. TCRs are typically less than 50 ppm/ $^{\circ}$ C between 0 and 70° C, and tracking is within 10 ppm/ $^{\circ}$ C.

Tolerances of less than ± 1 percent after laser trimming are possible with the 1600 series resistors. They do not generally require encapsulation, except to provide mechanical protection or protection from severe environments.

Firing cycles as short as 30 minutes may be used with little effect on performance characteristics. Otherwise, processing conditions are the same as for other Birox resistor compositions: screen printing to a dried-film thickness of 25 μ m and firing in

air to a peak of 850° C. The series exhibits narrow fired-resistance value distributions, with coefficients of variation typically between 2 and 5 percent.

The series comprises six compositions, with sheet resistivities ranging from 10 ohms per square to 1 megohm per square. Quantity prices range from \$1.40 to \$1.90 per gram, depending on the resistivity.

Detailed information is available in bulletin E-06529 from the Electronics Materials Div., Photo Products Dept., Du Pont Co., Wilmington, Del. 19898.

Circle No. 42 on Reader Service Card

Guide for authors

If you wish to publish an article in an IEEE publication, send the manuscript to the editor (listed below) of the appropriate journal. If you are unsure of the appropriate publication, send your manuscript to E. K. Gannett, Director, Publishing Services, IEEE, 345 E. 47 St., New York, N.Y. 10017.

If you require guidance in the IEEE style, send for "Information for IEEE Authors," which is available from the IEEE Editorial Department at the above address. In the listing below, frequency of publication is identified as follows: (M), monthly; (BM), bi-monthly; (Q), quarterly; (A), aperiodically.

Proceedings of the IEEE

Fundamental papers of broad significance and long-range interest in all areas of electrical/electronics science and technology. Contributions describing original work are included, but emphasis is on papers that provide in-depth reviews and tutorial coverage of fields of current interest. A "Letters" section assures quick publication of brief reports concerning new research and development results. A number of times each year an entire issue is devoted to an intensive examination of a single subject. (M)

W. R. Crone, Managing Editor
PROCEEDINGS OF THE IEEE
345 E. 47 St., New York, N.Y. 10017
(212) 644-7557

IEEE Electrolatina

A technical periodical of, by, and for the Latin-American Region of the IEEE, where it is edited and produced. All material appears in Spanish or Portuguese and is selected for its interest to IEEE members in South and Central America, Mexico, and the Caribbean area, who receive ELECTROLATINA automatically. (Q)

Ing. Erik Wallsten
Monte Libano 875, Mexico 10, D.F., Mexico

IEEE TRANSACTIONS AND JOURNALS

These publications of IEEE Societies and Groups provide the means by which the IEEE member keeps abreast of the advances in a specific field of specialization. Their mission is to record and disseminate new scientific and technical information for both present and future members of the profession.

Acoustics, Speech, and Signal Processing, IEEE Trans.

Technology of communication at audio frequencies and of the audio-frequency portion of radio-frequency systems, including the acoustic terminations and room acoustics of such systems, and recording and reproduction from recordings. (BM)

William E. Collins, General Radio, 300 Baker Ave., Concord, Mass. 01742
(617) 646-7400, Ext. A-231

Aerospace and Electronic Systems, IEEE Trans.

Equipment, procedures, and techniques applicable to the organization, installation, and operation of functional systems designed to meet high-performance requirements of earth and space systems. (BM)

Dr. Harry R. Mimno, 83 Pleasant St., Lexington, Mass. 02173
(617) 862-4936

Antennas and Propagation, IEEE Trans.

Experimental and theoretical advances in electromagnetic theory and in the radiation, propagation, scattering, and diffraction of electromagnetic waves, and the devices, media, and fields of application pertinent thereto, such as antennas, plasmas, and radio astronomy systems. (BM)

William F. Croswell, NASA Langley Research Center, Mail Stop 490, Hampton, Va. 23665
(804) 827-1110, Ext. 3631

Note to IEEE Spectrum authors

IEEE Spectrum is the world's largest-circulation magazine in the electrical/electronics field; it affords the primary link between the IEEE and all its members. *Spectrum's* objectives are to provide interesting and useful information on a broad range of technical and career-oriented topics, and to provide current awareness for its readers of fields outside their immediate specialties. The staff of *Spectrum* works closely with authors to help them revise their manuscripts, drastically when necessary, to gain high readability and utility to the reader. *Spectrum* encourages articles of high interest to a large percentage of its readers. Before submitting an article to *Spectrum*, you may wish to discuss it by telephone with the editor.

Donald Christiansen, Editor

IEEE Spectrum, 345 E. 47 St., New York, N.Y. 10017
(212) 644-7556

Automatic Control, IEEE Trans.

The science and technology that underlie control systems, and that can be represented through common mathematical symbolism. Topics include: optimization, adaptation, modeling, components, self-organization, and their application to physical systems. (BM)

Prof. Stephen Kahne, Dept. of EE, University of Minnesota, Minneapolis, Minn. 55455
(612) 373-9751 or 373-5746

Biomedical Engineering, IEEE Trans.

Application of the concepts and methods of the physical and engineering sciences in biology and medicine, covering a very broad spectrum ranging from formalized mathematical theory through experimental science and technological development to practical clinical applications. (BM)

Dr. Hun H. Sun, Biomedical Eng. & Science Dept., Drexel University, 32 & Chestnut Sts., Philadelphia, Pa. 19104
(215) 895-2240

Broadcasting, IEEE Trans.

Broadcast transmission systems engineering, including the design and utilization of broadcast equipment. (Q)

Phil Rubin, Director of Engineering, Corporation for Public Broadcasting, 1111 Sixteenth St. N.W., Washington, D.C. 20036
(202) 293-6160

Circuits and Systems, IEEE Trans.

Design and theory of operations of circuits for use in radio and electronic equipment. (M)

Prof. Omar Wing, Dept. of EE and Computer Sciences, Columbia University, 1306 Mudd, New York, N.Y. 10027
(212) 280-3103

Communications, IEEE Trans.

Technology of telecommunications (theory and application) including telephony, telegraphy, and the transmission of other data; also point-to-point radio and television; treatment of systems and subsystems using one or a combination of means of transmission. (M)

Prof. Donald L. Schilling, EE Dept., City University of New York, Convent Ave. & 140 St., New York, N.Y. 10031
(212) 690-6621

Computers, IEEE Trans.

Theory, design, and practices relating to digital and analog computation, and information processing. (M)

Dr. Richard E. Merwin, Ballistic Missile Defense Program Office, Attn.: DACS-BNT, 1300 Wilson Blvd., Arlington, Va. 22209
(202) 694-5281

Consumer Electronics, IEEE Trans.

The design and manufacture of consumer electronics products, components, and related activi-

ties, particularly those used for entertainment, leisure, and educational purposes. (Q)

Chester W. Sall, RCA Laboratories, Princeton, N.J. 08540
(609) 452-2700

Education, IEEE Trans.

Educational methods, technology, materials, and development programs in the electrical engineering disciplines. (Q)

Prof. Gerald R. Peterson, Dept. of EE, University of Arizona, Tucson, Ariz. 85721
(602) 884-2435

Electrical Insulation, IEEE Trans.

Electrical insulation common to the design and construction of components and equipment for use in electric and electronic circuits and distribution systems at all frequencies. (Q)

E. J. McMahon, Plastics Dept., ESL323, E. I. du Pont de Nemours & Co., Inc., Wilmington, Del. 19898
(302) 772-2585

Electromagnetic Compatibility, IEEE Trans.

Origin, effect, control, and measurement of radio-frequency interference. (Q)

Richard B. Schulz, IIT Research Institute, Electromagnetic Compatibility Analysis Center, North Severn, Annapolis, Md. 21402
(301) 267-2316

Electron Devices, IEEE Trans.

Electron devices, including particularly electron tubes, solid-state devices, integrated electronic devices, and energy sources. (M)

Dr. Roland Haitz, H-P Associates, 640 Page Mill Rd., Palo Alto, Calif. 94304
(415) 493-1212, Ext. 202

Engineering Management, IEEE Trans.

The management sciences and technology applicable to organizations engaged in or overseeing research, development, design, evaluation, production, or operation of electric or electronic equipment/systems or allied activities. Also, the socioeconomic impacts of technology on society. (Q)

Prof. A. H. Rubenstein, Dept. of Industrial Engineering & Management Sciences, The Technological Institute, Northwestern University, Evanston, Ill. 60201
(312) 492-3680 or 3667

Geoscience Electronics, IEEE Trans.

Research, development, and techniques in instrumentation for geophysics and geochemistry, especially gravity and seismic measurements, magnetics, well logging, space exploration, meteorology, oceanography, and aerology. (Q)

Dr. H. N. Kritikos, Moore School of Elec. Engrg., University of Pennsylvania, Philadelphia, Pa. 19104
(215) 243-8112

Industrial Electronics and Control Instrumentation, IEEE Trans.

The application of electronics and electrical sciences to industrial processes. (Q)

Roger W. Bolz, Automation for Industry, Inc., 8437 Mayfield Rd., Suite 101, Chesterland, Ohio 44026
(216) 729-7275

Industry Applications, IEEE Trans.

Application of electricity in industry, transportation, commerce, and the home. (BM)

Norman Peach, Gibbs & Hill, Inc., 393 Seventh Ave., New York, N.Y. 10001
(212) 760-4290

Information Theory, IEEE Trans.

The fundamental nature of the communication process; transmission and utilization of information; coding and decoding of digital and analog communication transmissions; study of random interference and information-bearing signals; and development of information-theoretic techniques in diverse areas, including communication systems, detection systems, pattern recognition, learning, and automata. (BM)

Prof. James L. Massey, Dept. of EE, Univ. of Notre Dame, Notre Dame, Ind. 46556
(219) 283-3496

Instrumentation and Measurements, IEEE Trans.

Measurements and instrumentation utilizing electrical and electronic techniques. (Q)

Prof. George B. Hoadley, Dept. of EE, North Carolina State University, P.O. Box 5275, Raleigh, N.C. 27607
(919) 737-2283

Magnetics, IEEE Trans.

Magnetic phenomena, materials, and devices as applied to electrical engineering. (Q)

Dr. Paul W. Shumate, Bell Telephone Labs., Rm. 2D344, 600 Mountain Ave., Murray Hill, N.J. 07974
(201) 582-4881

Send manuscripts to:

Dr. Allan B. Smith, Sperry Research Center, 100 North Road, Sudbury, Mass. 01776
(617) 369-4000, Ext. 315 or 280

or

Prof. S. H. Charap, Dept. of EE, Carnegie-Mellon Univ., Pittsburgh, Pa. 15213
(412) 621-2600

Manufacturing Technology, IEEE Trans.

All aspects of manufacturing technology as it relates to the manufacturing of electrical and electronics products. (A)

Hy Natkin, 1757 Russet Drive, Cherry Hill, N.J. 08003
(215) 687-8200, Ext. 2373

Microwave Theory and Techniques, IEEE Trans.

Microwave theory, techniques, and applications, as they relate to components, devices, circuits, and systems involving the generation, transmission, and detection of microwaves. (M)

Dr. Don Parker, Stanford Research Institute, 333 Ravenswood Ave., Bldg. 406B, Menlo Park, Calif. 94025
(415) 326-6200, Ext. 3903

Nuclear Science, IEEE Trans.

Nuclear science and engineering, including instrumentation, plasma and high-energy physics, reactor controls, and radiation effects. (BM)

Richard F. Shea (May 1–Nov. 1)
7 Barkley St., South Yarmouth, Mass. 02664
(617) 394-1501

(Nov. 1–May 1)

255 Inner Drive East, Venice, Fla. 33595
(813) 485-4396

Oceanic Engineering, IEEE J.

The uses of electrical and electronics engineering in advancing the understanding of any facet of the ocean environment as represented by theoretical and/or experimental papers which describe significant developments. (Q)

Prof. Donald M. Bolle, Div. of Engineering, Brown University, Providence, R.I. 02912
(401) 863-2671

Parts, Hybrids, and Packaging, IEEE Trans.

Physical properties, performance characteristics and procedures, and techniques pertaining to component parts, materials, and circuit packaging and manufacturing. (Q)

Gustave Shapiro, Engineering Electronics Section, National Bureau of Standards, Room A307, Bldg. 225, Washington, D.C. 20234
(301) 921-3537

Effective March 1976

Dr. Charles M. Tapp, Electronic Components Dept., Sandia Labs., Albuquerque, N.Mex. 87115
(505) 264-3751

Plasma Science, IEEE Trans.

Plasma science and engineering, including magnetofluid dynamics and thermionics; plasma dynamics, chemistry, and sources; electron beams; laser-plasma interactions; diagnostics; colloidal and solid-state plasmas; controlled thermonuclear reactions. (Q)

Dr. James E. Drummond, Maxwell Labs., Inc., 9244 Balboa Ave., San Diego, Calif. 92123
(714) 279-5100

Power Apparatus and Systems, IEEE Trans.

Planning, research, development, design, application, construction, installation, and operation of apparatus, equipment, structures, materials, and systems for the safe, reliable, and economic generation, transmission, distribution, conversion, and control of electric energy for general industrial, commercial, public, and domestic consumption. (BM)

E. W. Morris, 4050 Valente Court, Lafayette, Calif. 94549
(415) 283-8260

Professional Communication, IEEE Trans.

The study, development, improvement, and promotion of effective techniques for preparing, organizing, processing, editing, collecting, conserving, and disseminating any form of information in the electrical and electronics fields. (Q)

W. F. Wells, Technological Industrial Associates, Inc., 5712 Frederick Ave., Rockville, Md. 20852
(202) 881-6044

Quantum Electronics, IEEE J.

Physics of quantum electronic devices, such as masers and lasers, and associated techniques including modulation, detection, and nonlinear optic effects. (M)

Dr. A. Gardner Fox, Bell Labs., Holmdel, N.J. 07733
(201) 949-2633

Reliability, IEEE Trans.

Reliability principles and practices used for electric and electronic equipment. (A)

Dr. Ralph A. Evans, 804 Vickers Ave., Durham, N.C. 27701
(919) 688-6207

Software Engineering, IEEE Trans.

All areas which form the middle ground that lies between the initial step of basic research and terminal operations of manufacture and utilization of computer software. It includes the following specific areas: programming methodology, software reliability, system performance evaluations, software program management, and programming tools and standards. (Q)

Prof. R. T. Yeh, Dept. of Computer Science, University of Texas, Physics Bldg. 328, Austin, Tex. 78712
(512) 471-4353

Solid-State Circuits, IEEE J.

Device coverage in the areas of central importance to circuits, and system coverage in areas contiguous with circuit considerations; emphasis is on practical applications providing a medium in the reviewed journal area for papers which should be commonly available in regular technical libraries. (BM)

Lewis M. Terman, IBM, Thomas J. Watson Research Center, P.O. Box 218, Yorktown Heights, N.Y. 10598
(914) 945-3000

Sonics and Ultrasonics, IEEE Trans.

Sonics, including ultrasonics and phonon technology. (BM)

Stephen Wanuga, General Electric Co., Electronics Lab., Rm. 207, Electronics Park, Syracuse, N.Y. 13201
(315) 456-2027

Systems, Man, and Cybernetics, IEEE Trans.

Theoretical and practical considerations of natural and synthetic systems involving men and machines. (M)

Dr. Andrew P. Sage, Office of the Dean, School of Eng. and Applied Science, University of Virginia, Charlottesville, Va. 22901
(804) 924-3050

Vehicular Technology, IEEE Trans.

Vehicular communications—land, airborne, and maritime mobile services, portable or hand carried, and citizens' communications services, when used as an adjunct to a vehicular system; vehicular electrical and electronics engineering, which includes equipment and systems ordinarily identified with the automotive industry, excluding systems associated with public transit. (Q)

George F. McClure, Communications & Electronics Div., Martin Marietta Corp., Sand Lake Road, Box 5837, Mail Point 437, Orlando, Fla. 32805
(305) 352-3782 or 2423

Below are listed the names and telephone numbers of the Senior Editor Supervisors, together with the publications for which they are responsible. Contact the Senior Editor at IEEE Headquarters whenever you have a problem concerning the status of a journal or of a paper scheduled to appear in one.

Nancy Budde (212) 644-7584

IEEE Transactions on
Biomedical Engineering
Broadcasting
Electrical Insulation
Engineering Management
Geoscience Electronics
Industrial Electronics and Control Instrumentation
Microwave Theory and Techniques
Parts, Hybrids, and Packaging
IEEE Journal of Quantum Electronics
IEEE Engineering Management Review

Ann Burgmeyer (212) 644-7588

IEEE Transactions on
Antennas and Propagation
Industry Applications
Information Theory
Magnetics
Manufacturing Technology
Power Apparatus and Systems
Sonics and Ultrasonics
Systems, Man, and Cybernetics
Vehicular Technology

Carolyn Elenowitz (212) 644-7570

IEEE Transactions on
Acoustics, Speech, and Signal Processing
Automatic Control
Communications
Computers
Education
Professional Communication
Software Engineering
IEEE Journal of Solid-State Circuits
IEEE Press
Communications Society Newsletter

Gail Ferenc (212) 644-7583

IEEE Transactions on
Circuits and Systems
Electromagnetic Compatibility
Electron Devices
Instrumentation and Measurement
IEEE Journal of Oceanic Engineering
Proceedings of the IEEE