

# IEEE spectrum

## articles

- + **29 Spectral lines** 'Soft' technology and the 'backup gap'  
Donald Christiansen  
*Deficient backup systems may do more to give technology a black eye than the technologist himself believes possible*
- + **30 Retrospective** The \$100 idea  
Edward L. Ginzton  
*How Russell and Sigurd Varian, with the help of William Hansen and a \$100 appropriation, invented the klystron*
- + **40 Instrumentation** LEDs: digital domination?  
Roger Allan  
*Light-emitting diodes proliferate as gas-discharge and liquid-crystal digital readouts find special niches*
- + **43 Transportation** Fixing BART  
Gordon D. Friedlander  
*A "million-dollar" backup for the automatic train protection system stems from BART's "Blue Ribbon Panel" report*
- + **46 Power/energy** Creative electric load management  
Thomas Laaspere, A. O. Converse  
*New tools for the utilities include rate options, clock-actuated switches, radio control, and ripple control systems*
- + **51 Instrumentation** Generating speech spectrograms optically  
Francis T. S. Yu  
*Coherent optics speeds analysis of speech samples on film: it's five times faster than older methods*

## departments

- |                         |                            |
|-------------------------|----------------------------|
| 6 Meetings              | 72 Scanning the issues     |
| 9 Calendar              | 74 IEEE tables of contents |
| 13 News from Washington | 84 Future special issues   |
| 14 Energy report        | 85 IEEE Standards          |
| 81 News from industry   | 85 Special publications    |
| 82 Regional news        | 86 Educational aids        |
| 15 Focal points         | 90 Book reviews            |
| 18 Inside IEEE          | 92 People                  |
| 24 Forum                | 93 In future issues        |



Copyright © 1975 by  
THE INSTITUTE OF ELECTRICAL AND ELECTRONICS ENGINEERS, INC.

**The Prime Computer User Plan  
Fights Inflation:**

**One Prime 300 system  
gives each of 15 users a  
completely independent  
virtual computer. Each  
with a 128k byte virtual  
memory and disk operating  
system. Each for less than  
\$7,400!**

**A Complete  
Virtual Computer  
for Every User.**

Think about it. For less than \$7,400, each user has access to a complete system that if purchased separately would cost over \$60,000. The Prime 300's virtual memory disk operating system automatically and transparently allocates all real system resources among the users of the virtual machines. By applying virtual machine techniques to the handling of I/O operations, each user terminal has direct on-line communication with any peripheral device in the system. Disk back-up can be handled on-line, data can be read directly from cards, tape or disk, and output can be transferred directly from a terminal to cards, tape, disk or printer.

A File Management System supervises the Prime 300's memory hierarchy and provides each user with a variety of direct and sequential file access methods.

**A Multilingual  
System.**

Each user is free to write programs in FORTRAN, BASIC, Macro Assembler and Micro Assembler languages. So they can fit the language to the problem instead of the other way around. In fact, problems can be divided into subtasks and each written in the language best suited to the task. For added convenience, programs written in one language can call subroutines written in other languages. And to wrap everything up, all Prime programming languages used the same file system so that any program, written in any language can access any data base without any modification or reprogramming.

**A  
Multifunction  
System.**

A virtual memory Prime 300 is like having up to 15 separate computers in one box. So there's a lot of computing muscle available to tackle just about any mix of applications. Users can develop real-time application software, execute batch command files, use the system as a sophisticated calculator via immediate-mode BASIC, handle data base management, even develop microprograms for the Prime 300's writeable control store or other microprogrammable devices.

**Three  
Systems to  
Get You Started.**

Prime has put together three starter systems, each with a different price/performance balance. If you buy them as packaged, you get a system complete with all necessary system software, one year maintenance policy and an attractive packaged system discount.

You can select a small system for up to four users built around a 300 with 64K byte main memory and 6M byte moving head disk for \$44,000. Or a system for up to eight users we call "The Personal Archive System," that features four diskette units for loading and unloading individual user files, a 12M byte work disk and 300 processor with 128K byte memory, for only \$68,000. For 15 users you can get a system with 256K byte main memory, 60M byte moving head disk, and 16-line asynchronous multiline controller for \$110,000.

**Virtually  
Unlimited  
Expansion.**

Any of these starter systems can be easily and economically expanded. You can add main memory up to 512K bytes. Attach a total of eight 60 million byte disks, four 12 million byte disks and eight diskettes. Add multiple printers and tape drives. Mix terminal types and speeds. And support it all with exactly the same operating systems and language processors you started with.

**Try it  
Before You  
Buy It.**

Find out how a Prime 300 virtual memory system can help you fight inflation. Attend a Try It Before You Buy It seminar at the Computer Caravan. In every caravan city, Prime will conduct seminars to help you test and evaluate the Prime 300. Complete details are available from any Prime sales office or by writing to Prime Computer, Inc., 145 Pennsylvania Avenue, Framingham, MA 01701.

PRIME

145 Pennsylvania Avenue / Framingham, MA 01701

Circle No. 2 on Reader Service Card

- + **57 Management Planning is for people**  
Leo Katz  
*Painful, yet educational, surprises greet the engineering planner as he takes his ideas to the public*
- **61 Information research Retrieval made easy**  
Nazir Bhagat, Jordan J. Baruch, Elwood K. Gannett  
*IEEE announces a new computer-based service designed to get you only the information you need—quickly and inexpensively*
- **65 Sociotechnology IEEE Code of Ethics**  
Arthur P. Stern  
*In response to the members' mandate, a set of guidelines on professional relationships is presented*
- 66 New product applications**  
*Instruments, solid-state devices, and other products now available that give the engineer greater scope for design and application are described*
- 70 Spectrum's hardware review**  
*A listing of new products and manufacturers, about which readers may obtain information*
- 71 Applications literature**  
*Brochures, manuals, and applications handbooks selected by the editors*

## the cover

*A page from Russell Varian's laboratory notebook shows the klystron's basic configuration. Now, 38 years later, the chairman of the board of Varian Associates recalls his early association, as an engineer, with the Varian brothers (page 30).*

## spectrum

### EDITORIAL STAFF

*Editor:* Donald Christiansen  
*Managing Editor:* Ronald K. Jurgen; *Senior Staff Writer:* Gordon D. Friedlander; *Senior Associate Editor:* Howard Falk; *Associate Editors:* Roger Allan, Marce Eleccion, Gadi Kaplan, Don Mennie, Ellis Rubinstein (Copy); *News Editor:* Evelyn Tucker; *Contributing Editors:* Nilo Lindgren, Alexander A. McKenzie, Michael F. Wolff; *Editorial Assistants:* Ann L. Battiste, Stella Grazda, Lynnette Peace; *Production Manager:* Ruth M. Edmiston; *Art Director:* Herbert Taylor; *Assistant Art Director:* Janet Mannheimer; *Technical Graphic Artist:* Morris Khan; *Art Assistant:* T. Dale Goodwin; *Business Manager:* Carl Maier

### EDITORIAL BOARD

*Chairman:* Donald Christiansen  
Norman Abramson, Roy Amara, Norman Balabanian, F. E. Borgnis, Charles Concordia, J. M. Early, C. A. Falcone, R. D. Grundy, Craig Harkins, A. A. J. Hoffman, Eugene Mittelman, E. N. Procter, Shigebumi Saito, R. L. Schoenfeld, Harold Sobol, A. J. Stegeman, J. J. Suran, A. S. Taylor, F. E. Terman, C. F. Walker, W. H. Ware.

# TOUGH JOB

Getting a quick, graphic look at a non-stationary event

# PROVEN SOLUTION

Real Time Analysis plus a 3-D "Waterfall" Display

A continuously updated "Waterfall" dramatically shows how each peak of noise and vibration rises and falls under changing test conditions. As new spectra are added, old ones fall away, updated at rates from 50 milliseconds to 12 seconds per spectrum. You can show 64 or 128 spectra on a non-storage type scope and change display conditions (amplitude, spacing, intensity, etc.) at will. A high-intensity cursor line and 5-digit LED display instantly identify the frequency of any peak anywhere on the screen.

Real Time "Waterfalls" are a great technique for observing machinery speed runs . . . studying

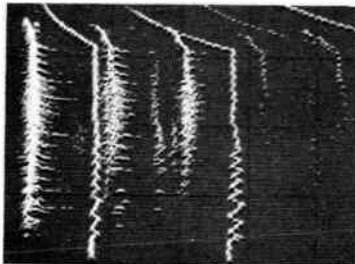

intermittent bio-med phenomena... making signature recognition studies . . . studying pass-by and flyby noise patterns . . . and analyzing non-stationary waveforms.

"Waterfalls" flow and move as data changes

# TOTALLY JOB-ORIENTED

SD301D Real Time Analyzer, 13151 Display Control and Scope

Send for complete application data and specs

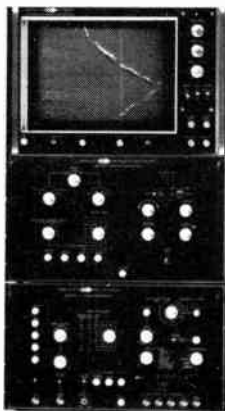

## Spectral Dynamics Corporation OF SAN DIEGO

P.O. Box 671, San Diego, Calif. 92112  
(714) 565-8211, TWX 910-335-2022

Circle No. 3 on Reader Service Card

## IEEE Publications Operations

### IEEE PUBLICATIONS BOARD

F. S. Barnes, *Chairman*  
J. E. Rowe, *Vice Chairman*

J. J. Baruch	E. K. Gannett	S. J. Kahne
W. R. Beam	G. I. Haddad	V. P. Kodali
Donald Christiansen	J. C. Herman	R. W. Lucky
P. J. B. Clarricoats	A. L. Hopkins	A. C. Schell

### STAFF

Elwood K. Gannett, *Director, Publishing Services*  
Patricia Penick, *Administrative Assistant to the Director*

H. James Carter, *Manager, Editorial Services*  
Elizabeth Braham, *Manager, Information Services*  
Lawrence Liebman, *Manager, Printing Services*  
W. Reed Crone, *Managing Editor*

*Proceedings of IEEE and IEEE Press*

William R. Saunders, *Advertising Director*  
Henry Prins, *Research Manager*  
Carl Maier, *Advertising Production Manager*  
Carol D'Avanzo, *Assistant Advertising Production Manager*

IEEE SPECTRUM is published monthly by The Institute of Electrical and Electronics Engineers, Inc. Headquarters address: 345 East 47 Street, New York, N.Y. 10017. Cable address: ITRIPLEE. Telephone: 212-752-6800. Published at 20th and Northampton Sts., Easton, Pa. 18042. Change of address must be received by the first of a month to be effective for the following month's issue. Please use the change of address form below. Annual subscription: IEEE members, first subscription \$3.00 included in dues. Single copies \$4.00. Nonmember subscriptions and additional member subscriptions available in either microfiche or printed form. Prices obtainable on request. Editorial correspondence should be addressed to IEEE SPECTRUM at IEEE Headquarters. Advertising correspondence should be addressed to IEEE Advertising Department, at IEEE Headquarters. Telephone: 212-752-6800.

Responsibility for the contents of papers published rests upon the authors, and not the IEEE or its members. All republication rights, including translations, are reserved by the IEEE. Abstracting is permitted with mention of source.

Second-class postage paid at New York, N.Y., and at additional mailing offices. Printed in U.S.A. Copyright © 1975 by The Institute of Electrical and Electronics Engineers, Inc. IEEE spectrum is a registered trademark owned by The Institute of Electrical and Electronics Engineers, Inc.



OTHER IEEE PUBLICATIONS: IEEE also publishes the PROCEEDINGS OF THE IEEE and more than 30 Transactions for IEEE Societies and Groups with specialized interests within the electrical and electronics field. Manuscripts for any IEEE publication should be sent to the editor of that publication whose name and address are shown on pp. 95-96 of the January 1975 issue of Spectrum. When in doubt, send the manuscript to E. K. Gannett, Publishing Services, at IEEE Headquarters, for forwarding to the correct party.

IEEE also copublishes, with the Institution of Electrical Engineers of London, England, *Electrical & Electronics Abstracts and Computer & Control Abstracts*, as well as their companion titles journals, *Current Papers in Electrical & Electronics Engineering* and *Current Papers on Computers and Control*.

# MOVING?

 PLEASE NOTIFY US 4 WEEKS IN ADVANCE

Name (Please Print)

Address

City

State/Country

Zip

MAIL TO: IEEE CODING DEPARTMENT  
445 Hoes Lane, Piscataway, N.J. 08854

ATTACH LABEL HERE

- This notice of address change will apply to all publications to which you subscribe.
- List new address above.
- If you have a question about your subscription place label here and clip this form to your letter.

# The \$100 idea

## How Russell and Sigurd Varian, with the help of William Hansen and a \$100 appropriation, invented the klystron

I first met Russell Varian in 1939 on a stairway landing in the Stanford University Physics Building. I had just been hired as a part-time research associate on the new Klystron Project at a then munificent \$90 per month, and was going upstairs to meet the Varians and their small staff. I had heard of the invention of this new electron tube that could generate centimeter waves, but I did not know how it worked, and indeed I had never even seen one. Thus, when I stopped and introduced myself to Russ, he thought the first order of business ought to be an explanation of the principle of the klystron. I remember his saying something like this:

“Just picture a steady stream of cars from San Francisco to Palo Alto; if the cars left San Francisco at equal increments and at the same velocity, then even at Palo Alto they would be evenly spaced and you could call this ‘a direct flow of cars.’ But suppose somehow the speed of some cars as they left San Francisco could be increased a bit, and others could be retarded. Then, with time, the fast cars would tend to catch up with the slow ones and they would bunch into groups. Thus, if the velocity of cars was sufficiently different or the time long enough, the steady stream of cars would be broken and under ideal circumstances would arrive in Palo Alto in clearly defined groups. In the same way, an electron tube can be built in which the control of the electron beam is produced by this principle—bunching—rather than by the direct control of the grid of a triode.”

This direct and simple explanation was an inspiring introduction to Russ and to the Klystron Project; it was destined to lead me to a lifetime profession, illuminated by close friendships with Russ, Sig Varian, Bill Hansen, and others at Stanford and, later, at Varian Associates, the company we started.

I wish to trace the genesis of the Klystron Project in this article not only because it was such an important milestone in electronics but because, with the benefit of hindsight, it can be seen as practically a textbook demonstration of the validity of some of today’s best known axioms about invention and the “management of technology.” It demonstrates, for instance, the wisdom of being “coupled to the marketplace,” and of identifying societal or market needs rather than merely advancing technology for its own sake. It also illustrates the benefits of working in a creative research community rather than in small groups or in isolation.

The klystron was invented during the summer of 1937 and announced formally to a world on the brink of war by the Varians in the February 1939 issue of *The Journal of Applied Physics*. Their letter began:

“The very efficient high frequency resonators described in this Journal by [William] Hansen have been made the basis for construction of amplifiers and oscillators of a new type in which the transit time of electrons, which is usually considered as a source of serious difficulties at very high frequencies, has been turned to constructive use.”

This somewhat diffident announcement was apparently overlooked in Germany—but not in England. Already deeply involved in the development of radar, scientists at Bristol University recognized that this ingenious new development would help make airborne radar possible by providing a lightweight source of microwaves for radar receivers. By late 1940—just as the Luftwaffe was switching to deadly night bombing—the RAF succeeded in equipping its night fighters with the klystron radar receivers that would help them win the Battle of Britain.

The klystron turned out to be more than an important wartime development, however. It was destined to play an important part in developing the new industry that is now generally referred to as microwave. It helped make commercial air navigation safe, it opened the possibility of worldwide communications for satellites, and it led to a variety of high-energy particle accelerators useful in medicine and in nuclear physics. It thus helped spawn a new technology and then a whole new industry.

On the personal side, the invention of the klystron represented the fruits of an ideal collaboration between three remarkable men, each uniquely talented: Russell and Sigurd Varian and William Hansen. Their backgrounds are essential to appreciating the nature of this collaboration.

### Two very different brothers

Russell Varian was the oldest of three brothers, who grew up in what must have been an unusually supportive and intellectually stimulating environment (see Box on p. 35). A tall, awkward boy, Russ had a remarkable ability to comprehend what he read, which more than compensated for a marked slowness in learning the mechanics of reading. Although he was kept back until he was some four years older than most of his high-school classmates, he was in many ways much more advanced and better informed. The science courses especially excited him, and as a teenager he was already able to explore complex scientific questions on his own.

The depth of his ability to explore a subject was matched by the diversity of fields he was anxious to explore: not only mathematics and physics, but, as he grew older, economics, medicine, biology, and chemistry all held equal fascination for him.

After graduating from high school with an excellent knowledge of science and related subjects, Russell



# spectral lines



## 'Soft' technology and the 'backup gap'

Even today, antitechnology enthusiasts drive their air-polluting vehicles to convocations where they decry the very acts they themselves perform. They burn the midnight oil while suggesting that citizens grind their own coffee beans by hand—by legal edict if they will not comply voluntarily. Exaggerated? Of course. Yet a breed of environmentalist exists that is readily visualized through such a caricature.

Fortunately, a more sophisticated school of humanist-environmentalist is emerging. Its members embrace a concept they call 'soft' technology (unrelated to software!). In Wales, the former editor of the *British Science Journal* directs a Soft Technology Research Community that aims to research and apply "small-scale, non-polluting technologies which could in the future substitute for our current large-scale technologies." One of the center's projects is a low-cost solar roof to supply hot water for the community. Soft technology's principal characteristic is defined as its compatibility with the environment, and so, frequently, low or intermediate technology is involved. Yet the definition seems to include the possibility that high, sophisticated technology can be soft, too.

E. F. Schumacher, the British economist and expert in technology for developing nations, coined the term "appropriate technology," in recognition that the high technology exploited in advanced nations may be largely useless for the underdeveloped countries. A hope that arises in this connection is that the developing countries can avoid some of the errors that were made in the unwise use of technology by the already highly developed nations. Still others dream of closing the loop completely, so that wiser application of technology by the developing countries can be adapted to change our own society for the better—in a sort of large-scale retrofit process.

This latter ambition leads to an examination of the concept of overconnection or overarticulation within a technologically developed society. Recall, for example, the Northeast blackout of 1965. Power companies ranging from Canada, through most of New England and New York State, to parts of New Jersey, having been interconnected in a modified pool configuration, were triggered into shutdown when a single relay of the Ontario Hydro Beck complex operated to trip a circuit breaker. Critics label this incident a classic example of a literal "overconnection" and its disastrous results.

At an even more complex level, one frequent writer on environmental topics observes that material goods, energy, and capital now move through very large loops and flow patterns that weave through one another, resulting in an interdependency such that a small disruption can cascade through interconnecting networks to impact successively larger areas. A proposal for avoiding this often takes the form of a suggestion that a society "unlink" itself into

many smaller, self-sufficient units. At the level of nations, one could view Project Independence as a manifestation of this concept. At a more "micro" level, the idea of an energy-self-sufficient community fulfills this concept (though it is seen as difficult if not impossible by many competent critics).

An alternative to a society of permanently unlinked elements is one in which the elements constitute modules of a system and are articulated, yet can be disengaged quickly, for due cause, and will operate independently (even if less efficiently). Such a concept is appropriate to a power grid, for example. Unfortunately, most systems in advanced societies are not readily definable hardware systems, but are amorphous hybrids of hardware, software, and people, and are understandably difficult or impossible to disengage or decentralize into self-contained units, even temporarily. (Consider, for example, the system for processing and distributing dairy products.)

A more realistic situation, then, is that in which an occasional complete and unexpected system failure may occur, so that backup systems, ranging from formal redundancy to various and sundry ad hoc temporary solutions at a local level are required. Such a breakdown can result in a "backup gap"—a gap that can be particularly great in technologically advanced societies, where whole levels of technology may have been obsoleted, forcing the citizen to go back to a very primitive level (e.g., candles in a blackout).

Furthermore, the more reliable the system, the more serious the gap is likely to be. In such cases, even if well-designed, second-level backup systems exist, they may be in disrepair, or operators may simply not know how to use them. The argument extends to low-level backups. For example, if power failures in the home hardly ever occurred, homes would probably be without emergency generators, Coleman stoves, or even candles.

Soft technology, when it involves mostly low technology, is less likely to require backup, and when it is needed, the situation is not likely to be as traumatic—the "gap" is minimal. (A farmer using a gasoline-powered hand cultivator can go back to the donkey and forked stick.)

A pair of lessons may reside in these observations. One, for the nontechnologist, is that high technology is not automatically "hard" (ecologically unsound and wasteful of energy); it can be both appropriate and soft. For the technologist, the lesson, perhaps, is that those of us working in highly developed societies must take pains to keep the backup gaps small, paying particular heed to the design of appropriate backup systems. In this regard, we may well exploit high, intermediate, and low technologies to produce a truly elegant "soft system."

Donald Christiansen, Editor



Sigurd Varian, the aviator, shown in a photo from his scrapbook

was admitted to Stanford which he worked his way through. He took a normal curriculum but continued to have difficulties with mathematical calculations and with subjects that required much reading; he always understood the principles but had difficulty in working out assignments. At the end of his sophomore year, he decided to major in physics as he thought this would require the least reading! At the University, he met some very able students, including Bill Hansen, and although he had to spend much more time than they on homework, his slowness did not prevent him from gaining a substantial depth of understanding and graduating with a B.A. in physics in 1925 and receiving an M.A. in 1927.

In contrast to Russell, Sigurd Varian had little interest in college. Three years younger than Russell, he had been—and would continue to be—the activist of the pair. Whereas Russell tended to be shy and absent-minded, Sig was gregarious, good-looking, full of life and humor, and an incredible story-teller who was never reticent about taking the center of the stage. Strongly inclined mechanically, he would be the one to build whatever models Russell might design so that he and their younger brother, Eric, could play with them. Once Russell had gotten his brothers onto the task of building something, he had little further interest in the project. As the boys grew older, it would be Sig who figured out how to make harnesses for their donkeys, how to put together some kind of a cart from scraps of lumber, and who was responsible for mechanical improvements around the house.

Over the years, this collaboration between Russell and Sigurd continued. Sometimes Sig might initiate a project by asking his brother how or why something worked; this would start Russell figuring out the answer, and frequently he would invent an unusual approach. As young men they thought about a different way of building a radio compass for air navigation; an airplane engine synchronizer; a ground-speed indica-

tor; an altimeter; and a variety of other instruments and devices. Although few of these ideas proved of particular worth, and there is no evidence that any were patented, or used, it indicates the nature of their relationship and the intense interest they had in

Young Russell Varian

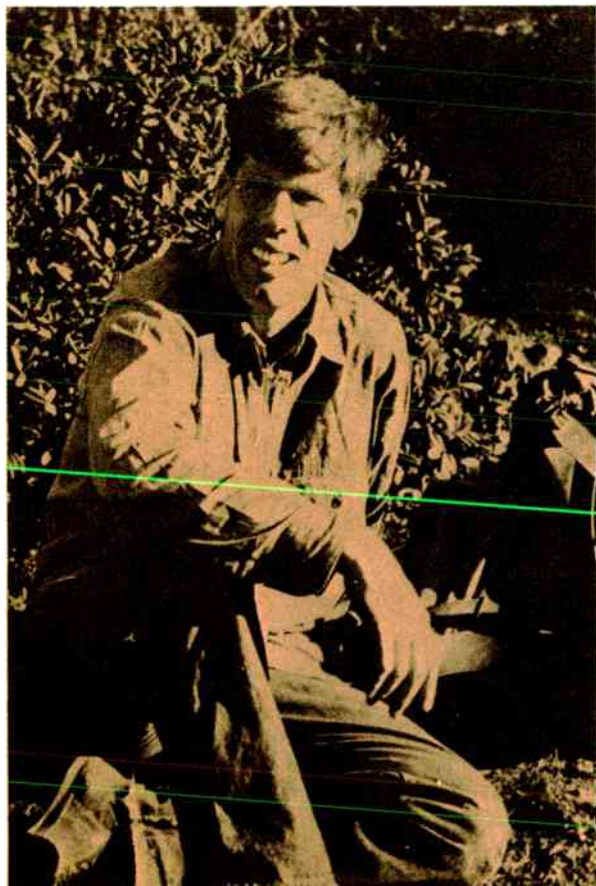

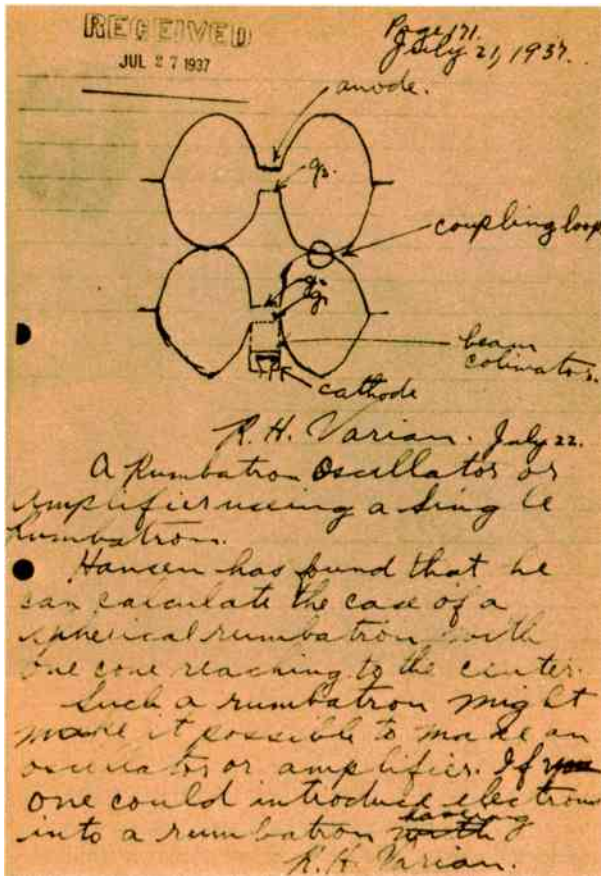

The basic klystron configuration is shown in Russell Varian's laboratory notebook entry for July 22, 1937.

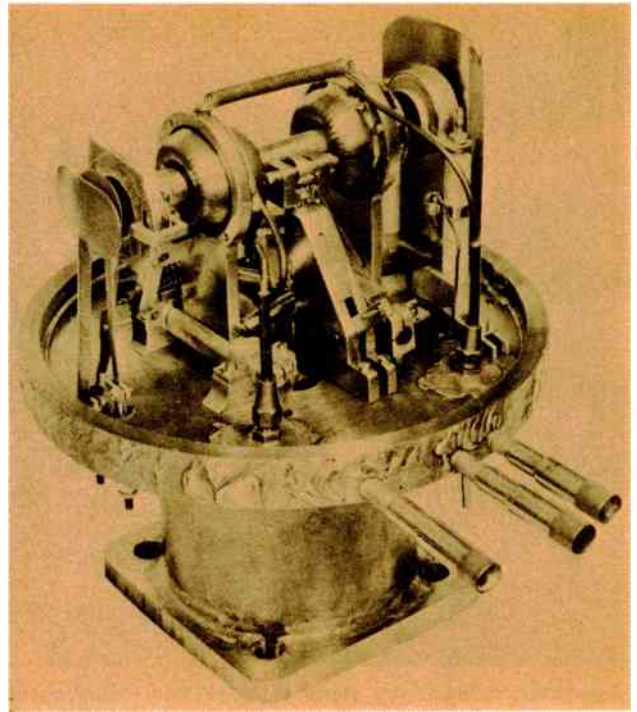

The Model B klystron was a handmade laboratory oddity able to produce only a few watts of microwave energy. It was superseded within a year by the first production model.

pursuing ideas which were new to them.

When Sigurd graduated from high school, he wanted the excitement of getting out in the world and earning money. A job as a lineman for the California Edison Company brought him near an airfield and he promptly lost his heart to aviation. He saved what money he could for lessons, and spent much of his spare time hanging around airfields, absorbing all he could about airplanes, flying, and mechanics. In 1923, Sig went to Los Angeles, learned to fly, and soon bought his first airplane—a World War I Jenny. He and his friends flew in air meets, stunted at county fairs, and had their share of the crashes, mishaps, and adventures that marked those wild early days of flying.

Eventually Sig decided to get a steadier job to support himself and his airplane. He became a flying serviceman for Southern Sierras Power Company and used his plane for making quick trips to locate line troubles and for transporting materials needed for construction or repairs. In his spare time, he gave flying lessons. In 1928, Sig's flying career was interrupted by a prolonged bout with tuberculosis (his second) and he was confined in a sanatorium for a year. His health restored, in 1929 he was employed by Pan American as a pilot on the company's Mexican and Central American routes. He was one of the first pilots to learn blind flying and he helped make instrument-flying an accepted practice.

Sig's flying experience was exciting and well-paid, but dangerous. There were few believable naviga-

tional maps, no weather forecasting, and initially no radio navigation aids; as a result, much of the flying was done by dead-reckoning. Frequently, he would encounter electrical storms and be lost over uncharted countryside. On several occasions, he came back alive by the skin of his teeth. And once, his plane crashed in the jungle. As I will make clear shortly, these experiences played a significant part in stimulating the invention of the klystron.

While Sig was flying, Russell joined the fledgling Farnsworth Television Laboratory where the brilliant inventor, Philo Farnsworth, was pioneering the development of television and a variety of the necessary electron tubes and devices. Here, Russell began his inventive career, producing at least eleven patentable devices or processes and many more that overlapped the ideas of others of whom he was unaware. In 1933, he returned to Stanford to continue his graduate work in physics. The following year, he and Bill Hansen roomed together and began to exchange ideas on the generation of high-voltage X-rays, cavity resonators, and many other exciting projects. This association developed into a lifelong respect for one another's skills and ideas. It was the basis for their collaboration on the klystron and, later, on nuclear resonance and many other scientific concerns.

### William Hansen and his rhumbatron

Hansen was a brilliant student who graduated from high school at the age of 14 and was sent to Stanford at the urging of his teachers. Immediately after receiving his A.B. in physics in 1929 he began his graduate work in the X-ray field. Quantum mechanics was still in its early stages of development, there were no reliable theories to explain X-ray phenomena, and unusually careful measurements were needed to com-



pile adequate information. At graduate school, his childhood training with tools and mechanics blossomed and he became an excellent machinist. Later, these mechanical skills became important in the klystron project as he was able to identify Russ's more practical ideas and to help Sig design equipment.

In addition to his productive research, Bill developed a flair for teaching and was made an instructor in the Physics Department almost immediately upon beginning his graduate work. The combination of his teaching skills and an extraordinary understanding of the basic laws of physics made it possible for him to pioneer teaching courses in microwaves, first at Stanford to his students and colleagues, and later, during the early days of the second World War, with a course at the M.I.T. Radiation Laboratory that was attended by some of his own professors. His notes on microwaves, simply known as "Hansen Notes" were classified and served as a foundation for radar research conducted at M.I.T.

In 1934, in addition to his teaching, Hansen became part of "The Supervoltage X-ray Committee." Comprising the entire six-man physics faculty, the Committee was formed to do the preliminary engineering for a 3 million-volt X-ray tube with which to explore more adequately the mysteries of the atomic and nuclear worlds. Hansen's recollections of this period provide a fascinating insight into the exigencies of university research during those Depression years. In a 1949 memo, he recalled that "any given faculty member might count himself very lucky to have \$500 to spend in one year and this money included everything—for example, the brass and small tools used in the shop. As to assistance, he might have about one fifth of one machinist (they also had to work on apparatus for instruction) and perhaps one or two inexperienced students.

"I remember spending a day or so with a sledgehammer breaking up a concrete pier—plain ditch-digger's work. And many other days of manual labor. I remember, too, that the very first time I ever met the head of the department of physics, he was painting the laboratory floor."

In recalling a vacuum tank project, Hansen continued: "I had first to learn enough mechanical engineering to be able to produce an adequate design. An annoyance here was the fact that the engineering faculty was acquainted only with the problems of pressure vessels—i.e., boilers. Next I had to do the drawings. Then I had to find someone to make it. This involved several thirty-mile trips to San Francisco, each taking a day. I then became purchasing agent problem, next saw it through the shops of Western Pipe and Steel who made it, and finally took delivery outside the physics department. Next I had to devise ways of moving this ton or so of steel inside and downstairs—without using heavy equipment. Finally, we needed to weld various pipes into the tank. The way to get these joints vacuum tight is to use atomic-hydrogen welding, and suitable outfits for the purpose are sold by GE. But we couldn't afford one, so I had to design and build such an outfit, and had to become a skilled operator with it.

"The above sounds like a lot of work. It was. But it was a big job for us. The price of the tank was \$245.15."

It was thus a notable achievement that a complete design for the tube was produced within a year. During that same year Hansen arrived at his famous rhumbatron cavity resonator design, which would prove so important to the subsequent invention of the klystron. It had occurred to Hansen that high voltages developed in a resonant circuit might be a good way to accelerate particles—perhaps in some similar way to the acceleration of protons by the cyclotron at the University of California at Berkeley. Hansen and his former roommate, Russell, "speculated," in Hansen's words, "on various dodges that might be employed to get the high velocity electrons without using a lot of money." Gradually Hansen gravitated toward the idea that a closed concentric resonant line might be the right solution. As surprising as it may seem now, the idea of a microwave cavity resonator was not yet known and Hansen was exploring the utility of the idea both intuitively and by complex mathematical analysis employing boundary value approaches. Soon, it began to appear that the resonator needed for X-rays would be extremely low-loss and that it could be made to have unusual properties, even at short wavelengths such as centimeter waves, by leaving out the inner conductor of the coaxial line! It is important to recognize that Hansen's search for a low-loss resonator for X-ray applications actually set the stage for the microwave advances that were about to follow—both by inventing the cavity resonator and by developing methods of analysis for a large variety of microwave circuits and devices.

### Recognizing a need for radar

While Hansen and Russ Varian were deep in their physics, Sigurd was finding the excitement of flying beginning to pall. Despite the adequate income and the pride he took in flying Pan American, Sig and his wife realized they wanted a change. After extensive correspondence with Russ about a variety of technical ideas, Sig decided to join Russ and Eric in starting a laboratory at their boyhood home town of Halcyon, 220 miles south of Palo Alto. Initially, the Halcyon laboratory was intended to get the brothers into the business of making optical diffraction gratings. They thought they could employ straightforward kinematic design to develop a new kind of ruling engine without being dependent upon extreme precision for the various parts. But the task soon became greater than they had anticipated and progress slowed.

Meanwhile international events were causing Sig great concern. During 1936 cities were being bombed in Spain and China, and Sig felt there was no way to combat attacking airplanes that might approach a city in bad weather or at night. From his experience as a flyer, he was sure he could find a target in overcast weather and that no enemy ground defenses could ever hope to detect him. He was groping for an answer to this potential danger and frequently discussed it with Russ.

As so often happened in their boyhood, Russ began to think about the problem. From his knowledge of basic physics, he recognized that the only way an attacking airplane could be detected through overcast was by means of radio waves and that accurate determination of direction with equipment of any reasonable size would require radio waves in the centimeter

wavelength region. By mid-1936, it occurred to Russ that Hansen's new resonator—the rhumbatron—might be adapted in some way to generate these waves.

Early in 1937, Russ and Sig began to consider specific requirements for a radar system—as yet unnamed—and the need for a practical source of the centimeter waves became clear. By then, Russ was well aware of the limitations placed upon generation of short radio waves by conventional methods as a result of the difficulties created by building suitable resonant circuits attached to conventional tubes. He knew that at shorter wavelengths the efficiency (or the  $Q$ ) of resonant circuits would be very low, but he did not realize initially that the flight time of electrons in a conventional tube would become even a greater fundamental limitation.

As a result of his collaboration at Stanford with Hansen, Russ was aware of Hansen's development of unusually effective resonant circuits in the form of cavity resonators. Russ thought that if radar requirements for microwave power were to be satisfied some way of employing cavity resonators had to evolve. However, he was dubious about undertaking such a project because he felt it might be too big for the brothers' slender financial means. Nevertheless, by February 1937, Sig's feelings about the importance of doing something to combat airplanes under conditions of poor visibility became so intense that he persuaded Russ, in spite of his misgivings, to come to Stanford and investigate the possibility of continuing their research there. Equipment at their own small laboratory was inadequate, and they also thought Hansen and others at the university could help clarify their thoughts.

Russ and Sig met with Hansen as well as D. L. Webster (head of the Physics Department) and found them most receptive to their ideas. As it happened, both men were amateur pilots and were therefore quick to appreciate the need for aids to navigation and defense.

Russ wrote later that "the credit for starting this project mainly belonged to my brother, since he was the one who was most insistent that this development should be attempted."

### The \$100 research project

Stanford's president, Ray Lyman Wilbur, arranged for the Varian brothers to become research associates in the Physics Department without salary to work on the project. The University would contribute laboratory space and \$100 a year for materials and supplies! The department shops were also to be at their disposal. If any financial returns were to be derived from this work, the proceeds were to be divided equally between the University and the two Varian brothers. Later, Hansen was given a small share of potential proceeds.

This deal turned out to be a great bargain for all concerned. It meant an honest-to-goodness project for Russ, and for Sig an opportunity to pursue an exciting objective with a potential for making some money in the end as well. I can't imagine that in today's world a university would grant the use of its facilities to two unknown young men who wanted to pursue a major objective with negligible resources. As for the

university, it eventually received over \$2½ million in royalties, as well as many fringe benefits from the momentum gained by pioneering microwave research. Much of Stanford's present reputation in electronics and physics can be attributed to the collaborative efforts of these three men and the students who worked with them.

At this point, it is important to recognize that the Varian brothers were not "randomly panning for gold," but knew almost exactly what they were looking for. For instance, they knew that in order to detect an aircraft in darkness and overcast, the signals which would be sent out would have to be radio waves rather than light or something else. Moreover, they would have to be short-centimeter wavelengths so as to make it possible to locate the object with some precision. Physical optics in Russ's training told him exactly the relationship between the physical size of the equipment and the desired wavelength. Furthermore, Russ was able to calculate the power that would need to be available for such a system to detect an object at some reasonable distance. This pretty much spelled out the characteristics of the new type of radio transmitter that had to be developed; now all they had to do was to figure out how to do it. And this was not at all obvious; other people had tried to invent microwave devices without much success.

Some inkling of the proper direction was provided by Russ's realization that one ingredient appeared to be already at hand: Hansen's newly invented cavity resonator. Very soon, however, he realized that there was a major difficulty: the transit time effect. As Russ mentions in his notes, in order to achieve the frequency they were interested in, they would have to eliminate "the trouble caused by the flight time of electrons in the ordinary grid control vacuum tube." Some 20 years later, he recalled, "We spent many hours thinking of all the types of controls that could be used. We very early arrived at one definite conclusion—that a cavity resonator must itself provide the electron control and that the electron control must be of a new type."

While Sig chafed anxiously, impatient to get started (he wrote his wife that "if everything works right, we are on the track of something awfully big"), Russell began to record ideas in his notebook. I have this notebook before me as I write, and I am struck by the fact that it was kept in ink, with a carbon copy, indicating that Russell had a clear realization that the ideas they were exploring might lead to patentable inventions and useful results. A scheme employing Hansen's resonator in the Farnsworth electron multiplier, a secondary-emission uhf oscillator, is examined. Other ideas follow in rapid succession, interspersed with other inventions unrelated to the task at hand, such as a method of electrostatic separation of sand particles!

In April 1937, Hansen conceived the idea of a circular swinging beam tube that would energize the rhumbatron through a series of holes in the rhumbatron along a circular path. This idea looked good enough to start experimenting with and, in May, Sig started the actual work on such a rotary beam frequency multiplier. This introduced Sig to vacuum techniques and the mysteries and frustrations of the vacuum; I remember him saying later that he won-

## Growing up inventive

The roots of many of the strengths and talents possessed by Russell and Sigurd Varian and Bill Hansen were evident in their early childhood. The senior Varians were Irish emigrants who settled in Palo Alto in 1903 when Sigurd was three years old and Russell, five. Their father, John, earned all the money in the family as a professional masseur but he was not licensed and did not have much education. Their economic status was reflective of a gentile poverty that was common in the United States in those years and the family was able to provide a warm and supportive environment for the children. The lack of money was not much of a hardship for the growing boys, but it did require them to build their own toys and to invent. Russ designed many things, such as cigar box planes, which Sig built.

As a small child, Russ and his father were particularly close. Russell's slowness in learning to read and to do simple arithmetic led to difficulties at school, and perhaps because of this, he tended to listen intently to whatever was being said around him. His mother, Agnes, would read to him, and his father liked to expound his political and social theories to him. While Russ made friends and participated in the usual activities of small boys—making models and brewing chemical mixtures—he had the habit of asking lots of questions and he spent much of his time discussing his ideas with his father.

Russell compensated for his slowness in reading by developing a remarkable ability to comprehend what he learned. He often took a long time to read a particular assignment, but what he read, he virtually committed to memory. By the time he reached high school, he was already a real scientist in the sense that he was always asking, "Why?" He would never take a statement in a textbook for granted unless he knew how the author reached a particular conclusion. This was partly because of his skepticism about the depth of research done by the author, but sometimes because he knew that knowledge in a given field is never complete and that there are always loose ends to be thought about and explored.

Because Russell was shy and awkward as a boy, with somewhat of an inferiority complex, I am sure few of his peers or his teachers appreciated his unusual points of view and his uniqueness during his college years. However, later in life, particularly when I knew him between 1939 and 1960, Russ attained a quality of respect and elder statesmanship because of his great breadth of knowledge and his power of synthesis.

When the boys were teenagers, the Varians moved to the small Theosophist community of Halcyon, California, some 220 miles south of Palo Alto. There, they ran a general store and the post office,

and their home became—as it had been in Palo Alto—well-known as a stopping place for a circle of friends that consisted of professional and liberal people—including Fremont Alder and Lincoln Stephens—from the fields of literature, music, art, and politics.

Fortunately for the boys' education, these visitors met frequently in the Varians' living room and talked animatedly on just about every subject of concern at that time—politics, economics, sociology, religion, labor problems, women's rights, women's suffrage, socialism, and education. Russell's widow, Dorothy, relates that Russell often sat in on these discussions, eating up all the ideas proposed, until the inevitable cloud of smoke would get too much for him and he would run around the block a couple of times before returning to listen some more. These discussions, and his parents' own liberal—almost socialistic—ideas influenced Russell very much and contributed to his own liberalism in adult life.

As Russell and Sigurd grew up they developed remarkably distinct characteristics. Sigurd, as described in the main text, was the extrovert and activist as well as the gifted mechanic who would build what Russell designed. Russ took life the way it came, exploring one idea after another—often more interested in thinking up new ideas than in pursuing the development of any given one. On his own, he might not have started the laboratory at Halcyon, might not have moved their joint efforts to Stanford, and perhaps would not have embarked upon the major enterprise of getting Varian Associates underway. But with prodding from his enterprising brother, Sig, he was willing to come along and try projects he was not all that certain of on his own.

Bill Hansen was born in Fresno, California, in 1909. His father had a limited education and had to go to work at the age of 12, but he augmented his education at night school and developed a good knowledge in mathematics and mechanics. Perhaps because of his native bent, the elder Hansen was able to encourage his son in several technical directions. Bill was given mechanical toys to play with but soon began to prefer electrical toys, many of which he made himself. Encouraged by both parents, he filled their house with a variety of electrical equipment which he reworked and with which he experimented. His interaction with his father was particularly satisfying in the area of mathematical problems and games, and this childhood practice developed into an absorbing passion that lasted through his lifetime. Bill Hansen's personal strengths of inventiveness, intuition, and ability to analyze mathematically were later to prove indispensable to the klystron project. E.L.G.

dered at the time that anyone could ever get a vacuum at all.

## Bunching—the thirteenth idea

Many other ideas relating to the generation of microwaves were examined conceptually and, in some cases, mathematically. Bill Hansen was not actually involved in the process of invention but was always available to examine Russ's ideas and was quick to point out their limitations. As weeks went by, so did the ideas until June 5, 1937, when the thirteenth idea was conceived. Remarkably, this was not an extension of previously known concepts, but was a radical departure in the control of an electron stream—the bunching principle combined with the rhumbatron

became the klystron tube.

The steps that led to this discovery were recalled by Russell in a 1957 paper on the history of the klystron:

"One day, after we had thought of a number of schemes, I was occupied in developing a classification for all the schemes we had thought of so that we could systematically investigate them all and not discover later that we had overlooked some of the most promising ones. In the process of developing this classification, I suddenly thought of the velocity-grouping principle. From a psychological viewpoint, it is rather interesting that this attempt at classification actually produced the invention of the klystron. The velocity-grouping principle did not fit any of the schemes of

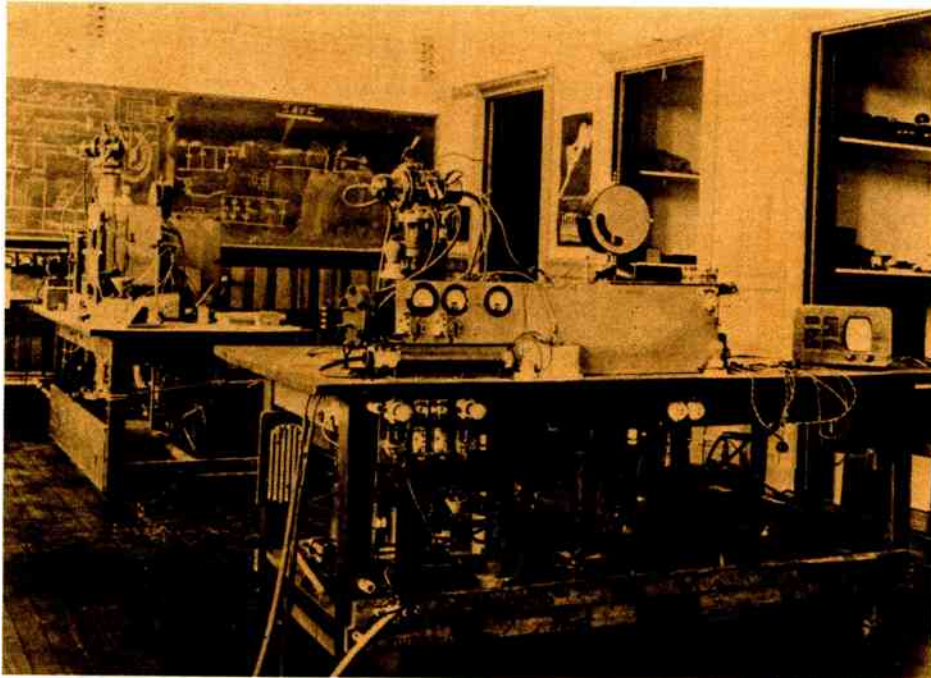

Early photo of the Klystron Laboratory in the Stanford University physics building shows the klystron transmitter and superheterodyne receiver used for the first transmission of klystron-generated signals across the room. Blackboard diagrams of the power supplies are by Prof. D. L. Webster, who did important theoretical analysis of the bunching principle that guided development of the klystron.

classification that I had contrived and I rather think that the idea occurred to me because I was unconsciously attempting to test the validity of my classifications. Hence I thought up an exception to the classification which actually turned out to be the basic concept of the klystron."

Russ explained velocity grouping in his notebook by pointing out that:

"The new method is a sort of grid control, but none of the electrons are prevented from passing the grid. They are merely slowed down or accelerated . . . Under these conditions, the electrons after passing the control grids will have variable velocities depending upon the phase of the oscillating circuit when the electrons went through.

"If the electrons continue in a straight line the accelerated ones will tend to catch up on the retarded ones, and the stream of electrons will transform from a uniform beam to one consisting of a series of concentrations or waves of electrons having the same frequency as the exciting frequency.

"One of the beauties of the system is that a mutual conductance is independent of frequency."

Immediately thereafter, Russ's notebook shows a mathematical analysis of this principle and explains how the mutual conductance and the amplification factor would depend upon the various operating parameters.

### Building the first klystron

How long should it take to transform a new and hazy concept of a device into a design having a good chance of working the first time it is tried? It depends, of course, upon how novel the concept is, but I am still amazed that only a few days of spirited debate followed Russ's conception until he, Bill, and Sig concluded that the invention could easily be transformed into an important device. The design work was started immediately, with Hansen's knowledge of the characteristics of the cavity resonators being an essential ingredient in the design.

What came next has been described by Sig, who wrote (in 1944) that he "remembered June 5, 1937, well because after replacing some fuses with brass pipe he burned up 15 feet of cord and blew most of the breakers in the University power house." His recollection continues:

"The invention of the klystron caused considerable interest about the department. Hansen calculated the dimensions for a 10-centimeter cavity and then we blew the dimensions up to the dimensions that John Woodyard could test with his wooden rhumbatron setup (which consisted of a large wooden box lined on the inside with copper foil).

"Hansen and Russell Varian calculated that the cavity would have to be of the reentrant type and when they furnished me with some dimensions I folded up one out of copper-lined cardboard. Woodyard's test on a model proved Hansen's calculations to be correct. The cavity of the klystron looked so much like a spittoon that it took several months to erase the name from that local nomenclature."

Now that the basic idea had jelled, Sig was able to go to work and construct the actual experimental tube. Here his ingenuity and manual dexterity matched Russ's intellectual concepts in furthering the invention. Tiny hexagonal honeycomb copper grids were hand-filed by Sig (with enormous labor," wrote Hansen later when he could "still recall the hamburger celebration that the completion of the first grid called for"); a cathode was fabricated, machine parts were made of unfamiliar materials, and microscopic adjustments were provided outside of the vacuum to tune the cavities. Vacuum problems were solved—which was not easy. Hansen's 1949 report explains what was involved:

"Perhaps the biggest troubles came from lack of a glassblower. Because of this lack it had become customary around the physics department to make practically all vacuum systems out of sections of flanged pyrex pipe, bolted together along with various fabricated metal sections. This was fine for X-ray tubes,

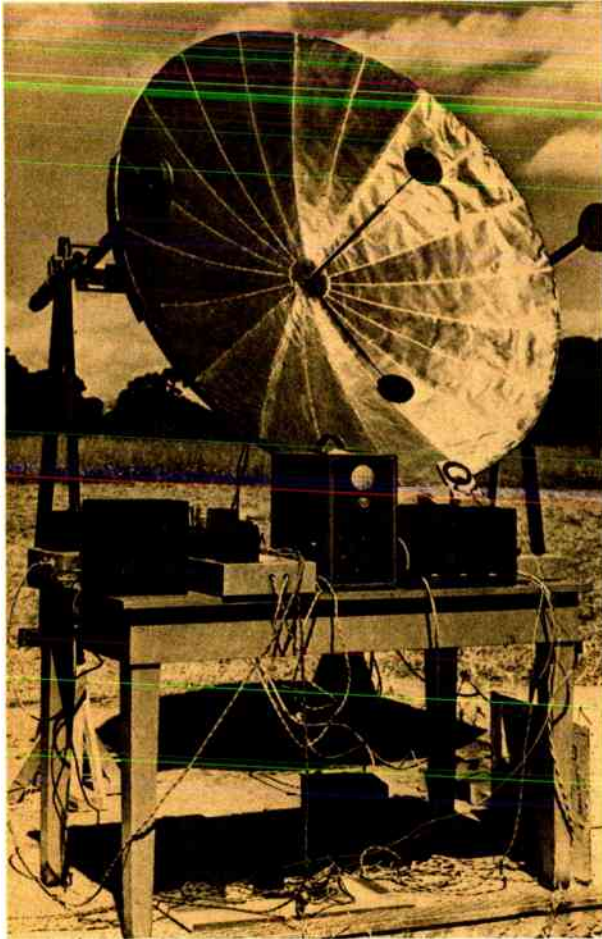

This 1939 Doppler radar was one of the early applications of the klystron at Stanford.

but not very flexible for anything else, especially since the maximum clear inside diameter was only about  $2\frac{3}{4}$  inches. But S. Varian finally devised an assembly with a cathode, two resonators (one adjustable), an adjustable coupling loop, and various other gadgetry, all of which would go inside a flanged pyrex pipe and with all leads and adjustments coming out of the metal and plate. S. Varian made most of this device himself, except for the resonators which were spun in [San Francisco].”

Sig recalled, “I had to water cool about everything in the tube because the diffusion pump I was using was of the original homemade pump type which the Physics Department had built. The pumping speed was nearly nil, any slight source of gas would stall the pump.

“To add a little zest to our experiments, there was a 200 000-volt generator for X-ray use, over my head. Every few minutes, nearly always during our tests, or tense moments, there would be a crack like a rifle and a 200 000-volt arc and myself would jump about the same distance.”

Despite such distractions, in an amazingly short time—about a month—a klystron evolved as a complex mechanical device encased in a vacuum bell jar. The main elements of the newly conceived klystron were sketched by Russ in his notebook under the date of July 22, 1937 (see cover and page 32). It is remarkable that even to this day klystrons do not differ ma-

terially from the initial Varian design.

The total cost involved in building the first tube was just half of their appropriation—\$50, mostly for the power supply condensers! As Russell later pointed out, this made it probably the cheapest project ever completed in microwaves. Interestingly, it wasn’t until their paper, “A high-frequency oscillator and amplifier,” had been submitted to the *Journal of Applied Physics* in January 1939 that they learned velocity modulation had been discovered in 1933 by A. Arsenjewa-Heil and Oscar Heil in Europe.

### How to know it oscillated?

There was one very important problem besides deciding on the type of oscillator to build. That was to find a way of knowing that it oscillated. As Russell described the situation in his 1957 paper:

“None of the measuring instruments now available in the microwave region had been developed, and the only detector we had that could be considered for the purpose was the old galena crystal detectors of early radio. We did not even know that these would function at all at microwave frequencies, and if they did function any meter that we could attach to them would be slow acting and the probability extremely high that we would never detect oscillations. I finally decided that we could allow a small part of the electron beam used to drive the klystron oscillator to pass through a hole in the last resonator and be deflected into a space beyond by a magnetic field so that it would land in a moderately small area of fluorescent screen. This would provide a quick and sensitive detection system for any oscillations which occurred. As it turned out this invention was probably about as important as the klystron invention itself, because without it we probably would never have discovered the oscillations although they would have been occasionally present. The first model we built produced some oscillations which my brother saw on the fluorescent screen, but the tuning mechanism was not capable of going smoothly through resonance and so we were never able to repeat the result. It was about the third model we built which gave reproducible evidence of oscillations.”

The Model A klystron oscillated for the first time on the evening of August 19, 1937. Sig wrote, a few years later, that:

“We observed repeatable flashes on our detector screen, but everything was very unstable and rather disappointing. Cathode emission died and came back with tuning. About August 21, I took the tube off the pump and replaced the tungsten grid wires with copper hex grids and installed a micrometer adjustment to the tuning. This was a major operation. On the morning of August 30, 1937, I was ready to try again. I threw the switch, tuned the tube a little, and there were the oscillations spread all over the fluorescent screen. We dug up an old dime store cat’s whisker crystal detector and a galvanometer and picked up rf energy all over the room. We made a quick check on the frequency by moving the crystal detector through the standing waves in the room. In our excitement we figured the wavelength to be 6.5 centimeters and were very embarrassed later to have to admit we measured half wavelengths or 13 centimeters being the correct wavelength.”

In September, the name klystron was formally adopted. It comes from the Greek verb *klyzo*, expressing the breaking of waves on a beach, and had been one of several words proposed by Prof. Frankel of the Stanford Classics Department.

### “Modern Physics” with Bill Hansen

September 1937 was also the time when I first heard of the klystron. I had just come to Stanford as a graduate student under Frederick E. Terman in the Electrical Engineering Department. The first course I took, Modern Physics, was a new course being developed by Bill Hansen who believed that one useful way of introducing physics to graduate students was to expose them to the ongoing research in this field. Thus, one of the early experiments we were asked to understand and to repeat was the behavior of the rhumbatron which Hansen had so recently invented. Whereas I had been accustomed to circuits with high  $Q$ —perhaps in the vicinity of several hundred—we discovered that a simple metallic container could resonate at unheard of frequencies with  $Q$ 's in the order of 30 000!

I remember Terman telling us about the invention of the klystron tube and of the remarkable properties it was supposed to have. But neither I nor other students heard much more about this, for the idea was not discussed openly because the impending war in Europe had already cast a blanket of semisecrecy in the U.S. What I did hear caused me to be interested but not terribly excited. Perhaps this was because I did not know enough about it, or perhaps because in the mid-1930s, there were a great many other advances in electronics, and important discoveries were being made frequently. For example, just then, a group of us in the E.E. Department were exploring the various aspects of negative feedback; and Bill Hewlett had just demonstrated the utility of the resistance-tuned oscillator, which was soon to be the foundation of the Hewlett-Packard Company.

The fall of 1937 was spent by the Varian brothers on the development of additional models to test the operation of the klystron. By November, the Model B tube (see photo on p. 32) was completed under a bell jar. Now displayed at the Smithsonian Institution, this tube was regarded as a major accomplishment. Since it was easily demountable and could be changed to permit testing a variety of improvements, it gave Russ and Sig Varian and Bill Hansen the means with which to do many of the things they had long wished to do with microwaves. As a result, what had been merely ideas and aspirations quickly became programs with well-defined objectives.

### Putting the klystron to work

During the next two years, two programs became prominent, with lots of subsidiary projects devoted to methods of amplification, detection, and measurement, as well as converting the rudimentary tube structures into devices that could be used in the field. The first program of major importance was the development of a practical radar system—of the Doppler variety. Russ and Bill Hansen developed some ideas about using an oscillating klystron as a detector so that the velocity of a moving object could be detected. Refinements of this idea, using more than one



Bill Hansen working with an early Rhumbatron.

transmitted frequency, were developed to permit the distance of the object to be determined. The second program involved development of klystrons suitable for instrument landing of aircraft; it quickly aroused the interest of the Civil Aeronautics Administration and resulted in collaborative work in this field.

Once it could be demonstrated that the klystron would oscillate, it became imperative to understand its general behavior, establish its electrical characteristics, and explore its utility for useful applications. Only a few people were involved up to this time, with almost all of the model construction being done by Sig. Some additional financial support was obtained and it was now possible, as well as necessary, to employ others—some trained in electronics and others in the art of tube-making.

I was one of only about 16 graduate students in the E.E. Department, where I was working on a thesis on negative impedance. Fred Terman must have recommended me to the Physics Department because early in 1939 Professor Webster asked to see me. He told me about the project in some detail and I became so fascinated by the ideas that when he offered me the job as a half-time research associate I promptly accepted. Although the \$90-a-month salary was great, the job itself—my first—was the main attraction; the opportunity to work on something new and exciting, and to be paid for it, was hardly believable.

John Woodyard, also a student from the E.E. Department, was already working with Hansen, and I became the second professional employee on the project. The duties became considerably more extensive because Sig Varian was again ill with tuberculosis and remained either bedridden or inactive for almost two years. By then Russ had become increasingly involved in patent problems and Prof. Webster in the administrative problems the project presented the University; there was only Bill Hansen to provide technical assistance to the staff—John Woodyard, myself, and two machinists.

By 1939, the general characteristics of klystrons

were fairly well understood and their wavelength and power had been measured by rudimentary means. Now we wanted to test the utility of klystrons in the usual radio circuits, such as master oscillator/power amplifier combinations and superheterodyne receivers, and in Doppler radar and other experimental systems. In addition, ideas for a variety of other klystrons abounded, and much work was done on such things as single-cavity (reflex) klystrons, and klystrons with multiple cavities for use as high-gain amplifiers and/or receivers. We built the klystrons in small batches—two or three at a time—in the basement of the Physics Building, where the Klystron Project maintained a small shop. Most of its equipment was very old, as but negligible funds had been spent on Physics Department facilities over the years. The project did buy one new Monarch lathe and it did have a Litton spotwelder, a Litton glass lathe, two hydrogen bell jars, and a few vacuum systems with hand-made oil diffusion pumps. Despite the rudimentary shop facilities, in the hands of skilled machinists—John Schultz, Don Snow, and one or two assistants—superb vacuum tubes were made even though the act of making them was strictly empirical.

Soon the klystron became not just an individual tube, but a circuit component, and we could explore its utility in a number of conventional combinations. Almost everything we tried—amplifiers, receivers, superheterodyne detectors, etc.—worked immediately and quite well. We were able to demonstrate that almost anything one could do with conventional radio tubes could be done by the klystron at microwave frequencies. In addition to the invention of the klystron, which took about two years to complete, our group was probably the first to demonstrate that it was possible to generate microwave signals, amplify them, detect them, and configure microwave circuits in a way that would correspond to the conventional requirements of ordinary radio systems.

### A search for money

There was one other major achievement during this period: the location of significant financial support! By the time the klystron invention was reduced to practice, the Varians had exhausted their own limited resources and the situation had become critical. In describing this period in 1944, Sig wrote:

“At this time we became more and more worried about the international situation and the danger and tragedy of aggressive air power. We did our best to interest the parties who should have been vitally interested.

“The first serious interest in our tube was furnished by Messrs. I. R. Metcalf and John Easten of the Bureau of Air Commerce and Mr. H. H. Willis of Sperry Gyroscope Company. The Sperry Gyroscope Company was immediately interested [they saw it as a replacement for their search lights] and it was not long until a contract was signed between the Varian brothers, Stanford University, and Sperry Gyroscope Company. Russell and I were happy to be put on a salary as we had been supporting ourselves for over three years on savings we had accumulated.”

Sperry provided about \$20 000 per year for further research on the klystron project and this was sufficient to fund about a dozen of us in a style to which

we had not been accustomed. “With this change,” wrote Hansen, “went innumerable conferences on the business end, all of great future importance. During this period we were all business men, amateur lawyers and patent attorneys in addition to doing our research.”

In the fall of 1940, Sperry asked the entire Stanford klystron group to move to its newly founded Garden City Laboratories. The Varians, Hansen, Woodyard, I, and several others moved to New York to spend the war years helping develop the klystron and related equipment for obvious war-related applications. This period is a whole other story and I will not attempt to cover it here. Suffice it to say that the klystron proved to be an important ingredient in the war effort, teaming up with the magnetron to make microwave radar practical. The Varian-Hansen group also continued its efforts in Doppler radar, and demonstrated the usefulness of this principle, especially in the form of coherent pulsed systems.

Russ had told his friends in 1940 that the move to the East was not to be the end of their ambitions to work in their own laboratory. He said that he and Sig intended to come back and build a research laboratory that would explore new ideas—their own and others developed at universities—and pioneer practical applications for advances in science. After the war, the Varians, Hansen, and almost the entire Stanford group did come back to California, attracting many other capable people with whom they had worked in Garden City. Some of this group came to Stanford either as faculty or as graduate students. Others came to found Varian Associates, in 1948, with six full-time employees and \$22 000 in capital. In this way, Russ and Sig finally fulfilled their ambition to have a laboratory for their own collaboration which could provide a research and development atmosphere for exploring new ideas. By now, the group had enough confidence in its own ingenuity and ability to know that it was certain to continue the process of invention, innovation, and reduction to practice. ♦

This material could not have been prepared without the rich biographical resources provided by Dorothy Varian, who was generous with her time in helping me accurately reconstruct the history of this project and of the three men.

**Edward L. Ginzton (F)** is chairman of the board of Varian Associates, the company he helped found in 1948. He received his Ph.D. in electrical engineering from Stanford University in 1940, after having been a member of the Varian Brothers—Hansen group where, as described in the article, he contributed to the development of the klystron. In 1941, he and the rest of this group transferred to the Research Laboratories of the Sperry Gyroscope Company, where he remained throughout World War II. In 1946, Dr. Ginzton returned to Stanford where he became Professor of Applied Physics and Electrical Engineering. From 1949 to 1959, in addition to teaching and his other academic responsibilities, he was director of the University's Microwave Laboratory. From 1956 to 1961, he also directed the project to design the two-mile 20-BeV electron accelerator. He was president of Varian Associates from 1964 through 1968 and has served as board chairman since 1959. He received the IEEE Medal of Honor in 1969.

# LEDs: digital domination?

## Light-emitting diodes proliferate as gas-discharge and liquid-crystal digital readouts find special niches

Only five years ago, few visible light-emitting-diode (LED) devices were used as instrument displays, and liquid-crystal displays were largely a laboratory curiosity. Gas-discharge, fluorescent, and incandescent readouts constituted the majority of instrument display devices then. Today, the venerable "Nixie" tube, the prototypical gas-discharge device, is still in use. And its successors continue to offer high readability and low cost. However, over one half of all instrument types now use LEDs and that fraction is growing and, according to most major instrument manufacturers interviewed by *Spectrum*, will continue to grow.

At the same time, improved liquid-crystal displays have made significant inroads into portable, field, and outdoor-instrument applications. They are finding increasing application in instruments with such special requirements as very low power dissipation and high ambient-light conditions. Gas-discharge displays and recent large LEDs provide visibility over long distances (required in production-line or monitoring applications).

### A bright future for LEDs

The most exciting developments in LED technology involve improvements in LED output light levels and quantum efficiencies. This has been made possible through recent nitrogen-doping techniques—the normal growing of GaAsP (gallium-arsenide-phosphide) on GaAs substrates using a vapor-phase epitaxial process is done by nitrogen-doping GaAsP on GaP. Results have yielded LEDs with luminous efficiencies many times greater than that of LEDs made by processing GaAsP on GaAs (Fig. 1). Different colors such as green, yellow, and orange, in addition to the conventional red, have been possible. The liquid-phase epitaxial process of GaP on GaP, developed at Bell Telephone Laboratories produces even more efficient green LEDs and higher output intensity levels.

As can be seen from Fig 1, the vapor-phase nitrogen-doped red-color LEDs peak in response around 6350 Å, a shift toward the orange color of the spectrum, compared to previous reds. Some of the newer orange LEDs are more efficient, hence contribute lesser amounts of electromagnetic interference since the energy levels to be switched are lower.

The LED display's principal advantages are its reliability of several years, its low cost, and its compatibility with TTL and MOS circuitry. It can operate with standard 5-volt logic power lines. For some instruments where absolute reliability is a must in an often hostile and rugged environment, the LED is the only choice. In an effort to decrease parts count, monolithic LEDs are being made—particularly among

displays with 0.1-in (0.25-cm) to 0.12-in (0.3-cm) heights—to be driven directly from MOS circuitry without the usual buffer drivers.

To get around the large costs of the LED materials in displays larger than 0.1 in (0.25 cm), the light-pipe technique is often used, especially where low cost is an overriding factor. Here, magnifying lenses or light-pipes are placed over an LED die. This technique also serves to improve the display's appearance by diffusing the light, at a tradeoff in output brightness levels and luminous efficiencies.

### Gas-discharge displays are alive and well

Two things have kept the gas-discharge display in competition for instrument applications: its high brightness and readability, even in direct sunlight, and its low cost. The latter advantage is fast being challenged, however, with 0.3- to 0.5-in-high (0.75 to 1.27 cm) LEDs selling for only \$0.35 to \$0.40 more per digit than the \$1.90 to \$2.10 cost (moderate quantities) of multichromatic gas-discharge displays.

Since the gas-discharge technology has been around the longest, devices made from it have demonstrated lifetimes in excess of 10 000 hours of operation, corresponding to several years of usage. However, the basic drawback of this type of display is the high voltage necessary to initiate the gas's (usually neon) ionization—typically, 170 to 200 volts dc. Some IC driver/decoder circuits for gas-discharge displays are more vulnerable to breakdowns, since the technology of manufacturing high-voltage ICs is not as advanced as that of low-voltage ones. And gas-discharge displays produce radio-frequency interference in nearby components, necessitating shielding.

Nevertheless, there is an effort underway to reduce this high voltage by redesign of the display's internal structure of anode and cathode, though no significant results have yet been produced. Another effort involves experimentation with coating different phosphor materials on the inside of the display's envelope. These powder-like coatings allow higher display efficiencies (by glowing from otherwise wasted ultraviolet radiations), in addition to making possible multicolor operation. Given the proper gas-phosphor mixture, any one of a range of colors may be possible by simply varying the ionization potential. Newer planar displays eliminate the "stacked-character" look of older Nixies, whose 0.76-cm depths made for narrow viewing angles.

### The changing face of liquid crystals

At first glance, liquid-crystal displays would appear to supersede all other types of instrument display. They're low in cost (potentially lowest in cost); they are very bright (brightest in direct sunlight—for reflective types); they are simple to manufacture and



## I. A comparison of leading digital-display technologies for instrument applications

Type	Power Dissipation (per digit)	MTBF*	Operating Temperature Range	Cost (per digit)	System Cost (per digit)
LED	50-500 mW	>20 000 hours	-55 to +100°C	\$0.50-\$2.50	\$1.00-\$3.50
Gas-discharge	50-500 mW	>20 000 hours	-30 to +70°C	\$0.75-\$1.90	\$1.50-\$3.00
Liquid-crystal	10 $\mu$ W to 15 $\mu$ W	5000 to 15 000 hours	0 to +70°C	\$0.35-\$2.00	\$0.85-\$2.75

\* Mean-time-between-failure

can be made in very large sizes; they dissipate extremely little power; and they are IC compatible. But liquid-crystal displays also have their limitations, some of which are a direct result of the liquid-crystal material's properties. Chief among these limitations are temperature constraints and shortness of life.

The newer field-effect liquid-crystal displays are improved over the conventional dynamic-scattering ones in operating-temperature range. Still, the best temperature range possible is 0 to +70°C. At the extremes of this range, a liquid-crystal display either slows down (lower-temperature end) or washes out (highest-temperature end), and its operation may not be satisfactory to all viewers, depending on an individual's patience. Liquid-crystal displays used in portable field instruments (due to their very low power dissipation) can freeze up in extreme temperatures. However, they resume operation once the ambient temperature is increased sufficiently.

One area of improvement has been the viewing angle, which is now at about 110 to 120 degrees for dynamic-scattering types. However, looking at a liquid-crystal display from different angles provides the viewer with a number of contrast levels. This factor is what many users would like to see improved.

The field-effect process, though slightly more expensive to implement than the older dynamic-scattering one, has certainly made possible lower-voltage displays (from 12 to 18 volts down to 3 to 6 volts), lower power dissipations (from 10 to 100  $\mu$ W per  $\text{cm}^2$  to 0.1 to 1  $\mu$ W per  $\text{cm}^2$ ), and longer lifetimes (from 5000 hours to 15 000 hours).

A major disadvantage of a liquid-crystal display is that it requires a switching circuit for each of its segments, making for complex drive circuitry. Liquid-crystal displays must be driven with ac signals. DC signals shorten a liquid-crystal display's life to one or two thousand hours. And liquid-crystal displays respond slowly to rapid signals.

### How they compare

Table I provides a quick look at how LED, gas-discharge, and liquid-crystal displays compare for instrument applications, for heights ranging from 0.3 to 0.5-in (0.75 to 1.27 cm)—average display heights for most instruments.

Note that the overall display system cost, including associated electronics and ancillary components, must also be looked at for a more valid comparison. And comparisons can vary considerably, depending on application of instrument and display height. At heights of less than 0.3-in (0.75 cm) for hand-held portable instruments, LED and liquid-crystal displays have the edge, since gas-discharge displays are generally not manufactured in sizes much below 0.3-

in (0.75 cm). Large heights of 0.6-in (1.5 cm) on the other hand are likely to be fulfilled with gas-discharge and liquid-crystal displays, since LED costs in such sizes are generally higher. The recent availability of LEDs in 0.6-in (1.5-cm) heights at competitive prices may change this situation, however.

The most striking difference among all three technologies is the amount of power dissipation per dis-

[1] Higher luminous efficiency and a shift toward the orange are results of vapor-phase nitrogen-doping LEDs. This involves growing GaAsP (gallium-arsenide-phosphide) on GaP. The same process without nitrogen yields LEDs with lower efficiencies and longer wavelengths. Conventional methods of growing GaAsP on GaAs result in even lower luminous efficiencies. The relative amount of GaP within the GaAsP/GaP compound is indicated by "X". Liquid-phase growing of GaP on GaP, not shown, produces even more efficient and intense green LEDs.

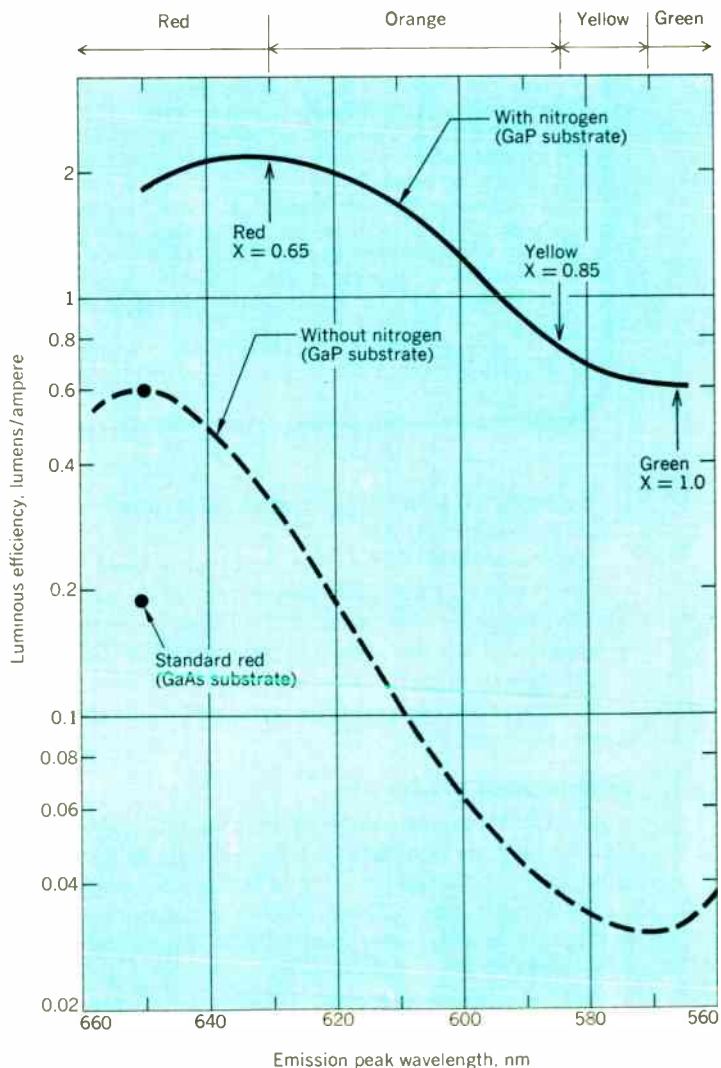

## A user sees LCDs in the future

As a manufacturer of instruments that use all three leading types of displays, Digilin, Inc., of Burbank, Calif., was asked for its assessment of the future of liquid-crystal displays (LCDs) in instruments. Here is what its president, E. B. Hibbs, Jr., had to say:

LCDs are here to stay. While they may never be an overnight sensation, they definitely have applications in instruments where very low power consumption and large display character height are important considerations. Life tests have already proven them to be highly reliable devices, with lifetimes of 100 000 hours or more of operation being projected.

As late as two years ago, LCDs were a controversial state-of-the-art type of display. Today, a variety of consumer products such as watches and calculators along with many instruments are using them. Nevertheless, LCDs are still not widely understood. Their advantages warrant our attention. Their successful use involves many considerations.

Because of its extreme simplicity (see illustration), the LCD is inherently very reliable. This is true for dynamic-scattering as well as newer field-effect types. Construction of an LCD is simple. All that is required is a 1-mil-thick (0.025-mm) layer, or less, of liquid-crystal material sandwiched between two sets of glass plates (two polarizers at right angles to each other for field-effect types). Characters are formed by clear conductive segments being etched from the clear conductive tin-oxide coating on the glass plates. This simple process does not require any bonding or metal-glass feedthroughs, as required in other display technologies.

LCDs are either transmissive or reflective in operation. Former types have a light source mounted behind the display, with light being transmitted through the liquid-crystal material to the viewer. Reflective types have a mirror finish behind the liquid-crystal material which collects ambient light and reflects it back to the viewer.

LCDs are the only displays that can be driven directly from MOS ICs and are voltage compatible with such circuits. Because they cannot be multiplexed, they must be driven in parallel, and hence are most useful for applications requiring up to four digits.

A number of MOS ICs are commercially available to drive LCDs in the ac mode at 50 to 200 Hz, over a

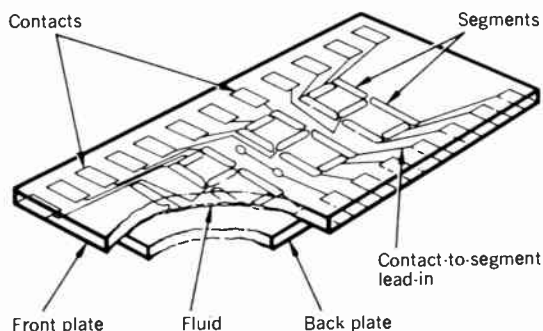

Liquid-crystal displays are inherently simple to construct: a layer of liquid-crystal material is sandwiched between two glass plates (two polarizers, in the case of field-effect liquid crystals), with no bonding or metal-glass feedthroughs required, as in other display technologies. The characters are formed by etching clear conductive segments from a conductive tin-oxide coating (Source: Hamlin, Inc.)

5- to 25-volt range. A misconception is that dc drive signals can cause sudden LCD failure. Such failure is the direct result of the liquid-crystal material's deionization. If anything, dc drive signals increase the material's ionization. What dc drive signals do, is to degrade slowly the LCD's life, by continuously degrading its aesthetic look. It should be noted that this method of life-shortening does not cause erroneous readings of the nature that other displays provide, when a burned-out or inoperative segment provides a false numeral.

Improvements are still wanting in LCD operating-temperature ranges. To some degree, increasing the magnitude of the ac drive signal compensates for the LCD's tendency to respond to drive signals slowly, at very low temperatures of 0°C or less.

Character heights for LCDs can be quite large, even larger than gas-discharge ones, at little or no penalty in price, with viewing distances up to 6 meters (20 feet) possible. The fact that raw liquid-crystal materials are plentiful and relatively inexpensive (per-digit prices are now competitive with those of LEDs) should ensure future price competitiveness with other display technologies.

play segment, with liquid crystals substantially ahead with a mere 10 to 15  $\mu$ W.

One very important factor is not mentioned in the table, since no easy quantitative or qualitative method exists for its evaluation. That factor is human acceptance. A display may have the greatest technical attributes on paper, but in reality it may be rejected by the user as not very pleasing to look at, or short on aesthetic qualities.

## Displays of the future

At the moment, nearly all instruments utilize numeric (and some alphanumeric) readouts as displays, but the information content is limited to roughly 30 characters at most. The exception is the oscilloscope, which by its very nature has a CRT display with analog signal-trace information.

The increasing invasion of instruments into non-technical fields, and the concurrent increase in instrument front-panel complexity, increases the likeli-

hood that future instruments will make use of a CRT- or alphanumeric-panel readout to simplify instrument use, not only in oscilloscopes, but in many other types of equipment. Not all instrument manufacturers agree on this point, however; some foresee the opposite—simpler instrument readouts of a few light point sources for easy decision-making by the operator.

A big future looms for plasma-panel displays such as the Burroughs Self-Scan and Owens-Illinois Digi-Vue systems. These monolithic planar panels fall between alphanumeric and CRT-type displays in resolution, having about 250 000 resolution elements. The key is whether or not such displays can be made at a low enough cost for applications in instruments. ♦

Reprints of this article (No. X75-021) are available at \$2.00 for the first copy and \$0.50 for each additional copy. Please send remittance and request, stating article number, to IEEE, 345 E. 47 St., New York, N. Y. 10017, Attn: SPSU. (Reprints are available up to 12 months from date of publication.)

# Fixing BART

## A "million-dollar" backup for the automatic train protection system stems from BART's "Blue Ribbon Panel" report

Depending on who you talk to, the BART saga thus far is seen either as a tragedy or, at best, a mock epic. Avid *Spectrum* readers have followed the chronicle from design and development to the surprise accident of October 2, 1972, when a crystal oscillator in the automatic train operating (ATO) subsystem transmitted the wrong speed command and a BART train overran the Fremont station, plowing into a sandpile installed for just such a circumstance. The chapters following that episode have delineated investigations and reports, suits and countersuits (the most recent, BART's \$237.8 million damage suit against its consultants and suppliers). But BART rolls on, as does its saga, and this month's chapter deals with retrofits, or how engineers have "edited" a mock epic in hopes of transforming it into an unqualified epic. The principal problems and disagreements centered on the original procurement procedures and on the selection and implementation of the automatic train control (ATC) system. Even now, as a \$1.3 million backup system to BART's primary train protection subsystem is being installed, Westinghouse stands firm in its insistence that it is an unnecessary elaboration.

### Westinghouse reminisces

Now that the dust has settled and BART is operational in full-route service—though still falling short of the original specifications in terms of train headways—*Spectrum* asked Westinghouse Electric how the original specs came about. The answer came from Woodrow E. Johnson, vice president and general manager of Westinghouse's Transportation Division in Pittsburgh (where BART's ATC system, its traction motors, etc., were built), from engineering manager Howard N. Miller, and from marketing manager Allan C. Sanderson. The three men recalled that BART and Parsons-Brinckerhoff, Tudor, Bechtel (PBTB), BART's design consultants, advertised in the early 1960s that special vehicles would be run on the Diablo test track to "demonstrate new concepts" only. Various companies, including General Electric (GE), General Railway Signal (GRS), Westinghouse Air Brake (WABCO), Westinghouse Electric, and, later, Philco-Ford, were invited to demonstrate their propulsion and ATC schemes. The first of Westinghouse Electric's ATC systems was based on its "Skybus" monorail concept for Pittsburgh. (This ATC was modified and adapted to control vehicles running on the Diablo test track in 1964-65.)

From the test track experience, a preliminary composite ATC specification was drafted to incorporate "any or all ideas demonstrated (on the test track), but *not* limited to test track experience." Thus, the

competing suppliers could bid on concepts not demonstrated. PBTB completed this preliminary spec in 1966 and submitted it to prospective suppliers for comment. The spec was revised, based on industry comments, and as a consequence, Westinghouse Electric eventually bid, on the basis of the final modified PBTB spec, to build an ATC system somewhat different from that tested on the track.

Westinghouse points out that the PBTB performance-oriented spec described "in minute detail" the interlocking system in accordance with Association of American Railroads (AAR) standards and the sequentially operating ATC (command and control) system. It did not describe, however, items such as signal frequencies, data rates, or specific electronics components to be used. Westinghouse further contends that schedule constraints did not permit time for building a complete station prototype for testing on the BART property. (The Westinghouse control system, demonstrated on the test track, was based on a "wiggly" wire or "Greek square" wire pattern with check-in/check-out detection logic. This concept did not meet the requirements of the PBTB specifications.) A continuous-detection closed-loop system was therefore proposed for BART, with blocks varying in length from 46 to 336 meters (150 to 1100 feet), and elements of such a configuration—but not the complete system—were demonstrated.

Westinghouse still believes that the PBTB specs for the ATC, along with some additional required interpretations provided by PBTB, were generally acceptable, though with certain qualifications: for example, the overall ATC spec was deficient in describing the interfaces with other equipments—namely, those for the vehicle, route and destination signs, station electrification, and yard signaling. A case in point: the spec on ATC during deceleration called for a rate of 4.8 km/h/s (3 mi/h/s). But a slippery track could reduce this rate to 3.5 km/h/s (2.2 mi/h/s) and thereby reduce the separation distances required to prevent collisions.

According to Westinghouse's Dr. Johnson, PBTB felt that, for true implementation of ATC, the train's cab attendant should not "be given more information than he needs"; otherwise, he would tend to "fall back on manual operation modes." However, Westinghouse disagreed with this viewpoint and requested, on several occasions, that additional signaling information be provided to the train cabin attendant.

As far as fail-safe design criteria philosophy is concerned, Westinghouse felt that a uniform, industry-wide method for design evaluation had to be set up. According to Westinghouse recommendations, uniform industry failure-mode definitions would be established; then, standardized evaluation techniques would be used to verify that these failure modes had

---

**Gordon D. Friedlander** Senior Staff Writer

been properly accounted for by the designer. The next decision would be to determine what circuits needed to be fail-safe. (In the PBTB specifications, train vehicle doors and programmed stops were not required to be of fail-safe design.)

The performance specs for BART stipulated a specific approach toward the implementation of fail-safe design. And this was reinforced by the requirement to submit the preliminary and final designs to PBTB for approval. In turn, PBTB relayed the fail-safe design proposals to the Battelle Memorial Institute for evaluation and comment.

### Bugs, gophers, and gremlins

To Westinghouse, the difficulties that began to snowball from that point could not have been foreseen. Since BART represented a new control concept in mass rapid transit, very little off-the-shelf hardware was available. This caused fabrication problems and subsequent delays in equipment installations. And, back in 1971, there were system integration problems along the four-station route (Hayward-Fremont) where static station equipment was being interfaced with the running laboratory test car.

Some of the initial problems included on-board terminal cabinet installation "foul-ups," lack of coordination between subcontractors, and circuit errors in the startup (laboratory) car. Furthermore, there was the headache of insufficient protection for the communications cable laid along the right-of-way, especially along sections at grade. Gophers found the insulation a tasty supplement to their normal diets;

thus, the contractor was obliged to bury the cable in gunitite-filled trenching. This, in itself, set back schedules by several months.

On top of all this was a massive debugging effort to eliminate numerous problems on the first six prototype cars delivered from Rohr. So the original "circulation" deadline for the prototype cars of June 11, 1971, along the system was delayed until November 1971. To close the gap of the interfacing problems encountered in the laboratory test car, two sets of revised car-borne electronics equipment were provided for two of the prototype cars. Then, in December 1971, a "human error" collision of the two cars required the rebuilding of this electronics equipment.

When the first production cars were delivered in 1972, it was discovered that the undercar circuit layouts differed from those of the prototype vehicles. This injected new troubles into an already complex situation: retrofitting was required, plus a complete new testing series before the rolling stock could be placed in revenue service. Also, there was a noise problem from third-rail ripple.

The set of acceptance test procedures were prepared by the contractors (Westinghouse Electric, Rohr Industries, etc.) and were submitted to PBTB for comment. Procedural disagreements were then ironed out between PBTB and the contractors, and the acceptance tests were supervised by PBTB. All subsequent test data requirements (except reliability) were met and accepted by PBTB before the provisional acceptance for initial revenue service of the Fremont line (Oakland-Fremont), inaugurated on Septem-

David Cochran and Leonard S. Cutler of Hewlett-Packard (left) demonstrate the function of the SOR added logic backup system on a specially constructed "Lionel Lines" scale model. The actual SOR system is now installed on the BART lines to provide logic backup to the existing train detection and protection system.

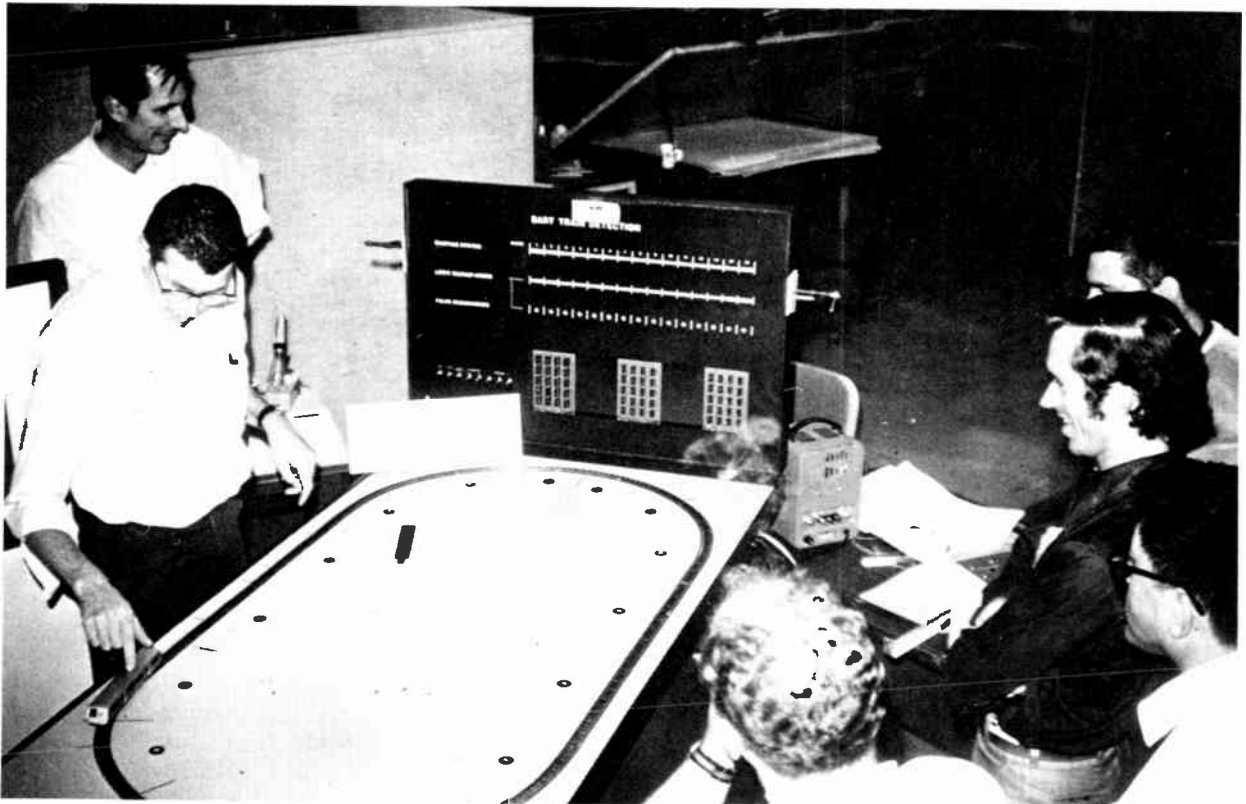

ber 11, 1972. Then came the accident, about three weeks later, at the Fremont Station.

### The pressure builds for retrofit

As might be expected, the immediate reaction of the companies involved, following the accident, was to level accusations. Representing the BART view, Lawrence Dahms, BART's acting general manager, since the July 1974 resignation of B. R. Stokes, and William Rhine, director of engineering, insist that there was inadequate shakedown time before the initial inauguration of revenue service in 1972, and BART operating personnel had insufficient training time for the handling and monitoring of the very sophisticated electrical and electronic equipment. Both men feel that Westinghouse nevertheless bears a contractual responsibility for the satisfactory functioning of the ATC system and other equipment provided by this supplier.

Westinghouse's Dr. Johnson, on the other hand, looks beyond the immediate cause (the faulty crystal oscillator) to the nine-week-long strike at Rohr Industries in late 1971 (resulting in an estimated 36 weeks of lost production time), which seriously impeded vehicle delivery schedules. Since BART was "pushing hard" to get more cars in revenue service, car running problems increased and reliability decreased. Furthermore, the A-unit (head end) car involved in the crystal malfunction had bypassed the acceptance test. On the evening before the accident (October 1), this vehicle was operated for the first time as part of a two-car train; the operator/attendant reported to the BART control tower at Hayward that the car "was running too fast." However, at that date, the tower did not have timely reporting procedures and the report was not relayed. Thus, the next morning (October 2), this hot-running car was mated with a different consist—and what happened at Fremont is now part of BART's historical experience. Therefore, considering the events leading to the accident, Westinghouse feels it bears no responsibility.

The public, for its part, as well as its representatives, has been less concerned with placing blame than with ensuring no further hazardous accidents. The first in a series of investigations and reports was that done by State Legislative Analyst A. Alan Post, and released in November 1972. The popular press next reported that the prestigious Battelle Memorial Institute had prepared a detailed safety analysis on the BART ATC system in 1971, and alleged that this document was being suppressed by BART management. Then, in December 1972, the California State Senate Public Utilities and Corporations Committee commissioned the "Blue Ribbon Panel" (*IEEE Spectrum*, Apr. 1973, pp. 40-44) to draft its findings in relation to the shortcomings in the ATC system, and to provide recommendations for fail-safe operation retrofit.

### Retrofits, redundancy—and more reports

After the Senate panel report, one of the first retrofits was to provide a second (redundant) crystal oscillator in all A-unit vehicles. One of the subsequent retrofits, to assist in the shunting of the low-voltage track signal from one rail (so that a following train will receive a signal not to approach the train ahead

at less than safe-braking distance), was the installation of off-the-shelf cast-iron mechanical wheel scrubbers. The purpose of the scrubbers was to scrape off the electrically insulating dirt from the wheel surfaces to permit the signals to be adequately shunted.

To this day, Westinghouse says that, although this was a conventional procedure used in conventional railway systems, the BART scrubbers were improperly installed and did not even contact the wheels, a contention that Bernard M. Oliver, Hewlett-Packard vice president of R&D disputes as "absolutely not true."

Then came the third, and most elaborate, attempt at retrofit, Hewlett-Packard's \$1.3 million sequential-occupancy-release (SOR) backup system, devised as an outgrowth of the Blue-Ribbon Panel report of 1973. Explained in simple terms, the SOR is a firmware logic addition to BART's primary train protection subsystem. Shown on the facing page is a photo of the SOR scale model that was designed and built by Leonard S. Cutler (F) and David Cochran (M) of Hewlett-Packard Laboratories, and the staff of H-P's industrial design department. The model layout contains 15 blocks (simulating a sector of BART system signal blocks). On the "BART Train Detection" panel-board (center) are three illuminated scales: the top one represents the signal status—red, amber, or green—that would be transmitted (by the ATC system) digitally, as speed equivalents, to the on-board console in the train attendant's head-end cab. Lights representing the speed signals, with the SOR backup overlaid, are shown in the center scale. Fault occupancies are shown in the bottom scale.

BART's early testing experience demonstrated that, on occasion, the automatic train protection subsystem intermittently lost the ability to detect dead cars in various zones or blocks on the line. It was determined, after extensive testing, that the installation of the SOR modification, with a check-in/check-out function, would solve the intermittent failure problem by adding a logic memory layer. Mainly, the SOR would ensure that once a train had been detected, the track circuits would remain logically locked up, maintaining train protection even if detection were subsequently lost. The track circuits are unlocked (or released) only when the train is positively detected by the primary system in the next block in which such detection can occur (if the next block has a false occupancy, such detection will be two blocks down the track). The train must still "hustle" through the false occupancy in manual control, but its rear end remains protected by the SOR system.

BART and Hewlett-Packard expect the \$1.3 million SOR, being installed by Westinghouse, to be completed by the time this article is distributed. A patent will soon be issued to Hewlett-Packard with a royalty-free license to BART.

### l'Envoi

Despite its construction, shakedown, and startup traumas—plus legal unpleasantries that may take years to resolve—the BART system has won widespread public acceptance as a viable (and preferable) alternative transportation mode for thousands of Bay Area commuters, shoppers, and the throngs of visitors and vacationers who are magnetically attracted to that jeweled setting of the West Coast. ♦

# Creative electric load management

## New tools for the utilities include rate options, clock-actuated switches, radio control, and ripple control systems

The Wisconsin Public Service Commission has ordered the Madison Gas and Electric Company to devise a rate structure in which its customers would pay for electricity at a rate closely related to the cost of producing and supplying it. In New England, the Central Vermont Public Service Corporation has introduced a rate option in which electricity used from 8-11 a.m. and from 5-9 p.m. costs six times more than that used outside these hours. What is behind these moves?

In the existing transition period between an era of abundance of relatively inexpensive electric energy and one in which energy of all types is scarce and expensive, increasing emphasis is being placed on techniques which improve the efficiency of generation, distribution, and usage of electricity. Such techniques are the basis of what is called electric load management or the programming of certain load segments, such as electric water heaters, for the purpose of smoothing out undesired variations in the demand for electricity.

### Old vs. New

Until now, U.S. utilities have largely followed a policy of making certain that enough generating capacity is available to meet the demands of the "rush hour." This objective has been met by having a sufficient reserve of water, oil, or gas-powered "peaker generators" which can be made to supplement the so-called base-load and intermediate-load generating capacity on relatively short notice. Now, however, the increasing fuel costs of the "peakers," as well as the high capital costs of additional generating capacity, are making it more and more attractive to look for ways of shifting some of the load from the peaks of the load curve into the valleys.

Load management techniques become attractive economically to a utility in order to increase the utilization of base-load generation capacity. In addition, with a significant portion of the load under remote control, it may be possible to reduce the requirements for generating equipment for "spinning reserve," since load reduction inherently increases this reserve. Remote load control also increases system security since some of the load can be removed for short time periods in the event of a loss of major generating units or transmission lines, while quick-start equipment is brought on line or emergency assistance is obtained from other companies.

Some U.S. utilities have either installed, or are now in the process of installing, fairly advanced load-management hardware systems. And regulatory agencies, as well as the utilities, have shown increasing interest in new rate structures which more adequately represent the various components of the cost of electricity; e.g., generating capacity, fuel, distribution, and service. To the extent that the new rates reflect the higher costs of supplying electricity during the hours of peak demand, it is hoped that they will induce the customers to use electricity in such a way as to smooth out the load curve. Whether or not this works out in practice remains to be seen.

### Deferrable loads

One basic requirement for load management is the existence of a deferrable load such as an electric water heater. How long such a load can be disconnected from the supply voltage without inconvenience or hardship to the customer depends on a number of factors, a very important one being the energy storage capacity of the load.

In the U.S., household water heaters represent at present essentially the only load segment having a substantial energy storage capacity. The volume of a typical water heater tank is about 190 liters (50 gallons), which is sufficient to avoid any great inconvenience to the customer under normal usage, if the heater is disconnected from the supply only for a few hours. Since the average diversified demand of a water heater during peak hours is about one kilowatt, a utility with 200 000 water heaters under control could thus reduce its load during the rush hour by about 200 megawatts.

In Europe, where load management techniques have been used for years, utilities and government agencies have encouraged the development of another load segment with a large energy storage capacity—electric storage heaters. These heaters consist of an attractively packaged and well-insulated pile of magnesite bricks which are heated electrically to a temperature up to 700°C during off-peak hours. Electric storage units for individual rooms include a fan and an air-mixing device to keep the air emerging from the unit at a roughly constant temperature as the central core cools down during the day. Operation of the hot-air fan is controlled by a room thermostat. The amount of energy stored in the unit is determined by a temperature sensor placed in contact with the outside wall and is proportional to the heat loss from the room to the outdoors. In addition, a control knob is provided for manual adjustment of the amount of stored energy.

---

**Thomas Laaspere, A. O. Converse**  
Dartmouth College

In the newest Siemens line, for example, the individual room units have a standardized height of 65 cm and a depth of 25 cm. The width depends on the heat capacity and varies from 59 to 123 cm. The rated charging times are 6, 8, and 10 hours. The charging power depends on the charging time and on the unit's heat capacity and ranges from 1.6 to 8 kW. The cost of a typical individual room unit is from \$200 to \$300. European manufacturers also produce storage heaters which are designed for use with central heating systems.

In Europe, energy to the electric storage heaters is supplied almost exclusively during the nighttime hours, with perhaps only a daytime boost. At least initially, when excess base-load generating capacity is available at night, this makes the storage heater load a more desirable one for a utility to control than water heaters, which can be deferred for only up to a few hours.

In addition to the fuel-cost savings effected when some of the electric heating load is shifted from peakers to base-load generating units, introduction of storage heat in a winter-peaking system would also reduce the requirements for new generating capacity. Estimates for these costs range from about \$45 to \$100 per kW per year, depending on whether one refers to the peaker-based capacity or to the average cost of the generating capacity. To equip a new house with storage heaters rather than with direct-heating baseboard units, when the average heat loss is 15 kW on the coldest day, would entail an incremental cost of about \$2000. This cost is equivalent to \$133 per kW or, when financed at 9.5 percent over 20 years, about \$15 per kW per year. Since the latter figure is less than that of the cost of the peaker-based capacity, the attractiveness of storage heating in relieving pressures for additional generating capacity becomes apparent.

If a large day-night differential rate is made generally available to encourage the use of storage heat to fill in the nighttime valley in the load curve, a situation may soon arise whereby the utility is faced with the reverse problem of developing a nighttime peak. Under such circumstances, the large day-night rate differentials introduced earlier no longer make sense. Some European utilities have, in fact, had to defend in court the restrictions they were impelled to impose on further growth of the storage heating load.<sup>1</sup>

It may be unwise to encourage the use of electric storage heating in the context of a standard time-of-day rate structure. A better approach might be to offer electricity for storage heating under an agreement custom tailored to each new storage heating customer. Time-of-day differentials should be limited to those uses of electricity which are controlled directly by the customer. This is, in fact, the policy now followed by the Central Vermont Public Service Corporation.

### The clock option

Assume that a utility has in its system a deferrable load which it wishes to place under control. What options does it have available, and at what cost?

In the simplest approach, each individual load unit is turned on and off automatically by a clock-actuated switch. This is one approach that is already used by U.S. utilities to control the water heater load.

In another approach, also already in use by some utilities in the U.S., the water heater tanks are equipped with two heating elements, each having its own thermostat. In the tank, where the cold water enters at the bottom and the hot water is drawn from the top, one heating element is located near the top of the tank, the other near the bottom. The thermostat of the upper element is set at around 55°C, that of the lower element about 5°C higher. The upper element is connected permanently to the supply voltage but a clock-actuated switch disconnects the lower element during preset time periods. During these times, power is used to heat water only when the temperature in the normally hottest top layers of the water falls below the temperature setting of the top thermostat.

The main advantage of systems using control clocks is their simplicity, which is reflected in the relatively low cost of the hardware. The present cost to the utilities of the basic residential single-phase watt-hour meter produced by U.S. manufacturers is approximately \$20. The same meter with built-in, clock-actuated, on-off switch costs about \$50. A two-register watt-hour meter with built-in, clock-controlled switch used in association with a two-element water heater costs about \$75.

The main problem with systems involving large numbers of control clocks is a low degree of reliability and a lack of flexibility. For example, clocks often need adjusting.

To make a change in the on-off times of the controlled load, each clock must be manually reset, which is a time-consuming, costly process. An administrator from the Central Vermont Public Service Corporation has estimated that the resetting of the clocks in their largely rural network requires an average of about half an hour, or \$5, per clock. With some 23 000 clock-controlled water heaters in their system, it would require thousands of manhours and cost tens

Diurnal variation of electric power consumption in the network of the Central Vermont Public Service Corporation on the peak demand day of the 1972-73 winter season (January 8, 1973). Peak demand: 367.8 MW. Outside temperature: -22°C at 08 hours, -20°C at 18 hours.

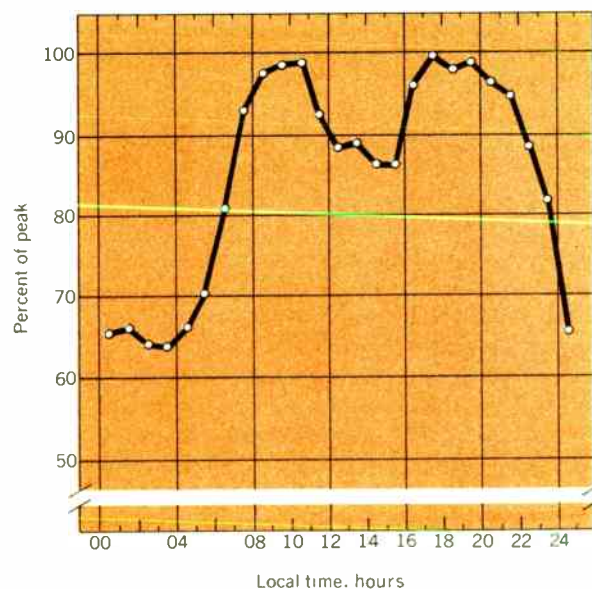

of thousands of dollars to change the on-off time of even only a quarter of the water heater load.

Clock-controlled load management systems are not suitable if adjustments in the control schedule are called for by seasonal changes in the load curve or by changes in switching from standard to daylight saving time. Another indication of the inflexibility of such systems is that the clocks normally operate on a 24-hour cycle. The load is turned off even if this is not necessary, such as on weekends and holidays, although weekend overrides are available on some utilities' systems.

Since the clocks run on line power, power outages shift (delay) the on-off times of the load. An extended power outage in an area involving a large controlled load may shift the on-period in such a way as to pose a serious problem for the utility. The situation is improved by providing the electrically driven clocks with a mechanical (spring) backup. The addition of a 10-hour carryover adds about \$20 to the cost of the meter.

### The ripple control option

In western Europe, and also in many other countries in different parts of the world such as Australia, New Zealand, and South Africa, ripple-control systems are in widespread use.

In this method of load control, a coded narrow-

---

## Time-of-day differentials should be limited to those uses of electricity that are controlled directly by the customers.

---

band (1-10 Hz bandwidth) AF signal is introduced into the power grid at the intermediate or the high-voltage level. This signal conveys switching commands to receivers placed at the desired locations at the low-voltage (consumer) end of the network. Thus, a utility control center is able to turn on or off the consumer's water-heating system. The amplitude of the control signal voltage is typically between one and two percent of the line voltage. The term ripple derives from the fact that if the line voltage were viewed on an oscilloscope, the higher-frequency control signal would appear as a small-amplitude ripple on the line-voltage wave form.

Since the transmission lines have been designed to operate at the frequency of ac power (50 Hz in Europe, 60 Hz in the U.S.), it is clear that the propagation characteristics of the control signal should be best the closer its frequency is to that of the ac power. On the other hand, some separation between the power and the control frequencies is required to filter out the control signal in the presence of high-amplitude line voltage. Also, for satisfactory operation of the ripple control receiver, the most important factor is not the absolute amplitude of the control signal, but its amplitude relative to that of all interfering signals, among the more important of which are the harmonics of the line voltage. For these reasons, the lowest control frequency used in Europe is just above the third harmonic of the ac power frequency. In Germany, the ripple-control systems have been as-

signed a number of channels between the frequencies of 183 and 750 Hz.

There are basically two methods of introducing the ripple control voltage into the power grid. In one method, the control voltage is placed across the line, i.e., in parallel with the load. In the other, the control signal is coupled in series into the network by a current transformer. Each method has advantages and disadvantages. The choice between the two is determined mainly by the impedance characteristics of the line. In general, parallel injection is used when the impedance of the network looking upstream (toward the generating end) is high compared to the load impedance. Series injection is used if the reverse is true. (Note that if the upstream impedance were low and parallel injection were used, the control signals would be shorted out by the low impedance at the generating end. Conversely, if the upstream impedance were high and series injection were used, most of the control signal voltage would appear across the high upstream impedance and not across the load as desired.) To complicate matters, the network impedances depend on the signal frequency. It follows that even in a given network, the method of injection (parallel or series) may be determined by the choice of control signal frequency.

In conjunction with a policy of encouraging the development of a storage heater load, the Central Vermont Public Service Corporation is acquiring a ripple-control test facility of European manufacture. The system will use parallel injection of a 220-Hz control signal on the low-voltage side of a 115/46-kV transformer. To reach the consumer, the ripple control signal in the network will have to pass through two transformers, one of which reduces the voltage from 46 to 12.5 kV, the other from 12.5 kV to 240 and 120 volts.

To cover the same number of customers, the ripple control hardware is considerably more expensive than that of a clock-controlled system. This is because, in addition to the individual receivers needed to decode the control message and provide the switching function, a ripple control system also requires a central control facility and a number of transmitters to inject the control signal into the network. Cost of the injection equipment depends on many factors and varies widely, but is of the order of \$1000 per MVA of installed transformer capacity.<sup>2</sup> A hypothetical utility, with 100 000 customers and an average of 5 kVA of transformer capacity per customer, would have to pay about \$500 000 for the injection equipment to cover the network. If this equipment were installed to control 20 000 water heaters, the ripple control receivers would cost approximately an additional \$100 per receiver for a total of \$2 million. The combined cost of the transmitters and receivers would be about \$125 per water heater customer. The cost of any new metering equipment, or the modification of the existing meters, would have to be added to these figures to arrive at the total cost of the ripple control system. It should be noted for comparison that if 20 000 basic residential watt-hour meters (costing about \$20 each) were replaced by meters incorporating a clock-actuated on-off switch (about \$50) with ten-hour carryover (about \$20), the incremental cost of the hardware would be  $(\$50 + \$20 - \$20) \times 20\ 000$  or \$1 million.



The main appeal of ripple control load management systems is their flexibility and reliability. Depending on the type of sending end equipment and the coding scheme used, the number of different command messages ranges from a couple of dozen to thousands. The transmission time of a message may be as short as a few seconds. The messages can be

---

## In western Europe, ripple-control systems are in widespread use.

---

sent manually, whenever necessary, or automatically, according to any predetermined schedule. As a further step in the degree of control, a ripple-controlled network can be turned into a closed-loop system by using a computer, or a similar device, to monitor the network status via hardline connections to the appropriate monitoring points in the network, and to initiate automatically the transmission of the appropriate commands.

In Europe, one of the most important uses of ripple-control systems is in the control of the charging times of electric storage heaters. Ripple control signals are, however, not only used for load management purposes, but also for a variety of other functions. These include control of lighting (streets, monuments, public buildings, and display windows), remote switching of multiple rate meters, etc. Since the injected control voltage is present at every wall socket, ripple control equipment could, in principle, also be used to transmit alert signals to "plug-in" receivers of volunteer firemen, policemen, members of the National Guard, etc. In addition, ripple control signals can be used by the utility in the execution of various functions in its own distribution network, such as the shifting of loads from one feeder to another, the closing and opening of circuit breakers, the switching in and out of capacitor banks, the switching of voltage control devices, etc.

The main European manufacturers of ripple control transmitting and receiving equipment are Landis & Gyr, Zug, Switzerland; Compteurs-Schlumberger, Montrouge, France; and Zellweger, Uster, Switzerland. The receiving equipment is also manufactured by other companies, such as Siemens of Germany.

Several U.S. companies apparently sense that load management and ripple control may become a widespread technique in the U.S. as well, and are planning to enter the field. General Electric, for example, is working on the development of a two-way control and communications system, including the capability for automatic meter reading, using the power grid as the communications medium. American versions of the ripple control systems with automatic meter reading capability have also been announced by American Science and Engineering, Inc., of Cambridge, Mass., whose work has been supported by General Public Utilities, and by the Automated Technology Corporation of Hackensack, N.J. The technical details of these systems are still sparse, but it appears that the American approach has been to employ frequencies higher than those used in the systems of European manufacturers. Higher frequencies

are desirable to make the transmitting equipment of the two-way system at the customer end smaller and less expensive. On the other hand, use of higher frequencies in general also increases the signal loss in passing through the transformers and along the transmission lines. The control signals in the American ripple-control systems are for this reason apparently designed to pass at most through two transformers. (In some European systems the control signals go through as many as four step-down transformers.) The high-voltage portion of the network is bypassed by hardline (or microwave) links between the central control facility and satellite stations distributed throughout the network. Use of frequencies much higher than 60 Hz is made possible by the fact that as the control signal frequency is increased and normal transformer action ceases, it is replaced to a certain extent by capacitive coupling between the primary and secondary windings.

A system (RETROBIT) for transmitting information via the power grid from the low-voltage end to the medium-voltage substations is now being tested by Zellweger. The system uses a frequency between the second and third harmonics of the line voltage. It has been developed primarily for network control and supervision.

### The radio control option

In principle, the transmission of control messages via radio waves offers even more possibilities than ripple control. This is because in contrast to ripple control, which is limited to the relatively low frequencies not too far above the 50 or 60 Hz for which the network has been designed, radio transmissions can be made at much higher frequencies where wider bandwidths, and thus higher information rates, can be employed. As a practical matter, it must be recognized, however, that the electromagnetic spectrum is already overloaded with users so that the designer of a radio control system works under severe limitations when considering the choice of the system's operating frequency and bandwidth.

The principle of radio control is simple. Radio transmitters are placed in suitable locations to cover the network by a sufficiently strong signal. The transmitted waves are modulated by some code containing an address for selecting the desired receiver group, as well as the control message itself. At or near the location of the load under control, a radio receiver detects and decodes the message and performs the switching function as in the case of a ripple-control receiver.

One load management hardware system that puts

### I. A comparison of existing load management systems

Type	Flexibility	Reliability Level	Approximate Cost of Hardware per Customer
Clock switch	Low	Low	\$30
Clock switch with carryover	Low	Medium	50
Radio	Medium	Medium	90
Ripple	High	High	125

these ideas into practice is manufactured by the Motorola Company and is designed to operate somewhere in the 150-174 MHz land-mobile radio band, using normally the frequency of 154.46375 MHz. The RF bandwidth is 0.002 percent—i.e., about 3 kHz at 154 MHz.

Whereas ripple control systems in effect use a type of pulse code modulation, the Motorola system utilizes tone modulation in which the transmitted RF wave is frequency-modulated by a short burst (about 400 milliseconds) of a sinusoid lying between 150 and 1000 Hz. The receiver performs the switching function only if the received tone matches the preset frequency of the receiver's tone filter. About 50 different modulating frequencies or channels are used, which could control 50 different load groups.

The Motorola receiver is normally in one of two positions. In the ON position, upon receipt of the proper tone, the receiver changes to the other (OFF) position for a nominal 7-minute period. After this time has elapsed, the receiver automatically reverts to the normal (ON) position. It follows that to keep the load turned off for more than a few minutes, commands must be transmitted repeatedly. This feature of the receiver does, however, prevent the load from being disconnected for a long time by a faulty transmission or an interfering signal. The timers which control the OFF period have been built from components which have only a  $\pm 20$ -percent tolerance. This means that while the nominal time-out period of a receiver is 7 minutes (this could be increased to about 30 minutes if desired), many receivers turn themselves back on earlier and later than this. A sudden instantaneous addition to the network load is thus avoided.

Motorola's system is being used by the Detroit Edison Company to control the load of about 200 000 water heaters. An additional system is now being installed, also for control of water heaters, in the area served by Buckeye Power, Inc., of Ohio.<sup>3-4</sup>

According to Motorola, their receivers respond to a minimum signal level of about  $20 \mu\text{V/m}$ , and can be reached by a 250-watt transmitter out to a distance of about 32 km in relatively flat terrain. The Detroit Edison System uses 10 transmitters, the Buckeye system started initially with 15. It should be noted that the Motorola system operates just below the frequency band assigned to television channel 7 (174-180 MHz). The signal in the Motorola system thus has essentially the same propagation characteristics, and may be subject to the same problems (such as shielding by hills and high-rise buildings) as the upper VHF TV channels (channels 7-13).

The cost of the Motorola receiver with a built-in receiving antenna and a switch operating a 30-ampere relay is comparable to that of a ripple-control receiver. According to Motorola, the transmitters cost "less than \$5000 apiece," and while this figure does not include the cost of the site, central control unit, and the communication link with the central control, it is clear that in an area with a high customer density, the cost of the radio transmitting equipment per customer will be considerably less than the cost of the ripple control injection equipment that would be required to cover the same load. The cost of the Buckeye Power System has been estimated to average only about \$90 per customer. For the control of a limited

number of load groups in areas having a relatively high customer density, the Motorola system appears to be an attractive alternative. On the other hand, it is probably true that for the execution of a more complex schedule of command functions including street lights, multiregister meters, electric storage heaters, etc., ripple control with its separate on and off commands and its greater immunity to interference, would be preferable. The characteristics of these methods of control are summarized in Table I.

### Other possibilities

Since phone service is provided to a large percentage of the households, it has been suggested that phone lines be used as a one- or two-way medium for the electric load management signals. There is no question that this would be technically feasible, but the interfacing of the phone and load management systems may turn out to be more expensive than some of the alternative control systems, primarily because of what the phone companies feel they must charge. There is also the problem of incomplete coverage of the electric load and the question of which utility should have priority over the lines. These problems make it unlikely that phone lines will be used for load management purposes in the foreseeable future. The same reasoning applies to the possible use of the one-way cable systems which are now used for the transmission of TV and FM signals. Two-way cable television systems would offer a wide range of possibilities, including automatic meter reading, but it is clear that the practical implementation of the so-called wired city idea still lies far in the future. ♦

This article has reported one aspect of an NSF-supported study of load management and the use of electric energy. The study involves the Vermont Public Service Board, the Central Vermont Public Service Corporation, the University of Vermont, and Dartmouth College. The authors are especially grateful to R. V. deGrasse at VPSB, G. Laber at UVM, and to G. Cook, J. Mullen, K. Pierce, and L. Senecal at the CVPSC for their assistance.

### REFERENCES

1. Borstelmann, P., "Die elektrische aus der Sicht des Elektrizitätsversorgungsunternehmens (EVU)," *Bulletin des Schweizerischen Elektrotechnischen Vereins*, vol. 17, pp. 994-998, Aug. 19, 1972.
2. Kniel, R., "Economics of ripple control installations for consumer load control," *Zellweger Impulses No. 4*, pp. 5-8, May, 1973.
3. Roberts, R. L., "Load factor improvement through radio controlled diversity," presented at the 1973 Rural Electric Power Conference, Minneapolis, Minn., Apr. 30-May 1, 1973.
4. "A new way to control a utility's load factor," *Business Week* (industrial edition), pp. 28E-28H, Aug. 24, 1974.

Thomas Laaspere (M) is a professor of engineering at Dartmouth's Thayer School of Engineering. Although his main research interests and publications have been in the area of electromagnetic-wave propagation, he is currently involved in problems relating to energy and resources.

Alvin O. Converse is also a professor of engineering at Thayer and has been interested in the technical aspects of public policy problems. He has published in the areas of fluid mechanics, optimization, and economics.

# Generating speech spectrograms optically

**Coherent optics speeds analysis of speech samples; it's five times faster than older methods**

The electronic sound spectrograph, a basic tool for analyzing and recording spectral composition of audible sound, was developed by Bell Telephone Laboratories about three decades ago. Since then the electronic sound spectrograph has been widely adapted by specialists in linguistics, phonetics, speech pathology, psycholinguistics, speech synthesis, and speech recognition. It has been used in training the deaf, in acoustically analyzing blood flow and even jet engine noise (to detect mechanical fatigue through abnormal vibrations), and, by police, to identify individuals through "voice prints." The instrument, which displays analyzed signals in frequency vs. time on electroinsensitive recording paper (frequency intensity is indicated by the degree of blackening of the paper), may eventually prove a powerful tool in applications as varied as voice-operated typewriters, supermarket checkout registers, and airport baggage-handling systems.

Now, continuous, near-real-time generation of speech spectrograms, potential extension of frequency range in speech analysis, and flexibility in data handling is offered in a new speech spectrogram generator using a coherent optical information processor. The spectrograms are obtained on a photographic film, and an input speech signal can be processed within an access time (delay between input signal and output spectrogram) of less than a minute. The delay depends mostly on film processing and transportation techniques, with the actual optical processing performed in almost-real time. Conventional speech spectrographs require about five minutes to process a speech sample of 2.5-second duration. Other speech-analyzing systems, including, sometimes, small or medium-size computers that can generate speech spectrograms by using a fast-Fourier-transform technique, need the same amount of time for similar processing. The optical technique used in the speech spectrogram generator described here permits the analysis of signals having frequency components within the ultrasonic or very-low-frequency ranges, and the system is capable of examining large amounts of data continuously throughout the processing.

In the spectrogram generator, portrayed in principle in Fig. 1, an acoustical signal is translated into an optical pattern by means of a z-modulated cathode-ray tube and a sawtooth generator. The optical pattern is recorded on a continuously moving photographic film. Following fast processing, the continuous film is inserted in the input plane of a coherent

optical processing system. The Fourier transform of the input-plane pattern is obtained at the output of the optical processor and the intensity of the spectrum is recorded on a moving film, through a narrow slit. The desired spectrogram is obtained from the developed film. The output of the optical processor can also be picked up by a vidicon television camera for immediate television display, or fed into an analog-to-digital converter for further automatic processing of the input acoustical signal.

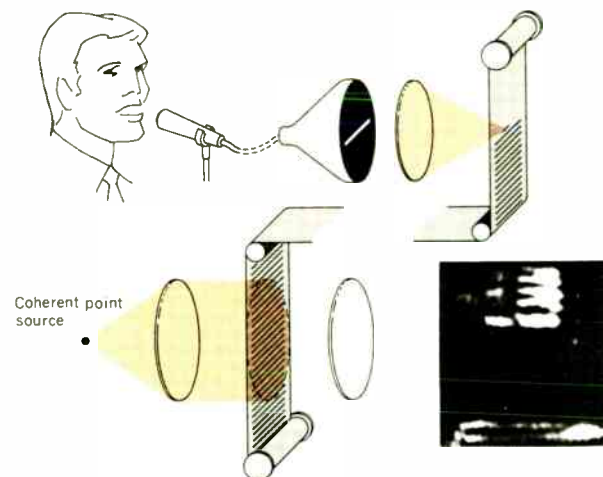

[1] Continuous generation of speech spectrograms by coherent optical processing.

[2] Slowly moving film transparency with bar pattern representing input signal is used as an input to the optical analyzer. Transparency is illuminated by coherent, plane wave.

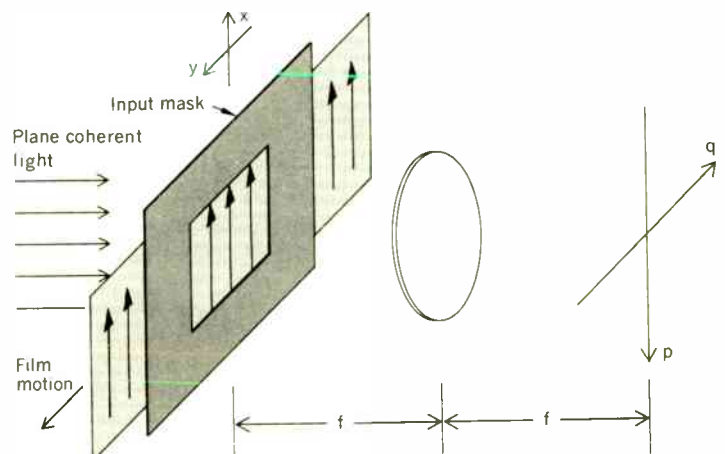

Francis T. S. Yu Wayne State University

## Speech modeled, analyzed, and displayed

In speech production, two different types of sound are distinguished: a *voiced* sound, represented by a quasi-periodic impulse excitation, and a *noise-like* sound, where a noise excitation takes place. Vowels are typical voiced sounds whereas fricatives, like the sound created when, for example, "s" is uttered, belong to the second category.

Spectrally, voiced sounds exhibit "formants"—resonance frequencies—that depend on the vocal-cavity configuration. For example, the voiced sound in the vowel of the word "all" has the formants 570, 840, and 2410 Hz. In addition, in voiced sounds, a "pitch-period" can also be defined as the period between two successive excitation impulses (of the vocal cords). The total output spectrum of a voiced sound is therefore made up of those harmonics of the fundamental frequency (pitch) that are within the neighborhood of the vocal-cavity formants. For unvoiced sound, the output produces a noise-like signal that has no unique spectral line.

Needless to say, during real speech, the vocal tract cannot be assumed to be in a fixed position, as it varies from one sound to another. If, as is commonly assumed, the variation of the vocal tract is not very rapid, then a short-time stationary linear model is commonly acceptable. The spectral envelope of such a model is similar to the amplitude spectrum of the linear model, employed to represent the acoustical cavity of the vocal tract in stationary voiced speech sounds.

In the short-time stationary linear model, frequency and time resolutions are interdependent. For example, if the system bandwidth of the model decreases, the frequency resolution at the output increases, and spectral lines are

therefore evident. But at the same time the output may lose its ability to follow instantaneous variation of excitation. On the other hand, if the system bandwidth increases, then the output response will have a better time resolution, but may lose its ability to resolve the spectral lines. To get "the best of two worlds," separate narrow-band and wide-band analyses are usually employed in speech analysis performed with spectrographs (see text on p. 51). Typical narrow bandwidth used in sound spectrographs is 45 Hz, whereas the wide band is usually around 300 Hz.

Speech spectrograms made by electronic spectrographs have a significant variety of characteristics, depending mainly on the bandwidth of the analyzing filter. Narrow-bandwidth spectrograms (see Fig.) show narrow spectral lines that represent the harmonic frequencies of the vocal-cord excitation. If, on the other hand, a wide filter bandwidth is used, broad spectral bands are displayed, with some vertical striation, which represents instantaneous variations of vocal-cord excitation. Voiced and unvoiced speech can also be identified in spectrograms. In voiced portions, distinct, continuous, relatively thin black traces, representing the formants, can be seen, whereas a patchy pattern, "smeared" over a wide frequency range, is characteristic of noise-like segments.

**Typical narrow-band speech spectrogram obtained by conventional electronic speech spectrograph, of the phrase: "Optical generation of speech spectrograms," spoken by a male voice.**

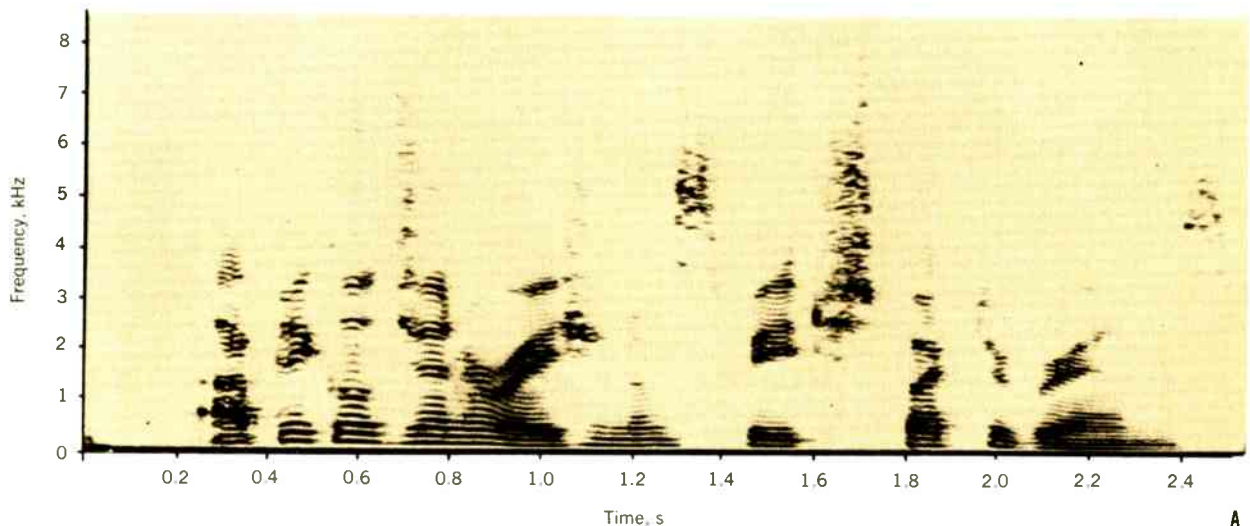

The optical information processor is based on a conventional optical spectrum analyzer, using a double-convex lens with equal focal lengths and a coherent, plane light beam. In this analyzer, the light pattern at the "output" focal plane, called the "spatial frequency domain," is the spatial Fourier transform of the analyzed transparency pattern in the "spatial domain"—the "input" focal plane, when this pattern is illuminated by coherent, plane light.

### Signal translated to optical pattern

To analyze an analog signal, such as a voltage representing pressure variations caused by speech, a scanning and recording mechanism, translating the electrical signal into an optical pattern, must be

added to this basic optical system.

To accomplish this purpose, the signal is applied to the z-axis of a cathode-ray tube (CRT) scanner, or to an intensity-modulated laser scanner. The velocity of the scanning electron-beam is assumed to be sufficiently high so that the highest speech frequency of interest can be resolved. It is also assumed that the return sweep of the electron-beam is sufficiently fast, compared to the inverse of the highest frequency of interest, so that the scanning will appear continuous. This scanning signal is then recorded on a narrow strip of slowly moving photographic film.

After the recorded film has gone through a proper development process, the film transparency is inserted in the input plane—the "spatial domain"—of a co-

herent optical processing system (Fig. 2). The complex light field at the “back” focal plane of the transform lens—the “spatial-frequency domain”—is the Fourier transform of the input transparency.

### Understanding optical patterns

The key term in analyzing optical transparency patterns is “transmittance”—the ratio of transmitted to incident light flux. To understand the analyzer’s operation, we first assume that the film at the input focal plane is static. Let’s now examine the light pattern obtained at the output focal plane—the spatial frequency domain—in a very simple case, when the input speech signal is a pure sinusoid. If the frequency of this signal is exactly  $k$  times the CRT scanning frequency, then exactly  $k$  cycles of the input sinusoid are recorded in each scanning, with the recorded sinusoid always in phase. As a result, the film transparency contains exactly  $k$  vertical sinusoidally varying transmittance bars across the strip of the recorded film. When this strip of transparency pattern is inserted in the input plane—spatial domain—of the optical processor, it acts like a diffraction grating, producing, at the back focal plane of the analyzing lens, “sequences” of periodic light spots. Different groups of light spots correspond to different “orders” of diffraction.

One spot, caused by the average (“dc”) transmittance, is present in all types of analyzed film transparencies, right at the “center” of the back focal plane—that is, at the origin of the  $pq$  plane in Fig. 2. This is the “zero order” spot. In the pure sinusoidal input case, in addition, two pairs of side spots, in anti-symmetry with respect to the  $pq$  origin (marked 1, 1', 2, 2' in Fig. 3), also appear in the light pattern in the  $pq$  plane. These four spots, stemming from the two-dimensional character of the analysis (similar to the two, positive and negative, Fourier components of a pure sinusoid in one-dimensional analysis), correspond to the “first order” diffraction effect.

But the “input” transmittance pattern, in the pure sinusoidal case, consists of a large number of vertical lines, according to the scanning mode, causing the appearance of many pairs of periodic light points, indicating higher-order diffraction effect, in the  $q$  spatial frequency direction. The separation in this direction between light spots of adjacent “order”—for example, between the first- and second-order spots—is inversely proportional to the distance between two

adjacent lines in the recorded scanning pattern (in the input,  $xy$ , plane in Fig. 2). For speech analysis, however, only first-order spectral light spots are used, as the higher-order ones have a much weaker intensity.

If the input frequency of the speech sinusoid is slightly increased, adding less than half a cycle per scanning line, the sinusoidal transmittance pattern of each vertical bar on the input ( $xy$ ) grating will shrink slightly in the  $x$  direction and the bar transmittances will not be in phase any more. The overall effect of such frequency shift is a “tilt” in the transmittance bar pattern of the spatial input grating in the  $xy$  plane (Fig. 2).

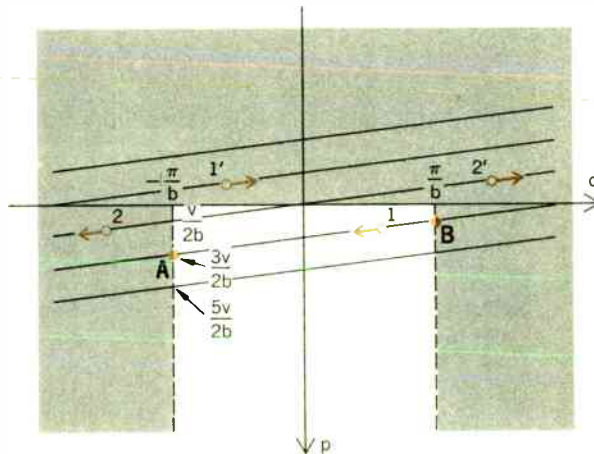

[3] Locus of light spots at the analyzer’s output plane—the “spatial frequency domain”—is a family of straight lines, whose separation is proportional to electron beam speed  $v$  of CRT scanner. This separation is also inversely proportional to the distance  $b$  between vertical bars in the input transparency of the optical analyzer. Four first order light spots (marked 1, 1', 2, 2'), obtained from a pure sinusoidal input signal and included as examples, will move in directions indicated by the arrows, as the input frequency increases. The shaded area indicates output masking (see text, p. 55).

[4] Bar pattern recorded from CRT scanner on film, when frequency of pure sinusoidal input to CRT’s  $z$ -modulation axis is exactly three times the CRT’s sawtooth frequency. The axis of this “grating” pattern will move clockwise or counter-clockwise, depending on whether input frequency is increased or decreased.

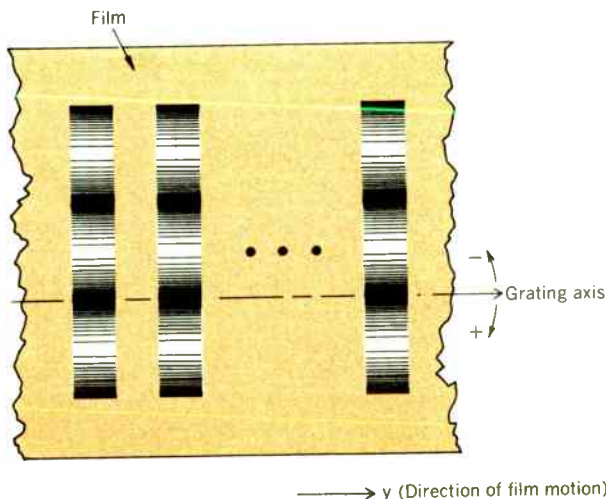

### For further reading

Optical technique for generation of real-time spectrum of large bandwidth signals is discussed by C. E. Thomas in *Applied Optics*, vol. 5, pp. 1782-1790, Nov. 1966. The same technique, applied to wide-band radio waves, was demonstrated by B. V. Markovitch in his paper, “Optical processing of wide-band signals,” 3rd Annual Wideband Recording Symposium, Rome Air Development Center, April 1969. More recently, optical methods for synthesizing sound spectrograms were offered by Prof. Yu in his paper “Synthesis of an optical sound spectrograph,” in the *Journal of Acoustical Society of America*, vol. 51, pp. 433-438, Feb. 1972.

## Image recording for coherent optical processing

In Prof. Yu's speech spectrogram generator (described in the text on pp. 51-56), the bottleneck that slows down the entire system is film processing and transportation techniques. The instrument could generate spectrograms or process input speech much faster if those stages were bypassed, or at least shortened.

Many alternative methods to those used by the author, to record either electrically or optically, image information for coherent optical analysis, now exist, but very few devices applying those methods are commercially available.

Selected technologies and devices for recording image information, in a manner suitable for coherent optical analysis are included in the following tables. These two tables are based on information included in David Casasent's papers in *Optical Engineering*, May-June 1974, pp. 228-234, and in the *Proceedings of the Society for Information Displays*, third quarter, 1974, pp. 131-139. Photographic

method is included in Table II for comparison. Some of the devices portrayed can operate relatively fast (about 30 frames/s), and the erasing time of one of them, the  $KD_2PO_4$ , is about 1 ms, which makes the device suitable for real-time optical information processing.

A wide range of resolution is encountered. Generally, the resolution of electrically addressed light modulators (EALMs) is lower than that in optically addressed light modulators (OALMs), and this is expected to remain so, mainly due to technological limitation in reducing the cross section of the electron beam or the electrodes in the device. Electronic addressing, on the other hand, offers the advantage of ease of modulation and higher intensity than with its optically addressed alternative. For better understanding of the tables, explanatory notes follow the table on optically addressed light modulators.

Gadi Kaplan

### I. Typical electronically addressed light modulators for coherent optical analysis

Category of Target Material	Physical Mechanism of Modulation	Addressing Method	Resolution (lines per mm X linear dimension of the device, mm)	Type of Modulation	Comments
Membrane light modulator	Deformation of membrane layer by electrostatic forces	Electrodes	500	Phase	Writes one row at a time; one-dimensional row-select addressing only; low percentage ( $\approx 5\%$ ) modulation only.
PLZT (hot-pressed mixture of $PbZrO_3$ , $PbTiO_3$ , and La)	Electrooptic effect in ferroelectric ceramic <sup>1</sup>	Electrodes	128	Phase	Electrical and optical fatigue (image destroys gradually); limited lifetime <sup>2</sup> ; non-uniformity problems, low contrast; microsecond switching at relatively high voltage ( $\approx 250$ V); crosstalk problems. <sup>3</sup>
Acoustooptic	Interaction of ultrasonic waves with light	Ultrasonic transducer	(note 4)	Phase	One-dimensional modulation only; no storage possible.
Liquid crystal	Dynamic scattering of light <sup>4</sup> ; field effect and many others <sup>5</sup>	Electron beam and electrodes	150	Amplitude <sup>7</sup>	Requires special (Schlieren) optical system; too slow for real-time operation, limited storage time.
Thermoplastic	Deformation of target by electrostatic forces	Electron beam	1800	Phase	Limited lifetime (100 000 cycles only); requires heating; slow (2-second) erasure.
Oil film	Deformation of target by electrostatic forces	Electron beam	800	Phase	Limited lifetime; erased by itself (by charge decay); storage and real-time operation not simultaneously obtainable.
$KD_2PO_4$	Linear electrooptic effect (Pockel's effect)	Electron beam	1000	Phase	Cooling to $-50^\circ C$ required for stated resolution; 30 frames/s operation possible; relatively fast erasure (within 1 ms) by secondary electrons.

Such tilt can be best visualized by using the concept of "grating axis"—the imaginary line connecting points of, say, corresponding transmittance maxima on all vertical bars of the spatial domain pattern in the  $xy$  plane. When input sinusoid and scanning frequency relation is an exact natural number, grating axis is parallel to  $y$  axis in input plane, whereas in the increased input frequency case, the grating axis tilts in a clockwise direction (Fig. 4).

Detailed analysis shows that when the input signal frequency is increased, the spectral spots at the spatial frequency ( $pq$ ) plane move along parallel straight lines—the "frequency loci" of these spots. According to theory, the slope of these straight lines is propor-

tional to the velocity of the scanning electron beam. For example, in Fig. 3 two of the "first order" spectral spots (1 and 1') move both toward smaller absolute  $q$  but larger absolute  $p$  values, as the frequency of the input signal increases.

Now, if the input frequency increases so that exactly 0.5 cycle is added in each successive scanning, then the transmittances of successive lines in the  $xy$  input transparency, will be apart by  $\pi$  radians. Two pairs of light spots will now share the loci of one. However, one pair will be heading toward larger absolute  $q$  values whereas the other one will be moving "inward," toward lower absolute  $q$  values. For example, when the spot number 1 (of the 1, 1' pair) in Fig. 3

## II. Typical optically addressed light modulators for coherent optical analysis

Recording Material	Resolution (lines/mm)	Sensitivity <sup>a</sup> (J/cm <sup>2</sup> )	Comments
Liquid crystal	35	10 <sup>-5</sup>	Low contrast, some storage
Elastomer	300	10 <sup>-4</sup>	Limited lifetime
PLZT	40	10 <sup>-3</sup>	Optical fatigue, low contrast <sup>b</sup> ; limited lifetime; nonuniformity problems
Photo KD <sub>2</sub> PO <sub>4</sub>	40	5 × 10 <sup>-3</sup>	Cooling to -50°C required
Bi <sub>12</sub> SiO <sub>20</sub>	150	10 <sup>-5</sup>	Different wavelengths required for image recording and transmitting (blue and red respectively); 30 frames/s operation possible
Photothermoplastic	1000	10 <sup>-5</sup>	Slow recording and erasure; limited lifetime
Manganese Bismuth	3000	5 × 10 <sup>-2</sup>	Needs temperature control
Photo dichroic	5000	10 <sup>-1</sup>	Needs temperature control, different recording and transmitting wavelength
Lithium Niobate	4000	5 × 10 <sup>-2</sup>	
Photographic film	1000	10 <sup>-8</sup> to 10 <sup>-6</sup>	Not real time; not reusable

### Notes for Tables I and II:

1. Voltage controls index of refraction of material which, in turn, changes the phase and polarization of light proportionally to the applied voltage. 2. "Lifetime" indicates how many times the device can be recorded onto and read from, before any noticeable degradation of stored information takes place. 3. Picking up information from undesired element of the device's 128 × 128-element, electroded matrix. 4. Up to 500-MHz carrier can be modulated. 5. Voltage between electrodes across the material creates light-scattering centers. 6. Fourteen different electrooptic effects are known. 7. Modulation varies according to effect; in most cases—amplitude modulation. 8. Sensitivity is defined as the amount of light intensity (power per unit area) multiplied by the time of exposure at that light intensity needed to record an image producing that light intensity. 9. About 10:1 is considered low contrast. In some devices, reduction of the device's speed may increase contrast.

reaches point A, another spot of a "new" pair will be at point B, moving in the same direction as spot 1.

Extending this argument further, if the input frequency increases so that exactly  $k + 1$  cycles are included in each scanning, successive scanning lines in the  $xy$  transparency pattern will again be in phase, this time during  $k + 1$  cycles. As a result, a new pair of spectral points will appear on the  $p$  axis, with larger absolute  $p$  coordinates than the original one.

### Masked output for unequivocal reading

To avoid ambiguity in the output spectral pattern only first order light spots should be considered. This can be accomplished by masking the area of the spa-

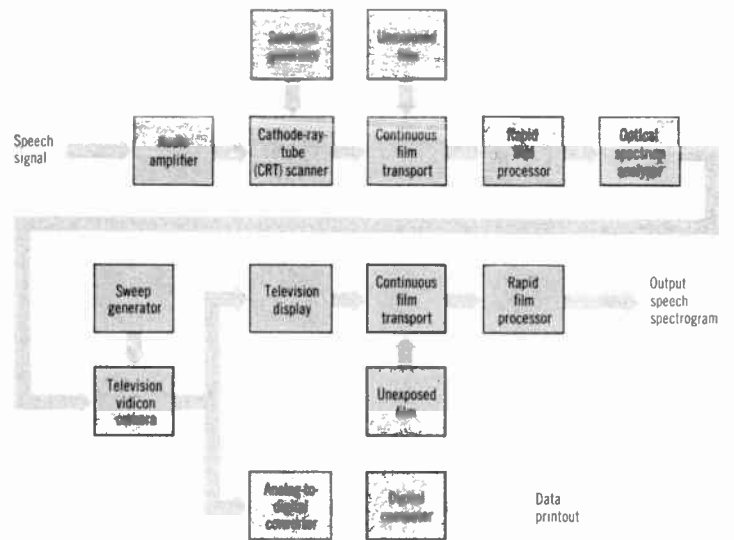

[5] Functional diagram of near-real-time speech-spectrogram generator, employing coherent optical spectrum analyzer. Computer for further analysis of input speech is connected, via an analog to digital converter, to a vidicon camera that picks up the spectral output pattern from the optical spectrum analyzer.

[6] Essentially, the optical speech spectrograph translates the input speech signal into an optical bar pattern recorded on slowly moving high-resolution film. After being processed, the film is analyzed by a coherent optical analyzer, using a coherent point source. The analyzer's output is recorded on a film passing a narrow output slit.

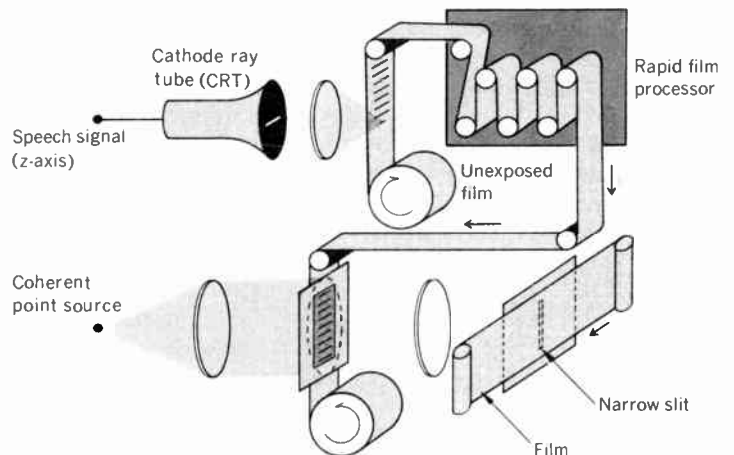

tial frequency ( $pq$ ) plane where unwanted, high-order light spots could be present. A typical masking is depicted by the shaded area in Fig. 3.

For speech analysis, a single frequency locus may be adequate. Thus, a single slit can be used at the output, "spatial" domain, for generating a speech spectrogram. To cover a range of about 8000 Hz, appropriate for most speech analysis purposes, a width of about 0.5 mm was selected for the "slit"—the unmasked area—in the output plane.

### Generating speech spectrograms

In the previous discussion, only single-frequency input signals were considered, and the optical input to the analyzer—the transparency pattern of equally spaced vertical lines with variable transmittances—

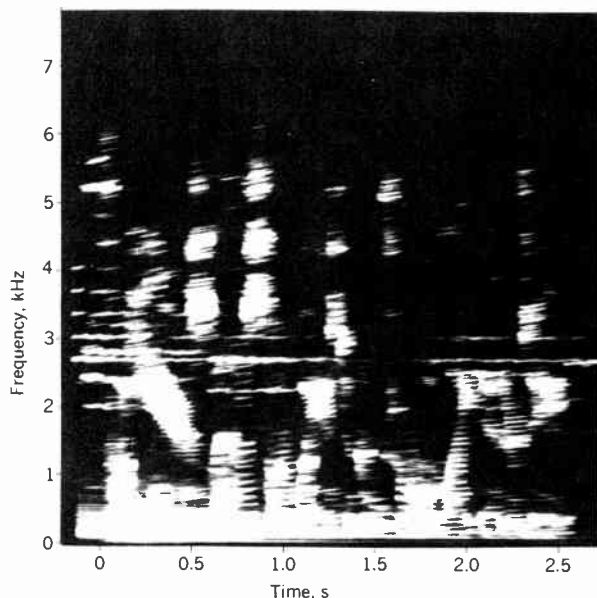

[7] First spectrogram generated by the optical speech spectrogram generator. Combined speech and background sitar music were used as an input. The speech part was the sentence: "For years men have sought to control light energy." (Courtesy Dr. Carl C. Alexoff, of the Environmental Research Institute of Michigan)

was static. Extending the case to speech input signals, containing many frequency components, and to continuously running photographic film strips both at input and output focal planes, the continuous, near-real-time operation of the speech spectrograph can be visualized.

Functionally, the entire spectrograph is portrayed in Fig. 5, while its optical and mechanical systems are depicted in principle in Fig. 6. A speech signal is applied to the  $z$  axis of a CRT (or a scanner based on intensity-modulated laser beam). Using a sawtooth generator, the signal is displayed on the CRT screen. The typical speed of a fluorescent spot across the CRT screen is 330 m/s, whereas the spot diameter is generally about  $4 \times 10^{-3}$  mm. Using a high-resolution lens, the CRT trace is recorded on a slowly moving, high-resolution microfilm. About 5 mm/s is found to be a suitable film velocity. To resolve about 10 microns, the distance between two adjacent bars recorded on the film, a resolution of 100 lines/mm is selected. The exposed microfilm is then transported to a rapid film processor for development and fixing. Following these processes, the continuous film strip is moved (at input film speed) past an aperture in the input plane ("spatial domain") of the coherent-light optical processing system, for spectral analysis.

Although, in principle, speech spectrograms can be directly generated by moving a film past a slit placed in the spatial frequency, output plane of the optical analyzer, and recording the light patterns obtained there on the film, a television vidicon camera is used to pick up the spectral output pattern in the actual spectrogram generator.

The camera provides a convenient interface to an analog to digital (A/D) converter, feeding a computer that is used for further signal processing. The TV camera also feeds a television display. The actual spectrogram is made by recording the display on a

continuously running strip of film and passing the film through a rapid film processor.

### Spectrogram and system evaluated

The first spectrogram generated by the system outlined in Fig. 5, includes both speech and music background (Fig. 7). Although this spectrogram still has a way to go to reach perfection, it has the characteristics of familiar speech spectrograms (see the box on page 52). For example, the variation of formants can be easily observed. In evaluating the optical generation of speech spectrograms, factors like the time span between input signal and output spectrogram initiation—the access time—and the flexibility in data handling, as well as the frequency range and optical quality (resolution, noise) of the spectrogram, must be considered.

This system can generate a continuous spectrogram with an access time of a few seconds to a minute. Its electronic counterparts, either analog or combined analog and digital, have about five minutes access time. The primary advantage, however, of this optical technique is the ability to process continuously a large amount of speech data in near real time. This feature is of vital importance in future research and development in automatic speech processing, synthesis, recognition, and translation.

Aside from flexibility in the handling of speech data, offered by continuous system operation, the optical technique can provide a broader frequency range than that encountered in conventional systems. For example, the system can be adapted for ultrasonic and very-low-frequency analysis of acoustical signals. In addition, by changing the width of the input aperture of the optical processor, narrow- or wide-band spectrograms can be obtained. And finally, better optical design can improve the quality of spectrograms generated by the system, particularly in reducing noise and increasing resolution. ♦

Francis T. S. Yu (M) is currently an associate professor at Wayne State University, where his research interests are in coherent optical processing, holography, information theory, and acoustics. In addition to his academic activities, Dr. Yu has also been a consultant to several industry and Government organizations. Prior to 1965, Dr. Yu had been with the University of Michigan, where he was a member of the research staff in the Communication Sciences Laboratory. Dr. Yu is author of one textbook and many technical articles in his areas of interest. Besides his IEEE membership, he is a member of the Optical Society of America and the Acoustical Society of America. He received his B.S.E.E. degree from Mapua Institute of Technology, Manila, the Philippines, in 1956, and his M.S. and Ph.D. degrees in electrical engineering from the University of Michigan in 1958 and 1969.

Reprints of this article (No. X75-022) are available at \$2.00 for the first copy and \$0.50 for each additional copy. Please send remittance and request, stating article number, to IEEE, 345 E. 47 St., New York, N. Y. 10017. Att: SPSU. (Reprints are available up to 12 months from date of publication.)



# Planning is for people

## Painful, yet educational, surprises greet the engineering planner as he takes his ideas to the public

Collide with a community's zoning regulations and you strike its tender nerve center, where neighborhood pride merges with the need for a sense of local self-determining strength. Woe to the corporation that offends those sensibilities.

For the telephone system, pressed by increasing demands for service, the need for more switching capacity leads inevitably to plans for physical building additions. Sometimes those additions call for an enlargement that exceeds zoning stipulations. Then, permission must be obtained from the local government before construction can proceed.

The long-range telephone planner is responsible for formulating the plans for expanded facilities, and for helping to obtain governmental permission to build them. In New York City, for instance, planning engineers responsible for telephone exchange buildings must get a variance-to-build from the New York Board of Standards and Appeals (BS&A). They are also required to inform all home owners within 500 feet of the building site, and must have the approval of the local Community District Planning Board.

The narrative that follows is a composite of many recent experiences of long-range telephone planners in the New York City area.

### Learning the facts of life

As we completed our factual testimony before the BS&A in support of the brief, the Chairman announced that there were a number of other witnesses to be heard. We returned to our seats, filled with curiosity, to face a barrage of unexpected questions from the new witnesses:

"Why does the Telephone Company want to destroy our neighborhood?"—"Why should it be built in *our* neighborhood?"—"We're sick of being pushed around."—"We don't see any growth in this area"—"Why don't these guys learn to *plan*?"—"We haven't been informed."

We had barely recovered from this "testimony" when it was announced that the hearing was adjourned for a few months to give "The Community" time to learn more about our request. At this point, we realized that the experience was more than upsetting; it was almost beyond our understanding. Our planning group had done this work for decades, and had always done it well. And this was such a carefully thought-out and scientific plan: "Just look at the numbers, it all checks out," some of our engineers insisted. Many of us had had at least 15 years professional experience in telephone planning. This just didn't make sense.

However, feeling the need to act reasonably, we

proceeded to meet with the local Community Planning Board (CPB). We knew our plan for the proposed one-story building addition was eminently rational and most objectively economical, and hoped we could get the CPB to understand us. After our diligent presentation, the community representatives responded to us with renewed indignation:

"We don't want you to change the character of our neighborhood."—"We don't want all that traffic and noise."—"You're just going to blot out the light."—"We don't believe you want only one story—you'll be back."—"Why can't you build *elsewhere*?"

We left feeling very misunderstood. The irony was that we just wanted to give them service. Our "facts" didn't seem to be making much of an impression. Yet, we felt obligated to provide for future telephone traffic demand and to maintain Bell System quality.

---

**'Why does the Telephone Company want to destroy our neighborhood? ... We're sick of being pushed around.'**

---

So, when the next BS&A meeting came to order, we dutifully took our places in the chamber and awaited our turn on the agenda. We informed the Board of our community contacts and reiterated our urgent need for the planned facility. When the Chairman requested once more the views of the community representatives—present that day in even larger numbers—the replies held still further surprises for us:

"Mr. Chairman, are you going to permit construction activity that endangers the lives of our children playing nearby?"—"Why didn't they build it right the *first* time?"—"Mr. Chairman, we demand to examine their fundamental plans and have our *own* experts brought in."

The meeting was again adjourned for a few months to give us time to gather more information and to make available any data the CPB might "reasonably request." That was a shocker, now our very planning process was being scrutinized—and by the lay public. After this encounter, we became acutely aware that the lead-time we had for our plans was running out. We also began to brood about the economic hardships that could be brought about by alternative plans. "If it costs us more, it will eventually cost the customer more," we reflected, "but we want to avoid having to go for a rate increase."

To make sure we hadn't missed anything and to re-

---

Leo Katz New York Telephone

view our plans in the light of the time that had elapsed from our previous objectives, we restudied, recomputed, and tightened our documentation. We held further meetings with individuals in the community, and to help ease tensions, we conducted a guided tour of the existing switching center facilities. Finally, we reappeared before the Community Planning Board, hoping for a better reception, but were again met with replies that were beginning to sound familiar:

“Your economic predicament doesn’t concern us at all!”—“We think you’re a poor neighbor!”—“When you build, while you’re at it, why can’t you upgrade the whole area around the building?”—“Our position is nonnegotiable.”

By this time, and for every “encounter” thereafter, the newspapers were beginning to carry prominent reports. Apparently, we no longer were going to be per-

mitted to retain our anonymity. Some items caught our eyes as we looked over the newspaper stories of local community views:

*The proposed expansion will kill the area “physically and spiritually” . . . [The proposed expansion is] a monumental aesthetic insult . . . an eyesore . . . detrimental to the area . . . [The company is] abusive of the rights of local residents.*

Once again, the time came to appear before the BS&A. On arriving, we found that supporters of the local community groups had been brought in by buses, all wearing buttons with slogans. That morning, we found that whatever we had said previously seemed to be misquoted before the Board by the spokesmen for these groups; whatever solid facts we brought up simply resulted in an automatic shift of position by a spokesman. Moreover, the Board, being committed to a “greater sensitivity to community voices,” listened

### Traditional telephone planning

In a Public Utility like the Bell System, capital investments are immensely large and often commit resources for periods of 30 years or more. The starting point for telephone planning is a set of fixed, anticipated technologies and, usually, a 20-year forecast of customer demand. In contrast, planners in commercial firms rarely consider periods longer than 3–5 years and technologies are variables in their calculations.

The objectives of telephone planning groups are to propose plans, normally covering a 20-year period, which they believe will assure a correct level of service at the right point in time and in an economical manner, while giving consideration to the modernization of existing facilities and to arrangements that can allow for practical day-to-day operation of these facilities.

The immediate tangible products of the planning effort include documentation for currently funded projects (in the form of fundamental plans, territorial replacement programs, long-range facilities charts,

etc.) as well as critical information for the control of business (special studies or broad perspectives for top management).

The telephone engineering planner’s strategy is to establish alternative plans and then operate on them with economic selection studies. To establish his planning alternatives, he collects various objective data that serve as necessary inputs. He then draws up “facilities charts,” like the one shown below, covering a 20-year planning period. These display service requirements (demand) versus capacity to serve. Each intersection represents a decision point. Traditionally, the growth in demand level, measured in number of subscriber stations, has been the major tool for assessing the future. The forecast of subscriber stations is received by the engineer from specified company forecasters. Based on the alternative plans, which he develops for serving the demand, he conducts an engineering–economy study to evaluate them. Having selected a solution, he documents the entire procedure and its results.

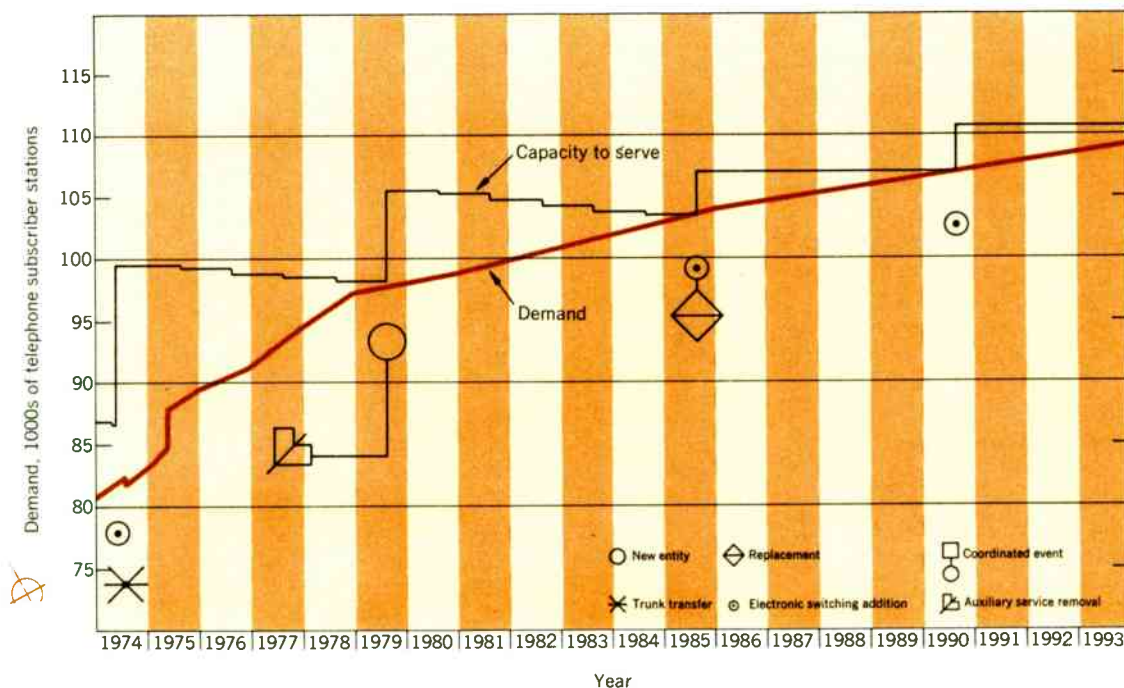

## Demography and tact as planning tools

The telephone planner's most vital new tool is a demographic profile of the area served by each central office. Data for the profile comes from the 1970 U.S. census report. To construct a profile, central office (CO) boundaries are superimposed on a map of census tracts, as shown below. Then, the population, economic, and housing statistics for the census tracts contained in the CO boundaries are totaled. The final profile consists of about 45 lines identifying characteristics such as income, rents, and housing values in absolute numbers, as well as population variables (household composition, race, ethnicity, etc.), education, unemployment, public assistance, occupation, industry, and mode of residence (single-family home, apartment), all shown in percentages.

These data are important to the planner because they are related to the use of telephones. A few typical parameters of telephone use, along with related demographic parameters, are shown in the table. Some of the relationships discovered in working with these data have been quite unexpected. For example, telephone use of COs serving black working-class neighborhoods is consistently *higher* than expected from mean family income figures, while telephone use in COs serving white, lower middle-class, conservative neighborhoods is consistently *lower* than expected. There are clearly cultural, as well as economic, factors involved in telephone use.

The planner must also deal with much-less-quantitative inputs. Thus, he might have a clear picture in his mind's eye that "this is an area of single- and two-family homes occupied by affluent and politically active people. They will have the motivation and resources to oppose the company tenaciously before the Board of Standards and Appeals at a variance hearing for a building addition." With this type of

knowledge, we can either consider a less provocative alternative or select a positive approach wherein all the beneficial features of the project can be explained to community planning boards in advance.

### Demographic Data for Telephone Planning

Telephone Parameters	Demographic Features*
Occupied household with a telephone station	Correlates directly with family mean income for the serving area
Telephone station location life	Relates directly to overall age of area's housing stock
Residential telephone station billing (dollars per month per account)	Both of these relate to a "compound factor" comprising family mean income and dominant "cultural values" held by area's residents†
Telephone Station Usage (average call seconds per hour per station)	

\* These relationships were deduced by comparing telephonic data to demographic data for all 38 serving areas in the Brooklyn-Queens-Staten Island section of New York City. All except six serving areas were at least 80 percent residential.

† The cultural values factor is selected from one of three representative demographic profiles. Therefore, the compound factor is reflected by using a set of three parallel curves of family mean income versus usage. In essence, then, usage relates directly to mean income at an appropriate "modifying level."

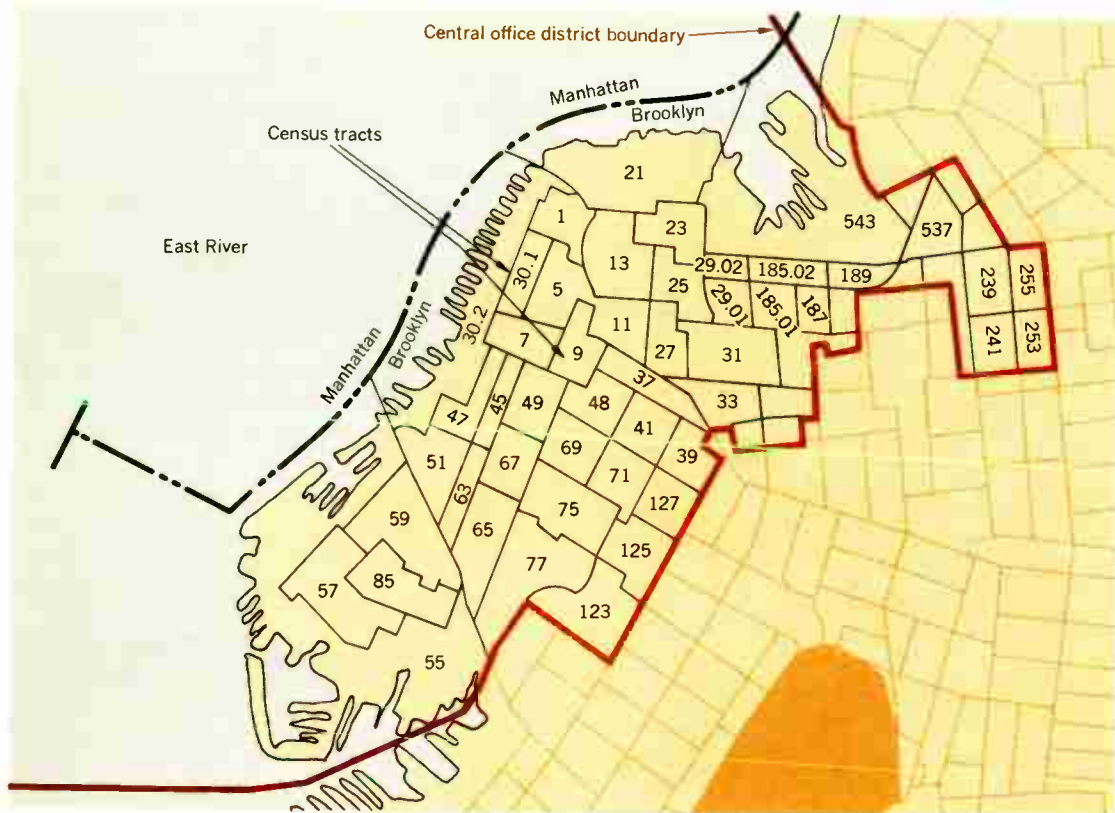

patiently to everything. Our opponents did not budge one iota that morning. And we began to learn that the general public simply *didn't* understand what we meant by economic intervals: telephone exchange buildings have to be built in stages, not in one step that will serve forever. They could not understand that a large corporation does *not* have access to unlimited funds, and that, as planners, we had budget constraints.

In the intervening weeks leading up to the final hearing, our once-peaceful planning environment seemed to take on the character of a war zone. Newspaper headlines informed us that: *Demonstrators [to protest variance application] are briefed on nonviolent action by civil rights veteran. . . . Two demonstrators corner and confront the president of New*

---

**'The proposed expansion is a monumental aesthetic insult . . . an eyesore, detrimental to the area.'**

---

*York Telephone in the driveway of his own home. . . . Residents refuse to accept defeat in their fight with Ma Bell."*

Then someone turned up a newspaper clipping from the late 1940s concerning the same exchange area with which we were now struggling. It lauded the breaking of ground for the new "block-long exchange building to supply dial service . . ." treating it as a community asset. The contrast between the 1940s and today brought us new insight. We reflected that many new things had been happening in American Society during the 1960s—generation gaps, protest movements, changing values, increasing affluence, reluctance to sacrifice or do without, speaking up—and then it finally dawned on us that *we had not been spared.*

### **Coping with future shock**

On this thought, we began to piece together our recent experiences. We were clearly dealing with communities that demanded to be heard—our plans for introducing switching facilities were being virtually "negotiated"—and with public bodies who were quite sensitive to community voices. Our reasoned arguments were being met by the tactics of the streets—hysterical rhetoric and selective deafness—the net result of all this was that our words were not even being heard.

With our increased awareness of change, we also began to notice that traditional economic solutions no longer satisfied the needs of operators and craftsmen using the facilities. The notion that unpleasant work had to be tolerated "because it was unavoidable" was on its way out. In connection with the consumer environment, we knew we were confronting increased vandalism and new hazards in entering certain blocks in the city. Moreover, the modern telephone subscriber expected "only the best" and was becoming very impatient and vocal.

It all came together. We were not just involved with another technical planning effort but, literally, with where the society was "at." We were no longer insulated from the nonengineering environment. Instead, we found ourselves being pounded by diverse segments of society, all of which had *demands*: government authorities, local residents, press reporters, operating employees, and consumers.

We were passing from computation to negotiation, from science to politics, from professional prerogatives to popular consensus. Nothing around us was standing still, and it was clear that we too had to change. Our planning parameters began to broaden and our data began to reflect sociopolitical factors. We followed community events and collected detailed demographic data—and even began to take courses in urban affairs. All this was superimposed on new, challenging, planning modalities: accelerating rates of change, greater complexity, and "discontinuities" to be anticipated in the future technological environment—all this, in a world which was clearly becoming ever more complex at the same time as it was becoming increasingly expensive.

To describe our new concepts, we had to learn a new vocabulary. Some of our data were now unfamiliar and not always quantifiable—but nevertheless vital to our planning efforts. For our most technically oriented engineers, there were anxious moments, based on uncertainty about how strong their contribution could be in the new nontechnical areas. Now, our planning mode was laced with nonrigorous data, ambiguous numbers, hypothetical concepts, and an atmosphere of imprecision, as well as the need to exercise choices frequently—in effect, to gamble. The technologists would now have to take into account "flesh and blood."

With our new-found sophistication we were able to formulate concessions such as off-street parking facilities for exchange building personnel, a new face for the entire building, and a landscaped strip on one side. Back at the Board of Standards and Appeals, we once again presented the hard facts behind the request for the variance, along with the additional features just mentioned, and reminded the Board of our record of frequent contacts with local community groups. When everyone had spoken, the Board thanked all the parties and stated it would soon have a decision. Two weeks later, we had our zoning variance. We heaved a sigh of relief and hoped that we could complete the construction in time to avert a serious service overload. ♦

Leo Katz (M) started his Bell System Career in 1959 when he began doing planning work on Project SAGE for Western Electric. Mr. Katz joined New York Telephone in 1965 and was appointed to his present position as supervising engineer, Local Office Plans, in 1970. He is currently responsible for all switching center fundamental plans for the New York City boroughs of Brooklyn and Staten Island. He received his N.D.Mech.E. in 1948 from Leeds College, England, and his B.E.E. in 1956 and his M.A. in social sciences in 1961, both from the City College of New York. He is a member of Tau Beta Pi and Eta Kappa Nu.