

IEEE spectrum

articles

43 Spectral lines **Some of us don't quit**

Donald Christiansen

One IEEE member is still going strong 38 years after his first retirement. He finds time each day for a variety of projects

44 Consumer **Aluminum wire: the heat is on**

Howard Falk

Is it possible your house could burn down for the simple reason that the contractor tried to save some money by using aluminum wire?

46 Guglielmo Marconi—100th Anniversary

46 The three jewels of Marconi

Alexander A. McKenzie

The "Father of Radio" also anticipated the daylight wave effect and long-distance centemeter-wave communication

47 Marconi's achievement: a systems outlook

Arnaldo M. Angelini

Yet another jewel in Marconi's crown was his ability to formulate an objective, to translate theory into practice, to develop a system

53 Computers
Self-contained microcomputers ease system implementation

Howard Falk

The user gets a microprocessor, memory, built-in software, a power supply, and input-output circuits so he can program his own hardware

56 Computers
Magnetic-stripe credit cards: big business in the offing

Jerome Svigals, Herman A. Ziegler

A new type of credit card brings a banker, or his cash-dispensing machine, on line and speeds checkout and payment for retail goods

departments

- | | |
|--------------------------------|-----------------------------------|
| 8 Meetings | 78 Scanning the issues |
| 14 Calendar | 80 IEEE tables of contents |
| 17 News from Washington | 89 Future special issues |
| 18 Energy report | 90 IEEE Standards |
| 99 News from industry | 90 Special publications |
| 100 Regional news | 91 Educational aids |
| 20 Focal points | 92 Book reviews |
| 24 Inside IEEE | 94 People |
| 28 Forum | 115 In future issues |



Copyright © 1974 by
THE INSTITUTE OF ELECTRICAL AND ELECTRONICS ENGINEERS, INC.

It has come to our attention that there are people who don't need all the speed of our 840.

So we've come up with a computer that goes a little slower. And costs a lot less.

The Nova 830.

The 830 uses our low-cost 32K byte memory boards.

But aside from that, you can't tell an 830 from an 840.

The 830 comes with the 840's Memory Management and Protection Unit that lets you expand up to 256K bytes, all of which are fully supported.

And it has the 840's Mapped Real Time Disc Operating System that helps you develop programs as much as it helps run them. (MDROS is one of Data General's family of compatible operating systems. So it can handle all our high level languages and all our peripherals.)

Like the 840, the 830 is a natural for dual operations: Timesharing and Batch, Remote Job Entry and Batch, Timesharing and Remote Job Entry, or if you're so inclined, Batch and Batch.

And like the 840, you can get an 830 in 45 days. Or less.

Unlike the 840, you can get an 830 with 128K bytes of memory for \$23,150.

Data General

The computer company you can understand.

♦ Data General Corporation, Southboro, Massachusetts 01772, (617)485-9100.
Datagen of Canada Ltd., Hull, Quebec (819)770-2030/Data General Europe, Paris, France 504-23-44.

Circle No. 1 on Reader Service Card

-
- 63 Instrumentation The state of logic analyzers**
J. Carver Hill
Simultaneous multichannel recording, pretrigger memory, and combinatorial triggering are now available for difficult digital measurements
- 71 Perspective Notes from the U.S.S.R.**
Ronald K. Jurgen
Popov Congress delegates report on Soviet developments in biological effects of laser radiation, charge-coupled devices, and color TV
- 72 New product applications**
Instruments, solid-state devices, and other products now available that give the engineer greater scope for design and application are described
- 76 Spectrum's hardware review**
A listing of new products and manufacturers, about which readers may obtain information
- 77 Applications literature**
Brochures, manuals, and applications handbooks selected by the editors
- 101 1974 Annual Index to IEEE Spectrum**
Retrieval by author and subject for feature articles and book reviews, plus a news index

the cover

Credit cards have become firmly entrenched in today's consumer transactions. With a newly evolving type of credit card—one with a magnetic stripe as an integral part of the card—many functions can be handled by the card in real time: instant credit check and automatic credit balance adjustment are two examples. To learn more about the versatility of these cards and how they work, see page 56.

spectrum

EDITORIAL STAFF

Editor: Donald Christiansen
Managing Editor: Ronald K. Jurgen; *Senior Staff Writer:* Gordon D. Friedlander; *Senior Associate Editor:* Howard Falk; *Associate Editors:* Roger Allan, Marce Eleccion, Gadi Kaplan, Don Mennie, Ellis Rubinstein (Copy); *News Editor:* Evelyn Tucker; *Contributing Editors:* Nilo Lindgren, Alexander A. McKenzie, Michael F. Wolff; *Editorial Assistants:* Ann L. Battiste, Stella Grazda, Lynnette Peace; *Production Manager:* Ruth M. Edmiston; *Art Director:* Herbert Taylor; *Assistant Art Director:* Janet Mannheimer; *Technical Graphic Artist:* Morris Khan; *Art Assistant:* T. Dale Goodwin; *Business Manager:* Carl Maier

EDITORIAL BOARD

Chairman: Donald Christiansen
Norman Abramson, Roy Amara, Norman Balabanian, F. E. Borgnis, Charles Concordia, J. M. Early, C. A. Falcone, R. D. Grundy, Craig Harkins, A. A. J. Hoffman, Eugene Mittelman, E. N. Procter, Shigebumi Saito, R. L. Schoenfeld, Harold Sobol, A. J. Stegeman, J. J. Suran, A. S. Taylor, F. E. Terman, C. F. Walker, W. H. Ware.

HELP YOUR STUDENTS FULLY UNDERSTAND HOW OPERATIONAL AMPLIFIERS BEHAVE

with
**Operational Amplifiers
Theory and Practice**

by **James Kerr Roberge**,
Massachusetts Institute of Technology

Now seniors and graduate students majoring in electrical engineering can thoroughly understand how operational amplifiers behave. This book emphasizes classical feedback concepts, covering such topics as *advantages of feedback, modeling, dynamic response, stability analysis via several methods, compensation, and an introduction to nonlinear analysis*—more material on feedback than found in any other text. Unlike other books that use mechanical systems examples and are usually biased to reflect a particular company's circuits, Roberge uses material that can be applied by electrical engineers and he compares alternative systems impartially.

1975 approx. 656 pages In Press

A Completely Self-Contained Text on Lasers

QUANTUM ELECTRONICS, 2nd Edition
by **Amnon Yariv**, *California Institute of Technology*

Beginning with basic principles, this text gives your electrical engineering students a better understanding of lasers and how laser light interacts with atomic media. Completely self-contained, the book contains all the necessary quantum mechanics background material and is the first text—

- to discuss coherent phenomena, as well as propagation in dielectric wave guides
- to use the coupled-mode formalism of integrated optics, and to explain distributed feedback lasers

Tables of physical properties and realistic examples are also included to help students with design experiments and practical systems.

1975 approx. 544 pages \$19.95 (tent.)

For complimentary examination copies write to Art Beck, Dept. 181, New York office. Please include course title, enrollment, and present text.

JOHN WILEY & SONS, INC.
605 Third Avenue
New York, N.Y. 10016

In Canada: 22 Worcester Road, Rexdale, Ontario



Prices subject to change without notice.

092 A 4588-AB

Circle No. 2 on Reader Service Card

IEEE Publications Operations

IEEE PUBLICATIONS BOARD

F. S. Barnes, *Chairman*

R. W. Lucky, *Vice Chairman*

George Abraham

J. J. Baruch

W. R. Beam

Donald Christiansen

Charles Concordia

J. M. Early

E. K. Gannett

R. C. Hansen

A. L. Hopkins

S. J. Kahne

V. P. Kodali

J. E. Rowe

A. C. Schell

W. J. Spencer

STAFF

Elwood K. Gannett, *Director, Publishing Services*

Patricia Penick, *Administrative Assistant to the Director*

H. James Carter, *Manager, Editorial Services*

Elizabeth Braham, *Manager, Information Services*

Lawrence Liebman, *Manager, Printing Services*

W. Reed Crone, *Managing Editor*

Proceedings of IEEE and IEEE Press

William R. Saunders, *Advertising Director*

Henry Prins, *Research Manager*

Carl Maier, *Advertising Production Manager*

Carol D'Avanzo, *Assistant Advertising Production Manager*

IEEE SPECTRUM is published monthly by The Institute of Electrical and Electronics Engineers, Inc. Headquarters address: 345 East 47 Street, New York, N.Y. 10017. Cable address: ITRIPLEE. Telephone: 212-752-6800. Published at 20th and Northampton Sts., Easton, Pa. 18042. **Change of address** must be received by the first of a month to be effective for the following month's issue. Please use the change of address form below. **Annual subscription:** IEEE members, first subscription \$3.00 included in dues. Single copies \$3.00. Nonmember subscriptions and additional member subscriptions available in either microfiche or printed form. Prices obtainable on request. **Editorial correspondence** should be addressed to IEEE SPECTRUM at IEEE Headquarters. **Advertising correspondence** should be addressed to IEEE Advertising Department, at IEEE Headquarters. Telephone: 212-752-6800.

Responsibility for the contents of papers published rests upon the authors, and not the IEEE or its members. All republication rights, including translations, are reserved by the IEEE. Abstracting is permitted with mention of source.

Second-class postage paid at New York, N.Y., and at additional mailing offices. Printed in U.S.A. Copyright © 1974 by The Institute of Electrical and Electronics Engineers, Inc. **IEEE spectrum** is a registered trademark owned by The Institute of Electrical and Electronics Engineers, Inc.



OTHER IEEE PUBLICATIONS: IEEE also publishes the **PROCEEDINGS OF THE IEEE** and more than 30 Transactions for IEEE Societies and Groups with specialized interests within the electrical and electronics field. Manuscripts for any IEEE publication should be sent to the editor of that publication whose name and address are shown on pp. 101-102 of the January 1974 issue of *Spectrum*. When in doubt, send the manuscript to E. K. Gannett, Publishing Services, at IEEE Headquarters, for forwarding to the correct party.

IEEE also copublishes, with the Institution of Electrical Engineers of London, England, *Electrical & Electronics Abstracts and Computer & Control Abstracts*, as well as their companion titles journals, *Current Papers in Electrical & Electronics Engineering* and *Current Papers on Computers and Control*.

MOVING?

PLEASE NOTIFY US 4 WEEKS IN ADVANCE

Name (Please Print) _____

Address _____

City _____ State/Country _____ Zip _____

MAIL TO: IEEE CODING DEPARTMENT
445 Hoes Lane, Piscataway, N.J. 08854

ATTACH LABEL HERE

- This notice of address change will apply to all publications to which you subscribe.
- List new address above.
- If you have a question about your subscription place label here and clip this form to your letter.



spectral lines



Some of us don't quit

The other day I stopped by to visit with Arthur Reynders, a long-time member of IEEE. Mr. Reynders was in his shop, carefully fitting the mitred corners of a picture frame he was making "to order" for a friend. He is in official retirement now, living in Heritage Hall in Agawam, Massachusetts. He seems much busier than most of his colleagues in residence, having commandeered a utility room to set up a respectably equipped shop, complete with power drill press, grinder, a broad array of hand tools, and some ingenious multipurpose jigs and fixtures of his own design.

"Let me show you a neat trick I'll bet you haven't seen before," he said to me, as he clamped the corners of the wood picture frame into four Sears aluminum picture frame gluing clamps. Whereupon he snapped a loop made of four pieces cut from an inner tube (tied one to another with four loops of string) completely around the outside of the frame. Then he removed the Sears clamps, and each piece of inner tube pulled together one mitred corner joint—much more snugly than the clamps had! "Ready for gluing," he said.

Mr. Reynders first retired from Westinghouse Electric Corp. on January 1, 1938. He had worked for Westinghouse for 38 years. But he was called back in April 1940 to carry out some factory reorganization chores for S.I.A.M. di Tella, Inc., a Buenos Aires affiliate of Westinghouse. He remained in Argentina for more than two years. By that time, the U.S. had become enmeshed in World War II, so Mr. Reynders returned to the U.S. to join the Springfield Ordnance District of the Army Services as a special engineer. He soon became assistant chief of the Small Arms Branch, then chief of the Industrial Division. After the war, Mr. Reynders retired once again, but by 1951 he was back in harness, this time undertaking a study for Westinghouse of the manufacturing operations of Industria Electrica de Mexico. He began that job at the age of 76.

Mr. Reynders' career got its impetus back in 1895, when he graduated with a degree in civil engineering from the University of Tennessee. It was at that point that he became intrigued with electrical engineering, and went back to the university to study advanced electrical subjects. While at the university, he ran the campus electric light plant and, during vacations, he worked in a Memphis electrical repair shop.

Entry into the profession in those days was not as routine as it often seems today. After college, Mr. Reynders took a job with the Knoxville Street Railway Company as a surveyor on railway extensions

and, later, was employed by several electric light and power companies and mining companies in east Tennessee. It was in June 1899 that he got his break with Westinghouse, obtaining a position as draftsman with what was then the Westinghouse Electric and Manufacturing Company of East Pittsburgh. For the next dozen years, he worked his way through the company's engineering department as draftsman, foreman of drafting, assistant chief draftsman, design engineer on circuit breakers and switches, general engineer on insulation, and assistant manager of engineering.

In 1912, he shifted to a new "career" at Westinghouse, when he was transferred to the manufacturing department as director of production. His bosses sent him to Springfield, Mass., to see if that would be a good place to open a manufacturing plant. But he told them "no"—citing a litany of good reasons. They opened it anyway and put him in charge. Eventually, he held the simultaneous posts of works manager of three Westinghouse plants: East Springfield, Chicopee Falls (also in Massachusetts), and Mansfield (Ohio), where the company manufactured transformers, electric motors, radios, and refrigeration units. Mr. Reynders' forte was manufacturing productivity. He conducted a number of special studies of factory organization for the company. Besides those already mentioned, he undertook projects for the South Philadelphia plant and for a Milan, Italy, affiliate.

In the thirties, Mr. Reynders was selected to serve on a committee appointed by Ohio's Governor Davey to study state government operations. He recalls that, alas, "political considerations" cited by the governor caused him "reluctantly" to override many of the best cost-saving suggestions made by the committee.

During my visit with Mr. Reynders, he was busy finishing up some projects for the holidays, including the wiring of a few dozen ceramic Christmas trees and several illuminated toadstools, to be sold through Heritage Hall's gift shop. He also showed me a cupboard full of wire animals of his own creation.

Mr. Reynders has tapered off somewhat from his stringent schedule of old. For example, he does not attend as many Rotary meetings as he once did. Nor is he as active as he once was in the community (as president of the Springfield Chamber of Commerce, for example, and as a member of the boards of directors of the Springfield YMCA and the Springfield National Bank). But he keeps up his important memberships in the alumni association of the University of Tennessee, in AAAS, and in IEEE.

Mr. Reynders will celebrate his 100th birthday next September.

Donald Christiansen, Editor

Aluminum wire: the heat is on

Is it possible your house could burn down because the contractor saved some money by using aluminum wire?

Do fires of an electrical origin occur more frequently in homes wired with aluminum instead of more expensive copper? The answer is not clear, although at least three investigations are underway in the U.S. exploring the facts that high-resistivity aluminum oxides and spot temperatures high enough to cause combustion have been found in aluminum wire connections of less than ideal design.

One consequence of these investigations is that aluminum wire manufacturers and construction industry leaders have a nightmare vision that Uncle Sam will order them to "repair, repurchase or replace" wiring installations in more than two million U.S. homes. Costs of such a recall effort would run into the hundreds of millions of dollars. In fact, the U.S. Consumer Products Safety Commission is now studying proposals to order such a recall. But, to date, the facts about the actual extent of aluminum-wiring hazards lie buried in the uncertain statistics on causes of fires.

What is clear, however, is that aluminum has several properties that are significantly different from those of copper. And handling aluminum in the same way as copper has been traditionally handled—particularly at receptacles, switches, and similar points of termination—can lead to dangerous consequences.

A branch-wiring problem

Long-term national needs clearly seem to point to increasing use of aluminum. Compared to copper, aluminum is much more abundant, and is in fact already widely used as an electrical conductor material.

Aluminum, reinforced with steel or aluminum alloys, is virtually the only conductor material now used for power transmission lines. These lines feed transformer distribution centers, where almost all conductors now being installed are aluminum. From the transformer centers, these conductors run to neighborhood transformers, where a service drop conductor—95 percent of those currently installed are aluminum—reaches the building. A service entrance cable then connects to the meter and to the service equipment inside the house, and about 80 percent of these cables now being installed are aluminum.

There seems to be no problem with any of these uses of aluminum conductors, all the way from the power station to the building service equipment. It is in the *branch circuits*—the wires that run from fuses or circuit breakers to wall-plug receptacles and switches—that aluminum-wiring problems show up.

Evidence in the ashes

There is some scattered evidence, from experiences with mobile homes, and from areas in New York and

California that aluminum wiring may be dangerous. During the past nine years, some 800 000 mobile homes have been equipped with aluminum wiring. About 70 percent of all such homes built in 1969, had aluminum wiring, but that was the peak year for this use of aluminum. By 1972, use of aluminum wiring by mobile homes manufacturers had almost completely ceased, presumably because of problems with the circuits. Spokesmen at the Foremost Insurance Co., the largest insurer of mobile homes, have noted a decline in electrical fires after 1972, and believe the drop was due to the declining use of aluminum wire. Underwriters Laboratories suggests that a simultaneous overall tightening of mobile home wiring inspection may have had an equally significant effect.

In Huntington Beach, California, about 1000 aluminum-wired homes have been built during the past few years. Local fire department records show 80 fires, traceable to aluminum wiring, over a four-year period. One 1971 Huntington Beach fire, whose cause was attributed to aluminum wiring, figured in the Congressional hearings on the bill to create the Consumer Product Safety Commission. Rep. John Moss (D-Calif.), who was particularly concerned about this fire, has been urging the Commission, since its creation in October 1972, into action on aluminum house wiring.

However, the overall significance of these examples remains unclear since they represent only a small fraction of all fires that can be attributed to electrical wiring. According to the National Fire Protection Association about 75 000 house fires are caused by electrical wiring each year, and this number has remained at the same level since 1963. Aluminum wire did not find widespread residential use until about 1965. The fact that there was no subsequent increase in electrically caused house-fire statistics certainly does not support suspicions about the fire-causing properties of the wire. But neither do these statistics clear away such suspicions. National statistics on causes of fires are simply not reliable enough to provide a conclusive answer.

Carl Duncan, captain of the Huntington Beach, California Fire Department was working in 1972 with John Rockett of the National Bureau of Standards to draft a national electrical wiring survey. A preliminary NBS survey indicated that there were field problems with aluminum, but the cost of a valid national survey was estimated to be 200 to 300 thousand dollars—more money than NBS budgets could allot at that time. A local area survey of one Virginia county was proposed, but that proposal got lost in bickering over jurisdiction with other organizations concerned with fire-hazard data.

The Consumer Products Safety Commission staff is now looking at possible candidate areas for a local

Howard Falk Senior Associate Editor

pilot survey that would combine door-to-door interviews with in-depth investigation and follow-up. A legally admissible nationwide survey could follow—one that might lay the basis for a recall order on existing aluminum branch-wiring installations.

Looking for the facts

Meanwhile, three major investigations of the aluminum wire screw terminal connection problem have been carried out in recent years. The first began in 1946 when the Underwriters Laboratories were pressured into labeling aluminum wire for building applications. Little or no UL testing was done at that time, and in the years that followed, use of small-sized aluminum wire was so rare that the issue was moot. Then, in 1965–1966 copper shortages prompted wide use of aluminum branch wiring in the home building industry. Telephone calls began coming into UL from electrical inspectors asking for guidance, and UL reacted by running some heat-cycle tests on aluminum wires connected to electrical receptacle screw terminals. Based on positive results from these tests, UL reaffirmed statements made in 1946 that aluminum wire could be safely terminated to binding screws on wiring receptacles and switches.

By about 1969—according to UL president Baron Whitaker—UL was hearing “numerous reports of difficulties in the field in connection with aluminum branch circuit conductors connected to wire-binding

Flickering lights, intermittent appliances, strange odors, smoke, and even building fires.

screw terminals of attachment plug receptacles and wall outlet snap switches. Many of the difficulties related to flickering of lights, intermittent operation of appliances, presence of static in radio and television receivers, and other manifestations of loose wire connections at terminals. Heating associated with such connections produced, in some cases, strange odors, smoke, and even building fires.” At that time, the people at UL believed that these problems stemmed from poor workmanship. As UL began to work with manufacturers of aluminum, aluminum wire, and wiring devices, changes in its requirements began to take shape. In 1971, requirements on physical properties of aluminum conductor material were “upgraded,” and requirements for new terminals, designated CO/ALR, were established for aluminum wire. These terminals have large brass binding screws, a good-sized contact plate, and use some restraint method to hold the conductor in place when the wiring device is pushed back into the switch or receptacle box. In 1972, UL further refined its test requirements for aluminum wiring material. These new requirements were the end result of a two-year test program, funded by aluminum wire manufacturers to the extent of about \$88 000 plus \$50 000 or more from UL’s own treasury. Finally, in 1973 UL required

that all terminals—other than CO/ALR terminals—be marked to warn users they are *not* for connection of aluminum conductors.

A second major research effort was launched at Battelle Memorial Institute in 1971. Manufacturers of wiring devices, wire and cable, and related products financed the effort. The Battelle results indicated that a central problem in aluminum wire screw terminal connections is microscopically small motion of the conductor with temperature changes. This motion produces fretting, resulting in an oxide film that may be compacted into the contact area. The effect may be failure, in the form of a sudden increase in contact resistance that results in terminal overheating. Such failure does not necessarily result in fire. Battelle researchers believe they have found a clear relationship between terminal operating temperature and time to failure, so their approach has been to control test temperature rather than test current alone.

The Battelle research has apparently reached no overall conclusion. William Abbot, program manager of Battelle, feels that the test procedures used “... have never been, and even now are probably not severe enough, nor do they consider some very real technical and human factors which exist.” Mr. Abbot believes that the practical technology exists to wire very reliable aluminum branch circuits but “the engineering data do not exist” to tell us if this has, or has not been achieved in commercial practice.

The third major investigation is being conducted by the National Bureau of Standards, at the request of the Consumer Products Safety Commission. The NBS research team discovered that in loose connections, tiny high-resistance welds can form between the wire and the retaining screw. The result is—with as little as 0.5 ampere flowing—the connection gets red hot. This “glow” effect was observed with aluminum wire used with steel screw terminals, but has not yet been found with the brass screws used in CO/ALR connections. Incidentally, the glow effect was also produced with copper wire and steel screws, but the possible implications of this discovery for wiring hazards have not yet been explored. NBS tests have also shown that aluminum wire connections can loosen even if they were initially tight. Connections taken from a burned house on Long Island, New York, were estimated by NBS to have been initially tightened to about 12 inch-pounds (the wires were flattened where held by the connection screws), yet these wires were loose when NBS examined them.

According to Jacob Rabinow, who heads the NBS investigation, industry did not do as good a research job on aluminum branch wiring as it should have. While Mr. Rabinow believes that CO/ALR devices are a significant improvement on the prior art, he feels that CO/ALR connectors are “not the final answer,” but that more reliable connections can be made by improved methods.

The Consumer Product Safety Commission staff believes it would be best if the electrical industry voluntarily agreed to adopt connections that are more reliable than the CO/ALR type. But the knottiest problem would remain: what will be done about the 2 million homes wired with aluminum branch circuits using screw connections that many knowledgeable engineers consider inadequate?

The three jewels of Marconi

Most men achieve greatness with one idea; the Father of Radio produced two more

Aboard his yacht *Elettra*, Guglielmo Marconi first used frequencies of about 500 MHz over long paths up to 250 km—almost nine times the optical distance. He was well aware that his observations did not square with accepted theory of the day. In fact, he noted: “The speculations that may arise from such results concern the entire theory of radio transmission over distances greater than the optical one.”

That was in 1895, and 42 years later, on the 100th anniversary of Marconi's birth, only a small number of propagation experts (much less the general engineering public) know that what Marconi had succeeded in doing on his yacht was to see far into the future of communications theory. With his experiment, Mar-

coni foretold what today is known as forward scatter, tropo, or tropospheric transhorizon propagation.

Much better known and of more immediate import was Marconi's initial success—his turn-of-the-century development of the first working wireless telegraph system. As was to be the case throughout his career, Marconi's accomplishment was not merely the result of unusual diligence or a willingness to buck prevailing theory—both of which characterized him. And neither was it a case of luck. Rather, Marconi was alert to improvements that might stretch the length of communications circuits. Although his addition of an antenna and a ground to Hertz's spark transmitter may have been fortuitous, he understood the resulting improvement to transmission and went on to enhance his techniques. He early realized the need for a reli-

(Continued on page 48)

Alexander A. McKenzie Contributing Editor

Guglielmo Marconi (left) and George Kemp. A photograph taken shortly after the successful transatlantic test of 1901. The 10-inch induction coil spark transmitter is on the right, with Morse inker and 'grasshopper' key in center.



Marconi's achievement: a systems outlook

Yet another jewel in Marconi's crown was his ability to formulate an objective, to translate theory to practice, to develop a system

Marconi's many successes have been attributed to his outstanding experimental ability, to his perseverance, to the courage he displayed in the face of numerous and considerable obstacles, to the enthusiasm he instilled in his assistants, and to his capability as an industrialist. All this is true, but it is not the whole story. The effective mobilization of such great human qualities, of so much energy, was possible because Marconi had in mind a clear objective. His goal—one he considered important enough to warrant the devotion of a lifetime's intellectual, moral, and material resources—was the creation of a system: wireless telegraphy.

Arnaldo M. Angelini
Ente Nazionale per l'Energia Elettrica

I stress that concept—the creation of a system—because I believe this is the key to an understanding of the inherent consistency of Marconi's work. Expressions such as “application of electric waves for the transmission of signals over distances” are, in fact, misleading. For, like Edison, Marconi had a goal that was system-oriented rather than conceptual.

There are other similarities between the two great inventors. Both were extremely skillful in the art of experimentation. Neither possessed a profound knowledge of mathematics, yet both displayed an extremely rare analytical shrewdness and ability to synthesize. Both were faced with the problem of financing their research; both resolved the problem by embarking upon industrial activity, exploiting inventions to gain the funds necessary for further research. Nei-

(Continued on page 49)

Much of Marconi's important research on the propagation of radio waves was accomplished at the laboratory aboard his yacht *Elettra*.



Marconi: three jewels (from p. 46)

able “detector” and squeezed much better performance out of a refined, glass-encapsulated version of Branly’s coherer. Because he made it all work, Marconi is credited with inventing the wireless telegraph.

But Marconi’s devotion to his work is part of the story as well. His father, for example, had long exhibited an ambivalent attitude toward Guglielmo’s continual experimentation. But his attitude changed markedly when his son was offered 300 000 lire for rights to his invention. He immediately wired his son to buy a neighboring property, even listing the livestock that would come with this purchase. The younger Marconi’s response was to be characteristic: He refused, replying that his wireless was worth infinitely more than mere property and that he would have to continue his work with it for a long time. He pursued this goal with a fidelity and devotion both hard on his assistants and disruptive of normal family life.

And Marconi often had more than his family to fight. In 1901, he announced that he had received the single, repeated Morse letter “S” at St. Johns, Newfoundland, from a transmitter at Poldhu, Cornwall, England, some 4827 km away. At first, few experts could swallow his claim. Even Thomas Edison initially retorted that it was, indeed, impossible. He soon reversed himself, saying that Marconi’s integrity was sufficient grounds for accepting the claim.

The second jewel in Marconi’s crown of accomplishment was his discovery of the “daylight wave.” Wireless communication had become practically possible over very long distances by continual increases in power and longer wavelengths. Marconi had shown the necessity for these trends, but he was painfully

aware that increased power was costly and atmospheric noise increased with wavelength.

In 1920, British Marconi Co. set up a radio telephone circuit between London and Hendon, a distance of about 161 km, using a transmission wavelength of about 15 meters. It was convenient to set up a directive antenna and propagation at that wavelength, and over such a relatively short path, the signals suffered no “daylight effect” of loss in strength. In the same year, American and British amateur radio operators tried to transmit signals across the Atlantic during hours of darkness, but failed. A better-organized effort succeeded in 1921, but even E. H. Armstrong, who had been active in the tests, believed that the partial success was likewise partial failure—the circuit worked only after dark.

Marconi, on the other hand, presented a paper before an AIEE/IRE meeting in June 1922, describing some recent work, including the London-Hendon circuit, concluding, “I have brought these results and ideas to your notice as I feel—and perhaps you will agree with me—that the study of short electric waves, although sadly neglected practically all through the history of wireless, is still likely to develop in many unexpected directions. . . .”

Initial intellectual opposition to his claim of long-distance wireless communication was based on the scientific knowledge of the time that electromagnetic waves were similar to light waves. They could therefore, in theory, be transmitted only over a line-of-sight path. But he had early demonstrated to his own satisfaction that he was able somehow to transmit “through” obstructions when his brother, by prearrangement, shot off a gun to signal successful reception beyond a hill near their home.

A pioneer ultrashort-wave radio circuit was established between the Vatican and the Pope’s summer residence, Castel Gandolfo, in 1933. Marconi, to the right of the directive antenna, is shown with Pius XI.



His later researches at about 100 meters showed that although daylight signals disappeared at about 2253 km, the nighttime signals at 4023 km were better than those from long-wave stations with much greater power. In 1924, Marconi received 32-meter signals at 3862 km—via the ionosphere, as yet unnamed! When the test transmissions were continued, reports were received in England from Argentina, Australia, Brazil, Canada, and the United States.

As Armstrong pointed out, if anyone, including Marconi, had thought to listen for the Hendon 15-meter signals from 1920 on, he might have been rewarded with the information that Marconi's patient, methodical search later revealed. As we now know, low-power, electron-tube, short-wave transmitters rather quickly supplanted the ponderous long-wave equipment with its high towers and long antennas. Transmission speeds, limited fundamentally by long-wave equipment characteristics, were immediately raised to essentially infinite limits.

Then in 1933 (in a paper not translated into English until 1956!), Marconi described his work using frequencies of about 500 MHz. He had already demonstrated satisfactory telegraphic communication over distances up to 4 km in 1896. A third of a century later, transmitting 57-cm waves from a point on shore to his yacht, and 26-meter waves for the return circuit, Marconi performed a series of demonstrations, culminating in successful transmissions over a distance of 270 km. The optical distance—even with the equipment removed from the yacht and installed on a tower—was only 116 km.

In the conclusion of his paper, Marconi stated, "In regard to the limited range of propagation of these microwaves, the last word has not yet been said. It has already been shown that they can travel round a portion of the earth's curvature, to distances greater than had been expected, and I cannot help reminding you that at the very time when I first succeeded in proving that electric waves could be sent and received across the Atlantic Ocean in 1901, distinguished mathematicians were of the opinion that the distance of communications, by means of electric waves, would be limited to . . . about 165 miles (265 km)."

Again, skepticism tarnished this third jewel in the crown of Marconi's dogged accomplishment. However, radio amateurs had already experienced some of the same long-distance phenomena and were, in their activity at 5 and 2½ meters, eventually to lend credence to Marconi's claims. During World War II, anomalous propagation of radar and other short-wave signals brought about a serious study of the mecha-

nisms through which long-distance signaling was accomplished. And, more recently, the initial U.S. television frequency-assignment fiasco—caused by interference between distant stations—proved the practical effect of Marconi's caveat.

Marconi died in 1937, too early to see the final flowering of his vision. But he had already composed an addendum to the longer 1932 paper (see Bibliography) and this was published, in Italian, in 1933. It is available in translation together with a commentary by T. J. Carroll (F), who believes that Marconi had unmistakably been "experimenting in the twilight region where the field strength attenuation rate is now known to be roughly 0.1 dB/km, instead of the value about ten times higher calculated from diffraction theory with a refraction correction." Marconi had reported reception of Morse signals on approximately 60 cm over a distance of 258 km—at almost nine times the optical distance. It seems likely that Marconi may again have outrun the rest of the world in using what we now employ as tropospheric transhorizon propagation.

BIBLIOGRAPHY

- Armstrong, E. H., "The spirit of discovery," *Electrical Engineering*, pp. 670-676, Aug. 1953.
- Burghard, G. E., "Station 1BCG," *Proc. Radio Club Am.*, Feb. 1922, and "The story of the first transatlantic short-wave message," 1BCG Commemorative Issue. *Proc. Radio Club Am.*, Oct. 1950.
- Carroll, T. J., "Marconi's last paper. 'On the propagation of microwaves over considerably distances,'" *Proc. IRE*, vol. 44, Aug. 1956.
- Marconi, D., *My Father, Marconi*. New York: McGraw-Hill, 1962.
- Marconi, G., "Radio telegraphy," *Proc. IRE*, pp. 215-238, Aug. 1922.
- Marconi, G., "Radio communication by means of very short electric waves," *Proc. Royal Inst. Great Britain*, vol. 22, pp. 509-544, 1933. (Presented on Dec. 2, 1932, in London, England.)
- Marconi, G., "Sulla propagazione di micro-onde a notevole distanza," Royal Academy of Italy, *Proc. of the Section on Physical, Mathematical, and Natural Sciences*, vol. IV, 1933, presented Aug. 14, 1933.
- Marconi, G., "Radio communications by means of very short electric waves," reprinted in *IRE Trans. Antennas and Propagation*, pp. 90-99, Jan. 1957.

Alexander A. McKenzie (LS) was fortunate to have been involved in the use of radio frequencies at 60 and 144 MHz at about the time of Marconi's third great revelation—among other things, operating a communications circuit over a 229-km path. In 1938, at the same location—the summit of Mount Washington, N.H.—he received signals on about 40 MHz from a high-power experimental frequency-modulation broadcast station at a distance in excess of 483 km. It was such "anomalous" propagation that Marconi's 1933 paper, presented some five years earlier, attempted to legitimize.

Marconi: systems outlook (from p. 47)

ther, therefore, could indulge to any great extent in unproductive research. Theirs was the spirit of modern technological enterprise, in which progress—indeed, survival—is based on innovation.

Birth of a "system"

It would be rash to believe that Marconi had in mind the scale and scope of modern radio communications when, while still an adolescent, he wondered

why no scientist had thought of using electric waves for the transmission of signals through space. The fundamental motivation shaping his work, at that time, was to develop a system that could serve shipping.

"I commenced early in 1895 to carry out tests and experiments with the object of determining whether it would be possible by means of Hertzian waves to transmit across a distance telegraphic signs and symbols without the aid of connecting wires," Marconi noted in his Nobel Prize address of 1909. "After a few

preliminary experiments with Hertzian waves. I became convinced that, if these waves could be reliably transmitted and received over considerable distances, a new system of communication would become available, possessing enormous advantages over flashlights and optical methods, which are so dependent for their success on the clearness of the atmosphere." (The reference to visual signals clearly indicates Marconi's maritime concerns.)

Marconi's experiments in the spring of 1897 were aimed at establishing radiotelegraphic communication between the shore and lightships. In July of that year, the first range tests at sea reached a distance of 16 km and demonstrated the feasibility of establishing links through apparatus installed on a warship. His goal was within sight, but it remained necessary to achieve independence of communication between nearby stations.

To this end, Marconi developed "syntonic telegraphy" by separating the transmission and reception functions from the oscillation-generating and -detecting functions. The trains of waves thus obtained were much less damped, enabling the attainment of better defined frequencies on which all four circuits were tuned.

These early efforts culminated in the celebrated "Patent 7777" of April 1900. In this connection, Marconi concluded his address to the Royal Society of Arts in 1901 with the following words: "I have come

to the conclusion that the days of the nontuned system are numbered. The ether about the English Channel has become—as a consequence of great wireless activity—exceedingly lively, and a nontuned receiver keeps picking up messages or parts of messages from various sources, which often render unreadable the message one is trying to receive. I am glad to say, however, that I am now prepared with syntonic apparatus suitable for commercial purposes."

Long-distance transmissions

The independence of different links was a basic condition for the establishment of a radiotelegraphic communications system, but no less important was the possibility of transmitting telegrams over long distances. Work in this direction proceeded in parallel with the development of syntonic radiotelegraphy. History was made in 1901 when signals transmitted from the Poldhu station in Cornwall, England, were received at St. Johns, Newfoundland. [See A. A. McKenzie's companion article for additional details—Ed.]

It was evident then that a transoceanic radiotelegraphy system capable of competing with cable communications was a feasible, if challenging, proposition. However, its realization was more distant than Marconi believed at the time, as evidenced by his remarks in his 1909 Nobel Prize address: "What often happens in pioneer work repeated itself in the case of

Marconi's assistants

The weather during those days preceding the first transmission was awful: P. W. Paget, with the icy rain lashing his face, kept watch over the kite to which the aerial was attached. The kite itself surged up and down in the gusts of wind, continually altering reception conditions. In a small, dark room, G. S. Kemp sat at the receiver, while Marconi sipped a cup of hot cocoa prior to taking his tour of duty.

"It was shortly after midday on December 12, 1901," recounted Marconi, "that I placed a single earphone to my ear and started listening . . . I was at last at the point of putting the correctness of all my beliefs to the test . . . The chief question was whether wireless waves could be stopped by the curvature of the earth. All along I had been convinced that this was not so, but some eminent men held that the roundness of the earth would prevent communication over such a great distance as across the Atlantic. The first and final answer to that question came at 12:30 . . . Unmistakably, the three sharp clicks corresponding to three dots sounded in my ear, but I would not be satisfied without corroboration. 'Can you hear anything, Mr. Kemp?' I asked, handing the phone to him. Kemp heard the same thing as I . . . I knew then that I had been absolutely right in my calculations."

There are other examples of the exciting, but uncomfortable, life the team led. During the Christmas of 1898 Kemp was forced to spend 22 days aboard a lightship because the rough seas made it impossible for another vessel to come alongside. He had rations for just one week and water was leaking into the equipment room. He wrote in his diary, "Fortunately during my stay on board I had taught the lightshipmen the Morse Code, as well as how to manage the aerial and the lead-in wire, and how to manipulate the transmitter and receiver . . ."

Another assistant, R. N. Vyvyan, narrowly escaped death when a hurricane destroyed the Cape Cod station before it could be brought into service.

Physical endurance was, of course, a secondary qualification for a job with Marconi. And, in the area of technical expertise, Marconi had the great gift of being able to choose the right man for the right job. In the company's early years, the small group of men who worked with Marconi displayed a remarkable harmony. All worked extremely hard in an almost fraternal atmosphere; yet there was never the slightest doubt as to who was the leader. The great esteem in which Marconi was held by his assistants—usually older and better educated—was certainly due in part to his outstanding ability as an inventor and experimenter, as well as to his exceptional organizational ability. Above all, however, it was his strong personality, undiminished by his apparent shyness, that inspired his assistants and eased the acceptance of his choices and decisions, even when they entailed great sacrifices and hard work.

An aspect of Marconi's work that I consider very important is the training of the company's personnel. In the autumn of 1901, despite the intense preparations for the transatlantic transmission and the company's financial difficulties, Marconi opened a school for the training of new personnel. This is probably the first example of a specialization school paid for by an industrial firm. The school was gradually enlarged in terms of buildings, equipment, and programs.

In this regard it is interesting to note that the Marconi Company offered shipping companies a fixed payment service that included the inboard apparatus, the provision of operators, and the use of land stations. As a result, the school also served as a training ground for maritime radio operators.

radiotelegraphy. The anticipated obstacles or difficulties were either purely imaginary or else easily surmountable, but in their place unexpected barriers presented themselves, and recent work has been directed to the solution of problems that were neither expected nor anticipated when long distances were first attempted."

Six years after the initial experiments at Villa Grifone, the first transoceanic transmission was achieved. Six more years passed before the start of commercial communications between the Clifden station in Ireland and the Glace Bay station in Nova Scotia. But these were by no means years of relaxation—this period saw the invention of the magnetic detector and a rotating disk apparatus for generating continuous, or, at least, nearly undamped, waves. However, the most important work still concerned the propagation of Hertzian waves. The reception tests conducted aboard the *S.S. Philadelphia* in 1902 not only convinced Marconi of the feasibility of establishing a radiotelegraphic link across the Atlantic, but also permitted the observation for the first time of "the very marked and detrimental effect of daylight on the propagation of electric waves at great distances. Apparently," concluded Marconi, "the length of wave and amplitude of the electrical oscillations have much to do with this interesting phenomenon—long waves and small amplitudes being subject to the effect of daylight to a much lesser degree than short waves and large amplitudes." As a consequence, the

subsequent development of long-distance radiotelegraphy made use of increasingly longer waves and more powerful and costly transmitters.

The worldwide "system"

At the close of his Nobel Prize address, Marconi declared that, "however great may be the importance of wireless telegraphy to ships and shipping, I believe it is destined to an equal position of importance in furnishing efficient and economical communication between distant parts of the world and in connecting European countries with their colonies and with America. As a matter of fact, I am at the present time erecting a very large power station for the Italian government at Coltano, for the purpose of communicating with the Italian colonies in East Africa and with South America."

In 1941, a proposal was presented to the British Government for the development of a radiotelegraphic communications system covering the entire empire. The Imperial Wireless Conference approved the proposal, but World War I and arguments over the merits and demerits of a state monopoly prevented any action from being taken until much later. In fact, it wasn't until 1924, when Marconi had just succeeded in proving the feasibility of a further, essential step forward in long-range communications by means of his low-power short-wave beam system, that a contract was signed between the General Post Office and the Marconi Co. That contract provided for the construc-

Marconi on the bridge of *Elettra* in 1934 when he demonstrated a new microwave radio beacon.



tion of short-wave radiotelegraphic stations capable of communicating to and from Canada, South Africa, India, and Australia. In March 1927, the Britain-Australia service, covering a distance of approximately 20 000 km, was commissioned, followed in May of that year by the Britain-South Africa service (approximately 10 000 km) and in August by the Britain-India service (approximately 9000 km).

The head of a large business

Having attained the goal that motivated all his work, Marconi resigned as chairman of his company, and management of the United Kingdom's entire telegraphic network was taken over by a single firm comprising several cable companies as well as the Marconi Co. Despite its strong bargaining position, the Marconi Co. settled for a minority holding.

Some maintain that this loss of control of the system he had created constituted for Marconi the end of a dream. But, in my view, Marconi's objective—not a dream, because he was too much a realist—was the creation and development of a system that would challenge the cable companies that had warned him to stop the experiments at St. Johns, Newfoundland. Having achieved this objective, his interest in routine management affairs diminished considerably. More fascinating matters occupied his attention: There was the field of microwaves to be explored, for example. Then there were his social obligations, in addition to the honors bestowed upon him throughout the world.

The affairs of the company provide a significant indication of the approach followed by Marconi in confronting challenges. Every move was preceded by extremely careful preparation. The creation of a vast wireless telegraphy system was impossible without the existence of an independent industrial organization, provided with manpower and financial resources. The young inventor clearly understood the inescapable requirement that an industrial operation be backed by technical and scientific research. And he satisfied that requirement by creating and personally managing an industrial enterprise—yet another expression of that consistency of thought and purpose to which I have already referred.

With a team of carefully chosen assistants, Marconi was able to experiment, invent, and build. Then, having marketed the results of his research, he would repeat the cycle, uninhibited by such contemporary problems as the transferral of research results to the production line.

But this activity as an industrial entrepreneur was a means, not an end, for Marconi. His purpose was not the creation of an industrial empire. In fact, he showed little interest in the extremely promising field of commercial broadcasting and in David Sarnoff's plan to bring radio into the home as an information and entertainment medium. But Sarnoff, who had begun his career as a clerk in the American Marconi Company, had an entirely different temperament from that of Marconi, even if their personal relationship was one of extreme mutual respect and friendliness.

Marconi the scientist

It would be rash to claim that science constituted a means to an end for Marconi—at least to the extent

that his entrepreneurial activity did. In the same way that the art of navigation was fundamental to the achievements of Columbus, so science was a vital element of Marconi's work. It was a necessary, though not solitary, condition for the attainment of his goals.

It is legitimate to ask, then, why men with more scientific training than Marconi did not arrive at the same fundamental conclusions about the propagation of electric waves. The work of the British mathematician Heaviside and the American physicist Kennelly dates back to the beginning of the twentieth century. Many other renowned scientists—Poincaré, Raleigh, Thomson, Sommerfeld, to name but a few—thoroughly investigated and extended this field of research, but none of them made a contribution to radio communications comparable to Marconi's observation that 32-meter waves underwent no daylight attenuation in the transmission from Poldhu to Beirut. These scientists had other objectives; they were motivated by different interests. Whereas *they* wanted to add a new chapter to the knowledge of physics, Marconi wanted to create a new system of communication between men.

Thus, questioning whether Marconi was a great scientist is rather like asking whether Columbus was a great navigator. The question is obvious, but by no means pertinent. If Columbus had not been seized with the idea of discovering a new route to the Indies, all his navigational expertise would not have sufficed for the discovery of America.

Recognition

On July 20, 1937, a heart attack ended Marconi's life, but the horizons his work opened remained. Indeed, if I can be excused for dealing in rhetoric, it could be said that these horizons reach to the stars, since the conquest of space would have been impossible without the radio links that ensure communications.

The highest honor that can be paid a man is the continuation of his work, and even if Marconi had received no other recognition, the application of his discovery to telemetry and telecommunications between space vehicles and ground stations would be honor enough. But other honors were received by Marconi—in fact, a list of his titles, awards, honorary degrees, and associations fills three pages of the *Bibliografia Marconiana*.

Nevertheless, I must refer to these awards as “ephemeral” because, in the final analysis, it is the name of a truly great man that will take its place in history—Guglielmo Marconi.

Araldo M. Angelini (F) is president of Ente Nazionale per l'Energia Elettrica, Rome. He is also a professor of electrical machines and electrical engineering at the University of Rome. A member of the Italian Atomic Energy Committee and past president and founding member of EURATOM, Prof. Angelini received the *libera docenza* degree in electrical engineering from the University of Rome in 1936. He was formerly managing director and general manager of the Terni Co., Italy. He has authored numerous papers on electrical machines and systems, nuclear energy, and the economics of power generation and transmission.

Self-contained microcomputers ease system implementation

The user gets a microprocessor, memory, built-in software, a power supply, and input-output circuits so he can program his own hardware

The engineer who designs microprocessor-based equipment sooner or later must bring software and hardware together into a working system. For many, a self-contained microcomputer, like those listed on the next two pages, may be the most effective means to achieve design goals. These development systems provide the user with a microprocessor, memory, built-in software, a power supply, and input-output circuits so he can program hardware that looks very much like the final product he intends to build.

The self-contained microcomputer is not for every user. In many cases—particularly when a system design must be completed quickly and sufficient money is available to purchase computer time—the best route to take is probably to design the system with the aid of a large, powerful computer. Cross assemblers and powerful debugging tools can then be used to design the desired microcomputer software rapidly and efficiently.

The self-contained development system is ideal for the engineer who needs to keep his design costs to a minimum and is looking for a practical, immediate solution to system implementation. With the development package, he can quickly configure his own system in hardware by plugging in various types of memory and circuits to interface the peripheral devices he needs. In this way he can get actual hardware verification of system operation.

Many engineers who would like to dip their toes into the ocean of microcomputer applications are put off by the fear that they will need to deal with time-sharing systems and exotic software before they can hope to get any useful results. For them, a free-standing microcomputer offers the opportunity to do simple programming.

Development system characteristics

Beyond the microprocessor itself, semiconductor memory is one of the most essential items in microcomputer design. Random-access memory (RAM) is very flexible because data can be repeatedly written and read from this type of memory. In a development system, user-written programs are often stored in RAM memory, where they can be altered as desired until they are adequately debugged and operating correctly. Then the completed programs can be permanently stored in a read-only memory (ROM) for final system use.

When only one, or just a few, systems will be built to a given design, programmable ROMs (PROMs) are

often the best choice. Several development systems provide built-in capabilities for programming PROMs, and for writing or "burning" the programs into them.

For systems that are to be produced in quantity, mask-programmable ROM memory is usually the most economical choice for program storage. These ROMs are produced on order by semiconductor manufacturers, usually from programs recorded on punched paper tape. To provide this type of tape output, the microcomputer development system must provide an interface to tape-punching equipment.

Perhaps the simplest means of communication between the user and his microcomputer development system is the teletype keyboard, often supplemented by a punched paper tape reader and punch. Most of the development systems listed in the table on the next two pages, provide a teletype interface.

Probably the most important development system program is the assembler, since it provides the means to write user software in a reasonably efficient manner. Debugging programs are also very important because one of the primary functions of the development system is to provide a means to get user software into operation, and debugging is an essential part of this effort. Tape loading and editing programs are a third key type of development system software. User programs developed on the system are often recorded on paper tape for later use, or for producing PROMs or mask-programmed ROMs. Other software written elsewhere for the system can be fed into RAM from paper tape.

Typically, the development systems come neatly packaged in a box that includes all the necessary circuit cards, connectors, and a power supply, as well as a set of switches and display lamps to help the user debug his software and hardware. These usually include a set of bit-switches for entering memory addresses, instructions, and data. In addition, other switches—there may be many or only a few—provide such functions as single-step execution of programs and reset to zero for the system program counter. Display lamps show memory and register contents; status lamps indicate whether the microprocessor is running, stopped, or waiting for information from memory or peripherals, as well as indicating other pertinent operating conditions.

Reprints of this article (No. X74-121) are available at \$1.50 for the first copy and \$0.50 for each additional copy. Please send remittance and request, stating article number, to IEEE, 345 E. 47 St., New York, N. Y. 10017. Att: SPSU. (Reprints are available up to 12 months from date of publication.)

Howard Falk Senior Associate Editor

Microcomputer development systems—some of the free-standing systems based on microprocessor chips

Development System	Micro-processor	Memory Capabilities	Input-Output Capabilities
PPS-4MP Assembler (Applied Computing Technology, Inc.)	Rockwell PPS-4	2k bytes of RAM for ROM, PROM emulation; 1k × 4 bits of RAM for data. Both ROM and RAM expandable to 4k. PROM programming	Teletype interface; four 4-bit outputs; five 4-bit inputs
LDS, MDS (Control Logic, Inc.)	LDS uses Intel 8008; MDS uses Intel 8080	3252 bytes of RAM; 512 bytes of PROM; expandable to 8k of mixed RAM and PROM. PROM programming and PROM burning	Teletype interface; two 8-bit inputs; one 4-bit output; two I/O peripheral connectors with logic
MPS (Digital Equipment Corp.)	Intel 8008	4k of PROM and 4k of RAM in any combination (expandable to 16k). PROM blaster	Teletype interface; 8-bit parallel TTL interface
Intellec-4, -40 (Intel Corp.)	Intellec-4 uses the Intel 4004; Intellec-40 uses the Intel 4040	4k bytes of RAM (4k bytes of PROM can be added). Data RAM is 320 bytes, expandable to 2.5k. PROM programming and PROM burning	Both the Intellec-4 and the -40 have eight 4-bit outputs (expandable to 48). The -4 has four 4-bit inputs; the -40 has three 4-bit inputs, and an interrupt line.
Intellec-8, -80 (Intel Corp.)	Intellec-8 uses the Intel 8008; Intellec-80 uses the Intel 8080	8k bytes of RAM; 1k of PROM (expandable to 16k bytes of mixed RAM and PROM). The -80 is expandable to 64k bytes external to the system. PROM programming and PROM burning	Four 8-bit inputs, expandable to eight, (16 for the -80); four 8-bit outputs, expandable to 24 (28 for the -80); UART for serial communications; one vectored interrupt line
Exorciser (Motorola Semiconductor Products Div.)	Motorola MC6800	256 bytes of RAM; 3k bytes of ROM (user RAM is expandable to 64k)	Teletype interface; 110–9600 baud, switch selectable; ten optional modules with four 8-bit I/O (expandable to 12 modules)
IMP-16P, -16L (National Semiconductor Corp.)	National IMP-16	4k, 16-bit words of RAM (expandable to 32k words)	One 16-bit input-output bus; one general interrupt line; one vectored interrupt line (-16L has four vectored interrupts); six control flags; four jump condition inputs; teletype and card reader interface. IMP-16L has direct memory access.
IMP-8P (National Semiconductor Corp.)	National IMP-8	8k bytes of RAM (expandable to 32k bytes)	One 8-bit input-output bus; one general interrupt; four control flags; one jump condition input
Micro Pac-80 (PCS Inc.)	Intel 8080	1k bytes of ROM; 4k bytes of RAM (expandable to 64k bytes of mixed ROM and RAM)	Teletype interface; one 16-bit I/O
SS-1, -1A, -1B (Pro-Log Corp.)	Intel 4004	1280 bytes of PROM (expandable to 1.5k bytes for SS-1A; to 4k bytes for SS-1B); PROM programmer	SS-1 has four 4-bit inputs; five 4-bit outputs; SS-1A and 1B have eight 4-bit I/O lines (card expandable to 128)
SS-2, -2A (Pro-Log Corp.)	Intel 8008	1k words of RAM; 1280 words of PROM (expandable to 16k words of mixed RAM and PROM); PROM programmer	Teletype interface; SS-2 has 28 I/O lines, one interrupt line; SS-2A has 32 input lines and 32 output lines (both are expandable to 128 lines)
COSMAC Micro Kit (RCA)	RCA COSMAC	1k bytes RAM, 512 bytes PROM, expandable to 24k bytes of mixed RAM and PROM	Teletype interface; UART for serial communications, 8-bit input, 8-bit output latch, one general interrupt line, two direct memory access request lines; four jump condition I/O flags, 16 output command lines for use with optional I/O controller cards (12 card slots)
TLCS-12 Computer Set (Toshiba)	Toshiba TLCS-12 Ex-1	500 words of RAM (expandable to 4k words of mixed RAM and PROM)	Teletype interface

Built-In Software	Display Functions	Switch Functions	Unit Price for Std. Configuration
Assembler; debugger; paper tape editor	16-bit address display; 8-bit instruction display; five status lamps	16-bit address entry, eight function switches	\$2495
Debugger (assembler, editor, and PROM-burning program are on paper tape)	Run indicator	8-bit address entry; three function switches	LDS, \$2990 MDS, \$3300
Assembler; editor; debugger	Optional	Optional	Price for minimal configuration is about \$1800
System monitor (includes tape loader and debugger); assembler (includes paper tape editor)	Six status lamps (the -40 has seven lamps), 12-bit address display, 8-bit instruction display, 4-bit memory display, 8-bit processor data-bus display, 8-bit memory address pointer display	12-bit address or data entry; 4-bit search address entry; 15 function switches (the -40 has 16 switches)	Intellec-4, \$2545 Intellec-40 to be announced
Systems monitor (includes tape loader and debugger); assembler; editor	16 status lamps; 16-bit address display; 8-bit processor data bus display; 8-bit instruction or data display	8-bit address or data entry, 14 function switches	Intellec-8, \$3540 Intellec-80, \$3840
Loader, tape puncher (memory verifier and debugger are on tape or cassette)	Two status lamps	Three function switches	\$2640
Loaders for paper tape and card reader; teletype and card reader service routines (assembler, editor, utilities, debuggers are on paper tape or cards.)	16-bit data display; 16-bit address display; 3 status displays	16-bit data, address entry; nine function switches; 11-position selector switch	IMP-16P, \$3850 IMP-16L, \$3950
Loader for paper tape and cards (assembler, debuggers, teletype, and editor routines are on paper tape or cards.)	Same as IMP-16P, L	Same as IMP-16P, L	\$3750
Loader and drivers for main control (assembler, debuggers, editor available on tape)	16-bit address and date display; run lamp	16-bit data entry; 12 function switches	\$2995
None	Clip-on tester has 12 data display lamps; eight instruction lamps; scope sync test point	Clip-on tester has 12 address switches; six function switches	SS-1, \$2950 SS-1A, \$3150 SS-1B, \$3350
Loader; editor; system monitor	Clip-on tester has 16-bit address display; seven status lamps; scope sync test point	Clip-on tester has 16 address switches; three function switches	SS-2, \$3800 SS-2A, \$3950
Monitor includes hex loader, terminal I/O (assembler, editor, file system, and full debug capability available on later model)	Run indicator	Four function switches	To be announced
Assembler	12-bit address display; 12-bit data display; four status lamps	12-bit address or date entry; 7-position selector switch; three function switches	\$2320 POB Japan

Magnetic-stripe credit cards: big business in the offing

A new type of credit card brings a banker, or his cash-dispensing machine, on line and speeds checkout and payment for retail goods

The magnetic-stripe credit card, a relative newcomer on the credit card scene, shows promise for expanding the traditional role of the credit card in our society. In addition to performing all of the conventional functions of embossed, physically coded, and other forms of magnetic data storage cards (see the box on p. 61 for a comparison of the various technologies), the magnetic-stripe credit card (MSCC) offers additional advantages. Prominent among these is the capability of performing on-line credit transactions in real time, which has led to unattended cash dispensers or on-line self-service banking. Another advantage is ease of magnetic reading of the card. Wand-type readers, moved by hand, can easily tolerate the velocity and acceleration variations that the human hand can produce. And the magnetic-stripe card can even be used, by the addition of a separate stripe, to perform part of the function of a data base in an on-line system—i.e., record allowable total cash dispensed, number of transactions, balance, etc.

MSCC characteristics

An important characteristic of MSCCs (Fig. 1) is *dual-density data storage*, whereby the magnetic stripe, located on the back of the card, is divided along its entire length into two equally wide data tracks, including high- and low-density data, respectively. The high-density track is mainly needed by airlines to ensure an adequate number of characters for the cardholder's name, an absolute "must" in the air transport industry. The lower-density track is intended for credit authorization and data-base access, where identification of the cardholder by number is adequate.

The magnetic stripe is precisely positioned with respect to the upper edge of the card. The first bit of the start character begins near the right-hand end of the stripe, the characters reading from right to left. The top half of the stripe, Track 1, contains the high-density data. On this track, data is recorded at 84 bits per cm, and the track can accept up to 84 six-bit characters plus parity alphanumeric data. Track 2, below, containing data encoded at 30 bits per cm, accepts 40 four-bit characters plus parity numeric data. The formats of the numeric and alphanumeric data on both tracks are specified by industry groups to ensure that all pertinent information can be included and to facilitate interchange. The data are encoded as magnetic flux transitions in a frequency/double-fre-

quency (F/2F) mode, for the binary "0" and "1", respectively. This mode comprises both data bits and clock bits in the data system. Consistency in the characteristics of the magnetic material as well as in the physical location of magnetically stored data on the card is required by the American National Standard Institute (ANSI), which has recently approved a standard for the MSCC. The MSCC is the same size as the conventional plastic (embossed only) credit card, also approved by ANSI.

How MSCCs are made

The substrate for the magnetic medium is the surface of the polyvinyl chloride (PVC) card stock. The magnetic material is standard computer or recording tape, and thus is readily available from numerous sources. The tape manufacturing process allows adjustments like varying oxide thickness, to be made, if necessary, to insure desired signal outputs at the reader. The magnetic material may be placed on the card stock by deposition, coating or wet striping, printing, or transfer coating from a carrier. The latter, also known as "hot stamping," seems to offer several distinct advantages.

The hot stamping process is inherently capable of the high production volumes required for MSCC systems and it produces a very tight bond between the plastic material and the oxide. Hot stamping presses have been used for years to produce signature panels on credit cards and need only be slightly modified to apply the oxide coating.

[1] Magnetic-stripe credit card layout. Standard specifications include both machine-readable stripe and embossed characters for optical character recognition applications. Dimensions are in cm.

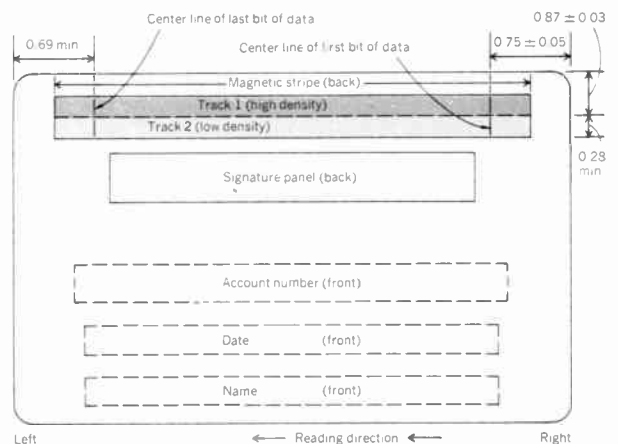

Jerome Svigals and Herman A. Ziegler
IBM Corporation

Credit system jargon

Here are some useful words, and their meanings, in credit system vocabulary: *Authorization*—the act of securing credit approval for purchase by contacting the card-issuing bank. *Bank Card*—credit card issued by a bank. *Credit Authorization System*—a system including a terminal, a communication channel, and a computer at a central bank location. (See also credit-authorization terminal.) *Credit-Authorization Terminal*—an on-line terminal, connected to a central bank computer, providing the computer with customer and merchant identifications and the amount of transaction. When a transaction is authorized by the computer, an audit trail number is displayed at the terminal. *Credit Limit*—a figure representing a cardholder's debt and payback capacity. *Embossing*—a process of raising the surface of a material. (By embossing a plastic card, information can be added to it.) *Floor Limit*—the dollar level beyond which a merchant must receive an authorization approval by the card-issuing bank. *Fraud*—the act of using a credit card with no intention of paying, or attempting to avoid debt (normally involves a card not belonging to the user). *Hot Card*—a credit card determined to be in fraudulent use. *Hot List*—a list of known hot cards in use, produced periodically and mailed to merchants. The merchant is obligated by agreement to check the list each time a credit sale

is made. *Imprinter*—a mechanical device at a merchant's location in which the cardholder information embossed on the credit card is reproduced on the sales draft. *Negative File*—file containing a list in encoded, machine-readable format, of account numbers that have been blocked from use in the system because of known or suspected fraud or misuse. *Point-of-Sale Terminal*—an on-line cash register with credit authorization and data capture facilities. *Positive File*—file containing all existing accounts and balance information. *Referral Clerk*—a clerk for individual handling of credit authorization, when such credit cannot be approved by normal procedures. *Teller Terminal*—a terminal attended by a bank teller for account inquiry, deposit, and cash withdrawal authorization. Such terminals consist of numeric or alphanumeric keyboard input, display, media-reading capability (for passbooks, identification cards, and credit cards) and data writing or printing capability, and they are connected (on line) to a central bank computer. *Unattended Teller Terminal*—a terminal for self-service transactions as cash dispensing or electronic funds transfer. The terminal accepts three inputs—customer's identification, customer's secret number, and requested amount of money. The outputs (for an authorized transaction) are the customer's card and the cash required.

The additional cost of adding magnetic stripes to plastic cards is relatively low. Hot stamping presses are low-cost machines and can be amortized over many millions of cards. One 480-meter reel of standard computer tape will produce well over 5000 MSCCs. Data is encoded on the two tracks of the magnetic stripes very much as in encoding magnetic tape.

Reading the MSCC

Unlike with optical character recognizers (OCRs) and other character recognition devices, reading magnetic stripes does not require scanning or conversion from human-readable to machine-language forms. Thus, a simple magnetic reading capability is adequate for preparing information for direct on-line system input.

A major advantage of the F/2F modulation, used for encoding the data on the stripe, is that the stripe need not be read at constant velocity. Consequently, magnetic-stripe readers, held by hand, can be tolerated. At a recorded density of 30 bits per cm, proper demodulation and data extraction can be accomplished despite the velocity and acceleration variations the human hand can produce. Densities higher than 30 bits per cm are even more tolerant of such variations. As a result, it is not necessary to use a mechanical card transport to control the reading rate; to the contrary, low-cost, hand-powered devices are adequate.

Two basic design approaches in MSCC readers are a slot reader and a hand-held wand. The slot-type reader (Fig. 2), is part of a keyboard display terminal. Such a keyboard, which may be either numeric or alphanumeric, contains programmable function keys that can be assigned specific meanings. A typical display used in such a terminal, has six rows of 40 alphanumeric characters each. A terminal of this

kind is generally designed to read various devices containing magnetic stripes like an MSCC, a bank passbook, or a straight identification card.

The teller slides any of the three devices through a magnetic stripe reader, and the encoded data is read and sent to a communication controller. If the coded data is an account number, the computer can process information entered at the keyboard against that specific account. The terminal may also be supplied with magnetic stripe encoding capability to enable it to write (or rewrite) coded information on magnetic stripes used in passbooks. Such coding is different

[2] Slot-type reader on top of IBM 3604 keyboard display terminal for finance applications can read magnetic-stripe or identification cards, as well as passbooks.



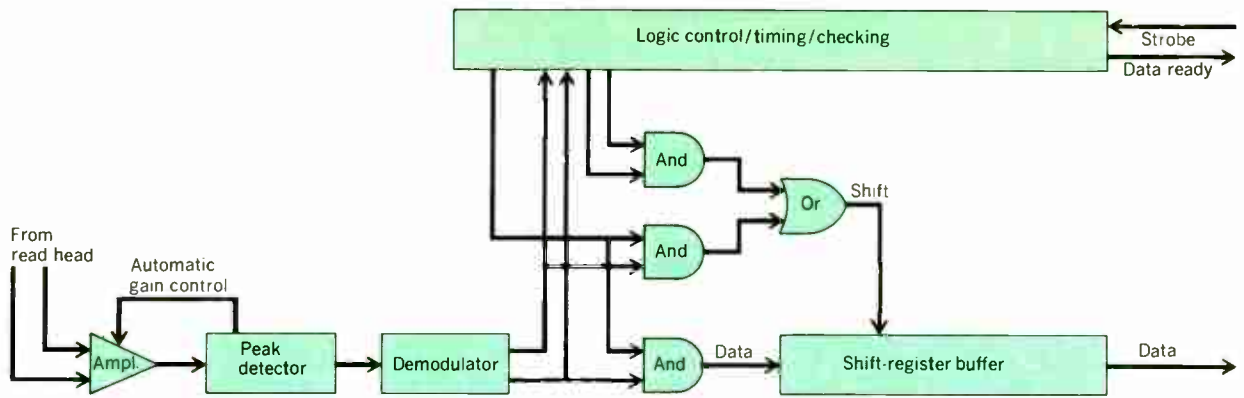

[3] Signal processing functions, including a full message buffer, required to interface variable-velocity card readers like slot and wand readers with a data processing system. The buffer is loaded based on a strobe derived from the data stream, and unloaded on the basis of either a system-derived clock or a local oscillator.

from MSCC coding to deter illicit issue of magnetic stripe credit cards.

Reading magnetic-stripe price tags

A hand-held wand can be used to read data directly from price tags and other documents containing magnetically encoded data. A slot reader is somewhat easier to use because its magnetic head can be precisely oriented and because head-to-stripe contact is

controlled by the terminal design and not by the operator. However, where the magnetic-stripe document cannot be separated from the merchandise, the hand-held wand can be successfully used by a sales person with very little training.

To facilitate the use of a hand-held device, however, three factors must be considered by the system designer: the message format should be designed to permit bi-directional scanning; the transducer design

[4] On-line credit authorization/data entry system includes point-of-sale store terminals that are on-line with bank's central computer.

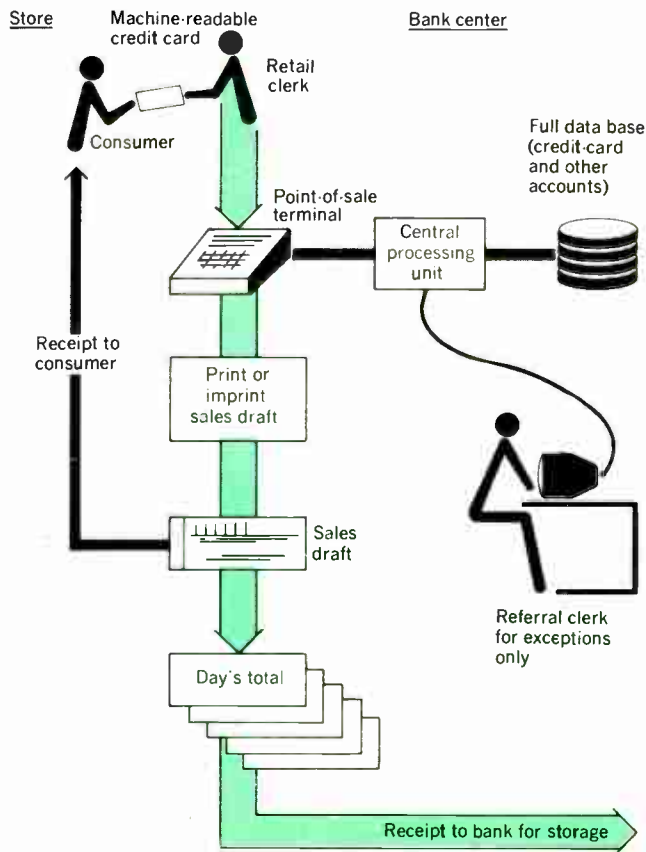

Embossed only and magnetic-stripe media status

Regular credit cards containing embossed information only will continue to be used in nonautomated transactions, where hand imprinters are employed for data capture. There are also several credit-authorization terminals that accept such cards. Embossing only, however, is not generally used in unattended teller terminals.

Among manufacturers of such terminals, known also as *cash dispenser* or *self-service units*, which accept MSCCs, are Bank Computer Network, Burroughs, Docutel, Financial Data Sciences, IBM, Money Machines, Mosler and NCR.

In *teller terminals*, the MSCC concept was only introduced last year. Main vendors of such teller terminals are Bunker Ramo, Burroughs, Financial Data Sciences (offering a magnetic-stripe version of its terminal only as an option), and IBM. Many companies will probably follow suit. Among *credit authorization terminals* that accept MSCCs are products by Addressograph-Multigraph, Data Source, IBM, Interface Industries, NCR, and Synergistics.

Nonembossed magnetic-stripe tickets have been in use for some time in security and access-control systems (for example, in central computer locations and military installations), as well as in transportation, and magnetic-stripe theater-ticket issuing machines are expected to be operative soon. But in all banking and shopping applications, where the card holder has to be identified, embossing of card-holder's name, account number, and expiration date on MSCCs will probably remain in practice. Another reason for expected continuation of embossing on magnetic-stripe credit card is the vast amount of embossing-reading equipment already in use.

should not require precise rotational or vertical alignment; and the stripe should either be recorded in a full-width single-track mode or some method of guiding the wand should be provided.

To interface variable-velocity scanners with data processing systems, either directly or through additional circuitry via a telephone network, signal processing using a full message buffer is required (Fig. 3). The buffer is loaded based on a strobe derived from the data stream, and unloaded on the basis of either a system-derived clock or a local oscillator.

MSCC, on-line—the principal advantage

Unlike off-line systems, on-line credit authorization/data entry systems (Fig. 4) include point-of-sale terminals, at one or more retail stores, that are directly on-line with a central processing unit (CPU) at the bank center.

Most credit card systems prior to the advent of the MSCC have been off-line credit authorization systems very much like that in Fig. 5. A transaction cycle begins as the consumer hands his bank card to a clerk in a retail store and ends with data entry and billing at the bank's computer center.

If a purchase is under the floor limit and the credit card involved is not on the hot list, the sales draft is imprinted with the consumer's name and account number and he is given a receipt. The day's accumulation of sales drafts is brought to the bank, where the merchant's account is credited. Depending on the nature of the bank's computer system, the informa-

tion on the sales drafts is converted to machine-readable form via key punching or magnetic ink character recognition (MICR) inscribing, and is then entered into the CPU for updating the merchant's account and for monthly billing to the consumer.

If the amount of the transaction exceeds the floor limit, however, the clerk at the point of sale—that is, the retail clerk—is required to telephone the bank center to obtain credit authorization. An authorizer (or relay clerk) at a cathode-ray tube (CRT) terminal connected to the CPU has direct access to the data base (or authorization file). If the amount of the current transaction plus outstanding credit is satisfactory with respect to the credit limit, the authorizing clerk relays his approval of the transaction.

Various algorithms covering other credit criteria, such as type of transaction and frequency of transaction for that credit card number, are likely to be included in the authorization process. The CRT terminal displays an authorization number, which the authorizer gives by telephone to the retail clerk. Exceptions are normally handled by another clerk. When the authorization file identifies a card in fraudulent use, the referral clerk is expected to notify the bank security staff or the police, according to a given procedure.

It can be seen that a credit authorization system using conventional embossed credit cards is therefore an off-line system with respect to the point-of-sale, even though the computer facility at the bank center may itself be a highly sophisticated on-line data pro-

[5] Key elements of manual, off-line credit authorization systems not using magnetic-stripe credit cards are "floor limit" and "hot list" of credit cards known to be in fraudulent use.

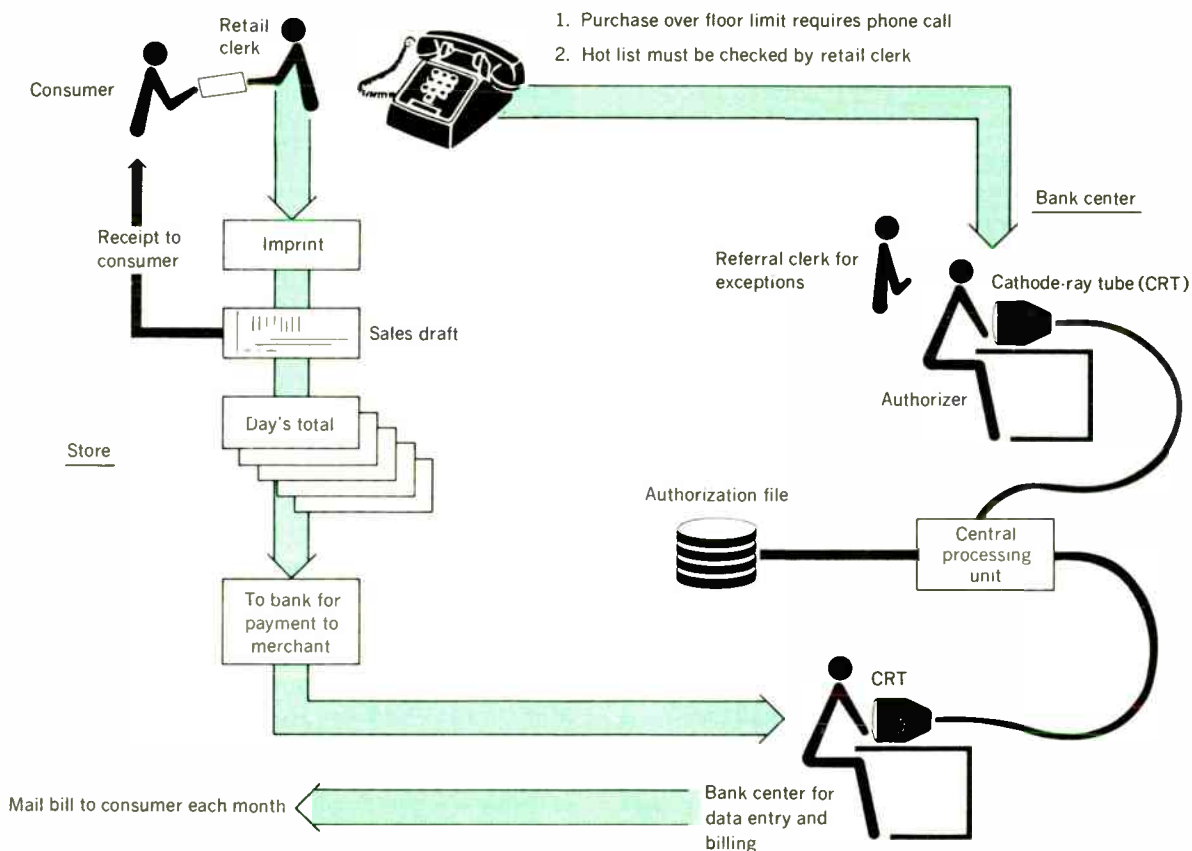

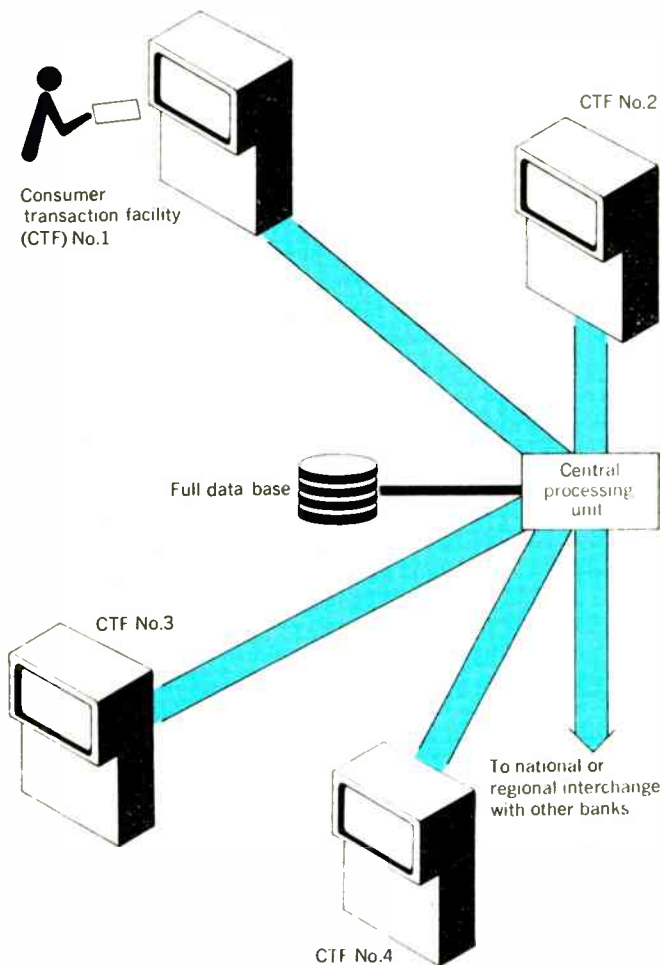

[6] On-line self-service banking system is similar to on-line system for credit transactions but is operated by customers themselves and allows direct cash withdrawals.

cessing system. There are several serious limitations to off-line value exchange transactions of this kind:

First, with the exception of the hot list, which is difficult to maintain as current, only about 20-30 percent of all transactions (the estimated amount above floor limit) are evaluated by the credit authorization system. Second, the credit authorization cycle is slow. However rapidly an authorization number is provided at the bank center, telephone authorization takes time both at the sales point and at the bank.

A third limitation is the time lag between the updating of the authorization file in the bank center and the consumer's current credit position. Finally, even when the authorizer has on-line access to the data base, the credit authorization cycle makes no contribution to relieving the manual data entry load.

In direct contrast, the MSCC, thanks to its capability of operating on-line, avoids such limitations. For example, the terminal reads the consumer's account number on the MSCC, and the retail clerk keys in the amount of purchase and any other data needed in the system. The CPU in the bank center immediately checks the hot list, positive file, and merchant and/or transaction-source files. The CPU then evaluates the credit purchase against established credit

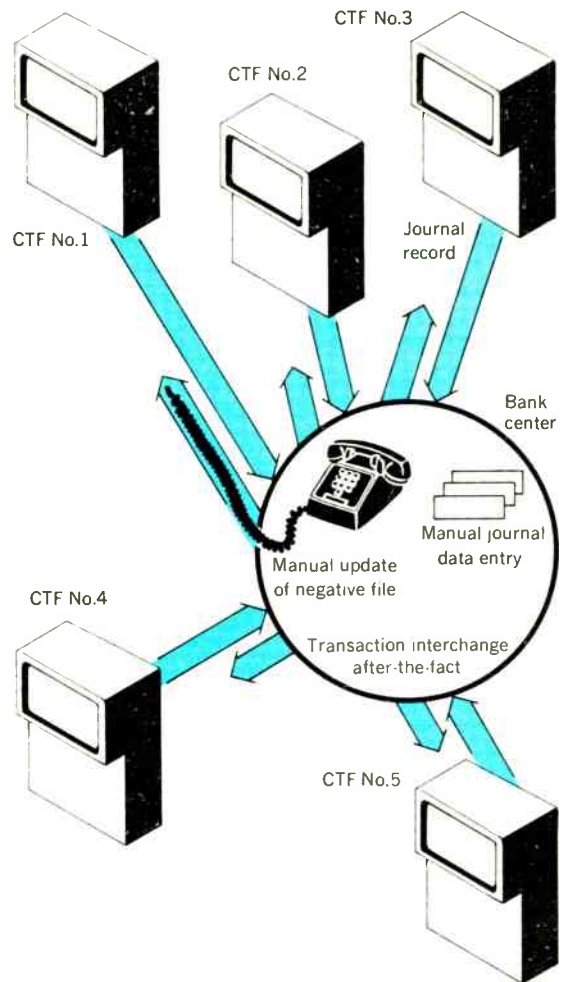

[7] Off-line self-service banking system has self-service facilities accepting encoded credit cards. Each facility operates independently of a bank's central computer. Cash dispensers themselves contain local hot lists and maintain daily records; additional information specific to a cardholder must be encoded on the card itself.

rules, like acceptability of purchase with respect to credit limit and frequency of use.

If the credit purchase is found acceptable, an authorization number is automatically displayed on a CRT at the point-of-sale terminal (audio response and hard-copy printers are other means of providing the authorization number). A limited number of referral clerks are still needed at the bank to handle exceptions, which are indicated by an audio or visual alarm or simply a CRT display of data.

Further advantages of the MSCC

Once an on-line system has been established in a bank for credit authorization, the bank can use the open line to its CPU to expand further its banking services. In particular, cardholders can be provided with checking account numbers, perhaps on the same MSCC, and checking-account files can be set up in the bank center. In this manner, checks can be authorized at the same point-of-sale terminals and the checking account file can be automatically updated.

Further, the availability of magnetic stripe technology has helped to achieve the newest wrinkle in bank

Credit-card technologies discussed

Extensive use of credit cards in shopping and banking—more than 275 million credit cards are in the eager hands of American consumers today—has stimulated engineering efforts to develop technologies and systems that can increase the scope of commercial transactions, making them faster, safer, and less susceptible to human error. "Hot stamping," one such technology, has been used for several years to place a magnetic stripe on credit cards, thereby permitting both the recording of machine-readable data onto a card, as well as reading data from it. Such magnetically coded data are generally additional to alphanumeric data "embossed" on cards.

But there are several other current technologies that provide for machine-readable data—these include: embossing (as in the conventional plastic credit card); physical coding by creating holes, raised bars, or notches on the card; optical coding; and magnetic data storage, using bars or dots from ferromagnetic material, adhered to the card.

In cards whose data are embossed only, machine reading is limited primarily to a single line of low-density numeric characters. (The standard-size credit card can have no more than 19 embossed alphanumeric characters on a card.) And embossing is subject to fraud through too easy alterations and to malfunction due to the deformability of plastics.

Physical coding methods such as holes, raised bars, and notches have low data densities, structurally weaken the card, and are relatively time-consuming and costly to encode.

Optical sensing of surface and under-the-surface marks, opaque and clear segments, and various chemicals that offer "invisible sensing" are usually characterized by low data density and can be modified from the surface. Cards made by this technique are rather expensive to produce because each requires individual marking procedures that handicap mass fabrication in large sheets.

Magnetic data storage on credit cards is accomplished either by encoding flux variations on a continuous magnetic stripe or by creating a pattern of magnetic and nonmagnetic areas along the card, using either small bars or dots from ferromagnetic material, with variable spacings between them. These two techniques basically differ from each other. While the stripe is stamped over the surface of the plastic card, during existing manufacturing processes, bars or dots have to be inserted in a special process, under the card's surface as they cannot be retained for a long time on a smooth card's surface due to their small area. Apart from the complicated manufacturing technology required for bars or dots, this technique offers low information density (about 4 dots or 20 bars per centimeter), whereas the highest data density on a magnetic stripe is about 80 bits per centimeter. Another difference between the two techniques is that data on the stripe can be erased at will and replaced by other data whereas the bars and dots are permanently inserted. Both bar or dot and stripe methods, however, are equally susceptible to relatively large magnetic fields like those in close proximity to high-current welding machines or electric traction motors.

More exotic technologies, like holograms, imbedded electronics or microcircuits, are possibly applicable but they are presently expensive and have limited information capacity.

A limited number of techniques, based on a recording on paper, offer machine-readable data. For example, optical character recognition (OCR) and magnetic ink character recognition (MICR) are both used frequently in processing paper generated in value transactions. In both these technologies, however, the character readers are extremely expensive, and, to achieve economy of scale, are usually operated in a batch mode. Projected OCR hand-held readers, in addition, will initially only be able to handle low-density data—about four characters per centimeter.

services—the unattended cash dispenser or self-service *consumer transaction facility* (CTF). The basic service of a CTF is to permit a person having a magnetically encoded "cash card," representing his checking or savings account, to obtain cash, usually at off-hours, at a self-service CTF located in a bank building. Since a CTF is essentially a checkless check-cashing machine, this device is certainly a further step toward full electronic funds transfer.

As with the retail credit purchase cycle, a CTF can be operated in either an on-line or off-line mode. In the *on-line* self-service banking system (Fig. 6), the cash card is inserted into a slot or another reading device, and the consumer keys in the amount of cash desired. The cash transaction is immediately authorized—or not authorized—on the basis of a hot list, a positive file and various security algorithms contained in the data base at the CPU in the bank center. An authorization results both in dispensing the requested cash and updating the consumer's checking or savings account records in the CPU. Note that any number of CTFs, located usually at bank branches, can be connected directly to the CPU.

The on-line self-service banking system can be expanded by introducing intermediate processing units—"intelligent controllers"—each connected to several CTFs, and to the bank's central processing unit. Equipped with computing power, data-storage capacity, and programmable interface, such controllers can supervise the operation of all CTFs connected to them.

They thus function as "concentrators" to improve overall system performance by reducing network traffic and CPU processing requirements. Intelligent controllers can also back up the CPU in the event of unscheduled interruptions and during off-hours. They include most of the same elements for authorization and data entry as the main CPU—positive and negative files, and algorithm security—however, their scope is generally limited to the accounts served by that bank branch only.

MSCCs, off-line

Not only can MSCCs be the heart of on-line systems but they can also play an active role in off-line systems, thus offering the "best of both worlds." For instance, in *off-line* self-service unattended facilities (Fig. 7), CTFs operate independently of the bank center, except for periodic replenishment of the cash supply and manual updating of appropriate data. The cash dispenser itself includes a local negative file (or hot list) and maintains a continuing daily record of all cash dispensing transactions.

Due to economic reasons, off-line cash dispensing facilities cannot have a large enough data storage capacity to include their own positive files containing all existing accounts and balances. Therefore, additional information specific to the cardholder must be magnetically encoded *on the card itself*. One approach presently evaluated is to add a third track in a separate stripe located below the stripe in the stan-

dard MSCC. This track, which is designed to contain 107 numeric characters, records allowable total cash dispensed, number of transactions (for protection from a too frequent use), and other built-in security algorithms. Using the card itself to perform part of the function of the data base in an on-line system, it is necessary that the third track be magnetically rewritten at the time of each transaction to reflect the latest total cash dispensed and number of transactions. For operations of this nature, that take place off line, the data base at the bank center, along with the negative file at the off-line facility, is manually updated at regular intervals. Any interchange transactions between the bank and other financial institutions are also periodically updated.

Security and the MSCC

The basic security measure for *off-line* operations is to record security data called "displacement" on the stripe. When this displacement is combined with the consumer's keyed-in personal identification (PID) number and processed through an algorithm, stored in the CTF, the result should equal all or part of the account number recorded on the card.

In the interests of security in *on-line* operations, there are two significant differences between data transmitted from the unattended cash dispensing terminals and the attended ones. First, a PID number, typically including four to six digits, must be keyed in by the consumer in the unattended terminal after the magnetically encoded data on the magnetic stripe cash card is read by the terminal. Secondly, the account number and PID are transmitted in encrypted form from the CTF to the CPU or intelligent controller.

The PID number, which is the foremost source of security at unattended terminals, must be protected from unauthorized access anywhere in the system. In addition, encrypting data transmission reduces the possibility of unauthorized persons with knowledge of communications breaking in on a line and controlling the operation of a CTF. The data transmitted from intelligent controllers to the CPU is encrypted too, so that the PID number has been encrypted twice by the time it reaches the bank center. The PID number are stored in encrypted form in the controllers and central data base.

Security of the encryption arrangement is maintained by regularly changing encryption keys. And when a consumer facility is opened up for maintenance, the existing code is automatically destroyed and a new code must be reintroduced when the unit is returned to service.

Furthermore, any value exchange medium, including MSCCs, is susceptible to abuse and fraud. The content of a magnetic stripe can be transferred from one card to another, or modified completely, when the proper facilities exist to effect the change. An unattended cash dispenser is most vulnerable to fraud.

Assuming that use of a cash dispenser always requires keying in a PID number, both on-line and off-line systems are protected against misuse by persons who do not have access to the PID number corresponding to the consumer's account number. If a person other than the card user gets the PID number, however, there is a substantial difference in the de-

gree of vulnerability between on-line and off-line systems. In off-line systems, for example, the relative protection when loss or theft of credit cards has been reported or when there is credit abuse over the limit depends on how often the negative file at the consumer transaction facility is updated.

A CTF can be expected to be most vulnerable when the MSCC is counterfeited and the PID number is known to the counterfeiter. In an on-line system, however, the degree of protection is the same as for an unreported credit card loss. Since the data base at the bank center is updated in real time, the total cash dispensed by even 100 copies of the same card still cannot exceed the established dollar limit for the original card.

In an off-line system, on the other hand, the bank's liability amounts to the product of the cardholder's credit limit, the number of counterfeits of the card that could be in circulation, and the number of independent off-line CTFs that will accept that card, yielding a theoretically unlimited amount.

Experience with unattended cash dispensers has indicated, however, that optimum security can be achieved with on-line systems, either direct-to-CPU or in a "sub-host" network (using an intelligent controller). But even an on-line system itself may occasionally receive its share of fraud and abuse. There will always be unreported card thefts with the potential for PID numbers available to the thieves, whatever the nature of the system or the card itself. It is well known that most current credit-card-induced bank loss is due to misuse by the legitimate cardholder himself—and, human nature being what it is, that can be expected to continue.

Jerome Svigals has been with IBM for 20 years. He has served in a wide variety of development and marketing positions. His activities in magnetic-stripe credit cards go back to the mid-1960s, and include the management of the magnetic-stripe technical and system development at IBM. He also managed IBM's first test, with American Airlines at O'Hare Airport in 1970, of self-service units. Most recently, Mr. Svigals has been manager for Self-Service Terminal Development. Mr. Svigals received the B.E.E. degree from the City College of New York in January, 1950.

Herman A. Ziegler (M) joined IBM in 1966 and served as an electrical engineer, developing terminals for the finance industry. In 1968, he became involved in the development of the magnetic-stripe credit card standard for the Air Transport Association of America and the International Air-Transport Association, and followed its course through the American Bankers Association and the American National Standards Institute. At the present, Mr. Ziegler is Manager of Advanced Self-Service Terminal Development Planning. Mr. Ziegler was graduated from California State University at Los Angeles in 1966 with the B.E.E. degree.

Reprints of this article (No. X74-122) are available at \$1.50 for the first copy and \$0.50 for each additional copy. Please send remittance and request, stating article number, to IEEE, 345 E. 47 St., New York, N. Y. 10017, Attn: SPSU. (Reprints are available up to 12 months from date of publication.)

The state of logic analyzers

Simultaneous multichannel recording, pretrigger memory, and combinatorial triggering are now available for difficult digital measurements

Recently, a large digital systems group had been playing the guessing game with an intermittent problem for about six weeks. When it became no longer enjoyable, a logic analyzer was purchased, pinpointing the problem within an hour after the analyzer arrived at the system site!

This example demonstrates why the logic analyzer promises to be as indispensable to digital systems as oscilloscopes are to analog systems. In fact, the characteristic features of this new class of instrument—pretrigger recording, multichannel simultaneity, and combinatorial triggering—have proven to be nearly ideal for solving difficult development, checkout, and maintenance problems typical of digital electronic equipment.

Logic analyzers are effective in digital applications because they extend and generalize the proven self-checking and debugging features that have evolved in complex digital systems over the past two decades. Unlike oscilloscopes (in which the data collection and data display processes are one and the same), logic analyzers have completely independent information acquisition and display processes, and operate in an entirely different manner.

This is not to say that logic analyzers will replace oscilloscopes, but rather that they are more effective for resolving specific problems typical of digital systems.

The logic analyzer

The most significant difference between oscilloscopes (Fig. 1) and logic analyzers (Fig. 2) is that, in the latter, the trigger event is used to stop the collection process, whereas in a scope the trigger event is used to start the collection process. Consequently, the analyzer collection shift registers contain the results of conversions preceding rather than following the trigger. Because it is often desirable to observe signals after the trigger as well, logic analyzers also make provision for postponing the termination of the data collection period for a selected number of conversion-clock ticks following the trigger. Hence, analyzers are capable of both positive and negative trigger delays.

For example, if the collection registers are 100 bits long and stopping is delayed after the trigger for 62 ticks of the clock, then the register will contain 38 pretrigger and 62 posttrigger conversions after collection has stopped. The amount of positive trigger delay is quite arbitrary, since it is implemented with

counters rather than delay lines. Consequently, some analyzers have a very large adjustment range for this delay (up to 10^6 clock ticks) to permit high-resolution observation of signals within time windows starting long after the trigger.

Because logic analyzers use the trigger to stop rather than start data collection, time can be taken to test for complex trigger criteria. Some analyzers use this time to compare all inputs (considered as one parallel word) against any one of the 3^n possible combinations of "true," "false," and "don't care" for n inputs. The trigger criterion is a match between the input "word" and the selected combination. Similarly, some analyzers use a match between the last n binary digits received at one input and a selected pattern as the trigger criteria (serial word recognition).

Thus, logic analyzers are adept at observing the timing relationships among a number of binary signals for a period of time preceding or following the occurrence of some defined pattern in those signals. This is precisely the type of measurement desired

[1] A typical oscilloscope diagram illustrates the interdependence of the data-collection and data-display processes.

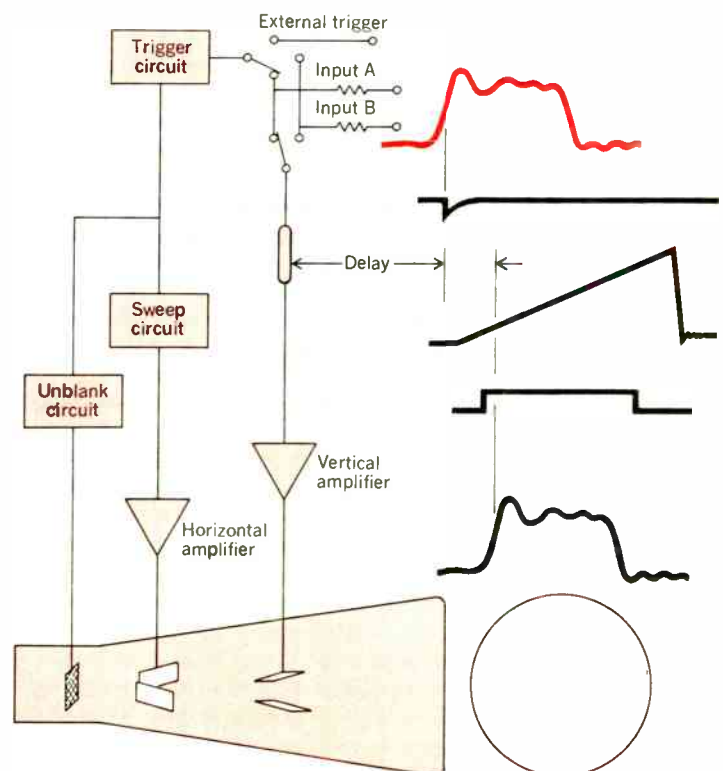

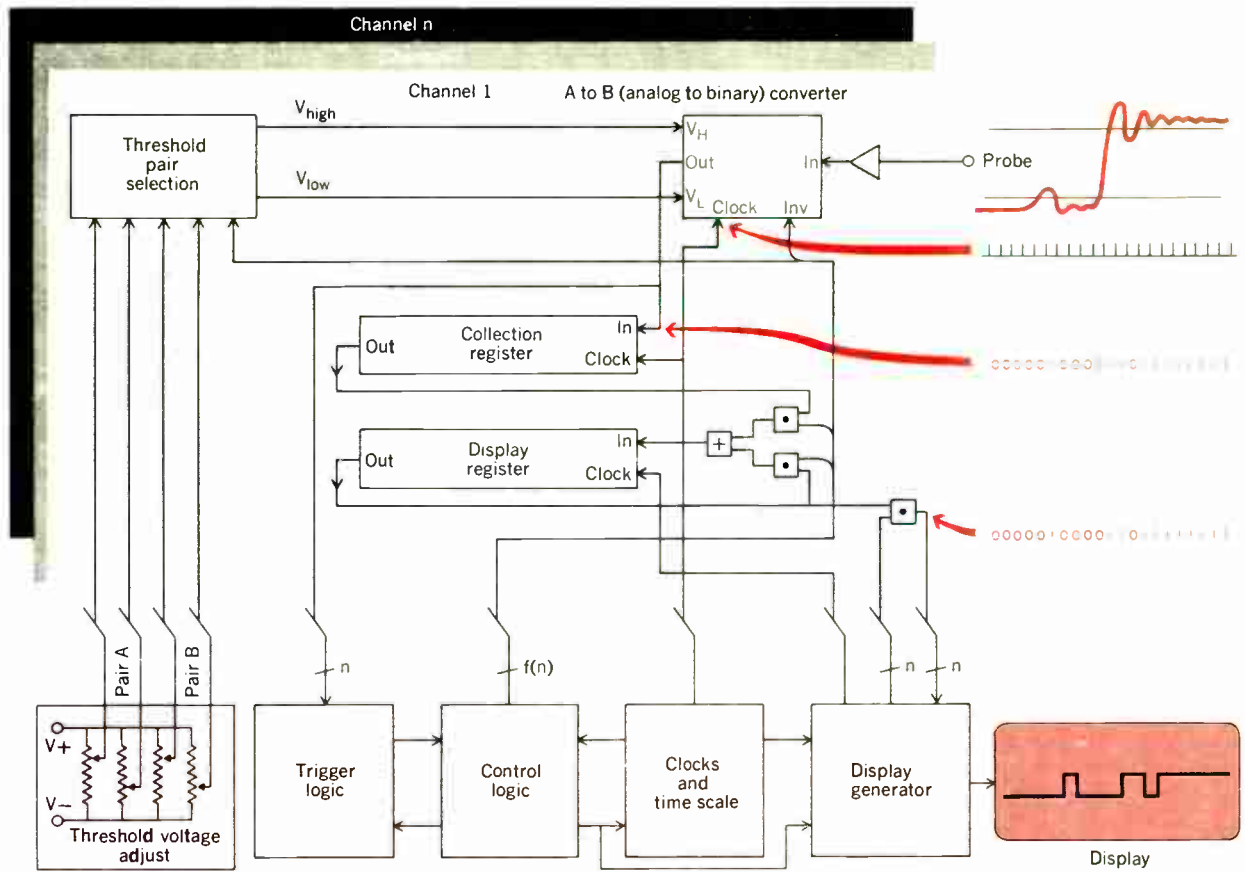

[2] The independence of data collection and display characteristic of all logic analyzers is seen in this basic diagram of the E-H Research AMC 1320 Digiscope.

Among the present logic analyzers on the market, there are a wide variety of displays, including A—light-emitting diodes (H-P 5000A), B—numeric readout on an oscilloscope (H-P 1601L), C—pseudo waveforms on a storage oscilloscope (Biomation 810-D), and D—pseudo waveforms on a video monitor (E-H AMC 1320).

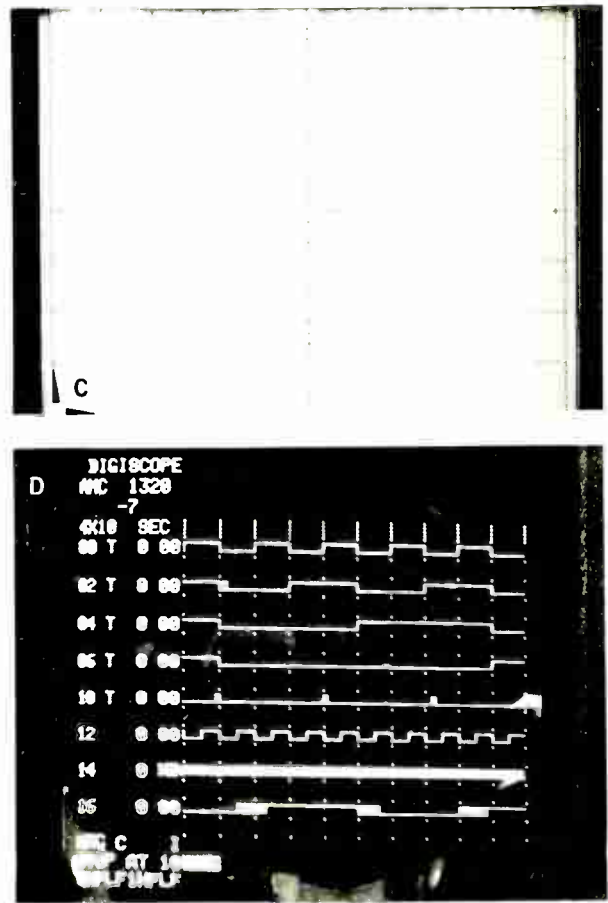

whenever the signals concurrently represent the state of the system, as is the case with digital systems.

State-sequence recording

The importance of simultaneity when observing many variables in a digital system cannot be overemphasized. The operation of any digital system can be pictured as a sequence of transitions in an n -dimensional state space. In general, for any given state, the "correct" next state is a function of the given state and the current values of the input variables. "Proper operation" of a digital system means that it follows a path through the state space that brings the system to the state that is correct for the input sequence up to that time. "Improper operation" means simply that the system gets lost in the state space. A system that is lost will either stop in some incorrect state (hang-up) or wander around in circles (hang-up in loop). The

problem is to determine where the system is in the state space and how it came to be there.

Precisely because the operation of the system was incorrect (i.e., it did not operate as it was conceived to operate), it is often impossible to make these determinations merely by applying deductive reasoning to a system model. It is necessary to restore the system to a known state (clear it) and repeat the input sequence (or the provocative part) while observing those variables most likely to reveal exactly where the system departs from the correct transition sequence.

If the instrument used for this analysis does not make simultaneous observations of the variables, the results can be very misleading (see Box, below).

Recording transient sequences

Virtually every computer system has at some time been plagued by an intermittent failure that occurred

How soon is simultaneous?

In the example illustrated below, variables A , B , C , and D are observed with an alternating sweep oscilloscope (bottom left) that triggers on the positive-going edge of variable A . As is common in digital systems, the transition times of the other variables are not separated from the transitions of A by a constant elapsed time. In asynchronous systems, this variation could be continuous; in synchronous systems, the variation will be quantized by the system clock. Because the timing relationships are not constant for each occurrence of the trigger event (A 's positive-going edge), the composite display generated by observing the variables seriatim is simply not correct.

The CRT display shows variables A , B , and C "simultaneously" high when in fact they never are, and it fails to show that variables B , C , and D are simultaneously high at times. Hopefully, most observers are too sophisticated to take the display at "face" value in this situation. Moreover, when the waveforms of the signals are of greatest concern,

as may well be the case in an analog system, ambiguity in their indicated timing relationships may be no more than a minor annoyance.

However, if it is the timing relationships themselves that contain the information of greatest concern, ambiguous timing measurements become a major difficulty rather than a minor annoyance.

Is the "system" shown below ever in a state A high, B high, C high? Is the system never in a state B high, C high, D high? How can we be sure?

If a logic analyzer with the combinatorial triggering feature (bottom middle) is programmed to trigger on A , B , and C all high, it will not trigger after thousands of complete system cycles, assuring that the specified state does not really occur. Similarly, if this logic analyzer is programmed to trigger on B , C , and D all high, it will find this state, trigger on it, and display it together with its preceding events (bottom right).

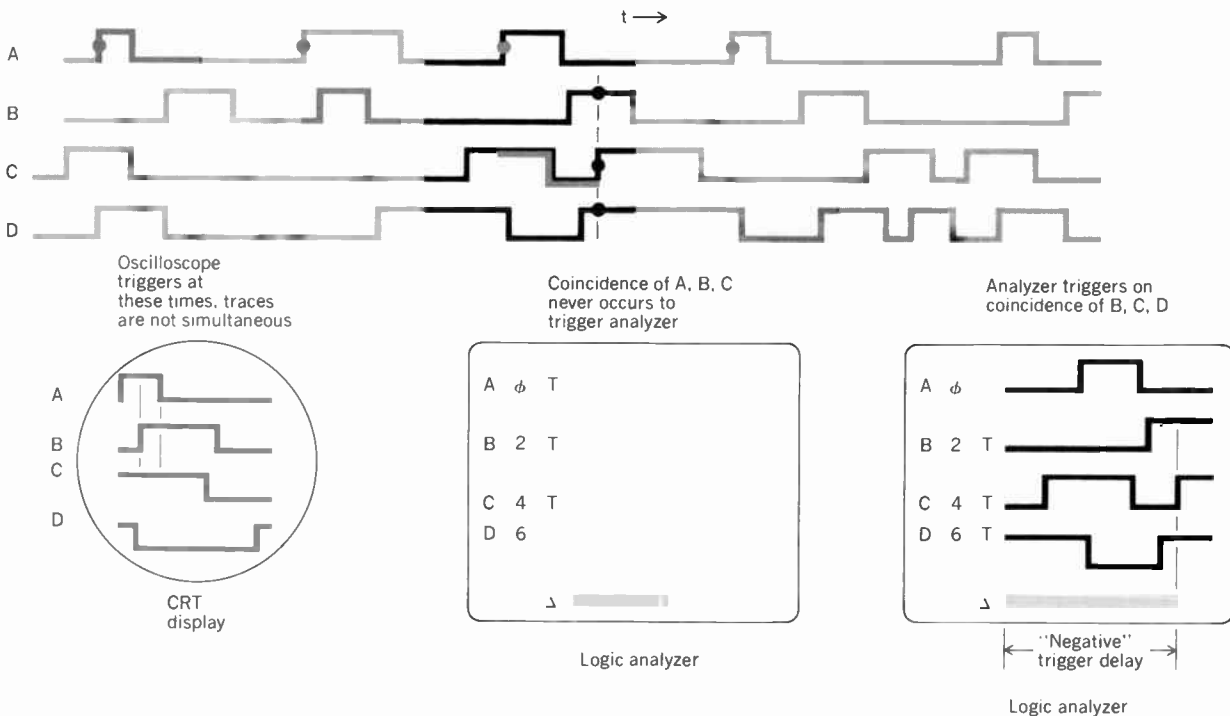

The quantization problem—latching “glitches”

While the characteristic features of logic analyzers make them effective instruments for observing the time relationships among binary signals, digital systems still use circuits and hence are affected by such waveform traits as dc offset, risetime, falltime, ringing, and noise. Logic analyzers employ several techniques to preserve such important diagnostic information.

If one considers the pulse shown in Fig. A, it can be seen that it is narrower than the conversion-clock period and might easily be undetected if it occurs between clock edges. To preclude this difficulty, most logic analyzers incorporate a latch in their A to B conversion circuit that stretches narrow pulses enough to have them occupy at least one bit in the collection register, regardless of the conversion-clock rate. This feature is particularly useful for capturing tiny noise spikes or “glitches” which can cause logic circuits to malfunction.

In Fig. B, the signal being observed is between five and six clock periods wide. At times, it intersects with five ticks of the clock and is entered as five “ones” in the collection register; at other times, the signal intersects with six ticks and is entered as six “ones.” In general, the edges of observed signals will not be synchronized to the internal clock of the logic analyzer; consequently, the timing of a logic analyzer will be correct only to within ± 1 clock period because of the quantizing effect of the clock.

Another anomaly of quantization can be seen in Fig. C, where the same signal is being observed on two channels. Because the positive-going edge of the signal happens to precede a clock pulse by neither more nor less than the typical setup time of the A to B converter, the signal may record as a logic “1” or “0” at the next clock edge. Since the respective circuits of different channels must have some difference, however small, in their speed of operation, recordings of the same signal made on different channels may be time-shifted by one period of the conversion clock (i.e., any signal-to-signal or channel-to-channel skew may be quantized to a value of one clock period). As a result, skew measurements—like any other time measurement made with a logic analyzer—are accurate to ± 1 period of the conversion clock. The fastest logic analyzer presently available has a conversion clock period of 5 ns (see Box, page 69).

In some circumstances, the quantizing effect can be eliminated with logic analyzers that are equipped with an external clock input. To remove the effect, however, there must be a signal within the system under test (bearing a constant time relationship to the signals being observed) that can be used as the clock. As an example, either edge of the read pulse to a memory might be suitable for observing the address signals, whereas only the trailing edge of the pulse might be suitable for observing the data read from the memory. Neither edge would be suitable, however, for observing events within the memory cycle, such as the operation of the address decoder or the propagation of the data through a parity tree. In order to make the best of any situation, some analyzers can be driven from either an internal or an external clock (see Box, page 69).

Risetimes and falltimes of logic signals present a special difficulty for logic analyzers, since they cannot be determined in one measurement with A to B converters that use a single threshold voltage to discriminate between logic “0”s and logic “1”s. In Fig. D, we see an example of this. Yet slow risetimes and falltimes are sometimes directly related to malfunctions; such signal transition-time information can be obtained in one measurement if a pair of thresholds are used in the conversion (see Fig. E).

In a dual-threshold conversion method implemented by one manufacturer, a logic “0” is shifted into the collection register whenever the signal is below the low threshold (positive logic assumed), and a logic “1” is entered whenever the signal is above the high threshold. When the signal is between thresholds, however, alternate “0”s and “1”s are shifted into the memory. This scheme provides a quantized reading of signal transition time that is adequate for the analyzer’s primary purpose of fault-finding.

This dual-threshold method also provides a clear indication of signals that do not attain sufficiently low zero-levels or adequately high one-levels. Since an improper signal level can be the origin of a malfunction, detecting amplitude anomalies is an additional advantage of dual-threshold conversion.

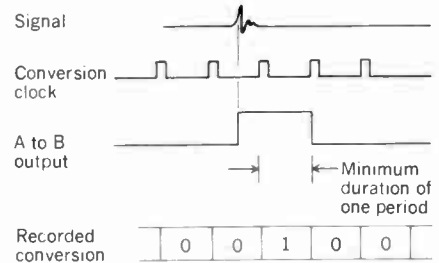

A

B

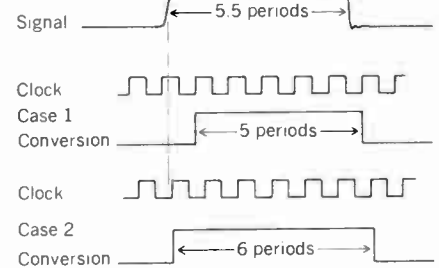

C

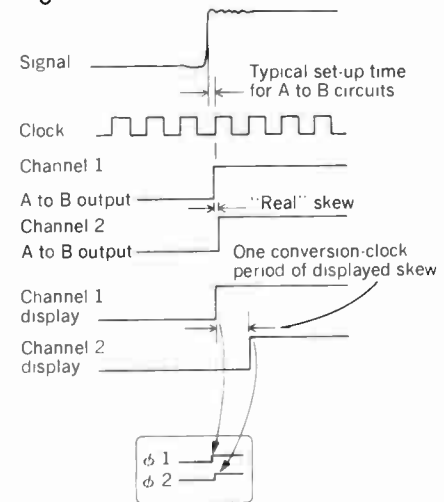

D

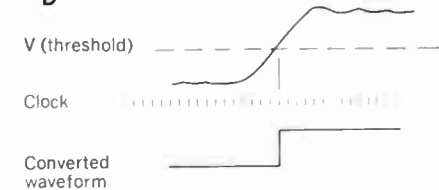

E

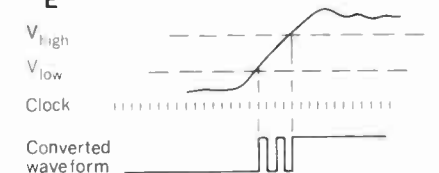

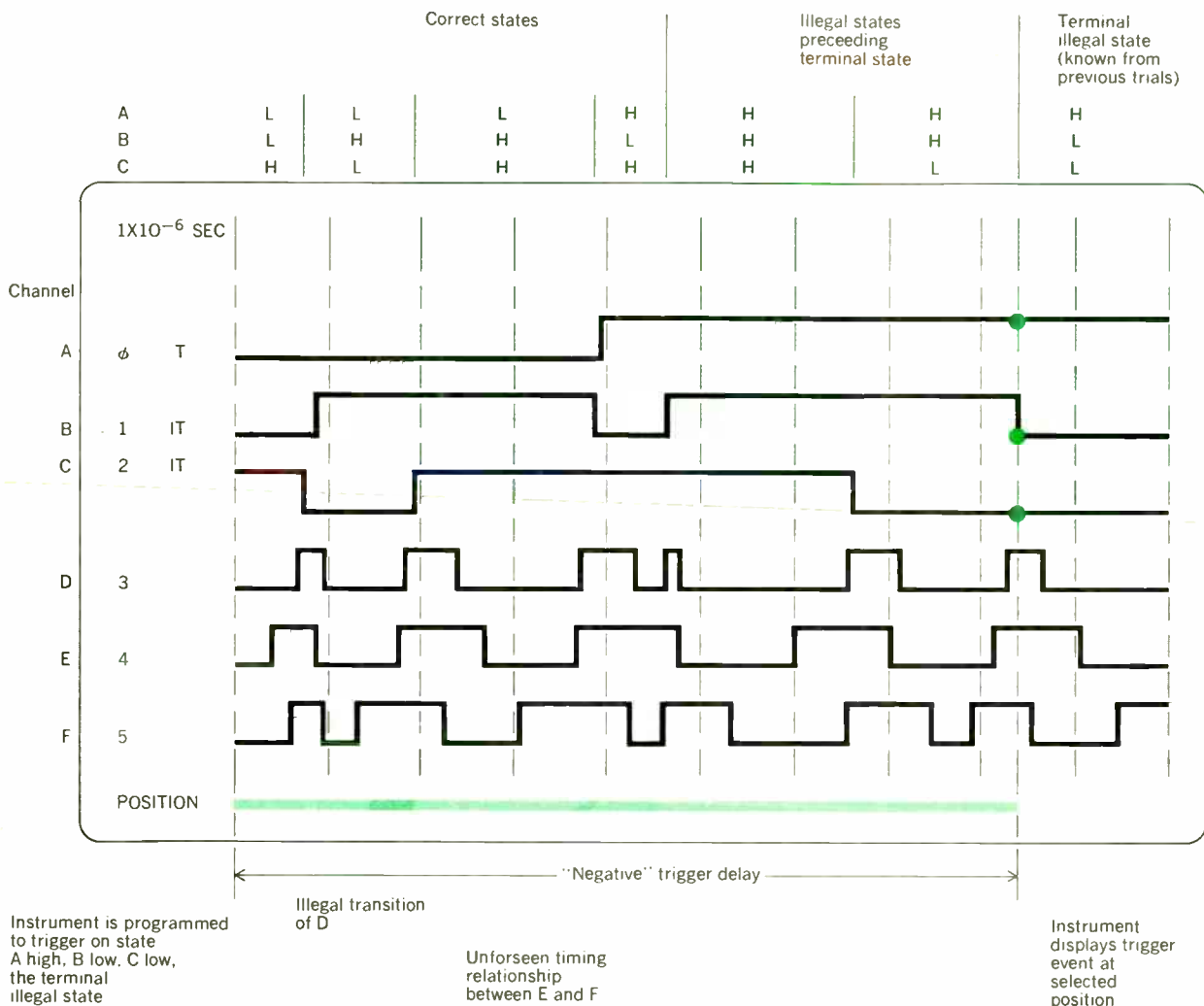

[3] A logic analyzer triggering on the terminal illegal state reveals a sequence of illegal states started by an undesired transition of signal D, which was caused by an unforeseen timing relationship between its implicants E and F.

no more often than two or three times a day. The appropriate instrument for tracking down intermittent failures in an analog system would be a transient recorder or storage oscilloscope. But again, the fact that critical information about a digital system resides more in the timing relationships among its signals (rather than their individual waveforms) severely limits the utility of one-channel or two-channel instruments.

However, the memory (collection registers) and simultaneous data acquisition employed by logic analyzers make them practical recorders of logic transients. Indeed, the ability of logic analyzers to record many channels of information for each occurrence of an intermittent system failure dramatically reduces the time required to gather sufficient data to understand and solve the problem.

Recognizing the necessity of simultaneous data acquisition, designers have often incorporated special features in their systems to permit simultaneous observation of variables. The most common technique is to provide a manual clock that provides the system timing when the system is put into a special maintenance mode. The manual clock is operated by a push-button and the static state of each variable under ob-

servation is written down after each tick of the clock. Relative to the clock signal, the observations are "simultaneous," even though it may take several minutes to determine and record the values of the variables after each clock tick.

Aside from its obvious tedium, this venerable technique of "single-stepping" through a sequence of state transitions has four drawbacks:

First, some problems related to propagation delays, circuit recovery time, etc., simply will not occur when the system is operated slowly.

Second, problems that, unknown to the investigator, are related to patterns in either the data or control signals are unlikely to occur in a stepping session of any reasonable length—that is, a "random" problem occurring about once an hour when the system is operated at 1 MHz may be expected to occur about once every 6000 years when the system is operated manually at 0.02 Hz.

Third, it is frequently the case that some part of the system, a disk for example, cannot be single-stepped. It then becomes necessary to build a simulator of this component to permit single-stepping the remainder of the system. Despite the costs of these internal simulators and the knowledge that they can-

not perfectly reproduce "real" conditions, they are quite common, if only because they have been necessary to permit adequate investigations of complex systems when they fail.

Fourth, a system cannot perform its intended function while it is being single-stepped.

An investigator using a logic analyzer, instead of built-in single-step hardware, cannot record an arbitrary number of variables in each measurement. However, he can use the logic analyzer while the system is in service, in its normal configuration, and operating at full speed. Consequently, the costs of resolving an intermittent problem by making a series of recordings on different sets of variables with a logic analyzer will almost certainly be less than the cost of recording one complete sequence of transitions using the single-step method.

Pretrigger recording

Pretrigger recording ("negative trigger delay") is extremely valuable in testing digital systems. Certainly there are some problems that occur in digital systems for which pretrigger recording offers no advantage, but these are the easy ones. If, for example, bit n is dropped every time a processor reads a word from a particular memory bank, it is a simple matter to force the computer into a loop that continually reads from that bank. Then a conventional oscilloscope can be used to trace the bit through its path until the circuit that drops the bit is found. The operation becomes easy because the time between errors can be forced to be short and nearly constant. As a result, triggering an oscilloscope on the n th occurrence of the error allows the $n+1$ st precipitation of the error to be observed on a suitable time scale.

Unfortunately, many difficult problems occur that cannot be attacked in this way. Suppose an I/O channel of a computer drops a bit under circumstances that occur about once every billion transfers. The nature of these provocative circumstances is unknown a priori; all that is known is that there is an I/O parity error detected about every 15 minutes (for a 1-MHz transfer rate). It is clearly impossible to trigger an oscilloscope upon the n th error and observe either the conditions (already past) that caused the error, or the conditions (beyond the period of observation on any usable time scale) that will cause the $n+1$ st error.

Moreover, examining individual signals at times removed from an error will only reveal what the signals look like 999 999 999 times out of a billion. It is that one period in a billion, immediately preceding an error, that contains useful information. With no way to observe signals at that time, the investigation usually deteriorates to making guesses about what might be causing the problem and then attempting to make observations that either prove or disprove these guesses. This guessing game is an enjoyable intellectual challenge—for a while.

The value of pretrigger recording has been evidenced in the past by a designer's occasional willingness to incorporate stacked status registers in key system components, such as multiplexers and controllers. Although these registers are never wide enough to record all the system variables, are seldom deeper than three levels, and are never even used until some-

Oscilloscopes vs. logic analyzers

A typical oscilloscope, represented in Fig. 1, begins a measurement when the trigger signal crosses a predetermined voltage threshold. After this crossing is detected, an unblank signal is generated so that the electron beam can strike the phosphor-coated face of the CRT, and a voltage ramp is applied to the horizontal deflection plates of the CRT to sweep the impact point of the beam from left to right across the tube face.

Since a few nanoseconds are required to unblank the tube and start the sweep, the signal to be observed is delayed and then used to modulate the vertical coordinate of the beam-impact point upon the CRT face. The fixed delay in the signal path allows the leading edge of the trigger signal itself to be observed, if desired. If two or more signals are to be observed "simultaneously," the signals (together with corresponding dc offset voltages) are alternately selected to drive the vertical deflection plates on successive repetitions of the sweep. The persistence of the phosphor causes a viewer to perceive all signal traces simultaneously if the trigger repetition rate is sufficiently high.

The only ways of obtaining truly simultaneous oscillographs are to "chop" or use a multibeam CRT. Chopping (switching the vertical deflection circuitry from one input to the other at high speed during the horizontal sweep) is useful only if the signal features of interest are considerably wider than the chop period. Multibeam CRTs suitable for high-speed oscillography with more than two beams are not practical.

In short, the oscilloscope is superb for observing the amplitude variation of some single variable for a period of time following a change in amplitude of that or some other variable. This type of instrument is precisely what is desired whenever the signal being measured is a continuous physical function or its analog.

Digital events

Whereas the scope is ideal for measuring a continuous analog signal, one can see its difficulty in trying to record simultaneous short-lived signals such as those from fast digital systems. The logic analyzer, however, thrives on these conditions.

The logic analyzer depicted in Fig. 2 is typical in that its data collection process consists of two stages. First, there is an A to B (analog to binary) conversion circuit for each channel that continually compares its input signal against threshold voltages and determines whether the signal is a logic "1" or a logic "0." Second, the results of A to B conversion for each channel are continually fed into a shift register (the collection register) at a rate compatible with the length of the register and the desired duration of signal observation. For example, if the collection registers are 100 bits long and signals must be observed for 2 μ s, then the conversion clock rate would be 50 MHz.

After information has been collected, it may or may not be transferred to a separate display memory, depending on whether or not the particular analyzer permits data collection for a new measurement to proceed while the previous measurement is being displayed.

Since the method chosen for displaying the signal data has absolutely no impact upon the data collection process, it is not surprising that there are as many display methods as there are logic analyzers. So far, they include rows of LEDs to represent the acquired "1"s and "0"s, rows of "1" and "0" numerals on a CRT, pseudo-waveforms displayed on a conventional oscilloscope, and pseudo-waveforms displayed on a television-type video monitor (see page 64, bottom).

Today's logic analyzer—progressing bit by bit

Despite the fact that logic analyzers may be the hottest new instruments on the scene today, only three companies have opted to market them: Biomation Corporation, E-H Research Laboratories, and Hewlett-Packard (see Table below). If one considers two limited but inexpensive hand-held analyzers—or "super logic probes," as they have been called—then Computer Product Service and Research (CPSR), Inc. (Bluebell, Pa.) and MITS Inc. (Albuquerque, N.Mex.) should be added to this list.

The philosophies underlying logic analyzer design vary widely and may very well reflect the differences in marketing attitudes among the companies. As an example, of the three companies listed in the table, H-P features external clocking for synchronous recording, E-H Research has asynchronous internal clocking, and Biomation has played it safe by offering both. Hewlett-Packard's justification for its choice is that "field experience has shown that a logic analyzer clocked by the user's system clock gives a better representation of circuit operation." On the other hand, E-H Research insists that "internal clocking is much to be preferred over external clocking simply because systems are not cooperative enough to always manifest their malfunctions precisely at system clock time!"

Although it is no longer on the market, the first logic analyzer to appear commercially was Phil DeVita's *Diana* (Data Display Systems) in 1967, a four-channel incandescent-lamp unit that was far ahead of its time with such features as a spike mode and combinatorial triggering. Hewlett-Packard later bought the rights to *Diana* and subsequently came out with their own logic analyzer—the 5000A—in April 1973, followed by the 1601L within a few months.

Biomation next introduced the 810-D at IEEE's WESCON show in September 1973, with E-H Research's 1320 Digiscope appearing in December 1973. In March of this year, Biomation announced the 8200 for delivery in September; at this writing, units have started to be delivered, according to a company spokesman, but the source refrained from disclosing how many.

It is interesting to note that author J. Carver Hill had been working on a logic analyzer as early as 1965, long before forming Digimetrics in 1972 with Bernard West. After the firm was acquired by E-H Research in December of last year, Hill's brainchild—the Digiscope—finally appeared, in some ways representing a dramatic departure from the rest of the field. Not only does it fill the gap between the 10-MHz and 200-MHz analyzers, but it is the only analyzer to feature dual-threshold recording, allowing the display of such signal characteristics as ringing, slow rise- and fall times, and high-"0"/low-"1" states.

Before purchasing a logic analyzer, a user must be sure to balance what he is getting with what he is paying. By letting price determine the choice of one unit over another, a buyer may find out that he is actually paying more because he must purchase additional probes, costing hundreds of dollars each, to do the job he wanted. On the other hand, it may turn out that the user's needs are satisfied by CPSR's model 0617B (10 MHz, 32 LED, two channel or serial, synchronous) at \$495 (with a 20-MHz option at \$635) or the MITS MS416 (2 MHz, four 16-LED channels, asynchronous) at \$189.50 assembled, \$127.50 in kit form. Don't expect to get the measurement power obtainable with the larger analyzers, however.

Marce Eleccion

Comparison of today's logic analyzers

Company	Model	Speed	Parallel Channels*	Storage per Channel	Maximum Resolution	Display†	Pretrigger Recording	Combinatorial Triggering	Dual Thresh-		Price	
									old	Ext		
Biomation Corp., Cupertino, Calif.	810-D Digital Logic Recorder	10 MHz	8	256 bits	100 ns/bit (10-ns latch)	CRT	Yes	Yes (optional)	No	✓	✓	\$1950 without display
	8200 Digital Logic Recorder	200 MHz	8	2048 bits	5 ns/bit (1-ns latch)	CRT	Yes	No (to be on future units)	No	✓	✓	\$17 400 mainframe
E-H Research Laboratories, Oakland, Calif.	AMC 1320 Digiscope	50 MHz	8/16	100 bits	20 ns/bit (5-ns latch)	TV monitor	Yes	Yes	Yes	✓	—	\$5000 mainframe
Hewlett-Packard Company, Palo Alto, Calif.	5000A Logic Analyzer	10 MHz	2	32 bits	100 ns/bit with 15 ns pos/neg spike mode	Two 32-LED rows	Yes	Yes	No	—	✓	\$2175
	1601L Logic State Analyzer	10 MHz	12	16 bits	100 ns/bit	0, 1 truth table on CRT	Yes	Yes	No	—	✓	\$2650

* To provide additional channel capacity, both Biomation analyzers can serve as the "master" for up to seven other "slave" units; the E-H Digiscope is expandable to 16 channels by replacing the four dual-channel plug-in modules with 4-channel plug-ins. According to sources at H-P, both the 5000A and the 1601L can be slaved to an indeterminate number of other units.

† Screen resolution is adjustable in Biomation and E-H analyzers: the 810-D displays 250 bits on each CRT line, expandable to 50 bits/channel (5 bits for each of the ten CRT divisions); the 8200 displays seven expansion factors, from all 2048 bits to 1/10 that amount (x100 scale)—the number of bits between two adjustable screen cursors is also read out; the 1320 Digiscope varies in sweep time from 100 ns/div to 500 s/div across a 10-division screen (there are 5 bits/div for the fastest sweep, 10 bits/div for all others).

thing goes wrong, they are worthwhile in complex systems. For example, just being able to determine the starting address of the last three disk transfers, as received by the disk controller, may provide a valuable clue to the cause of a system crash.

Logic analyzers can conveniently perform the archival functions of stacked registers and can be used to record any of the system variables, not just those hardwired to a particular register.

Combinatorial triggering

Combinatorial triggering is a particularly useful feature for observing digital systems. It is an intrinsic property of these systems that their states are defined by the simultaneous condition of many variables rather than the transitions or value of any one variable. Consequently, the ability of the logic analyzer to recognize a particular digital-system state and trigger on it is comparable in function and importance to an oscilloscope's ability to trigger at a particular voltage level.

When a digital system goes awry and stops in an illegal state, or falls into a loop containing an illegal state, it is often possible to characterize that illegal state by means of a relatively simple combination of variables.

For example, a processor might hang-up with the variables "Jump in Progress," "Fetch Next Instruction," and "Indirect Address" all true. Assuming that these three variables should never occur simultaneously, then this combination, although it does not completely define the erroneous state, is sufficient to differentiate that state from any proper system state.

Consequently, three channels of a logic analyzer can be used to monitor the three variables named above, and the other channels can be used to record additional variables judged likely to reveal the nature of the malfunction. When the analyzer is set to trigger on the coincidence of the three variables characterizing the anomalous state, it will ignore all instances of these variables being true one or two at a time. When at last the three variables are concurrently true, however, the logic analyzer will stop collecting data and provide a record of the chosen variables immediately preceding transition to the illegal state.

Frequently, this record will reveal the existence of a prior illegal state (see Fig. 3). The logic analyzer can then be used to trigger on this preceding condition to obtain a record of its origin. Using this technique of working back through a series of anomalous logic transitions, the exact point of system failure can be found and studied.

The honorable system-feature ancestor of logic analyzer combinatorial triggering is the popular "stop-on-address-*n*" provision incorporated in the console controls of many computers (primarily as a software debugging tool, but one that finds considerable secondary use as a hardware maintenance aid). A not-so-honorable ancestor is the practice of temporarily wiring specific system variables to unused AND gates and triggering an oscilloscope on the gate output—a well-known last resort in attempts to track down intermittent failures.

However, the pretrigger recording of the logic ana-

lyzer makes its combinatorial triggering feature more effective than either address-stop or gate-oscilloscope techniques.

Where to now?

By direct application, the new instrumentation capability of the logic analyzer is expected to reduce the development time for new systems, speed the check-out of systems in production, and increase the up time of installed systems. Indirectly, logic analyzers may well raise the levels of system complexity and sophistication considered practical by each designer.

The proliferation of digital techniques and applications, considered in the broadest sense, has already affected the career of every engineer. It may have done nothing more than replace his slide rule or change his skills inventory—or it may have made years, even decades, of his experience less relevant, seriously eroding the base of knowledge needed for mature technical judgement.

Whatever effects have transpired, there are more to come. And although logic analyzers may accelerate the pace of "digitization," they will also make it much easier for the individual engineer to create and apply digital innovations in his area of expertise.

BIBLIOGRAPHY

- Farnbach, W. A., "The logic state analyzer—displaying complex digital processes in understandable form," *Hewlett-Packard J.*, vol. 25, pp. 2-9, Jan. 1974.
- Hill, J. C., and Marshall, M., "Logic analyzers: single vs double threshold," *Electron. Products*, vol. 17, p. 44, July 15, 1974.
- Marshall, M., "Logic scopes speed diagnostics of faults in digital circuits," *Electronics*, vol. 47, pp. 119-123, Oct. 3, 1974.
- Hill, J. C., and West, B. G., "The Digiscope logic analyzer—a new digital test instrument," *IEEE Intercon. Conf. Record*, 1974.
- Lutheran, V., and Floersch, B., "Dual-beam: an often misunderstood type of oscilloscope," *EDN*, vol. 19, pp. 45-49, Aug. 5, 1974.
- Marshall, M., "Intelligent instruments," *EDN*, Sept. 20, 1974.
- Marshall, M., "Logic scope handles 50 MHz data rate," *Electronics*, vol. 46, p. 125, Dec. 20, 1973.
- Tottingham, R., "Logic analyzers open a direct path from digital theory to practice," *Electron. Products*, vol. 17, pp. 39-45, July 15, 1974.

J. Carver Hill (M) cofounded Digimetrics, Inc., in 1972. When Digimetrics was acquired by E-H Research Laboratories, Oakland, Calif., Dr. Hill became chief engineer of the AMC Division. Previously, from 1964 until 1968, he was a member of the design group for a large multiprocessor time-sharing system—the OCTOPUS—at Lawrence Livermore Laboratory, Livermore, Calif. In 1969, he became computer-system architect for the U.S. Atomic Energy Commission's automated system of experiment control and data collection (NAD) at the AEC Nevada test site. Dr. Hill received the B.S. in electrical engineering from Clemson University in 1961, and the M.S. in E.E. and Ph.D. in computer science from Oregon State University in 1964 and 1969, respectively. He has published and presented papers in the areas of communication networks, system architecture, and digital instrumentation.

Reprints of this article (No. X74-123) are available at \$1.50 for the first copy and \$0.50 for each additional copy. Please send remittance and request, stating article number, to IEEE, 345 E. 47 St., New York, N. Y. 10017, Attn: SPSU. (Reprints are available up to 12 months from date of publication.)

Notes from the U.S.S.R.

Popov Congress delegates report on Soviet developments in biological effects of laser radiation, charge-coupled devices, and color TV

The trend toward the application of electronics engineering to biomedical problem-solving is as evident in the U.S.S.R. as anywhere else in the world, according to members of this year's IEEE delegation to the annual Popov Society Congress. For example, considerable experimentation is underway in the Soviet Union using lasers on individual cells, tumors, and organs to determine both the positive and negative effects of laser radiation.

Two quite different areas of strong Soviet interest, as reported by the institute visitors, involve work with charge-coupled devices, particularly for space applications, and the manufacturing of color picture tubes.

But apparently the most rewarding stop on the IEEE delegations' Soviet tour was the Kiev Research Institute of Experimental and Clinical Oncology where, since 1967, promising research and clinical work has been carried out on the biological effects of laser radiation. Said one impressed IEEE delegate, "The institute provides an excellent example of what can be accomplished by bringing together the art of medicine and the useful application of electronic engineering."

I. Lasers in medicine

High-power, pulsed neodymium lasers have been used to "clinically cure" some 500 patients with superficial benign tumors. It has been concluded by the Soviets that laser therapy is better than X-ray therapy, particularly for pigmented tumors in which the laser beam is apparently selectively absorbed. It has also been noted that there are fewer side effects with laser therapy than with X-ray therapy and that the treatment period is frequently shorter. The researchers feel that malignant skin tumors can probably be treated satisfactorily using laser therapy. Techniques for treating other malignant tumors, however, are still in the very early developmental stages.

Fundamental studies to determine the effects of laser radiation on biochemical and biological materials such as enzymes, proteins, and single cells are in progress. Continuous and pulsed submicron diameter beams formed by passing laser radiation through a microscope in the reverse direction have been used to irradiate single cells. At low power levels, the main effects appear to be due to heating. At high power levels, additional shock effects are observed. For example, if a small field of cells is irradiated by a series of pulses of moderate power, the cell membranes are altered and the field of cells becomes fragmented. For higher pulse powers, lesions which could only be produced by mechanical shock are observed. Finally, if short, high-power pulses are used, standing wave patterns of lesions can be produced. Experiments to determine the effect of wave-length have been planned and some work using tunable dye lasers manufactured at the Institute of Physics in Minsk is already underway.

II. Charge-coupled devices

Interest in charge-coupled devices (CCDs) is apparently high in the U.S.S.R. and 128-bit linear CCD shift registers have been constructed. The devices are primarily p-channel although there is some indication that n-channel work has been done. Charge transfer efficiencies of 99.5 to 99.9 percent have been obtained and single-level metallization, three-phase structures with electrode lengths of 5 microns and interelectrode gaps ranging from 1 to 1.5 microns have been used.

Soviet CCD interest is centered on both memories and imagers with most research work taking place in laboratories of the Ministry of Electronic Industry. CCDs are manufactured in Kiev, Leningrad, Moscow, and Zelenograd. The best units are probably made at the Microelectronic Center in Zelenograd.

The silicon wafers used for CCDs

are about 5 cm in diameter although some work is being done on 3-cm-diameter material. One apparent problem area is the development of suitable photomasks for device manufacture.

The special features of CCDs, according to Soviet researchers, might be used to advantage for spacecraft applications where the small size, low power, and high resolution of CCD imagers would be significant.

II. Color tube manufacturing

Half a million color picture tubes are produced on a three-shift basis, with 60 persons per shift, at the Chromatron manufacturing plant on the outskirts of Moscow. The plant carries out final assembly of the Elkar 3, 59LK-3C, 23-inch color picture tubes from components such as the front plate glass, envelope, funnel, stainless-steel mask, and three-gun assembly provided by other plants.

The machinery used in the manufacturing process was developed within the U.S.S.R. and appears to be as highly automated as one would find in such an industry anywhere in the world. A system of modular replacement is used for the production units including the vacuum pumps which evacuate the tubes.

All the spraying of the phosphorus slurries, the rotation of the tubes distributing the slurries, and the baking of the tubes are completely automated and are somewhat reminiscent of the dispensing of photolithographic fluid in semiconductor production.

Tubes currently being manufactured cost about 147 rubles (about \$200) to produce, are sold to television receiver manufacturers for 160 rubles, and to the public as replacement tubes for 180 rubles.

Ron Jurgen

This report is based on information provided by IEEE delegates Arthur H. Waynick, F. N. Trofimenkoff, and D. R. Collins.

New product applications

Medium-speed minicomputer features versatility at a reasonable price



Computer Automation's LSI Type 2/10 is a medium-speed minicomputer whose 600-ns internal cycle time and \$1750 price (for a 4k 16-bit core memory) places it between the faster, and more expensive, LSI Type 2/20 and slower, but less expensive, LSI Type 1. All three are fully compatible, electrically, mechanically, in spares, and in programming.

The large-scale-integration (LSI) Type 2/10 medium-speed minicomputer, with an internal cycle time of 600 ns, is about half as fast and slightly less expensive than the high-speed LSI Type 2/20, and about twice as fast and costs slightly more than the LSI Type 1. All three of the central processors in the LSI family fea-

ture the same architecture, instruction set, and input/output (I/O) modes. They differ in terms of performance and internal implementation: with the Type 2/10 implemented with MSI TTL operating at 600 ns. The Type 2/10 offers I/O rates ranging from 40 000 words per byte per second, in the direct-memory-channel (DMC) mode, to 1 020 000, in a standard direct-memory access (DMA) mode. Other I/O provisions include interleaved DMA, block, and programmed I/O transfer (standard via registers).

Any component from any LSI model may be used in any one of the three machine models thus giving the user a potential of tens of thousands of different configurations.

Type 2/10 hardware priority interrupts provide automatic handling of three major functions. These are recognition of an external event that requires immediate attention, identification of which event actually occurred, and assignment of priority when several events occur simultaneously. The machine offers add/subtract times of 4.12 μ s using 980-ns core memory.

Physically, the 2/10 (and 2/20) processor occupies a 40.6- X 41.2-cm printed-circuit board, with memory and

interface modules mounted on additional boards. All models use the same power supply, chassis, and control panel with hexadecimal keyboard and LED displays. All three processor models are plug-to-plug compatible, and may be interchanged as required in the same mother-board without program alterations. They have the same general features, including 188 instructions (168 for Type 1), hardware multiply/divide, and direct-memory access, and share the full repertoire of LSI programs and operating systems including three assemblers.

Software includes Advanced BASIC, Extended BASIC, and a Disk Operating System (DOS) with a new FORTRAN IV compiler for fast development of user programs. Memory is expandable to 256 000, 16-bit words for all three processors, with parallel processing of both 16-bit words and 8-bit bytes.

Price of the model 2/10 minicomputer varies according to quantity and memory mix. Typically, a machine with a 4000, 16-bit core-memory module is \$1750 in quantities. Delivery is 30 days after receipt of order. For further information, write to Computer Automation, Inc., 1865 Von Karman, Irvine, Calif. 92664.

Circle No. 40 on Reader Service Card

Multijunction thermal converter features 1-ppm ac/dc transfer difference

Multijunction thermal conversion is one of the older methods of measuring rms values of ac current or voltage in terms of its equivalent dc value. An upgraded version of this technique is used in a device designed and developed by F. J. Wilkins of the National Physical Laboratory, Teddington, England.

The device is the most accurate implementation available for the measurement of rms values of currents and voltages. It offers typical ac/dc transfer difference of one part in 1 000 000, and guaranteed difference of one part in 100 000 over dc to 100 kHz. Previous attempts at such accuracy levels have been hampered by effects from Thompson heating at the low- and mid-frequency ranges and heater-element resistance at higher frequencies.

In this device, there are two elements, each consisting of thermocouples attached at discrete intervals to a twisted bifilar heater. The combined voltage of these series-connected thermocouples gives a highly accurate indication of the temperature rise of the heater. The cold couples are all in thermal contact with a relatively large heat sink, which in turn is supported on a copper base about 25 mm

in diameter. Overall thermal stability and removal of spurious zero readings is achieved by surrounding the elements with copper shields that are maintained at the temperature of the cold couples. The entire assembly is then mounted in a copper can and evacuated, thus eliminating loss of heat from the converter by convection.

The heaters for the lower current ranges are formed from an enameled quaternary alloy; higher current heaters are formed from manganin. These materials have low temperature coefficients of resistance. The through leads are O.F.H.C. copper or tinned manganin and constitute a heater circuit that is free from thermoelectric voltages and whose resistance is almost independent of frequency.

The calculated ac-to-dc transfer difference is determined from the measurement of temperature gradients along the heater. At any point in the frequency band from dc to 100 kHz, the difference is less than 1×10^{-6} of the output voltage. At frequencies from 40 Hz to 10 kHz, where Thompson heating is the sole limiting factor, the difference is less than 1×10^{-9} of the output. At the lower

frequencies, when the output voltage contains a marked double-frequency ripple, the difference does not deviate appreciably from 1×10^{-10} of output. Above 10 kHz the reactive components become operative, but even at 100 kHz, the transfer difference is less than 1×10^{-6} of the output. The difference at 1 MHz is typically 1×10^{-5} , and at 10 MHz, 1×10^{-4} .

The difference in output voltage on reversal of the flow of a direct current never exceeds 5×10^{-6} of the output. The rated current gives an output of 100 mv, corresponding to an input power of 30 mW and a temperature rise of 15°C. Maximum safe overload current is four times the rated current. Output voltages up to 1.6 volts may be derived from all elements by using currents in excess of the rated value.

The time taken for the output voltage to rise to within 0.1 percent of its final value is approximately 8 seconds. Too small a response time would result in unwanted double frequency components in the output.

For further information, contact the Barker Electronic Sales Co., P.O. Box 405, Ship Bottom, N.J. 08008.

Circle No. 41 on Reader Service Card