

IEEE spectrum

features

27 Spectral lines: The Editor's mail pile

In the original plan for Spectrum, one of its functions was to be the publication of "News of political and social interest to the profession." Such a policy must result in controversial articles, which in turn mean a large pile of mail for the Editor

+ 28 Silicon-gate technology

L. L. Vadasz, A. S. Grove, T. A. Rowe, G. E. Moore

There is but one diffusion step needed for making silicon-gate devices. But there are five steps during which a thin film must be deposited. If these are properly followed, the results are lowered threshold voltage and higher functional density

+ 36 Space exploration—wisdom or folly?

Heinz Trauboth

The space program—which costs the United States only 2 percent of its government expenses—already has generated numerous spin-offs and meaningful products

+ 40 Acoustooptical approaches to radar signal processing

W. T. Maloney

There are two classes of acoustooptic processors and, depending on their operating-frequency band, they are identified either as Raman-Nath or Bragg processors

+ 49 Solid-state power electronics in the U.S.A.

H. F. Storm

During the past ten years no other electrical components have had a greater impact in reshaping and upgrading the world of power engineering than semiconductor power devices

+ 60 Art and technology: a merger of disciplines

Gordon D. Friedlander

The evidence of history reveals that collaboration between artists and engineers has been practiced for a long time, and that the criteria for such interdisciplinary efforts have been based on reason, logic, and planning to produce esthetic, enduring results

+ 73 Thick films or thin?

Rudolf E. Thun

Both thick and thin films possess unique advantages. To obtain the best results in a given application, complex multilayer hybrids may be the answer



THE INSTITUTE OF ELECTRICAL AND ELECTRONICS ENGINEERS, INC.

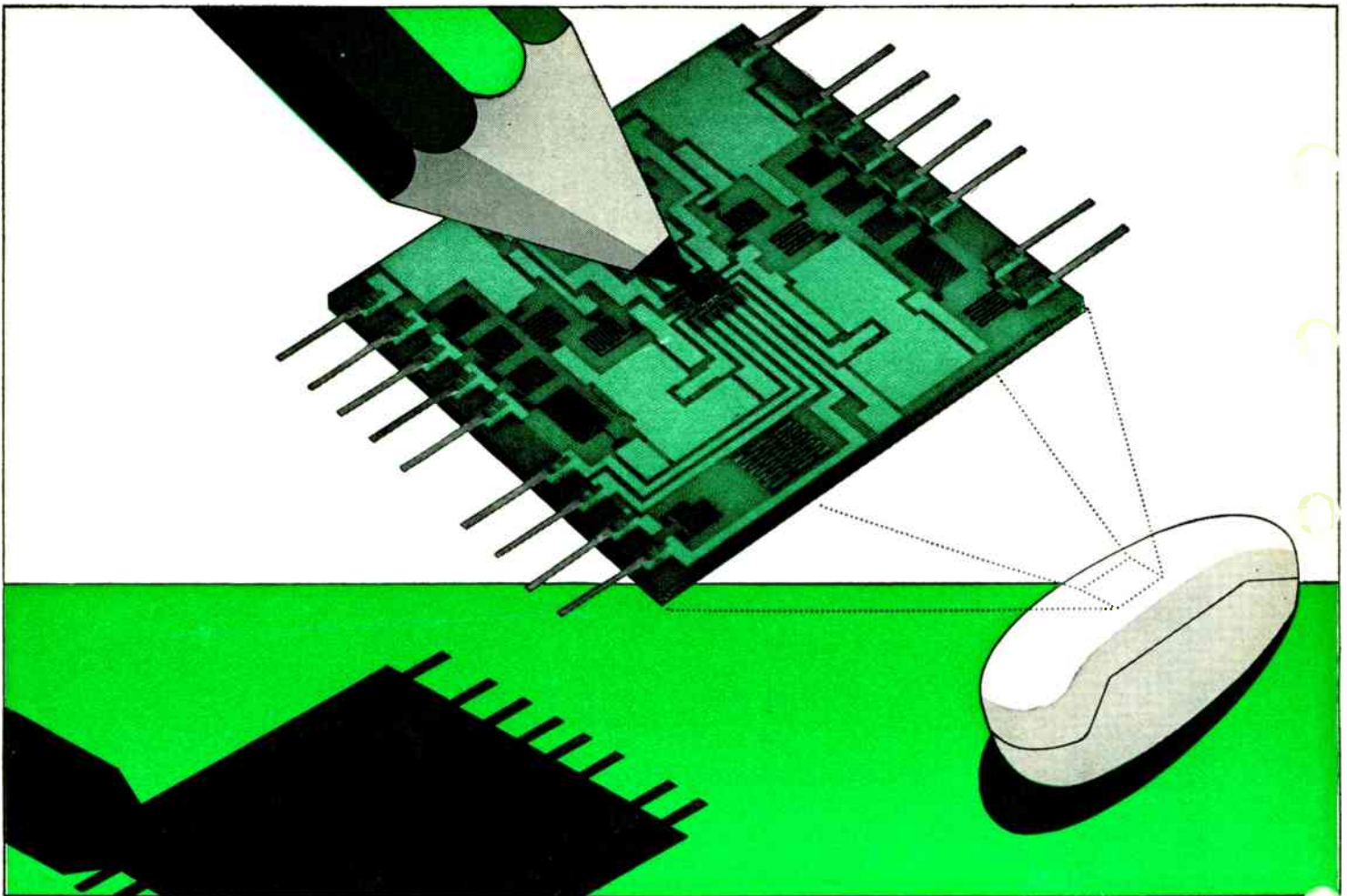

Big future for little circuits

Bell Laboratories engineers have developed a special TOUCH-TONE Trimline® handset that suggests great possibilities for designers of future telephones. In this one, the musical tones you hear when you push the buttons are generated by two oscillators in a "hybrid" integrated circuit (one combining tantalum and silicon technology).

Such tiny, inexpensive circuits free designers from limits imposed by bulky, costly to assemble, discrete components—which restricted the type and complexity of circuit functions that could be designed into a telephone handset. Now, designers can think of people first—of what is easy to use—knowing that the electronics can be made to fit. The postage-stamp size, rugged integrated circuit above, for instance, contains 14 transistors, a diode, and

16 resistors in the silicon chip (under the pencil point), and 19 resistors and 8 capacitors made with tantalum film on the substrate.

Much of Bell Laboratories' integrated circuit work combines tantalum thin-film circuits (for precision passive components) and silicon integrated circuits (for active devices). To unite the two, we invented beam leads—small gold conductors which are formed as an integral part of the silicon circuit. They allow us to bond the silicon to the tantalum circuit in a simple one-shot operation. We've also developed a chemical-metallurgical system which fully seals off and protects the vulnerable parts of the circuit from environmental damage. So, we don't need costly vacuum-tight enclosures.

The extreme operational and environmental conditions of tele-

phone use gave us some problems: Tailoring the resistance of thin-film resistors so that the resistance-capacitance product remains constant despite changes in temperature. Designing oscillator circuits whose output frequencies are not affected by varied loadings due to differing cable lengths between telephone and central office. Finding an encapsulant to adequately insulate closely spaced conductors in high humidity.

To customers who use them, handsets with this new circuit will seem like other TOUCH-TONE Trimline sets—though a trifle lighter. But this new telephone technology opens the way to greater freedom for designers and even better telephones for Bell System customers.

From the Research and Development Unit of the Bell System—



Bell Labs

80 New product applications

A staff-written report on some carefully selected new products emphasizing one or more of their potential applications as an aid to engineers who may wish to apply these products to solve their own engineering problems

89 Short courses in electrical and electronics engineering— Fall-Winter 1969-1970

the cover

The cover shows a photomicrograph of a corner of an integrated 256-bit memory using silicon-gate MOS technology. The area shown is about 0.13×0.20 cm. The memory bits are the regular pattern in the upper left of the illustration. The bottom and right borders show circuitry associated with selecting a particular bit and interfacing with other integrated circuits. The technology that led to development of the memory is described in the article beginning on page 28

departments

8 Forum

16 Focal points

Transients and trends, 18

22 Calendar

95 Scanning the issues

98 Advance tables of contents

Future special issues, 99

104 Translated journals

108 Special publications

110 Book reviews

New Library Books, 114

Recent Books, 114

116 News of the IEEE

132 People

136 Index to advertisers

IEEE SPECTRUM EDITORIAL BOARD

F. E. Borgnis; C. C. Concordia; A. C. Dickieson; Peter Elias; E. G. Fubini; E. W. Herold; S. Karni; D. D. King; B. M. Oliver; J. H. Rowen; Shigebumi Saito; J. J. Suran; Charles Süsskind; Michiyuki Uenohara

IEEE SPECTRUM EDITORIAL STAFF

Robert E. Whitlock, *Senior Editor*; Seymour Tilson, *Staff Writer*; Evelyn Tucker, Marcelino Eleccion, W. J. Evan-zia, Paul Hersch, *Associate Editors*; Stella Grazda, *Editorial Assistant*; Ruth M. Edmiston, *Production Editor*; Herbert Taylor, *Art Director*; Bonnie J. Anderson, *Assistant Art Director*; Janet Mannheimer, *Assistant to the Art Director*; Morris Khan, *Staff Artist*

IEEE PUBLICATIONS BOARD

C. L. Coates, Jr., *Vice Chairman*; F. S. Barnes; F. E. Borgnis; D. K. Cheng; P. E. Gray; E. E. Grazda; Y. C. Ho; J. J. G. McCue; Seymour Okwit; Norman R. Scott; David Slepian; G. W. Stagg; David Van Meter

PUBLICATIONS OPERATIONS

Elwood K. Gannett, *Director, Editorial Services*; Alexander A. McKenzie, *Assistant to the Director*; Patricia Penick, *Administrative Assistant to the Director*; Ralph H. Flynn, *Director, Publishing Services*; William R. Saunders, *Advertising Director for Publications*; Henry Prins, *Manager, Marketing Services and Research*; Carl Maier, *Advertising Production Manager*

J. J. G. McCue, *Editor*;

Ronald K. Jurgens, *Managing Editor*;

M. E. Van Valkenburg, *Chairman*;

Elwood K. Gannett, *Director, Editorial Services*;

NEW

PROGRAMMABLE ATTENUATOR

from KAY'S ATTENUATOR WORKSHOP

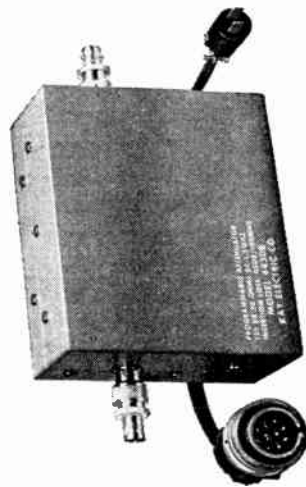

MODEL 4430B

Frequency Range: DC-1.3GHz
Attenuation Range: 0-135db in 1db steps
Typical Overall Accuracy: ± 1.5db
Maximum VSWR: 1.4:1
Maximum Insertion Loss: 0.7db
Control Logic Required: 9BCD @ 18ma Plus Common
Line Weighings: 1248:1236
Switching Speed: <20ms/step
Price: \$695.

KAY ELECTRIC COMPANY
 Pine Brook, N.J. 07058 • (201) 227-2000

Circle No. 3 on Reader Service Card.



THE INSTITUTE OF ELECTRICAL AND ELECTRONICS ENGINEERS, INC.

BOARD OF DIRECTORS, 1969

F. K. Willenbrock, *President*
 J. V. N. Granger, *Vice President*
 J. H. Mulligan, Jr., *Vice President*
 M. E. Van Valkenburg, *Vice President*,
Publication Activities
 R. W. Sears, *Secretary*
 Harold Chestnut, *Treasurer*
 S. W. Herwald, *Junior Past President*
 W. K. MacAdam, *Senior Past President*

G. J. Andrews	D. G. Lampard	W. T. Sumerlin
H. P. Bruncke	H. R. Mimno	R. H. Tanner
Werner Buchholz	D. C. Ports	J. G. Truxal
E. E. David, Jr.	C. F. Savage	R. P. Wellinger
R. G. Elliott	George Sinclair	J. R. Whinnery
F. A. Hawley		
L. C. Hedrick		
Hubert Heffner	A. N. Goldsmith, <i>Editor Emeritus and Director Emeritus</i>	
D. M. Hodgkin	E. B. Robertson, <i>Director Emeritus</i>	

HEADQUARTERS STAFF

Donald G. Fink, *General Manager*

John L. Callahan, <i>Staff Consultant</i>	William J. Keyes, <i>Director, Administrative Services</i>
Richard M. Emberson, <i>Director, Technical Services</i>	John M. Kinn, <i>Director, Educational Services</i>
Ralph H. Flynn, <i>Director, Publishing Services</i>	Leon Podolsky, <i>Staff Consultant</i>
Elwood K. Gannett, <i>Director, Editorial Services</i>	Betty J. Stillman, <i>Administrative Assistant</i> <i>to the General Manager</i>
	Howard E. Tompkins, <i>Director, Information Services</i>

Committees and Staff Secretaries

<i>Awards Board:</i> Una B. Lennon	<i>Long Range Planning:</i> W. J. Keyes
<i>Educational Activities Board:</i> J. M. Kinn	<i>Membership and Transfers:</i> Emily Sirjane
<i>Fellow:</i> Emily Sirjane	<i>Nomination and Appointments:</i> Emily Sirjane
<i>Finance:</i> W. J. Keyes	<i>Publications Board:</i> E. K. Gannett
<i>History:</i> W. R. Crone	<i>Regional Activities Board:</i> Emily Sirjane
<i>Information Services:</i> Howard Falk	<i>Standards:</i> J. J. Anderson
<i>Information Systems Advisory:</i> H. E. Tompkins	<i>Student Branches:</i> Robert Loftus
<i>Internal Communications:</i> Audrey L. van Dort	<i>Technical Activities Board:</i> R. M. Emberson
<i>Intersociety Relations:</i> J. M. Kinn	<i>Translated Journals:</i> A. A. McKenzie
<i>Life Member Fund:</i> W. J. Keyes	

IEEE SPECTRUM is published monthly by The Institute of Electrical and Electronics Engineers, Inc. Headquarters address: 345 East 47 Street, New York, N.Y. 10017. Cable address: ITRIPLEE. Telephone: 212-752-6800. Published at 20th and Northampton Sts., Easton, Pa. 18042. Change of address can be made effective with any particular issue if received by IEEE Headquarters by the 10th of the preceding month. Annual subscription: IEEE members, first subscription \$3.00 included in dues. Single copies \$1.00. Prices for nonmember subscriptions available on request. Editorial correspondence should be addressed to IEEE SPECTRUM at IEEE Headquarters. Advertising correspondence should be addressed to IEEE Advertising Department, at IEEE Headquarters. Telephone: 212-752-6800.

Responsibility for the contents of papers published rests upon the authors, and not the IEEE or its members. All republication rights, including translations, are reserved by the IEEE. Abstracting is permitted with mention of source.

Second-class postage paid at Easton, Pa. Printed in U.S.A. Copyright © 1969 by The Institute of Electrical and Electronics Engineers, Inc. IEEE spectrum is a registered trademark owned by The Institute of Electrical and Electronics Engineers, Inc.



OTHER IEEE PUBLICATIONS: IEEE also publishes the PROCEEDINGS OF THE IEEE, the IEEE STUDENT JOURNAL, and more than 30 Transactions for IEEE Groups with specialized interests within the electrical and electronics field. Manuscripts for any IEEE publication should be sent to the editor of that publication whose name and address are shown on page 10A of the January 1969 issue. When in doubt, send the manuscript to E. K. Gannett, Editorial Services, at IEEE Headquarters, for forwarding to the correct party.

Forum

Readers are invited to comment in this department on material previously published in IEEE SPECTRUM; on the policies and operations of the IEEE; and on technical, economic, or social matters of interest to the electrical and electronics engineering profession.

Engineering and politics

In the past issue of SPECTRUM the letters from engineers objecting to the recent statement (April 1969, p. 8) by concerned scientists at M.I.T. came as a surprise to me, for I had considered this article a significant statement in a technical magazine recognizing the engineer's and scientist's involvement in a social and political society—the type of statement that has been needed for some time.

Although I have been in industry for only a short time, I would like to know how one can keep politics and engineering separated in industry. Even if we as engineers were to try and make no statements or commitments about political situations we are involved in a political structure that has a large footing on a technically based society.

It is my opinion that it is past time for most engineers and scientists to start considering the significance of their work, much as the men at M.I.T. did, and then to reach personal goals and work toward long-range goals for man's advancement. I agree with the dissenters of the referenced article that if engineering were separated from politics it would be an improvement; but such is not the case.

Thus, first I support the ideas of the men at M.I.T., and then I support your idea of publishing such an article in a technical journal concerning a technical situation arising in our profession today.

*Ralph D. Taylor
Kansas City, Mo.*

Just a note to compliment IEEE SPECTRUM on its increasing concern for relating the engineer to social problems, particularly "The New Responsibility of the Engineer" (August 1969).

If man is to survive on this planet the engineer must take the lead in closing

"the morality gap" between our technical knowledge and our wisdom in application.

In light of this, just consider how few scientists and engineers are in the state legislatures or in Congress.

Those who are concerned must be encouraged to seek public office and those who are apathetic must be awakened to the reality of a possible "1984."

And in contrast just consider the qualifications of those who *are* making the decisions that will determine the destiny of our nation in the years to come.

*Robert H. Parrish
Stow, Ohio*

Character recognition

I become very angry when I read of vast sums of money being spent on recognition schemes for handwritten characters for possible use by the U.S. Post Office (IEEE SPECTRUM, June 1969, p. 8). Nothing characterizes the antediluvian thinking of that agency better than their insistence on retention of that notoriously "noisy" communication channel, the unaided-human-hand-with-stick. It is outrageous that such a device still allows entry to the postal service in 1969, let alone being contemplated for 1975 and even 1980. This makes as much sense as if the telephone service refused to introduce standardized character formats via dial pulsers, tones, etc., and insisted on machine recognition of spoken addresses.

The idea becomes overwhelmingly ludicrous when we consider that the necessary information originates in the user's brain in a digital (i.e., alphanumeric) code, but has to be converted into a monstrous analog (script) from, from which the proposed equipment must attempt to reconstruct the original digital code for processing.

Could not some part of the Post Office's research effort be devoted to development of a low-cost standardized addressing device (puncher, notcher, ink stamp, etc.), which the originator of mail would be required to use either in his home or office or at the point of entry into the system? Then we could get on with the task of automating the entire service instead of being forever bogged down at this trivial first step.

*Daniel P. Petersen
University of New Mexico
Albuquerque, N.Mex.*

The article on optical character recognition (OCR) devices in the June issue of SPECTRUM was quite interesting. The development of an OCR no doubt represents a fascinating technical challenge. However, while reading the article, a heretical thought crossed my mind. When the OCR is fully developed, it will at best perform about as well as a barely literate human now performs. Humans, with only a moderate degree of training, are already capable of reading addresses correctly, and are not sensitive to the problems that seem to bother OCRs. Does it make economic and social sense to spend money to develop a machine that will compete with semiskilled humans, when we have a shortage of money and cities full of semiskilled humans desperately in need of a useful role in the economy?

*Joseph P. Martino
Holloman AFB, N.Mex.*

Pro and con

As a concerned citizen and engineer, I strongly support publication of important and timely articles in SPECTRUM on such subjects as "The Antiballistic Missile" (August 1969). The letters to the editor in the same issue on Professor George Wald's article show that others are concerned also. However, I am disturbed that the attitude of several who wrote appears to be negative or static.

Engineers, who support a positive approach to a rapidly advancing and consequently ever-changing technology,



surprisingly often seem to be ultraconservative in their consideration of socioeconomic problems. In the technical area we know that we cannot just "hold a tiger by the tail." We must and do find answers to the problems. I think we must approach socioeconomic problems in the same way. Perhaps we are addressing the wrong problems. Maybe we have not even asked the right questions.

We are spending almost \$30 billion each year in Vietnam. We propose to spend from \$10 to \$100 billion on the ABM. We *question* whether we can afford to spend another \$4 billion for improved welfare as President Nixon rather reluctantly proposed. How much have we spent on the U.S. Arms Control and Disarmament Agency? How many engineers have even heard of it? Have we realistically considered the right priorities?

I believe that as engineers we should and must be more concerned with questions and answers to the basic problems that underlie ABM, armaments, and the war in Vietnam. We need not ask how effective the ABM will be. Does it really matter whether 20 or 120 million Americans will die if we do use it? For that matter is it not equally relevant to realize that 20 or 120 million Russians will die too? What is the truly positive approach? Can we afford to spend \$10 to \$100 billion on finding effective ways to live together in the world? Can we afford not to?

It is true that such questions imply idealistic answers. Even though I am 56 years old and a Fellow in the IEEE, for "whatever that means," as George Burruss, Jr., says, I find identity with students and others who challenge the present society even though sometimes I do not agree with the methods used. I believe that they, Professor Wald, and a few of the rest of us are usually asking the right questions. If we ask the right questions and work at them, sooner or later we will get the right and realistic answers. We can't just "hold the tiger by the tail" and do nothing.

So this letter constitutes my answer to item 4 on the Antiballistic Missile poll in August's SPECTRUM. I encourage SPECTRUM and IEEE to keep at it.

*K. N. Mathes
Schenectady, N.Y.*

As an IEEE member I'm in disagreement with the recent editorial and publication policy of SPECTRUM magazine (the April Forum by the editor; June, "A Generation in Search of a Future" by G.

Wald; and the editor's answers to letters referring to these articles). It seems that the editor has taken an excessively broad interpretation of the Board of Directors 1963 assigned objective "to publish news relating to electrical engineering."

The social implications of the work of our profession should indeed be of concern to our members, but I feel our publication dollars should be reserved for technical articles rather than political philosophy available to members at any newsstand. The Wald article in particular has no claim to technical content and had appeared in a number of previous publications, including the *Chicago Tribune*.

The IEEE should not compete with daily newspapers in the presentation of political dialogue except with technical subject level above that of the usual news media, and then only with both sides of the issues presented, as in the August ABM article. The Institute cannot afford censure or reproach for political bias and must let its members look to other sources for the nontechnical aspects of political issues.

*Louis S. Van Slyck
American Electric Power Service
Corporation
New York, N.Y.*

Professionalism in engineering

I am becoming increasingly irritated with SPECTRUM articles concerning engineering professionalism, responsibility to society, and civic activity. It is time for the IEEE to assume a more realistic position.

First of all, over 70 percent of engineers are employed in defense or other government-supported projects and hence their lives are somewhat akin to nomads following the contracts and trying to keep one step ahead of the layoffs. In addition, we can usually include six to ten hours per week of graduate school class time and preparation to avoid "technical obsolescence," which is exceeded in its peril to EE's only by the purple plague. These conditions leave minimum time and motivation for community affairs and political aspirations. This is why politics is usually dominated by people who have a more direct interest, such as local businessmen and lawyers. How many medical doctors do you know of besides Dr. Benjamin Spock who have become active in government and civic affairs?

Secondly, engineers and scientific personnel in general are extremely hor-

ing speakers, as can be attested to by anyone who ever attended a symposium or technical session at a convention. Since they usually put their constituents to sleep, it is doubtful they could arouse the interest of the general public with a political speech.

It is time engineers and the IEEE realize that unless an engineer engages in private business such as a consultant, he is not a professional and cannot be considered in the same category as doctors and lawyers. In fact, a licensed plumber in business for himself is more of a professional than an engineer pushing red and yellow pencils processing engineering change notices.

Rather, engineers are workers subject to the whims of management. Therefore what is truly needed is a national organization to establish higher salary levels and fringe benefits such as a national pension plan so that engineers can keep pace with the plumbers, electricians, and masons. I suggest that the IEEE concentrate its efforts toward this end.

*Gregory M. Cinque
Stamford, Conn.*

Hooray for our side! I just read your editorial in the latest SPECTRUM. If you need to use any of the money I pay in for dues to perform a study on what can be done—please do.

Personally I do not feel unionism is an answer to the engineer's problems of sociological and financial advancement. Psychologically, engineers, I believe, tend to introversion to such an extent that they often feel their professional advancement is only based upon their job performance. There may have been such a time when that reasoning was valid. However, in the present economic situation the raise an engineer gets may be much more closely tied to the changes in the prime interest rate than to his own effectiveness as an engineer, and there is not much he can do about it.

Your editorial mentioned the problem of the large-scale layoff and hirings tied to contracts. Some companies seem to be trying to help their employees who get caught in such a layoff situation, but not really for the sake of the engineer but to try to keep a good name for the company. Possibly a professional engineering organization whose prime interest was the welfare of the engineering profession and its members could devise a more effective solution for all concerned.

Such a professional organization could be a voice to the world, including the

A good introduction means a lasting interest

Wiley Presents Two New Introductory Engineering Texts

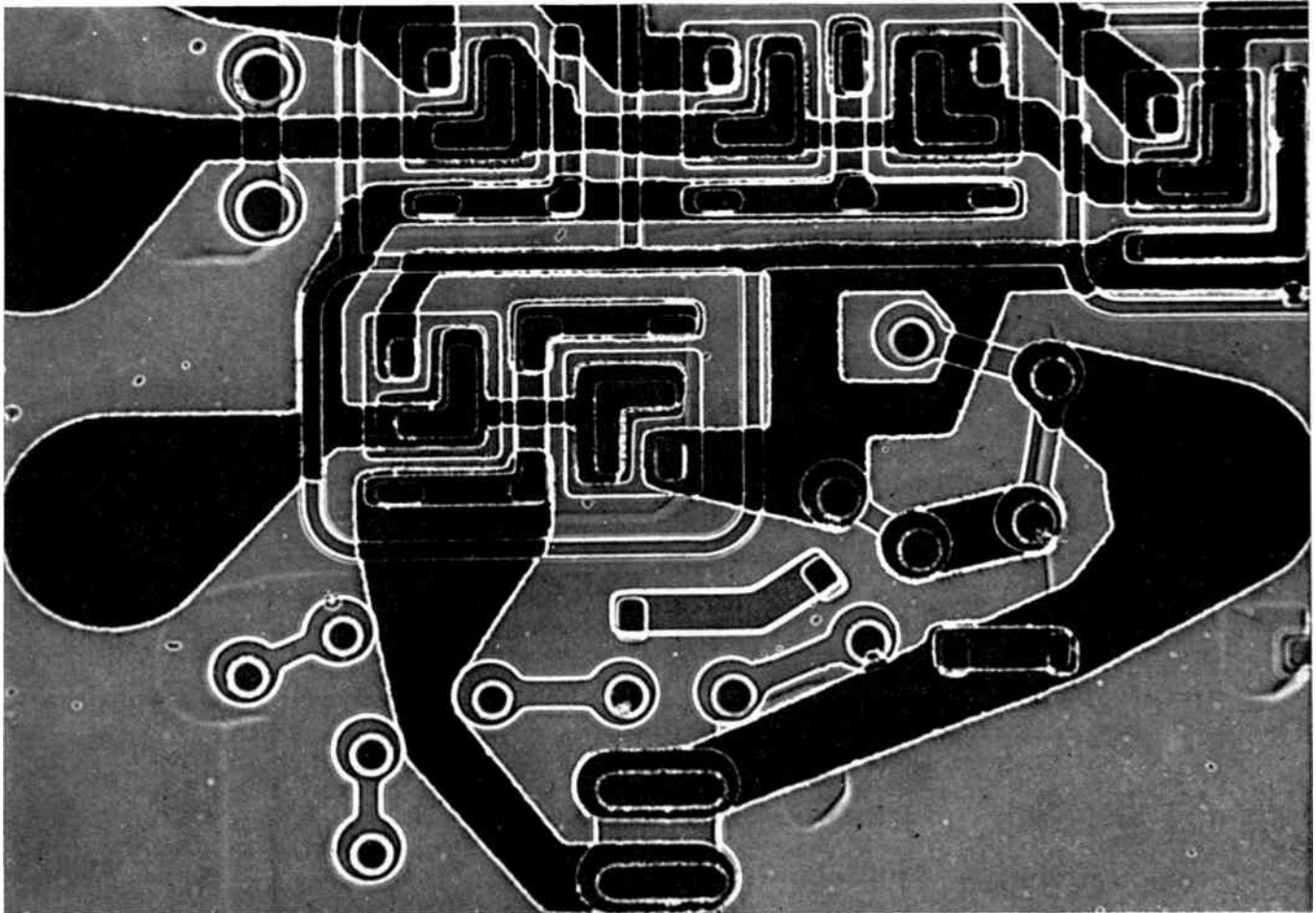

ELECTRONIC PRINCIPLES: PHYSICS, MODELS, AND CIRCUITS *The authors have shaped this text to meet the educational needs implied by the dominance of integrated circuits in electronic technology and by the use of digital computers in engineering design. The book begins with the physical principles that are involved in the operation of semiconductor components, and proceeds through the physical electronics, modeling, and circuit characteristics of these components. It then deals with the questions and problems that arise as well as functional assemblies of the type found in modern integrated-circuit packages. A Teacher's Manual including solutions and overhead projector plates are available.*

By PAUL E. GRAY and CAMPBELL L. SEARLE, both of the Massachusetts Institute of Technology.

1969 Approx. 896 pages Prob. \$14.95

ENGINEERING OF DYNAMIC SYSTEMS *The purpose of this text is to introduce the student to the basic concepts and techniques useful in the design of dynamic systems. Many physical systems of this type, as well as dynamic system concepts, are useful in understanding wholly man-made systems in such fields as economics, transportation, and organizational systems.*

By WILLIAM R. PERKINS and JOSE B. CRUZ, Jr., both of the University of Illinois.

The authors use the exciting Apollo 11 attitude-control problem as a theme. Various aspects of this problem are used throughout the book to motivate and illustrate the material. In this way, the student sees new concepts interpreted concretely and new techniques applied to a familiar problem. Attitude control is perfect for this purpose, since it is a system problem of intermediate difficulty, complex enough to exhibit the strengths of the systems approach without overwhelming the student.

1969 Approx. 608 pages \$13.95

John Wiley & Sons, Inc.

605 Third Avenue, New York, N. Y. 10016

In Canada: John Wiley & Sons Canada Ltd.
22 Worcester Road, Rexdale, Ontario



Circle No. 6 on Reader Service Card.

government, for the engineer. For example, we see news items about "AMA announces..." or "NEA declares..." or "Bar Association announced..." but who ever heard of any engineering association saying anything that had impact on the general public? How about a headline "IEEE (or whatever) demands Congress have U.S. convert to metric system by 1980"?

The various possible involvements of such an organization seem endless, but the benefits could be great.

To me one of the symbols of professionalism is that the profession through its individual practitioners enhances society and the general standing of mankind. Electrical engineers, buried in their own little worlds with their general fates directed by the whims of government officials and decisions from profit-minded corporate executives, should find it hard to consider themselves professionals. An organization that considers more than just enhancing the technical competency of engineers but includes the impact of the engineers' achievements on society should be a big step in the right direction. Let's get started!

D. T. Hooper, Winston-Salem, N.C.

Your editorial on professionalism in engineering is chock-full of the same meaningless clichés about "individual merit" vs. "the welfare of the hive" that have long served to mask the real-life situation from our somewhat naive engineering view.

Engineers are salaried employees—white-collar workers—hired on a mutual "at-will" basis, wherein the employer can fire and an employee can quit at will. No contract guarantees the terms of employment, as it does for any true professional or any member of a collective bargaining entity. The engineer, in distaining the collectivity's contract security, aspires to, but does not reach, the contract security of the professional. It is only to the interest of the corporation for which he works to encourage this absurd attitude on the part of the engineer, since it serves to perpetuate the "at-will" nature of his employment. The corporation can exploit the engineer's moral commitment to professionalism, while failing to reward him with either the status or the security of the professional. The corporation reaps doubly; the engineer not at all.

I, for one, have no fear of the stigma of collective bargaining, but rather would welcome an industry-wide retirement plan, wherein one would not lose all benefits by leaving a company. The

benefits could belong to a person through the bargaining agency. Medical/dental plans would be similarly handled; why should such fringe benefits vary from one major corporation to another in such a migratory transient industry as this? An AMA-type organization would do nothing to change the noncontract salaried nature of our employment but would merely reinforce our self-delusive belief in our professional status. What we need is an organization that will address itself to the realities of the situation instead of the mythology.

C. B. Pearlston, Jr., Torrance, Calif.

In "Spectral lines" for July, Dr. McCue raised good points for discussion.

Why is an association of medical technicians considered a union but an association of medical doctors is not? Why are associations of engineers considered unions but associations of attorneys are not?

The aims of most professional groups are nearly identical. It's true that many labor unions consider seniority a subject equal to wages and working conditions. Note that this does not define the aims of all unions.

The primary purpose of the associations representing engineers is seldom seniority. Their goals are usually in the areas of adequate compensation and professional working conditions (e.g., clock punching).

Why do our professionals willingly participate in mass hiring and mass lay-off but consider it unprofessional to join voices voluntarily to discuss mutual problems with their employers?

The problem seems to be of self-image. Lawyers have what may be the tightest closed shop in the country and M.D.s aren't far behind. A union by any other name is still a union.

D. H. DeVries, P.E., Seattle, Wash.

The question ("Spectral lines," July SPECTRUM) as to how can we get non-engineers to see the light in regard to electrical engineering as a profession has certainly been unanswered for a long time. There are many factors involved, but I have come up with one thought that I believe is important. The editorial's reference to the American Medical Association touches on this thought. The M.D.s have a common identity in those very initials. There isn't a journal that they put out, or an article that they author, or a committee that they are on that the person involved is not identified with those initials. For example, I am on committees here in the city. The roster

of the committee is compiled by a layman who will list Sam Jones, M.D., and Janet Smith, R.N., but stops at that point and continues to list Clarence Ahlgren as a committee member along with the businessmen, etc. There are a number of factors in the case of the Medical Association members, but one thing is definite; that is that they have always very dutifully used those magic initials after their name, whereas the most that engineers do is use a title like Chief Engineer.

Again, for example, I recently received two letters, one from the Chief Engineer of the Water Supply and Pollution Commission in New Hampshire and the other from the chief custodian of the local school department. Both were signed as Chief Engineer. What layman could really tell the difference? I have since persuaded the Water Supply Commission to identify their engineers with the initials, P.E., and I can report that it has made a substantial difference because it has brought attention to the fact that there is a difference in the promiscuous use of the title of engineer. I have carried this campaign on throughout the state and it has grown to such an extent that the lay people are now recognizing that P.E. means Professional Engineer and that this does mean that he is different from the stationary or power engineer.

I have used the same pitch with a number of consulting engineering firms by pointing out to them that the staff roster of medical clinics, etc., identifies the staff by either M.D. or R.N. or the word clerk, and suggested that it was just as important that a staff of an engineering firm be identified.

We do need a common identity like that of the medical people and one that we will use continuously, just as they do. It must be an effort on our part in the beginning, but I feel that it will be an automatic one both by the profession and by our fellowmen after it has been in use universally for eight or ten years.

*Clarence L. Ahlgren, P.E.
Manchester Water Works
Manchester, N.H.*

There have been several meetings at various locations throughout the United States, attended by representatives from the various segments of the engineering profession, including engineers in industry, consulting engineers, engineers from utilities, engineers from government, from the National Council of Engineering Examiners, and from the various engineering societies. The purpose of these meetings and such future

meetings of this group is to determine what should and can be done to improve registration laws and procedures for Professional Engineers to make them more compatible with industry and engineering society viewpoints, and to enhance the status of the engineering profession. There is a possibility that the requirements for registration as a Professional Engineer should be made more stringent to the point that some day all state laws would require a minimum of the bachelor of science degree in engineering from an approved engineering school, passing of written examinations, and adequate engineering experience. (See, for example, "A New Concept of Engineering Registration," Publication 2211 of National Society of Professional Engineers.)

Section 51-2-12(1) (d) of the current Laws of the State of Colorado allows an applicant who is a graduate engineer to take both the Engineer-in-Training and Professional Engineer Examinations immediately upon graduation. If he passes both examinations, the granting of his license to practice engineering is withheld until he meets the additional requirements of four years of engineering practice and 25 years of age. This section of law has been in effect for four years in the State of Colorado and it has been instrumental in encouraging many young engineers to become Registered Professional Engineers just as soon as they meet the minimum qualifications of 25 years of age, four years of experience, the B.S. in engineering degree, and passing of the Engineer-in-Training and Professional Engineer Examinations. Copies of the Colorado Laws, together with statistics covering four years of data on the results of applicants under this section of our law, are available from the Colorado Board of Registration for Professional Engineers and Land Surveyors.

When the problem of requirements for registration as Professional Engineer are resolved, then I believe we are ready to knit the engineering societies closer together with the registration process with the mutual benefit of enhancing the status of the Registered Professional Engineer and all organizations concerned. This could be achieved as follows:

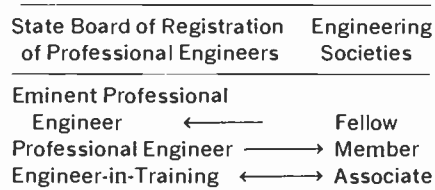

To explain the proposed relationship, the Engineer-in-Training and Associate Member are the entry levels and there would be no interrelationship requirement unless the engineering societies would prefer to make this a requirement. The engineering societies would include among their requirements that their Associate Member must become a Registered Professional Engineer before he could progress to full membership. The State Registration Laws would require that an engineering society member must become a "Fellow Member" of the society before he could be granted a certificate as "Eminent Professional Engineer." When the registered "Professional Engineer" is approved as an "Eminent Professional Engineer," the State Board of Registration for Professional Engineers would issue an "Eminent Professional Engineer's Certificate." Therefore, the steps of the interwoven ladder of the engineering societies and registration boards would be Eminent Professional Engineer, Fellow Member, Full Member, Professional Engineer, and Engineer-in-Training-Associate Member. If the engineering societies required EIT status before granting Associate Member status, it would certainly enhance the status of the Associate Membership classification.

Since the engineering societies have long been accepted by all segments of the engineering profession, the proposal as presented would make registration more acceptable to all segments of the engineering profession, and, therefore, it is conceivable that registration as a Professional Engineer could eventually become a requirement for all practicing engineers just as it is now a requirement in many other professions, such as law and medicine. If the engineering profession is to attain the status it rightly deserves, in comparison with other recognized professions, all practicing engineers must meet certain minimum standards and the most logical way to bring this into being is through the combined efforts of the engineering societies and the State Boards of Registration for Professional Engineers. These are well-grounded, experienced, and long-established organizations, and if they will work together for the good of the engineering profession much can be accomplished to enhance the status of the profession, the Registered Professional Engineer, and all engineering societies.

*Henry J. Ochs, Jr., Executive Secretary
 Colorado State Board of Registration
 for Professional Engineers and
 Land Surveyors, Denver, Colo.*

Charles Carter in his article "Trade Secrets and the Technical Man" (IEEE SPECTRUM, Feb. 1969, p. 51) felt that companies should protect themselves by requiring engineers to sign extensive legal documents requiring, among other things, intricate patent agreements, and in some cases restriction on future employment with a competitor. Other professionals are not bound in this respect, e.g., doctors, lawyers, and patent lawyers who draw up these recommendations for company protection. Maybe the engineer is to be considered a chattel servant without ethics. It appears prohibitive "agreements" are above professional ethics to Charles Carter and, possibly, the IEEE for publishing the article.

Keith A. Barnes, Rochester, N.Y.

I read with interest the "Spectral lines" editorial in the August 1969 SPECTRUM and a related article on "The New Responsibility of the Engineer." I applaud the decision of the IEEE in not subscribing to the proposed Canon of Ethics. It seems to me that paragraphs 2.7 and 2.8 are especially weak in that they create confusion or unnecessarily restrict the freedom of action of engineers.

For example, in paragraph 2.7, assume a consultant in design writes some computer programs in connection with work being done for a client. What must he do to use these programs for work for a second client? Obtain permission from the first client? Use them for the second client without charge? Both? I find the guidance of 2.7 very weak here.

In paragraph 2.8, assume an engineer works for a supervisor who frequently coerces him to work overtime without pay. Does this engineer have to get this man's permission to buy a part interest in a car wash business, for example, if this business will occupy the engineer a few hours a week? I believe it is an employed engineer's right to engage in any legal, nonconflicting, noninterfering outside activities of his own choosing. I feel that 2.8 asks him to throw away that right to no purpose.

I believe a Canon of Ethics can and should be written that would be helpful to employed engineers, supervisory engineers, and consulting engineers—one that would guide us as well as let others know what to expect of us as people of integrity without attempting to force us into a more saintly mold than that of other professional people.

It seems to me that any group advocating a Canon of Ethics for engineers acquires at the same time a responsibility

to these engineers to help them suppress such abuses as coerced unpaid overtime and also to improve their bargaining position in such matters as rights in patent.

David A. Stewart, Liverpool, N.Y.

Mr. E. A. Bromfield's article in the June issue of *SPECTRUM* was informative and interesting, as he described the Technician Engineer in Britain.

Reading the article brought to mind some similar problems in the United States, and how they might be solved.

If it takes approximately four non-degreed, highly skilled Technician Engineers for each degreed engineer, then it becomes quite obvious that a great army of workers fall into the Technician Engineer category in the U.S., with its large number of degreed engineers in active practice.

We suggest that the IEEE total membership in the U.S. be polled to determine whether sufficient interest prevails to support a similar professional society.

To point out a few situations that exist in the U.S. with many highly skilled persons capable of performing work in the Technician Engineer field, consider the following:

1. Many technicians are referred to as "designers." This implies that they are "super draftsmen," but not professionals since they usually are not degreed; in some cases, however, they may be registered engineers in a particular state, and by the legal meaning in that state are professional engineers. Many employers distinguish the designer from the engineer by awarding the engineer special privileges such as private offices.

2. Many designers feel that their work is important, interesting, and challenging. Although they are the "quarterbacks" of the engineering team—getting the "hard core" of the engineering job at hand done and working closely with technical persons, degreed engineers, and frequently with management—they also admit that theirs is a "dead-end" situation, ruled out of professional status for lack of a degree. Moreover, they may be near the top of their earning power as a nonprofessional.

3. ICET (Institute for Certification of Engineering Technicians) on the face of a certificate issued as a "Senior Engineering Technician" recognizes that the person receiving the certificate "through education, experience and knowledge, has met the standards set forth by ICET and is capable of properly communicating with engineers and performing appropriate technical functions for the

engineering profession."

4. Next, consider if you will the classifications concerning the engineering team as outlined in the United States Department of Labor Statistics Bulletin Number 1617 "National Survey of Professional, Administrative, Technical and Clerical Pay." Engineering technicians are classified I through V, showing skills necessary as well as salary ranges, but it further states that the engineering technician classification "excludes production or maintenance workers, quality control testers, craftsmen, draftsmen, designers, and engineers."

At this point we conclude that a designer is above draftsman classification skill not considered to be classified as a technician, and at the same time "outlawed" from falling into engineer classification (except where he may be registered in a certain state, but not degreed), in which case he can enjoy professional engineer status only as long as he resides in his state where registered.

5. Designers may wish for professional status but, being practical persons, many take the attitude "it doesn't matter whether you are or you are not a professional, and it matters not what tag they assign to you, as long as you receive what you as an individual feel is sufficient pay for your particular field or endeavor." But in all honesty some will admit that there is pride in being a professional and that salary horizons are not so tightly restricted as they are in subprofessional classifications.

In conclusion, there is a distinct possibility that the creation of a "technician-engineer" status in the U.S., as a recognized profession, would inspire many men to move into this group; and it is possible that, by such a move, the entire nation could gain overall professional stature by recognizing proven ability even though a formal degree is not a requisite.

*George H. Stain
Union Carbide Corporation
S. Charleston, W.Va.*

ABM

Your entire presentation of the ABM issue has been ridiculously one-sided and shallow.

1. I support deployment of Safeguard.
2. I don't give a damn what it does to the arms race. If serious escalation results, which is unlikely, there will be more serious concerns than the fact of escalation.
3. I am in favor of research and pos-

sible deployment of thicker systems when indicated by initial deployment.

4. The Soviet is controlled by an international communist conspiracy. Even if it were not, world government is not a route to world peace. We should certainly continue to assess the motives of Soviet leadership.

R. B. Hobson, Phoenix, Ariz.

Weather modification

The three-part series, "Electricity and Weather Modification" (*IEEE SPECTRUM*, April, May, June 1969) by Seymour Tilson, covers the subject exceedingly well. I think, however, that too much has been made in Part III of the published statistical analysis by Jerzy Neyman of a single carefully designed experiment in precipitation modification, Project Whitetop.

As I have maintained elsewhere (*Science*, vol. 164, p. 1341, 20 June 1969), the conclusion that can be drawn from a statistical analysis of the data from a specific experiment, no matter how stratified, is uniquely applicable to the data used and the experiment as conducted.

The conclusion drawn by Neyman that because the employment of a certain technique produced unexpected results, the technology involved "does not appear reliable enough for practical use" is not a valid conclusion. Other than statistical considerations must be involved if an evaluation is to be meaningful.

Although cloud-seeding techniques have been employed for many years, it is only recently that we have been able to develop mathematical models that include the effects of cloud seeding and that *have been able to predict* the observed negative and positive effects of cloud seeding as applied to particular cumulus clouds. Clearly the technology involved is approaching adequacy to the task.

I am concerned that piecemeal pessimistic analyses can prejudice the total effort to develop and apply the resources and knowledge necessary to solve the intricate weather puzzle. I was closely involved in the initial cloud-seeding experiments by Langmuir and Schaefer. I have followed Langmuir's, and more recently Schaefer's, observations concerning natural seeding of clouds by ice crystals from above them. I have studied movies of a radar screen displaying precipitation as it was occurring within and only within three plumes from silver iodide generators.

I am convinced that man can affect the weather deliberately to a limited degree; that he is affecting the weather inadvertently to an as yet undetermined but probably deleteriously significant degree; and that the capability to enhance the former and adequately arrest the latter is well within the current state of the art. What is needed is a coordinated development and application of the pertinent technologies under the guidance of a Congressionally approved plan. Hopefully, the recent interest manifested by the environmental resources and weather modification legislation now before the U.S. Congress will spur us to some real accomplishments in this area.

Myron Tribus

The Assistant Secretary of Commerce
Washington, D.C.

Transportation

While reading "The Electronic Highway" in July's issue, I was more impressed by the substantial costs and complications involved in developing adequate transportation systems than by the potential realization. In the San Francisco Bay Area, we have the Bayshore Freeway, which now consumes large areas of land in providing three, and sometimes four, lanes of traffic between San Francisco and San Jose. Additional lanes seem to be necessary approximately every three years. Clearly a different approach is necessary to meet the need if it continues as it has. There is not sufficient ground area available at reasonable cost.

For business purposes I choose to drive to San Francisco rather than take the train because of convenience: the train is neither frequent enough, nor convenient enough because of its terminal location. Bay Area Rapid Transit, of course, hopes to alleviate this problem to a substantial extent. For recreation purposes, I choose normally to drive for convenience, and also for cost reasons. With four children in the family the cost of multiple tickets far exceeds the cost of driving. Furthermore, I have already made my capital investment in the automobile and I have only incremental operating costs to bear in making any individual trip.

It seems to me that an approach to the transportation system may be to provide free train service, pumping gasoline tax and other tax monies into paying for road beds, equipment, and operating expenses. By increasing service as demands require, it should be possible to

attract increasingly more motorists to public transportation systems.

This approach, although politically difficult, should be compared in cost and effectiveness to costs involved in developing automated highways. It appears that the public transportation approach would more likely meet the surface area limitation problem, as well as provide safer transportation.

William A. Gross

Ampex Corp.

Redwood City, Calif.

Abstracts

In an editorial in the IEEE SPECTRUM (November 1966), "Importance of Secondary Publications," F. K. Willenbrock developed the need for the "publication of abstracts or indexes of articles published in a large number of primary journals," and pointed out that a "careful study will be made of services presently available through Engineering Index, the Institution of Electrical Engineers in the United Kingdom, the Engineering Societies Library, and various governmental information processing agencies." The editorial closed with the statement that: "While the Institute should work, and is working, cooperatively with other agencies in this field, it has the particular responsibility of insuring that the particular needs of its members are adequately provided for."

One of the results of the study was that in 1968 *Electrical and Electronics Abstracts* was made available to the membership of the Institute at \$21 per year. This was a real service because a subscription in the United States, in 1967, was \$84 from the Institution of Electrical Engineers. Alas, this service was to be short-lived.

In November 1968, Howard E. Tompkins, Director, Information Services, sent a letter to "Dear IEEE Member Subscriber," in which he stated "there is a need for information products better designed to meet the needs and pocketbooks of individual members." The accompanying folder carried the bad news: the annual subscription price of *Electrical Engineering Abstracts* had been hiked to \$156 for all subscribers, which is certainly not "designed to meet the needs and pocketbooks of individual members."

The Institution of Electrical Engineers in the United Kingdom initiated the two major science abstract publications: *Physics Abstracts* and *Electrical and Electronics Abstracts*. In the past these have been available to the general

public and to institutions at a standard subscription price, and to members of the Institution of Electrical Engineers and of cooperating societies at a much lower privilege price.

The 1968 subscription and privilege prices were as follows:

Abstracts	Subscription Price	Privilege Price		
		IEE	AIP	IEEE
Physics	£50(\$140)	£10	\$24	—
E.E.	£40(\$120)	£7 10s	—	\$21

The 1969 privilege price of *Physics Abstracts* to American Institute of Physics members is \$30. Why should a member of the Institute of Electrical and Electronics Engineers be soaked \$156 for *Electrical and Electronics Abstracts*?

Bayard R. Corson

Hughes Aircraft Co.

Vacuum Tube Products Div.
Oceanside, Calif.

Mr. Corson has raised an important and serious question; here are the reasons for the situation he describes. Soaring costs in England where the abstracts journals are produced, an all-too-small subscription base, and the tendency for some companies to acquire their copy through a personal subscription at the member rate, all led us to abandon the member price this year. The member price did not come even close to meeting direct costs, and we could not afford to continue such a subsidy. Mr. Corson may find comfort in the fact that the American Institute of Physics is abandoning the special member discount price as of 1970, just one year behind us. To provide a small note of cheer, we and our copublishers, the IEE of London, England, are happy to report that we can maintain our 1970 subscription prices for our abstracts journals at the same level as in 1969. \$156 for *Electrical and Electronics Abstracts*, \$84 for *Computer and Control Abstracts*, with a special \$192 rate for the pair.

For the individual member, whom we do want to serve in whatever way we can, we offer corresponding "titles" journals, *Current Papers in Electrical and Electronics Engineering* at \$14 to members for 1970 (up from \$12 in 1969), and *Current Papers on Computers and Control* at \$12 to members for 1970 (up from \$9 in 1969). These prices are very low for up-to-date coverage of the world's literature over such a broad field, and should be within the budget of most active U.S. scientists or engineers.

In 1969, publication and distribution have run into delays because of difficulties with new computer-based techniques on both sides of the Atlantic. In 1970 we expect the promptness of publication and distribution to improve substantially.

In the near future, we hope to have other specialized information products, such as computer tapes derived from our technical-information data base. In each case, we must try to have these products carry their full share of the cost of their production. Unfortunately, this will usually mean prices that fit more into company or project budgets than into private ones. Whenever this is not the case, and a low-cost valuable product can be produced, we shall do so. We would welcome any suggestions as to what these might be.

H. E. Tompkins
 Director, Information Services
 IEEE

Correction

As the result of a typographical error, the title of the article by Luigi Paris (September issue, page 44) appeared incorrectly. The title should be "The Future of UHV Transmission Lines."

ELGENCO 603A NOISE GENERATOR \$545



Many obsolete vacuum tube noise generators can be replaced/updated with this solid state 5 Hz to 20 kHz/500 kHz/5 mHz Random Noise Generator with greatly improved characteristics. Very useful where previous equipment is not adequate for present needs. Other Models covering the range of DC to 30 mHz are available. For name of nearest Sales Rep see EEM or contact Elgenco, Inc., 1550 Euclid, Santa Monica, Calif. 90404, Ph. 213-451-1635.

Circle No. 8 on Reader Service Card.

Designed for

Application

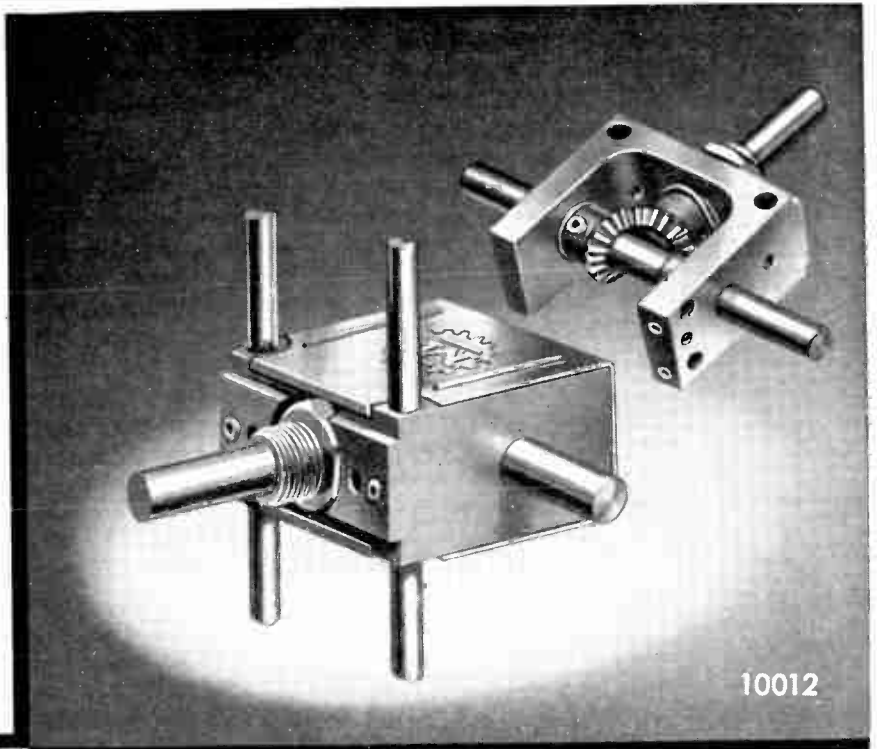

RIGHT ANGLE DRIVES

Extremely compact, with provisions for many methods of mounting. Ideal for operating potentiometers, switches, etc., that must be located, for short leads, in remote parts of chassis. No. 10012 for 1/4 inch shafts. No. A012 Miniature for 1/8 inch shafts.

JAMES MILLEN MFG. CO., INC.
 MALDEN
 MASSACHUSETTS

Circle No. 29 on Reader Service Card.

Focal points

Mariners 6 and 7 answer some questions, and raise some others, in trip around Mars

If seeing is believing, then Mars—as seen through the “eyes” of Mariners 6 and 7—is unbelievably desolate.

Although Mariners 6 and 7 provided man with details about Mars hitherto only hinted at, the latest scientific assault

on the red planet was actually a two-pronged attack. In addition to the some 400 or so pictures and the ultraviolet and infrared data gathered by the Mariners and radioed back to the earth, ground-based equipment also played a

vital part in unraveling the Martian mysteries.

This earth-bound equipment did more than simply “tune in” on the Mariners. It also helped put the craft where they were supposed to be; “cleaned up”

ALTHOUGH THE MARINERS provided the dramatics, there could have been no drama without the earth-based electronics. This sequence of pictures taken by Mariner 6 shows one way in which ground equipment aided project. Picture at top left is

partially degraded by interference pattern (analyzed by computer, top right) and camera orthicon tube blurring. Bottom left picture has been freed of “basket-weave” pattern. Bottom right picture has been electronically sharpened.

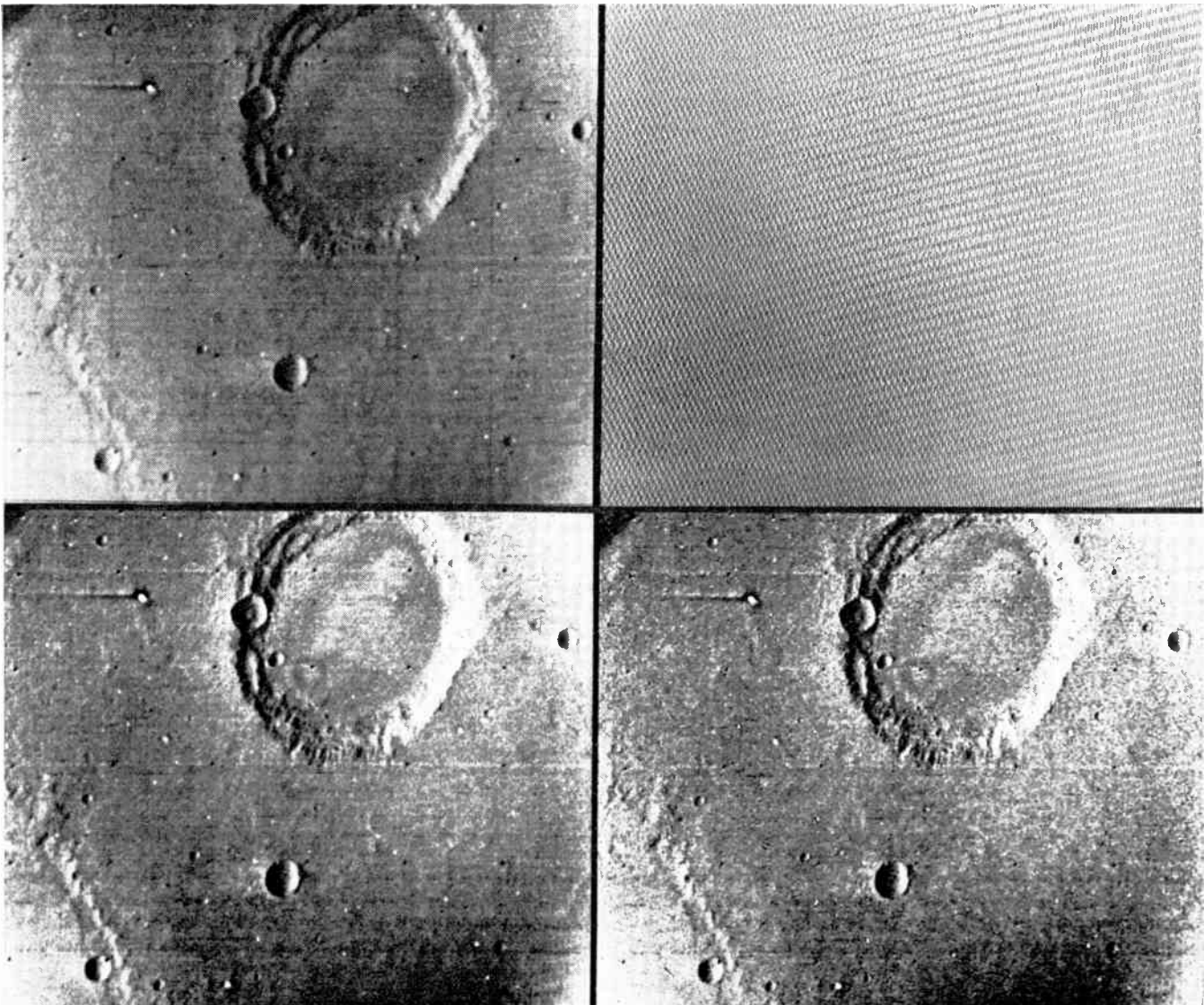

Spectral lines

The Editor's mail pile. By joining the 1968 and 1969 vacations end-to-end, I achieved during the summer a long absence. Now, at the end of August, I have reached the bottom of the accumulation of letters about IEEE SPECTRUM.

Many of them concerned the Wald article (SPECTRUM, June). Of these, the most stimulating dealt with the request of one Senior Member to his Congressman that I be tried for treason. I will be interested in how this turns out. I'm not sure how long it has been since a registered Republican has been tried for treason, but it must be quite a while.

The Wald article is not SPECTRUM's prescription for the military policy of the U.S., nor for its foreign policy. Its significance to us as engineers is that it expresses the frustrations of those scientists and engineers who have utterly lost faith in the Pentagon, which has funded a large fraction of the employment in electronics in the U.S. for nearly a generation, and has sponsored a large fraction of the research. As citizens and amateur strategists, we may concur in Wald's fear that escalating armaments will destroy our children and our civilization, or we may feel that everything will probably turn out all right, or we may simply feel that we have no alternative, so why worry. But regardless of our own outlook, we must expect that worry on the part of other citizens will animate a drive for change in the sponsorship for research in electronics. Already, the loss of faith has resulted in the disbanding of the Laboratory for Applied Electronics at Stanford University, and in the severance of the ties between that university and Stanford Research Institute. At M.I.T., the Lincoln Laboratory (electronics for defense and space) and the Instrumentation Laboratory (guidance systems for Apollo and other astronautics, and for submarine-launched missiles) are under fire.

The mail vote regarding the Wald article tallied about 30 approvals, 80 protests, and 150 000 abstentions. Most of the protests said that Wald was ignoring the crimes of the Nazis and the belligerence of the Russians; a considerable number of the protesters, however, voiced the opinion that IEEE publications should stick to purely technical material. Most letters of praise mentioned not the substance of the Wald article, but approval that SPECTRUM is taking an interest in social and political problems that affect engineers. On this question, the mail vote was nearly even. Two of the most thoughtful letters are published in this month's Forum.

There is certainly room here for a difference of opinion. In the plan for SPECTRUM originally laid down by the Board of Directors in 1963, one of the functions of SPEC-

TRUM was to be the publication of "News of political and social interest to the profession." Until the past few months, this policy has been pretty much of a dead letter. If it is taken seriously in these times of questioned values, it must result in the treatment of controversial themes.

One thing that many correspondents have called for, and that no editor can provide unless he kills most of the interesting material, is simultaneous publication of "the other side." The first time I ran into this problem was when the reviewer of Forshay's article on equipment purchases by the Tennessee Valley Authority (SPECTRUM, September 1968) told me it must not be published unless accompanied by an article explaining why the U.S. Government should buy domestic products even when foreign ones cost less. I invited him to write such an explanation, but he said No. Nor would he name anybody who might write it. A policy of "Both sides or nothing" would have meant rejection of the Forshay article.

In being able to give balanced coverage of the ABM problem, we were just lucky. I had been trying for a year to get an authoritative article on one view or the other, but had got nothing.

Demands for "the other side" can be completely bewildering. Some were made, for example, in connection with the announcement sent in by a member on behalf of the Union of Concerned Scientists (SPECTRUM, April, p. 8), saying that the organization had been formed and would hold a meeting for a stated purpose. What is "the other side"?

Many letters came in response to the remarks on professionalism made on this page in July. Only one letter (page 11) backed collective bargaining. A larger number felt that IEEE should take direct action in regard to the economic well-being of its members. This is not a simple question, because it may involve not only the Institute's charter, but also its status in respect to taxes of various kinds. This month's Forum prints a diversity of opinions and suggestions; further comment will be welcome.

These lines must go to the printer before he mails the September issue that contains (on its page 6) President Willenbrock's request for an expression of opinion concerning publication of controversial material; therefore it is not possible at present to make any assessment of the members' response on that question.

One thing cheers me. Even apart from complaints and plaudits concerning the Wald article, mail to the Editor has in recent months grown by about a factor π . I interpret the increase as meaning that more readers are finding SPECTRUM interesting.

J. J. G. McCue

Silicon-gate technology

Low-cost, large-scale integrated electronics based on metal-oxide-semiconductor design benefits from the application of silicon-gate technology

L. L. Vadasz, A. S. Grove, T. A. Rowe, G. E. Moore Intel Corporation

Silicon-gate technology provides an advantageous approach for implementing large-scale integrated arrays of field-effect transistors. Its advantages—principally resulting from the low threshold voltage and the self-aligned gate structure buried under an insulator—ease the problem of interfacing these circuits to bipolar integrated circuits and increase both their performance and functional density, making MOS integrated circuits easier and more economical to use. This article reviews recent progress with this technology and shows its application to the construction of complex digital functions as illustrated by a memory circuit.

Much of the early enthusiasm for metal-oxide-semiconductor (MOS) integrated circuits stemmed from their promise as low-cost digital functions. Optimism was based upon the apparent simplicity of integrated circuits made completely with self-isolated enhancement-mode transistors that could be constructed with a single diffusion step. By comparison, conventional bipolar integrated circuits typically involve four such steps.

However, the growth of MOS circuitry has been slow—compared with early expectations—for many reasons.

1. Early devices often had reliability problems, principally relating to ion drift in the oxide films or to dielectric breakdown in the thin gate insulator resulting from static electricity.

2. There were device-availability problems, and systems designed for MOS structures were delayed. (This suggests that the production yields were not as high as expected.)

3. For economy and to overcome the high-impedance drawback of MOS, it's important to build large functions. This aim contributed to the yield difficulties.

4. The expected cost advantages have also been slow in materializing. Yield problems have kept device costs high; but extra cost was incurred interfacing MOS to bipolar electronics, an important requirement in many systems. Generally, this factor related to the incompatibility of power supply and of signal levels between the two types of circuits, and tended to force designers to all-MOS or all-bipolar systems rather than use each to its advantage.

5. Performance of MOS circuits has restricted their applicability. The speed of MOS circuits is limited—for quite fundamental reasons—below bipolar structures.

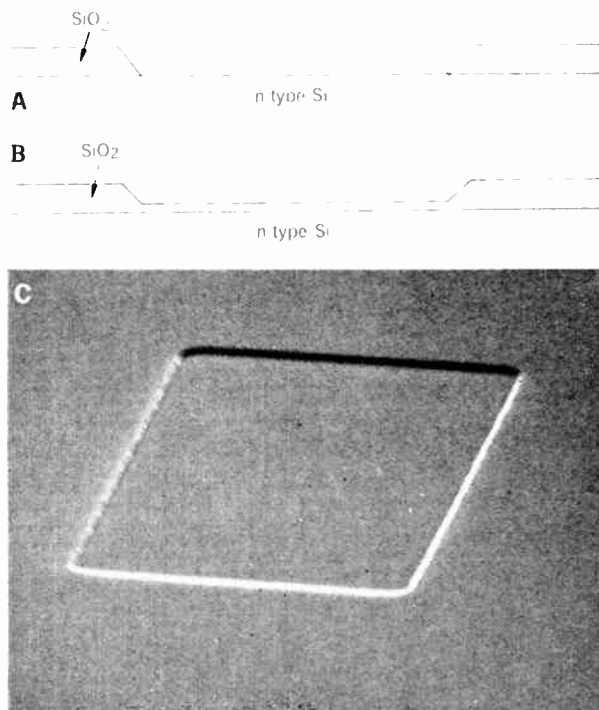

FIGURE 1. A—First oxide cut after initial oxidation for subsequent source, drain, and gate region. B—Second oxidation to define gate oxide thickness. C—Scanning electron microscope (SEM) photograph of a transistor fabrication at stage B.

On the other hand, MOS circuits clearly have certain advantages.

1. Their use permits logic circuits to be designed in a straightforward manner.

2. The ability to use such combinations as series gates greatly simplifies the circuitry, and the large fan-out and fan-in potential of a voltage-controlled device allows large margins for reliable operation.

3. New circuit forms, particularly multiphased-clocked circuits, are practical.

4. High-functional packing density can be achieved—probably two to ten times as much function per unit silicon area as with conventional bipolar circuits using the same geometrical tolerances. The cost of processing

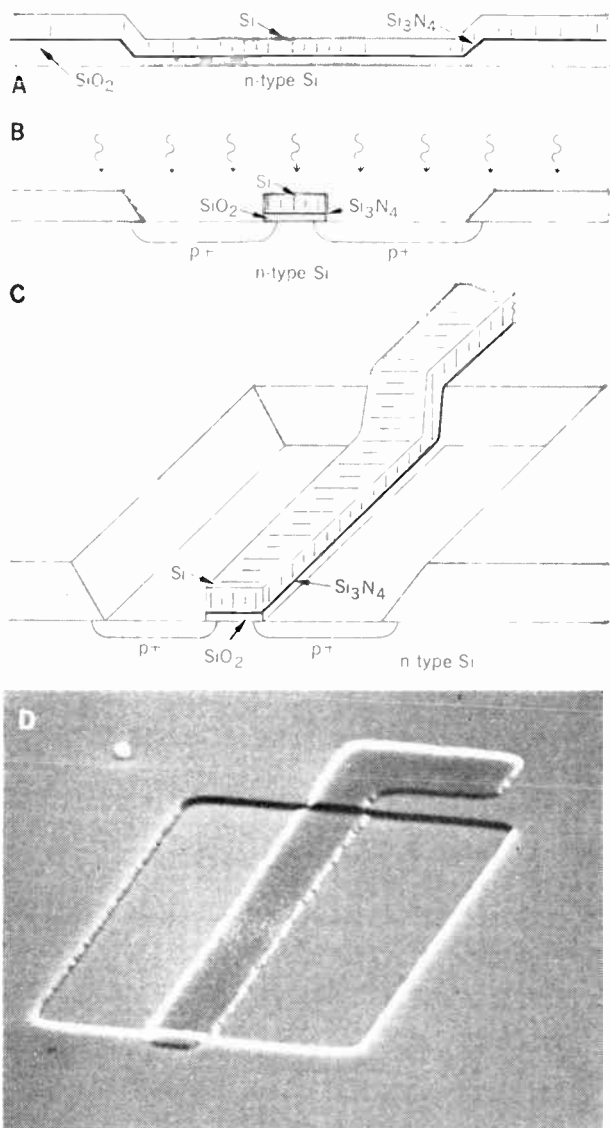

FIGURE 2. A—Device of Fig. 1(B) after deposition of nitride and amorphous silicon sandwich. B—Definition of gate insulator and gate electrode dimensions and subsequent boron diffusion. C—Perspective view of structure of 2(B). D—SEM photograph of the structure at end of this fabrication stage.

is more nearly related to area than complexity, pointing to low cost per function in complex circuits.

5. Mask layout is simplified. No special isolation structures need be considered. The high impedance levels and resulting lower current densities greatly simplify the interconnection problems by allowing use of high-resistance signal paths. Fewer mask layers are generally required. The result is many fewer oversights.

Much effort has gone into improving MOS technology to remove the limitations while preserving as many of the advantages as possible.

In general, there are several ways that each limitation can be attacked. However, the use of polycrystalline silicon for the gate electrode affords a unique and powerful combination of properties that removes many of the objections that have been raised regarding metal-insulator-semiconductor (MIS) devices.^{1,2}

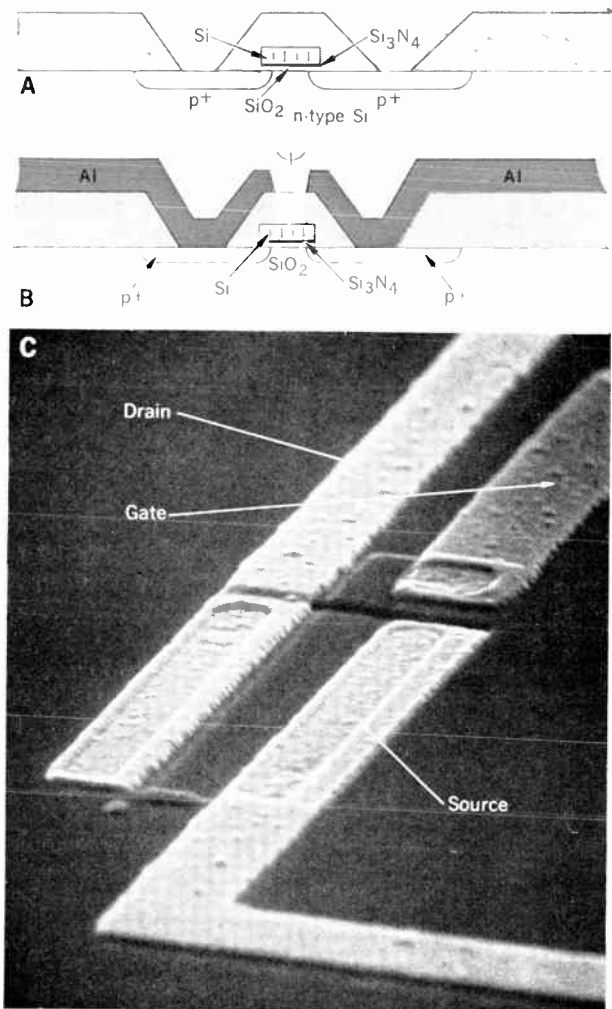

FIGURE 3. A—Device of Fig. 2(B) after deposition of silicon dioxide and definition of contact regions. B—Final structure after deposition and definition of metal interconnections. C—SEM photograph of the completed transistor structure.

A look at the technology

As in conventional MOS technology, the starting material for silicon-gate technology is n-type silicon. The wafer is first placed into an oxidizing atmosphere at high temperature and a relatively thick (about 1 μm) layer of silicon dioxide is formed on its surface. Next, regions for the source and drain of the final device and the eventual channel regions are defined by photomasking. The oxide is then etched from this area, as shown in Fig. 1(A). The slice is placed into an oxidizing ambient again, and a layer of silicon dioxide about 0.1 μm thick is formed in the window [Figs. 1(B) and 1(C)].

Subsequently, a thin layer of silicon nitride (Si_3N_4), another insulator, is deposited onto the entire surface of the wafer. This layer affects both the electrical characteristics and the reliability in a desirable manner.

Next, a thin layer of amorphous silicon is deposited on the wafer. The device structure at this point is as illustrated in Fig. 2(A).

The structure now is returned to photomasking for removal of the silicon and silicon nitride layers except where the gate area is to be or where the silicon film

is intended for use as a circuit interconnection layer. The thin oxide is also removed by exposing it to an oxide etch, as shown in Fig. 2(B).

Finally, the wafer is placed into a diffusion furnace and boron—a p-type impurity that diffuses with relative rapidity in silicon, but very slowly in silicon nitride or in silicon oxide—is diffused into the surface of the structure. Consequently, after exposure, boron impurities will convert both the n-type silicon wafer, where exposed, and the deposited silicon layer into p-type silicon; but the n-type regions under the oxide-covered areas are unaffected [Figs. 2(B), 2(C), and 2(D)].

The device structure, except for the necessary interconnections, is now complete. A layer of silicon dioxide is deposited onto the entire surface—the exposed regions of the silicon wafer, the thick oxide layer covering most of the surface, and the deposited gate silicon. Openings are photoetched in this deposited silicon dioxide layer wherever a contact between the subsequent metalization and the underlying silicon wafer or deposited silicon is desired, as shown in Fig. 3(A). Aluminum is evaporated onto the surface so that it enters into these contact openings, and the desired interconnection patterns are defined by another photomasking operation. The device now appears as shown in Figs. 3(B) and 3(C).

It is desirable to protect the device both from mechanical damage to its intricate interconnection pattern and from contamination. For this reason, another layer of glass is deposited onto the wafer surface, and patterned by subsequent photomasking and etching to expose the pads where bonding wires are to make contact with the aluminum interconnection pattern.

It is interesting to note that, in fabricating this device, there is only one diffusion step, but there are five steps in which a thin film—an insulator or a conductor—is deposited. In the silicon-gate technology, yields, performance, and reliability—thus, success or failure—all depend on the manufacturer's ability to control the thin-film deposition steps.

Overcoming MOS's past, poor performance

Two key aims of MOS technological developments have been easier interfacing with bipolar circuitry, and higher component densities to decrease further the cost

of electronic functions. The silicon-gate technology achieves significant improvements in both directions.

Low threshold voltage. The minimum operating voltages that must be used in an MOS circuit are determined by the gate voltage required to create a conducting channel between source and drain—called the *threshold voltage* (V_T). It is important that V_T be relatively low, not only to interface to bipolar circuits, but to improve circuit performance.

To demonstrate the improved performance attainable with the low threshold voltage compared with standard high-voltage technology, consider the use of a simple dc stable (static) inverter. The significant points of comparison are power dissipation and speed. A figure of merit is the speed–power product. An appropriate tradeoff can be made for any given application.

The inverter stage of Fig. 4 has an MOS transistor (Q_1) and an MOS resistor (Q_2) in series. It can be shown that the limit of circuit performance will be determined by the output transition from “zero” to “one.”

We can define an equivalent RC time constant for this transition. Since the MOS resistor, Q_2 , is a nonlinear resistor, a true time constant will not exist, but one can be approximated for the initial part of the transition. In terms of this time constant, the advantage of a low-voltage circuit is simply that, for the same power level, the resistor value can be significantly lower. In the power-dissipating state the dissipation of an inverter is given by

$$P \approx \frac{V_{DD}^2}{R_{eq}} \quad (1)$$

The characteristic time constant is given by

$$t \approx R_{eq}C \quad (2)$$

where C is the load capacitance.

The combination of these two equations will result in the expression for the power–speed product

$$Pt \approx V_{DD}^2C \quad (3)$$

Equation (3) illustrates that, for a given capacitive load, lower-voltage operation gives a more meritorious figure.

In the silicon-gate technology, lowering the threshold voltage is achieved because a dielectric sandwich of silicon dioxide and silicon nitride is used under the gate and the gate electrode is made of heavily doped p-type silicon rather than of aluminum, as in conventional MOS technology. The threshold voltage depends on the *electric field* in the silicon reaching a certain critical value before a conducting channel appears. The higher the dielectric constant of the insulator, the lower the gate voltage has to be.

Silicon nitride has roughly twice the dielectric constant of silicon dioxide, so its use might be expected to lower threshold voltages. When silicon nitride is deposited directly onto a silicon wafer, however, spurious, undesirable charges appear near the interface between the nitride and the silicon and actually increase the threshold voltage. But if the layer of silicon dioxide under the layer of nitride is thick enough, these charges can be eliminated and one can still benefit from the higher average dielectric constant of the resulting sandwich.

The material from which the gate electrode is made also has a significant effect on the magnitude of the threshold voltage. The gate electrode and the silicon

FIGURE 4. A dc stable (static) inverter circuit. Figure of merit depends on operating voltages.

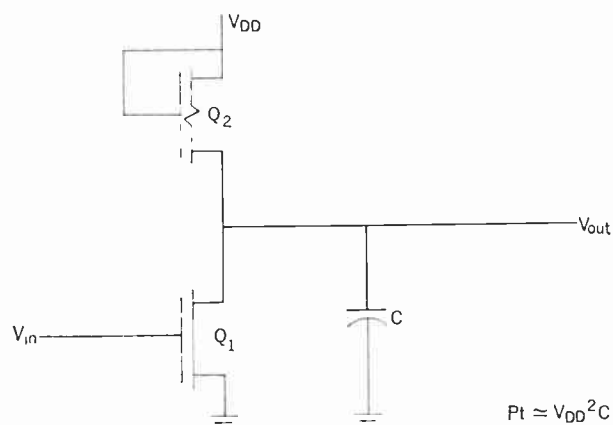

wafer act, in a way, like the two electrodes of a battery; an electromotive force is developed between them that can add to or subtract from the threshold voltage. Accordingly, the use of p-type silicon for the gate produces a threshold voltage for p-channel devices whose magnitude is about one volt lower than it would be in a comparable aluminum-gate MOS. Thus, the combined use of a silicon nitride-silicon dioxide sandwich and of a p-type silicon gate electrode results in threshold voltage values that are typically two volts.

Reducing parasitics. Reductions in parasitics attributable to silicon-gate technology are equally impres-

sive. This advantage accrues from a basic feature of this technology—the gate electrode and the p-type diffused regions are “self-aligned” as shown in Fig. 2(B). The gate electrode, or rather the dielectric under the gate electrode, is the diffusion mask that defines the edge of the source and drain regions. Thus, they are automatically aligned. In conventional MOS technology, this alignment is done by the superposition of two sequential masking operations. The inherent inaccuracy of manually aligning two patterns causes a certain tolerance for misalignment that has to be included in the design. This tolerance wastes space, resulting in larger device structures, and, in particular, introduces relatively large interelectrode capacitances that degrade performance. Major advantages of the self-aligned gate structure result from these reduced parasitic capacitances.

1. *Reduced gate capacitance.* The thin gate oxide area is smaller. For a given channel length, the thin oxide region will extend over the source and drain regions only to the depth of the source-drain diffusion, typically $<1\ \mu\text{m}$ with the silicon-gate technology. Since standard technologies have as much as an 8–10- μm gate overlap above the source and drain regions, gate capacitance reduction can be as much as 50 percent.

2. *Reduced Miller capacitance.* From item 1, it is obvious that the gate-to-drain overlap capacitances have been reduced significantly by the use of a self-aligned gate. This reduction can be as much as an order of magnitude for equivalent device size.

3. *Reduced junction capacitance.* The reduction is mainly the result of reduced junction area. In a conventional metal-gate device, the size of the drain junction is larger primarily because a minimum separation has to be kept between gate metal and the line connecting to the drain. With the silicon-gate technology, the metal connected to the drain can overlap the gate regions since there is an insulating layer separating the gate from the metal. The only constraint is the proximity of the drain contact to the gate region; junction area reduction is about 30–40 percent.

High functional density. Smaller devices obviously contribute to higher packing density, but even more important is the circuit interconnection flexibility inherent in the silicon-gate technology. Figure 3 shows

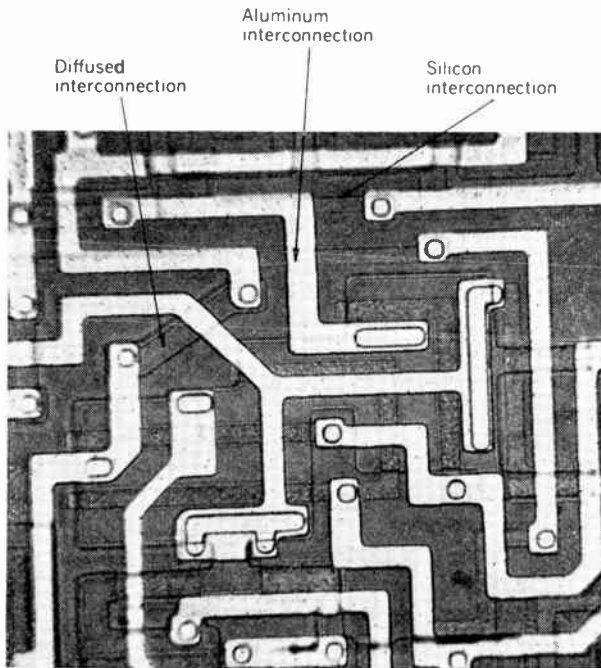
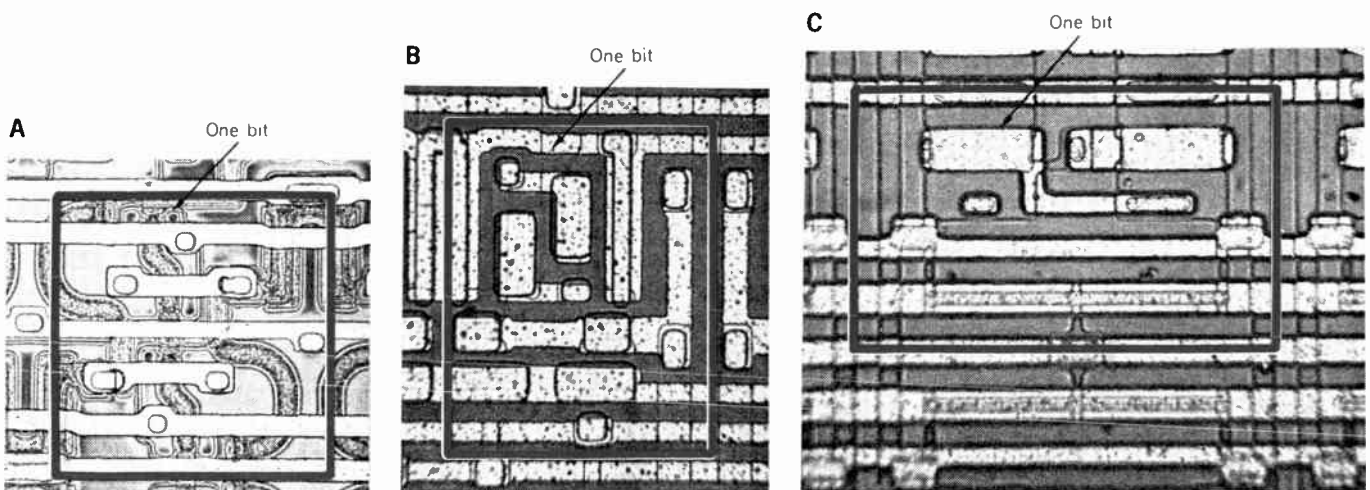

FIGURE 5. Photomicrograph of a small region of Intel's i-1101 256-bit RAM, showing the three possible modes of interconnection: diffused regions within the wafer, deposited silicon, and metal interconnecting lines.

FIGURE 6. Photomicrograph of static memory bits of three MOS memory products: (A) Intel's i-1101, (B) TI's 4003, (C) Fairchild's 3530.



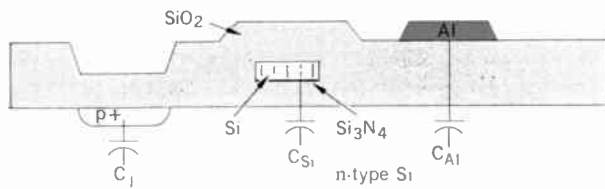
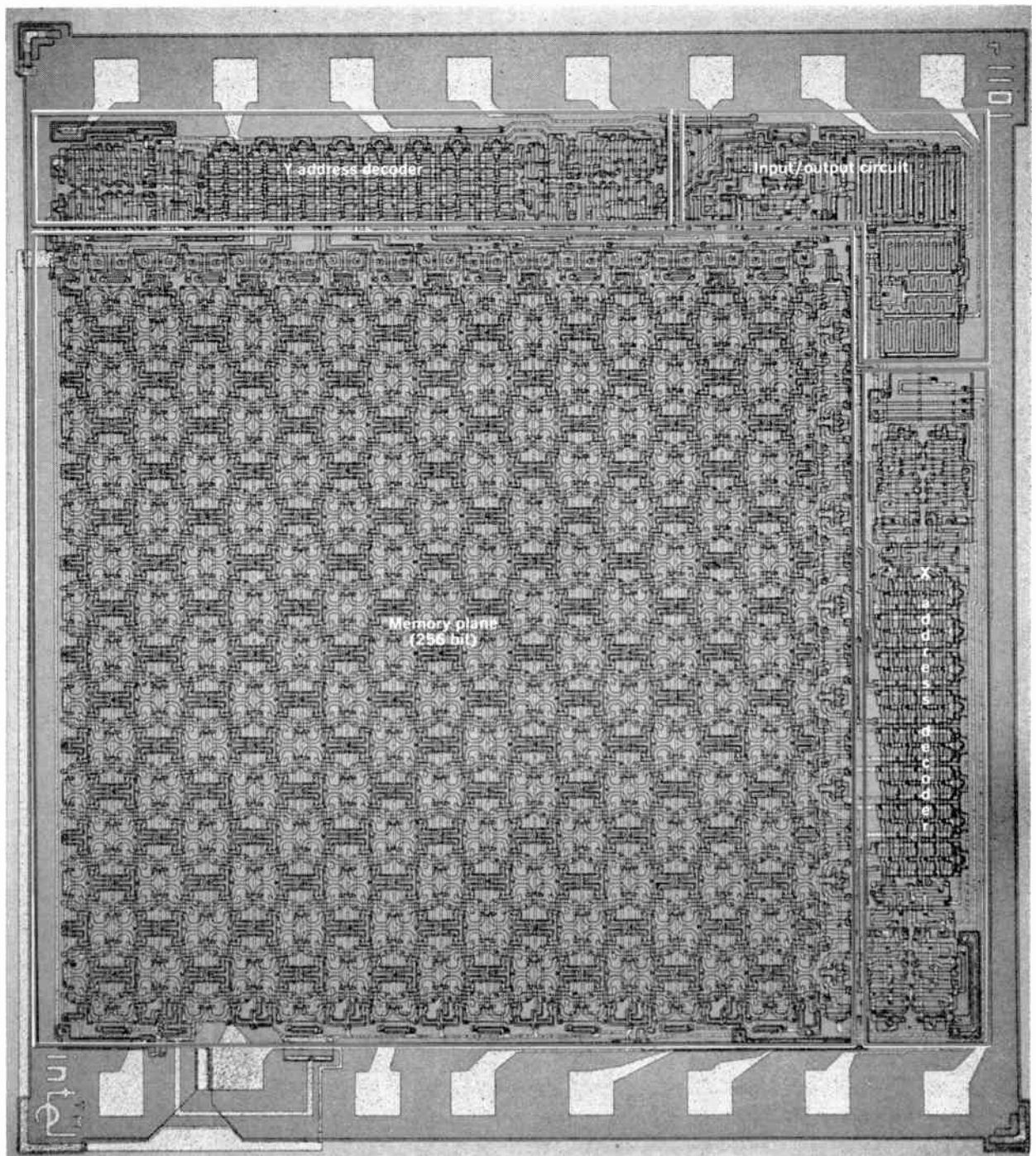

FIGURE 7. Capacitances associated with various types of interconnecting lines. Both metal and deposited silicon have a smaller capacitance per unit length than diffused region interconnections. For 10- μ m-wide lc lines, $C_j = 2.21$ pF/mm; $C_{Si} = 0.35$ pF/mm; and $C_{Al} = 0.28$ pF/mm.

that the aluminum interconnections are separated from the silicon-gate electrode by an insulator. Basically, this establishes all features necessary for metal patterns to cross the silicon film conductors, resulting in two layers of conductors above the substrate. The additional use of diffused conductors in the substrate, as in other MOS technologies, gives flexibility approaching that of three layers for interconnecting complex functions efficiently. These interconnections are illustrated in Fig. 5. By contrast, in the standard MOS technology, the only crossover possible is metal-crossing diffused regions.

An illustration of the higher packing density of this

FIGURE 8. Photomicrograph of Intel's i-1101 256-bit RAM. Block diagram is superimposed.



newer technology is given in Fig. 6, which compares a static memory bit from the silicon-gate memory array (described later) with a comparable bit from a circuit made using standard technology. The area saved approaches 50 percent. Similar area savings can be realized in other circuits, using static or dynamic schemes.

The use of deposited silicon for interconnection also reduces interconnection capacitances, further contributing to improved performance. Figure 7 shows the capacitance per unit length of three types of interconnection lines. Clearly, metal or silicon layers are associated with smaller parasitic capacitances than are diffused interconnections.

Lowering the failure rate. In addition to the device characteristic advantages and component density increase that silicon-gate technology provides, reliability benefits also result. The gate electrode and gate region in this device are buried under two layers of dielectrics. This shields the most sensitive region of the device from external contamination. In addition, the Si_3N_4 layer is a very effective barrier to ion migration. The use of lower voltages stresses the insulator less—also an advantage.

Manufacturability. It has been well established that yield is a strong function of integrated circuit area. Thus the higher packing density can be expected to produce higher yields for a given circuit complexity. The early protection of the sensitive, thin insulator region by the silicon-gate electrode minimizes the chance of damage during subsequent processing. It appears that the high yields and resulting low costs and product availability originally projected for MOS circuits will be realized with the silicon-gate structure.

Theory is one matter—practice proves

All of the advantages of the silicon-gate technology can be illustrated by Intel's i1101, a 256-bit, random-access memory element, fully decoded on the chip (i.e., including the circuitry necessary to select a particular bit from

an eight-bit, binary-coded address) and with controls for read/write and inhibit modes provided. The functional block diagram superimposed on a photomicrograph of this element is shown in Fig. 8. The chip size is $3.10 \times 2.8 \text{ mm}$. It is packaged in a 16-lead dual inline package (DIP). Operation and performance of this element are:

An 8-bit address code will select any one of 256 bits for either read or write operation. All address input logic levels are compatible with standard bipolar TTL or DTL logic levels. The mode of operation ("read" or "write") is determined by the R/W input control. In the "read" mode, the information from the memory will be available on the outputs, typically, less than $1 \mu\text{s}$ later than application of an address code. Note that there is no need to rewrite the data into the memory after a read operation since the read is nondestructive.

The "chip-select" function is accomplished by the "inhibit" input. This renders both R/W and data input leads ineffective and stops information transfer through the output buffer. The address decoder, however, is not inhibited—creating an effective increase in memory speed. The output leads are open while the memory array is inhibited, allowing OR-tying of many memory arrays.

Typical access times—defined as the lapse between application of an address code and the output of the TTL load—measured on the circuit are shown in Fig. 9.

The difference between positive-going output delay and negative-going output delay is due to the difference in driving capability of the push-pull output stage from the memory: A positive output transition from the TTL gate (negative transition from the MOS output) will always be 200–300 ns slower.

The access time degradation as a function of capacitive loading is also shown in Fig. 9. Note that the degradation is about 1 ns/pF .

Direct driving of bipolar circuits is accomplished by the use of a push-pull output stage on the i-1101. This output stage will typically "sink" 8 mA at a +0.45-volt output voltage (worst-case TTL logic zero level). Although this drive capability is reduced at higher tem-

FIGURE 9. Typical access time of i-1101 as a function of temperature. Outputs are those of TTL load and thus inverted from the actual memory output. Access time of i-1101 at a function of capacitive loading is also shown. Measurements are at room temperature.

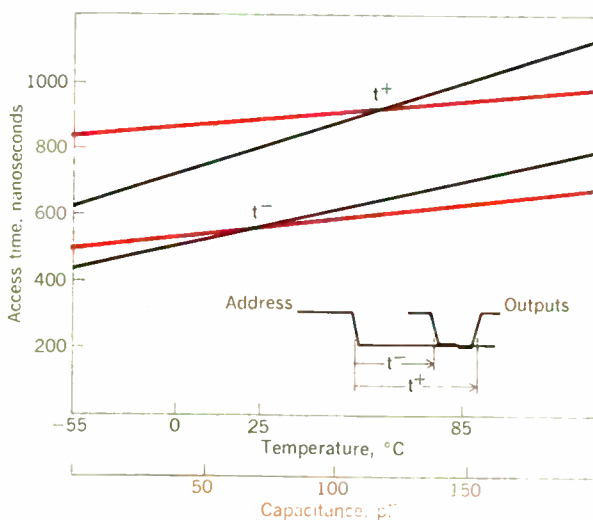
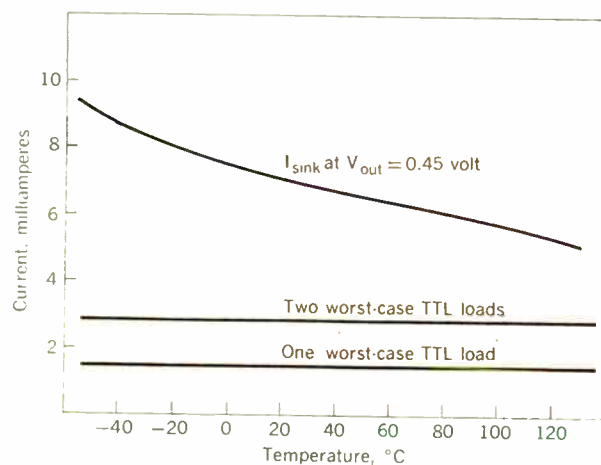

FIGURE 10. Typical current sinking capability of i-1101 at $V_{\text{out}} = +0.45 \text{ volt}$ (worst-case TTL, DTL logic zero level) as a function of temperature. Note that two worst-case TTL loads need only 2.8 mA, whereas the i-1101 can sink more than double this figure over the whole temperature range of operation.



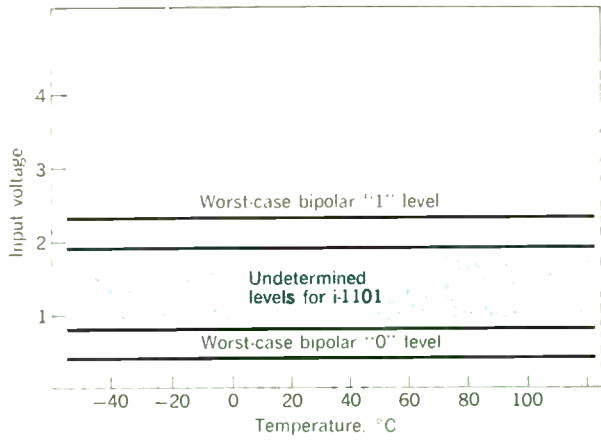

FIGURE 11. Invalid input voltage levels for i-1101 compared with worst-case logic zero and one levels of TTL gates.

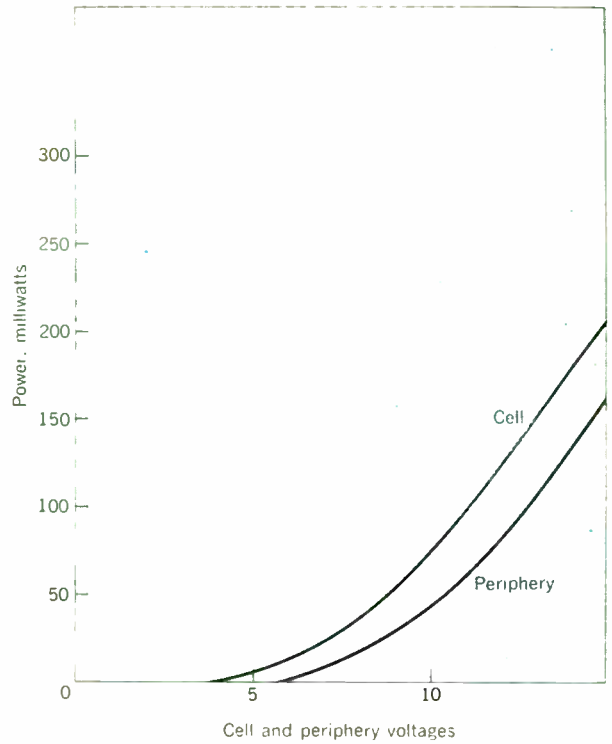
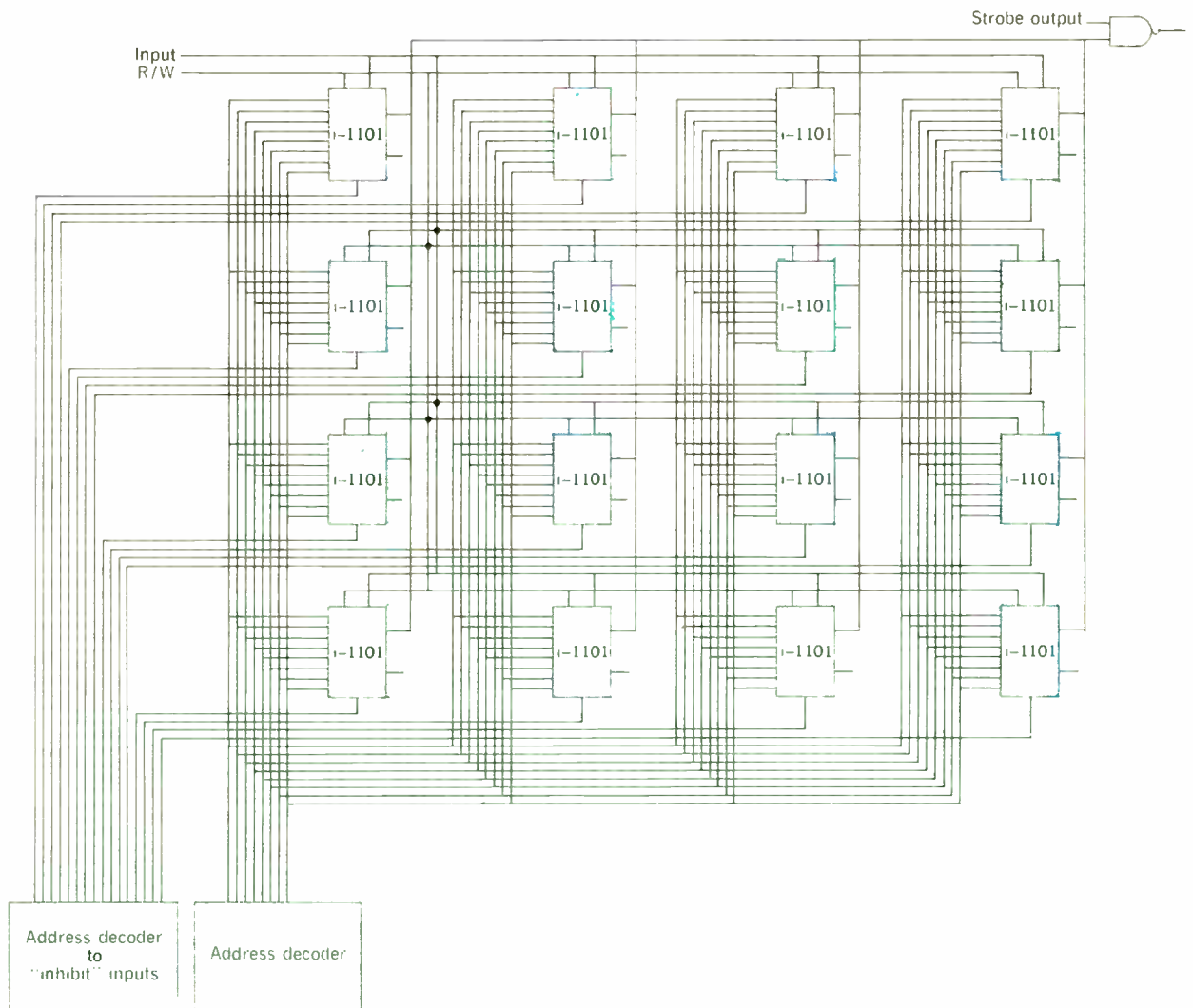

FIGURE 12. Power dissipation in the cells and in the peripheral circuitry (I/O, decoder) for i-1101. Measurements are at room temperature.

FIGURE 13. A 4096-word by one-bit RAM organization using i-1101 RAM elements.



peratures, good fanout capability (>2 loads) is maintained even at 125°C. This is shown in Fig. 10.

Input voltage levels also are compatible with bipolar circuitry. Figure 11 shows the range of invalid input voltages at various operating temperatures. For comparison, worst-case logic 1 and 0 level specifications for bipolar circuits are also included. Ample margins exist at all temperatures for direct bipolar/MOS interfacing.

Power dissipation is typically less than 2 mW per bit for normal operation. This, however, can be lowered to below 50 μ W. In standby mode—when the chip will only store information, but does not need to be accessed—the peripheral power supply can be completely shut down. This “idle” cuts the total power drain by a factor of 2. Furthermore, the cell power can be reduced considerably by reducing the cell voltage to -2 volts. This generates only -7 volts across the memory bits and is adequate for holding information in the memory cells. Figure 12 shows typical power dissipation in both the cells and peripheral (decode, I/O) circuitry. In this mode of operation, the total power dissipation is less than 12 mW, and corresponds to less than 50 μ W/bit.

Larger memory arrays can easily be built with this memory element. Sixteen packages can make a 4096-word \times 1-bit memory by simply OR-tying the outputs, paralleling all address lines, and decoding to each inhibit lead. This is shown in Fig. 13.

An interesting feature of an array of i-1101 memory elements is that the inhibit lead becomes part of the address inputs. This will allow improved performance for certain modes of operation. Since the inhibit/enable operation is much faster (~ 200 ns) than the address decoding, it is possible to address all 16 elements of the array of Fig. 13, at the same time inhibiting 15 of the 16 packages. Once the first element is accessed (say in 1 μ s), 15 more bits of data at 200-ns intervals are obtainable only if the inhibit leads are switched. This gives a total of 4 μ s for accessing 16 bits of data, or 250 ns average access time per bit.

The combination counts

To be sure, other MIS processes possess some of the advantages of the silicon-gate technology. Lowered threshold voltages can be obtained using different crystal orientation, or by utilizing multiple dielectric layers under the gate electrode.³ Use of a molybdenum gate electrode⁴ can also achieve a self-aligned structure and the use of ion implantation⁵ can give the same result with conventional aluminum electrodes. However, the combination of desirable features available with the silicon-gate structures appears to be truly unique.

REFERENCES

1. Sarace, J. C., Kerwin, R. E., Klein, D. L., and Edwards, R., “Metal-nitride-oxide silicon field-effect transistors with self-aligned gates,” *Solid State Elec.*, vol. 11, pp. 653-660, July 1968.
2. Faggin, F., Klein, T., and Vadasz, L., “Insulated gate field effect transistor integrated circuits with silicon gates,” presented at the IEEE Internat'l Electron Device Meeting, Oct. 1968.
3. Nigh, H. E., Stach, J., and Jacobs, R. M., “A field-gate IGFET,” presented at the Solid-State Device Research Conf., 1967.
4. Brown, D. M., Engeler, W. E., Garfinkel, M., and Gray, P. V., “Refractory metal silicon device technology,” *Solid State Elect.*, vol. 11, pp. 1105-1112, Dec. 1968.
5. Bower, R. W., Dill, H. G., Aubuchon, K. G., and Thompson, S. A., “MOS field-effect transistors formed by gate masked ion implantation,” *IEEE Trans. Electron Devices*, vol. ED-15, pp. 757-761, Oct. 1968.



Leslie L. Vadasz (M) received the bachelor of engineering degree from McGill University, Montreal, Quebec. He has accumulated extensive experience in the field of semiconductor technology during the past eight years—first with Transitron, then with Fairchild Semiconductor, and more recently with Intel. At Transitron, he studied gold doping of silicon

and the radiation resistance of silicon materials and devices. As manager of the MOS Circuit and Technology Section at Fairchild, he worked on bipolar integrated circuit development and MOS circuit technology.



Gordon E. Moore (F) has participated in the creation of two companies within the last 13 years. In 1957 he was cofounder of Fairchild Semiconductor. After serving Fairchild as manager of engineering and director of research and development, he left last year to help found—and become vice president of—Intel Corporation. Earlier in his career Dr. Moore received the

B.S. degree from the University of California, Berkeley, and the Ph.D., in chemistry and physics, from California Institute of Technology. He then worked for three years at the Applied Physics Laboratory, Johns Hopkins University, and another year at the Shockley Semiconductor Laboratory, Beckman Instrument Corporation. He has authored more than a score of technical papers and contributed to a McGraw-Hill text.



Andrew S. Grove (M) was awarded the B.S. degree from the City University of New York (1960) and the Ph.D. degree from the University of California, Berkeley (1963). Thereupon, he joined the Physics Department at the Research and Development Laboratory, Fairchild Semiconductor. In 1966 he became head of Fairchild's Surface and Device Physics

Section, and in 1967, assistant director of research and development. Last July, he participated in founding Intel Corporation and is now its director of operations. Dr. Grove lectures at the University of California, Berkeley, and serves on the Administrative Committee of the IEEE Electron Devices Group. He is author of more than 30 technical papers and a book, “Physics and Technology of Semiconductor Devices” (Wiley). He also holds the IEEE Region Six 1969 Achievement Award for contributions to MOS technology.



Thomas A. Rowe earned the bachelor of science degree (metallurgy) and the master of science degree (materials) from the Massachusetts Institute of Technology and then joined Fairchild Semiconductor where he worked until joining Intel last year. At Fairchild he had responsibility in the areas of metalization, dielectric deposition, masking, epitaxial, and

starting wafer evaluation and product responsibility for TTL logic devices. He has also done research on dual-layer metal processing and metalization reliability and on the development of a high-reliability process for bipolar military products. Mr. Rowe previously coauthored an article for the Physical Review.

Space exploration— wisdom or folly?

The potentials of space exploration may be far greater than we can even begin to realize. Thus, it could be tragic if public confidence in space programs were shaken by a few influential critics whose opinions on the subject are hostile

Heinz Trauboth

*National Aeronautics and Space Administration**

Many of man's greatest technological achievements were greeted with disdain, if not ridiculed, at the time of their inception. Today there are many critics of our space program—the noted British historian Arnold Toynbee among them—who believe that space exploration represents a technological dead end, an enormous waste of money, and a force that promotes increased nationalism. This article was written as a challenge to these and other charges that have been leveled at space exploration in general and the U.S. space program in particular.

In a recent article,† the respected British historian Arnold Toynbee gave his thoughts to print about space exploration in light of the successful flight of the Apollo 8 around the moon. He compares the slender flying tower, the Saturn V, to the monstrous achievement of ancient technology, the Egyptian pyramids. Then, as now, these achievements of advanced technology were borne on the back of the suffering impoverished masses, he wrote. He goes as far as to ask, “Are not pyramid building and moonmanship follies that are also crimes?” He sees the strivings of man into the unknown dimension of space as a waste of resources. He also thinks that the space race promotes nationalism, the main cause of wars, which prevents establishing a peaceful world government.

These claims are not new and could easily be ignored if Toynbee were not a scholar widely known throughout the world and if we were not reaching a crucial turning point in the exploration of space. His assertions can affect public opinion, which in turn can influence the future of the U.S. space program. This influence might be even more far-reaching: it might determine mankind's future

* The author has stressed that the statements expressed herein are personal opinions and not necessarily those of NASA.

† The article, “Toynbee Sees Moonmanship as Folly Equal to Egypt's Pyramid-Building,” appeared in *The Huntsville Times* on January 2, 1969, as a reprint of an original paper in *The Observer*, distributed by the Los Angeles Times-Washington Post News Service. The present article is a revised version of a reply to the Toynbee piece, also published in *The Huntsville Times* and *The Observer*.



**Mechanical Power Subduing
Animal Speed .**

technological progress. Therefore, Toynbee's statements are sufficiently provocative that they ask for a vigorous challenge.

We now stand at the beginning of a new technological era, which opens up a new dimension of reality and thought. This new dimension is space. As in the case of most important scientific discoveries of the past, it is impossible to forecast its eventual impact exactly. It is premature and reckless to make the flat assertion that "spacemanship is a dead end."

Lessons from the past

Let us briefly look back and examine how the major technical inventions that are now shaping our society, our economy, and even our existence—the railways, the automobile, and the airplane—were received by their contemporaries.

When the first settlers came to America they experienced the vast land as a hostile dimension. The continent was gradually conquered by covering it with a huge spider-weblike transportation system made up of roads and tracks. This was made possible only by the invention of the steam engine for the railway locomotive and the combustion engine for the automobile. However, when the first railway trains appeared in Europe, spitting black smoke through the land, they were assailed as "devil's breed" by the horrified people. The majority of the population—then working on farms—could not understand how such a monster could give them any benefit. The first railways in Europe, therefore, were mere prestige expenditures for the rival kings and sovereigns. They served then as the main connection between the few big cities for the well-to-do city people. That the railways would later transport the main resources of an industrialized economy such as coal, ore, lumber, food, and the products of its factories was not foreseen in the early days.

The automobile also was greeted as a curious piece of iron, created for a few snobs who endured the hardships of being shaken and covered with dust on unpaved roads to show that they were different from (though not faster

than) their horse-drawn fellow citizens. Who could then conceive that the automobile would become the main consumer product of the United States and would help unite the many dispersed states into a controllable nation by allowing rapid movement of people and merchandise over long distances?

The first penetration into another dimension, the air, away from earth, dreamed by mankind since its recorded existence, was not welcomed as a glorious event. The first air pioneers had to give acrobatic circus shows to stimulate some public interest. Although the military exploited new technological achievements rather early, the commercial value and the real potential of the airplane—that of linking continents together—was not realized before a courageous Lindbergh made his famous transatlantic flight, nearly 25 years after the first motorized jump by the Wright brothers. Orville Wright himself never visualized that flying would reach a point where passengers would be carried on a scheduled basis.

This recital of "breakthrough" inventions, their early struggle and dubious purpose, could be greatly expanded. We who live in this modern world often fail to realize that the important technological achievements (such as the electric light, the telephone, and the automobile) were at first unappreciated, or even ridiculed, not only by the general public but often by the established scientific community as well.

The advent of a new era

Now we are living spectators to the advent of a new era, in which man left not only earth's surface but also its atmosphere. The first spaceship was certainly not the most efficient and least expensive one, as the first automobile and first aircraft were not the most efficient and least expensive ones. And now we hear voices decrying this new child of technology, as in the past. However, there is one big difference. In the past, a few courageous individuals could still pursue and finance a new technology, even though the majority of the people did not support their ideas. Today, the governments of two huge nations, the U.S. and the U.S.S.R., decide whether to

build mammoth rockets and their extensive ground support systems. Not even a large corporation like General Motors has the financial and technical means to pursue the new space technology by itself. Because a wrong decision by the government can now kill or delay the future of a new technology, the decision on the future course of the U.S. space program is critical.

If the right decision is to be made, the history of those technologies that are the basis of our modern existence should be thoroughly examined. This is what I expected from a modern expert on history! At this time, it is important to think in long-range terms, not only forward into the future, but also back into the past. Only then can we grasp the magnitude of the consequences of Sputnik and the Apollo missions. These accomplishments should spur our imagination about the future. In judging the potential of a new technology we should extrapolate from past achievements to future possible achievements and try to imagine what the impact of a new technology could be on the life of mankind in the next hundred years. This is a long time span relative to one's lifetime, but short in comparison with the history of mankind.

In the process of extrapolation we should open ourselves to far-reaching ideas of our imagination, even question our present known limits in physics. When Einstein declared his theory of relativity 60 years ago it caused a shock to the physicists who believed in the irrevocable laws of Newton's mechanics. When the foundations of nuclear physics were laid, a process of revision of basic thinking in science began. We did not know then and we do not know now what the limits of nature's possibilities are. It could very well be that limitations imposed by Einstein's theory—i.e., that the speed of light cannot be surpassed—prove surmountable some day, thus making it possible for man to reach far-distant stars; this view might be overoptimistic, however. Nevertheless, during the past 20 years I have had to revise twice what I had learned about the fundamental limits of nature. In 1945, my mathematics teacher at high school taught me that no self-propelled aircraft will ever fly faster than sound. And in 1952, my respected professor in mechanics at the university told us that man will never be capable of producing enough thrust to propel a vehicle out of the earth's gravitational field. During my professional career in the electronic computer field I have also had to change my assumptions about possible computation speeds and memory sizes several times.

At first glance, inhabitation of the moon may seem highly unlikely, since man would have to live in a completely man-made environment. But why shouldn't man get used to living in such an artificial environment? Let us look at an American suburbanite during a workday. He sleeps and spends most of his free time in his climate-controlled house, drives the climate-controlled car to work, spends his money-making time in a climate-controlled, windowless office, and buys his life essentials in a climate-controlled shopping center. If he happens to live in the North and if in the winter his climate control—i.e., his heating system—fails, he is exposed to freezing death. Modern man is already here on earth dependent on a sophisticated life-support system in the form of distribution systems for electricity, water, food, and gasoline. These systems will become more complicated in the future with denser population. Granted, the life-support system for a moon settlement is still more com-



plex, but it is similar in principle. Our ancestors living on farms a hundred years ago would view present life in New York City just as unbearable and artificial as we now view life on the moon.

Possible spin-offs

By going into outer space, man might discover novel energy sources and learn how to tame them. Through earthbound telescopes we know already that pulsars in galaxies radiate energy with an enormously high density; we would reach this density if we could generate the energy of all power stations on earth within an area as small as a stamp. This indicates how far we are from the limit of efficient energy generation. Orbiting telescopes or a moon-based telescope, unhindered by the earth's atmosphere, might discover revolutionary phenomena that could be utilized for more efficient energy generation on earth, thus reducing energy costs to a fraction of present costs. These new energy sources might also enable space vehicles to travel at speeds unknown today. The understanding of these phenomena might in turn lead to the discovery of new chemical and nuclear processes for the production of materials on earth with properties unknown today.

Although the pyramids of Egypt did not produce economical spin-offs (except foreign exchange from tourists 2500 years later), the space program—which costs the United States only 2 percent of its total government expenses—already has generated not only numerous spin-offs but new economically meaningful products:

worldwide communication systems via satellites (a prerequisite for Toynbee's world government), and satellites that monitor weather and crops, and detect new food, mineral, and oil resources on land and in the sea. Moreover, the space program has had many side effects that stimulated science and generated new industries. One aim in eliminating poverty should be to train the poor for these new industries, in order to have them participate in the space effort, rather than to reduce the space effort.

The question of nationalism

Toynbee fears that the space race between the United States and the Soviet Union encourages nationalism. However, nationalism reaches its peak during wartime, and nationalistic wars were mostly fought to gain land. Such land is valuable because its resources in the form of minerals, food, industry, and manpower can be exploited by the winner of a war. Besides, the gained land might serve as an important strategic place to protect the winner's possessions. Since cultivating the oceans is important for future food and mineral supply, nationalistic struggles for mineral deposits and fish farms in the non-homogeneously rich oceans are more likely to be expected than struggles for uniformly empty space or moon land. Moreover, when man is in space, thousands of miles away from the earth, he realizes the frailness of his existence as a human being and tends to lose his nationalistic outlook. He cannot drive claim stakes into space. His main enemy is nature and he may realize that space can be converted into a livable and beneficial environment only by unified efforts on earth.

Space itself is attractive because it contains a property that does not exist and cannot be simulated on earth: weightlessness. This physical property soon may be utilized for specialized manufacturing and biological processes. The exploitation of weightlessness may have similar consequences as the discovery of vacuum about 200 years ago. This discovery was a prerequisite for the invention of the steam engine, which in turn caused the first industrial revolution; without this phenomenon our gasoline motors would not turn. Hence, the phenomenon of weightlessness may some day stimulate another industrial revolution.

The full utilization of space will require large resources, and only a superpower can afford a strong national space program. Such space programs are based on large administrative organizations and industrial complexes employing hundreds of thousands of people. Once the view expands that "claim stakes" in the vastness of space are meaningless and that common goals prevail, these national organizations might be willing to cooperate more closely. As the increasing mergers of large corporations across nationalistic borders in Europe might develop into the forerunner of a political unification of Europe, so could the national space programs develop into a functioning global space organization. Even if this situation does not come about in the near future, at least we could establish viable communications between the superpowers in this sector of international affairs and thereby reduce the danger of war. Before a war between two nations starts, the communications between them usually break down first. Thus, our first effort should be to maintain a field of common interest by keeping communications alive.

Technology as a coordinating force

The fear often prevails that modern technology is to a great extent the cause of our present violent problems. But technology itself is neutral; it is a tool in the hands of businessmen, politicians, and the military. Technology is created in the many universities and industrial complexes, which employ millions of people. The enormous progress in technology has been possible only by the disciplined cooperation of these people. It might be noteworthy that in the creation of new technology all the human conflicts that make relationships between nations so violent also exist within the laboratories and offices of big industry, but here they are tamed by rules and resolved by such relatively nonviolent fights as negotiations and disputes. (I never heard of one company bombing another or a president of a company being assassinated by gunmen of another company.) The astonishing progress of technology has gone hand in hand with the phenomenon of organizing masses of people of different educational backgrounds, from the production worker to the university professor, with all their conflicting individual ambitions, to reach certain technological goals in a peaceful way. As large companies expand their organizations beyond national borders they can reduce nationalistic tensions within their area of influence and lay the groundwork for international governmental organizations. The space program succeeded in coordinating the largest number of industrial organizations in mankind's history to reach the goal of exploring space. There is hope that the national organizations now working on the exploration of space may develop into international organizations. These then may become living models for a world government capable of settling the world's problems peacefully.

Heinz H. Trauboth (M) was born in Berlin, Germany, in 1931. He received the M.S. and Ph.D. degrees in electrical engineering in 1956 and 1965, respectively, from the Institute of Technology in Munich. In 1953 he worked with General Electric Company, Ltd., in Coventry, England, and in 1955 he was with N. V. Van Wijk & Visser, Geldermalsen, Netherlands, as a junior engineer on an exchange program. In 1956 he joined the Central Research Laboratories of Siemens & Halske AG, Munich, where he did research work on automatic long-distance telephone switching. He received a scholarship from the German Academic Student Exchange Association and a Fulbright Travel Grant to pursue graduate studies in digital computer design at the Massachusetts Institute of Technology during the academic year 1957-1958. During this period he worked on a part-time basis for Baird Atomic, Inc., and Photon, Inc., in the development of electronic pulse circuits. He then returned to the Siemens Central Research Laboratories, where he was engaged in planning, logic design, and advanced programming of digital process-control computers.

In 1965 Dr. Trauboth joined the Computation Laboratory of the George C. Marshall Space Flight Center, NASA, Huntsville, Ala., where he is now chief of the Systems Analysis Branch, which develops real-time software and engineer-oriented computer languages for automatic check-out, test, and design of space vehicles. He is also the author of several published works on digital simulation and numeric techniques.

Dr. Trauboth is a member of the Association for Computing Machinery, Simulation Councils, and Nachrichtentechnische Gesellschaft.



Acoustooptical approaches to radar signal processing

The electronic computer hasn't been made that in real time will digest and decipher the jumble of blips that would fill a radar screen during an "all-out" missile attack. Optical processing is one remedy

W. T. Maloney Sperry Rand Research Center

To realize full benefit from a radar, the analyzed echoes must be strong and sharp. Two options are available: Either the transmitted burst must be an intense, short pulse (often not a propitious arrangement) or the onus can be put on the receiver to process the echo into something more than it appears to be. One method for "upgrading" the received signal beyond a feeble echo from a not-too-powerful transmitted beam is acoustooptical processing, in which the reflected radar beam is converted to an acoustic wave that is used to modulate a light source. Then with the appropriate operation on the modulated light, the radar echo input is correlated against an optical filter. Of the two acoustooptic correlator classes described here, one works well below 150 MHz and the other is appropriate for frequencies above 150 MHz.

In a radar system, a pulse of RF energy is emitted in the general direction of a target, and the echo is studied to find where the target is (range) and how fast it is approaching (velocity). The choice of pulse shape and the nature of the "study" are matters of some sophistication.¹

The range of a radar system increases as the transmitted pulse energy increases; the range resolution increases as the pulse bandwidth increases. Thus it is possible to achieve both long range and high resolution by transmitting a short-duration, high-power pulse. Unfortunately, the peak pulse power is usually limited by the generating capabilities of the source or by breakdown

in the transmission line.

But the problem of achieving long range and good range resolution can also be met by other special signals. These signals must be processed at the receiver, however, in order to extract the desired information—an operation frequently referred to as radar signal processing or radar pulse compression.

As shown in the example of Fig. 1, the pulse energy in this approach can be quite large. The transmitted pulse has a modest amplitude but a long duration T ; the pulse frequency is swept linearly over a wide bandwidth B . When the radar echo received from the target is passed through a dispersive delay line—producing a time delay linear in frequency—the echo "piles up" while passing through the line. The output pulse has a very high intensity and a very short duration ($\tau \approx 1/B$). The ratio $T/\tau = TB$ is called the *compression ratio* or *time-bandwidth product*. Because it describes the enhancement of signal-to-noise ratio and hence range, it is clearly a figure of merit of the receiver.

From a slightly different point of view, the processor may be regarded as a linear filter operating on a radar signal $s(t)$. It can be shown² that, in the presence of additive random noise, the optimum ratio of peak signal power to rms noise power will be achieved when the filter—dispersive delay line—is "matched" to $s(t)$. More generally, if $s(t)$ has the Fourier transform $S(\omega)$, the appropriate matched filter will have transfer function $S^*(\omega)$. As shown in Fig. 2, the output of the matched filter is the inverse transform of $S(\omega)S^*(\omega)$:

FIGURE 1. When radar processing a linear FM pulse, the dispersive delay line serves as a matched filter for the swept pulse.

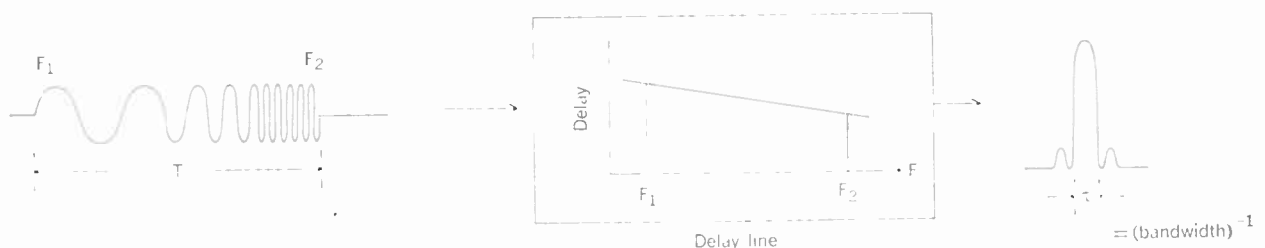

T/τ = compression ratio = time-bandwidth product—a figure of merit for processors

$$\frac{1}{2\pi} \int_{-\infty}^{\infty} d\omega e^{i\omega t} S(\omega) S^*(\omega) = \int_{-\infty}^{\infty} dt' s(t')s(t'+t) \quad (1)$$

which is the autocorrelation function of $s(t)$. (A correlation function describes how well a function conforms to an expected one.) Eq. (1) states that the best signal-to-noise ratio, and hence maximum range, will occur when the processor calculates the autocorrelation function of $s(t)$.

Of appropriate processors, acoustooptical radar types are of particular interest because they are capable of (1) linear filtering (2) in real time (3) for a wide range of signal waveforms. In many cases they can produce an output that is linear with applied signal amplitude. In some forms, the acoustooptical processor can generate the complex radar signal to which it is matched.

Acoustooptical processors divide naturally into two classes characterized by the nature of the acoustooptical interaction: The first comprises low-frequency ($f \leq 100$ MHz) processors that use incident light parallel to the acoustic wavefronts (Raman-Nath processors). They generally feature heterodyne, phase-preserved detection and are capable of great coding flexibility.^{3,4} Readily available modulator materials, such as fused silica, allow processing times longer than 100 μ s although bandwidth is limited by acoustic losses to about 100 MHz.

A second type of processor operates at high frequencies and the light source interaction is characterized as Bragg reflection.^{4,5} These Bragg processors can usually accommodate bandwidths of hundreds of MHz. However, because light rays must strike the acoustic wavefronts at or near the Bragg angle ($\theta_B = \lambda/2\Lambda$, where λ and Λ are, respectively, the light and sound wavelengths), satisfactory illumination is usually possible only for a linear FM signal. Heterodyne detection is difficult to achieve; the output is usually a video pulse.

Many past articles describing real-time signal processors may seem to have little in common. They are, in fact, tied together by two underlying problems: high-frequency acoustooptical modulators all are phase modulators requiring sophisticated optical-filtering techniques; ultra-high frequency acoustooptical modulators require proper (Bragg) angle illumination. The many approaches to date are all attempts to deal with one or the other of these problems.

Low-frequency processors

Figure 3 shows an acoustooptical Raman-Nath modulator. A transducer at $x = 0$, excited by an electric signal, launches an elastic strain field $s(x - Vt)$ down the modulator in the $+x$ direction at velocity V . A

FIGURE 2. For operation of a matched filter, filter output must be the autocorrelation function of the input signal.

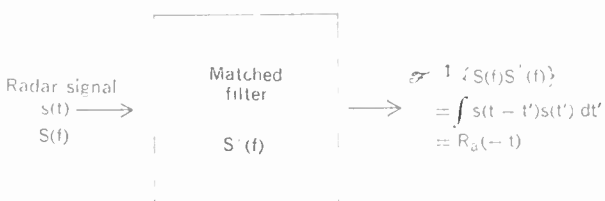

collimated monochromatic light wave is incident parallel to the acoustic wavefronts. Local strain variations change the refractive index and cause the light front to be locally advanced or retarded by the presence of the acoustic field. The emerging light front is effectively corrugated in passing through the modulator—the depth of modulation being related to the amplitude of $s(t)$ and the spatial period to the frequency of $s(t)$. In brief, the radar signal is “written” across the light front. Every part of the signal is present in the processing aperture at one instant.

This “snapshot” explanation of the light-sound interaction is valid because the transit time of the light across the acoustic beam is only a tiny fraction of the RF period. For an incident light beam propagating as $e^{-i\omega t}$, the emerging field E_{out} may be written

$$\exp[-i\omega t + i\alpha s(x - Vt)]$$

where α is the depth of modulation. For small α , this expression may be approximated by

$$E_{out} \approx e^{-i\omega t} [1 + i\alpha s(x - Vt)] \quad (2)$$

It is important to note that the i in the second term expresses the fact that the modulated component is 90 degrees out of phase with the unmodulated light (first term). This phase difference is a property of all phase modulators. For comparison, note that an amplitude modulated wave can be written as

$$E = e^{-i\omega t} [1 + \alpha s(x - Vt)] \quad (3)$$

and the i is absent. The presence of the i in Eq. (2) is an inescapable fact and a central problem in the discussion of low-frequency optical correlation.

Figure 4 is a diagram of a straightforward acoustooptical processor—which unfortunately will not work as shown. An analysis indicates why. An acoustooptical

FIGURE 3. This acoustooptical modulator is operating in the low-frequency or Raman-Nath limit. The incident light phase front is locally advanced or retarded by the acoustic wave, corrugating the emerging wavefront.

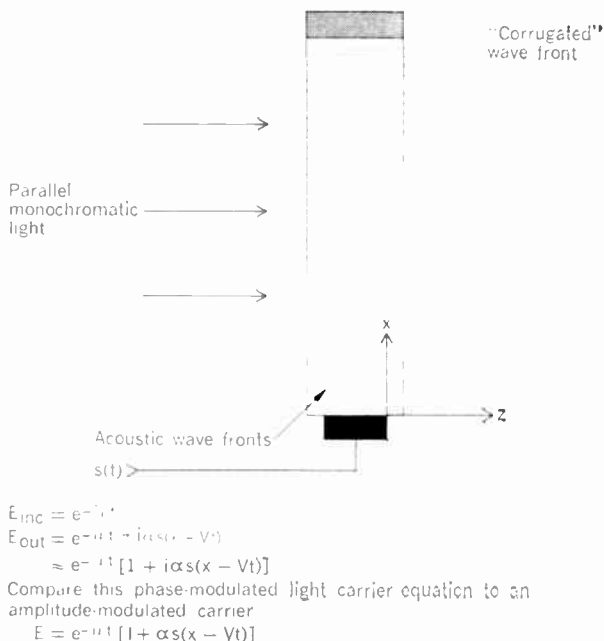

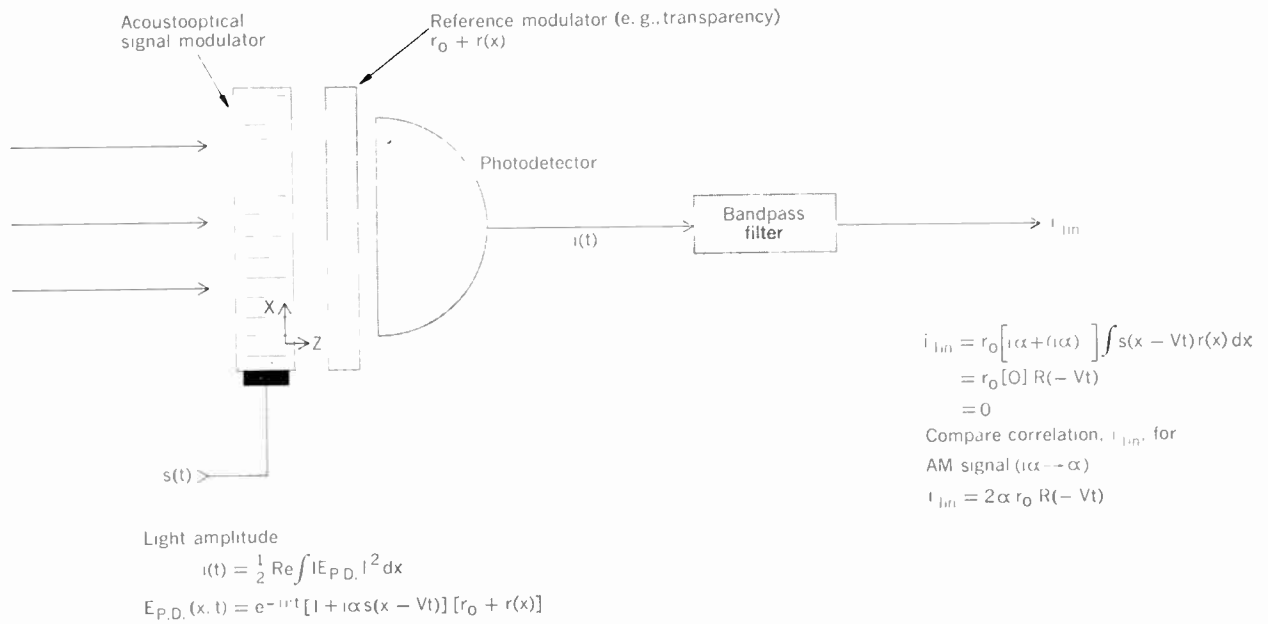

FIGURE 4. Here, a straightforward optical processor does not work! The phase nature of the signal modulator prevents attainment of a proper correlator output. By comparison, an amplitude modulator would work well.

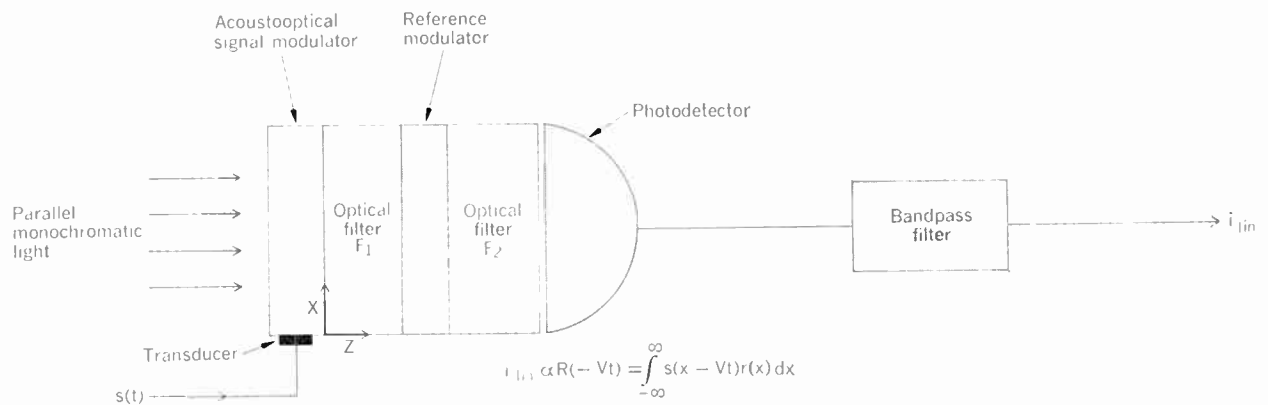

FIGURE 5. Block diagram shows an acoustooptical processor incorporating optical filters. Preferrference processing or modulation conversion can be effected by F_1 . Postreference processing can be accomplished by F_2 .

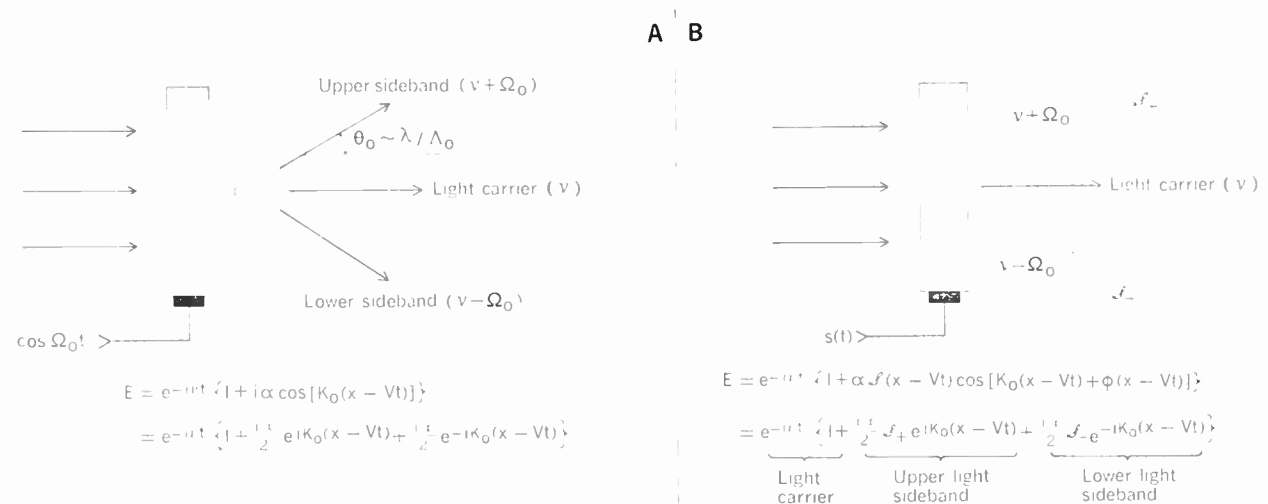

FIGURE 6. Corrugated wavefront from an acoustooptical modulator driven by a cosine wave is represented by plane waves. Figure on right shows the spread of plane waves when the modulator is driven by a modulated cosine wave.

modulator (signal modulator) writes the radar signal $s(t)$ onto the light front. The light emerging from the modulator immediately passes through a reference modulator whose amplitude transmittance is given by $r_0 + r(x)$. (This reference may be a transparency with varying amplitude transmission or varying thickness. It may be a corrugated mirror, or a second acoustooptical modulator. But for this discussion, we choose it to be an amplitude reference.) The light output from the reference modulator then impinges onto a photocathode. The electric field may be represented as

$$E_{PD}(x, t) = e^{-i\omega t} [1 + i\alpha s(x - Vt)][r_0 + r(x)] \quad (4)$$

The photodetector calculates the intensity of light at each x and sums contributions from all x to provide an output current

$$i(t) = \frac{1}{2} \text{Re} \int |E_{PD}|^2 dx \quad (5)$$

But $|E_{PD}|$ is

$$\left\{ 1 + [(i\alpha) + (i\alpha)^*]s(x - Vt) + \alpha\alpha^* [s(x - Vt)]^2 \right\} [r_0 + r(x)]$$

Thus, the current $i(t)$ will consist of a dc term, a term in a frequency band about $s(t)$, and a term quadratic in $s(t)$ and centered partly at dc and partly at the second harmonic of $s(t)$. If a bandpass filter is inserted to block all but the linear term, the final output current, designated i_{lin} , is then given by

$$\begin{aligned} i_{lin} &= r_0[(i\alpha) + (i\alpha)^*] \int s(x - Vt)r(x) dx \\ &= r_0[0] R(-Vt) \\ &= 0 \end{aligned} \quad (6)$$

But for the canceling terms in square brackets, the output current would be proportional to the correlation R of the function s with r . (It is easy to show that a phase reference

filter also leads to zero output.) On the other hand, if the output of the signal modulator had been amplitude modulated and not phase modulated, a nonzero correlation between input and amplitude reference would be obtained. The extensive literature on Raman-Nath processors is largely a study of ways of circumventing the limitation imposed by the phase modulator.

The problem can be attacked in two ways, indicated schematically in Fig. 5. One technique involves optical filtering, before the light reaches the reference modulator, to produce an amplitude image of the signal aperture at the reference plane. This "prereference" processing or "modulation conversion" is represented by the filter F_1 . Alternatively, two modulators may be placed in contact and optical filtering performed after the reference plane, indicated schematically by F_2 .

Prereference filtering

To understand the nature of prereference processing, it seems best to begin from the plane-wave representation of the corrugated wavefront sketched in Fig. 6. When, as in Fig. 6(A), an acoustooptical modulator is driven by a pure cosine RF signal at frequency $\Omega_0/2\pi$, the resulting sinusoidal wavefront corrugation may be represented as three plane waves. The first wave is light unaffected by the modulator and may be considered a light "carrier." Upper and lower "sidebands," shifted up and down in frequency by $\Omega_0/2\pi$, propagate at angles $\pm\theta_0$ to the light carrier given by $\theta_0 = \lambda/\Lambda$. When $s(t)$ is more realistically a complex signal, the same general description still applies. For band-limited signals whose spectral energy is contained in a relative bandwidth less than $1/2$, the modulated light can be described as a modulated light carrier, with nonoverlapping sidebands. However, each sideband will consist of a bundle of plane waves propagating in a range of directions centered on $\pm\theta_0$. Again, the modulated component of light is

FIGURE 7. Modulation conversion is accomplished by means of ideal transforming lenses and focal-plane filtering. Three possible filters are indicated.

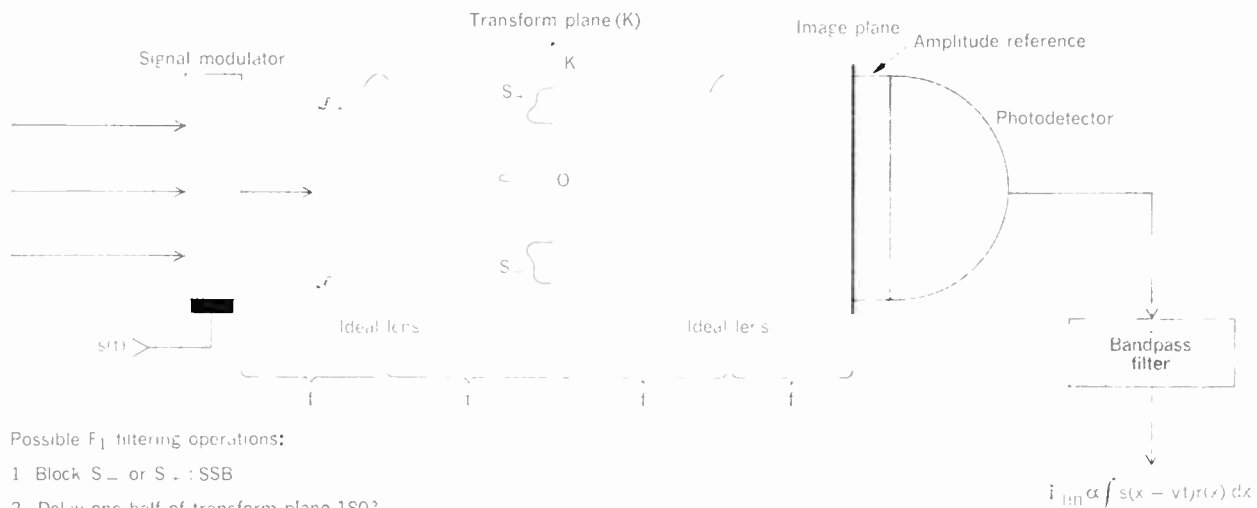

Possible F_1 filtering operations:

1. Block S_+ or S_- : SSB
2. Delay one half of transform plane 180°
3. Delay carrier by $\frac{\pi}{2}$

In all cases, part or all of light modulation is made real, so that $i_{lin} \neq 0$

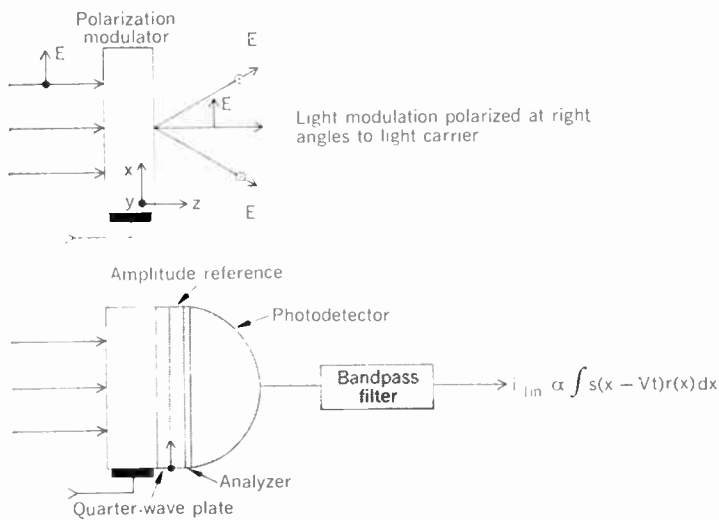

FIGURE 8. Modulation conversion is accomplished by a quarter-wave plate that introduces the required 90-degree relative phase shift. Focal-plane filtering is replaced by polarization selection.

FIGURE 9. In modulation conversion by Fresnel diffraction, the different path lengths traversed by modulated and unmodulated components accumulate phase shift.

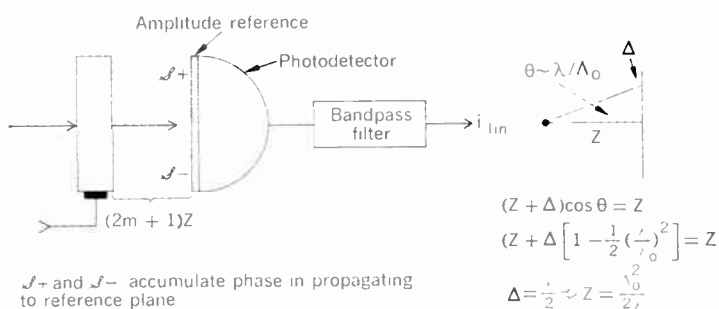
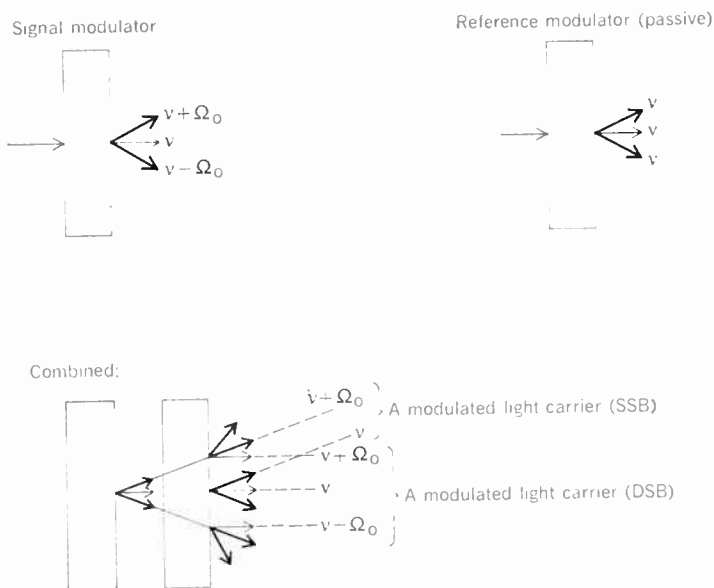

FIGURE 10. Adjacent signal and reference modulator setup can be analyzed by plane-wave treatment. When signal and reference modulations are matched, plane-wave outputs of the signal modulator are realigned by the reference modulator into groups of strictly parallel waves.



90 degrees out of phase with the light carrier. If a way could be found to separate the carrier and sidebands from each other, it would then be possible to operate independently on them and adjust their relative phase.

Separating frequencies

These sideband components may be separated in space with the ideal lens shown in Fig. 7. An ideal lens focuses a plane wave to a point—the location of the point depending on the angle the plane wave makes with the lens axis. The amplitude distribution at the back focal plane of the lens will be proportional to the spatial Fourier transform of the aperture distribution.⁶ Thus the carrier and sideband spectra will be separated in space. A second ideal lens retransforms the light, and an image of the modulator aperture reappears in the image plane—reversed, but still a phase image. Any one of three filtering operations, in the transform plane, can produce amplitude modulation in the image plane:

1. Suppression of one spatial sideband. The resulting single-sideband light image will have a component of amplitude modulation.⁷
2. Delay of one half of the transform plane by 180 degrees.^{7,8}
3. Delay of the carrier relative to the modulation by 90 degrees. This is the principle of the Zernicke phase-contrast microscope.⁹

Other approaches involving suppression of the carrier and consequent video detection wherein phase information is lost and generally inferior signal-to-noise ratios result, and needlessly complex alternatives in which a carrier with the proper phase is reinserted will not be discussed.

Approaches 1–3, applied as shown in Fig. 7, require optical bench rigidity and diffraction-limited lenses. Fortunately there are other ways of accomplishing the F_1 filtering operation that demand less critical adjustment.

By proper choice of incident-light polarizations and elastic modes, an acoustooptical modulator can produce modulated light polarized at right angles to the unmodulated light.¹⁰ A processor featuring this principle is shown in Fig. 8.¹¹ With such a polarization modulator, the light carrier and modulated terms are separately available via polarization selection. Insertion of a quarter-wave plate following the modulator produces the needed 90-degree relative phase shift. A polarization analyzer is then required to reduce the components to a common polarization. This approach gives a simple, rugged mechanical sandwich with no critical adjustments.

Modulation conversion can also be achieved by taking advantage of Fresnel diffraction.^{12,13} Since the light sidebands propagate at an angle to the light carrier, and since the wavelengths are nearly equal, the sidebands will “accumulate phase”^{13,14} faster in propagating a distance z along the axis (see Fig. 9). At a distance $z = Z \equiv \lambda^2/2\lambda$, the relative phase accumulation is 90 degrees and an amplitude image occurs. Although it is clear that not every sideband component suffers the same phase shift, it can be shown¹⁴ that, for the band-limited signals previously described, any resultant distortion can be negligible. The z -position must be correctly, but not critically, chosen. For example, at $\Omega_0/2\pi = 30$ MHz, $Z \approx 1$ cm, and a positioning accuracy of 1 mm is sufficient. Again, no optical tolerances or ideal lenses are involved.

In all of the foregoing approaches, a linear correla-

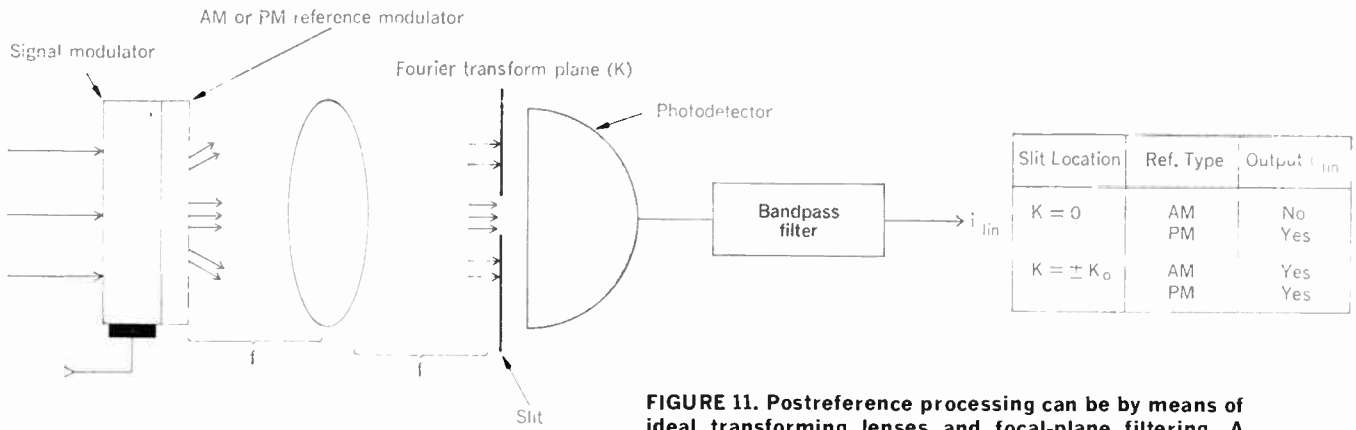

FIGURE 11. Postreference processing can be by means of ideal transforming lenses and focal-plane filtering. A slit in the output plane selects one or another of the groups of parallel waves. Table indicates output expected for particular slit locations and reference modulators.

tion output is achieved. In fact, although we have not elaborated, the linear output results from heterodyning a signal derived from the light carrier (and hence at frequency $\nu/2\pi$) with a signal derived from the modulation terms. This heterodyning is accomplished in a natural way without the problems associated with an interferometer.

Postreference filtering

Postreference processing (F_2 in Fig. 5) is easiest to understand by considering the plane waves sketched in Fig. 10. The signal modulator converts a plane wave at frequency $\nu/2\pi$ to three plane waves: at $\nu/2\pi$, $(\nu + \Omega_0)/2\pi$, and $(\nu - \Omega_0)/2\pi$. (We ignore the spreading of the side-band plane waves for the present.) A plane wave at frequency $\nu/2\pi$ impinging on a passive reference modulator again produces a spatial carrier and sidebands (for simplicity, consider only the lowest orders), but no frequency shift. When the two modulators are placed in contact, each plane wave from the signal modulator will induce three waves from the reference modulator. At the instant of correlation—when the pattern in the signal modulator registers exactly with that of the reference modulator—the composite output consists of groups of plane waves. Components within a group are strictly parallel—hence the name “collinear heterodyning.” (It should be evident that the prereference processor is also characterized by a similar collinear heterodyning.) One might suspect that if these groups were separated, and only one or another group detected, a nonzero output might be obtained. This is indeed the case.

The groups are easily separated in space with an ideal lens as shown in Fig. 11 and previously discussed for pre-reference filters. A slit located in the transform plane passes any one group. The table in Fig. 11 shows the proper slit location for a given reference modulation.¹⁷⁻²⁰

As before, the ideal lens and optical bench may be eliminated if polarizing modulators are used for both signal and reference. The resulting configuration is shown in Fig. 12. The slit positions of Fig. 11 are simulated by choice of analyzer axis.

It is worth emphasizing that all of the configurations discussed thus far feature linear, phase-preserving, heterodyne detection. If an active reference is used (for example, a second acoustooptic modulator), the output frequency will not be $\Omega_0/2\pi$, but will be determined by the *relative velocities* of the signals in the modulators.

FIGURE 12. When postreference processing by means of polarization discrimination, two polarization modulators are employed. Plane-wave groups are selected by polarization analysis.

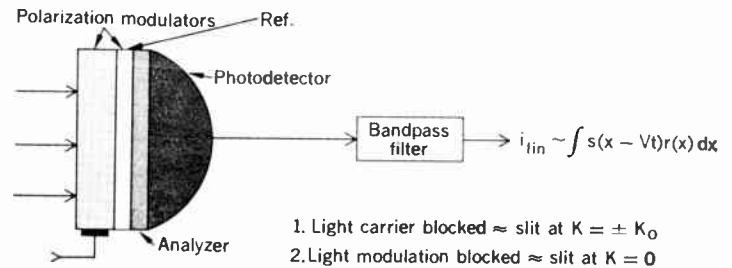

For identical modes in identical materials with no scale-changing optics, this frequency will be $2\Omega_0/2\pi$.

Since the output current is always the correlation of the reference function with an input signal, it is clearly possible to generate complex waveforms using a photographic transparency. If the signal modulator is driven by a short RF pulse of sufficient bandwidth, the output will be a time replica of the transparency. For example, if $s(t) = \delta(t)$, then

$$\int_{-\infty}^{\infty} s(x - Vt)r(x) dx = \int_{-\infty}^{\infty} \delta(x - Vt)r(x) dx = r(-Vt)$$

That is, the output is a time-varying RF signal corresponding to the spatial variation of the reference.

Code changing can be accomplished as fast as transparencies can be substituted. A digital beam deflector can select any of several references from a single photographic plate. If an active reference is employed, codes can be changed on a pulse-to-pulse basis. (Note, however, that the signal-to-noise ratio will generally be poor unless special precautions are taken to block out unneeded, noise-producing light.²¹)

High-frequency processors

In spite of the many advantages of Raman-Nath processors, acoustic losses limit their processing bandwidths

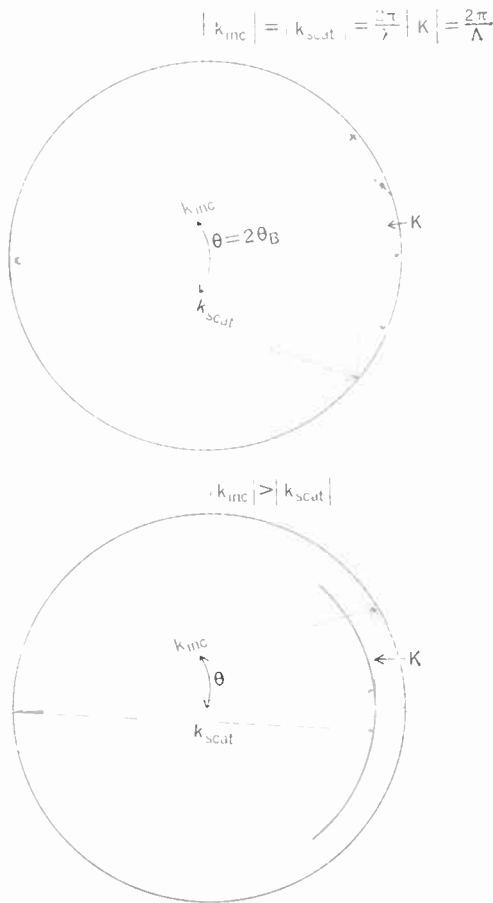
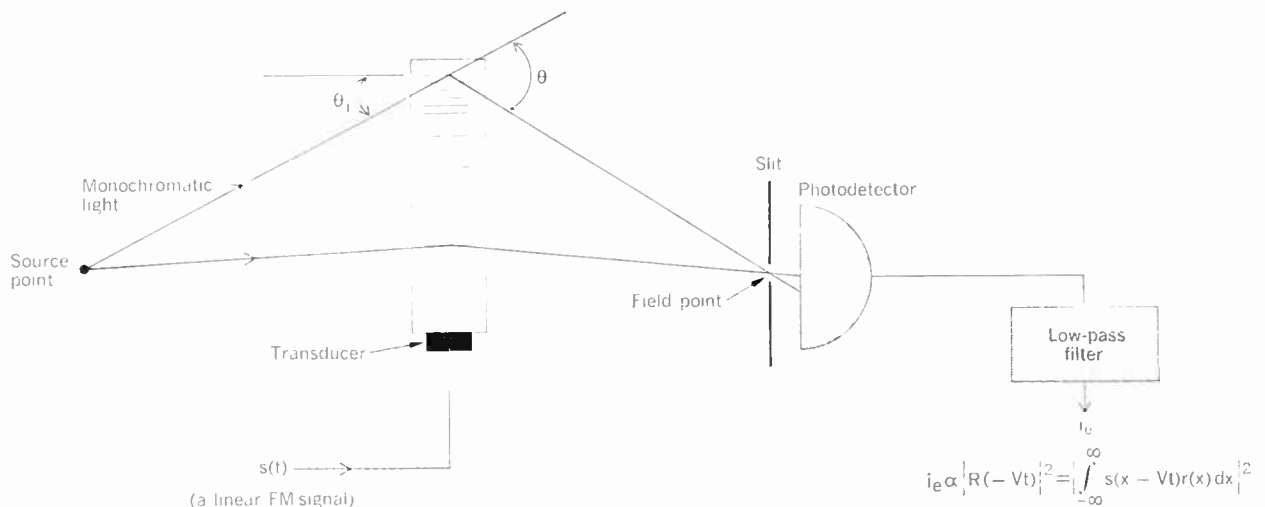

FIGURE 13. A—Momentum is conserved for normal Bragg scattering. Incident and scattered wavelengths are equal. Therefore incident and scattered light waves make equal angles with the acoustic wave. Angles must change when K (proportional to acoustic frequency) is changed. B—Momentum is also conserved for modified Bragg scattering. In a birefringent modulator, incident and scattered light waves can have different wavelengths and thus different propagation vectors. The vector diagram is modified so that it is possible to satisfy momentum conservation over a range of K (frequency) with a fixed direction of incident light k_{inc} . This allows parallel light to be used to illuminate a wide-band acoustic signal.

FIGURE 14. For a high-frequency (Bragg) processor with divergent source illumination, the Bragg incidence condition is satisfied as shown only for a linear FM signal.



to approximately 150 MHz at best. Large absolute bandwidths can be achieved, but only at much higher frequencies and only with crystalline materials to minimize acoustic losses. Processing times are limited to a few tens of microseconds by the size of available single crystals. Moreover, the width of the acoustic beam required for adequate collimation is such that the acoustooptic modulator can no longer be regarded as merely modifying the phase of the light waves. Analysis⁵ shows that a more suitable physical picture is the specular reflection of plane waves from the acoustic wavefronts. By analogy with reflection of X rays from crystal planes, this type of interaction is called Bragg reflection and the modulator is called a Bragg modulator. The modulated light from a Bragg modulator appears only as a single sideband.

A The condition of specular reflection from the acoustic wavefronts, which characterizes the Bragg interaction, is derived from the requirement that the momentum, which is proportional to $2\pi/\lambda$, be conserved. Thus the Bragg scattering process may be represented as a simple momentum vector diagram such as that of Fig. 13(A). Here the incident momentum k_{inc} minus the acoustic momentum K equals the scattered momentum k_{scat} . Since $|k_{inc}| = |k_{scat}| = 2\pi/\lambda$ (the difference between ω/c and $[(\omega + \Omega)/c]$ may be neglected), the triangle is isosceles; hence specular reflection is required. The light must be incident on the acoustic wavefronts at or near the Bragg angle θ_B given by

$$\sin \theta_B = \lambda/2\Lambda = |K|/2|k|$$

at each frequency. The achievable fractional bandwidth of the system is clearly limited by the ability of the illuminating system to meet this requirement. Nevertheless, because of the high center frequencies involved, absolute bandwidths can be very large—approaching 1 GHz.

The question of modulation conversion does not arise since modulation is single sideband. The difficulty of recollimating modulated and unmodulated components without introducing phase distortion is formidable. Most systems are not designed to attempt heterodyne detection but collect only the modulated component of the light. Phase information is thereby lost and the output is proportional to the square of the correlation integral. The central problem in the Bragg regime is, then, not modulation conversion but proper illumination.

The simplest and most straightforward form of Bragg processor²²⁻²⁴ is shown in Fig. 14. A short time after a linear FM signal is applied to the transducer the proc-

essing aperture is filled by an acoustic signal whose frequency varies linearly in x . Consequently, the angle, $\theta_i(x) = \lambda/2\lambda = \frac{1}{2} \frac{\lambda}{V} \frac{\omega(x)}{2\pi}$, at which the incident light ray must strike the acoustic wavefront also varies linearly in x . For light diverging from the source point of Fig. 14, it is clear that $\sin \theta_i = x/d$ where d is the distance from the source point to the modulator centerline and x is the distance along the modulator to the wavefront in question. Therefore only a properly located point source will correctly illuminate the wavefronts to produce optimum Bragg scattering. Moreover, since the total diffraction angle $\theta(x) = 2\theta_i(x)$ also varies linearly in x , the modulated light is refocused at a field point a distance d to the right of the modulator.

As the acoustic signal propagates down the modulator, the field spot sweeps along in a parallel plane. If a narrow slit is located in this "slit plane," the concentrated spot will sweep across it at a time defined as the correlation instant. At this moment, a burst of current i_e will flow from the low-pass filter. Since the light energy from the entire aperture of T seconds in length produces a current pulse of length τ , it is clear that pulse compression has been accomplished with a compression ratio of T/τ . Only a linear FM signal can be handled by this type of processor since only the linear FM signal can provide the needed refocusing. Nonetheless, quite large fractional bandwidths can be achieved using high Ω_0 .

Figure 15 represents a modification of the previous system wherein a birefringent polarization modulator has been substituted.²⁵ Crystal axes and the acoustic and light directions are selected so that incident and modulated waves are polarized at right angles to one another.

Moreover, the polarized waves propagate with different phase velocities in the modulator material. Thus the incident and scattered waves have different wavelengths and different momenta. The Bragg condition is therefore relaxed somewhat as shown in Fig. 13(B). Here, the modulated (scattered) light is shown as having the longer wavelength and hence shorter k -vector. For a given fixed direction of k_{inc} , the direction of k_{out} can vary through a range and the momentum diagram will still approximately close. No change in the direction of k_{inc} is required. It is thus possible to satisfy illumination requirements over a reasonably wide bandwidth (a few hundred MHz) with parallel incident light.²⁶ Because this system also depends on a focused field spot, only linear FM waveforms can be processed. Unfortunately, the efficiencies of available birefringent modulators tend to be small for the configurations desired.

The Bragg correlator²⁷ of Fig. 16 is unusual in that it allows heterodyne detection and can process more general waveforms. As drawn, its useful bandwidth is limited by the need for parallel illumination, but this limitation can be relaxed if birefringent modulators are substituted. Two active modulators are employed. Operation is most easily understood in terms of ray optics. At the instant of correlation, when the acoustic patterns in the two modulators are exactly in register, whatever bending of light rays is produced in the signal modulator is exactly undone in the reference modulator. The emerging rays are thus accurately realigned parallel to the unmodulated light (shown dotted) and collinear heterodyne detection is possible. (Unfortunately, due to the single-sideband nature of Bragg modulation, optical phase

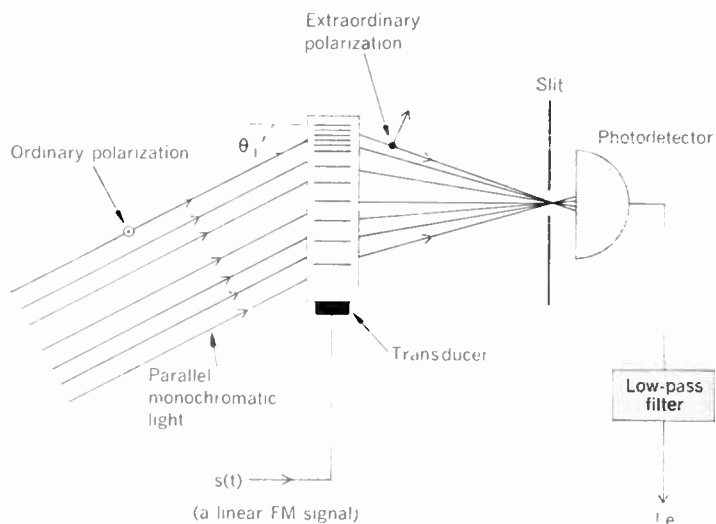
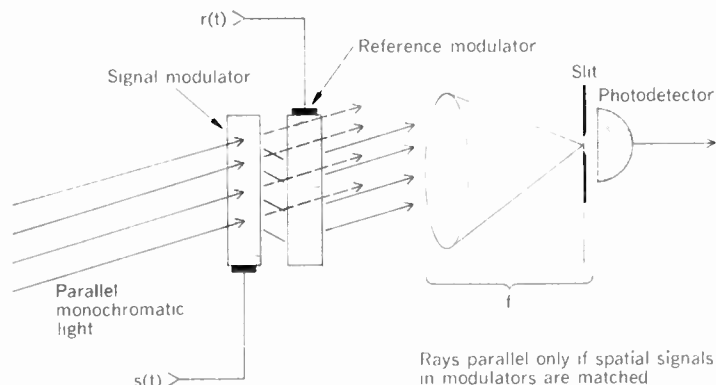

FIGURE 15. High-frequency (Bragg) processor with polarization modulator and parallel light illumination uses a birefringent modulator, allowing Bragg incidence requirements with parallel light to be satisfied. Only a linear FM signal can produce the focused output spot.

FIGURE 16. This high-frequency (Bragg) processor features flexible coding and heterodyne detection. When signal and reference modulations are matched, diffracted light is realigned strictly parallel to the incident light and heterodyne detection is possible.



distortion is translated directly, without scaling, to the RF output and so stringent optical tolerances must be held.) The output current will be linear in $R(-2V/\tau)$ since the relative sound velocity is $2V$. A wide variety of signal codes can be handled.

This processor can also be operated with the unmodulated light blocked and the more usual video detection employed in a slightly modified scheme: A corrugated mirror recollimates²⁸ the modulated light, which is then focused onto a slit with the aid of an additional lens.

Some comparisons

A rough comparison of the possibilities of Raman-Nath and Bragg correlators is presented in Table I. In order to give the reader a feel for correlator performance, parameters are given in Table II for each type. The superiority of signal-to-noise ratio in the Raman-Nath case derives partly from the improved efficiency of heterodyne detection and partly from the lesser noise bandwidth.

I. Correlator comparison

	Raman-Nath	Bragg
Heterodyne output	usually	usually not
Arbitrary signal waveform	yes	usually linear FM
Rapid code change	yes	possible
Signal generation possible	yes	no
Real time	yes	yes
Processing times	→100 μs	→20 μs
Signal bandwidth	<150 MHz	→1000 MHz
Processing time-bandwidth product	→2000	→10 000
Modulator materials	amorphous	crystalline
Signal-to-noise and dynamic range	40-60 dB	<40 dB

II. Two typical correlators*

	Raman-Nath	Bragg
Acoustic mode	shear	longitudinal
Material	fused silica	LiNbO ₃
Processing time T, μs	50	10
Processing aperture, cm	19	5.5
Bandwidth B, MHz	40	300
TB product	2000	3000
Modulation index, α'	5%	5%
Signal-to-noise ratio, dB	55	43
Acoustic power, watts	7	1.2
Signal power required, watts	28	5

*50-mW helium-neon laser, S-20 photocathode. 10-dB loss in optics, 6-dB transduction loss.

The achievable limit will ultimately be dictated by the background scattered light. A 6-dB transduction loss is assumed for both examples, although high-frequency transducers usually have losses greater than 12 dB.

Acoustooptical modulators can be used as read-in devices in low-frequency optical processors providing proper steps are taken to deal with the phase modulation they produce. Great coding flexibility is obtained. At high frequencies, large bandwidths and time-bandwidth products are possible. Rugged and simple formats are available for field use. On the other hand, current material interaction efficiencies and transducers are not as high as one might desire, and the problem of uniformly illuminating large processing apertures with collimated light is not a simple one.

REFERENCES

1. Cook, C. E., and Bernfeld, M., *Radar Signals*. New York: Academic Press, 1967.
2. Turin, G. L., "An introduction to matched filters," *IRE Trans. Information Theory*, vol. IT-6, pp. 311-329, June 1960.
3. Raman, C. V., and Nath, N. S. N., "The diffraction of light by high frequency sound waves," *Proc. Indian Acad. Sci.*, vol. 2, pp. 406-412, 1935; vol. 2, pp. 413-420, 1935; vol. 3, pp. 75-84, 1936; vol. 3, pp. 119-125, 1936.
4. Quate, C. F., Wilkinson, C. D. W., and Winslow, D. K., "Interaction of light and microwave sound," *Proc. IEEE*, vol. 53, pp. 1604-1623, Oct. 1965.
5. Adler, R., "Interaction between light and sound," *IEEE Spectrum*, vol. 4, pp. 42-54, May 1967.
6. Cutrona, L. J., Leith, E. N., Palermo, C. J., and Porcello, L. J., "Optical data processing and filtering systems," *IRE Trans. Information Theory*, vol. IT-6, pp. 386-400, June 1960.

7. Papoulis, A., *Systems and Transforms with Applications in Optics*. New York: McGraw-Hill, 1968.

8. Lowenthal, S., and Belvaux, Y., "Observation of phase objects by optically processed Hilbert transform," *Appl. Phys. Letters*, vol. 11, pp. 49-51, July 1967.

9. Born, M., and Wolf, E., *Principles of Optics*. New York: Pergamon, 1959, pp. 423-427.

10. Carleton, H. R., and Maloney, W. T., "Advantages of transverse-wave light modulators," *Proc. IEEE*, vol. 55, pp. 1077-1078, June 1967.

11. Carleton, H. R., Maloney, W. T., and Meltz, G., "Collinear heterodyning in optical processors," *Proc. IEEE*, vol. 57, pp. 769-775, May 1969.

12. Hiedemann, E. A., and Breazeale, M. A., "Secondary interference in the Fresnel zone of gratings," *J. Opt. Soc. Am.*, vol. 49, pp. 372-375, Apr. 1959.

13. Korpel, A., Laub, L. J., and Sievering, H. C., "Measurement of acoustic surface wave propagation characteristics by reflected light," *Appl. Phys. Letters*, vol. 10, pp. 295-297, May 1967.

14. Meltz, G., and Maloney, W. T., "Optical correlation of Fresnel images," *Appl. Opt.*, vol. 7, pp. 2091-2099, Oct. 1968.

15. Slobodin, L., "Optical correlation technique," *Proc. IEEE*, vol. 51, p. 1782, Dec. 1963.

16. Arm, M., Lambert, L., and Weissman, I., "Optical correlation technique for radar pulse compression," *Proc. IEEE*, vol. 52, p. 842, July 1964.

17. Slobodin, L., Author's comment, *Proc. IEEE*, vol. 52, p. 842, July 1964.

18. Lambert, L. B., Arm, M., and Achette, A., "Electro-optical signal processors for phased array antennas," *Optical and Electro-optical Information Processing*. Cambridge, Mass.: M.I.T. Press, 1965, pp. 715-747.

19. King, M., Bennett, W. R., Lambert, L. B., and Arm, M., "Real-time electro-optical signal processors with coherent detection," *Appl. Opt.*, vol. 6, pp. 1367-1375, Aug. 1967.

20. Felstead, E. B., "A simple real-time incoherent optical correlator," *IEEE Trans. Aerospace and Electronic Systems*, vol. AES-3, pp. 907-914, Nov. 1967.

21. Maloney, W. T., "An ultrasonic shutter for noise reduction in real-time optical correlators," *Appl. Opt.*, vol. 8, pp. 443-446, Feb. 1969.

22. Gerig, J. S., and Montague, H., "A simple optical filter for chirp radar," *Proc. IEEE*, vol. 52, p. 1753, Dec. 1964.

23. McMahon, D. H., "Pulse compression via Brillouin scattering in the Bragg limit," *Proc. IEEE*, vol. 55, pp. 1602-1612, Sept. 1967.

24. Schultz, M. B., Holland, M. G., and Davis, L., Jr., "Optical pulse compression using Bragg scattering by ultrasonic waves," *Appl. Phys. Letters*, vol. 11, pp. 237-240, Oct. 1967.

25. Collins, J. H., Lean, E. G. H., and Shaw, H. J., "Pulse compression by Bragg diffraction of light with microwave sound," *Appl. Phys. Letters*, vol. 11, pp. 240-242, Oct. 1967.

26. Dixon, R. W., "Acoustic diffraction of light in anisotropic media," *IEEE J. Quantum Electronics*, vol. QE-3, pp. 85-93, Feb. 1967.

27. Squire, W. D., and Alsop, J. M., "A wide-band optical correlator and matched filter using diffraction of light by ultrasonic waves," Naval Underwater Warfare Center TP 71, May 1968.

28. Jernigan, J. L., "Correlation technique using microwaves," *Proc. IEEE*, vol. 56, p. 374, Mar. 1968.

William T. Maloney (SM) received the B.S. and M.S. degrees in electrical engineering from Case Institute of Technology, Cleveland, in 1957 and 1958, and the A.M. and Ph.D. degrees in applied physics from Harvard University, Cambridge, in 1959 and 1964. His Ph.D. research involved microwave studies of high-temperature arc plasmas—an area he continued to explore for two additional years at



Harvard as a research fellow. In 1965, he joined the research staff of the Sperry Rand Research Center, Sudbury, Mass., and investigated microwave-plasma interactions, and ultrasonics in solids. More recently, his interests have shifted to the field of optical signal processing. Dr. Maloney is a member of the American Physical Society.

Maloney—Acoustooptical approaches to radar signal processing

Solid-state power electronics in the U.S.A.

Because of their light weight, ruggedness, high reliability, and freedom from mechanical difficulties, solid-state devices are finding increasing application in the broad field of power conversion and control

H. F. Storm General Electric Company

This article focuses on the conversion and control of large blocks of electric energy by solid-state power devices such as silicon rectifier diodes and thyristors. Power conversion fulfills the important requirement of delivering a desired type of electric energy when the available form is unsuitable. Examples include the energization of dc machines, dc fields, and batteries when the available source is single-phase or polyphase alternating current. Another example relates to variable-speed drives for induction and synchronous motors when the power source is either dc or fixed-frequency ac. Power control is concerned with varying the level of power delivered to a load, as in on-off switching, or varying the output voltage of a rectifier.

Many technical means are used to achieve electric power conversion and control: transformers, rotating machinery, magnetic amplifiers, high-vacuum and gaseous tubes, pool-type mercury-arc rectifiers, and solid-state devices. The field of conversion and control implemented by solid-state power devices is generally referred to as solid-state power electronics.

Solid-state power devices have brought about great changes in the field of power conversion, because they are relatively small, light in weight, insensitive to shock and orientation, and free of wear and tear; they produce no sparks, require no heat-up time or a closely controlled ambient temperature, and are not subject to arc-backs. Compared with other means of conversion and control, solid-state power conversion efficiency is generally higher, and often the equipment costs are lower.

In the solid-state power devices described here, the active element consists of a semiconductor wafer with a diameter up to about 4 cm, and a thickness-to-diameter ratio in the vicinity of 1 to 100. The junction arrangements and the function of the solid-state power devices are explained in the Appendix.

In view of the severe technological dislocations caused by rapidly spreading power diode and thyristor applications, they are grouped in the following text in context with the older technology they displaced. Preceding the applications, data are presented on U.S. production and sales of power semiconductor devices in 1968, and electrical component capabilities. For a more extensive treatment of power electronics, see Refs. 1-6.

The production and sales data in Table I originated

from the Electronic Industries Association, and are presented in rounded numbers. Actual numbers are somewhat higher because some manufacturers do not disclose their full levels of production.

Characteristics of power semiconductor devices

The purpose of Tables II and III is to provide general guidance regarding the upper electrical capabilities of today's production devices.

Silicon rectifier diodes. In Table II, item 4 is a high-speed recovery diode, used for feedback and freewheeling functions in inverter and chopper circuits, and as power rectifiers for frequencies between 400 and 10 000 Hz.

Thyristors (unidirectional triode thyristors). For large power applications, thyristors are available with ratings of up to 550 A half-cycle average forward current, and 7000 A peak one-cycle surge current; the maximum forward and reverse peak voltage ratings are 1800 V for production models, and 2600 V for limited production models used in prototypes. A typical instantaneous forward voltage drop at rated current is 1.2 to 1.5 V. Two such thyristors connected in antiparallel control a current of 1200 A rms, continuous.

Inverter thyristors are usually characterized by families of curves involving many parameters. Space does not permit including all such curves, and the few parameters presented in Table III are intended only as guidance to the capabilities of today's production inverter thyristors.

I. U.S. 1968 production and sales of power semiconductors

Device	Number Produced, millions	Sales, millions of dollars
Silicon and germanium rectifier diodes with average current ratings of 7.5 A or more	90	43
Thyristors, including triacs, with average current ratings of 7.5 A or more	3.2	28
Silicon transistors with dissipation ratings greater than 60 W	13	41
Germanium transistors with dissipation ratings greater than 60 W	22	23

II. Silicon rectifier diodes

Item No.	Average Half-Cycle Forward Current,* amperes	Peak One-Cycle Surge Current, amperes	Transient Peak Reverse Voltage
1	1500	15 000	1100
2	625	8 000	3000
3	500	6 000	5000
4	250	3 500	1550

* This term relates to a current having the shape of a half-cycle sine wave and averaged over the length of a full sine wave.

III. Inverter thyristors

Item No.	Average Half-Cycle Forward Current, amperes	Frequency Limit, kHz	Approximate Forward and Reverse Voltage
1	300	1	1200
2	200	3	700
3	80	10	700

Triacs (bidirectional triode thyristors). Triacs are available with current ratings from 2 A to 200 A rms. Some triacs are rated in terms of rms voltage up to 277 V; others are rated in terms of peak off-state breakover voltage up to 1100 V. Device properties usually limit their application to power frequencies. The majority of triacs in use are in the 10-A range, and for 120- and 240-V applications.

Transistors. Based on the product of maximum continuous load current and maximum sustained reverse voltage, the transistor price is many times the thyristor price. It follows that transistors are generally employed only where they present a technical advantage over thyristors. The use of transistors for linear control is such an instance. Another advantage of transistors is that they do not need turn-off circuits. They also may offer a higher frequency capability than thyristors.

Aside from the higher cost, the disadvantages of transistors as compared with thyristors include a base current that is orders of magnitude higher than the corresponding gate current of a thyristor and that must flow as long as load current flow is desired, and a sharp increase of saturation voltage drop with overload.

Typical larger n-p-n production transistors range from 40 A continuous collector current, 300 V collector-emitter voltage, and 166 W power dissipation, to 250 A, 120 V, and 625 W, respectively. The saturation voltages are in the range of 1.5 to 2.5 V. In some applications the higher permissible junction temperature of 200°C for silicon transistors, against 125°C with production thyristors, is the basis for favoring transistors.

Germanium p-n-p transistors offer lower saturation voltages than are available with thyristors and thus are useful for applications in which the supply voltage is low. Examples of production transistors are rated 25 A continuous collector current, 150 V collector-emitter voltage, and 166 W dissipation, and 150 A, 60 V, and 250 W, respectively. For very-low-voltage applications, germanium transistors are available with a saturation

voltage of 0.07 V, a collector current of 200 A, a collector-emitter voltage of 5 V, and a dissipation of 250 W. (For additional information, see Ref. 7.)

Displacement of dc machines

Problems with dc machines often involve the commutator and brushes, which by their nature require periodic maintenance. A further problem is commutator deformation, caused by centrifugal forces and by local heating and consequent improper brush contact. If high rotational speed is combined with high power rating, the limits of normal machine design are reached.

Additional problems are encountered under special environmental conditions, such as high altitudes, where rapid brush wear occurs, and in explosive atmospheres, where special enclosures become necessary.

In view of these difficulties, it is not surprising that other ways have been sought for dc power generation and torque production. With the advent of solid-state power components, such solutions have become feasible, and have often produced other benefits as well. The following examples bear this out, and also demonstrate the truly revolutionary impact of solid-state devices.

Exciters. The development of so-called static exciter systems began about two decades ago when magnetic-amplifier-type devices were energized by the main alternator, and the outputs of the amplifiers were controlled, rectified, and fed into the field of the main alternator.⁸ Over the course of years, static exciters were placed into operation with alternators of ever-increasing ratings.⁹ For instance, a 500-MVA alternator uses a static exciter delivering 2 MW, consisting of 16 three-phase full-wave bridges in parallel. Each of the six legs of each bridge has two water-cooled diode strings in parallel, each string consisting of two silicon diodes and one fuse in series (Figs. 1 and 2). Systems of twice this capacity are expected to make their debut within the next five years.

Another system consists of an ac exciter directly coupled to the main alternator shaft. The ac exciter has a stationary dc field and a spinning three-phase armature. The armature is connected to silicon diodes that also spin with the shaft. Finally, the diodes feed into the field of the main alternator. By varying the stationary field of the ac exciter, the field current of the main alternator can be controlled without the use of brushes.¹⁰ Installations of this system are in widespread use for alternators up to the largest sizes.

In another excitation system, use is made of the inherently rapid response of thyristors. The power source is a self-excited three-phase ac exciter, directly coupled to the main alternator. The latter's terminal voltage and speed variations act on the firing circuits of thyristors connected between the ac exciter and the main alternator field. By phase-angle control, the thyristors can quickly raise the main alternator field current by rectification and also rapidly lower it by inversion. Improved stability margins are expected for alternators connected to long-distance ac transmission lines.¹¹

The first application involves an ac transmission line of 1000 km and a cross-compound steam-turbine alternator consisting of a turbine rated 755 MW, scheduled to go into service in 1969. One main alternator is rated 483 MVA (3600 r/min) and has a 1.9-MW thyristor exciter; the other main alternator is rated 426 MVA (1800 r/min)

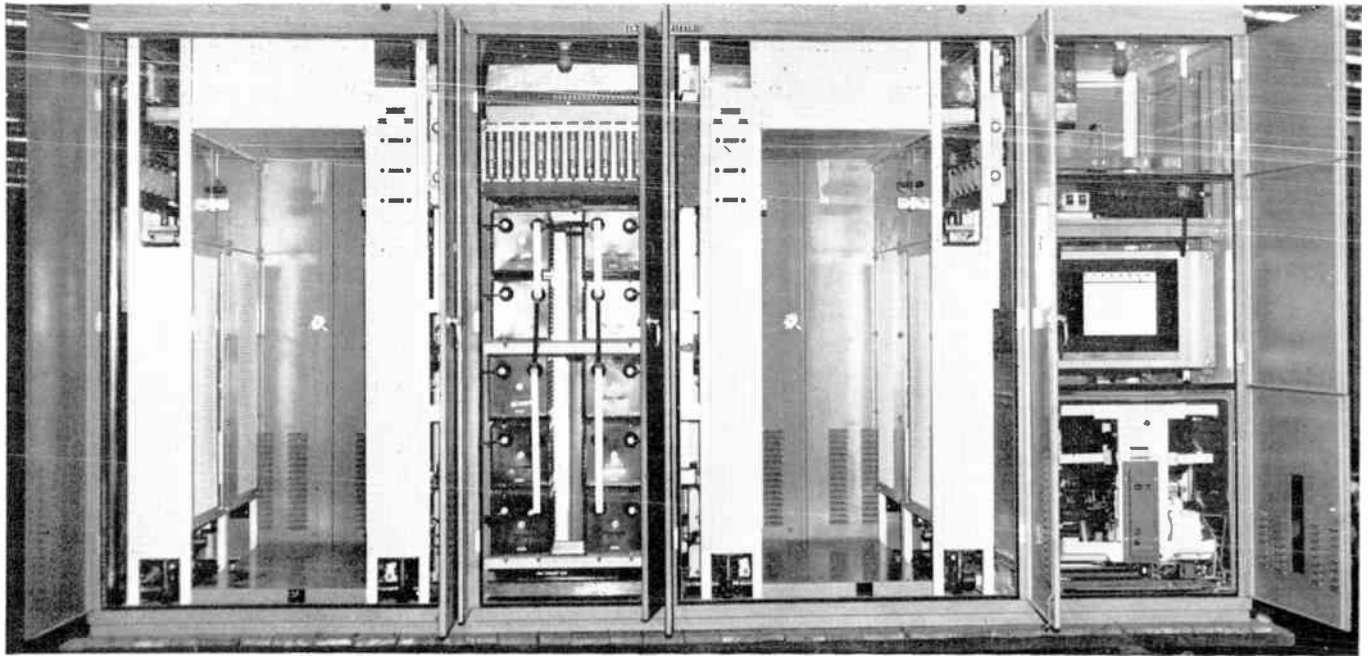

FIGURE 1. Walk-in cabinets, containing all diodes for a 2-MW exciter.

and has a 0.7-MW thyristor exciter. The rated exciter voltage is 500 V, with a ceiling of 800 V.

The 1.9-MW thyristor exciter consists of six three-phase full-wave bridges in parallel. Each of the six legs of each bridge has two water-cooled thyristor strings in parallel, each string consisting of two thyristors and one fuse in series (Fig. 2). Neon indicating lights are connected across the thyristors and fuses.

Solid-state excitation systems are now so well-established that new installations of large alternators only rarely call for rotating dc exciters.

Diesel-electric vehicles

Locomotives. Presolid-state diesel-electric locomotives utilized a diesel-driven dc generator feeding the traction motors. With increasing speed and horsepower rating of the diesel motors, practical limitations for the commutator were approached. In consequence, the power system was changed to one consisting of a diesel-driven alternator, silicon diodes, and dc traction motors (Fig. 3). The alternator may have a brushless exciter, as described previously.

By way of example, in a 3000-hp (2250-kW), four-axle locomotive, the diesel-driven alternator has 12 poles, producing 100 Hz at 1000 r/min. The maximum alternator voltage is 1360 V rms, line to line. Two traction motors are connected in series, and two such strings are connected in parallel. A three-phase, full-wave silicon rectifier bank is connected in between. Each rectifier symbol in Fig. 3(A) represents six strings of diodes connected in parallel, and one such string is shown in (B). The total number of diodes is 72. Each diode is rated 1200 V peak repetitive reverse voltage, and 225 A average current. The diodes do not require close matching because current division is assured through series resistors R_s . For static and dynamic voltage balance, each diode is shunted by a resistor R and a capacitor C . The diodes are cooled with forced, filtered air of ambient temperature.

The first domestic diesel-electric locomotive so

FIGURE 2. Two of the 16 parallel-connected water-cooled three-phase diode bridges for a 2-MW exciter.

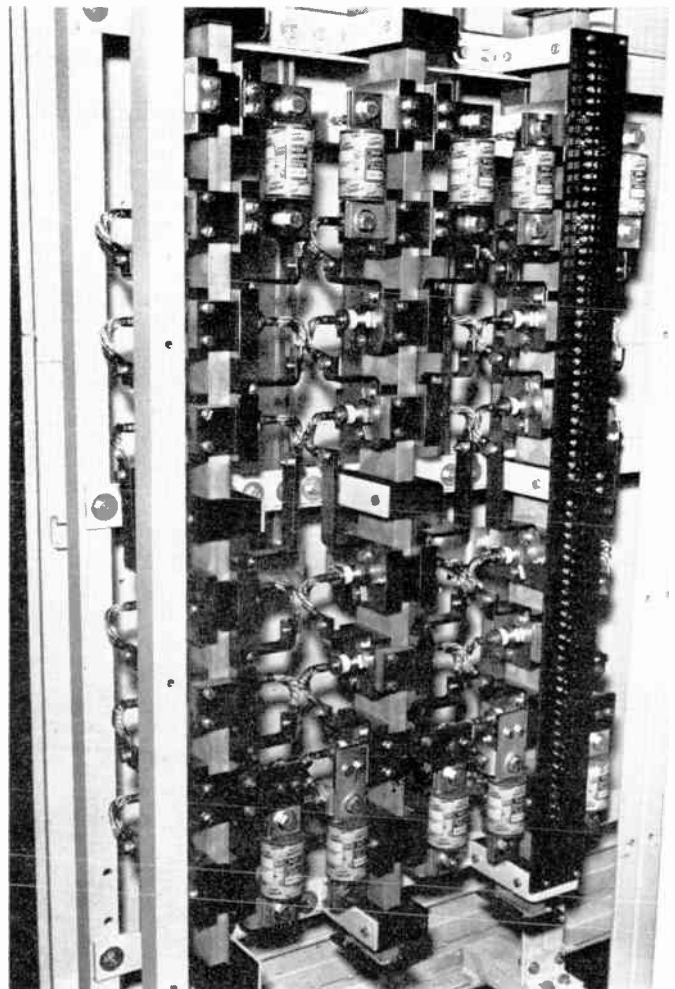

equipped went into service about four years ago.¹² In the meantime, the alternator-rectifier system has gained widespread acceptance and has become today's preferred power system for large diesel-electric locomotives.

Trucks. For reasons paralleling those for diesel-electric locomotives, the traction system just described also has been applied to trucks powered by diesel engines in the 1200- to 1500-hp (900- to 1120-kW) range.

The purpose of these large 150-tonne trucks is to carry ore or overburden in large open-pit mines, principally in copper and iron mines. Such trucks are normally operated at speeds up to 64 km/h at ambient temperatures from -50°C to 50°C , from sea level up to an altitude of 3000 meters, and occasionally they have to operate on very dusty roads or in mud more than a meter deep.

The truck has four wheels of which two are driving wheels. Each of the driving wheels is motorized (Fig. 4). It consists of a dc series-field motor of up to 625 hp (470 kW), 1100 V, 500 A continuous, and 1300 A short-term. The motor is located in the hub of the wheel. The yoke structure of the motor also serves to support the vehicle and the planetary gears that transmit the motor

torque to the tires.¹³ The traction motors are energized through a three-phase full-wave silicon-rectifier bridge. Each of the six legs of the bridge consists of two diodes in series, and four such strings in parallel. Two legs are mounted in one panel. The diodes are graded for forward voltage drop. No resistors are needed to achieve equal load current distribution or to obtain steady-state reverse-voltage equalization. Capacitors ($0.5\ \mu\text{F}$) for transient-voltage equalization are connected in parallel with the force-ventilated diodes.

The motors are controlled for constant power input through a static function generator that controls the field of the alternator by means of a circuit containing a switching thyristor. The alternator field is energized from the truck battery. The speed control of the truck is accomplished by a foot-operated throttle.

Adjustable-speed dc motor drives. The introduction of solid-state devices to adjustable-speed dc motor drives caused a major change in the appearance and performance of such installations. More specifically, reference is made to a motor-drive system consisting of a motor-generator set to produce the variable and reversible dc output for the driving motors. The motor-generator consists of an induction or synchronous motor driving a dc generator. In this application the solid-state devices displace the entire motor-generator set. Among the resulting advantages are improved overall economy, higher efficiency, higher reliability, and less maintenance.¹⁴

The very important application of solid-state devices to motor drives in hot-rolling mills has resulted in a spectacular growth in scope and capability of the electric system.¹⁵ Not only does the present trend of installing thyristor power supplies replacing the motor-generator sets offer the foregoing advantages, but in addition, the inherent high speed of response of the thyristor power supplies, in combination with a process computer, produces an end product of greater uniformity in terms of size and material properties, and thereby reduces costly scrapping and reworking. The net effect is a decrease in the overall operating cost of the mill.

Present steel-mill installations use drive motors up to 6000 hp (4500 kW) per armature.¹⁶ Because of operational requirements of a reversing mill, the thyristor-motor system is provided with the capability for motoring and regenerative loads of 225 percent of rated load, in both directions.

The motors for a 6000-hp (4500-kW) twin-drive 2-meter-diameter roughing mill are in the foreground of Fig. 5 and the motors for a 12 000-hp (9000-kW) twin-drive finishing mill are in the background. The cabinets on the mill floor contain control circuits and the thyristors, of which there are 12 to a drawer. Since this installation in 1965, the power ratings of thyristors have been markedly increased. The result is a considerable saving of space for housing today's thyristor installations.

In addition to custom installations, such as those described, there are innumerable applications for variable dc motor drives that are served by packaged motor drives using solid-state components. The control functions of these packaged drives cover quite a range of sophistication, from simple unidirectional speed controls to four-quadrant operation with high speed and accuracy, linear acceleration, overcurrent limits, and many other features.

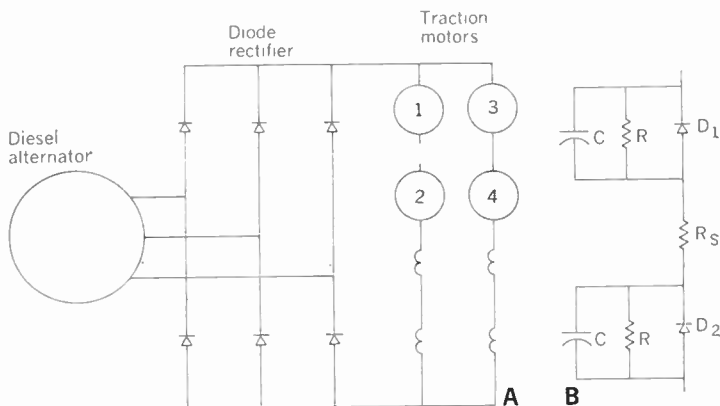

FIGURE 3. Power system for 3000-hp diesel-electric locomotive. A—Schematic diagram. B—String of two diodes; six such parallel-connected strings are indicated by one double symbol in (A).

FIGURE 4. 150-tonne diesel-electric truck driven by two "motorized" rear wheels.



Packaged motor drives are available from fractional-horsepower sizes up to several hundreds of horsepower. They are produced in the United States by over two dozen manufacturers.¹⁷

The experience with solid-state dc motor drives has been so satisfactory that motor-generator sets in future installations of large dc motor applications will generally be used only where the leading-power-factor capability of synchronous motors is required.

Adjustable-speed ac motor drives. Since the induction, synchronous, and reluctance motors referred to here have no commutator, they are free of its maintenance, its limitation in speed, and its susceptibility to certain atmospheres. Load-torque variations affect the speed of induction motors only slightly, and do not affect the speed of synchronous and reluctance motors at all. The motor speed can be varied by controlling the frequency of the power supply. In applications such as synthetic-fiber plants, where a large number of motors must run synchronously at adjustable speeds, synchronous and reluctance motors become the natural choices.

Thyristor-controlled ac motor drives have been used in crane hoists, blowers, pumps, and in many other applications.^{14,18} An application to high-precision speed control in which a group of motors must run synchronously occurs in synthetic-fiber plants. For such multiple synchronous drives, the typical thyristor inverter provides three-phase power at an adjustable frequency of about 20 to 120 Hz. The number of motors running synchronously varies from a few up to over 100. The motor rating is usually between $\frac{1}{8}$ and 2 hp (94 and 1500 W) per motor. The power supply to the motors may be through one or a plurality of inverters, all controlled from the same master frequency.¹⁹ Considerable interest exists in packaged ac motor drives²⁰; for a list of manufacturers of adjustable-speed ac drives, see Ref. 21.

Uninterruptible power supply. An outage of ac supply power may be a matter of grave consequence for hospitals, communication systems, special computers, and others. Emergency power supplies are in use in the form of diesel-generator sets or battery-energized motor-generator sets. In view of the maintenance and the low efficiency of such emergency supplies, they are not activated until after the outage has occurred, and hence the ac power to the customer is interrupted for a short time before it is reestablished.

With the advent of thyristors, new emergency power supplies became available that—by virtue of the nearly zero maintenance requirements and the high electrical efficiency—can be kept on line continuously. The result is an uninterruptible power-supply system. It consists of a silicon-rectifier section, a battery, and a thyristor inverter. The rectifier converts the incoming ac energy to charge the battery, which, in turn, energizes the inverter. The inverter changes the dc energy to ac energy to supply the critical load. Thus, the supply to the critical load remains uninterrupted in the event of the interruption of incoming power. Systems rated up to 1000 kVA have been installed and are in successful operation.

Displacement of single-phase commutator motors

The commutator problem of ac motors is greater than that of dc motors because the part of the armature winding that is short-circuited during commutation by the

brushes acts like a transformer secondary winding to the motor main field, and causes a short-circuit current to pass between brushes and commutator. If brushes and commutator are to have a reasonable life expectancy, the magnitude of the commutator short-circuit current must be kept below certain levels. This is accomplished (1) by reducing the flux density of the main motor field, using narrower brushes, and using a larger number of poles, all of which increase the size and cost of the motor, and (2) by reducing the frequency of the power supply. For instance, in the case of ac-energized locomotives, using ac commutator motors, a special power generation and distribution system of low frequency, such as 16 $\frac{2}{3}$ or 25 Hz, has been widely used.

In electric railroads, the introduction of solid-state devices permits the replacement of the ac commutator motors with the highly preferable dc motors. In addition, since the special requirement for a low-frequency supply is avoided, the problem of power generation is simplified and the prospect for future railroad electrification is thereby enhanced. It should be pointed out that prior to the solid-state era ignitrons had been used for the same purposes, but most of these installations have been converted to solid-state.

Electric locomotives. The introduction of silicon power diodes to ac electric locomotives began about 1960. An example is the six-axle, class E44 locomotive, rated 4400 hp (3300 kW) and weighing 160 tonnes.²²

The locomotive operates from an 11-kV 25-Hz system. A transformer with a secondary-load tap changer and resistors provides voltage control of the secondary winding, with a maximum of 2520 V rms. The locomotive has six traction motors, one per axle. Two motors are permanently connected in series, and three such strings in parallel. The rated current for the total of six motors is 3000 A dc, obtained through a single-phase full-wave diode bridge. In recent installations each of the four bridge legs has six diodes in series, and eight such strings in parallel, making a total of 192 diodes for the bridge.²³ Series resistors are used for current equalization, and shunt RC components for voltage equalization [Fig. 3(B)].

FIGURE 5. Roughing mill, Bethlehem Steel Corporation, Burns Harbor, Ind.



FIGURE 6. Schematic circuit diagram for 20-MW 60-Hz induction heater. Each thyristor symbol indicates 39 thyristor strings in parallel, with each string consisting of eight thyristors in series.

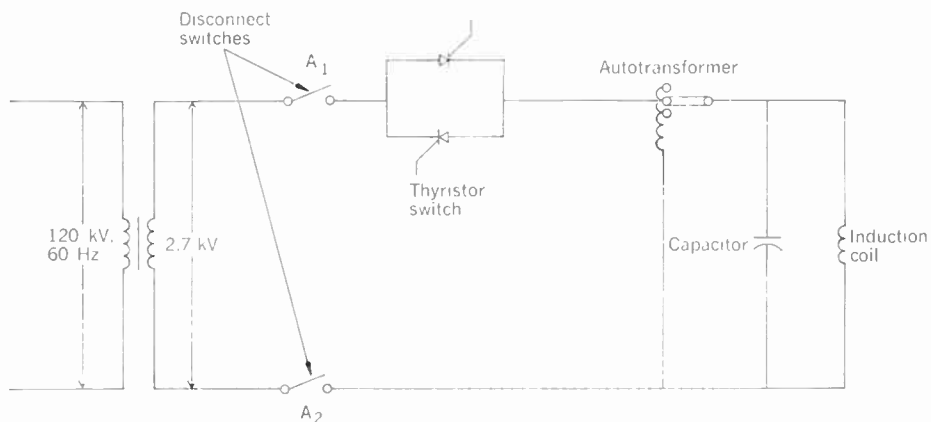
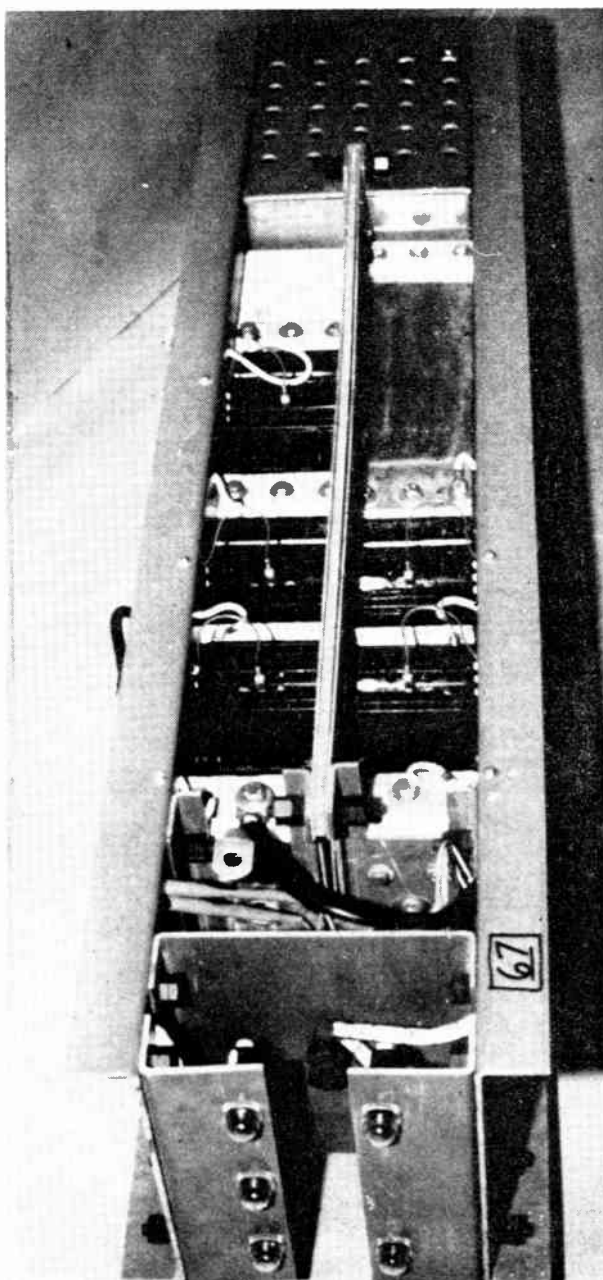

FIGURE 7. Thyristor module, showing a five-thyristor string as needed for the 5-MW induction heater. Up to eight thyristors can be accommodated in this module. Signal lights are in front of module.



Thyristor-controlled electric locomotive. Although the primary purpose of the electric locomotive under discussion is to haul a coal train, a secondary—but very important—goal of this particular design is to study the latest technologies available for railroad electrification, including automatic (unmanned) operation. Two 5000-hp (3700-kW) locomotives were built, each weighing 165 tonnes.²⁴ Speed control is obtained by phase-angle control of a bank of thyristors in conjunction with a number of full-wave diode bridges and contactors. The thyristor bank consists of 18 thyristors, arranged in two groups in antiparallel, each group having nine thyristors in parallel. A coaxial, radial construction similar to that shown in Fig. 9 is used to promote uniform current distribution among the nine thyristors. In addition, each thyristor is connected in series with an air-core inductance of 22 μH .

It is of general interest to note that the catenary voltage is 25 kV at 60 Hz, and that the on-board high-voltage circuit breaker is of the vacuum interrupter type.

Displacement of electromechanical contactors

Electromechanical contactors are extremely useful. However, even though they have reached a high peak of development over a long period of time, some of their basic weaknesses are still with us: the need for maintenance of contacts and other moving parts, the electrical and acoustic noises they generate, their bulkiness, and their limited speed of operation. Hence, the replacement of contactors by thyristors was an obvious thought. However, thyristors have problems of their own: When off, they do not completely interrupt a circuit, and when on, a voltage drop of 1 to 1.5 V occurs across the thyristor, producing a continuous power loss. Furthermore, the thyristor cannot turn off dc unless special turn-off circuits (called commutating circuits) are provided for. In addition, the cost of a thyristor switch is still higher than that of a contactor.

However, if more functions are required than just on-off switching, the chances greatly increase for the selection of a thyristor switch in favor of a contactor, as will be shown in the following example.

Induction heating. Thyristors offer several advantages over contactors for 60-Hz induction heating of large ingots. The thyristors not only perform the switching of huge amounts of ac power, but they also serve to prevent inrush currents, and in addition, quickly terminate the

current flow under short-circuit conditions of the load circuit.

Steel slabs require heating before entering the hot-rolling mills. The traditional manner of slab heating is by fuel-fired furnaces, and a period of about four hours is required for a 30-tonne slab to reach 1260°C. In a recent installation, induction heaters energized by 60-Hz power were applied, and resulted in the following advantages: reduction of heating time from four hours to less than one hour, less scale on the slab, greater uniformity of heating, improved temperature control, and the elimination of air pollution. The installation consists of 18 induction furnaces, six each rated at 5, 10, and 20 MW, heating steel slabs of about 0.3 × 1.5 × 8 meters. The 20-MW installation requires a full-load current of 9250 A rms. A schematic diagram is shown in Fig. 6.

A number of double-sided, air-cooled thyristors are packaged in a module; see Fig. 7. Electrically insulating materials serve as structural components, and laminated nonmetallic nuts and bolts are used for nonelectric connections.

The thyristors provide more than on-off switching. The power can be gradually turned on to avoid large inrush currents to the capacitors used for power-factor correction. Moreover, if a fault occurs in the induction coils or the capacitors, the gate signals are removed, resulting in the termination of current at its next, natural zero point.²⁵ During the heating process, the thyristors are phased fully on, and, therefore, do not generate harmonics in the utility lines. So far, the operating experience has been most satisfactory. For a view of an induction-heating installation, see Fig. 8.

Displacement of mercury-arc devices

Mercury-arc rectifiers, ignitrons, thyratrons, and related devices require maintenance and replacements. Moreover, they are subject to arc-backs, they require a relatively narrow ambient temperature range, and their frequency capability (and often their power-conversion efficiency) is far inferior to that of thyristors. In view of these shortcomings, thyratrons in many applications have been replaced by thyristors, as exemplified by the packaged dc motor drives described earlier. These displacements have occurred not only in relatively low power systems but also in very large ones, as the two following examples will show.

Electrolytic-cell lines. In electrolytic installations, very large blocks of dc power are needed. For example, a typical aluminum reduction line, also called a pot line, requires 150 kA at 1 kV (150 MW). This large amount of current is supplied by six three-phase full-wave rectifier bridges, each rated 25 kA, 1 kV (25 MW).

Each of the 25-MW bridges has one silicon diode per bridge leg, with 16 or more connected in parallel (Fig. 9). The diodes are graded for a forward-voltage-drop variation of not more than ±20 mV at a given current. All diodes are fused, and signal lights connected across all fuses. With this symmetrical design, no further means are necessary for uniform current division among the cells of each bridge leg. The diodes are cooled by forced air. The total forward drop per bridge consists of two diode forward drops totaling roughly 2.6 V as compared with 16–17 V with mercury-arc ignitrons in a star connection.

Vernier voltage control of 2 to 3 percent is accom-

plished by saturable reactors connected in series with the secondary windings of the rectifier transformers. A larger range of voltage control (approximately 2:1), involving all rectifiers simultaneously, is obtained from a master regulating transformer.

One may ask why diodes were chosen over thyristors, considering the latter's ability to provide voltage control. One reason is that voltage control by phase-angle control reduces the power factor in the power-supply system; in the case of the 2 to 3 percent vernier control, the reduction in power factor would be acceptable, but the increased cost of thyristors over diodes and reactors would not. Furthermore, if the 2:1 voltage variations were produced by thyristors, the resulting power factor would become unacceptably low.

In summary, the diode rectifier systems introduced to electrolytic-cell lines have been so successful that mercury-arc devices are no longer considered for new installations.

High-voltage thyristor valve for high-voltage dc transmission. In recent years, interest has increased substantially in dc transmission for a number of applications, including the following: (1) transmitting large amounts of power more economically over long-distance overhead lines; (2) bringing additional energy into densely populated areas with underground cables, or transmitting electric energy across bodies of water using underwater cable; and (3) interchanging energy between two ac systems operating at different frequencies.

A dc system now appears more economical than an ac system for overhead transmission distances exceeding approximately 500 km and underground or underwater cable systems exceeding approximately 30 km.

Since 1954, seven commercial high-voltage dc systems have been installed throughout the world, and three additional ones are under construction. All of the existing high-voltage dc systems utilize mercury-arc valves to perform the power-conversion function. Operating difficulties with these valves include arc-backs and the need for continuous maintenance involving a permanent

FIGURE 8. 60-Hz induction-heating installation. The slab is lifted into the heater coil.



group of skilled technicians and a controlled environment area for service. These difficulties can be avoided by replacing the mercury-arc valves by thyristors.

In order to achieve a valve rating of several hundred kilovolts and several kiloamperes using the largest commercially available thyristors, it is necessary to connect several hundred thyristors in series and a few in parallel. However, this series-parallel array of thyristors would not survive the turn-on and turn-off transients arising in the high-voltage dc application without the addition of series inductors and parallel resistors and capacitors. A thorough analysis followed by extensive laboratory experimentation has demonstrated the feasibility of such an array of thyristors and other components.²⁶

The circuit has been constructed in modular form, so a valve of any desired voltage can be obtained by merely connecting the appropriate number of modules in series. The firing system of a GE thyristor valve contains a light link that circumvents the insulation problem of firing a large number of thyristors at varying potentials up to several hundred kilovolts with respect to ground. Light pulses from centrally located and properly controlled light-emitting diodes are transmitted by fiber optics into the vicinity of the thyristors. There, a light detector, powered by the voltage across the anode and cathode of a group of thyristors, transforms the light signal into an electric signal, which triggers the thyristors.

A complete prototype 20-kV 1.8-kA rectifier-inverter system and, finally, a 200-kV thyristor valve (Fig. 10) were constructed and extensively tested. The results of these tests in conjunction with extensive economic and reliability studies indicate clearly that this 200-kV thyristor valve is ready for commercial installation.

FIGURE 9. Radial diode assembly of one leg of a three-phase full-wave bridge rectifier rated 25 kA at 1 kV dc.

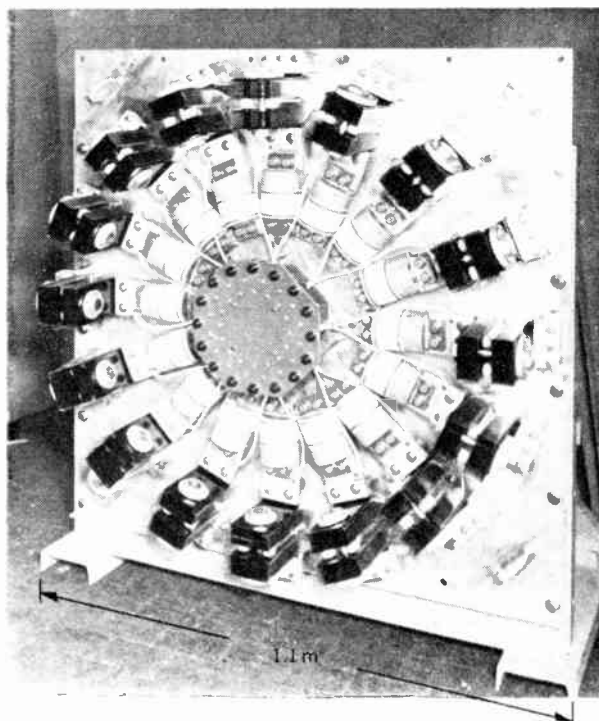

Displacement of unidirectional thyristors

Triacs. The relentless quest for new devices and new techniques never ceases, and the displacer may quickly become the displaced. This evolutionary trend leads directly to the bidirectional thyristor, or triac, which can pass current in both directions and thereby perform the function of two unidirectional thyristors. The importance of the triac, however, is not primarily as a displacer, but as a device in its own right, whose inherent economics make applications practical that on the basis of two unidirectional thyristors would have been impractical.

Since their inception in 1963, an estimated 10 million triacs have been put into service, predominantly in the consumer and light industrial markets where they are the power-controlling element in light dimmers, resistance heaters, and motor control applications, to name only a few.²⁷⁻²⁹ The field of application is expected to widen even more with the recent arrival of a low-cost, epoxy-packaged triac containing a glass-passivated pellet.

There is a further trend under way, widening the application base for triacs and unidirectional thyristors: the utilization of existing general-purpose microcircuits and the appearance of new microcircuits that are specifically designed for use with solid-state power components.³⁰⁻³²

Expectations

Improvements in the gate configuration of thyristors will permit turn-on rates of 800 A/ μ s at 400 Hz. Inverter thyristors will become available for frequencies of 10 kHz, at 250 A (average), and repetitive forward and reverse peak voltages of 1200 V. Factory-assembled clusters of parallel-connected thyristors will provide much

FIGURE 10. 200-kV thyristor valve. Six such valves are connected in a three-phase full-wave bridge for 200 kV, 1800 A dc.

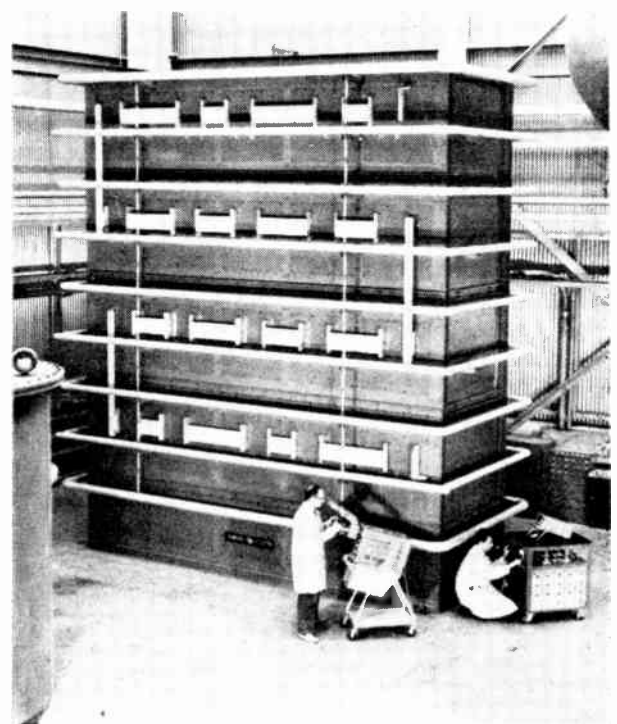

higher current ratings—for instance, a 1500-A half-cycle average current at an 1800-V repetitive forward and reverse voltage (Fig. 11).

A further upgrading in thyristor performance will be accomplished by increasing the pellet diameter. In the next few years, pellet diameters up to 70 mm may be reached. A larger pellet offers a higher continuous and surge current rating. By way of tradeoffs, other thyristor characteristics may be improved. For instance, diode ratings of 10 kV and thyristor ratings of 5 kV are expected for power frequencies at an average current of 500 A.

Considerable efforts are directed toward cost reductions of thyristors. An example is the triac described earlier, whose pellet has been glassivated and epoxy encapsulated (Fig. 12). Indirect cost reductions will be realized through thyristor types of higher ratings, which reduce the number of thyristors and auxiliaries, and by improved thyristor properties, which simplify their control.

Standard digital microcircuits are already used to achieve logic and firing functions at decreased cost, and are expected to be used even more widely. Microcircuits developed specifically for thyristor control functions will

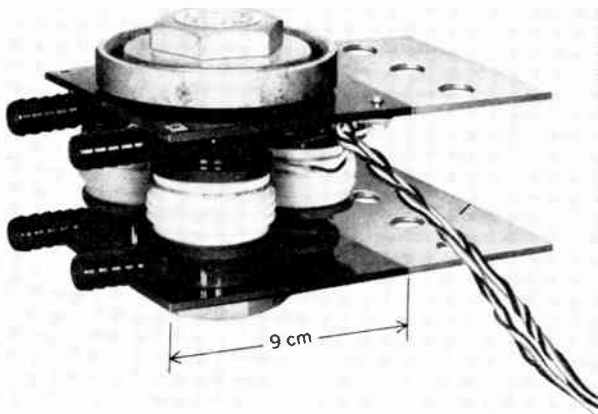
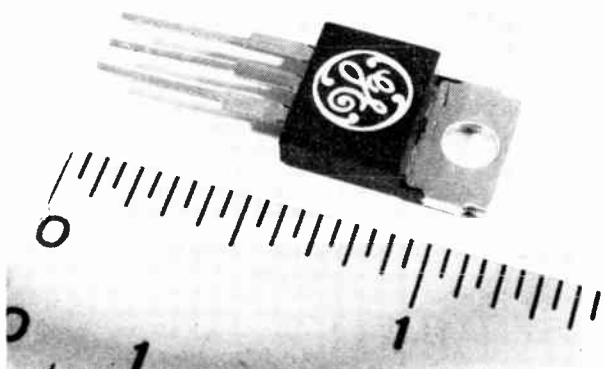

FIGURE 11. Water-cooled thyristor assembly; half-cycle average current = 1500 A; repetitive peak forward and reverse voltage = 1800 V.

FIGURE 12. Triac, rated 10 A rms, repetitive peak off-state voltage 200 and 400 V.



be marketed for a large number of control functions.

In conclusion, the present outlook is for continuous and vigorous growth of solid-state power electronics. It is probably no exaggeration that during the past ten years no other electrical components have had a greater impact in reshaping and upgrading the world of power electrical engineering than the semiconductor power devices. It is expected that their use will continue to increase for many years to come.

Appendix: Basic junction arrangements and electromechanical analogs of solid-state power devices

Diode rectifier. The diode structure consists of a wafer having one layer of p conductivity and the other layer of n conductivity [Fig. 13(A)]. For an explanation of the diode action in terms of solid-state physics, see Ref. 34. An electromechanical analog of the diode is sketched in Fig. 13(B). The symbol *R* denotes a rheostat whose wiper arm is positioned by the joint action of a spring *S* and an electromagnet consisting of a permanent magnet armature *PM* and a winding *W*. The spring may operate in a compression or a tension mode.

In the absence of current through *W*, the spring positions the wiper arm of *R* as shown in Fig. 13(B). If the terminal voltage is more positive at *A* than at *C*, the permanent-magnet armature turns the wiper arm clockwise and thereby reduces the resistance between *A* and *C*. In case of opposite polarity, the resistance is increased. This nonlinear resistance variation can be utilized to rectify ac, and hence a diode usable for rectification is called a diode rectifier.

For a voltage variation between *A* and *C* from 1 V to -1 V, a typical current ratio of 10^4 results. Thus, if ac is applied to terminals *A* to *C*, a current with a dominant dc component is produced by the diode action. The direction of the dc is indicated by the arrow. For more on power diodes, see Ref. 34.

Transistor. The transistor function is obtained by arranging the impurities in the wafer in three layers with the sequence pnp or npn [Fig. 14(A)]. The load current flowing between *C* (collector) and *E* (emitter) is monotonically controlled by a current admitted to the center layer, called the base, through terminal *B*.

The electromechanical analog of a transistor is il-

FIGURE 13. Diode rectifier. A—Junction arrangement. B—Electromechanical analog.

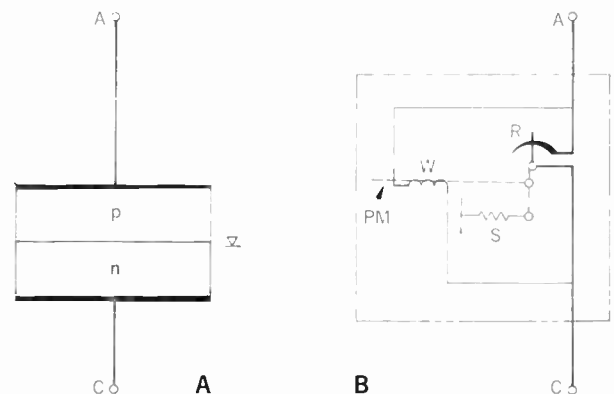

lustrated in Fig. 14(B). With no base current flowing, the wiper of the rheostat R is positioned at maximum resistance by the compression spring S . If a current is sent into B , the soft-iron armature of the electromagnet will turn the wiper clockwise until the magnetic pull equals the spring force. Thus, the current flow between C and E is facilitated.

In silicon transistors, the base current produces a resistance variation between C and E , having a ratio of about 10^4 . The required base current has a magnitude of 1 to 10 percent of the load current. The voltage between

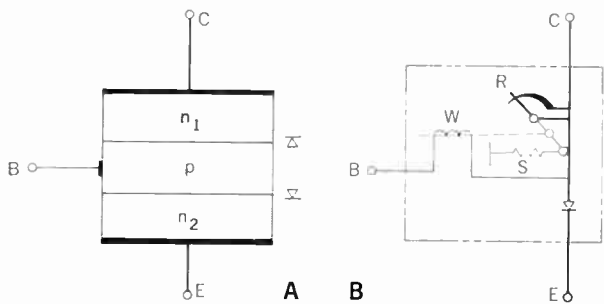
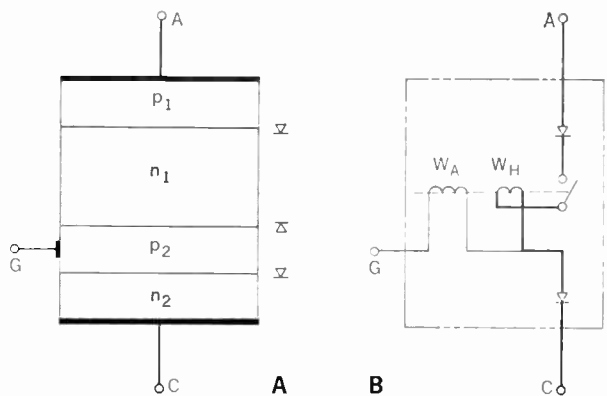

FIGURE 14. Transistor. A—Junction arrangement. B—Electromechanical analog.

FIGURE 15. Unidirectional triode thyristor (silicon controlled rectifier, or SCR). A—Junction arrangement. B—Electromechanical analog. Contactor-actuating winding is W_A ; holding winding is W_H .



B and E is less than 1 V, and the minimum voltage drop between C and E with rated current is about 1 V. Under current-overload conditions, the voltage between C and E , called the saturation voltage, increases and may cause thermal failure of the transistor. (For more information on transistors, see Refs. 34–36.)

Unidirectional triode thyristor (silicon controlled rectifier). In many power-conversion or control applications, the gradual resistance control as performed by the transistor is not desirable because of large heating losses at intermediate resistance positions; moreover, the rise of the saturation voltage cannot be tolerated in cases where overload currents are part of the normal operation. In these applications on-off switching is preferred. The thyristor can perform a switching function more economically than the transistor; in addition, the thyristor forward voltage drop increases only slightly with an overload current, whereas the voltage increase for the transistor may become so high as to cause failure.

The switching function is obtained by arranging four impurity layers in the wafer, usually in the $p_1n_1p_2n_2$ sequence [Fig. 15(A)]. The function of the device will be explained through its electromechanical analog [Fig. 15(B)]. If a so-called gate current is applied to G , the actuating winding W_A causes the switch to close. Load current now flows easily from A to C , by way of the holding winding W_H . Gate current flow is no longer necessary if the load current is larger than 10^{-4} to 10^{-3} of its rated value. The gate current for closing is about 10^{-4} to 10^{-3} of the rated load current, and the necessary gate voltage between G and C is usually smaller than 3 V.

Normally, the gate current cannot open the switch and thereby interrupt the load current. In the case of an ac supply, the load current goes to zero each cycle by itself, upon which the switch may open. However, if dc is supplied, special circuits, called commutating circuits, must be added to the power circuit to force the load current to zero before the switch may open again.

The turn-on time for this type of thyristor is a few microseconds. As far as turn-off is concerned, the forward voltage between A and C cannot be reapplied immediately after current cessation (insufficient contact clearance of the analog). The time between current cessation and effective reapplication of the forward voltage is called the recovery time, and may be as much as two orders of

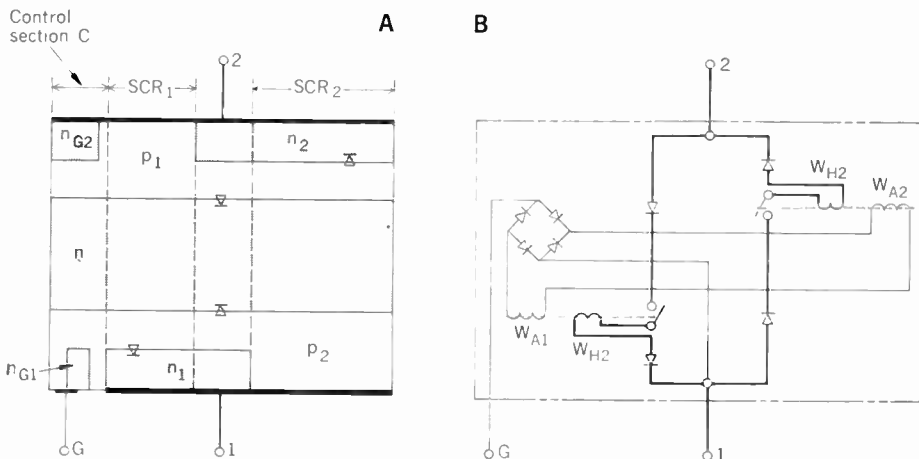

FIGURE 16. Duodirectional triode thyristor (triac). A—Junction arrangement. B—Electromechanical analog. Contactor-actuating windings are W_{A1} , W_{A2} ; holding windings are W_{H1} , W_{H2} . Bridge rectifier indicates actuation irrespective of polarity voltage at G .

magnitude larger than the turn-on time. (For more on thyristors, see Refs. 4, 6, and 36).

Some readers may have wondered about the origin of the name *thyristor*. The key is the analog between the solid-state device and a switch, gate, or door. The Greek word for door is *θυρα* (*thura*) and *istor* is the same ending used in *transistor* and *resistor*. The term *thyristor* is also analogous to *thyatron*, designating a grid-controlled gaseous electron tube having control characteristics similar to that of the thyristor. In fact, the thyristor has also been called a solid-state thyatron.

Bidirectional triode thyristor (triac). The junction arrangement of a triac is shown in Fig. 16(A) and the function is detailed in Ref. 28. A highly simplified electro-mechanical analog is shown in Fig. 16(B). One recognizes two thyristors connected in antiparallel and hence the ability of the triac to switch and control ac. The name *triac* has been coined from *three-terminal ac* switch. The gate current flows through a rectifier before reaching the actuating winding W_{A1} , W_{A2} , indicating that the turn-on may be achieved irrespective of gate-current polarity.

Revised text of an invited paper presented at the VDE Special Conference on Electronics, Hannover, West Germany, April 29–30, 1969.

The author acknowledges the valuable assistance rendered by his colleagues in the electrical industry through their contributions of source materials and technical discussions. He also expresses his appreciation to D. W. Borst and A. Kusko for their constructive criticisms and suggestions in reviewing the manuscript for IEEE SPECTRUM.

REFERENCES

- Heumann, K., and Stumpe, A. C., *Thyristoren* (in German). Stuttgart: Teubner, 1969.
- Special Issue on High-Power Semiconductor Devices, *Proc. IEEE*, vol. 55, Aug. 1967.
- Gutzwiller, F. W., "Thyristors and diodes—the semiconductor workhorses," *IEEE Spectrum*, vol. 4, pp. 102–111, Aug. 1967.
- Gutzwiller, F. W., ed., *SCR Manual*, 4th ed., General Electric Co., Syracuse, N.Y., 1967.
- Harnden, J. D., Jr., "Present-day solid-state power switches," *IEEE Spectrum*, vol. 2, pp. 107–112, Sept. 1965.
- Gentry, F. E., Gutzwiller, F. W., Holonyak, H., Jr., and Von Zastrow, E. E., *Semiconductor Controlled Rectifiers*. Englewood Cliffs, N.J.: Prentice-Hall, 1964.
- Eimbinder, J., "Power transistors," *EEE*, pp. 76–81, Jan. 1968.
- Storm, H. F., "Static magnetic exciter for synchronous alternators," *IEEE Trans.*, vol. 70, pt. 1, pp. 1014–1017, 1951.
- Lane, L. J., Mendel, J. E., Ewart, D. N., Crenshaw, M. L., and Todd, J. M., "A static excitation system for steam turbine generators," presented at the 1965 IEEE Winter Power Meeting, New York, N.Y., Jan. 31–Feb. 5.
- Hoover, D. B., "Brushless excitation system for large ac generators," *Westinghouse Engr.*, vol. 24, pp. 141–145, Sept. 1964.
- Concordia, C., and Temoshok, M., "Generator excitation systems and power system performance," presented at the 1967 IEEE Summer Power Meeting, Portland, Oreg., July 9–14.
- "Progress in railway mechanical engineering, 1964–1965," *Trans. ASME J. Eng. Ind.*, vol. 87, 1965.
- Kusko, A., and Magnuson, L. T., "Off-highway vehicles," *Proc. IEEE*, vol. 56, pp. 600–604, Apr. 1968.
- Harris, W. R., "The solid-state revolution in industrial drive systems," *Westinghouse Engr.*, May 1968.
- Brown, E. H., "Electrical systems for hot-rolling mills," *Westinghouse Engr.*, May 1967, pp. 83–87.
- Gerdt, P. H., and Greblunas, J. A., "Thyristor-powered 80-inch combination side trim, temper and recoil line," *Iron Steel Eng.*, pp. 79–86, Dec. 1968.
- Kusko, A., "Packaged SCR dc drives," *Control Eng.*, pp. 76–81, June 1966; pp. 59–65, July 1966; pp. 74–76, Oct. 1966.
- "75 Jahre Käfigläufermotoren," (in German), *AEG Mitt.*, vol. 54, pp. 87–140, 1964.
- Dinger, E. H., "Digital applications of ac motor controls," *IEEE Trans. Industry and General Applications*, vol. IGA-88, pp. 291–299, May–June 1969.
- "An ac drive for better control," *Iron Age*, pp. 85–86, June 20, 1968.
- Kusko, A., "What's available in adjustable speed ac drives," *Control Eng.*, pp. 58–63, Aug. 1968.
- Brown, J. C., and Horine, J. W., "Applications of silicon rectifiers on electric locomotives in the United States," *IEEE Trans. Applications and Industry*, vol. 82, pp. 131–135, May 1963.
- Friedlander, G. D., "Railroad electrification: past, present, and future," *IEEE Spectrum*, vol. 5, pp. 50–65, July 1968; pp. 56–66, Aug. 1968.
- Oliver, J. A., Hamlin, F. C., Smith, R. M., and Ryan, P. T., "Electric locomotives for the Muskingum Electric Railroad," *IEEE Conf. Record 3rd Ann. Meeting IGA*, 1968.
- Pollard, E. M., Flarity, C. W., Hodges, M. E., and Laukaitis, J. A., "Thyristor ac switch for induction heating power control and protection," presented at the 1969 IEEE International Convention, New York, Mar. 24–27; also presented at the IEE Conference on Power Thyristors and Their Applications, London, May 6–9, 1969.
- Dewey, C. G., Ellert, F. J., Lee, T. H., and Titus, C. H., "Development of experimental 20-kV, 36-MW solid-state converters for HVDC systems," *IEEE Trans. Power Apparatus and Systems*, vol. PAS-87, pp. 1058–1066, Apr. 1968.
- Gentry, F. E., Seace, R., and Flowers, J., "Three-terminal ac switch," presented at the IEEE Electron Devices Meeting, Washington, D.C., Oct. 31–Nov. 1, 1963.
- Storm, H. F., and Watrous, D. L., "Silicon gate-controlled ac switch and its applications," *IEEE Trans. Magnetics*, vol. MAG-1, pp. 36–42, Mar. 1965.
- Cooper, D., "Triacs bid for ac power control," *Electro-Technology*, pp. 53–59, Mar. 1968.
- Gutzwiller, F. W., and Galloway, J. H., "Power grab by linear IC's," *Electronics*, pp. 81–86, Aug. 21, 1967.
- Galloway, J. H., Harnden, J. D., Jr., Kram, W. P., and Watrous, D. L., "Monolithic switch system for low-cost power control," *Proc. Nat'l Electron. Conf.*, vol. 23, pp. 285–290, 1967.
- "IC cuts speed-control cost for split-phase motor," *Product Eng.*, pp. 66–68, Aug. 12, 1968.
- Jonscher, A. K., *Principles of Semiconductor Devices*. New York: Wiley, 1960.
- Blundell, A. J., Garside, A. E., Hibberd, R. G., and Williams, I., "Silicon power rectifiers," *Proc. IEE (London)*, vol. 108, pt. A, pp. 273–294, Aug. 1961.
- Gärtner, W. W., *Transistors—Principles, Design and Applications*. Princeton, N.J.: Van Nostrand, 1960.
- Svensson, R., "High-power thyristors," *ASEA J.*, vol. 41, no. 1, pp. 3–8, 1968.

Herbert F. Storm (F) received the E.E. degree in 1932 and the doctor of engineering sciences degree in 1933 from the Technische Hochschule in Vienna. He joined the Industry Control Department of the General Electric Company in 1946, where he was engaged in advanced development work in industrial electronics. Later he transferred to the Advanced Technology Laboratories (which later became part of the Research and Development Center), where his efforts were concentrated on static controls of the magnetic type, including magnetic amplifiers. Subsequently, the work area was broadened to include semiconductor devices and circuits, both for power and information handling. For more than ten years he also served as adjunct professor of electrical engineering at Rensselaer Polytechnic Institute.

Dr. Storm holds more than 20 patents and has written more than 40 professional papers. His book "Magnetic Amplifiers" (Wiley, 1955) has been translated into French, Japanese, and Russian. He has served the IEEE in many capacities, including first chairman of the Magnetics Group and first chairman of the Intermag Conference. At the present time he is serving as chairman of the Conference Executive Committee of the IEEE Magnetics Group.



Art and technology:

The productive collaboration of artists and engineers can and should be something more than random patterns and electronic "happenings"

The successful alliance of art and technology is hardly a novel concept; it has been practiced for centuries, from antiquity, through the Renaissance, to the present day. Historically, the collaborative efforts of artists, artisans, engineers, and builders have been predicated upon the exacting criteria of the respective trades and professions: the integrity of achievement that demands order, logic, and reason in planning and execution, plus the responsible freedom of expression that is regulated by self-discipline—rather than by license—for the betterment of society and the progress of civilization and culture. Much recent copy has been devoted in our literature to some far-out and anarchic present-day trends in the collaboration of artists and engineers, with the apologia that it is "something that is really going on." But one might logically observe that robbery, rape, and mayhem are also things that are really going on!

At least in theory—if not in practice—the architect should be an ideal combination of artist and engineer. Thus, pragmatically, there is a saying to the effect that if an architect designs a building without an engineer as collaborator, it will probably fall down; but if an engineer constructs a building without an architect, *the public will tear it down!*

A historical synopsis

The ancient Egyptians, and the Aztec, Mayan, and Toltec civilizations of Middle America, were confronted by just this sort of architect-engineer problem (not having any clear demarcation between the two professions). Thus these widely separated cultures of Africa and America, in one of history's amazing examples of independent, parallel design solution—unless Thor Heyerdahl proves otherwise—devised the pyramidal structure, whose center of gravity and geometric shape do not readily permit it

FIGURE 1. The ancient stoa of Athens, as reconstructed by precise modern archaeological techniques, is an excellent example of the beautiful proportionality of Greek post-and-lintel design and construction.



a merger of disciplines

Gordon D. Friedlander
Burndy Library

either to fall down or to be torn down but, rather, only to fall in upon itself.

As these early civilizations developed their cultures and degrees of technical sophistication, their competent artisans, who were both architects and engineers, created the post-and-lintel system, consisting of massive stone columns that supported entablatures and roof structures (Fig. 1). These buildings did not possess the inherent stability of the pyramids and hence time, the elements, and man's depredations have left many of them in ruin.

The next significant technical advance in construction came with the Romans. Although their architecture and fine arts were mainly limited to fine eclectic simulation of the Greek and Mycenaean styles, the Romans were the great engineers who developed the arch and keystone and the flat dome of the Pantheon. They apparently sensed that the theory of the dome is similar to that of the arch but, in addition, dome construction relies upon ring tension at the base to absorb the horizontal thrust components. Needless to say, the ancient Romans had neither scientific formulas nor slide rules. Their mathematics was "artistically intuitive" and relied, to a large extent, upon empirical methods. We do not know how many of their aqueducts and bridges failed structurally and collapsed into the valleys before enough design and construction experience was gained to erect the remarkable—and beautiful—structures that stand today in France, Italy, and Spain (Fig. 2), almost intact after 2000 years.

Essentially, intuitive mathematics is based upon the proposition that sound design is only possible through the help of an inborn sense of proper scale relationship and dimensional proportionality so that, nine times out of ten, if a structure *looks* good—in overall design, form, and geometric proportions—it *is* good. Therefore we must admire the inherent ingenuity of the ancient artisan-engineer who set the first keystone to interlock the voussoirs of the original segmental arch structure. He must have logically reasoned a priori that the vertical load imposed upon his structure would be transmitted as a horizontal thrust against the abutments of the arch. His basic theory is unchanged today—except that we have the science of mathematics and the art of structural engineering to prove that he was right.

It was almost 1000 years after the fall of the Roman Empire of the West before the next notable advance in architectural engineering design and construction was evolved: the "flying buttress" of the French Gothic cathedrals (Fig. 3). Basically, the flying buttress is a straight, inclined masonry bar carried by an arch, and a solid vertical pile against which it abuts—thereby taking up the lateral thrust of the roof or vault construction. This device permitted the exterior walls of the church to be constructed much lighter and thinner than usual to

withstand the horizontal forces. It accounts for the apparent fragility and delicacy of the French Gothic architectural style.

The flying buttresses, graceful and functional components of medieval structural architecture, were designed and built by unknown craftsmen trained in the school of practical experience, many of whom were, in truth, composite artist-technologists. Thus they "collaborated" with themselves and with fellow craftsmen similarly trained by the empirical method—plus the in-born disciplines of logic, reason, and orderly patterns—to produce the magnificent cathedrals of Chartres, Amiens, Rheims, Rouen, and Notre Dame de Paris. The exterior and interior motifs in religious iconography, grotesque gargoyles, stained-glass rose windows, buttresses, and vaulting all combine in a harmonious entity that is, in total, a subtle and esthetic blend indicative of

FIGURE 2. A 2000-year-old Roman marvel—the triple-tiered arch construction of the Pont du Gard aqueduct, which still stands near Nimes, France.

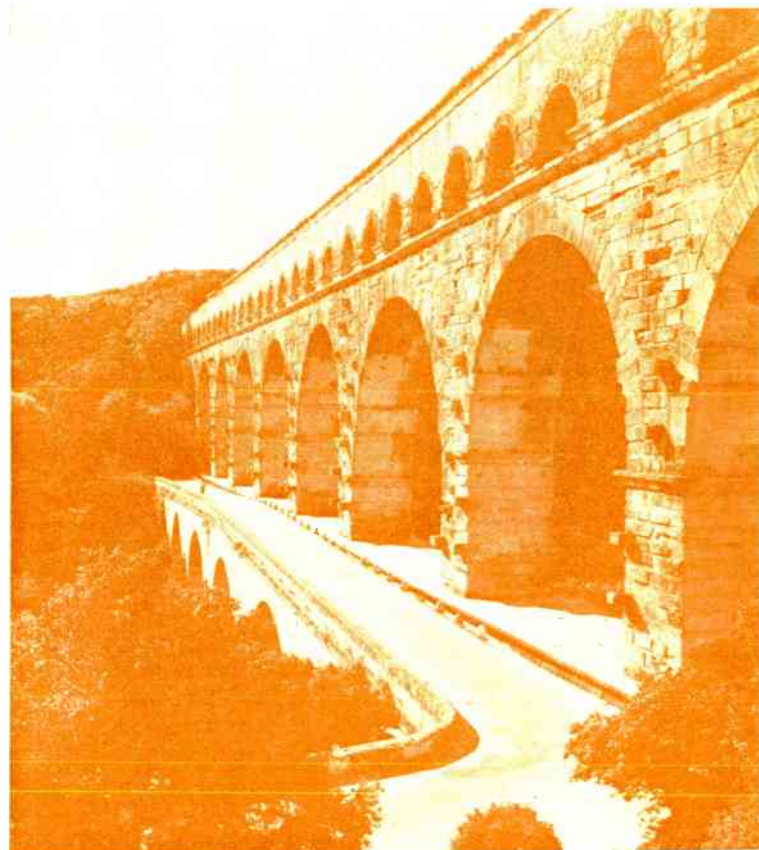

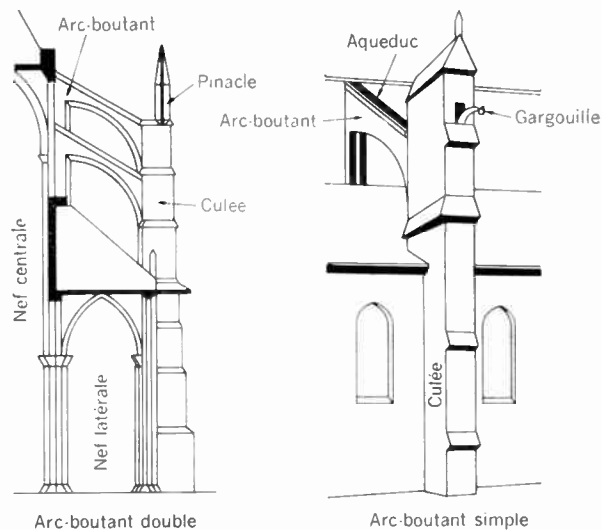

FIGURE 3. Simple and compound flying buttresses, designs typical of those used in French Gothic cathedral construction such as Notre Dame in Paris.

the optimum achievement in interdisciplinary collaboration between technology and the fine arts.

Unfortunately, the names of most of the great medieval craftsmen either went unrecorded or have been lost in the dusts of time. We do know, however, that the 12th century architect who was imported to England to begin the design and construction of Canterbury Cathedral was called Gulielmus Gallicus (William the Frenchman), and that his successor on the job was Gulielmus Anglicus (William the Englishman).

Without doubt, the greatest name of the Renaissance period was that of the renowned artist, engineer, inventor, and anatomist. . .

Leonardo da Vinci (1452–1519). Combining the interdisciplinary skills of art and science, perhaps to the most remarkable extent of any individual in history, Leonardo was indeed a “Renaissance man”¹ in the most complimentary sense of the epithet. Many of us think of him primarily as the painter of the “Mona Lisa” and “The Last Supper,” but he was much more than that. Leonardo also was

1. A military engineer who envisaged practical weapons engines far beyond the technology of his time. (He drew elaborate sketches of primitive tanks, aircraft, and submarines that employed ingenious mechanical gadgetry and gear principles for propulsion—plus designs for machine guns, a parachute, and a helicopter.)

2. A civil engineer with an intuitive knowledge of the strength of materials, working stresses, and the principle of the truss. (He is credited with constructing the first hand-operated elevator, installed in the Milan cathedral.)

3. A research scientist and geologist who anticipated the principle of inertia and who understood the acceleration of falling bodies nearly a century before Galileo and two centuries before Newton. (He apparently subscribed to the heliocentric theory of the solar system, and Copernicus may have heard of his views; he considered the possibilities of long-continued structural changes in the earth two centuries before Hutton; and he had a good grasp of the principles of fluid mechanics.)

4. An inventor who devised instruments for measuring wind velocity and the speed of ships.²

5. An anatomist who studied the structure and function of the human heart and its valves, and speculated on the circulation of the blood a century before Dr. William Harvey. (Many of his anatomical drawings are beautiful and accurate; he constructed models to enable him to study the actions of the muscles.)

Unfortunately for the world, Leonardo was an extremely versatile self-collaborator in art and technology who kept most of his great ideas to himself by recording them in mirror writing in voluminous notebooks and sketchbooks. Most of his wonderful ideas and thoughts did not come to public attention until more than two and a half centuries after his death.

To round out this brief historical overview, it might be well to mention just one other great practitioner in art, science, and technology. . .

Sir Christopher Wren (1632–1723). Architect, mathematician, astronomer, anatomist, Wren was one of an elite group of talented professionals who made Restoration England a bright spot¹ in the annals of art and science. His works, like those of Leonardo, have endured in the crucible of the “test of time.”

Wren became noted as a mathematician as an adolescent, when he wrote treatises on dialing and spherical trigonometry. While at Oxford University, he exhibited many ingenious mechanical inventions and formulated a hypothesis on the moon’s libration. In 1657, he was appointed professor of astronomy at Gresham College in London. Following the disastrous Fire of London in 1666, he was commissioned to rebuild St. Paul’s Cathedral in accordance with one of his architectural designs. Today, this structure is considered to be the epitome of classical architecture.

In 1668, Wren was made Surveyor-General of Public Works, and thereafter devoted progressively more time to architecture.² In all, he designed 80 buildings in London and 20 more throughout England and Ireland, including structures at Eton, Oxford, and Cambridge, and the Custom House and Trinity College in Dublin.

Wren’s mathematical achievements included his determination of the length of the arc and center of gravity of the cycloid. He also discovered the two systems of generating lines on a hyperboloid of one sheet. (In this context, he wrote on the properties and grinding of hyperbolic mirrors.)

In astronomy, his most noted and enduring work is the Greenwich Observatory. He probably anticipated Huygens in explaining the telescopic appearance of Saturn and in attempting to make a wax model of the ringed planet. Wren also made a scale model of the moon, showing its topographic features in relief. This was probably the first construction of the lunar globe.

He was one of the founders of the Royal Society of Great Britain and became its president in 1680. Wren’s epitaph¹ is one of the best known in history: *Si monumentum requiris, circumspice* (“If you would see his monument, look around”); he is buried in his great cathedral.

Now, the present state of the art—and technology

In retrospect then, the evidence of recorded history reveals that the valid and constructive collaboration between artists and engineers has been practiced for a very

long time, and that the criteria for such interdisciplinary efforts have always been based upon reason, logic, and orderly planning to produce esthetic and enduring results. These criteria have been applied dramatically and esthetically to contemporary interdisciplinary ventures in which artists, designers, architects, and engineers were the active participants. Let us review a few examples of such successful collaborations in the areas of structural, civil, acoustical, electrical, and electronics engineering. By this exercise we may demonstrate that the alleged “anomalous estrangement” of art and technology in recent times is more artificial than factual.

Long spans and suspension bridges. The designers, architects, and engineers who collaborate to produce bridges as graceful in line, span, esthetic form, and proportionality as the Bronx–Whitestone, Verrazano, and Golden Gate show by their products that such structures need not look like erector sets in order to be functional and utilitarian.

As far back as 1883, George Washington Roebling demonstrated in the design of the famous Brooklyn Bridge that Gothic symmetry and the esthetics of classical and monumental magnificence could be incorporated in the masonry towers and sweeping catenary of this long-span American prototype of the suspension bridge. Even the diagonal storm stays—at once beautiful and functional—lend a gossamer delicacy to the geometric pattern of the vertical support cables when viewed at a distance.

In the Bronx–Whitestone Bridge (Fig. 4), completed in 1939, Aymar Embury, II, architect, and Othmar H. Ammann, structural engineer, collaborated to produce one of the most beautiful suspension bridges in the United States. The use of steel plating as an integral part of the structural design of the towers is an excellent application of a modern material, possessing true structural integrity but giving the illusion of masonry. The Renaissance-style arch portals provide an esthetic and dramatic simplicity, and serve to blend the good proportionality and scale relationship of the structural and architectural components into a pleasing pattern of overall harmony that is essential to sound collaborative design. Thus there is no discord between esthetics and functionalism; all criteria have been met and fulfilled in the best interdisciplinary tradition.

Good site planning: engineering, esthetics, architecture. The natural topography and landscape features of a choice suburban site often are either abused or entirely eliminated through improper site clearance and grading. Unfortunately, some architects do not possess a three-dimensional concept of site grading and landscaping, or realize its prime esthetic importance to the ultimate success of a project. Such architects labor under the impression that the only site requirements necessary for the accommodation of their maximum-density building designs are

- Bulldozers to clear the land of all obstacles—including valuable trees and shrubs.
- Large-volume earthworks in site leveling and preparation.

Proper site grading is actually a sculptural problem in three dimensions that requires the utilization of existing land contours to best advantage by means of careful reshaping and molding. In this way, both the architectural and site-development aspects may realize optimum ful-



FIGURE 4. The Bronx–Whitestone suspension bridge. This graceful structure, a product of the collaborative design of architect Aymar Embury, II, and engineer Othmar H. Ammann, was opened to traffic in 1939.

fillment through an esthetic, functional, and practical adaptation of natural site assets. Thus if the architect will collaborate with competent and imaginative site engineers and landscape architects, a far more satisfactory site-development plan will evolve.

The skilled site engineer will retain natural surface drainage flow, insofar as possible, to eliminate costly construction appurtenances such as culverts, deep retention manholes, retaining walls, tree wells, etc. By means of esthetic grading, layout of access roadways, parking areas, and planting, the competent site engineer and landscape architect can do much to enhance the building architecture as well. And whenever standardized architectural design leaves much to be desired in the way of warmth and decorative motifs, artistic site development will often compensate for the deficiency.

From 1959 to 1961, the writer was the project engineer for the design and construction of a large regional shopping center (Figs. 5 and 6) in Vancouver, B.C., where a difficult existing terrain (a 35-meter contour differential), plus seismic design considerations, presented many unusual problems.³ By the close collaborative efforts of a team of site and structural engineers, architects, and landscape architects, esthetic and functional solutions

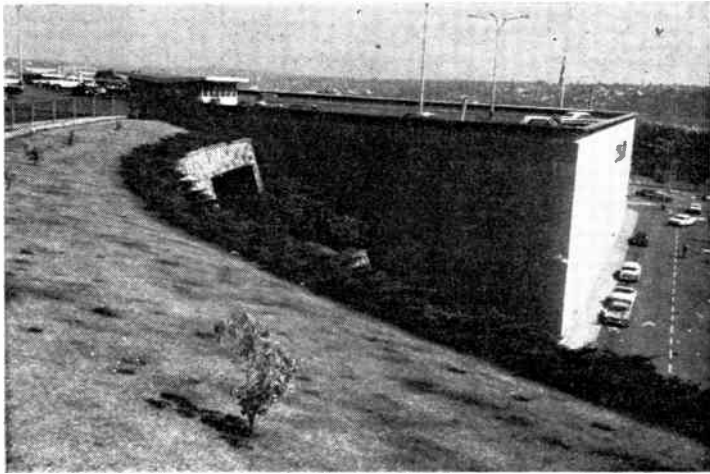

FIGURE 5. View from rooftop parking access road shows the steep embankment that posed major problems in esthetic site grading and seismic structural design at the Brentwood Shopping Centre near Vancouver, B.C.

FIGURE 6. Three-tiered retaining walls with terraced planting levels—the result of engineer-landscape architect collaboration—provide esthetic solution to high embankment problem beyond the department store structure at Brentwood.

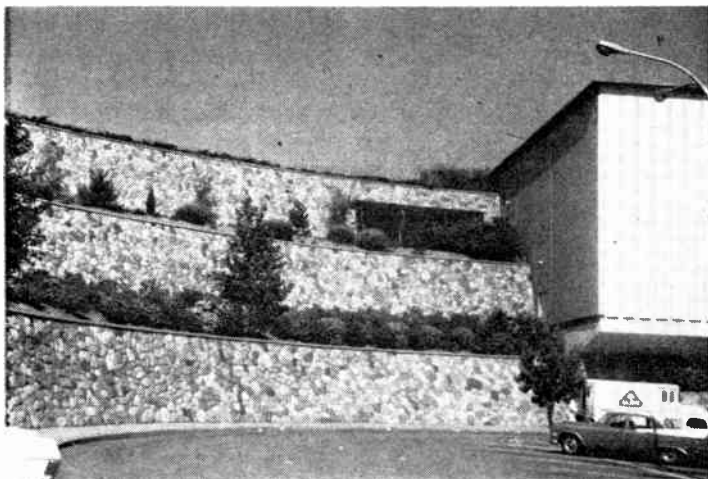

FIGURE 7. View of the horseshoe-shaped shopping plaza in Lake Anne Village, Reston, Va. One in a series of “new city” concepts, Reston is an excellent example of the merger of art and technology in design and construction.



were achieved. In this project, a high earth embankment was isolated from the building structure and concealed by a continuous bridge to provide access to the rooftop parking area over a large department store.

Beyond the building structure (Fig. 6), the steep embankment is contained by triple-tiered masonry-faced retaining walls, whose planting terraces are supported by concealed structural-steel falsework. The landscape architects provided flowering shrubs and other plant materials in the one meter of topsoil cover over the falsework along each terrace.

Unlike the initial architectural design, which usually remains static after construction, the site development plans are dynamic entities that will often change with time. Thus the site planning group must anticipate increased traffic flow and parking requirements for the future, and the possibility of further site development in successive phases as more funds become available.

But the ultimate joint effort in this area of the application of art and technology is in the planning of the “new cities” (Fig. 7), in which not only architects, engineers, and landscape architects participate, but also mural painters, sculptors, economists, and psychologists are part of the collaborative venture. This exciting concept was explored in depth by the writer in the April 1967 issue of IEEE SPECTRUM.⁴

Art and hydroelectric engineering. In the June 1965 issue of IEEE SPECTRUM, the writer discussed the adverse public reaction to unsightly overhead transmission lines, substations, and other electric utility installations.⁵ Many examples were provided in the article to indicate how the utilities in the U.S. and abroad were solving this problem in esthetics.

Perhaps the most notable collaborative efforts among mural painters, sculptors, architects, and engineers—in this category—are shown in Figs. 8 and 9, which are views of the Salime Dam and hydroelectric station in Spain. In Fig. 8, we see that the European designers have incorporated extensive mural decoration, polished marble paneling, and structural forms and masses in the generator room of this major hydro station that are simultaneously esthetic and functional. Although the elaborate artistic decor may seem unwarranted and extravagant at first glance, one must remember that operating personnel spend many hours of the day in these usually impersonal environments. Certainly, artistic and warm surroundings will give a lift to employee morale and efficiency; therefore, the art is “functional.” Figure 9 shows the exterior of the same power station and the impressive dam that impounds the reservoir. Here, the architect gave rein to his artistic bent through the design of the massive vertical counterforts of the central spillway section, which are both handsome and functional structural components. Note also the sculptural relief panels (lower center) on the downstream exterior facade of the powerhouse. Finally, the entire hydro project seems to blend harmoniously with and mold itself into the contours and landscape of the natural background.

Architecture, acoustics, engineering—and the performing arts

Although the writer cannot entirely subscribe to the glowing promotional “puff pieces” in praise of the overall esthetic result, in the Lincoln Center for the Performing Arts in New York City we have a group of buildings—

each dedicated to specific artistic functions and occupancies—that certainly represents a grand-scale effort in contemporary interdisciplinary collaboration. In this concentration of concert halls, opera houses, and theaters, acoustical engineers, lighting engineers, and mechanical engineers have worked closely with architects and interior designers (with varying degrees of success) to match the physical esthetics and requirements of interior design with the aural beauty of fine acoustics and the visual effect of dramatic lighting.

Vivian Beaumont Theater. Four major convictions guided architect Eero Saarinen and designer Jo Mielziner in the design of the Vivian Beaumont Theater (Fig. 10), an example of this teamwork:

1. The special character of repertory theater requires simplicity, flexibility, and variety in stage and lighting arrangements.

2. The theater should provide comfort and convenience, and should concentrate every element of architectural design, mechanics, and engineering toward creating a unique experience in sight and sound for audience and actors.

3. The theater must ensure the facility for changing sets for two different productions daily, or for changing sets on short notice.

4. The architecture of the building should express the character of a theater and reflect the excitement of this performing art.

This environment has been achieved architecturally, visually, and aurally by bringing these elements into a unified scheme. Thus all the mechanical elements—acoustics, illumination, air conditioning—have been incorporated into a ribbed ceiling, which not only gives unity and scale relationship to the entire auditorium, but also emphasizes and focuses the directional lines toward the stage. As may be seen in Fig. 10, the rippled edge of the loges and the vertical ribbing of the walls are coordinated into this architectural-mechanical theme. The consistent use of a dark monochrome motif throughout the house walls and ceiling reinforces the desired psychological environment of the theater and has the added advantage, once the stage is lit, of removing the usual distraction of reflected light within the house. All this, of course, heightens the desired sense of interrelationship and participation between audience and actors.

Metropolitan Opera House. The new Metropolitan Opera House (Fig. 11) is the central theme building of the Lincoln Center complex. The \$46 million structure is the product of the collaborative efforts of architects, muralists, structural engineers, acoustical and lighting consultants, and many other artists, artisans, technicians, and craftsmen. Space limitations permit only a brief description of its numerous features.

The grand staircase in Fig. 12 is an excellent example of esthetic architectural engineering in its pleasing expanse of line, form, and scale relationship to the surrounding interior decor. The structure is essentially a monolithic, splayed arch, with bearing and support points only at the floor levels, thereby providing the long and dramatic sweep of the unsupported stairway soffits.

For acoustical purposes, the false ceiling of the house is composed of 3.8-cm-thick plaster that is suspended on springs to isolate the interior from exterior sound. This ceiling is fitted with recessed lighting troughs.

The main lighting is provided by a central “star-burst”

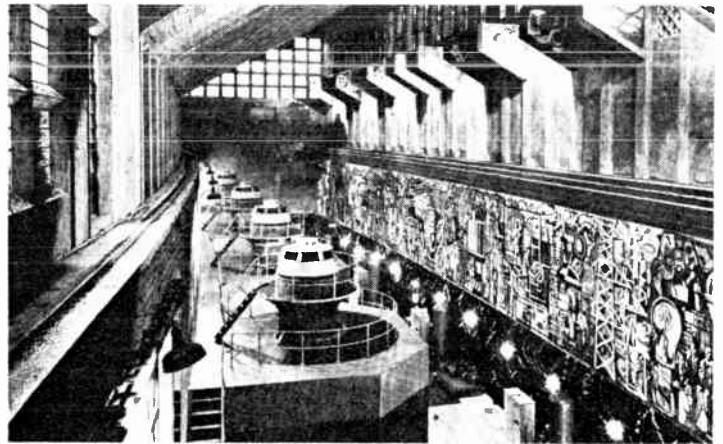

FIGURE 8. Generator room of Salime (Spain) hydroelectric project, showing elaborate mural decoration and structural forms that are at once esthetic and functional.

FIGURE 9. View of Salime Dam, in which esthetic architecture and engineering, plus sculptural motifs, harmonize in a theme of true collaboration in art and technology.



FIGURE 10. Acoustical engineering, esthetic interior design, and dramatic lighting effects combine in unique and functional patterns in the Vivian Beaumont Theater, Lincoln Center, New York.



crystal chandelier and 21 smaller satellite chandeliers, which may be raised and lowered for maintenance. A master control station, which handles the complex stage lighting, is at the rear of the orchestra. Six light bridges and eight light ladders are controlled from this station. In addition, motorized footlights permit flexibility for ballet or other special performances, and floor pockets on each side of the stage furnish complete illumination of upstage areas.

Backstage, a huge electric-motor-driven stage wagon, with a 17.7-meter-diameter turntable, permits sets for another scene to be assembled while another production is on the main stage. Completing the electric and electronic circuitry, the prompter's box is fitted with a closed-circuit television monitor that connects with the conductor and offstage assistants for audio and video communications.



FIGURE 11. The new Metropolitan Opera House, Lincoln Center, is another example of the continuing collaboration of art and technology.

FIGURE 12. The grand staircase in the new Opera House merges sound structural engineering design with the grace of architectural form and scale relationship.



Art, hydraulics, and electronics

The Lincoln Center Fountain (Fig. 13), designed by architect Philip Johnson, combines 568 water jets—with a flow of 37 000 liters per second in full operation—and 88 lights (rated at a total of 26 000 watts) for illumination. Water can be projected in heights varying from 1 to 46 meters vertically. A wind-activated device (anemometer) automatically controls the spray height according to the velocity of the wind. It can also shut down the fountain if the wind becomes too strong.

The fountain can be programmed automatically on punched plastic tape. A variety of such tapes have been prepared to permit variable sequences of esthetic and dramatic hydraulic effects. The fountain can also be controlled by master clocks for automatic operation or shut-down at any desired time during the day or night. Once initiated, however, a programmed display will run until completed, at which time the fountain spray will stop automatically. The fountain is then ready for the next programmed sequence at the time set on the master clock. A manual control console has also been installed so that on special occasions the fountain can be operated for unique display combinations. The console consists of numerous buttons, each controlling a specific display of water.

A new type of water-effects valve, to permit an instantaneous change in water direction, was used here for the first time in fountain design and construction. The pneumatically operated valve causes small jets to rise

FIGURE 13. View of the Lincoln Center Fountain. This central plaza theme motif is the result of cooperative planning among architects, hydraulic engineers, and electrical and electronics engineers.





instantly and sequentially to give the illusion of a marching hydraulic procession in any direction along the radial spoke headers of the fountain. This startlingly beautiful pattern is created by air pressure being applied to a small piston within the small-effect valves. The technique has been automatically programmed on tape to obtain a sequence of variable water patterns and effect both around the fountain and along the length of its various spokes.

All of the underwater fountain lights were specially designed to direct illumination into the water streams. The central core of the fountain has a cool blue lighting that blends subtly with the warmer tones that enhance the peripheral hydraulic sprays. The lights are automatically controlled to operate during the evening hours.

FIGURE 14. Sculptor Leo Friedlander (right) confers with superintendent of National Park Service during the erection of the Arlington Memorial Bridge equestrian groups, "Valor" and "Sacrifice," June 1951.

FIGURE 15. Appearing like a modern version of the Trojan Horse, the assembly of equestrian group "Sacrifice" required extensive wood truss bridging, plus sound structural and mechanical engineering design to ensure precision alignment.

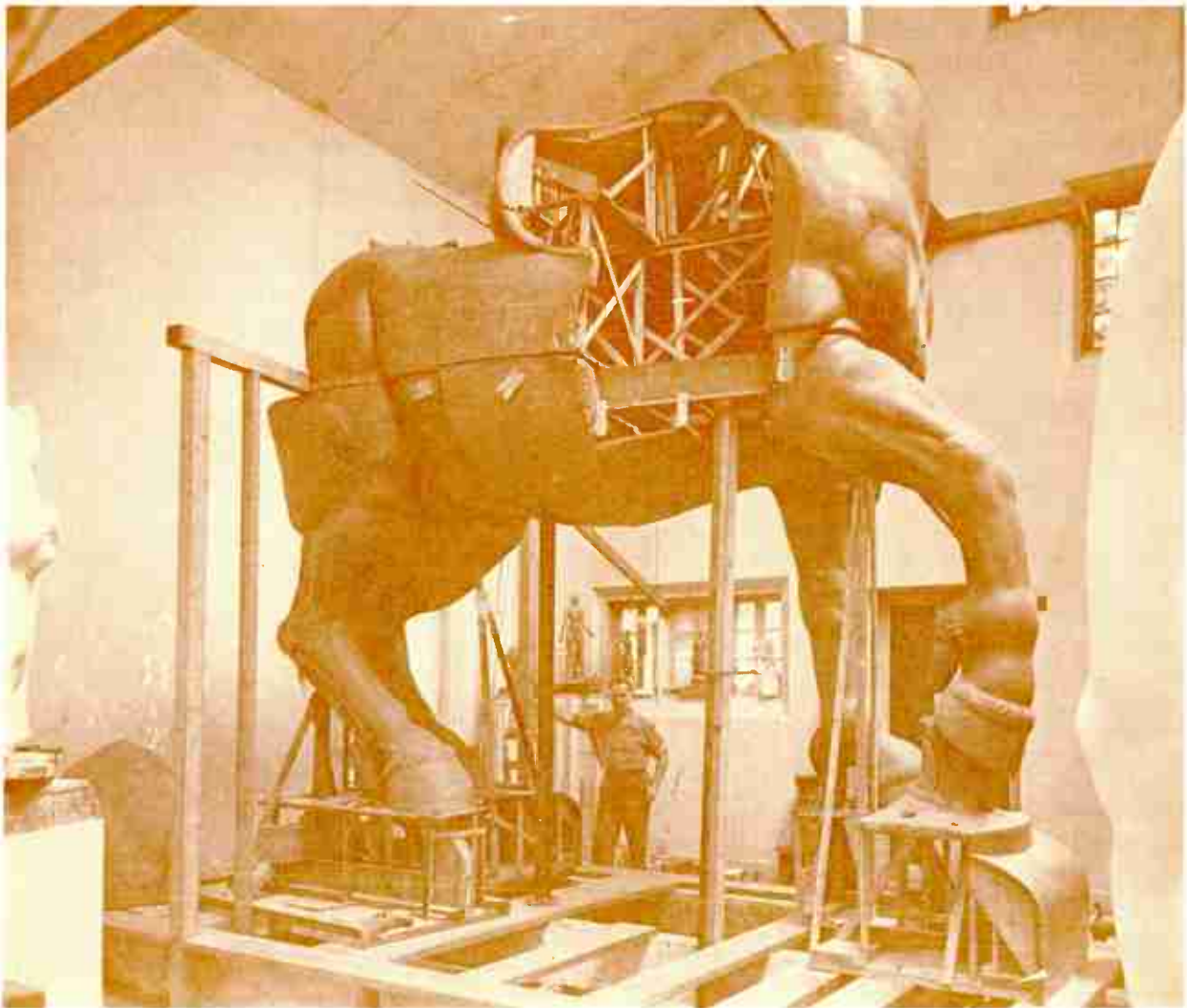

Monumental sculpture and engineering

On September 26, 1951, the largest bronze equestrian groups (6.1 meters from base to crest, exclusive of the stone pedestals) to be cast since Leonardo da Vinci's projected equestrian statue of Francesco Sforza, Duke of Milan, were dedicated by President Truman and Premier de Gasperi of Italy at the site of their installation on the Arlington Memorial Bridge in Washington, D.C. (Fig. 14). These colossal war memorials, entitled "Valor" and "Sacrifice," were designed and executed by the writer's father, Leo Friedlander. Each of the finished, gilded bronze groups weighs 11 tonnes. The project required 22 years from start to dedication.

The sculptor was initially required by the Memorial Bridge Commission (then under the authority of the U.S. Army Corps of Engineers) to prepare small-scale study models, then to enlarge the approved compositions either by direct modeling or by pantographic mechanical pointing techniques to $\frac{3}{16}$, one half, and finally, full size.

As may be seen in Fig. 15, the internal structural complexity of the full-size partial assembly of "Sacrifice" rivaled that of the fabled Trojan Horse. The works were mechanically enlarged from one half to the illustrated full size in numerous plasteline sections, then modeled and refined to the finished forms. The horse's body was bridged between leg supports by massive wood trusses to prevent any sag in the midsection that could either crack or dislodge the plasteline modeling material. When this stage was completed, the groups were next cast in plaster in more than 30 sections each, complete with Roman joints and pin connections so that they could be assembled and disassembled like a three-dimensional jigsaw puzzle.

It was the writer's responsibility to make the necessary structural engineering calculations and to design the internal plywood trusswork for the plasteline models as well as the structural pipe supports forming the interior framework of the plaster sections. Also, the mass balance and centers of gravity of sculptural works that each weighed about four tonnes in plasteline and six tonnes in plaster had to be carefully determined so that the huge equestrian groups could be rotated easily when set on fifth-wheel turntables. Further, the volumes and surface areas of the assembled groups had to be computed so that the foundries could estimate the amounts of bronze and gilding that would eventually be required.

Following the approval of the full-size models in plaster, the works were disassembled, packed, and crated with extreme care, and shipped to bronze foundries in Florence and Milan, Italy. In Italy, in a merger of art and technological disciplines spanning over 4000 years, the equestrian groups were cast by the "lost wax" process that was originally developed in ancient times and was improved in the 16th century by the famous (and notorious!) Florentine sculptor and goldsmith, Benvenuto Cellini.

Another technical problem in works of such great mass and volume was the control of bronze shrinkage when the molten metal cools at varying rates. This can be as much as one percent in volume. Thus great care had to be taken to regulate the rate of cooling evenly in the many cast sections, each of which varied in size and in quantity of poured metal.

The gold finish of the groups was obtained by the "flame gilding" process, a development of modern metallurgy. In this technique, the bronze sculptures were coated with an amalgam of gold and mercury. When the amal-

gam had set, blow torches were applied to the surfaces. At about 320°C, mercury vaporizes, leaving a residual finish of burnished gold.

A plea for planning, order, and logic

The writer has attempted to illustrate, both by historical reference and contemporary examples, that the collaboration of art and technology has been, is, and should continue to be practiced—despite Marshall McLuhan—as orderly and planned interdisciplinary ventures. Art and engineering should be considered as constructive forces often working in unison and harmony for the betterment and esthetic pleasure of mankind, not as vehicles for sophistry and unpredictable sensory thrills.

By definition, the term "interdisciplinary" indicates a merger of orderly skills, and it implies something more than the haphazard patterns produced by shrapnel bursts or the results of spontaneous and unrehearsed happenings. We are aware of recent exhibitions in which bizarre sights, sounds, and sensations have been produced by the cult of electronic gimmickry in conjunction with "op" and "pop" art practitioners. But actually, such grotesque applications make a mockery of the professions of art and engineering: chaos is not order; a happening is neither a logical nor a planned project. Under these circumstances, the criteria for the sound and successful collaboration of art and technology are swept away in an avalanche of anarchy and nihilism.

The credo of the far-out cult seems to debase the term "art" and the definition of an artist. To its advocates, apparently, anyone who plugs himself into an electronic circuit, lights up in all the colors of the rainbow, shoots fireworks out of his ears, and then collapses in a state of complete entropy is, *ipso facto*, an artist! But furious assaults upon the physical senses are temporal and, like the wasted heat and light of pyrotechnics, they are soon lost to darkness and fleeting memory.

Therefore, let the truly creative engineer draw and absorb his sense of esthetics from the schooled artist, for such an engineer will benefit society to a greater degree than will the artist who adapts his *métier* to electronic fads and shock effects. The great collaborative works of antiquity, of the Renaissance, and of contemporary culture will endure much longer in the esthetic, functional, and utilitarian service of man, society, and civilization.

Picture credits: Figure 2, Cultural Services of the French Embassy; Fig. 4, Triborough Bridge and Tunnel Authority; Figs. 8 and 9, Spanish Embassy Commercial Office; Fig. 10, Ezra Stoller Associates (for Lincoln Center); Fig. 11, Martha Swope (for Lincoln Center); Fig. 12, Joseph Costa (for Sylvania Electric Products, Inc.); Fig. 13, Guy Gillette (for Lincoln Center); Fig. 14, Abbie Rowe, National Park Service.

REFERENCES

1. Asimov, I., *Asimov's Biographical Encyclopedia of Science and Technology*. Garden City, N.Y.: Doubleday, 1964.
2. Williams, T. I., *A Biographical Dictionary of Scientists*. London: Adam & Charles Black, 1969.
3. Friedlander, G. D., "A center for shockproof shopping," *Civil Eng.*, pp. 44-47, Dec. 1961.
4. Friedlander, G. D., "Birth of the 'new city': An exciting creation," *IEEE Spectrum*, vol. 4, pp. 70-82, Apr. 1967.
5. Friedlander, G. D., "Esthetics and electric energy," *IEEE Spectrum*, vol. 2, pp. 46-55, June 1965.

Gordon Friedlander's biography appeared on page 43 of the February issue.

Thick films or thin?

Recently, hybrid circuits have found greater use because of their power-handling capability and high reliability. However, the choice of which film technology to use in circuit development is more than a simple matter of dollars and cents

Rudolf E. Thun
Raytheon Company

It is sometimes difficult to decide between thick-film and thin-film technologies in the fabrication of hybrid integrated circuits consisting of a ceramic substrate with deposited passive components and attached active devices. In the case of thick films, the deposited pattern of conductors, resistors, capacitors, and inductors is applied to the substrate by screen-printing and firing special conductive, resistive, or dielectric pastes. Thin-film layers, on the other hand, are deposited in vacuum by evaporation or cathode-sputtering of appropriate source materials. This article discusses the advantages and disadvantages of both technologies as well as their application ranges.

In the late fifties, it became quite apparent that due to the increasing complexity of electronic systems, particularly computers, significant size and cost reductions as well as improvements in system reliability were required, and that these could best be achieved by switching from the assembly of individual component parts to batch fabrication processes—in other words, by developing “integrated circuits.” Since this requirement coincided with a flurry of new device discoveries evolving out of thin-film research in magnetics, semiconductors, superconduction, and electron tunneling, industry was tempted to develop common-substrate component arrays of these exotic devices. These efforts failed—at least for the time being—due to the cumulative difficulties of simultaneously productionizing a wide range of interrelated advanced research projects. Only two technologies were at the time (or even today) sufficiently industrialized to provide a realistic base for the low-cost manufacture of complex integrated circuits: the planar silicon transistor process, which led to monolithic circuits, and the art of depositing planar resistors and capacitors, which provided the base for hybrid integrated circuits.

Since monolithic circuits combine active and passive elements in a single structure at high component densities, they can be manufactured economically with very little automation. Hybrid circuits, on the other hand, are handicapped by the necessity for attaching transistors and diodes, and by their greater bulk, which limits the number of circuits coprocessed at any one station. As a consequence, monolithics conquered the largest share of the integrated circuit market, and hybrids were largely confined to applications requiring some precision components, power-handling capability, or small production

runs that could not support the higher tooling costs of monolithics.

Lately, however, hybrid circuit technology is undergoing an impressive resurgence. This is caused by a number of factors:

1. The necessity for size reduction forces the use of microelectronic techniques in more and more subsystems. Because of shorter design time, higher power-handling capability, and easier conversion from discrete-component breadboards, hybrid circuits are favored over monolithics for many analog and special digital circuit applications in complex military and commercial systems.

2. Pressures for low cost and high reliability force the integration of many mass-produced circuit functions, which—because of high power or voltage requirements—can be implemented better in hybrid than purely in monolithic form. Hybrids are being used in the television, automotive, and instrumentation industries.

3. Despite the rapid growth in integration levels achieved in bipolar, and particularly MOS, monolithic technologies, various difficulties are encountered in extending device complexity. Decreasing yields, difficulties in obtaining error-free masks, and the complexity of automatic test programs tend to restrict the monolithic component count to a level below that desirable from the viewpoint of system partitioning. In such a case, thick- or thin-film hybrids can be used as high-density interconnection boards for a number of MSI or LSI devices. Because hybrids accept unpackaged chips and provide better line densities and power-handling capabilities than printed circuit boards, considerably higher packaging densities can be obtained than by the alternative approach of mounting LSI devices on individual headers, and mounting the headers in turn on printed circuit cards. This packaging approach is often referred to as “hybrid LSI” and is becoming quite common in sophisticated logic or memory systems.

Now that we have established the reasons for using film circuits, we have to answer the question, “Thick films or thin?” A comparison of both technologies encompasses the areas of process technology, performance characteristics, and, finally, packaging and reliability.

Film circuit process technologies

In thick-film technology, the materials for conductors, resistors, and dielectrics are specially prepared inks. A mixture of metal and glass powders in an organic binder

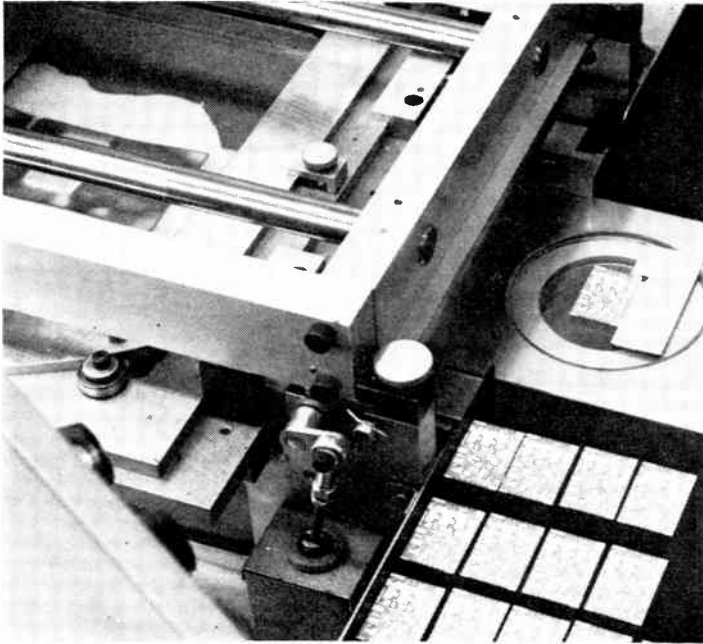
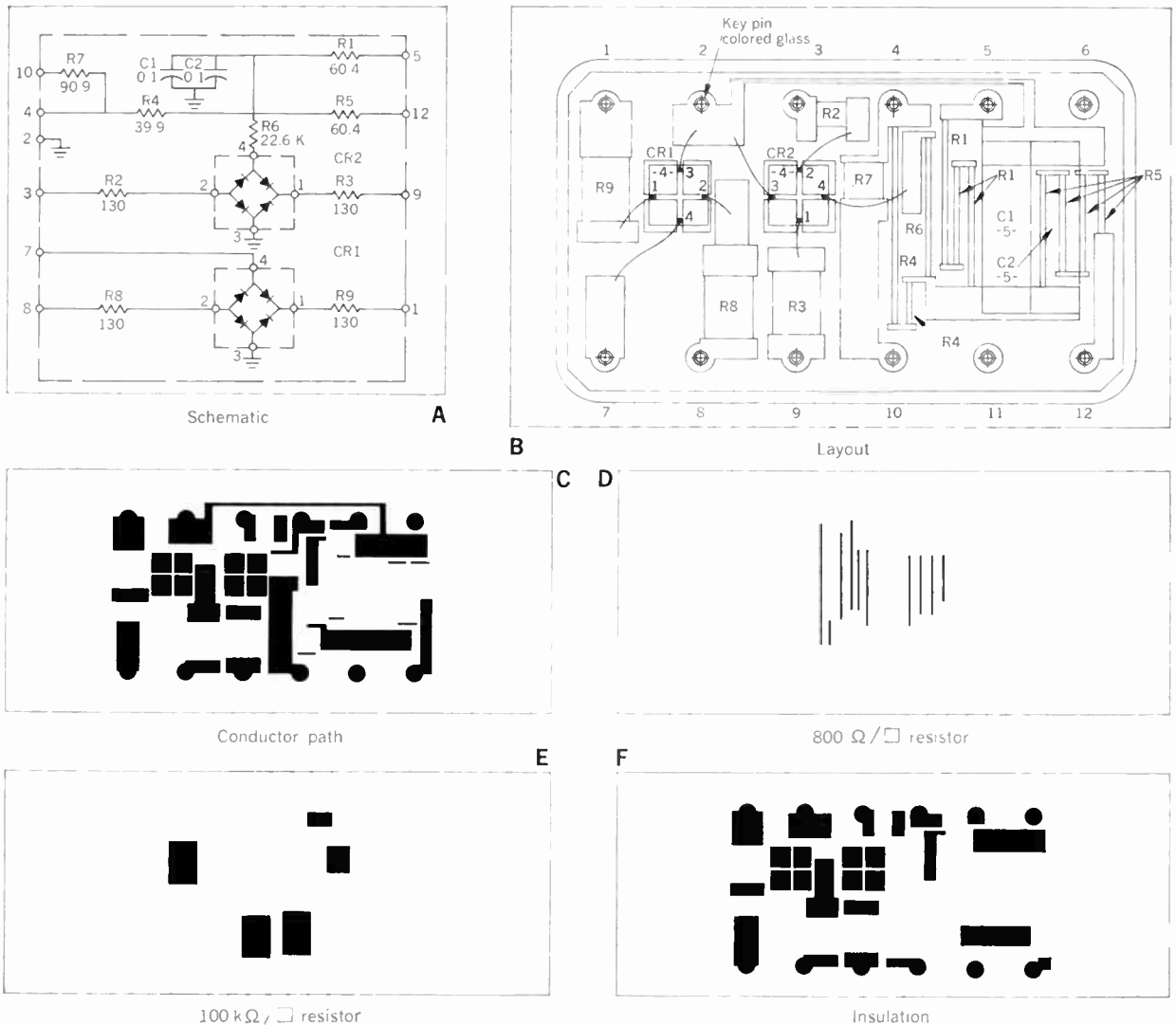

FIGURE 1. Screen printer used in thick-film manufacturing.



FIGURE 2. Laboratory workers prepare processed screen for insertion into firing furnaces.

FIGURE 3. Design sequence for thick-film production.



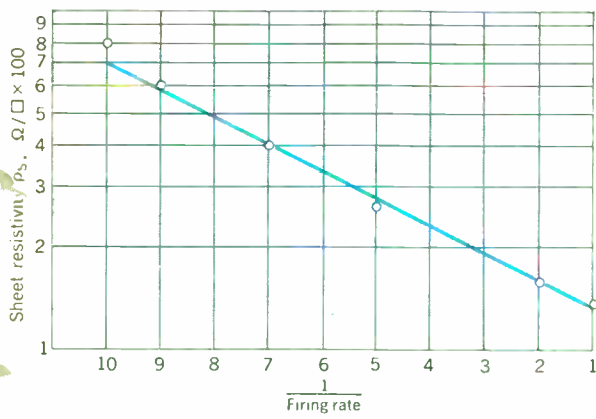
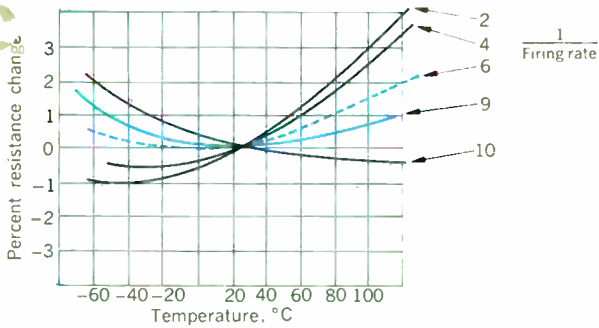

FIGURE 4. Firing characteristics of a resistor composition.

FIGURE 5. Temperature coefficient of a fired resistor.



is used for resistors and conductors; and powdered dielectrics (with binder) are used for insulating layers, capacitor dielectrics, and protective overcoats.

These inks are applied through a photographically formed stencil mask that consists of a metal mesh screen coated with an emulsion (silk screen). After the pattern has been screened onto a ceramic substrate and dried, it is fired in a furnace at temperatures from 500°C to 1200°C; this burns off the organic binder and refloWS the glass frit. The screening and firing equipment are quite simple. Figure 1 shows a typical screener. It consists mainly of a frame with a sled (far left, only partially visible), which, during its stroke, presses ink through the screen. In Fig. 2 lab workers place inked circuit substrates on a belt that passes them through the firing furnace.

Figure 3 indicates the straightforward sequence with which a breadboard circuit can be converted into a thick-film circuit.

Although thick-film processing equipment is simple, the underlying materials technology is complex and not too well understood. Moreover, the important process parameters such as particle-size distribution, ink composition, uniformity of mixing, ink viscosity, firing temperature, firing rate, firing atmosphere, and type of protective overcoat are difficult to control. Figures 4 and 5 give examples of how sensitive thick-film properties (in particular resistor properties) are to process parameters. Thus, it is not surprising that thick films rarely approach thin-film performance with regard to component tolerances and long-term stability.

Thin-film processing technology is just the opposite.

Thin—Thick films or thin?

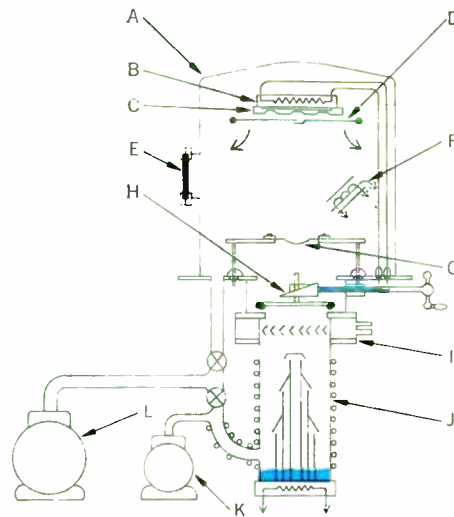
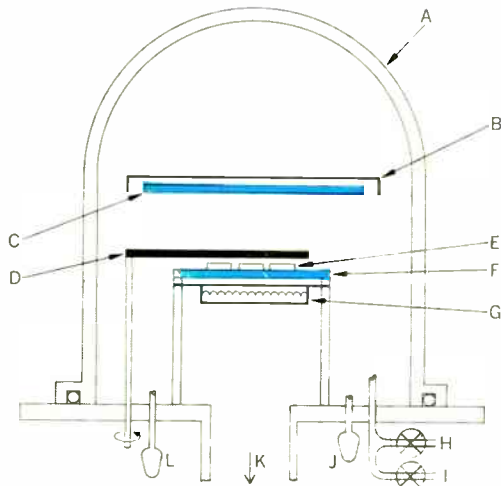

FIGURE 6. Diagram of a thin-film evaporation system. A—Bell jar. B—Substrate holder with heater. C—Mask. D—Shutter. E—Window. F—Ion gauge rate monitor. G—Evaporation source. H—Main valve. I—Cooling baffles. J—Diffusion pump. K—Mechanical holding pump. L—mechanical roughing pump.

FIGURE 7. Diagram of a thin-film sputtering system. A—Bell jar. B—Grounded cathode shield. C—Cathode. D—Rotatable shutter. E—Substrates. F—Grounded anode. G—Substrate resistance heater. H—Inert gas leak valve. I—Reactive gas leak valve. J—Ionization gauge. K—Exit to high vacuum valve, liquid nitrogen, and pump. L—Pirani gauge.



The vacuum equipment primarily used for thin-film deposition is much more complicated and expensive, as are the processing cycle and its labor content; but critical process parameters are less numerous and more amenable to scientific analysis and control.

Two methods are available for thin-film deposition: evaporation of the source material in high vacuum, and cathode sputtering in a low-pressure glow discharge. Figures 6 and 7 illustrate the apparatus used in the two processes.

Since evaporation rarely allows the stoichiometric transfer of alloys or compounds, cathode sputtering has gained increasing importance during the last ten years.

I. Sputtering methods

Method	Advantages	Materials
DC diode	High rate, simple	Metals, semiconductors
DC multiplate systems	Lower pressure	
Bias dc	High cleanliness	
Radio frequency	Sputters insulators	Dielectrics (metals)
Radio frequency with discharge support	Lower pressure	
RF bias	Better control of asymmetry	
Inert	High purity	Metals, dielectrics, semiconductors
Reactive	...	Compounds
Multisource systems	...	Metal-metal, metal-dielectric
Sputter etching	...	Contaminations, surface layers, photoresist

Numerous new sputtering methods have been developed, such as radio-frequency sputtering, which permits the tailoring of processing parameters to suit a particular material (Table I).

Industry invested many dollars to develop techniques of evaporating (or sputtering) completed film pattern through stencil masks (analogous to the printing of thick films through silk screens). But because of the almost insurmountable problems of mask stress and particle contamination encountered in this approach, evaporation through masks has been largely abandoned—at least for intricate patterns. Instead the films are laid down in continuous sheets covering the entire substrate area, and the patterns are subsequently etched by photolithographic methods.

After being coated with photoresist and baked, the substrates are exposed—thin-film side up—to photomasks in special mask aligners (this is very much like the process in which the silicon slices used in the manufacture of transistors or integrated circuits are processed). The next step is the development and selective dissolution of the

II. Etchants for selected deposited films

Deposited Film	Possible Etchant	Comments
Aluminum	Ferric chloride Sodium hydroxide	Tantalum, titanium, gold, and platinum unaffected by these etchants
Chromium	Hydrochloric acid	Sulfuric acid also will work but is less desirable
Copper	Ferric chloride, concentrated hydrochloric acid Ammonium persulfate	Also for high-copper alloys
Gold	Aqua regia	
Molybdenum	Concentrated sulfuric acid, diluted nitric acid	Can also be etched anodically in chromic acid
Nichrome	Concentrated hydrochloric acid and water	Suitable for nickel and nickel-base magnetic alloys
Platinum	Aqua regia	Also for platinum alloys
Silicon	Ferric chloride, concentrated nitric acid, and concentrated hydrofluoric acid	
Silicon dioxide	Saturated aqueous solution of ammonium fluoride	Removes about 100 nm of oxide per minute
Silver	Ferric nitrate	Dilute nitric acid may also be used but is less desirable
Tantalum	Concentrated hydrofluoric acid, diluted nitric acid	Gold and nichrome unaffected by this etchant, but on glass these may slough off if not protected
Titanium	Diluted hydrofluoric acid	Gold, nichrome, and tantalum unaffected by this etchant

III. Properties of bulk metals and alloys used for the preparation of thin-film components

Metal	Specific Resistivity, 20°C, Ω·cm	Temperature Coefficient of Resistivity, ppm/°C	Melting Point, °C	Vaporization Temperature, °C
Aluminum	2.69	4200	659	1082
Chromium	19.0	5880	1903	1267
Copper	1.67	4300	1083	1132
Gold	2.30	3900	1063	1252
Nickel	6.84	6844	1455	1382
Niobium	13.1	3950	2497	2447
Palladium	10.8	3770	1550	1317
Tantalum	13.5	3800	2997	2817
Titanium	55	3500	1667	1577
Tungsten	51.5	4600	3377	2977
Nichrome (80/20)	107	400	1395	...

photoresist that forms the etch mask. Finally, the thin film itself is etched. When circuit substrates containing various conductor, resistor, and dielectric layers are processed, the need for selective etchants creates a rather complex processing technology (Table II). The metals most useful for thin-film circuits are given in Table III together with some pertinent physical properties.

The properties of thin films are quite sensitive to changes in such deposition parameters as source temperature, deposition rate, residual atmosphere, substrate temperature, substrate surface, and composition of the film material. This makes thin-film deposition one of the most difficult industrial processes. These problems cannot be discussed here in detail, but two examples may serve as an illustration: Figure 8 shows the specific resistivity and composition of nichrome films as a function of film thickness, and Fig. 9 depicts the influence of the source temperature on the magnitude of the mechanical stress encountered in silicon monoxide films. Control of the mechanical stress in thin films is, of course, important to avoid delamination and stress-induced solid diffusions.

Cost comparison

The wide product range covered by hybrid circuits makes it difficult to provide a cost comparison between thick films and thin films. Factors such as component tolerances, circuit complexity, quality control requirements, production volume, and price of associated components influence total circuit cost to a much larger degree than the deposition technology itself. Nevertheless, a few observations on the relative cost picture seem appropriate even though they should be treated with caution.

There is no question that for the low-cost consumer market, thick-film technology has a clear cost advantage since substrates require less surface finish, and screening and firing have a very small labor content when compared with photomasking and etching. The yield too is higher because of greater film thickness and the mechanics of the deposition process.

The same cost advantage holds true for thick films in a laboratory and pilot-line environment, but for somewhat different reasons. First of all, the initial capital investment is smaller. A thick-film firing and screening facility with an annual capacity of about half-a-million circuits can be established for less than \$100 000, excluding resistor trimming equipment. A thin-film facility of similar capabilities will approach a cost of \$500 000 because of the more sophisticated clean-room requirements and the relatively expensive vacuum-deposition and photoengraving equipment needed. A second reason is the more demanding design effort necessary to lay out thin-film circuits that are often designed for a higher component density. The cost of fabricating prototype circuits, however, is less important than the development cost per circuit type. In the experience of the author, this average cost of developing a circuit from breadboard to delivery of a certain number of sample circuits is (for typical aerospace hybrid circuits) about 50 percent higher for thin than for thick films. (Development cost for such a hybrid circuit falls between \$1000 and \$3000, depending on complexity.)

The manufacturing cost for complex hybrid circuits, on the other hand, does not depend upon film-deposition technology. Precision hybrid circuits cost anywhere from

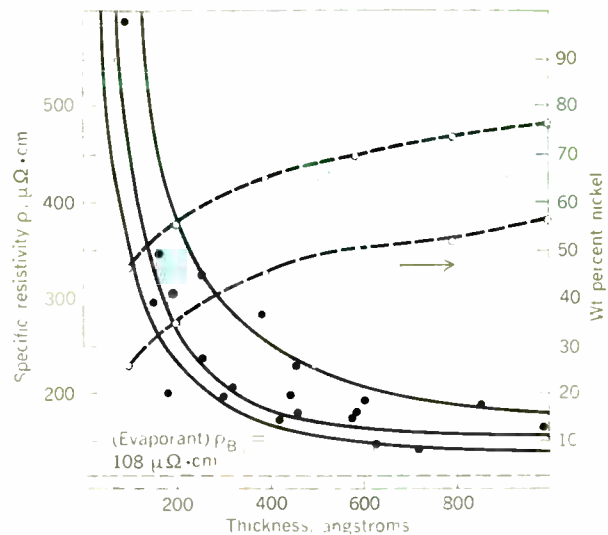
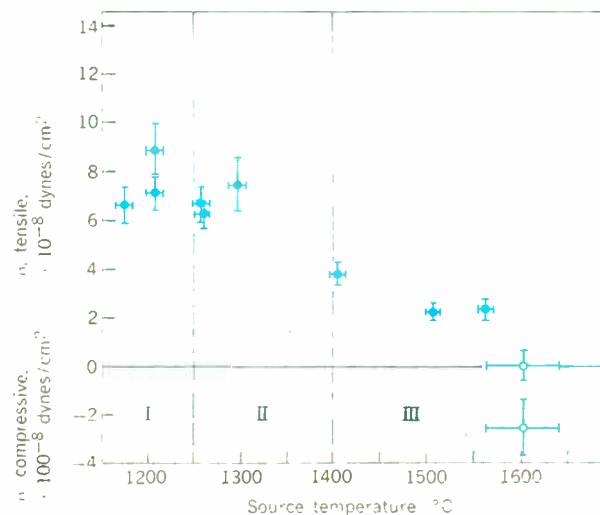

FIGURE 8. Resistivity and composition of nichrome films as a function of film thickness.

FIGURE 9. Stress of silicon monoxide films deposited on nickel substrates as a function of source temperature.



ten to a few hundred dollars in moderate production quantities. Most of this is the costs of components, assembly, and test, and not the cost of the film substrate, which rarely exceeds a few dollars. In other words, in the product areas of computers, test equipment, and military electronics, thick-film and thin-film hybrid circuits are cost-competitive. Here, the selection of the best fabrication technique must be based on a detailed analysis of the available manufacturing resources and the given component and circuit specifications.

Recent processing developments

The previous discussion has shown the respective advantages of thick and thin films. Thick films require less costly capital equipment and are cheaper to develop and manufacture. In use, they're rugged and work in high humidity, in corrosive atmospheres, and under high power loads. Thin films, on the other hand, provide resistors, capacitors, and inductors with closer tolerances

IV. Deposition methods

Method	Thick-ness, μm	Substrate Temperature, $^{\circ}\text{C}$	Usage	Materials	Remarks
Evaporation in vacuum	0.01-5	10^2	Circuit patterns	Atomic metals, some inorganic dielectrics	Clean, controllable, but problem of decomposition
Ion beam deposition	<0.1	$10-10^3$	Semiconductor doping	Not fully established	Mainly for dopants, not fully developed
Cathode sputtering	0.01-2	10^2	Circuit patterns	Metals, alloys, inorganic compounds	Controllable, provides nearly stoichiometric deposition
Vapor decomposition	~ 0.1	10^2-10^3	Insulation and protection	Refractory metals, oxides, nitrides	Clean, less expensive than evaporation or sputtering
Polymerization from vapor phase	0.1-3	$10-10^2$	Insulation and protection	(Organic) polymers	Moisture problems with thin organic films
Flame spraying	1-100	$5 \times 10^2-10^3$	Not exploited	Metals, some simple inorganic dielectrics	Has potential—not fully explored in electronics
Screening and firing	10-100	$5 \times 10^2-10^3$	Circuit patterns	Molybdenum, noble metals, glasses	Low-cost batch process—but not easily controlled
Decal transfer and firing	1-10	$5 \times 10^2-10^3$	Special patterns	Noble metals, glasses	Alternative to screening in limited use
Sedimentation and firing	1-100	$5 \times 10^2-10^3$	Insulation and protection	Primary glasses	Requires postprocessing to provide structured pattern in film
Electrodeless plating	0.1-100	$10-10^2$	Conductor patterns	Chrome, nickel, noble metals	Often adhesion problems
Electroplating	0.1-100	$10-10^2$	Conductor patterns	Chrome, nickel, noble metals, refractory metals	Supplemental to evaporation or sputtering to form thicker films
Interface reactions (gas-solid and liquid-solid)	0.01-0.5	10^2-10^3	Insulation and protection	Oxides, nitrides, carbides	Can provide dielectric or protective films

V. Comparison of integrated components in thick- and thin-film technologies

	Thin Films	Thick Films
Conductors		
Line width, μm	Etched: 12 Stencil mask: 127	Etched: 50 Screened: 254
Line crossings per square cm (measure of interconnection density)	Etched (12- μm lines): 15×10^4 Stencil mask: 15×10^3	Etched: 93×10^3 Screened: 390
Film thickness, μm	2 to 10	25
Sheet resistivity, ohms/square	0.005-0.01	0.01-0.1
Resistors:		
Sheet resistivity, ohms/square	10 to 1000	1 to 200 000
Temperature coefficient, ppm/ $^{\circ}\text{C}$	± 100	+100
Resistor tolerance (trimmed, end of life), %	0.01	0.1 to 0.2
Power dissipation, watts/ cm^2	1.6 to 4.75	5.4
Resistance density, megohms/ cm^2	0.15	15.5
Drift, % per 1000 hrs at 150°C	0.1	0.2
Capacitors:		
Dielectric constant	3 to 1000 (rutile)	4 to 1000 (ceramic)
pF/ $\text{cm}^2/\mu\text{m}$ thickness	1860 (rutile)	15 500 (ceramic)
Breakdown strength, volts	100	300
Dielectric thickness, μm	1 to 2	25 to 50
Capacity, pF/ cm^2	23 300 to 46 500 (rutile)	7750 to 15 500 (ceramic)

and less drift. The interconnection density and (except for resistors) the component density can be considerably higher. Furthermore, since thin metal films can be deposited with close to bulk properties, capacitors and inductors can be obtained with lower loss tangents. In addition, thin films are more suitable for an extreme nuclear radiation environment because many low-atomic-weight materials can be vacuum-deposited, whereas thick-

film conductors and resistors are almost exclusively based on heavy noble metals.

Naturally, the question arises: Why thick films or thin? Might it not be possible to combine materials and processes to obtain better results? And are silk-screening and vacuum deposition really the only suitable methods for fabricating hybrid film circuits?

As Table IV shows, there are indeed other processes

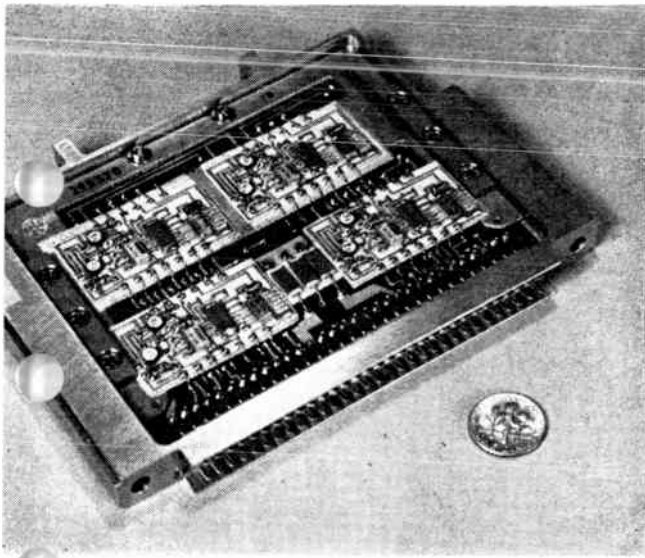

FIGURE 10. Four thick-film hybrid circuits mounted on a common module. This unit is used in airborne equipment.

usable for depositing electronic film components. In particular, chemical plating finds widespread application in the fabrication of MICs (microwave integrated circuits). Such hybrid microwave circuits primarily use microstrip conductors, but often contain film termination resistors and decoupling capacitors as well. Moreover, to obtain the best of all worlds, various process technologies can be mixed in the fabrication of complex multilayer hybrids.

When used as crossover isolation, screened glasses, for instance, give a better yield and lower capacitive coupling than evaporated or sputtered dielectrics because of their greater thickness, smaller mechanical stress, and, in most cases, lower dielectric constant. For high-density multilayer interconnections, thick films are often used for the first interconnection layer and the insulation, and a vacuum-deposited metal for the other layers. This technique achieves a higher line density.

Advantageous combinations of technologies are numerous. A vacuum-deposited layer can be plated chemically to improve its conductance. In particular, a film might be selectively plated through openings in a photo-resist layer, or a thick screened film is deposited as a continuous sheet and then photoetched to achieve narrower and more densely spaced conductors or resistors. Within the constraints of this article, it simply is not possible to discuss even those deposition combinations that already have proved their worth. However, it seems quite clear that the technology for fabricating hybrid microcircuits is, at present, again in a state of flux.

Application examples

In conclusion, it might be worthwhile to list typical component values that can presently be obtained with either thick-film or thin-film techniques. Such a list has been compiled in Table V for conductors, resistors, and capacitors. Naturally, the component values obtained in a particular circuit design might not approach the listed data because of design, materials, or processing constraints.

In addition, an example of a modern thick-film circuit design is presented in Fig. 10, which shows an electronics panel for airborne applications that contains four thick-film hybrid circuits. These hybrids are typical analog circuits. Each consists of a screened resistor and interconnection substrate with attached ceramic capacitors and hermetic semiconductor packages. The thick-film resistors are sufficiently rugged to pass military specifications without resorting to a hermetic package, an advantage that considerably reduces overall packaging cost.

In reality, then, it isn't a question of thick films or thin. Rather, recent development trends emphasize the use of a wide variety of deposition methods to optimize the electronic capabilities of hybrid integrated circuits.

BIBLIOGRAPHY

Thin-Film Papers

- Gregor, L. V., and Jones, R. E., "Thin film conductors and insulators," *Solid State Technol.*, vol. 2, pp. 40-46, May 1968.
- Lessor, A. E., Maissel, L. I., and Thun, R. E., "Thin-film circuit technology, part I," *IEEE Spectrum*, vol. 1, pp. 72-80, Apr. 1964.
- Needham, V., and Ebdon, A. J., "Thin film circuits," *Lucas Eng. Rev. (G.B.)*, vol. 4, pp. 52-57, May 1968.
- Schmitt, R. W., "Thin films," *Internat'l Sci. Technol.*, Feb. 1962.
- Colloquium on electronic properties of thin films, *J. Phys. (France)*, vol. 29, suppl. pp. C1, C2, and C165, Feb.-Mar. 1968.
- Proc. 1968 IEEE Microelectronics Symp.*
- Progress in thin film circuit production techniques, *Compon. Technol. Progress in thin film (G.B.)*, vol. 3, pp. 30-34, May 1968.

Thick-Film Papers

- Tramoschi, R. F., and Miller, W. A., "Novel preparation of microminiature thick film circuits," *Proc. 1968 IEEE Microelectronics Symp.*
- First unofficial thick-film symposium, London, *Microelectronics and Reliability*, vol. 7, May 1968.
- Proc. 1968 Hybrid Microelectronics Symp.*, Western Periodicals Co., North Hollywood, Calif.
- Special thick-film issue, *Solid State Technol.*, vol. 9, June 1966; vol. 10, June 1967; vol. 11, June 1968; vol. 12, June 1969.

Books

- Berry, R. W., Hall, P. M., and Harris, M. F., *Thin Film Technology*, Bell Telephone Laboratories Series. Princeton, N.J.: Van Nostrand, 1968.
- Hass, G., and Thun, R. E., eds., *Physics of Thin Films*, vols. 2 and 3. New York: Academic Press, 1966.
- Holland, L., *Vacuum Deposition of Thin Films*. New York: Wiley, 1956.
- Marshall, S. L., ed., *Microelectronics Technology*. East Stroudsburg, Pa.: Cowan Publishing Corp., 1968.
- Thick Film Handbook A-62319*, E. I. du Pont de Nemours & Co., Inc., Electrochemicals Dept., Electronic Products Div., Wilmington, Del.

Rudolf E. Thun (SM) received the diploma and Ph.D. degree in physics from the University of Frankfurt a.M., in 1954 and 1955 respectively. He is manager of the Electronic Product Design Laboratory at Raytheon, Bedford, Mass. Previously, he held the position of manager of microelectronics and was technical director of Raytheon's Commercial Component Division. Prior to joining Raytheon, he was employed by IBM, the U.S. Army Laboratory at Fort Belvoir, and the Degussa in Germany. Dr. Thun has



published a number of papers on microelectronics, thin films, physical optics, X-ray and electron diffraction, vacuum technology, and materials research and has contributed to the "Encyclopedia of Physics." He is a member of the Electron Microscope Society, Optical Society, Physical Society, and Scientific Research Society.

New product applications

Two new operational amplifiers offer a variety of application possibilities

Two new op amps just introduced by Philbrick/Nexus Research, Allied Drive at Route 128, Dedham, Mass. 02026, have many potential applications.

The Model 1405 High-Performance

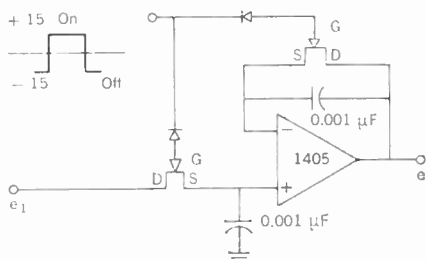

FIGURE 1. Sample and hold circuit.

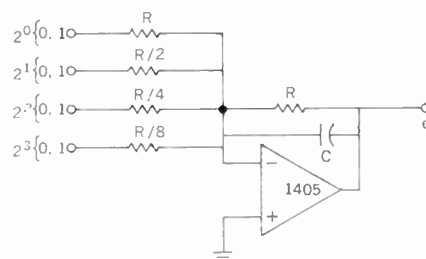

FIGURE 2. A 4-bit D/A converter.

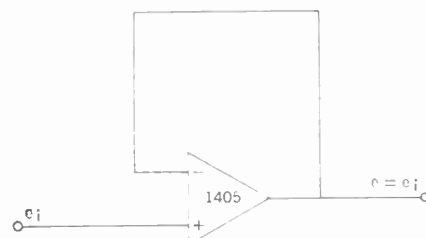
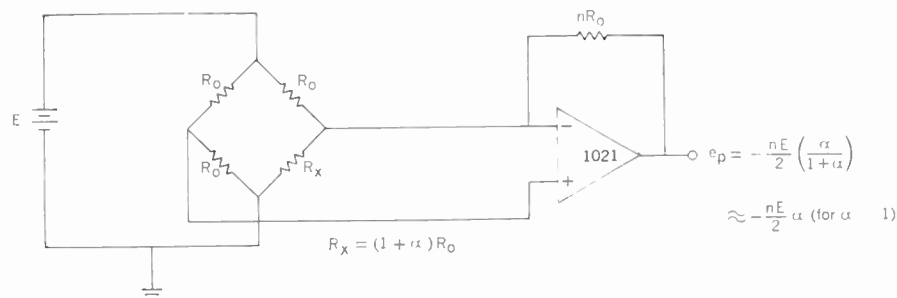

FIGURE 3. Fast follower circuit.

FIGURE 4. High-impedance bridge amplifier.



FET Input Hybrid Op Amp provides high-speed operation over a wide bandwidth — up to 1 MHz at full output and 10 MHz for small signals. It is especially suited for use in high-speed applications such as D/A and A/D converters, integrators, function generators, sampling, and video amplifiers.

The unit has a settling time of 5 μ s to 0.01 percent, which is of particular interest to designers with pulse applications. Construction of the 1405 includes a combination of thick and thin films mounted on separate substrates. Figures 1, 2, and 3 show some typical applications.

In Fig. 1, a sample and hold circuit, the logic voltage is applied simultaneously to the gates of two switching FETs. By matching the input and feedback impedance levels and time constants, the errors due to phase shift and voltage drops across the junctions are minimized.

In Fig. 2, a 4-bit D/A converter, the rapid slewing rate and fast settling time of the Model 1405 are used to advantage. The quick response of the amplifier is required in order to track the fast switching time of the digital inputs. The value of capacitor C should be small so as to have as little effect on the speed of the output as possible but it should be large enough to maintain stability.

In Fig. 3, a fast follower, the symmetrical input stage of the Model 1405 unit gives equal frequency response when used either as an inverter or a follower.

Circle No. 86 on Reader Service Card

The Model 1021 High-Performance FET Input Op Amp is a low-cost unit. It has an extremely high common mode rejection ratio (CMRR) of typically more than one million.

Suggested applications for the Model 1021 include its use as a follower, subtractor, voltage comparator, or in any other differential application.

The Model 1021 unit is an excellent choice as a high-impedance bridge amplifier as shown in Fig. 4. The very low bias currents and high CMRR aid in minimizing the errors in the bridge circuit. For circuits where α is small in comparison with 1, the output voltage is directly proportional to the value of α .

In a peak-detector circuit, Fig. 5, the extremely high input impedance and very low bias currents of the Model 1021 unit minimize the errors that the amplifier contributes to the output voltage. In this circuit, diodes D_1 and D_2 — low-leakage silicon diodes — are a first-order compensation for the voltage drop across diodes D_1' and D_2' .

In the buffer amplifier application of Fig. 6, the inherent stability and low drift characteristics of the amplifier make it well suited for unloading high-impedance sources such as high-impedance transducers or for taking biological measurements.

Circle No. 87 on Reader Service Card

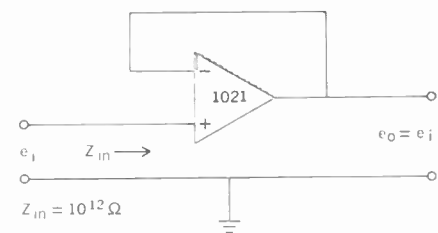
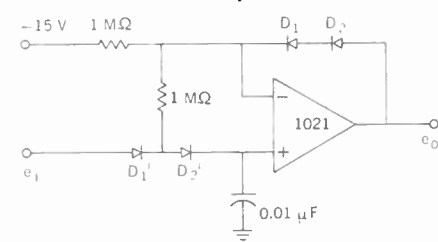

FIGURE 5. Peak detector.

FIGURE 6. Buffer amplifier.



New product applications

Modular lock-in amplifier measures small signals buried in noise

The Model 220 Lock-In Amplifier provides signal recovery capability previously attainable only from larger rack-mounted instruments. It measures the amplitude of a low-level signal of constant frequency in the presence of noise. It is continuously tunable over a frequency range of 1 Hz to 110 kHz with an output filter whose time constant is variable from 1 ms to 30 seconds. Figures 1 through 4 show some typical applications for the lock-in amplifier.

The minimum detectable signal in many low-level data-processing systems incorporating several amplifiers located in close physical proximity is dependent upon the amount of crosstalk or mutual interference generated. Because the crosstalk level is usually extremely low, it is difficult to measure by standard techniques. The use of a lock-in amplifier, as shown in Fig. 1, provides a straightforward and reliable method of routinely performing this measurement.

In all standard bridge measurements a compromise between null sensitivity and bridge input power is usu-

ally required. If standard techniques are used, attempts at greater precision and null accuracy can lead to overdriving the bridge circuit, introducing inaccuracy as the result of self-heating or distortion.

A lock-in amplifier can be used to eliminate the overload problem, as shown in Fig. 2. The bridge is excited by the internal oscillator input of the bridge. The external null detector terminal of the bridge is connected to the signal input connector of the lock-in amplifier.

The open-loop gain of high-performance operational amplifiers can be measured by monitoring the summing point voltage while operating the amplifier in its normal closed-loop configuration. The problem usually encountered in this measurement is the difficulty in accurately recording the summing point voltage over a wide frequency range. The use of a lock-in amplifier, as shown in Fig. 3, simplifies this measurement because of its capability for monitoring the extremely low-level summing junction voltage. Since the operational amplifier can be

set in its normal operational configuration, very accurate and stable measurements of the open-loop gain can be easily accomplished.

The resistance of precious metal wire, high-quality commutating switch contacts, precision attenuators, and other extremely low impedance devices must often be measured accurately at very low power dissipation. The use of dc methods is limited by random thermal voltages, temperature rise due to dissipation in the element, and drift and noise in the dc detection system.

A lock-in amplifier can be used to effectively measure these low-impedance devices and eliminate the problems. The reference output of the amplifier, Fig. 4, through a relatively high resistance, serves as an ac constant-current source. The small voltage developed across the low-resistance device can then be measured easily by the high sensitivity of the lock-in amplifier.

A similar technique can be used to measure and record the ac output impedance of dc power supplies and power amplifiers over a wide range of frequencies.

For more information contact Princeton Applied Research Corp., P.O. Box 565, Princeton, N.J. 08540.

Circle No. 88 on Reader Service Card

FIGURE 1. Amplifier crosstalk measurement.

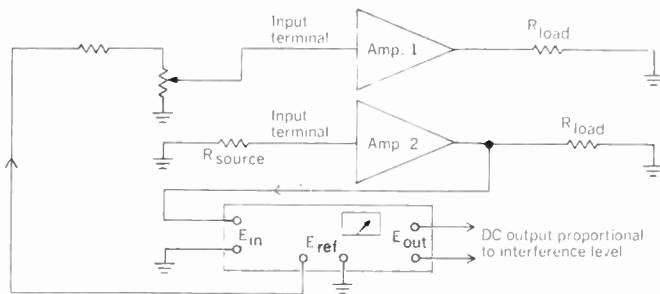

FIGURE 2. Bridge oscillator/null detector.

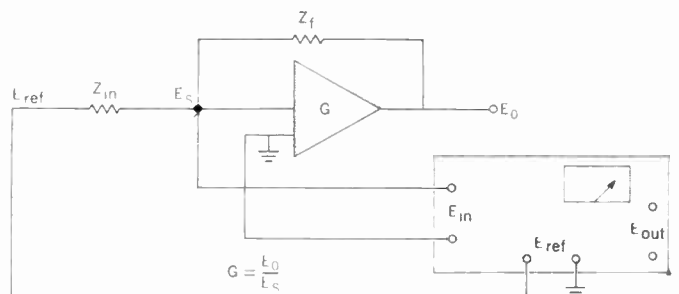

FIGURE 3. Op amp open-loop gain measurement.

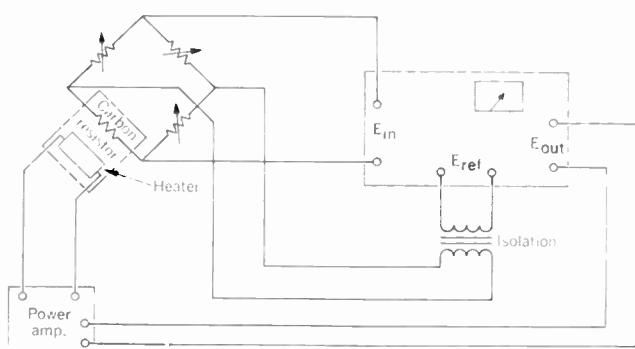
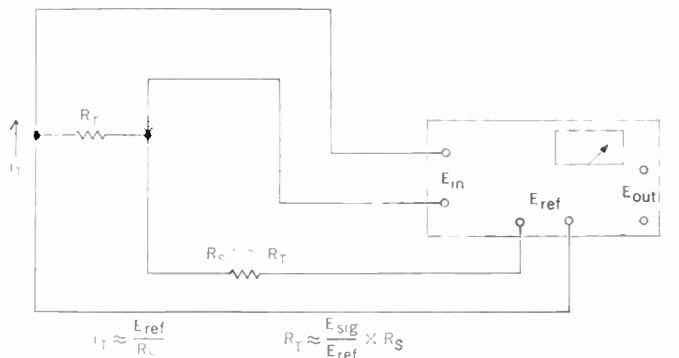

FIGURE 4. Low-level impedance measurement.



New product applications

Synchro repeater simplifies digital displays

A new Size 11, DC Synchro Repeater, CR4 0928 001, is designed for use as a torque repeater in displays operating directly from sources such as digital or pulse analog computers. More directly computer-compatible and simpler to drive than ac counterparts, the repeater functions when its two stator windings are energized by dc voltages proportional to the sine and cosine of an angle, causing its permanent magnet rotor to orient in the resultant field to an equivalent angular position.

Since the device is a dc equivalent of a conventional ac synchro torque repeater, it can simplify repeater indicator displays for A/D and D/A conversion and digital computer applications by using digital pulses directly.

In a typical application, an ac output signal from a synchro, resolver, or some other angular position measuring transducer, Fig. 1, converts to dc signal pulses proportional to an angle

by a dual-channel synchronous demodulator that conditions the original analog signal for entry into a digital computer's dc-to-digital conversion module. For a continuous visual display of angular positions, the new repeater driving the pointer of a

dial indicator readout uses the demodulator-derived signals directly (through op amps) to provide an instantaneous and accurate indication of the angular data being fed to the computer.

More information is available from Singer-General Precision, Inc., Kearfott Div., 1150 McBride Ave., Little Falls, N.J. 07424.

Circle No. 89 on Reader Service Card

FIGURE 1. Application in which the new repeater drives pointer on display.

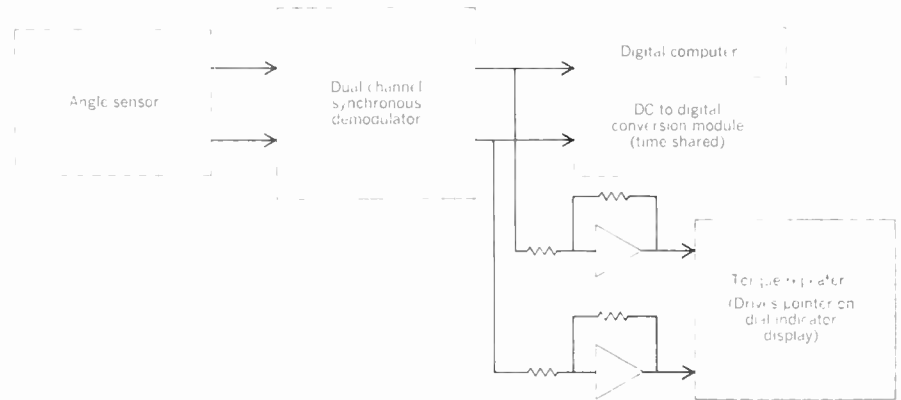

Multimeter/calibrator has digital/analog readout

The new Model 220 Dialmatic Multimeter/Calibrator provides six precision measurement functions and two accurate calibration capabilities in one package with no plug-ins. The instrument provides laboratory-standard measurements of direct voltage, dc ratio, alternating voltages, ohms, ohms ratio, and frequency and precision calibration outputs for direct voltage and frequency. Digital/analog readout with six-digit resolution is used. Figures 1 and 2 show typical applications.

If a 10-kV potential is to be measured, as in Fig. 1, the potential is first lowered to under 100 volts to take advantage of the Model 220's potentiometric capability. A precision voltage divider with matched film resistors, or equivalent, is used. The voltage across the last resistor in the string is tapped off, which results in approximately a 100-volt input for the Model 220. The potentiometric design of the Model 220 provides an input impedance that is greater than 100 000 megohms and any error due to the voltage divider will be negligible. If, on the other hand, the 10-kV measurement is made with a dc voltmeter having a 10-megohm

input impedance, which is common, an error of about 10 percent can result unless an awkward correction is made.

To measure small voltage changes, Fig. 2, the Model 220 is used between the thermocouple and the recorder. A voltage variation of 0 to 100 μ V will

result in 0- to 300-mV change at the Model 220's recorder terminals. The instrument can therefore be used for recording a 100- μ V variation as a full-scale swing.

More information is available from Wavetek, 9045 Balboa Ave., San Diego, Calif. 92123.

Circle No. 90 on Reader Service Card

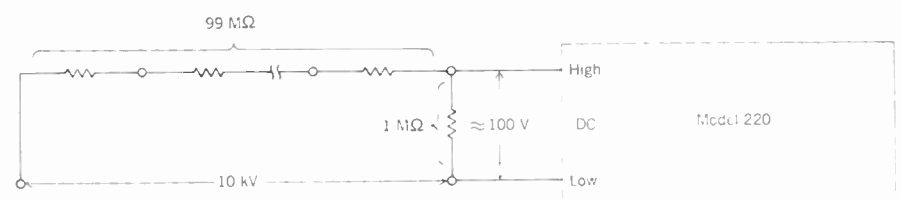
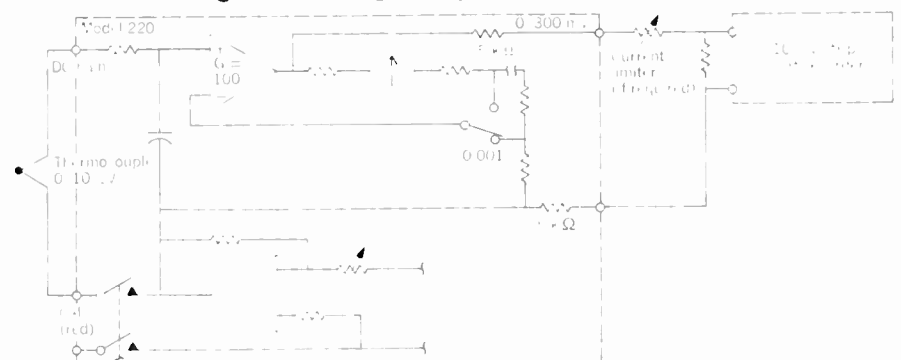

FIGURE 1. Accurate measurement of high voltages.

FIGURE 2. Recording of small voltage changes.



New product applications

Angle encoders have 12- to 18-bit resolution

A family of solid-state, Shaft-Position Encoders with resolution to 18 bits has been announced. Output is parallel binary word, continuous following, with optional BCD code output.

In a typical application, Fig. 1, a 7-bit encoding system is shown. In this case, a $32\times$ and $1\times$ resolver is used with the 13 least significant bits taken from the $32\times$ shaft. Octant switches switch the sine and cosine data into the feedback networks to make it appear to these networks that they are operating over a single 45° segment. Each 45° segment is, additionally, subdivided into a total of eight sectors.

Of the 13 bits in the high-speed input, the three most significant bits are used to indicate the specific octant, the next three bits signify the value of the tangent of the angle for the particular sector in the 45° segment, and the last seven bits indicate directly the angle within the sector.

The ac output is demodulated from the feedback and a second-order filter is used to minimize the system's sensitivity to noise and transients. This

results in an effective K_v and K_a similar to that of a servo. Typical values for K_v and K_a are $10^6/\text{second}$ and $5 \times 10^3/\text{second}^2$.

More information is available from Encoding Systems Dept., Datex Div. of Conrac Corp., 1600 S. Mountain Ave., Duarte, Calif. 91010.

Circle No. 91 on Reader Service Card

FIGURE 1. Typical 17-bit encoder.

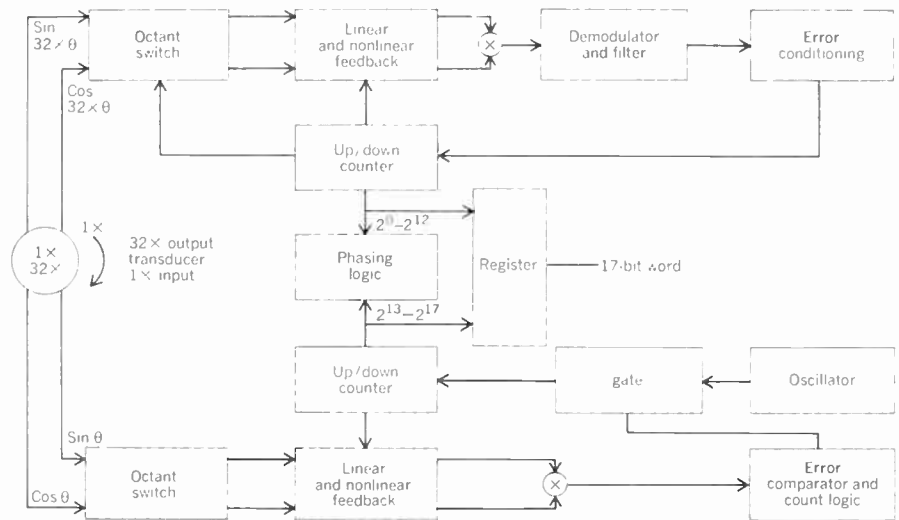

Low-cost instrumentation amplifiers

The Models 3264/14 and 3263/14 Encapsulated Instrumentation Amplifiers should find wide application. In many differential-input circuits they may even displace op amp circuits. Only one external resistor is required to set the gain to any value from 1 to 1000. Complicated op amp summing networks are not needed. The amplifiers have high input impedance.

The amplifiers are ideal for use in any circuit where the combination of high input impedance and accurate

differential gain is needed. The high common-mode rejection makes it possible to accurately amplify small differential signals riding on a large common-mode input. A very common differential-amplifier application is the amplification of a bridge signal. Pre-amplifying a signal right at its source will often reduce system noise problems considerably. With the new amplifiers, it is much more economical to commit an amplifier to each transducer bridge in a data acquisition sys-

tem than to purchase very costly and complex low-level multiplexers.

Figure 1 shows a typical bridge amplifier application. The amplifier gain A will typically be within ± 1 percent of the value set by

$$A = 1 + \frac{200 \text{ k}\Omega}{R}$$

By trimming the gain with the 500-ohm pot, gain accuracy of ± 0.1 percent is easily obtained.

More information is available from Burr-Brown Research Corp., Tucson, Ariz. 85706.

Circle No. 92 on Reader Service Card

INSTRUMENTATION AMPLIFIERS in new line.

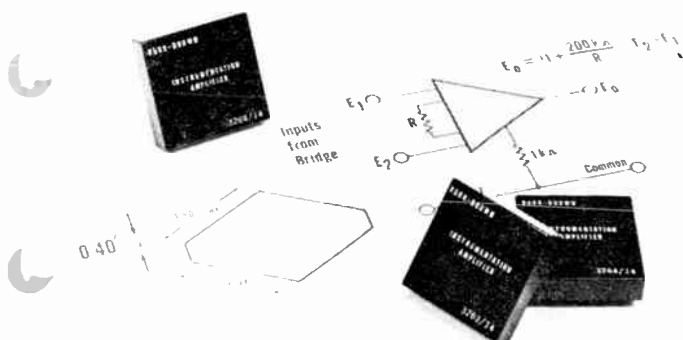
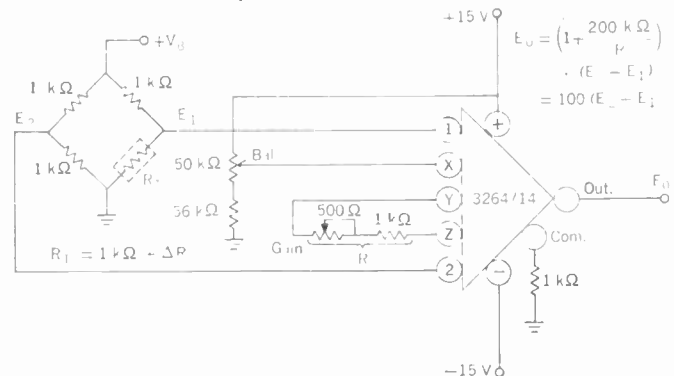

FIGURE 1. Bridge amplifier application.



New product applications

Versatile digital resistance deviation system

The Model 501 Digital Resistance Deviation System is designed for volume testing or manufacturing of resistors. It uses a fully automatic Kelvin bridge combined with a resistance standard. With the addition of one or more pieces of peripheral equipment, it can become the nucleus of a test or process control station for a variety of "measure and record" resistance applications. Peripheral equipment available includes scanners, data couplers, limits comparators, automatic parts handlers, data loggers, and computer control.

Basic applications that are covered by the new system with its auxiliary equipment are rapid sorting of resistors of all accuracy classes, automated testing for environmental and temperature coefficient characteristics, and computerized matching of resistors by value and/or temperature coefficients. Features of the system include: only 100 ms per measurement cycle, 0.01 percent accuracy with 0.001 percent optional, automatic cancellation of thermal emfs, high rejection of normal mode ac, and automatic connection verification.

Figures 1 through 3 show some typical applications of the new system.

Figure 1 shows a system for testing temperature coefficients. The resistors are batch tested in an oven that is programmed to take them through desired heat points. At every temperature level each of the resistors is measured sequentially and its deviation from nominal value is printed out. These data can be fed to a computer for analysis to produce a temperature coefficient for each resistor together with average and mean deviation at any selected temperature.

A system for high-speed sorting is shown in Fig. 2. In such a system, the sorting can be stopped at any time and the actual value of a component confirmed because each component is measured before categorization.

For process control, as shown in Fig. 3, the bridge system can provide complete control for resistor manufacturing. As an example, in adjusting thin-film resistors by trim anodization, the system can monitor the process at intervals and provide the shutoff signal to the anodization equipment. A scanner allows the bridge to measure large batches of resistors in sequence.

More information on the system is available from Electro Scientific In-

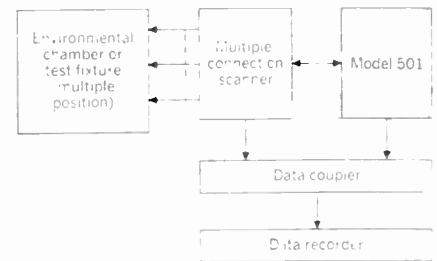

FIGURE 1. System for testing temperature coefficients.

FIGURE 2. High-speed sorting.

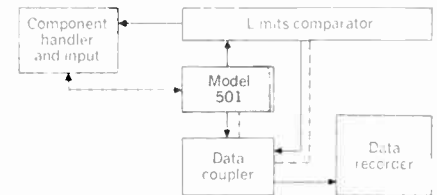
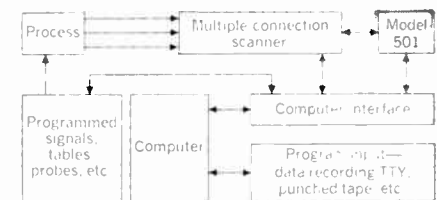

FIGURE 3. Process control.



dustries, Inc., 13900 N.W. Science Park Drive, Portland, Oreg. 97229.

Circle No. 93 on Reader Service Card

Instrument measures power losses in steel

Designers and users of rotating machinery and transformers that use electrical steel must pay close attention to the eddy-current and hysteresis losses in the steel. The Apoli-



meter is a new portable instrument for nondestructive testing of these losses. The steel sample is placed in a vector inductance bridge by applying a probe to the face of the sample sheet. The resistive component, representing loss, is displayed on a meter readout. The measurement is made at standard values of 60 Hz and B_{max} of 15 kilogauss. Calibration is direct for four steel thicknesses from 0.012 to 0.025 inch.

In using the instrument, the probe is applied directly to the sheet or lamination to be tested. Readings on the meter represent loss of the specific area under the probe. Complete measurement of a sheet or wider area is possible by moving the probe step by step over the area to be measured and recording or color coding each area. Sorting of sheets or separating high- and low-loss areas on a single sheet is possible. Lamination selec-

tion is also a simple matter of piece by piece testing.

Fabrication of electrical steel sheets can be controlled with the instrument. Continuous or sampling techniques can be applied on the production floor, in the warehouse, or in quality control areas.

Lamination fabricators can use the Apolimeter to grade sheets and area of a single sheet before and after processing. Final testing of the lamination is possible to improve tolerance and satisfy premium requirements. Grain orientation can be determined quickly and optimum cutting patterns established. Control of heat treating processes is speeded by measurement near the processing area.

More information is available from James Electronics Inc., Instrument Div., 4050 N. Rockwell St., Chicago Ill. 60618.

Circle No. 94 on Reader Service Card

New product applications

Digital voltmeter provides computer interface

The new Model 370 Digital Voltmeter features high accuracy (0.0025 percent) in a small package. It is a basic dc instrument but, with plug-in modules, it is capable of measuring alternating voltage (to 100 kHz), ohms to a resolution of one milliohm, and ratio (0.99999:1). In addition to five-digit readout, the instrument offers buffered BCD outputs and remote control. These features make it useful for process control and other systems applications.

Measurement of environmental conditions is the common denominator in all industrial situations. Knowledge is always needed regarding the parameters defining temperature, velocity, acceleration, pressure, and frequency. These parameters are becoming standards for control of situations in changing environments where the control is being performed by a computer. Since small-scale computers are becoming increasingly price competitive, more industrial complexes are turning to them as a means of rapidly obtaining, assessing, and reacting to process data. But the means by which the data are being acquired by the computer are often an area of high expense as compared with the price of the computer.

An analog/digital converter in the right price range can be an answer to the problem.

The primary need is for low-cost (under \$500), relatively slow (5 to 10

samples/second), accurate (0.01 percent) converters.

Of all the techniques available for A/D conversion, the one perhaps most suitable for computer interface is dual-slope integration.

Dual-slope technique

When using a dual-slope type of digital voltmeter to make a measurement, the counter portion of the voltmeter is first set to zero. The voltage to be measured passes through the integrator portion of the voltmeter. This voltage, divided by the RC time constant of the integrating network, V_{in}/RC , appears at the input of a zero detector that is also part of the voltmeter.

When the counter accumulates its maximum count, normally 100 000, it tumbles over to zero and the logic portion of the voltmeter switches the input to a reference voltage. The reference voltage starts to discharge the integrator capacitor and the counter starts counting. The input to the zero detector is now V_{ref}/RC . When the integrator capacitor is discharged to zero, the zero detector triggers the logic to stop the counter. The counts accumulated are proportional to the input voltage and are displayed on the digital readout.

Now let us look at an example of environment measurement making use of the dual-slope technique that was just described.

Weighing application

Assume that a requirement exists for weighing packages through the use of a load platform to determine weight, an A/D converter to provide a weight figure, and a processor to take the weight figure and act upon this information by processing the weight, printing a mailing label, and initiating a postage label. The portion of the system of interest in this discussion is the A/D converter and how it provides the

interface from the scale to the processor. Figure 1 shows the elements of the system.

The package to be weighed is placed on a load platform that is basically a resistance strain gauge, as shown in Fig. 2. An excitation voltage, V_{ref} , is applied at the nodes to the bridge and an output voltage, V_{out} , is sensed at the opposite nodes. Since the strain-gauge output is known in terms of millivolts per pound, a weight can be determined by a voltage-measuring device.

The voltage-measuring device in this example is a digital voltmeter, or rather, the front end of a digital voltmeter. If the measurement is made with the dual-slope integration technique, the operation is as follows:

1. The package is placed on the scale, causing a voltage to be generated at the V_{out} nodes.

2. The operator or the processor can now initiate the measurement cycle.

3. The A/D converter — the front end of the digital voltmeter — begins to integrate the voltage, V_{out} , as applied to its input terminals.

4. When integration is complete, the data are available for further processing by a computer or for display to the operator.

5. The cycle may now be reinitiated for another measurement.

The application just described was one for determining weight but any other type of measurement can be performed by the same technique. Because of the simplicity of the dual-slope technique, there is no problem in maintaining long-term accuracies. The measurement component most likely to be changed is the integration capacitor and clock errors are to be expected. But both these errors negate themselves since the error-causing components are used in both portions of the measurement cycle.

More information on the digital voltmeter is available from Data Technology Corp., 1050 East Meadow Circle, Palo Alto, Calif. 94303.

Circle No. 95 on Reader Service Card

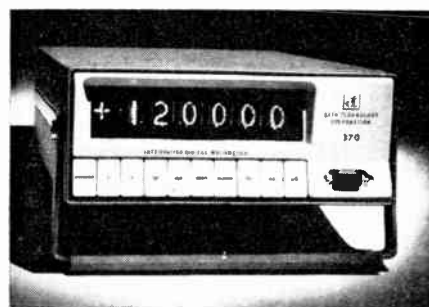

FIGURE 1. Components of the weight-measuring system.

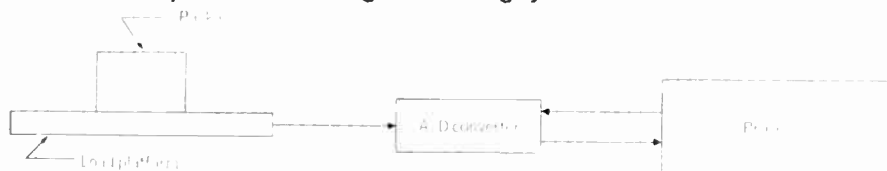
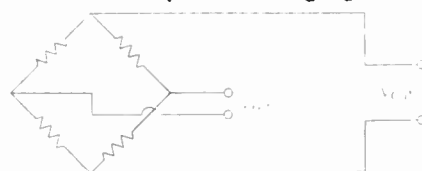

FIGURE 2. Simplified strain gauge.



New product applications

Digital output broadens use of mag pickups

A new Digital-Output Magnetic Pickup from Electro Products Laboratories is reportedly the first of its kind and extends the applications range normally associated with magnetic transducers.

Trade-named Di-Mag, the Model 58364 is said to sense slower changes in magnetic flux at greater distances than its predecessors. Because it can be built compactly (less than 1/2 cm in diameter) and because thermal stability and noise offer few problems, the digital magnetic pickup is said to be ideal for use with computer card punchers, low-speed tachometers, and industrial control equipment where—but for such a device—speed monitoring would be restricted.

As with other magnetic pickups, the output from Di-Mag's coil is analog. However, a tiny integral amplifier and proprietary Schmidt trigger circuit convert an otherwise weak signal into a constant amplitude (5 or +12 or -12 V) signal that is unaffected by

noise. Where conventional magnetic pickups are nominally limited to placement within 10 mm of the part being monitored, the new device, for many high-speed sensing applications, can be placed a centimeter or more from the moving target.

In addition to reducing the problem

MAG PICKUP SENSITIVITY improves with go/no-go signal, so gap can widen.

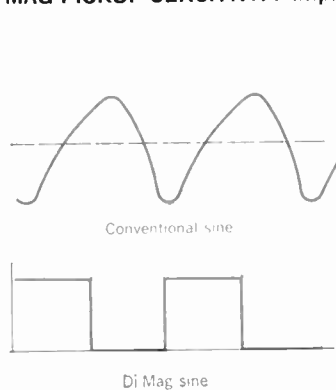

of output noise that ordinarily inhibits operation of conventional magnetic pickups, the new device also overcomes input noise that is common to both terminals.

Di-Mag is also reported to be a cost saver, since interface circuitry is eliminated and operating errors are reduced. Additional product information is available from Electro Products Laboratories, Inc., 6125 West Howard Street, Chicago, Ill. 60648

Circle No. 96 on Reader Service Card

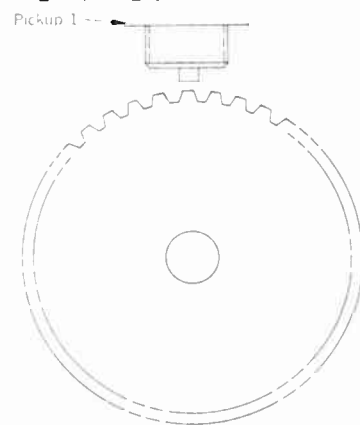

High-speed printer meets unfilled needs

A. B. Dick Company has introduced its compromise solution to the computer printout cost/speed conflict. Called Videojet 960, this moderately priced unit "paints" 250 characters per second on standard computer or Teletype paper by squirting 66 000 tiny ink drops each second.

Applications range widely because of the printer's

Versatility: It can print in a variety of widths, and character spacing is a variable between 5 and 15 per inch. Paper accommodation includes widths in the range of 3 1/2 to 14 7/8 inches and weights from 20 to 125 lbs. In this regard it can satisfy 80-character communications requirements and the 13.6-inch-wide computer format.

Compatibility: Character print speed matches the transmission rate of voice-grade telephone-line data transmission, and thus the need for interface storage devices is eliminated.

Adaptability: The printer can be operated as a high-speed communications printer or function as the printer for the newer small "mini" computers

coming into vogue.

Suitability: Lacking the clack of impact-type printers makes the 960 suitable for use where quiet must be preserved — e.g., hospitals and some offices. In addition, with the right choice of ink, the printed form can serve as a photo-offset master for duplicate hard copies.

The principle behind the new printer's operation is electrostatic. Par-

ticles of ink formed under pressure are variably electrostatically charged and deflected to an appropriate point within an 11- by 9-dot matrix. Uncharged droplets are collected and returned to the ink reservoir; see figure. The printer has also been designed with reserve speed capability to meet future contingencies.

Additional details about the Videojet may be obtained from A. B. Dick Company, Niles, Ill.

Circle No. 97 on Reader Service Card

PNEUMATIC INK EJECTION during printout is noiseless—good for hospital use.

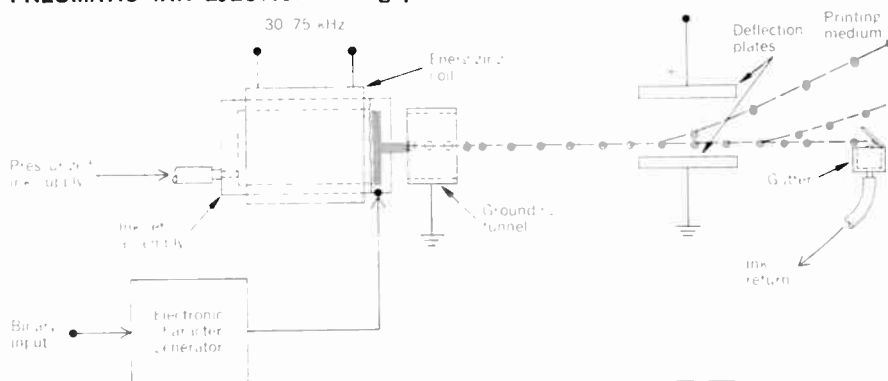

New product applications

Computerized electrical system for automobiles

A Computerized Energy Distribution and Automated Control System (CEDAC) for application as a replacement for automotive electric circuits and related equipment has been announced. Advantages of the system are said to include increased reliability, easier trouble diagnosis, simple part replacement, design flexibility, better assembly procedures, and improved safety — with more driver convenience. A diagnostic computer can be used with the new system to interrogate the CEDAC system. In this manner, maintenance problems can be isolated in seconds.

The new system is an electrofluidic control system incorporating a central computer with a single energy distribution and control harness that is routed throughout the vehicle. The central logic unit sends and receives information to and from actuators and sensors. The single harness carries signal information and electric and pneumatic power to all automotive subsystems.

The central logic system can be used by every function on the car from antiskid control of the braking system to lamp outage detection in the lighting system. A block diagram showing the central logic unit and its relationship to all automotive functions is shown in Fig. 1.

Lighting, power assist, high current, climate control, transmission, ignition, air fuel, display, and command input functions interact with the logic element. Because of this interaction — which utilizes the memory portion of the logic element — there can be a substantial reduction in the complexity of switches, control levers, and interconnections.

Digital techniques can be incorporated in lighting to provide different current levels to lamps for high initial intensity and dual intensity for day-night driving. Lamp-outage detection can be incorporated using the same techniques with small design additions. Lamp on-off delays can also be incorporated if desired.

The logic element can be used to turn the power assist functions on and off. Logic circuits can be incorporated into the braking system to vary pressure on the master power brake cylinder as a function of brake pedal position and other operational variables. And the logic element can be used on antiskid braking systems. It can control power door locks and power windows and, by remembering command input information, reduce the required complexity of switchgear.

In the high-current system, the logic element can be used to regulate the alternator voltage level. It will detect when the battery is charging and discharging. It will also inhibit starting the car in gear and prevent engagement of the starting motor when the engine is running.

The climate control system is well suited to digital computer control. A counter in the computer will, upon command, recirculate a count from 65 to 85 and display the count on a digital readout. Stopping the count at the desired degree setting will automatically program the temperature control unit. Another sequential switch may be used for on, comfort, defrost, and off settings. Binary operations, such as vent and mode selection, as well as heater core and compressor on-off controls, are easily handled by the logic element.

The transmission system is a binary system that utilizes hydraulic power servos to implement gear selection. The computer can operate on data such as manifold vacuum, speed, and engine r/min, selecting the correct gear under all operating conditions as well as preventing abuse of the transmission by improper gear selection.

Ignition timing is well suited to digital techniques and is extremely important in exhaust emission control. An electronic counter driven from the camshaft can change firing times by varying its phase relationship to camshaft position. The logic element will select a firing time after operating on information such as engine r/min and load.

Air-fuel mixtures are also very important for exhaust emission control. The logic element can operate on engine temperature, engine r/min, manifold vacuum, and air-flow information to select the fuel pulse width for injection.

The new system depends for its operation on low-energy command signals from the logic element being used to apply high energy to primary devices located throughout the automobile. When the correct code is received by a receiving element, the primary device associated with the receiver is actuated. Each receiver contains an integrated circuit and either a power transistor or a fluidic integrated circuit or both. The integrated circuit provides the control signal that turns on the electric or pneumatic power, as shown in Fig. 2.

More information is available from Essex International, Inc., 1601 Wall St., Fort Wayne, Ind. 46804.

Circle No. 98 on Reader Service Card

FIGURE 1. Central logic for computer system.

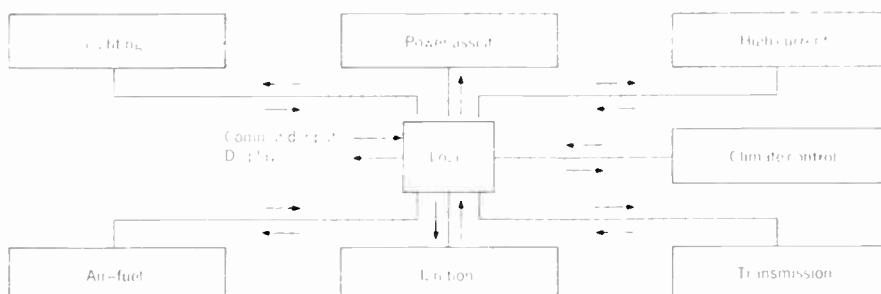
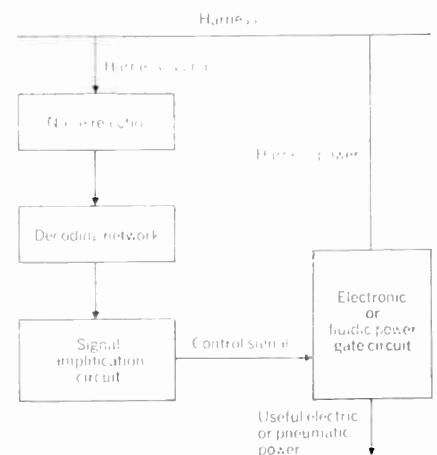

FIGURE 2. A receiving element.



New product applications

IC designs improved with bus-bar backing

A new series of Laminated Bus Bars offering production and design advantages for use with IC boards should have special appeal for computer circuit designers.

Marketed by Methode Manufac-

turing Corporation and designated Omny-Bus, the multilayered power distributors are said to provide these product design opportunities:

- A way of designing more than one circuit into each IC board — discrete

circuits being selected by the appropriate choice of bus-bar configuration.

- Lowered impedance of the bus/IC board combination attributable to a certified uniform capacitance (in the range of 9000 to 16 000 pF) that can be used to offset IC inductance.

- More latitude in IC card size and circuit layout and increased latitude in current density selection via tailored bus-bar conductor dimensions.

From a production applications standpoint, the company claims that a manufacturer can benefit from these features:

- The bus bar eases production technique requirements particularly when used for stacked IC configurations and two-sided IC boards. Because handling is eased, errors are reduced and production is increased.

- The bus bar is reclaimable if the IC board is damaged and vice versa.

- The card and bus can be wave-soldered as an assembly.

Presently, two series of buses are offered: 40001 and 40002. The latter provides higher capacitance. For more information, contact Methode Manufacturing Corporation, 1700 Hicks Road, Rolling Meadows, Ill. 60008.

Circle No. 99 on Reader Service Card

TWO OF THE MANY CONFIGURATIONS that can be tailored to design of IC card.

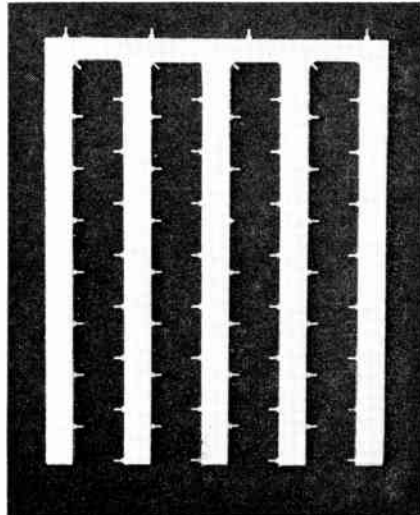
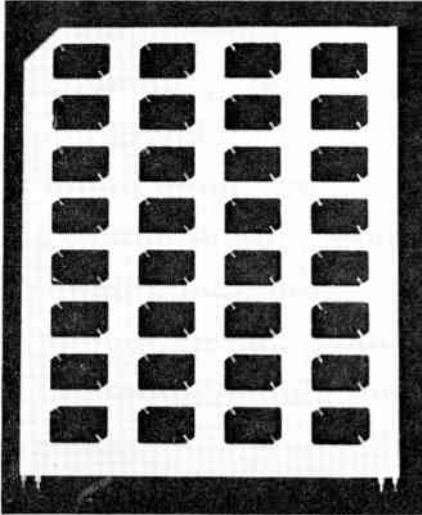

Digital annunciator for varied applications

The MDDA Digital Annunciator Series consists of an alphanumeric and numeric display using cold-cathode display tubes. The alphanumeric portion has the ability to display all letters of the alphabet, the numerals 0 through 9, and several special characters. The numeric portion, which has built-in decimal point indication, decodes and displays the numerals 0 through 9 from standard 5-V, BCD logic.

Applications for the "Mini-Diget" MDDA annunciator are numerous and

may be grouped in the following categories:

1. Digital displays for process control computers or peripherals on which various parameters of control can be displayed by sequencing, such as speed, flow rate, batch mixing, etc.

2. On-line presentation of various parameter tests in integrated circuit testing.

3. Medical applications where information about the condition of different patients is required such as blood pressure, heart rate, and respiration, each of which has a different alphanumeric description.

In addition, the annunciator can be combined with other standard display devices such as high-speed counters where output from the counter can feed directly into the numeric section of the annunciator.

The alphanumeric section of the unit consists of 13 individual segments that can be illuminated directly from TTL, 5-V logic. In the current design, the alphanumeric section must

be driven from 13-bit information. The characters appear as bright red-orange neon glows that can be read easily under high ambient light conditions at distances of up to 30 meters. The numeric section characters are readable from distances up to 20 meters.

The annunciator is available in four models: MDDA 330, consisting of three numeric and three alphanumeric positions; MDDA 340, with three numeric and four alphanumeric positions; MDDA 430, with four numeric and three alphanumeric positions; and MDDA 440, with four numeric and four alphanumeric positions.

The entire display package is enclosed in a rugged, extruded, aluminum housing that allows optimum viewing angle and features a snap-off bezel that offers easy access to the display tubes. The snap-off bezel permits customizing with the customer's logo and/or display function.

More information is available from Instrument Displays, Inc., 18-36 Granite St., Haverhill, Mass. 01830.

Circle No. 100 on Reader Service Card

