

# IEEE spectrum

## features

- 49 Spectral lines
- + 50 The Haystack microwave research facility  
H. G. Weiss  
*A sensitive multipurpose facility has been developed for long-range space communication and tracking experiments in the microwave portion of the radio spectrum*
- + 70 Giant generators for growing power demand  
Gordon D. Friedlander  
*The proven economy and efficiency of huge turbogenerators has provided the impetus for their general acceptance by public utilities in the United States and Western Europe*
- + 87 A new electronic switching system  
W. Keister, R. W. Ketchledge, H. E. Vaughan  
*System's stored-program real-time data processor facilitates modifications and additions to future service at low cost*
- + 95 Energy storage and conversion  
L. J. Giacoletto  
*The various means for storing energy are classified and compared, and energy conversion techniques are discussed*
- + 103 Report on the 1964 Conference on Precision Electromagnetic Measurements  
Robert F. Cotellessa  
*Topics cover large portions of the frequency spectrum: frequency and time standards, quantum electronics, dc and audio-frequency measurements, radio-frequency and microwave measurements*

## 111 Authors

Departments: *please turn to the next page*

## the cover

*A portion of the 150-foot-diameter metal-space-frame radome of Lincoln Laboratory's Haystack microwave facility is depicted on this month's cover. The 1375 frame members have an aggregate length of 3 miles; the 930 triangles, covered with glass-fiber-reinforced plastic 0.032 inch thick, have a total area of 1.5 acres. See article beginning on page 50*



THE INSTITUTE OF ELECTRICAL AND ELECTRONICS ENGINEERS, INC.

## departments

9	Transients and trends	
10	Reflections	
18	Focal points	
	National Power Survey Report sets pattern for power growth	18
	A fourth test of general relativity with Haystack	24
	Alabama seminar will explore value analysis	28
	Harvard physicists reaffirm Einstein principle	30
	Advanced "supermagnet" is successfully tested by AEC	32
	EHV transmission line uses all-aluminum H-frame towers	34
	Cassiopeia's radio-emitting shell structure is confirmed	34
	Space Science Board urges unmanned exploration of Mars	37
	National Engineer's Week will emphasize 'human' aspects	38
	Optical relay may improve spacecraft telemetry	38
	Many layers add up to nearly perfect laser mirror	38
44	Correspondence	
144	News of the IEEE	
	National Academy of Engineering formed	114
	IFIP Congress 65 and Interdata 65, May 24-29 in New York City	115
	IFAC will hold Third Congress in London, June 20-25, 1966	117
	Eleven IEEE award winners to be honored at 1965 International Convention	117
	IEEE, AIAA, ISA continue to sponsor National Telemetry Conference	118
	Midwest Symposium on Circuit Theory scheduled June 14-15	119
	Papers are solicited on applied industrial control	120
	IEEE to contribute panel in Science and Engineering Television Journal	120
	USNC-URSI to meet April 19-22 in Washington, D.C.	121
	American Power Conference schedules 31 technical sessions	121
	Sixth symposium slated on human factors in electronics	122
	IEEE-ASME Conference dated April 7-8 in Pittsburgh	122
	Conference planned on thin film active devices	124
	17th Annual SWIEEEO slated April 21-23 in Dallas	124
	Bioengineering Symposium to be held May 3-4 in Denver	124
	Conference to be held on automatic support systems	125
127	Calendar	
130	People	
134	IEEE publications	
	Scanning the issues, 134	Advance abstracts, 136
	Special publications, 153	Translated journals, 149
156	Book reviews	
	Science and the Future of Mankind, Hugo Boyko, ed. Reviewed by Arthur Bronwell	

mation; electronic devices are now the mainstay of many manufacturing organizations, and everybody is aware of the multiple uses of radioisotopes.

Our age is one in which each new instrument has multiple uses; consequently, it is eagerly sought. In economic terms, the seller's market prevails. Eventually, however, the buyer's market will prevail; then tailor-made instruments will predominate. This will come about when the principles of operation, and the power and limitations, of electronic and scientific instruments are more widely understood and appreciated. It will occur when the present generation now in school takes the lead. Our accomplishments will be no surprise to them since one cannot be surprised by the expected. Instead, they will demand devices that suit their particular needs and will have no sympathy with failure.

With these things in mind, let us look with a broad perspective at developments in this huge electronics industry and ask: What have we done? What are we doing? What will we do?

Of the three questions posed, the most difficult by far to answer is that concerning the future. The near future can be predicted with some precision, but any guess at the distant future is fraught with difficulties. This is so because science progresses by qualitative leaps and bounds and not by purely quantitative growth. These leaps and bounds are most often the product of one man's mind and occasionally result in such profound changes as to significantly affect future developments. By their very nature these events are unpredictable. One might cite as examples Faraday's laws of electromagnetism, which permitted the development of electric power equipment, but which could not have been predicted; or the discovery of the fission of uranium, which permitted the development of nuclear reactors, but which again could not have been predicted.

#### **What did we think of?**

First, what *did* we think of, or what have we succeeded in doing thus far? What are our electronic accomplishments?

We have certainly extended the range of man's senses. We can convert a surprising number of physical phenomena into meter readings, numbers, or paper tape. We can detect and measure and record many phenomena, including some that man, unaided, cannot detect. We have instruments that can measure weight and density, particle size, thickness of materials, radiation—and for the most part with astonishing accuracy. This type of instrument has shown steady development from a simple device that merely detected to one that measured, although crudely, and then, finally, to one capable of precision measurement. As the years go by, we will see the extension of this technology into other areas, into other phenomena to be measured and converted into numbers for man's convenience so that he may appreciate them with his own senses.

What do we do with this information, so accurately and painstakingly provided by our electronic instruments? The answer indicates two main areas of use. First, the data can be utilized in research programs for better measurements. Faster and better research techniques mean knowledge gained more quickly; as research progresses and knowledge accumulates this knowledge can be applied to close the circle and design

more instruments for measuring other phenomena, which in turn provides more information for additional research.

The closed circle touches the lives of all people somewhere along its circumference, whether through an instrument with various uses, through the useful products of an applied research program, or simply through the intellectual excitement of new knowledge.

The second area of use for our instruments seems to be to provide a man with information that can help him to act in some constructive manner. In other words, the human being is but one link in another kind of circle. He becomes one element in a production or control system. In many cases the human being is included because he is still indispensable; in other cases he is used because an instrument replacement would be too expensive. But in still other cases the human being is used only on an interim basis until the necessary instrument can be procured.

Playing the key role in closing the control loop, the electronics engineer is particularly aware of the increasing development of automation and, in fact, even welcomes it as the means to free man of the burden of manual labor. But is this the complete answer? (Another aspect of instrument development is its considerable impact on industries such as communications and entertainment. However, in the frame of reference of this presentation, these developments will not be considered as they are not properly classed as instruments.)

#### **What will we think of?**

What of the future? What will we think of next? It is easy to give an answer to this question from a somewhat microscopic view, since we know with a high degree of certainty that our instruments are destined to become smaller in size, larger in scope, faster, more accurate, and, hopefully, more reliable. These are the obvious improvements; they are the directions in which our technology is moving and we have still a way to go to reach the peak of this development.

Presumably, as new instruments develop more accurate measurements of a larger variety of phenomena, it will be possible to feed more information more accurately and faster to the research scientist and the engineer. Many of these instruments will be converted from a mere provider of information to an element in a control loop, thereby replacing more men. This development can be predicted with a very high degree of certainty. Already, rolling mills in the steel industry are almost completely automated; there is a steady progression toward complete automation in the production and distribution of electric energy, and studies are under way that may result in completely automated ships. Not many years ago a Geiger counter (or a scintillation detector) was a device seen only in the research laboratory. Today, it is an element in a control loop in the paper industry. Similarly, one would expect that nuclear magnetic resonance, or the Mossbauer effect, will eventually find its way into industry.

With the more efficient machine replacing man in the production of goods and services, how is he to consume these goods and services? How is he to spend his energies? In short, where is man's place in modern life? We are automating as rapidly as we can but are we producing heaven or hell, Utopia or a nightmare? We have

the knowledge and need to invent, design, and produce new devices, but who is accepting the responsibility for their consequences?

#### **What should we think of?**

Where is the path of future development? What kind of instruments should we be developing?

Although today there are devices of extreme sensitivity and accuracy that extend our senses into otherwise unattainable areas, some of man's senses, especially the more quantitative ones, still have not been duplicated. We have no instrument with a sense of smell as good as that of a man—even one with a head cold. Yet this sense is relied upon heavily for our day-to-day existence. As the sense of smell is both a measuring and a warning device, there is not much doubt but that an instrument possessing this sense would be of value.

Neither are there instruments that can even approach man's ability to see. We can make excellent lenses with a resolution much better than that of the human eye, but not with the range of variability that the combination of the eye and the brain can achieve. Present-day television systems present an abysmal picture in terms of human vision. The amount of picture information contained on a television screen is far less than the information provided by the eye and brain. Our attempts so far at stereoscopic presentations are not very good, nor is our use of color. Finally, in any critique of our visual instruments, one must mention the pattern recognition problem. A small child can be instructed to separate square blocks from round ones and he will do this with ridiculous ease because he can easily tell the difference between them. However, an instrument to do this simple task has yet to be developed. Our eye is very good at judging the straightness of lines and the roundness of circles, but it would take a very complex instrument to handle even these problems, particularly the ranges over which the human eye can operate.

Most of our instruments tend to copy man in the way in which he performs his various tasks. Taking the evolutionary attitude, one presumes that millions of years of genetic development have provided a reasonable selection of that which is best. It is therefore eminently reasonable to emulate that which is considered to be the best product of evolution.

With this line of reasoning, it is perhaps worthwhile to look at the importance that our senses attach to the qualities of imprecision. As was pointed out earlier, our instruments are perpetually moving in the direction of greater and greater accuracy, but imprecision also has values—and by imprecision we do not mean inaccuracy. For example, with our combination of eye and brain, we can either accept information reaching our eyes across the whole field of vision with a rough constancy of vagueness or concentrate on one small area and study this with greater precision, letting the rest of the field of view recede into vagueness. This is an extremely valuable property of our visual system and one that is singularly lacking, for example, in television systems.

A similar capability exists with our sense of hearing; it is possible even in the most crowded room to concentrate on one particular sound to the exclusion of others or to relax and be overpowered by the total volume of all sounds. Again, our mental abilities have the same kind of property. We can either daydream and think

about nothing in particular (or perhaps a large number of things with a kind of grand haziness), or we can concentrate on one small facet to the exclusion of all else.

It is this ability of man to concentrate when he so chooses that we have yet to emulate in our instruments. It is a kind of uncertainty principle applied to man's senses that man has found to be of immense value. It is almost certainly this property that enables him to think and, in particular, to think creatively or to invent. It is quite likely a thinking machine will not be invented until this kind of uncertainty principle can be applied.

The thinking process is essentially an imprecise process. It is a case of juggling roughly known facts from a variety of areas into a chance coincidence until they suddenly coalesce into an idea. Computers are at the moment much too precise for this process. Their memory is fundamentally different from that of the human mind. Whatever a computer remembers, it does so with great precision, whereas the human mind remembers many things with varying degrees of precision. However, it is not unreasonable to assume that eventually machines will be developed that can think.

One should not be frightened by such a prospect. At first impression, it appears machines will eventually completely replace people. This is not so. Such a computer or a thinking machine would think only in terms of the knowledge available to it, and human beings have knowledge and feelings and sensations that could never be communicated to a machine.

#### **'What will they think of next?'**

To summarize: There will certainly be instruments and devices that are larger, faster, and more accurate than the ones we have today. Their use will steadily spread into new and more complicated technical phenomena and into economic and social areas. As computers, for example, grow in size, they can be used for keeping all kinds of records: bank accounts, income tax data, medical histories, even criminal records and fingerprint files, perhaps on a national scale. Information will be digitized by existing, or yet to be developed, instruments, and stored for ready availability.

Instruments and devices will undoubtedly become smaller, cheaper, and more reliable, thus permitting new applications not only to technical problems, but, increasingly, to social problems as well. We have already seen the use of the more expensive instruments for communications and for control of air traffic, and such developments as the use of radar to detect petty offenses such as speeding automobiles. However, if these devices were sufficiently compact and cheap, they could also be made available for such purposes as crime prevention, automobile control, and accident prevention; and, of course, their medical use would be greatly expanded.

The future also will see the development of better thinking machines. We already have machines that play tocktacktoe and checkers. In one group of checkers players, a computer already ranks tenth. As computers grow in size, they may even be used to play chess.

Finally, let us hope that as our instruments become better and more advanced, our wisdom to use these instruments will develop apace.

This article is an abridged version of a speech delivered by Dr. Crewe at the National Electronics Conference held in Chicago, Ill., Oct. 19-21, 1964.

## Half-wavelength power transmission lines

*Use of a half-wavelength system for long-distance point-to-point power transmission eliminates many of the operational and design problems that are normally associated with conventional long transmission lines*

*F. J. Hubert, M. R. Gent*    *City of Los Angeles Department of Water and Power*

Large load centers are often located great distances from abundant sources of hydroelectric power. Because the long electric power transmission line thus far is the only economical means of transporting this energy, utilities are developing more interest in extra-high-voltage (EHV) and extra-long-distance (ELD) point-to-point transmission lines.

Historically, the first long high-voltage transmission line appeared in 1914 when the Southern California Edison Company placed into service the 150-kV (in 1924 changed to 220-kV) 243-mile line from the Sierra Nevada Mountains to Los Angeles.

The next 50 years witnessed longer and higher voltage lines. Some of the more notable ones are the Los Angeles Department of Water and Power 265-mile 287-kV Boulder lines feeding Los Angeles (completed in 1936), and Sweden's 593-mile 380/420-kV line completed in 1952. At present, Hydro-Quebec of Canada is building a 700/735-kV 400-mile system to draw on the abundant hydroelectric potential of northern Canada.

Economical ELD transmission lines are becoming difficult to design, chiefly because of the high initial cost of compensating equipment that must be used to maintain stability. Sufficient stability is provided only if the phase shift over the line does not exceed 30 electrical degrees. At 60 c/s, a 250-mile line with surge impedance loading (SIL) has a phase angle of approximately 30°. But to maintain this angle for ELD lines longer than 250 miles (at SIL), 100 per cent compensation is required for all lengths in excess of 250 miles. Therefore, as the line increases, the cost per unit length (including compensation) increases.

If the line is *electrically* lengthened so that its effective electrical length is between  $\frac{1}{2}$  and  $\frac{3}{4}$  wavelength (or 180° and 270°), an interesting phenomenon occurs.

The system is as stable as one operating in the first quadrant (0° to 90°). For example, if the generator terminal voltage is 190° with respect to the load voltage, the stability limit of the system is the same as if the generator is operating at 10° from the load. In addition, the electrically lengthened line has none of the usual long-line operating problems such as surplus reactive volt-amperes (vars) during light load conditions, Ferranti effect, and generator self-excitation.

The most attractive feature of the half-wavelength system is that the cost per unit length decreases as the line length increases. At 60 c/s, if we view only the initial investment and disregard for the moment other advantages, we can see that the transition point between conventional and half-wave design is about 900 miles.

The half-wave transmission line is not a new concept, in that communication engineers have worked in terms of wavelength for many years. However, studies pertaining to transmission of bulk power to a utility load on a half-wavelength system have been virtually nonexistent. Generally speaking, the communication engineer is not faced with the problem of instability, because high-frequency loads usually consist of passive impedances. Similarly, he is not as concerned as the utility engineer with the efficiency of the line because of the small amounts of power that the line is required to transfer.

This article will describe the advantages and disadvantages of a half-wave point-to-point transmission system, particularly with regard to the aforementioned problems.

### **The basic design approach**

An explanation of the phenomenon of a half-wavelength transmission line can best be illustrated through

the technique of designing a hypothetical line and then conducting load-flow, short-circuit, and transient-stability studies.

The wavelength of an uncompensated overhead line at 60 c/s is approximately 3000 miles. Changing the line parameters—such as conductor size, grouping, phase spacing, and voltage—has practically no influence on the wavelength, provided the frequency is held constant. Assuming that all practical 60-c/s transmission lines are less than 180 electrical degrees in length, two methods can be used to enable a 900-mile 500-kV overhead line to be electrically increased to a half-wavelength system. In the first, all the tuning equipment is placed at the ends of the line; in the second, shunt capacitors are added along the line to increase the line's SIL and simultaneously to shorten the 60-c/s wavelength.

For two reasons it is desirable for the transmission system, including the transformation means, to be 10 or more degrees longer than one-half wavelength. First of all, this practice, as will be discussed in more detail later, reduces the required sensitivity of the generator var output control. Second, it assures the presence of a full half-wavelength transmission line during temporary reduced-speed operation of the system. The wavelength is inversely proportional to the frequency; therefore, if the system frequency drops 5 per cent, the wavelength increases 5 per cent, thereby electrically shortening the line. If a sufficient margin of safety is not provided, a loss of power flow may occur.

The following have been assumed for the first design:

Length	900 miles
Operating voltage	500 kV
Type of conductor	Twin Chukar, 1780 thousand cmil, 1.6-inch OD, ACSR, 18-inch spacing
Phase spacing	39 feet

The following are computed per-unit (pu) values on a 1000-MVA base:

$$z = 0.0123 + j0.249 \text{ ohm per 100 miles}$$

$$y = 0 + j0.167 \text{ mho per 100 miles}$$

$$Z_0 = \sqrt{\frac{z}{y}} = 1.22 - j0.00303 \text{ ohms}$$

where  $Z_0$  is the line's surge impedance or characteristic impedance.  $z$  is its series impedance, and  $y$  is its shunt admittance.

From these data the classical equation

$$\alpha + j\beta = \sqrt{zy}$$

can be solved to determine the phase shift attributable to the characteristics of the line alone. In this equation  $\alpha$  is the attenuation constant in nepers per unit length and  $\beta$  is the phase constant (phase shift at SIL) in radians per unit length. For this case the attenuation constant is negligible compared to the resulting phase shift.

$$\begin{aligned} \alpha + j\beta &= \sqrt{(0.0123 + j0.249)(j0.167)} \\ &= 0.005 + j0.204 \text{ per 100 miles} \end{aligned}$$

Therefore

$$\beta = 0.204 \text{ radian per 100 miles}$$

For the 900-mile transmission line

$$\beta = 9(0.204) = 1.835 \text{ radians}$$

For this value of  $\beta$  the phase shift  $\theta$  can be expressed as

$$\theta = 1.835 (57.3^\circ) = 105^\circ$$

For a half-wavelength system, another  $75^\circ$  of phase shift is necessary. However, as suggested earlier, to provide a  $10^\circ$  margin the line is extended instead to 190 electrical degrees in length, making the necessary additional phase shift  $85^\circ$ . To achieve the desired phase shift of  $85^\circ$ , T-section tuning equipment is inserted in the system.

The T sections may be placed in series anywhere in the line with the same overall result, but because of the existence of a high-voltage hazard near the center of the line during faults the T sections should be placed as far from the electrical center as possible. Dividing the T sections into two equal portions and installing all the tuning equipment at the line terminals will reduce the momentary high voltage to which the equipment may be exposed. Also, this technique allows the use of the transformers as part of the branch of two of the T sections. Fortunately, there is a considerable range obtainable in the transformer impedances, and thus there is flexibility in fitting the transformers into the T sections. Additional benefits in reduced insulation are realized if the T sections are placed on the low-voltage side of the transformers.

There are numerous methods of determining the number and size of the T sections because there are many sizes of sections that will give satisfactory results. The method employed here involves dimensioning relatively small T sections of equal size in order to approximate 60-c/s transmission-line operation.

The assumed line has a reactance of  $j0.249$  ohm per 100 miles or  $9(j0.249)$  pu total. To obtain the desired additional  $85^\circ$  of phase shift, a total impedance in the T sections of  $j1.81$  ohms is required.

In this example four T sections are used, two at each end of the line. As shown in Fig. 1, the transformers at both ends make up part of these T sections. At the sending end the inductors and capacitors necessary to complete the T sections are placed between the generator terminals and the low-voltage side of the transformer bank, and at the receiving end they are placed between the low-voltage side of the transformer bank and the load. The reactance needed for each of the T sections is

Fig. 1. One-line diagram showing T sections of 500-kV 900-mile single-circuit twin-conductor half-wavelength system on a 1000-MVA base.

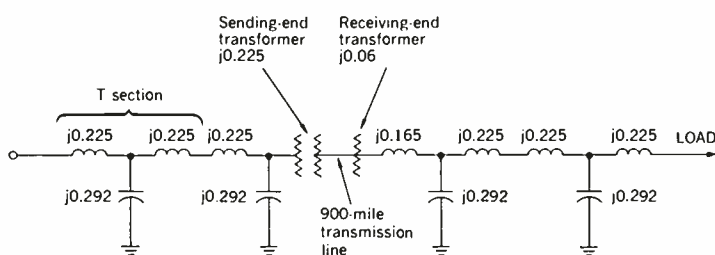

$j1.81/4$ , or  $j0.45$  pu. The sending-end transformer, with  $j0.225$  pu reactance, furnishes half the reactance of one T section. The assumed reactance of the receiving-end transformer is  $j0.06$  pu ohm. The adjacent inductor is consequently  $j0.165$  pu ohm reactance, so that the two in series make up half of the first receiving-end T section.

The next step is determining the size of the shunt capacitors for the T sections. The T-network equation that describes this situation is

$$Z_0 = \sqrt{y \left( z + \frac{z^2}{4} \right)}$$

Rearranging this equation to solve for  $y$  gives

$$y = \frac{1}{\frac{Z_0^2}{z} - \frac{z}{4}}$$

Substituting the established values for  $Z_0$  (same as in the line) and  $z$  (total T section series inductive reactance) gives  $y = j0.292$  mho pu admittance per T section.

The completed design, as shown in Fig. 1, requires 1170 Mvar of shunt capacitors and 1017 Mvar of series inductors for a total of 2187 Mvar for the system.

### Load flow

To illustrate the uniqueness of the half-wave transmission line a load flow and voltage study may be considered. Three important conditions of line loading will be covered: SIL, loading greater than SIL, and loading less than SIL. The SIL reference is used because it is the most efficient and natural loading of an ELD line. This analysis consists of calculating the sending-end and line conditions for various receiving-end unity power factor loads.

The specified receiving-end loads are 0.82, 1.0, and 0.64 pu ampere, representing SIL, and loading greater than and less than SIL, respectively. Holding the potential at 1.0 pu volt in all cases satisfies the practical requirement that the receiving-end voltage remain essentially unchanged from no load to full load. The receiving-end voltage angle is used as the reference and held at zero degrees; all other angles in the system are measured with respect to the receiving end.

Two approximations are made to simplify the calculations: first, the resistance is assumed to be negligible, thereby creating a lossless system; second, the transformer magnetizing currents are assumed to be negligible because they have no appreciable effect on the final results.

Figure 2 shows the calculated voltage at the receiving end, the receiving-end transformer high-voltage side, the sending-end transformer high-voltage side, and the generator terminals, as well as at 100-mile intervals along the transmission line. Note that at SIL (820 MW), the voltage level varies less than  $\pm 2$  per cent. If it were not for the slight mismatch of the tuning equipment, the voltage would be uniform from end to end.

It should be noted that a load 20 per cent greater than SIL causes the peak value of voltage to rise 20 per cent; conversely, a 20 per cent decrease in load from SIL causes a dip in voltage of 20 per cent. Not shown on the graph is the no-load-voltage profile. At zero load (open receiving end) the voltage at the line's electrical center is near zero in spite of the fact that both ends maintain normal voltages.

It can be seen from Fig. 2 that the line voltage is extremely sensitive to the amount of power being transferred. However, regardless of the load requirement, the sending-end voltage is virtually unchanged as long as both the receiving-end voltage and frequency remain the same.

To substantiate the analytical approach just presented, an ac network calculator was used to conduct a load-flow study to show the system with its appropriate resistance included. Figure 3 is a one-line diagram of the system with the metered values shown.

If the transmission system (including transformation) were shorter than  $190^\circ$ , a special generator var control would be necessary because the conventional voltage regulator would not be of sufficient sensitivity. To illustrate this type of var problem, consider the case when two generators are tied directly to a bus with no impedance between them. A cross-current compensator is required to control the var flow of the two generators. Similarly, a transmission system of exactly  $180^\circ$  would be equivalent to a system with no series impedance between the sending and receiving ends, and some special means would have to be provided to control the current. For this reason it is advisable, as stated before, to design the line for a minimum of  $190^\circ$  operation.

The advantage of the half-wavelength transmission system, as pointed out by this study, is that the generator appears to be separated from the load only by that portion of the line that is in excess of  $180^\circ$  instead of the physical 900 miles. Therefore, the factors that limit line loading are efficiency, line insulation, and radio interference at the center of the line, and the thermal capability at the terminals. Stability is not a limiting factor in the case of half-wavelength line transmission.

### Short circuits

An extensive ac network calculator analysis was made of short-circuit currents and voltages. The results in-

Fig. 2. Voltage profile of a 500-kV 900-mile half-wave transmission system for various transmitted loads.

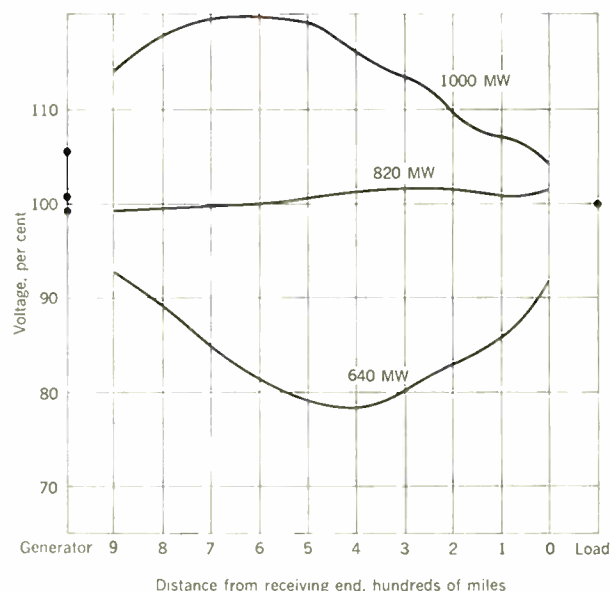

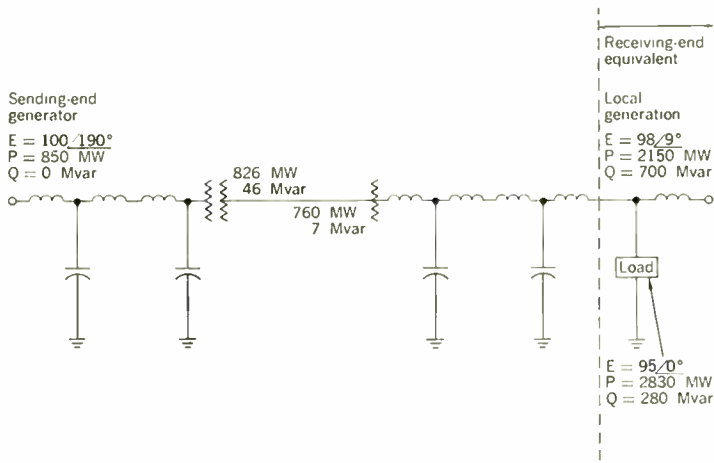

Fig. 3. Results of ac network calculator load-flow study at SIL conducted over a half-wave 500-kV 900-mile system. Voltages are in per cent.

indicated that the currents did not present any unusual problems because their magnitudes were within accustomed ranges. The fault currents varied widely with the location of the fault. Faults at the center of the line produced ground currents smaller than SIL, and faults near either end of the system caused ground currents of the order of 15 to 20 times SIL.

For the T-section design, studied here in detail, a subtransient reactance was assumed for the sending-end generator and also for the local generation equivalent. These values were 15 per cent and 7 per cent, respectively, on a 1000-MVA base. It was further assumed that the sending-end step-up transformer bank was delta-Y grounded and that the receiving-end step-down transformer was a grounded-Y autotransformer bank.

Complete tests were made for one-, two-, and three-

phase-to-ground faults at all locations. The generator positive-sequence currents vary from near zero for three-phase faults 90° away to some high value related to the transient impedance for faults near the generator terminals.

Table I shows the more pertinent results of the faults in terms of phase voltage. At the line ends (transformer high-voltage side), highest voltages developed on the unfaulted phase during a two-phase-to-ground fault at the system's receiving end (load). For the three-phase-to-ground fault the transformer voltage rise was slightly less severe. The faults of most interest, not shown in Table I, are faults within the T sections. Three-phase faults at this point cause voltages up to seven times normal at the center of the line. However, locating the T sections within the sending and receiving stations would minimize the occurrence of short circuits of this nature and would also serve to minimize the high voltages that are associated with them. Nevertheless, the possibility that this type of short circuit might occur necessitates the investigation of higher transformer insulation levels.

To control the high voltages resulting from faults near the ends of the line, arc gaps could be used near the line's mid-point. In addition to collapsing the voltage, grounding the mid-point reduces the terminal breaker duty. The arc gaps could be set above the gap required for minor lightning surges to a value necessary to handle only voltages resulting from short circuits. The normal lightning surges could be handled by lightning arresters at the transformer high-voltage side.

Worth mentioning again in connection with short circuits is the unusually low magnitude of ground currents associated with center of the line faults. For the cases of one-, two-, and three-phase-to-ground faults, the follow-up current was less than SIL.

### Stability

The steady-state stability of a half-wave transmission system is unquestionable because when properly de-

### I. Per cent voltage at high-voltage sides of sending- and receiving-end transformers during one-, two-, and three-phase-to-ground short circuits

Type and Location of Fault	Per Cent Voltage at High-Voltage Side					
	Sending-End Transformer			Receiving-End Transformer		
	Phase A	Phase B	Phase C	Phase A	Phase B	Phase C
<b>Three-phase faults:</b>						
Sending-end transformer, high-voltage side	0	0	0	166	166	166
Receiving-end transformer, high-voltage side	222	222	222	0	0	0
Load	190	190	190	232	232	232
<b>Two-phase-to-ground faults:</b>						
Sending-end transformer, high-voltage side	69	0	0	170	136	194
Receiving-end transformer, high-voltage side	265	225	242	41	0	0
Load	68	178	167	163	219	226
<b>Single-phase-to-ground faults:</b>						
Sending-end transformer, high-voltage side	0	99	74	171	49	165
Receiving-end transformer, high-voltage side	235	180	99	0	89	79
Load	142	31	162	204	141	131



signed the generator appears to be approximately only  $10^\circ$  from the load.

In studies of the transient stability of the half-wavelength transmission system several cases were run on an ac network calculator. To simulate actual system conditions as closely as possible, typical kinetic energies and transient reactances were assumed for both the sending-end and receiving-end equivalent generators. The internal impedances, on a 1000-MVA base, were 0.20 and 0.089 pu ohm reactance respectively. The kinetic energies assigned to the generators were 8100 and 10550 megawatt-seconds respectively.

Faults of exaggerated duration were employed to illustrate the strong synchronous tie. In the case discussed here, a two-phase-to-ground fault was applied in the region of the receiving-end network equivalent and maintained for 17 cycles.

The phasor diagrams of Fig. 4 indicate the unusual transient reaction. They show the sending-end generator and line-voltage magnitude and angle with respect to load before the fault, 1 cycle after clearing ( $T = 18$  cycles), and 11 cycles after clearing ( $T = 28$  cycles).

If the phasor diagrams for before and immediately after clearing the fault—Figs. 4 (A) and (B)—are compared, it can be seen that the terminal-voltage angles never swing less than  $180^\circ$  with respect to each other even though the sending-end generator is momentarily in the second quadrant with respect to the load. During second-quadrant operation, the sending-end generator is acting as a motor, the power flow in the line is reversed, and simultaneously the voltage along the line is oriented in the opposite quadrant; therefore, the motoring generator is still more than  $180^\circ$  from the other end. Using the phasor diagram for reference, it can be said that the power flow is always in the clockwise direction, taking the longest path measured in terms of electrical degrees.

To arrive at the conditions shown in Fig. 4(C)—for  $T = 28$  cycles—the motoring action of the generator and the turbine drive combines to force the generator back into normal operation. Here, at 28 cycles, the power flow has again reversed and coincidentally the voltage has flipped back toward its original position. In tests at lower clearing times, motoring did not occur.

In summary, the remarkable transient stability of the half-wavelength transmission system to a fault of extraordinary duration is self-evident in Fig. 5, the swing curve for the 17-cycle fault.

### Alternate designs

**The second design.** If greater line-carrying capacity is desired without the use of higher voltages, the SIL of the line can be increased by the addition of shunt capacitors along the line. This additional admittance not only increases the SIL but lengthens the line electrically. For purposes of this example, assume that the SIL of the line in the first design (900 miles of single-circuit twin Chukar at 500 kV) is to be increased from 820 MW to 1400 MW.

For SIL of 1400 MW the line admittance necessary would be

$$y = \pm I^2 = j0.249(1.4)^2$$

$$= j0.489 \text{ pu mho per 100 miles}$$

on a 1000-MVA base

Fig. 4. Voltage phasor diagram of a half-wavelength 500-kV 900-mile system at SIL. A—Under normal operating conditions. B—After clearing of 17-cycle fault. C—At 28 cycles (11 cycles after clearing).

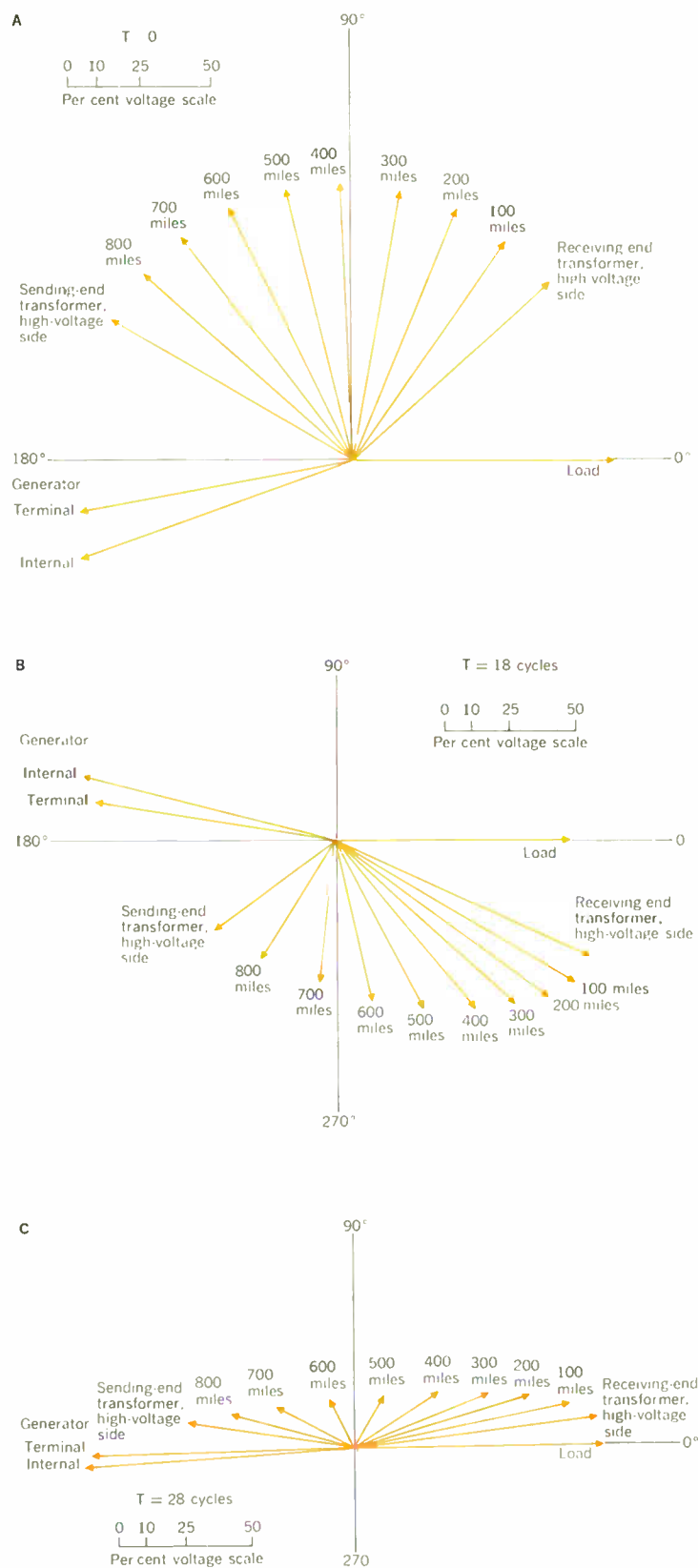

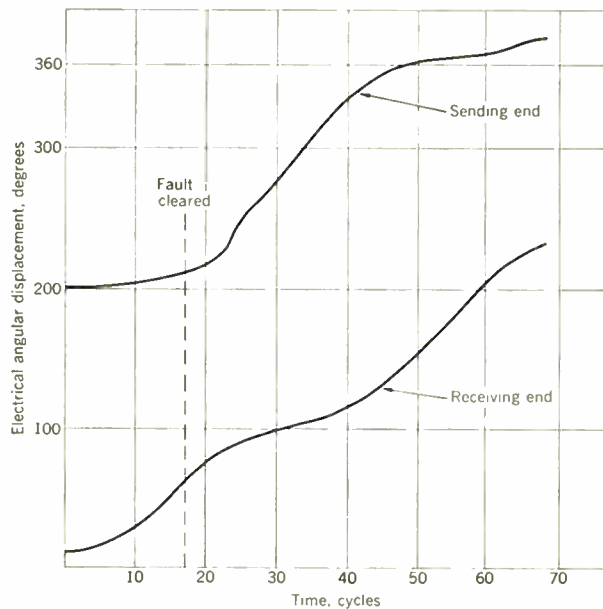

Fig. 5. Swing curve of generator internal voltage angles for fault of 17-cycle duration applied in region of receiving-end equivalent of the half-wavelength 500-kV 900-mile system.

The natural per-unit admittance of the line is  $j0.167$  per 100 miles. Therefore, the difference of  $j0.322$  has to be made up with shunt capacitors. A total of  $9(0.322)$  (1000) or 2900 Mvar, distributed at 100-mile intervals along the line, is required to increase the SIL from 820 MW to 1400 MW.

Since the admittance of the line has been increased, the phase shift over the line has also been increased. The new phase shift over the 900-mile line is

$$\theta = 57.3^\circ L \sqrt{zy} = 57.3^\circ(9)\sqrt{(0.249)(0.489)} = 180^\circ$$

Therefore, no additional tuning equipment is needed at the terminal because the transformer impedance will add a sufficient margin of safety to insure continual  $180^\circ$  operation.

Comparing the second design with the first, 33 per cent more tuning equipment is necessary in terms of Mvar. However, the power-transmitting capability of the line has been increased 71 per cent. This advantage in reduced capital cost per megawatt must be weighed against the additional  $I^2R$  losses in the line. The efficiency of the line decreases when the SIL is increased with shunt capacitors.

**The third design.** In this example let us assume that a single conductor is used instead of twin conductor and that the shunt capacitor method of increasing the electrical length of the line is to be used.

It is assumed that 1150 MW is to be transmitted at SIL for a distance of 900 miles at 500 kV over a line of 2½-inch OD, expanded ACSR, with 39-foot horizontal spacing. On a 1000-MVA base,  $z = j0.305$  pu and  $y = j0.137$  pu per 100 miles. The total admittance required per 100 miles is

$$y = zI^2 = j0.305(1.15)^2 = j0.403 \text{ pu}$$

The shift in voltage angle, end to end, is

$$\theta = 57.3^\circ L \sqrt{zy} = 57.3^\circ(9)\sqrt{(0.305)(0.403)} = 181^\circ$$

Therefore, no additional tuning equipment is needed.

The total required charging is greater than the natural line charging; therefore, shunt capacitors are required at 100-mile intervals along the line. To make up the difference,  $9(403 - 137)$  or 2400 Mvar is needed for the 900-mile line. This result compares favorably with that of the first design, which required 1170 Mvar of shunt capacitors and 1017 Mvar of series inductors for a total of 2187 Mvar of tuning equipment to transmit 820 MW.

### Conclusions

As increased attention is being focused on the more remote hydro energy sources, a need for a more economical transmission system is developing. As an alternate to dc and conventional ac lines, a half-wave ac point-to-point transmission system has been proposed with three designs, or variations of designs. The advantages of the half-wavelength transmission line as compared to a conventionally designed ELD ac line are as follows:

1. For 60-c/s lines longer than 900 miles, the half-wavelength line would require less capital investment than a line of the same rating that uses series capacitor and shunt inductor compensation. The need for tuning equipment decreases with distance up to 1500 miles, and thus the necessary breakthrough of the cost barrier of an ac system is provided.

2. Half-wavelength systems are completely free of the special problems of Ferranti effect, excessive charging current, and the possibility of generator self-excitation associated with generating plant start-up and energizing a long transmission line. For all practical loadings, the terminal voltage of the generator is essentially constant.

3. The system is stable under severe fault conditions.

4. Unlike the ac lines of conventional design, the voltage of the half-wave line in the regions away from the terminals is a function of the transmitted load. The line potential automatically adjusts to different loading conditions. In any of the three ELD designs presented, the line megawatt capacity can be increased above SIL simply by dimensioning the system for higher operating voltage levels in the region away from the system terminals and larger currents near the terminals. The flexibility of the half-wavelength design offers the engineer a wide variety of choices from which he may make selections that fit his particular requirements.

Essentially full text of paper TP65-12, scheduled for presentation at the IEEE Winter Power Meeting, New York, N.Y., Jan. 31-Feb. 5, 1965.

### BIBLIOGRAPHY

- Central Station Engineers of the Westinghouse Electric Corporation, *Electrical Transmission and Distribution Reference Book*. East Pittsburgh, Pa.: Westinghouse Electric Corporation, 1950.
- Crary, S. B., *Power System Stability*, vols. I and II. New York: John Wiley & Sons, Inc., 1947.
- DuBois, E. W., Fairman, J. F., Jr., Martin, D. E., Murphy, A. M., and Ward, J. B., "Extra-Long-Distance Transmission," *Trans. AIEE*, pt. III (*Power Apparatus and Systems*), vol. 80, 1961 (Feb. 1962 section), pp. 1108-1116.
- Lyskov, Yu. I., and Sokolov, N. N., "Characteristic of the Tuned Transmission of AC Power," *Elek. Stantsii (U.S.S.R.)*, no. 5, May 1963, pp. 46-50 (in Russian).
- Ware, L. A., and Reed, H. R., *Communications Circuits*. New York: John Wiley & Sons, Inc., 1944.

# Authors

**E. W. Herold** (M) was born in New York City in 1907. He completed his undergraduate work at the University of Virginia, from which he received the B.S. degree in physics in 1930. He received the M.S. degree, also in physics, from the Polytechnic Institute of Brooklyn in 1942; the same institution awarded him the honorary D.Sc. degree in 1961. In 1924 he joined the staff of the Bell Telephone Laboratories, Inc., where he worked until 1926. From 1927 to 1929 he was employed by E. T. Cunningham, Inc. In 1930 he joined the Radio Corporation of America, and was associated with that company until 1959, by which time he had become the director of the Electronic Research Laboratory of RCA Laboratories' Princeton, N.J., facility. From 1959 through 1964 he was vice president in charge of research at Varian Associates, Palo Alto, Calif. He has just rejoined RCA at Princeton as a member of the staff of the vice president of research and engineering.

Dr. Herold has specialized in electron tube and semiconductor device research for many years. He is a member of Phi Beta Kappa and Sigma Xi and has served on the Boards of Directors of IRE and WESCON.



**R. M. Fano** (F), Ford Professor of Engineering and professor of electrical communications at Massachusetts Institute of Technology, and director of M.I.T.'s Project MAC, has made important contributions to communications and information theory. He did part of his undergraduate work at the School of Engineering in Turin, Italy, before coming to the United States in 1939. He received the B.S. and D.Sc. degrees, both in electrical engineering, from M.I.T. in 1941 and 1947 respectively. He joined the M.I.T. staff in 1941 as an assistant in electrical engineering, and became an instructor in 1943, a research associate in 1945, an assistant professor in electrical communications in 1947, an associate professor in 1951, and a professor in 1956. In 1962 he was appointed Ford Professor of Engineering, in which capacity he continues to hold his department affiliation but is primarily concerned with interdisciplinary teaching and research. Professor Fano is the author of a book, *Transmission of Information*, and the coauthor of two textbooks on electromagnetic theory. He is a Fellow of the American Academy of Arts and Sciences, and a member of ACM, Sigma Xi, and Eta Kappa Nu.



**Richard T. James** received the E.E. degree from Rensselaer Polytechnic Institute in 1935. After graduation he worked in technical assignments for the General Electric Company in Pittsfield, Mass., and for radio station WOR in New York City. He joined the Long Lines Department of the American Telephone and Telegraph Company in 1942 and was concerned with the transmission aspects of broadband carrier systems, both cable and radio. His duties in this assignment included work on the video program and telephotograph networks, as well as various special services. He was appointed a district plant engineer in 1949 and later became a staff assistant in plant operation and maintenance. In 1952 he was transferred to the General Engineering Department, where he worked on special services. At the present time he is in charge of a system engineering group that is involved in the provision of wide-band systems for special services of all types. These include high-speed data systems, high-speed graphic systems, and telemetry systems.





**Albert V. Crewe** is director of the Argonne National Laboratory as well as a professor at the University of Chicago's Enrico Fermi Institute for Nuclear Studies. A native of England, he received the bachelor's degree in physics in 1947 and a doctoral degree in physics in 1951, both from the University of Liverpool. While associated with that university as assistant lecturer, and later as lecturer, he assisted in the construction of the first diffusion cloud chamber built in England and also was responsible for a peeler-regenerator system constructed for the Liverpool synchrocyclotron. Dr. Crewe's work at Liverpool University led, in 1955, to an invitation to join the faculties of The University of Chicago and of its Fermi Institute. At the University of Chicago he directed construction of a large magnetic spectrometer for work with the proton beam of the school's synchrocyclotron, and he conducted a research program on meson production and proton interactions. Because of his previous accomplishments in high-energy physics research, Dr. Crewe was appointed director of Argonne's Particle Accelerator Division in 1958, with major responsibility for the design and construction of the zero-gradient synchrotron. He was named director of the laboratory in 1961.

Dr. Crewe recently received the Immigrants Service League award for outstanding achievement in the field of science. He is a member of the American Physical Society, the American Nuclear Society, and the Scientific Research Society of America.

**F. J. Hubert** (M), a registered professional engineer, received the B.S. degree in electrical engineering from Princeton University in 1948, and then went into electric utility substation design for the Southern California Edison Company. He joined the Facilities Design Department of the Aerojet Corporation in 1951, and in 1952 joined the Stone and Webster Corporation, where his duties were in the field of steam generating station construction.

Mr. Hubert has been associated with the Department of Water and Power, City of Los Angeles, since 1954. After six years in transmission-line research, he became a member of the transmission and network studies group concerned with power system planning and preliminary design. At present he is in charge of the electrical unit connected with the inspection, maintenance, and repair of major power system equipment.

**M. R. Gent** (M) did his undergraduate work at the Texas Agricultural & Mechanical University, from which he received the bachelor's degree in electrical engineering in 1963. At the present time he is taking graduate courses in the evening at the School of Engineering of the University of Southern California, in Los Angeles, in preparation for receiving the master's degree in electrical engineering.

Before he began his association with the City of Los Angeles, Department of Water and Power in 1963, Mr. Gent served as an operator of the ac network calculator being run under the auspices of the Texas A & M Research Foundation. His principal activities in connection with his present position with the Los Angeles Department of Water and Power are in the fields of ac and dc interconnections, extra-high-voltage studies, and systems analysis.

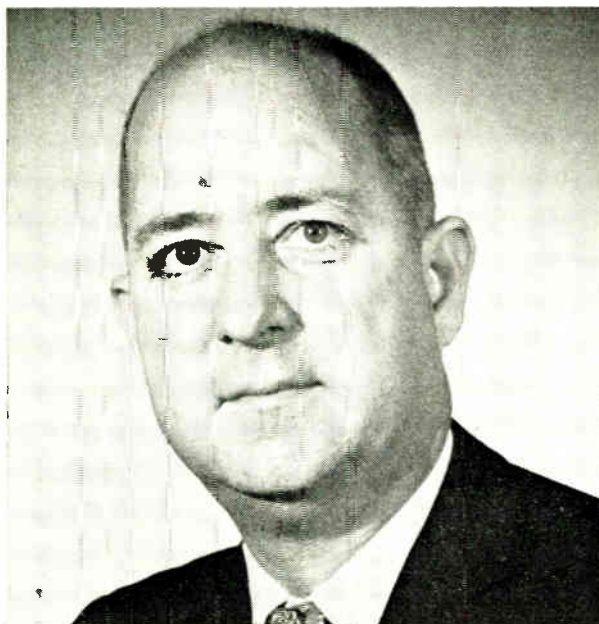

# Spectral lines

**On the Operation of a Professional Society.** Professional societies are complex organizations. Whether or not such organizations can adapt effectively to rapidly changing circumstances concerns all the members of the IEEE.

Parkinson has pointed out, with both shrewdness and humor, many of the failings that are characteristic of large organizations. However, an examination of some of the specific characteristics of professional societies in general, and of the IEEE in particular, may clarify some of the problems we face and indicate possible solutions.

One characteristic of professional societies is that they operate primarily through the voluntary efforts of a large number of people who have interests in a common professional field. These efforts are usually assisted by a paid staff that performs many of the functions that cannot be effectively carried out on a voluntary basis. In the case of the IEEE, the voluntary efforts upon which it depends come from people widely dispersed geographically and having a wide range of technical interests.

Can such an Institute adapt itself rapidly to changes in the scientific and technical world? Can its operations be characterized by both foresight and efficiency?

Since World War II, scientific and technical knowledge and activity have expanded rapidly and this expansion has caused many changes in the operations of industry, government, and universities. Have the technical societies also changed their operations? One indication that they have not changed rapidly enough is the large number of conferences, symposia, and meetings devoted to technical subjects that lie within the fields of interest of existing professional societies, which are sponsored by universities, government agencies, and industry. Another example is the advent of many new technical periodicals of an archival nature being published by private publishers. If such meetings and publications are satisfying needs of the profession, it is evident that the professional societies either have not recognized, or have not adequately responded to, these needs.

The pessimistic attitude that a professional society is too cumbersome an organization to respond effectively and rapidly to new conditions can be refuted by the many instances in which professional societies have acted with both foresight and dispatch. As an example, the need to shorten the delay time between the submission and publication of technical communications was recognized by the American Physical Society and new periodicals devoted to the rapid publication of "Letters to the Editor" were started. There was a decrease in this delay time from a minimum of about 48 days to a minimum of 12 days. Clearly, this profession is now being better served.

The IEEE has certainly undergone many changes in the past several years as it has progressed from a stage

in which these were two overlapping, and to an extent competing, societies to its present status of being a quite completely merged Institute. However, it is clear that many challenges still lie ahead.

What steps can the IEEE take to make sure it is not only meeting the presently known needs of its membership but also recognizing and anticipating future needs? Many industrial organizations use long-range planning groups to assist management in anticipating possibilities for new products and to develop capabilities for their production. Perhaps the IEEE needs a similar technique. A step in this direction was the appointment several months ago of an ad hoc committee of the Board of Directors to examine how effectively newly emerging technical areas are being served by the Institute. In addition there exists a General Committee of the newly organized Technical Activities Board that is concerned with new technical activities.

However, in addition to the ability to recognize new needs, the IEEE must also have the ability to respond to them with dispatch. Clearly a capable and well-equipped staff is needed. With the coming consolidation of the headquarters staff at a single location, and the availability of a computer to improve staff services, it is evident that progress is being made in this direction.

There is also a need for efficient organization of the members upon whose voluntary efforts the Institute so clearly depends. Here again many steps have been taken recently, such as the consolidation of the former AIEE Technical Divisions and Committees and the IRE Professional Groups into the new Technical Activities Board and its associated Groups and Committees. Considerable effort has been expended to remove redundancies and provide a simple and flexible operating structure. It is incumbent upon the Institute to make efficient use of the donated man-hours of its members. Unproductive or overlapping activities need to be eliminated.

In directing attention to the organizational dangers that the Institute faces, its many significant assets should not be overlooked or minimized. Perhaps the most important is the fact that there is, in the profession, a strong tradition of voluntary service to technical societies. Thus, some of the best talent available in the profession can be mobilized to meet the needs of the Institute. Also, there is a tradition of rotation in office which, if wisely handled, can result in a regular input of new ideas into the management of the Institute.

In summary, there are difficult problems facing the IEEE as it attempts to improve its service to its membership and to the future of its profession. However, there are also significant capabilities that can be mobilized to attack these problems.

*F. Karl Willenbrock*

## The Haystack microwave research facility

*A versatile new ground station, employing a Cassegrainian antenna 120 feet in diameter, has been developed for experimental space communications as well as for radar and radio physics investigations*

*H. G. Weiss    Lincoln Laboratory, M.I.T.*

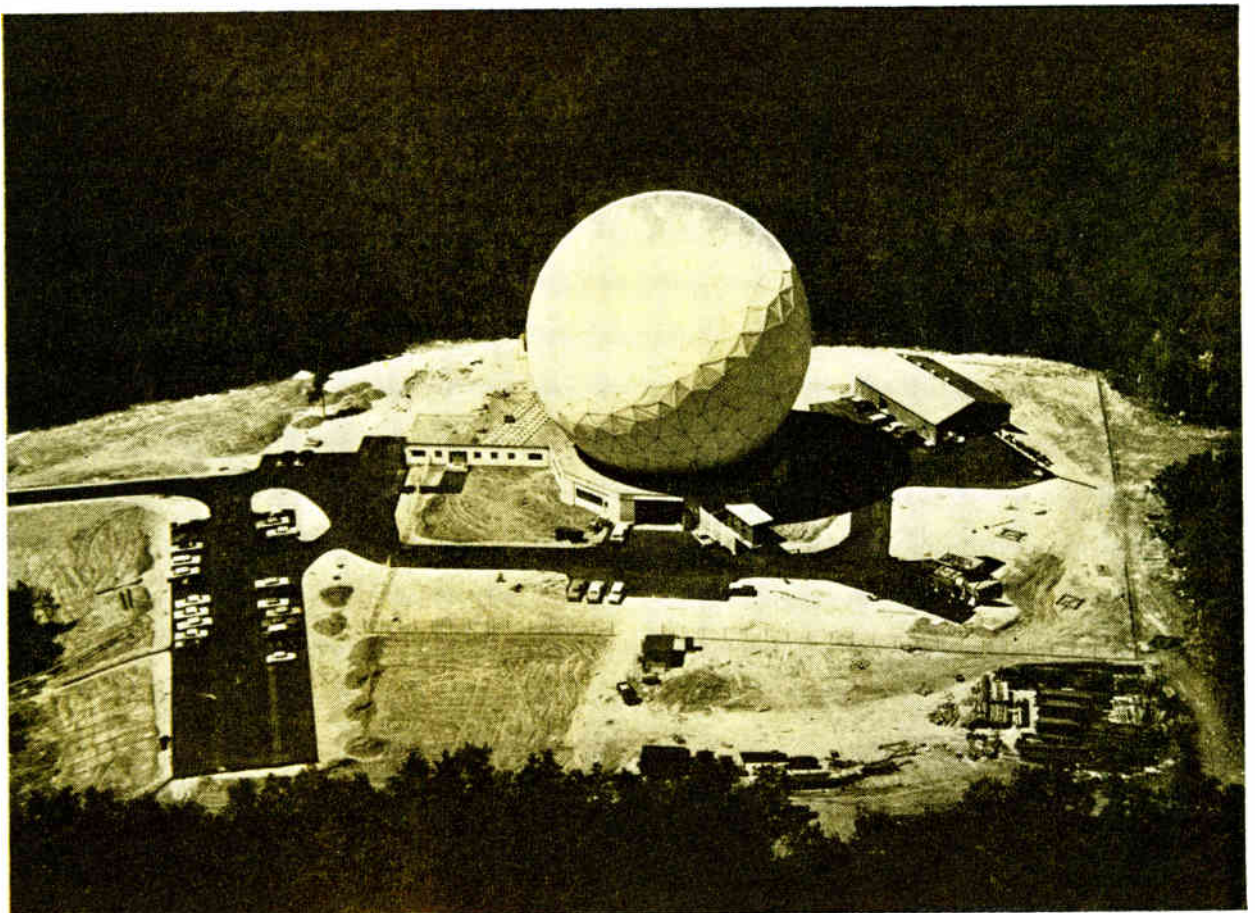

Since 1951, the M.I.T. Lincoln Laboratory has been conducting exploratory investigations in electronics, with emphasis on communications, radar, radio physics, and data processing. About five years ago, it became apparent that a new and more sensitive experimental facility would be needed in the microwave portion of the radio spectrum for long-range space communications and tracking experiments. The proposed investigations required a steerable, large-aperture antenna capable of high-power transmission and low-noise reception in a variety of modes over a frequency range from 1 through 35 Gc/s. Support for the development of this new microwave ground terminal was obtained in 1960 from the Electronic Systems Division of the U.S. Air Force. After four years of intensive work, the formal dedication ceremonies of the new installation were held in October 1964. The site is located approximately 30 miles northwest of Boston and about ½ mile from the Millstone Hill radar.

Haystack is a multipurpose facility, designed to operate as a versatile ground terminal for satellite, space communication, and radio propagation experiments, as a powerful tracking and measurements radar, and as a sensitive, high-resolution radio telescope. In each of these applications, the Haystack system has a performance capability superior to that of any existing microwave facility. The philosophy underlying this system's design and the new analytic and measurement techniques developed for its construction and evaluation are likely to have an influence on future radio telescopes, radars, and space communication terminals.

Among the novel and significant aspects of the Haystack system are the following:

1. A metal-space-frame radome is employed for the first time in a low-noise microwave system. Radomes of this type are of interest since they can be constructed in even larger sizes and can provide good electrical performance over a wide frequency range. The protection provided by the radome has made it possible to design and construct a large antenna system of unprecedented precision (Fig. 1).

2. Improved techniques have been developed which now make it possible to analyze and predict the behavior of a complex space-frame and shell structures with an uncertainty of only one part in 100 000. This precision is about two orders of magnitude better than could be accomplished by design techniques previously available.

3. A precision optical surveying means has been integrated into the antenna to enable the antenna surface contour to be measured at any desired orientation angle.

4. An unusual hydrostatic bearing has been developed which has low static friction and permits the positioning and control of the antenna with great precision. This type of bearing is essentially free from wear.

5. The on-line use of a digital computer in the antenna control system enables an unskilled operator to utilize the antenna in an efficient and flexible manner. The computer is also used in real time to reduce and record experimental data and to monitor equipment performance, and in non-real time to simulate conditions for future experiments.

6. The integration of a "plug-in" equipment room within the antenna structure and a versatile system of interconnecting cables makes it possible to employ the facility for many different applications. The RF configuration is efficient and permits the use of low-noise receivers and high-power transmitters. In addition, the plug-in equipment concept will permit the system capability to be updated easily.

#### The radome

Because it was desired to locate the facility relatively near the Lincoln Laboratory, the antenna had to be ca-

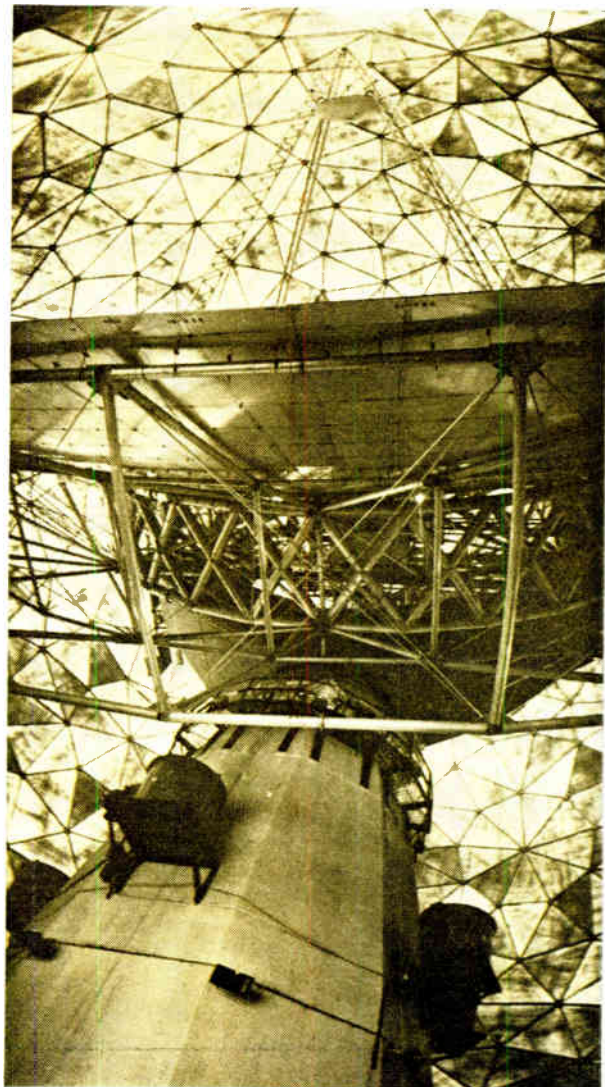

(Left) Aerial view of Haystack facility.  
Fig. 1 (Right). Haystack antenna system.

pable of surviving the rigors of a New England environment. It did not seem feasible to construct a large, steerable microwave antenna with the required surface tolerance and pointing precision unless it were protected from the wind, snow, and ice. Although both radomes and movable shelters were considered for this purpose, a radome was chosen because it would enable the antenna to operate under all weather conditions.

An air-inflated radome did not appear practical for this application because it would have to be constructed from a relatively thick fabric to survive in a New England environment and this would degrade the system performance at the shorter wavelengths. An all-plastic rigid radome seemed equally unsuited for use at microwave frequencies. Studies started at the Lincoln Laboratory in 1956 led to the development of a new type of radome, with improved microwave performance, which used a structural framework of metal beams to support relatively thin, low-loss dielectric panels. At the time that the Haystack program was being formulated in 1959, a 150-foot-diameter metal-space-frame radome in the shape of a  $\frac{5}{8}$  sphere, designed to withstand a 200-mi/h Arctic environment, was under procurement by the Air Force. This particular radome was overdesigned for a New England environment, but studies indicated that it could be modified to  $\frac{3}{10}$  of a sphere without weakening the structure below the wind survival specification of 130 mi/h that had been established for the Massachusetts location. The Haystack radome was built by the H. I. Thompson Fiber Glass Company to the Lincoln Laboratory design.

Thus, the decision to take advantage of the availability of the 150-foot-diameter radome influenced the choice of the antenna size. An antenna diameter of 120 feet was selected because it was the largest fully steerable parabolic aperture that could be fitted into this radome on an elevation-azimuth mount. The clearance between the radome and the rim of the reflector is about  $3\frac{1}{2}$  feet.

Approximately 6 per cent of the spherical surface of the radome is occupied by the metal space framework. However, since a substantial portion of electromagnetic energy passes through the radome surface at an oblique angle, the aperture blocking is increased. Because of the large ratio of antenna diameter to radome diameter chosen to fit the largest possible antenna into the radome, and because the shape of the metal beams is not optimum, the computed aperture blocking is about 11 per cent, which is higher than would be necessary in an optimum design. Even with this larger blockage, electromagnetic scale-model tests indicated that the beam pattern distortions and the boresight shift due to the metal-space-frame radome would be acceptably small. The loss of 11 per cent of effective aperture seemed tolerable in return for an improved environment for the remaining 89 per cent of the antenna surface.

The metal members of the radome framework, varying in length between 9 and 15 feet, are hollow aluminum extrusions approximately 3 by 5 inches in cross section. This framework supports 0.032-inch-thick fiberglass dielectric panels, having a loss tangent of about 0.01. The electromagnetic behavior of the radome has been calculated and is shown in Fig. 2. Throughout the frequency range from 1 to 10 Gc/s, the loss in antenna gain attributable to the space frame is about 1.1 dB. The membrane has a dielectric constant of 4 and reflects an increasing amount of the RF energy at frequencies above 8 Gc/s.

At a frequency near 90 Gc/s, where the membrane thickness approaches a half wavelength, the reflections at the front and rear boundaries of the membrane cancel and the losses are reduced.

Of the energy reflected by the radome, only the part that is scattered toward the ground contributes to the system noise temperature. This noise contribution is a function of antenna elevation angle, aperture illumination, and wavelength.

The electromagnetic performance of the Haystack radome, though acceptable, is not ideal. Today it is possible to design a more satisfactory space-frame radome with an overall loss of about 0.5 dB. This could be accomplished by designing the structural members for a 130-mi/h instead of a 200-mi/h environment, by constructing the beams of high-tensile-strength steel instead of aluminum, and by shaping the beam cross section to minimize oblique-angle blockage. The analytic techniques subsequently developed to design the Haystack antenna can also be used to optimize the design of the space frame. The use of a radome that is larger in proportion to the antenna diameter would reduce the electrical blockage, and the electromagnetic performance of the radome at the higher frequencies could be improved by the use of membrane materials that have recently become available.

### The antenna

**Performance requirements.** The most challenging element in the Haystack system is the precision antenna and its control system. The experimental programs required that the antenna function efficiently over a wide frequency

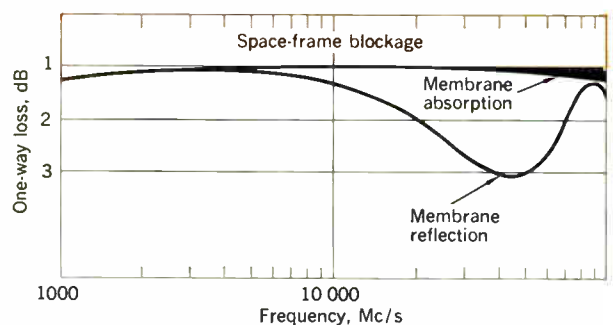
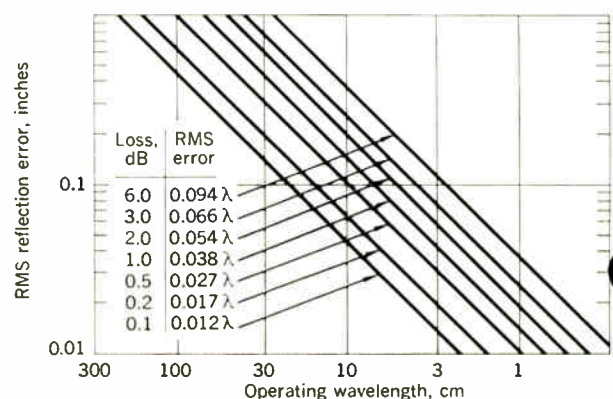

Fig. 2. Electrical performance of radome.

Fig. 3. Loss due to reflector tolerance.





range, be fully steerable, accurately track relatively fast-moving satellites and slow-moving radio stars and planetary bodies in both open-loop and closed-loop modes, and permit the efficient use of a variety of very-high-power transmitters and low-noise receivers. An examination of the antenna systems in use or under design at the outset of the Haystack program quickly established that they fell far short of the desired performance in terms of sensitivity, precision, and flexibility.

The specification of the operating frequency range was guided by the variety of proposed uses for the system. Several specific radar and communication studies required the use of a large-aperture antenna at a wavelength of 3 cm, and other programs could make effective use of a large antenna at considerably shorter wavelengths. The longest nominal operating wavelength was chosen to be 30 cm to permit the antenna to be used for both hydrogen-line and L-band radar studies.

To achieve a large antenna with efficient performance at high microwave frequencies, the requirement was established for an aperture efficiency only 0.3 dB below that obtainable from an ideal 120-foot-diameter parabolic reflector at a wavelength of 3 cm. The fulfillment of this requirement would permit the antenna to be useful at wavelengths as short as 8 mm.

The relationship between the surface tolerance of a reflector antenna and its aperture efficiency at several wavelengths is plotted in Fig. 3. To meet a 0.3-dB loss criterion, the reflector surface should not deviate more than  $0.025\lambda$  (rms) from an ideal parabolic contour. For  $\lambda = 3$  cm, this corresponds to 0.075 cm. When working with production drawings, manufacturing operations, and field measurements, it is more appropriate to specify peak tolerances rather than rms tolerances; and since experience has shown that the peak surface deviation of a typical antenna will be approximately 2.5 times its rms deviation, the 0.075-cm rms tolerance was converted to a peak value of  $\pm 0.187$  cm, or about  $\pm 0.075$  inch. Therefore, the antenna specification was written to require that no point on the reflector surface depart more than  $\pm 0.075$  inch from an ideal parabolic contour under any anticipated operating conditions. This allowable peak error of 0.075 inch must include all surface errors resulting from gravity forces (which vary with elevation angle), thermal effects, manufacturing errors, and field erection and calibration errors. To meet this requirement, it was necessary to develop design and measurement techniques that would contribute an uncertainty of perhaps only 0.02 inch maxi-

mum. In a structure 120 feet in diameter, this value corresponds to about one part in 70 000 and represents a substantially more stringent design requirement than has been achieved in any other large movable structure to date.

The challenge that this design objective poses is illustrated in Table I by a comparison of the present Haystack antenna with a number of large radio-astronomy antennas currently in operation. Some of these other antennas are not fully steerable, and none has the agility required of Haystack for satellite tracking. Each reflector is representative of the best contour accuracy that could be achieved in its size range, within the state of the art (and the state of the pocketbook), at the time it was built. The reward for good contour precision in proportion to antenna diameter is indicated by the figures for highest efficient operating frequency and the beam width at that frequency. The tolerance estimates presented have been assembled or deduced from various sources with varying degrees of reliability and may be regarded as representative, if not exact.

In recent years, serious difficulties have been encountered in several programs for constructing large steerable antennas. It seemed particularly important, therefore, to demonstrate that much of the risk could be eliminated in the design of large antennas by thorough planning and by an intensive design and engineering effort. One of the most important lessons of the Haystack program has been the reaffirmation of the value of a methodical scientific approach in the design of new antenna systems.

A perfectly parabolic 120-foot-diameter antenna at a frequency of 10 Gc/s will produce a radiation pattern with a main lobe width that is  $0.05^\circ$  between 3-dB response points, and it is necessary to point this narrow beam with an error that is only a small fraction of a beamwidth. Hence, the specifications were written to require that the pointing error not exceed  $0.005^\circ$  (18 arc seconds) at the tracking rates to be encountered in most experiments. It was anticipated, however, that sometimes it would be desirable to transfer from one target to another in a relatively brief period. Hence, it was specified that the antenna be able to move from any one pointing position to any other, and to achieve a pointing error of less than  $0.005^\circ$ , in less than 60 seconds.

The utilization of such a narrow beam would be difficult, if not impossible, without some form of pointing computer, and it seemed advisable to integrate a general-

## I. Typical radio astronomy antennas

	Diameter (D), feet	Tolerance ( $\epsilon$ ), inches rms*	Precision (D/ $\epsilon$ )	Frequency, Mc/s†	Beam Width minutes‡	Remarks
Jodrell Bank	250	1.2	2500	650	26	Fully steerable
Stanford	150	0.55	3270	1420	20	Fully steerable
Greenbank	300	0.47	7600	1660	8.5	Transit instrument
Arecibo	1000	1.0	12 000	780	5.4	Zenith-looking spherical reflector
Parkes-CSIRO	210	0.14	18 000	5600	3.5	Steerable
Michigan	85	0.043	23 600	18 000	2.75	Fully steerable
Lebedev	72	0.025	34 500	31 000	1.9	Fully steerable
Haystack	120	0.020	72 000	39 000	0.9	Fully steerable in radome

\* Data from various sources; sometimes inconsistent.

† Frequency at which loss due to reflector surface tolerance is 3 dB.

‡ Half-power beam width at frequency indicated.

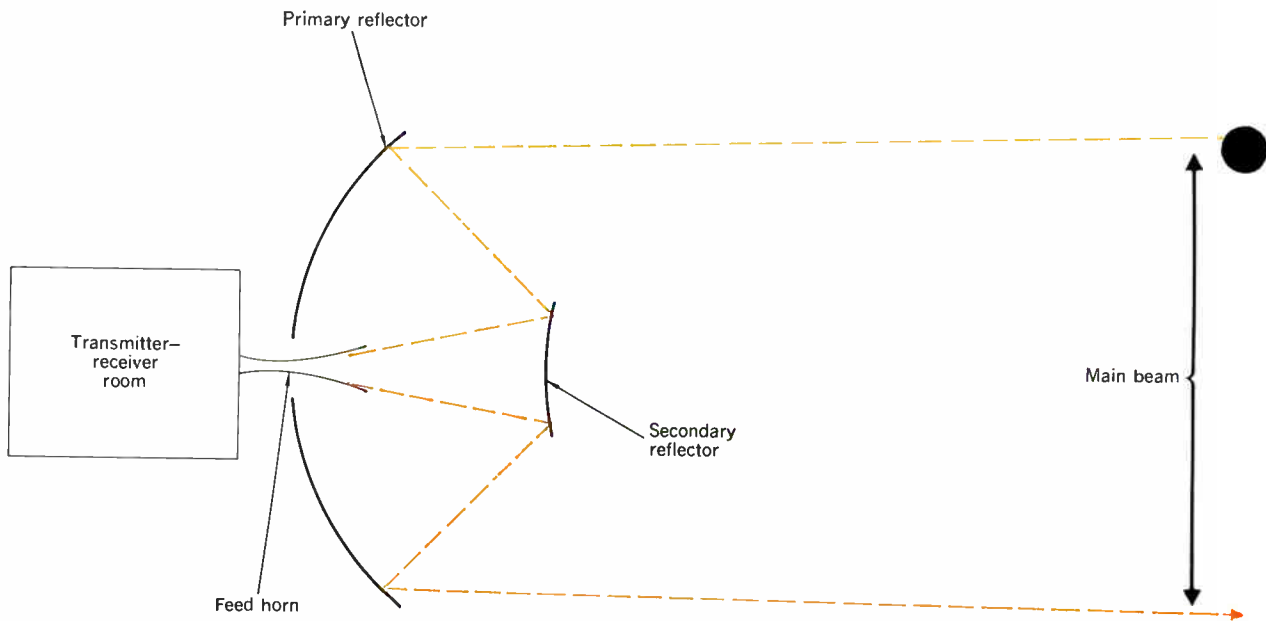

Fig. 4. Schematic diagram of Cassegrainian reflector configuration.

purpose digital computer into the antenna control system. Such a computer could generate rapid and accurate parallax and time-delay corrections and thus enable the antenna to be directed from data obtained over telephone or radio circuits from a remote location. It would also permit semiautomatic compensation of systematic pointing errors resulting from displacement of the feed with elevation pointing angles, lack of orthogonality in the elevation and azimuth axes, systematic errors in the shaft encoder, etc. It would provide a method for introducing pointing corrections for beam bending due to the refractive index of the atmosphere, which would be significant at elevation angles below  $15^\circ$ .

A Cassegrainian reflector system (illustrated in Fig. 4) was selected because it combined good electromagnetic performance with a basic configuration that permitted the placement of electronic components near the center of gravity of the moving structure. The energy spillover from the primary feed horn of a Cassegrainian antenna is largely in the direction of the "cold" sky, a desirable attribute for a low-noise antenna. The size of the hyperbolic secondary reflector was chosen to be about 9 feet in diameter so that, at the lowest nominal wavelength—namely, 30 cm—the diameter of the secondary reflector would equal that of the feed horn.

The concept of interchangeable "plug-in" instrumentation rooms was evolved to provide a convenient way for using the antenna for a variety of experiments, and a hoist system was incorporated into the antenna structure to handle them. An artist's drawing of the antenna system in the radome (Fig. 5) shows the primary and secondary reflectors, the backup structure and counterweight systems, and a plug-in room being hoisted up into place behind the primary reflector.

**Development approach.** After the general characteristics of the antenna system were established, performance specifications were prepared and design proposals were solicited from 29 industrial firms. Many of the 14 firms that responded had had considerable experience with con-

ventional antennas, but a study of the proposals revealed that an adequate engineering basis for designing an antenna to fulfill the stated performance objectives did not exist. The techniques available in 1960 for estimating the performance of a complex structure like an antenna required that it be approximated by a greatly simplified two-dimensional mathematical model. Studies revealed that these simplifying assumptions would make it impossible to obtain, for this type of complex, moving structure, a valid analysis that would be accurate to better than about one part in about 500.

To provide a sound engineering base for the development of this very precise structure, the specification was amended to incorporate additional supporting studies. These included: the development of a rigorous mathematical model of the antenna and the analysis of the behavior of the structure by the use of a digital computer; the construction and testing of a  $1/15$ -scale structural model and a comparison of the behavior of this model with that predicted by the computer program; and the preassembly of the complete antenna system at the contractor's plant and the proof loading and comparison of its behavior with the computer-predicted performance. The specifications called for the submission of all drawings to Lincoln Laboratory for approval prior to release to production. To review and comment competently upon the adequacy of the drawings, it became necessary for Lincoln Laboratory to establish a small design group to analyze and evaluate the design details independently. Much of the success of the overall effort can be related to the use of two engineering design teams, each independently evaluating the structure in great detail.

**The Haystack antenna configuration.** In December 1960, a contract was awarded by the Air Force to the North American Aviation, Inc., Columbus (Ohio) Division for the design, construction, and installation of the Haystack antenna system. The structural configuration proposed by NAA can be seen in Fig. 5. The reflector backup structure consists of five concentric ring trusses inter-

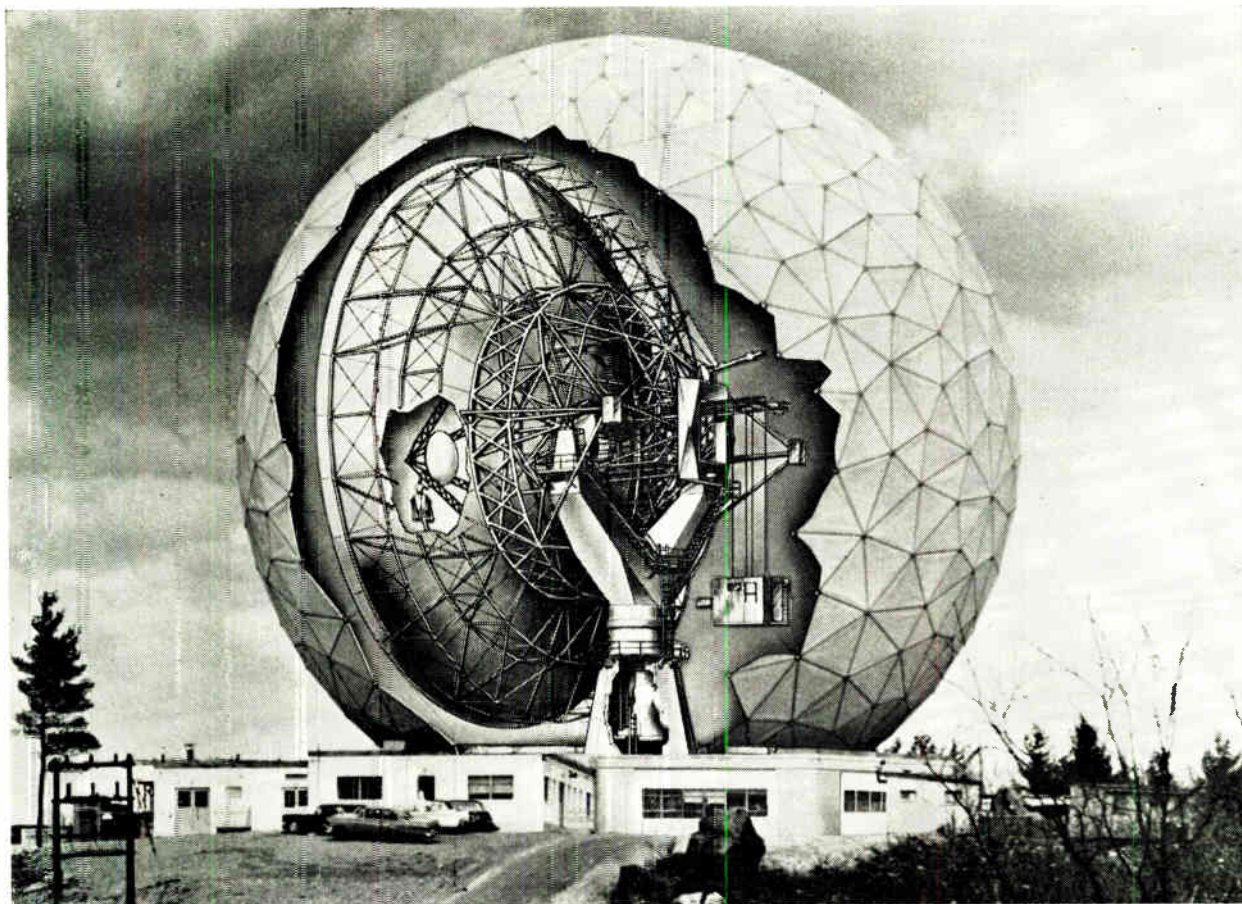

Fig. 5. Placement of antenna within radome.

connected by pretensioned diagonal rods. The main supporting ring, which is 60 feet in diameter, is bridged by two trunnion trusses that are attached to the main ring at its quadrant points and carry its load to the elevation bearings. Two ring trusses are positioned outboard of the main support ring, and two smaller ring trusses are positioned inboard of the main ring. The pretensioned interconnection rods are designed to work without stress reversals as the antenna rotates. In the trunnion beams and the support rings, where high compression loads occur, and where some stress reversals cannot be avoided, heavy-wall large-diameter tubing was used, and considerable effort was expended in the development of a bolted joint that was not susceptible to creep. This configuration results in a structure that is unusually stiff in proportion to its weight.

The reflector surface, which is supported from the backup structure by means of adjustable standoff studs, is made up of 32 inner panels and 64 outer panels. These panels consist of thin, prestretched aluminum skins bonded to a 1/2-inch-thick aluminum honeycomb core. The panels are interlocked by shear keys. Adjustable expanders are located at 2-foot intervals along the radial edges of each panel to determine the gap between panels. One circumferential edge of each inner and outer panel is firmly attached to a 60-foot-diameter annular ring, which in turn is supported by adjustable standoffs from the main ring. Each panel is also attached to two of the other ring

trusses by adjustable standoffs, which are placed normal to the local contour. These have ball and socket joints at each end and thus take only axial loading.

The 96 individual reflector panels are made to behave as a homogeneous shell by the use of 26 concentric circumferential cables located behind the reflector surface. These pretensioned cables, which act as large "elastic bands," are guided by adjustable rollers mounted on the back of the reflector panels, close to the panel surface. The exact contour of the reflector surface can be adjusted by the interpanel expanders, the adjustable standoffs at the rings, and the spacing between the cable rollers and the back of the panel. If the individual panels are made to work as a homogeneous shell, the stiffness of the reflector surface is increased about tenfold, and the relatively lightweight reflector surface contributes significantly to the overall rigidity of the complete antenna system. When the reflector is rotated away from the vertical, the integral shell is restrained from lateral movement relative to the backup structure by 32 shear pins installed between the shell and the trunnion trusses.

The Cassegrainian secondary reflector is a 9-foot, 4-inch-diameter hyperbolic surface supported by a planar truss quadripod. The reflector surface was explosively formed from a 0.188-inch-thick sheet of aluminum, which was then backed by an expanded aluminum honeycomb core and milled in a digital controlled boring mill. In this manner a relatively rigid, lightweight, precision-contour

secondary surface was obtained. The surface of the secondary reflector has a tolerance of  $\pm 0.005$  inch. While the reflector axis was established in the boring mill, a 2-inch-diameter optical flat was carefully located at the center of the reflector with its axis coincident with that of the reflector to within 1 second of arc. The position and tilt angle of the secondary reflector are remotely adjustable by lead screw actuators.

**Quality control and measurement system.** Great care has been taken in the design and fabrication of the reflector panels. Refined measurement and quality control techniques had to be developed by NAA to produce panels that would conform to the theoretical contour with an rms deviation of approximately 0.010 inch when measured in a precision test fixture in a temperature-controlled environment. The panels, which are nearly 30 feet long, were fabricated on a precision, doubly curved mold. A thermal-setting epoxy was used to bond the prestretched aluminum skins to the honeycomb core. The panels were then trimmed in a precision drill and trim fixture, still in a constant-temperature room, and 16 optical targets were carefully located on each reflector panel surface in such a way that there would be eight circular rows of targets on the finished reflector. The tolerance in locating these targets within any given panel is  $\pm 0.003$  inch.

After the antenna had been assembled, the surface was adjusted by the use of the system of optical elements

shown schematically in Fig. 6. The optical system consists primarily of alignment telescopes, precision levels, ruled circles, targets, pentamirrors, and a calibrated tape. Each element is the most precise unit of its kind available. To facilitate the use of the alignment system, the overall antenna configuration was designed to preserve optical paths from the ground through the azimuth and elevation axes.

The primary optical probe for adjusting the surface contour was built by Keuffel and Esser Company under subcontract from North American Aviation. This probe is mounted in a plug-in room, which has its center of gravity and total weight matched to that of a typical plug-in equipment room. A special chair on gimbals has been provided to permit an observer to use the optical probe while the antenna is rotated in elevation. The upper head of the calibration probe, which may be rotated, contains eight indexable fixed-angle pentamirrors that permit observation of the eight circular rows of targets on the reflector surface. Each pentamirror, which has been calibrated to have an error of less than 1 second of arc, rotates the line of sight the proper amount to view one circle of targets. This system, which does not require an outside reference, permits referencing all target points with respect to four "hard points" located where the secondary reflector quadripod legs join the main support ring. Experience in using the optical probe at the Haystack site has indicated that, when the thermal environment is relatively stable (at night), the repeatability of the optical measurements on a day-to-day basis is within 2 seconds of arc. This corresponds to an uncertainty of about 0.007 inch in a direction normal to the line of sight at a radius of 60 feet.

**Bearing and control system.** The bearings used for the elevation and azimuth axes of the antenna are of two distinctly different types. In the azimuth axis, an externally pressurized oil-film bearing was developed to minimize static friction (Fig. 7). This type of bearing provides extremely smooth performance and is expected to have long life.

The lower portion of the azimuth bearing consists of a 6-foot-high load distribution cylinder, which is located between the rotating portion of the antenna and the concrete tower. The azimuth bull gear, which is about 14 feet in diameter, is bolted to this distribution cylinder and serves as a support ring for the hydrostatic bearing pads, each of which has an effective surface of 8 by 14 inches. Sixteen pads are used for the vertical support thrust bearing, and eight pads are used for the radial thrust bearing. The combined weight of the pad, ring, and structural member is 42 000 pounds. Adjustable wedge-block assemblies are used between the concrete tower and the load distribution cylinder to permit releveling of the bearing.

The upper load distribution ring is approximately 14 feet in diameter and 4 feet high. The ring, which weighs approximately 24 000 pounds, contains integral thrust and radial runner surfaces that have been flame-hardened and surface-ground. It is very stiff weldment, designed to distribute the concentrated loads that are conveyed from the yoke arms. The bearing pads operate with an oil-film thickness of approximately 0.005 inch.

Conventional self-aligning, spherical, roller-bearing assemblies are used in the elevation axis. The diameter of the elevation bearings is relatively small (10.5 inches), so the "stiction" torques are very small. An oil circulation

Fig. 6. Haystack antenna optical alignment system.

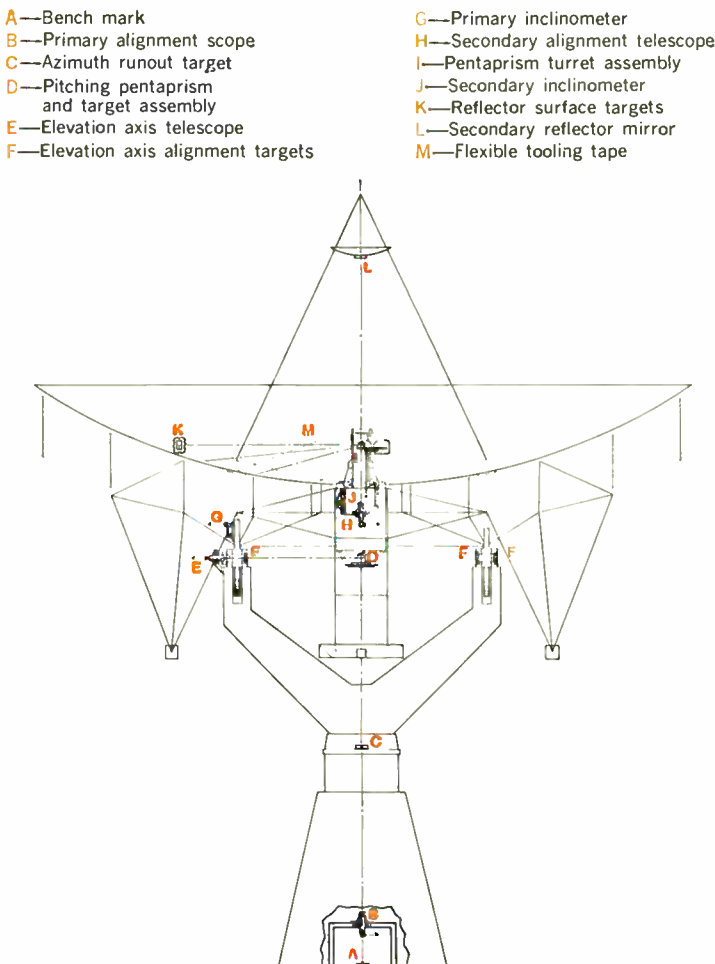

system is used to force-lubricate these bearings. An optical path has been provided along the bearing axis to facilitate their alignment.

The azimuth and elevation antenna drives each employ two hydraulic motors and gear-reducer systems. Dual pinion drives contact the bull gear at each gear box and use two parallel gear trains hydromechanically loaded to minimize backlash. The 20-hp hydraulic servomotor, which employs a series of radial pistons that rotate a multilobe cam, has extremely smooth low-speed characteristics.

The Haystack antenna has two angle-data systems. One system is a conventional one-speed synchro loop and provides a standby position control for checkout operations and emergency control with an accuracy of  $\pm 0.1^\circ$ . The more precise digital control and data system was specifically developed for the Haystack antenna. A shaft-angle transducer consisting of two electrostatically coupled 8-inch-diameter glass disks was developed by the Whitaker Corporation. One disk revolves on its own bearings and is coupled directly to the antenna shaft, rotating with the antenna at one speed; the other is fixed to the encoder housing. Clearance between disks is approximately 0.003 inch. One disk contains three sets of electrically conductive patterns consisting of paired  $90^\circ$ -displaced sine waves. This electrostatic resolver provides 256 fine-electrical-phase vector rotations and eight medium-phase vector rotations for one antenna shaft revolution. Quantizing electronics converts the electrical phase information into pulse form for use in a counter comparator. The least significant bit of the precision shaft encoder corresponds to 2.47 seconds of arc. Specially designed shaft couplers are employed to permit small alignment errors between

the encoder shaft and the moving antenna without introducing angular errors.

**Analytic and test program.** The analytic program that led to the final design of the antenna structure utilized two large digital computer programs, one developed at M.I.T. and one independently by North American Aviation. A third program, developed more recently by IBM, has since been used extensively and very successfully for detailed analysis of the antenna structure.

In 1957, the Department of Civil Engineering at M.I.T., under the sponsorship of Lincoln Laboratory, developed a computer program called STAIR (for STructural Analysis Interpretive Routine), for use in analysis of large space-truss structures. This program, capable of handling up to 60 joints, was expanded to permit the analysis of structures with up to 4000 joints. STAIR treats the Haystack backup structure as if it were made up of truss members with pin-ended joints; it does not deal with bending or torsion, or moment transfer at the joints.

A  $\frac{1}{15}$ -scale structural test model was constructed and tested for deflections under various loading conditions. STAIR was utilized to predict the model deflections with the applied loads in various tests. Correlation of model and computer results fell within 15 to 20 per cent. This provided the first opportunity to establish the validity of the STAIR program.

By mid-1961, under the terms of the Air Force contract, NAA had completed an independent analysis, using a separate NAA-generated computer program. The NAA program was then utilized as a design tool to analyze about 40 antenna configurations with up to 30 loading conditions each. After five months of analysis, modifications to the backup structure were established that would

Fig. 7. Azimuth bearing and gear train.

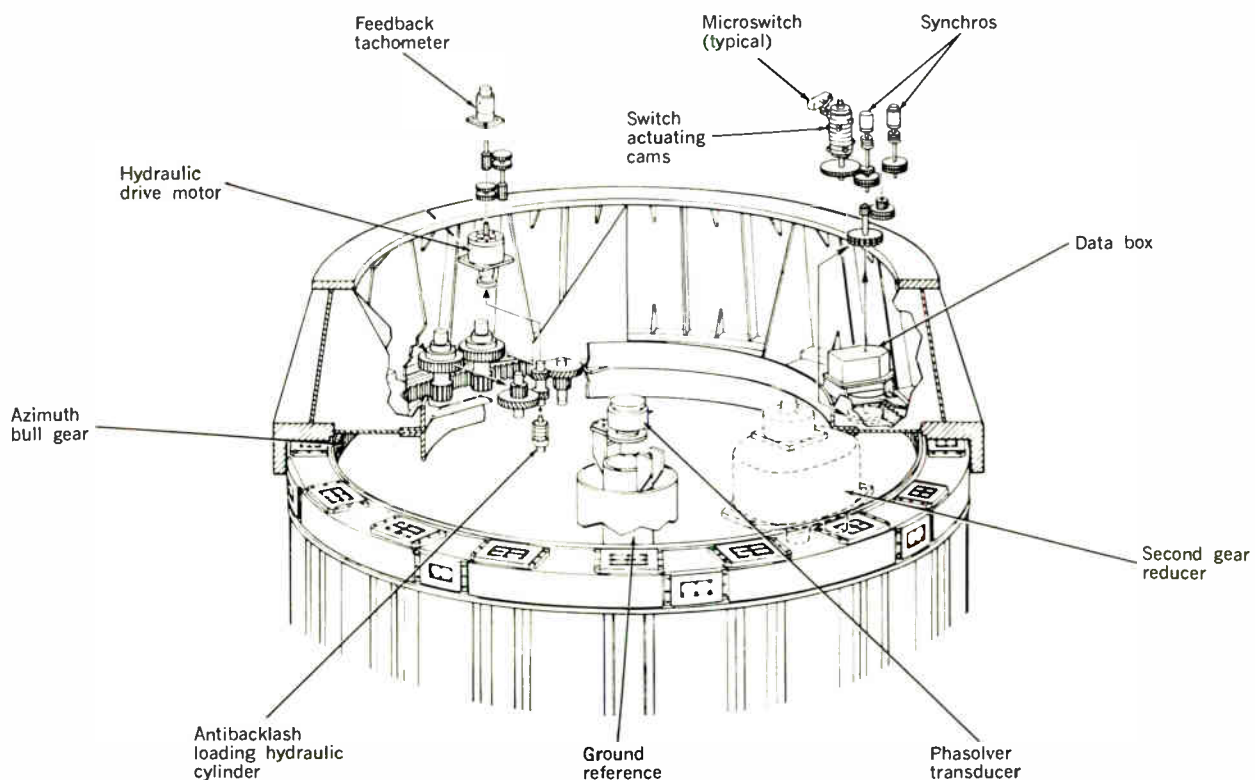

reduce the deflections to meet the specifications. Computer time totaled approximately 150 hours on an IBM 704, and about 7000 man-hours of support and evaluation were utilized. Meanwhile, in the same period at Lincoln Laboratory, 50 hours of IBM 7090 time were expended in STAIR runs on 10 to 15 configurations with up to 10 loading conditions per configuration. Approximately 2000 man-hours supported this effort, with substantial assistance from the firm of Simpson Gunpertz and Heger, Inc. At the conclusion of this phase of the project, results of both computer programs indicated that it would be possible to predict the deflections of the backup structure to within  $\pm 0.005$  inch. The maximum deflection due to gravity in any orientation of the antenna, as computed by NAA and checked by STAIR, was  $\pm 0.040$  inch.

To minimize reflector distortion attributable to thermal effects, all parts of the reflector system were made of aluminum. For design studies, the vertical temperature gradient of the air within the radome was estimated to be approximately  $10^\circ\text{F}$  and, in addition, the temperature of the air near the side of the radome facing the sun was estimated to be about  $10^\circ\text{F}$  above that of the air near the opposite side. The effect of these gradients on the structure was studied using the STAIR program. These studies predicted that surface distortions as large as  $\pm 0.017$  inch would occur with a  $10^\circ\text{F}$  gradient across the radome diameter. Later experience has shown that the estimate for the temperature gradient may be exceeded on hot sunny days, so an air-moving system has been incorporated into the radome.

A third computer program, named FRAN, an acronym for FRame ANalysis, developed in the intervening time by IBM, has allowed the inclusion of the effect of rigid instead of pin-ended joints and the analysis of the behavior of the membrane panels. The basic characteristics of FRAN, as programmed for Haystack on the IBM 7094, are indicated in Fig. 8.

In December 1962, the actual backup structure was assembled on the floor of the North American plant at Columbus, static loads were applied at various points, and measured deflections were checked against computer predictions. The structure was not complete, but the missing parts were also omitted from the computer analyses. It was found that 94 per cent of the measured deflections were within 0.010 inch of the STAIR-computed values, and 69 per cent were within 0.005 inch. This correlation was quite satisfactory, since the accuracy of the

reduced test data was only about  $\pm 0.010$  inch. The NAA and FRAN predictions were also in equally close agreement with the measured results.

After disassembly, shipping, and final complete assembly at the site, even more comprehensive tests were made. For these tests, the structure was complete, and its integral shell was included. A comparison between computed deflection values based on the FRAN analysis and loading tests of the complete antenna indicates that the analytical values agree within 0.010 inch of these test values.

FRAN has been used to evaluate the optimum use of three variable counterweights that have been added to the structure to permit gravity compensation of sectors of the surface. Two of these are pendulum ballast beams, which apply cable forces to the top of the antenna as a function of elevation angle; the third is an outboard counterweight system, which modifies the forces on the backup structure as a function of elevation angle to give a minimum distortion to the surface.

The amount of structural testing on the Haystack system has been much more extensive than on other comparable structures. The results indicate that the analytical tools now available can provide data that are even more precise than data obtained by carefully controlled optical measurements.

Plots of the present antenna surface contour at  $30^\circ$  and  $60^\circ$  elevation orientations, shown in Fig. 9, were made by combining the antenna contour optical survey data with the FRAN calculations. This contour information was used in a computer program to compute the antenna gain and sidelobe levels under a variety of conditions. Based on these computer runs, it is estimated that the antenna gain should be within 2 dB of that for an ideal antenna at 35 Gc/s. The half-power beam width values at 8, 16, and 32 Gc/s are shown in Fig. 10.

The major residual contour errors are attributable to surveying and panel adjustment inaccuracies, which could be further reduced. If the optical equipment were recalibrated and the panel contours readjusted for minimum distortion at a  $45^\circ$  elevation angle, the electrical performance of the whole antenna in a stable thermal environment could be quite acceptable at frequencies above 50 Gc/s.

#### Antenna pointing system

To utilize a high-gain antenna effectively, it is necessary to be able to point the antenna beam with an uncertainty

Fig. 8. Representation of FRAN program.

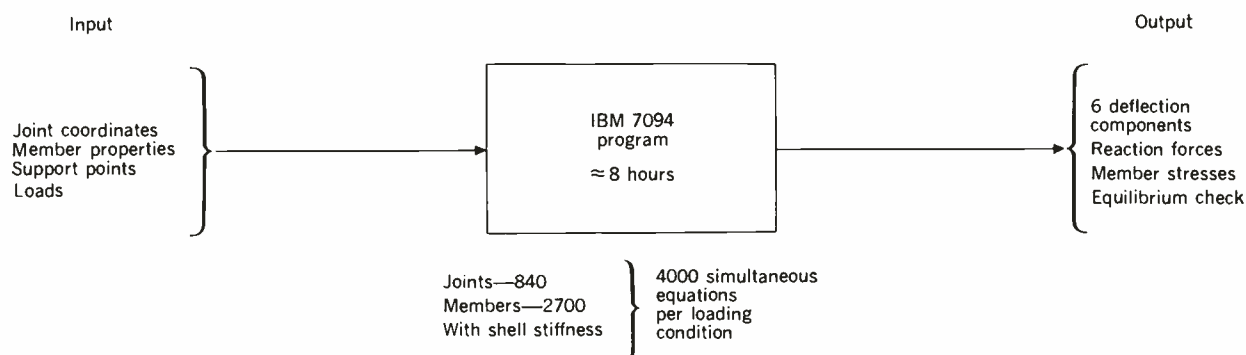
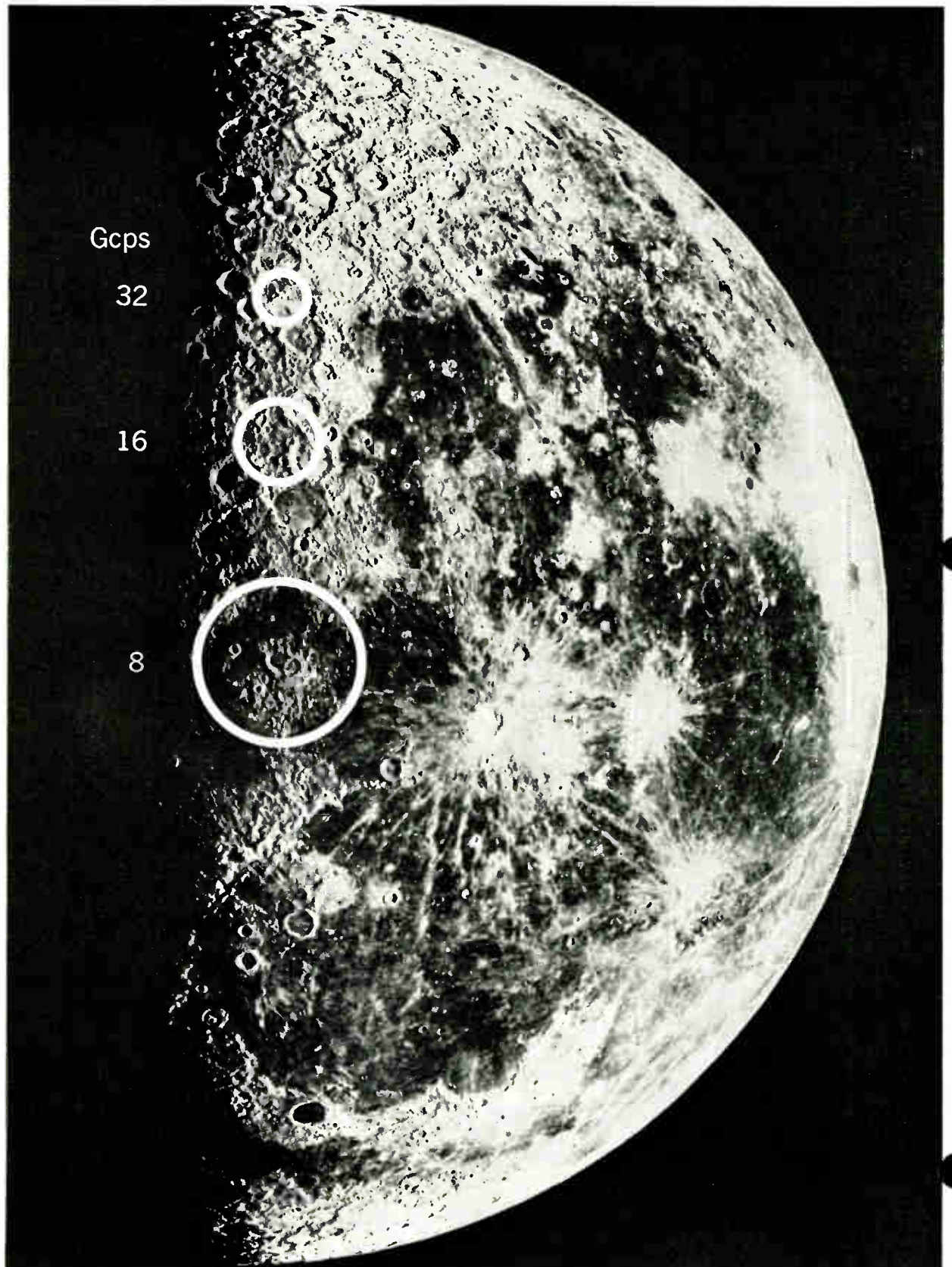

Fig. 9. Peak deviations of reflector surface, as rigged May 14, 1964, calculated from face-up survey data plus calculated gravity effects (nominal temperature environment). Numbers represent peak departures from an ideal parabolic contour in thousandths of an inch. A—30° elevation angle. B—60° elevation angle.



Fig. 10. Half-power antenna beam width.





not greater than  $\frac{1}{10}$  beam width, and there are some experiments that could utilize an even more precise beam-pointing capability. With the Haystack antenna, the half-power beam width will be  $0.05^\circ$  at a wavelength of 3 cm, and the fulfillment of even the  $\frac{1}{10}$  beam width requirement under dynamic conditions requires a sophisticated control system.

The pointing problem is most severe for low-altitude satellite targets because they pass through the narrow antenna beam at high angular rates. For example, a 200-mile-high satellite at closest approach will have an angular rate of approximately  $1^\circ$  per second as seen from a ground station, whereas a satellite at a 2000-mile altitude at closest approach will move through the beam at an angular rate of  $0.1^\circ$  per second. Targets such as the moon, the sun, planets, and stars have angular rates of approximately  $0.004^\circ$  per second, determined largely by the earth's rotation. Hence, even distant targets such as radio stars will pass in and out of the beam in a period of less than 15 seconds. Since the antenna drive will permit angular rates as high as  $3^\circ$  per second, the pointing system must achieve smooth motion with high precision.

A high-speed general-purpose digital computer (Sperry Rand Univac 490) is used to control the antenna. Backup facilities in the form of manual digital and analog controls also have been provided. A greatly simplified pointing system diagram is shown in Fig. 11.

The computer permits a relatively unskilled operator to control and direct the antenna in a precise manner.

Through the use of a standard typewriter keyboard, the operator can request the antenna to point to designated coordinates or follow one of many preplanned tracking sequences. Computer programs that have been prepared permit an operator to request that the antenna track such targets as the moon, the planets, and certain known satellites by simply typing the target designation in clear text. The computer responds in a clear text by means of the teleprinter and, if necessary, will ask the operator for additional pertinent information. The operator can interject modifications to the routine in use and can request one of a number of scan and search modes to be superimposed on a tracking sequence.

Once a target has been selected by an operator, a main computer program cycle takes place every 2 seconds. At that time, the new position of the target is determined, superposition of selected scanning takes place, and the position is transformed from celestial to radar coordinates. Corrections for refractive and structural deformation are superposed, and four-point interpolation is used to determine the 250 points per second required to provide smooth direction of the antenna servo system.

The positions of stars, planets, the sun, and the moon are found by interpolation from stored magnetic tape tabulations of basic Nautical Almanac data. Positions of earth satellites and the West Ford belt are computed in an on-line mode by evaluation of basic equations and orbit parameters.

The computer system can be run in speeded-up time to

Fig. 11. Antenna control system.

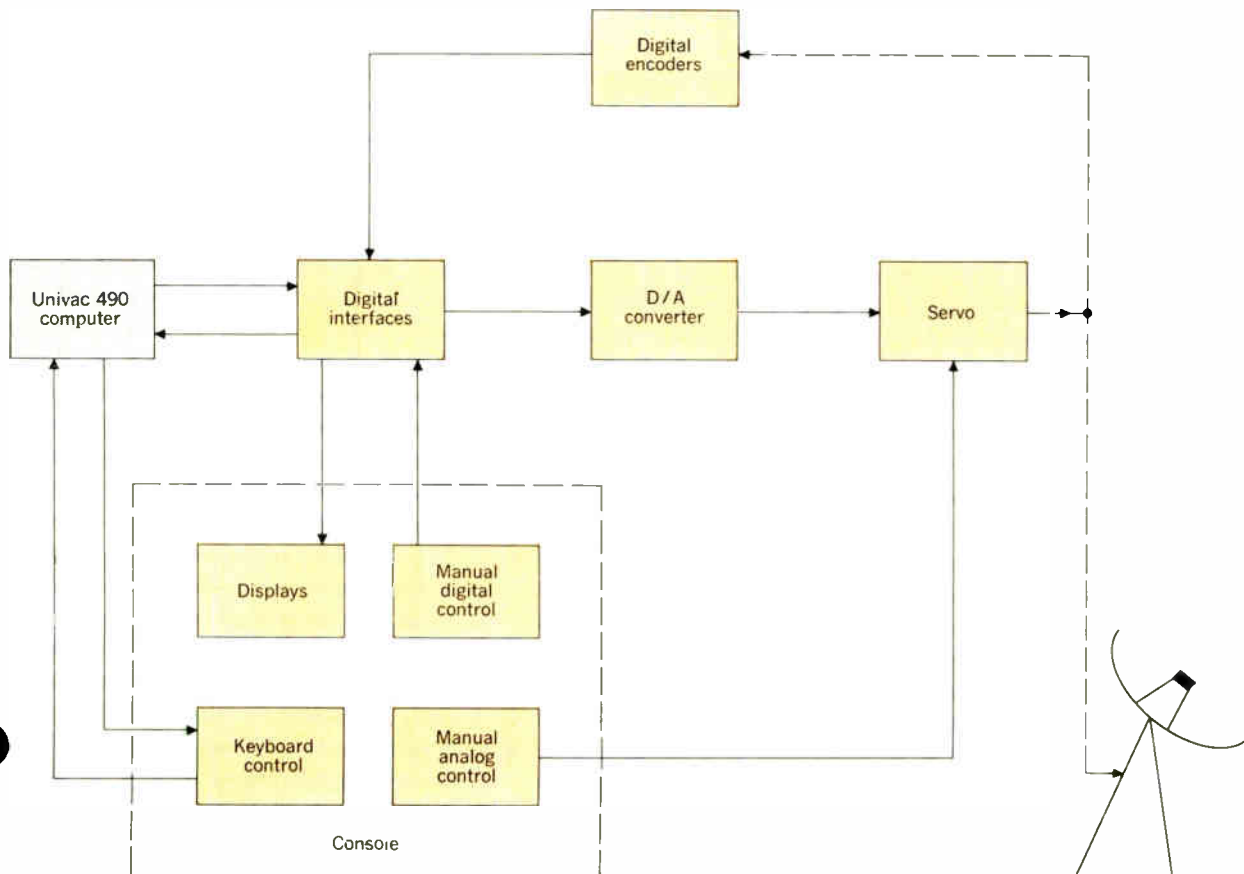
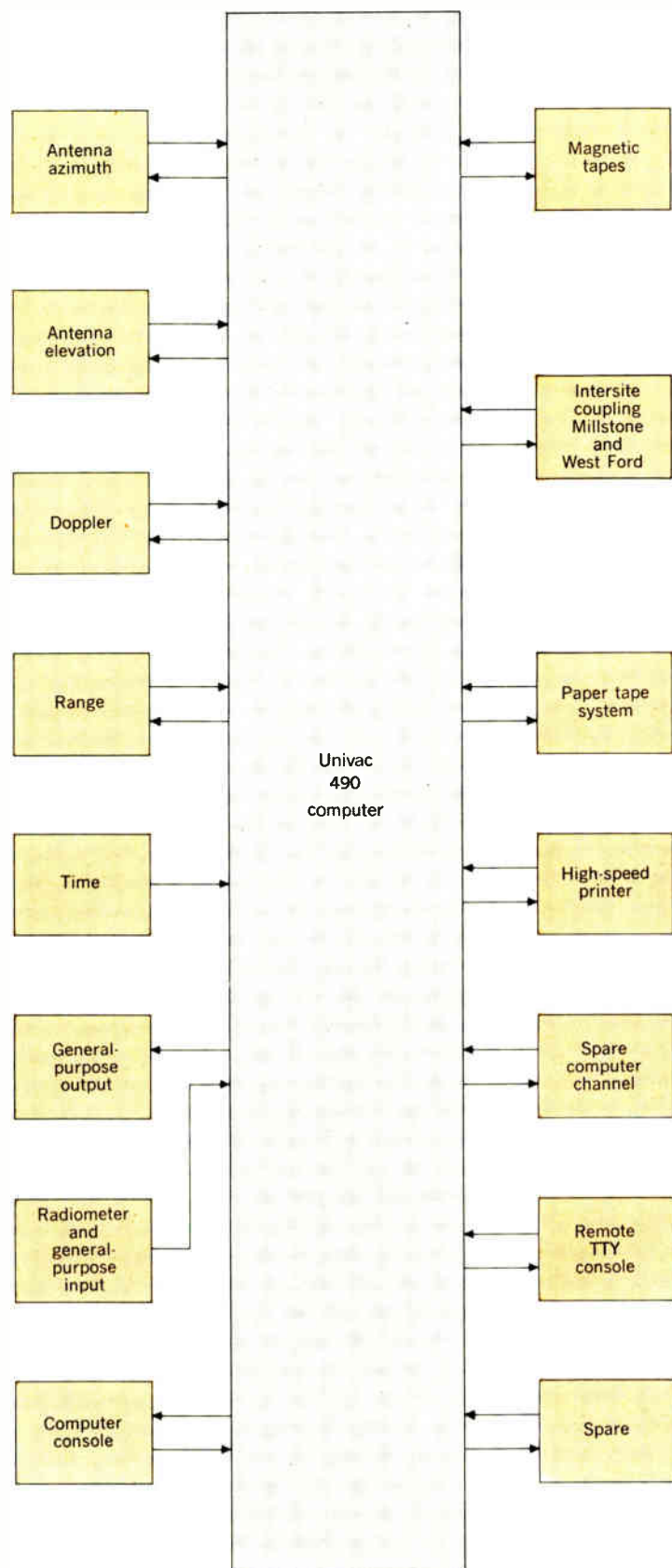

Fig. 12. Connections to Univac 490 computer.



serve as a planning device; thus, one can easily determine the precise conditions to be expected in azimuth, elevation, range, and Doppler for a particular planetary observation some time in the future. Even while a tracking sequence is in operation, the operator may interact with the computer system to modify the pointing control mode. In addition, the computer makes it possible for the system to accept pointing information from remote sources and to make this information useful for directing the Haystack antenna. This operation requires the generation of parallax and time-delay corrections in real time. Thus, the Haystack facility may be operated in conjunction with the adjacent Millstone Hill radar and the nearby West Ford communication site, or with other sites at greater distances.

Computer programs have also been prepared to calibrate the response function of the antenna servo system. A number of interesting new diagnostic techniques are expected to evolve from this flexible capability.

The Univac 490 digital computer was chosen for Haystack because its word length of 30 binary bits and its input-output system were compatible with the pointing precision requirements and because its computational speeds permitted the generation of pointing commands in real time from orbit parameters. One of the unique features of this computer is its flexible input-output system, which permits the computer to time-share functions. With this capability, several input and output devices can supply and receive data without interfering with other computer functions. Interconnections between the computer and other elements of the Haystack system are summarized in Fig. 12.

#### Plug-in electronic equipment

To facilitate the use of the Haystack system over a wide frequency range and for a variety of experiments, the antenna structure has been designed to accommodate interchangeable plug-in equipment boxes or rooms. These equipment rooms are used to house low-noise receiver components, cryogenic equipment, and the final amplifier of high-power microwave transmitters. Provision has been made to mount any one of a number of equipment rooms directly behind and along the axis of the main parabolic reflector. This equipment configuration is efficient, since the primary antenna feed horn may be mounted directly onto the face of the plug-in room, thereby eliminating the need for rotary joints and long runs of waveguide. A hoist system designed as an integral part of the antenna structure will raise and lower an 8- by 8- by 12-foot plug-in room with a maximum gross weight of 7000 pounds.

It is not intended that operating personnel will remain within the plug-in room when the antenna is in use, hence provision has been made to control and monitor the electronic equipment remotely. Since the equipment room rotates  $\pm 300^\circ$  in azimuth and  $90^\circ$  in elevation, cable-wrap systems have been incorporated into the antenna structure. The azimuth cable wrap consists of 33 large cables plus a compressed-air line and two 4-inch high-pressure hoses that supply cooling water to transmitter components in the plug-in room. Special cables were procured to obtain the desired compliance and to insure that they would survive repeated flexing.

A versatile interconnection system has been provided to permit the simultaneous operation of one plug-in room in the antenna and a second plug-in room at a ground test-

stand. High-quality multiconductor plugs and jacks are employed to allow rapid patching of approximately 3000 power and control leads and several hundred coaxial connections. For transmitter operations, high-voltage electric power, compressed air, and up to 260 gallons of cooling water per minute are available in the antenna and at the test stand.

The second test stand is situated outside the radome, approximately 150 feet from the main antenna location, to permit radiometric measurement unimpeded by the radome. It permits the operation of the radiometer room in conjunction with a calibrated feed horn, as shown in Fig. 13.

#### The radiometric system

The Haystack radiometric system has been designed for research investigations of the earth's atmosphere, the moon, the planets, stellar radio sources, interstellar gas clouds, and external galaxies. Radiometers operating at frequencies of 5, 8, and 15.5 Gc/s have been completed and others are planned for 1.42 Gc/s (hydrogen-line frequency), 1.67 Gc/s (OH-line frequency), and 35 Gc/s.

The radiometric system employs several concepts and devices that are new to radio astronomy. Novel approaches have been taken in the following areas:

1. Wide-band tunnel diodes have been used in the input amplifiers of the 5-, 8-, and 15.5-Gc/s radiometers. Since radiometer sensitivity is proportional to the system noise

temperature divided by the square root of the RF bandwidth, a tunnel-diode receiver with 1000°K system temperature and 1000-Mc/s bandwidth is equivalent to a maser or paramp receiver with 100°K system temperature and 10-Mc/s bandwidth. The reliability, stability, and absence of cryogenic equipment makes the use of tunnel diodes attractive for early tests.

2. Precision square-law and synchronous detectors and integrators have been designed for use with digital processing equipment. The solid-state synchronous detector and integrators have a drift that is 0.01 per cent of maximum output.

3. A flexible data system can couple any combination of seven 30-bit digital data sources and 16 analog data sources to a computer, a paper-tape punch, or a printer at a fast, buffered rate. In addition, analog data from 50 monitor points in the radiometric system can be fed into any of these devices at a slow, unbuffered rate.

4. Real-time processing of radiometric data is accomplished in the digital computer that is also employed for antenna pointing. A completed computer program calibrates the radiometer output and also prints and plots antenna temperatures. In addition, the computer checks the 50 radiometer monitor points to see whether they fall within preset limits. Extensive use of the on-line computer for radiometer control, monitoring, and data analysis is anticipated.

5. The spectral-line receivers will utilize an accurate

Fig. 13. Radiometer test stand.

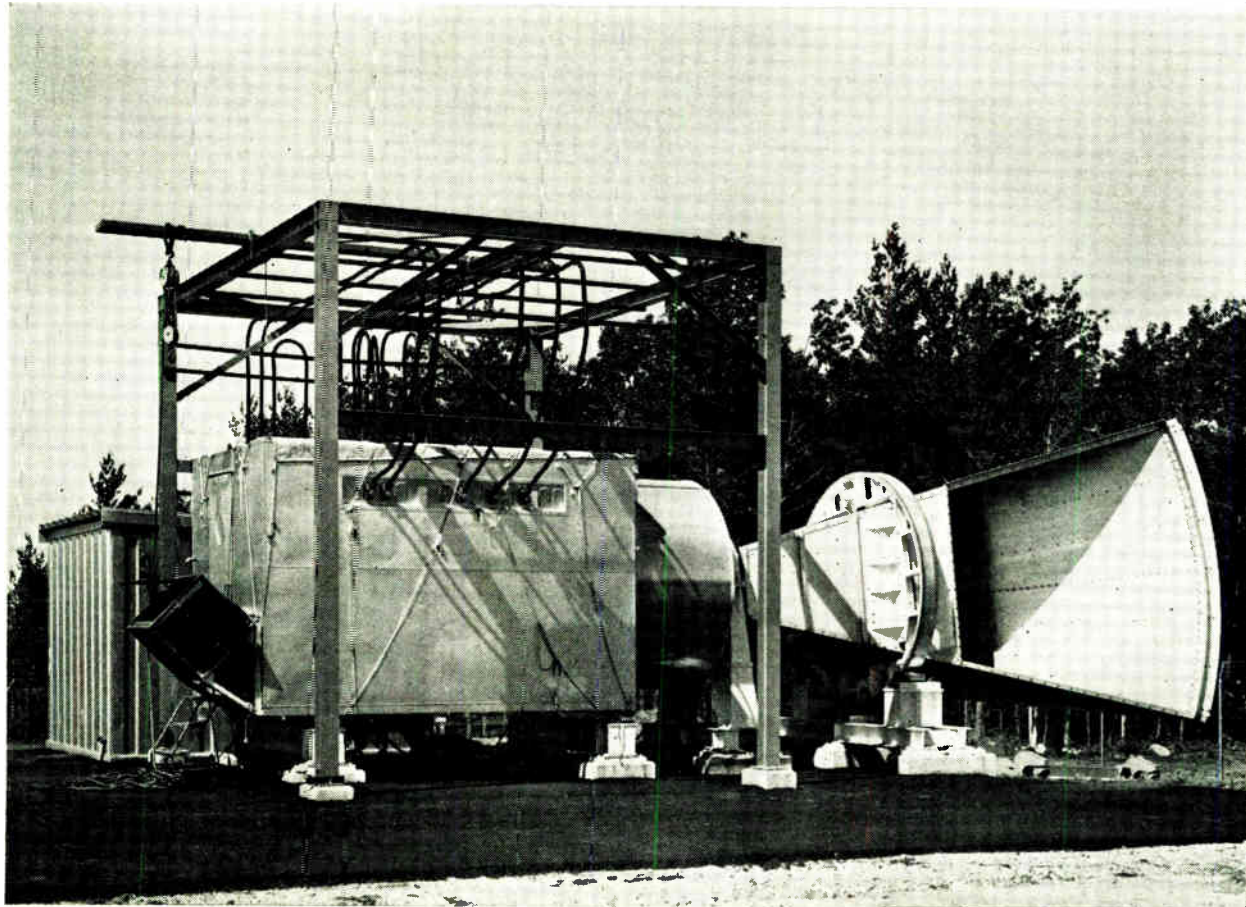

and versatile 100-channel, 10-Mc/s clock-rate, digital autocorrelator for spectral analysis.

The radiometer equipment room is shown in Fig. 13. The circular extension on the front of the room supports the antenna feed. Future cryogenic front-end equipment will be mounted in this circular extension, in close proximity to the antenna feed.

Normally, the complete RF portion of a radiometer will be installed in the equipment room, and the synchronous detectors, integrators, and data-processing equipment will be located in the control room. However, for the purpose of testing, a complete radiometer system with analog pen-recorder output can be operated in the equipment room.

The temperature environment of radiometric front ends is extremely critical. For example, if a front-end component has a small loss of 0.25 dB and its temperature changes by 2°C, a 0.1°K spurious signal will be introduced into the radiometer. Since the inherent sensitivity of the radiometers in use is of the order of 0.01°K for ½

hour of integration, this is a serious error. A temperature stability of  $\pm 0.025^\circ\text{C}$  over 24 hours has been achieved in the radiometer room by the use of proportionally controlled heaters in conjunction with an air conditioner.

The link between the radiometers and the data-recording system is through a synchronous detector-integrator designed for operation on radiometer signals, which are to be digitally processed; it has a drift and noise level of 0.01 per cent of maximum output.

The synchronous detector contains both an *R-C* integrator for analog pen-recorder display and a true finite-time integrator for digital recording equipment. The true integrator is sampled by a high-speed analog-to-digital converter at the conclusion of the integration period, which can be varied between 0.3 second and 30 seconds. The high-speed A/D converter can be used to sample sequentially many true integrators. This a more flexible and economical approach than the method, commonly used in radio astronomy, of employing an integrating type of A/D converter for each radiometer channel.

#### The transmitter power supply and heat exchanger

The Haystack plug-in equipment room concept has made it feasible to operate over a wide frequency spectrum in both radar and communication modes, as well as for radiometry. Hence, provision was made for a power supply and cooling system that could operate with a variety of transmitter tubes, including klystrons, traveling-wave tubes, and amplitrons, in both CW and pulsed applications. To obtain reasonable balance between the cost of the transmitter and the other relatively expensive components necessary in the experimental system, it appeared appropriate to install a versatile high-voltage power supply with approximately a 1-MW dc output capability. This capability was greater than needed to supply the microwave transmitter power tubes available in 1960, but improved transmitter tubes probably will be available during the next few years.

The high-voltage dc supply is capable of producing, on a continuous basis, at least 1000 kW of dc power at any voltage from 20 kV to 120 kV. The maximum peak-to-peak ripple of the dc output voltage is less than 0.5 per cent of the output voltage under any combination of voltage and power output. Sufficient energy storage is provided to limit the voltage droop to 4 per cent of the initial voltage when the supply is delivering a 2-ms pulse containing 10 000 joules of energy. The power supply is capable of operating with either the negative or positive output terminal grounded.

The power supply was procured from Energy Systems Inc. (formerly Radiation at Stanford). The required flexibility is achieved by the use of a plate transformer having three primary windings and six independent secondary windings. Different transformer connection configurations will be used for low-voltage high-current operation and for high-voltage low-current operation.

The rectifiers used in this supply are semiconductor diode stacks, chosen because they could supply the required load current with large overcurrent capability. This is an important consideration for the prevention of damage to a rectifier string in the event of power-supply faults or external circuit failures. The peak current in a rectifier stack is limited by the reactance of the transformer windings, which was chosen both to limit the current and to serve as part of a filter, to meet the ripple

Fig. 14. High-voltage rectifier stack and capacitor bank.

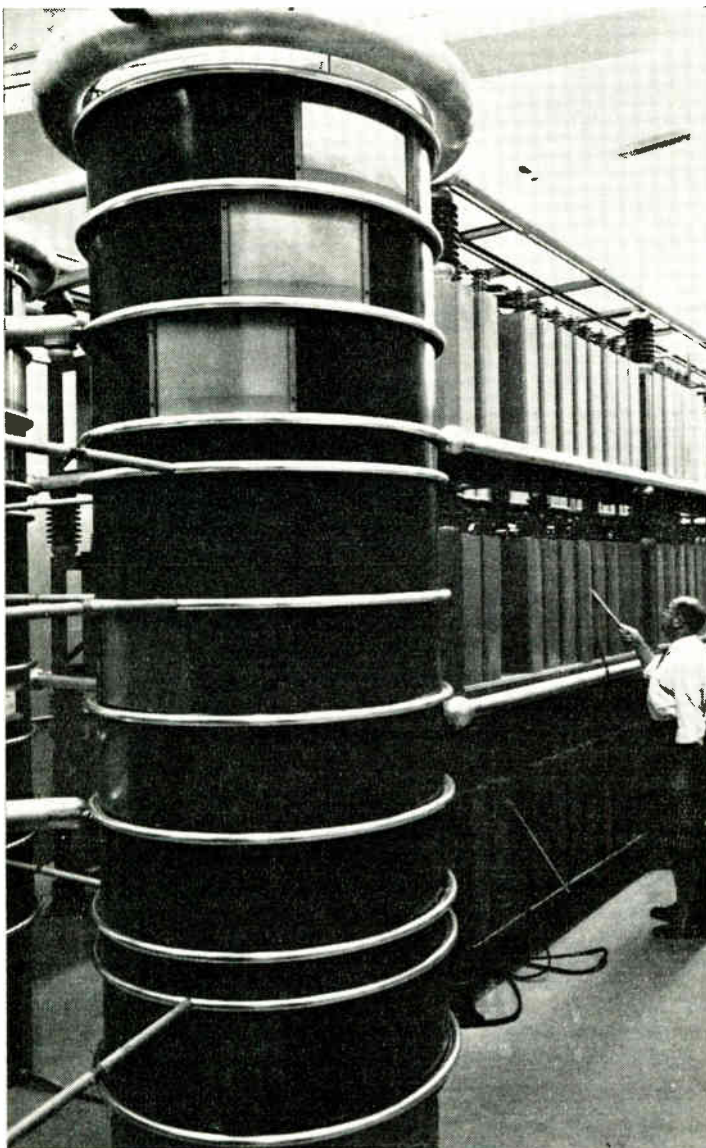

requirements without the use of a separate choke. The use of semiconductor rectifiers eliminates the need for high-reactance heater-isolation transformers, which would be required if thermionic diodes were used. The interconnections for operation at the various voltage levels and power-supply polarities are also simplified by the use of semiconductor rectifiers.

The 4160-volt three-phase 60-cycle input to the power supply goes through a fused disconnect switch and high-speed vacuum switches, which respond in less than one cycle. An Inductrol is used to control the input to the plate transformer, allowing essentially continuous voltage variation. A dc feedback regulator loop on the Inductrol serves to regulate the voltage output of the supply to within  $\pm 1$  per cent over a 25 to 100 per cent output range.

The energy storage bank is composed of three decks, each consisting of 124 capacitors rated at  $1.68 \mu\text{F}$  each at 40 kV, which may be connected in various configurations. Thus  $625 \mu\text{F}$  at 40 kV may be obtained with all decks in parallel,  $70 \mu\text{F}$  at 120 kV with all decks in series, and  $156 \mu\text{F}$  with a series-parallel combination of decks. The capacitor bank is designed with mechanical short-circuiting bars, which discharge the capacitors whenever the system is de-energized. The individual capacitors have series current-limiting resistors to prevent catastrophic discharging of a deck of the bank into a faulty capacitor on that deck, and also to limit the peak current that can

be drawn under fault conditions. Figure 14 shows the capacitor bank and one of the three cylindrical rectifier stacks.

A test load is provided so that power-supply operation can be verified over its entire range. The load consists of several water columns in parallel. The resistivity of the load is controlled by varying the salinity of the solution flowing in the columns.

The system heat exchanger is a double closed-loop system. A distilled-water loop is provided for cooling the transmitter tubes and components. An intermediate liquid-to-liquid exchanger transfers the heat from the closed-loop distilled-water system to an ethylene glycol system, which includes a liquid-to-air heat exchanger outdoors. This same ethylene glycol system is connected to the test load for the power supply. The heat exchange problem in this system is not a simple one, since the major heat source, the transmitter, is located on the antenna a considerable distance away from the intercooler, and a highly effective temperature control system is needed to minimize phase fluctuations of the transmitted signal resulting from variations in the body-cooling water temperature.

In a system with 500 000 joules of stored energy, a fast-acting protective circuit is essential to remove the voltage from the transmitter in the event of an arc. A crowbar protective circuit is used, consisting of a two-ball gap with a triggering "needle" located on the equipoten-

Fig. 15. Simplified diagram of transmit-receive system.

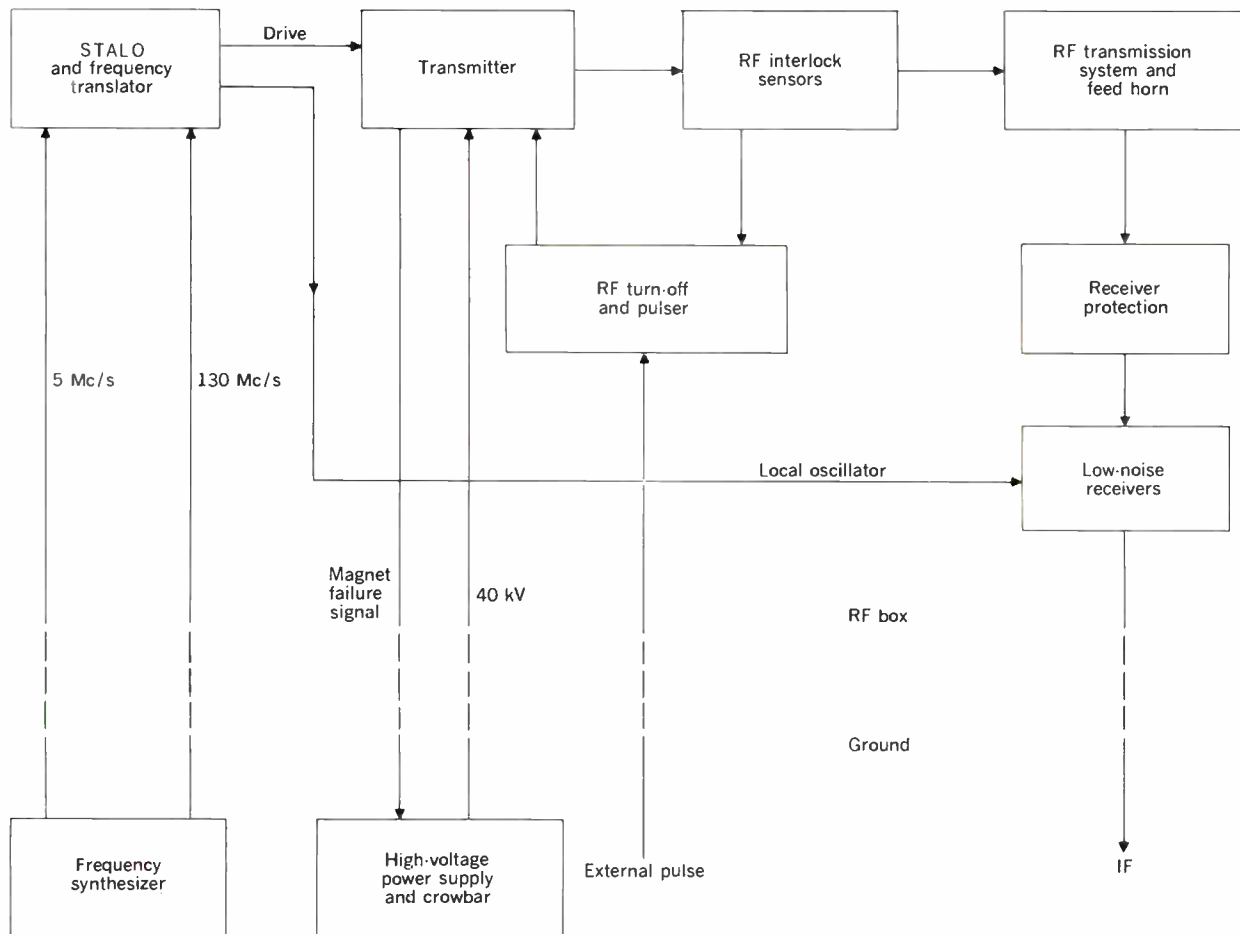

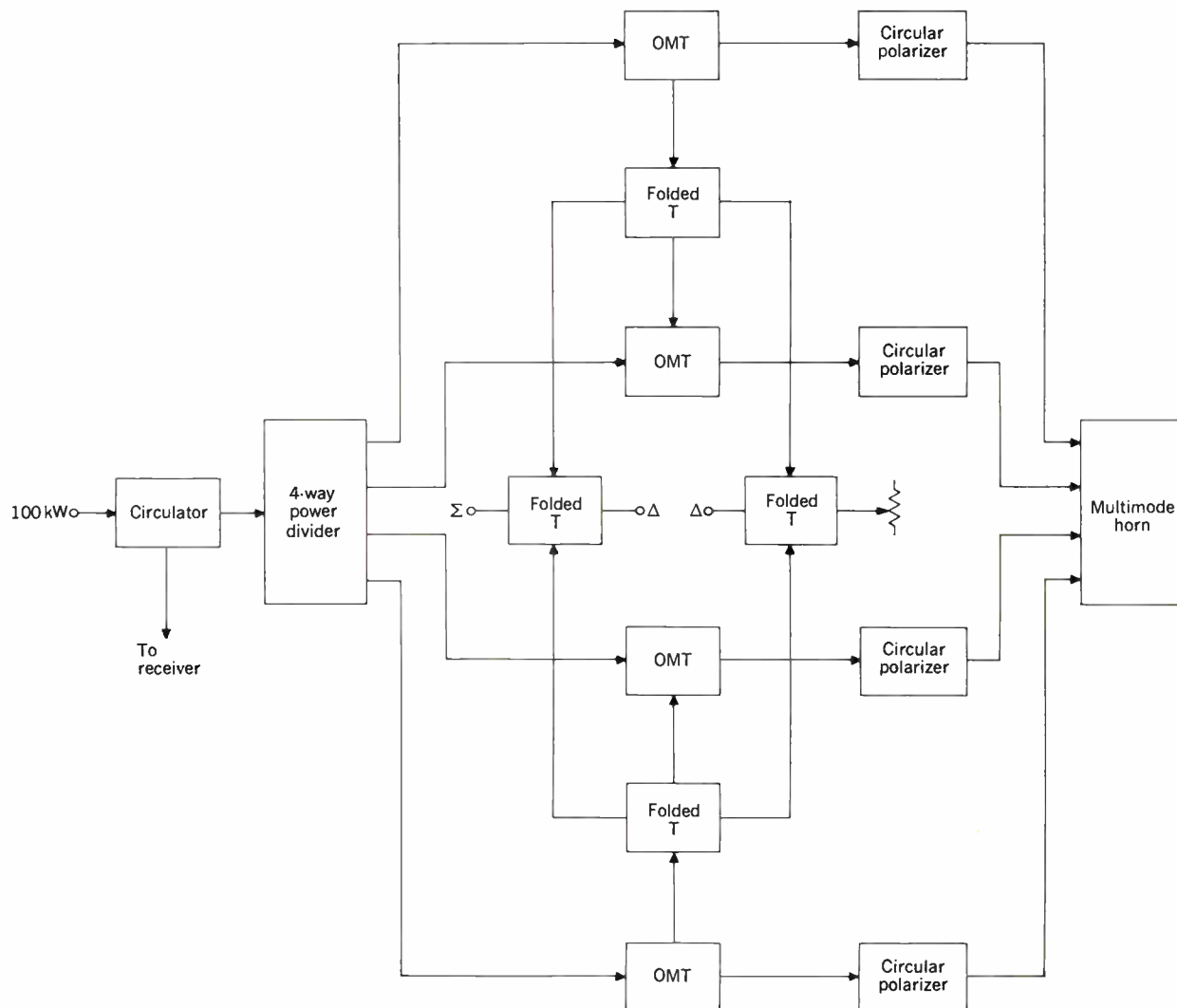

Fig. 16. Radio-frequency monopulse system.

tial plane between the two gaps. The input-logic circuits are designed to operate in the event of excess tube current (an arc), capacitor failure, or capacitor bank overvoltage. One important feature of the crowbar triggering system is the use of a number of sequential triggers closely spaced in time to prevent damage that could result if the crowbar arc were to extinguish before the primary power circuits opened.

#### The initial high-power communications-radar system

The initial high-power X-band plug-in equipment room has been designed for communication experiments requiring simultaneous transmission and reception and for planetary radar experiments. This plug-in room contains (1) a 100-kW average power 7750-Mc/s transmitter; (2) high-power microwave circuits and feed system; (3) low-noise receivers; and (4) the microwave portions of the frequency synthesizer. A simplified block diagram is shown in Fig. 15.

The klystron final amplifier, recently developed by Varian Associates, has an output power of 100 kW CW, a gain greater than 50 dB, a 3-dB bandwidth of about 40 Mc/s, and an overall efficiency greater than 40 per cent.

The waveguide in the RF system is of oxygen-free high-conductivity copper. WR-137 large waveguide was chosen to provide a greater margin of safety against voltage breakdown. All flanges in the high-power waveguide are the CPRF type, made from stainless steel, and are used with a copper gasket that was designed to provide the best possible contact between mated pieces of waveguide. In resonant-ring tests using this type of flange joint, power levels of over 300 kW CW have been transmitted in WR-137 without breakdown.

Even with the low loss of WR-137 OFHC copper waveguide (approximately 0.015 dB per foot), the ohmic loss in the walls is sufficient to raise the temperature to intolerable values at the 100-kW power level. Cooling water is passed through copper tubing attached to the waveguide walls, thereby reducing the surface temperature to very nearly the temperature of the cooling fluid.

Protective circuits have been incorporated to prevent damage to the transmitter tube if an arc should occur in the waveguide system. Two types of protection are provided: (1) against an abnormally high voltage standing-wave ratio, which might result in internal damage to the tube, and (2) against arcs, which might travel

toward the window and almost certainly would result in window damage and thus destroy the vacuum. A microwave circuit is used for the VSWR interlocks; the arc detector uses an optical interlock circuit that can detect an arc in the vicinity of the window. Either of these two circuits will feed a pulse to the fast-turn-off circuits associated with the traveling-wave-tube driver. The klystron drive signal can be reduced 45 dB in less than 3  $\mu$ s and 80 dB in less than 5  $\mu$ s.

Receiver protection is required both for radar experiments, when the transmitter will be turned off while receiving, and for communication experiments, when simultaneous transmission and reception will be required. For planetary radar experiments, the times involved are so long that mechanical switches will be used for receiver protection. Waveguide switches with electrically driven actuators provide a minimum of 80-dB isolation between the input and the disconnected terminal. It is expected that the circulator and the orthogonal-mode transducers will both provide a minimum of 20-dB additional isolation, so the maximum peak power incident on the receivers should be  $10^{-6}$  watt.

For more conventional radar applications, where the transmitted pulse might be 2 to 5 ms long and the range a few hundred or a few thousand miles, the mechanical switches are much too slow. A gaseous discharge attenuator that will provide 80 to 100 dB of protection has been designed. The low-level insertion loss has been measured to be less than 0.05 dB.

In the communication mode of operation, in which transmission and reception occur simultaneously, there was concern that the second harmonic of the transmitted signal leaking to the receivers might be of sufficient amplitude to impair reception. When parametric amplifiers are used, the idler frequency is close to the second harmonic of the transmitted signal; thus, any incoming second harmonic can be picked up by the idler circuits and cause possible saturation effects or undesirable modulation products. A leaky wall filter, which is water cooled, is used to remove the second and higher harmonics. This filter has an insertion loss at the transmitter frequency of 0.1 dB and provides approximately 50-dB attenuation at the second harmonic.

Reflection filters are used for the purpose of reducing the amount of transmitter power leaking to the receiver. Some 90 dB of rejection has been achieved over the 30-Mc/s transmitter bandwidth, and it may be possible to eliminate the diplexers for experiments that do not require reception at the transmitter frequency.

A feed horn has been designed to provide inputs to a monopulse comparator. The system can transmit right-hand circular polarization and receive both senses of circular polarization. Monopulse tracking will be done only with the left-hand circularly polarized received signal. The monopulse system is shown in Fig. 16. The transmitter power is fed into a four-way power divider, into the orthogonal-mode transducers, through the circular polarizers, and into the multimode horns.

The multimode horn, fed by four square waveguides, consists of several sections: (1) a transition from four waveguides to a large square cross section; (2) a length of straight waveguide of the large square cross section; and (3) a pyramidal horn. The transition from the four square waveguides to the large square cross section is designed to excite the modes necessary for obtaining

angle information and suppressing undesirable modes, which may upset the antenna pattern. Although not all undesirable modes are completely suppressed, the feed has good patterns in the band between 7700 and 8400 Mc/s.

Compared with a conventional four-horn monopulse feed, the forward gain of this feed is greater by nearly 1 dB from 7750 to 8350 Mc/s. The side lobes of the sum pattern are over 18 dB below the main lobe in both planes, compared with 7.5 dB and 12.5 dB for a typical four-horn monopulse feed.

The low-noise receivers in the initial high-power plug-in room are two-stage, diode parametric amplifiers capable of being cooled in either liquid nitrogen or liquid helium. Initially, only two channels—the normal circularly polarized return and the orthogonal circularly polarized signal—will be received, at either 7750 or 8350 Mc/s.

The parametric amplifiers operate in the nondegenerate mode with a pump frequency of 24 Gc/s. To insure good amplitude stability, four-port circulators are employed and the pump level is regulated. With 13-dB gain per stage, the overall bandwidth of a cascade at the 3-dB points is 40 to 60 Mc/s. At this gain the receiver noise temperature is 300 to 330°K at room temperature, 100 to 125°K in liquid nitrogen, and 30 to 65°K in liquid helium. It is anticipated that these amplifiers will eventually be replaced by models with lower heat capacity and improved microwave characteristics.

Initial experiments will be conducted using batch-filled Dewars. Units manufactured by Cryenco, Inc., have demonstrated ability to hold helium for ten hours and nitrogen for three days. A recently developed Dewar using superinsulation held helium for 18 hours. Provisions are being made for installation of closed-cycle helium refrigeration systems (Fig. 17) in the RF box to permit continuous operation at liquid-helium temperature. The units were designed to accommodate four two-stage parametric amplifiers, the four first stages being at liquid helium temperature and the second stages located at an intermediate heat station (approximately 60°K).

#### Auxiliary instrumentation

**Frequency control and translation equipment.** The basic frequency standards at the station are a rubidium vapor frequency standard and stabilized crystal oscillators. These units are checked against the U.S. national frequency standard by comparison methods, using HF and VLF broadcast time and frequency signals. The long-term accuracy of the frequency standard system as determined by the rubidium unit is 5 parts in  $10^{11}$  per year. The crystal oscillators are checked against the rubidium standard and serve as flywheels, which can continue in operation in the event of power failure.

Multiples or subharmonics of standard reference frequencies are derived to drive synthesizers and synchronizers to produce frequencies in 10-Mc/s increments up to a limit of about 12 Gc/s. Phase-coherent frequency translation equipment is used to produce the desired transmitter and intermediate frequencies required for processing received signals. Special modulation can be applied to any of the higher-frequency signals. The Doppler shift of a received signal may be removed by using a precomputed ephemeris table with an accuracy of 1 c/s and a precision of 0.1 c/s. Planetary and lunar radar experiments will use the narrow-bandwidth 5-

kc/s intermediate frequency. If the signal-to-noise ratio is adequate, a detector system is provided to develop a phase-locked reference for closed-loop Doppler tracking.

**Real-time digital clock.** A digital clock has been constructed which accepts a 100-kc/s signal from a frequency standard and produces signals in binary, binary-coded decimal, and decimal words. The binary word is composed of 30 bits with a 100- $\mu$ s least-significant bit. The least-significant bits of the binary-coded decimal and decimal words represent 10  $\mu$ s of time. The digital clock also contains a real-time pulse generator consisting of ten identical circuits, providing ten independent outputs. Each circuit will allow an operator, through the use of eight decade switches, to select pulses in increments of 1/100 second throughout a 24-hour period. These pulses are available for trigger, monitoring, and display purposes.

**Range encoder and tracker.** When the Haystack facility is used in the radar mode, equipment is available for encoding the range of the received signal and for automatically tracking a designated target in range as well as in azimuth and elevation. This unit encodes the range of a detected radar return in a 25-bit binary register that can accommodate a maximum range of approximately 550 000 nautical miles. When the unit is driven by a 5-Mc/s frequency standard, it provides a range resolution of approximately 100 feet. This equipment also provides a tracking gate and a false-alarm gate at a range determined manually or by the computer or by the sequential Doppler processor. Manual handwheel control of the tracking-gate width and toggle control of the false-alarm-gate width are provided in all modes of gate position control.

**Sequential Doppler processor.** Provision has been made for a sequential Doppler processor (SDP), which permits compensation of a frequency shift in a received narrow-

bandwidth signal. This compensation is needed to make efficient detection possible, and to generate an indication of the Doppler shift of an observed target. This equipment accepts a 2000- $\mu$ s pulsed-radar return at 130-Mc/s intermediate frequency and performs an estimation of the radial velocity of the target based on each individual return. A pulse generated in the SDP following each signal return is used by the range encoder to count the range of the target and to initiate the transfer of the Doppler estimation (a 21-bit binary word) into the Univac 490 computer via the Doppler-interface equipment. The SDP produces an output Doppler word whose least-significant bit represents a return frequency shift of 1 c/s (velocity of approximately 0.05 foot per second at 8 Gc/s) for any input frequency shift up to  $\pm 750$  kc/s (corresponding to radial velocities of approximately  $\pm 37$  000 feet per second).

**Monopulse angle estimator.** The monopulse estimator is a "sum and difference" system with amplitude comparison for generation of an absolute error signal and phase comparison for derivation of error sense. Signal normalization in the monopulse circuits is accomplished by use of a common amplifier channel with frequency multiplexing. This equipment accepts from the 130-Mc/s IF amplifiers three 2000- $\mu$ s radar-target return signals, which represent the sum, azimuth difference, and elevation difference signals at the antenna. These are delayed until a CW signal is received from SDP to remove the Doppler frequency shift. Then the difference signals are normalized to the sum signal and all three are passed through narrow-band filters to improve the signal-to-noise ratio. The normalized difference analog error signals are used by the antenna drive servos and are digitized (seven bits plus sign for each axis), for use in the Univac 490 computer.

**Test-signal generator and target simulator.** A general-purpose signal source for checking system operation is provided by means of a test-signal generator and target simulator. The output is an X-band signal, shifted by an amount up to 2 Mc/s with very high stability. The output can also be pulse-modulated with pulse lengths from 1  $\mu$ s to infinity (CW). Output power from the simulator will be controlled by a precision attenuator so that sensitivity checks can be made in the system receiver. Since independent phase and amplitude control of the signals sent to the error channels of the monopulse receiver will also be provided, the tracking system can be controlled by the simulator. All the variable parameters in the system will be capable of either manual or computer control.

**Contour-monitoring microwave interferometer.** A novel radio-frequency interferometric technique has been devised to permit monitoring the displacement of selected points on the reflector surface even while it is in normal use. In this monitoring system, RF phase measurements are used to observe changes in the path length between selected target locations on the reflector surface and a test unit located near the secondary reflector. A bread-board version of this system was tested on the Lincoln Laboratory antenna test range and, with the transmitter and target separated by 25 feet, a 0.005-inch motion of the target was readily detected. This system will provide an independent technique for cross checking the deflectional behavior of the reflector with results obtained from optical measurements.

Fig. 17. Closed-cycle refrigerator with amplifiers.

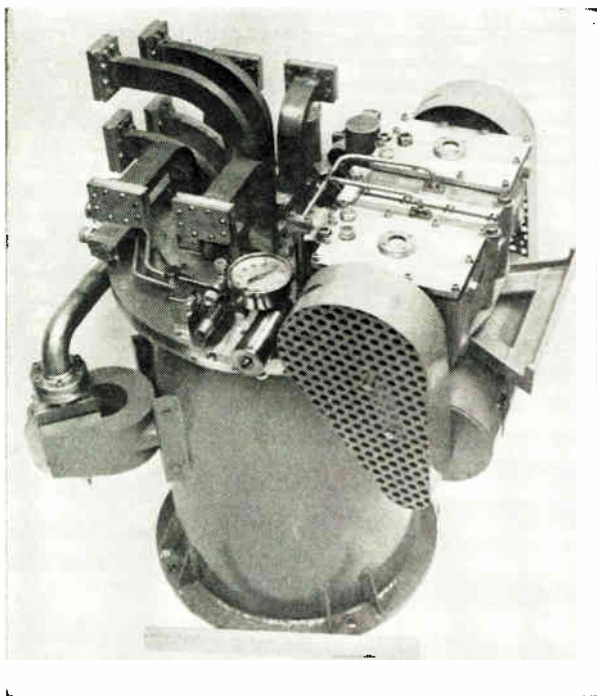



## Status and future plans

All the major elements of the Haystack system have been installed at the Tyngsboro site. The mechanical test program on the antenna has been completed, and preliminary pattern measurements taken at 8 Gc/s indicate that the beam width and side-lobe structure of the antenna are in good agreement with theoretical estimates. A more comprehensive calibration program has been started to determine the antenna gain and system temperature at 8 Gc/s, 15 Gc/s, and 35 Gc/s. For the past year a Lincoln Laboratory committee has been planning an experimental program for the Haystack facility. The high angular resolution, large effective area, and high power of this system offer new capabilities to the experimenter, and many different users will avail themselves of the antenna in the years ahead. The installation is well suited to multiple-user operations, and the digital computer control system should make it possible to utilize the available operating time efficiently.

An important early application will be to explore the potential usefulness of a very-high-gain ground terminal for space communications. These studies will initially be carried out near 8 Gc/s, so that coast-to-coast experiments may be conducted in conjunction with the Project West Ford site near Camp Parks, California. Communication experiments utilizing the moon, Echo-type balloons, the West Ford dipole belt, and other passive reflectors will receive early attention, and communication tests will be made with a small mobile terminal. The Haystack system will also be used to explore the effects of the atmosphere and weather upon microwave communications at 8 Gc/s and at higher frequencies. When appropriate satellites are in orbit with microwave transponders, the Haystack terminal will be available for transmission tests.

In the radar mode, the Haystack system will be employed to obtain high-resolution measurements of the moon, Venus, and other planetary objects. Strong radar echoes from the planet Venus should be detectable for many months of the year, and the increased system sensitivity should permit improved measurements. The system should be capable of obtaining radar back-scatter echoes from a medium-sized satellite at a range of 20 000 miles and will be able to detect very small targets at ranges of several thousand miles.

The Haystack antenna will also be used for radio astronomy studies at wavelengths throughout the 1.4- to 35-Gc/s region of the spectrum. Because of the high resolution of the antenna, it should be possible to map celestial radio sources with unprecedented precision.

Initial testing and operation of the Haystack facility provides assurance that the objectives of the arduous development program have been achieved. Lest this be any temptation to complacency, however, a new challenge has already appeared. Just as this article is being written, a new test of Einstein's theory of general relativity has been proposed, the first significant test to be formulated since the theory was definitively published almost 50 years ago. The test deals with the effect of an intense gravitational field on the speed of light waves (and radio waves).\*

Haystack's high system sensitivity at X-band frequencies, and the low side-lobe level of the antenna

pattern, render the new facility almost uniquely well suited to carrying out an experiment in which it is predicted that radar echoes from Mercury or Venus should experience a relativistic delay of as much as 0.2 ms (in addition to the expected round trip travel time of some 25 minutes) when the target planet is at superior conjunction and the radar beam passes very close to the sun. Indeed, the realization that Haystack's capabilities would render this experiment practicable contributed substantially to the formulation of the proposed new test, which has aroused considerable scientific interest.

The experiment is judged to be practicable (though far from easy) but, say the experiment planners wistfully, there would be much greater assurance of an accurate, successful result if only there were a few more decibels of system sensitivity. With the high degree of flexibility and growth potential inherent in the Haystack system design, the facility is well suited to meet this new challenge and others that surely lie ahead.

The planning, design, installation, and testing of this new facility have been successful only because of the diverse talents of a large number of individuals and organizations. The author wishes to express his thanks to the U.S. Air Force for funding support and contract administration; to the North American Aviation, Inc., Columbus Division, for major contributions to the success of the antenna; to Dr. H. Simpson, of Simpson Gumpertz and Heger, Inc., structural consultant; and to the many members of the Lincoln Laboratory staff who carried forth the myriads of tasks that arose throughout the four-year program.

## BIBLIOGRAPHY

- Banche, J., and Ulry, D. N., "Axial Load Design for High-Performance Radar Antenna Structures," *ASME Paper 62-WA-302*, 1962.
- Carroll, G. R., "A Hydrostatic Bearing for Haystack," *ASME Paper 62-WA-299*, 1962.
- Dion, A. R., "Investigation of Effects of Surface Deviations on Haystack Radiation Patterns," Tech. Rept. 324, Lincoln Laboratory, M.I.T., Lexington, Mass., July 29, 1963.
- Frachtman, H. E., "Haystack Pointing System: Sun," Group Rept. 1964-40, Lincoln Laboratory, M.I.T., July 29, 1964.
- Galvin, A. A., "A Sequential Detection System for the Processing of Radar Returns," *Proc. IRE*, vol. 49, Sept. 1961, pp. 1417-1423.
- King, T. F., and Farnsworth, L. P., "Mechanical Design of a 150-Foot Diameter Metal Space Frame Radome," *ASME Paper 59-A-271*, 1959.
- Kuhnel, A. O., "Haystack Antenna System Status Report," Tech. Rept. 328, Lincoln Laboratory, M.I.T., Sept. 13, 1963.
- Massey, L. D., "Computer Programs for Haystack Servo Testing," Group Rept. 1964-38, Lincoln Laboratory, M.I.T., July 29, 1964.
- Mathiasen, A. A., and Drinan, J. D., "Haystack Pointing System: Computer Program Structure," Group Rept., Lincoln Laboratory, M.I.T., to be published.
- Ruze, J., "The Effect of Aperture Errors on the Antenna Radiation Pattern," *Nuovo Cimento (Suppl.)*, vol. 9, no. 3, 1952, pp. 364-380.
- Ruze, J., "Physical Limitations on Antennas," Tech. Rept. 248, Research Laboratory of Electronics, M.I.T., Cambridge, Mass., Oct. 30, 1952.
- Shapiro, I. I., "A Fourth Test of General Relativity," *Phys. Rev. Letters*, Dec. 28, 1964.
- Simpson, H., "Structural Aspects of Large Precision Antennas," *NEREM Record*, vol. 4, 1962, p. 70.
- Simpson, H., and Antebi, J., "Space Frame Analysis and Applications to Other Types of Structures," *Proc. First Annual Workshop of SHARE Design Automation Committee*, 1964.
- Smith, P. D., "Haystack Pointing System: Digital Equipment Organization," Group Rept., Lincoln Laboratory, M.I.T., to be published.
- Weiss, H. G., "The Haystack Experimental Facility," *NEREM Record*, vol. 4, 1962, p. 108.
- "Large Steerable Radio Antennas—Climatological and Aerodynamic Considerations," *Ann. N.Y. Acad. Sci.*, vol. 116, art. 1, 1964, pp. 1-355.

\* This late development is described on page 24 of this issue.

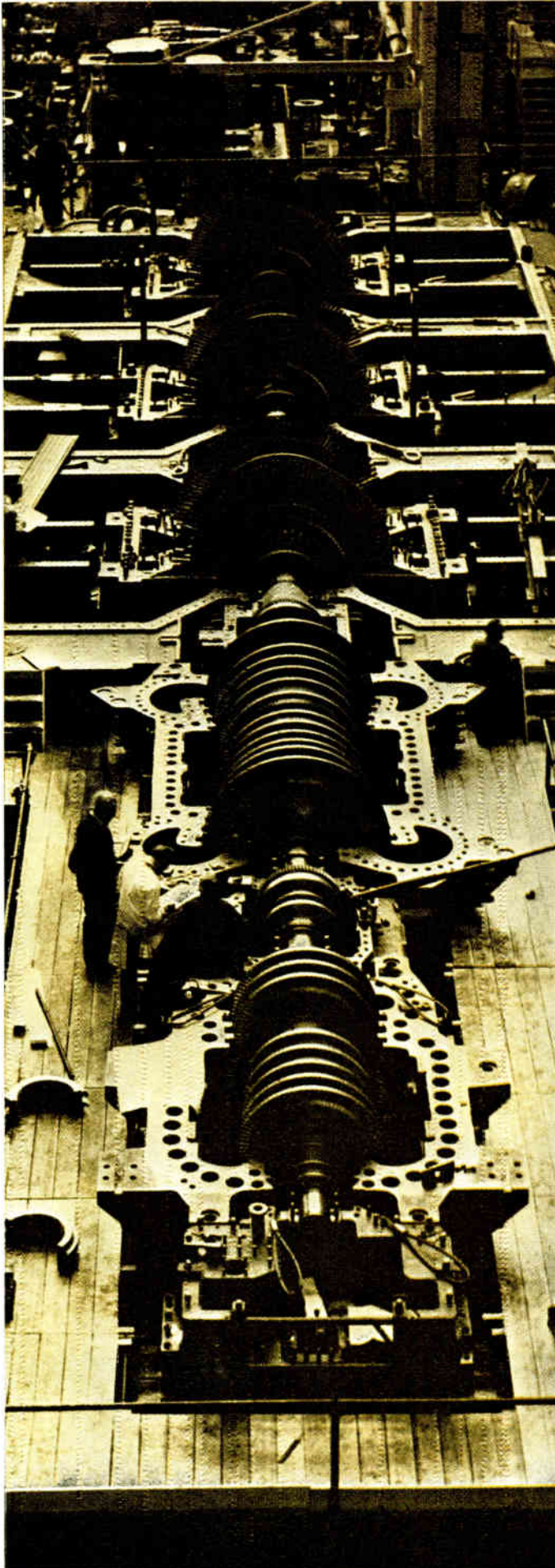

## Giant generators

*During the past fifteen years the individual size of generating plants has increased at a fantastic rate. This power development has introduced a new class of ever-larger steam turbine-generators for large outputs*

*Gordon D. Friedlander    Staff Writer*

In previous articles, the writer examined tidal power projects<sup>1</sup> and pumped-storage systems<sup>2</sup> as two means of meeting the rapidly increasing power demand. In this article, a third method—the very large rotating generator—is explored.

Since the end of World War II, the regenerative reheat steam power plant cycle, operating at inlet steam conditions of 1450 psig at 1000°F and higher, has achieved universal acceptance by American electric utilities as the most practical method of meeting the insistent demand for efficient, low-cost power generation. Rising fuel and capital costs were the paramount reason why the demand had to be met.

Since about 1949, the development of the large steam turbine-generators has been achieved primarily by the General Electric Company, Allis-Chalmers, and Westinghouse Electric in the United States, by English Electric in the United Kingdom, and by FASMA, Inc. (Société Rateau-Schneider), and Brown-Boveri in Western Europe.

### The GE investigation

About a dozen years ago, the prime question for which the manufacturers sought a definitive answer was: Are very large turbogenerators economical and practical? In 1955, General Electric conducted an investigation of the economic size of steam-electric generating units,<sup>3</sup> the purpose of which was to determine the optimum size of such units that should be added to an expanding power system. The study attempted to consider such factors as the size of a system, forced outage rate, rate of load growth, installed cost of larger generating units, the effect of a maintenance program, and the effect

High-, intermediate, and low-pressure elements for a 500-MW single-shaft turbogenerator during erection in shop.

## for growing power demand

on the transmission grid caused by the use of larger generating units.

**System under study.** For the purposes of this study, a basic existing system of 2000-MW total generating capacity was assumed. It consisted of twelve 25-MW, twenty 50-MW, and seven 100-MW units. And all units of the basic system were assumed to be of the unitary scheme: a single boiler, turbogenerator set. It was further assumed that the system was adequately designed to carry the full output of the generating stations to the load areas.

As the first step, expansion of the system was theoretically effected from the basic 2000-MW system to one of approximately 10 000 MW; and, in this expansion, four basic patterns were investigated: an 8 to 5 per cent, a 10 to 7 per cent, a 15 to 10 per cent, and a 250-MW

expansion. These patterns are shown in Figs. 1(A) through 1(D).

**Method of analysis.** The method employed to determine the most economical pattern of system expansion consisted of

1. The establishment of the reserve capacity required on the system to maintain the assumed standard of reliability for each pattern of system expansion through consideration of the size of the generating units, the forced outage rate of generating units, the weekday peak load duration curve, and a planned maintenance program.

2. The application of the assumed cost factors to each pattern of expansion was done by the loss of load probability method that is widely acceptable today.

For each combination of generators, consisting of the

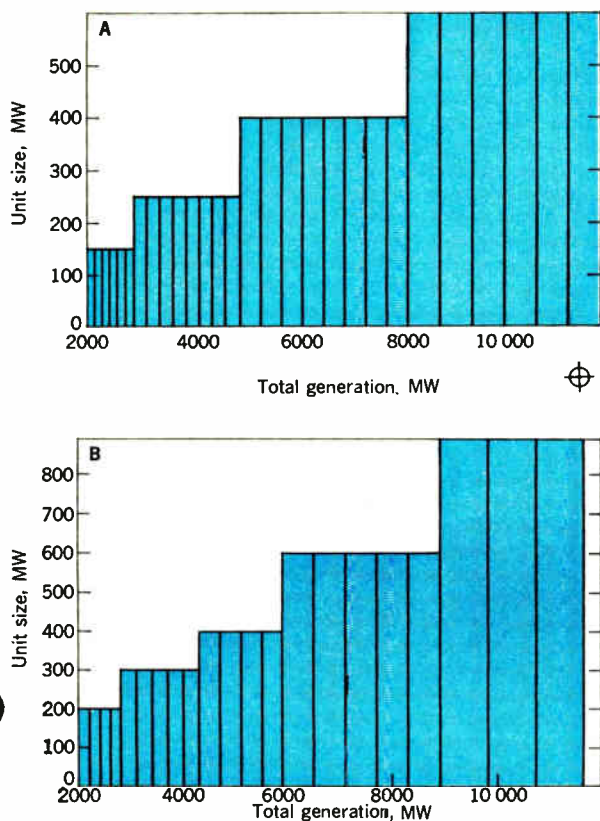
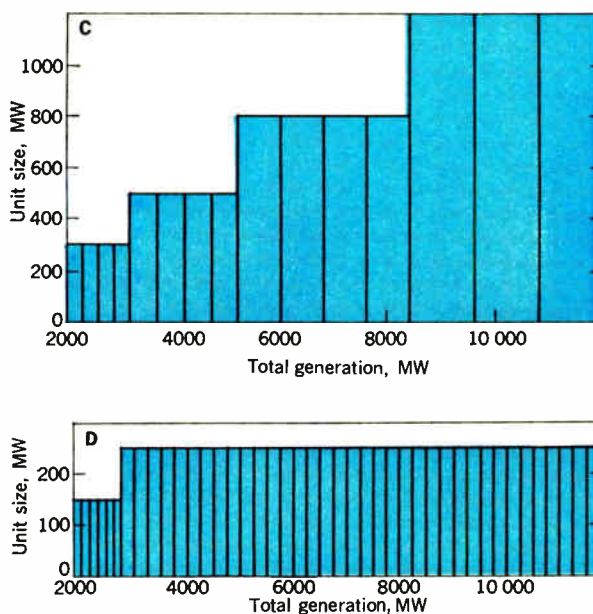

Fig. 1. A—Unit size plotted as a function of the total generation, with 8 to 5 per cent expansion. B—Unit size shown as a function of the total generation, with 10 to 7 per cent expansion. C—Graph showing unit size plotted as a function of total generation with 15 to 10 per cent expansion. D—Unit size plotted as a function of total generation, with 250-MW expansion.



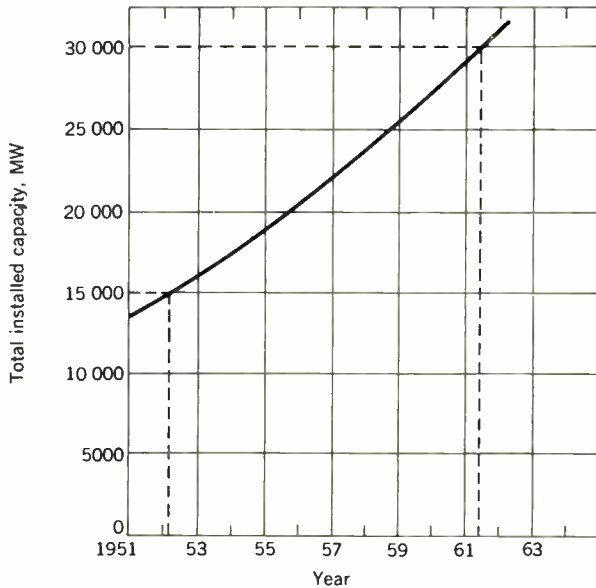

Fig. 2. Graph showing increase in the installed capacity of the CEGB (Great Britain) system between 1951 and 1963.

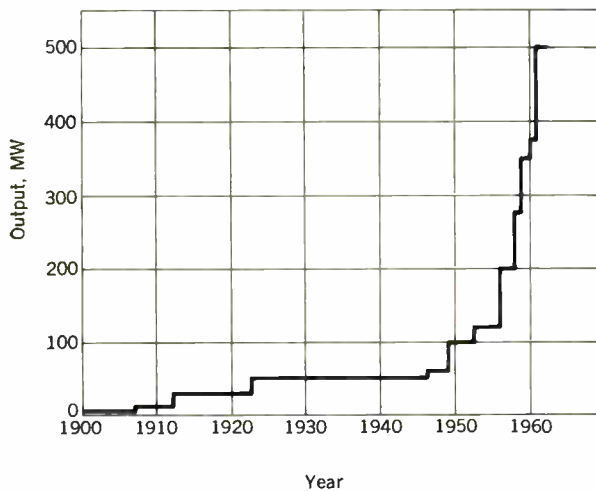
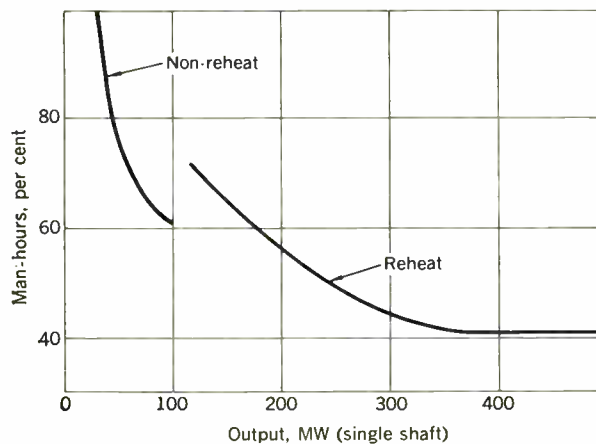

Fig. 3. Increase in rating of single-shaft 3000-r/min (British) turbogenerators from 1900 to the present day.

Fig. 4. Graph indicating how the man-hours required for manufacture per kilowatt fall with increasing unit size.



existing generators and all new generators added to the system in accordance with the just-mentioned patterns of expansion, the probability of availability of particular quantities of generation was ascertained. This was achieved for each pattern of expansion by using a 2 per cent forced outage rate. Also, a forced outage rate of 3 per cent was used for all units over 250 MW in the 8 to 5 per cent and the 10 to 7 per cent expansion patterns. Since the smallest unit on the system was 25 MW, the probability of availability was determined in 25-MW steps to the point at which this factor was practically zero.

#### Some conclusions are drawn

Based on the assumptions and analyses of the study, the following conclusions were noted:

1. If the investment cost of large units continues to decrease with size, and the forced outage rate for large generators remains at the present level (2 per cent or lower), the most economical pattern of system expansion is to add units of between 10 and 7 per cent of the size of the system studied. *The slope of the cost curve per kilowatt vs. size is the determining factor rather than the absolute values of investment cost.*
2. If the investment in dollars per kilowatt remains constant above any size, there is no practicality in using units above this optimum size.
3. Any increase in the forced outage rate of large units will slow up the move to such units.
4. For the range of rates of load growth normally encountered, the individual rate for a system has no appreciable effect on the size of units that can be economically justified in a system.
5. Because of the decreasing gain in investment cost and operating costs as unit sizes increase, units that are a larger percentage of system size can more easily be justified on smaller systems than on large systems.
6. Because of the decreasing gains from larger units, the rate of increase of the maximum size of units may slow down, *but there is no indication that the maximum economic size of units has yet been reached.*
7. Based on the factors considered in this study, it can be conservatively estimated that *unit sizes of the order of 500 to 600 MW will be economically utilized within the next ten years.*

It is interesting here to note the conservatism of this 1955 prediction, because today—exactly ten years later—units of 500 to 600 MW are on the line, and units of nearly twice this size are on order.

#### Parallel development in Great Britain

Nearly 40 years ago the Central Electricity Generating Board (CEGB) was formed in Great Britain to build and operate the "British grid," the interconnection of power stations formerly operated by municipalities and private companies. This enabled larger turbogenerators to be installed, and since the establishment of the CEGB very few sets of less than 20 MW have been built for public supply.

Following World War II, there was a concentration on two standard sizes of turbogenerators (30 MW, operating at 600 psig, 850°F; and 60 MW at 900 psig, 900°F) to build up British generating capacity as quickly as possible. In 1947, the electric utility industry was nationalized, and the British Electricity Authority and

Scottish Boards were formed to be responsible for all generation and power distribution in Great Britain. Growth continued at a high rate, and, as shown in Fig. 2, the installed capacity in England and Wales doubled from 15 000 to 30 000 MW between 1952 and 1961. At the end of March 1963, the installed capacity was over 34 000 MW, and the annual consumption was up by 11.4 per cent. The remarkable increase in the size of turbogenerators is shown in Fig. 3.

**Present-day requirements.** The conditions of operation in Great Britain,<sup>1</sup> for example, have had a major influence on steam turbine-generator design. As of today, the total interconnected capacity is extremely large—over 37 000 MW—and this makes it possible to install the largest units that can be built economically and reliably, and to derive full benefit from their lower specific cost and higher efficiency.

Figure 4 shows how the man-hours required for manufacture per kilowatt fall rapidly with increasing unit size, so that the relative cost for a 300-MW turbine is less than half that for a 30-MW unit.

As suitable sites for power stations are scarce in Great Britain, it is essential to install the maximum possible amount of power at any available location. Also, since there is very little hydro power available, the load variations of the British system must be carried on steam equipment.

To keep the high-pressure casings of large turbines as simple as possible, all units of 60 MW and above are *C/MER* machines (whose *continuous maximum* and *most economical rating* is at 100 per cent load), and there is no intention of running them at the less economical partial loads. Thus the British practice is to keep the sets operating either at full load or to shut them down completely. In short, fluctuations in the system load are met by starting up and shutting down the turbogenerators rather than by varying the load on individual sets. For example, if the load on the grid system were 30 000 MW, and it dropped by 1 per cent, 300 MW would be shut down. With present conventional plant equipment, this means that five 60-MW sets would probably be taken off the line, or a larger number of smaller and less efficient units. But in future plans, a single 300-MW set would be shut down, and for larger load drops, the biggest units on the system would be operated in like manner. For this reason, all newly built turbines must be designed for two-shift operation.

The operating requirement of maximum flexibility and reliability in service also has the effect of limiting the maximum steam temperature to a value below that for which austenitic steel becomes necessary. This material, with its high coefficient of expansion and low thermal conductivity, is unsuitable for temperature cycling. The maximum stop valve temperature has generally been limited to 1050°F, and only two 375-MW units thus far have been ordered that operate at supercritical pressure and 1100°F.

**Modern large British units.** Contemporary practice is best illustrated by considering some of the design features of a particular turbine such as the 500-MW unit shown in the title illustration, and Fig. 5. This unit, one of four similar single-shaft turbines for the CEBG's 2000-MW power station at West Burton, Nottinghamshire, operates at 2300 psig, 1050°F, with reheat to 1050°F.

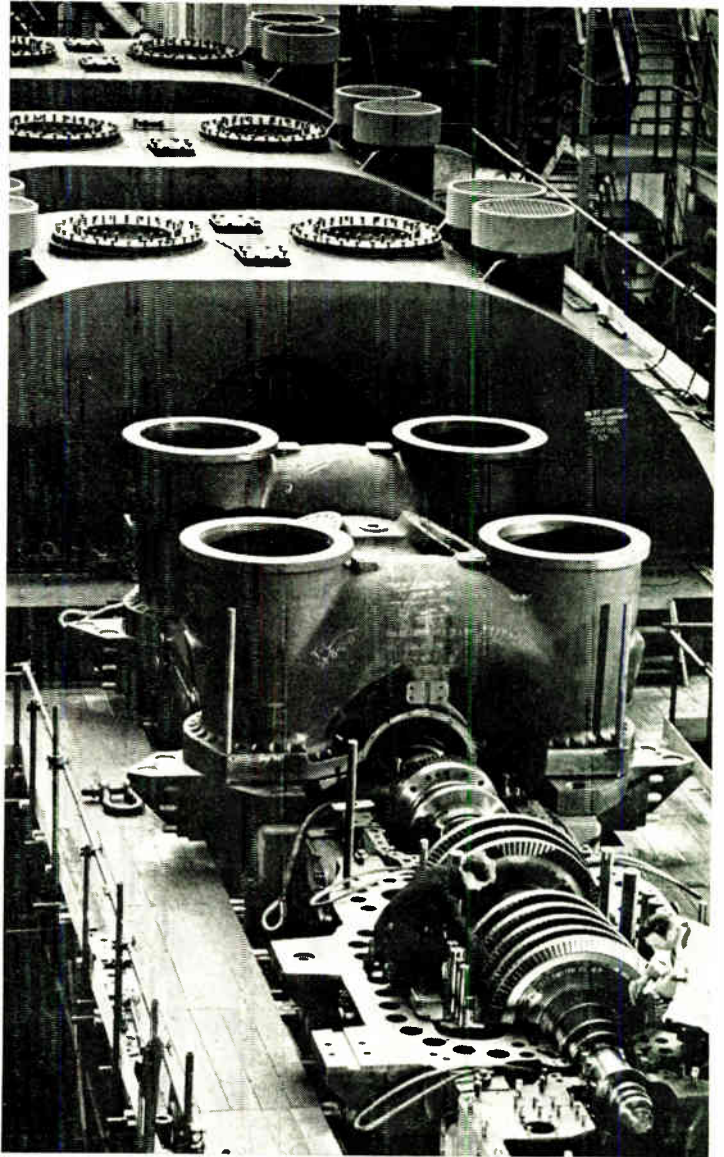

Fig. 5. View of one of the four 500-MW single-shaft turbines for the first 2000-MW power station at West Burton, England. Engineers in the foreground are checking clearances of the high-pressure rotor in the bottom casings.

The requirement that even the largest units should be capable of two-shift operation—being started up and shut down frequently with complete safety, reliability, and without harmful effect on the turbine—has already been explained. The essential features for the achievement of this optimum condition are:

1. Adequate running clearances between rotors and casings.
2. Design of components to give uniform heating and cooling.
3. Full admission at the first-stage nozzles. (Nozzle governing is not necessary since the unit will not normally be required to operate on partial load.)
4. Use of double casings. These are required to ease temperatures and pressure gradients with high-steam conditions.

5. Sturdy construction of rotors and blading, with particular attention to the maintenance of accurate alignment.

6. Full use of supervisory instrumentation.

**Governing and control gear.** A block diagram of the overspeed protection system<sup>3</sup> for a large turbogenerator is shown in Fig. 6; it indicates that the amount of integral protection equipment is kept to a minimum to reduce the possibility of inadvertent shutdowns. Maximum safety, however, is achieved by operating this equipment with all the primary protection elements.

Fig. 6. Block diagram of electrical-mechanical overspeed protection system.

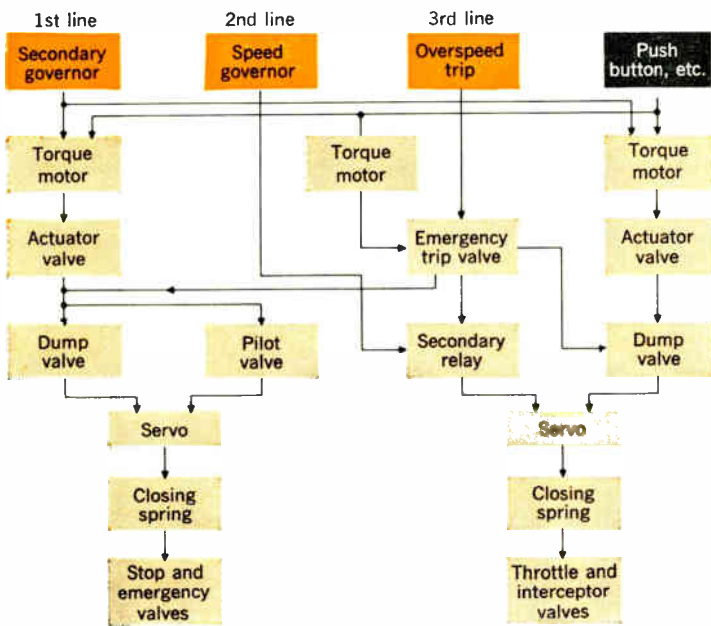

**Control system requirements.** The control of the speed and safety of a large turbogenerator unit consists of a system of mechanical, hydraulic, and electric devices that are coordinated as shown in Fig. 6. The equipment, selected to provide fast response, maximum reliability, and simplicity, consists of

1. A speed governor—a speed-sensing device to control the hydraulic primary and secondary relays that operate the steam admission throttle valves and reheat steam admission interceptor valves.

2. A secondary governor—a load-loss sensing device that operates all steam admission throttle and emergency stop valves.

3. An overspeed trip device to operate all steam admission valves.

4. An electrical system to shut down the unit following the activation of a number of protective devices such as the emergency stop push button, low-vacuum trip, and the generator electrical fault.

5. Special automatic unloading devices that include low vacuum, low boiler pressure, or load limiting.

#### The basic turbine units

Essentially, two types of turbine configurations are used both in domestic and foreign turbogenerator systems—the *tandem compound* and the *cross compound*. As a general rule in the United States, the selection of one of the two systems depends upon the geographical location of the power plant where the units are to be installed. Cross compounds are more practical in colder climates in which low-temperature condensing water is available for higher vacuums, and the tandem compounds are more adaptable for use in warmer areas. For example, in the eastern half of the United States, cross-compound units have been frequently installed along the Great Lakes, while plants south of the Ohio River are usually found to have the tandem-compound turbines.

In Great Britain, however, where a relatively mild climate prevails throughout Scotland and England, the

Fig. 7. Tandem-compound quadruple-flow turbine. This arrangement can be rated up to 500 MW on a single shaft.

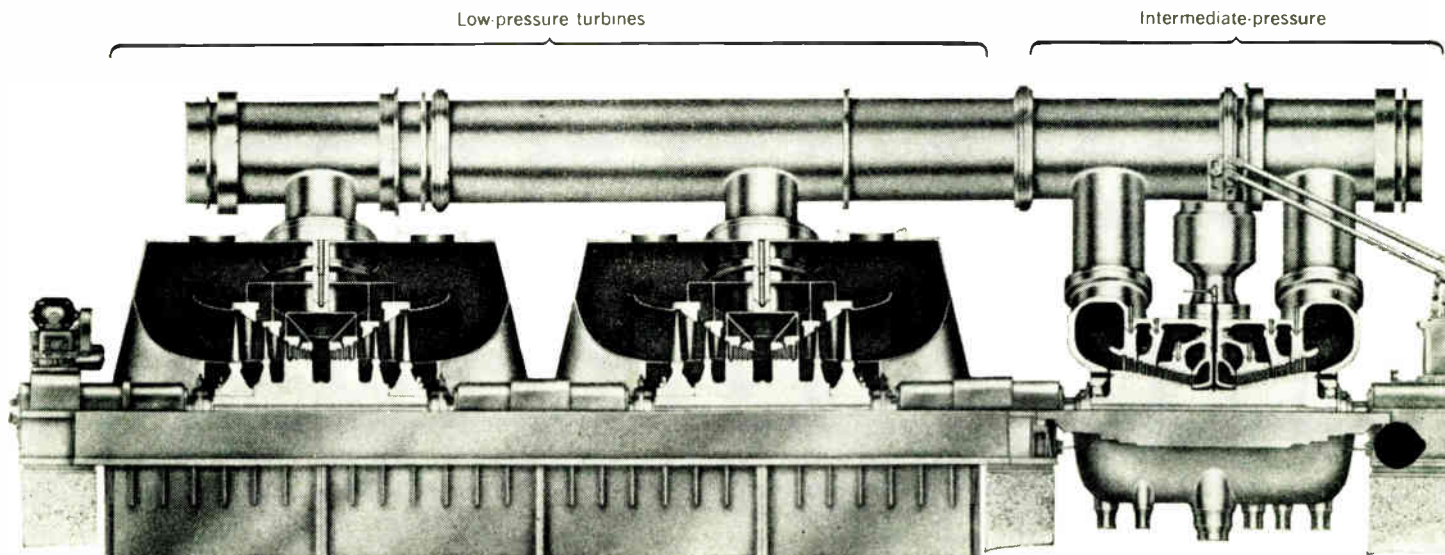

tandem compound has been used almost exclusively. The cross compound has made its appearance there only recently.

**The tandem compound.** The tandem-compound turbine receives superheated steam that is first introduced into the high-pressure turbine (see Fig. 7), from which the expanded and somewhat cooler steam is exhausted to the intermediate-pressure turbine component, and this, in turn, exhausts steam into the low-pressure turbine elements before condensing. Thus the steam flow is in a straight line through three or four turbine elements—with or without a reheat stage—and then is passed through the condenser. Tandem-compound turbogenerators (single shaft) have been built up to 600-MW capacity, and, according to English Electric, an 800-MW set is in the design stage. In general, the American-built tandem-compound turbogenerators rotate at 3600 r/min, whereas the English equipment operates at 3000 r/min.

**The cross compound.** The cross-compound turbine, shown in Fig. 8, consists of superheated steam injected first into the high-pressure turbine. The exhaust steam from this component is then passed to a reheater, and thence to the reheat turbine elements, which are on the same shaft as the high-pressure turbine and the 3600-r/min generator. Exhaust steam from the reheat turbine is then introduced into the two low-pressure turbines which drive an 1800-r/min generator.

**Advantages and disadvantages.** One advantage of the tandem compound may be in the structural and spatial requirements for its installation and support. As this type of unit is a straight-line flow system along a single shaft, combined footings and support foundations may be built to accommodate a unit whose length to width ratio may be as high as 5 to 1. Also, when the power plant output drops below peak capacity, the tandem unit may be shut down without taking as much output off the line, since the cross-compound units may be rated at 800 MW or more. The foundations, vibration damping, speed-matching systems, and space requirements are more complex for the cross-compound turbogenerators.

Some advantages of the cross-compound turbines include:<sup>6</sup>

1. The greater flexibility given to the generator designer in the largest size units because of the split in total unit capacity between the two turbine shafts. This flexibility is not possible with single-shaft units.

2. The general optimum efficiency afforded by the combination of 3600- and 1800-r/min high- and low-pressure elements. Since the radial length of the 1800-r/min buckets are greater, there is some reduction in leakage losses. It is also possible with an 1800-r/min, low-pressure turbine to provide more easily the sufficient exhaust annulus area to reduce the exit losses.

3. Larger capacity cross-compound units have been available at any given year in time. Consequently, progress toward larger capacities often dictates the use of cross compounds at upper limits because of their flexibility and efficiency.

**Variations in cross-compound design.** Although the more popular cross-compound arrangement is the standard 3600-1800-r/min unit, a second physical arrangement, the 3600-3600-r/min unit design, has been applied to some extent as it offers a different approach to station arrangement. The 3600-3600 unit can provide duplication of turbine rotors and electric equipment spare parts requirements—specifically in generator and excitation systems.

The arrangement of these 3600-3600 units can result in an approximately even power division between the two shafts at all loads, because the low-pressure stages are on each of the turbines. This power division with load differs from the typical power division shown in Fig. 9 for a 3600-1800 unit.

**Cross-compound electrical arrangement.** The circuit-breaker requirements for tying a cross-compound unit to the transmission system do not differ from those of a tandem unit. The cross-compound turbogenerators must always be tied together for operation, and a single,

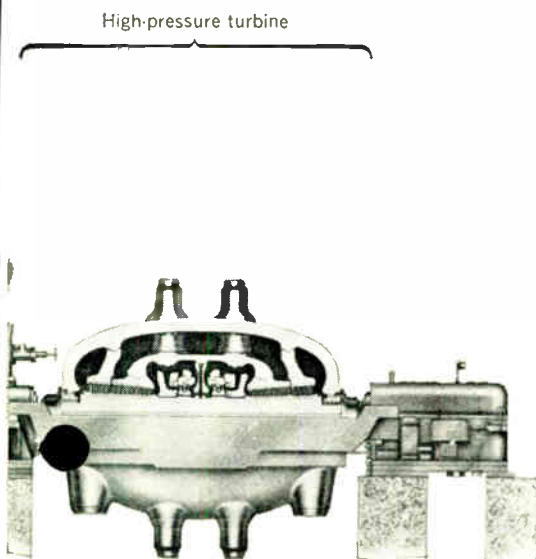

Giant generators for growing power demand

Fig. 8. Plan view of the 900-MW 3600-1800-r/min cross-compound steam turbine-generator for the Tennessee Valley Authority's Bull Run Station.

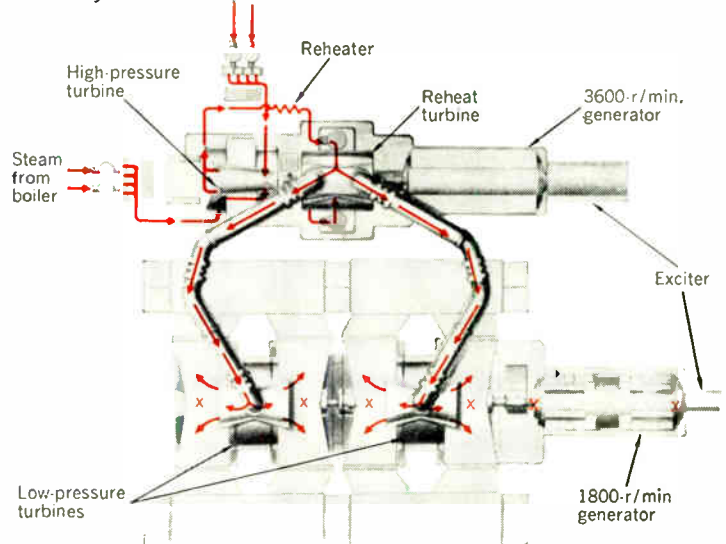

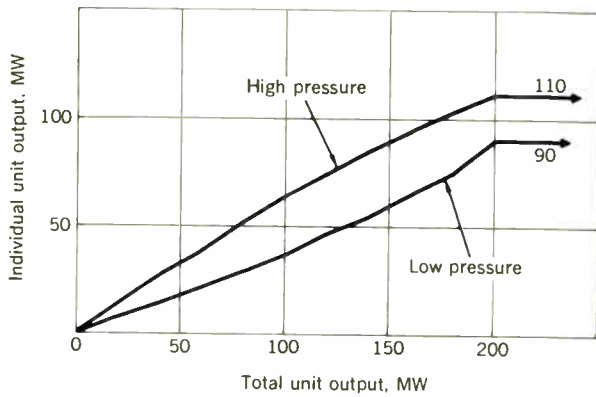
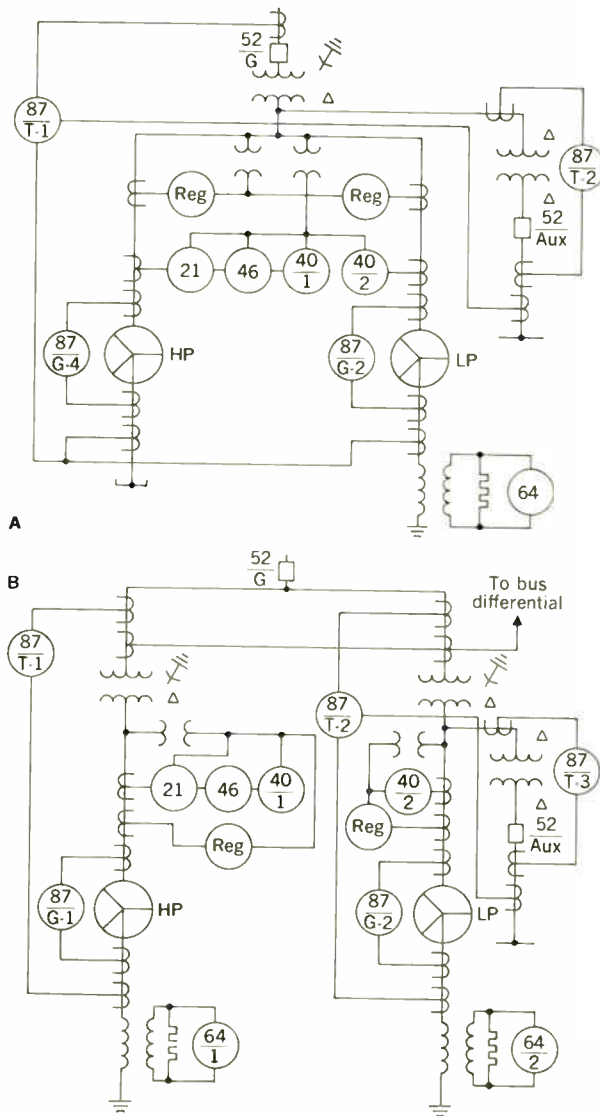

Fig. 9. Load split for 3600-1800-r/min cross-compound unit.

Fig. 10. A—Typical one-line and relay diagram for a cross-compound unit using two single-winding generators bussed at their terminals, and one main power transformer. B—Typical one-line and relay diagram for a cross-compound unit using two single-winding generators, and two main power transformers bussed on the high-voltage side.



high-voltage breaker is therefore used for switching the entire unit.

The necessary bussing of the generators may be at the generator terminals, as shown in Fig. 10(A), at the transmission voltage generator terminals, as shown in Fig. 10(B), or by means of a three-winding transformer as the step-up bank. The choice of these methods is a matter of economics and individual user preference.

Auxiliary power requirements differ only to a small degree from those of a tandem unit. Certain turbine and generator auxiliaries such as oil pumps and turning-gear motor feeds must be duplicated, and one exciter must be motor driven to provide start-up excitation.

The generators of a cross-compound unit are relayed essentially as two individual generators, with each protected by a differential relay as well as a loss-of-field relay. The functions of the auxiliary tripping relays are similar to those for tandem-compound units.

### Generator cooling systems

In general, there are two basic classifications for generator rotor and stator cooling—gas systems and liquid systems. This is an area in which continuous research, development, and improvement are being undertaken by all the major manufacturers of very large turbogenerator units.

**Hydrogen systems.** The gas coolant almost universally used is hydrogen. Since the successful operation of the first hydrogen-cooled generator in 1937, steady progress has been made to incorporate the highest degree of safety and reliability in the design and performance of hydrogen control and sealing systems commensurate with simplicity and ease of operation. These vital qualities in hydrogen system design are greatly dependent upon the performance of the shaft seal. Because of its ruggedness and proved reliability, the floating radial, ring-type seal has been used since 1941 as a standard design.

Further simplicity in hydrogen systems and added safety in the operation of hydrogen-cooled generators have been achieved from the development and application of a bearing oil trap drain system that was first applied in 1952. The trap drain incorporates a loop seal in the bearing oil drain piping which prevents hydrogen from passing down the drain to the turbine oil tank, thereby avoiding the possibility of an explosion occurring in the main turbine oil tank as a result of accidental accumulation of hydrogen gas above the oil. If a sudden or accidental leakage of hydrogen beyond the sealing point should occur, the gas will pass into the detraining tank and exhaust freely from the roof vent.

As a pure gas, hydrogen will not support combustion; however, when mixed with air in proportions ranging between 4.1 and 74.2 per cent hydrogen by volume, it forms an explosive mixture. But there is little risk involved in operating hydrogen-cooled generators, provided that the gas supply is reliable and that adequate regulators and controls are used.

**Liquid cooling.** Although conventional hydrogen cooling was a notable epoch in ventilation and cooling improvement, the introduction of liquid cooling has apparently opened some new vistas in the design and construction of large turbogenerators. The stator winding thermal barrier is no longer the primary determinant of size and rating. The door is now open to generator designs of 1000 MW or higher.



Liquid conductor cooling is carried inside the ground insulation of the stator windings so that it can absorb the heat generated by  $I^2R$  and eddy-current losses more directly from the current-carrying conductors. With the elimination of the large temperature differential through the ground insulation that exists with ordinary ventilation, the total temperature rise of the winding is greatly reduced for the same current flow.

The successful application of liquid for cooling stator windings has been achieved. Originally, transil oil was used as the coolant because of its high dielectric strength, good cooling properties, and chemical inertness. Water, however, has more than twice the heat removal ability of oil, and it also has the advantages of nonflammability and availability. It is an efficient coolant for the larger generators; it is presently employed in a number of generators in service, and will be used extensively in the future by some manufacturers. With air assigned the value of unity, the relative heat removal ability of the various coolants is: hydrogen (30 psi), 3.0; transil oil, 21.0; water, 50.0.

### The continuing investigation

The major producers of large turbogenerators in the United States and overseas have not slackened in their investigative efforts to build ever-larger and more economical machines. In 1963, some significant information, based on further investigations on the influence of interconnections and unit reliability on optimum size, was added to the literature. In this study,<sup>8</sup> it was stated that the investigations of the economics of generating unit size and system reserve must take into account a great number of factors, many of which are widely variable with respect to conditions existing at certain times and for specific electric utilities. Some of these factors are not accurately determinable, and therefore must either be estimated or assumed. And as such economic studies are readily affected by variations in parameters, cost studies made of actual utilities or typical hypothetical operating conditions may give conclusions that appear to be contradictory.

**System reserve.** The characteristics of generating units that provide incentive to larger units are investment cost, operating and maintenance cost, and heat rate. When individual generating units are combined into a practical, growing system to serve a utility load with reliability, a prime factor, which opposes larger units, is encountered—that is, the need for installed reserve generating capacity.

In some systems amounts of installed reserve may be needed to provide for scheduled maintenance outages. But in all systems, reserve is needed to provide for forced outages of generating units. The magnitude of this component of reserve is a function of both unit size and unit forced outage rate.

The curve in Fig. 11 shows per cent reserve capacity and unit size as per cent of installed capacity. An arbitrary point on the abscissa, such as the indicated 7 per cent, does not mean that all the units on the system are of that size, but rather that the system has grown by invariably adding units that are 7 per cent of system capacity at the time they are added. Thus, at any one time, only the newest and largest unit is of 7 per cent size. The reserve level of about 16 per cent is based on all units having a forced outage rate of 2 per cent,

and this reserve gives a loss of load probability of one day in ten years—which is a typical standard value for such studies.

The Fig. 11 curve measures the penalty in extra capacity required for larger percentage unit sizes. Figure 12 represents the combined effect of the investment, operating, and maintenance cost factors on the total cost of a block of new capacity. The ordinate of this graph may be considered as generating costs in dollars per year, or equivalent dollars per kilowatt. A convenient measure of the shape of the curve is the percentage reduction in cost when unit size is doubled. This is called the *D* factor, and the analysis of reported costs of units, ranging in size up to 300 MW, indicates the *D* factor to be in the range of 8 to 15 per cent. That is, when the unit size doubles, the investment, operating, and maintenance costs go down from 8 to 15 per cent.

The Fig. 12 curve is drawn with a constant *D* factor of 10 per cent. Proceeding on this assumption, we may consider Fig. 13, which gives the amount of capacity required.

If a system adds units of 7 per cent size, it means that it maintains a system reserve of about 16 per cent. But if this system increases its unit size to 14 per cent, or

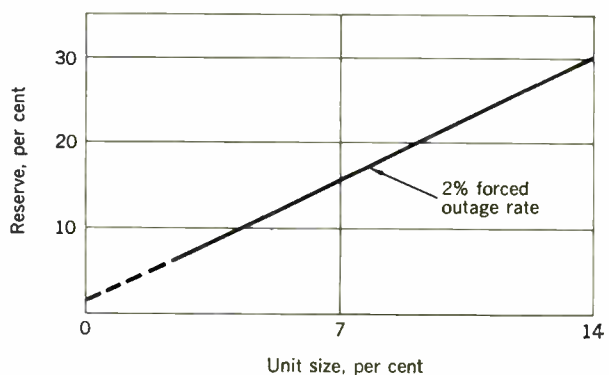
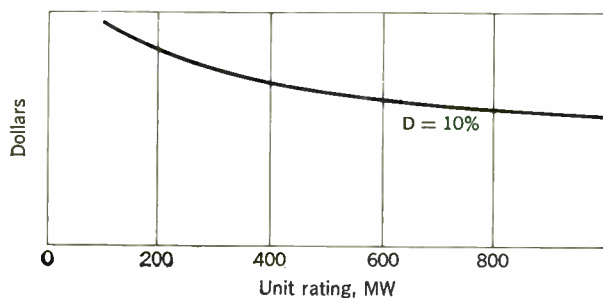

Fig. 11. System reserve for forced outages. Curve shows per cent reserve capacity and unit size as percentage of installed capacity. The curve also measures the penalty in extra capacity required for larger percentage size units.

Fig. 12. Combined effect on the investment, operating, and maintenance cost factors on the total cost of a block of new capacity. The ordinate represents the relative generating costs in dollars per year, or equivalent dollars per kilowatt (trend of generating cost).



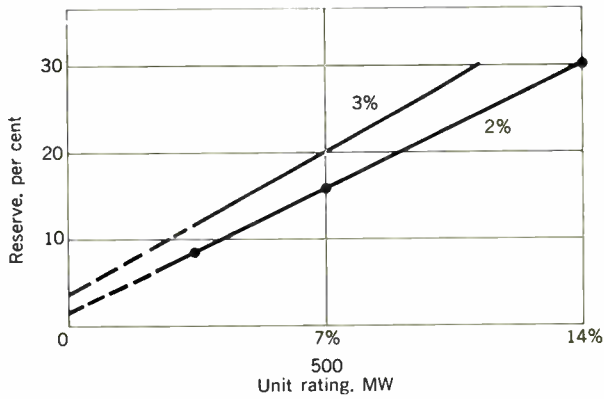

Fig. 13. System reserve for forced outages, showing the amount of capacity required for 2 and 3 per cent forced outages. Note that on the horizontal scale the 500-MW turbine-generator unit is shown as 7 per cent of system size.

Fig. 14. Unit forced outage rate plotted against megawatt rating. Note that an increase to 3 per cent in the forced outage rate occurs at 500 MW, the point where a new unit would be added in conformity with the practice of installing 7 per cent units.

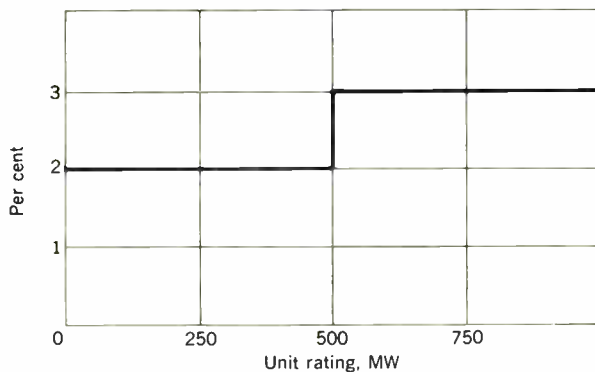
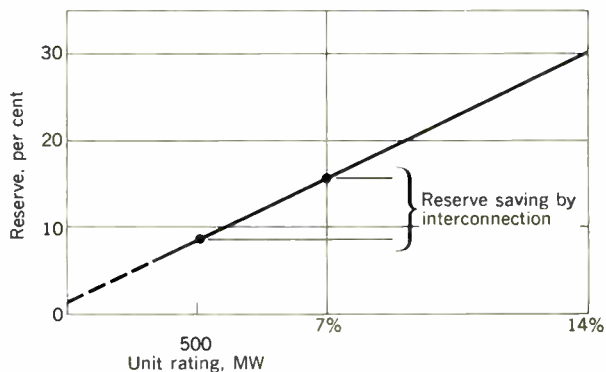

Fig. 15. Graph showing that the reserve for the pool, or for each system, may be reduced from 16 to 9 per cent. Note that on the horizontal scale the 7 per cent unit sizes (500 MW) now become 3½ per cent unit sizes on the pool base.



double size, Fig. 12 indicates a saving of 10 per cent in cost of capacity. While doing this, however, the system reserve would have to be increased from 16 to 30 per cent as shown. Thus the increase in *amount* of capacity would overcome the decrease in the *cost* of capacity.

If the unit size is not doubled, it might be cut in half (3½ per cent size). This could be achieved by adding constant megawatt unit sizes and permitting the system to grow for 8 or 10 years until its capacity is doubled, thereby cutting the unit size percentage in half. In this process, the reserve could be reduced gradually from 16 to 9 per cent—a reduction of about 7 per cent in amount of capacity. But in holding constant megawatt size, the system would have to forfeit a 10 per cent saving in cost of capacity that it could have had by doubling megawatt size over the same period. Thus there appears to be no economic advantage in cutting unit size in half.

Figure 14 shows an increase in the forced outage rate to 3 per cent at the point (500 MW) where a new unit would be added in conformity with the practice of installing 7 per cent units. It is apparent that the system should suspend the policy of installing 7 per cent at this point because the reserve penalty increases substantially by the acceptance of the higher forced outage rate (Fig. 13).

**Grid interconnections.** The considerations reviewed thus far have considered only an isolated system, with little or no connection with neighboring utilities in a grid. If the system establishes such an interconnection with another system of about the same capacity and with the same 7 per cent unit size policy, the two systems—with sufficient tie-line capacity—can be considered as one system for purposes of determining reserve requirements. On the pool base, the 7 per cent unit size becomes 3½ per cent. Figure 15 shows that the reserve for the pool, or for each system, may be reduced from 16 to 9 per cent. This saving would probably be taken in each system by omitting a unit addition in the year the interconnection was effected.

Table I is a tabulation that attempts to determine whether this capacity saving would be enough to pay for the transmission line. The left-hand column refers to system conditions when isolated; the middle column to conditions after interconnection with another similar system. As may be seen from the table, there is a saving in the interconnected system of 460 MW each, or 920 MW for both. Based on a figure of \$120 per kilowatt plant cost, the cash saving would be about \$111 million.

### I. Interconnection economics

System Statistics	Mode of Operation	
	Isolated	Interconnected
System load, MW	6000	6000
Unit size, MW	490	490
Unit size, per cent	7.0	3.5
Reserve required, per cent	16.7	9.0
Capacity required, MW	7000	6540
Capacity saving, both systems, MW		920
Value at \$120/kW, dollars		111 million
Line capacity required, MW		490
Savings available for interconnection, \$/kW		226

These studies have indicated that the tie-line capacity required to integrate two systems is approximately equal to the size of the largest unit—in the illustrated case, 490 MW. Thus the \$111 million saving would allow a line cost of \$226 per kilowatt of line capacity. In actuality, however, the transmission line would be built with about twice the indicated capacity to allow for future system growth. But even so, the available savings amount to \$113 per kilowatt, and this is two or three times the cost of a typical 200-mile line of this capacity. Therefore, the reserve savings are more than enough to pay the transmission cost of the interconnection.

Finally, it should be emphasized that the 7 per cent unit size is not a “magic number,” but is used arbitrarily for illustrative purposes. The final results can be influenced greatly by the shape of the cost curve, or *D* factor, plus individual system characteristics of load shape and rate of load growth.

### Summary of conclusions

The 1963 survey concluded that

1. Higher forced outage rates are a severe penalty for isolated systems.
2. Interconnection reserve savings are generally ample to pay transmission costs.
3. Interconnection reserve levels give less penalty for larger unit sizes.
4. Interconnection reserve levels give less penalty for higher forced outage rates.

The reason for the continuing increase in unit size of turbogenerators is therefore economic.<sup>9</sup> The manufacturers have historically met the requirements of the utilities as larger units are wanted. Larger turbine units are expected to be more efficient because the increased size helps to justify the application of more efficient steam conditions, and also, of smaller significance, parasitic losses may be reduced. Figure 16 shows the present worth of coal fuel saved in Great Britain by generating electricity in four 500-MW units instead of by twenty 100-MW units. To translate the value in English pounds to American dollars, multiply by a factor of 2.80.

As unit size increases there are corresponding savings in other items of power station plant (boilers, buildings, etc.), but the need for strong and reliable interconnection calls for a higher capacity transmission system capable of efficient transfer of large blocks of power.

### Steam conditions for turbines

There has been very little change in steam temperatures in recent years throughout the world practice. Because of the relatively higher cost of plant for 1100°F steam temperatures, generating units over 200-MW capacity have used initial temperatures of 1000° or 1050°F, with first reheat temperatures of 1000° or 1050°F; and occasionally, very large units have employed double reheat, with the second reheat temperature in the same range.

Pressures up to 2300 psig can be reliably generated in a drum-type boiler, with which there has been much successful service experience. Temperatures of 1050°F have been successfully used with known combinations of ferritic and austenitic materials in the boiler, and such temperatures do not require any austenitic material in the turbine. Many of the larger modern plants are using

supercritical pressure, drumless boilers with initial turbine pressures of 3500 psig.

**Comparative heat rates.**<sup>10</sup> Figure 17 illustrates the comparative heat rates at the capability point for different unit megawatt sizes, steam conditions, and turbine exhaust end loadings. The net heat rate is defined as the heat supplied to the turbine from the boiler divided by the output at the generator terminals, minus the power supplied to the motor-driven boiler feed pumps. In the case of turbine-driven boiler feed pumps, the denominator is merely the output at the generator terminals. Thus the variation of boiler feed pump power with different steam conditions has been considered. Assuming equal boiler efficiencies and equal

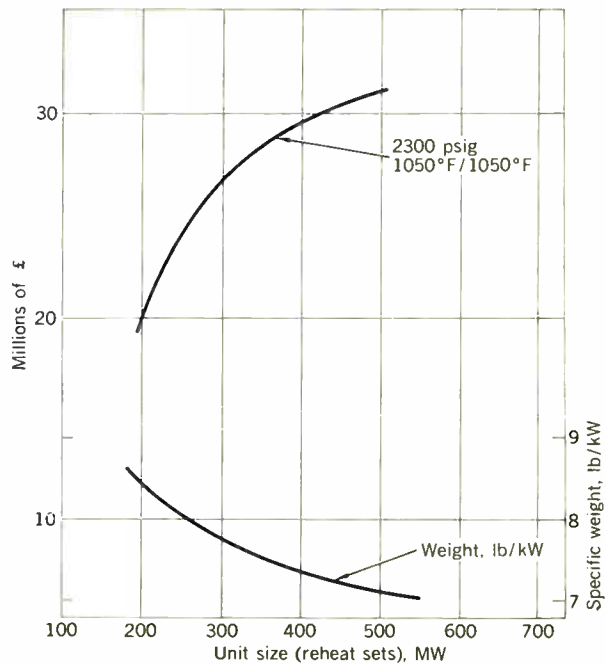
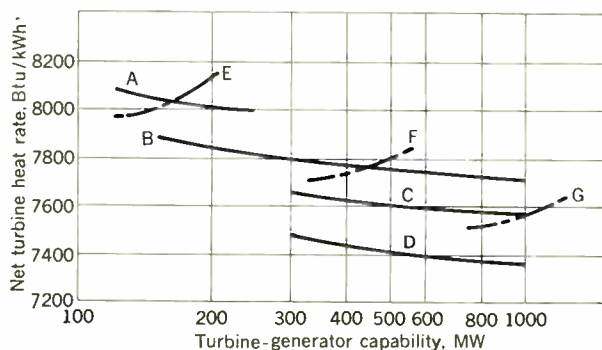

Fig. 16. Graph showing the present worth of coal fuel saved in Great Britain by generating electricity in four 500-MW units instead of by twenty 100-MW units. Other operating conditions include: 60 per cent load factor, 89 per cent boiler efficiency, and 70 shillings cost per ton of coal of 10 000 Btu per pound calorific value. Upper curve indicates saving with sets of larger output than 100 MW non-reheat.

Fig. 17. Graph of turbine-generator net heat rates plotted against unit capability.



percentages of power consumption for auxiliaries other than boiler feed pumps, the percentage variation of net turbine heat rate is the same as the percentage variation of net station heat rate.

Curves *A* through *D* in Fig. 17 are drawn for constant exhaust end loading of 2000 kW/ft<sup>2</sup> of total last stage annulus area. And they illustrate the heat rate gains available from the larger ratings after eliminating the variables of alternate turbine last stage bucket lengths and number of parallel flows. The slight divergence of these curves illustrates the availability of the larger capacity units to realize more effectively the heat rate improvement theoretically available from the higher steam conditions. This is achieved primarily by the decreased susceptibility to internal efficiency loss of the larger units. The curves in this group show heat rate gains at constant steam conditions varying from 0.5 to 1.2 per cent as the unit capacity is doubled. In actual practice, however, this course is seldom followed because higher steam conditions are usually adopted as unit capacity is increased. The steam turbine is in-

herently one of the most efficient of heat engines, and the per unit cost increase for higher steam pressures is generally less at the larger ratings. Similar characteristics exist in other station components, with the result that the per kilowatt cost increase of higher steam conditions is usually diminished as unit capability increases. For these reasons, higher steam conditions are usually economically justifiable at the larger unit capacities. Therefore a doubling of unit capability from 150 to 300 MW can produce a heat rate improvement of 3 per cent in going from curve *A* to *B*. Similar gains are available elsewhere in the range of unit capabilities considered in this graph.

Curves *E* through *G* illustrate heat rate differences occurring when a turbine with a given annulus area is applied at different capabilities and with the same cycle conditions.

### Some of the giant installations

Tables II and III list a few of the largest turbogenerator installations in the United States and abroad. Figure

## II. American turbogenerator units rated at more than 500 MVA (partial list)

Utility Company	Station	MVA	Power Factor	Year in Service	r/min	Cooling
Commonwealth Edison	Kincaid No. 2	733.0	0.90	1969	3600	Hydrogen
Detroit Edison	Trenton Channel No. 9	595.0	0.90	1969	3600	Water
Carolina Power & Light	Roxboro No. 2	730.0	0.90	1968	3600	Water
Northern States	Allen S. Wing No. 1	704.0	0.85	1968	3600	Hydrogen
New England Gas & Electric	Cape Cod No. 1	640.0	0.925	1968	3600	Hydrogen
Niagara Mohawk Power	Nine Mile Point No. 1	755.0	0.85	1967	1800	Water
Commonwealth Edison	Kincaid No. 1	733.0	0.90	1967	3600	Hydrogen
Arkansas Power & Light	Helena No. 2	604.7	0.85	1967	3600	Hydrogen
Ohio Power	Cardinal No. 1	723.8	0.85	1966	3600	Water
Mississippi Power & Light	Baxter E. Wilson No. 1	640.7	0.85	1966	3600	Hydrogen
Texas Power & Light	Stryker Creek No. 2	585.2	0.90	1966	3600	Hydrogen
TVA	Bull Run No. 1 (H.P.)	527.8	0.90	1965	3600	Water
	Bull Run No. 1 (L.P.)	527.8	0.90	1965	1800	Water
Public Service Electric and Gas	Hudson No. 1	535.0	0.85	1964	3600	Hydrogen
Texas Electric Service	Handley No. 3	506.0	0.80	1963	3600	Hydrogen

## III. Large turbogenerator units in foreign installations

Country	Station	Size of Unit, MW	Year in Service	Turbine Type
United Kingdom	Longannet	600	1967	Cross compound
France	Porcheville	600	1967	Tandem
United Kingdom	West Burton	500	1965	Tandem
United Kingdom	Drakelow	375	1965	Tandem
United Kingdom	Blyth "B"	350	1964	Tandem
France	Centrale Nucléaire des Ardennes	288	1965	Tandem
United Kingdom	Blyth "B"	275	1962	Tandem
France	Gardanne	250	1967	Tandem
France	Champagne-sur-Oise	250	1961	Tandem
France	Vaires-sur-Marne	250	1961	Tandem

18 shows a view of a large power plant installation in England, and Fig. 19 is an interior view of the largest power station in Australia.

Perhaps the most notable trend in the United States has been the rapid growth in unit megawatt size. The largest capacity units in service were 500 MW in 1960, and 650 MW in 1963.

A new milepost in power generation is being established today in the design of the world's largest capacity steam turbine-generator—a 1000-MW unit for Consolidated Edison's Ravenswood Station in New York City. Designated as "Ravenswood Unit 3," it is a 3600-1800-r/min, cross-compound turbogenerator, with the close-coupled arrangement originated by its manufacturers, Allis-Chalmers.

The high-speed shaft system consists of a double-flow high-pressure turbine and a double-flow intermediate-pressure turbine connected in tandem to drive a 3600-r/min generator.

The low-speed shaft system consists of three double-flow low-pressure turbines connected in tandem to drive a four-pole generator and two tandem exciters with a common gear drive.

The generators for Ravenswood Unit 3 will both be fully supercharged, with rotors and stators conductor-cooled by hydrogen supplied from a shaft-mounted blower.

Ravenswood Unit 3 is expected to go on the line in June 1965.

A close runner-up in size to the Ravenswood unit is a 900-MW turbogenerator for the TVA's new Bull Run Station. The design concept of the 3600- and 1800-r/min cross-compound turbines and generators that comprise this giant unit is the result of years of research, development, and experience in the art of turbine-generator engineering. The Bull Run Station is also scheduled to go on the line this year.

It is reported that a larger unit than Ravenswood, a 1150-MW cross-compound turbogenerator, is now under construction for future delivery to the TVA system.

#### **Size limitation—practical and theoretical**

As nearly as can be determined from the manufacturers of large turbogenerators both in this country and abroad, the only practical limitation on size is transportation restrictions. Because of tunnel and bridge clearances, and other limitations, railroads can only handle equipment up to certain maximum permissible physical sizes and dimensions. And this physical limitation applies also to highway transportation.

As far as theoretical size limitations are concerned, there is no apparent limit. Turbogenerators are now being built in the 900-1000-MW range, and one manufacturer is talking in terms of building such equipment up to

Fig. 18. View of the five 200-MW steam turbogenerators for the High Marnham Station of the British Central Electricity Generating Board.

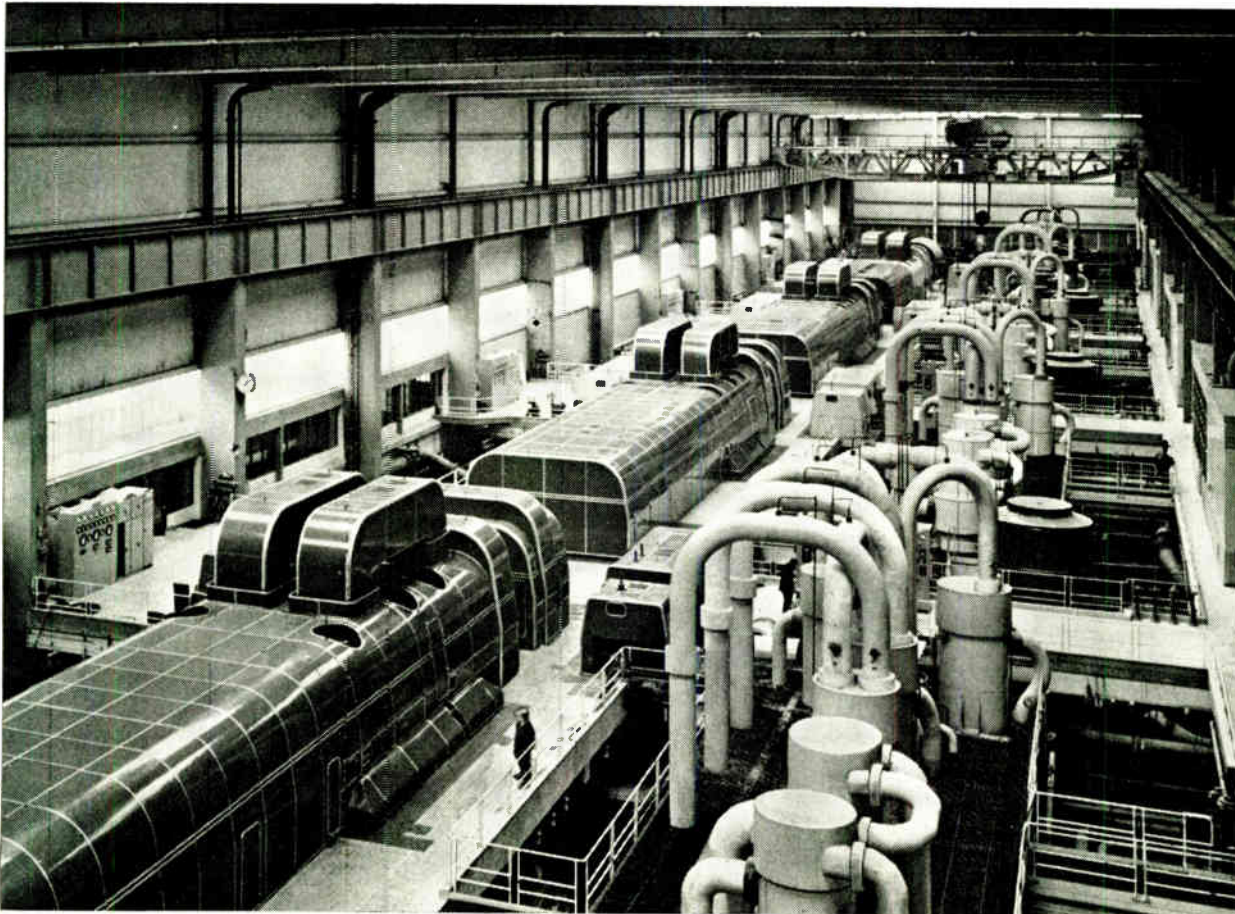

Giant generators for growing power demand

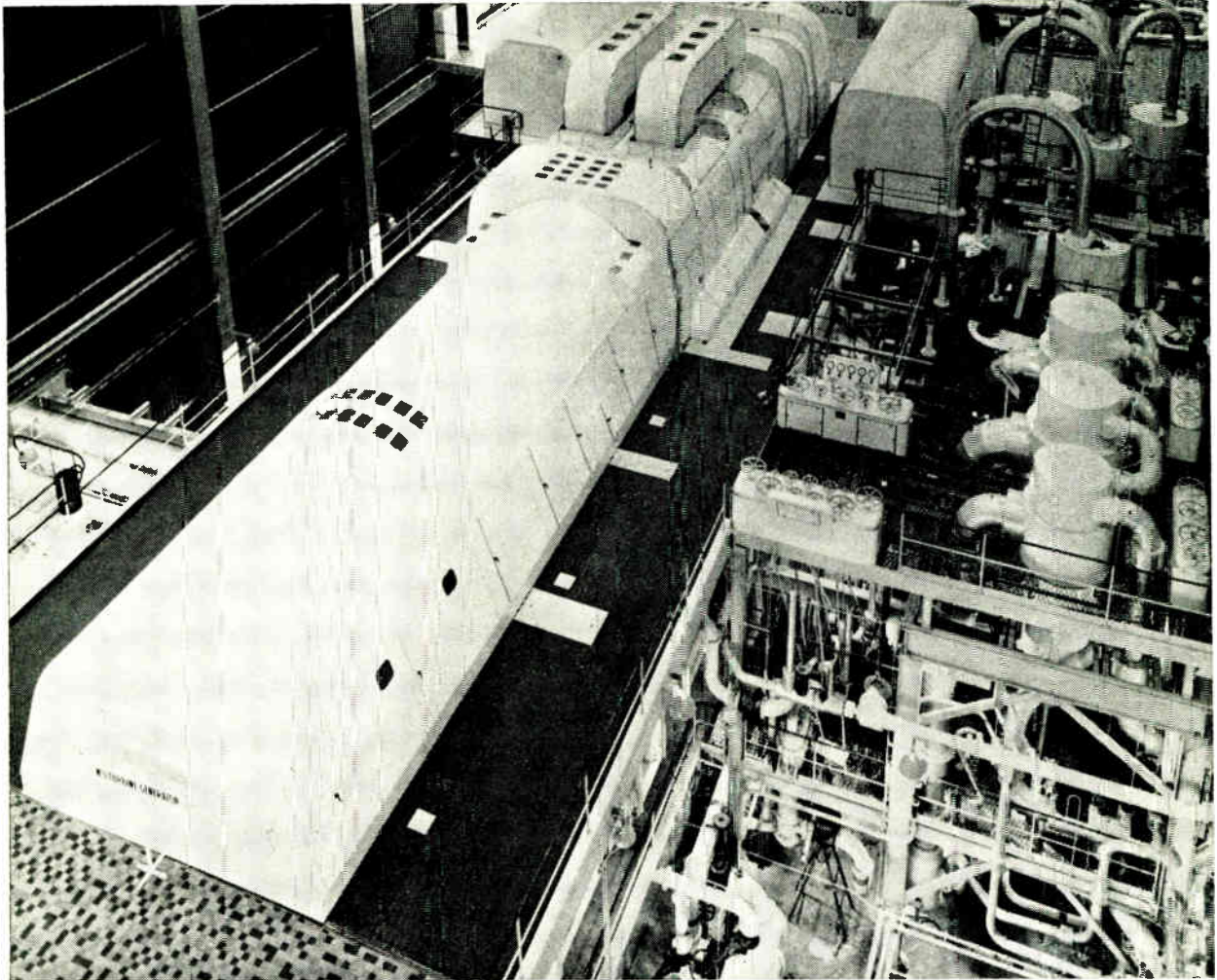

Fig. 19. View of Vales Point, the largest power station in New South Wales, Australia. The station contains three 200-MW steam turbogenerators.

2000 MW eventually. Cooling of the generators has presented something of a problem, but this has been largely overcome with the breakthrough in conductor water cooling.

Technological progress in steam turbine-generators has made a vast contribution toward the achievement of reduced fuel consumption, lower fuel costs, increased power per turbine casing, lower installation and maintenance costs, and lower operating costs.

The planning, research, and development by the manufacturers, private utilities, public utilities, and the Federal Power Commission are quite consistent and coordinated. As we have seen, units of over 1000-MW capacity will soon be in service on both public and private power systems, and the FPC predicts a number of 1500-MW units by 1980.

Certainly these sizes can be achieved, whether or not the tremendous "east-west zone interties" visualized by the FPC ever become practical realities.

The author wishes to acknowledge the courtesy and cooperation of the General Electric Company in making available Figs. 1, 8-15, and 17; J. Spencer and Miss J. Schiller of English Electric for furnishing the title illustration, Figs. 2-6, 16, 18, and 19; the Westinghouse Electric Corporation for providing Fig. 7; K. A. Hovington of FASMA, Inc., for providing information on large European turbogenerator installations; and John L. Black

of Allis-Chalmers Manufacturing Company for information on Ravenswood Unit 3.

#### REFERENCES

1. Friedlander, G. D., "The 'Quoddy Question—Time and Tide,'" *IEEE Spectrum*, vol. 1, no. 9, Sept. 1964, pp. 96-118.
2. Friedlander, G. D., "Pumped Storage—An Answer to Peaking Power," *Ibid.*, vol. 10, Oct. 1964, pp. 58-75.
3. Kirchmayer, L. K., Mellor, A. G., O'Mara, J. F., and Stevenson, J. R., "An Investigation of the Economic Size of Steam-Electric Generating Units," *Trans. AIEE*, pt. III (*Power Apparatus and Systems*), vol. 74, Aug. 1955, pp. 600-609.
4. Hirst, Alex C., "The Modern 'English Electric' Steam Turbine for Large Outputs," *English Elect., J.*, vol. 19, no. 3, May-June 1964, pp. 12-24.
5. Peters, R. W., "Governing and Control of Large Turbo-Generators," *Ibid.*, vol. 18, no. 1, Jan.-Feb. 1963, pp. 18-30.
6. Benner, P. E., Brown, P. G., Buell, R. C., and Mellor, A. G., "Simplicity of Station Design and Operation with Cross-Compound Turbine-Generator Units," *Trans. AIEE*, pt. III (*Power Apparatus and Systems*), vol. 76, Apr. 1957, pp. 129-134.
7. Barton, S. C., Massingill, J. A., and Taylor, H. D., "Design Features and Characteristics of Large Steam Turbine-Generators," *Ibid.*, vol. 79, 1958 (Feb. 1959 section), pp. 1335-1346.
8. Marsh, W. D., "Interconnections are Raising Economic Unit Size," *Elect. World*, Nov. 18, 1963, pp. 76-126.
9. Ecker, R., "Current Trends in Steam Turbine Design," *Engineering*, Feb. 24, 1961.
10. Downs, J. E., "Large Steam Turbines and Generators for Economical Power Production," presented at World Power Conf., Lausanne, Switzerland, Sept. 13-17, 1964.

# A new electronic switching system

*The evolution of telephone switching systems is toward common control. This first commercial electronic system is centered about a stored-program real-time data processor that facilitates modifications and additions to future service at low cost*

*W. Keister, R. W. Ketchledge, H. E. Vaughan*

*Bell Telephone Laboratories, Inc.*

Telephone switching systems have evolved through the years to meet ever-burgeoning communication needs. The evolution is marked by stages in which new switching machines are introduced to service needs that can no longer be adequately met by existing equipment. The No. 1 Electronic Switching System (No. 1 ESS) marks the attainment of such a stage today. It both meets the need for additional types of services and anticipates future needs at relatively low cost. Two-wire and/or four-wire switching for local, toll, or tandem applications are provided at a cost economically competitive with present applications.

To achieve this flexibility, many new concepts of switching-system organization and new kinds of apparatus were used, making No. 1 ESS the largest development project ever undertaken by Bell Laboratories for the Bell Telephone System.

This article covers some of the history and outlines the organization and objectives of the new system.

## History

The main trend of the evolution has been toward centralized or common control. Briefly, this means that complex equipment for processing information is used on each call only during the stage at which its processing capability is required. It is then released and made available to serve other calls. In this way, the construction of more sophisticated and costly equipment can be justified since its use is time-shared among a number of customers.

The first elements of common control were introduced in the Panel System, which went into service in the early 1920s. The important concepts were digit registration and translation. The No. 1 Crossbar System in the late 1930s was the next important advance in system philosophy. It contains a marker unit, the first truly common control unit. In addition to performing the decoder task of translating digits dialed by the customer, this system also locates idle trunks and controls the network that makes connection with the selected trunk. The network is completely free of constraints that might otherwise

be imposed by the numbering system and can be engineered in an optimum way to meet traffic requirements.

The No. 5 Crossbar System, first placed in service in 1947, is the latest in the Bell System's evolution of common-control electromechanical systems.

All of these systems, however, were mechanical or electromechanical. Electronic techniques for switching were investigated as part of a research program begun in the middle 1940s. An experimental system, using a large central memory in a common control, named DIAD<sup>1</sup> (drum information assembler and dispatcher) was one result of this work. Its switching network used "one-at-a-time" operation with "end-marking" of reed-diode crosspoints. In parallel with this experiment, another group demonstrated that a good talking path could also be set up through a multistage network of special gas tubes.

An appraisal of the state of the art showed that the advantages of such a system did not justify development at that time. Later developments, such as the transistor and new memory techniques, stimulated the design of the world's first electronic switching office, which was operated at Morris, Ill., from 1960 to early 1962. The trial at Morris<sup>2</sup> demonstrated the value of many of the basic concepts used in No. 1 ESS; in particular, the use of stored program and the basic maintenance philosophy. The system at Morris provided customers with regular commercial-grade service in addition to some new services, establishing valuable guides for production design in hardware, data formats, and programming. Also, many young engineers obtained experience and training that later played a major role in the design of the No. 1 ESS. Two issues of the *Bell System Technical Journal* were devoted to their design contributions.<sup>3</sup>

## Objectives

**Economics.** A new switching system must be at least the equivalent in service features of existing systems for some significant segment of the market. The basis of comparison must be today's market rather than some hypothetical market of the future, since the new system is

introduced in an environment of a very large number of older systems; thus the general capability of the overall switching network will be determined largely by the capability of the majority of the offices.

Improvements in the overall system are gradual, extending over a period of years. However, the inherently greater capability of the new system means that improvement can be realized at a gradually increasing rate as the percentage of new offices increases. This points up another essential: compatibility. A new office must be compatible with the older offices with which it operates, since modifications of older units in service could reduce the economic advantages of a new office design.

The problem of achieving an economic balance over a range of sizes in the No. 1 ESS plan is quite different from that in electromechanical common-control offices such as the crossbar type. The electronic system is based on a single high-speed central processor that is essentially the same in both large and small offices. In a system such as No. 5 Crossbar, a multiplicity of control units must be used because of their slower speed. This allows the amount of control equipment—for instance, the number of registers and markers in the crossbar system—to be increased as the office grows so that the full burden of a control capable of handling a large office need not be borne by a small initial installation.

The new system must meet the standards of dependability that have been established by electromechanical systems. Where dependability is of prime importance, the operation of a complete office by a single central processor poses a definite problem. In a multimarker office of No. 5 Crossbar, the failure of a single marker merely reduces the traffic capacity of the office. However, in an office depending on a single central processor, the failure of the controller would make the office completely inoperative. The solution followed in No. 1 ESS is to duplicate all units essential to proper office operation.

The economic objectives of No. 1 ESS are being realized through a basic design stressing optimization of details and economy in production and operation over a period of years. The design of the equipment itself and its component parts was based on quantity manufacture. Through the use of the stored program, it was possible to plan a system that requires no wired options during manufacture, thus promoting production efficiency. And because system units were designed for a minimum of interconnections between frames, most of the wiring and much of the detailed testing can be done at the

factory rather than during the process of installation.

Trouble detection and fault location have been highly automated through the use of stored program. Since most of the system logic involving telephone service features has been placed in the stored program, the introduction of new service features and the modification of existing features will be greatly simplified. In many cases, modifications will be possible by changing programs rather than by wiring changes.

### Size

Determination of the range of sizes over which the system would be applicable is an important item in system planning. In the design of No. 1 ESS, two major parts were greatly influenced by size: the network, which had to serve the entire range with systematic growth from the smallest to the largest size encompassed by the design; and the central processor, whose call-processing capacity had to be both sufficient to handle the largest office and economical when used at only a fraction of its total capacity in smaller offices.

The appropriate size range was determined by a survey of the range of office sizes for which there is a demand.

Information for this survey was obtained from the operating telephone companies who provided information on the number of wire centers and the size of each wire center in their company. This information, covering a total of over 30 million lines in the Bell System, was analyzed by a digital computer to provide statistical information on the make-up of the potential market.

The general nature of the results is indicated in Tables I and II. Two things are apparent: (1) the large number of very small wire centers, and (2) the large volume of business handled by large wire centers. Approximately 50 per cent of the total lines are served from wire centers of 19 000 or more lines. However, an office large enough to accommodate the largest wire centers was not necessary, since the cost per line decreases as the office size increases and flattens out in the larger office sizes. For example, the cost of two 50 000-line units is not significantly higher than the cost of a single 100 000-line unit; hence, an upper size limit of 65 000 lines would be reasonable. This has been verified by a number of studies. The lower size limit is determined by pure economics; however, it should extend down to at least the 4000- to 5000-line size since the survey showed that a large number of offices are initially installed in this range.

From a traffic standpoint, the maximum size of the system is set by the capacity of the central processor for handling calls in real time. The capacity of the No. 1 ESS has been set at 100 000 calls in the busy hour. This figure was determined through studies of the cost and complexity of central processors of various designs, weighed against the traffic needs in the wire centers of the Bell System. (The capacity of the central processor is determined by the basic speeds of the electronic circuits, its basic clock cycle time, the complexity of its individual logic operations, and the amount of processing done in parallel.)

**Flexibility.** The system has been planned for maximum use of the flexibility inherent in a stored program. The wired logic of central control represents basic logic operations that are related to telephone switching functions only through the sequences of instructions in the program. By means of the stored program, most of the logic

#### I. Distribution by buildings of total Bell System lines in service

Total Lines, per cent	Number of Lines in Building
75	over 7500
50	over 19 000
25	over 32 000

#### II. Total central office building

Per Cent	Lines Served
25	less than 230
50	less than 750
75	less than 3000



decisions in call processing have been converted to basic logic operations.

This philosophy is extended to items such as trunk circuits. The physical equipment in a trunk circuit is limited in most cases to that necessary for detecting and generating the signals required on these trunk circuits, and for performing basic switching operations such as loop closure or loop reversal. All operational sequencing, including timing of the duration of signals, is performed by central control under instructions from the program. As a consequence, the variety of trunk circuits required has been reduced—and their cost has been reduced also, since changes in timing or sequence of operation can be made through changes in the program.

The switching network has been designed for flexibility in a variety of situations. Line frames and trunk frames are connected together by groups of junctors of three types: (1) junctors between line frames and trunk frames for connections between lines and trunks; (2) junctors from line frames back to line frames for line-to-line connections; and (3) junctors between trunk frames for tandem traffic and other trunk-to-trunk connections. The number of line frames and trunk frames can be varied independently and the junctor group sizes adjusted according to the mix of inter- and intraoffice and tandem traffic. The network has been designed so that frames of four-wire switches can be used without modification of the central processor complex or its basic network control programs. Hence, the single basic system design can be adapted to local, toll, and tandem applications that, in the past, have required quite different system designs.

### System organization

**Outline of system plan.** The basic concept of the No. 1 ESS—a single high-speed electronic central processor operating with a stored program to control the actions of the central office on a time-sharing basis—is illustrated in Fig. 1. Through the switching network, interconnections can be made between system lines and trunks and access provided to the various service circuits required in handling telephone calls; these include tone sources, signaling detectors, and ringing sources. All information processing is handled by a central processor consisting of central control and the temporary and semi-permanent memories. The temporary memory is used for storage of the transient information required in processing calls such as the digits dialed by the subscriber, or the busy and idle states of lines and trunks. The contents of the semipermanent memory, containing the stored program and translation information, do not change during the processing of a call. When the semipermanent information must be changed for any reason, the changes are made manually. The semipermanent memory also has the advantageous characteristic that its stored information cannot be erased by circuit malfunctions.

It is important to note that central control consists of wired logic for performing information-processing operations, organized on a word basis with a word length of 24 bits and operating on a basic cycle time of 5.5  $\mu$ s. Since the telephone switching logic is also contained in the stored program, the hardware of the control complex is largely independent of the type of tele-

Fig. 1. Central information processor with stored program.

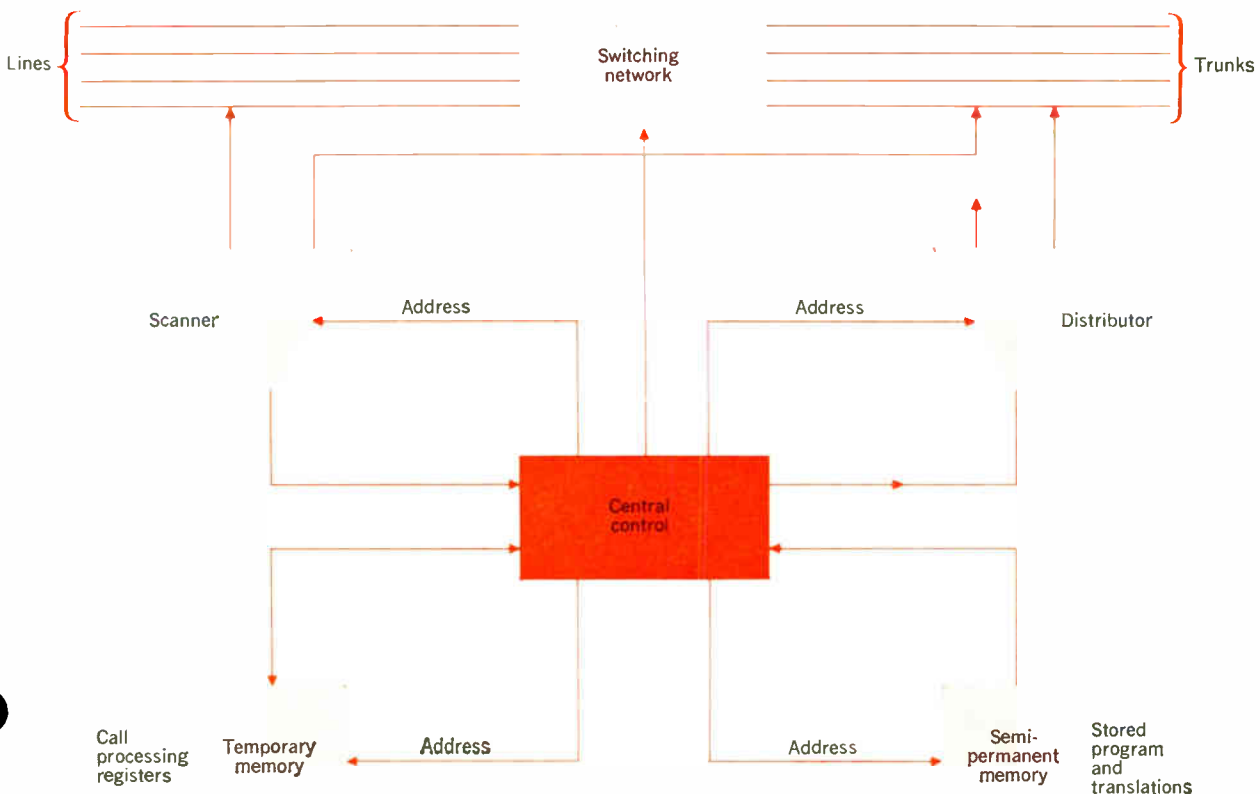

phone service provided and the service treatments offered subscribers. Great flexibility is achieved in this manner, as the same equipment can be used with different programs to provide a variety of services.

Input information for the central processor is provided by scanners connected to various points in the system where information must be obtained; these include the lines, trunks, and signal receivers. The scanners are directed periodically to the lines to detect service requests, to the trunks to detect incoming calls, and to the signal receivers to detect dialed digits and other control data.

The distributor is the inverse of the scanner. It is connected to the various points in the system where actions must be controlled by the central processor. Central control can address the distributor to a particular terminal where a flip-flop or other memory device can be set to start an action. At a later time, central control can address the distributor to terminate this action. The system handles this distributor action through two types of units: (1) the central pulse distributor, which is all electronic and is used for high-speed actions; and (2) the signal distributor, which uses a relay tree and is utilized for lower-speed actions such as the control of trunk relays.

To summarize, the facilities provided in the system are divided into four main categories:

1. Switching network, with its associated terminal circuits that perform the physical functions required in making connections, detecting, and producing signals.

2. Central processor, with its wired logic to perform basic information-processing functions.

3. Scanner and distributor, providing input and output communication for the central processor.

4. The stored program, containing instructions for performing all the switching tasks in ordered lists of instruction words.

Particular distinction must be made between the program and translation information contained in the semi-permanent memory. The program is the lists of instructions for performing all of the service features. It is part of the basic design of the machine and is not influenced by the characteristics of the particular installation. Ordinarily, it will not be changed except for some significant change, either in its features or in the sequence in which actions are performed. The translation section contains the specific layout of facilities in the particular office; the association of subscriber directory numbers with the equipment location of their lines; the classes of service to be provided, such as individual and two-party, coin, extended area dialing, etc.; and specification of trunk routes, their location, and alternate routes to be used when available. This information must be changed periodically and means must be provided for making these changes on a routine basis.

**Hardware.** The equipment and apparatus of No. 1 ESS has been designed for large-volume manufacture at minimum cost. A volume of 1 million lines a year requires over 15 million ferreed crosspoints, 1½ million electronic circuit packages, 5 million transistors, 15 million diodes, etc. Such production rates call for high mechanization.

Equipment and apparatus should be adaptable to low-cost mechanized manufacture. Further, the high manufacturing volume justifies greater development effort and the creation of special devices and components. Thus, No. 1 ESS uses many items of apparatus developed for this particular application and whose design has been tailored for mass manufacture.

A good example of the ferreed switch used in the switching network is shown in Fig. 2.<sup>4,5</sup> It is manufactured as an 8 × 8 array of 64 crosspoints, with a minimum of individual handling of the crosspoints. The control coils are wound in simultaneous rows and columns from continuous lengths of wire.

Standardization and minimization of codes are other important steps to low-cost volume manufacture. In No. 1 ESS, strong efforts were made to standardize the hardware and achieve the necessary variability by program or translation methods. The network equipment is an example of equipment standardization. Only six codes of frames permit assembly of a switching network suitable for any local office. Two additional codes take care of four-wire networks for toll offices. The use of only two codes of transistors—the low-power 29A and the relatively higher power 20D—is an example of device standardization. The 29A is found in many logic circuits, audio amplifiers and oscillators, and in broad-band feedback amplifiers and regulators.

Standardization has also virtually eliminated wired options. Most electromechanical switching equipment makes liberal use of wired options to meet the variations

Fig. 2. Ferreed switch used in the switching network.

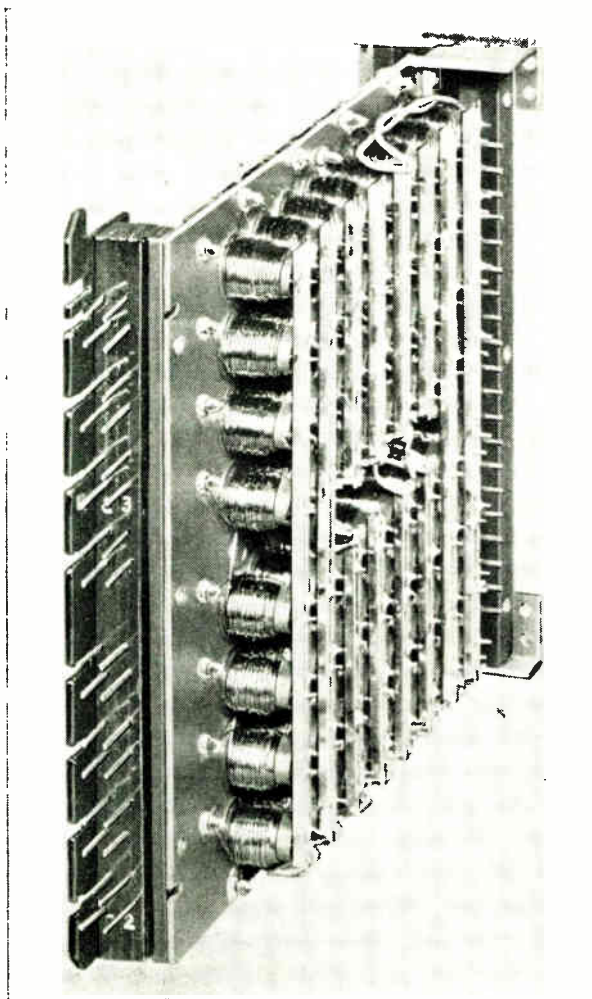

of size and features of different installations; thus, the equipment is specially wired and tested at the factory. In No. 1 ESS, the factory makes a particular frame the same way each time, according to a fixed set of test requirements.

The need for special buildings is avoided through choice of seven-foot-high equipment design (instead of 11½ feet), which permits maintenance from the floor, without ladders. This also contributes to the objective of simplified installation and growth. To insure dependability and to permit reuse of existing buildings, air conditioning is not required for machine operability.

Power dependability has been enhanced through use of storage batteries. And by designing the equipment to operate over a ±10 per cent voltage variation, power equipment was simplified; and end cells, counter cells, and their associated switches eliminated.

Transmission received particular attention. All outgoing trunks include loop-compensation networks to improve return-loss characteristics. Tones are generated by precision transistor oscillators and are fed to lines and trunks out of precise balanced terminations. These and other similar measures, including careful control of noise, were taken in recognition of the role of the switching center in the maintenance and improvement of transmission objectives.

A No. 1 ESS office can be assembled from only 30 codes-of-equipment frames. Figure 3 shows two of the six frame codes used to assemble two-wire switching networks. These four-to-one concentration-line switch frames contain two stages of ferreed switches with their associated control circuits and scanners<sup>6</sup> to detect call originations.

The duplicated network controllers in the four-to-one

### III. Programs for Succasunna\*

Type	Number of Programs	Number of Words
Operational		
Call	22	25 500
Administration	24	20 000
Special services	2	4 500
Subtotal	48	50 000
Maintenance		
Fault recognition	7	13 000
Diagnostics	7	14 500
Routine tests	11	12 400
Administration	12	12 100
Subtotal	37	52 000
Total	85	102 000

\*Larger offices will require some additional programs with a maximum of about 150 000 words.

Fig. 3. Line switching frames for four-to-one concentration ratio.

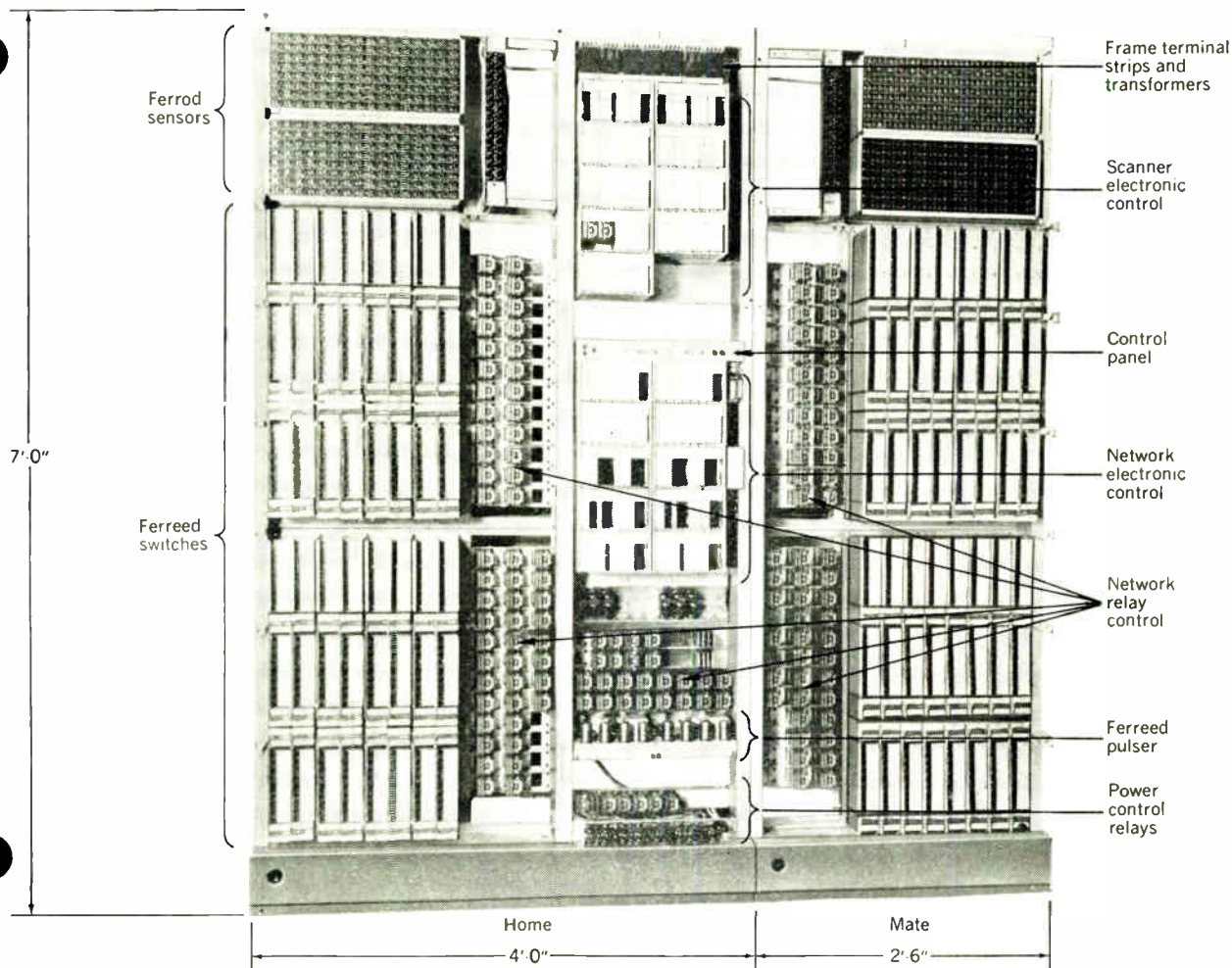

concentration-line switch frames serve both the home and mate frames. This allows the office to grow in steps of 512 lines, but spreads the controller cost across 1024 lines.

The central control shown in Fig. 4 comprises the logic portion of the system central processor. It includes approximately 2400 circuit packs, the majority of which contain low-level-logic circuits. This basic logic circuit, a diode-transistor AND-NOT gate, generates all logic functions and memory cells or flip-flops. Central control contains over 12 000 such gates.

The advent of nanosecond logic circuits has brought the circuit and equipment designer into closer cooperation than was previously necessary in relay switching systems. Wiring patterns and rules had to be developed to insure satisfactory switching speeds, circuit crosstalk protection, and a consistent manufactured product. Such requirements dictated dense packing of components.

A 23-bit bus system is used for data handling within the central control and this required an unconventional circuit pack organization. To provide uniform operation for all bits of a word and to meet timing requirements, no bus bit lead could exceed six feet in length. Apparatus for the various registers is distributed over several mounting plates. A particular register function also is distributed over several mounting plates, each bit occupying only a few circuit packs on each plate. This permits the assignment of the output gates of eight different registers associated with the same bus bit to the same circuit pack,

thus minimizing bus lead length and simplifying flip-flop control leads and maintenance diagnosis.

The program store is the large, semipermanent memory for program and translation storage. It has a capacity of 131 072 words of 44 bits each, or  $5.8 \times 10^6$  bits in all. The store shown in Fig. 5 consists of three frames. Two double-bay frames contain the twistor memory modules,<sup>7</sup> access circuits, and other related circuits, while the single-bay frame at the right contains circuits associated primarily with readout. Because of the high density of the memory modules, their frames are the heaviest in No. 1 ESS, with a weight of approximately 1900 pounds each.

The memory modules are arranged in a square  $4 \times 4$  array to permit the  $256 \times 256$  coordinate access wiring to be made on the rear with short jumpers between modules. Readout connections between modules are also relatively short with this arrangement. Readout connections are made on the front side of the store with cable running vertically in shielded ducts between the columns of modulus and horizontally in ducts between the first and second, and third and fourth rows of modules. Cables are further protected from noise pickups by use of close-twisted pairs and by limiting to two inches the unshielded length of leads that connect to the twistor tapes.

Memory modules are mounted on the frame with three-point suspension to avoid distortion as a result of warping or twisting of the frame during shipping and installation.

Fig. 4. Central control utilizing functional logic unit.

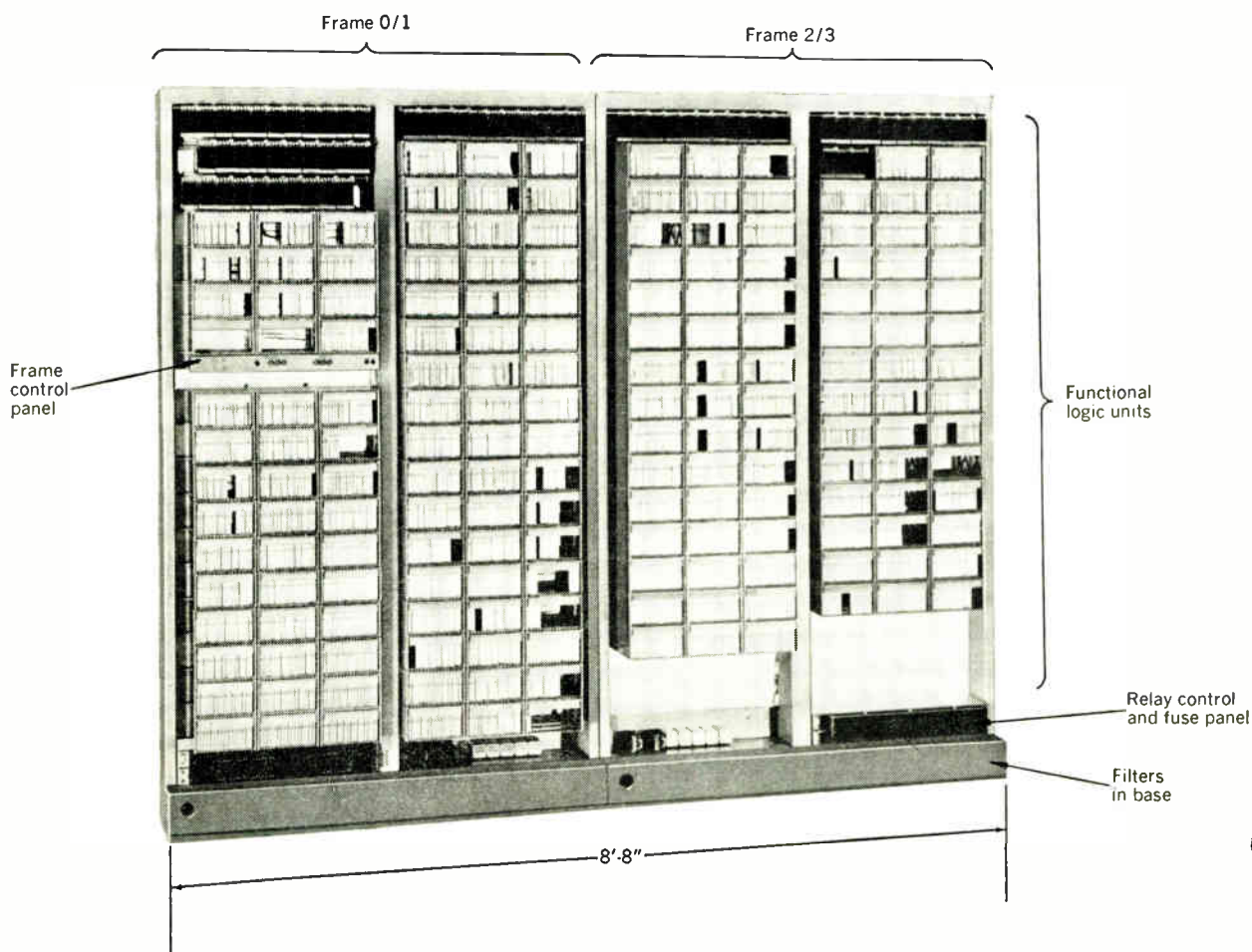

Sliding covers are provided in front of the memory modules to protect memory cards from accidental damage. Each cover over a module containing program information is locked in place with a screw as a guard against accidentally disturbing the office program during translation changes.

**Programs.** As mentioned previously, the central processor is a real-time stored-program-control system. The stored programs are ordered sets of instructions to the processor on how to control a particular function, either internally or in cooperation with the peripheral equipment. One group—call programs—provides the solution to any problem a customer can present to the system through his telephone set, either directly or through some other switching system. An assembly of call programs must establish a tailor-made connection according to the demands of the customer.

When needed by an executive program, the processor can use multiprogramming, with the programs called in to determine what task must be performed at particular states of a call. Small delays of up to a tenth of a second in processing a call are unnoticed by customers. However, some input data, say dialing information, must be sensed and processed as it occurs in real time since any delay may cause an error. Processing of such data is

called an undeferrable task and is handled by interrupting other programs if necessary at predetermined intervals. Other interruptions are used for maintenance. Call programs are a part of the operational group that includes several programs for general administration, traffic measuring, and some special services.

In addition to the operational programs, there are numerous maintenance programs to insure system dependability. More than half of the overall total instructions are for these maintenance programs. Table III gives the size of several programs by groups for the first office, installed at Succasunna, N.J.

Programs for a large number of different offices can be evolved from one of several approaches. A generic program, which is the same for each office, with detailed differences listed in a parameter table, is the approach used in No. 1 ESS. The generic program includes all features for a large number of offices, covering sizes from 2 000 to 65 000 lines and means for handling growth and changing traffic conditions. This approach simplifies record keeping, because only the parameter tables that specify present size and operating conditions are unique to each office. Additional data characterizing a particular office are also found in translation tables in the program store. Typically, 18 different sets of translations are

Fig. 5. Program store (semipermanent memory).

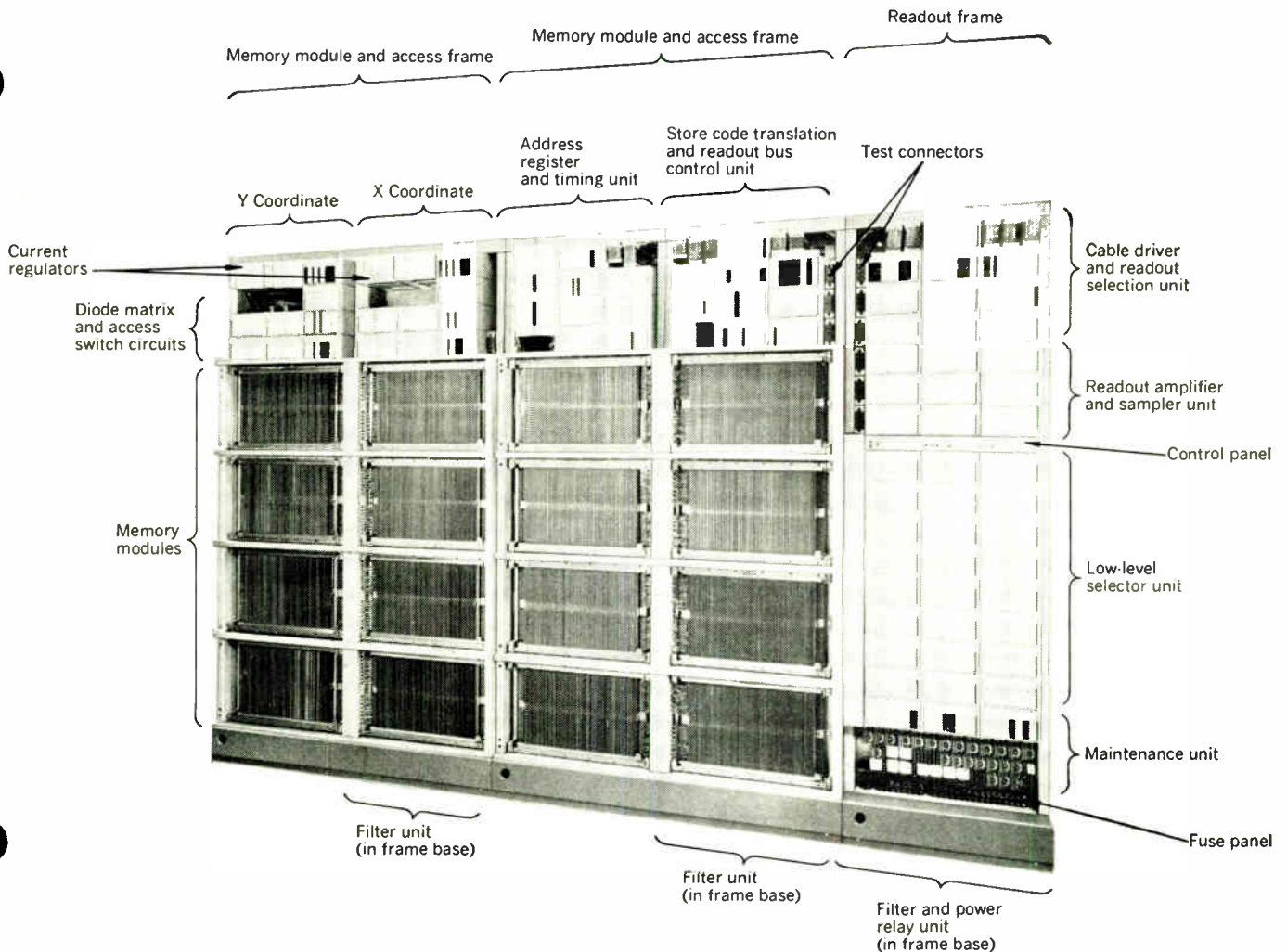

required in each office. These include directory number to equipment number translations for lines and trunks, class of service, and special treatment for lines and trunks.

In the future, economics may dictate the need for several generic programs—for instance, one for small offices, one for large offices, one for four-wire offices, and perhaps some combination of these.

The development and preparation of programs for the system require the use of several utility programs written for a general-purpose digital computer. These programs are used to convert the language of the programmer to the language of the machine, to assemble and compile the individual pieces of call and maintenance programs, and to load information onto a tape which finally controls the writing of the magnets on the twistor cards. Additional programs are used to assemble, compile, and load parameters and translations.

### Dependability

**Objectives.** Dependability, in a telephone office, is limited only by the state of the technology. Certainly a new system must at least be comparable to existing offices, which means outages of no more than a few minutes in 40 years. Heretofore, no large electronic machines have been able to approach this degree of dependability. In fact, the required dependability represented one of the major challenges of the No. 1 ESS development. Since No. 1 ESS is a large digital information processor, it is a cousin of the general-purpose digital computer. However, the required dependability dictated that No. 1 ESS be a system of a very different kind, with a much higher level of redundancy.

**Comparison.** The large size of No. 1 ESS and the unique dependability requirement implies that No. 1 ESS is a new kind of information processor, a kind that has never been developed before. One way of contrasting No. 1 ESS with a general-purpose computer is to compare the relative hazards of a machine data-processing error and a total machine failure. In a general-purpose computer, a machine stoppage is a nuisance; the problem must be rerun, but a data-processing error could be called a disaster because the results come out wrong. In No. 1 ESS, it is the other way around. A data-processing error may cause a particular call to be mishandled. This is a nuisance, particularly to the customer whose call must be redialed. A total machine failure, however, in a telephone office means no telephone service during the outage and the magnitude of such a disaster need not be argued. The key point is that the dependability demands on No. 1 ESS are both unusually severe and quite different from those on the general-purpose computer.

**Duplication.** Since some failures of individual components are bound to occur over decades of system service, duplication is essential. Every major system unit required to maintain service must be provided in duplicate. Not only must there be duplication but, to minimize exposure to system failure due to multiple troubles, troubles must be found and corrected quickly. This means that all units must be continually monitored so that trouble in the stand-by unit can be found just as quickly as in the unit giving service; in addition, both detection of troubles and switching of service when units fail must be automatic.<sup>8</sup>

**Repair.** When a trouble occurs in an operational machine, telephone actions are interrupted as briefly as

possible. Then, on a less urgent basis, the defective unit is diagnosed by the system itself and the results printed on the maintenance teletypewriter.

Where offices are unattended during at least part of the day, alarms and a remote teletypewriter are provided at a location where 24-hour attendance is available.

**Maintenance programs.** As shown in Table III, more than half of the stored instructions are used for maintenance programs. These programs must provide the solution to any problem generated by the system's hardware. Some of these programs, in conjunction with logic wired into the hardware, detect and report faults and troubles; others control routine tests, diagnose troubles, and control emergency actions to insure a satisfactorily operating system, either by eliminating faulty subsystems or by reorganizing usable subsystems into a new operating combination. The classes of maintenance programs are arranged in a hierarchy of interrupt levels. When an error or a trouble is detected, the processor is forced to stop what it is doing; make a record in memory of where it is in the program and of all pertinent data; and, after the proper maintenance action is taken, retrieve the temporarily stored information and restore itself to normal operation. In the hierarchy, a higher class can interrupt any lower class of maintenance or operating program. Operational programs are at the lowest levels.

### Status

The first set of No. 1 ESS equipment manufactured by Western Electric was installed as a laboratory model and has served as a hardware and program development vehicle since early 1963. The next system was installed at Succasunna in late 1963. It has undergone extensive testing and provided additional machine capacity for program development. This first regular office at Succasunna will be put into service early this year. Other two-wire installations still being tested are located in Chase, Md., and New York City. Installations have been started at other locations. In addition to these two-wire offices, several four-wire offices are being installed.

No. 1 ESS is a large undertaking, absorbing the efforts of many hundreds of people. Space limitations, however, preclude a listing of all who contributed in an important way. Even listing the numerous organizations within the Bell Laboratories would be difficult since this would exclude the many people in the Western Electric Company, the American Telephone and Telegraph Company, and the operating companies who have contributed in important ways.

### REFERENCES

1. Malthaner, W. A., and Vaughan, H. E., "An Automatic Telephone System Employing Magnetic Drum Memory," *Proc. IRE*, vol. 41, Oct. 1953, pp. 1341-1347.
2. Keister, W., Ketchledge, R. W., and Lovell, C. A., *Proc. IEE*, vol. 107, pt. B, suppl. no. 20, 1960.
3. *Bell System Tech. J.*, vol. 43, no. 5, pts. 1 and 2, Sept. 1964.
4. Feiner, A., "The Ferreed," *Ibid.*, Jan. 1964, p. 1.
5. Feiner, A., Lovell, C. A., Lowry, T. N., and Ridinger, P. G., "The Ferreed—A New Switching Device," *Ibid.*, vol. 39, Jan. 1960, p. 1.
6. Freimanis, L., Guercio, A. M., and May, H. F., "No. 1 ESS Scanner, Signal Distributor and Central Pulse Distributor," *Ibid.*, vol. 43, Sept. 1964, p. 2255.
7. Stammerjohn, L. W., "An Evaluation of the Performance of the Permanent Magnet Twistor Memory," *Proc. Internat'l Conf. Nonlinear Magnetics*, Apr. 1964.
8. Downing, R. W., Nowak, J. S., and Tuomenoksa, L. S., "No. 1 ESS Maintenance Plan," *Bell System Tech. J.*, vol. 43, Sept. 1964, p. 1961.

## Energy storage and conversion

*Storage and conversion factors, which represent the ratio of energy and power to mass and volume, serve as useful indices of comparison between the various energy storage methods and energy conversion systems*

*L. J. Giacoletto* Michigan State University

The energy that is being used up at such a prodigious rate by modern society comes chiefly from fossil fuels, as chemical energy, and from sunlight, as nuclear energy. From these two basic sources, energy is subsequently stored in a variety of forms and by energy conversion processes changed to yet other forms. The second law of thermodynamics assures us that as energy is converted from one form to another, the order or coherence of the energy is reduced and less energy is as readily available for subsequent use.

From Fig. 1, which shows cumulative world energy consumption, it can be seen that the vast bulk of the energy usage has occurred in the most recent era of history. Until the 18th century the world's supply of energy was predominantly from replaceable wood and similar fuels, and man was in rough energy balance with the source, sunlight. More recently, in part because of substantial increases in world population and in part because of exponential increases in per capita usage,<sup>1</sup> such insatiable demands for energy have been made that energy reservoirs are being rapidly depleted. It is indeed fortunate that nuclear fission has been discovered and developed commercially so as to make the second fundamental source of energy available to man. Hopefully, nuclear fusion also will be commercially feasible soon.

### Basic energy storage requirements

Energy from primary sources is converted at major energy conversion sites and then distributed for use or possibly stored in secondary fixed sites. Energy storage problems become particularly acute in mobile applications. It is possible by inductive, radiation, or similar means to distribute energy continuously to a moving vehicle. All known methods of continuous energy distribution to a vehicle in motion are either too restrictive of the movement of the vehicle or too wasteful of energy. More typically, energy is stored within the vehicle to be converted for use as required.

The automobile represents an extensively used system

of energy storage in a moving vehicle. If we arbitrarily pick 300 miles as the desired operating distance of an automobile, then a 20-gallon tank capacity is required for an average performance of 15 miles per gallon. Twenty gallons of gasoline weigh roughly 126 pounds, occupy a volume of 2.7 cubic feet, and have an energy content of 932 horsepower-hours.

Only a small fraction of the gasoline energy content is "usefully" used to accomplish the basic transportation task.<sup>2</sup> As shown in Fig. 2, about 75 per cent is lost directly as heat. Actually, the power requirement for the basic transportation task is rather nominal, as is shown in Fig. 3 for a 4000-pound automobile. Part of the power is required to overcome friction (predominantly tire flexing), and the balance is required to overcome air resistance. There are also incidental but negligible power requirements for control, safety, passenger comfort, etc. As seen in Fig. 3, a cruising speed of 50 miles per hour

Fig. 1. Cumulative world energy consumption.

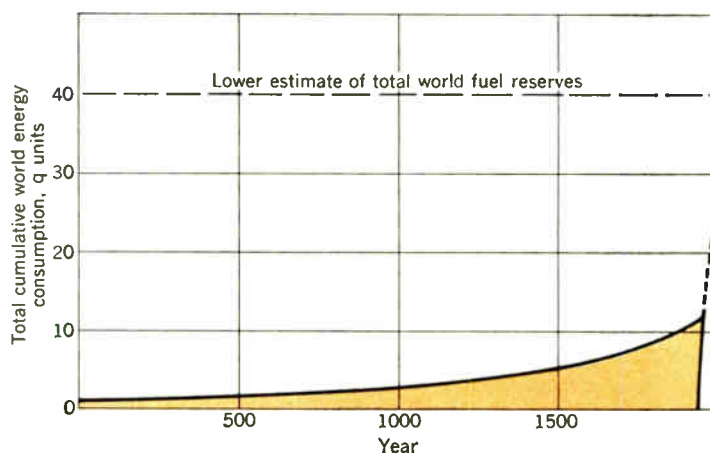

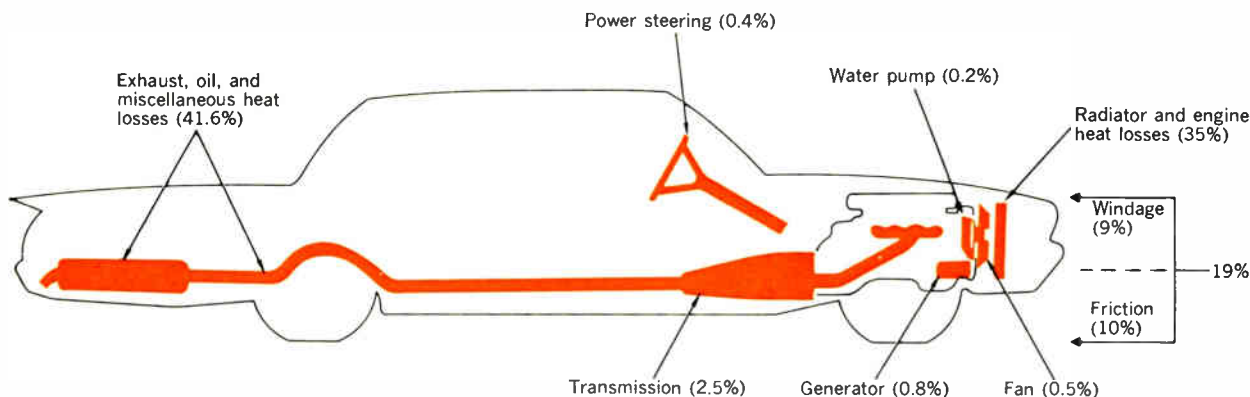
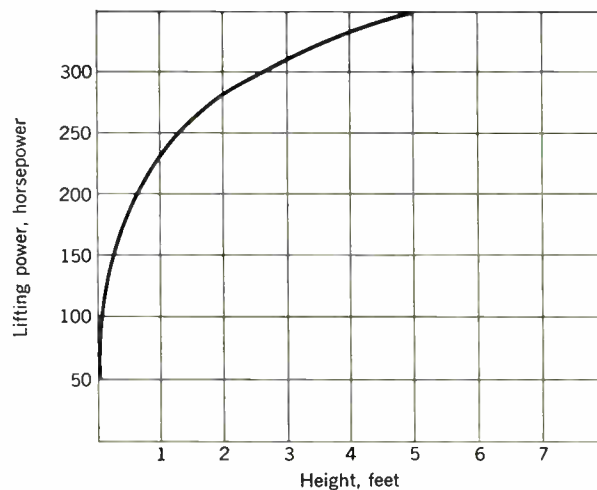
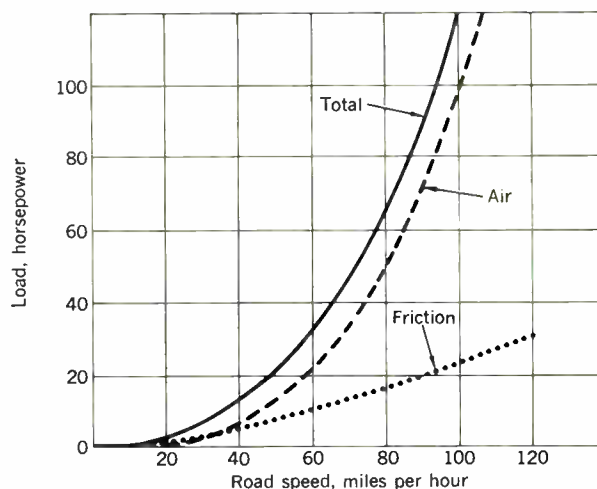

Fig. 2 (above). Distribution for medium-size automobile at 50-mi/h cruising, 120 hp total.

Fig. 3 (right). Horsepower requirement for a typical 4000-lb automobile to overcome the effects of friction and air resistance.

Fig. 4 (lower right). Lifting-power requirements for a typical 4000-lb vehicle.



requires a total of 20 hp. Thus, for the 120-hp automobile of Fig. 2 the overall utility efficiency is  $20/120 = 16.7$  per cent. The energy storage requirement would change significantly if this efficiency could be increased.

From Fig. 3 it is seen that the energy storage requirement could be decreased significantly if friction were eliminated—perhaps by lifting the vehicle off its wheels. For this mode of operation the friction power requirement is replaced by lifting power requirements, as shown in Fig. 4. The amount of friction power available for exchange depends upon the road speed contemplated.<sup>3</sup> At present road speeds of less than 100 miles per hour, the power utilized to overcome friction could be used to raise the vehicle only a very small amount. Operation would have to be over a well-defined and carefully maintained roadbed and therefore could probably be feasible only for a mass-transportation system.

At higher road speeds, say around 300 miles per hour, the frictional power would be significant, and exchange with lifting power makes ground-effect vehicles feasible.<sup>4</sup> Lifting the vehicle still higher requires but a little more power, and airplane transportation is then attained. As the vehicle is lifted off the ground and friction power is exchanged for lifting power, the energy requirement for forward motion to overcome air resistance remains substantially the same until the vehicle is some distance off the ground. Then, also, the energy requirement for a given transportation task would remain about the same as for vehicles near the ground. The net energy requirement depends upon the efficiency of conversion (chemical to mechanical for the automobile). At this point we shall neglect conversion efficiency and examine energy storage only in terms of storage factors—that is, energy/mass and energy/volume.

Energy storage requirements for space travel can be used to highlight the importance of these factors in making

comparisons of different energy storage methods. Consider a space vehicle of mass  $m$ , traveling with velocity  $u$ ; the gravitational force is negligible. Then the forward force ( $= m \Delta u / \Delta t$ ) imparted to the vehicle by the burning fuel must be equal and opposite to the force ( $= u_e \Delta m / \Delta t$ ) exerted by the mass  $\Delta m$  being exhausted with a velocity,  $u_e$ . Accordingly,

$$\frac{\text{Impulse generated}}{\text{Mass change}} = \text{specific impulse} = \frac{m \Delta u}{\Delta m} = u_e$$

$$= \text{exhaust velocity} = \text{characteristic velocity} \quad (1)$$



Now, if the energy for propulsion arises from the chemical combination of two species of mass  $m_1$  and  $m_2$ , which are ejected to provide the forward thrust,

$$\Delta m = m_1 + m_2 \rightarrow \text{energy} = \frac{1}{2}(m_1 + m_2)u_c^2 \quad (2)$$

then

$$\frac{\text{Energy of ejected mass}}{\text{Mass ejected}} = \frac{\text{energy}}{\text{mass}} = \frac{1}{2}u_c^2 \quad (3)$$

This is a simple quadratic relation between the characteristic velocity associated with a chemical reaction and the energy/mass storage factor. Also, the space vehicle's terminal velocity can be directly related to the characteristic velocity of the fuel, so the ratio of energy to mass is of great importance in space travel.

### Energy storage factors

The various methods of energy storage can be classified into categories. Specific examples in the separate categories can be evaluated for energy/mass and energy/volume storage factors. The results are given in Table I and exhibited graphically in Fig. 5 normalized to gasoline.\* The first significant feature apparent from Fig. 5 is that strictly on the basis of energy storage factors, nuclear fission and nuclear fusion are superior to gasoline by a factor of  $10^6$ . It can also be seen that the various heats of reaction as typified by the combustion of gasoline have roughly the same energy/mass factors. This observation is

\* Computations were carried out in 1956 when the author was with the Ford Motor Company. Several former colleagues—A. Arrott, C. Phillips, and C. Welling—assisted in preparing the tabulation.

## I. Classification and performance properties of energy storage methods

Storage Principle and Method	Remarks	Energy/Mass		Energy/Volume	
		joules per kilogram	hp · h per 1000 lb	joules per meter <sup>3</sup>	hp · h per 100 ft <sup>3</sup>
<b>Random Motion:</b>					
Heat capacity	Beryllium at $\Delta T = 1000^\circ\text{C}$	$3.0 \times 10^6$	510	$5.4 \times 10^9$	$5.7 \times 10^3$
	Aluminum at melting point of $650^\circ\text{C}$ with $\Delta T = 600^\circ\text{C}$ . Time constant $\approx 1$ month	$0.59 \times 10^6$	100	$1.6 \times 10^9$	$1.7 \times 10^3$
Compressed gas	Air at 35 000 psi	$0.1 \times 10^6$	17	$0.3 \times 10^9$	316
	Air at 200 000 psi	$0.4 \times 10^6$	68	$2.4 \times 10^9$	$2.5 \times 10^3$
<b>Directional Motion:</b>					
Mechanical inertia	5000 rpm. Used in some buses	$53.3 \times 10^3$	9	$0.81 \times 10^9$	850
	10 000 rpm. About ultimate practical strength	$220 \times 10^3$	37	$3.2 \times 10^9$	$3.4 \times 10^3$
<b>Charge Movement:</b>					
Magnetic field	Dipole-dipole interaction. Curie temperature $\approx 0.1^\circ\text{K}$ Iron at 20 000 gauss	3.0	$0.5 \times 10^{-3}$	$23.6 \times 10^3$	$2.5 \times 10^{-3}$
Orbital electrons	Superconductors. Same order as dipole-dipole interaction	Negligible			
<b>Spin Alignment:</b>					
Electron spin	Curie temperature $\approx 1000^\circ\text{K}$	Acts as an increase in heat capacity, but is not as large as heat capacity above			
Nuclear spin	Down by factor of $10^3$ from dipole-dipole interaction. Curie temperature $\approx 10^{-4}\text{K}$	Very small			
<b>Separation of Mass:</b>					
Gravity	1000-ft elevation, 100 lb/ft <sup>3</sup> , 100 ft <sup>3</sup> per vehicle	$2.96 \times 10^3$	0.5	$4.80 \times 10^6$	5
<b>Separation of Charges:</b>					
Electric field	Mylar film, $E = 6.5 \times 10^8$ volts/meter	$4.34 \times 10^3$	0.732	$5.98 \times 10^6$	6.31
	Ultrathin glass film, $E = 10^{10}$ volts/meter	$1.26 \times 10^6$	212	$3.54 \times 10^9$	$3.74 \times 10^3$
Ionization	Ionized beryllium; 1st ionization potential = 9.32 volts. Complete ionization containment pressure $\approx 10^{30}$ newtons/meter <sup>2</sup>	$990 \times 10^6$	$170 \times 10^3$	$61 \times 10^9$	$64 \times 10^3$

(Table continues on next page)

## I. Classification and performance properties of energy storage methods (continued)

Storage Principle and Method	Remarks	Energy/Mass		Energy/Volume	
		joules per kilogram	hp·h per 1000 lb	joules per meter <sup>3</sup>	hp·h per 100 ft <sup>3</sup>
<b>Combination and Separation of Nucleons:</b>					
Nuclear fission	Strontium 90. Initial 39 kg needed for 150 hp. Inadequate supply. Minimum radiation	$2.89 \times 10^{12}$	$0.488 \times 10^9$	$0.107 \times 10^{18}$	$0.113 \times 10^{12}$
	Pure uranium 235. Severe radiation problem	$83 \times 10^{12}$	$14 \times 10^9$	$1.59 \times 10^{18}$	$1.67 \times 10^{12}$
Nuclear fusion	Most favorable reaction, $D + T = n + He_4 + 17.6 \text{ MeV}$	$340 \times 10^{12}$	$57.3 \times 10^9$	$0.0237 \times 10^{18}$	$25 \times 10^9$
<b>Combination and Separation of Atoms:</b>					
Mechanical spring	Steel	59.3	0.01	$0.379 \times 10^6$	0.4
	Rubber	$6.20 \times 10^3$	1.0	$6.20 \times 10^6$	0.5
Battery	Lead-lead dioxide including the weight and the volume of the case	$0.16 \times 10^6$	27.0	$0.46 \times 10^9$	$0.405 \times 10^3$
	Silver peroxide-zinc including the weight and the volume of the case	$0.48 \times 10^6$	84.2	$1.0 \times 10^9$	$1.05 \times 10^3$
	Mercury oxide-zinc (R-M) cell	$0.425 \times 10^6$	74.4	$1.49 \times 10^9$	$1.56 \times 10^3$
	Ideal battery, no electrolyte or case. Neg. electrode: Li <sup>+</sup> at -3.04 volts. Pos. electrode: F <sup>+</sup> at 2.85 volts, with F <sup>+</sup> as a liquid	$21.9 \times 10^6$	3695	$18.9 \times 10^9$	$19.9 \times 10^3$
Latent heat, molten Be at 1280°C melting point	Latent heat	$1 \times 10^6$	180	$1.8 \times 10^9$	$1.9 \times 10^{-3}$
	Latent heat + heat content to 25°C	$4.4 \times 10^6$	740	$8.1 \times 10^9$	$8.5 \times 10^3$
Latent heat, molten Al at 650°C melting point	Latent heat	$0.4 \times 10^6$	70	$1.1 \times 10^9$	$1.2 \times 10^3$
	Latent heat + heat content to 25°C	$1.0 \times 10^6$	170	$2.7 \times 10^9$	$2.8 \times 10^3$
Chemical reaction, heat of recombination	$H + H \rightarrow H_2$ . Reactants at 0°K and atmospheric pressure	$216 \times 10^6$	$36 \times 10^3$	$9.6 \times 10^6$	10
	$H_2 + O \rightarrow H_2O$ . Reactants at 0°C and atmospheric pressure. No container	$121 \times 10^6$	$20 \times 10^3$	$11 \times 10^6$	11.6
	$H_2 + O \rightarrow H_2O$ . Reactants at 0°C and 500 times atmospheric pressure, including container	Heat: $2.0 \times 10^6$ Comp. gas: $0.1 \times 10^6$ $2.1 \times 10^6$	$0.34 \times 10^3$ $0.02 \times 10^3$ $0.36 \times 10^3$	$4.5 \times 10^9$ $0.3 \times 10^9$ $4.8 \times 10^9$	$4.7 \times 10^3$ $0.3 \times 10^3$ $5.0 \times 10^3$
Chemical reaction, heat of reaction (oxygen from atmosphere)	(a) $LiH + H_2O \rightarrow LiOH + H_2$ (b) $H_2 + \frac{1}{2}O_2 \rightarrow H_2O$ Computations based on energy from (b) and weight and volume from (a)	$9.2 \times 10^6$	$1.56 \times 10^3$	$8.6 \times 10^9$	$9.1 \times 10^3$
	$H_2O_2 \rightarrow H_2O + \frac{1}{2}O_2$	$1.55 \times 10^6$	$0.26 \times 10^3$	$2.2 \times 10^9$	$2.3 \times 10^3$
	Gasoline	$44 \times 10^6$	$7.4 \times 10^3$	$33 \times 10^9$	$35 \times 10^3$
	Bituminous coal	$30 \times 10^6$	$5.0 \times 10^3$	$25 \times 10^9$	$26 \times 10^3$
	Algae	$23 \times 10^6$	$3.9 \times 10^3$	$32 \times 10^9$	$34 \times 10^3$
Chemical reaction, heat of adsorption	$H_2 + x \text{ Pt} \rightarrow H_2 \text{ adsorp.}$ Monomolecular layer on platinum	$140 \times 10^3$	23	$2.4 \times 10^6$	2.5
Chemical reaction, heat of hydration	$CaO + H_2O \rightarrow Ca(OH)_2$	$92 \times 10^3$	15.5	$185 \times 10^6$	195

a direct manifestation of the basic fact that heats of reaction energies are associated with the bond between orbital electrons of atoms. The energy released with the re-arrangement of orbital electrons in the chemical combination of two atoms is typically about  $2q = 3.2 \times 10^{-19}$  joules ( $q = 1.6 \times 10^{-19}$  coulombs is the elemental charge). Assuming an average relative atomic mass of 10, the corresponding energy/mass factor

$$\frac{3.2 \times 10^{-19}}{2 \times 10 \times 1.7 \times 10^{-27}} = 10^7 \text{ joules per kilogram}$$

as compared with  $4.4 \times 10^7$  for gasoline.

Energy storage by ionized atoms is better than heat of reaction by roughly the ratio of the ionization voltage (typically 20 volts) to the orbital binding voltage (typically 2 volts, as used in the preceding paragraph). The calculated value for complete ionization of one electron of the beryllium atom would merit consideration as a method of energy storage were it not for the enormous containment pressure that would be required. A significant invention is required here; that is, we need a solid-state plasma that does not neutralize itself until "triggered off."

Triggering difficulty is present with the attractive heat-of-recombination method:

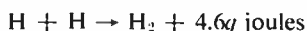

There is no known way of preventing this recombination from occurring on its own, except possibly by keeping the reactants at extremely low temperatures.

Let us next consider storage batteries as a means of energy storage. Conventional lead batteries as used in automobiles have storage factors that are about two orders of magnitude smaller than that of gasoline. If the storage battery is highly idealized by assuming that it is formed of the lightest, most electronegative element (fluorine) and the lightest, most electropositive element (lithium), and if the mass and volume of case and possible electrolyte are neglected, then an energy/mass storage factor about half that of gasoline is obtained. In view of the idealizations made, the prospects for batteries becoming as effective as gasoline for energy storage are not very good. However, batteries have some desirable operating characteristics and even small improvements in energy storage factors are important; in fact, small improvements have been made, and batteries are being used for many new applications.

From Fig. 5, the next most attractive method is energy stored in an electric field, as in a capacitor. For this method, assuming a parallel-plane capacitor,

$$\frac{\text{Energy}}{\text{Mass}} = \frac{1}{2} K \epsilon_0 \frac{E^2}{\rho} \quad (4)$$

Fig. 5. Energy/mass (shown in gray) and energy/volume (shown in color) normalized to gasoline.

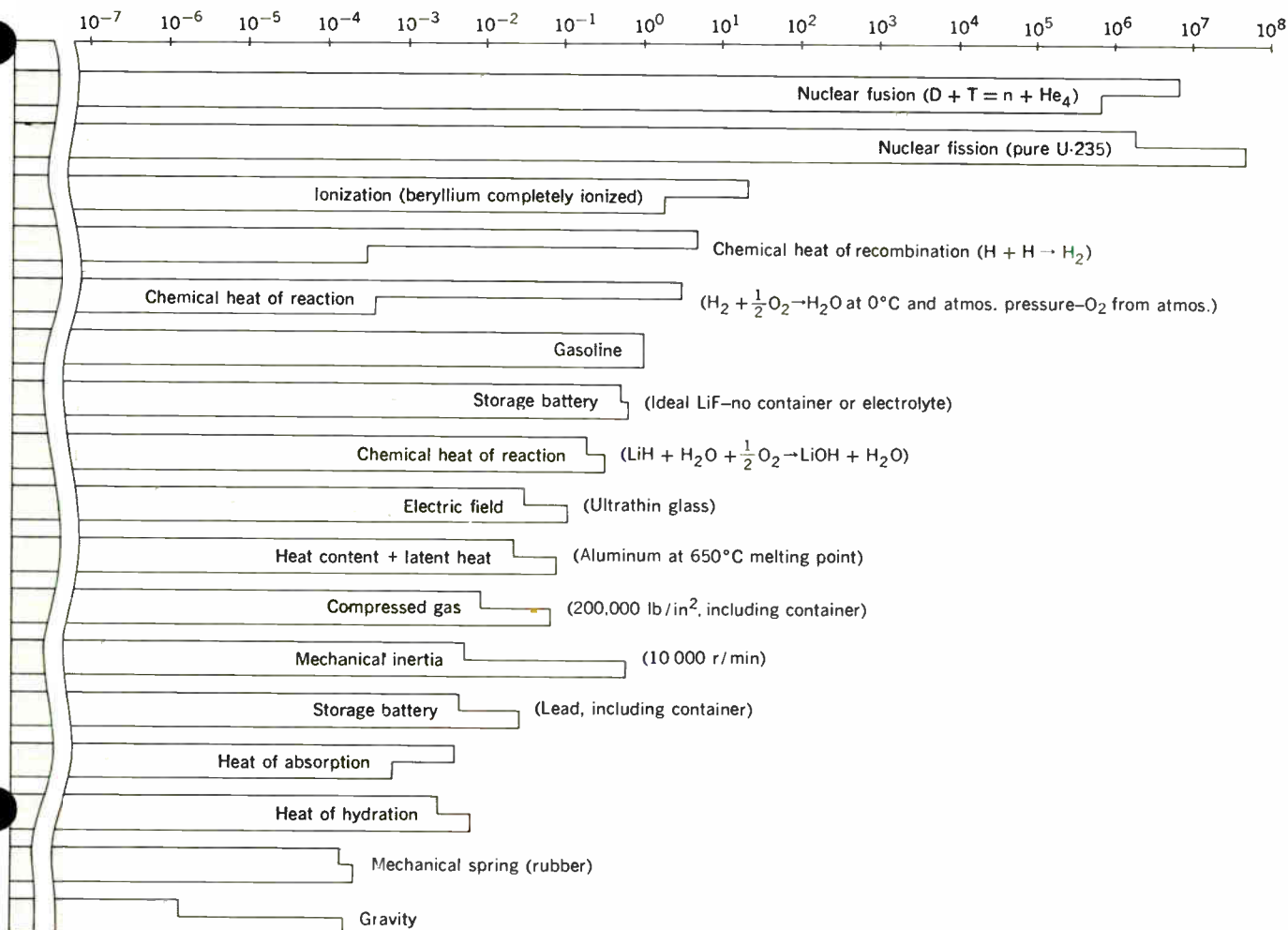

where  $K$  is the relative permittivity of the dielectric and  $\epsilon_0$  the permittivity of free space,  $E$  is the electric field, and  $\rho$  is the density of the dielectric. Mylar is one of the best presently available dielectric materials. For Mylar,<sup>5</sup>

$$\frac{\text{Energy}}{\text{Mass}} = 4.3 \times 10^3 \text{ joules per kilogram} \quad (5)$$

This energy/mass ratio is four orders of magnitude poorer than that of gasoline. Specially processed, exceedingly thin films of glass have exhibited dielectric strengths corresponding to about  $10^{10}$  volts per meter over small areas. The energy/mass ratio of  $1.2 \times 10^6$  joules per kilogram is about 1/30 that of gasoline. This material represents a spectacular improvement over Mylar and raises hopes as to future prospects.

There is perhaps a real question as to whether the half life for energy storage in a capacitor can be made sufficiently large for many practical applications. If this question is sidestepped, the next question of paramount interest is: What is the potential maximum value of energy/mass? A quantitative answer is not available now; but qualitatively, it is certain that the limit is set by fundamental properties of the dielectric and electrode materials. These properties are, in turn, intimately associated with atomic binding energies, so theoretically an energy/mass storage factor comparable to that of heats of reaction can be expected. In fact, a generalization of this situation seems reasonable; namely, the various methods of energy storage when pushed to the limit will be restricted by the same fundamental properties, atomic binding strengths. Thus energy/mass storage factors about equivalent to that of gasoline can be expected, with one notable exception: for nuclear fission and fusion it is the nuclear binding energy that enters and determines limiting properties. The nuclear binding energies are about  $10^6$  times as great as atomic binding energies. This is an attractive margin to work with, and simple but not very effective methods of using nuclear energy storage are available at the present time.

The limit imposed by fundamental properties can be clearly seen in the case of energy storage via mechanical inertia, as limited by the rupture strength of the rotor. The ultimate rupture strength, in turn, can be related to binding energy of constituent atoms. It is of interest to note that a large spinning top has been used commercially in a passenger vehicle. The bus<sup>6</sup> weighs 16.5 tons fully loaded with 35 seated and 35 standing passengers. A 5-foot 4-inch flywheel weighing 3000 pounds is rotated to 50 revolutions per second by an electric motor, which is periodically connected to electric power lines at stops spaced 5 miles apart. At top speed the rotor stores 9 kWh of energy. The rotor operates in a sealed hydrogen environment and on standby it slows to one third of its top speed in about 4.5 hours.

An energy/mass storage factor of  $2 \times 10^5$  joules per kilogram, corresponding to mechanical inertia and lead storage batteries, represents about the lower limit of acceptability for automotive energy storage. Lead storage batteries are still used for special-purpose passenger vehicles, such as golf carts and delivery trucks.

The chemical heat-of-reaction system, in which



has long been a particularly attractive means for energy storage. It features a large energy/mass factor; com-

patibility of the reaction product, water, with man and his environment; rather efficient means of obtaining the reactants by electrolysis, starting with the readily available supply of water; and, more recently, the availability of a hydrox fuel cell, which can be used to provide direct conversion of stored chemical energy to electric energy. One important deficiency of this energy storage method is the unacceptably small energy/volume storage factor. Even a moderately large containment pressure would not suffice. Hydrogen liquefaction can be used in special cases, as in space vehicles, for instance. Another method is to bind hydrogen chemically in a solid form, as in lithium hydride. Hydrogen can be released by the addition of water in a manner similar to the generation of acetylene for use in headlights of automobiles before the advent of electric lights. The performance capabilities of lithium hydride when computed on the basis of the mass and volume of the original reactants are not quite as good as those of gasoline, but are sufficiently good to be of interest.

### Energy conversion

Although energy can be stored by any method that is feasible, it is usually necessary to convert the stored energy to another form for use. The conversion apparatus has mass and volume and is inefficient. For specific systems it would be desirable to examine all the storage-conversion factors. Energy conversion has even more ramifications<sup>7</sup> than energy storage, and the material here will serve only to give some idea of the range of power/mass factors for the various conversion methods. The efficiency of the conversion process is not tabulated. The ultimate efficiency of thermal-to-mechanical conversion corresponding to conversion from high disorder to low disorder is given by the Carnot formula. There is no comparable formula for conversion from one low-disorder form of energy to another, such as from electric energy to mechanical energy. Typically, conversion between energy forms of low disorder is accomplished with efficiencies approaching 100 per cent. Energy conversion from a low-disorder form to a high-disorder form can take place with 100 per cent conversion efficiency. Energy conversion from one form to the same form involving transformation (from one impedance to another) and/or translation (from one location to another) can take place with high efficiency, but the efficiency obtained has some relation to the degree of transformation and the extent of translation required.

Shown in Fig. 6 are power/mass factors as a function of the power output in a number of energy conversion systems. These results, which were computed from data obtained from a variety of sources, represent actual performance. For closely related systems an attempt has been made to exhibit a trend by drawing a "best" curve through the data. As a general rule the power/mass factor increases as the power output increases.

Calculations of factors associated with energy conversion can be made for simplified and idealized systems. As an example, consider a Faraday unipolar (acyclic) electromechanical machine shown in cross section in Fig. 7. A cylindrical iron shell of length  $L$  is rotated in a magnetic field of flux density  $B$  at an angular velocity  $\omega$ . The open-circuited end-to-end voltage is

$$V_o = Br_2L\omega \quad (6)$$

The rotor mass  $M_R$  and resistance  $R_R$  are

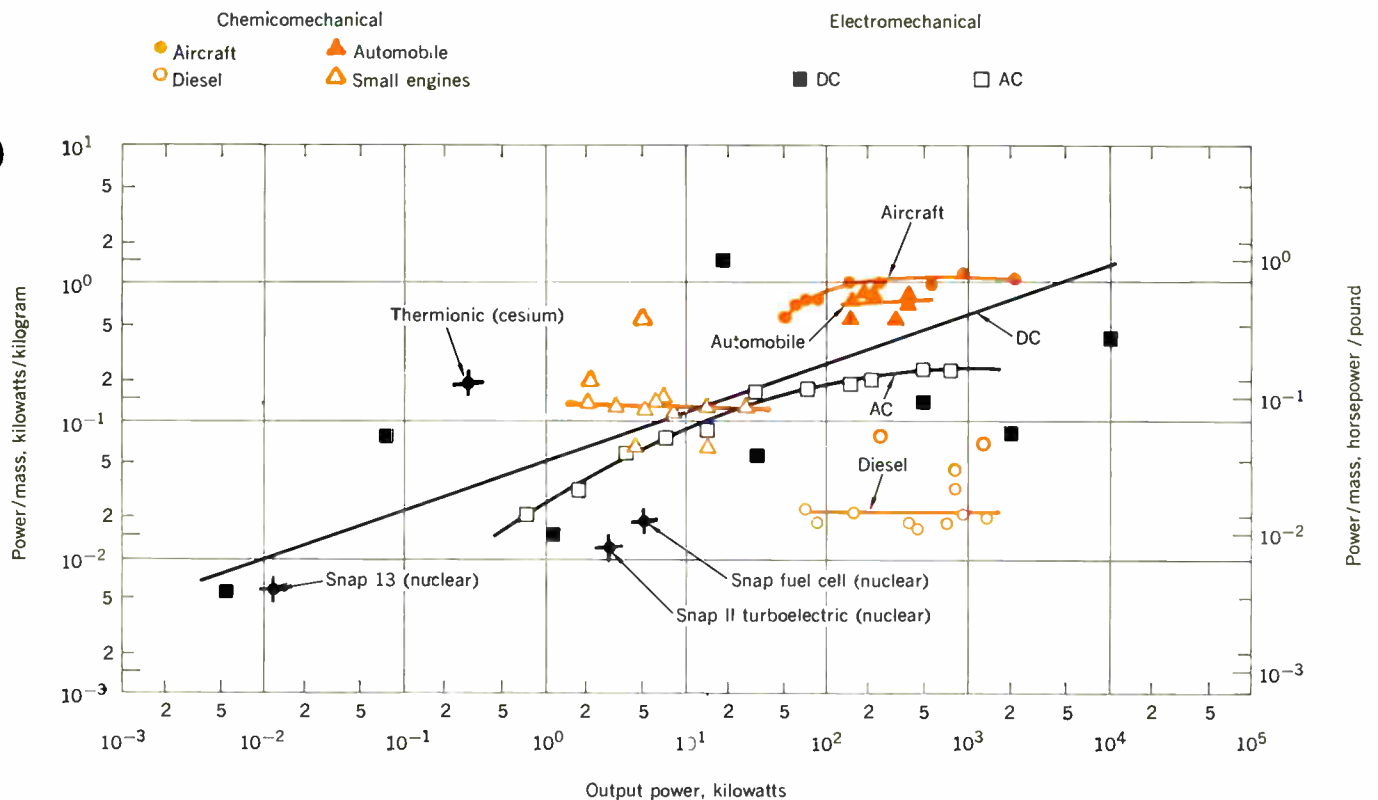
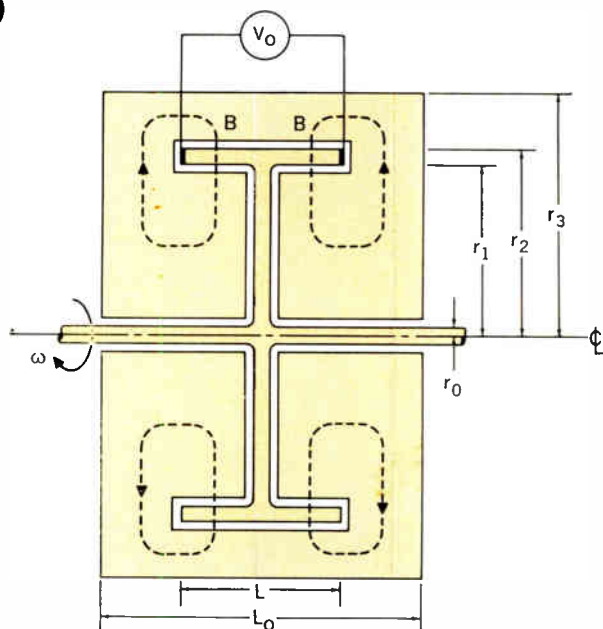

Fig. 6. Power/mass as a function of output power.

Fig. 7. Unipolar electromechanical converter.



$$M_R = \pi \rho_m L (r_2^2 - r_1^2) \quad (7)$$

$$R_R = \frac{L}{\pi \sigma (r_2^2 - r_1^2)}$$

where  $\rho_m$  and  $\sigma$  are rotor density and conductivity respectively. As a mechano-electrical converter operating into a load resistor  $R_L$ , it would have an electrical

efficiency  $\eta_e$  of approximately

$$\eta_e = \frac{R_L}{R_L + R_R} \quad (8)$$

The electric power into  $R_L$  would be

$$P_{R_L} = \left( \frac{V_o}{R_L + R_R} \right)^2 R_L = \eta_e (1 - \eta_e) \frac{V_o^2}{R_R} \quad (9)$$

When the device is used as an electromechanical converter, the mechanical output would be related to  $P_{R_L}$  through a mechanical efficiency  $\eta_m$ . Thus,

$$P_o = \eta_m P_{R_L} = \eta_m \eta_e (1 - \eta_e) \frac{V_o^2}{R_R} \quad (10)$$

$$= \eta_m \eta_e (1 - \eta_e) \pi u^2 B^2 \sigma (r_2^2 - r_1^2) L$$

where  $u = r_2 \omega$  is the rotor-tip velocity. Weight and volume must also be allocated for the magnet structure, bearings, rotor contacts, etc. The major additional weight and volume would be that required for the magnet structure, and the approximate overall weight and volume can be obtained by examination of this structure. As shown in Fig. 7, if we assume the magnet structure to be designed so that  $B$  is approximately constant throughout its path,  $r_1 \approx L$  is required,  $r_3 = \sqrt{2} r_2$ , and the overall length  $= L_o = 2L = 2r_1$ . The resulting cylindrical structure would have a volume

$$V = \pi r_3^2 L_o = 4\pi r_2^3 \quad (11)$$

and being essentially all iron, would have a mass

$$M = 4\pi r_2^3 \rho_m \quad (12)$$

The power factors are

$$\frac{P_o}{M} = \eta_m \eta_e (1 - \eta_e) \frac{u^2 B^2 \sigma}{\rho_m} \frac{1}{4} \left[ 1 - \left( \frac{r_1}{r_2} \right)^2 \right] \left( \frac{r_1}{r_2} \right) \quad (13)$$

$$\frac{P_o}{V} = \rho_m \frac{P_o}{M} \quad (14)$$

If  $r_1/r_2 = 1/\sqrt{3}$ , then  $P_o/M$  is maximized to

$$\frac{P_o}{M} = \frac{1}{6\sqrt{3}} \eta_m \eta_e (1 - \eta_e) \frac{u^2 B^2 \sigma}{\rho_m} \quad (15)$$

For common steel,  $B_{\max} = 2$  Wb/m<sup>2</sup>,  $u_{\max} = 700$  m/s,  $\rho_m = 7.8 \times 10^3$  kg/m<sup>3</sup>, and  $\sigma = 10^7$  mho/m. For these values, and assuming  $\eta_e = 0.95$  and  $\eta_m = 0.9$ ,  $P_o/M = 10^4$  kW/kg. This value is much greater than those shown in Fig. 5, and represents the ultimate possible value, if saturation flux density, rupture velocity of the rotor, and other factors are taken into consideration. The dc electromechanical converter corresponding to  $P_o/M = 1$  hp/lb in Fig. 6 is for a small, experimental unipolar machine<sup>8</sup> and that corresponding to  $P_o = 10^4$  kW in Fig. 6 is for a large, stationary machine.<sup>9</sup>

Equation (15) serves to illustrate a common aspect of effective energy conversion. The power/mass factor increases as the interaction velocity increases, provided that the mechanical losses increase at a slower rate. Thus, rotary equipment is particularly advantageous since interaction often occurs at the rotor periphery where the velocity is large, but the rotor is supported on the shaft where the velocity and the associated mechanical losses are small.

An analysis similar to the one carried out for the unipolar dc electromechanical converter can be used to obtain factors for an idealized gasoline chemomechanical converter (engine). As shown in Fig. 8, the engine piston has an initial position corresponding to volume  $V_1$ , temperature  $T_1$ , and pressure  $p_1$ . The piston is moved

up to compress the gasoline-air mixture to a volume  $V_2$ , temperature  $T_2$ , and pressure  $p_2$ . The mixture is ignited and  $T_2$  goes to  $T_3$ ,  $p_2$  goes to  $p_3$ , and the piston is driven to the original position. If the complete four-stroke cycle is repeated  $f$  times per second, the net output power, based upon an ideal Carnot cycle with efficiency  $\eta_c = 1 - (T_1/T_2)$ , is

$$P_o = p_1 V_1 f \frac{\eta_c}{1 - \eta_c} \ln \frac{V_1}{V_2} \quad (16)$$

The ultimate limiting volume of the converter is  $V_1$ , so

$$\frac{P_o}{V} = p_1 f \frac{\eta_c}{1 - \eta_c} \ln \frac{V_1}{V_2} \quad (17)$$

Assuming a volumetric compression ratio of 10 to 1, an  $\eta_c = 0.9$  (corresponding to  $T_1 = 300^\circ\text{K}$  and  $T_2 = 3000^\circ\text{K}$ ),  $p_1 = 5 \times 10^4$  newtons/meter<sup>2</sup> ( $1/2$  atm), and  $f = 30$  c/s, then  $P_o/V = 31.5 \times 10^3$  kW/m<sup>3</sup>. This ideal result can be compared with a typical value for automobile engines of  $22.8 \times 10^3$  kW/m<sup>3</sup> (0.5 hp/in<sup>3</sup>) based upon volumetric displacement. If the cylinder is considered to be formed by a material of sufficient thickness to contain the maximum pressure  $p_2$ , a rough calculation of energy/mass can be formulated.

### Conclusions

Energy storage factors are very important for mobile applications and become critically important for space vehicles, where added energy is required to transport the fuel to be used and the terminal velocity of the space vehicle is directly related to the energy/mass storage factor of the fuel. Chemical fuels, as represented by gasoline, have roughly the same energy/mass storage factors. The other methods of energy storage, except nuclear, have smaller energy/mass factors.

In a complete system, the conversion efficiency and the power/mass factor of the conversion equipment contribute significantly to the overall effectiveness. In the case of automobiles and airplanes, the combination of large power/mass factors of the conversion equipment and large energy/mass factors of the fuel produces a highly effective overall system. Although the conversion efficiency of such a system is not very high, it is sufficient to make the system attractive for most mobile uses.

Fig. 8. Gasoline engine chemomechanical converter.

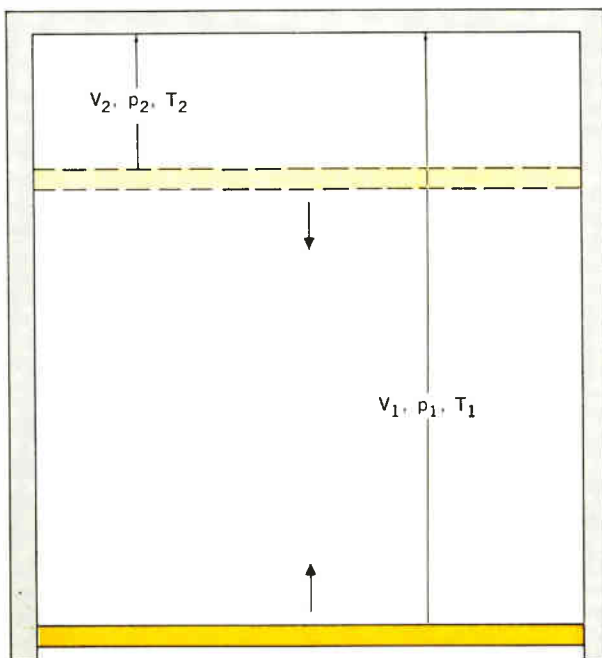

### REFERENCES

1. Felix, Fremont, "Growth of Energy Consumption and National Income Throughout the World," *IEEE Spectrum*, vol. 1, July 1964, pp. 81-102.
2. Burke, C. E., et al., "Where Does All the Horsepower Go?" *Trans. SAE*, vol. 65, 1957, pp. 713-738.
3. Gabrielli, G., and von Karman, T., "What Price Speed? Specific Power Required for Propulsion of Vehicles," *Mech. Eng.*, vol. 72, Oct. 1950, pp. 775-781.
4. Park, F., "Near-Surface Vehicles," *Intern. Sci. Technol.*, vol. 1, Feb. 1962, pp. 12-22.
5. Inuishi, Y., and Powers, D. A., "Electrical Breakdown and Conductivity Through Mylar Films," *J. Appl. Phys.*, vol. 28, Sept. 1957, pp. 1017-1022.
6. "The Oerlikon Electrogyro," *Automob. Eng.*, vol. 45, Dec. 1955, pp. 559-566.
7. Levine, S. N., ed., *Selected Papers on New Techniques for Energy Conversion*. New York: Dover Publications, Inc., 1961.
8. Zeisler, F. L., "A High Power Density Electric Machine Element," *1964 IEEE Nat'l Conf. Record on Automotive Electrical and Electronics Engineering*.
9. Burnett, J. R., and Kaestle, F. L., "Acylic Generator—New DC Power Generator Tool for Industry," *Direct Current*, vol. 8, July 1963, pp. 196-201.



## Special Conference Report

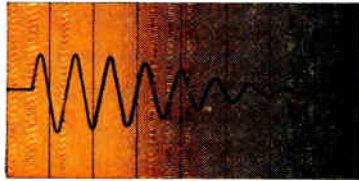

# Report on the 1964 Conference on Precision Electromagnetic Measurements

*Robert F. Cotellessa*    *New York University*

“As science and technology have grown from infancy through adolescence to a proliferating maturity, every stage in the growth has been assisted, gauged and confirmed by measurements, especially precision measurements.” In these words, E. W. Houghton, chairman, 1964 Conference on Precision Electromagnetic Measurements, held last summer at the National Bureau of Standards Boulder Laboratories, Boulder, Colo., described the import of the conference to the engineering and scientific community. These biennial conferences provide a forum for the discussion of electromagnetic measurements, foster the research aspects of measurement, encourage the international exchange of information in this field, and speed communication between industry and national standards laboratories. The emphasis on precision measurements enabled a wide-ranging discussion of topics covering large portions of the frequency spectrum: frequency and time standards, quantum electronics (lasers), dc and audio-frequency measurements, radio-frequency and microwave measurements, and measurements on materials.

### **DC and audio-frequency measurements**

Papers at the session on dc and audio-frequency measurements were notable for the advances reported in a classical field. For example, most work on bridges considers the arms to be two-terminal elements, even though the presence of electrostatic shields, Wagner grounds, and transformers as ratio elements is well recognized. A. M. Thompson (National Standards Laboratory, Australia) examined the extension of transformer ratio techniques to some general bridge networks that may be balanced in a way which leads to simple relations independent of the ground admittances between the four direct admittances. The key elements in his approach are

the use of coaxial chokes and the reduction of the equivalent circuit to that of a three-terminal admittance. Several examples of four-arm bridge networks that use adjustable decade ratio transformers as the main balance controls and fixed ratio transformers for multiplication or inversion were discussed.

A discussion by R. D. Cutkosky followed the Thompson paper. Cutkosky emphasized the far-reaching implications of Thompson's work, particularly with regard to the benefits that may be expected to accrue in the operation of any four-arm bridge in which Thompson's balance procedure is followed. Indeed, he later described a passive direct-reading ratio set for the comparison of admittances in the frequency range of 160 c/s to 16 kc/s, using Thompson's results to obtain a rapidly convergent balancing procedure.

Perhaps one of the most interesting features of this group of papers is the degree of precision to which transformers may be constructed to permit measurements extending from dc to the upper limits of the audio-frequency range. The principal element is the current comparator which, in one version, is a highly stable three-winding current transformer whose current ratio is very nearly equal to the turns ratio. N. L. Kusters (National Research Council, Canada) pointed out that such a device is sensitive, highly stable, linear, dissipates little power, and is capable of realizing large ratios in one unit. Its frequency range can be extended to zero by varying the permeability of the core by means of a separate winding. He reported measurements whose error was less than 1 part per million up to a frequency of 16 kc/s (Fig. 1).

The principal sources of error in a current comparator arise from nonuniformities in the windings and in the core, and from capacitive currents flowing within and

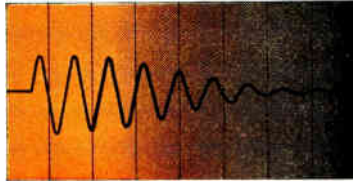

between the windings and between the windings and ground. P. Miljanic (Belgrade University, Yugoslavia) has derived equations for the capacitance error for various current comparator constructions and has shown that the capacitance error increases almost as the square of the frequency and with higher transformer ratios. Theory and measurement indicate that for currents of 10 amperes and above, an error of less than  $1 \times 10^{-7}$  may be achieved.

A quite different current comparator, whose accuracy is greatest in the low audio-frequency range and which makes use of a novel six-terminal shunt, was constructed by J. H. Park (Boeing Metrology Laboratories). The shunt is constructed of flat manganin ribbon 10 feet in length, but with a potential lead located at the exact center; voltage drops on either side of the center lead are compared using an inductive voltage divider. Each of the currents to be compared is successively passed through the two sides of the shunt and their ratio determined in terms only of the divider ratios. The error

in current ratio is found to increase both with frequency and with the current ratio itself; an accuracy of 2 parts per million was realized at a frequency of 60 c/s and with a 1:1 ratio. At a ratio of 2:1, the measurement was accurate to 10 parts per million and to 1 minute in phase angle.

An interesting combination of a current comparator in a high-voltage capacitance ratio bridge with a feedback amplifier was devised by O. Petersons (National Research Council, Canada) for the continuous measurement of corona losses on experimental transmission lines. The balance current, which is supplied by the feedback amplifier, is resolved into in-phase and quadrature components with respect to the current in a reference capacitor, thus providing a measure of the unknown capacitance and the equivalent loss conductance. The bridge is balanced manually to 0.1 per cent and the function of the feedback amplifier is limited to balancing small deviations. The accuracy of the built-in current comparator is 0.001 per cent and that of the feedback amplifier is 1 per cent so that if the bridge is balanced manually to 0.1 per cent the full bridge capabilities are realized.

In contrast to the methods of comparing currents, an absolute amperemeter was described by P. Grivet, *et al.* (University of Paris, France). Their objective is to obtain a device capable of providing a continuous current measurement of moderately high accuracy in a laboratory where the stray magnetic fields are of the order of 1 mGs. A pair of Helmholtz coils is used to link a current to a magnetic field, which in turn is converted to frequency by a spin oscillator (operating at 42 kc/s) utilizing a nuclear magnetic resonance signal as the coupling between electromagnetically uncoupled coils. A strong proton resonance signal is obtained by prepolarization of the water medium to enable the use of a higher static field. Further improvements are currently being made to the amperemeter; at the present time the precision of a current measurement is 10 parts per million. C. H. Page (National Bureau of Standards) posed the intriguing question of the possibility of achieving audio-frequency maser action if the water flow and the prepolarization field are adjusted properly. Grivet indicated that such a possibility does exist, but that an auxiliary source would be required to invert the population, using the technique of adiabatic fast passage.

Anyone who has had to make precision measurements at dc has encountered the problems of thermal emf's and stable amplification. J. J. Hill (National Physical Laboratory, England) has developed an ac technique in which a few measurements may be made in the frequency range of 40 c/s to 1 kc/s; the data obtained are used to determine the coefficients of a polynomial which expresses the resistance-frequency relationship. A Kelvin double bridge is employed, the outer and inner ratio arms consisting of inductively coupled voltage dividers with 1 part in  $10^{-7}$  accuracy. The bridge was used to measure four-terminal resistors to an accuracy of a few parts in  $10^7$ . The accuracy, ease of operation, and flexibility of the instrument hold great promise for wide application of the new technique.

For half a century, the Weston saturated cadmium cell has been used as a voltage standard, but its high-temperature coefficient has always been a problem. However, it is known that a broad maximum in the emf of the standard cell exists at approximately 3°C. A. R. Karoli (The

Fig. 1. Typical zero-burden error characteristics of audio-frequency compensated current comparators.

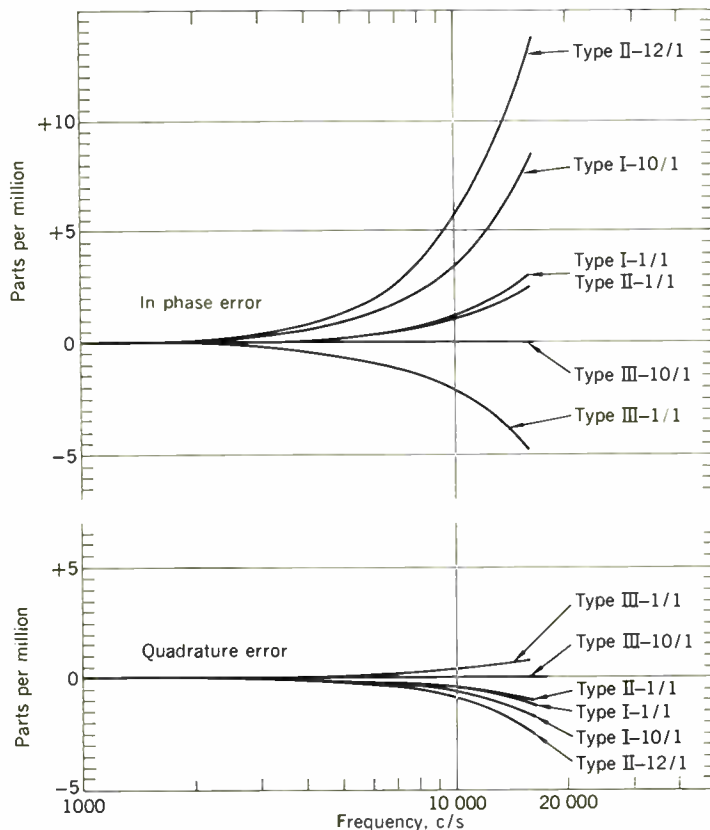



Eppley Laboratory) and R. E. Nelson (Energy Conversion, Inc.) have constructed a thermoelectric refrigerator which utilizes the Peltier effect in bismuth telluride couples to maintain a standard cell at the optimum temperature. It was found that a saturated standard cell provides a 1 part per million reference between the temperatures of 2.5°C and 3.5°C, which is a fiftyfold improvement over room temperature operation.

### Quantum electronics (optical)

In sharp contrast with the field of dc and audio-frequency measurements are the possibilities of new techniques of laser measurement. A perspective view of the role of lasers in the field of measurement was provided by A. G. Fox (Bell Telephone Laboratories): "The field of coherent-wave optics is young . . . having been born about four years ago. It was the child of quantum mechanics on the one hand and of microwaves on the other; it was baptized with a fanfare of publicity and optimistic predictions such as few new fields have had . . . We know that this field is going to come forth with new techniques that are going to allow us to do things with a refinement and to make measurements that we have not been able to make before."

In spite of their better coherence properties, optical masers still leave much to be desired in stability; gas lasers are of primary interest here, since to date solid-state lasers have not proved to be as accurate tools. In view of the length of the optical cavity, a gas laser is sensitive to vibrations and thermal shifts which produce undesirable frequency changes.

One approach to establishing a more stable He-Ne laser was described by K. Shimoda (M.I.T./University of Tokyo) in which the laser is frequency-modulated at a low frequency by automatically controlling the separation of the plane parallel mirrors at the ends of the cavity. It is found necessary to place the mirrors in vacuum to avoid the effects of ambient air variations and it is necessary to use a pure isotope of neon rather than a normal distribution of isotopes. The fundamental, the second harmonic, and the third harmonic components of the modulation frequency in the output light provide correction signals to control the tilt of the mirrors, the power level of the excitation, and the separation of the mirrors. The photo-beat between two stabilized masers was observed and indicated that the frequency stability of each maser may be as good as several parts in  $10^{10}$ .

A different approach was discussed by A. D. White, *et al.* (Bell Telephone Laboratories), who employed a modulated sensing cell, external to the laser itself, to tune the laser cavity by controlling the position of one of the spherical mirrors with a piezoelectric transducer. The tuning sensitivity of this transducer is 5 Mc/s per volt. In one arrangement, an atomic line is split, either by the use of a magnetic field or by isotopes in an external gas-discharge cell, and a discriminator characteristic is achieved by measuring the interaction between the laser beam and the gas-discharge medium. In a different single-beam arrangement, a switching device such as a rotating quarter-wave plate or a switched magnetic field is employed to obtain the discriminator characteristic. Photo-beat experiments have indicated a short-term stability of about 5 Mc/s, which is about twice as much as the long-term stability of the laser.

One of the most exciting papers at the conference dealt with a new measurement technique that is expected to have great impact on spectrochemical analysis. S. P. S. Porto (Bell Telephone Laboratories) described methods for performing Raman scattering experiments with lasers. In addition to describing the significant results which he has obtained, he traced the history of the development of the technique, including his failures as well as his successes in arriving at an extremely practical and useful method of measurement. When a sample is irradiated by a laser light, the emitted light consists of the laser frequency, together with the laser frequency plus or minus the frequencies associated with molecular vibrational transitions. Since the intensity of the Raman spectral lines is of the order of  $10^{-4}$  of the incident light, the characteristics of light from a laser offer several advantages when compared with non-coherent sources. It is now found possible to place a sample in the path of the laser beam, to have the Raman-scattered light collected at the entrance slit of a spectrometer, and to achieve high signal-to-noise ratios. Indeed, the signal-to-noise ratio for one benzene line is greater than 10 000:1 for a sample 1 cm in length and  $\frac{1}{2}$  cm in diameter. Other advantages of the technique include the ability to measure the complete vibrational spectrum, on solids as well as on liquids and gases, in a short period of time, and to measure the spectrum to as low a frequency as 20 wave numbers, compared with a minimum of approximately 170 wave numbers obtainable with infrared spectroscopic techniques.

A method for measuring the relative phases of laser modes by the simultaneous observation of beats between the modes and the optical spectrum with a scanning spherical mirror interferometer was presented by R. L. Fork (Bell Telephone Laboratories). Part of the laser beam is imaged into the interferometer cavity in which the lowest order transverse mode is excited by varying the spacing of the mirrors over a 2-Gc/s range by having one mirror oscillate at a 60-c/s rate. If the two beat frequencies of adjacent modes are identical, their relative phase can be measured. Near threshold, a Brewster window He-Ne laser can be made to oscillate with the relative phases of alternate beat frequencies equal to  $\pi$ , to minimize pulsations in the populations of levels participating in laser action.

W. M. Macek and G. R. White (Sperry Gyroscope Co.) reviewed the current status of the development of ring lasers. The ring laser is an interesting device which is sensitive to rotation of the ring and whose use makes it possible to observe nonreciprocal phase changes as differences between resonance frequencies for oppositely directed waves. The problems of maintaining a constant rate of rotation and of mode coupling limit performance.

The lower frequency limit for the beat between mode pairs was reported to be 100 c/s because of the locking problem. It is anticipated that the ring laser will have application as a flow meter or as a device for the measurement of the conductivity of films.

### Frequency and time standards

In his introduction to the subject of frequency and time standards and techniques, G. E. Hudson (National Bureau of Standards) defined the time interval as the integral of a reciprocal cyclic frequency over the changing phase of a periodic physical phenomenon. Its frequency is,

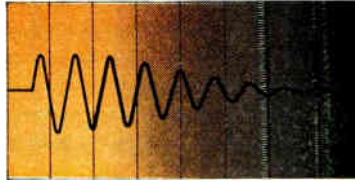

of course, measured with respect to a suitable frequency standard. Historically, the choice of phenomenon as the basis of a time scale has usually been that which showed an almost constant frequency measure. In case the phenomenon itself is also the basis for the standard of frequency, then its frequency would, of course, be constant by definition. The time scale so defined would increase exactly linearly with the number of oscillations. The most recent candidates for a basic standard of frequency are transitions between atomic energy states, notably in cesium, thallium, and hydrogen. A method for generating physical time, the NBS-A time scale, was described by J. A. Barnes, *et al.* (National Bureau of Standards). It is based on the United States Frequency Standard (NBS II), defined as 9 192 631 770 c/s, accurate to  $1.1 \times 10^{-11}$ , and corresponds to the quantum transition to the ground state in cesium.

As it is impossible to keep the cesium beam standard running for long periods of time, comparison with the USFS is made with four quartz crystal oscillators and a rubidium gas cell on a working day basis. It has been found that the rms time error of a quartz crystal oscillator is linear in time between calibrations so that it is possible for a computer to average the readings from the quartz oscillators and the rubidium cell to arrive at a time scale which is known as NBS-A. Comparison of this time scale with those maintained by the U. S. Naval Observatory and the Laboratoire Suisse de Recherches Horlogères in Switzerland is made using Loran C and radio station WWV, respectively, and differences of no more than 1 or 2 parts in  $10^{11}$  have been observed. In the ensuing discussion, W. Markowitz (United States Naval Observatory) made the rather startling comment that he was not aware of a single requirement for the epoch of atomic time, as distinguished from time interval.

In addition to the aforementioned NBS II there are two other atomic beam frequency standards in operation at the National Bureau of Standards, known as NBS I and NBS III. The performance and capability of each of these standards were discussed by R. E. Beehler, *et al.* (National Bureau of Standards). The interaction lengths of the three standards are increasingly greater, a longer length corresponding to a narrower spectral line width. NBS III is a cesium standard and is the newest and longest of the three (366 cm); recent developments indicate that an accuracy of  $1 \times 10^{-12}$  is attainable with only minor improvements. NBS III, when evaluated fully, probably will become the United States Frequency Standard. Eventually, it is desired to convert NBS II to an atomic beam standard based on a thallium hyperfine structure line. The most recent determination of the frequency of this transition is 21 310 833 945.9 c/s  $\pm$  0.21 c/s, accurate to 1 part in  $10^{11}$ . NBS I has been converted from a cesium to a thallium standard and has been operating for

one and a half years with an accuracy of  $1 \times 10^{-11}$ .

A problem in achieving high stability in atomic beam frequency standards is that associated with cavity detuning errors; several systems are employed for their correction. R. S. Badessa, *et al.* (Massachusetts Institute of Technology) pointed out that the use of sine- or square-wave frequency modulation does not permit discrimination between modulation distortion and differential phase error between the two cavities. They reported results obtained by square-wave phase modulating (i.e., frequency-impulse modulating) the RF signal applied to the beam tube. Since an essentially distortionless type of modulation is employed, the odd harmonic content may be measured and used to correct for differential phase between the cavities. Preliminary results, using the NC 2001 cesium beam tube, showed short-term stabilities of  $2 \times 10^{-12}$  (Fig. 2) and a daily frequency variation of less than  $1.5 \times 10^{-12}$ .

A number of people are optimistic about the adoption of a hydrogen maser, operating at approximately 1420 Mc/s, as a highly stable frequency standard. J. Vanier and R. F. C. Vessot (Varian Associates) have constructed two masers which were tuned within 0.01 c/s and for which the maximum relative excursion in frequency during a period of a month was approximately  $2 \times 10^{-12}$  (Fig. 3). When the pressure in one of the masers is increased fourfold, no shift larger than 2.1 parts in  $10^{13}$  is observed. Teflon is found to be the best material for coating the walls of the cavity. H. G. Andresen (U. S. Army Electronics Research and Development Laboratories) presented a preliminary report of techniques for stabilizing the resonant frequency of a hydrogen maser. The apparatus is placed in a constant-pressure enclosure and temperature detuning is reduced by employing a water jacket; the temperature of the water is held to within  $\pm 0.01^\circ\text{C}$ . The beat between two units was measured and the standard deviation of the frequency difference was found to be  $2.5 \times 10^{-13}$ . The radiative lifetime and thus the  $Q$ -value of the hydrogen resonance are periodically quenched by inducing low-frequency Zeeman transitions. This technique can be used to achieve an automatic cavity-tuning system.

Although the use of frequency standards has made it possible to achieve very accurate clocks in a particular location, the dissemination of a time scale so that master clocks in two different locations may be synchronized accurately has proved to be a problem. The first detailed report of a cooperative experiment in which the Telstar I satellite was employed to relate the master clocks at the U. S. Naval Observatory, Washington, and the Royal Greenwich Observatory, Herstmonceux, was given by J. McA. Steele (National Physical Laboratory, England), and W. Markowitz and C. A. Lidback (U.S. Naval Observatory). Employment of Telstar made possible a completely reciprocal transmission path of good signal-to-noise ratio and with 3 to 6 Mc/s bandwidth. Pulsed signals, 5  $\mu\text{s}$  in duration, at the rate of 10 per second, were transmitted simultaneously over the satellite circuit from the ground stations at Andover, Maine, and Goonhilly Downs, Cornwall. The time difference between received and transmitted pulses is measured at each station and from these results, the relative setting of the station clocks is obtained directly (Fig. 4). The Goonhilly clock was found to be  $72.6 \pm 0.8 \mu\text{s}$  ahead of the Andover clock on Aug. 27, 1962. A comparison of the measured

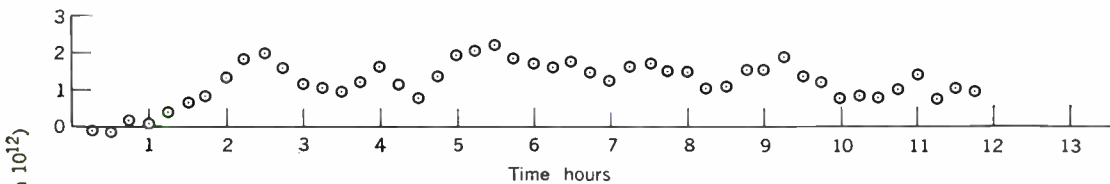

Fig. 2. Frequency stability data.

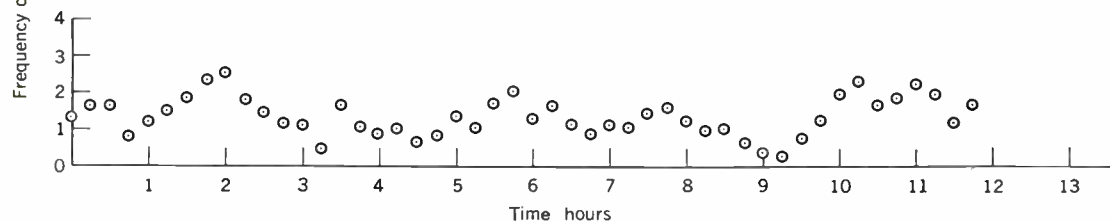
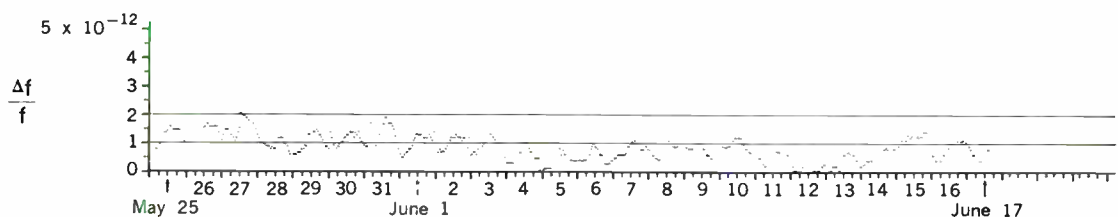
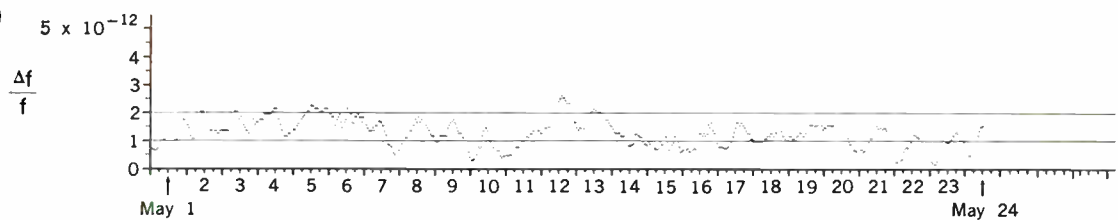
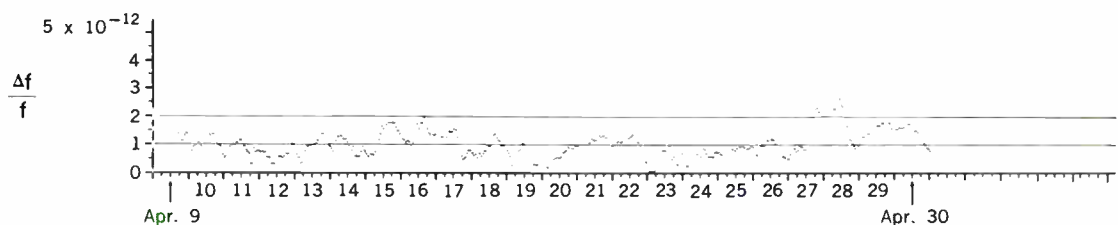

Fig. 3. Frequency difference between two hydrogen masers.



time delays of the signals over the whole or parts of the path was made with the value calculated from the satellite ephemeris, based entirely on Minitrack observations. The ranges based on the ephemeris agree with those measured to about 1 km. The time synchronization between the ground stations was extended to the Observatory clocks by low-frequency ground wave signals and it was determined that the time standard of the RGO was ahead of the USNO by  $2234 \pm 10 \mu\text{s}$ .

Statistical techniques have played an important part in making time measurements and in establishing frequency standards. W. A. Teso (Ohio State University) described an experiment to determine long-term propaga-

tional variations by making a statistical comparison of the relative phase records obtained at different locations from two separate VLF (very-low-frequency) transmitters. The introduction of a third station, together with a statistical comparison of the two sets of measurements, is found to result in improved precision. In a somewhat more abstract vein, E. L. Crow (National Bureau of Standards) discussed the question of how weights should be formulated for combining the data from the several national or laboratory standards to establish the most accurate international standard. He pointed out that the "best" combination of observations for estimating a theoretical mean value depends on the

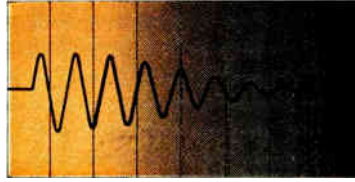

theoretical frequency distribution from which the observations are drawn. Since the theoretical frequency distribution for observations from different laboratories is generally unknown, a weighted linear combination reasonably good for many distributions is suggested, in which the weight of each observation depends only on its order when the observations are ordered in size. W. Markowitz posed the following question: Two years from now, will people worry about combining standards? For example, the hydrogen maser with a stability of  $1 \times 10^{-12}$  has greater stability than can be transmitted by VLF, or by Loran C in one day; consequently, the emphasis on combining standards may be expected to decrease.

#### Radio-frequency and microwave measurements

A group of papers that indicate the existence of a considerable amount of activity concerning coaxial connectors was presented. V. Weill (U.S. Naval Applied Science Laboratory), C. C. Camillo (FXR), and L. V. Gumina (Department of the Navy) are serving on an ASA committee that is cooperating with the Defense Electronic Supply Center to create a new specification based primarily on performance requirements, rather

than standardized dimensions, for general purpose (Class I) and field precision (Class II) connectors. The committee has generated a two-part specification: (1) catalogue of test methods for each connector, which can be updated without affecting its specifications; and (2) detailed specifications. Four years ago at this conference, a subcommittee of the IEEE G-IM Technical Committee on Electronic and High-Frequency Measurements came into being to establish recommended practices to standardize definitions, testing procedures, and mechanical and electrical characteristics for precision connectors. The work of this committee was described by D. E. Fossum (Sandia Corporation), who indicated that the parts "General Requirements and Definitions" and "Parameters to be Specified" have been completed. Two sizes of connectors, 7 mm and 14 mm, have been proposed for standardization.

R. W. Beatty (National Bureau of Standards) presented an analysis to answer the following question: If the attenuation of a stable, fixed attenuator is measured at the same operating frequency in two different systems, to what extent is the difference in results attributable to differences in the waveguide (coaxial) connections used at the insertion points? He adopts a model in which the attenuator, when installed in a circuit, is no longer represented by a single two-port but by three cascaded two-ports, the outer ones representing the connector pairs and the inner ones representing the core or kernel of the attenuator. His results indicate that significant errors are possible with present connectors, but that these become negligible when "high precision" connectors are used. The analysis permits a determination of how good a connector must be for a specific application.

Impedances of devices having small reflection coefficients relative to a given system can be determined accurately (0.1 per cent) by comparison with the nominally calculable characteristic impedance of a quarter-wavelength air-spaced coaxial line. I. A. Harris and R. E. Spinney (Ministry of Aviation, England) analyzed the errors introduced by the existence of effective series impedances at the contacts at the ends of the lines, through the presence of distributed impedances in the line conductors and by the departure of the lines from uniformity. They discussed the design of suitable lines with unsupported center conductors and integral connectors as well as the techniques for making impedance comparisons. In another approach to this problem, B. O. Weinschel, *et al.* (Weinschel Engineering) employed as an impedance standard a precision air line, which is connected through a beadless laboratory precision connector to a slotted line. A load with a low and stable reflection coefficient is moved in the air-line standard and is synchronized with the probe travel in the slotted line. Since the impedance of both lines is usually different, a transformer integral with the slotted line near the load termination is adjusted at a fixed frequency to produce a constant probe output. Over the 400 to 6000 Mc/s range, an accuracy of 0.0008 is achievable in the measurement of small reflection coefficients.

H. M. Altschuler (Polytechnic Institute of Brooklyn) showed that impedance measurements of nonreciprocal two-ports could be aided by interchanging the generator and detector with an attendant increase in sensitivity. A sufficient condition is that a matched generator and a matched detector be used.

Fig. 4. Reception of pulses at Andover from Goonhilly on Aug. 27; (A) at 17h 52m 20s; (B) at 17h 54m 00s, with extended time scale. Top traces: time marker and 100-kc/s timing wave. Middle traces: 5- $\mu$ s pulse from Goonhilly, leading edge at left. Bottom traces: Loran C pulse from Nantucket Island.

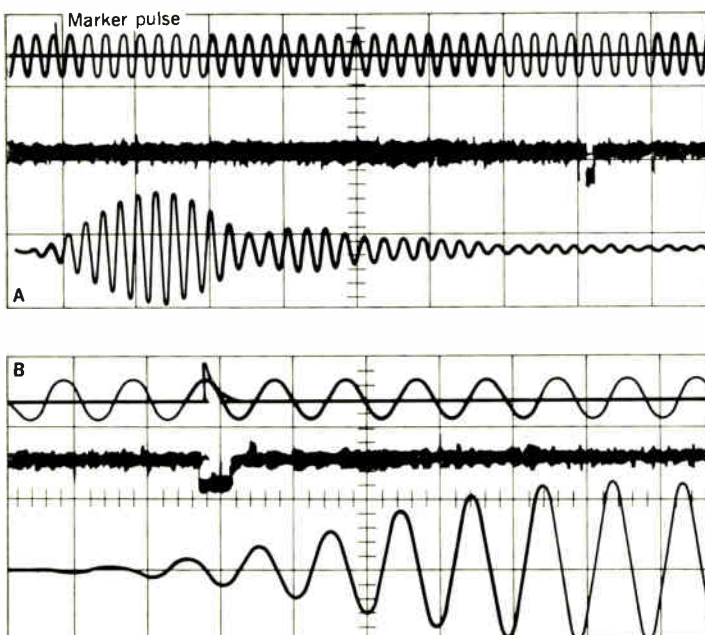

A problem occurs in the laboratory of connecting a system having one type of termination to a power meter having a different type of termination; e.g., adapting from waveguide to a coaxial bolometer mount. G. F. Engen (National Bureau of Standards) has developed a calibration procedure, which is based on two views of how the adaptor is inserted. In one view, the adaptor is considered attached to the coaxial bolometer mount; since there will be some power absorbed in the adaptor, too high an efficiency is measured. In the other view, the adaptor is considered attached to the waveguide; here too low an efficiency is measured. The mean or the quotient may be taken to determine the calibration. If the adaptor efficiency is nominally 98 per cent and impedance conditions are optimum, the error introduced by adaptor losses is only of the order of 0.01 per cent.

A method developed by King and Mandeville has been extended by W. H. Steier (Bell Telephone Laboratories) for helix waveguide attenuation measurements in the 100–125-Gc/s frequency band. The cathode of a backward wave oscillator is pulsed to provide a signal frequency shifted by 70 Mc/s from that of the unpulsed oscillator. Consequently, the same backward wave oscillator (BWO) is made to act as signal generator and local oscillator. Despite difficulties due to small reflections from the waveguide components and the BWO frequency instability, an attenuation of 3.5 dB/mi was measured; this compares with the computed value of 3.0 dB/mi.

M. G. Arthur, *et al.* (National Bureau of Standards) described a prototype noise-power comparator based upon a theory given by Allred. It is a servo-controlled null-type instrument whose principal components are a reference CW voltage generator, a hybrid junction, a dual-channel amplifier and bandpass filter, and an analog multiplier. The principal advantage of this comparator is that the adverse effects of changes in amplifier gain are essentially eliminated without resorting to the use of high-speed switching. Its measurement range capability is such that it can measure generators having equivalent noise temperatures ranging from 75°K to 30 000°K in a 7.5-kc/s frequency band centered at 3 Mc/s. At the present stage of development, the uncertainty in a measurement is less than 1 per cent for generators at 75°K, decreasing to 0.2 per cent for generators with noise temperatures above 500°K.

Conventional methods of measuring field strength at VLF use either a loop antenna or a whip antenna with a ground connection. R. P. Harrison and E. A. Lewis (Air Force Cambridge Research Laboratories) reported results obtained with an instrument that they developed to measure the electric field directly and quickly without the need for a ground connection. A special antenna-receiver unit is supported on a 10-foot telescoping non-conducting mast with a termination box remotely located from the antenna. Keyed CW and steady signals have been measured to accuracies of 5 per cent.

J. J. Hoote (United States Naval Ordnance Laboratory) described two rather simple procedures for the measurement of the length of microwave waveguide delay lines. Both techniques make use of a cavity frequency meter to measure a differential number of nulls obtained from a swept microwave signal introduced at the delay line input. In one method the output end is shorted, giving rise to a two-way transmission, while in the second method,

the signal obtained at the output of the unknown line is compared with that obtained at the output of a reference line. Using equipment commonly found in the microwave laboratory, an accuracy within  $\pm 0.5$  per cent is obtained.

In a rather complex application of precision measurement techniques and apparatus, R. Borghi and F. Patton (Stanford Linear Accelerator Center) discussed methods for adjusting the phase velocity of the periodic accelerating structure of the Stanford two-mile accelerator. Over 90 000 cavities are required for adjustment and a semi-automated apparatus has been designed which makes possible the quantity precision adjustment of the cavities.

#### Measurements on materials

In the performance of precise measurements on dielectric materials, perhaps the greatest limitations on reproducibility of the measurements are the degree of homogeneity and isotropy of the specimens. Measurements were made at three laboratories, the National Bureau of Standards (H. E. Bussey, *et al.*), the National Physical Laboratory (E. Rushtin, *et al.*), and the National Research Council (D. Morris), using two samples of each of three materials: fused silica, glass, and alumina. The homogeneity and isotropy of the samples were within 0.1 per cent but the measurements in the radio and microwave regions of the frequency spectrum were in error by a greater amount. The results show agreement among the three laboratories to better than 1 per cent for the real part of the permittivity, but the agreement on loss tangent is less satisfactory. A second round of measurements is in progress with the expectation that closer agreement will result.

An instrument for obtaining the dielectric permittivity and loss of materials, without the use of contacting electrodes, from a measurement of the mechanical torque generated by an electric field applied to a suitably shaped specimen has been developed by L. E. Cross and F. Groner (Pennsylvania State University). The method is similar in principle to one first used by Hertz (1881) for special applications, but analysis shows that the method should be applicable to general-purpose measurements of dielectric and magnetic susceptibilities. A specimen of regular ellipsoidal geometry is suspended in a time-varying electric field, and a torque is generated either by a sinusoidal field fixed in direction or by a constant field whose direction is rotated. Spherical samples were employed in the frequency range of 0.001 c/s to 80 kc/s, and the torque was measured by balancing the field-generated torque with a countertorque generated by a long, thin torsion fiber.

In recent years there has been considerable interest in the dielectric properties of paraelectric and ferroelectric materials in the upper portion of the microwave spectrum. G. A. Burdick, *et al.* (Sperry Microwave Electronics Co.) developed an approach for making such measurements at 35 Gc/s. The principal problem in performing the measurement is to obtain a sample uniformly thick to within 0.1 wavelength in the material, and to mount such a sample in a waveguide with adequate contact. The sample was mounted in a tool steel diaphragm placed between two pieces of waveguide. The thickness of the sample was determined to within  $\pm 0.0002$  inch, and the sample itself was bonded to its holder with a conducting epoxy cement and ground to each new thickness. Attenuation

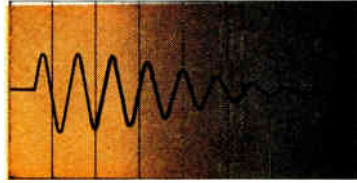

and phase change were measured as a function of thickness for a mixture of barium and strontium titanates; the estimated error was approximately 5 per cent. In a comment following the presentation of the paper, it was suggested that smaller corrections would be possible if a circular  $TE_{01}$  mode had been employed.

The refractive index of a gas is determined to high accuracy by measuring the change in resonant frequency when the gas is admitted to a previously evacuated microwave cavity. A. C. Newell and R. C. Baird (National Bureau of Standards) reported measurements made at a frequency of 47.736 Gc/s, the first of this type to be reported in this frequency range. Two types of resonant structures were used in this measurement, a conventional

cylindrical cavity and a Fabry-Perot resonator with one plane and one spherical mirror. Results were obtained for  $N_2$ ,  $O_2$ ,  $H_2$ , Ne, Ar,  $CO_2$ , He, water vapor, and air. Measurements made with each type of resonant structure agreed within  $\pm 5$  parts in  $10^8$  and the accuracy of the measurements was  $\pm 1$  part in  $10^7$ .

A problem of considerable interest is the determination of the resistivity of a semiconductor epitaxial layer. M. R. E. Bichara and J. P. R. Poitevin (Centre National d'Etudes des Telecommunications, France) have developed a nondestructive method which depends upon a measurement of the attenuation suffered by an electromagnetic wave upon reflection from a semiconducting surface. They used a 70-Gc/s microwave bridge to compare the amplitude of the wave reflected by the semiconductor pressed flat against the end of a waveguide, with that reflected by a short circuit. The resistivity and thickness of the epitaxial layer grown on a highly doped substrate are determined from amplitude and phase measurements. The accuracy of the measurements was  $\pm 2.5$  per cent and agreed very well with calculated values. J. J. Muray and R. A. Scholl (Stanford Linear Accelerator Center) showed how an electron magnetic resonance magnetometer was being applied to measure pulsed magnetic fields to  $\pm 0.01$  per cent accuracy on a pulse-to-pulse basis to obtain precise separation of the interlaced beams propagated in the Stanford accelerator.

Two other magnetometer systems were discussed; J. R. Mulady (W. A. Brobeck and Associates) has developed a Hall-effect probe with a precision of 0.001 per cent by closely controlling ambient temperature to  $0.1^\circ C$  and using a thermistor-resistor temperature-compensation network. A new technique which overcomes the requirements of large sample size and field homogeneity in using a proton resonance magnetometer, was disclosed by C. F. Hempstead (Bell Telephone Laboratories). His method utilized an 0.011-inch-diameter YIG sphere with a line width of 1.3 gauss, and is capable of measuring inhomogeneous fields greater than 800 gauss to within 20 mGs in 5 or 6 seconds.

K. M. Eisele (Bell Telephone Laboratories) pointed out, in measuring microwave amplifier effective input noise temperatures below  $60^\circ K$ , that it is necessary to use a liquid-helium-cooled termination and random noise sources whose noise temperatures are accurately known. With sufficient care, effective input noise temperatures accurate to  $1^\circ K$  may be obtained.

M. Cohn and J. D. Rodgers (Advanced Technology Corporation) exploited the high-temperature coefficient of ferroelectric materials in the vicinity of their Curie temperatures to fabricate a sensitive, frequency-independent instrument for a low-level absolute power measurement. The ferroelectric bolometer element consists of a ceramic mixture of 45 per cent  $PbTiO_3$  and 55 per cent  $SrTiO_3$  and power levels as low as  $4 \mu W$  have been measured at frequencies from 64 to 300 Gc/s.

As anyone knows who has visited Colorado, the climate is delightful in the summer, but many may not be aware of the excellent facilities for conferences of this type, with which the National Bureau of Standards Boulder Laboratories are endowed. While many individuals contributed to the success of the 1964 CPEM, one person, James F. Brockman of NBS, deserves special commendation for the thought and energy which he devoted to achieving an extremely well-run conference.



(Above) D. Schon, director, NBS Institute of Applied Technology, discusses major technical innovations in new and "traditional" industries. (Below, left to right) P. Grivet (France), P. Miljanic (Yugoslavia), N. L. Kusters (Canada), K. Shimoda (Japan), and W. Markowitz, chairman, International Affairs for the Conference (U.S.).



# Authors

**H. G. Weiss (F)** received the S.B. degree in electrical engineering from the Massachusetts Institute of Technology in 1940. He joined the M.I.T. Radiation Laboratory in 1941, where he worked on the development of the first microwave radar receivers, automatic-frequency-control equipment, and airborne microwave radar. Later he joined the Los Alamos Scientific Laboratory and was in charge of instrumentation activities in 1947 during the Bikini Atoll atomic tests. Since 1951 he has been at M.I.T.'s Lincoln Laboratory, where he directed programs for large radar systems, including those now installed in the DEW Line, in the Alaska and Greenland early warning radar networks, and in BMEWS. He also led the group that developed Lincoln Laboratory's Millstone Hill radar, which paced the further development of radars for missile and satellite tracking and for research in geophysics and astronomy.

Mr. Weiss is a member of Sigma Xi and the American Physical Society. He has twice been awarded the Presidential Certificate of Merit, and recently received the Air Force System Command's Award for Outstanding Achievement for his contributions to the Haystack microwave research facility.



**Gordon D. Friedlander**, a staff writer for IEEE SPECTRUM, has also written feature articles for *Civil Engineering*, *Journal of the A.I.A.*, *Engineering Graphics*, and *Industrial Art Methods*. In addition, he is the author of a series of articles on engineering and architecture for the Sunday editions of the *St. Louis Post-Dispatch*. During his engineering practice, he was associated with Ebasco Services, Inc.; Ford, Bacon & Davis, Inc.; Bechtel Associates; and P. T. Mikluchin & Associates, Ltd. (Toronto) as a design supervisor and project engineer involved in the structural design and construction of steam-electric and hydro-electric power plants, substations, industrial buildings, shopping centers, and institutional buildings.

Mr. Friedlander has lectured at engineering management seminars sponsored by the Industrial Education Institute and the University of Wisconsin. He attended Rensselaer Polytechnic Institute, the University of Michigan, and the University of Florence (Italy), and holds B.S. and M.S. degrees in civil engineering. His memberships include the Architectural League of New York, the American Ordnance Association, and the Society of Naval Architects and Marine Engineers.

**W. Keister (M)** is director of the Electronic Switching Systems Engineering Center of Bell Telephone Laboratories at Holmdel, N.J., where he is responsible for the engineering planning of electronic switching systems to meet present and future needs of the Bell System. Besides planning specific system features, his group does fundamental studies and research on programming methods and the organization of machines controlled by stored programs.

Mr. Keister joined Bell Laboratories in 1930 following his graduation from the Alabama Polytechnic Institute. He first worked on the development and testing of toll switching and signaling circuits, and later on special studies involving relays and dial telephone switching systems. During World War II he taught theory and maintenance of radar equipment to military personnel in the Bell Laboratories School for War Training. After the war he joined the staff of the Bell Laboratories Communications Development Training Program for graduate engineers. He was appointed to his present position in 1958. He is a coauthor of the book, *The Design of Switching Circuits*, and is a member of Eta Kappa Nu, Tau Beta Pi, and Phi Kappa Phi.





**R. W. Ketchledge** (F) is director of the Electronic Switching Laboratory at Bell Telephone Laboratories in Holmdel. His organization is responsible for developing memories, switching networks, and logic equipment for the electronic switching system. He directed the development work on all circuits and equipment for the Morris, Ill., experimental electronic central office.

Mr. Ketchledge joined Bell Laboratories in 1942, the year he received both the bachelor of science and master of science degrees in electrical engineering from the Massachusetts Institute of Technology. Until 1946 he was associated with military development in the fields of infrared detection and underwater sound. During the next six years he participated in the development of a submarine cable system and a broadband coaxial carrier system. In 1954 he was named electron tube development engineer, in which capacity he worked primarily on gas tubes and storage tubes. The following year he assumed the position of switching system development engineer, and devoted his efforts to electronic memories and switching networks for electronic switching systems. He was made assistant director of switching systems development in 1956, and in 1959 was appointed to his present position. He is a member of Sigma Xi and has been granted 51 U.S. patents.



**H. V. Vaughan** (F) is director of the Electronic Switching System Center of Bell Telephone Laboratories' Holmdel, N.J., facility. He received the B.S. degree in civil engineering from The Cooper Union, New York City. He joined the Bell Telephone Laboratories in 1928, and first devoted his efforts to voice-operated devices for toll transmission systems and transatlantic radio and cable. In 1937 he turned to investigations of the various effects of speech and noise on voice-frequency signaling systems. During World War II he worked on military projects, and after the war was engaged in research on high-speed digital signaling systems as well as research on data transmission, electronic switching, and other complex electronic systems. In 1958 he became director of the Systems Research Center, and in this capacity was responsible for research in the fields of visual communication, fixed and mobile communications, data transmission and processing, and digital control systems. He has been in his present position since May 1962.

Mr. Vaughan is the author of a number of technical articles on the subjects of electronic switching and pulse transmission. He holds 26 patents covering voice-operated devices, signaling systems, and electronic switching devices.

**L. J. Giacoletto** (F) received the B.S. degree in electrical engineering from Rose Polytechnic Institute, the M.S. degree in physics from the State University of Iowa, and the Ph.D. degree in electrical engineering from the University of Michigan. He served for five years with the Signal Corps Engineering Laboratories, where he was concerned with development activities in the fields of radio, navigational, and meteorological direction-finding equipment. He subsequently was associated with the RCA Laboratories as a research engineer. His work there was chiefly in semiconductor devices, including transistors, for which he has received 21 patents. He has contributed extensively to transistor measurement and standards programs, as published in more than 45 articles and two books.

In 1956, Dr. Giacoletto became manager of the Electronics Department of the Ford Motor Company Scientific Laboratory, where he developed a program of research into electronic instrumentation, physical electronics, and electric systems. Since 1960 he has been a professor in electrical engineering at Michigan State University. He is a Fellow in the American Association for the Advancement of Science and a member of the American Physical Society. He served on the Boards of Directors of IEEE and the National Electronics Conference, and the Editorial Review Committee of PROCEEDINGS OF THE IEEE.

