

THE NEWSPAPER FOR  
THE HOBBYIST OF VINTAGE  
ELECTRONICS AND SOUND

# THE HORN SPEAKER

Science and Invention for April, 1924

## Radio Set and Phonograph Combinations

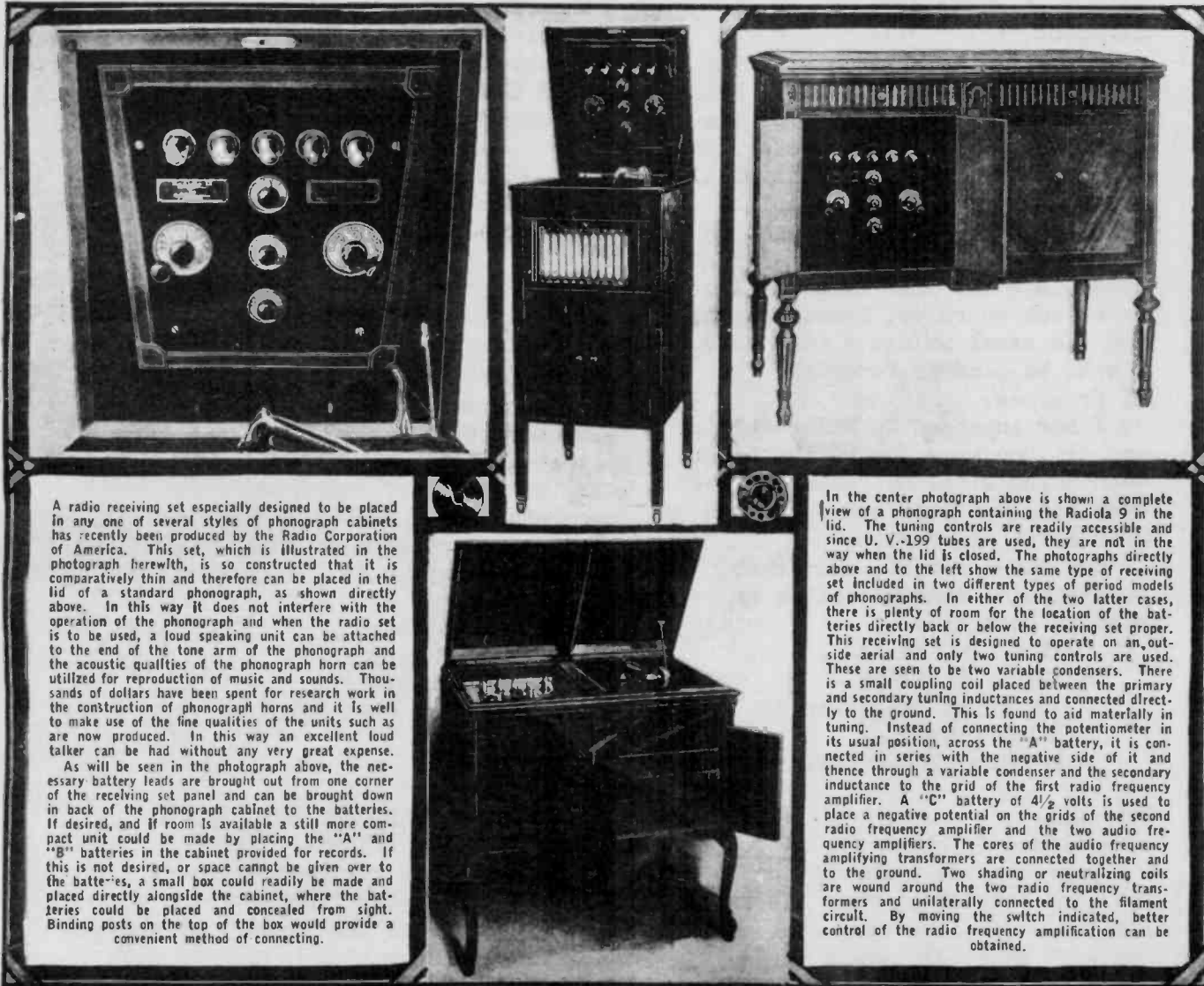

A radio receiving set especially designed to be placed in any one of several styles of phonograph cabinets has recently been produced by the Radio Corporation of America. This set, which is illustrated in the photograph herewith, is so constructed that it is comparatively thin and therefore can be placed in the lid of a standard phonograph, as shown directly above. In this way it does not interfere with the operation of the phonograph and when the radio set is to be used, a loud speaking unit can be attached to the end of the tone arm of the phonograph and the acoustic qualities of the phonograph horn can be utilized for reproduction of music and sounds. Thousands of dollars have been spent for research work in the construction of phonograph horns and it is well to make use of the fine qualities of the units such as are now produced. In this way an excellent loud talker can be had without any very great expense.

As will be seen in the photograph above, the necessary battery leads are brought out from one corner of the receiving set panel and can be brought down in back of the phonograph cabinet to the batteries. If desired, and if room is available a still more compact unit could be made by placing the "A" and "B" batteries in the cabinet provided for records. If this is not desired, or space cannot be given over to the batteries, a small box could readily be made and placed directly alongside the cabinet, where the batteries could be placed and concealed from sight. Binding posts on the top of the box would provide a convenient method of connecting.

In the center photograph above is shown a complete view of a phonograph containing the Radiola 9 in the lid. The tuning controls are readily accessible and since U. V.-199 tubes are used, they are not in the way when the lid is closed. The photographs directly above and to the left show the same type of receiving set included in two different types of period models of phonographs. In either of the two latter cases, there is plenty of room for the location of the batteries directly back or below the receiving set proper. This receiving set is designed to operate on an outside aerial and only two tuning controls are used. These are seen to be two variable condensers. There is a small coupling coil placed between the primary and secondary tuning inductances and connected directly to the ground. This is found to aid materially in tuning. Instead of connecting the potentiometer in its usual position, across the "A" battery, it is connected in series with the negative side of it and thence through a variable condenser and the secondary inductance to the grid of the first radio frequency amplifier. A "C" battery of 4½ volts is used to place a negative potential on the grids of the second radio frequency amplifier and the two audio frequency amplifiers. The cores of the audio frequency amplifying transformers are connected together and to the ground. Two shading or neutralizing coils are wound around the two radio frequency transformers and unilaterally connected to the filament circuit. By moving the switch indicated, better control of the radio frequency amplification can be obtained.

## The "Soup-Plate"

A Novel Type of Transmitter that Reverses the Principle of the Loud Speaker

By FREDERICK SIEMENS

THE problem of getting a large volume of sound converted into electricity for use in modulating the high-power transmitting stations that are now being used for radio broadcasting has become of increasing importance during the last year.



© Keystone View Co.  
Arthur Stringer, the well-known poet, recites his Irish poems by radio, from the broadcasting station at Fort Wood

Several systems have been worked out to attain this result, but most of them have this serious disadvantage: while they produce a large amount of voice-controlled electricity, at the same time they distort the voice wave that is impressed upon them. Thus the reproduction is not as clear or as faithful as it should be.

One particular method that gives a very good quality of speech and relies upon the electromagnetic principle for

Continued on page 2

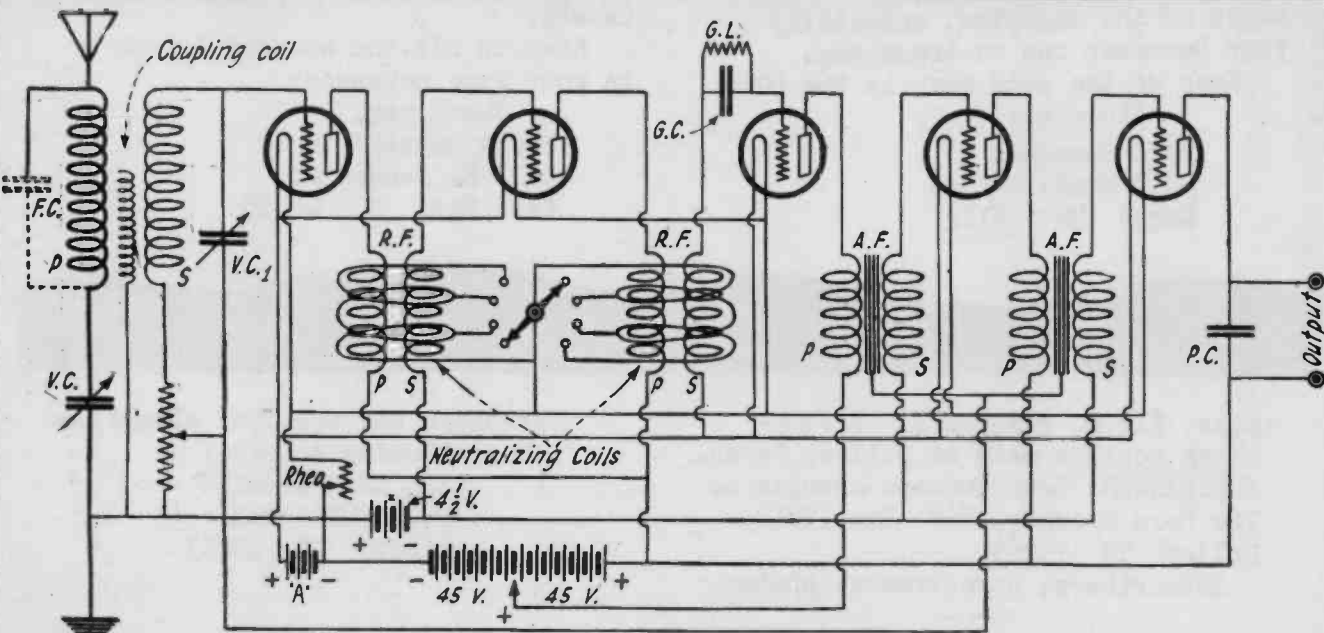

its action is illustrated by the accompanying picture. The speaker or singer throws his voice into the "soup-plate" transmitter, as it has been nicknamed, which consists of a large paper diaphragm that vibrates in accordance with the voice wave that impinges upon it. The center of this diaphragm is attached to a moving coil which is placed in the magnetic field of a powerful electromagnet. When the diaphragm vibrates, the coil moves back and forth with it; this motion causes it to change its position in the magnetic field of the electromagnet. These motions of the coil back and forth, which conform with the voice waves, cause electric currents to flow in the coil which also are controlled by the voice waves. In this way the voice wave is changed from a sound wave into an electrical wave without depending on the old style transmitter which distorts so much and which uses carbon grains which are pressed tightly together or loosely as the voice causes them to vibrate.

The voice currents produced by the new method are remarkably true in following the complex voice vibrations as used by everybody in ordinary speech, and are remarkably effective in the reproduction of music. The current obtained from this instrument is magnified or amplified by means of vacuum tube amplifiers, somewhat similar to those used by the amateur, except that the tubes used are larger and are known as power amplifiers.

The cylindrical object that is shown, supported from the rim of the cone-shaped diaphragm by the three radial supports, contains the electromagnet and the moving coil.

The principle of the new transmitter is just exactly the reverse of the loudspeaker used for receiving. In the latter the electrical energy is converted into sound and in the transmitter the sound is converted into electrical energy. The same apparatus can be used for both purposes with slight modifications.

POPULAR RADIO, July 1922

# letters

Dear Jim,

I have been expecting to hear from you as I have the feeling that my subscription to the Horn Speaker must have run out. As I require your renewal notice to enable my bank to release U.S. funds, would you please let me

have the reminder as soon as possible.

A recent acquisition has been a Majestic 90B console in excellent condition. This model brings back many happy memories, as while I was at school my father bought one of these for the then princely sum of £49-10 (\$NZ99). That was real money in those Depression days! The year was 1929. I did a lot of DX work with that set logging well over 400 U.S.A. stations, as well as many Asians, Australians and Europeans. The stimulus which that set provided was largely responsible for my making radio my work in life. And now I again have one which will just about bring me to retirement, hi!

Probably the most interesting news is that with a friend I have been largely responsible for the formation of a vintage radio club in Auckland. We believe it will probably be the only one in the Southern Hemisphere. We meet on the 25th Feb. 1980 to formally constitute the club, give it a name, set up rules, subscriptions and the usual things a club does. I will be pleased to advise you of progress.

I had intended to write earlier and let you know how well you have been doing with the "Horn Speaker" over the last year but do so now with great pleasure.

But don't forget, Jim, that subscription renewal notice as soon as possible.

With kind regards,  
Arthur E. Allen  
452 Point Chevalier Rd.  
Point Chevalier  
Auckland 2 New Zealand

Dear Jim:

Inclosed is check for \$12.00 for a 2 year renewal subscription to The Horn Speaker at your new rate. I enjoy your paper very much and await it anxiously every month. I also like your stories on the front pages of the magazine, especially your December one on Armstrong.

Keep up the good work in the 80's.

Sincerely,  
Jeff Simonsen  
2057 Emerald Lane  
Eagan MN 55122

Dear Sir:

RCA suggested I write to you for information about a victrola that I own.

I would like to know the year the victrola was made and its value. I need this information for insurance purposes but would also like to satisfy my own curiosity.

The victrola was manufactured by VICTOR TALKING MACHINE CO. VV-1X-236302G this number is on a metal plate next to the turntable.

The victrola is in excellent condition and does work. It is not a floor model-it sits on a record cabinet made of the same wood.

I would also appreciate information on the care and preservation of the victrola, where I can obtain needles (if available) and whether or not the spring can be replaced if need be.

Thank you for your time and effort.

Sincerely,  
Diana Battan  
7109 Swinford  
San Antonio TX 78239

EDITOR...You should find the help you need in the ads.

Dear Sir:

Enclosed is a check for a years subscription. I would like to say that I enjoy your paper very much. My main area of interest is in crystal sets, and would like to see some articles on these. I'm also interested in indoor loop antennae.

Thanks much,  
Dennis Knurik  
2203 Concord Dr.  
Lakewood, Ohio 44107

Dear Jim:

Please renew my subscription to THE HORN SPEAKER. I am enclosing \$7.00 for another year. I enjoy all your fine articles on old radios and the history of the great pioneers that helped so much to make this hobby so special to us all.

Keep up all the wonderful work in your fine newspaper.

Thank you,  
Frank Mejaski  
4118 S. Seeger St.  
Cass City MI 48726

POSTAL IDENTIFICATION STATEMENT  
The Horn Speaker (USPS 956120) is published monthly, except July and August by Jim Cranshaw, 9820 Silver Meadow Dr., Dallas, Texas 75217. Subscription rates are \$7.00 per

year, \$12.00 two years. Second-class postage paid at Dallas, Texas. POSTMASTER: Send address changes to The Horn Speaker, P.O. Box 53012, Dallas TX 75253. Subscribers, advertisers, photo-

graphers and writers, please use the following address;  
THE HORN SPEAKER  
P.O. BOX 53012  
DALLAS TX 75253



Dear Jim:

Enclosed is a check for \$12.00 please renew my subscription for two years. I really have enjoyed the last couple of issues concerning early T.V.

Hope to see some articles on early A.C. sets and AC-DC sets of the "40s".

Thanks,  
Robert Pote  
39 E Ridge Dr.  
Greenwood IN 46142

Dear Jim:

Enclosed is check for \$7.00 for another years subscription.

Would like to see an article from some old mag. about the history, (Branly) operation & application of the Coheren.

Best regards,  
J. F. Teasdale  
1461 Hillside Rd.  
Hubertus, Wis. 53033

EDITOR....A good idea. We will try it.

Dear Sir:

Am enclosing a postal money order in the amount of \$3.72 as payment for a two time insertion of advertisement on seperate sheet. I have counted the two-in-one words as single, please advise re. hyphenated words.

Yours truly,  
D'Arcy Brownrigg  
Chelsea, Quebec JOX 1N0  
Canada

EDITOR.....counting the spaces between words is O.K.

Enclosed \$5.50, 1 year subscription.

How about more antique construction projects in the paper.

Enjoy paper very much.

Thanks,  
Everett

Dear Jim:

I saw your ad in a recent issue of COLLECTOR'S CORNER.

I am looking for western programs. RED RYDER, HOPALONG CASSIDY, TALES OF THE TEXAS RANGERS....detective/mystery programs MR. DISTRICT ATTORNEY(JOSTYN), MYSTERIOUS TRAVELER. If you can help me locate some, I'll be grateful.

Thank you,  
Sincerely,  
Jack H. Haase  
1115 Churing  
San Antonio TX 78245

Dear Jim,

Enclosed is my check for \$12.00 to renew my subscription for 2 years.

I enjoy the Horn Speaker very much. However I am not really a collector. All I have is a Truetone table model. I am a ham (K5DAH) and I like old ham gear. I have a National HRO-60, a Hammarlund SP-600-JX, a Hallicrafters SX-71, a Meissner EX Signal Shifter, some old Globe transmitters and etc.

I do some work as a broadcast engineer (1st phone ticket) and am also interested in broadcast history. So anything you publish along those lines would appeal to me.

Thanks 73  
Lowie  
L. Poirrier  
2731 Hearne  
Pasadena TX 77502

Dear Sirs:

I would also appreciate any information you might have on Grandfather clock radios. Are they considered rare items? Are there any that can be seen in museums? Do you have any idea of the price range that these bring should one be found?

I realize that I am probably asking questions that you may not be able to answer but I remember the days when my Father played the one he owned, a Philco, many years ago. I would like to find one.

Sincerely,  
W. Peters  
163 S. Broadway  
Linderhurst N.Y. 11757  
EDITOR.....More collectors are beginning to specialize.

Dear Jim,

I'm writing to see if some of your readers can come up with some technical advice. I do restorations for other collectors, so I'm always in need of parts. These parts are sometimes hard to find, at least at prices that make it economical to buy in quantity. Most parts catalogs nowadays deal mainly with parts for microprocessors!

You can acquire a good collection of used tubes if you look hard enough; capacitors & electrolytic condensers with a high enough voltage rating are not as common as they used to be, but they can still be purchased new. Resistors are no problem & output transformers can be acquired by stripping them from discarded tube type T.V.s. (A push pull output transformer can be made by putting 2 regular transformers together & matching the polarity).

My main worry is getting interstage audio transformers & knobs, and that's where I need the advice. In case the supply ever dries up, I would like to know if there is any way to make a simple substitute for the typical interstage transformer (center-tapped & non center-tapped). How many turns, what size wire on on what size core? There may come a day when we don't care how it looks, as long as it works!

The other question is that I would like to know if there is anything available that you can use to mold a plastic version of a knob, if you have one you wish to copy. I remember seeing a kit with which

you could make a rubber mold of any shape & use it to cast that shape in plastic. The answer to this question may make a good "clinic" column.

Thanks,  
Ron  
Ron Boucher  
376 Cilley Rd.  
Manchester N.H. 03103

Dear Jim:

I really look forward to receiving The Horn Speaker. Your ads are the best of any antique radio publication I have seen. I also like your club and museum news features.

The price of radios seems to be continuing upwards, but every now and then one comes across a real find. This past year I managed to buy a DeForest D-12 complete with loop antenna and 4 DeForest tubes at a flea market for \$85. With some loving care I should be able to restore it completely. The decal in the center of the loop antenna is partially worn off. Does anyone know where I can get a reproduction? As an alternative, I would pay up to \$1 for a snapshot of the decal so I could try to copy it. The decal says "DeForest Coil Antenna...." and some patent numbers, etc. Also, does anyone have suggestions on how to restore the faded leatherette cover?

The other bargain I found this past year was a Majestic console model 90 in reasonable condition with all tubes for \$9. If only one could be so lucky more often!

## CLINIC

Here's a hint that may be useful to those who do not already know it. I tried several types of detergents and cleaners for cleaning off layers of dirt, grease, and oxidation on old radio chassis. None really seemed to do a complete job. Then I discovered that muriatic acid (hydrochloric acid) which can be purchased in quart or half gallon bottles at any hardware store works very well - shines up the metal. It's strong stuff, so wear rubber gloves and goggles and don't splash even tiny drops on your clothes - it burns holes immediately. Also, don't take a deep breath of the fumes - they are irritating to the lungs and throat.

I use it diluted half and half for general cleaning and full strength for tough spots. Work on a small area, rubbing with a small pad of fine steel wool or a rough cloth. Be sure to wash off the acid thoroughly with water when you are through with each area, and be careful not to get too close to fiber or rubber parts that may dissolve. Muriatic acid can also be brushed onto the contacts of

old tube sockets and other small parts to shine them up like new.

Thanks for publishing a fine newsletter, Jim. I wish you continued success.

Sincerely,  
Brian Belanger  
616 Nelson St.  
Rockville, Maryland 20850

## FIND

You and your readers may be interested in my most recent find in Antique Radios. A few months ago I was told that there were some old "I quote" "Doctor electric Quack Apparatus" if you are interested in it, it's upstairs in the attic, we will tear the house down tomorrow. Reluctantly said I'll drive out and take a look. When I arrived at the old house the Dozer was ready to push the house down. I ran up and found a Federal 59 and a Clapp-Eastham Tuner with the two step amplifier, the Federal was in excellent condition except for a layer of dust and dirt. The wrecking crew said they never knew that radios looked like that. And the best part didn't cost me a cent.

Cordially yours,  
Ralph G. Maddox  
Purgitsville W VA 26852

## on the air

### FEDERALS AT MEET

I thought you might like to hear the results of our last meet. We tried something different. At least for Buffalo it was different. We had a mid-winter meet! I guess the last Saturday in February is about as mid winter as you can get. There were no talks, just a get-together with club members to discuss recent acquisitions and a chance to see a very fine collection of antique radios.

The meet was at Ann and Dick Schamberger's nice home. As you may know, they have one of the best collections of Federal Telephone radios that you will see anywhere, plus a lot of other very rare and unusual items. About 35 people attended which we thought was very good for Buffalo in February, but I must admit that the weather cooperated very nicely. We even had a little flea market activity.

Now let me get back to Dick and Ann's Federal collection. I guess they must have just about every one of the early ones that Federal made,

and Federals are not all that easy to come by even when you live a few miles from the Federal plant like Dick and Ann.

I'm enclosing a few pictures, just in case you want to show your readers a few of the Federals. They were not known for performance but the appearance is very impressive as the photos show. They are therefore very nice to collect and are generally sold for a good price.

Now, getting back to Dick and Ann, the only early Federal that I can recall which they don't have is the Federal Junior Amplifier. And there are not many of them around. Dick and Ann had in their display the Federal 55 and 56 rf amplifiers, as well as the 57 and DX-58 receivers, also the type 59 and one that is very rare, the #60 tuner. They even showed us the No. 9-2 stage amplifiers and the No. 8 Detector and one stage amplifier. Of course we also saw a nice Federal #61 receiver and the Federal #110. They even included one prototype set which was never produced. It was a big fancy receiver similar to the 59 or 61.

Jim, probably by the time you have this our spring meet will be over, but let me tell you our plans for our summer meet. We are having a joint meet with the AWA here in Buffalo. As announced in the March AWA OTB, this meet will be held 16 August 1980. It will be on board a Naval destroyer in the new Buffalo Naval Park. The subject of the meet will be Crosley. The talks are going to be on Crosley and the equipment contest is on anything made by Crosley. The flea market will be held on shore in the Naval Park parking lot.

A catered luncheon will be served. Following the meet there will be a sponsored (free) cocktail party (wine and cheese) in the lobby of the Big "E" Bank in the Main Place Mall in downtown Buffalo. This party is open to all who attend the meet. Our club the NFWA, will have an extensive exhibit of our members antique radios displayed in the Bank lobby during the month of August and it may be viewed by everyone at the Cocktail party. The exhibit includes exhibits from the prebroadcast days to the early AC days and of course will include some nice examples of very early Crosley from Art Albion's and other members' collection.

We think this should be a great meet and it is of course open to anyone who wishes to attend. We know the cocktail party will be a success because we did the same thing two years ago and everyone including the wives thought it was great.

The pictures enclosed show just a few of the sets we saw at our last meet at Ann and Dick Schambergers. The AK breadboard is a very rare one, a real beauty! Also his Amrad re-

ceiver and amplifier is one you don't see every day. Finally there are pictures of five Federals including the Federal JR, #57, #58, #61 and 110.

Thanks for publishing a fine paper, Jim. Most of our members are subscribers. I always read the classified first, get my SASE's in the mail and then set down and read the rest of the Horn Speaker in detail. Incidentally, how about publishing or sending me info. on first class membership? Do you have such a service and what is the additional costs for mailing first class?

Cordially,  
Larry Babcock  
president, NFWA  
8095 Centre Ln.  
E. Amherst NY 14051

EDITOR... Thank you for a letter I know should be of interest to all readers. First class subscription is \$12.00 yearly. Please specify when ordering first class because two years at second class is also \$12.00.



CLUB MEMBERS AT THE NFWA COCKTAIL PARTY

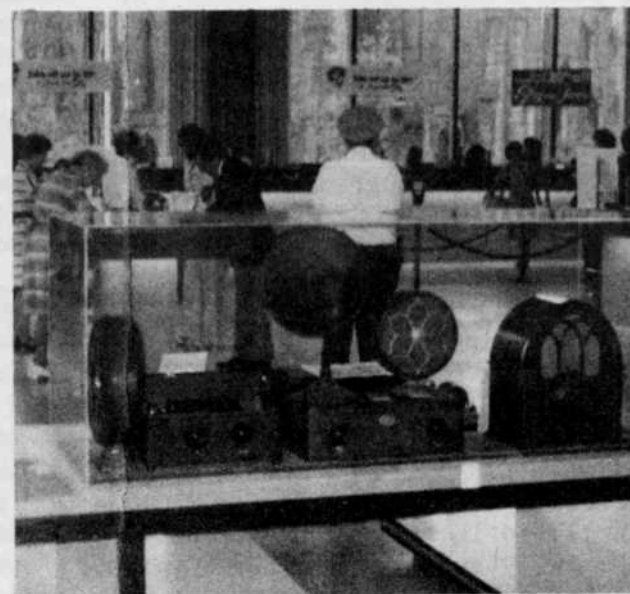

A BANK LOBBY IS AN EXCELLENT PLACE TO EXHIBIT RADIOS



FEDERAL 57

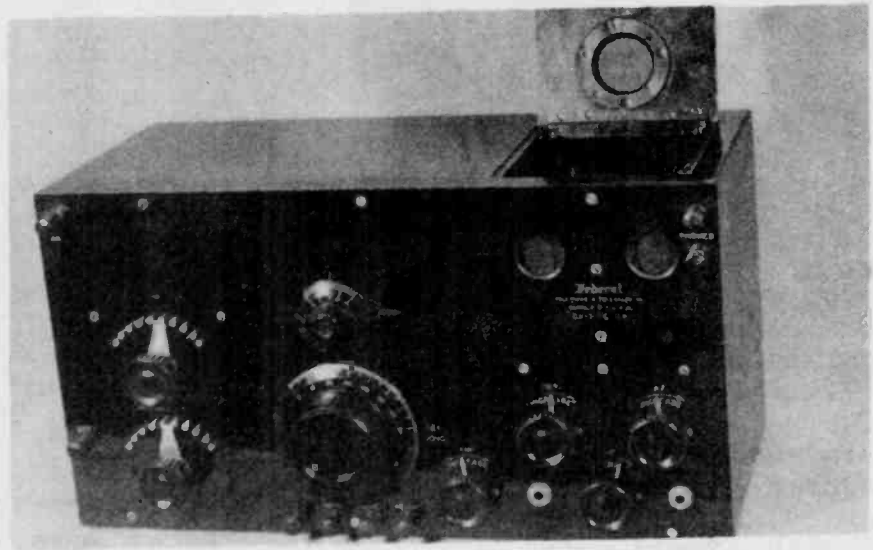

FEDERAL DX type 58

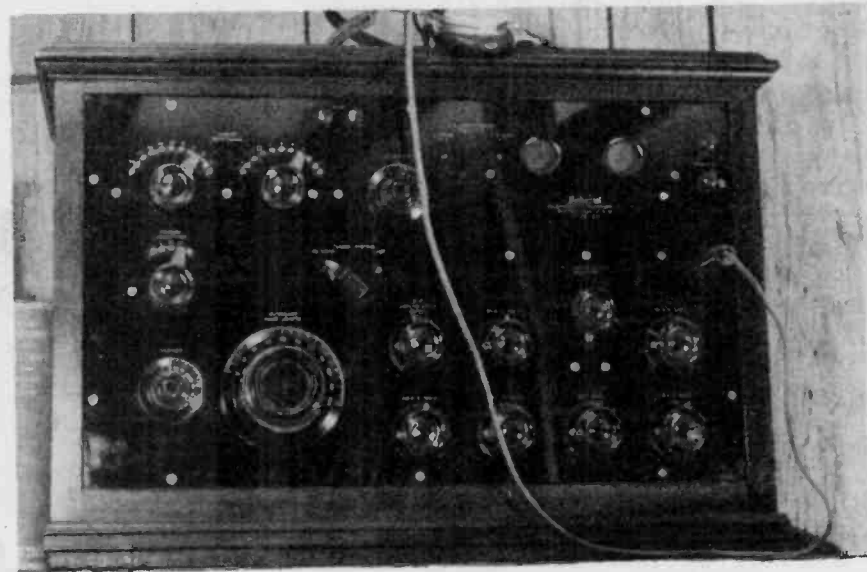

FEDERAL 61



FEDERAL type 110



FEDERAL JR. crystal set



# club news

## ANTIQUA RADIO CLUB OF ILLINOIS

Dr. Larry Wright sent some information about the newly formed club popularly called ARCI. This Club has already been incorporated under the state laws of Illinois. The first meet was at the Holiday Inn in Elgin, Illinois and the second meet was scheduled for the same place on Saturday, May 17, 1980 at 3:00 p.m. with a swap meet.

A club letter said, "The purpose of the club is to be a regional magnet that draws the members together so that they may carry on the activities of radio collecting. We encourage all types of radio collectors to participate whether they be primarily interested in AC sets, battery sets, consoles, T.V., or whatever."

For more information write to Dr. Larry Wright, secretary-treasurer, 131 Hilltop Drive, Lake in the Hills, IL 60102.

## HOUSTON VINTAGE

### RADIO ASSOCIATION

A lot of activity, all in one day, was scheduled for HVRA in the Herman Brown Auditorium at the Museum of Natural Science in Houston, TEXAS on May 17, 1980 from 9:00 a.m. to 5:00 p.m.

A one day vintage radio contest and auction is planned to keep radio collectors happily occupied for the day. For more information on this day or HRVA call Frank Cooper, 482-6781.

## DALLAS CLUBS

The new club, Antique Radio Collectors Club of Dallas, and the older and familiar Vintage Radio and Phonograph Association are each carrying on with activities. VRPS is concentrating on programs about radios and phonographs with little or no business at their monthly meetings. Basil Abbott gave the last talk, which was about crystal sets.

For local V R P S information call: Dave Medley, president, (214) 386-3982. For information about A R C C, which is concentrating on an informal gathering with demonstrations, shows, swap sessions and they need more enthusiasm; call: Walt Jackson at (214) 262 7855.

## ANTIQUA RADIO CLUB OF AMERICA

This year the ARCA WIRELESS Meet will be at a location that will surround radio collectors with history. The place is Mystic, Connecticut, in which the Mystic Seaport Museum, the nation's largest indoor-outdoor museum of American maritime history, can be visited.

The secretary of ARCA is: Mr. William Denk, 81 Steeplechase Road, Devon, PA 19333. For more information about the Meet see the page out of THE ANTIQUA RADIO GAZETTE, which describes the event.

## INDIANA HISTORICAL RADIO SOCIETY

Roger Rees, who won two second place prizes at the last IHR S Spring Meet on April 19, 1980, said that all went well and that

he really enjoyed it. Congratulation to I H R S for holding such a splendid event at Auburn, Indiana.

## SPERDVAC

Some radio collectors and music collectors have expressed an interest in the history of radio drama and the leading organization for that end seems to be the SOCIETY TO PRESERVE and ENCOURAGE RADIO DRAMA, VARIETY and COMEDY. For more information write: SPERDVAC, Box 1587, Hollywood, CA 90042.

## PHONOGRAPH CLUBS

More information is needed about clubs which specialize in the hobby of record and phonograph collecting. THE HORN SPEAKER will be glad to help the collectors who write about music clubs.

# ARCA WIRELESS MEET

ARCA'S 1980 ANNUAL CONFERENCE  
MYSTIC, CONNECTICUT  
MAY 29, 30, and 31.

Main events will be held at the Ramada Inn, in Mystic, located at Routes I-95 and 27. This is less than an hour's drive from the fabulous New England Museum of Wireless and Steam where we will have an Auction Saturday morning.



The Contest will be held Friday at Mystic and includes 10 classes.

1. Crystal Sets
2. Regenerative Receivers
3. Tuned Radio Frequency Sets
4. Superheterodynes
5. Other receivers not included above
6. Transmitters, both Tube & Spark
7. Maritime Radio Equipment. Bring a piece of equipment that was used in maritime service. A receiver or transmitter will fit this category, but a specialized device like a radio compass would be an outstanding entry.
8. Headphones

9. Landline Communications Equipment including ---- Telegraph, Telephone, and Wired System. A chance to display your related communications equipment.
10. Tube History. Entries in this category require the display of several tubes that tell a story. Some examples are: Bootleg triodes mounted to show names; a set of tubes tracing the development of the triode; a set of rectifiers showing the development of the 5Z3 from the 213; a set of tubes showing the development of getters; a set of tubes illustrating the development of the screen grid. The emphasis in this category is on a display of several tubes that any collector may have, rather than some extremely rare item. The quality of the display, and the effectiveness of the historical development illustrated, will count heavily in the judging of this category.



We plan to have four technical presentations on Friday. In the evening we are planning a slide show on phonographs. Saturday afternoon Mel Comer will conduct a Show and Tell, and in the evening there will be a banquet. Both events will be held at Mystic.

# WALTS EMPORIUM

909 N.E. 11th. Grand Prairie, Texas 75050  
Evenings 214-262-7855

ALL SOUNDERS, RELAYS, AND PONY RELAYS ARE USED. THEY HAVE BEEN CLEANED, BUT NOT POLISHED. FURTHER CLEANING AND FINISHING MAY BE DESIRED. MONEY BACK GUARANTEE IF NOT SATISFIED.

TELEGRAPH KEYS  
OLD...just like  
GrandPa used to have  
\$21.00



We will shut-down through the Summer months and see you in the next issue of "THE HORN SPEAKER" in September.

RELAYS...mainly goose neck types  
very good quality...\$40.00

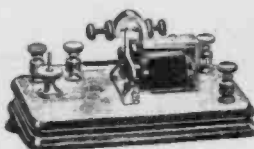

MANY COPIES OF THE TELEPHONE JOURNAL  
*Telephone (+) & (-)*  
1916  
CASE IF INTERESTED ---

**WANTED**  
★ CROSLY - #50 - #51 - #52  
OTHERS  
JUNKERS OR WORKING  
PARTS - CABINETS - PANELS  
★ MIKES OF THE 30s ---  
"8 BALL" ANYONE?  
★ ARRL HAND BOOKS TO 1933  
★ ALLIED RADIO TO 1935  
★ RCA SERVICE NOTES - ALL



June 6, 7 & 8, 1980,  
North Park Inn  
Dallas, Texas

### Indoor Air Conditioned Flea Market

This year's Flea Market will again be indoors in the air conditioned Exhibit Hall. You may reserve your space by sending \$5.00 per table along with your registration. This will assure you a spot. Tables will also be available for purchase at the door but only on a first come basis.

### ANTIQUE RADIO PROGRAM

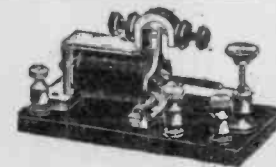

PONY RELAYS  
\$30.00

SOUNDERS...4 and 110 ohm, OLD checked, cleaned and re- to go...\$40

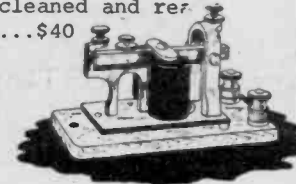

## Radios that Work for Free

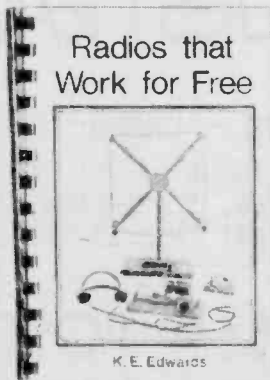

"Radios that Work for Free" is a "How to" book for all ages. This is the most comprehensive work of its kind. Not only does the reader get a new hobby, but the skills necessary to continue in a science and art that needs revival. The projects can be built from recycled junk on the kitchen table by the novice with assured success. Years of research and countless hours of experimentation have been accumulated to provide this base for the beginner. You will fill many hours building, listening and experimenting with "Radios that Work for Free."

### ORDER FORM

HOPE and ALLEN  
Publishing Company  
P. O. Box 535  
Belmont, California 94002



Please place my order for \_\_\_\_\_ copies of "Radios that Work for Free" by K. E. Edwards at \$5.00 per book. (CA. add 6% tax) Please add 50¢ for postage/shipping. Check must accompany order.

Ship to: \_\_\_\_\_  
\_\_\_\_\_  
\_\_\_\_\_

## IMPORTANT ANNOUNCEMENT

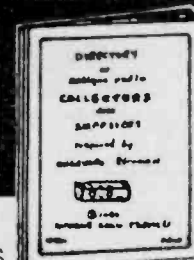

The newest DIRECTORY OF ANTIQUE RADIO COLLECTORS AND SUPPLIERS is now available. More than 400 listings are included in the national/international, state, foreign, and publications sections.

It's the most complete directory we know of. Now you can contact collectors and suppliers of antique radios, phonographs, parts and servicing info. in your home town and throughout the world.

Don't delay! This will be a limited edition. Order now.

### NO-RISK TRIAL ORDER COUPON

Please send me a copy of the new **DIRECTORY**. CD-4

Name \_\_\_\_\_  
Address \_\_\_\_\_  
City \_\_\_\_\_ State \_\_\_\_\_ Zip \_\_\_\_\_

ENCLOSE \$3. MAIL TO: Antique Radio Services  
646 Kenilworth Terrace  
Kenilworth, IL 60043

Satisfaction guaranteed or money back.

# NEW from

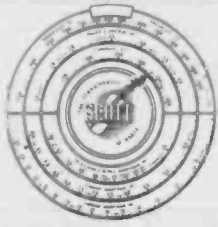

## PUETT ELECTRONICS

PUBLISHERS OF

P.O. BOX 28572 DALLAS TEXAS 75228

ANTIQUE RADIO TOPICS &

THE CLASSIC RADIO NEWSLETTER

### how to order:

- (1) MAKE ALL CHECKS OR MONEY ORDERS PAYABLE TO PUETT ELECTRONICS. ALL PAYMENTS MUST BE IN U.S. FUNDS AND NEGOTIABLE WITHOUT PAYMENT OF A BANK COLLECTION FEE. MONEY ORDERS ISSUED BY POST OFFICES IN CERTAIN COUNTRIES (CANADA FOR EXAMPLE) ARE ACCEPTABLE IF THEY CAN BE CASHED IN A U.S. POST OFFICE.
- (2) ALL ORDERS ARE POSTPAID AND INSURED. THE PRICE OF ALL ITEMS INCLUDES POSTAGE AND INSURANCE CHARGES.
- (3) TEXAS RESIDENTS ONLY - ADD 5% STATE SALES TAX. A HANDY ORDER BLANK IS INCLUDED ON THE BACK OF THIS LIST.
- (4) YOU CAN USE YOUR MASTER CHARGE OR VISA TO CHARGE YOUR PURCHASES. VISA CUSTOMERS SEND YOUR ACCOUNT NUMBER AND EXPIRATION DATE WITH YOUR ORDER. MASTER CHARGE CUSTOMERS SEND YOUR ACCOUNT NUMBER, YOUR INTERBANK NUMBER (above your name on your card) AND YOUR EXPIRATION DATE. WE MUST HAVE THIS INFORMATION IF YOU WISH TO CHARGE YOUR PURCHASES.



VOLUME 2 - \$7.95 POSTPAID

V/2 PRICE GUIDE - \$2.00 POSTPAID

## THE ENCYCLOPEDIA OF ANTIQUE RADIO

VOLUME 2 OF THE ENCYCLOPEDIA OF ANTIQUE RADIO IS A CONTINUATION OF THE REFERENCE MATERIAL FOUND IN VOLUME 1. THE ENCYCLOPEDIA IS A PANORAMA OF RADIO HISTORY ENCOMPASSING SPARK EQUIPMENT, CRYSTAL SETS, BATTERY POWERED AND AC POWERED RECEIVERS, TUBES, COMPONENTS AND TEST EQUIPMENT.



SECOND EDITION - \$3.00 POSTPAID

ADDENDUM SHEET - \$1.00 POSTPAID

## DIRECTORY BY JWF PUETT OF ANTIQUERADIO SERVICES

THE DIRECTORY OF ANTIQUE RADIO SERVICES LISTS SOURCES THROUGHOUT THE U.S.A. AND IN OTHER COUNTRIES. DEALERS IN ANTIQUE RADIO MERCHANDISE AND SERVICES ARE LISTED.

IF YOU ALREADY HAVE A COPY OF THE FIRST EDITION OF THE DIRECTORY --- THERE IS NO NEED TO PURCHASE A COPY OF THE SECOND. THE ADDENDUM SHEET LISTS 33 NEW SOURCES PLUS ERRATA AND NUMEROUS ITEMS.



## 48 TUBES THE WORLD'S LARGEST RADIO

THE ULTIMATE SCOTT RADIO RECEIVER - FULLY DESCRIBED - ORDER TODAY!

WE HAVE CAREFULLY REPRODUCED EVERY DETAIL OF THE APRIL 1936 ISSUE OF THE SCOTT NEWS. THIS RADIO RECEIVER CONSISTS OF 4 LARGE CHROME-PLATED CHASSIES, 5 SPEAKERS, AND A RECORD CUTTING AND RECORD PLAY-BACK TURNTABLE. WE BELIEVE THAT THIS IS THE LARGEST RADIO RECEIVER EVER MANUFACTURED.

IT IS VERY DIFFICULT TO TELL OUR REPRODUCTION FROM THE ORIGINAL 1936 COPY.

ONLY \$4.00 POSTPAID

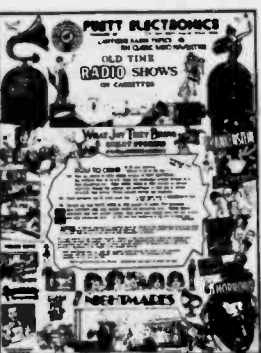

**ANNOUNCING...** 700 MORE THAN 500 NEW RADIO SHOWS!

OLD TIME  
**RADIO SHOWS**  
ON CASSETTES

SEND TWO 15¢ STAMPS FOR OUR NEW LIST TODAY! OUR NEW LISTINGS INCLUDE:

AMOS & ANDY, FIBBER MCGEE & MOLLY, I LOVE A MYSTERY - TEMPLE OF VAMPIRES (complete), ABBOT & COSTELLO, X MINUS ONE, DIMENSION X, MERCURY THEATER, STAN FREEBERG, DUFFY'S TAVERN, BABY SNOOKS, JACK BENNY, GANGBUSTERS, SUPERMAN, THE AVENGER, CRIME CLUB, SAM SPADE, LUM & ABNER, THE LUX RADIO THEATER, SUSPENSE, THE SHADOW, THE GREEN HORNET, DRAGNET, I LOVE ADVENTURE, THE BICKERSONS, THE GREAT GILDERSLEEVE, FRED ALLEN, ESCAPE, RICHARD DIAMOND, CHARLIE MCCARTHY, and many many more!!!



# THE ENCYCLOPEDIA OF ANTIQUE RADIO

VOLUME 2

BY JWF PUETT

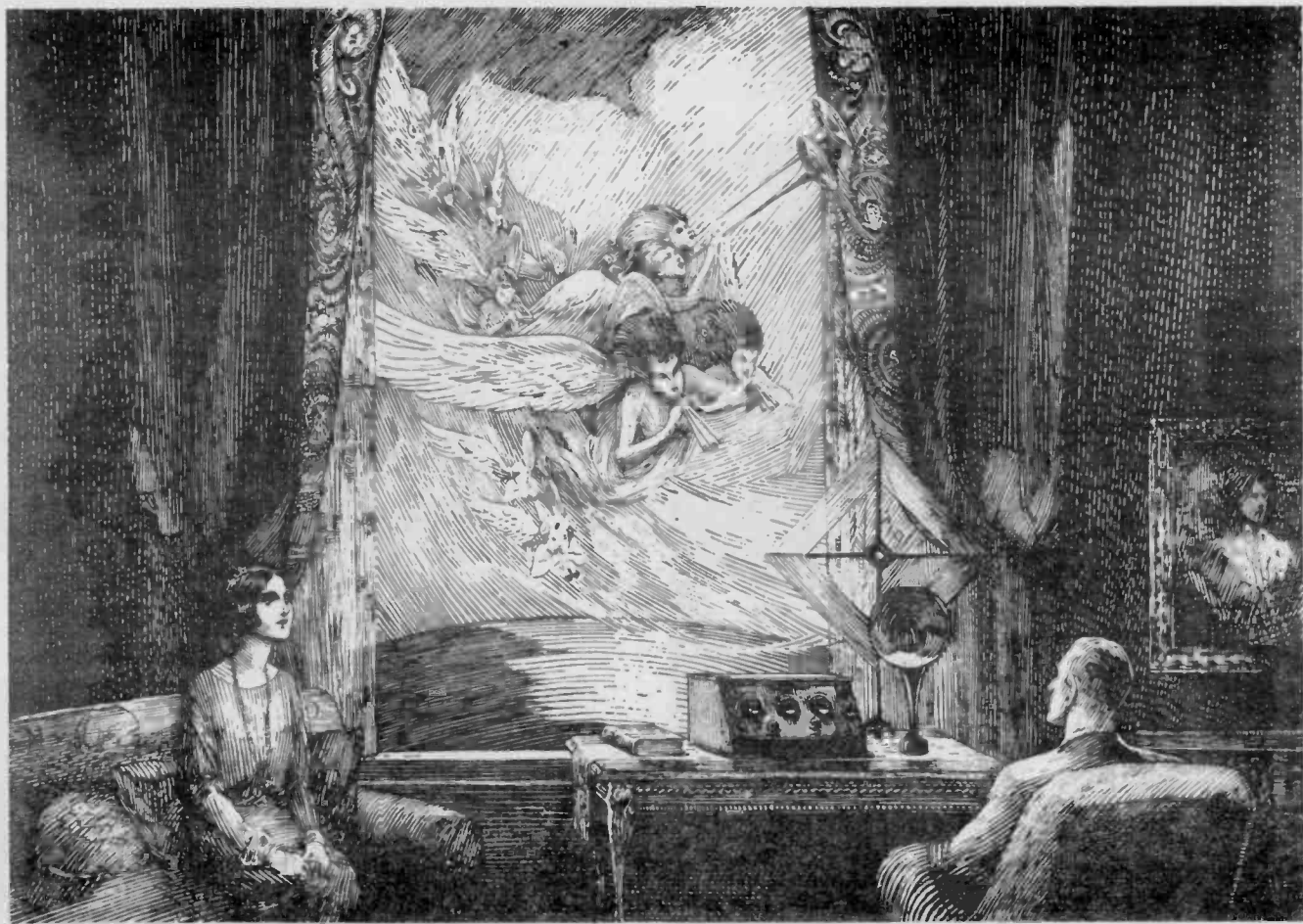

**PUETT ELECTRONICS**

PUBLISHERS OF

P.O. BOX 28572 DALLAS TEXAS 75228

ANTIQUÉ RADIO TOPICS &  
THE CLASSIC RADIO NEWSLETTER

VOLUME 2 OF THE ENCYCLOPEDIA OF ANTIQUE RADIO WILL BE READY FOR SHIPMENT 15 MAY 1980!!!

SPECIAL OFFER --- THE REGULAR PRICE FOR VOLUME 2 WILL BE \$7.95, AND THE PRICE GUIDE WILL BE \$2.00,

IF YOUR ORDER IS RECEIVED BEFORE 1 JUNE 1980, YOU MAY ORDER VOLUME 2 ONLY AT \$6.95,

OR YOU MAY ORDER VOLUME 2 AND THE PRICE GUIDE FOR ONLY \$8.95!!!!!!

WE HAVE EXPERIENCED A SMALL DELAY IN PRODUCTION (FROM MAY 1 ST. TO MAY 15 TH.), BUT IN SO DOING, WE ARE ABLE TO PASS THIS SPECIAL SAVINGS ON TO YOU, OUR CUSTOMERS.

# Wanted To Buy

Cash - Paid

## AC RADIOS 1 or 100

Cash - Paid

Will Pick-Up or Arrange Shipping

Radio - Clocks

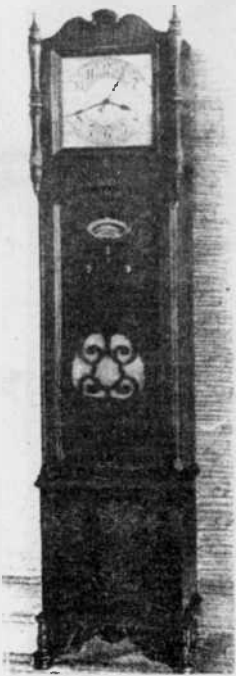

Mirror - Radios



Sparton 1936 Line

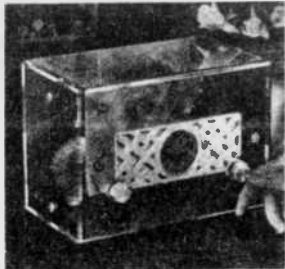

Giffman "Glass" Radio

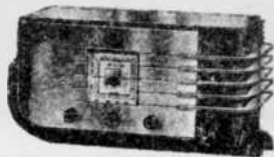

Model 557  
5 Tubes

Zenith Stratosphere  
Radio #2501 PC



Chrome & Wood  
Radios

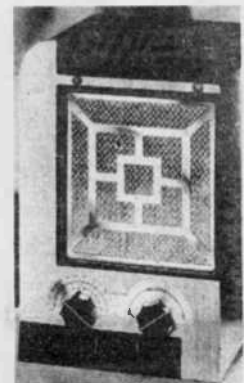

Majestic Model 49

Cathedral or Mantel Radios



Colored Radios



Large Zenith  
Table Radios



Dual-Tuner Radios



Nate Alexander, Jr.  
P.O. Box 866  
Milwaukee, Wisconsin 53201  
1-414-276-6773

Zenith Stratosphere  
Radio #2501 PC



18 or 25 tube

# Wanted To Buy

Radios by E. H. Scott and McMurdo Silver and I want the Zenith Stratosphere

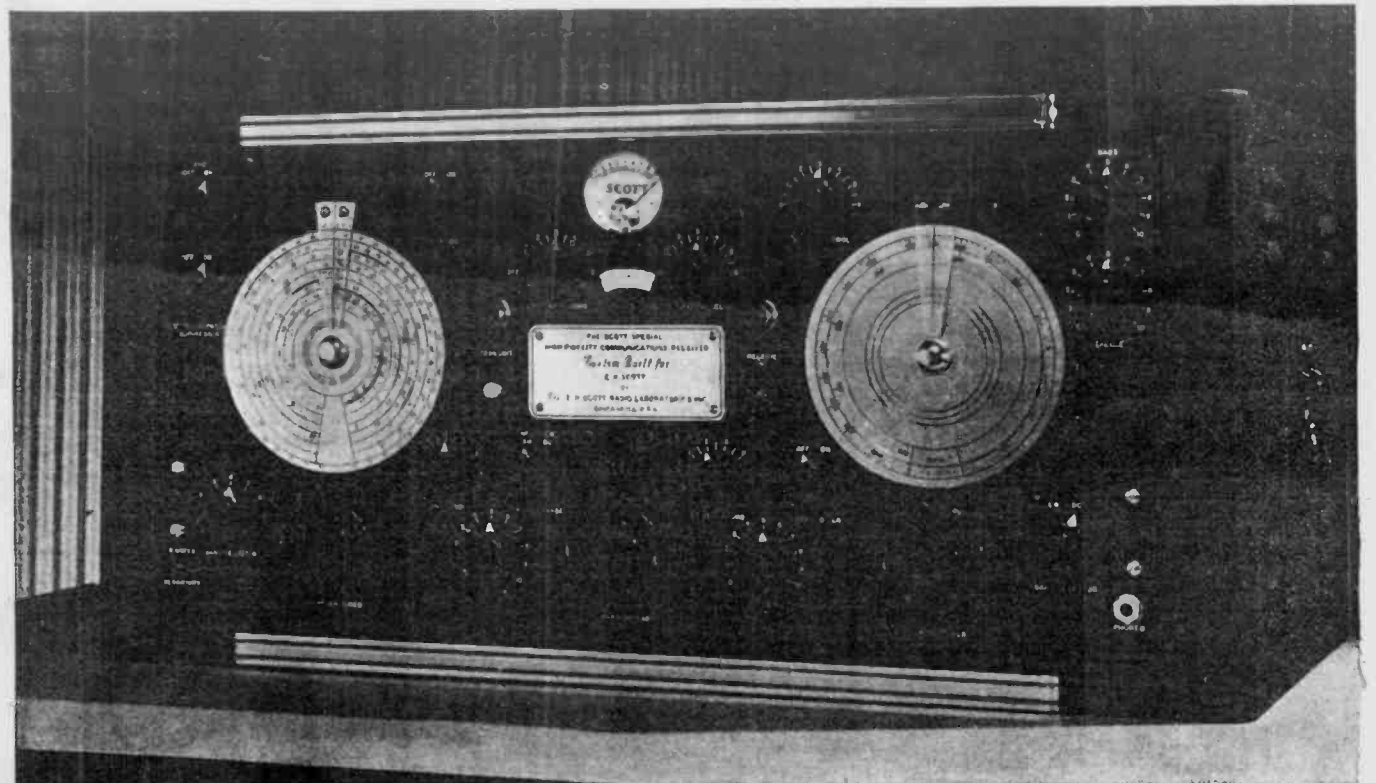

The Dual Tuning Chassis of the Special High Fidelity Communications Receiver

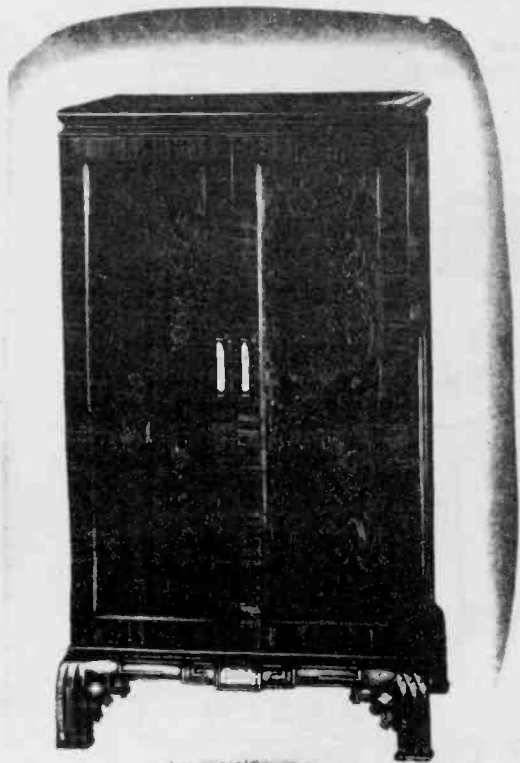

*The Roslyn Grande*

## The Scott Communication Receiver

NEED NOT WORK BUT MUST BE ORIGINAL  
AND COMPLETE

ROGER REES  
P. O. Box 4154  
Rockford, IL 61110

(815) 964-8199

# SCOTT

Also looking for radios by Leutz and Norden Hauck

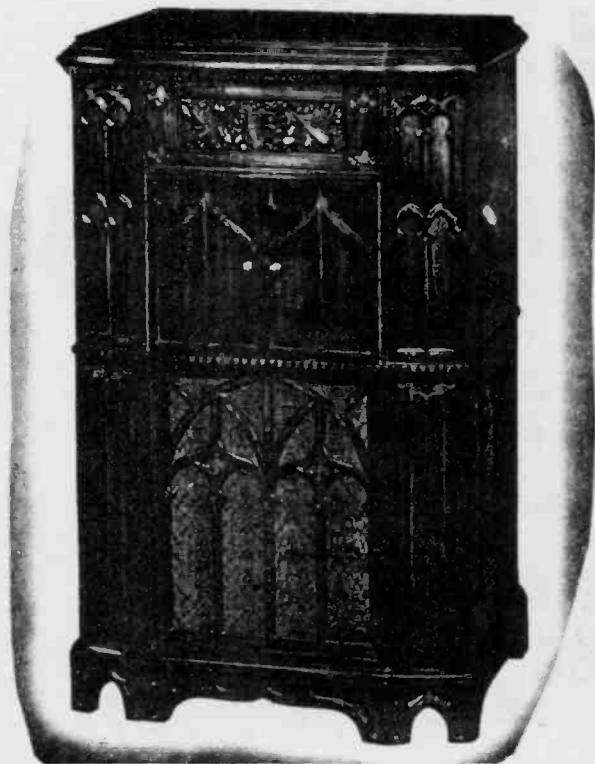

*The Gothic Grande*

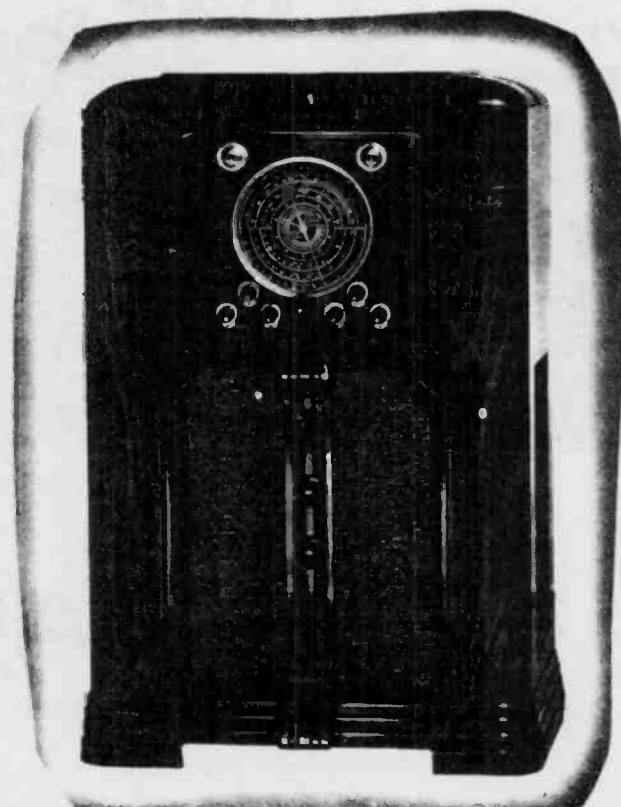

*The Warrington*

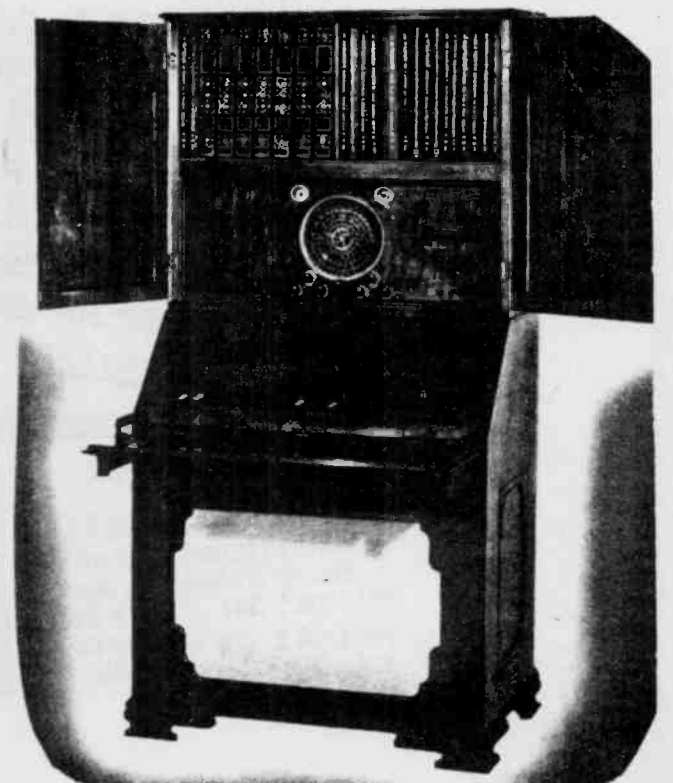

*The Secretaire*



# 1980 OLDE TYME RADIO SPECIALS

JUST IN!  
NEW SUPPLY  
ANTIQUE HEADPHONES  
GROUP A  
COMMON TYPES \$2.50 EA  
GROUP B  
DESIRED TYPES  
AUTO RADIO VIBRATORS \$3.00 EA



ELECTROLYTICS F.P. TYPE

Cap. in MFDs	Working Vols.	PRICE
1/20x40	150V	\$1.00 EA
80x100x40	150V	
80x40x40	250V	
20x20x20	200V	
30x20x20	450V	

BROWN SILK TYPE  
POWER CORD .25/FT  
OLDE TYME TEST EQUIPMENT  
WRITE US

OLDE TYME SINGLE  
CONDUCTOR CLOTH  
INSULATED WIRE.  
ASSORTED COLORS  
.12/ft

- OLDE TYME BAKELITE BINDING POSTS (SINGLES) .50EA OR 3/\$1.00
- OLDE TYME BAKELITE BINDING POSTS (TRIPLES) \$1.00 EA OR 3/2.50
- OLDE TYME RADIO PANEL LAMPS 2.5V, 3.0V, 6.3V SCREW BASE OR BAYONNETTE STATE YOUR NEEDS
- INTERSTAGE & OUTPUT TRANSFORMERS \$4.00 EA
- OLDE TYME PORTABLE CABINET HARDWARE  
WRITE

TUBES - FROM THE '20'S, '30'S, '40'S & '50'S.  
USED & BRAND NEW  
MOST TYPES

ALL TUBES TESTED  
{USED} WRITE FOR  
{NEW} QUOTE

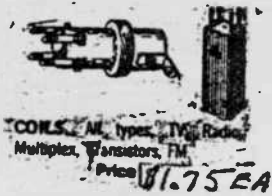

COILS - All types, TV, Radio, Multiplex, Transistors, FM  
Price \$1.75 EA



ELECTROLYTIC CONDENSERS. F.P. types, tubular types. Single and multiple sections.  
Price \$1.00 EA

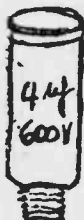

OLDE TYME SCREW BASE CAPACITORS POPULAR MFR  
\$2.00 EA

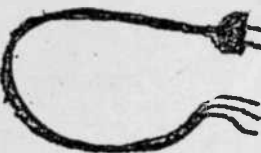

RESISTOR LINE CORD REPLACEMENT KITS FOR USE WITH SETS EMPLOYING 0.3A TUBES (6A7, 6DG, 75, 43, 2525 ETC)  
MODEL

- RLC-1 4-TUBE SETS \$3.50
- RLC-2 5-TUBE SETS \$4.50

FOR OTHER COMBINATIONS PLEASE WRITE FOR DETAILS

## TRANSFORMERS

A large variety of transformers; most types in substantial quantities.



## POWER TRANSFORMERS

- STANCOR PRI: 117VAC
- SER:
- 1) 350-0-350V @ 70MA.
- 2) 5.0V @ 2.0A
- 3) 6.3V @ 2.0A
- OTHERS



PRICE \$9.50 EA  
BRAND NEW



BRAND NEW I.F. TRANSFORMERS 175KC AND OTHER POPULAR FREQUENCIES \$2.50 EA  
OSC. COILS 175KC AND OTHER POPULAR FREQUENCIES \$2.00 EA

## OLDE TYME RADIO BATTERY CABRE COMING SOON WATCH OUR AD

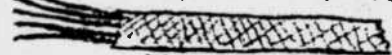

5 CONDUCTOR BROWN - ALL CLOTH AT WATER KENT STYLE

## NOW AVAILABLE

6 CONDUCTOR BROWN ALL CLOTH AT WATER KENT STYLE \$1.00 PER FOOT  
BROWN SILK STYLE POWER WIRE .25/FT

PLACE YOUR ORDER NOW

SCHEMATICS FOR SETS MANUFACTURED FROM 1920 THRU 1940 \$1.50

## ORDER FROM:

OLDE TYME RADIO CO.  
2445 LYTONSVILLE RD.  
SILVER SPRING, MD. 20910  
PHONE: 301 585 8776  
PRICES DO NOT INCLUDE SHIPPING & HANDLING CHG.

**S. LEONARD**  
**WANTED!**

Horn phonographs music boxes  
crank organs, daguerreotypes, clocks,  
old mechanical toys, battery toys,  
Bought, sold, traded and serviced.

P.O. Box 127  
Albertson, L.I.,  
N.Y. 11507  
U. S. A.  
(516) 742-0979

**RATES FOR THE HORN SPEAKER**  
One year.....\$7.00  
Two years.....\$12.00  
Special rates for one year  
First class.....\$12.00  
Foreign air mail.\$16.00



Classified ad rate: 6¢ per word  
Photo ads: \$2.00 extra  
Deadline: 20th of the preceding month.

List ads - 35¢ per line

**AD SPACE:**  
full page.....\$50.00  
half page.....\$25.00  
quarter page..\$12.50  
multiple runs.....  
20% discount

\*\*\*\*\*  
FOR SALE: CATHEDRAL, battery and AC radios from 1930s. Please send large SASE. Sumter Hickman, 1008 W. 10th Street, Plainview, Texas 79072.  
\*\*\*\*\*



LIKE NEW 1974 SONY am/fm matrix stereo portable radio. Has 3 speakers. Model # MR-9400W. Can't tell from new. \$65.00. I'll pay U.P.S. Mike Hanke, 1036 S. 15th Avenue, Wausau, WI 54401.  
\*\*\*\*\*

**FOR SALE OR TRADE**

\*\*\*\*\*  
TRADE: KENNEDY 281 for Hallcrafters ultra-Skyrider SX-10 receiver. May consider clean S-36 Military version. Ross Smith, 1133 Strong, Elkhart, IN 46514.  
\*\*\*\*\*

FOR SALE: ANTIQUE RADIO COLLECTION, mostly 1920's. Reasonable. S.A.S.E. for list. J. Manion, 60 Winnet Dr., Dayton OH 45415  
Phone: 513 275-3945.  
\*\*\*\*\*

**TELKOM ROARING '20's DECORATOR TELEPHONE**



NEW ROARING 20'S DECORATOR TELEPHONE. ROTARY DIAL AND RINGER WITH VOLUME CONTROL. FCC APPROVED, MODULAR PLUG. COLOR: IVORY, ORDER TODAY. \$89.95 POSTPAID. KEITH ELECTRONICS, 209 BELLEFONTE AVE., LOCK HAVEN, PA 17745  
\*\*\*\*\*  
FOR SALE OR TRADE. HAVE SEVERAL CATHEDRAL RADIOS. They are in good to excellent condition. Will trade for battery type radios only. Ralph G. Maddox, Vali-HI Farm, Purgitsville, WV 26852. Tel. (304) 289-3069.  
\*\*\*\*\*

\*\*\*\*\*  
REPAIRS MADE ON ANTIQUE CRANK-TYPE PHONOGRAPHS. Sound reproducers overhauled. Springs repaired. Also WANTED any parts to these phonographs. John Nagy, Route 1, Box 135, Walcott, IA 52773. (319) 843-2108 evenings.  
\*\*\*\*\*  
WANT TO REPAIR SETS that you cannot. Meticulous work always done. Hand-rubbed-varnish refinishing services available. Twenty years experience. WANT several RIDER manuals. Maury Zivitz, Ph. D., 11503 Atwell Dr. Houston, TX 77035. (713) 723-4254, after 3.  
\*\*\*\*\*

FOR SALE: RCS-728 power supply now in 9th year of manufacture. Do you have yours yet? Send SASE for spec sheet to: Gary Schneider, 6848 Commonwealth, Parma Hgts., Ohio 44130..  
\*\*\*\*\*

**FOR SALE OR TRADE**



radio horns for sale 48 of them priced from \$20. each to \$225. each. Send \$1.00 for list of 'old radios. To Charles Seidel, 925 Starlite, Grants Pass OR 97526. 503 476-1078.  
\*\*\*\*\*  
20s BATTERY SETS, HORNS, 29-39 AC sets. Parts AK components. SASE for list. Wards Wireless Waves, 301 SW 16 St., Fort Lauderdale FL 33315.  
\*\*\*\*\*

FOR SALE: RIDER'S TV MANUALS, vols. 3 through 20. \$9.00 each, \$8. for four or more, \$7. for ten. Postage additional. Alan Smith, Stonehedge, Lincoln MA 01773. Telephone 617 259-9351.  
\*\*\*\*\*

ATTENTION TESLA ENTHUSIASTS\* Information on Tesla is difficult to obtain. Now there is a magazine for Tesla historians and electrical experimenters:\*\*\*\*\* TESLA'S TECHNOLOGY\*\*\*\*\*. Published 6 times yearly; 8 1/2" by 11", nicely printed, Each issue contains; feature article, reprint of old Tesla article, Tesla patent, serial articles, notices. Subscription \$10.00 yearly. Tesla Research Society, 151 Grofftown Road, Lancaster, Pa 17602.  
\*\*\*\*\*

**BACK ISSUES**

**ORDER NOW!**

- All 10 for 1073...\$8.00  
Single..\$1.00
- All 10 for 1974...\$6.00  
Single..75¢
- All 10 for 1975...\$5.00  
Single..75¢
- All 10 for 1976...\$5.00  
Single..75¢
- All 10 for 1977...\$5.00  
Single..75¢
- All 10 for 1978...\$5.00  
Single..75¢
- Single issue for 1979....\$1.00  
50¢

THE HORN SPEAKER  
Box 53012  
Dallas, Texas 75253

**FOR SALE OR TRADE**

\*\*\*\*\*  
 FOR SALE: ANTIQUE RADIO COLLECT-  
 ION, mostly 1920's. Reasonable.  
 S.A.S.E. for list. J. Manion,  
 60 Winnet Dr., Dayton OH 45415  
 Phone: 513 275-3945.  
 \*\*\*\*\*  
 FOR SALE: RADIOLA VIII in ex-  
 cellent condition complete with  
 tubes, \$100.00. Louis Yadevia,  
 601 Church La., Upper Darby PA  
 19082.  
 \*\*\*\*\*

**FOR SALE OR TRADE**

\*\*\*\*\*  
 FOR SALE OR TRADE: Edison T-  
 shirts and tote bags! Send for  
 descriptive flyer. Phonograph  
 postcards, send stamp for sample  
 New Amberola, 37 Caledonia, St.  
 Johnsbury VT 05819...  
 \*\*\*\*\*  
 I SELL AND REPAIR OLD TIME RADI-  
 OS - 1930's - 1960's and carry  
 tubes for them. (216) 879-5936  
 weekdays 9 to 5 - GENE'S RADIO

**FOR SALE OR TRADE**

& TV SERVICE, 4334 Erie, Navarre  
 OH 44662.  
 \*\*\*\*\*  
 COMPLETE LINE OF DIAMOND NEEDLES  
 for juke boxes; AMI, Rock-ola,  
 Seeburg, Wurlitzer. Please  
 write for listing and prices.  
 KEITH ELECTRONICS, Lock Haven,  
 PA 17745 Phone (717) 748-7163  
 ..\*\*\*\*\*  
 FOR SALE : EARLY BATTERY AND AC  
 RADIOS PLUS MANY RELATED ITEMS.  
 BROWN AND BLACK SPEAKER CORDS,  
 ALSO THE RADIOLA 17-18 DIAL LITE  
 HOOD "MAKE IT YOURSELF" INSTRU-  
 CTIONS AND TAB MATERIALS ARE  
 STILL AVAILABLE. A LARGE SASE  
 PLUS A 15 CENT STAMP WILL BRING  
 LIST READY MAY 15TH. FRANKLIN  
 C. HASS, 207 WEST 30TH, HUTCH-  
 INSON, KS 67501.  
 \*\*\*\*\*

**For sale Battery**

- RCA III W/manual .....\$65
- IIIA " " .....\$75
- RC W/instructions.....\$200
- Crosley 51 .....\$75
- Freshman V.R. p 89(top) .....\$55
- Ac
- RCA Coinop .....\$35
- 143 nice, hum no sound .....\$35
- small Brunswick cathedral,not work \$30
- Philco 38A 2volt model .....\$75
- 70 nice restored .....\$125
- 90 " " .....\$160
- 20 " " .....\$120
- 18 " " .....\$160
- 16 " Working .....\$130
- Crosley 124 restored .....\$140
- 167 nice working .....\$90

**Speakers**

- Horns**
- Music Master 14" reglued.....\$75
- RCA 1325 .....\$50
- Tower .....\$40
- Atlas .....\$30
- AK M,L, .....\$45 ea
- Herald .....\$60
- Remo trumpet concert .....\$110
- Magnavox M-1,4 \$50ea.. R-2,3 \$95ea
- Western Electric 518-W .....\$90
- Miller(like small AK H).....\$75
- Akerman (small WE 518W) .....\$75
- Stromberg 1A base (wood) .....\$30
- Thorola base and spare driver .....\$40
- Others**
- Music Master wood box (mint) .....\$35
- RCA 103 .....\$35
- 100A .....\$20
- 100 .....\$25
- Ak E2 \$35 , E \$35 , E3 \$50
- Teletone \$15
- Operadio \$45
- Graybar .....\$10
- Sonochord .....\$15
- FADA dynamic .....\$15
- Bremer Tully .....\$15
- Peerless .....\$20
- Base and driver for large floor stand cone \$30

D. S. Dexter, 151 Hudson Street,  
 New York City, NY 10013.  
 (212) 226-4885 eve + W.E.



BEAUTIFUL REPRODUCTION DeFOREST  
 DEALER SIGN in dark blue, light  
 blue, white and orange colors.  
 Professionally silk screened on  
 13" by 19" galvanized sheet met-  
 al stock. Sample color photo -  
 \$1.00 refundable with purchase  
 and return. Price is a modest  
 \$60. ppd. Don Patterson, 636  
 Cambridge Rd., Augusta, GA 30909  
 \*\*\*\*\*

FOR SALE OR TRADE: OLD RADIO  
 BOOKS, next 5 sales lists for a  
 \$1.00. RADIOGRAPHICS BOOKS, Box  
 18492, Cleveland Heights, OH....  
 44118. ....  
 \*\*\*\*\*

FOR SALE: CATHEDRAL, BATTERY  
 and AC RADIOS from 1920's and  
 1930's. Please send large en-  
 velope with two stamps. J. Al-  
 bert Warren, Box279, Church St.,  
 Waverly, PA 18471. ..  
 \*\*\*\*\*

LAST CALL ON "ANTIQUE RADIO  
 BROADCASTER" unit which allows  
 you to play old time radio cas-  
 settes by wireless through your  
 vintage radio. I won't build any  
 more after May 31st (moving). S.  
 A.S.E. for info or send \$39.95  
 to: H. Burke, 1201 Happy Hollow,  
 Plattsmouth, NE 68048.  
 \*\*\*\*\*

PARTING OUT a 1925 GREBE MU-1  
 SYNCHROPHASE. mostly chassis,  
 panel and cabinet parts avail-



**FOR SALE OR TRADE**

able. H. Burke, 1201 Happy Hollow, Plattsmouth, NE 68048.

\*\*\*\*\*  
FOR SALE: ROLA CONE SPEAKER, W.E. 6368 horn speaker, Philco 90, Federal DX-58, SASE, W6THU, 1545 Raymond, Glendale, CA 91201.

\*\*\*\*\*  
FOR SALE: AUTHENTIC REPLICAS: FRONT PLATES FOR AK VARIO COUPLERS, VARIOMETERS, TYPE 11 TUNER, DIALS, KNOBS, POINTERS, BINDING POST NUTS, PUSH BUTTONS, BELT DRIVE PULLEYS FOR AK AND MUCH MORE. SASE FOR LISTINGS. K. PARRY, 17557 Horace, Granada Hills, CA 91344.

\*\*\*\*\*  
RIDERS RADIO MANUALS 6-16 eleven volumes \$10.00 each. Radio diagrams \$1.25 each. Give make and model no. Phonograph needles pak of 25 for 90 cents. Willis Housel, 1640 S. 38, Lincoln, Nebr. 68506.

\*\*\*\*\*  
SALE: CATHEDRAL RADIOS \$45 to \$65, working. Edison records, cylinder and disc \$1.50 to \$2.00 each. Battery radios at good prices. Sen S.A.S.E. for free list to Arthur Harrison, 1021 Falcon Drive, Columbus, MO 65201

\*\*\*\*\*  
SELL LARGE COLLECTION OF BATTERY RADIOS, OLD RADIO PARTS, MAGAZINES, ETC. SASE FOR LIST. BILL LAVERTY, RD 1, BOX 62K, EGG HARBOR, NJ 08215.

\*\*\*\*\*  
ADAMS MORGAN (PARAGON) 1922 catalog reprint. VT control, crystal, radios, transmitter,, etc. 16 pages illustrated, \$2.95 ea. plus .50 handling mailing. Cecil Bounds, Pine Springs Rte. Carlsbad, NM 88220.

\*\*\*\*\*

**WANTED**

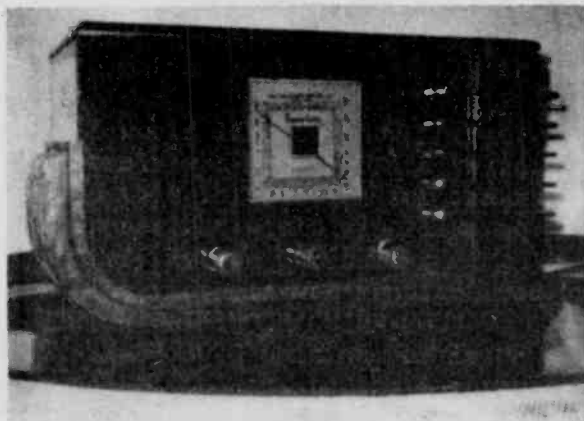

COLORED MIRRORED RADIOS (blue, peach and green) wanted by obsessed collector. I'm also interested in colored mirrored clocks. Can use any unusual items from art deco period, such as chrome radios, etc. Also wanted: Philco Predicta television sets, ccin operated radios. Barbara Groton, Box 1252, Dayton, OH 45401. (513) 253-5073 evenings.

.....  
WANTED: WIRE RECORDERS: Armour, Brush, unusual types only. Also: VLF Signal Simulator, c.1968, pre-1940 TV literature. H. Lyster, AV-SFSU, 1600 Holloway, San Francisco, CA 94132.

.....  
WANTED: HALLICRAFTERS, manuals, books, catalogs, advertising items, accessories, parts. G. Barber, P.O. Box 31654, Aurora, CO 80041.

.....  
WANTED: CAR RADIOS 1929-1957 original types. Also any parts, literature and associated items, vibrators, antennas, etc. Cash paid. Please price and describe. Marvin Roth, 14500 LaBelle, Oak Park, Michigan 48237

.....

**WANTED**

RADIOLA III, III-A, balanul amp. Aeriola Sr., Jr. & amp. in good condition. Have large quantities of 201-A & 301-A tubes for trade Bruce Harbeck, 1316-38th St. Sioux City, IA 51104 (712) 258-6855 evenings.

-----  
ANY INFORMATION ON CRACKLE-BASE PAINT FINISH. ALSO BRUSH-on WRINKLE PAINT MANUFACTURE. INFORMED OF TWO-LACQUER SLOW AND FAST DRYING COAT PROCESS, BUT NO SPECIFICS. DARCY BROWNRIGG CHELSEA, QUEBEC; JOX 1N0 CANADA

-----  
RAYTHEON TELEVISOR LAMP for Jenkins Scanning Disc TV. Top price paid for scanners. Bill Russell, 6463 1/2 Fulton Ave. Van Nuys, CA 91401 (213) 989-4086.

-----  
PHILCO JR. SUPERHETERODYNE model 80 radio, with or without cabinet. Also any type of literature on grandfather clock radios. W. Peters, 163 S. Broadway, Lindenhurst, NY 11757

-----  
WANTED CRYSTAL SETS: BABY GRAND AIRPHONE GOLD GRAIN, COMMERCE RADIOPHONE, REMLER, G.E. ER-753, VICTOR, TWO CIRCUIT, MEEPON, NATIONAL RADIOPHONE, AEREX, LEMCO, BROWNIE, RAD-SCO, C.D.T., STANFORD ELECTRIC, AERIOLA X, MULTIPHONE, BETTA-PHONE, PHILMORE, WORLD, A.C. GILBERT, GREGSOR, HOWE, -- DARCY BROWNRIGG, CHELSEA, QUEBEC, JOX 1N0 CANADA

-----  
WANTED: CANADIAN COLLECTORS' ATTENTION! CANADIAN GENERAL ELECTRIC, MONTREAL QUEBEC; ANY AND ALL RADIO ADVERTISING AND SERVICING LITERATURE UP TO 1948. I WILL COPY YOUR ORIGINALS, IF AGREEABLE. DARCY BROWNRIGG CHELSEA, QUEBEC, JOX 1N0 CANADA

.....  
WANTED: 6CD7, 6AF7 or EM34 TUNING-EYE TUBE. Ron Boucher, 376 Cilley Rd. Manchester, NH 03103, Must be in good condition.

-----  
EARLY FANS, TABLE, ceiling, floor standing, etc., especially open motor Edison, Mesco or odd or unusual types. Richard Cane, 8391 N. W. 21st St., Sunrise, FL 33322.

.....  
WANTED: COMMERCIAL RADIO telegraph eqpt., receivers and transmitters. Also want wire telegraph apparatus keys, relays and sounders. Also want high speed Bomey telegraph equipment. Ralph G. Maddox, Vali-Hi Farm, Purgitsville, WV 26852 Telephone (304) 289-3069.

.....

KEEP THE ADS COMING

*"Wanted:*

*MILITARY RADIOS BEGINNING WITH THE LETTERS "SS" - (EXAMPLE SSTR-1); MILITARY RADIOS BUILT INSIDE COMMERCIAL STYLE SUITCASES; SMALL MILITARY RADIOS; RS-6.*

*MELTON, BOX 2037, OGDEN, UTAH - (801)-394-3290*

*"*

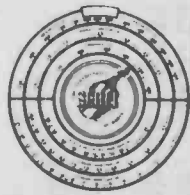

# PUETT ELECTRONICS

PUBLISHERS OF P.O. BOX 28572 DALLAS TEXAS 75228

ANTIQUE RADIO TOPICS

THE CLASSIC RADIO NEWSLETTER

LIST NO. 18A

### how to order:

(1) MAKE ALL CHECKS OR MONEY ORDERS PAYABLE TO PUETT ELECTRONICS. ALL PAYMENTS MUST BE IN U.S. FUNDS AND NEGOTIABLE WITHOUT PAYMENT OF A BANK COLLECTION FEE. MONEY ORDERS ISSUED BY POST OFFICES IN CERTAIN COUNTRIES (CANADA FOR EXAMPLE) ARE ACCEPTABLE IF THEY CAN BE CASHED IN A U.S. POST OFFICE.

(2) ALL ORDERS ARE POSTPAID AND INSURED. THE PRICE OF ALL ITEMS INCLUDES POSTAGE AND INSURANCE CHARGES.

(3) TEXAS RESIDENTS ONLY - ADD 5% STATE SALES TAX.

(4) YOU CAN USE YOUR MASTER CHARGE OR VISA TO CHARGE YOUR PURCHASES. VISA CUSTOMERS SEND YOUR ACCOUNT NUMBER AND EXPIRATION DATE WITH YOUR ORDER. MASTER CHARGE CUSTOMERS SEND YOUR ACCOUNT NUMBER, YOUR INTERBANK NUMBER (above your name on your card) AND YOUR EXPIRATION DATE. WE MUST HAVE THIS INFORMATION IF YOU WISH TO CHARGE YOUR PURCHASES.

**IN A HURRY!** You may call J. W. F. Puett at his residence from 9:00 AM to 10:00 PM Central Standard or Central Standard Daylight Time. We will be glad to help you with free technical consultation. 214 - 321-0927 or 327-8721.

**NEW! JUST OUT!!** **ANTIQUE RADIO CATALOG** No. 18A -- EVERYTHING FOR ANTIQUE RADIO RESTORATION APPROXIMATELY 800 DIFFERENT TUBE TYPES IN STOCK!! INTERSTAGE & POWER TRANSFORMERS, CAPACITORS, RESISTORS, DIAL LAMPS, ETC. PUBLICATIONS, LISTS, BOOKS, SCHEMATIC DIAGRAMS, TECHNICAL DATA, INSTRUCTION MANUALS, ETC. ORDER YOUR COPY TODAY --- ONLY \$1.00 POSTPAID!!

ANTIQUE RADIO TUBES		HERE ARE A FEW OF THE 600 DIFFERENT TYPES OFFERED IN OUR CATALOG No. 18A! ALL TUBES ARE GUARANTEED. SEE OUR POLICY STATED IN CATALOG.	
6J7	\$5	7B8	\$5
6K5	\$4	7C5	\$4
6K6	\$4	7C6	\$5
6K7	\$5	7C7	\$5
6R8	\$5	7F8	\$7
6L5	\$5	7G7	\$5
6L6	\$4	7H7	\$5
6L7	\$5	7Y4	\$5
6Q7	\$5	10	\$8
6SA7	\$4	12A7	\$5
6SB7	\$4	12AT6	\$3
6SC7	\$4	12AV6	\$3
6SC7	\$5	12B7	\$5
6SJ7	\$4	12BA6	\$3
6SK7	\$4	12BE6	\$3
6SL7	\$4	12K7	\$5
6SQ7	\$4	12Q7	\$5
6U5	\$8	12AS7	\$4
6U7	\$6	12SG7	\$4
6V6	\$3	12SK7	\$4
6X5	\$3	12SQ7	\$4
7A5	\$4	14A7	\$5
2A6	\$5	24A	\$6
3Q5	\$4	25L6	\$4
3V4	\$4	25Z5	\$4
5A2-A	\$6	25Z6	\$4
5U4	\$3	26	\$7
5Y4	\$4	27	\$5
5Y4	\$4	27	\$5
5Z3	\$4	30	\$6
6A7	\$7	32	\$5
6A8	\$5	34	\$5
6C5	\$4	35	\$5
6C6	\$5	35A5	\$5
6D6	\$5	35L6	\$4
6E5	\$8	35W4	\$4
6F5	\$8	35Y4	\$5
6F6	\$6	35Z5	\$4
6G5	\$8	36	\$5
6H6	\$3	37	\$5
6J5	\$4	38	\$4
		39	\$4
		40	\$8
		41	\$5
		42	\$5
		44	\$4
		45	\$7
		46	\$5
		47	\$8
		50	\$8
		50A5	\$4
		50B5	\$4
		50C5	\$4
		50L6	\$4
		51	\$5
		55	\$5
		56	\$4
		57	\$4
		58	\$5
		70L7	\$6
		71A	\$8
		75	\$5
		76	\$4
		77	\$5
		78	\$5
		79	\$5
		80	\$4
		81	\$7
		83V	\$4
		84	\$4
		85	\$5
		89	\$5
		117L7	\$6
		117Z3	\$4
		117Z6	\$5

### OLD TIME RADIO SHOWS ON CASSETTES

SEND ONE FIRST CLASS MAIL STAMP FOR OUR SHORT LIST OF PROGRAMS. HUNDREDS ARE LISTED IN OUR CATALOG No. 18A.

Amos & Andy, Fibber McGee & Molly, Inner Sanctum, etc.

**THE ENCYCLOPEDIA OF ANTIQUE RADIO** \$7.95 POSTPAID  
SIMILAR CONTENT, BUT COVERING SETS OTHER THAN THOSE INCLUDED IN *Vintage Radio* AND *A Flick Of The Switch*.

**THE DIRECTORY OF ANTIQUE RADIO SERVICES** \$3.00 POSTPAID - SERVICES & SOURCES THROUGHOUT THE U.S.A.



**BOOKS, BOOKLETS, LISTS & DATA**

Booklets listed in (1) thru (5) below are \$2. each, 3 for \$5., 4 for \$6. or 5 for \$7.

- (1) The Acquisition Of Antique Radios by J. W. F. Puett
- (2) The Complete Restoration of Battery Powered Antique Radios by J. W. F. Puett
- (3) The Complete Restoration of AC Powered Antique Radios by J. W. F. Puett
- (4) When Was That Old Tube Made? by James R. Wilkins
- (5) Antique Radio Tube Substitution by J. W. F. Puett

- (6) SILVER GHOSTS by J. W. F. Puett (history of E. H. Scott) \$8.95
- (7) THE CLASSIC RADIO COLLECTORS HANDBOOK by J. W. F. Puett \$10.00
- (8) THE APPRAISAL OF ANTIQUE RADIOS by J. W. F. Puett \$4.95
- (9) The PUETT ELECTRONICS Super Antenna - Ground System Plans \$2.00
- (10) Cross Reference List of Military vs. Commercial Tube Type Numbers \$1.00

See listing for Encyclopedia and Directory on this page.

### SCHEMATIC DIAGRAMS

WE HAVE SCHEMATICS FOR NEARLY ANY ANTIQUE RADIO RECEIVER! Send name of manufacturer & model number of set - \$1.50 postpaid. Without name of mfg. and/or model No. we will search our files for \$3.00, but we must have a sketch of top of chassis showing type numbers and location of all tubes and location of front panel & dial.

### APPRAISAL

WE OFFER THOROUGHLY DOCUMENTED APPRAISALS FOR INSURANCE PURPOSES. Many insurance companies offer special antique insurance policies which cover items which have been properly appraised. SEND ONE FIRST CLASS MAIL STAMP FOR OUR APPRAISAL BROCHURE.

ANTIQUE RADIO TOPICS & THE CLASSIC RADIO NEWSLETTER

THREE PERIODICALS IN ONE!!! YOU GET ALL THREE!!!  
ANTIQUE RADIO TOPICS --- THE CLASSIC RADIO NEWSLETTER  
THE ANTIQUE RADIO NEW ACQUISITIONS LIST

SEND FOUR FIRST CLASS MAIL STAMPS FOR A SAMPLE ISSUE. PUBLISHED TEN TIMES PER YEAR. ALL SUBSCRIBERS RENEW IN JANUARY OF EACH YEAR. PLEASE WRITE FOR OUR SUBSCRIPTION RATES. CLASSIFIED ADS ARE FREE! WHEN PUETT ELECTRONICS HAS RARE TUBES TO SELL (6X-11, 99, 01A, etc.), OUR SUBSCRIBERS HAVE THE FIRST OPPORTUNITY TO PURCHASE THESE THROUGH THE ANTIQUE RADIO NEW ACQUISITIONS LIST WHICH IS SENT TO SUBSCRIBERS ONE WEEK BEFORE IT IS MADE AVAILABLE TO OTHER CUSTOMERS.

MAY

75¢

# THE HORN SPEAKER

1980

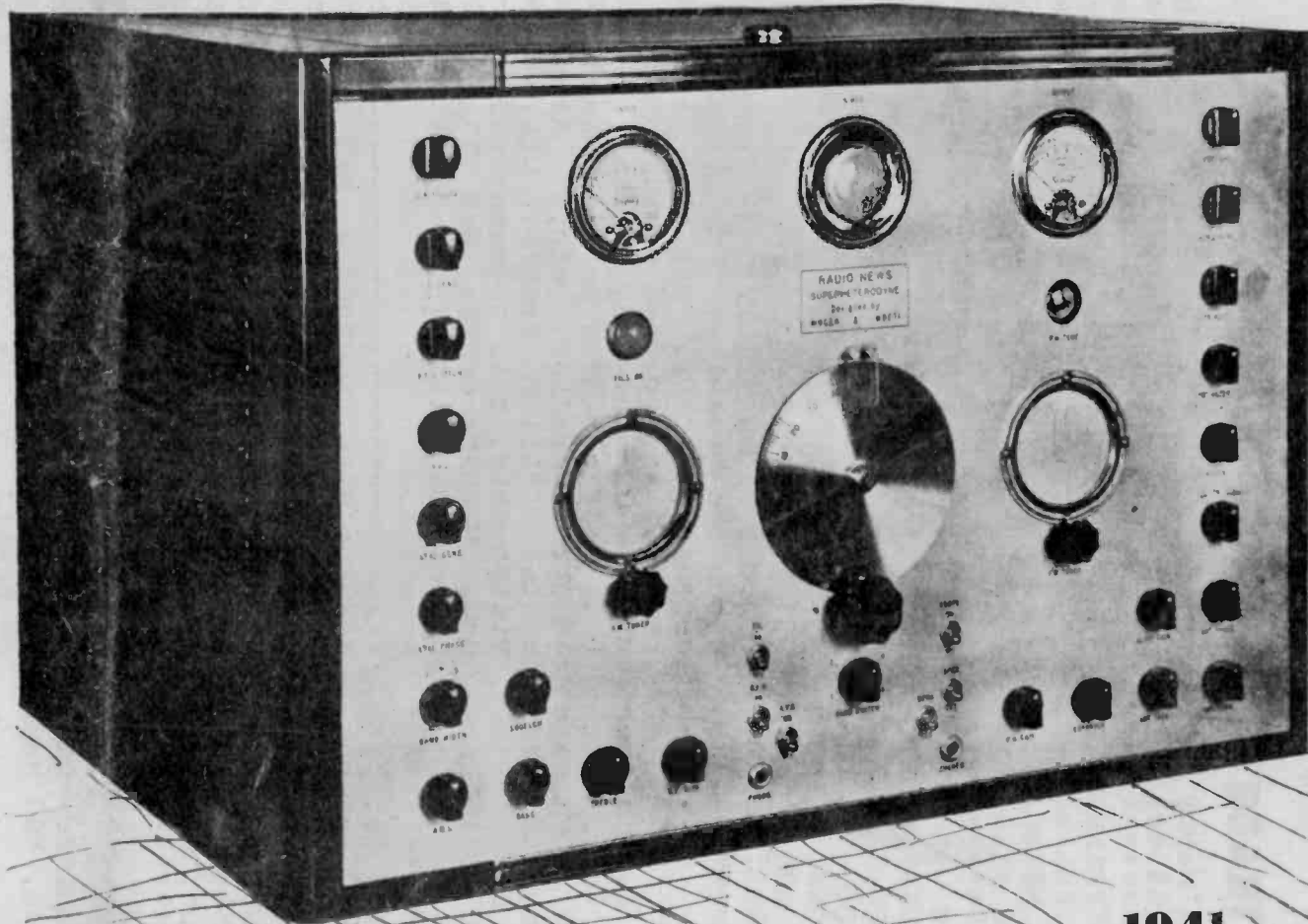

1941

RADIO NEWS Super Superheterodyne

**S**

R O HILL  
3739 37TH ST EXT  
BEAVER FALLS  
PA-15010