

HOBBY
ELECTRONICS

48784

\$2.50 U.S.
\$2.95 CANADA
MAY
1988

Hands-on Electronics

THE MAGAZINE FOR THE ELECTRONICS ACTIVIST!



Build the... High-Voltage Pulse Generator

Add spark power to your experiments!



Laboratory Pulse Generator



Fence Charger Model

Fixing garage-door opener components

Troubleshooting IC's with a multimeter

Discover radio through building-blocks

Learning all about static electricity



A
GERNSBACK
PUBLICATION

Plus: Topics on scanners, decibels, DOS, PC color snapshots, shortwave, voltaic cells, antique tubes, and more!



1-800-445-8399
 AK, Puerto Rico - 218 681 8674 Telex - 62827914 FAX - 218 681 3380 TWX - 910350882 DIGI KEY CORP



NATIONAL SEMICONDUCTOR • PANASONIC MACHINE • EVC, INC. • INTERSIL • AD EAC, INC. • W. MILLER • AAVI ENGINEER • F. JOHNSON • ATLANTIC SEMICONDUCTOR

256K (262,144 x 1) DRAM 150NS \$5.70/1; \$39.95/9
Factory Firsts

DIODES • DIAMOND TOOL • UNGAR • ES • CW INDUSTRIES • AMDEK • G.E. IGAR • YAGED • J. W. MILLER • LUXO SC CHEMICALS • ARIES • PLESSEY

INTEGRATED CIRCUITS		
7400 TTL	7400	1.88
7401	7401	1.88
7402	7402	1.88
7403	7403	1.88
7404	7404	1.88
7405	7405	1.88
7406	7406	1.88
7407	7407	1.88
7408	7408	1.88
7409	7409	1.88
7410	7410	1.88
7411	7411	1.88
7412	7412	1.88
7413	7413	1.88
7414	7414	1.88
7415	7415	1.88
7416	7416	1.88
7417	7417	1.88
7418	7418	1.88
7419	7419	1.88
7420	7420	1.88
7421	7421	1.88
7422	7422	1.88
7423	7423	1.88
7424	7424	1.88
7425	7425	1.88
7426	7426	1.88
7427	7427	1.88
7428	7428	1.88
7429	7429	1.88
7430	7430	1.88
7431	7431	1.88
7432	7432	1.88
7433	7433	1.88
7434	7434	1.88
7435	7435	1.88
7436	7436	1.88
7437	7437	1.88
7438	7438	1.88
7439	7439	1.88
7440	7440	1.88
7441	7441	1.88
7442	7442	1.88
7443	7443	1.88
7444	7444	1.88
7445	7445	1.88
7446	7446	1.88
7447	7447	1.88
7448	7448	1.88
7449	7449	1.88
7450	7450	1.88

TI I.C. SOCKETS		
1 Pin	1 Pin	1.18
2 Pin	2 Pin	1.18
3 Pin	3 Pin	1.18
4 Pin	4 Pin	1.18
5 Pin	5 Pin	1.18
6 Pin	6 Pin	1.18
7 Pin	7 Pin	1.18
8 Pin	8 Pin	1.18
9 Pin	9 Pin	1.18
10 Pin	10 Pin	1.18
11 Pin	11 Pin	1.18
12 Pin	12 Pin	1.18
14 Pin	14 Pin	1.18
16 Pin	16 Pin	1.18
18 Pin	18 Pin	1.18
20 Pin	20 Pin	1.18
24 Pin	24 Pin	1.18
28 Pin	28 Pin	1.18
32 Pin	32 Pin	1.18
36 Pin	36 Pin	1.18
40 Pin	40 Pin	1.18
44 Pin	44 Pin	1.18
48 Pin	48 Pin	1.18
52 Pin	52 Pin	1.18
56 Pin	56 Pin	1.18
60 Pin	60 Pin	1.18
64 Pin	64 Pin	1.18
68 Pin	68 Pin	1.18
72 Pin	72 Pin	1.18
76 Pin	76 Pin	1.18
80 Pin	80 Pin	1.18
84 Pin	84 Pin	1.18
88 Pin	88 Pin	1.18
92 Pin	92 Pin	1.18
96 Pin	96 Pin	1.18
100 Pin	100 Pin	1.18
104 Pin	104 Pin	1.18
108 Pin	108 Pin	1.18
112 Pin	112 Pin	1.18
116 Pin	116 Pin	1.18
120 Pin	120 Pin	1.18
124 Pin	124 Pin	1.18
128 Pin	128 Pin	1.18
132 Pin	132 Pin	1.18
136 Pin	136 Pin	1.18
140 Pin	140 Pin	1.18
144 Pin	144 Pin	1.18
148 Pin	148 Pin	1.18
152 Pin	152 Pin	1.18
156 Pin	156 Pin	1.18
160 Pin	160 Pin	1.18
164 Pin	164 Pin	1.18
168 Pin	168 Pin	1.18
172 Pin	172 Pin	1.18
176 Pin	176 Pin	1.18
180 Pin	180 Pin	1.18
184 Pin	184 Pin	1.18
188 Pin	188 Pin	1.18
192 Pin	192 Pin	1.18
196 Pin	196 Pin	1.18
200 Pin	200 Pin	1.18

SOLDER TAIL DIP SOCKETS		
1 Pin	1 Pin	1.18
2 Pin	2 Pin	1.18
3 Pin	3 Pin	1.18
4 Pin	4 Pin	1.18
5 Pin	5 Pin	1.18
6 Pin	6 Pin	1.18
7 Pin	7 Pin	1.18
8 Pin	8 Pin	1.18
9 Pin	9 Pin	1.18
10 Pin	10 Pin	1.18
11 Pin	11 Pin	1.18
12 Pin	12 Pin	1.18
14 Pin	14 Pin	1.18
16 Pin	16 Pin	1.18
18 Pin	18 Pin	1.18
20 Pin	20 Pin	1.18
24 Pin	24 Pin	1.18
28 Pin	28 Pin	1.18
32 Pin	32 Pin	1.18
36 Pin	36 Pin	1.18
40 Pin	40 Pin	1.18
44 Pin	44 Pin	1.18
48 Pin	48 Pin	1.18
52 Pin	52 Pin	1.18
56 Pin	56 Pin	1.18
60 Pin	60 Pin	1.18
64 Pin	64 Pin	1.18
68 Pin	68 Pin	1.18
72 Pin	72 Pin	1.18
76 Pin	76 Pin	1.18
80 Pin	80 Pin	1.18
84 Pin	84 Pin	1.18
88 Pin	88 Pin	1.18
92 Pin	92 Pin	1.18
96 Pin	96 Pin	1.18
100 Pin	100 Pin	1.18
104 Pin	104 Pin	1.18
108 Pin	108 Pin	1.18
112 Pin	112 Pin	1.18
116 Pin	116 Pin	1.18
120 Pin	120 Pin	1.18
124 Pin	124 Pin	1.18
128 Pin	128 Pin	1.18
132 Pin	132 Pin	1.18
136 Pin	136 Pin	1.18
140 Pin	140 Pin	1.18
144 Pin	144 Pin	1.18
148 Pin	148 Pin	1.18
152 Pin	152 Pin	1.18
156 Pin	156 Pin	1.18
160 Pin	160 Pin	1.18
164 Pin	164 Pin	1.18
168 Pin	168 Pin	1.18
172 Pin	172 Pin	1.18
176 Pin	176 Pin	1.18
180 Pin	180 Pin	1.18
184 Pin	184 Pin	1.18
188 Pin	188 Pin	1.18
192 Pin	192 Pin	1.18
196 Pin	196 Pin	1.18
200 Pin	200 Pin	1.18

DISC CAPACITORS		
100pF	100pF	1.88
200pF	200pF	1.88
300pF	300pF	1.88
400pF	400pF	1.88
500pF	500pF	1.88
600pF	600pF	1.88
700pF	700pF	1.88
800pF	800pF	1.88
900pF	900pF	1.88
1000pF	1000pF	1.88
1500pF	1500pF	1.88
2000pF	2000pF	1.88
2500pF	2500pF	1.88
3000pF	3000pF	1.88
3500pF	3500pF	1.88
4000pF	4000pF	1.88
4500pF	4500pF	1.88
5000pF	5000pF	1.88
5500pF	5500pF	1.88
6000pF	6000pF	1.88
6500pF	6500pF	1.88
7000pF	7000pF	1.88
7500pF	7500pF	1.88
8000pF	8000pF	1.88
8500pF	8500pF	1.88
9000pF	9000pF	1.88
9500pF	9500pF	1.88
10000pF	10000pF	1.88
15000pF	15000pF	1.88
20000pF	20000pF	1.88
25000pF	25000pF	1.88
30000pF	30000pF	1.88
35000pF	35000pF	1.88
40000pF	40000pF	1.88
45000pF	45000pF	1.88
50000pF	50000pF	1.88
55000pF	55000pF	1.88
60000pF	60000pF	1.88
65000pF	65000pF	1.88
70000pF	70000pF	1.88
75000pF	75000pF	1.88
80000pF	80000pF	1.88
85000pF	85000pF	1.88
90000pF	90000pF	1.88
95000pF	95000pF	1.88
100000pF	100000pF	1.88

TANTALUM CAPACITORS		
100µF	100µF	1.88
200µF	200µF	1.88
300µF	300µF	1.88
400µF	400µF	1.88
500µF	500µF	1.88
600µF	600µF	1.88
700µF	700µF	1.88
800µF	800µF	1.88
900µF	900µF	1.88
1000µF	1000µF	1.88
1500µF	1500µF	1.88
2000µF	2000µF	1.88
2500µF	2500µF	1.88
3000µF	3000µF	1.88
3500µF	3500µF	1.88
4000µF	4000µF	1.88
4500µF	4500µF	1.88
5000µF	5000µF	1.88
5500µF	5500µF	1.88
6000µF	6000µF	1.88
6500µF	6500µF	1.88
7000µF	7000µF	1.88
7500µF	7500µF	1.88
8000µF	8000µF	1.88
8500µF	8500µF	1.88
9000µF	9000µF	1.88
9500µF	9500µF	1.88
10000µF	10000µF	1.88
15000µF	15000µF	1.88
20000µF	20000µF	1.88
25000µF	25000µF	1.88
30000µF	30000µF	1.88
35000µF	35000µF	1.88
40000µF	40000µF	1.88
45000µF	45000µF	1.88
50000µF	50000µF	1.88
55000µF	55000µF	1.88
60000µF	60000µF	1.88
65000µF	65000µF	1.88
70000µF	70000µF	1.88
75000µF	75000µF	1.88
80000µF	80000µF	1.88
85000µF	85000µF	1.88
90000µF	90000µF	1.88
95000µF	95000µF	1.88
100000µF	100000µF	1.88

7400 TTL		
7400	7400	1.88
7401	7401	1.88
7402	7402	1.88
7403	7403	1.88
7404	7404	1.88
7405	7405	1.88
7406	7406	1.88
7407	7407	1.88
7408	7408	1.88
7409	7409	1.88
7410	7410	1.88
7411	7411	1.88
7412	7412	1.88
7413	7413	1.88
7414	7414	1.88
7415	7415	1.88
7416	7416	1.88
7417	7417	1.88
7418	7418	1.88
7419	7419	1.88
7420	7420	1.88
7421	7421	1.88
7422	7422	1.88
7423	7423	1.88
7424	7424	1.88
7425	7425	1.88
7426	7426	1.88
7427	7427	1.88
7428	7428	1.88
7429	7429	1.88
7430	7430	1.88
7431	7431	1.88
7432	7432	1.88
7433	7433	1.88
7434	7434	1.88
7435	7435	1.88
7436	7436	1.88
7437	7437	1.88
7438	7438	

CONSTRUCTION

- 25 **The Building-Block Radio**—if you work block-by-block and section-by-section, you'll suddenly hear sound from thin air!
- 28 **The High-Voltage Pulse Generator**—build the fence charger or laboratory models and experiment with lighting, neon, or animal behavior
- 39 **The RGB Switch Box**—two computers but one monitor is no problem even with inversion
- 62 **Building Voltaic Cells**—you've built everything under the sun, but have you built a battery?
- 73 **Build a BCB Trap**—get rid of noise quick and easy with this simple one evening project

FEATURES

- 16 **Computers—That's the Life**—humor from beyond the cathode-ray tube
- 34 **Rebuild Your Door Chimes**—use these tips to save money and make life more musical
- 43 **Servicing Garage-Door Openers**—Service your garage-door opener and it'll be around to serve you for many years to come
- 60 **Hamshack Nostalgia**—a few artifacts of your hobby can enrich your base of operations
- 64 **Checking out Static Electricity**—one of the most destructive forces can be generated and controlled with household items
- 67 **Troubleshooting IC's With a Multimeter**—if you have no scope, then you need this article more than you need clean socks
- 75 **TAME the DOS Tiger**—unleash the power of the machine to do your bidding
- 77 **E-Z Math**—Logarithms number crunching is super easy with logs and decibels; you may give up multiplication!

SPECIAL COLUMNS

- 84 **Ellis on Antique Radio**—kicking triodes into high gear
- 86 **Jensen on DX'ing**—the Vatican has a lot to say and uses SW to say it
- 88 **Saxon on Scanners**—whip up an instant weather report wherever you are on a new Regency release
- 92 **Circuit Circus**—sequencers revisited; more power, but only a few IC's
- 94 **Friedman on Computers**—hot off the presses: color photos from your PC!

DEPARTMENTS

- 2 **Editorial**—Times Are Changing
- 4 **Letter Box**—free-flying information from readers and staff
- 7 **New Products Showcase**—it hits our pages before it hits the shelf
- 17 **Bookshelf**—your safari for information should make camp here
- 37 **FactCards**—our card section packs the down and dirty facts
- 49 **GIZMO Special Section**—written by people who try before you buy
- 71 **Free Information Card**—a few circles can bring you a world of information



Building Block Radio—page 25



High Voltage Generator—page 28

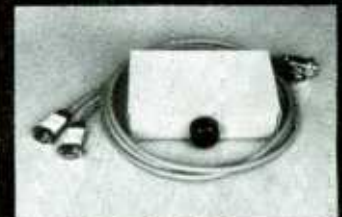

The RGB Switch Box—page 39



Garage-Door Openers—page 43



Hamshack Nostalgia—page 60



Friedman on Computers—page 94

Hands-on Electronics®

The Magazine for the Electronics Activist!

Times are changing!

Every so often I sort out my papers at home, because the filing cabinet is packed tightly. Sorting through the papers helps me decide what to throw out and what to keep. I'll admit it is a losing battle, but it is good to reminisce once in a while.

I came upon an old speech I gave at the Communications Equipment Distributors Association (CEDA) meeting in St. Louis on November 5, 1977. At that time the personal computer marketplace was a fledgling compared to the consumer electronics items being sold through conventional outlets. I explained to the members of CEDA attending the meeting that I expected the marketplace to gross one-billion dollars in 1978. Considering the sales of Tandy and Zenith during that period along with 30 to 50 emerging hardware and software companies of that time, I'm sure that I passed the mark. I prophesied personal computing products appearing in traditional electronic shops and outlets across the nation.

So much for forecasting the future. Today I checked the Sunday newspaper and was amazed at the number of local independent computer outlets and stores selling complete computer systems to the general public. Computers have entered our everyday life. Not only at work, but at home and school. Who would send a child off to college without a basic computer system with word-processing software? In fact, high school students look to Christmas and birthdays hoping that that would be the day when they got their first computer system.

What's my point? Electronics hobbyists have been shunning computer projects and leaving them to the *hacker* and *vice versa*. It's about time both groups realize that the computer itself is a tool that will help them in almost any aspect of their technical hobby as well as their every-day life. Junk your electric typewriters, dictionaries, and even my filing cabinet. I've got 60-megs of memory home, and some of it is for storing what's on my old papers. Anybody interested in a slightly used four-drawer filing cabinet?

Times are changing.



Julian S. Martin, KA2GUN
Editor

STAFF

Volume 5, No. 5

May 1988

Larry Steckler, EHF, CET
Editor-in-Chief & Publisher

Art Kleiman, editorial director

Julian S. Martin, KA2GUN, editor

Robert A. Young, associate editor

Herb Friedman, W2ZLF, associate editor

John J. Yacono, associate editor

Brian C. Fenton, associate editor

Carl Laron, WB2SLR, associate editor

Byron G. Wels, K2AVB, associate editor

M. Harvey Gernsback, contributing editor

Doris Kelly, editorial assistant

Teri Scaduto, editorial assistant

Ruby M. Yee, production director

Karen S. Tucker, production manager

Robert A. W. Lowndes, editorial associate

Marcella Amoroso, production assistant

Jacqueline P. Cheeseboro, circulation director

Arline R. Fishman, advertising director

BUSINESS AND EDITORIAL OFFICES

Gernsback Publications, Inc.
500-B Bi-County Boulevard
Farmingdale, NY 11735.
516/293-3000
President: Larry Steckler
Vice-president: Cathy Steckler

NATIONAL ADVERTISING SALES

(For Advertising Inquiries Only)
Joe Shere MIDWEST/PACIFIC
1507 Bonnie Doone Terrace
Corona Del Mar, CA 92625
714 760-8697

The Patis Group
310 Madison Ave. Suite 1804
New York, NY 10017
212-/953-2121

Composition by
Mates Graphics

Cover photo by
Herb Friedman



Hands-on Electronics, (ISSN 0743-2968) Published monthly by Gernsback Publications, Inc., 500-B Bi-County Boulevard, Farmingdale, NY 11735. Second-Class postage paid at Farmingdale, NY and at additional mailing offices. One year, twelve issues, subscription rate U.S. and possessions \$28.00, Canada \$33.00, all other countries \$35.50. Subscription orders payable in U.S. funds only, International Postal Money Order or check drawn on a U.S. bank. U.S. single copy price \$2.50. © 1988 by Gernsback Publications, Inc. All rights reserved. Trademark registered in U.S. and Canada. Printed in U.S.A.

Postmaster: Please send address changes to **Hands-On Electronics**, Subscription Dept., P.O. Box 338, Mount Morris, IL 61054-9932.

A stamped self-addressed envelope must accompany all submitted manuscripts and/or artwork or photographs if their return is desired should they be rejected. We disclaim any responsibility for the loss or damage of manuscripts and/or artwork or photographs while in our possession or otherwise.

As a service to readers, **Hands-on Electronics** publishes available plans or information relating to newsworthy products, techniques and scientific and technological developments. Because of possible variances in the quality and condition of materials and workmanship used by readers, **Hands-on Electronics** disclaims any responsibility for the safe and proper functioning of reader-built projects based upon or from plans or information published in this magazine.

SELECT 5 BOOKS for only \$3.95

(values to \$123.75)
and get a Free Gift!

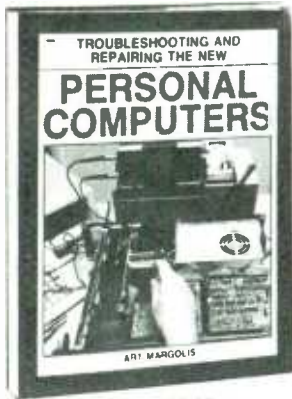

2809 \$26.95
Count as 2

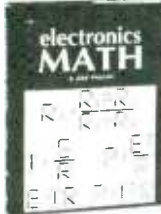

1962 \$22.95



1625P \$14.95



2960 \$24.95



2645P \$10.95



1536P \$8.95

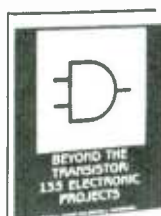

2887 \$16.95



1300P \$24.95
Counts as 2



2613 \$23.95



2758 \$24.95



1604 \$16.95



2839 \$15.95



2753P \$16.95



2733 \$14.95



2660P \$17.95



2617 \$17.95



1897P \$13.95



1999P \$14.95



2922 \$24.95



1775P \$18.95

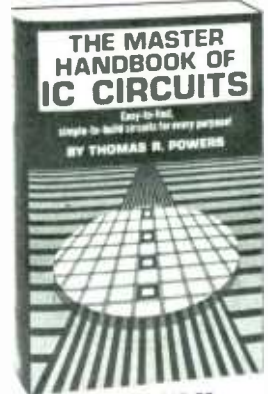

1370P \$15.50

Electronics projects . . . ideas . . . the latest technology
all at up to 50% off publishers' prices!

Membership Benefits • Big Savings. In addition to this introductory offer, you keep saving substantially with members' prices of up to 50% off the publishers' prices. • **Bonus Books.** Starting immediately, you will be eligible for our Bonus Book Plan, with savings of up to 80% off publishers' prices. • **Club News Bulletins.** 14 times per year you will receive the Book Club News, describing all the current selections—mains, alternates, extras—plus bonus offers and special sales, with hundreds of titles to choose from. • **Automatic Order.** If you want the Main Selection, do nothing and it will be sent to you automatically. If you prefer another selection, or no book at all, simply indicate your choice on the reply form provided. As a member, you agree to purchase at least 3 books within the next 12 months and may resign at any time thereafter. • **Ironclad No-Risk Guarantee.** If not satisfied with your books, return them within 10 days without obligation! • **Exceptional Quality.** All books are quality publishers' editions especially selected by our Editorial Board.

All books are hardcover unless numbers are followed by a 'P' for paperback (Publishers' Prices Shown)

FREE when you join!

Handy, Pocket-Sized
Resistor and Inductor
Color Code Calculator

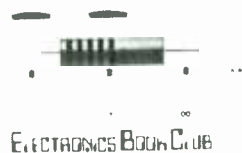

ELECTRONICS BOOK CLUB

ELECTRONICS BOOK CLUB
Blue Ridge Summit, PA 17294-0810

Please accept my membership in the Electronics Book Club* and send the 5 volumes listed below, plus my FREE Resistor and Inductor Color Code Calculator (502E), billing me \$3.95 plus shipping and handling charges. If not satisfied, I may return the books within ten days without obligation and have my membership canceled. I agree to purchase at least 3 books at regular Club prices (plus shipping and handling) during the next 12 months and may resign any time thereafter.

Name _____
Address _____
City _____
State/Zip _____ Phone _____
Signature _____

Valid for new members only Foreign applicants will receive special ordering instructions Canada must remit in U.S. currency This order subject to acceptance by the Electronics Book Club Signature of parent or guardian required for all new members under 18 years of age RESP-588



1218P \$14.95

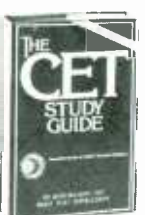

2941 \$21.95



2790 \$18.95



1199P \$14.95



1532P \$14.95



2731 \$21.95

CIRCLE 14 ON FREE INFORMATION CARD

LETTER BOX

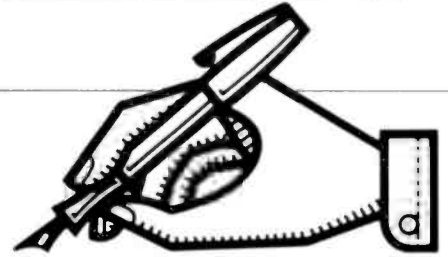

Hands-on Electronics, 500B Bi-County Boulevard, Farmingdale, New York 11735

High Capacity

I would like to congratulate you on a first class publication. It certainly meets the need of the hands-on hobbyist. The projects are great and very educational.

Perhaps you would consider doing an article or a series of articles on the use of capacitors in DC circuits. When capacitors are used in AC circuits there seems to be plenty of information around on how to calculate the required value but when it comes to DC I can find nothing.

A case in point was a Wheatstone bridge circuit (a fairly recent project) used to detect continuity on any line with under 10 ohms resistance. The output from the circuit fed an op amp which activated a buzzer when an imbalance was detected. The device is intended for circuit tracing and is set to ignore values greater than 10 ohms. On the output line from the bridge to the op amp there is a 0.27- μ F capacitor providing a path to ground. I assumed it was to stop spikes from the detection circuit. When I built the circuit the capacitor looked too big, but I had no basis for calculating anything to resolve the question in my mind.

Can you do anything like that?

—J.H., Garden Grove, CA

A general article on the subject of capacitance had been presented in the June 1987 issue. It would be a little difficult to publish articles that went into detail on parts substitution (and there are many readers who just wouldn't like them). I strongly suggest you check the public library nearest you if the article provides insufficient help.

Alarming Letter

In reference to the letter from J.W. of Ashland, AL, entitled "Washed Out" in the February 1988 edition of **Hands-On Electronics**, I say fine, go ahead and house your alarm in a metal box along with shielded cable, as the response to his letter suggests. Shielding the circuit will reduce false triggering, but if you look at the schematic (page 63, Jan./Feb. 1986 the solution to J.W.'s problem is to debounce that mechanical key switch. No counter, timer, inverter, buffer, etc., can function properly in a circuit

with a mechanical switch without debouncing and no diagram should ever be shown (particularly when it's aimed at the novice because it "appears" simple) that forgets to include this important parameter.

I have two suggestions that I feel certain will resolve J.W.'s problem. First throw out that stone-age 555 and replace it with the CMOS version (Radio Shack No. 276-1718). In addition to low power consumption the CMOS noise immunity while not perfect, is vastly better than the other logic families.

Second there are countless debouncing circuits, both simple and complex. The circuit in Fig. 1 is a very simple one using a 4584 Hex Schmitt Trigger. When

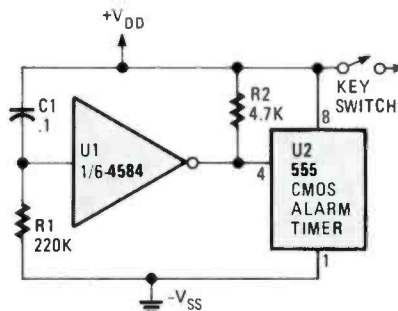

FIG. 1

the switch is closed the RC time constant determines how long the input to the inverter is held high. The reset pin (pin 4) is held momentarily low preventing the chattering of the switch contacts from prematurely triggering the timer.

—D.K., Willingbord, NJ

You are of course quite right. If the problem is more than just false triggering (indicated by the units triggering for no good reason) then debouncing will solve the other problems. We proposed a solution to the one problem that definitely existed hoping it would be enough.

Scan This!

Help! I am unable to find any information on how to obtain a service manual for my Bearcat 150 scanner. (Please don't tell me to throw it out.) *Howard Sams* does not list it, and I have heard that Electra, the company that manufac-

tured it, has gone out of business. Anyway, I wrote to them and I never received an answer. Any help you can give me will be gratefully appreciated. William L. Heaton

P.O. Box 786
Weaver, AL 36277

Would any of our readers drop a note to William should they be able to assist?

More Numbers

Did you publish an article about six to ten months ago on a Centronics parallel printer port for the Timex/Sinclair 1000 computer? Please include the volume and issue number if applicable.

—W.W., Honolulu, HI

A miss is as near as a mile in electronics. The story we ran in November 1986 was for the Sinclair ZX-81. There may be some similarities in the machines, but I wouldn't swear to the 1000's compatibility with the project we showed in the article.

High and Dangerous

Where can I pick up a neon lamp high-voltage transformer for a project I am working on?

—B.M., Dayton, OH

*Most neon lamp high-voltage transformers are rated at 7300-volts AC at 5 mA. That's enough soup to kill. Whatever you do, do it carefully, and place warning signs near the project so that others will stay clear. American Design Components, 62 Joseph Street, Moonachie, NJ 07074 sells such a unit for \$9.95. Understand that this is a limited supply of surplus units, so order today! In a rush? Call them at 800/524-0809. Tell them **Hands-on Electronics** sent you.*

Tune up

I'm writing you about the Hour Tune project in the June 1987 issue. After comparing the information that came with the Melody Generator UM3482A, the schematic on page 34, circuit layout on page 35, and parts layout on page 36, I noticed a discrepancy. I don't know if it



Now Hands-on Electronics® Every Month!

■ IF YOU'RE THE KIND OF READER that doesn't want to wait, you can order your next copy of **Hands-on Electronics** now. **Hands-on Electronics** is crammed full of electronic projects that you won't be able to wait to build for yourself. You can expect top-notch digital projects, fun-to-play electronic games, valuable add-on computer projects, BCB and shortwave receivers, photographic/darkroom gadgets, devices to improve your car's performance, test equipment ideas, and more in every issue of **Hands-on Electronics**.

■ YOU CAN HAVE THE NEXT TWELVE ISSUES of **Hands-on Electronics** delivered to your home for only \$18.95 — saving \$11.05 off the single copy price.

■ EVERY ISSUE OF **Hands-on Electronics** will continue to contain a variety of construction articles to suit every taste. In addition, feature articles on electronics fundamentals, test equipment and tools will round out each issue. Of course, **Hands-on Electronics** will continue to provide new product and literature listings to keep you up to date on the latest developments in electronic technology.

■ GET IN ON THE ACTION! Order your next issue of **Hands-on Electronics** today. Use the convenient order coupon below. Be sure to send check or money order—no cash!

Hands-on Electronics SUBSCRIPTION

I want to be sure I don't miss any issues. Send me ONE FULL YEAR — twelve issues — of **Hands-on Electronics** for \$18.95 (Canada \$23.95 U.S. Funds).

Payment Enclosed

Please charge my

Visa

Mastercard

Signature _____

Bill Me Later

Acct. # _____ Exp. Date _____

Allow 6-8 weeks for the first issue to arrive. Offer valid in U.S. Funds Only.

Please print

(Name)

(Street Address)

(City)

(State)

(Zip)

Detach and mail today

to:
HANDS-ON
ELECTRONICS
SUBSCRIPTION DEPT.
P.O. BOX 338
MOUNT MORRIS, IL
61054

AHOE8

was to test the readers or just an error. But C1 and R3 are not included in Fig. 1 and a connection between pin 16 on U2 (UM2483A) and V_{cc} at B1 (+ side) at pin 9 on U2 is also missing. I have enclosed a new schematic with all the corrections drawn in and highlighted. I hope this will help whoever builds the project.

Also, I had a problem with a low audio output at SPKR1. No matter how I adjusted R6 and/or R7, I would still only get very-low audio output. I found connecting pins 9 and 10 on the Melody Generator together brought the sound up to full level. The only problem is that that causes a small amount of feedback and audio distortion, but not enough to bother you if you're not listening for it, and if R6 and R7 are adjusted properly. I would like to know if anyone else had that problem, and if so, what did they do to correct it.

—C.E.F., Titusville, FL

Thanks, it's not easy keeping track of all the parts for a project of that size. While we can't print the schematic here, the additions are as follows:

Connect C1 to the ground and pin 16 of U2.

Connect R3 between pin 12 of U2 and pin 4 of U4.

Connect pin 16 of U1 to B1 on the positive side.

We haven't heard from anyone with the audio problem you describe. If you're out there, write in about it.

Tuned Out

I read Electronic Fundamentals by Louis E. Frenzel Jr. in **Hands-on Electronics** March 1987 issue, and I don't understand something on page 80. I can't figure out the math used to find the resonant frequency in step 8. It reads:

$$\begin{aligned}C &= .1\mu\text{F or } .0000001\text{F} \\f &= (1/6.28)/(2 \times .0000001) \\f &= (1/6.28)/.0000002 \\f &= 1/6.28(.000447)\end{aligned}$$

I don't know where you get the .000447. I'm just a beginner in the field. Please help me.

Also, could you please tell me where I can find some books on electronics formulas? I sure would appreciate it very much.

—T.B., Portage, WI

You'll be happy to know you've made a bright start in this field! The error is not yours but ours. after the third line it should read:

$$\begin{aligned}f &= 1/(6.28 \times .0000002) \\f &= 1/(.000001256) \\f &= 796178.35 \text{ Hz}\end{aligned}$$

The best place I can think of to find

books on electronics is between these pages. You'll find quite a variety of technical books in our The Bookshelf column and among the advertising every month. (Read those ads! They are informative and reduce a lot of leg work.)

Variety: the Spice of Life

When I was building the "Rip-Off Retarder Alarm" that appeared in the July '87 issue of **Hands-on Electronics**, I found an error in the foil pattern that was provided to make the PC board. The positive end of C8 should be connected to the junction of R1, R2, and D5 in order for the relay to get its current. The schematic diagram was correct, but the foil pattern wasn't.

Also, I am having a terrible time finding C3, a 10-160 pF trimmer capacitor. Could you please tell me where I can find one?

—H.V., Mt. Airy, NC

Sorry to say we had trouble getting them too. Try getting something more common such as a 6 to 50pF and double them up if 50 pF isn't enough.

Feet On the Ground

Here is a response to the letter on Grandpa's Radio on page 31 in the October issue on shorting out the battery. That letter is found in the Letter Box of the February 1988 issue.

Resistor R4 is the regeneration control. Regeneration takes place towards the high end of the control at the drain terminal of Q2. That control is hardly moved at all after regeneration takes place. Remember the little radio pulls only 9.6 mills under working conditions.

In event R4 would get lowered towards ground and left there, place a 4.7K ohm resistor between the ground terminal of R4 and common ground, to provide battery protection.

—Homer L. Davidson

It can be assumed that the potentiometer should be adjusted to its highest resistance before power is applied, for those who do not wish to add the safety resistor. Thank you for your reply.

Errors? What Errors?

This is my first year to subscribe to your magazine and from what I have been seeing, reading, and putting together it will not be my last.

There is one thing I do have to ask you. About the problems that I have found and read in your Letter Box section, are they real goofs or are they there to teach lessons to those that are smart enough to catch them?

—J.R., Highland, IL

While I could tell you that everything is

planned; mistakes, the letters themselves (including yours), and so on, are bonafide. Yes, we produce real mistakes, do not be fooled by imitations. We would never purposefully mislead our readers (except perhaps in April) for any reason.

Our educational value lies not in our errors, but in our dedication to our own hobby. I don't mean to make little of our errors, but pick up our magazine and compare the number of construction projects we put out to that of any other publication of our kind. Skip the columns and just concentrate on the projects alone. You'll find more in our magazine for sure. Now add on the number of columns that also contain buildable circuits such as Circuit Circus, and you'll get an idea of how many schematics there are in one issue. Being human (as some editors hate to admit) mistakes are bound to sneak by in the flood of information we wade through.

When all is said and done, we really appreciate the readers who carefully read the articles and inform us of any discrepancies. They have really helped the magazine (and this column) become the source of useful information that it is.

Death to Computers

In the February 1988 issue you said you wanted complaints as well as praise. Well, your response to the request to "Stay low on computer stuff" was "Not to worry," that we would not see "How to Build a Clone from the Gates Up;" that's fine, but I see a gradual creep of more and more computer software articles. After seeing one popular electronic magazine go that way I get nervous when 15% of the best magazine for the electronics activist is dedicated to computer-related stuff. Please don't turn our great magazine into Hands-Off Electronics.

—W.E.H., Huntsville, AL

Again, I must quell your fears. This magazine does software reviews that are brief and do not compose 15% of the magazine. Perhaps 15% if you count the items on the contents page; but how many pages are dedicated to software?

Also, consider the scope of such articles. They can't be called hardcore, they simply expound on the features of each package.

Sit-Down Walkman

I am interested in connecting a Walkman-type tape player to my stereo system. I realize that there is a substantial difference in the output of such a unit vs. that of a tape deck. What type of matching circuit can you suggest? Would the installation of a pair of small,

(Continued on page 103)

NEW PRODUCTS

Cassette Care Tote

The K-1000 is the only carry bag for pull-out cassette receivers that features a full cleaning and demagnetizing kit, built into the bag. The *K-1000 Carry Bag & Cassette Care Kit* consists of *Intraclean's* proprietary *C-911 Cassette Cleaner*, a *D-501 Electronic Cassette Demagnetizer*, and a



CIRCLE 93 ON FREE INFORMATION CARD

nylon carry bag design to fit any pull-out cassette receiver.

Suggested retail for the K-1000 is \$59.95. For more information contact American Recorder Technologies, Inc., PO Box 3592, 4505-2H Industrial Street, Simi Valley, CA 93063; Tel. 805/527-9580.

Multifunction Frequency Counters

The *Model 9810 Frequency Counter* and the *Model 9800 Frequency Counter* provide period-measurement, period-average and totalize functions. Both feature a large, eight-digit LED display with annunciators. All inputs and functions are front-panel mounted and clearly marked for ease of use.

The Mercer 9800 counter, with a 10-Hz range, is ideally suited for general purpose service, lab use, education, audio test, digital and hobby applications. Its period, totalize the period average functions make it a value-priced instrument for production applications as well. Suggested resale price is \$255.00.

The Mercer Model 9810 counter provides an extended range—10 Hz to 1 GHz—to satisfy the product testing and



CIRCLE 73 ON FREE INFORMATION CARD

servicing requirements for UHF radio communication systems and cellular UHF phone radio links. Suggested resale price is \$475.00.

For complete details and specifications, contact your electronics distributor or Mercer Electronics, 859 Dundee Avenue, Elgin, IL 60120-3090; Tel. 312/697-2260.

AM/FM 5-Band Graphic-Equalizer Stereo

The *Sparkomatic SR38 AM/FM Stereo Radio Cassette Player* features easy-to-use slide controls for its 5-band graphic equalizer, which is designed to shape the sound to the car's environment and listener's preference.

The radio incorporates a locking fast-forward button and pushbutton eject and balance/fader control which adjusts sound balance. Other mode controls are non/stereo, AM/FM selectors and a local distance switch.



CIRCLE 83 ON FREE INFORMATION CARD

The *Sparkomatic SR38* also features indicator lights that tell the driver when the unit is in the tape or radio mode or in mono or stereo. Full night lighting illuminates the unit's functions, making them visible to the night driver.

Specifications for the *Sparkomatic SR38* are: 12 Watts (@ 10% (RMS) THD/ 10 Watts (@ 1% (RMS) THD). Suggested retail price is \$79.99.

Free Famous hi-tech catalog



A very special guide to what the exciting world of computer and electronics kit-building can do for you.

The informative Heathkit Catalog shows you more than 450 exciting electronic products that will challenge, instruct, and entertain you. You'll find countless kits that you can build and enjoy, from computers and robots to color tv's and a variety of home products. And each is backed by our years of experience and our promise, "We won't let you fail!"



IBM-PC Compatible Expandable Computers



HERO® 2000 Educational Robot and Courseware



Precision Test Instruments

Electronic Keyless Doorlock



PackKit Multi-Mode TNC



Send NOW for your FREE Heathkit Catalog.

Send to: Heath Company, Dept. 107-652
Benton Harbor, Michigan 49022

Name _____

Address _____

City _____ State _____ Zip _____

A subsidiary of Zenith Electronics Corporation CL-784R3

Heathkit
Heath
Company

CIRCLE 11 ON FREE INFORMATION CARD

For additional information, contact Sparkomatic Corporation, Milford, PA 18337; Tel. 800/233-8831. In Pennsylvania 800/592-8891.

Two-Way Speaker System

The *ALS-52 2-Way Speaker System* features a 5¹/₄-in. woven, carbon-fiber cone woofer incorporating a 1-in. flat-ribbon wire voice coil with double damper and a 8.65 oz. strontium magnet. The midrange/tweeter uses a 14-mm polyimide dome with magnetic fluid for damping and heat dissipation.

The Altec Lansing door-mounted speaker system has been engineered to withstand the extremely high and low temperatures usually found in automobile interiors. Further, the system has been designed to provide the wide dynamic range and fast, accurate transient response needed for optimum music reproduction of Compact Discs, high-quality cassettes, and stereo broadcasts. The system may be installed in most late model American, European, and Japanese automobiles.



CIRCLE 77 ON FREE INFORMATION CARD

The ALS-52 has a frequency of 80 Hz to 22 KHz \pm 3 dB and sensitivity (SPL) of 90 dB/watt/meter. At 1 watt the THD is 0.8% Hz over a range from 150 Hz to 22 KHz. Power-handling capacity is 30 watts nominal and 60 watts maximum. Impedance is 4 ohms.

Suggested list price for the ALS-52 is \$160.00 per pair. For additional information contact Altec Lansing Consumer Products, Milford, PA 18337; Tel. 800/ALTEC 88.

Automatic Radio Switch

The *Automatic Radio Switch, Model ARS05*, hooks up to both the cellular telephone in a car and the car's sound system. If the sound system operates and the cellular phone is ringing, or if an outgoing call is attempted, the sound

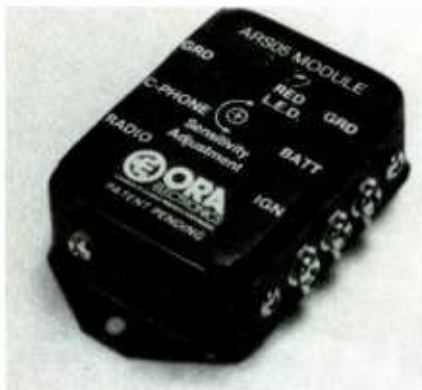

CIRCLE 85 ON FREE INFORMATION CARD

system will switch off. Thus, the user is able to immediately start conversing without having to first turn off the sound system. Upon termination of the call, the system resumes normal operation.

The ARS05 is small in physical size, easy to install, and requires only five connection points. Because the ARS05 uses electronic switching, reliability is high, and there is no additional power consumption by the unit. Adjustable sensitivity control enables the unit to be used with virtually any cellular telephone on the market.

The ARS05 carries a suggested retail price of \$49.95. For more information, contact ORA Electronics, 20120 Plummer Street, Chatsworth, CA 91311; Tel. 818/701-5848.

Modulink Mobile Microphones

The *Model 890TT and 590T Modulink Systems* are two mobile communication microphones that feature a unique modular-cordset which enables each microphone to plug into over 40 radio models in just 30 seconds. The cord can be released quickly and easily, but a locking-action tab prevents inadvertent release—a miniature screwdriver must be inserted into a rear-

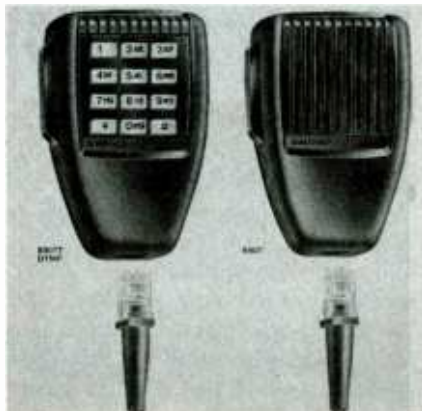

CIRCLE 71 ON FREE INFORMATION CARD

access port to release the cord.

The 890TT uses sophisticated CMOS integrated-circuit technology to provide DTMF dialing. It also features memory storage of up to ten 16-digit telephone numbers, has automatic last-number-dialed memory storage, audible tone confirmation, selectable dialing speed, and automatic transmitter keying. Another key feature of the 890TT is that it illuminates from the microphone line, eliminating the need for a separate 12-volt power line.

Further, they eliminate the need to open the microphone or the radio to set radio deviation levels. With *ModuLink System 1*, you can easily and quickly set levels through a rear access port. Accidental readjustment is prevented because a miniature screwdriver is needed to make the setting.

Both 890TT and 590T models feature a million cycle plus leaf switch and an Armo-Dur case that's immune to oil, grease, most fumes and solvents, salt spray, sun, rust, and corrosion.

The pricing of the units is: \$208.25 for the Model 890TT; and \$47.00 for the Model 590T. They're available from Shure Brothers Inc., 222 Hartrey Avenue, Evanston, IL 60202-3696; Tel. 312/866-2527.

Soldering Iron Stand Collects Excess Dross

A sturdy, soldering iron stand that features a coil spring holder and a thick sponge for tip wiping and dross collection is available from M.M. Newman Corporation.

The *Antex ST-4 Soldering Iron Stand* features a noncharring plastic base with a coil spring holder that dissipates heat to prolong tip life and includes a 1/2 inch thick sponge for tip wiping, along with

(Continued on page 12)



"Harry used his computer software to write his will. Now some hacker inherited his money!"

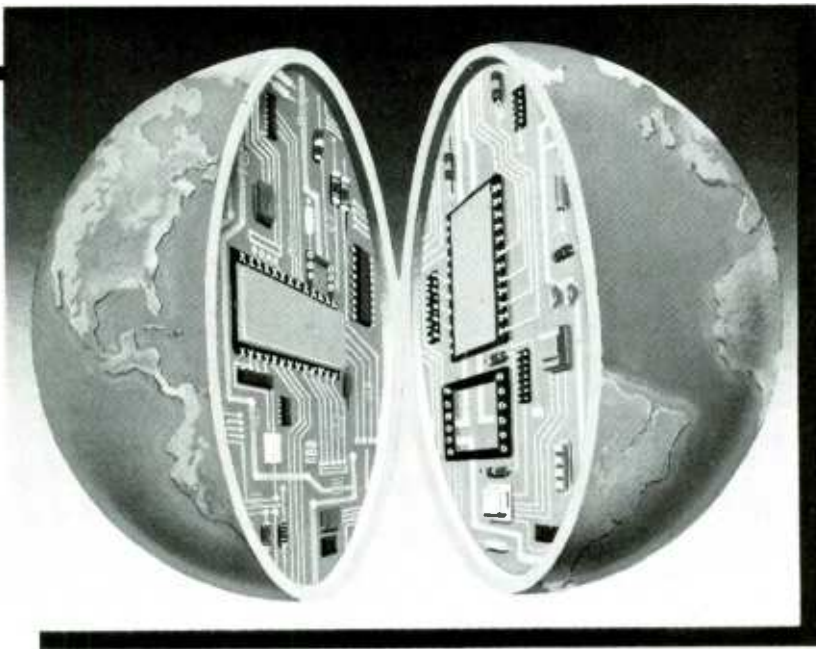

can even earn your Associate in Applied Science Degree in Electronics Engineering Technology. Of course, you set your own pace, and, if you ever have questions or problems, our instructors are only a toll-free phone call away.

The first step is yours.

To find out more, mail in the coupon below. Or, if you prefer, call toll-free 1-800-321-2155 (in Ohio, 1-800-523-9109). We'll send you a copy of CIE's school catalog and a complete package of enrollment information. For your convenience, we'll try to have a representative contact you to answer your questions.

CIE MAKES THE WORLD OF ELECTRONICS YOURS.

Today's world is the world of electronics. But to be a part of it, you need the right kind of training, the kind you get from CIE, the kind that can take you to a fast growing career in business, medicine, science, government, aerospace, communications, and more.

Specialized training.

You learn best from a specialist, and that's CIE. We're the leader in teaching electronics through independent study, we teach only electronics and we've been doing it for over 50 years. You can put that experience to work for you just like more than 25,000 CIE students are currently doing all around the world.

Practical training.

You learn best with practical training, so CIE's Auto-Programmed® lessons are designed to take you step-by-step, principle-by-principle. You also get valuable hands-on experience at every stage with sophisticated electronics tools CIE-designed for teaching. Our

4K RAM Microprocessor Training Laboratory, for example, trains you to work with a broad range of computers in a way that working with a single, stock computer simply can't.

Personalized training.

You learn best with flexible training, so we let you choose from a broad range of courses. You start with what you know, a little or a lot, and you go wherever you want, as far as you want. With CIE, you



AHO-81

CIE Cleveland Institute of Electronics

1776 East 17th St., Cleveland, Ohio 44114

YES! I want to get started. Send me my CIE school catalog including details about the Associate Degree Program. I am most interested in:

- | | |
|--|---|
| <input type="checkbox"/> computer repair | <input type="checkbox"/> television/high fidelity service |
| <input type="checkbox"/> telecommunications | <input type="checkbox"/> medical electronics |
| <input type="checkbox"/> robotics/automation | <input type="checkbox"/> broadcast engineering |
| <input type="checkbox"/> other _____ | |

Print Name _____

Address _____ Apt. _____

City _____ State _____ Zip _____

Age _____ Area Code/Phone No. _____

Check box for G.I. Bulletin on Educational Benefits
 Veteran Active Duty

MAIL TODAY!

CIRCLE 9 ON FREE INFORMATION CARD

ELECTRONIC COMPONENTS CATALOG

... yours FREE by dialing

1-800-992-9943

In Texas: 817/ 483-4422

Call Today for your FREE subscription to the 1988 Mouser Electronics Catalog. Contains 176 pages featuring over 16,000 in-stock, quality electronic components.

..PLUS..Mouser's proven service and prompt delivery.

(Outside U.S.A., Send \$2.)



MOUSER ELECTRONICS
2401 Hwy 287 North
Mansfield, Texas 76063

DISTRIBUTION CENTERS NATIONWIDE

CIRCLE 12 ON FREE INFORMATION CARD

AMAZING SCIENTIFIC & ELECTRONIC PRODUCTS

PLANS—Build Yourself—All Parts Available In Stock

• LC7—BURNING CUTTING CO ₂ LASER	\$ 20.00
• RUB4—PORTABLE LASER RAY PISTOL	20.00
• TCC1—3 SEPARATE TESLA COIL PLANS TO 1.5 MEV	20.00
• IOG1—ION RAY GUN	10.00
• GRA1—GRAVITY GENERATOR	10.00
• EML1—ELECTRO MAGNET COIL GUN/LAUNCHER	6.00

KITS

• MFT1K—FM VOICE TRANSMITTER 3 MI RANGE	49.50
• WPM5K—TELEPHONE TRANSMITTER 3 MI RANGE	39.50
• BTC3K—250.00 VOLT 10-14" SPARK TESLA COIL	199.50
• LHC2K—SIMULATED MULTICOLOR LASER	39.50
• BL51K—100,000 WATT BLASTER DEFENSE DEVICE	69.50
• ITM1K—100,000 VOLT 20" AFFECTIVE RANGE INTIMIDATOR	69.50
• PSP4K—TIME VARIANT SHOCK WAVE PISTOL	59.50
• PTG1K—SPECTACULAR PLASMA	
TORNADO GENERATOR	149.50
• MVP1K—SEE IN DARK KIT	199.50

ASSEMBLED

• PG70H—MULTICOLORLED VARIABLE MODE PLASMA GLOBE 7"	199.50
• BTC10—50,000 VOLT—WORLD'S SMALLEST TESLA COIL	44.50
• LGU40—1MW HeNe VISIBLE RED LASER GUN	199.50
• TAT20 AUTO TELEPHONE RECORDING DEVICE	24.50
• GPV10—SEE IN TOTAL DARKNESS IR VIEWER	349.50
• LIST10—SNOOPER PHONE INFINITY TRANSMITTER	169.50
• IPG70—INVISIBLE PAIN FIELD GENERATOR—MULTI MODE	74.50

• CATALOG CONTAINING DESCRIPTIONS OF ABOVE PLUS HUNDREDS MORE AVAILABLE FOR \$1.00 OR INCLUDED FREE WITH ALL ABOVE ORDERS.

PLEASE INCLUDE \$3.00 PH ON ALL KITS AND PRODUCTS PLANS ARE POSTAGE PAID. SEND CHECK, MO, VISA, MC IN US FUNDS.

INFORMATION UNLIMITED

P.O. BOX 716 DEPT. HO AMHERST, NH 03031

HANDS-ON ELECTRONICS

NEW PRODUCTS

(Continued from page 8)

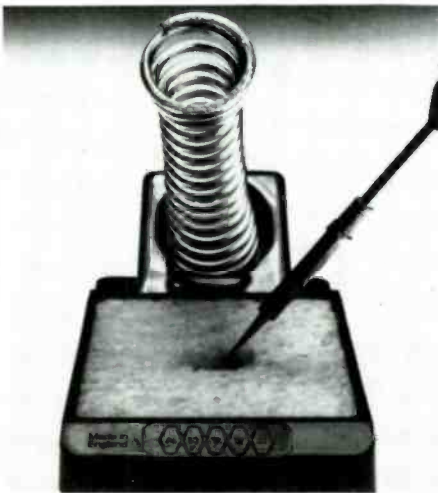

CIRCLE 89 ON FREE INFORMATION CARD
a center hole for collecting excess dross.

Designed for use with all miniature soldering irons, the Antex ST-4 measures 6 x 2 1/2-in. and has four, non-skid, non-scratch, rubber feet to keep it securely in place.

The Antex ST-4 Soldering Iron Stand sells for \$7.20 (suggested, retail). For more information contact: M.M. Newman Corporation, PO Box 615, Marblehead, MA 01945; Tel. 617/631-7100.

Quiet Power Conditioner

These *Super-Quiet* models feature exceptionally low audible noise of only 40 dBA, making them ideal for office environments or other areas where low audible noise is a primary consideration.

The Super-Quiet models offer the



CIRCLE 81 ON FREE INFORMATION CARD

same broad input voltage range and narrow output band of other *Escort* models. Constant regulation is maintained within +3% to -6% of nominal rated voltage for fluctuations as large as +15% to -35% of nominal. The exceptionally fast response time of 16 milliseconds provides critical protection against voltage sags and brownouts.

In addition, Super-Quiet *Escort* models provide common-mode noise attenuation at a ratio of two million to one (126 dB) and normal-mode noise attenuation at a ratio of 1,000 to one (60 dB), virtually eliminating costly noise-related problems.

Super-Quiet *Escort* Power Conditioners are available in convenient line-cord/receptacle models from 70 VA to 2 kVA. Prices start at \$195. For complete information, contact your nearest Topaz distributor or Tel. 619/279-0831.

Communications Surge Suppressor

The *Perma Power Surge-Protected Outlet Strip*, provides four power-line outlets, one telephone-line input, and one telephone-line output. It is the first *Perma Power* strip unit to combine the two functions.

Data communications equipment, is particularly vulnerable to erratic operation from spikes and transients, because there are two potential ports of entry for spikes and transients: the telephone line and the power line. The *Perma Power Model RTD410 Communications Surge Suppressor* provides protection for both lines, including protection from all three ways that surges can travel on the power lines—in the normal-mode and both common-modes.

The Tele-Line surge suppressor circuit employs a three-element gas tube and three metal-oxide varistors (MOV) in a coordinated design, to reduce the



"Herb and I couldn't possibly correct the overheating problem 'till after lunch."



CIRCLE 65 ON FREE INFORMATION CARD

transient surge energy to a safe value. Most carbon-block surge arresters were designed for electromagnetic telephones, and are not adequate for protecting electronic equipment.

The Perma Power Communications Surge Suppressor also offers the particular protection of failsafe automatic shut-down. If the power-line surge suppressor element wears out or burns out from handling large or repetitive surges, a patented circuit disconnects the equipment from the power line so that computers, modems, or other equipment are never exposed to raw, unprotected power. A neon light turns off to indicate that automatic shutdown has occurred. Other surge suppressors may burn out without providing any indication they have done so, thus allowing equipment to operate unprotected.

The unit offers the convenience of a master on/off switch with indicator light. A six-foot, double-insulated, power-line cord (#14/3 SJT) and mounting bracket with screws allow convenient placement. A seven-foot telephone-line jumper cord is included for connection to the telephone line. Manufacturers suggested user price is \$72.60.

Perma Power products are available from electronic, computer and office supply outlets nationwide. Free literature is available from Perma Power Electronics, Inc., 5601 West Howard, Chicago, IL 60648; Tel. 312/647-9414.

Phone Aid

Have you ever had a conversation over the telephone with an elderly person or someone suffering from hearing loss and had to talk louder so they could effectively hear you?

The clever slip-on amplifier makes voices sound louder and clearer. It comes with an adjustable volume control and fits any standard telephone receiver. It measures 2 1/2 in



CIRCLE 75 ON FREE INFORMATION CARD

diameter and operates on a single "AA" battery (not included). Will make a thoughtful gift for anyone with a hearing problem.

It costs \$9.95 plus \$1.00 S&H. NC residents add 50 cents. Contact BRT Enterprises, 211 Meadowview Drive, Suite 428, Boone, NC 28608.

CB Preampifier

Dubbed *RFTR Signal Intensifier* this amplifier is specifically configured to improve the coverage of citizens-band transceivers by amplifying the received signals to improve reception. The FCC limits transmitter power, not the receiver sensitivity. By making the receiver more sensitive with an RFTR

Do You Suffer From...

- High Prices
- Limited Selection
- Slow Delivery
- Unfriendly Service
- All of the above



MCM Electronics Brings Relief!

If you're tired of all the "headaches" that come from dealing with an electronics supplier that doesn't seem to understand your needs, it's time to pick up your phone and ask for a **FREE** copy of MCM's new catalog! This 168-page "powerhouse" of electronic parts and components offers some of the best values in the industry on nearly 10,000 of the most commonly requested items.

You'll appreciate the friendly, personalized service provided by our courteous Sales Representatives and some of the most flexible payment terms in the industry. And you'll be pleased to learn that thanks to our huge inventory and state-of-the-art order entry system, your products can usually be on their way to you in 24 hours! So, get your copy today and get the relief you've been looking for. You won't be disappointed!

For your **FREE** copy, call **TOLL-FREE!**

1-800-543-4330

In Ohio, call 1-800-762-4315

In Alaska or Hawaii, call 1-800-858-1849



MCM ELECTRONICS
858 E. CONGRESS PARK DR.
CENTERVILLE, OH 45459
A PREMIER Company

SOURCE NO. HO-14

CIRCLE 10 ON FREE INFORMATION CARD

TV, RADIO COMMUNICATIONS



□ **BP91—INTRO TO RADIO DXING** . . . \$5.00. Everything you need to know about radio DXing and how you can get into this fascinating hobby area.

□ **BP155—INTL RADIO STATIONS GUIDE** . . . \$6.95. New edition lists station site, country, frequency, ERP provides for thousands of short wave radio stations. Nine sections cover a variety of broadcast services.



□ **BP105—ANTENNA PROJECTS** . . . \$5.00. Practical antenna designs including active, loop, and ferrite types that are simple and inexpensive to build, yet perform well. Also included are antenna accessories.

□ **BP125—SIMPLE AMATEUR BAND ANTENNAS** . . . \$5.00. Shows how to build 25 antennas starting with a simple dipole and working on up to beam, triangle and even a mini rhombic.



□ **BP132—25 SHORT-WAVE BROADCAST ANTENNAS** . . . \$5.00. Good antennas can be inexpensive. Here's 25 different ones ranging from a simple dipole, through helical designs to a multi-band umbrella.

□ **BP136—25 INDOOR AND WINDOW ANTENNAS** . . . \$5.00. If you can't put up a conventional antenna because of where you live, one of these 25 designs is likely to solve your problem and deliver great reception.



MAIL TO: Electronic Technology Today Inc.
P.O. Box 240
Massapequa Park, NY 11762-0240

SHIPPING CHARGES IN USA & CANADA
\$0.01 to \$5.00 . . . \$1.00 \$30.01 to 40.00 . . . \$4.75
\$5.01 to \$10.00 . . . \$1.75 \$40.01 to 50.00 . . . \$5.75
\$10.01 to 20.00 . . . \$2.75 \$50.01 and above \$7.00
\$20.01 to 30.00 . . . \$3.75

OUTSIDE USA & CANADA
Multiply Shipping by 2 for sea mail
Multiply Shipping by 4 for air mail

Total price of merchandise . . . \$ _____
Shipping (see chart) . . . \$ _____
Subtotal . . . \$ _____
Sales Tax (NYS only) . . . \$ _____
Total Enclosed . . . \$ _____

Name _____
Address _____
City _____ State _____ Zip _____

NEW PRODUCTS



CIRCLE 91 ON FREE INFORMATION CARD

it will appear as if all your friends were running illegal 100 watters.

The RFTR simply installs in the antenna lead of any (AM or SSB) CB transceiver and connects to the units 12-volt power supply. Received signals are increased a minimum of 13 db. By means of an internal relay, the preamp is automatically bypassed when transmitting. Insertion loss and VSWR are negligible and the unit draws only 80 ma at 10-15 volts DC.

RFTR Signal Intensifiers are available for \$49.95. To order or for additional information contact the Sales Department, Electron Processing, Inc.; Tel. 516/764-9798.

Precision Tools Pamphlet

A free folder is available from *Mini-tool Inc.* showing the company's line of precision miniature hand tools for laboratory and production tasks, as well as for fine assembly work, delicate deburring jobs, and printed circuit artwork and repair. Shown are Minitool sets with hardened tool steel and Carbide tips, Technician sets, Minitool kits, Diamond scribers, Electrical micro-test probes with interchangeable probe handles, Micro test probes with integrated handles and audible beepers, unique Precision pin vises, Sapphire



CIRCLE 62 ON FREE INFORMATION CARD

Burnisher and direct-reading Micro-rulers. Also shown are Micro-lapping kits, Zirconium ceramic scissors and ceramic-tipped tweezers.

Free folder includes technical data as well as prices and ordering information. Contact Minitool, Inc., 1334/F Dell Avenue, Campbell, CA 95008; Tel. 408/374-1585.

Technics Power Amplifier

Technics has four car-audio amplifiers with the top-of-the-line model, the *CY-M400*, offering tri-mode operation with a maximum total-power output of 400 Watts (200 × 2, 200 + 100 × 2, or 100 × 4 bridgeable max). The *CY-M400* has been designed for varied applications, including multiple amps.

The three other models include the *CY-M200* (100 Watts/channel max), and the *CY-M50* (25 Watts/channel max.)

All four units offer DIN/RCA dual input to mate with all Technics head units as well with head units from many competitors. The *CY-M400* has a 5-mm DIN cord to facilitate trunk mounting while the other three units come with a 1.5-mm DIN cord.



CIRCLE 87 ON FREE INFORMATION CARD

An input-level adjustment for each unit allows the listener to fine-tune amplifier response to the car speaker's sensitivity. Adjustments are made by tuning the control via a recessed screw on the front panel.

Frequency response for the *CY-*



"Gladys, what happened to the power?"

M50. Total harmonic distortion for the CY-M400 is 0.007% (at 1kHz, 4 ohms), 0.009 for the CY-M200 and CY-M120, and 0.03 for the CY-M50. Signal-to-noise ratio for the CY-M400, CY-M200, and CY-M120 is 100dB and 90dB for the CY-M50. The prices are: \$720 for the CY-M400; \$370 for the CY-200; \$200 for the CY-M120; \$130 for the CY-M50.

For more information contact Technics, One Panasonic Way, Secaucus, NJ 07094.

Satellite-Audio Receiver

Check out the *SCS-200 Tunable Satellite Audio Receiver* for major religious, communications, and news networks. The SCS-200 receiver uses audio sub-carriers on a video transponder for satellite transmissions to radio broadcasters, supermarket networks, data services, etc. The SCS-200 is fully compatible with United Video's Satellite Communications System (denoted SCS).



CIRCLE 79 ON FREE INFORMATION CARD

The SCS-200 is a complete wideband receiver with a high-stability microwave downconverter, frequency-agile SCS demodulator, preset tuning for selection of up to 4 different frequencies, base-band output to drive competitive demodulators, and the AVCOM AVPAND-A Audio Processor. Continuous tuning over an entire transponder is optional. Also available are narrow band models and compatibility with LNA or LNB systems.

The SCS-200 retails for \$1,189.00. For further information contact Avcom, 500 Southlake Blvd., Richmond, VA 23236; Tel. 804/794-2500.

2-MHz Sweep/Function Generator

The *Model 9805 Sweep/Function Generator* provides full signal generation and monitoring capabilities in one instrument. It is designed and priced for service, laboratory, training, and production applications. As a sweep/function generator, the Mercer Model 9805 generates sine, triangle, and square waveforms and provides both linear- and log-sweep outputs for circuit testing. The output frequency (.02 Hz to 20 MHz in 7 ranges) can be precisely set using the internal 6-digit LED display.



CIRCLE 67 ON FREE INFORMATION CARD

The same instrument provides frequency-counter capabilities to 10 MHz with monitoring via the built-in 6-digit display. This value-packed sweep/function generator from Mercer also features voltage-controlled frequency (VCF) input, variable-amplitude output, and a 2-position (-20 dB and -40 dB) attenuator. All functions and inputs are front-panel mounted and clearly marked for ease of operation.

The Mercer Model 9805 Sweep/Function Generator is available from stock. Suggested resale price is \$329.00.

For complete details and specifications, contact your electronics distributor or Mercer Electronics, 859 Dundee Avenue, Elgin, IL 60120-3090; Tel. 312/697-2260.

AC/DC Clamp-on Probe

An AC/DC clamp-on current probe, Model 159, extends the range and capabilities of a VOM or DMM in power and control-circuit measurements. The design of the Model 159 allows access to cables mounted in almost any position and the circuit under test does not have to be broken. Measurements are performed without circuit interruption.

The Hall-effect technology employed in this Simpson instrument provides DC measurement capability.

Features of the Simpson Model 159 clamp-on include: 0.1-A to 500-A, AC or DC measurement range; DC to 440 Hz frequency range; autoranging; maximum operating voltage of 660-Volts (rms). It is usable with digital or analog meters, and has a maximum jaw opening of 1.3 inches (33 mm) to accommodate large cables and busses.

The Model 159 clamp-on current probe has a suggested resale price of \$169.00. For complete information and specifications, contact your electronics distributor or Simpson Electric Company, 853 Dundee Avenue, Elgin, IL 60120-3090; Tel. 312/697-2260.

CIRCLE 76 ON FREE INFORMATION CARD

SEND FOR FREE 1988 CATALOG... 52 PAGES!

QUALITY PARTS • DISCOUNT PRICES • FAST SHIPPING!

ALL ELECTRONICS CORP.

<p>SWITCHING POWER SUPPLY</p> <p>Compact well regulated switching power supply designed to power Texas Instruments computer equipment INPUT: 14-25 Vac @ 1 amp OUTPUT: +12 Vdc @ 350 ma. +5 Vdc @ 1.2 amp -5 Vdc @ 200 ma SIZE: 4 3/4" square CAT# PS-30 \$3.50 each</p>	<p>BLACKLIGHT ASSEMBLY</p> <p>Complete, functioning assembly includes ballast, on-off switch, power cord, sockets and F4T5-BL blacklight Mounted on a 7 1/8" X 3 1/8" metal plate Use for special effects lighting or erasing EPROMS CAT# BLTA \$10.00 each</p>	<p>MINI PUSH BUTTON</p> <p>S. P. S. T. momentary Push to make CAT# MPB-1 35c each * 10 for \$3.25</p>												
<p>THIRD TAIL LIGHT</p> <p>Sleek high-tech lamp assembly Could be used as a third auto tail light, emergency warning light, or special effects lamp Red reflective lens is 2 3/4" X 5 1/2" is mounted on a 4" high pedestal with up-down swivel adjustment Includes 12 V replaceable bulb CAT# TLB \$3.95 each</p>	<p>VIC 20 MOTHERBOARD</p> <p>26 IC's including 6520A and 6560 Not guaranteed but great for replacement parts or experimentation CAT# VIC-20 \$15.00 each</p>	<p>NICKEL-CAD CHARGER / TESTER</p> <p>Will charge most nickel-cad batteries even button & N CAT# UNCC-N \$15.00 each</p>												
<p>XENON FLASH TUBE</p> <p>3/4" X 1 1/8" dia CAT# FLT-1 2 for \$1.00</p>	<p>LED'S</p> <p>Jumbo T 1-3/4 (5mm) RED CAT# LED-1 10 for \$1.50 GREEN CAT# LED-2 10 for \$2.00 YELLOW CAT# LED-3 10 for \$2.00 TWO PIECE HOLDERS FOR ABOVE LED'S CAT# HLED 10 for 65c 100 for \$5.00</p>	<p>RECHARGEABLE NICKEL-CAD BATTERIES</p> <table style="width: 100%; font-size: small;"> <tr><td>AAA SIZE 1.25180mAh</td><td>\$2.25</td></tr> <tr><td>AA SIZE 1.25V 500mAh</td><td>\$2.00</td></tr> <tr><td>AA with solder tabs</td><td>\$2.20</td></tr> <tr><td>C SIZE 1.2V 1200mAh</td><td>\$4.25</td></tr> <tr><td>SUB-C with solder tabs</td><td>\$4.25</td></tr> <tr><td>D SIZE 1.2V 1200mAh</td><td>\$4.25</td></tr> </table>	AAA SIZE 1.25180mAh	\$2.25	AA SIZE 1.25V 500mAh	\$2.00	AA with solder tabs	\$2.20	C SIZE 1.2V 1200mAh	\$4.25	SUB-C with solder tabs	\$4.25	D SIZE 1.2V 1200mAh	\$4.25
AAA SIZE 1.25180mAh	\$2.25													
AA SIZE 1.25V 500mAh	\$2.00													
AA with solder tabs	\$2.20													
C SIZE 1.2V 1200mAh	\$4.25													
SUB-C with solder tabs	\$4.25													
D SIZE 1.2V 1200mAh	\$4.25													
<p>ORDER ORDERS TO: ALL ELECTRONICS P O BOX 567 VAN NUYS CA 91408</p>		<p>TOLL FREE 800-826-5432 INFO: (818) 904-0524 FAX: (818) 781-2653</p>												
<p>MAIL ORDERS TO: ALL ELECTRONICS P O BOX 567 VAN NUYS CA 91408</p>		<p>QUANTITIES LIMITED MINIMUM ORDER \$10.00 CALIF. ADD SALES TAX U.S.A.: \$3.00 SHIPPING NO C.O.D.</p>												

CIRCLE 5 ON FREE INFORMATION CARD

THIS SPACE CONTRIBUTED AS A PUBLIC SERVICE

A defense against cancer can be cooked up in your kitchen.

There is evidence that diet and cancer are related. Follow these modifications in your daily diet to reduce chances of getting cancer.

1. Eat more high fiber foods such as fruits and vegetables and whole grain cereals.
2. Include dark green and deep yellow fruits and vegetables rich in vitamins A and C.
3. Include cabbage, brox colt, brussels sprouts, kohlrabi and cauliflower.
4. Be moderate in consumption of salt, cured, smoked, and nitrate cured foods.
5. Cut down on total fat in take from animal sources and fats and oils.
6. Avoid obesity.
7. Be moderate in consumption of alcoholic beverages.

No one factor causes cancer alone.
AMERICAN CANCER SOCIETY

COMPUTERS—THAT'S THE LIFE!

FUN FOR PROJECT BUILDERS



BP82—PROJECTS USING SOLAR CELLS . . . \$5.00. Simple circuits have applications around the home. All are powered by the energy of the sun. Have fun and stop buying batteries.



BP83—VMOS PROJECTS . . . \$5.50. Primarily concerned with VMOS power FETs. Projects include audio circuits, sound generator circuits, DC control circuits, and signal control circuits.



BP99—MINI-MATRIX BOARD PROJECTS . . . \$5.00. Includes 20 useful projects that can all be assembled on a small circuit board, Vero board, or solderless breadboard. Try them, you'll like them.



BP103—MULTI-CIRCUIT BOARD PROJECTS . . . \$5.00. Make only one printed-circuit board and you can build all of the 21 different projects in this book. Whenever possible, the same components are used too.



BP95—MODEL RAILWAY PROJECTS . . . \$5.00. Useful but reasonably simple projects for the model railroader. Controllers, signal and sound effects, and more.



BP94—PROJECTS FOR CARS AND BOATS . . . \$5.00. Fifteen fairly simple devices for use with your car and/or boat. Complete description of how each one works and a circuit board pattern.

MAIL TO: **Electronic Technology Today**
P.O. Box 240
Massapequa Park, NY 11762-0240

SHIPPING CHARGES IN USA & CANADA

\$0.01 to \$5.00 . . . \$1.00	\$30.01 to 40.00 . . . \$4.75
\$5.01 to \$10.00 . . . \$1.75	\$40.01 to 50.00 . . . \$5.75
\$10.01 to 20.00 . . . \$2.75	\$50.01 and above \$7.00
\$20.01 to 30.00 . . . \$3.75	

OUTSIDE USA & CANADA

Multiply Shipping by 2 for sea mail
Multiply Shipping by 4 for air mail

Total price of merchandise	\$ _____
Shipping (see chart)	\$ _____
Subtotal	\$ _____
Sales Tax (NYS only)	\$ _____
Total Enclosed	\$ _____

Name _____
Address _____
City _____ State _____ Zip _____



"They sure make these computer games realistic, Dad! That's the Evil Dragon."



"Of course, Julian, playing 'Hangman' isn't the only thing you can do with this baby!"



"Oh, Herb? He lost an entire document in the computer this morning."

BOOKSHELF

Satellite, Off-Air & SMATV By Frank Baylin, Steve Berkoff and Tim Meints

For you super-satellite buffs, this manual is a comprehensive source of information about all aspects of satellite master-antenna TV systems. The authors have taken care to ensure that both interested laymen or industry professionals can easily understand concepts such as designing, bidding, installing, and operating private cable systems. The targeted markets include apartment complexes, hotels and motels, condominiums, hospitals, mobile-home parks as well as many other multi-unit applications.

The book first explores the background and history of this young field. Next, the authors explain the steps required to legally purchase and resell satellite entertainment for profit. That section includes a survey of available satellite programming. That is followed by a study of the contracts required to support the sale of an SMATV system, and an examination of the economics and regulations underlying the field.

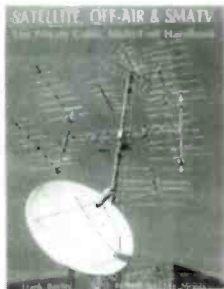

CIRCLE 100 ON FREE INFORMATION CARD

The next three chapters are devoted to the details of the site survey, and the planning and design phases of a private cable system. The technical background of each step is clearly explained. In the chapter on off-air and satellite headends, all components which are required to supply a high quality signal to every television set. Those sections are rich with examples which have been added to logically lead readers through each design step.

The remainder of the manual explores the process that follows completion of the detailed design.

First the basics of bidding projects is outlined. Next construction and installation are studied. At that stage, the important choice is between in-house versus subcontracted labor. The manual presents time-proven methods to locate as well as manage competent subcontractors. Other more complex design issues, such as inserting locally originated signals, two-way services, and satellite audio reception are studied in that chapter. The chapter on systems operations presents methods to manage one or more systems as well as a logical approach to troubleshooting. Following the final chapter on frontiers of private cable systems, eight thorough reference appendices are included for your information in the text.

Satellite, Off-Air and SMATV is a 272 page book, retailing for \$39.95 U.S., plus \$2.00 for shipping. It's available from ConSol Network, Inc., 1905 Mariposa, Boulder, Colorado 80302; Tel. 303/449-4551. Canadian residents can obtain the manual from Meints/Schuster, 410 Boulevard Roger Pilon, Dollard-des-Ormeaux, Quebec, Canada H9G 2K2.

Audio/Video IC's

If you need up-to-date info on IC's, check out *Audio/Video IC's* which provides device specifications on more than 4,500 audio and video application IC's, updated information on another 1,000 devices, and many new sources for both general and application specific IC's.

The book is good for the technical professional working in the consumer electronics field because it is the only single source for specifications and logic drawings for the following *hot* IC's: on-screen channel and time displays; picture-within-a-picture video processors (ITT); stereo TV decoders/receivers; compact disc (CD) player circuits; laser amps/receivers; sound processors/synthesizers; power management circuits; automotive application circuits; remote control circuits for toys; STK power amps (Sanyo); TVRF circuits for U.S., European and Asian transmission standards, including those

ATTENTION! ELECTRONICS TECHNICIANS

EARN YOUR B.S.E.E. DEGREE



THROUGH HOME STUDY

Our New and Highly Effective Advanced-Placement Program for experienced Electronic Technicians grants credit for previous Schooling and Professional Experience, and can greatly reduce the time required to complete Program and reach graduation. No residence schooling required for qualified Electronic Technicians. Through this Special Program you can pull all of the loose ends of your electronics background together and earn your B.S.E.E. Degree. Upgrade your status and pay to the Engineering Level. Advance Rapidly! Many finish in 12 months or less. Students and graduates in all 50 States and throughout the World. Established Over 40 Years! Write for free Descriptive Literature.

COOK'S INSTITUTE OF ELECTRONICS ENGINEERING



4251 CYPRESS DRIVE
JACKSON, MISSISSIPPI 39212

CIRCLE 7 ON FREE INFORMATION CARD

EASY TESTING & REWIRING OF RS-232 INTERFACES! B & B ELECTRONICS "BUDGET BREAK-OUT BOX"

- opens signal lines
- monitors RS-232 signals
- re-wires lines

\$49.95



Ideal for troubleshooting Break-Out Box Model 232MAB incorporates nine 2-color LED's for monitoring TD, RD, RTS, CTS, DSR, CD, and DTR, plus 2 spare LED's.

Includes one male and one female RS-232 connector, requires no AC power or batteries. Also includes 24-page instruction manual.

**"SAME DAY SHIPMENT
DIRECT FROM THE MANUFACTURER,
B&B ELECTRONICS"**



**"MONEY-BACK
GUARANTEE"**
"One Year Warranty
For All Products"

WRITE OR CALL FOR
FREE COMPREHENSIVE
RS-232C Interface and Monitoring
Equipment CATALOG
from B&B Electronics

B & B electronics

MANUFACTURING COMPANY
1540E Boyce Memorial Drive
P.O. Box 1040 • Ottawa, IL 61350
(815) 434-0846

CIRCLE 16 ON FREE INFORMATION CARD



- OSC-10**
- 5" Single Trace Triggered Oscilloscope
 - XYZ Axis
 - 1 MEG Impedance
 - Scanning Speed 1-10-100-1000 Micro-Seconds
- Excellent Beginners Scope Under \$310

PS6-C2

- 4 Amp Non Regulated Continuous Current D.C. Power Supply
 - This Unit With Auto Reset Circuit Breaker Meets All Govt Specs
 - Built-in Cigarette Lighter Adaptor.
- Under \$28.



RF-1

- Solid State RF Generator to 150 MHz
- Frequency Accuracy $\pm 3\%$
- RF Output 100 M.V.

Available At Your Local Distributor,
Catalog House Or School Supply Company.

We Also Have Digital Multimeters, Dual Trace Scopes, Analog Multimeters, Sine & Square Wave Generators, Resistance Sub & Decade Box

EMCO ELECTRONICS

P.O. Box 327, Plainview, N.Y. 11803
Free Catalog

CIRCLE 15 ON FREE INFORMATION CARD

BRIEF CASE RECORDERS



**NEW
12 HOUR
MODEL**

**USES
D-120
TAPE**

\$359.00**

Modified Panasonic recorder installed in top quality 3 inch Samsonite™ Attache Case. Has built in electret condenser mike. Recorder is activated by combination lock on brief case. Unit provides complete portable recording capability. Fold down work table conceals recorder. TDK DC 120 Cassette furnished.

OTHER AMC ITEMS

12 hour modified Panasonic recorders, \$105.00**. Also Telephone Recording Adaptors \$24.50*, VOX SWITCHES \$24.95*, Micro recorders with tie clip microphone, VOX activated micros, Wired mikes, Transmitter detectors, etc. Send for FREE data. **Add \$4.00 each shipping and handling. *Add \$1.50 shipping and handling. Calif. residents add sales tax. Mail Order.

AMC Sales Inc., Dept. (213) 869-8519
9335 Lubec St., Box 928, Downey, Calif. 90241

CIRCLE 6 ON FREE INFORMATION CARD



CIRCLE 70 ON FREE INFORMATION CARD

programmable for PAL, NTSC, etc. Additional features of the book include logic/circuit drawings and outline drawings with dimensions for all referenced devices; an index that identifies audio and video application IC's available in surface mount packages; and complete manufacturer information, including logos to aid in identifying the devices needing replacement.

A companion book with specifications on discontinued audio/video application IC's that are no longer in production is also available from D.A.T.A., Inc.

Audio/Video IC's Edition 6 is published annually. The price is \$95 U.S.

For additional information on *Audio/Video IC's* or to place an order, write to D.A.T.A., Inc., 9889 Willow Creek Road, P.O. Box 26875, San Diego, CA 92126; Tel. 800/854-7030. In California: Tel. 800/421-0159.

**The Transducer Project Book
By Michael J. Andrews**

Here is a text that offers a unique collection of practical transducer devices that you can put together simply and inexpensively!

Whether you're looking for a hands-on guide to bring you up to date on the use of transducers, or you're simply looking for a collection of projects that are both practical and different, *The Transducer Project Book* is your source! It's a goldmine of practical circuits that can be easily built in only a few hours from inexpensive and readily available components. Plus, each circuit is capable of being expanded into a more elaborate design that will challenge even the experienced hobbyist.

Leading off with a review of important electronics fundamentals with tips and hints to simplify your project building, the author provides an overview of transducers and their capabilities as well as helpful advice on basic amplifier and power supply circuit design. From here on, the

emphasis is all on hands-on project building.

You'll find instructions, plans, and schematic diagrams for building a seismic sensor that can detect subaudible sounds of very low frequency...a temperature survey meter that can detect even the heat from a flashlight as far as 12 feet away (a practical tool for checking the efficiency of home insulation or window caulking)...an open door annunciator...a moisture detector...an automatic night light...and more.

And, unlike many project guides, this book gives full explanations of how and why each device will function once it's completed.



CIRCLE 98 ON FREE INFORMATION CARD

Designed to appeal to a wide range of electronic interests, these projects all have immediate practical applications potential...and all are guaranteed to clarify and reinforce your understanding of transducer technology.

Michael J. Andrews is a professional electronics technician and electronics hobbyist and experimenter whose interests include communications and amateur radio-astronomy. Soft cover, 140 pages, \$8.95 TAB Books, Inc., Blue Ridge Summit, PA. 17214; or tel. 717/794-2191



"It works fine now, but it melts in the spring!"

Train with NRI for a high paying career servicing computers.

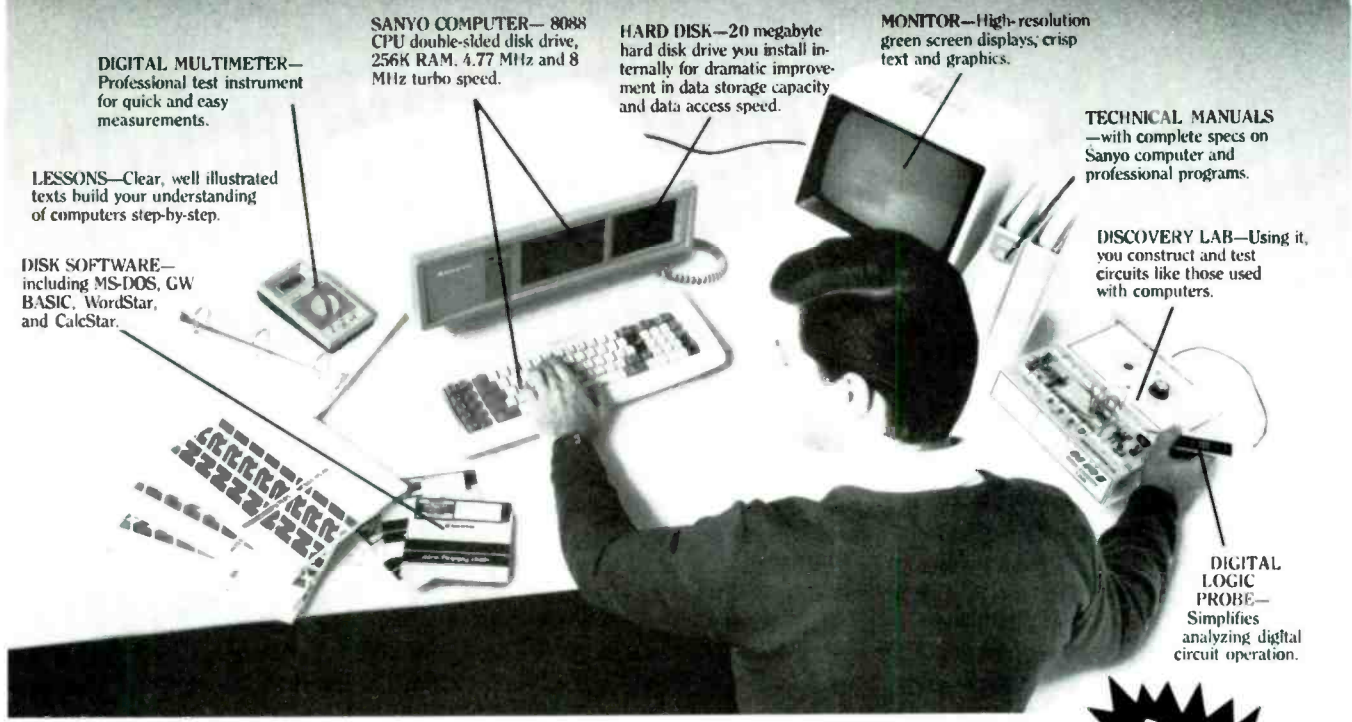

DIGITAL MULTIMETER—Professional test instrument for quick and easy measurements.

LESSONS—Clear, well illustrated texts build your understanding of computers step-by-step.

DISK SOFTWARE—including MS-DOS, GW BASIC, WordStar, and CalcStar.

SANYO COMPUTER—8088 CPU double-sided disk drive, 256K RAM, 4.77 MHz and 8 MHz turbo speed.

HARD DISK—20 megabyte hard disk drive you install internally for dramatic improvement in data storage capacity and data access speed.

MONITOR—High-resolution green screen displays; crisp text and graphics.

TECHNICAL MANUALS—with complete specs on Sanyo computer and professional programs.

DISCOVERY LAB—Using it, you construct and test circuits like those used with computers.

DIGITAL LOGIC PROBE—Simplifies analyzing digital circuit operation.

Get started now by building this fully PC-compatible computer



Now you get it all . . . training for one of America's fastest-growing career opportunities . . . training to service all computers . . . training on a total computer system. Only NRI can give you the well-rounded training you need, because only NRI gives you a complete computer system . . . computer, monitor, floppy disk drive, hard disk drive, software, even test instruments like a DMM and logic probe to work with and keep. It all adds up to training that builds the knowledge and ability you need to succeed as a computer service specialist.

Get inside the newest Sanyo Computer—fully compatible with the IBM PC*

As an NRI student, you'll get total hands-on training as you actually build your own latest model Sanyo 880 Series computer from the keyboard up. It's fully compatible with the IBM PC and, best of all, it runs programs almost twice as fast as the PC. As you assemble the Sanyo 880, you'll perform demonstrations and experiments that will give

you a total mastery of computer operation and servicing techniques. You'll do programming in BASIC language—even run and interpret essential diagnostic software.

Understanding you get only through experience

You need no previous knowledge to succeed with NRI. You start with the basics, rapidly building on the fundamentals of electronics with bite-size lessons. You perform hands-on experiments with your NRI Discovery Lab and then move on to master advanced concepts like digital logic, micro-processors, and computer memories.

Learn at home in your spare time

You train in your own home at your own convenience, backed at all times by your own NRI instructor and the entire NRI staff of educators and student service support people. They're always ready to give you guidance, follow your progress, and help you over

the rough spots to keep you moving toward your goal.

Free 100—page catalog tells more . . . send today

Send the postage-paid reply card today for NRI's 100-page catalog that gives all the facts about computer training plus career training in robotics, data communications, TV/audio/video servicing, and many other fields. If the card is missing, write to NRI at the address below.

*IBM is a registered trademark of International Business Machines Corp.

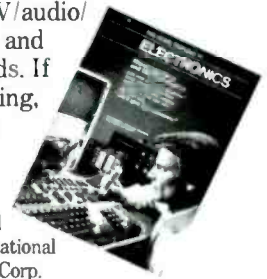

NRI SCHOOLS
McGraw-Hill Continuing Education Center
3939 Wisconsin Avenue
Washington, DC 20016

We'll give you tomorrow

ELECTRONIC PARTS OUTLET

TECH-TRAINER II

Power Supply and Frequency Generator

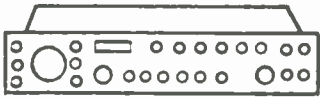

\$89.00 Quantity Price 1

2 CHANNEL VHF TRANSMITTER & RECIEVER

With Schematics

\$8.95

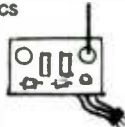

3 DIGIT PANEL METER KIT

DCV or DCA
\$14.95

AA Size 1.25V 500mA	\$1.75
Hobby Motor 6-12VDC Colman	\$1.75
24 wt 7.5Ω PWR Resistor	\$0.25

ELECTRONIC PARTS OUTLET, INC.
2815 FONDREN, HOUSTON, TX 77063
713/784-0140

QUANTITIES LIMITED • MIN. ORDER \$10.00
TEX. ADD SALES TAX • USA \$3 SHIPPING • NO COD
VISA / MASTERCARD / DISCOVERY

CIRCLE 17 ON FREE INFORMATION CARD

Slate of the Art Kits by Hal-Tronix, Inc.

VARIOUS CLOCK KITS

HAL-5314 (Most Famous Clock Kit) \$12.95
6 DIGIT ELECTRONIC CLOCK KIT 12 OR 24 HOUR
FORMAT COMPLETE KIT LESS POWER SUPPLY
ADAPTOR AND CASE RUNS OFF ANY 12 VOLT A C
SOURCE REQUIRES 250 MA

HAL-5375 (Alarm Clock Kit) \$16.95
6 DIGIT ELECTRONIC CLOCK KIT 12 HOUR FORMAT
ONLY OPERATE ON 12 VOLTS A C OR D C HAS TIME
BASE ONBOARD COMES COMPLETE LESS POWER
ADAPTOR AND CASE

HAL-79 (Student Class Kit) \$7.95
4 DIGIT BASIC ELECTRONIC KIT WITH OPTIONS AND
PROVISIONS TO MAKE IT AN ALARM CLOCK AND A
D C OPERATED CLOCK COMPLETE LESS OPTIONS
POWER SUPPLY ADAPTOR AND CASE

OPTION #1 - TO MAKE IT AN ALARM CLOCK \$2.95
OPTION #2 - TO MAKE IT A D.C. 12V CLOCK \$4.95

**CLOCK CASE - Reg. \$6.50 Clock Case - When Bought with
Clock Kit (ONLY) \$4.50**

**12 VOLT A.C. ADAPTOR - Reg. \$4.95 - When Bought with
Clock Kit (ONLY) \$2.95**

60HZ TIME BASE Complete - \$4.95

CRYSTAL TIME BASE KIT USING MM5369

HAL NTSC RF MOD \$19.95
BUILD YOUR OWN VIDEO RF MODULATOR A MINI TV
TRANSMITTER FOR CHANNELS 3 OR 4 USING A S A W
OUTPUT FILTER KEEPING CO-CHANNEL INTERFER-
ENCE AT A MINIMUM COMES COMPLETE LESS CASE
POWER SUPPLY AND HARDWARE
NOTE: CASE POWER SUPPLY AND HARDWARE
ENCLOSE \$12.95 Extra

HAL FG 100 \$69.95
FUNCTION GENERATOR KIT 1 HZ TO 100 KHZ IN FIVE
BANDS AMPLITUDE AND OFFSET ADJUSTABLE OUT-
PUT IMP 500 OHMS WAVE FORMS - SINE SQUARE
AND TRIANGULAR AND TTL CLOCK 0 TO 5V LEVEL 200
NS RISE AND FALL TIME COMPLETE WITH CASE AND
POWER SUPPLY AND ALL ELECTRIC PARTS INCLUD-
ING MANUAL

SHIPPING INFORMATION: PLEASE INCLUDE 10% OF
ORDER FOR SHIPPING AND HANDLING CHARGES
(MINIMUM \$2.50 MAXIMUM \$10) CANADIAN ORDERS
ADD \$7.50 IN US FUNDS MICHIGAN RESIDENTS ADD
4% SALES TAX FOR FREE FLYER SEND 22c STAMP
OR SASE

HAL-TRONIX, INC.

12671 Dix-Toledo Hwy.
P.O. Box 1101, Dept C.
Southgate, MI 48195
(313) 281-7773

Hours: 12:00 - 6:00 EST Mon.-Sat



NOW A DEALER FOR
TEN-TEC AND M F J

CIRCLE 13 ON FREE INFORMATION CARD

An Introduction to 68000 Assembly Language

By R.A. and J.W. Penfold

As you probably know, a vast increase in running speed can be obtained by using programs written in assembly language, which entails direct programming of the computer without using a high-level, built-in language such as BASIC. However, that can only be undertaken by someone who has a reasonable understanding of the microprocessor and some of the other hardware used in the computer, but it is not as difficult as one might think and this book tells the story.

An Introduction to 68000 Assembly Language

By R.A. and J.W. Penfold



CIRCLE 97 ON FREE INFORMATION CARD

The microprocessor dealt with is the 68000 series which is widely acknowledged as one of the most powerful chips currently available, leading to its use in some of the latest home and business computers such as the Commodore Amiga, Atari ST range, Apple Macintosh range, and the Sinclair QL etc.

An Introduction to 68000 Assembly Language contains 102 pages, and retails for \$6.00 plus \$1 shipping and handling, from Electronics Technology Today, PO Box 240, Massapequa, NY 11762.

Hard Disk Management with MS-DOS and PC-DOS

By Dan Gookin and Andy Townsend

In the past, computers equipped with hard disks were employed primarily by power users. But with the decreased cost of hard disks, the increased storage requirements of applications programs, and the advent of the 80286 and 80386 generations of computers, the hard disk has now become a standard and necessary component of most user's systems.

This book provides beginning and intermediate users with an easily understandable guide to making the most of the expanded storage capacity offered by the hard disk drive. The book addresses the three primary

HARD DISK MANAGE- MENT

with MS-DOS and PC-DOS



CIRCLE 98 ON FREE INFORMATION CARD

concerns applications users have when approaching a hard disk: organization and access to data; data protection and security; and operating performance.

Power users will find this information valuable when they are called upon to configure hard disks for less experienced users. With PC Menu, the DOS shell, and the other software tools available with the book, this task can be reduced from hours to a matter of minutes, resulting in a professional, attractively presented, menu-driven system complete with an easy-to-use DOS shell and password security.

Three appendices contain a summary of DOS commands, and extended ASCII chart that includes the IBM character set, and documentation for the public domain programs available on diskette.

Hard Disk Management With MS-DOS and PC-DOS, contains 324 pages costing \$18.60 paperback from Tab Books Inc., PO Box 40, Blue Ridge Summit, PA 17214; Tel. 717/794-2191.

Programming With Paradox By Cary N. Prague, James E. Hammit and Mark R. Nowacki

Paradox is the increasingly popular relational database software offered by Ansa. A very powerful database management tool, Paradox's PAL (Paradox Application Language) offers many advantages and features not found in traditional computer languages. Now, Prague, Hammit, and Nowacki offer proven tips, techniques, and shortcuts that make it amazingly easy to use Paradox for solving even the most complex business data-processing problems.

Written for the novice, businessperson and experienced Paradox user, *Programming with Paradox* provides a wealth of practical guidance covering everything from the special features offered by Paradox and procedures for creating, using and maintaining databases in direct mode, to techniques for using PAL for creating original programs to handle your own specific data handling needs.

PROGRAMMING WITH PARADOX

CIRCLE 98 ON FREE INFORMATION CARD

Programming With Paradox is well documented and filled with invaluable example programs including a sophisticated customer and order-entry system. This book provides a full listing of Paradox commands, tips on editing, debugging and subroutines, and step-by-step guidance in such basic programming tasks as preparation of forms, formats and reports. The authors also offer plenty of practical advice on program design and implementation.

Far more complete than ordinary program manuals, *Programming With Paradox* delivers the hands-on programming guidance expected from on-site consultants—at a fraction of the cost.

Programming With Paradox, order No. 2906, 400 pages, \$19.95 paperback available from Tab Books Inc., PO Box 40, Blue Ridge Summit, PA 17214; Tel. 717/794-2191.

Computer Music Projects By R.A. Penfold

For those of you that like electronics and tunes, this book offers you the opportunity to enjoy both at once.

The purpose of the book is to show some of the ways in which a home computer can be used for the production of electronic music. Topics covered include sequencing and control via analogue and MIDI interfaces, computers as digital-delay lines, and sound generators for computer control.

Included are circuits for CV

Computer Music Projects



CIRCLE 97 ON FREE INFORMATION CARD

interface, multi-channel CV generator, keyboard-CV reader, drum synthesisers, cymbal and metallic sound generators, audio digitiser, compander and MIDI interface, etc.

Everything has been kept as simple and jargon-free as possible, but it has necessarily been assumed that the reader has at least a small amount of experience with computer software, and with techniques of constructing simple electronic projects.

Computer Music Projects contains 96 pages, and is available for \$6.95 plus \$1 shipping and handling, from Electronics Technology Today, PO Box 240, Massapequa, NY 11762.

Networking with the IBM Token-Ring By Carl Townsend

The long-awaited introduction of IBM's Token-Ring networking system has finally provided a true standard for LAN systems. Based on components that are also available to other hardware producers for the development of compatible products, the Token-Ring provides the greatest versatility and future upgrade potential of all available LANs! It can be installed as a relatively low-cost, low-level system utilizing telephone lines already in place, and be gradually.



CIRCLE 98 ON FREE INFORMATION CARD



"Art, are you sure that a ransom note on a floppy disk can't be traced back to us?"

Put Professional Knowledge and a COLLEGE DEGREE in your Technical Career through HOME STUDY

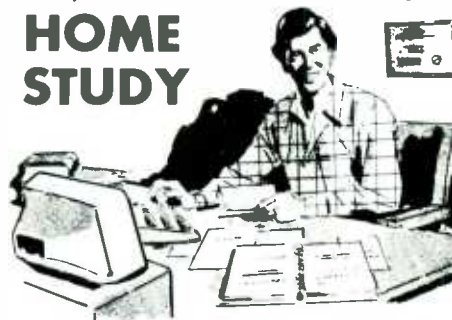

Add prestige and earning power to your technical career by earning your Associate or Bachelor degree through directed home study.

No commuting to class. Study at your own pace, while continuing on your present job. Learn from easy-to-understand lessons, with help from your Grantham instructors when you need it.

Grantham College of Engineering is a specialized institution catering to adults who are employed in electronics and allied fields such as computers. These fields are so enormous that opportunity to *move up* is always present. Promotions and natural turn-over make desirable positions available.

An important part of being prepared to *move up* is holding the proper college degree, but the essential part is *really knowing your field*. Grantham offers two B.S. degree programs — one with major emphasis in *electronics* and the other with major emphasis in *computers*. Both programs are offered by correspondence.

Write for our free catalog (see address below) or telephone us at (213) 493-4421 (no collect calls) and ask for our "degree catalog."

Accredited by
the Accrediting Commission of the
National Home Study Council

GRANTHAM
College of Engineering
10570 Humbolt Street
Los Alamitos, CA 90720

NEW FROM ETT



RATCHET — ELEVEN-PIECE RATCHET TOOL KIT.....\$10.00. Includes reversible ratchet handle, extension bar, six bits, two precision screwdrivers, and a cutter. Comes in fitted case. Get one for your shop, another for your car, another for your tool kit.

TOOL KIT—NINE-PIECE TOOL KIT.....\$10.00. Includes saw, bubble level, three screwdrivers, torque multiplier, calipers for inside and outside measurements, nippers, and a tape measure.



BP233—ELECTRONIC HOBBYISTS HANDBOOK.....\$7.95. Provides an inexpensive single source of easily located data that the electronics enthusiast is likely to need in his day-to-day hobby activities. 8 x 10 inches.

A CONCISE INTRODUCTION TO MS-DOS.....\$5.95. If you are a PC user and want to get the most out of your computer, you must learn its MS/PC-DOS operating system. That's what this book shows you.



MODERN OPTO DEVICE PROJECTS.....\$6.25. Provides a number of practical designs that use opto-electronic devices such as fiber optics, LED's, and passive IR detectors.

TRANSISTOR SELECTION GUIDE.....\$10.00. Prepared from a vast database of specifications. Unique guide offers a wide range of selection tables. More than 1400 devices are listed along with specs.



MAIL TO: Electronic Technology Today Inc.
P.O. Box 240
Massapequa Park, NY 11762-0240

SHIPPING CHARGES IN USA & CANADA

\$0.01 to \$5.00	... \$1.00	\$30.01 to 40.00	... \$4.75
\$5.01 to \$10.00	... \$1.75	\$40.01 to 50.00	... \$5.75
\$10.01 to 20.00	... \$2.75	\$50.01 and above	\$7.00
\$20.01 to 30.00	... \$3.75		

OUTSIDE USA & CANADA

Multiply Shipping by 2 for sea mail
Multiply Shipping by 4 for air mail

Total price of merchandise \$	_____
Shipping (see chart) \$	_____
Subtotal \$	_____
Sales Tax (NYS only) \$	_____
Total Enclosed \$	_____

Name _____
Address _____
City _____ State _____ Zip _____

expanded, as user needs dictate to a sophisticated SNA system.

Writing in jargon-free layman's language, the author does not assume that his reader is a computer expert. This is a book designed for managers and administrators. It minimizes the use of technical terms; when used, these terms are carefully defined. Putting his emphasis on planning, installing, and using the network, Townsend provides the insight needed to effectively evaluate LAN systems and to decide if Token-Ring is, in fact, the right one for a particular application or situation.

The first section of *Networking With the IBM Token-Ring* introduces the basic concepts of local area networking—defining types of LANs, their components, and LAN rules and conventions. The second portion deals specifically with IBM's Token-Ring options making it easy for even the most inexperienced LAN user to decide exactly what equipment is needed and how to use it. By far the most practical and up-to-date book yet on the IBM Token-Ring network, this is a selection that is must reading for anyone interested in multi-user systems in general and LANs in particular—a network manager, user, or potential user.

The book contains 220 pages costing \$16.60, from Tab Books Inc., PO Box 40, Blue Ridge Summit PA 17214.

Understanding Local Area Networks
By Stan Schatt

This book is appropriate for anyone wanting broadly-based coverage of local area networks, why they are important to business, and how they are configured to transmit information from one location to another.



CIRCLE 95 ON FREE INFORMATION CARD

Covering the basics of LAN technology for IBM PCs, the author emphasizes the importance of gateways from local area networks to mainframe computers. Appropriate illustrations and learning aids for an introductory audience provide the reader with coverage of net-

works in the MS-DOS environment, fiber optic networks, the development of fault tolerant networks, and voice data integration.

Topics covered include: an overview of local area networks, the basics of a local area network, gateways, the IBM PC network and token ring network, novell's local area network systems, 3Com's local area networks, AT&T's Starlan and ISN, the Corvus local area networks, a guide to networkable software, local area network selection and management.

Understanding Local Area Networks, No. 27063, retails for \$16.95 and is available at bookstores, electronics distributors or direct from the publisher SAMS, 4300 West 62nd Street, Indianapolis, IN 46268; Tel. 800/428-SAMS.

Build Your Own Working Fiberoptic, Infrared and Laser Space-Age Projects
By Robert E. Laninini

Probe the possibilities of high technology devices—lasers, fiberoptics, and high-voltage electrical devices. Discover



CIRCLE 98 ON FREE INFORMATION CARD

the challenge and the satisfaction of building sophisticated and practical electronic and scientific devices for a fraction of the comparable commercial cost. And do it all far more easily than you would (Continued on page 96)



"First, Larry, the good news!"

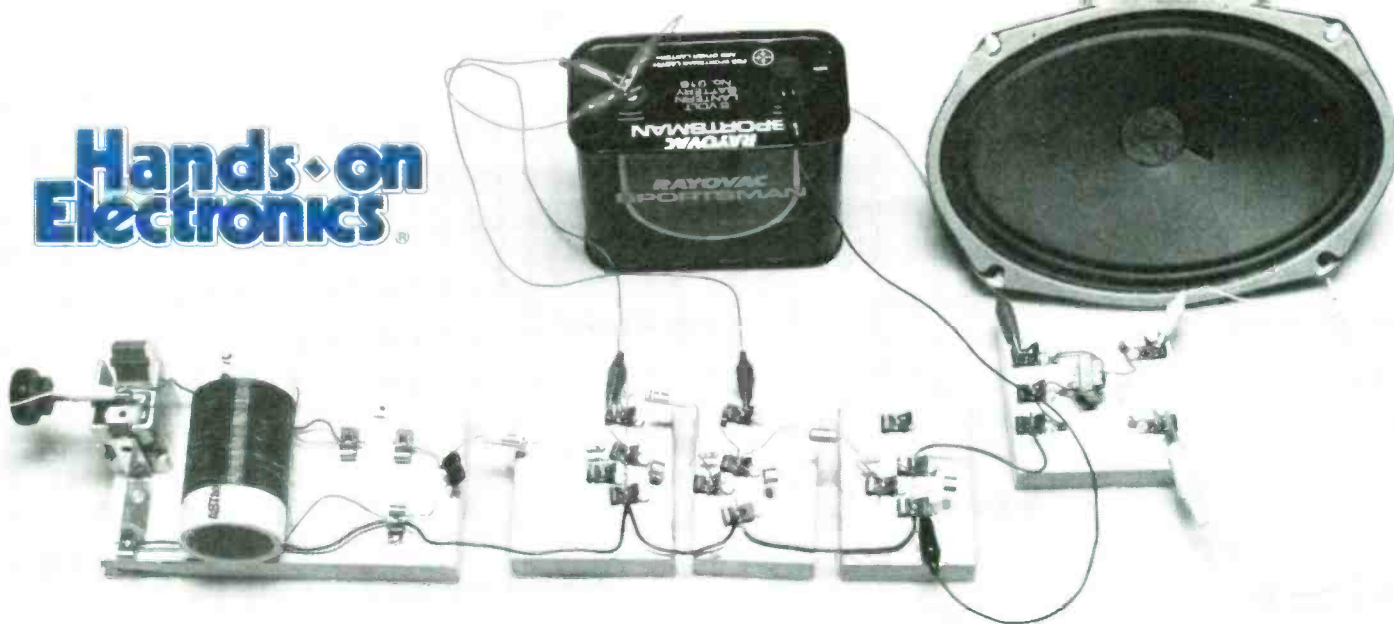

THE BUILDING BLOCK RADIO

Each stage is mounted on a separate piece of wood that lets you test each stage before adding the next. You can experiment with a part of the circuit without disturbing the rest.

By Larry Lisle

PULLING MUSIC AND VOICES OUT OF THIN AIR WITH A bunch of wires and parts that you've put together yourself is still one of the great thrills of electronics. Even after 30 years of building, I'm still awed by the wonder of radio.

Lately, I've been having a lot of fun with the little set shown in the photos. The circuitry is conventional, but its construction is a little different. Each stage is mounted on a separate block of wood—hence the term, "Building Block" radio.

Why Bother?

There are several advantages to building a radio in this way.

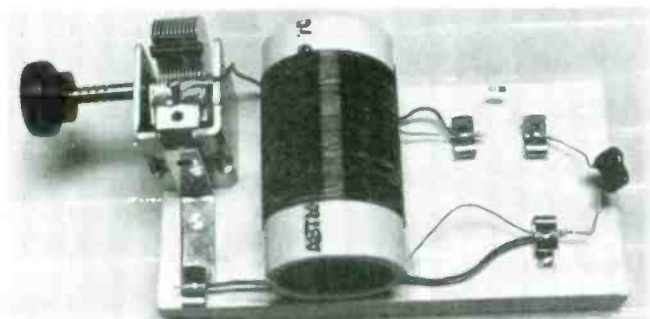

Here's the detector stage, a standard crystal set. The coil is wound on a piece of plastic pipe and the capacitor salvaged from an old broadcast set. Maybe you have other ideas. The building block concept makes them easy to try!

First, the detector can be wired and placed in operation to make sure it's working. Then, additional stages can be added and tested one at a time. That is the easy way to build and troubleshoot a radio.

Second, stages can be modified and experimented with to your heart's desire without disturbing the rest of the radio. Third, the stages can be pulled off the shelf ready to use for other projects. And finally, if you want to preserve a particular hook-up and make it look nice, just glue the blocks to a larger piece of wood and build a cabinet around it!

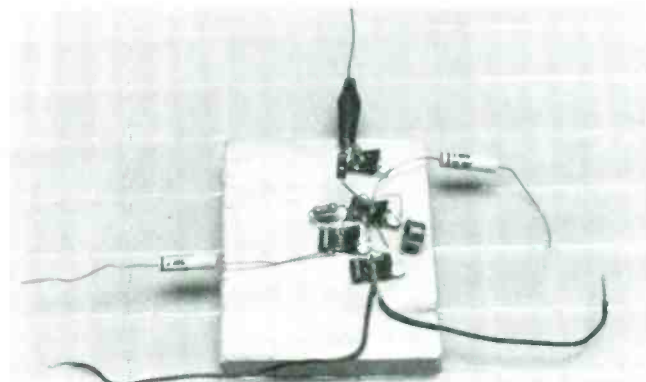

The intermediate amplifier stage is about as straightforward as an amplifier can be. The blocks are handy to have around for other projects too.

The Detector

Let's start with the first stage, the detector. The coil is wound with #22 enameled wire on a piece of 2-in. dia. plastic pipe or other insulating material of about the same size. For the broadcast band, the coil is close-wound to a length of 2¼-in. The shortwave-band coil has 10 turns spaced to occupy an inch of the form. The exact wire size, diameter and length aren't critical. Drill two small holes in the tube near each end of the windings and push each lead in one and out the other to keep the coil from unwinding. Trim the lead wires from the coil to about 4 inches and scrape the enamel from the ends to make contact with the clips.

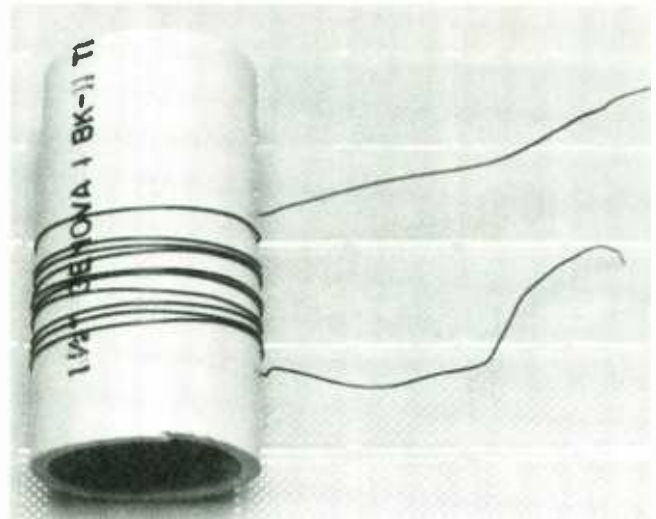

This is the shortwave coil. Surprisingly good reception can be had from foreign stations with proper positioning.

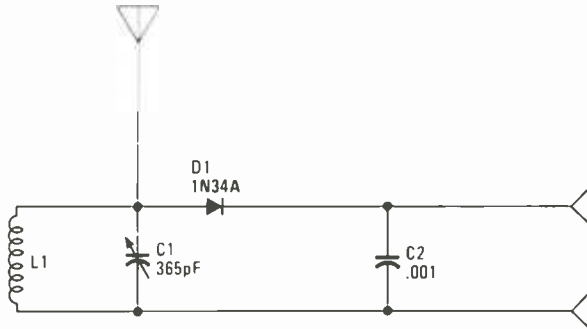

Fig. 1—The detector stage uses the time-honored crystal set circuit. The diode may be connected in either direction.

The capacitor can be salvaged from an old broadcast set. (Please don't use a real antique!) Mount it on its side with a brass angle and fasten the angle to the board with a screw and fahnstock clip. That makes a connection to the rotating plates. Solder a wire to the little tab on the stationary plates and trim it to about 6 inches. Mount the other fahnstock clips as shown in the photos and connect things together. The diode may be connected either way in the circuit.

Theory

In operation, radio-frequency signals are picked up by the antenna and passed onto coil L1 and capacitor C1. Those two components form a parallel-resonant circuit and select the frequency to be passed on to the diode D1. The diode turns the

high-frequency alternating current into pulsating direct current. If you clip a pair of high impedance earphones across bypass capacitor C2 you can hear the audio-frequency part of the signal. If you don't have high impedance headphones you can use the transformer block as an adapter and listen with the more-common, low-impedance headphones. Connect the 1000-ohm primary across C2 and 8-ohm secondary to the 'phones.

With 30 feet or so of wire strung around the room you should be able to hear nearby broadcast stations. For really satisfactory reception you'd need a good indoor antenna if you were to use only the detector, but adding amplification will make a short indoor antenna practical.

The Amplifier

The basic amplifier stage is shown in Figs. 2 and 3. Electrons from the minus (–) terminal of the battery flow into the emitter of the transistor Q1, pass through the base and exit via the collector. They then go through resistor R2 (Fig. 2) or the primary of the output transformer (Fig. 3) and back to the positive (+) side of the battery.

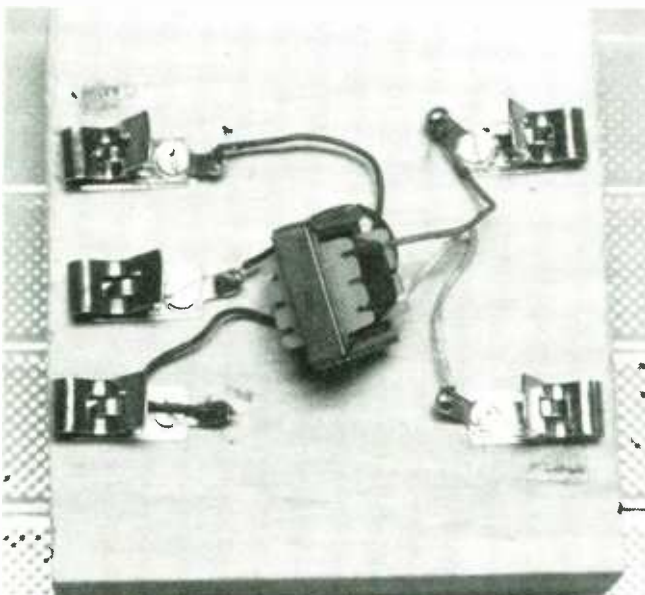

The output transformer can be mounted on a block of its own. How many times have you wished you had one of these ready to pull off the shelf for a project?

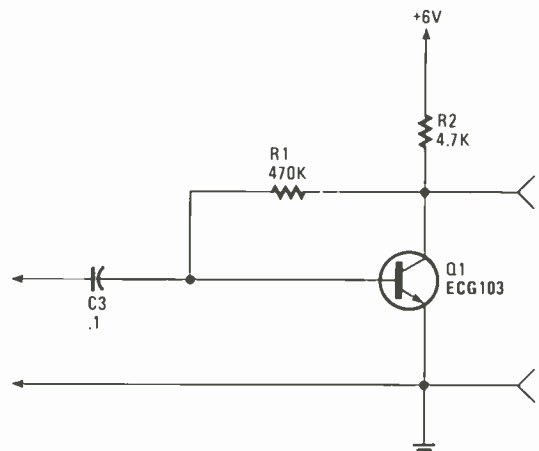

Fig. 2—In the intermediate amplification stage, C3 passes the audio to the base of Q1 which acts as an electronic valve. The load resistor is R2, and R1 sets the bias.

The amount of current that flows through the transistor is determined by the audio-frequency signal applied to the base connection. The transistor therefore acts like an electronic

“valve,” and amplifies the signal.

The 470K resistors provide bias to the transistor and keeps the *valve* half open with no signal. That lets the collector current swing up or down depending on whether the signal on the base is positive or negative at any given instant and prevents distortion. The .1- μ F capacitors keep the direct current where it belongs while passing audio.

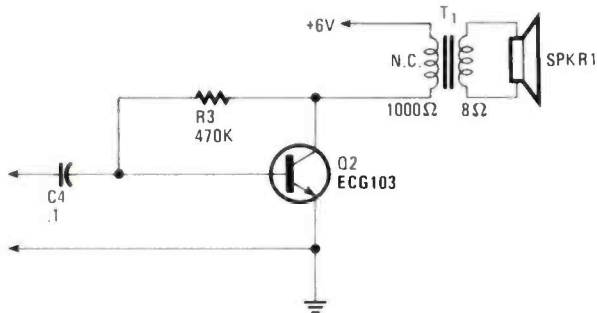
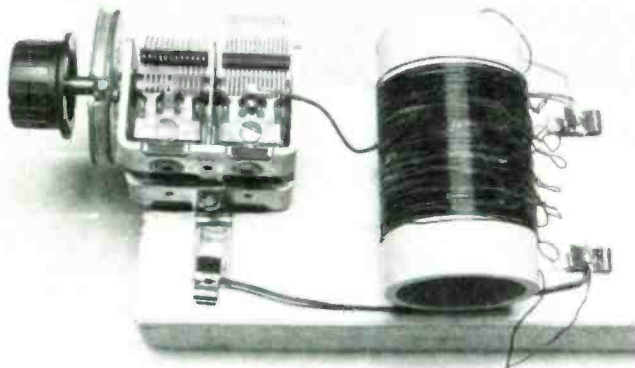

Fig. 3—The output stage replaces the load resistor with a transformer. You can replace it with high-impedance earphones or use low-impedance phones instead of the speaker.

You can use up to about 4 stages of amplification (3 blocks of Fig. 2 and 1 block of Fig. 3) before feedback and over driving become troublesome. The arrows on the diagrams show how the stages are hooked together electrically. Mechanically, you can use either short lengths of hook-up wire or clip leads.



Need more selectivity? Add another tuned circuit between the antenna and the radio. This one is for the broadcast band, but a shortwave tuner would require only a different coil. Note that the coil is tapped every few turns. Just make a small loop in the wire every now and then as you wind the coil and sand off the enamel at the tap points.

In the radio shown in the photos I used hook-up wire for the negative or circuit's ground connections and clip leads for the positive battery voltages. It's a good practice to use red wire for positive, black for negative and another color for wires carrying the signal.

Operation

When you put the set in operation you'll be surprised at the volume and how many stations you can hear—especially on the shortwave band.

Unfortunately you'll sometimes hear too many at the same time! The solution is to add another tuned circuit between the antenna and the radio. One for the broadcast band is shown in the photos. It can be connected in many different ways and I think I'll leave it for you to discover them!

That's the most enjoyable part of the building block radio.

It's so easy to experiment and try different things that you'll be using it for a long time to come. It's perfect for teaching kids the basics of radio reception. It makes a perfect classroom trainer. And, let's face it, its down right fun! Enjoy! ■

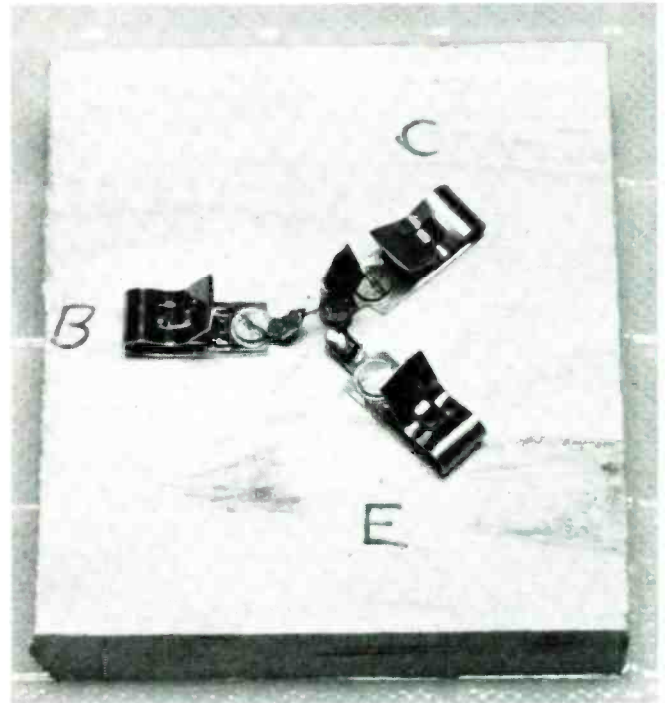

Want to use transistors with short leads? Here's how: Just solder the leads to solder lugs laced under the screws. Be sure not to damage the transistor by over heating.

PARTS LIST FOR THE DETECTOR STAGE

- C1—365-pF variable capacitor salvaged from an old crystal or miniature radio
- C2—.001- μ F, 25-WVDC capacitor
- D1—1N34A germanium diode
- L1—Use number 22 enameled wire (see text.)

PARTS LIST FOR THE AMPLIFIER STAGE

- C3—.1- μ F, 25-WVDC capacitor
- Q1—ECG103A or RCA SK3835 NPN germanium transistor
- R1—470,000-ohm, 1/2-watt, 5% resistor
- R2—4,700-ohm, 1/2-watt, 5% resistor

PARTS LIST FOR THE OUTPUT STAGE

- C4—.1- μ F, 25-WVDC capacitor
- Q2—ECG103A or RCA SK3835 NPN germanium transistor
- R3—470,000-ohm 1/2-watt, 5% resistor
- T1—1000-ohm to 8-ohm output transformer

ADDITIONAL PARTS AND MATERIALS

- 8-ohm speaker or high impedance headphones, knobs, fahnstock clips, flathead screws, wire, solder, boards, etc.

If you've ever wanted a high-voltage generator to create neat lightning effects, perform Kirlian photography experiments or play with neon lights, then this one's for you!

A HIGH-VOLTAGE PULSE GENERATOR

By Dale Hileman

We will describe a laboratory pulse generator using an auto-ignition coil and capable of delivering a train of pulses having a peak potential up to 30,000 volts. With a couple of minor circuit and construction variations, the project is suitable for use as an electric-fence charger, operating at a lower voltage, but capable of much higher output current.

Applications for a high-voltage spike are numerous: electromagnetic and radio-frequency interference studies, electrostatic-discharge simulation; investigation of insulation breakdown; flammability experiments; strobe effects; etc. A DC power supply or battery is required, and pulse potential may be varied simply by changing the supply voltage. With a 12.6-volt input, the ignition-coil model delivers its maximum pulse, but a unique multivibrator-driver circuit makes operation possible down to a supply voltage as low as 1.5 volts, yielding an output pulse of only a few hundred volts. Its pulse frequency is set by a front-panel control, with a range from about 0.3 Hz to 20 Hz.

An ignition coil, however, is not well adapted to the fence-charger application since its output resistance is so high: typically 10,000 ohms. Thus its output pulse is strongly dependent on loading. With a short fence, long sparks might be struck at risk of igniting brush; while on the other hand, with a long fence, shunting by weeds or by dirt and moisture may reduce its output voltage below an effective value. Hence for the fence-charger version the RATE prf control must be omitted for reasons of safety.

No-load output of the fence-charger option is typically 4 Kv pk (kilovolts peak), or about half that value when connected to a 1-mile fence. A car battery powers the fence-charger model for about one year before recharging is needed (at recommended pulsing rate of 20 pulses/min.)

Two lamps mounted on the circuit board and visible through the see-through front panel are important indicators of the unit's performance.

Precautions

While a single jolt from an ignition coil is itself rarely traumatic, the resulting-reflex muscle contraction could have unfortunate consequences. If a continuous train of pulses causes you to involuntarily grasp the high-voltage conductor, for instance, you might not be able to let go. On the

other hand, if a proper return circuit is not provided, an equally distressing shock could be had by contact with the primary circuit. Because the ignition coil is an autotransformer, the return circuit for the high-voltage pulse includes the power leads. Therefore, one side of the power supply should, if possible, be Earth grounded. That precaution, besides preventing shock by contact with the power leads, also precludes arcing within the power supply itself as the high-voltage pulse seeks the shortest return path.

Applying that reasoning to the fence-charger option, we can see why a fixed pulse rate is specified, as there is a strong likelihood of accidental human contact with the fence wire; a rate of 60 pulses per minute or less being considered safe. Also, since there is a good chance of personal contact with the power or battery leads, a good ground connection is essential, as with any electric-fence system.

For maximum safety, we recommend a battery supply for the fence-charger system.

If you should happen to reverse the power-supply leads to either project, the current-limitation lamp, a large automotive bulb easily seen in the photos, lights brightly to warn you. However, the equipment must not be allowed to remain in this condition for more than a few seconds. Even if you never expect to make this mistake, the lamp should be included because it limits excessive surge currents that could otherwise occur under some operating conditions and which could blow the power transistor.

About the Circuit

As shown in Fig. 1, free-running variable multivibrator Q1 and Q2 drive Darlington power amplifier Q3, which makes and breaks the primary current to coil T1 as in an auto ignition system. Duty, or "dwell" is a few milliseconds, and the high-voltage pulse is generated at the end of the period when the circuit is broken and the field of T1 rapidly collapses through the winding.

An unconventional multivibrator circuit was developed to provide high saturation currents over a wide range of supply voltages. In this design both transistors Q1 and Q2 conduct at the same time and both cut off at the same time. Another unique feature: For safety in the fence-charger application, the circuit is designed to automatically shut down if driver Q2 should fail to conduct for any reason (fluctuation



of supply voltage, intermittent connection, etc.)

Starting with both transistors cut off; C3 is discharging, its negative plate rising toward ground at a rate determined by various series resistances; while its positive plate is held near zero volts by a relatively low-resistance path through R6 and R7 and a resistor internal to Q3 across its emitter-base junction.

The series combination of C5 and C6 (discussed later) has negligible effect on the charging rate, which is therefore determined mainly by C3 with the series combination of RATE control R9 and resistor R2 (or R2 alone, in the fixed-frequency version).

Capacitor C3 discharges fully, and then begins charging in the opposite direction as its negative plate rises above

zero volts. When Q1 begins conducting, and its collector voltage has dropped far enough to start Q2 conducting also, then a positive-feedback action is initiated, forcing both transistors into saturation. At the same time, power transistor Q3 is turned on by the current supplied through R7.

Dwell is determined by the time constant $R6 \times C3$. When the charging current of C3 diminishes below the value which will sustain conduction of Q1, then a regenerative action is again established, this time cutting off all three transistors. It is at that moment the high-voltage pulse is generated.

Further Details

Capacitors C5 and C6 form a voltage divider which ensures rapid cutoff of Q1; while C6 acts as a bypass to prevent Q1 from being retriggered by pickup of the high-voltage pulse.

Dwell must be long enough to permit the field around

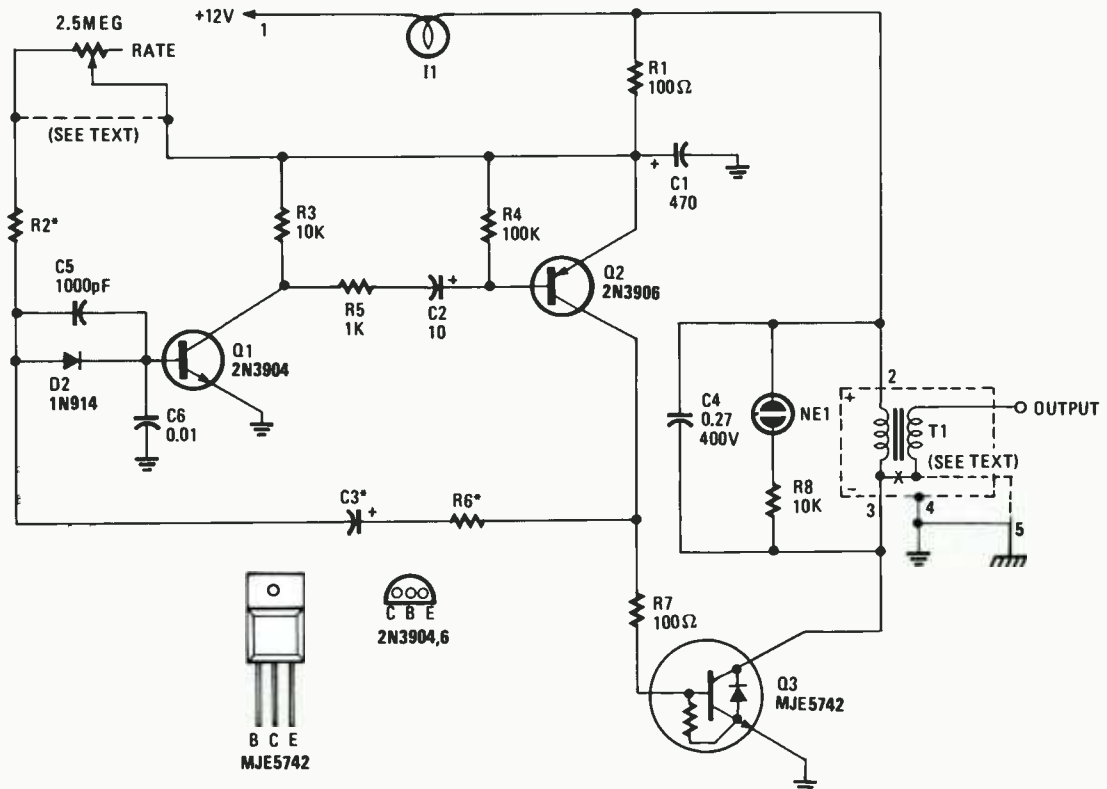
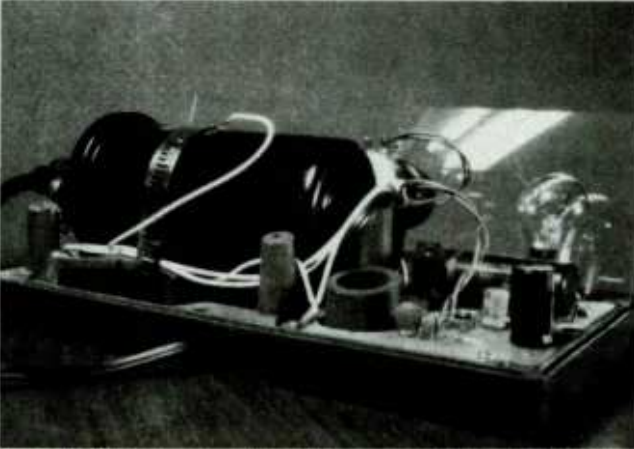

Fig. 1—The pulse-generator version has a variable rate control and requires different values for C3 and R6 than does the fence charger version. The fence charger version has a fixed rate and uses a conventional transformer instead of an auto coil (see dashed lines).

T1 to be fully developed to its steady-state condition under all anticipated conditions of loading. Although the period is not critical, it may be set for optimum results with a particular coil or transformer, as described later.

A higher capacitor value at C3 is specified with the fixed-frequency, or fence-charger version, for reasons of safety. It allows the use of a lower resistance value for R2, reducing the shunting effect of dirt or moisture which might otherwise cause a significant increase in the repetition rate. That is the reason we specify an axial type for C3, so that its pads are more widely spaced than they would be with a radial.



The frequency control is mounted on the see-through front panel behind the ignition coil here. The auto lamp on the circuit board limits current, and lights if the power leads are connected backward. The chimney protruding through the hole in the corner of the circuit board accommodates the 1/2-in. pipe used in the fence-charger version.

Power Amplifier

Because the field of T1, as might be supposed, collapses through the primary as well as the secondary, the inductive “kick” comprises a positive pulse on the collector of Q3. Capacitor C4 is required, as in the conventional auto-ignition system, to prevent excessively rapid voltage build up. Nevertheless, that reactive voltage reaches several hundred volts, and we take advantage of it to light neon indicator NE1. Thus, each flash verifies the integrity of the power-amplifier circuit.

If no arc is drawn, the positive pulse on the collector of Q3 is followed by a negative-going excursion. Transistor Q3, designed for inductive loads, contains a shunt diode which prevents that “backswing” from being applied to the base through the base-collector junction. That diode also protects Q3 if the power-supply leads are accidentally reversed.

Automotive lamp 11, as we said, limits surge currents occurring as a result of various normal operating conditions, as well as accidents, such as the reversal of power-supply polarity. Also, it absorbs the energy of the backswing.

The Transformer

Practically any 12-volt ignition coil having a primary resistance of around 1.5 ohms will work as T1 for the high-voltage pulse generator, but there’s a minor consideration in the choice of a transformer for the fence-charger project. A common 12-volt lamp transformer with 115-volt primary can be used here—hooked up backward of course, so that the 115-volt winding serves as secondary.

The rapid collapse of its field when Q3 cuts off, as compared to the relatively slow 60-Hz sinewave for which it is designed, explains how several thousand volts can be developed across the 115-volt winding ($E=L di/dt$). That winding will typically be found to measure 30 to 120 ohms DC, while the 12-volt winding will have a resistance of around 1 ohm. The author has tried many such transformers for T1, including the Stancor P-8392 and P-8393. (The latter provides a somewhat bigger jolt although it costs more than the former.) The problem, however, lies in the breakdown rating of the 115-volt winding.

In most transformers of the species, the winding is rated for breakdown at 1500-volts RMS (corresponding to 2100-volts pk), with a safety margin that may vary depending on the manufacturer; the Stancor rating proving remarkably conservative. The author subjected the winding of a P-8393 to 40 million pulses of 4-Kilovolt amplitude without breakdown. However, he does not guarantee equally good luck in your application.

One way to preclude breakdown with such a transformer is to always operate the fence charger with an appropriate load. If your fence isn’t long enough to load T1 to 2-3 Kv pk, you could reduce the supply voltage: Say, use a 6-volt battery instead of 12 volt. Or you could substitute for bulb 11 a type having a lower current rating, and therefore a higher resistance. Either of those approaches, naturally, will somewhat reduce the effectiveness of the unit.

Otherwise, the author offers a transformer specially wound for the fence-charger option and rated at 5 Kv pk (see note at end of parts list).

Other parts

A type MJE5742 transistor is specified for Q3, rated at 400-volts under heavy inductive load. However, you can at some risk substitute the cheaper MJE5741 (350-volt rating) or MJE5740 (300-volt rating), depending on T1. In any case, breaking the circuit to an inductive load is tricky and so if you plan extensive experimentation you should obtain a few spare Q3’s.

Potentiometer R9 for the variable pulse generator project can be any 2.5-megohm unit from the junk box. If you use one with a linear taper, though, you will find the control very touchy at the high end of the frequency range. The simplest resolution of that minor inconvenience is to use an ordinary audio-taper potentiometer connected backward; that is, with the high end of the frequency range at the CCW (counter clockwise) end.

For reasons already mentioned, the time constant $C3 \times R6$ determines dwell, or “on” time. As we have said, dwell is not critical; but if the capacitor you use for C3 is a low-quality part with an excessively high equivalent series resistance (ESR), then dwell may turn out to be greater than necessary to serve the needs of T1. If in doubt, use a tantalum type for C3.

The Incandescent Lamp

We have emphasized the importance of 11, the current-limiting lamp, and have specified a type 1156 auto bulb. The merit of an incandescent bulb as a protective device lies in the dependence of its resistance upon the value and duration of applied current. With a cold resistance of only about 1/2-ohm, the Type 1156 degrades performance only slightly; but in the case of a current surge or accidental short circuit, its resistance quickly rises to a “hot” value

of around 6 ohms, sparing power amplifier Q3 from the devastating requirement of breaking an excessive current into an inductive load. Nevertheless, there is some leeway in the selection of I1.

For instance, in the lab-generator version where the load has a DC resistance of 1.5 ohms, a lower-resistance bulb will give a slightly better spark at high frequencies. The author has used a Type 1157 bulb here, connecting its two filaments in parallel, with satisfactory results. On the other hand, as we have indicated above, to prolong the life of T1 in the fence charger, you may elect a lower-current or higher-resistance bulb. Try the smaller of the two 1157 filaments, alone before experimenting further. After the unit is built feel free to try others.

PARTS LIST FOR THE FENCE CHARGER

SEMICONDUCTORS

D1—No D1 in project; please ignore
D2—1N914 silicon diode or similar
Q1—2N3904 NPN silicon transistor or similar
Q2—2N3906 PNP silicon transistor or similar
Q3—MJE5742 8 amp, 400-volt, NPN Darlington power transistor (see text)

CAPACITORS

C1—470- μ F, 16-WVDC electrolytic
C2—10- μ F, 16-WVDC electrolytic
C3—For lab model: 2- μ F; for fence charger: 10- μ F, both 16-WVDC electrolytic, axial (see text)
C4—0.27- μ F, 400-WVDC film
C5—1000-pF disc
C6—0.01- μ F disc

RESISTORS

(All fixed resistors are $1/4$ -watt, 5%-precision units.)
R1, R7—100-ohm
R2—Selected (see text)
R3, R8—10,000-ohm
R4—100,000-ohm
R6—For lab model: 470-ohms; For fence charger: 150-ohm
R9—2.5-megohm pot (see text)

ADDITIONAL PARTS AND MATERIALS

T1—For lab model: Wells C1819 or similar ignition coil; 1.6-ohm primary, 10,000-ohm secondary; For fence charger: 12-volt, 1-amp transformer (see text)
NE1—Neon glow lamp; Type NE-23 or equivalent
I1—12-volt, 2-amp automotive bulb, Type 1156 or equivalent

Cabinet or case; circuit board; solder lugs of various gauge, with internal teeth; cable to power supply, #14 to #18-gauge zip cord or whatever suits, spacers, screws, nuts, lockwashers, hookup wire, cable ties, solder, etc.

Additional parts for the lab model only: 1-in. to 2- $3/4$ -in. radiator-hose clamp to mount ignition coil; 7-mm spark-plug wire, coil clip, coil nipple, alligator clip, alligator insulator; knob for R9; two banana plugs or other suitable terminations for cord to power supply.

Additional parts for the fence charger only: two battery clips, Mueller #46C or the like; $1/2$ -in. pipe, $1 1/2$ -in. large nipple, coupling, etc., for grounding system.

All parts except water pipe, caulk, hookup wire, and solder are available individually or in kit form from Maps and Zaps, 1132 Rosta Dr., Topeka, CA 90290. Please write for price list.

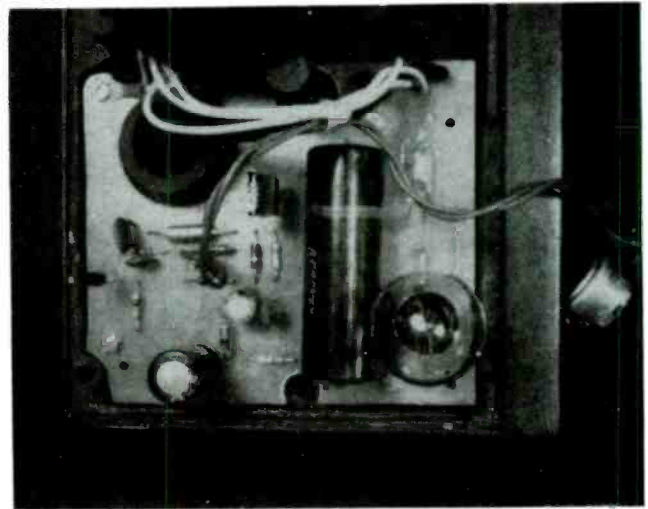

This is a top view of the circuit board. Note the ample space provided between components. That is to prevent arcing between the leads of high-voltage components.

Circuit Construction

All parts for either version of the project are available, including the 2-piece plastic cabinet having provisions for mounting at the end of an ordinary $1/2$ -in. water pipe or upon a standard camera tripod. You may choose to build either version of the project in whatever kind of cabinet suits your needs. If you decide to use wire-wrap construction however, the ground bus and all connections in the power-amplifier circuit should be made with wire no smaller than #24 gauge.

In the author's prototypes, power transistor Q3 stands off the circuit board, but if space limitations permit, a slight margin of safety is affordable by bolting it down flat so that the circuit board provides a measure of heat dissipation.

Omit R2 from circuit board and don't connect the supply conductor to the plus end of T1 until ready to fire up. Also, leave the secondary leads unconnected for the fence charger.

In planning chassis layout, keep high-voltage output conductors well away from the circuit board, especially in the version using an ignition coil as output transformer. A metallic or otherwise conductive cabinet must be connected to the circuit common. Since a 30-kv pulse is capable of jumping a 1-in. gap, however, you may have some difficulty finding a feedthrough insulator big enough to handle the high-voltage conductor. One way to meet that requirement is to use a spark-plug wire, which may be passed through the cabinet wall using only a grommet to prevent chafing. Or the neck of the coil itself may be used as a feedthrough device, as in the author's mode of construction.

Lab Cabinet Loading

If you are using the author's recommended cabinet, situate the circuit board in the left end of its bottom. The board itself can be used as a template for drilling the four mounting holes in the bottom of the cabinet. Mount the board assembly on four $7/16$ -in. metal spacers. The conductive coating in the cabinet bottom may be grounded with a solder lug placed under one of the screws securing the board to a spacer.

For variable-frequency or lab model, situate the RATE control R9 in the clear-plastic front panel. Bring the power cable into the cabinet through the hole in the bottom rear, using a suitable grommet.

The coil mounts on a platform toward the other end and is secured with a hose clamp. Using the coil called out in the parts list, some filing of the platform is required. The coil case must be grounded or internal arcing may occur. Do not depend on casual contact between the coil case and the conductive coating. A grounding connection can be made by inserting an internal-tooth solder lug between the clamp and coil case. At its base, the coil is stopped by its neck passing through a hole drilled in the end of the cabinet top. Hence, it's not likely to come loose with normal handling.

At the free end of spark-plug wire install an alligator clip or other suitable connector. At the other end, first slide the coil nipple onto the wire, and then install the coil clip. Important: To preclude arcing, solder the end of the wire to the clip. Push it into coil neck and slip the nipple into place. When the top is installed later, the nipple provides a tight seal.

Fence Charger Version

Construction of the fence-charger version is somewhat simplified by less-stringent needs for insulation and by the more conventional mounting means for T1. Whatever chassis layout scheme you employ, however, the Earth grounding requirements described above also apply to this model: If you use a conductive cabinet, it must be connected to the circuit Earth, and so must the case of T1. Don't forget that a means must be provided to connect that common to an external ground.

In the author's model of the fence charger, T1 is mounted in the cabinet bottom. To ensure a good connection to the transformer case, first scrape any varnish or wax from the mounting flanges. Then mount with 1/2-in. metal standoffs and 8-32 hardware. Use two or three solder lugs as required for various grounding connections.

Mount a ceramic feedthrough insulator in middle of the platform for fence connection. The underside of the platform comprises a recess which, in an outdoor installation, keeps the output end of the insulator clean and dry.

The chimney referred to earlier provides the means for connection to an external ground. A pipe nipple and coupling are required. First solder a length of hookup wire to the inside of the nipple. A hot iron (say 200 watts) is required for good wetting. Loosely engage the coupling to the nipple; and passing the wire up through the chimney, screw the nipple into the opening by turning the coupling. The nipple may engage the coupling as it engages the chimney. Although the chimney hole is not threaded, the nipple will nevertheless seat securely. Turn the coupling until it is tight up against the bottom of the cabinet. If desired, apply super glue sparingly around top edge of the nipple, bonding it permanently to the chimney. Now, if you later need to remove the coupling for any reason, the nipple will remain in place. Solder other end of the wire to common at the circuit board or at one end of the lugs on the transformer flanges.

High-Voltage Attenuator

Before proceeding with test and adjustment, you may wish to provide yourself with some means for measuring voltage pulses beyond the range of your oscilloscope. To that end, you can build a 90-megohm attenuator, as shown in Fig. 2. When used with a standard 10-megohm probe, the device extends the vertical range of your scope by a factor of ten.

The attenuator consists of nine 10-megohm resistors connected in series. A length of spark-plug wire provides support for the resistor array and also serves to introduce distributed capacitance for AC equalization. To preclude arcing, each end should extend an inch or two beyond the terminal.

Once you have commissioned your pulse generator or fence charger, you can fine tune the attenuator by adjusting the bus-wire gimmicks at either end of the spark-plug wire. That is most easily done by generating a high-voltage pulse within the range of your oscilloscope (say 1600 volts peak), measuring with only the 10-megohm probe; then, trimming the length of the gimmicks to give the same deflection with the probe connected to the 90-meg attenuator (setting the sensitivity 10 times higher, of course).

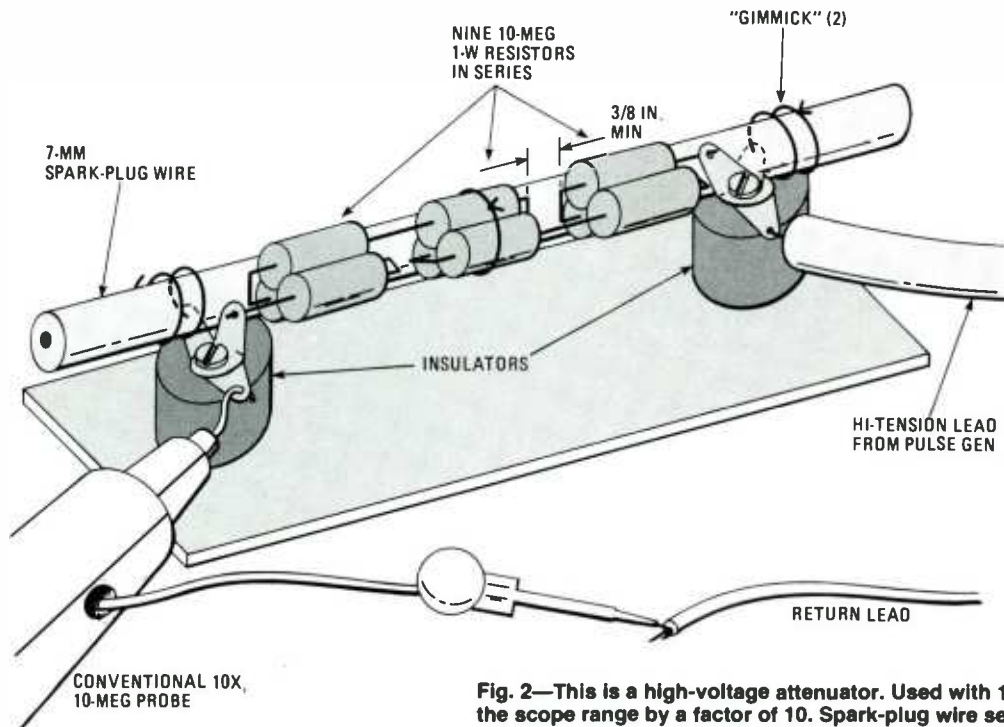

Fig. 2—This is a high-voltage attenuator. Used with 10x probe, it extends the scope range by a factor of 10. Spark-plug wire serves to support resistors and provides distributed capacitance for AC compensation.

Selecting R2

We had advised you during construction to omit one connection to the primary of T1 so that you can now select R2 without energizing the power amplifier. Using clip leads, first connect typical value shown in parts list. Then connect your 'scope to the junction of R6 and R7, and apply power.

For the lab pulse-generator version, now set the RATE control to maximum frequency and select a value for R2 which gives a repetition rate of about 20 Hz. For the fence-charger model, select a value which gives the desired rate, but no higher than 60 times per minute. Remember that the slower the rate, the longer between recharging.

Now turn the supply off and add the missing wire to the power-amplifier circuit. In the author's lab-generator chassis layout, it is necessary to first loosen the coil in order to free the circuit board. If you plan to test the unit with the circuit board loose, be sure to temporarily replace the lugs grounding the coil case and cabinet. Place a cardboard sheet under the circuit board to insulate it from accidental contact with the cabinet coating, etc. The unit is now ready for a performance test.

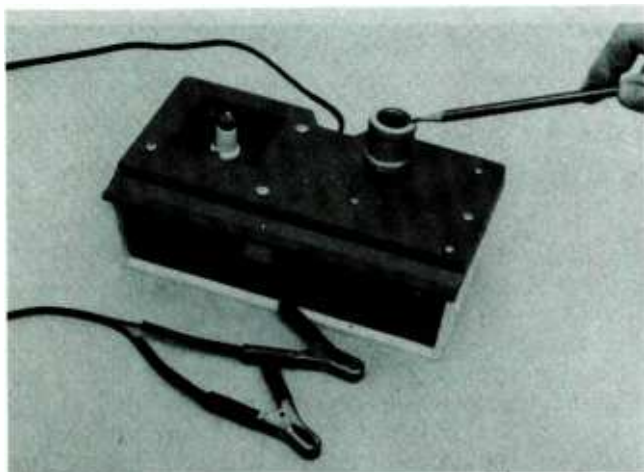

The fence charger model has a nipple for mounting on a fence-type pole. It effectively grounds the system.

Testing

Connect the high-voltage output to the 90-meg probe or whatever instrument you wish to use to observe the high-voltage pulse. Turn the power supply on and gradually increase the voltage (adjusting the lab-generator rate as desired), synchronizing the 'scope to display the largest excursion. (When you don't know exactly what to expect, it's easy to be fooled into syncing on the backswing or some other minor lobe.)

The unit should start working at a supply voltage of 1.5 to 3 volts, but it will shut itself down if you vary the voltage too abruptly. If that happens, just turn the power off and then back on.

At a 12-volt input you should get a pulse of about 20 to 30 Kv pk from the lab generator or 3.5 to 5 Kv pk from the fence charger. In the latter version, proceed as follows to decide which secondary lead should be grounded:

1. Turn power off and disconnect scope from both ends. Turn power back on, and using an insulated tool (to avoid getting zapped), bring each end in turn to the transformer case, leaving the opposite end free. One will probably draw a small arc and the other won't.

2. Turn power off and ground the one which drew the smaller arc. Connect the other to the output feedthrough.

3. Reconnect scope, apply power, observe polarity of output pulse. If you get a positive pulse, reverse the primary connections. A negative pulse jumps a longer gap from a small object (the fence wire) to a larger one (the victim) than does a positive pulse (believe it or not).

If you wish to view the current pulse, temporarily hook 0.1 to 0.2-ohm resistor in series with negative power-supply lead, and connect a 'scope across it (being careful to avoid ground loops, as can arise through test connections or via the power-line safety ground). With fence-charger option, if possible, stimulate 1-mile wire by connecting 0.015- μ F, 2000-WVDC capacitor across its output. A rising waveform characteristic of *inductor charging* should be obtained—the abrupt drop at its trailing edge of course representing the cutoff of Q3 and the generation of the high-voltage pulse.

With the lab-generator version, dwell is not critical thanks to the relatively low inductance of the typical ignition-coil primary. In the fence-charger option, however, primary inductance will probably be much higher and will vary considerably depending upon your choice of a transformer. Fig. 3 shows the current waveform typical of such a primary. If it ends too soon, that is before the field has reached its steady-state value (A), then maximum output capability cannot be attained. If it ends too late (B), then average current consumption is higher than necessary. To get optimum results (C), adjust the width by changing R6 as needed.

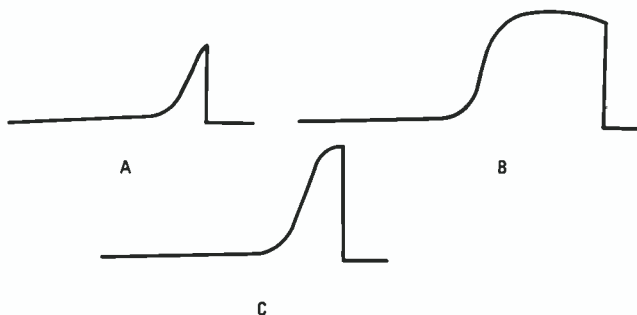

Fig. 3—For the fence-charger option, this is a current pulse seen across the small resistor in series with the supply: in A the pulse width is too short; in (B) The pulse width is too long; and in (C) the pulse width is correct.

If you know the exact value of the small resistor, given the peak voltage appearing across it you can now calculate peak current ($I = E/R$). A typical value is 4 to 6 amps.

Buttoning Up

Reinstall the circuit board, remembering to replace the lugs which ground the cabinet, pipe coupling, T1, case, etc., and to secure the coil. Test the unit once more, then assemble the cabinet.

If you're using the author's recommended cabinet with the pulse-generator option, leave the high-voltage cable and nipple connected to the coil, passing the other end through the hole in the cabinet top as you bring the top into place. Slide the front panel up into the cabinet top. Now, close the cabinet by swinging the left side down. Moderate force is required to push the coil nipple into the hole. Make sure tongues in the cabinet top engage the mating slots in the

(Continued on page 106)



REBUILD YOUR DOOR CHIMES

While you're doing your spring cleaning, consider sprucing up those lame door chimes

By Herb Friedman

Sticker shock is the term used to describe a shopper's reaction on first learning how expensive things have become. Actually, it's a temporary paralysis of the brain that occurs when someone who paid about \$3500 for their first full size, "fully loaded" *Detroit Iron*, must now lay out about \$15,000 for a car barely large enough to hold four Munchkins. And to add insult to injury, the state will probably sock him with another \$1500 or so in taxes.

Although we've all come to expect sticker shock when it comes to cars, the replacement and repair costs of what was formerly inexpensive household hardware, still comes as a numbing surprise; and often, you never know, or at least no one will tell you, that you can make the repair yourself. For example, take the common household door chime: the type that goes *bong-bong* for the front door and just *bong* for the rear door. Yours probably came with your home, or you bought it for pocket change.

Years have gone by. Now the bong-bong can barely be heard, even if you put your ear right on the chimes, and so you head for the local electrical supply house—where you find that a replacement chime will cost you from \$25 to more than \$50; and if you want to go for really big bucks, they have electronic models that beep-out any of a dozen or more tunes.

Ask if the chime can be repaired, or if spare parts are available, and you will either be treated with contempt, or taken for a madman.

There Are Parts

Well, don't be intimidated. There are replacements parts available, only you'll have to locate them yourself. If you do, you'll probably end up paying less than \$2 for components that will take less than 15 minutes to install. You will

also probably have to figure out how to do things yourself because the instructions will refer to fittings and situations that no longer—if ever—exist: such as telling you to remove screws when the parts are riveted together, or insisting that a main part cannot be removed although it's actually been designed to literally pop out into your hand.

The photographs show how to go about repairing the common *Nu-Tone*-type electric chime, which is among the most

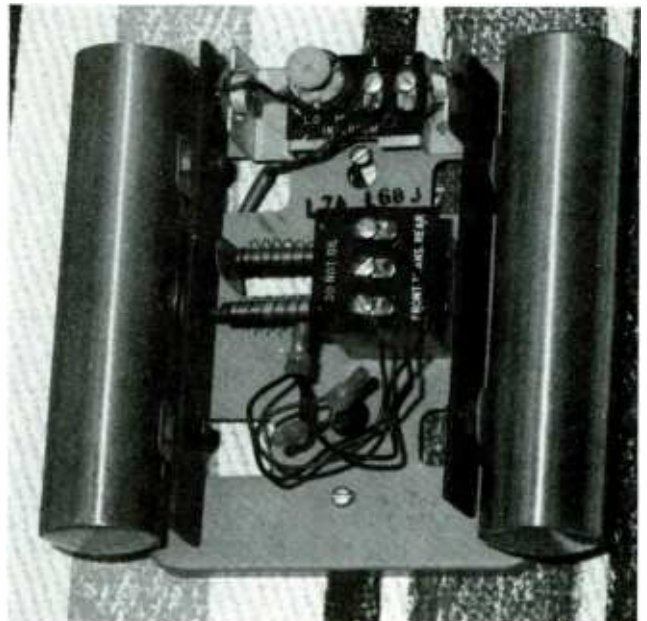

Remove the cover from the chime and make a written record of the connections that show the color-coding of the wires. If the chime has pickup coils or microphones at the top, also make a note of, and remove the wires.

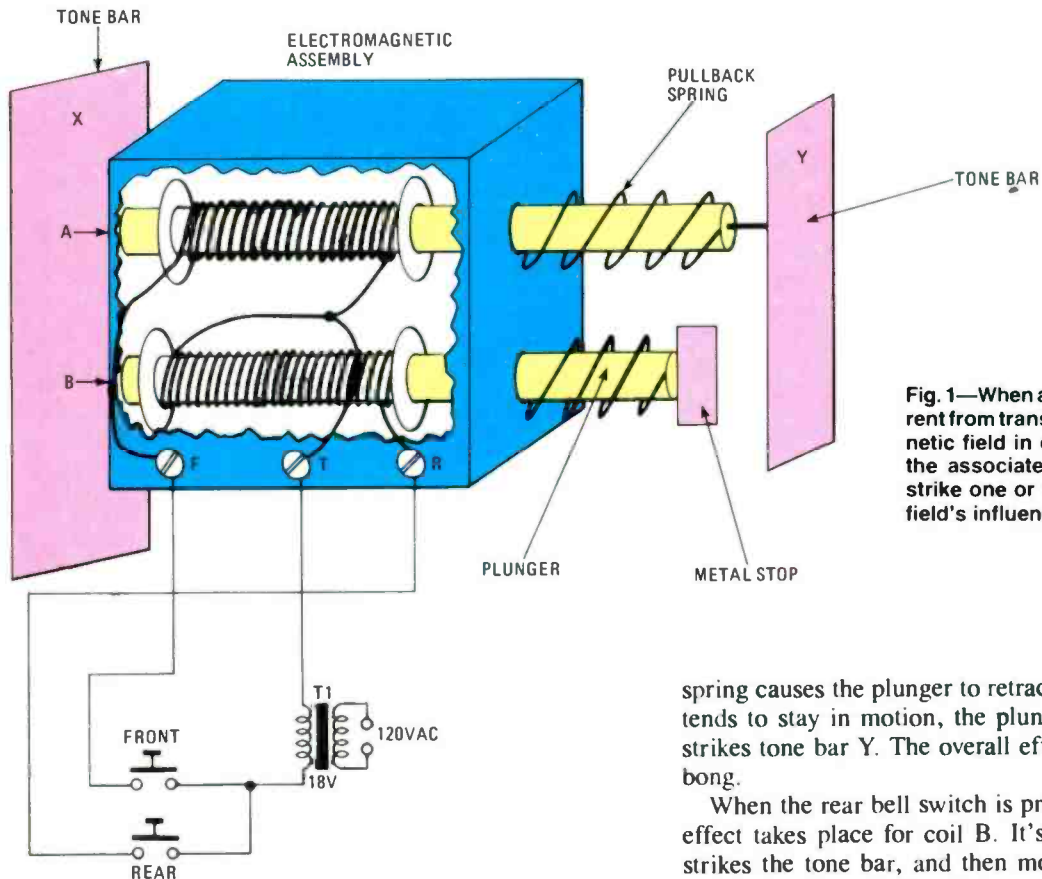

Fig. 1—When a bellswitch is closed, current from transformer T1 sets up a magnetic field in coil A or B. That causes the associated plunger to move and strike one or two tone bars under the field's influence.

popular types. The same general mechanism was used for the compact model shown (which has short tone bars and resonators), and for the *house rockers*, the same general mechanism but with long, deep-bass tone bars and resonators that can vibrate walls and windows.

An Electromagnet

Figure 1 shows how a conventional doorchime works. A single housing contains two electromagnets: one for the front door, the other for the rear door. When the front bellswitch is closed, current flows through coil A, causing a metal plunger to move forward and strike tone bar X. When the door switch is released, the magnetic field collapses and a

spring causes the plunger to retract. Since a body in motion tends to stay in motion, the plunger keeps moving until it strikes tone bar Y. The overall effect is the two-tone bong-bong.

When the rear bell switch is pressed, the same electrical effect takes place for coil B. Its plunger moves forward, strikes the tone bar, and then moves backwards when the switch is released. But it is prevented from striking and sounding tone bar Y by a small metal stop. And so the rear bell switch results in a single bong. That's all it takes to tell you whether to answer the front or rear door.

Obviously, there's little that can go wrong. Early plungers had rubber striker tips that eventually disintegrated or fell off, resulting in a low-volume metallic "tink" sound (modern plungers have plastic tips that don't disintegrate). Or years of accumulated goo in the plunger slots jammed the plungers, or the plungers rusted (it can happen), or one or both plunger springs broke or lost their tension, or the electromagnetic assembly developed a somewhat rare open in one or both coils.

In most instances, doorchime problems are caused by the

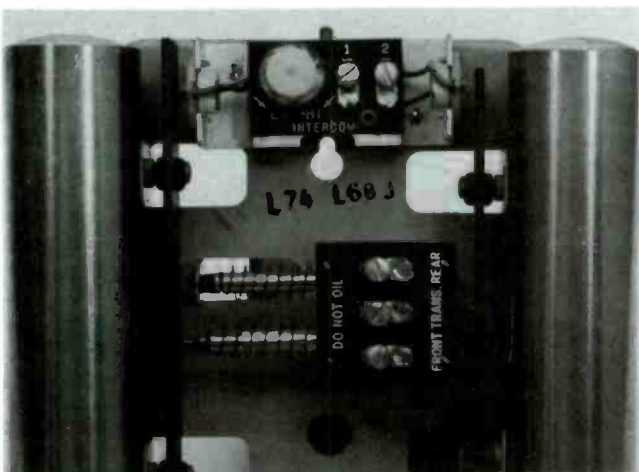

The model number is printed or stamped somewhere on the chime. Don't leave home without it! It's the only way for the parts supplier to know what parts to sell you.

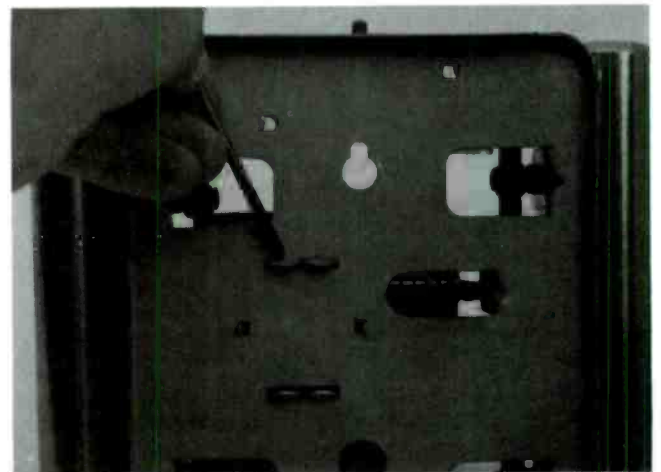

No matter what the instructions say, the electromagnet assembly is most likely secured by tabs that release when pushed by a metal pointer, nail, or screwdriver.

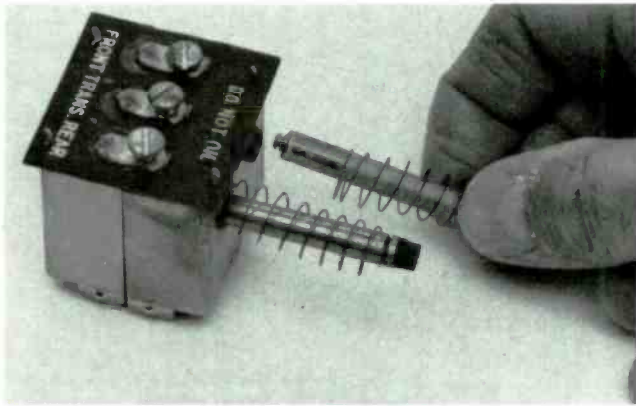

Aha! The problem is that the rubber striker tip of the front door's plunger has disintegrated. Replace both plungers with proper parts (silicon rubber won't do).

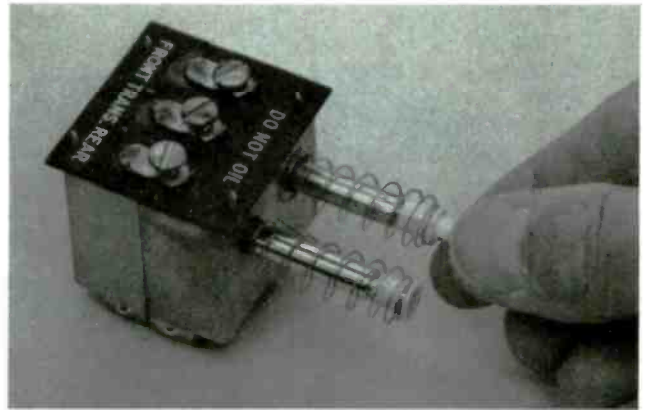

Install the plungers so their springs tend to keep them withdrawn. The first-strike tips should be placed inside the electromagnet coil assembly first.

plunger itself, and so all you have to do is replace the plungers. Every major manufacturer has a repair service, stores that stock, or will get you the plunger assemblies—which come complete with soft tips and springs. A complete set of plungers for the *Nu-Tone*-type L74 mechanism—one of the most popular designs—costs under \$2 for “the works.”

How do you know what plunger type you need? Simple, somewhere there's an alphanumeric number stamped or printed on the chime assembly. Give the number to the parts supplier and he will know what parts to give you.

How It's Done

Simply follow the steps in the series of photographs and

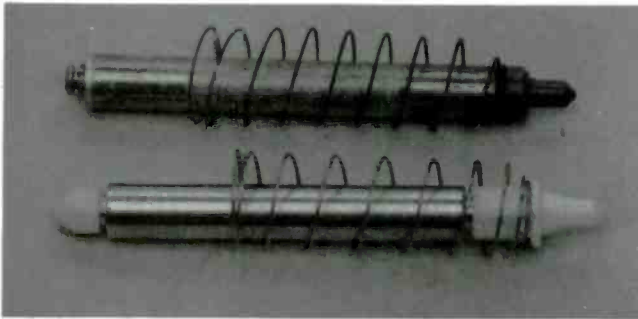

The old plunger at the top and its replacement on the bottom. The main difference between them is the old plunger used rubber tips; the new plunger has plastic tips. Be extra careful not to damage the springs.



Use a cotton Q-tip dipped in cleaner to remove goo from the plunger tubes. But be certain not to oil the tubes nor the plungers (not even a drop), or use an oil-based cleaner.

you'll find that repairing an electric chime is one of the easiest repairs you'll ever make.

First step, as shown in Photo A, is to remove the cover from the chime. Usually, the cover will simply snap off. Carefully note the color of the wires connected to the FRONT, REAR, and TRANS terminals on the electromagnetic assembly and disconnect the wires. If there are other wires, such as for electromagnetic pickups (microphones) used to feed the chime sound to an intercom system, also note their color and remove them. (The pickups and their volume control are located at the top of the chime in Photo A).

Photo B shows the model number—in this instance L74 L68J—stamped between the plunger and microphone assemblies. Whatever number you find on your chime is the one that tells the parts supplier what kind of parts to sell you.

If you have service instructions for the chimes it probably tells you to remove the tone bars and resonators to get the plungers out. Forget it! Most likely the stuff is mounted with rivets. Instead, as shown in Photo C, flip the chime over and you'll probably find that the electromagnetic assembly is secured by quick-release tabs. Use a metal pointer or a nail to push them down and the assembly will fall into your hand.

(Continued on page 102)



The pointer shows how the back of the front-door plunger rests against a tone bar. That is the position it returns to in order to make the second “bong” sound.

wiring together common pins, with the switch selecting the A or B connector.

Use a continuity tester to be sure that there are no shorts between pins, and that each wire goes to the right pin or switch terminal. (Neither I nor this magazine can be responsible for any inconvenience or damage caused by incorrect construction or incompatible interfacing.)

External Cables

The standard output of the IBM CGA board is a DB-9 female connector, just like on the RGB Switch Box. Therefore, to go from the computer to the RGB Switch, you'll need an 8-wire cable with a DB-9 male connector (Radio Shack No. 276-1537) on each end, wired pin-to-pin (that is, 1 to 1, 2 to 2, etc.) You should also plan on using hoods (RS No. 276-1539) with each of the four connectors, to prevent wire flexing at the ends. Although pin 7 is not used, it can also be wired. You can purchase the cables already wired, as you'll see in a moment.

You'll need two cables (8 or 9-wire) and four DB-9 male connectors. The length of the cables will depend on your physical layout. In my case, the computers that would be "sharing" the RGB monitor were about six feet apart, with the monitor next to the IBM and about five feet from the Sanyo.

Shielded cable is preferred, to subdue radio-frequency interference (RFI) from the computers. Multiple-wire cable is invariably color coded. Use the colors to relate to the connector pin numbers, and be careful to wire to the correct pins at each connector.

When you've finished the cables, check them out with an ohmmeter or other continuity device (buzzer or light) to verify that there are no shorts between pins, and the wires are connected pin-to-pin.

Using the RGB Switch Box

Once you've verified the proper pin connections on the RGB Switch Box and cables, plug one cable into the RGB output of each computer, and the other ends of the two cables in the A and B connectors on the Switch Box. Place the Switch Box in the A position, and turn on computer A and the RGB monitor.

If you have both monochrome and CGA cards in your IBM (or compatible) computer, you may have to use the MODE.COM file on your DOS disk with the command MODE CO80 to get the computer into the CGA mode. You should now see the output of computer A on the monitor. If you don't, go back and check your work carefully.

Now turn on computer B and go into the CGA mode. Flick the switch to the B position, and you should see the output of computer B on the RGB monitor. That's all there is to it. You can switch back and forth between computers as you wish.

PARTS LIST FOR THE RGB SWITCH BOX

DB-9 9-pin female connector (see text)
Enclosure
8-pole, double-throw switch
Ribbon cable (see text)
U1—74LS04 hex inverter, integrated circuit
Perfboard, solder, wire, hardware, etc.



The RGB Switch uses two cables—one to each of the two computer's RGB outputs—ending in DB-9 connectors.

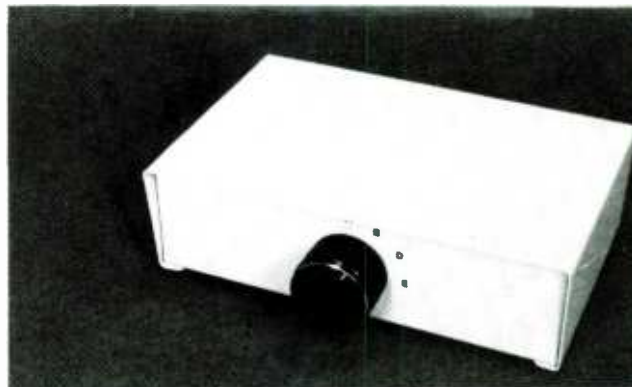

The MS4-MAC 4-Port DB-9 Data Switch from Computer Friends was originally made for the Macintosh computer for another purpose, but works perfectly to switch a TTL RGB monitor between up to four microcomputers, called A, B, D and E.

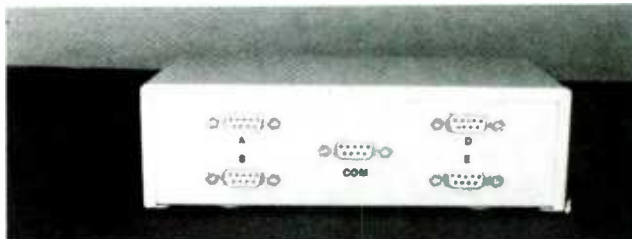

The MS4-MAC has five DB-9 female connectors on the back. The COM output goes to the RGB monitor, while A, B, D, and E are inputs from the RGB outputs of the computers, which are selected by way of a front panel rotary switch.

Ready-Made Switch Box

After I had gone to the trouble of finding the connectors, cable, box and wire, and building my own RGB Switch Box and connecting cables, I discovered that a commercial switch box (see photo) is available to do the job. It was not designed for this task, but rather to be used with a Macintosh computer for something or other. The point is that it has an 8-pole 4-position switch and five DB-9 connectors (four input, one output) already connected pin-to-pin! You can actually use that switch box to drive one RGB monitor from any one of four computers.

The MS4-MAC 4-Port DB-9 Data Switch is available from Computer Friends, Inc., 14250 N.W. Science Park Drive, Portland, Oregon 97229 (Phone 503/626-2291) for \$50, plus \$4 shipping and handling. At the same time, it would be smart to order their CBL-130 DB-9 M-M cables for \$15 each, with no extra shipping if placed on the same order.

That amounts to a total cost of \$84 to allow you to use your RGB monitor with two different computers (or up to four computers, if you get two more cables). Considering that

RGB TTL monitors usually sell for at least \$250 these days, that's a bargain.

Unless you are handy with a soldering iron, have a good source of parts, and are very careful doing point-to-point wiring, I'd suggest that you get the MS4-MAC and cables rather than building your own.

Sanyo RGB Sync Inverter

Since most RGB monitors support the IBM PC RGB signal (positive sync) they won't work as is with the Sanyo MBC 550/555 or other Japanese micros that use negative sync pulses. As already mentioned, some RGB monitors have an external selector switch or internal jumpers to accept negative sync pulses, but most don't. If your RGB monitor requires positive sync pulses, they can be provided by a sync inverter adapter.

Figure 3 shows the schematic of a Sanyo RGB Sync Inverter designed specifically for the Sanyo MBC 550 series computers. It "pirates" voltage from the keyboard socket to power the inverter chip. The same design, with the proper connectors, should work with your existing negative sync computer, since most keyboards have +5 volts available at the connector.

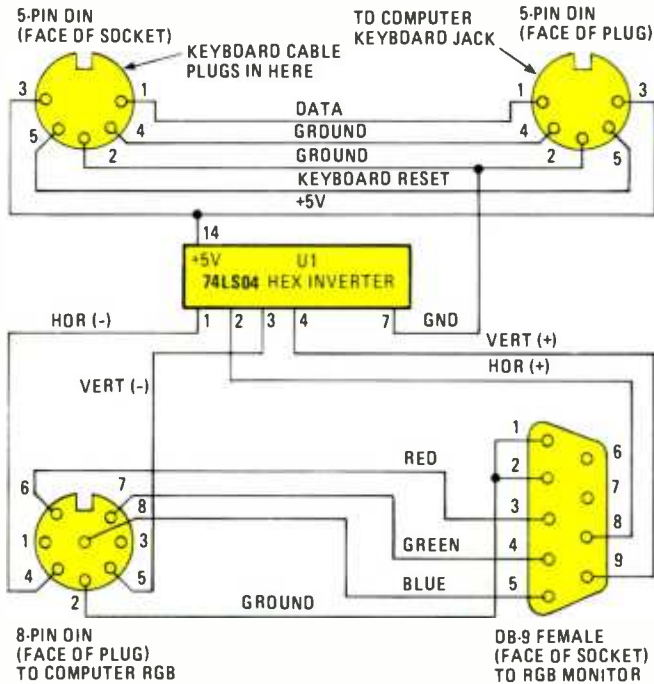
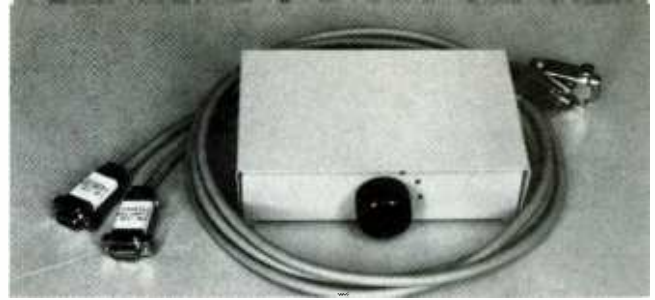

Fig. 3—This schematic diagram shows the inverting section of the project, which was designed specifically for the Sanyo MBC 550 series computers. The same design, with proper connectors, should work with your negative sync computer.

If you have a Sanyo or other negative-sync computer and want an RGB sync inverter, you'll need to build it yourself. Please don't ask me to do it. Each computer has its own connector and wiring configuration, which you'll need to know. If you have a Sanyo 550 or 555, the design in Fig. 3 has worked perfectly with over six RGB monitors that I've tried it out on during the writing of my 360-page book, "Sanyo MBC Beginner & Intermediate Guide" (available from the author with a disk of 59 programs for \$25 postpaid).

All the functional parts (connectors, cables, and integrated circuits) are available from Jameco Electronics, 1355 Shoreway Road, Belmont, CA 94002 (Phone:



Computer Friends also sells ready-made RGB cables to use with their switch box, or with your own RGB Switch Box.

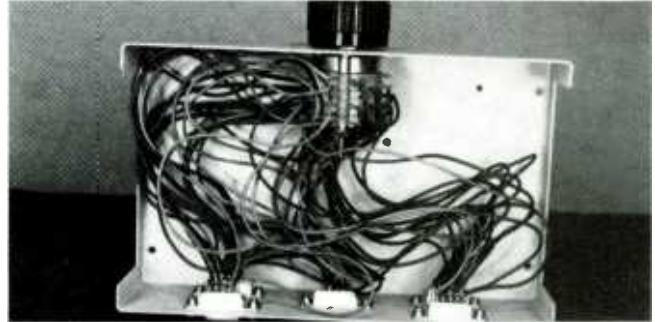

The MS4-MAC never went into mass production, so it is hand wired. A special 8-pole, 4-position rotary switch is used.

415/592-8097). Send or phone for their catalog. Their minimum order is \$20, but their catalog is so full of goodies that you should have no trouble coming up with a minimum order. But no matter where you buy the DB-9 connectors, their cost, when weighed against the alternatives—purchasing a second RGB monitor—is a mere drop in the bucket.

How It Works

The Sanyo RGB Sync Inverter (see photos) is built into a small plastic box, with one 5-pin DIN female connector mounted on the box, and three cables with their connectors extending from the box.

As shown in Fig. 3, the 5-pin DIN socket and plug are wired together (pin-to-pin) with the +5V and ground tapped off to power the 74LS04 hex inverter chip, U1.

The vertical and horizontal sync signals from the 8-pin DIN plug are routed to the input pins of two of the IC inverters. The outputs of these inverters go to the proper pins of the DB-9 female socket. The red, green, blue, and ground connections (in Fig. 3) are wired straight through. What that all amounts to is that the sync signals are inverted from negative to positive, and everything else is fed through to the DB-9 female, which in turn is connected to the RGB monitor.

In use, you simply unplug the keyboard from the Sanyo, and instead plug it into the RGB Sync Inverter 5-pin DIN socket. Then you plug the 5-pin DIN into the keyboard socket on the Sanyo, and plug the 8-pin DIN into the RGB socket, and you're in business. Of course, if you're using the RGB switch, you'd go from the output of the Sync Inverter into one of the RGB Switch inputs (see Fig. 1).

Summary

If you only have one computer and one RGB monitor, at least save the schematic diagram from this article. If you are like most computists, you'll be getting a second computer that can also drive an RGB monitor. Making or buying the RGB Switch Box can save you the cost of another RGB monitor.

If you have one of the older micros that has negative sync outputs, the RGB Sync Inverter (which you'll have to build) will allow you to use a standard TTL RGB monitor. ■

SERVICING GARAGE-DOOR OPENERS

If you've got a garage-door opener, you know what a blessing it can be, but you may start cursing if it goes on the fritz. Here's what to do if that happens to you.

By Homer L. Davidson



THE GARAGE-DOOR OPENER HAS TRAVELED MANY MILES since the early sixties. Both the transmitter and receiver operated with small tubes and transistors back in those dark ages. Remember when the transmitter was located under the hood and operated from the car battery? When the transistor arrived on the scene, the hand-held transmitters became light weight, pulled less current, and were easy to carry around. Now, two different transmitter/receivers can be found within a single garage-door opener.

Most GDO transmitting units made today are solid-state devices. Either transistors or ICs are found within the hand-held transmitter. The small solid-state portable transmitters may be stored in a glove compartment, under the seat, in a pocket, or clipped to the dash or the sun visor. Simply point the transmitter at the receiving antenna within the garage. The portable transmitter may have a range from 30 to 60 feet.

The operating frequency of the garage-door transmitter and receiver may be from 5 KHz up to 465 MHz. Some older units used the CB band frequencies (26.97 to 27.255 MHz). Today, most units operate within the VHF band. The higher the frequency, the advantage of being free of man-made noise, including radiation from neon signs, auto ignition, lightning and etc. Of course, someone close by may be using the same frequency code as yours. Simply change the frequency code in the opener and transmitter to prevent someone from opening your garage door.

The Transmitter

The early garage-door transmitter used nothing but tubes. Later, the hand-held transmitter operated with a small vacuum tube and transistor (Fig. 1). A few years later the transmitter was entirely transistorized. Today, one IC component controls the transmitting chores, while some units have a

two-button hand-held transmitter to open/close and secure your garage door.

To prevent a thief or someone else opening your garage door, some of the newer transmitters have a digital-coded signal, like wireless telephones. Simply set the digital rocker switches on the rear panel of the opener and hand-held transmitter (see Photo 1 next page). Both units must be set in the same position. Do not leave the switches in the "purchased" position. With a pen or pencil, press any combination of switches to set your own personal frequency code.

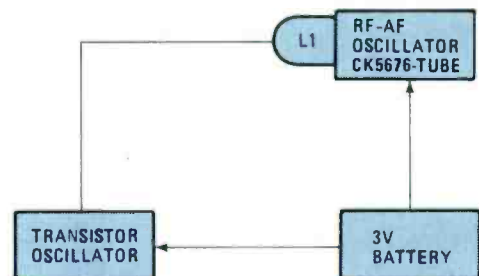
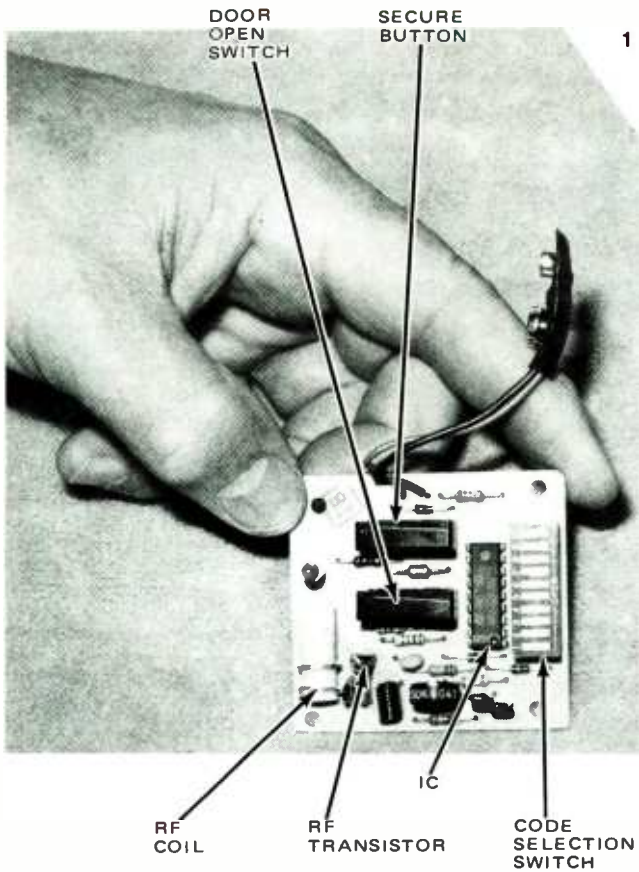

Fig. 1—Here is a block diagram of the early hybrid transmitter using a tube as part of an RF-AF oscillator modulated by a transistorized audio oscillator.

Checking The Transmitter

Many problems related to the garage-door opener are actually caused by the hand-held transmitter. The transmitter is easily dropped or bounced around in the glove compartment, loosening up components and contacts, breaking wiring, and damaging circuit boards.

Dead or weak operation may be caused by defective batteries. Suspect weak batteries when the door will not open until the car is real close to the garage. Before tearing into the



1

Some GDO units may have digital code switches like those found in wireless telephones. Simply change the code if outside interference accidentally opens the garage door.

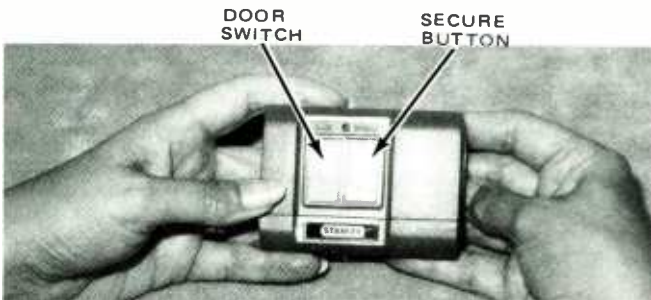

Today, the GDO transmitter is quite small and may have another secure function besides the regular door button.

opener in the garage, check the transmitter batteries and replace them if necessary.

If a VOM or DMM is handy, check each battery with the button of the transmitter pressed down. Always, replace the batteries with alkaline or heavy-duty types. Inspect the battery terminals for poor or corroded contacts. Sometimes the battery plug or wires may break off while replacing the battery. Usually, the GDO transmitter operates with 1.5, 4.5, 9 or 22.5 volt batteries.

After replacing the batteries, if the transmitter still does not open the door, check the RF signal with a radiation tester or indicator. A neon or LED lamp is located in some transmitters and will light if RF is radiated. The RF radiation tester or indicator is held to the front side of the small transmitter for testing.

If you do not have an RF radiation tester, coil up 10–22 turns of solid #22 hookup wire and solder a 1N34 diode to one end of the coil (Fig. 2). Now, connect the diode and other

end of the coil to a 100 or 250 μ A meter. You can also use the lowest voltmeter dc scale in a sensitive VOM.

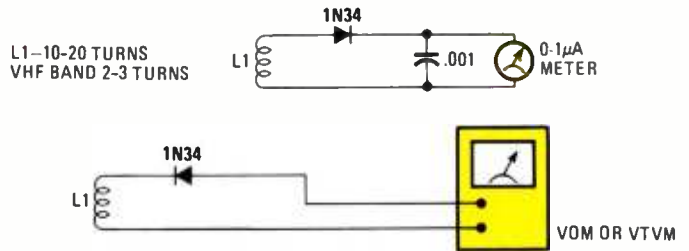

Fig. 2—This is a simple RF-transmitter tester to determine if the transmitter is operating. Use the low range of a VOM or VTVM for this test.

GDO Indicator

You can build your own garage-door indicator within minutes. The VHF indicator will operate with most of the latest door garage-door openers. Only seven small components are needed. All components except the piezo buzzer is located inside a $3\frac{1}{4} \times 2 \times 1\frac{1}{8}$ inch plastic container. A 9-volt battery powers the small tester.

The small indicator is constructed around the 8-pin op-amp IC U1 (a 741). A small PC-mount piezo buzzer is used as the audible indicator. The buzzer operates from 3 to 20 VDC with a sound level of 75 dB around 3800 Hz \pm 500 Hz. Always check for correct polarity when wiring up a piezo buzzer as a transistor circuit is enclosed within the buzzer. Now let's get started as one minute has already skipped by.

The Indicator Circuit

The RF pickup coil (L1) is wound around a large pen or pencil to form the coil. Wind two complete turns of #22 solid hookup or bell wire. Spread the coil out to $\frac{1}{2}$ -in. width. Leave

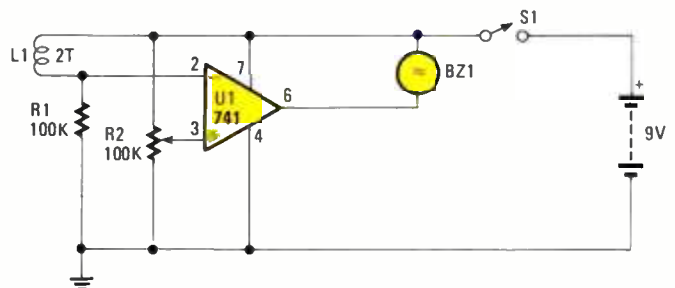

Fig. 3—This little GDO indicator has only seven components and can be constructed within two hours.

one inch length to each end to connect through the small perf-board holes. The small coil connects directly to input pin 2 of U1 and the B+ line (Fig. 3). Change L1 to 10 to 15 turns to check GDO transmitters of lower frequencies.

Since R2 (100K) was to be adjusted just once, a small fixed thumb or screwdriver control was used at input terminal 3. Pin 4 of the IC connects directly to ground while pin 7 ties into the 9-volt source. The piezo buzzer is connected to terminal 6 and the power source. Remember, the positive (+) terminal of the buzzer is connected to the 9-volt source. If not, the piezo buzzer may be damaged and the indicator will not perform.

Construction

Cut a piece of perf board so it will fit snug inside the bottom area of the plastic box. Mount L1 at one end so it can be bent close to the plastic housing. Remove $\frac{1}{2}$ -in. of the

RGB SWITCH BOX

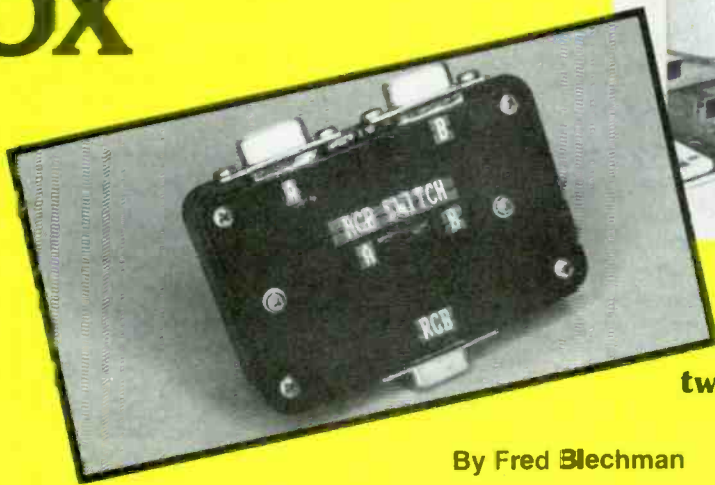

Here's an extremely simple and inexpensive way to hook two computers to a single monitor

By Fred Blechman

IF, LIKE MANY COMPUTER HOBBYISTS, YOU'VE BEEN INTO the game since the computer's initial onslaught, you've probably got more than one of those little workhorses hanging around your home. (I sure do!) Having more than one computer can really put a strain on your pocket—each needs a monitor, and monitors can run into big bucks, particularly when you're talking about color monitors.

If you already own an RGB monitor and use it with IBM PC CGA, the *RGB Switch Box* described in this article will allow you to use your RGB monitor with two different computers by just throwing a switch, provided that both computers can use the same RGB monitor—that is, provided that both put out either positive or negative sync pulses.

If you'd rather not build the RGB Switch Box, I'll tell you about one I discovered after I built my own. It's more expensive, but it sure saves a lot of work! And, just in case you have a Sanyo MBC 55X (or a similar Japanese computer that normally requires a special RGB monitor), the project includes an RGB sync inverter that you can build—allowing you to use an IBM PC compatible RGB monitor with your Sanyo. If you also use the RGB Switch Box, you can use one RGB monitor with both your IBM PC and your Sanyo.

Background

Prior to the arrival of the IBM PC, most microcomputers that provided color used either a TV for the display (awful!) or a "composite color monitor" (much better.) However, if high resolution and a clearer picture were required, a special monitor called "RGB" (standing for the three primary display colors, red, green, and blue) was almost a necessity.

Instead of a single coaxial cable used to couple the TV or composite monitor to the computer, an RGB monitor uses six or seven separate wires for ground, red, green, blue, vertical and horizontal sync, and (sometimes) intensity.

Analog and TTL (digital) RGB monitors have been available for years in the video-broadcasting field because of their ability to produce a superior picture. But when the IBM PC was introduced using a TTL RGB monitor with a CGA (color graphics adapter) card, production of that type of monitor

jumped, followed by a natural decline in price.

New monitors were produced especially for the IBM PC and its compatibles, and most new microcomputers were designed with an RGB output using IBM's standard connector and pin assignments.

Incompatibility

A few Japanese manufacturers (such as Sanyo with the MBC 550 series) departed from the standard by inverting the polarity of the horizontal and vertical signals. They used negative sync pulses instead of the positive pulses used by the IBM PC CGA. They also (for reasons obscured in history) frequently used different kinds of connectors.

RGB monitor designs also started to vary. Some had internal connections to invert the sync signals, and some used an external switch for that purpose. Most had neither! Almost all provided a cable intended to plug into the DB-9 female, 9-pin socket on the back of an IBM PC CGA board.

In my case, I ventured into the RGB world with a Sanyo MBC 550, and found a monitor (TAXAN 420) and cable that



The Sanyo RGB Sync Inverter is built into a small plastic box. The Sanyo keyboard cable plugs into the box jack, another plugs into the computer RGB output, and the long cable connects to the RGB monitor input cable.

worked. The TAXAN has a sync-polarity switch on the back, and optional cable that was wired for use with the Sanyo 8-pin DIN RGB output connector.

When I got my IBM PC/XT, I connected the RGB monitor to that 8-pin DIN. Because of the difference in sync polarity and connectors, and the physical separation between the Sanyo and the new position of the monitor, I stopped using the RGB monitor with the Sanyo—a real sacrifice, since the Sanyo's color graphics are terrific. Then I came up with the idea of an RGB switch.

RGB Switch Box

Figure 1 shows a typical two-computer, one-RGB-monitor situation. Assuming that the computers have the standard IBM PC RGB output (positive sync), you can use an 8-pole 2-position switch to select which computer will drive the monitor. If you have a computer that uses negative sync signals (like the Sanyo MBC 550 series), you'll also need the sync inverter described further on in this article.

Why is an 8-pole switch used if there are only seven wires? The standard IBM PC RGB output defines two ground wires, therefore eight wires are used instead of seven. Figure 2 shows the wiring diagram using an 8-pole, 2-position switch. The three connectors shown are all DB-9 female sockets, with pin 7 unused. Alas...would that it were only so simple! The problem is two-fold: finding the switch, and doing the wiring.

Finding The Switch

An 8-pole, 2-position switch is usually designated as 8PDT (8-pole double-throw), and is made in slide and rotary switch versions, but they are hard to find. I used a 12PDT slide switch that I found in my junk box, apparently salvaged from an old piece of equipment I'd taken apart some time ago. Of course, I only used eight of the 12 poles.

I found catalog listings for two rotary switches (CTS #T218 and Centralab #PA-1025) that would do the job. Both are two-section non-shorting, *break-before-make*, switches with each 4PDT section on a common shaft.

Be sure to specify "non-shorting," otherwise the outputs of the two computers will be connected together as you

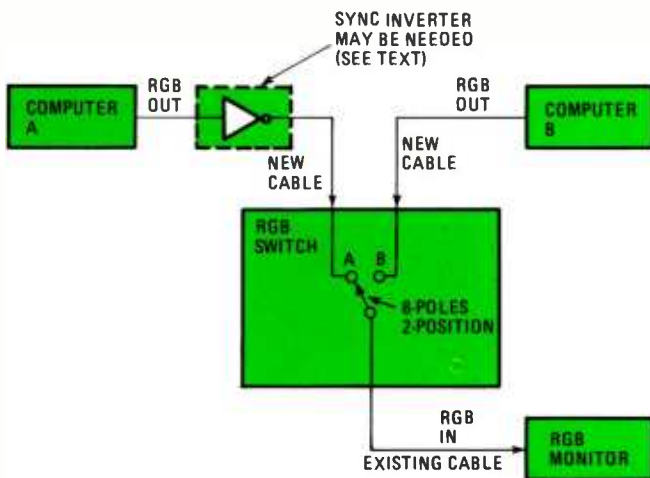

Fig. 1—Shown here is a typical two-computer, one-RGB-monitor situation. Assuming that the computers have the standard IBM PC RGB output (positive sync), you can use an 8-pole 2-position switch to select which computer will drive the monitor. If you have a computer that uses negative sync signals (the Sanyo MBC 550 series, for instance), you'll also need the sync inverter.

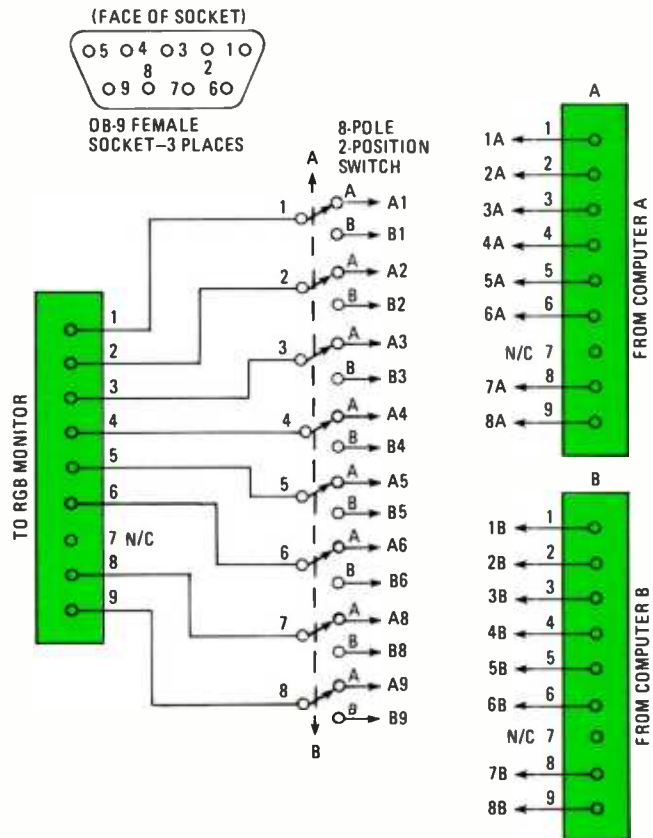

Fig. 2—Shown here is the wiring diagram for the switching section of the RGB Switch/Sync Inverter. Note that in each connector illustration pin 7 is unused, and that all three connectors are DB-9 female sockets.

switch, and I can only believe that would be very undesirable! If you can't find an 8PDT switch, use two 4PDT slide switches (non-shorting) side-by-side, and physically gang the switch tops so they move together. Toggle switches are also available in 4PDT versions.

Wiring the RGB Switch Box

First mount the three DB-9 female solder-type connectors (Radio Shack Cat.No.276-1538 or equivalent) in a small plastic box such as Radio Shack's 3-1/4 x 2-1/8 x 1-1/8 inch experimenter box (Cat.No.270-230). I mounted the two input connectors along one side of the box, and the output connector (the one that feeds the monitor) on the other side, as shown in the photos.

Mount the switch where appropriate—on the box cover (as I did), or on one end of the box. Actually, you might wish to use a larger box for ease of wiring, and you might have to use a larger box to accommodate the switch (or several) that you may want to use.

Use colored wire between the switch and each of the connectors. Small multi-colored ribbon cable (about 28-gauge, stranded wire) is ideal, if you can find it. The colors follow the resistor color code, (brown = 1, red = 2, orange = 3, yellow = 4, green = 5, blue = 6, purple = 7, gray = 8), so you can use the colors to wire to the corresponding pin numbers that are usually embossed on the face or back of the connector.

In any case, regardless of the wire you use, be very careful about connecting the wires as shown in Fig. 2. Since you'll be looking at the back of the connectors, it's easy to read the number sequence backwards. Essentially, all you're doing is

insulation at the ends of the coil so they will push through the holes. Bend the bare ends back up through another perf-board hole nearby. That will hold the coil in place. All other components are mounted near L1 (see Photo 2).

Now, mount the 8 pin IC socket in one side of the small perf board chassis. All other parts can be mounted as they are wired in the circuit. Place R2 so the control can be set easily or drill a small hole in the front end so a small screwdriver may be inserted for easy adjustment. The terminal connections of R2 fit right through the small perf board holes for solid mounting. Leave room for the 9 volt battery between R2 and BZ1.

Next, wire up all components at the bottom side of the perf board with regular hookup or 30 AWG Kynar wrap wire. Cross off each component and wiring as you proceed to

2

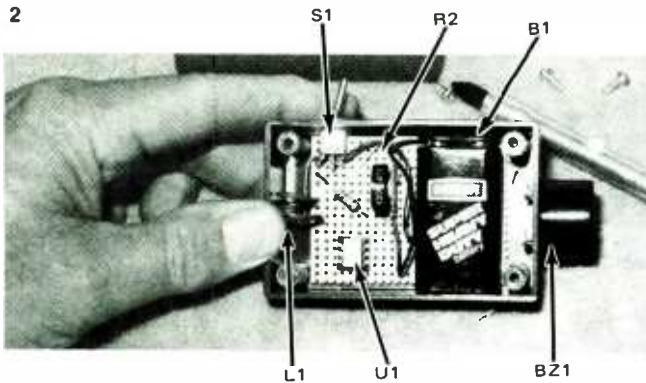

Mount L1 at one end. No particular mounting of parts is required except to make room for the 9-Volt battery and positioning the coil close to the case wall.

solder up the connections. Double check each component and correct connections so no wiring mistakes are made.

Prepare the plastic case by drilling two small terminal holes in the end for mounting the PC buzzer. Drill a 1/4-in. hole at the top left side for S1. The screwdriver adjustment hole can be drilled after the wired chassis is dropped inside the plastic container. Be sure and remove the small chassis before drilling the hole.

Now, mount S1. Place a dab of silicone cement between the two contact terminals of the buzzer and press tightly into



Check the battery with the DMM or VOM to determine if it is weak. Replace batteries with alkaline or heavy-duty types.

PARTS LIST FOR THE GDO INDICATOR

- BZ1—PC-Mount Piezo Buzzer 3800 Hz
- L1—2 turns of #22 solid hookup wire spaced 1/4-in. over 3/8-in. foam
- R1—100,000-ohm, 1/4-watt, fixed resistor
- R2—100,000-ohm printed-circuit board potentiometer
- S1—SPST miniature switch
- U1—741 Op-amp integrated circuit

ADDITIONAL PARTS AND MATERIALS

- 9-volt battery, battery clip, small PC board, 8-pin IC socket, solder etc.

position. Wipe off the excess cement with cloth or paper towel. If not, a messy mount job results. Let the cement set for a few minutes while soldering connecting wires to the perf chassis.

Connect the B+ wire to one side of S1. Run a piece of wire from the same connection to the positive terminal of BZ1. Be real careful when soldering up the lead terminals to the buzzer. Too much heat from the iron may unsolder the terminals or cause poor contact inside the piezo buzzer. Solder the hookup lead wire from pin 6 of U1 to the negative terminal of the buzzer. The positive (red) lead from the battery-snap lead connects to the other terminal of S1. Notice the battery fits snug between the sides of the plastic cabinet. Place a dab of silicone rubber cement on each side of the perf chassis after the indicator is operating.



Notice that the RF indicator is about the same size as the GDO transmitter. Line the transmitter coil up with the RF coil within the indicator for best testing.

Testing

After all components are in place and wired up, the indicator is ready to be tested. Once more double check all the wiring to components tied to the perf board chassis. Place U1 into the small socket. Make sure the dot is at pin 1. To make wiring of the perf chassis a lot easier, mark terminal 1 on the top and bottom sides of the chassis. Set R2 in the center of rotation. Now flip S1.

A loud tone indicates the indicator is correctly wired up. If not, check out the wiring. Adjust R2 just where the noise stops—near the end of rotation. The tone should quit at this point. Back the control up until the tone or noise starts again. If the adjustment is too far away from the point of no sound, then the tone is much weaker when triggered by the door opener transmitter. Leave R2 set near the point where the tone just stops. After that adjustment is made R2 should not be moved again.

Bend L1 so it rubs against the plastic end of the container. You want L1 as close to the GDO transmitter as possible. Place the GDO transmitter right against the end where L1 is located. Usually, the RF coil inside the transmitter is mounted at one end or the front of the transmitter case. Push

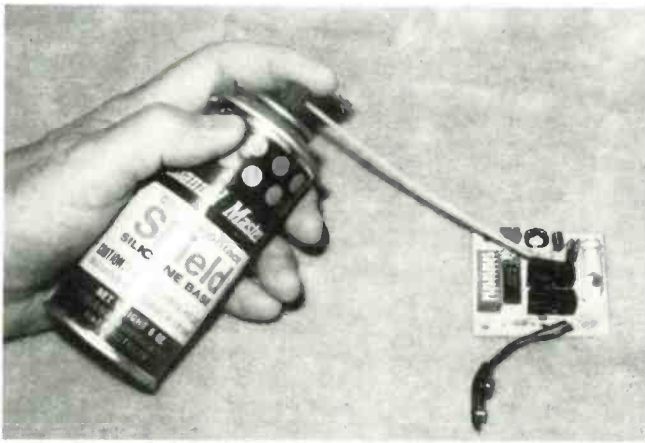

Suspect dirty or poor contacts of the transmitter switch with erratic or intermittent operation. Spray cleaning fluid right down inside the on/off button.

down the button of the transmitter and move it around until the loudest chirping noise is heard. Most GDO transmitters will operate one or two inches from the indicator. In fact, you can tell if the batteries or transmitter are weak by recording the distance between transmitter and indicator.

If the indicator took 60 or 120 minutes to build, do not fret, this unit will last for years.

Dead Indicator

Suspect incorrect wiring or a defective component if the indicator is dead without any tone noise. Remove one end of the battery terminals and insert a millampere meter in series with battery terminal and battery. The little indicator pulls only 0.42 mA when first turned on and when the GDO transmitter is pressed against the case 3.45 mA is measured. If more than 1.5 mA of current is measured with the indicator turned on, suspect a defective U1 or BZ1.

Remove the chassis and check the wiring once again. Has U1 been mounted incorrectly? Measure the resistance across the BZ1 terminals. No resistance should be measured on the 200K scale if BZ1 is normal. Reverse the wires on the terminals of BZ1 if the positive terminal is not connected to S1. The indicator is operating when a loud tone is heard out of the buzzer with R2 at middle range.

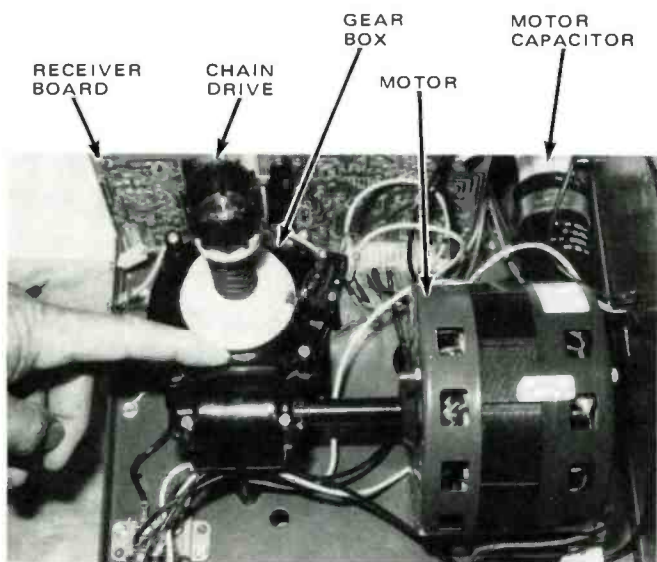

The finger points at the gear box which is directly driven by the 1/2-horsepower motor in a Stanley model 3500 GDO.

Servicing The GDO Transmitter

Suspect a defective transmitter when no signal can be seen or measured and the RF signal will not trigger the GDO indicator. Remove the plastic case. Check the batteries and terminals. Remove the battery and perform a continuity check across the switch terminals. A dirty switch contact may cause erratic or lack of operation of the transmitter. Push down on the transmitter button and measure the voltage applied to the IC and transistors. If the voltage is low on the IC or transistors with a new battery, suspect a leaky component.

Measure the resistance across the battery terminals after removing the battery. If the resistance measurement is lower than 2K, suspect a leaky component inside the transmitter. Take a current measurement between one battery terminal and lead. Insert a small piece of cardboard between a battery-clip terminal and its battery terminal. Insert mA meter probes in series with battery and terminal. Alternatively, if you can get at the on/off button terminals, clip the meter leads across

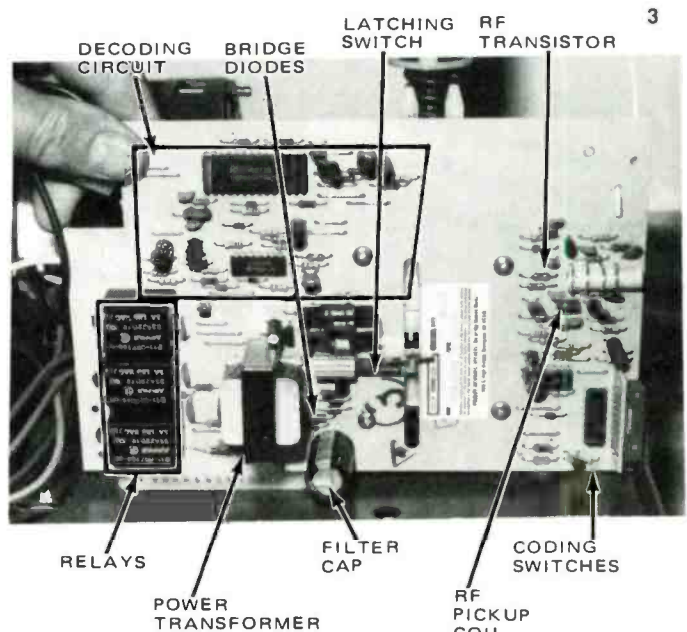

The GDO receiver is found on a PC board with the motor circuits in the motor opener assembly within the garage.

them with the switch off for a current check. Most transmitters pull from 10 to 20 mA of current. Suspect a leaky component with a reading above 20 mills of current.

Check each transistor and diode with a transistor tester or the diode test of a DMM. Real-low voltage on the supply voltage terminal of the IC may indicate a leaky IC.

Inspect the PC board for breaks or corroded wiring. Improperly soldered connections may cause a dead or intermittent GDO transmitter. If the transmitter opens the door one time, but the next time it will not open, lightly tap the transmitter case for possible loose connections. Notice if the LED or RF light is erratic when the button is pressed. Clean up the switch button contacts with cleaning fluid. Place the small tube so that the fluid will go directly into the switch area. Inspect all soldered connections. Remember, if the transmitter is erratic it will produce an erratic tone on the test indicator.

Receiver Troubleshooting

Most of the early GDO receivers are built like a regular radio receiver except a relay is added in place of the speaker

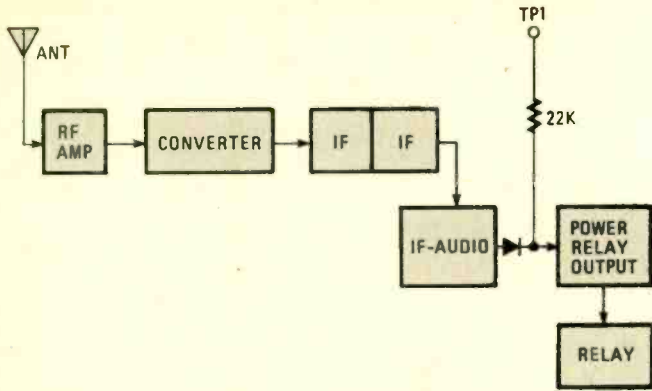

Fig. 4—The block diagram of an early GDO receiver with a signal measuring test point for quick troubleshooting.

(see Photo 3, previous page). Check all transistors and diodes within the receiver with a transistor tester or diode transistor test of the DMM. Make sure no low-ohm resistor or coil is found across a low measurement of the transistor terminals when suspected of leakage.

Some receivers have test points (like TPI in Fig. 4). Connect a VOM or VTVM to the test point and chassis. In other chassis, connect the meter after the final diode in the receiver. Press the transmitter button, the meter reading should increase. Take critical voltage and resistance measurements in the receiver circuits if the transmitter is normal. Check the supply voltage from the low voltage power supply. Low, or no DC voltage across the electrolytic capacitor may indicate a leaky voltage-regulating transistor or open filter capacitor. A receiver schematic is a must tool with voltage and resistance measurements.

Inspect the receiver chassis for burned components. Suspect lightning or voltage outage when components are charred and burned around the DC power supply. Burned resistors may result from leaky transistor or IC components. Burned relay points or frozen magnetic reed switches may prevent or cause intermittent operation. Clean up all relay points with a rough piece of cardboard or emory paper. A small finger-nail file may help. Always spray and wipe out the contacts after cleanup.

Transmitter/Receiver Tuneup

Short-range operation may be due to poor RF and audio-transmitter alignment. That is especially true if the transmitter has been dropped several times. Make sure the batteries are good. In some transmitters the RF coil alignment hole is found at the end of the coil. A special alignment tool is needed. Aligning the transmitter to the receiver may be accomplished with the receiver on the bench or mounted in its permanent location. The alignment adjustment is very critical. Always follow the manufacturer's alignment procedures when a new receiver or transmitter has been added to the system.

Both transmitter and receiver can be returned to your dealer or serviced by a service depot in your area if you can not find the trouble. Often, the receiver will unplug from the motor-control circuits and may be exchanged. Check with the manufacturer's directions in the installation literature which came with the garage-door opener. Check Table 1 for additional troubleshooting methods.

Motor-Control Circuits

The motor-control circuits may consist of a latching relay

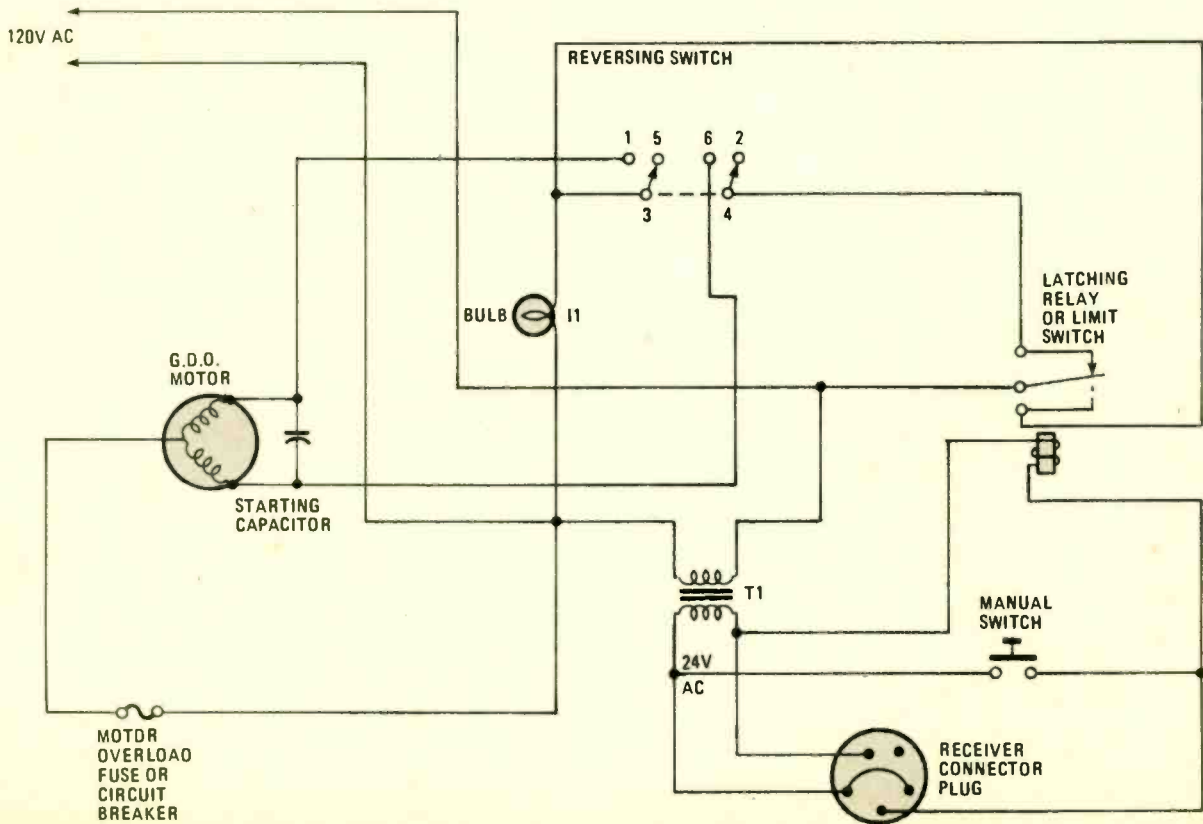

Fig. 5—Here's a typical motor-control circuit found in the motor assembly at the end of the door track.

TABLE 1—TROUBLESHOOTING CHART

TROUBLE	TRANSMITTER	RECEIVER
Opener does not work.	<ol style="list-style-type: none"> 1. Is the transmitter dead and manual switch operates the door? 2. Try the other transmitter and see if it operates the GDO if the manual switch is okay. 	<ol style="list-style-type: none"> 1. See if opener works on manual switch. 2. Some openers have a 10 second no operation period. 3. Make sure motor control assembly plugged in. 4. Is power turned on in garage? 5. Check overload protector and reactivate or reset. 6. See if door is jammed.
Short range operations.	<ol style="list-style-type: none"> 1. Check for weak batteries. 2. Check RF output with radiation indicator. 	<ol style="list-style-type: none"> 1. Check antenna location—make sure antenna is not torn loose. 2. Check receiver alignment with transmitter. 3. Check signal at test points.
Erratic or intermittent operation.	<ol style="list-style-type: none"> 1. Check battery connections. 2. Check for cracked PC board. 3. try another transmitter to see if one is erratic or intermittent. 4. Check for ntermittent transistor or IC in transmitter. 	<ol style="list-style-type: none"> 1. Check for loose antenna connections. 2. Check transistors and IC. 3. Check limit or latching switch points. 4. Inspect relay contacts.
Door operates by itself.	<ol style="list-style-type: none"> 1. Check for stuck down transmitter button. 2. Check to see if someone in neighborhood on same code. 3. Check for broken manual switch or defective wiring. 	<ol style="list-style-type: none"> 1. Inspect motor assembly for stuck relay.
Motor continues to run unless power turned off.		<ol style="list-style-type: none"> 1. Check for defective or sticking relay contacts. 2. Check for defective relay controller. 3. Clean up relay points.
Door closes, contacts floor then reverses.		<ol style="list-style-type: none"> 1. Does the door reach the full closed position of opening? Readjust black closed position on reverse adjustment. 2. Is there a build-up of snow or ice under the door? Remove all obstructions under door.
Motor fails to reverse.		<ol style="list-style-type: none"> 1. Check defective reversing limit switch. 2. Check for defective motor. 3. Go over the safety reverse adjustment in the service manual.
Opener reverses or stops before full open or closed.	<ol style="list-style-type: none"> 1. Check for frozen button on transmitter. 2. Check for defective manual switch assembly. 	<ol style="list-style-type: none"> 1. Check the door for binding or sticking while opening and closing. Disconnect door and operate manually to see if door operates freely. 2. Check for something obstructing the door and remove it. 3. Readjust latching or limit position switch assemblies. 4. Check the door for a broken or misadjusted balance spring.
Lights flashing.		<ol style="list-style-type: none"> 1. Change direction of receiver antenna. 2. Check for stuck or binding door. 3. Something obstructing door. 4. Poor limit or latching switch adjustment. 5. Check garage door opener service manual.

or switch which makes the motor rotate in one direction closing the door. When the door is closed, the latching or limit switch reverses the motor field and will raise the door when either the manual switch or transmitter button is pressed. Check the latching or limit switch for dirty or broken contacts when the door will not move. In some units the latching relay, manual button, and receiver solenoid may

operate from a 24 VAC circuit (Fig. 5).

Most manual switches are conveniently located on the garage wall. The manual button is used to operate the door within the garage or for emergency use. Some GDO motor units have a digital-code keyless-entry system box that may be mounted on the outside of the garage. Inspect the manual

(Continued on page 100)

GIZMO

MAY 1988

ELECTRONIC PACIFIERS FOR GROWNUP KIDS

VOLUME 1, NUMBER 3

Liteset Cordless Telephone pg. 1
Code-A-Phone Corp. Personal
Answering System pg. 2
Casco Products Corp. AromaLyte
Air Freshener pg. 3
Casio Digital Diary pg. 4
Maxim Chop & Shake pg. 5
JVC CD Portable pg. 6

GIZMO/BYTES

Discwasher CD Storage
System pg. 8
Delos 3-in. Compact Discs pg. 8
Altec Lansing Amplified
Loudspeaker System pg. 8
Studer Revox Time Controller . . pg. 8
Windmere Clothes Shaver Plus pg. 9
Olympia USA Olyfax 100 pg. 9
Sparkomatic Automotive AM/FM
Stereo Radio Cassette Player pg. 9
Windmere Curly Top Diffuser/
Dryer pg. 9
Sima Campod pg. 9
Blaupunkt Rinspeed Intelligent
Steering Wheel pg. 10
Panasonic TV/VCR pg. 10
Sharp Z1000 Stereo System . . . pg. 10
Plus USA Voice Memo pg. 10
Bang & Olufsen RL-35
Bookshelf Speaker pg. 11
Panasonic NN-6307 Microwave
Oven pg. 11
Sharp VC-D800U Digital VCR pg. 11
Fuji 3.5-in. Color-Shelled Floppy
Discs pg. 11
Mitsubishi HS-C30U Super
VHS-C Camcorder pg. 11



Personal Best:

LITESET CORDLESS TELEPHONE (RF100/01). Manufactured by: Plantronics, Inc., 345 Encinal St., Santa Cruz, CA 95060. Price: \$219.95.

Given the proliferation of telephone designs, it's perhaps surprising how many consumers opt for the standard cradle-and-handset style of phone. It's no real mystery, however, because so many of the newer designs aren't really very practical. Different, novel, but in no way an improvement on the standard telephone.

But there are practical new-style phones, including the *Liteset Cordless* from Plantronics, Inc. Besides doing away

with the cord, the *Liteset* is also a comfortable "hands-free" telephone. The traditional handset has been replaced with a small ear-fitted capsule, 3-in. long and 1/4-in. wide weighing 4 grams. The telephone (or dial pad) easily fits into a shirt pocket at 4-in. long, 2 3/4-in. wide and a little more than 3/4-in. thick.

The base unit, which recharges the dial pad's nickel-cadmium battery pack and connects with a standard phone jack and via an adaptor an electrical outlet, takes up no more room than the standard AT&T phone. The base also incorporates a telescoping antenna and the system's paging capability. Signals from the base are received by the capsule

In ten days use in the GIZMO office,

MAY 1988

the *Liteset* proved to be perhaps the best cordless and undoubtedly the most practical hands-free phone we've ever encountered. Its reception, although not flawless, was always acceptable, no small feat given the urban setting and the cats cradle of electrical and electronic interference buzzing around the location. Those on the other end of the line seldom guessed we were using anything but a standard telephone. There was no getting used to the *Liteset*. Instead, as soon as it was in place, it performed as advertised.

Plantronics takes considerable care to make sure that users can adapt to its unique capsule. The unit is sold with a set of 9 ear adapters; 3 different sizes of round, oblong and conical-style, the last designed to fit in the outer portion of the ear canal. Time spent selecting the proper size and shape for the user's ear pays off in comfortable use.

The dial pad incorporates a standard telephone keypad, as well as redial and mute functions and on/off controls. Mute and the on/off switches are duplicated on the top of the unit, making for easy access if the pad is carried in a pocket or fastened to a belt with the included plastic clip.

On the bottom of the dial pad is a receiver volume control (which we kept on low) and a SECURITY CODES SWITCH. This allows users to prevent other cordless telephones from accessing the unit's line. It must be set to the same position (there are three) as a matching switch in the base. The pad's battery case is also accessed via a sliding door on the bottom.

When in use, green signal lights on both the base and dial pad are illuminated. The dial pad mimics the sound of a rotary dial

(Continued on page 7)

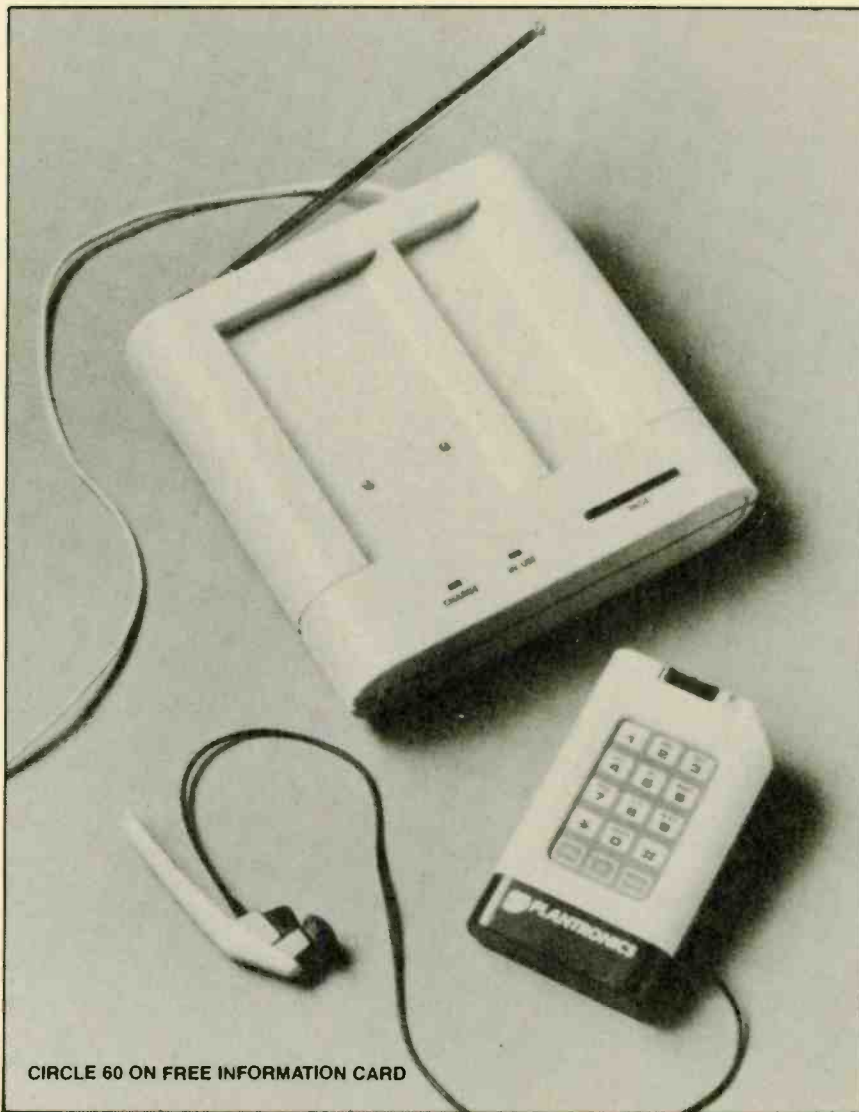

CIRCLE 60 ON FREE INFORMATION CARD

READY ON CALL

PERSONAL ANSWERING SYSTEM (1300). Manufactured by: **Code-A-Phone Corp., P.O. Box 5656, Portland OR 97228. Price: \$89.95.**

In a news release sent out during the January Consumer Electronics Show, Oregon's *Code-A-Phone Corp.* took note of its 30th anniversary as "one of the first companies to manufacture telephone answering devices." A photo with the release shows one of the company's earliest models, the 600. A box about the size of a portable tape recorder of the era, it came complete with a telephone handset and a dial control which closely resembles a TV channel selector of the same period.

The historical photo makes an illuminating contrast to a current, low-priced *Code-a-Phone* model, the 1300. In

terms of size, at least four of these contemporary *Personal Answering Systems* would likely fit into the space taken up by the pioneer machine. More importantly, the 1300 has features and capabilities undreamed of three decades ago in a unit aimed at budget-minded buyers for their personal, at-home use.

What we immediately liked about the 1300 is its compact size and uncluttered appearance. While telephone answering devices (or TADs) have gotten smaller even in the past decade, too many consumer models are still bigger than a telephone. The 1300, on the other hand, is about the size of a hardbound book with a minimum of controls and adjustments.

This small package contains some large capabilities however. Besides playing an announcement and taking messages on its microcassette, this unit features beeperless remote features—including message playback, save and cancel, new announcement recording and machine activation. A "toll

saver" feature allows the user to check up on messages received without necessarily paying long distance charges.

System monitor features include a resistive fuse, to protect the unit from power surges and a signal system, via the message light, which indicates if the tape is full or damaged or needs an announcement. A double beep when either the MESSAGES or STOP buttons are pressed signals that the 1300 is not ready, that a new tape should be installed or a new announcement should be recorded.

Very similar to its predecessor model, the 1000, this *Code-a-Phone* rearranges its features and incorporates some cosmetic changes. The earlier model included a MEMO button. On the 1300 this has been eliminated. The 1000's message light was a tiny, green bulb. This uses a slightly larger red light, mounted under a see-through, red-tinted cover.

One change doesn't necessarily seem an improvement. The 1300's volume and

on/off controls are combined. This is a bit awkward. The wheel-type control is so soft in turning the machine off that at first the user isn't quite sure at which point power off has been reached. Also, unless the machine is kept on at all times, this arrangement means that volume is reset every time the 1300 goes on. It might be argued that one control is better than two, at least in the interest of more simplified operation.

On the back of the machine is a RING DELAY switch. Kept off, it signals the unit to answer after two rings, engaged the machine answers after four rings. A third position activates the "toll saver" function. In a footnote to one of the telecommunications mysteries of our era, the instructions note, "the number of rings your caller hears will not always match the rings at your phone." This makes us wonder where the extra rings go, or come from, as well as raising the larger question of whether telephone rings are merely an accommodation to human expectations, or do they actually reflect some sort of system process?

Remote operations depend on the machine's preset code number. When calling from another phone, this number, punched in on a touch tone keypad at the appropriate point, tells the 1300 to play back the accumulated messages, allows the user to record a new announcement or even turns on the machine. To turn the machine on from a remote location, the user calls and allows the phone to ring ten times. The machine will respond with a "two second, steady low tone." Entry of the access code number will activate "three double beeps," signaling that the unit is on. According to instructions, in case of a power failure, "the first incoming call restores the on/off status that existed before the



CIRCLE 54 ON FREE INFORMATION CARD

outage."

To play back messages remotely, the user presses the access code number for two or three seconds after the beep that follows his or her announcement. At the end of the messages, the machine will generate four beeps. If message are to be saved, the remote phone is hung up at that point. If playback is to be repeated, the code is again entered. If the user wants to erase the messages, he or she hangs up before the four beeps are heard.

In the "toll saver" mode, the 1300 signals the user with the telephone's rings. If there are messages waiting, the machine picks up after two rings. If there are none, it allows the phone to ring four times, giving the caller time to hang up before toll charges kick in. Of course, these remote

functions depend on the availability of a touch-tone phone. *Code-a-Phone* offers a touch tone coder (ACC-588).

One nice feature of what is a budget-priced answering machine is the clarity of the 1300's voice recordings. Although crowding the microcassette will lessen audio quality noticeably, this is one simple, low-priced machine which doesn't sound as if it's operating underwater.

It could be that if the voice-chip machines just coming onto the consumer market take off, the 1300 and other tape answering machines might become as archaic as those first *Code-a-Phone* models of three decades ago. In the meantime, if you're in the market for a *Personal Answering System*, this is a compact TAD with a price that's equally small—G.A.

Vehicular Ventilation:

AROMALYTE AIR FRESHENER CAR LIGHTER. Manufactured by: Casco Products Corp., 512 Hancock Ave., Bridgeport, CT 066055. Price: \$9.95.

Given the intense controversy surrounding smoking today, how long will it be before some automotive manufacturer stops installing dashboard lighters in its vehicles? Given the familiar device's increasing importance as a power outlet for portable electronic products, any change is likely to be cosmetic. The lighter won't be called a lighter.

All of which makes us think that *Casco Products* may be a little late with its *AromalYTE Air Freshener Car Lighter*,

nothing less than the world's "first electronic air freshener and fragancer for your car." Despite its snazzy 24-carat gold electroplated barrel, the product looks like a conventional car lighter. Beneath its black plastic handle, however, is the unit's unique *fragancer*.

The handle isn't a handle after all, but a "fragrance cartridge." When the user wants to change scents, he or she merely buys a replacement handle-cartridge and snaps it into place. The cartridge itself contains a strip of cotton, held in place by a metal fitting, impregnated with one of six fragrances—Country Air, Vermont Woods, Southern Grove, Oriental Moon, Malibu Midnight and New Car. The replacement cartridges retail for \$1.98 each.

Our test unit's fragrance was, we think, Oriental Moon, and for our tryout we selected a vehicle driven by a cigar smoker. After a brief time on the road with the

windows up and the cigar in play, as per directions, we pushed the lighter in. A few minutes after it popped out, the fragrance, activated by the heat from the lighter's element, was more than noticeable, it was close to overpowering.

The handle housing allows adjustment for the amount of scent released, but not when it's hot. In addition to the very discernible odor, *Casco* says the product contains "a patented ingredient that effectively removes undesirable odors." Both its fragrance and odor-eating properties can be enhanced, according to the manufacturer, by opening the car's windows after a few minutes of fragrance in order to increase air circulation or by merely removing it from the socket and waving it around.

Each of the scent cartridges is said to be good for up to 100 uses, while the lighter itself has a "lifetime warranty" provided

the user doesn't "abuse" the product.

At the end of a two-week period, we were almost ready to agree with *Casco* that the *AromaLyte* is "a high-tech air freshener that represents the next generation of car lighters and is sure to revolutionize the industry." Almost in that the product releases a bit more scent than we care for. The cigar-smoking owner of the car we tested it in was even less complimentary. His description of what the *AromaLyte* makes his car smell like probably doesn't belong in **GIZMO**.

This gadget may well be a high-tech replacement for hanging pine trees and Playboy bunnies, but those automotive air fresheners at least have the advantage of being passive. After a few weeks of use, the scent released is mild.

In contrast, the *AromaLyte* after two weeks was still going strong, and we mean strong. Maybe a less exotic-scent wouldn't be so overwhelming (our original choice was New Car), but the suspicion lingers that a less-dramatic fragrance might not do the job of masking unwanted odors.

Finally, we puzzled for some time over what qualifies this product as an *electronic air freshener*. Apparently its activation via the lighter's electric heating element makes it an *electronic* product. At least *Casco* didn't claim it was digital.—G.A.

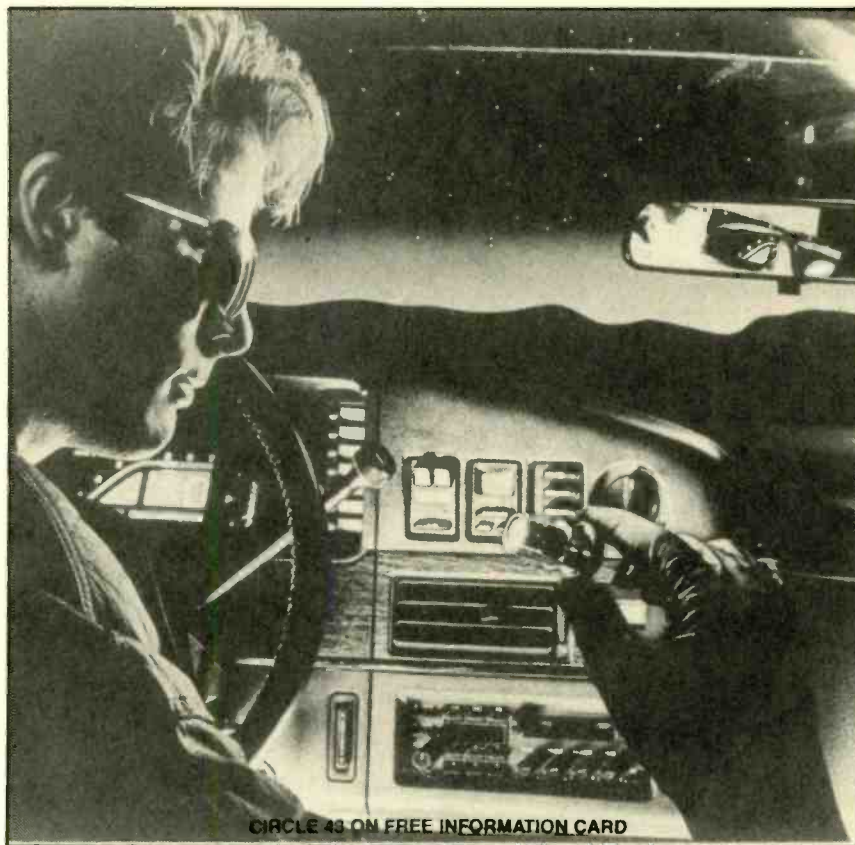

CIRCLE 43 ON FREE INFORMATION CARD

PC in Your Pocket?

DIGITAL DIARY (SF-3000). Manufactured by: Casio, Inc. (15 Gardner Rd., Fairfield, NJ 07006. Price: \$99.

We've always had our doubts about electronic memo pads and pocket computers. Although their advantages are easily grasped—"never fumble for pad and pencil again"—these miniaturized, dedicated computers sometimes appear to be more trouble than they're worth. Fumbling for pad and pencil seems no trouble at all compared to learning arcane or too-complicated entry routines in order to record some short piece of information or perform a calculation.

This is not, of course, a universal attitude. Although we still suspect that more of these data gadgets are given as gifts than purchased by people planning to use them, they're firmly established as an electronic product category. Among the best received of these devices is the *SF-3000 Digital Diary* from Casio, Inc.

Closed, the *SF-3000* resembles a sleek pocket case or address book. Open for business, the unit engagingly mimics full-sized PC keyboards. On the top cover's left is the unit's display. At the right is the

numerical keyboard which also contains various functions controls—cursor left and right movement, display clear, insert delete and numeric value clear (used in calculation), all clear, a mark key which sets aside data for retention during reset operations or "marks a specific month as the first to be recalled" when displaying a full calendar and a colon key, for inserting a colon during schedule input. Used in conjunction with the SHIFT key positioned at the bottom of the *SF-3000*'s second keypad, the colon key "sequentially displays data contents" of the unit.

Under the display is a row of function input/output keys (telephone, memo, schedule, calendar and a security feature designated SECRET) and the scroll up and down controls. The alphabetic keypad features the standard keyboard configuration of letters and in its lower left includes shift, space and and data in/out.

Above this keyboard are the calculation command keys—plus, minus, multiply, divide, equals, percent, square root—and three keys which add or subtract displayed values to the *SF-3000*'s independent memory and recalls, displays or clears independent memory. A date key calls a particular year, month or date during schedule input/output.

As with any computer keyboard, keys perform double duty. For example, the

shift key, in conjunction with the secret key activate the cursor keys to increase or decrease the display's contrast. The speed of automatic data display can be controlled by pressing a numeric key, followed by shift and display. A chart in the operation manual gives the display speed in seconds for each of the numeric keys.

Data input, in our brief test, seemed relatively simple and straightforward. Inputting a telephone number requires the user to press the data key. Under the main display, the word "in" appears. Then the main display is cleared with the AC and clear keys, bringing the cursor to the home position. The user types in a name and presses the telephone key. The prompt "number?" appears on the screen. The calculation command minus sign stands in for the customary dash in phone numbers, while pressing the MEMORY RECALL key will print out "MR." After inputting the number, a second press to the telephone key puts it in memory. A second pressing of DATA exits the input mode. Once entered, name are alphabetized in memory.

The *SF-3000* can store information for approximately 80 individual telephone entries, provided 18 characters are used for the name and number. In finding a particular number, the user has a choice of four different search procedures. The SEQUENTIAL SEARCH displays entries in

the order they were added. Each press of the telephone key calls up the next entry. The forward and reverse scroll keys can also be used to accomplish this. Holding down either of these keys "allows high speed scrolling."

In direct search, the user enters the name and presses the telephone key which displays the desired number. In a variation, a colon followed by a name and then pressing the telephone key will call up the appropriate number. Finally, inputting the first letter or two letters of an entered name and pressing the phone key will display the full name and number.

The memo function allows storage of both numerical and alphabetic data of up to 58 characters per item in unalphabetized sequence. To input, data, all clear and clear are pressed, followed by the memo function key. To search for data in this mode, the shift and memo keys activate *spell search* which looks for data using the first character inputted in the individual memo. Memos can also be displayed sequentially using the scroll keys. Information can also be inserted in existing memo items or deleted. In addition, calculation results can be stored in memo function and numeric values in the memo file can be used in calculations.

The SF-3000's built-in calendar covers January 1, 1900 to December 31, 2099, which according to Casio "provides the potential to input data over a range of 200 years (subject to memory capacity limitations)." Full month calendar displays can be scrolled forward or back and inputting a specific date can be used to call up the approximate month which will be displayed with the inputted date flashing. Schedules for single days as well as full-year schedules can be stored in calendar memory. A maximum of 30 characters can be input per schedule item, while several events can be listed for each date, "provided memory limitations are not exceeded."

All of this information can be made relatively secure with use of the secret function. The user selects a password of up to 47 characters, then enters the file (telephone, memo or schedule) item which is



CIRCLE 56 ON FREE INFORMATION CARD

to be kept secret. To access this information, input of the password is required. Without that, the word "secret" appears on the screen when confidential information is requested.

Data can be edited using combinations of input keys (shift, clear, etc.) and the Casio Digital Diary will display its remaining capacity via the shift and decimal point keys. One-month reset allows quick deletion of no longer current data. Specific reset is used to clear all data except the selected password and data which has been marked for retention. All reset removes all inputted data from the unit. These three functions are carried out by a combination of keypad input and the reset button on the back of the unit.

Power for all this pocket memory is supplied by three lithium batteries (good for approximately 120 hours of continuous use) and a single lithium back-up battery

(approximately 2 years).

Despite the relatively simple routines necessary for data input and output, the SF-3000 didn't entirely overcome our doubts about these devices. An operations manual of some 64 pages is necessary to outline use of the *Digital Diary*. Happily, Casio did a good job of clearly explaining procedures, which helps account for the lengthy instructions. Also, compactness brings some complications of its own. When using the shift key to switch from lower to upper case, it's necessary to engage it before and after each capital letter. The size of the keypads can also present a problem, at least at first, to the stubby fingered. As with full-size computers, practice makes for practicality. With enough time, the *Casio Digital Diary* could become a useful pocket companion for its owner.—G.A.

Double Duty:

MAXIM CHOP & SHAKE (CS-20). Manufactured by: The Maxim Co., 164 Delancy St., Newark, NJ 07105. Price: \$45.

Kitchen gadgetry appears to be heading in two directions at once. On one side are products which promise to speed up meal making, like the microwave oven. On the other, various tools which suggest time is no object in preparing gourmet vittles. In

its chopper and milkshake maker. The Maxim Company appears to have combined both gourmet and time-saving imperatives.

The *Chop & Shake* actually combines two Maxim products. Or as a company news release has it, the device joins "the functional versatility of a chopper/grinder with the fun of a milkshake maker." The uncombined appliances, as well as this hybrid, depend on a sturdy, high-speed and powerful 120-volt electric motor. Fan-

cooled, the power unit is designed for both continuous and pulse action.

The motor sits atop one of two supplied wide-mouth plastic containers, a 19 oz. *chopping jar* and a 27 oz. *milk shake jar*. Each comes with its own mixing agitator. For milk shakes, a long metal shank fitted with a plastic disc on its end does the blending. For chopping, two single-edged stainless steel blades on the end of a plastic assembly rotate on a short metal spindle built into the chopping jar's bottom. Also

included with the *Chop & Shake* is a plastic spatula used to move food towards the blade in chopping.

Easy to use, if difficult to describe, *Maxim* utilizes a unique motor assembly to facilitate the appliance's functions. The instructions probably explain it as clearly as possible. The user, "grips the motor housing and jar cover [two separate pieces] with one hand," while the other hand, "twists top of motor housing in direction of arrow [embossed on the motor's top] and presses the red button to start motor." If this sounds awkward, don't worry. None of the food processing the *Chop & Shake* is capable of takes more than 30 seconds. Some items can be prepared "in a second or less."

Besides, in the interest of safety this two-handed operation tends to concentrate the user's attention on what is a fairly powerful small kitchen appliance. As a further, and more fool-proof, safety feature, the *Chop & Shake* motor will not operate unless it's securely attached to the container.

The instructions list some 33 food items the *CS-20* can chop, grind, grate or puree, ranging from anchovies and avocados to shallots and tuna fish. In *GIZMO*'s tests we chopped onions, garlic, nuts and ground coffee and peppercorns. A *chopper processing chart* lists maximum quantities, indicates continuous or pulse action and offers hints for processing specific foods. Bacon for example should be very crisp, while milk chocolate must be frozen. The device can also be used to prepare salad dressing, chicken, tuna or similar salads and to prepare baby food.

Perhaps the main drawback to operation of the chopper end of this combo is just how quickly it does its work. Or as the instructions rather blandly put it, "moist foods tend to liquify if timing is excessive." Meaning, for example, that onions chopped for more than just a few seconds become onion puree. As might be expected, making milkshakes isn't quite as tricky, although the instructions do warn, "excessive mixing will detract from the quality of the shake," a mistake we were careful to avoid in the *GIZMO* test kitchen.

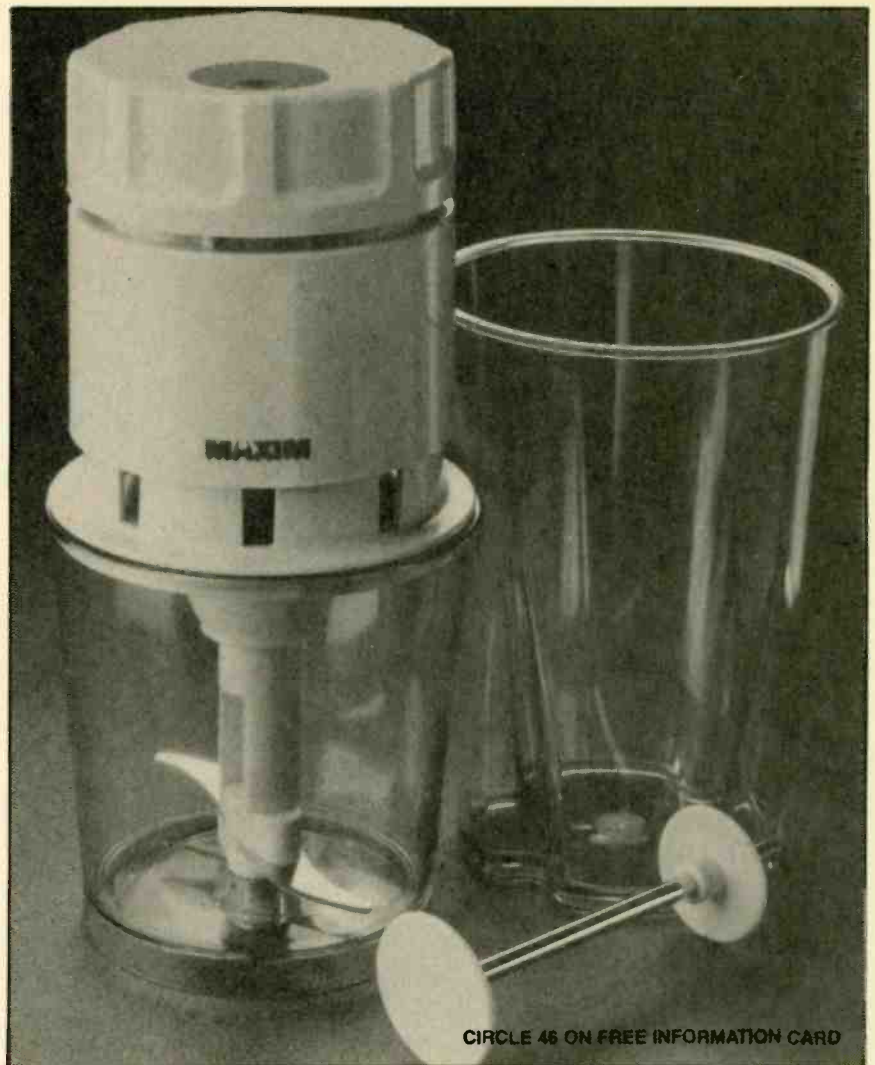

en. In its shake maker guise, the *CS-20* will also prepare whipped cream.

In a kitchen where fairly serious meal preparation takes place, the *Maxim Chop & Shake* doesn't seem to be one of those culinary gadgets which ends up gathering dust unused in some cabinet. Besides, any gizmo that can turn out milkshakes isn't going to go unappreciated, especially in a household with kids. It's efficient, lightning fast and easy to clean after use. The

motor assembly, of course, shouldn't be immersed in water or rinsed and in washing up, the chopper blade demands the sort of respect which any sharp-edged cutting tool deserves.

We don't know if this will knock 'em dead in gourmet food circles, but as a fast method of accomplishing the often tedious task of fine chopping, the *Chop & Shake* is one device on the cutting edge of kitchen science.—G.A.

Junior System, Grown-up

JVC CD PORTABLE SYSTEM (PCV2J). Manufactured by: JVC Co. of America, 41 Slater Dr., Elmwood Park, NJ 07407. Price: \$399.95.

One of the real pleasures of the current electronic era are the strides made in the design of consumer items. No longer confined by space or volume requirements, the best designs allow function to dictate

form in ways not previously possible.

A prime embodiment of this trend would have to be the *JVC CD Portable System*, singled out at the 1987 summer Consumer Electronics Show as among "the most distinguished achievements" of the year in electronics. With its detachable speaker duo removed, the unit is a little bigger than the proverbial breadbox. The CD player is on the top of the *Portable System*, with the tape deck accessed via the front of the box. Standard audio controls for AM/FM and short wave radio reception and the system's CD and tape

capabilities, along with a five-band graphic equalizer are also on the front.

The configuration of controls and functions makes for easy operation. With its speakers attached and its telescoping antenna in storage position, a folding bar-style handle makes this compact, and at 15.5 lbs. hefty, package eminently totable. But what makes this an award winner is its successful marriage of form and function. The *PCV2J* may sound as good as it looks.

Using what *JVC* calls *hyper bass*, the unit's bass port, at the bottom of the component cube, puts out low-end sound with

the strength of a sousaphone. Activated with a switch designated 3D, a hand held a few inches in front of the hyper bass output actually feels gusts of air. Not so many years ago, a speaker the size of a small child would have been necessary for that level of audio performance.

The compact disc system is certainly the equal of the flashy personal units which have attained such amazing popularity, including its range of sophisticated playback functions. But in this package it strikes us as a good deal more practical for remote location listening. Four stubby, round, rubber feet give the unit ample, and adjustable, support.

As an audio duplicating unit, the *PCV2J* incorporates a Dolby noise reduction system and offers "synchronized recording" with the CD player. For recording from AM or SWL broadcasts, a BEAT CUT switch controls unheard "beats which may occur during radio reception." Its performance as a tape recorder matches that of expensive systems of the recent past.

Used on a camping trip, the system's short wave reception came into its own. In a fairly remote wilderness area, it pulled in signals from an impressive number of foreign services. In urban areas, without the addition of an external, non-system antenna, its short wave capability is for the most part, moot.

The design unfortunately, isn't entirely portability oriented. After only a few months of real-life use, one of the equalizer knobs snapped off. It didn't disable the band, but it made us wonder why



CIRCLE 59 ON FREE INFORMATION CARD

something more durable than semi-brittle plastic couldn't have been used for the controls and switches.

At home, plugged into an aging stereo system, the *PCV2J* acted just like a grown-up component, with its CD and tape capabilities easily out-performing our turntable's tired output. With hyper bass switched on, its mite-sized speakers gave our floor models a run for their audio money. Speaking of money, at-home use had the advantage of AC power. All that

compact audio power tends to devour its remote power supply (eight "D" batteries) at an alarming rate.

We may just be showing our age, but such concentrated power and performance in an entirely portable form still sounds like a marvel. It's customary to speak of audio *sacrifices* made on behalf of portability. But to at least one pair of veteran ears, any sacrifices of sound made in configuring the *PCV2J* were pretty much inaudible.—C.P.

Personal Best

(Continued from page 2)

and its design incorporates a slot for storage of the capsule. The instructions warn that the capsule should not be kept in the slot when the dial pad is returned to the base, instead there's an indentation for its storage. The mute button is the electronic equivalent of putting your hand over the phone's mouthpiece. Held down, it block's the user's voice transmission.

Set up is simple. Once the dial pad battery is installed, the unit must be left in the base for 24 hours of recharging for wireless use. The phone works during the charging, provided the pad isn't removed from the base. Once charged up, the pad and capsule will operate at a distance of up to 1,000 feet from the base unit. Besides selecting a security code, the user selects

either tone or pulse operations via an adjustment on the base. With line connections in place and the base plugged into a wall outlet, the *Liteset* is ready for use.

The advantages of hands-free telephone use quickly made themselves obvious. It was possible to work at a keyboard, search out material we wanted to refer to in conversation and carry out a host of other activities without breaking off the phone call.

Still there are, if not drawbacks, limitations to the *Liteset*, about which *Plantronics* is straightforward. Both steel-frame construction and fluorescent lighting can interfere with telephone operations, at least limiting the distance from the base at which the key pad and capsule will operate. The user guide warns not to use the instrument "while in the bath or shower or over a full washbasin." The phone is not compatible with inductively coupled

hearing aids. Persons with "a history of ear infections or allergies to plastics" are cautioned about use of the cone-shape ear adapter, as well as being cautioned to "consult your physician" before use of the other styles of earpieces. Finally, electrical storms can make the *Liteset Cordless* potentially hazardous.

As a smart redesign of the telephone, however, the *Liteset Cordless* is entirely satisfactory in our experience with the instrument. Comfortable to wear, clear in its transmission and reception and requiring no more space than the standard telephone. Although the car radio-style antenna provides of an incongruous design note, in all other respects this is a handsomely designed instrument. It may never replace the standard cradle-and-handset telephone, but it's a real alternative for consumers looking for both cordless and hands-free communications.—G.A.

Gizmo/Bytes



Discwasher CD Storage System

If market research indicated that consumers are "looking for a sophisticated, precision-crafted storage center" for their compact discs, what would the well-adjusted corporation probably do? If the company was *Discwasher* (4310 Transworld Rd., Schiller Park, IL 60176), it would likely introduce an elegant CD Storage System. Pointing to the burgeoning CD market, Discwasher is offering a swivel-based storage cabinet, "handcrafted from solid American Walnut" with a capacity of up to 36 CDs. In announcing this addition to its CD-related product line, Discwasher said it was particularly aimed at "the high end consumer who takes great care with home furnishings." Price: \$79.95.

CIRCLE 80 ON FREE INFORMATION CARD



Delos 3-in. Compact Discs

It seems as if the compact disc just isn't compact enough for some audiophiles out there. Since last September, *Delos International, Inc.* (2210 Wilshire Blvd., suite 664, Santa Monica, CA 90403) has been offering 3-in. Compact Discs. The new size was introduced as part of the label's *Pocket Classic* series, with "up to 20 minutes of music" on each of the mini-CDs. Some 20 different jazz and classical titles are planned, "putting the world's greatest music in the palm of the listener's hand, quite literally," according to firm. The company also hopes that the 3-in. format's lower price will "encourage consumers to experiment with new and unfamiliar styles of music." The Delos discs are compatible with all existing CD players but do require a plastic adaptor (supplied) for use in players with a sliding door mechanism. No adaptor is required for portable players with a center spindle mechanism. Price: \$3.99.

CIRCLE 45 ON FREE INFORMATION CARD



Altec Lansing Amplified Loudspeaker System

Out there on the cutting edge of audio technology, the air gets pretty rarified. Distinctions which would tax a canine's ears become the basis for arcane disputes, claims and counter claims. We won't be surprised at the hornet's nest of controversy that *Altec Lansing* (Consumer Products Division, Rts. 6 & 209, Milford, PA 18337) will likely stir up with its new *Amplified Loudspeaker System* (550). Offering a total of 1400 watts of power, a pair of 550s are controlled by a remote which adjusts the levels of the system's ten amplifiers. The speaker utilizes three drivers, operating from upper bass to tweeter range, which swivel 15 degrees side to side to "improve imaging and dispersion." Remote control is via a module which "duplicates the loudspeakers' control panel" and allows for amplifier adjustments of "6 dB in 2 dB increments," as well as controlling left-right balance, and volume, or as Altec Lansing prefers in its press release, "the overall response curve according to listener preference or room environment." Speaker-mounted controls adjust the level of each amplifier individually. Finished in walnut veneer, the 550s utilize Altec's *acoustic cabinet resonance system* of double construction. Price: \$12,000.

CIRCLE 58 ON FREE INFORMATION CARD



Studer Revox Time Controller

It's getting harder and harder to announce "the world's first" anything, especially in electronics and related fields. None the less, *Studer Revox America, Inc.* (Revox Division, 1425 Elm Hill Pike, Nashville, TN 37210) thinks it's got an authentic premiere in its *Time Controller* (B205), "the world's first computer interface to fully automate a music system." Not coincidentally, the music system is made up of Revox 200 Series stereo components. With its "optional software package," the Time Controller can program hours of music with random access to CD tracks and taped segments or make unattended audio recordings from broadcasts. Used in conjunction with the Revox remote control module (B205), the PC-linked unit makes "remote operation an easy, one-touch operation."

Its as yet unpriced software, compatible with any MS DOS home or personal computer prompts the user and creates a series of commands from the prompts. During operations, "the computer checks the audio equipment to determine whether commands are being executed and completed." Price: \$600.

CIRCLE 44 ON FREE INFORMATION CARD

Windmere Clothes-Shaver Plus

One of the big TV marketing success stories of recent seasons was a little wardrobe maintenance device which even made its way into comedians' monologue. We're referring to the *clothes shaver*, for removing fuzz and pills from all manner of garments. As an encore, the item's manufacturer, *Windmere Corp.* (4920 N. W. 165th St., Hialeah, FL 33014) has announced the Clothes Shaver Plus (CS-2).

If not newer and better, this model at least has the advantage of being a lot bigger. The *clipping head*, which rotates beneath a perforated safety cover is nearly five times larger than on the original little Shaver. Windmere calls it "ideal for upholstery, bedspreads, and drapes." This larger unit can be plugged in with a supplied transformer or used with four "AA" batteries. Enthusiastic clothes shavers the world should find that the Plus offers more shaving with less motion. Price: \$19.95.

CIRCLE 52 ON FREE INFORMATION CARD

Olympia USA Olyfax 100

Facsimile equipment is a field that has attracted a number of recent market entries. Latest to leap into the fax fray is *Olympia USA, Inc.* (Box 22, Somerville, NJ 08876-0022). The office equipment and typewriter manufacturer is offering a trio of models, including the basic *Olyfax 100*. That briefcase-sized portable weighs 12.2 lbs. and can transmit a standard letter in 20 seconds. Its features include one-touch auto and speed dialing, an auto-reduction function, which reduces all larger documents to 8-1/2 by 11 inches, and automatic feed and receive. Price: \$1,795.

CIRCLE 63 ON FREE INFORMATION CARD

Sparkomatic AM/FM Stereo Radio Cassette Player

When it comes to electronic toys and goodies, it's the high end of the market that grabs most of the attention, which can leave the consumer with nose pressed against the window of the future. That's why it's nice when a company remembers the rest of us. The new automotive *AM/FM Stereo Radio Cassette Player* (SR38) from *Sparkomatic Corp.* (Milford, PA 18337) is decidedly not high end. It's rather frankly described as a "low-cost manually tuned" model, but with features that include a locking fast forward button, balance/fader control five-band graphic equalizer and full night illumination. Price: \$79.99.

CIRCLE 41 ON FREE INFORMATION CARD

Windmere Curly Top Diffuser/Dryer

What delivers "1200 Watts of controlled and diffused air that dries curls intact and will not blow out volume or wave?" If you guessed *The Curly Top Diffuser/Dryer* (CT-1) then you probably also know that this hair-care product has dual heat and speed settings and is suggested for use with "permed as well as naturally curly or wavy hair." The *Windmere Corp.* (4920 N. W. 16th St., Hialeah, FL 33014) also says its new blower is "ideal for today's more-natural hairstyles." Price: \$14.95.

CIRCLE 64 ON FREE INFORMATION CARD

Sima Campod

Wobbly video movies have got to be one of the chief embarrassments of the video lifestyle. Rapidly shifting frames and jerky, out-of-focus figures are a figment of the old days of home celluloid, not the smooth new world of video. Fortunately, relief is at hand from *Sima Products Corp.* (4001 W. Devon Ave., Chicago, IL 60646). Realizing that many camcorder users value mobility above all, the company has introduced its *Campod*, "the only monopod specifically designed for action videotaping." Anchored by a step-on foot brace, the Campod retracts to a 17-in. length and weighs 22 oz. Outfitted with "snap action leg locks," its six telescoping sections expand to 64-in. A *fine tuning* height adjustment requires only one hand to use and Campod's panhead is multidirectional. We imagine that after especially strenuous location shooting, it could also be used as a walking stick. Price: \$59.95.

CIRCLE 74 ON FREE INFORMATION CARD

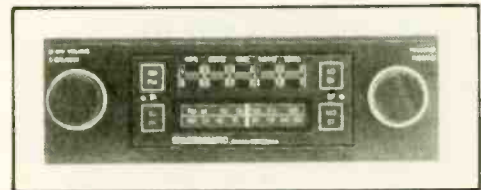
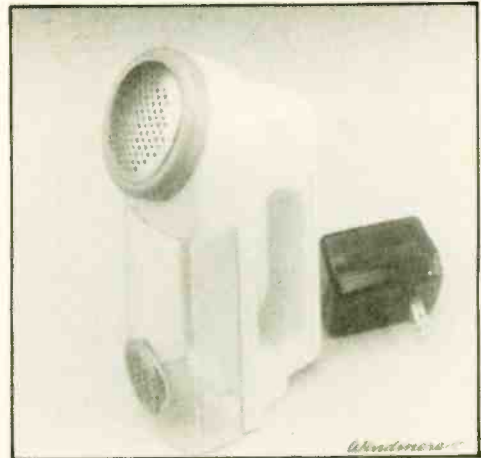



Blaupunkt Rinspeed Intelligent Steering Wheel

In today's fast-lane automotive-electronic sector, a driver can touch a control on the wheel and make a phone call, tune in a traffic bulletin, turn up the car stereo's volume and, in all perform some 20 different functions. Provided, of course that the driver is behind a *Rinspeed Intelligent Steering Wheel* in a vehicle outfitted with specially modified components or cellular equipment from *Blaupunkt (Robert Bosch Corp. P.O. Box 4601, N. Suburban, IL 60198)*. This high-tech steering wheel is "based on a high-quality Italian-made Momo steering wheel with twenty-four pushbuttons to control several different *Blaupunkt* AM/FM cassette receivers, CD player and mobile cellular phone." Among the functions performed are switching from AM to FM to tape, adjustment of volume, scanning and selecting preset stations, changing tape direction and dial or answer a cellular phone call. The horn, by the way, is controlled from the spokes of the wheel. The *Intelligent Steering Wheel* utilizes an infrared transmitter to send instructions to a dash-mounted pickup, which is wired to a compact receiver that converts the instructions into electrical impulses. *Blaupunkt* says this deluxe wheel can be "installed on most cars," although it would be difficult to imagine one in a 1965 Dodge. Price (exclusive of radio, CD or cellular phone): \$995.

CIRCLE 49 ON FREE INFORMATION CARD



Panasonic TV/VCR Combo

Combination TV/VCR units seem a new trend on the video front. The latest manufacturer to announce a combo unit is the *Panasonic Co.* (1 *Panasonic Way, Secaucus, NJ 07094*). The new *PV-M2027 TV/Video Cassette Recorder* features a twenty-inch diagonal color television monitor, while the VCR has digital quartz tuning which, according to *Panasonic*, does away with by-hand fine tuning, always a fussy step in VCR set-up.

The *PV-M2027* will "automatically fine tune all 155 available FCC channels." *Panasonic's* "Omnisearch" system, in the SLP mode, "can conduct a search at twenty one times the standard playback speed," with "the screen imaging remaining clear during the search." The VCR is automatically activated by inserting a VHS cassette. "When recording is completed, the tape automatically rewinds and the *PV-M2027* turns itself off."

The company says that the system is aimed at those who "become confused by the video cable connections between a television and a VCR," a condition that the psychiatric profession has yet to label "connection anxiety." Price: \$800.

CIRCLE 84 ON FREE INFORMATION CARD

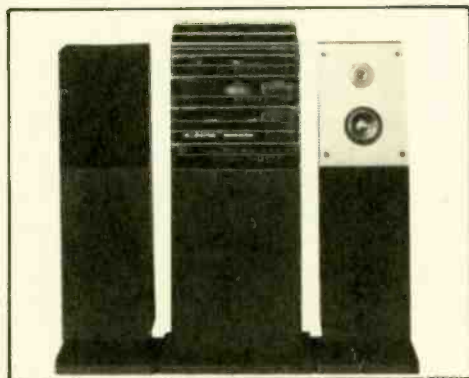

Sharp Z1000 Stereo Component System

The past couple of years has seen the return of the single-brand stereo-component system, informally labeled "rack systems." Now, the aggressive marketers of *Sharp Electronics Corp.* (*Sharp Plaza, Mahwah, NJ 07430*) have taken the trend one step beyond, introducing what the firm dubs a "rackless rack system."

The *Z1000 Stereo Component System*, besides "sleek European design," features a 120-watt per channel AM/FM receiver, a seven-band graphic equalizer and a semi-automatic belt-drive turntable. Its twin tower speakers each contain a "down-firing" 5-in. woofer along with 5-in. midrange and 1/2-in. dome tweeters. A *Z1000 CD Player* is available as a separately priced option. Price: \$899.95.

CIRCLE 42 ON FREE INFORMATION CARD



Plus USA Voice Memo

Just as American offices are getting filled up with those ubiquitous yellow stick'em pads, along comes an electronic product which claims to "eliminate the need to ever use a note pad again." It's called the *Voice Memo*, a palm-size tape recorder which will store and playback a 30 second memo. A product of *Plus U.S.A. Corp.* (10 *Reuten Dr., Closter, NJ 07624*), it's touted as "ideal for students, executives, children and home makers," in short anyone who might want to leave a note for someone or record a reminder for themselves. Power is supplied by two "N"-type batteries and a message light indicates if there's something recorded. With it's 30 second time limit, the *Voice Memo* should at least cut down on wordy communications. Price: \$29.95.

CIRCLE 90 ON FREE INFORMATION CARD

Bang & Olufsen RL-35 Bookshelf Speaker

Is there such a thing as the ultimate shape for a loudspeaker? Given the variables, probably not, but that doesn't stop engineers from searching. Bang & Olufsen (1150 Feehanville Dr., Mt. Prospect, IL 60056) gained a good deal of praise (including Industrial Design Magazine's annual design award two years ago) for its RL Series loudspeaker. Now the firm has added a Bookshelf Speaker (RL-35) to its line.

The new compact size measures 15¾-inches wide, 12½-inches high, and 5-inches deep and weighs 7.8 lbs. The unit's cabinet construction does not produce audible mechanical vibrations of its own and the speakers can be positioned either horizontally or vertically, on the floor, shelves, or wall mounted. Techniques used in designing the RL Series include "laser holography, computerized design and testing, and a test chamber," which "is one of the world's largest. The search for the final speaker continues. Price (per pair): \$380.

CIRCLE 47 ON FREE INFORMATION CARD

Panasonic NN-6307 Microwave Oven

There's always got to be a better, or at least different, way. Take the most recent "mid-size" *Microwave Oven* (NN-6307) from *Panasonic Co.* (1 Panasonic Way, Secaucus, NJ 07094). This model handles the defrost function with an "auto-weight defrost." By entering the weight of a frozen item on the unit's control pad and touching the start key, the user can thaw out meat, fish, or poultry without estimating time or selecting a power setting. The NN-6307 also features a ceramic "cook-a-round turntable," designed to help ensure that foods will be cooked evenly without manual turning. Price: \$299.95.

CIRCLE 66 ON FREE INFORMATION CARD

Sharp VC-D800U Digital VCR

With the VCR firmly ensconced in the bosom of nearly half of all TV households in this country, manufacturers are looking to increase sales beyond first-time buyers. *Sharp Electronics Corp.* (Sharp Plaza, Mahwah NJ 07430) is offering high-end features at a surprisingly low suggested-retail price. The company's *VC-D800U Digital VCR* features nine-channel search display, picture-in-picture capability, and perfect freeze frame. Sharp also proclaims that "digital strobe" from broadcast or VCR sources will add an exciting new dimension to video entertainment, at least in households inclined to enjoy a digital strobe. In a less-flashy vein, the company's exclusive *blue-screen noise-elimination system* replaces the loud "snow" at the end of a videotape and/or static from non-active channels with a silent, soft blue screen which, at least, seems like a nice refinement. Price: \$699.95.

CIRCLE 61 ON FREE INFORMATION CARD

Fuji 3.5-in. Color-Shelled Floppy Discs

Here's a colorful development on the computer media front. *Fuji Photo Film U.S.A.* (555 Taxter Rd., Elmsford, NY 10523) is now offering 3.5-in. *Color-Shelled Floppy Discs* in five different hues, blue, green, pink, gray and ivory. Besides contributing to breaking up visual monotony, Fuji stresses the colored shells' utility in "enabling quick and easy identification in a wide range of situations from personal filing to business applications." The discs are double-sided, double-density and are shipped in ten packs containing two discs in each of the five offered colors. Colored shells are also available on Fuji's 5.25-in. discs. Price: \$42.

CIRCLE 82 ON FREE INFORMATION CARD

Mitsubishi HS-C30U Super VHS-C Camcorder

Another market entry into a new format is being made by *Mitsubishi Electric Sales America, Inc.* (5757 Plaza Dr., P.O. Box 16007, Cypress, CA 90630-007). The company has announced its first *Super VHS-C Camcorder* (HS-C30U). The model, according to Mitsubishi, can produce "over 400 lines of horizontal resolution for richly detailed images that actually surpass television broadcast quality." Under 3 lbs. in weight, the HS-C30U uses a CCD image sensor and features fully-automatic operations along with a variable four-speed electronic shutter. The Camcorder's viewfinder can be adjusted vertically. Price: \$1,600.

CIRCLE 86 ON FREE INFORMATION CARD

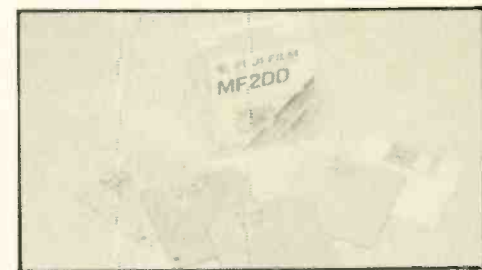
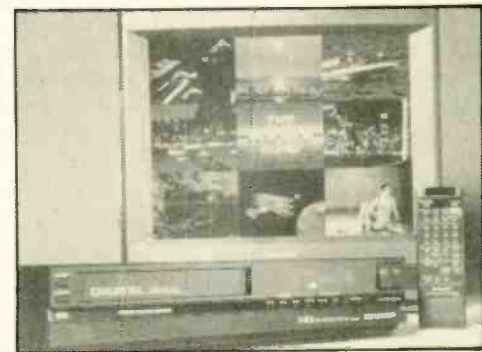
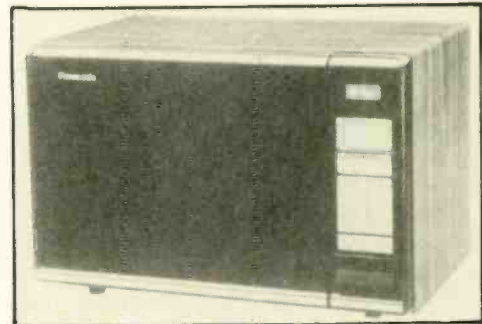
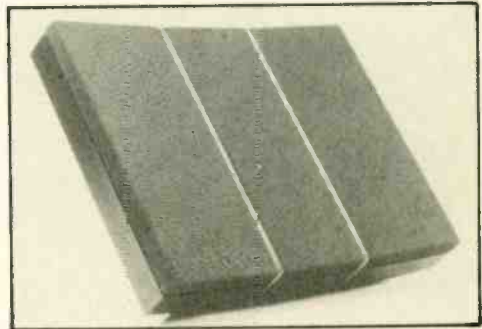

HAMSHACK

NOSTALGIA

Put some ol' time spark equipment in your modern hamshack
and show your friends just how far amateur radio has come.

By Larry Lisle

YEARS AGO HAMSHACKS USUALLY LOOKED LIKE A cross between a science-fiction movie and a junk pile. From the spark era into the sixties, radio gear was bulky and often homebrew. Wires ran everywhere and there was usually an overflowing junk-box under a bench. The smell of burned insulation and over-heated transformers hung in the air. The smell of *radio*.

Today most of us use modern, super-efficient, super-compact transceivers and there's nothing wrong with that. Still, wouldn't it be nice to have a few things around to remind us of radio's past while we live in radio's present and think of radio's future?

In this article I'd like to suggest some ideas for recapturing some of the feeling of early radio and putting it in the hamshack. Call them decorations, or display items if you like.

Some require a little building, some require some scrounging at hamfests; look them over, see what appeals to you or come up with your own idea.

Hey Sparky!

Take a look at Photo 1. That, kiddies, is a genuine no-foolin' spark transmitter. Well, actually it's a Ford Model-T spark coil hooked to a key and battery. But that's exactly what most beginners started with when the world was wireless in a world not yet used to wires. The antenna was attached to one side of the gap and the ground or counterpoise to the other.

Later, the ham would have used a bigger spark coil or a transformer (if they had AC in the house) added a glass plate

capacitor and "oscillation transformer" (coil), and a better spark gap, but that was where we began, fellow hams.

There's nothing at all to building something like that. Spark coils are still available from antique auto dealers, the base is a cutting board from a hardware store and the key can be any you happen to have on hand.

The alligator clip is out of place, of course, which brings us to the question of how authentic you want your project to look.

You can scour the hamfests and antique dealers and come up with enough old parts and wire to make what you build look like it just came out of someone's attic, or, you can do it like I do and just try to recapture the spirit of what you're recreating. It's up to you—whichever is the most fun!

Playing with TNT

Photos 2 and 3 show two transmitters that would have been show-stoppers back in 1930. Fig. 2 is for 80 and Fig. 3 is for 40 meters. Both use the then new TNT circuit, with a broadly tuned grid circuit on the same frequency as the "high-C" plate circuit. Copper tubing is used for the tank coil and connecting wires because of the high RF current.

The tube is a 211 "50-Watter" and those little rigs would have really punched a hole in the band when most people

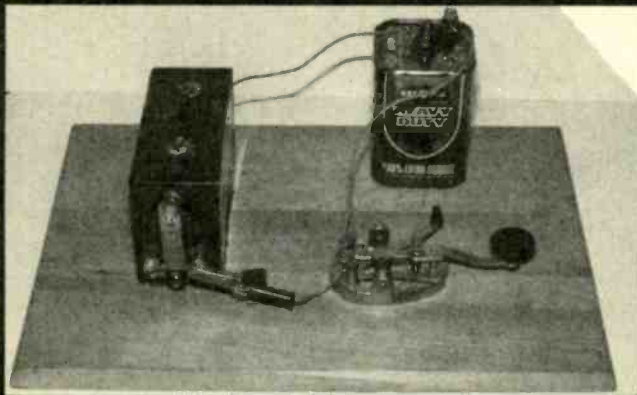

This is how many beginners got their start in the spark era, with a Ford spark coil and a key. Don't put it on the air or your first QSL may be from the FCC.

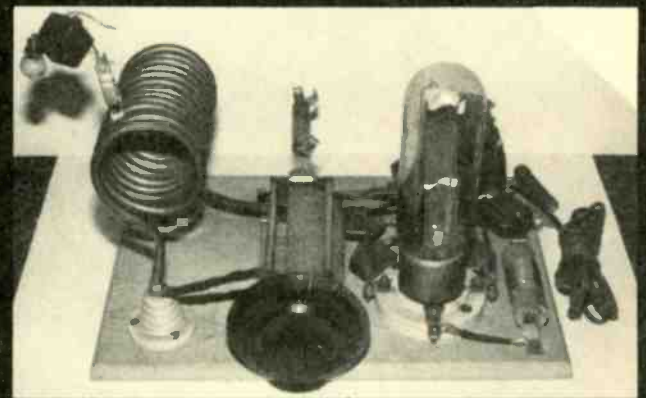

A 1930's style 50 Watter. This one is for 80 meters and uses a "TNT" circuit (gunpowder not included).

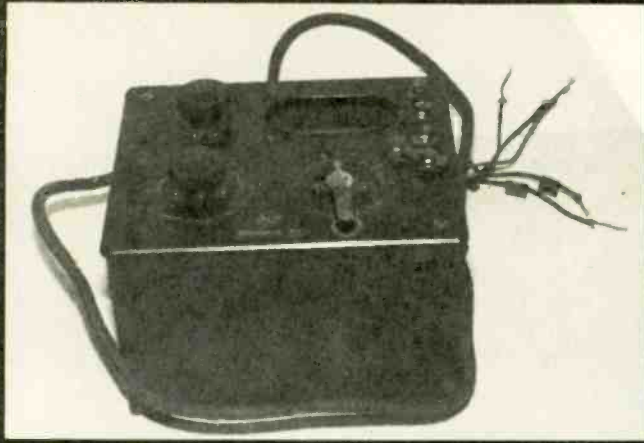

Though not a ham receiver this Radiola III was very popular and is a nice bit of nostalgia for the ham shack.



Here's a one tube shortwave receiver designed by the ARRL for the Boy Scouts. It's still good for code practice.

were using "0A's" or "210's" or maybe a pair of "45's" in push-pull.

The antenna (a Windom) was connected to the tank coil through the automobile light and capacitor. The clip was moved until maximum current was obtained.

Dor't put one of these babies on the air! First of all they're dangerous. They'll expose you to high voltage all over the place! Secondly they will chirp and drift badly if everything isn't just so. If you want to build a rig like this to use, try a crystal controlled 'OIA. You'll be surprised at how well they'll work, and you won't have to be worried about being an extra bleeder across a 1000-volt supply.

Tubes of Old

Speaking of old tubes, Photo 4 shows a display of old tubes and the year they were introduced. It's sure no problem to make a board like this and it will add a lot of flavor to any

shack. I'll leave it to the reader to figure out which tubes I used—they were all important in ham history.

The Receiving End

Photo 5 shows an old RCA Radiola III from about 1923. This was state-of-the-art in those days, and it's nice to have an old receiver around as a reminder.

Photo 6 shows a receiver I built about a year ago. This is a recreation of the one the ARRL designed for the Boy Scout Merit Badge series of books. I always wanted to make one of these when I was a kid but it looked too complicated.

With a good antenna and a quiet room you can use that
(Continued on page 98)

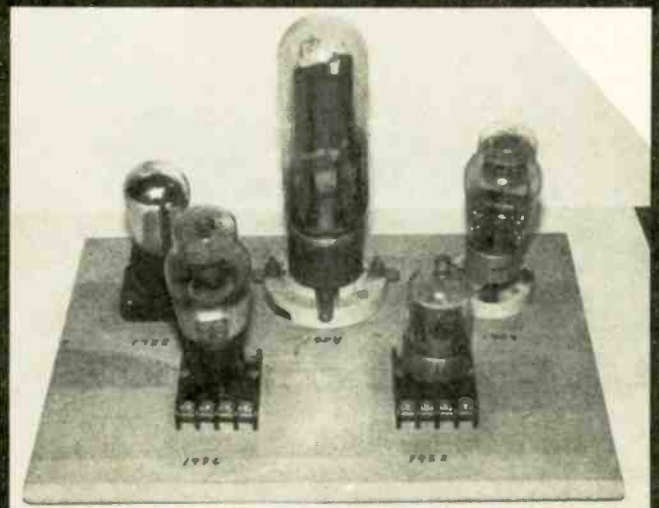
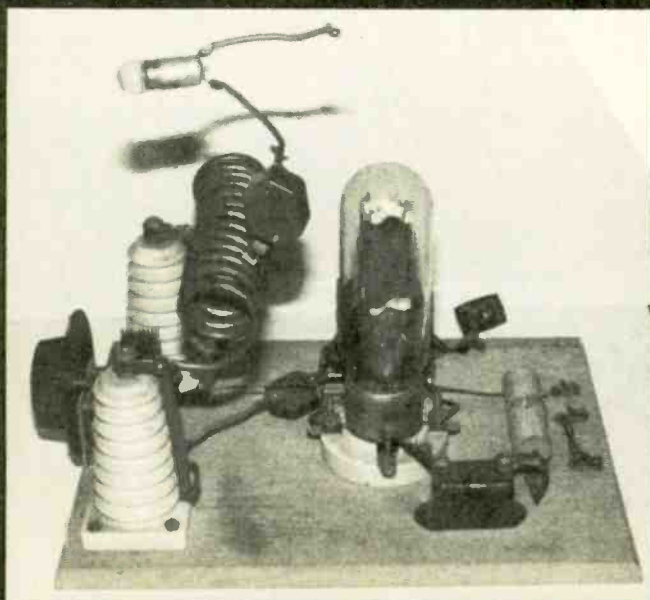

Here's a display of tubes that were important in ham history and the dates they were introduced. Can you name them?

Here's an ancient 40 meter rig. This one also uses a "TNT" hook-up, but the Hartley and TPTG were also popular.

BUILDING VOLTAIC CELLS

**We use cells in our hobby all the time,
but when was the last time you
experimented with one you built yourself?**

Less than two hundred years ago, there was no way of producing a continuous current of electricity. All electrical machines and generating techniques created transient static charges by means of friction. Towards the end of the eighteenth century, this situation began to change.

In 1791, Luigi Galvani, professor of anatomy at the University of Bologna, published his now classic study of "animal" electricity. Galvani found that when a bimetallic arc of iron and copper was held up against a disembodied frog leg the leg would twitch. Galvani believed that was due to the discharge of a *nerveo-electrical fluid* within the frog's organism.

A Different Perspective

Galvani's work came to the attention of Alessandro Volta, a professor of physics at the University of Pavia. Volta arrived at an interpretation very different from that of Galvani. The electrical influence, said Volta, came not from the frog, but from the contact of dissimilar metals separated by the moist flesh.

Volta's conclusion led directly to the first electric batteries. The famous Volta Pile was a stack of zinc disks and silver disks, each pair separated from every other pair by cardboard disks made wet with salt solution. The trouble with them was that the cardboard separators dried out too quickly. Volta solved the problem by suspending the metals in small cups containing various fluids such as salt water, acid, or alkali. Those primitive cells furnished the first continuous electrical currents. Subsequent developments have since transformed our civilization.

Getting In On It

You can build a simple electric cell very similar to the ones designed by Volta so long ago. It's fun, easy, and makes a great elementary science project. Some scrap zinc and some scrap copper (instead of silver, which is too expensive) are the two major requirements. Nearly any solid form in which you may find these metals will do; but fairly thick, heavy pieces are the best choice. Thin strips are hard to clean without bending or breaking.

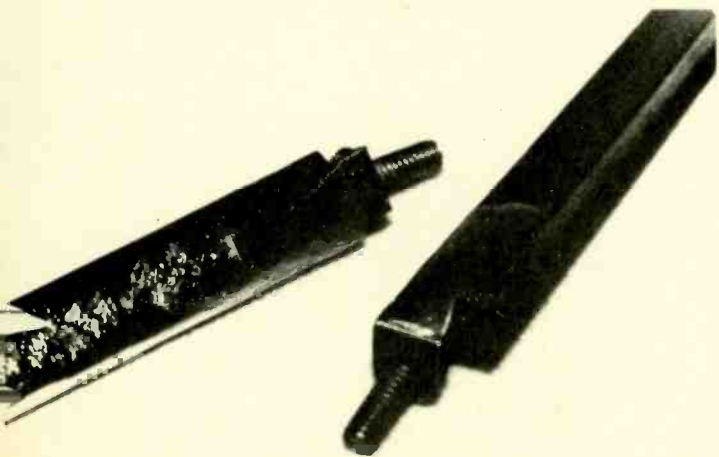

Here's one way to prepare your electrodes for mounting. Obtain a couple of large soldering lugs. Attach the lugs to the electrodes as shown. For best results, use a high-wattage soldering iron. The electrodes pictured are approximately 3 1/2-inches long and 3/8-inch thick.

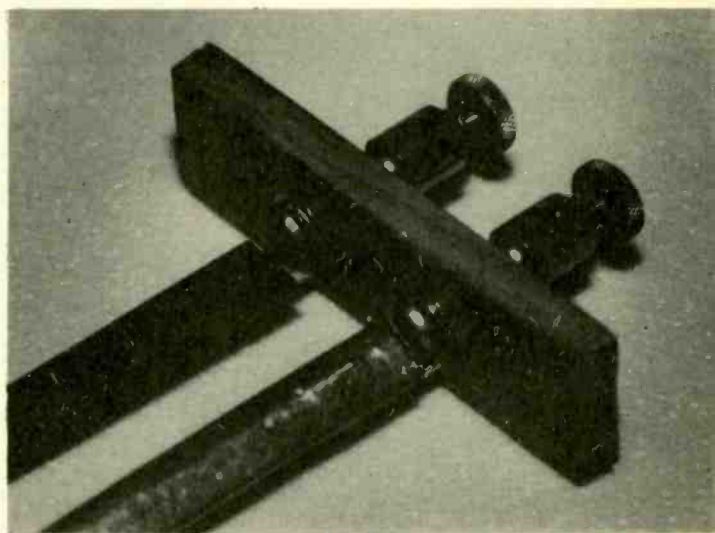

Electrodes can be suspended from the underside of a small wooden or plastic bridge. Binding posts hold the electrodes up from the top. Bridge is 3 inches long, 7/8-inch wide, and 1/4-inch thick. The electrodes are about 3/4-inch part. However, the dimensions are not critical to the cell.

Voltaic cell with table salt electrolyte registers 0.788 volt. Zinc electrode (negative polarity) is on the right. Copper electrode (positive polarity) is on the left.

By Stan Czarnik

PARTS LIST FOR THE VOLTAIC CELL

Binding posts
Copper bar
Small jar, cup, or beaker
Large soldering lugs
Voltmeter (see text)
Wood or plastic strip
Zinc bar
Ammonia
Table salt
Vinegar
Hook-up wire
Solder

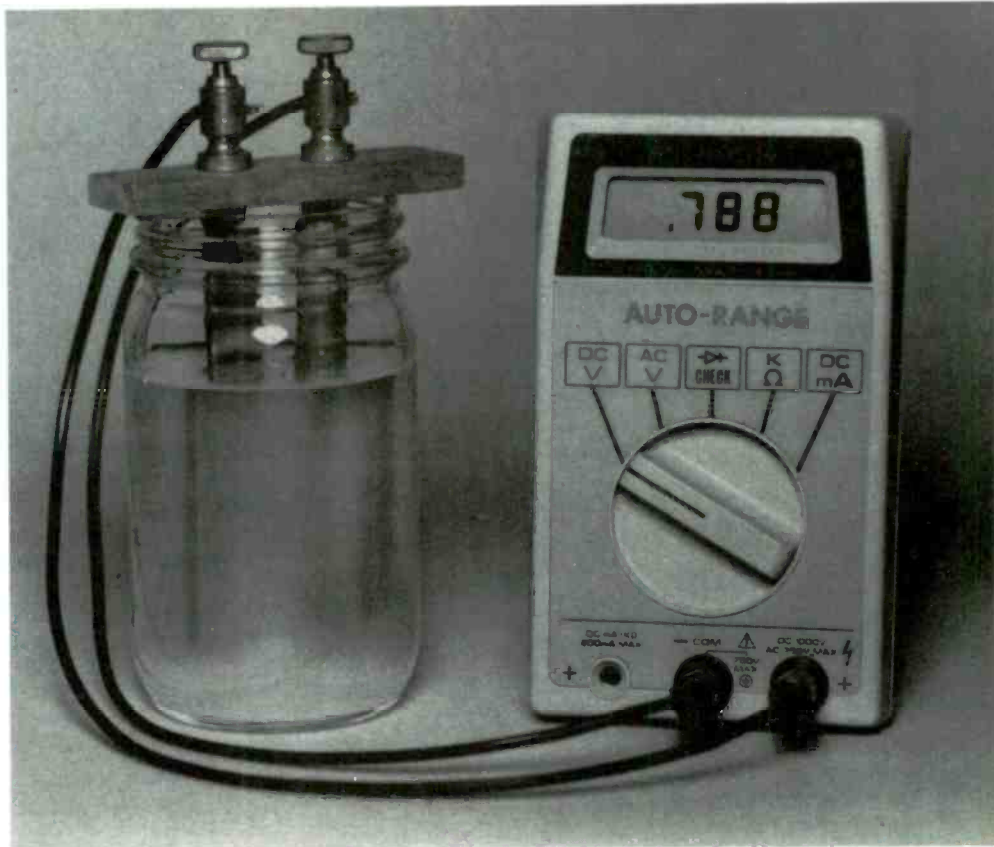

Once you have obtained the metal bars, it is very tempting to just dunk them in various liquids and see what shows up on the voltmeter. That will work, of course. Keeping the rods from touching each other, however, will drive you crazy. In the long run, making a small wooden or plastic bridge from which to hang the metal will prevent a lot of frustration. It also looks better, and, with the addition of a couple of binding posts, is much easier to wire up. Make sure the bridge is larger than the diameter of the container you will be using and that the metal bars are no longer than the container is deep.

Taking Data

A word on your measuring instrument. Nearly any kind of voltmeter with a low-voltage range will work. But the clarity and precision of digital readouts are welcome features.

Now run a wire from the zinc to the negative input of your meter and another wire from the copper to the positive input. You're ready to start experimenting.

The Solution

The fluid in cells of this type is called an electrolyte. Most acid, alkali, and inorganic salt solutions are electrolytes. You need look no further than a well-stocked kitchen cabinet for examples. A strong solution of ordinary table salt (4 teaspoons in 6 ounces of water) gave me close to 0.8 volts. Household ammonia, containing the alkali ammonium hydroxide, produced about 0.9 volt. And generic vinegar, containing acetic acid, developed just a bit over 1 volt. Your own voltaic system may give you slightly different results.

Set up your hardware, including the voltmeter, before adding the electrolyte. That way, you are free to watch the

voltage level rise as the liquid and the metals begin to react.

Do not allow any solder joints or external connections to touch the electrolyte. That may prevent an accurate reading on the voltmeter.

How's it Work?

The generation of an electron flow may be understood in terms of something called the electrochemical series, an idea first suggested by Volta. Zinc occupies a fairly high place in the electrochemical series. This means that zinc has a negative electrode potential relative to the element hydrogen. The standard electrode potential of hydrogen is set at zero. Copper, on the other hand, occupies a fairly low place in the electrochemical series. That means copper has a positive electrode potential relative to hydrogen. The further apart two substances are in the electrochemical series, the greater the electromotive force created between them.

When the zinc and copper bars are immersed in an electrolyte, the zinc begins to dissolve. Zinc atoms go into solution as ions and the liberated electrons move from the zinc, through the external circuit, over to the other electrode. And so electricity is produced.

The oxidation of the zinc in your cell will turn the metal dark and finally black. The copper will not be affected in the same way. In fact, the copper may be brighter and shinier when you take it out than before you put it in. That will only happen to the section of copper that was actually beneath the surface of the electrolyte. Both electrodes should be cleaned thoroughly before experimenting with different liquids.

For further information on Volta and Galvani, see Samuel Ruben's, *The Founders of Electrochemistry* (La Salle, Illinois: Open Court, 1975).

CHECKING OUT STATIC ELECTRICITY



Want to have fun with one of mother natures most interesting forces? Throw together this simple static lab and learn why those CMOS's fry!

By Stan Czarnik

Amber is a translucent, yellowish-brown fossil resin found mainly along the shores of the Baltic Sea. The Greek philosopher, Thales, knew that amber, when rubbed, had the peculiar ability to attract bits of chaff, feathers, and other light objects. That attractive power is among the first known indications of what we now call static electricity. In fact, our term "electricity" traces back historically to "elektron," the Greek word for amber.

Some 1500 years later, in the 16th century, the English physician William Gilbert noted that many substances, substances other than amber, could be made to exhibit "the amber effect." He experimented with sulphur, glass, sealing wax, and other materials. He called these things "electrics." With Gilbert came the first recognition that electrical activity was not restricted to some isolated segment of the physical world.

A small collection of ordinary household paraphernalia will provide nearly everything necessary to conduct a whole series of intriguing experiments with static electricity. Most of these demonstrations will work better, and usually much better, when the relative humidity is low. However, if you are stuck with fairly moist atmospheric conditions (like I am here in Chicago), it is possible to compensate somewhat by keeping all experimental materials, including your hands, very clean and very dry.

Typing-Paper Generator

It is perhaps a little difficult to believe that electricity can be generated with a piece of ordinary typing paper, but it's true. And, just imagine, it's enough electromotive force to light a small neon lamp!

First, bend the wire leads of an NE2 bulb so that each lead forms a 90-degree angle with the internal electrode to which it is attached. The prepared lamp should look like the example in Photo 1. Second, warm both sides of a sheet of

typing paper over a source of dry heat, like a space heater. An electric hair dryer will work too. Third, lay the paper on a clean, dry wooden (or plastic) surface. Stroke the paper firmly in one direction with your fist about fifteen or twenty times. Do not wrinkle or bend the paper. Finally, place the neon bulb on the sheet and peel the sheet briskly from the surface. As the bulb slides across the paper, the neon will ionize and begin to glow. The experiment works best in a darkened room.

The frictional charge is released when the paper is lifted. There is no simple technique for measuring static voltages. However, since we know it requires about 90 volts to ionize the neon, we know that at least 90 volts have been generated.

If conditions are right, this method will also ionize the mercury vapor inside a small fluorescent tube. I had good luck on a fairly dry day (relative humidity 37%) with an 8-watt Sylvania Cool White Standard.

Triboelectric Series

Further experimentation requires an understanding of something called the triboelectric series. The triboelectric series is a list of materials any one of which can be given a positive charge (fewer electrons than normal) by rubbing it with another material further down the list, or, a negative charge (more electrons than normal) by rubbing it with another material further up the list. To put it in another way, the substances towards the top of the list tend to take on a positive charge while the substances towards the bottom of the list tend to take on a negative charge. The first triboelectric series was formulated more than 200 years ago by Swedish electrician Johan Carl Wilcke. One possible triboelectric series is given in Table 1.

For example, suppose a piece of plastic is rubbed with a piece of wool. The plastic receives a negative charge while the wool receives a positive charge. Now suppose a piece

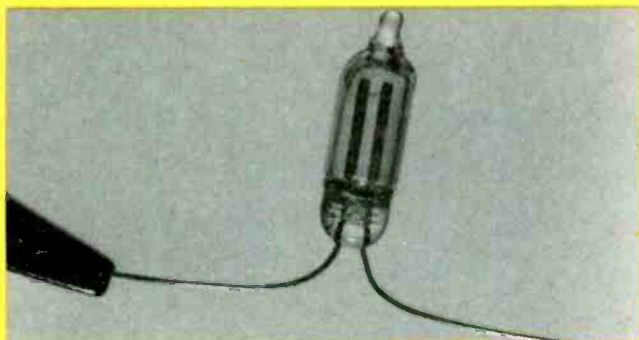

Here's a Neon lamp with its leads bent to pick up a static charge. It will really light up from simple static.

of glass is rubbed with a piece of plastic. The glass receives a positive charge while the plastic receives a negative charge.

Obtaining the Glass Rod

The glass rod turns out to be one of the more important pieces of equipment in your static electricity laboratory. But some of you may have some trouble finding one. Here are a couple of ideas. In many large department stores, the housewares department will often stock nice heavy glass rods for stirring drinks. In fact, the local tavern may still have some glass swizzle sticks lying around. If all else fails, you can always order some glass stirring rods from a laboratory supply house, and these are very inexpensive. I recommend Hagenow Laboratories, 1302 Washington, Manitowoc, Wisconsin 54220 (catalog \$1.00)

Attraction and Repulsion

The triboelectric series, along with knowledge of the fact that like charges repel while opposite charges attract, allows one to predict how various electrified materials behave.

Suspend a length of polyester thread from a metal support made from a stiff wire coat hanger. The thread should swing freely and be at least 6-in. long. Stroke the thread firmly several times with a piece of wool or flannel. Now quickly rub a glass rod with a piece of soft plastic wrap, the kind found over shirts and coats when you get them back from the cleaners. Bring the rod within 1 or 2 inches of the suspended thread. The thread will be attracted to the rod. Instead of the glass, a nylon rod will also work, but not quite as well.

So what's happening here? When you stroked the polyester thread with the flannel, you gave the thread a negative

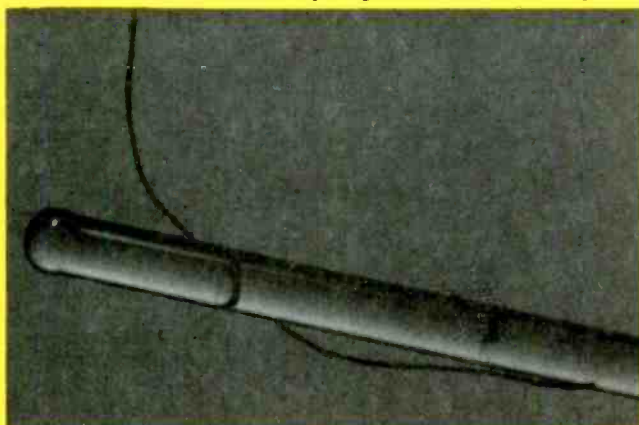

A positive charge on glass rod attracts the negative charge on a polyester thread causing it to bend. The surfaces can be charged by rubbing them on the appropriate materials.

TABLE 1—TRIBOELECTRIC SERIES

Material	Material (cont.)
Air	Wood
Human hands	Amber
Rabbit fur	Sealing Wax
Glass	Copper
Mica	Silver
Human hair	Rayon
Nylon	Polyester
Wool	Styrofoam
Silk	Polyurethane
Aluminum Paper	Polyethylene
Cotton	Vinyl
Steel	Silicon
Teflon	

charge. When you rubbed the glass with the plastic, you gave the glass a positive charge. Since opposite charges attract, the thread is drawn to the glass.

Now repeat the experiment using a plastic ballpoint pen in place of the glass rod and flannel in place of the soft plastic. Under these conditions, the negative charge on the polyester is repelled by the negative charge on the pen.

Remove the polyester thread and replace it with a piece of silk thread. I just happened to have some surgical silk suture lying around my workshop, but any kind of clean, uncoated silk thread will do. Stroke the silk thread with the soft plastic wrap. Then rub your glass rod with the plastic material. Move the rod into the neighborhood of the thread and the silk will fly away. This time, the positive charge on the silk is repelled by the positive charge on the glass. With a little practice, it is possible to *push* the thread around in a most mysterious way with invisible electrical charges.

The action of soft plastic on glass produces a powerful charge on the glass. Crush a dry styrofoam drinking cup and break it into fairly small pieces. Place the styrofoam bits on a piece of sheet metal. Charge up your glass rod. The electrified glass will pick up the styrofoam. the metal prevents any attractive charges between your working surface and the styrofoam from interfering with the experiment. If you can find some styrofoam packing material, it may perform even better than the broken cup.

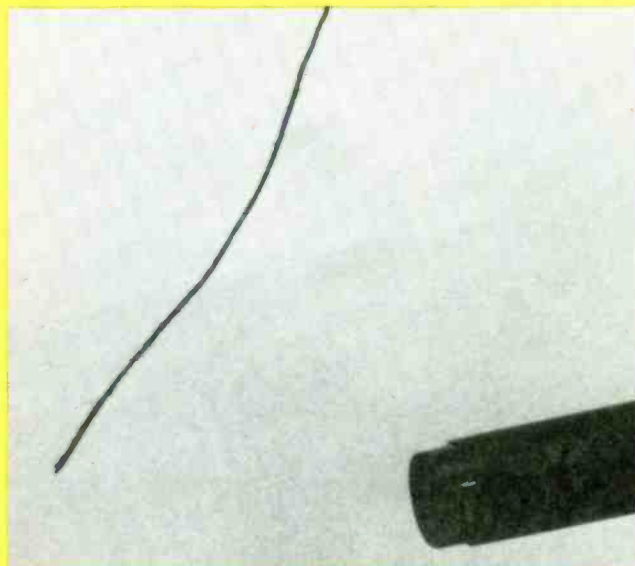

The negative charge on a plastic pen repels the negative charge on a polyester thread. That would happen if the two materials had been positively charged as well.



The positive charge on a glass rod repels the positive charge on silk thread. Positive charging results from depleting a material of its electrons.

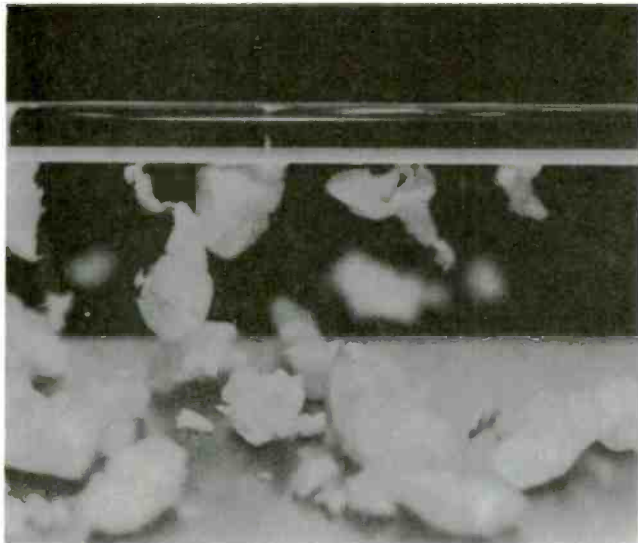

An electrified glass rod attracts bits of styrofoam packing material. The grayish surface in the foreground is sheet metal.



The versorium is an interesting curiosity because it will show attraction for either negative or positive charges.

PARTS LIST FOR THE STATIC ELECTRICITY LAB

- Aluminum foil strips
- Coat hanger
- Large cork or small cube of soft wood
- Scrap flannel or wool
- Small fluorescent tube (8 watt Sylvania cool White Standard of similar)
- Glass rod
- NE2 neon lamp (Radio Shack 272-1102, or equivalent)
- Nylon rod (optional, see text)
- Plastic ballpoint pen
- Plastic wrap (the thin, soft, flexible kind)
- Polyester thread
- Large sewing needle
- Sheet metal, 5 or 6 inches square
- Silk thread
- Styrofoam drinking cup or packing material
- Typing paper

The Versorium

One of the simplest, as well as one of the oldest, indicators of static electricity you can build is the versorium, from a Latin word meaning "to turn". The versorium, little more than a small pivoted metal vane, was used by Girolamo Fracastoro, a 16th century Italian physician, to show that amber could be made to attract silver as well as bits of chaff. William Gilbert used the versorium to investigate the electrical properties of all sorts of materials, and so can you.

Obtain a large cork, like a thermos bottle cork, or a small piece of soft wood, like balsa wood. Push a fairly thick sewing needle into the small end of the cork as shown in the photograph. The sharp end should be sticking up. Cut out a piece of aluminum foil approximately 2-1/2-in. long and 3/8-in. wide. Fold the aluminum once down the center the long way. If that gives you some trouble, try molding the aluminum over the edge of a triangular ruler. Now, very carefully, work the center of the strip into a point. This is a delicate operation that requires a steady hand. You may spoil one or two aluminum strips before you get it right, but don't give up.

When you're done, gently place the aluminum vane on the needle. The vane should turn freely. It should also balance. If it does not balance, snip a little foil off the long end with a sharp pair of scissors. Your versorium is complete.

The sensitivity of this device may surprise you. Bring a charged object near the one end of the aluminum vane. The metal rotates rapidly in the direction of the charged object. On a dry day, the aluminum may be attracted from a distance of perhaps 4 or 5 inches.

The versorium works by induction. Suppose the charged object carries a positive charge, like a glass rod rubbed with soft plastic wrap. The vane and the rod are attracted due to the migration of negative charges (electrons) in the aluminum towards the positive charge on the glass. That means that the positive charges in the aluminum are at the opposite end of the vane. Move the glass rod quickly to this end of the vane and the vane will be repelled.

For further projects and experiments with static electricity, see Charles K. Adams, *Nature's Electricity* (Tab Books Blue Ridge Summit, 1987). For an excellent historical account of early electrical experimentation, see J.L. Heilbron, *Electricity in the 17th and 18th Centuries* (University of California Berkely Press, 1079).

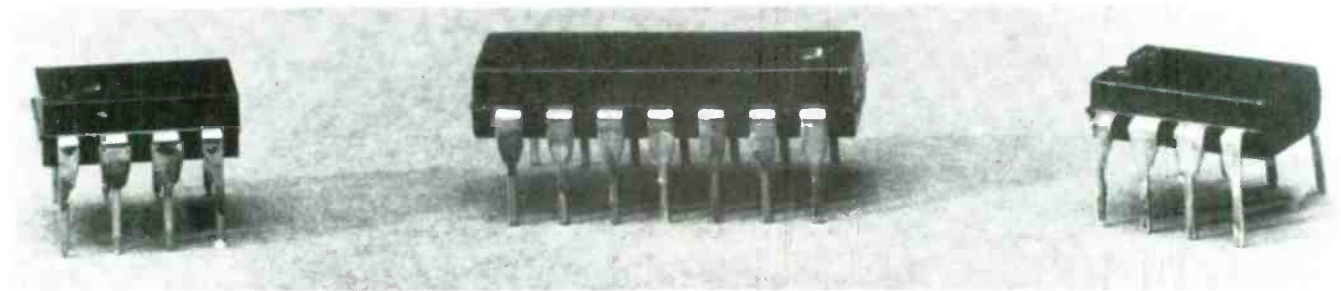

TROUBLESHOOTING IC's WITH A MULTIMETER

**Even complicated repairs can be performed
using nothing more than your pocket DMM.**

By Homer L. Davidson

THE HOT COURTROOM SCENE WAS VERY QUIET AND scary as I stood before the judge and jury on an overtime auto parking ticket. Sweat was running down my face. My legs were wobbly and shaking at best. Every eye in the room was staring at me. What had I done to deserve all this...when the judge's voice boomed out and echoed around the room.

"Since you are a so-called electronic expert, I can let you off with a light sentence. You are sentenced to one-year in jail...or one-hour in my office, to repair my boom-box tape deck. If the unit is not repaired in one hour, off to jail ye shall go, for this hideous crime."

That all seemed like a dream...or was it? Could I possibly service that deck in one short hour? Is it possible to check all those IC components with only my little old trusty pocket DMM? What have I to lose but one-year of my life! Dream or no dream, let's give it a try.

Accurate Voltage Measurements

Although the scope is ideal to check the signal in and out of an IC, accurate voltage and resistance measurements on the terminals can locate a leaky or open IC chip (see photos). The most important voltage test is on the terminal with the highest voltage source. Take critical voltage tests on each terminal and record them on the schematic. Always, have the correct schematic diagram handy. It can save many, many hours of service frustrations.

After double checking the voltage measurements against those found on the diagram, determine if the IC is leaky or open. A really-low voltage on the supply terminal may indicate a leaky IC or improper supply voltage from the power supply. Usually, only a few voltages are off base, so to speak, with a leaky IC (see photos). You may find the voltages are high and change only slightly with the open chip.

Remove the IC's voltage-supply pin from the circuit if the voltage measured is more than just slightly low. A soldering iron and some wicking material heated and pulled around the

supply terminal removes all excess solder. Flick the pin with a pen or pencil to see if it is loose. A couple of trips may be necessary to remove all solder from the pin and PC wiring.

Now, fire up the chassis and measure the voltage on the PC-wiring tie point. If the voltage has come up to normal or slightly above, suspect a leaky IC. Measure the resistance of the supply pin to chassis ground. A low resistance measurement (under 1K) may indicate a leaky IC (Fig. 1). Why not take a resistance measurement before removing the pin connection? Usually the normal power-supply resistance is always low and you are placing it in parallel with a possible leaky IC pin connection. Sometimes if voltage and resistance measurements are off by less than a volt, replacing the suspected IC may be the only answer.

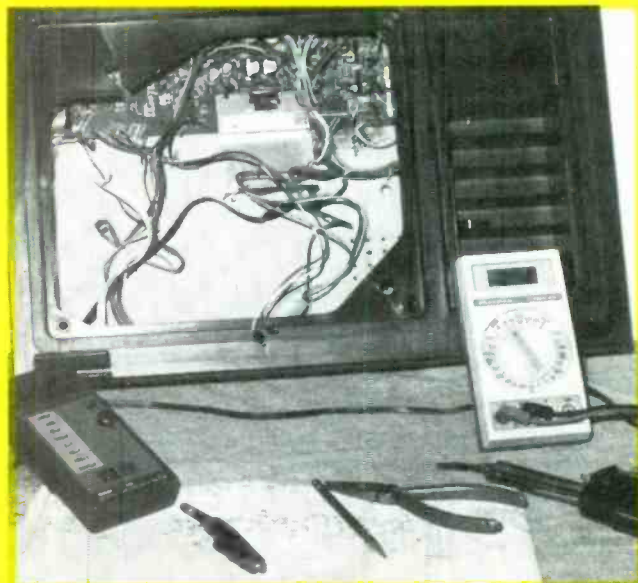

A good VOM or DMM with schematic diagram can easily locate a leaky or open IC component.

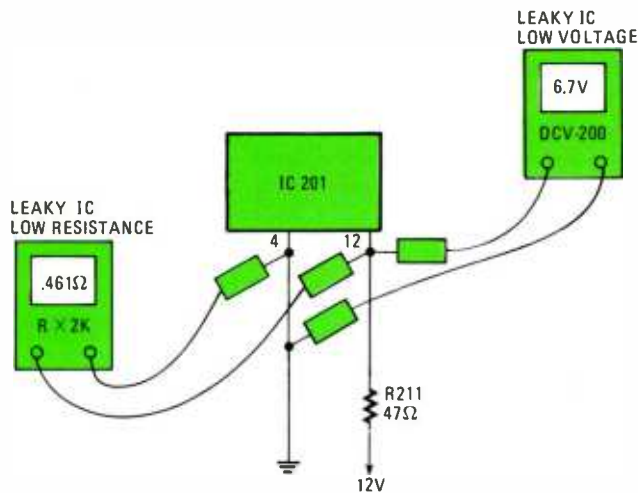

Fig. 1—Critical voltage measurements on the supply source pin of the IC chip may indicate a leaky component. Then take a resistance measurement to chassis ground.

Resistance Checks

You might locate a leaky IC or defective component tied to the pin connections with resistance measurements. Start with the meter's 2K range and check from each pin connection to chassis ground. Record all low resistance measurements on the schematic. Take a peak at the same pin connection to determine if a low resistor, diode, or coil is in the path of measurement. Sometimes, you may find an open resistor, leaky diode, or shorted capacitor tied between terminals and common ground.

You may find the VOM or DMM will change readings on certain pins with a higher ohmmeter range. Actually, the measurement may slowly go higher or lower—an affect caused by a charging electrolytic capacitor in the circuit. Keep the ohmmeter on the 1K or 2K range to locate a leaky terminal of the IC. Often a leaky capacitor or change of resistance may cause the IC not to function.

If a normal diode is found in the circuit, a low resistance may be found in one direction, and no reading with reverse test leads. Remove one end of the diode for accurate resistance measurements. Now check the resistance between the IC's terminal and chassis with one end of the diode removed from the circuit for leakage tests. Check the diode in the circuit with the diode test of the DMM. (See photos).

Checking the Front End

Today, even small kitchen radios contain IC's in the RF, oscillator, and IF stages. The RF and mixer stages of the FM section may contain transistors, while most present-day receivers use an IC in the AM stages. In addition, the same IC may also serve as AM/FM IF amplifier. Critical voltage and resistance measurements on the IC terminals can help to determine if the IC or perhaps some other component is defective (Fig. 2).

Note that the supply terminal of IC1 (HA-1197) is pin 3. The highest voltage applied to the +V terminal comes from the power supply. In this case, the supply voltage is switched into the circuit via the AM/FM switch, S1a. No voltage at the +V terminal may be the result of an internally shorted IC, open R151, poor switch contacts, or low-voltage power supply (see photos). A really-low voltage at the +V input may be caused by leakage within the IC, increased resistance of R151, or the power supply.

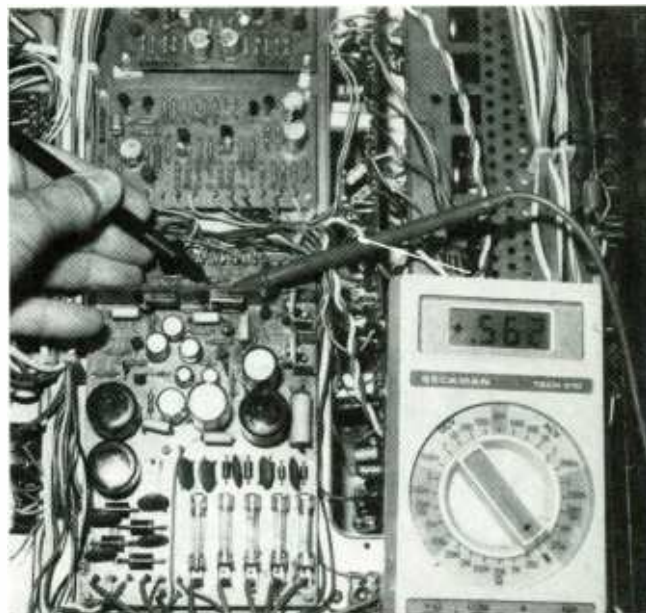

The DMM with diode-transistor test will locate a leaky diode. Remove one end of the diode for accurate tests.

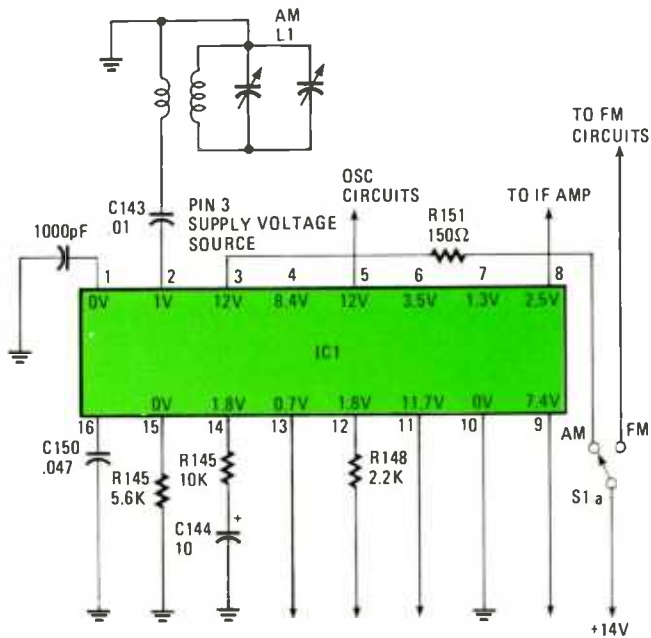

Fig. 2—Critical voltage measurements on IC1, within the AM section, may locate a defective AM-FM Converter chip.

Switch Tests

Simply switch the radio to FM, and if it operates or the voltage at the switch is normal, you may assume that IC1 is leaky. Turn the AM/FM switch to FM, and make a resistance measurement between the +V terminal and ground. If the resistance is below 1K, suspect a leaky IC. Measure the resistance of each terminal. The DMM is a very-accurate test instrument in really low-voltage measurements made on the IC terminals.

Preamp Measurements

Today, most tape decks that need repair are of the stereo variety. The deck's preamp circuits may contain transistors, separate IC's, or an IC component serving both channels. Usually, the tape head winding feeds through the isolation

resistor and coupling capacitor to the input terminal of the pre-amplifier (see Fig. 3). The output of the preamp is switched into the Dolby amp or audio-output amplifiers.

Although the preamp stages seldom break down due to low supply voltages, one IC serving as both high-gain circuits (left and right channels) can cause both channels to appear dead. Make sure the tape is moving with a no-sound symptom. Wave a screwdriver blade in front of the tape head with the sound wide open (maximum volume) with the cassette removed. You should hear a *thud* as the blade crosses the tape gap area. Next, touch the screw-driver blade to each input terminal. With no sound, go to the output terminals of the stereo preamp IC. A loud hum should be heard.

Measure the supply voltage at pin 4 (+11.5 V). Low voltage at pin 4 may indicate a leaky IC201. Check the voltage at all pins on the IC. Then take critical resistance measurements. A leaky C503 may lower the voltage at pin 4. Open C412 and C413 (3.3 μ F) may produce weak sound (see Fig. 3). Always, suspect a small coupling capacitor of drying up, causing a weak and distorted signal. Do not overlook an open tape-head winding with a dead channel. Take a low-resistance continuity measurement across the suspected tape head winding.

Phono-Amp Checks

The phono preamp may consist of a dual op-amp IC or the entire phono amplifier may be contained in one large IC component with the present day phonograph. Usually, the

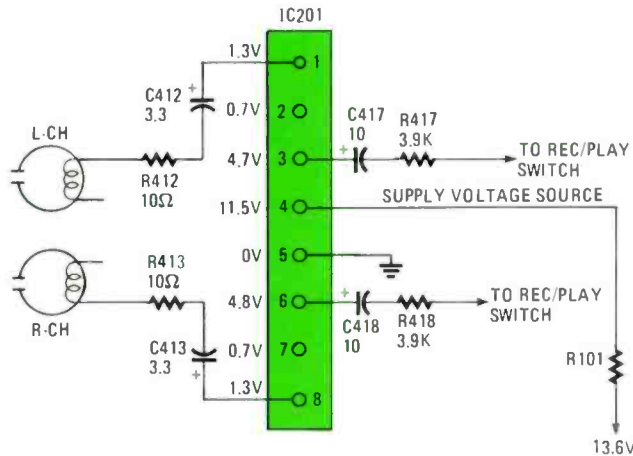

Fig. 3—Check for an open tape head besides a defective IC. Often a loud rush can be heard with an open or broken tape head wire connection with the volume turned up.

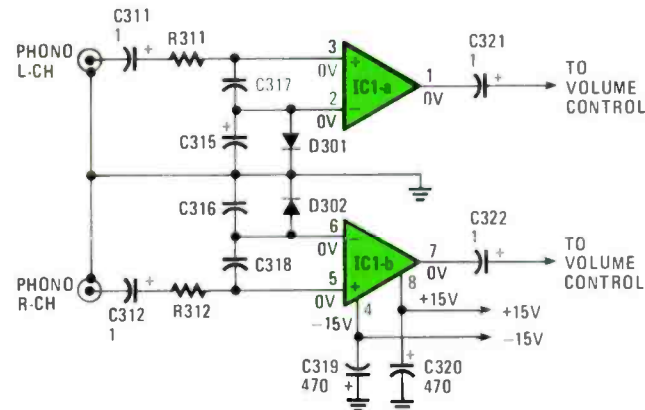
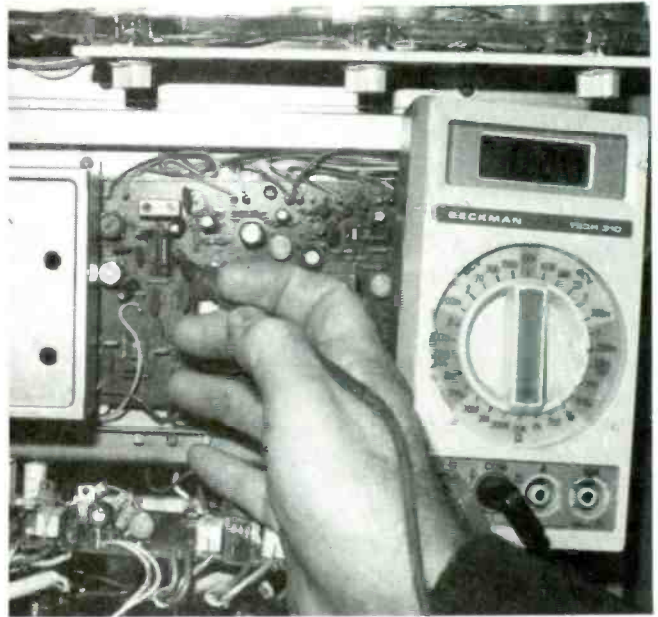
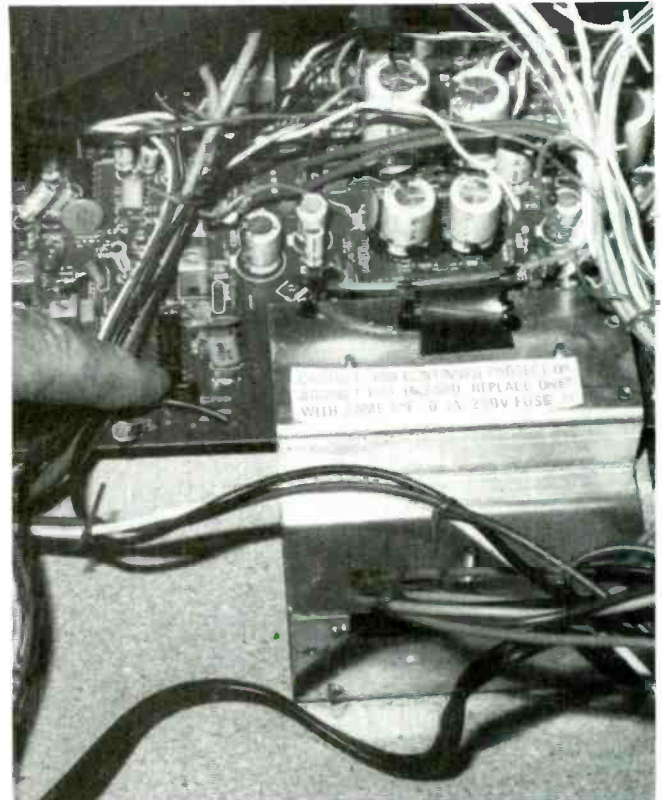

Fig. 4—A phono preamp may turn up as an op-amp IC. Notice both a positive and negative voltage is fed to the chip.



A low-resistance measurement on the front end IC indicated that the IC was leaky. Rotate the selector switch to another function to determine if the supply voltage is normal.



Check for leaky bypass capacitors and burned resistors around the suspected IC component. Sometimes the IC may be replaced with leaky components still in the circuit. Make sure the IC is defective with accurate tests.

op-amp IC component has a separate negative and positive voltage fed to the IC circuits (see Fig. 4). The separate input terminals have a positive and negative polarity. When one of these voltages is missing or improper, weak sound and distortion may result.

Measure both the negative and positive voltages at pins 4 and 8. These voltages should measure the same, except for opposite polarities. The other input terminal voltages are

zero. Often, the supply voltages are fed directly from the low-voltage power supply. Check the power supply circuits if one voltage is lower than the other. Remove both voltages and take another measurement. If the voltages are the same, suspect a leaky IC phono preamp. When one voltage is lower, check the Zener diode or IC regulator circuits in the power supply. A leaky IC or transistor regulator may increase the DC voltage source. Check for a lower voltage if the transistor or Zener diode is shorted or leaky. Sometimes the open IC or transistor regulator may increase the low voltage source.

Audio Output

The audio-output stages produce 85 percent of the trouble in small radios, tape decks or phonographs. Often, higher voltages are fed to the audio-output IC's for greater power fed to the speakers. Always, keep speakers connected to the output terminals or 10- to 20-ohm, 10-watt resistors. A load should be applied to the speaker output terminals at all times, to prevent damages to the output IC or transistors. Some technicians turn the volume to zero while servicing the audio-output circuits. You must then remember to leave the volume control alone.

Check the audio-output circuits for a dead channel, weak and distorted sound. With speakers attached, raise the volume to about 1/4 maximum and touch the center terminal of the volume control. Make sure the balance control is in the center of rotation. You should hear a loud hum in the speakers. If the volume is turned up half-way or full on, you may damage the speakers. Check both channels with the finger test. Notice if both channels are dead or if only one is defective.

Measure the voltage source at the power supply if both channels are dead. Do not overlook open speaker or B+ fuses protecting the speakers or output voltage circuits. You may find both speaker channels are fused in larger power-output amplifiers. Sometimes low-voltage power supply, and output IC voltage and resistance measurements, can be made without removing the chassis from the cabinet (see photos).

Right In Line

Next, locate the defective output channel. Often, the output channels are laid out in line when facing the front of the unit. If the right channel is weak and distorted, look for the right audio IC to the right rear of the chassis. Check the parts layout chart in the service manual. Of course, many of the latest audio output channels are contained in a single large IC, as shown in Fig. 5.

After locating the correct power IC, measure the voltage on the supply terminal. Compare your measurement with the good stereo IC or schematic diagram. Often, only one supply voltage is fed to one terminal of a power IC when used for both channels. Measure each terminal voltage and compare it with the good channel. Check each bias (low ohm resistor) tied to the IC terminals. An open or burned resistor may produce weak and distorted sound.

Built-in Signal Tracer

You may use the audio output as a signal tracer if one channel is normal. Simply remove the center terminal from the volume control of the good channel. For safety reasons, connect a 5- μ F/50-WVDC electrolytic capacitor to the removed lead. Attach an alligator-clip lead to the capacitor and with the other clip trace the bad channel (Fig. 6). That same signal tracing method may be used in transistorized circuits.

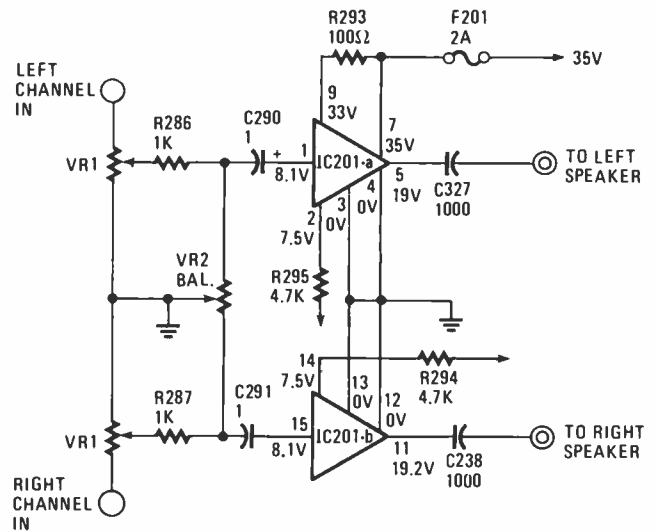

Fig. 5—One large output IC may contain both audio-stereo channels in many tape decks. In the pocket tape player one large IC may house the entire audio channel.

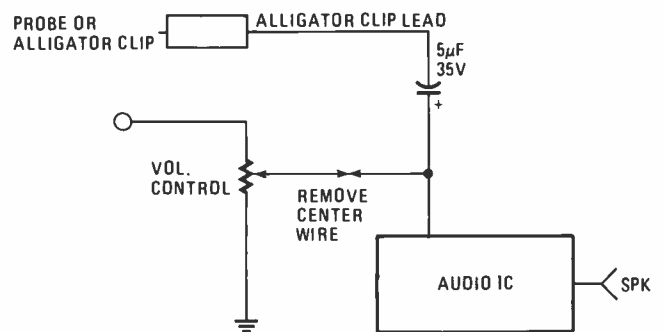

Fig. 6—You can use the normal stereo channel to signal trace the defective channel by adding a capacitor and clip lead.

Replacing IC's

Remove the defective IC with the soldering iron and solder-wick. The soldering gun is ideal to work with excess solder mesh material. Use a 30-watt or less soldering iron when replacing the IC to prevent heat damage. Remove all solder around each terminal. Be careful not to damage the PC wiring.

The surface-mounted component found in the TV chassis, CD players, and Camcorders must be removed and replaced with extreme care. Straighten and line up each pin for the correct hole or PC trace.

Make sure terminal one is at the number one spot. Apply silicone grease to power output IC components bolted to the heat sink (see photos). Always, replace the heat sink before firing up the unit. Double check the wiring for shorted terminal connections and poor soldered joints by taking resistance measurements between each terminal and chassis ground. Compare those readings to the good stereo channel.

Twenty Minutes To Go

Now back to the judge's Sanyo cassette player... The radio-cassette deck was dead in both channels. Even the finger test at the volume control was nil. A quick voltage measurement on pin 11 was only 5.7 volts. The voltage shot up to 16.5 volts after cutting the foil at pin 11. The resistance measurement between pin 11 and chassis was 561 ohms. ■

Here's a trap that snares broadcast-band images, makes them give up the troublesome ghost and lets the real, live signals come through!

By Michael Covington

Is your shortwave receiver haunted by the ghosts of nearby AM broadcast stations? Do you tune in faint signals that seem to be coming from halfway around the world, only to hear commercials from the local Oldsmobile dealer? If so, you need a *BCB Trap*.

First off, let's say that BCB stands for *BroadCast-Band*. Now you know where we are! This article tells how to build a simple device that connects between your antenna and shortwave receiver, and blocks strong local BCB signals, while leaving other frequencies unaffected. It has only five components and makes an excellent project for beginners. This trap is almost as simple as a mouse trap and many times more effective.

Recognizing the Problem

The signal from a local broadcast-band radio station (520-1600 kHz) may be as much as one-billion times stronger than the weakest signals your receiver can pick up. This places a heavy load on even the best-designed (an acronym for expensive) receivers. Some symptoms of receiver overloading are discussed below.

Images. If your receiver has a 455-kHz IF, an image of a strong local station usually appears 910 kHz above the station's frequency. If your local station is at 1000 kHz, you may also hear it when you tune to 1910 kHz. Some receivers produce a lot of images even when they're not overloading; if you get images even from weaker signals, check the front-end alignment or buy a better receiver. The BCB Trap cannot help you much when you start out with junk.

Mixing products. Suppose you have two local stations, one on 1000 kHz and one on 600 kHz. You may hear mixing products at the sum and difference of these frequencies (1600

BUILD A BCB TRAP

and 400 kHz respectively). The mixing product is usually modulated with the sound from both stations. Unlike a real station, a mixing product disappears if you turn down the sensitivity (RF gain) even slightly. Mixing happens even if only one of the local stations is overloading your receiver—its signal will mix with other signals that are coming in at normal levels. Some longwave receivers are almost useless in North America, because they get so many low-frequency mixing products from nearby AM stations.

Harmonic. Harmonic signals are multiples of the station's frequency. You may hear your 1000-kHz local station on 2000, 3000, or 4000 kHz. Unlike the other problems, harmonics don't always originate within the receiver. They can come from the diode-like action of a poor connection in the antenna or ground circuit. And some harmonics actually come from the transmitter site. You can recognize a transmitter harmonic signal, because it doesn't match the signal you hear on the fundamental frequency. Suppose you tune your shortwave receiver to 2000 kHz and hear a harmonic of a distant 1000-kHz station, but when you tune to 1000



OSCILLATOR COIL

TUNING CAPACITOR

In a pocket-portable transistor radio (the ultra-inexpensive type), the oscillator coil (bottom center) is the one nearest the tuning capacitor; its tuning slug is usually painted red.

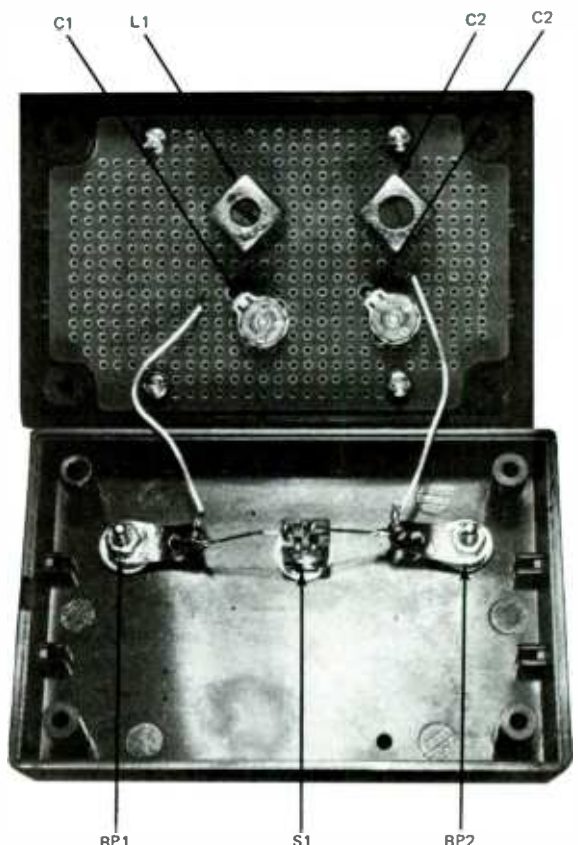

The author's BCB Trap is housed in a small plastic box. Keep the wire lengths short and neatly placed to reduce the effect of stray capacitances that will defeat the purpose of the unit by acting as an antenna for the undesirable BCB signals.

kHz, you hear a different, nearby station. In such a case, the distant transmitter is emitting a harmonic, but the nearby station isn't. The local station drowns out the distant station on 1000 kHz, but it has no harmonics to wipe out the distant station's harmonic.

How It Works

The BCB Trap consists of one or more parallel-tuned circuits connected in series with the antenna near the receiver's antenna terminal. Each tuned circuit blocks a particular frequency. Refer to the schematic diagram of the BCB Trap shown in Fig. 1.

The coil in each tuned circuit (L1, L2) is an oscillator coil salvaged from an old transistor radio. The oscillator coil is the one nearest the tuning capacitor and is almost always color-coded red. Refer to the photo of the transistor radio. The capacitors (C1, C2) used in the BCB Trap are 150-pF trimmers from Radio Shack.

Why didn't I use the antenna coil and tuning capacitor from the transistor radio? To begin with, they aren't very sharply tuned, whereas the oscillator coil has a much higher Q. Moreover, antenna coils aren't shielded, which means that if you put two of them in the same enclosure, they'll influence each other, because of coupling by mutual conductance. Finally, the tuning capacitor is designed to turn easily; the vibration of moving the receiver or BCB Trap would knock it out of alignment.

The diagram shows a BCB trap with two tuned circuits (L1/C1 and L2/C2), but you can use any number of parallel-tuned circuits. Include one parallel-tuned circuit for each local station that you want to tune out. If you find that you've built more tuned circuits than you need, tune several of them to the same station.

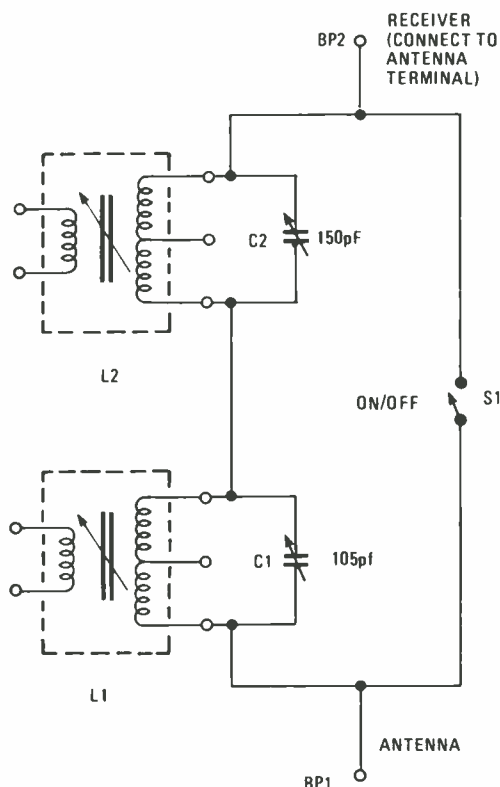

Fig. 1—The author's version of the BCB trap has two tuned parallel-tuned circuits, but you can include as many as you like, with each parallel-tuned circuit connected in series.



The assembled BCB Trap is connected between the antenna system and the receiver, with the receiver's connecting wire kept short. Here it is mounted on the back of the author's receiver.

Arrange the parts neatly in a small enclosure, and keep the wires short, but leave them long enough that the trap can be operated with its case open during initial tuning. I used a small plastic enclosure with a custom-fitted circuit board (see photo). Neither the oscillator coils nor the trimmer capacitors fit the standard 0.1-inch hole positions of a perf-board or pre-drilled foiled breadboard; I managed to make the coils fit diagonally, but had to enlarge some holes for the trimmer capacitors.

Each trimmer capacitor has three terminals, but a close look shows that two of them are connected together. (If you can't tell which two, check continuity with an ohmmeter.) A standard oscillator coil has three terminals on one side and two terminals on the other; use the three-terminal side and ignore the middle terminal, exactly as shown in the schematic diagram (Fig. 1).

The toggle switch, S1, allows you to take the BCB Trap out of the antenna system circuit when you are into BCB DX'ing. Note that the BCB Trap is *on* when the switch is open—that is, when there is no path from antenna system to receiver except through the project. Closing the switch bypasses the trap, in effect turning it off. These actions are the opposite of the *on* and *off* positions of a switch usually found in normal use.

If your local BCB station is not on the air for 24-hours, you may want to place a shorting on-off switch across the parallel-tuned circuit aligned to that station's carrier frequency.

Installation and Tuning

The BCB Trap is connected between the antenna system and the receiver. It should be placed as physically close as possible to the receiver's antenna terminal (Fig. 4). To adjust the BCB Trap, first set each coil to the middle of its range. Tune the receiver to one of the signals you want to block out, and if possible, turn down the sensitivity (RF gain) so that the receiver is not overloaded. Make sure the traps switch, S1, is open, allowing the BCB Trap's circuit to function. Then choose one of the trimmer capacitors and turn it slowly with a plastic alignment tool. At some point, the incoming signal will suddenly become much weaker.

Set the trimmer capacitor to this point as carefully as pos-

(Continued on page 96)



TAME THE DOS TIGER

Having little knowledge of DOS puts
a lot of power at your fingertips

By Jeff Holtzman

YOU'VE BECOME PROFICIENT WITH BASIC DOS COMMANDS; now let's make a real power user out of you. We'll show you how to set up your CONFIG.SYS and AUTOEXEC.BAT files, define a custom-system prompt, set up an efficient path, and more.

Configuring the System

You've probably seen a file called CONFIG.SYS in your root directory. It's simply an ASCII text file that contains information that DOS uses to configure (hence the file name) your system when booting. You can specify the maximum number of files that may be open at one time, the amount of memory used to buffer disk data, and several other parameters in CONFIG.SYS. Consult your DOS manual for more information on the other parameters.

Further, in CONFIG.SYS you specify the names of program files used to control special hardware (a mouse, for example), a RAM disk, the ANSI (American National Standards Institute) screen driver ANSI.SYS (included with DOS), and many others.

Figure 1 shows a real-world CONFIG.SYS file. Let's go through it a line at a time. The first line specifies the number of 528-byte buffers that DOS will set aside for disk access. The more buffers that you have, the more likely it is that DOS will find data it needs in memory, without having to read from the disk. However, the more buffers you use, the more memory you give up, and time spent determining whether a sector is in memory increases.

Ten is an average number; you might go as high as thirty for some applications that do much disk thrashing—desktop publishing or database management. A simple application (word processing, for example) usually won't need more than ten buffers.

Line two specifies the maximum number of files that may be open at once. Again, ten is an average number; desktop publishing, database managers, and other applications that open many files simultaneously may require a value of 20 or even 30.

Now we get to the device drivers. Note that each line

begins with "device = ". Next follows a drive, a path, and a file name. Some drivers have additional unique parameters. Notice that, for the sake of organization, all drivers are located in the same subdirectory (\SYS).

The first two drivers control hardware devices, an expanded memory (EMS) board that, in this case, provides 1.3 megabytes of memory, followed by a Microsoft mouse driver.

Next are the software drivers. First is the ANSI.SYS screen driver. Few programs require that ANSI.SYS be loaded, and most ignore it. However, you can use the DOS PROMPT command (which does require ANSI.SYS) to provide a fancy command-line prompt (more on that below).

```
buffers = 30
files = 20
device = C:\sys\appmm.sys w3 p5
device = C:\sys\mouse.sys
device = C:\sys\ansi.sys
device = C:\sys\amdisk.dvd
```

Fig. 1—Shown here is a real-world CONFIG.SYS file. The first line specifies the number of 528-byte buffers that DOS will set aside for disk access. The more buffers, the more likely that DOS will find data it needs, without reading from the disk.

The last driver in the example controls a RAM disk; it is used in conjunction with a program that you run from the command line; that program allows you to vary the size of the RAM disk. The RAM disk driver, two adjustment programs, and documentation are all included on the DOS Tool Kit disk in the file ADJRAM.ARC.

When you boot your PC and AMDISK.DVD is loaded, a 64K RAM disk is set up for you as the next available disk drive—D: on a standard XT. Thereafter, use ADJRAM.EXE to vary the size of the RAM disk. For example, to increase its size to 128K, you'd type:

```
CADJRAM D: 128
```

An additional program, ADJRAMEM.COM, uses memory



LOGARITHMS AND DECIBELS

E-Z
MATH

By Louis E. Frenzel

You've heard the one about snakes not being able to multiply because they're adders, but did you know that adders can multiply by "Logs?" Here's how, with help on decibels too.

DOES IT SEEM AS THOUGH EVERY TIME YOU TURN around, you run across some math problem associated with your electronic work? Math is such an important part of electronics that it will crop up whether you are designing a new circuit, servicing a piece of equipment, experimenting with a breadboarding project, or just trying to understand how an electronic component or circuit works. As it turns out, the more math you know, the better off you are. Thankfully, most of the math is pretty simple. It may not seem that way if you've never understood it, but in general, most electronic math is pretty straightforward stuff. It doesn't get a whole lot beyond basic addition, subtraction, multiplication and division or simple algebra. As you saw last month, trigonometry does enter the picture, but even *that* isn't difficult.

This month we tackle another topic that seems to throw a lot of people—namely logarithms and their primary application in electronics—decibels. Again there is nothing mysterious about all of it, although the terminology does sound a little scary. But isn't that the truth about the unknown? Once you get finished with this article, the topic will no longer be a mystery and you will be quite adept at handling logarithms and decibels. Then, next time you tackle an electronic project, you will gain that tremendous satisfaction that comes from really understanding what you are doing.

Logarithms Primer

Logarithm has an evil sounding ring to it. It seems like a subject difficult to comprehend. In reality, it's all very simple. But to get ourselves in the right frame of mind, let's first stop using the evil word "logarithms," and in its place substitute the more commonly used and less scary term "logs."

In simple terms, a log is just a number that is used to represent another number. That sounds like a crazy thing to do, and we won't try to explain it just yet. But in effect, all that logs really are, are substitutes for other numbers, namely very large and very small numbers. Electronics as well as engineering and science in general is full of techniques for dealing with very large and very small quantities. You saw that when we discussed the scientific-notation method several issues back. Using logs is another way to get a handle on large and small quantities and to make them a great deal easier to deal with.

But to be more specific, a logarithm or log is the exponent of a number called the base. The log is simply the power to which the base number must be raised to get the quantity in question.

This is expressed in simple math terms as:

$$N = B^L$$

N is the number whose log you want to find, B is the base while L is the log of N.

You can use any number for the base, but in general the most commonly used base is the number 10. Logs with a base of 10 are generally referred to as "common logs." The log then is simply the power to which 10 must be raised to obtain the number of interest. A simple example will illustrate that even better. For example, the log of the number 100 is two simply because $10^2 = 100$. You can easily determine all the logs of the numbers that are some power of 10, such as 0, 1, 10, 100, 1000, and so on. They are listed for you in Table 1.

TABLE 1
LOGARITHMS OF POWERS OF 10

Number (N)	Power	Log
1	10^0	0
10	10^1	1
100	10^2	2
1000	10^3	3
10000	10^4	4
100000	10^5	5
1000000	10^6	6

That's all pretty easy to understand, of course. But what about numbers in between the powers of 10, such as the number 78? To what power must 10 be raised to get 78? The answer is, 10 must be raised to the 1.892 power. In other words, the log of 78 is 1.892.

$$78 = 10^{1.892}$$

Remember when learning basic algebra the definition of an exponent was the number of times that the base is to be multiplied by itself to obtain the answer. This definition is pretty easy to understand when the exponent is a whole number or integer. Ten to the fourth power (10^4) means

that you multiply 10 by itself four times or $10 \times 10 \times 10 \times 10 = 10,000$. But how in the world do you multiply 10 by itself 1.892 times? Well, that's really not too easy to explain and I'm not even going to attempt it here, primarily because it doesn't make a whole heck of a lot of difference. Let's just say that it can be done and leave it at that. Let your scientific calculator worry about such details.

That naturally leads to the question "How in the world do you find the log of a number?" In the olden days of electronics, logs were found by using special printed tables. Someone spent a lot of time computing the logs of just about every number. These tables of logs are listed in math reference books and even appear in the appendix of some of the older electronic texts. Many math textbooks, particularly those for algebra and trig, also typically have log tables in the back. To find the log of a number, you look it up in the tables.

All scientific calculators are capable of computing the log of a number. The way to find the log is simply to key in the desired number and then press the LOG button. On the display you will see the log or the exponent to which 10 must be raised to get the desired number. Just to be sure you understand how to do this, get out your calculator and key in each of the numbers below to see that you actually do get the same figures we show.

$$\begin{aligned}\text{Log } 1.6 &= .2041 \\ \text{Log } 82 &= 1.914 \\ \text{Log } 57943 &= 4.763\end{aligned}$$

There are many times that you wish to find the number associated with a given log. In other words, you know the exponent and you want to find out what number it represents. That is called the antilog. Using the example we used earlier, if we had the exponent as 1.892, what number is represented by that? That is written as:

$$\text{antiLog } 1.892 = 78$$

To find the antilog, you use the key on your calculator labelled 10^X . Remember, 10 is the base of the common logs and X is the exponent or log. All you do is key in the log value and press the 10^X key. Usually this is not a separate key but instead is the same key you used for logs. To compute the antilog you first key in the log or exponent, then press the inverse (INV) key, and finally press the LOG key and the correct number will be computed. Again, to be sure you understand how this is done, find the numbers represented by the following logs to see that you get the correct answers.

$$\begin{aligned}\text{antiLog } 2.805 &= 638.26 \\ \text{antiLog } 1.734 &= 54.2 \\ \text{antiLog } 0.0069 &= 1.016\end{aligned}$$

On some calculators, a separate 10^X key may not be available. Instead, you may have a key marked X^Y . You can still use that key to compute the antilog. In that case, X is simply the base and Y is the exponent or log. To use this key, you typically punch in the base 10, then press the X^Y key and enter the log value. To complete the calculation you simply press the equals button to get the answer. The results will be the antilog as with the other method. Try that technique yourself on the examples given below to be sure that you can do it correctly.

$$\begin{aligned}\text{antiLog } 4.9 &= 79432.8 \\ \text{antiLog } 1.5 &= 31.623\end{aligned}$$

As we indicated earlier, almost any number can be used as

the base. However, the base 10 has been generally agreed upon and, therefore, is the most widely used. Another base that you will often see used in electronics is the base e. Base e is equal to 2.7182818. It is an odd base to use but it has its particular usefulness in various scientific and engineering applications. We will actually show you how to use it in a later issue. For now, all you have to know is that e is the base of natural or Napierian logs. It is usually written as "ln" instead of "log". Most scientific calculators also have an ln button so that natural logs can be computed. It also usually has the e^X function so that the antilog of natural logs can be computed. For now, just disregard the natural log and let's concentrate on using common logs.

While all of our examples have been with numbers greater than 1, you can also find the log of numbers less than 1. For example, what is the log of .25? The answer is -0.602 . The way you can tell whether or not a log is less than one is to note that it is negative. Compute some of the other less than one logs listed below to see that you get the right answers.

$$\begin{aligned}\text{Log } .5 &= -0.301 \\ \text{Log } .03 &= -1.523 \\ \text{Log } .0001 &= -4\end{aligned}$$

If you remember the rules about working with exponents that you learned in high school algebra, you can easily see why numbers less than one result in a negative log. Let's take a simple example to illustrate the point. Assume that we are working with the quantity 10^{-2} . The rules of exponents say that we can rewrite this expression so that it is equal to:

$$10^2 = 1/10^2$$

In other words, 10^{-2} is equal to the reciprocal of 10^2 . In working out the mathematics you find that the actual value to be 0.01. Therefore, the log of 0.01 is -2 . Table 2 shows the logs of the powers of 10 less than one.

**TABLE 2
LOGARITHMS OF POWERS OF 10
LESS THAN ONE**

Number (N)	Power	Log
.1	10^{-1}	-1
.01	10^{-2}	-2
.001	10^{-3}	-3
.0001	10^{-4}	-4
.00001	10^{-5}	-5
.000001	10^{-6}	-6

Incidentally, you cannot find the log of a negative number. If you try to do this on your calculator, all you will get is an "E" indicating error. Just remember that logs are for positive numbers only.

As we said earlier, a log is simply one number that represents another. But why would we want to do that? We answered that question earlier by saying that using logs is an attempt to make it easier to deal with very large and very small numbers. You can see how this is done by referring to Table 3.

There we have listed the logs for numbers over a very-wide range. Looking in the first, you can see that the numbers represented extend from 0.001 to 1,000,000. That's an overall range of $1,000,000/0.001 = 10^9$, or 1 billion. But now, look at the second column you can see that the logs represent numbers only from -3 to $+6$, a range of only 9! As you can see,

**TABLE 3
LOGARITHMS FOR A WIDER
RANGE OF NUMBERS**

Number	Log
.001	-3
.02	-1.699
.6	-0.2218
1.9	.27875
3.2	.5051
99.8	1.999
786.4	2.896
5000.0	3.699
76475.0	4.884
803026	5.905
1000000	6.0

by using logs we have compressed an incredibly wide range of numbers down into a much smaller range. The logs, therefore, are simply smaller and easier to work with than numbers with all those decimal points and zeros.

Another thing that logs enables you to do is simplify math operations with very large and very small numbers. For example, by taking the logs of very small numbers, you can perform multiplication by doing simple addition.

If you remember your basic rules about powers from high school algebra, you will remember that whenever you are multiplying numbers raised to a power, if the bases are the same all you have to do is add the exponents to compute the answer. Some examples of that are given below.

$$10^4 \times 10^2 = 10^{4+2} = 10^6$$

$$10^{-5} \times 10^9 = 10^{-5+9} = 10^4$$

To make use of that concept, we introduce the use of logs to give us the expressions:

$$\text{Log}(A \times B) = \text{Log}A + \text{Log}B$$

$$A \times B = \text{antiLog}(\text{Log}A + \text{Log}B)$$

What that says is that the log of the product of two numbers is simply equal to the sums of the logs of the numbers. That means that you can compute the product of two large numbers by simply adding their logs together.

Suppose we want to multiply 204,879 by 78,135,620. That is messy, even on a calculator. What you do is find the log of each number:

$$\text{Log } 204,879 = 5.311$$

$$\text{Log } 78,135,620 = 7.893$$

Now add the two exponents (logs):

$$5.311 + 7.893 = 13.204$$

Finally, find the antilog:

$$(A \times B) = \text{antiLog } 13.204 = 1.59955 \times 10^{13}$$

The product is a 14 digit number, so the only decent way to express it is in scientific notation.

That also works for dividing numbers. Instead of dividing very large or very small numbers, you can reduce it to a simple subtraction problem if you use logs. This is expressed as:

$$\text{Log}(A/B) = \text{Log}A - \text{Log}B$$

$$A/B = \text{antiLog}(\text{Log}A - \text{Log}B)$$

The procedure is the same as that for multiplication, but you subtract the exponents.

At one time when scientific calculators were not available,

logs were very widely used for such calculations. Today, however, the inexpensive scientific calculator with scientific notation virtually eliminates the need for such operations.

Now that you've got a feel for what logs are and how they work, let's take a look at their biggest application in electronics, computing decibels.

Introduction to the Decibel

The decibel is a unit used to express the gain or loss in an electronic component, circuit, or system. The term itself is made up of two parts, "deci" and "bel". The term "bel" is derived from Alexander Graham Bell after whom the term is named. "Deci" is a prefix meaning one-tenth. The term decibel, therefore, means one-tenth of a bel. It is generally abbreviated dB.

The bel is used to express the relationship between the input and output power of a circuit or component. Bels are computed with the simple formula:

$$B = \text{Log}(P_o/P_i)$$

The number of bels is equal to the log of the ratio of the output power (P_o) of a circuit to the input power (P_i).

Since the bel is a very small unit for most applications, we normally express the power ratio in terms of decibels. The formula for decibels is:

$$\text{dB} = 10\text{Log}(P_o/P_i)$$

In many electronic circuits, it is necessary or desirable to express the power gain or loss in a circuit in some convenient terms. For example, a power amplifier as shown in Fig. 1 receives a small input power, but amplifies the signal and

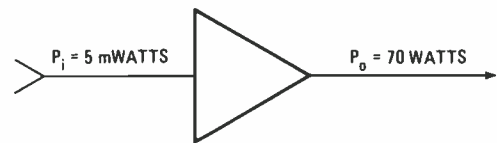

Fig. 1—Once you can handle decibels, it's a snap to figure out the overall gain of an amplifier circuit like this one.

produces a large output power. The power gain of the circuit is the ratio of the output power to the input power, or:

$$\text{Gain} = P_o/P_i$$

$$\text{Gain} = 70/.005 = 1400$$

There is no reason why you can't express the gain of the circuit simply as the power output to power input ratio. But, as we have said before, many times the power gains or extremely high and result in large numbers. It is usually more convenient to express the gain in terms of a smaller number. By using decibels, we find the log of the ratio and thereby create a term which expresses the large gain as a smaller number. In the example above:

$$\text{dB} = 10\text{Log}(P_o/P_i) = 10\text{Log}1400$$

$$= 10(4.146) = 41.46 \text{ dB}$$

Let's take another example. A high-power radio transmitter starts by generating a signal of 100 milliwatts in the oscillator, but produces an output power of 1000 watts. The power gain, therefore, is:

$$\text{Gain} = 1000/.001 = 1 \text{ million}$$

A more convenient way of expressing the power gain is to

use decibels. This is done by using the formula given earlier:

$$\text{dB} = 10\text{Log}(1000/.001)$$

$$\text{dB} = 10\text{Log}(1 \text{ million})$$

$$\text{dB} = 10(6) = 60 \text{ dB}$$

A power gain of one million is the same as a power gain of 60 dB.

The important thing to remember when using decibels is that the decibels are not a specific unit within themselves. For example, the unit of power is the watt. The unit of resistance is the ohm. The unit of current is the ampere, and so on. Decibels is not such a unit. Decibels simply express the ratio of two powers. In effect what decibels do is compare one power to another and express their ratio as a number.

On the other hand, a widely used variation of the decibel compares an output power to a reference input power. That is done in the unit known as the dBm, where the m stands for milliwatt (mW). A milliwatt is one-thousandth of a watt. The use of dBm is a way of expressing the gain or loss of a circuit compared to one milliwatt. In that case, the one milliwatt level becomes a reference against which another input or output power level is compared. For example, if the output of a circuit is 2 watts, its decibel gain compared to one milliwatt is:

$$\text{dBm} = 10\text{Log}(2/.001)$$

$$\text{dBm} = 10\text{Log}(2000)$$

$$\text{dBm} = 10(3.301) = 33 \text{ dB}$$

By using the dBm unit, the output or input power level can be expressed in absolute terms when compared to the one milliwatt reference. Another frequently used reference is dBW where the reference is one watt.

The decibel is also used to express loss in a circuit. Many circuits or components attenuate the power level of a signal. An example is a filter or impedance-matching circuit. Those circuits perform specific functions, such as frequency selectivity or matching input and output impedances to ensure maximum power transfer. But in performing their function, they also introduce a loss or attenuation. The circuits themselves absorb some of the input power so that the output power is lower.

Another example is a long coax cable used to feed power from a transmitter to an antenna. Coax cable attenuates the signal so that its output is less than its input.

Suppose that the input power to a long coax transmission line is 100 watts while the output is 85 watts (see Fig. 2). The loss expressed in decibels is:

$$\text{dB} = 10\text{Log}(85/100)$$

$$\text{dB} = 10(-.0758) = -.758 \text{ dB}$$

Note the negative sign in the result. The log of a number less than one is negative. A negative answer tells you that the expression is a loss because the output power is less than the input power. It is not necessary to use the negative sign on the dB value if it is indicated elsewhere that the value is a loss. The use of the negative sign is a clear indication that it is a loss compared to a gain.

To give you a feel for the relationship between the various power ratios and the equivalent decibel value, please refer to Table 4.

The decibel value for power ratios of 1 through 10, and then in factors of 10 are given. There are a couple of interesting things to note in that table. First, note the power ratio of 1.

Fig. 2—Loss in a cable is just one calculation performed with logs. Line loss is perhaps the most important transmitter-station characteristic you need to know.

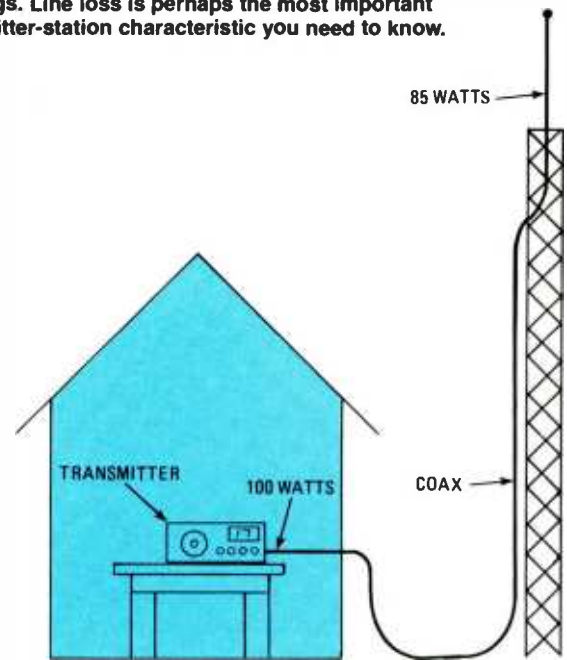

The input and output powers are equal so there is no gain, so dB = 0. Next, note the power ratio 1.995. That is approximately a power ratio of 2-to-1. A power ratio of 2-to-1 represents a 3-dB gain or loss. If the power is doubled, it represents a 3-dB gain. If the power is halved, then the loss is 3 dB. There will be numerous instances where you will use the 2-to-1 power-ratio figure so that it is convenient for you to remember that it represents 3 dB.

Notice also that a power ratio of 10 gives you a decibel figure of 10. The even powers of ten (100, 1000, 10,000, etc.) provide decibel values of 20, 30, and so on. A 10-to-1 power ratio is another common relationship you will encounter and it is easy to remember that it represents a 10 dB gain or loss.

TABLE 4—POWER RATIO vs dB

Power Ratio (P _o /P _i)	dB
1	0
1.259	1
1.585	2
1.995	3
2.512	4
3.162	5
3.981	6
5.012	7
6.310	8
7.943	9
10.0	10
100.0	20
1000.0	30
10000.0	40
100000.0	50

Using Decibels in Electronics

One of the neat things about decibels is that the overall gain or loss in a system can be obtained by simply adding together all of the gains and losses of the circuits or components that a signal passes through from input to output. For example, refer to Fig. 3. There, a 5-watt transmitter feeds a transmission line with a 1.5-dB loss. The transmission line applies the signal to a directional antenna that has a gain of 7 dB.

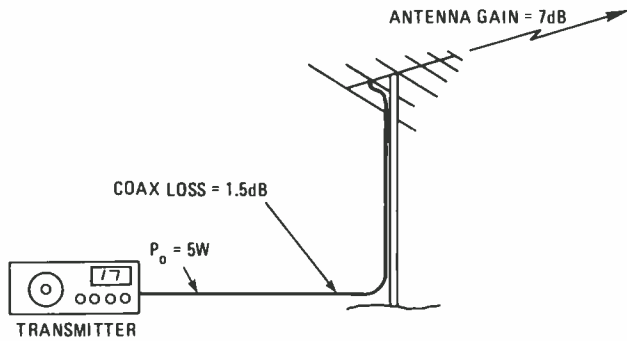

Fig. 3—Overall gain or loss can be computed by addition with decibels. The overall gain can then be used to compute output power if you know the transmitter power.

Therefore, the antenna gain is greater than the transmission-line loss, and so, the overall system gain is:

$$\text{Gain} = 7 - 1.5 = 5.5 \text{ dB.}$$

That brings us to another version of another way to use decibels. If the transmission line input is 5 watts, and the overall gain is 5.5 dB, what is the effective output power from the antenna? In that case you know the dB value and must work backward to find the power ratio. Then, knowing either the input or output power, the remaining value can be computed from the ratio. In this case, our gain is 5.5 dB, therefore, we can write the expression:

$$\text{dB} = 5.5 = 10\text{Log}(P_o/P_i)$$

To solve this problem, we can divide both sides of the equation by 10 to get:

$$.55 = \text{Log}(P_o/P_i)$$

You probably recognize the solution to the problem is to use the antilog.

$$\text{antiLog } .55 = 3.548$$

That value then is our power ratio or:

$$P_o/P_i = 3.548$$

Therefore, the antenna power output is equal to:

$$P_o = 3.548P_i$$

$$P_o = 3.548(5) = 17.74 \text{ watts}$$

As you can see, a power gain of 5.5 dB represents an increase from 5 watts to 17.74 watts.

A more sophisticated example is shown in Fig. 4. It represents the total gain and loss in a satellite communications system. Using the individual gain and loss dB figures given, the overall system gain or loss can be computed.

The signal to be relayed from Earth station 1 to Earth station 2 by way of the satellite, is received by a large parabolic antenna. The dish power gain is 64 dB. Large transmitting Earth stations use a power in the 10 to 10,000 watt range. That power is amplified by the highly directional dish antenna. So the system gain begins with 64 dB. The up-link path to the satellite has a tremendous loss. Most satellites are set in geosynchronous orbit exactly over the equator 22,300 miles away. A satellite positioned in the geostationary orbit rotates in synchronism with the Earth and, therefore, remains in a constant position with respect to any point on the Earth. The satellite, while rotating many thousand miles per hour, seems fixed in space. The signal loss between the Earth station and

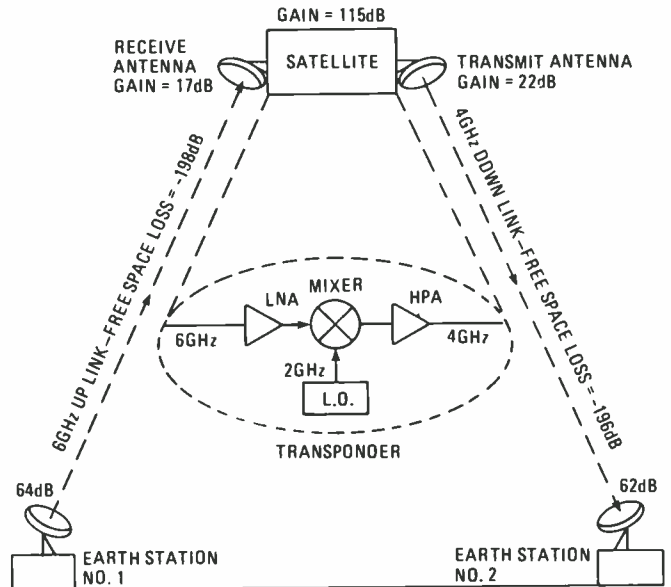

Fig. 4—Satellite-link system calculations also lend themselves easily to decibels. You can figure the total gain/loss of the system by simple addition/subtraction.

the satellite over that distance is extremely large. At 6 GHz, a common up-link frequency, the loss may be 198 dB as indicated. That free-space loss varies with frequency and the geographic location of the Earth station. Typically the loss increases with frequency and is well over 200 dB in the Ku satellite band (14 to 17 GHz). The loss increases even further during periods of rain, snow or other known atmospheric disturbances.

Note that the satellite has a receiving antenna with a gain of 17 dB. Inside the satellite is a transponder whose input is a low noise amplifier (LNA) that increases the signal gain. A down converter in the satellite translates the frequency to 4 GHz. The 6 GHz input signal is mixed with a 2 GHz signal from the local oscillator (LO) to produce 4 GHz ($6 - 2 = 4$). Obviously a satellite cannot receive and transmit a signal on exactly the same frequency. Any modulation on the original signal is carried on through the frequency translation process to 4 GHz. A high power amplifier (HPA) usually from a travelling wave tube (TWT) further amplifies the signal. The overall gain of the transponder, including the low noise receiving input amplifier, the mixer, and the high power amplifier, is usually in the 100 to 130 dB range, not including antenna gains. For our example here a figure of 115 dB is used. The output signal is further amplified by the highly directional antenna with a gain of 22 dB.

Now the signal takes the long downlink path back to Earth station 2 through free space. Here the loss is only 196 dB because of the lower operating frequency. Finally, the receiving Earth station picks up the signal on its large dish antenna which provides a gain of 62 dB as shown here.

Now let's take a look at the overall gain of the system from input to output. As indicated earlier, all you have to do is simply add the various values of dB given from input to output. One way to do that is starting with the gain of the transmit Earth station, you can simply list the gains and losses and tally them up.

$$\text{System Gain or Loss} = 64 - 198 + 17 + 115 + 22 - 196 + 62$$

$$= -114 \text{ dB}$$

As you can see, the gains of the earth station antennas and the gain of the satellite itself still does not offset the awesome up-link and down-link losses. The remaining 114 dB loss, of course, is made up in the earth station transmitting and receiving amplifiers. Just note how easy it is to obtain the overall system gain by simply adding the dB values.

The other approach is simply to add up all the gain figures, and then add up the loss figures and subtract the two. The gain figures in our example are:

$$\text{System Gain} = 64 + 17 + 115 + 22 + 62 = 280 \text{ dB}$$

The total losses in the system are:

$$\text{System Loss} = -198 + (-196) = -394$$

The total system gain then is $280 - 394 = -114$ dB as determined earlier.

While decibels are used primarily in expressing power gain and loss, you will also see them used on many occasions to express the voltage or current gain or loss in a circuit. The gain of an amplifier is often expressed as a voltage ratio rather than a power ratio. Again, the decibel can be used. The formulas for expressing the ratio of two voltages or two currents in decibels are given below:

$$\text{dB} = 20\text{Log}(V_o/V_i)$$

$$\text{dB} = 20\text{Log}(I_o/I_i)$$

Where V_o is the output voltage and V_i is the input voltage.

Voltage ratios are, of course, far more common than current ratios. An example is the open loop gain of an operational amplifier. Assume a voltage gain of 15,000 or 15,000 to 1. The voltage gain expressed in dB then is:

$$\text{dB} = 20\text{Log}(15,000)$$

$$\text{dB} = 20(4.176)$$

$$\text{dB} = 83.52 \text{ dB}$$

The most important thing to remember about using current and voltage values is that the decibel figure is meaningless unless the input and output impedances are equal. When using the power-ratio dB formula, it doesn't matter whether the input and output impedances are equal or not, the power expression is valid. But with voltages or currents, different input and output impedances make the value meaningless unless a correction factor is applied. If the input and output impedances are different, you can compute the dB value with the expression given below:

$$\text{dB} = 20\text{Log}(V_o\sqrt{Z_i}/V_i\sqrt{Z_o})$$

Here Z_i is the input impedance and Z_o is the output impedance.

In most cases, an attempt is made to keep the input and output impedances constant so that such complex corrections are not required.

Again, the total voltage gain or loss in a circuit can be determined by simply adding together the various dB-gain or -loss figures contributed by each stage or component as it processes the signal. For example, in Fig. 5 a signal is applied to a voltage amplifier followed by a filter with loss and then another voltage amplifier. The dB gain and loss figures are indicated. The overall gain of the circuit between input and output then is:

$$\text{Gain} = 2.8 - 6.7 + 5.3 = 1.4 \text{ dB}$$

If the input to the circuit in Fig. 5 is 80 millivolts (mV),

what is the output voltage? Well, we know the dB value but we want to find the voltage ratio.

$$\text{dB} = 20\text{Log}(V_o/V_i)$$

$$1.4 = 20\text{Log}(V_o/V_i)$$

We divide both sides of the equation by 20 to get:

$$1.4/20 = \text{Log}(V_o/V_i)$$

$$.07 = \text{Log}(V_o/V_i)$$

To get the voltage ratio, all we do is find the antilog of 0.07.

$$V_o/V_i = \text{antiLog } .07$$

$$V_o/V_i = 1.175$$

Now, we know $V_i = 80$ mV or .08V. Now we can calculate V_o .

$$V_o = 1.175V_i$$

$$V_o = 1.175(.08)$$

$$V_o = .094 \text{ or } 94 \text{ mV}$$

Another time you will run into decibels is in working with frequency response curves such as those produced by filters, amplifiers, or tuned circuits. Take the response curve of a bandpass filter like that in Fig. 6. That represents the voltage output with respect to frequency. The curve peaks at the center frequency f_c , then tapers off on either side. Note that the filter passes frequencies over a narrow range above and below f_c but rejects or at least greatly attenuates the others.



Fig. 5—Gain computations are not more complex for circuits containing filters. A filter's gain is simply negative for a given signal. Subtracting the loss from the gain gives you the overall gain or loss figure.

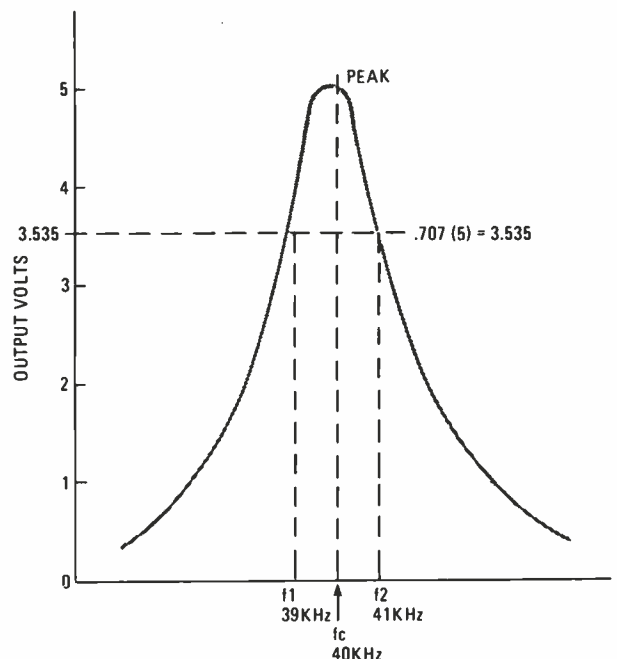

Fig. 6—A bandpass filter attenuates the frequencies outside the bandwidth. Actually it attenuates the frequencies in the bandwidth but not more than three dBs.

A measure of a filter performance is its *selectivity*. Selectivity refers to the ability of a filter to pass desired signals but reject others. A measure of the filter's selectivity is its *bandwidth*. Bandwidth (BW) is the difference between the upper (f_2) and lower (f_1) cut-off frequencies illustrated in Fig. 6.

$$BW = f_2 - f_1$$

The cut-off frequencies are those frequencies above and below f_c where the voltage is down 70.7% from the peak. For example, in Fig. 6 the peak is 5 volts. Now, 70.7% of that is $5 \times .707 = 3.535$ volts. That level defines f_1 and f_2 . Finding f_1 and f_2 permits the bandwidth to be computed. From Fig. 6, $f_1 = 39$ kHz and $f_2 = 41$ kHz. The bandwidth is:

$$BW = f_2 - f_1$$

$$BW = 41 - 39 = 2 \text{ kHz}$$

The points on the curve where the output is down .707 are usually called the 3-dB down points. Why? When you know logs and dB, the answer is easy.

$$dB = 20\text{Log}(V_o/V_i)$$

Here V_o/V_i is not the output/input ratio. Instead, it is the ratio of the output at the cut-off frequencies to the output of the center frequency or .707/1. In the example, it is $3.535/5$. So:

$$dB = 20\text{Log}(.707)$$

$$dB = 20(-.15058)$$

$$dB = -3.0116$$

Now you know why .707 of the peak is 3 dB down.

Miscellaneous Uses of Logs

Besides their use in decibel calculations, logs also pop up in various other electronic calculations. For example, transmission-line calculations. As you know, there are two basic types of transmission lines, parallel wire and coax. These lines are rated by their characteristic or surge impedance (Z_o). A popular parallel line is the familiar 300 ohm twin lead. An example of coax is the widely used RG-59/U with an impedance of 73 ohms.

Those impedance figures are directly related to the physical size of the line. Take the parallel line in Fig. 7. Its impedance depends upon the diameter of the wires (d) and their spacing (D). The impedance is:

$$Z_o = 276\text{Log}(D/d)$$

Assume that D is .5 inch and that d is .041 inch. So:

$$Z_o = 276\text{Log}(.5/.041)$$

$$Z_o = 276\text{Log}(12.195)$$

$$Z_o = 276(1.086)$$

$$Z_o = 299.8$$

or about 300 ohms.

A typical coax line is shown in Fig. 8. It has a center conductor surrounded by an insulator and a shield made of fine braided wire. Over that is an insulating sheath. Its characteristic impedance is:

$$Z_o = 138\text{Log}(D/2d)$$

where D is the inside diameter of the shield and d is the diameter of the center conductor.

Assume that the shield inner diameter is .2 inch while the center conductor has a diameter of .087 inch. The impedance

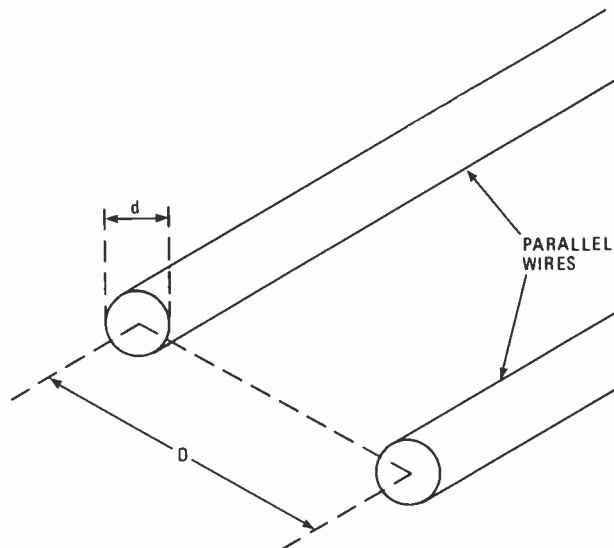

Fig. 7—If you've always wanted to know how the impedance rating of zip cord is computed, then an understanding of logs may help. The wire diameter and separation determine it.

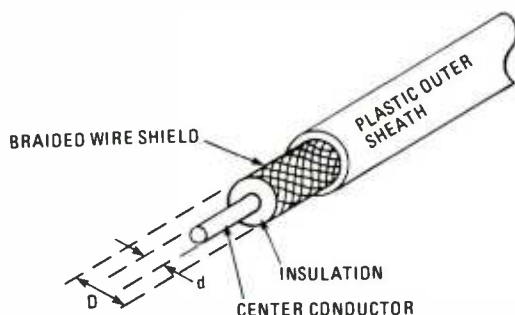

Fig. 8—Coax impedance is computed with the same formula as zip cord but only the diameter of the center conductor is used, and the distance is between the conductor and shield.

of this coax, therefore, is:

$$Z_o = 138\text{Log}(.2/.087)$$

$$Z_o = 138\text{Log}(2.3)$$

$$Z_o = 138(.3617)$$

$$Z_o = 50 \text{ ohms}$$

Fifty ohms is a common coax cable impedance.

Another use of logs is in computing the number of binary digits (bits) to represent a decimal number. Binary numbers are made up of 1's and 0's. To represent a decimal value, it takes a specific number of 1's and 0's (bits). The decimal number 90 in binary is 1011010 or 7 bits. (Count 'em!)

To find out how many bits, B , it takes to represent the decimal number, N , you use the formula:

$$B = 3.32\text{Log}N$$

Let's use $N = 90$, so:

$$B = 3.32\text{Log}90$$

$$B = 3.32(1.954)$$

$$B = 6.487$$

Well, you can't have a fraction of a bit, so you round upward to 7. So it takes 7 bits to represent 90 as you saw earlier.



ELLIS ON ANTIQUE RADIO

Souping Up the Triode Vacuum Tube

□BACK IN APRIL OF LAST YEAR, WE concluded a three-part series on early vacuum tubes. Beginning in 1920, when the first tubes used in broadcast-type entertainment receivers were introduced, that series of articles covered the key types released through 1927. One of my new year's resolutions for the 1988 series of columns was to pick up the tube story where I left off and discuss the next few major developments.

Last year's series ended with the 1927 introduction of the type 27. The new tube contained a brand new element, which surrounded the filament and was called the *cathode*. In the type '27, the filament no longer directly supplied the electron stream necessary to operate the tube. Instead it heated the cathode, which—in turn—generated the electron flow that was used.

The new design made it possible for the 27's filament (or *heater*, as it was now called) to be operated on AC power without introducing unacceptable hum onto the signal. This freed listeners from the necessity of maintaining the messy lead-acid storage batteries formerly used to light filaments, and paved the way for the first *socket power* AC line-operated receivers. In order to make the necessary circuit connections to the cathode, the 27 required a 5-pin socket—departing from the familiar 4-pin design used for all standard receiving tubes up to that time.

In October 1927, not quite six months after the release of its type UY-227, RCA announced another new type—the UX-222 (The letters and first number identified the base style and manufacturer of the tube. From here on out, we'll drop them, as the electronics industry did in 1930). The 22 contained an extra grid that resulted in a dramatic increase in the tube's amplifying power. It was the first true *tetrode* (4-element) tube commonly sold in this country.

The background behind the design of the 22 vacuum tube lay in an inherent



Type 24A tetrode vacuum tube was most common screen-grid device used in consumer radios in the early '30's. Originally released with a pear-shaped envelope, it was changed to the "ST" style shown here a few years later.

limitation of triode amplifiers operating at radio frequencies. Such amplifiers could produce only so-much gain before feedback created by the internal grid-plate capacitance of the tubes resulted in instability and self-oscillation. Such feedback could be minimized by various methods, including the famous "Neutrodyne" circuit (which I plan to discuss in a future column). But self-oscillation problems continued to keep a lid on amplification.

Self-oscillation in triodes became even more of a problem at higher operating frequencies. And with increased interest in short-wave communication, there was need for a way around the limitations of triode amplifiers. Experimenters working in different countries discovered, almost simultaneously, that the triode's internal grid-plate capacity could be reduced several hundred percent by the insertion of an additional *screen grid* between the original *control* grid and the plate.

A technical explanation is beyond the scope of this article. But the capacity-reduction effect results from "electrostatic shielding" caused by maintaining the screen grid at a positive voltage with respect to the filament or cathode. The positive voltage was generally appreciably less than that used on the plate. In this country, the research that led to RCA's introduction of the type 22 tetrode (or screen-grid tube) was done in the laboratories of the General Electric Company.

The name *screen grid* came about because a fine mesh screen shaped into a cylinder was placed in the vacuum tube with the filament/cathode elements on the axis of the cylinder and the plate (actually a plate of metal) wrapped as a cylinder around the screen grid. Of course suitable spacing and separating mica insulators held them in place within the vacuum of the glass shell.

The Screen-Grid Revolution

In referring to the introduction of the screen grid, one historian said "the improvement in gain and efficiency permitted by the this development over the original triode has not been duplicated by any single advancement since that time." Certainly the effect on the radio industry was immediate and electric. Manufacturers advertised screen-grid sets; hobby magazines featured screen-grid construction articles; shortwave and broadcast listeners everywhere mar-

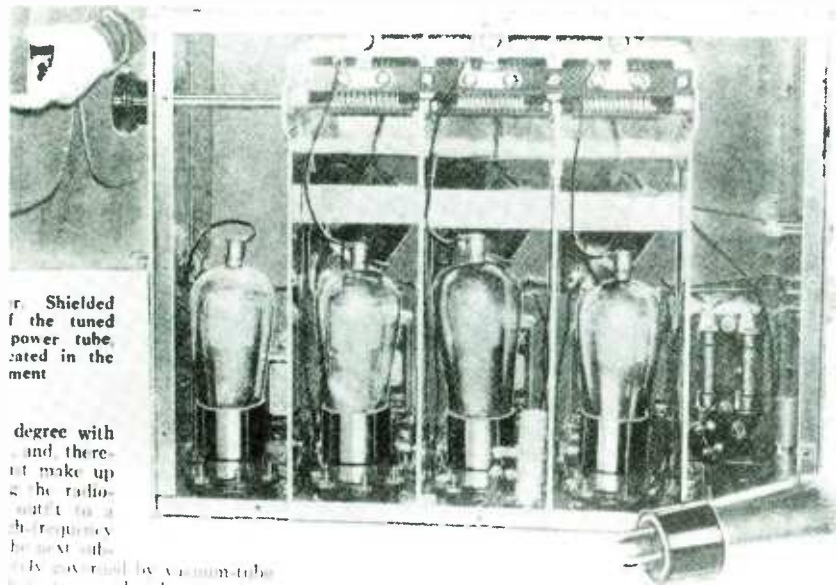

Four 24's were used in this broadcast tuner designed by two of the great names in radio. Illustration was taken from a 1929 National Co. advertisement.

veled at the remarkable performance of the new circuitry. Moving from a triode set to one of the new screen-grid jobs was akin to trading in the old tin Lizzie on a high-powered Lincoln.

And the appearance of the 22 tetrode didn't exactly detract from its high-tech image. In providing a connection for the extra electrode, designers chose not to change the original 4-pin base, but to add a metal cap at the top of the tube. By bringing the control-grid lead up to the cap instead of down to the base with the other element leads, they could further minimize capacitance between control grid and plate. The four base connections were used for filament, plate and screen grid (the 22 didn't have a cathode).

A row of three or four screen-grid tubes, each with a rubber-covered wire lead extending from its top cap to a nearby variable condenser or coil enclosure, made an impressive sight indeed. It suggested power and high-tension, not unlike the spark-plug-and-distributor system of a fast car.

Later Screen-Grid Vacuum Tubes

The 22 tube never became widely used because it had a battery-operated filament. At the time of its release, the first true AC-operated tube—the type 27—was already on the market and the era of plug-in sets was dawning. I don't have any type 22's in my collection, and I'd advise those of you who do to hold

onto them. After the initial "let's get on the screen-grid bandwagon" was over, the tube fell into decline and is hard to find today.

The immediate successor of the 22 was the type 24, introduced in May, 1929. This was an AC-operated tube having a cathode and a 2.5-volt heater patterned on those of the type 27. It used the same 5-pin base as the 27—and these pins were assigned to the heater, cathode, plate and screen grid. The control grid was brought up to a top cap like that of the 22. Very soon after the 24 was released, it was replaced by the 24A—a quicker-heating version of the 24.

Like the type 22, the 24 quickly fell



ANNOUNCING THE UY-224

A FOUR electrode, screen grid tube, Radiotron UY-224, embodying a 2.5 volt heater element which permits operation from alternating current will be placed on the market around May 1st by the Radio Corporation of America, it has been announced. This new Radiotron is recommended for use primarily as a radio frequency

RCA's announcement of the type UY-224 vacuum tube was picked up in the very first issue (July, 1929) of *Radio -Craft*. This early dominant Gernsback publication was a direct ancestor of *Hands-on Electronics*.

A New Screen-Grid Tuner

by Glenn H. Browning and James Millen

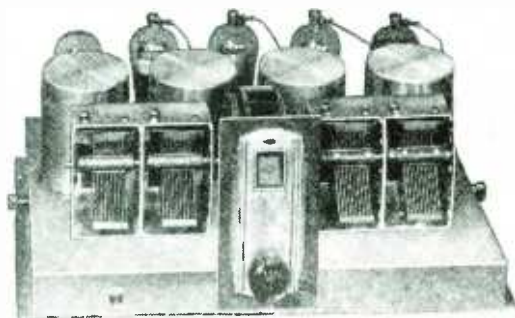

An auto radio featured in an April, 1930 *Radio News* construction article incorporated four 24 vacuum tubes. These new tubes were chosen for this application because their high sensitivity and rugged heater element.

into disuse and is hard to find today (though it's probably more common than the 22). If you own some examples, hang onto them! The 24A was the really common tube of the screen-grid era. Most every tetrode set I've ever seen sported a row of them. Many such sets were certainly first equipped with 24's, but were re-tubed with 24A's at replacement time.

The Variable-mu Tube

As the new screen-grid sets went into service—many of them in densely-populated areas supporting several powerful radio stations—a problem became
(Continued on page 100)



By Don Jensen

JENSEN ON DX'ING

Vatican Radio is an early SW broadcaster that's still growing.

□ AS SOVEREIGN STATES GO, THE VATICAN doesn't seem like much. That city-state, tucked away in the heart of Rome, has a population of not much more than a thousand. Its borders are measured in meters, not miles and its area is less than half a square kilometer. Even its "army"—a handful of men in 17th century uniforms carrying pikes and spears—is only for show.

But of course, in the affairs of Men and Nations, the Vatican, as the center of Roman Catholicism, plays a role much-larger than its size suggests. Its mission is global, and it was Pope Paul VI who recognized the potential of worldwide radio.

In 1929, the Pontiff commissioned none other than Guglielmo Marconi, the father of radio, to establish the first station. Two years later, *Vatican Radio* was inaugurated at 4:30 p.m., February 12, 1931, with an address by Pius XI. "Listen, oh heavens to what I am going to say," he said in that initial broadcast. "Listen, oh Earth, to the words of my mouth. Hear and listen, oh people, from afar!"

The early experimental broadcasts developed (by 1939 when its papal patron died) into a truly international service with programs in nine languages.

All of Vatican Radio's transmitters and antennas, for several decades, were located in the Vatican gardens. But by the 1950s, the station had outgrown the available space within the ancient walls. Most of the shortwave-transmitting facilities were established at Santa Maria de Galeria, 11 miles outside Rome. That site was given extraterritorial status by the Italian government, making it, in effect, part of the Vatican.

New transmitters, up to 500 kilowatts in power, were added. An antenna switching arrangement allows six transmitters to feed a complex of 21 antennas, including a unique rotating antenna mounted on a circular monorail. Two 260-foot steel towers, sus-

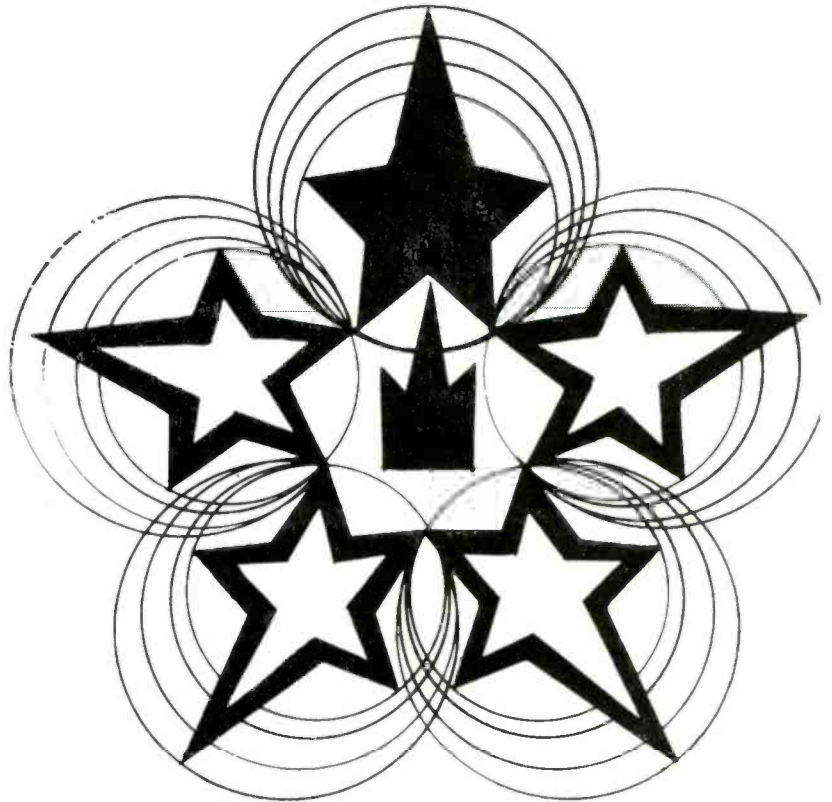

МОСКВА РАДИО

The Cyrillic alphabet may be a bit confusing, but the words mean Moscow Radio. This pleasing graphic design is from the cover of a Radio Moscow program schedule sent to listeners who request it.

pending a curtain of dipoles, can rotate around a central pivot to beam signals to any part of the world.

Now Vatican Radio broadcasts in 35 different languages, a total of 30 hours per day. English-language programs are directed to North America twice daily: 0050 to 0110 UTC on 6.030, 9.605 and 11,780 kHz, and 0310-0330 UTC on 6.150 kHz.

Vatican Radio also has other English programs during the day, beamed to other parts of the world. Those include transmissions at 1950 UTC on 9,645

kHz; at 2045 UTC on 11,700, 11,760 and 15,120 kHz, and at 2205 UTC on 9,615 and 11,830 kHz.

Reception reports may be sent to Vatican Radio, Vatican City.

SW Pinch Hitter

Rarely do SWLs have the opportunity to hear the "Israeli Army Radio," *Galei Zahal*. Normally its broadcasts are aired only on medium wave and FM frequencies that are not audible overseas. But every now and then—most recently last fall—the staff

of Kol Israel's shortwave foreign service, along with the rest of the Israeli government's broadcasters, go on strike.

When the labor-contract dispute triggered the walkout October 6, *Kol Israel* was left without any programming, although there was no work stoppage among the engineers of the separate state-run telecommunications agency that operates all of the shortwave transmitters.

What happened then, as it had back in 1981, was that broadcasting authorities substituted the programs of the Army's independent Galei Zahal network, feeding them to the powerful international-shortwave transmitters.

For the first time in about six years, North American SWLs were able to hear the Army station, with the best reception reported to be on 13,750 kHz from around 2100 to 2300 UTC.

It was an unusual shortwave catch, even though few foreign listeners actually could understand much of the Hebrew language programming. That was too bad, too, since Galei Zahal has a reputation within Israel as a sassy, unpredictable operation, often more fun to listen to than the regular government broadcaster.

Galei Zahal was founded in 1950 by the army as a patriotic voice "to educate the public" and to assist the military callup of reserve soldiers in time of war. But during the 1973, Israelis demanded more news than the 19-hour-per-day Israeli Broadcasting Authority provided, so Galei Zahal filled the gap by broadcasting around the clock, a schedule that it still follows. Since then, the army station has developed its own independent, and very-often controversial news service.

Compared to the IBA, which has an \$18 million annual budget, Galei Zahal operates on a fiscal shoestring, only \$2.5 million a year. Its 232-member staff includes 128 active-duty military men and women, 27 career officers and 67 contract civilians.

About 1,500 Israeli high school grads compete each year for a coveted 15 broadcasting, reporting, and producing jobs at the station. The lucky ones

selected spend their compulsory hitch in the army—three years for men, two for women—working for Galei Zahal.

The station is youthful and aggressive. One announcer says that anything the IBA can do with its multi-million dollar budget, "we can do better. We have no union problems here, and no sacred cows...or sheep!"

Programming is heavy on the pop music—that's what most North American SWLs heard during the shortwave

ABBREVIATIONS

BBC	British Broadcasting Corporation
DX	long distance (over 1000 miles)
DX'er	listener to shortwave broadcasts
DX'ing	listening to shortwave broadcasts
FIBS	Falkland Islands Broadcasting Service
FM	frequency modulation (modulated)
HCJB	Voice of the Andes
IBA	Israeli Broadcasting Authority
kHz	kiloHertz (1000 Hertz or cycles)
kw	kilowatt (1000 watts)
QSL	verification reply from broadcaster
QSL'ing	sending of reception report to station
RCI	Radio Canada International
RSI	Radio Sweden International
SABC	South African Broadcasting Corporation
SW	shortwave
SWB'ers	shortwave broadcasters
SWL('s)	shortwave listener('s)
RAI	Radio Austria International
VHF	very-high frequency
US	United States
USSR	Russia (Union of Soviet Socialist Republics)
UTC/GMT	Universal Time Code/ Greenwich Mean Time
VOA	Voice of America

stint last fall—but also features a wide range of innovative and even avant-garde features. They range from university-of-the-air classes to political satire, book reviews by none other than the nation's foreign minister to sheer nonsense comedy shows.

Galei Zahal's fierce determination to remain separate from IBA programming was tested when an Israeli military chief of staff tried to cut the army radio's budget to force the station to merely pickup the IBA newscasts.

The station therefore took him to court and won.

Though news is important, Galei Zahal never forgets that entertainment

comes high on the priority list of its audience.

"Soldiers on the Golan Heights want to hear about the basketball scores or the Tina Turner concert," says Nachman Shai, director of Galei Zahal, "not the latest anti-tank weapon!"

Feedback

"Years ago," writes Arthur M. Feeny of Detroit, "I used to listen to shortwave a lot. I got away from it until recently, when I bought a new shortwave receiver and started tuning again."

"I remember a program for shortwave listeners called 'Sweden Calling DXers,' which had news about different shortwave stations that you could hear. Is it still on the air?"

Yes, indeed, Art. That program on Radio Sweden International started back in the 1940s and it's still going today. Try tuning 11,785 kHz or 15,345 kHz at 1400 UTC Tuesdays. But a number of other SW stations also have programs specifically for their SW audiences. Here is a sampling of them, day by day, through the week:

Monday: 0230 UTC. "DX Party Line." HCJB. Quito, Ecuador, on 6,205, 9.875 or 11.775 kHz.

Tuesday: 0245 UTC. "Worldwide SW Spectrum." *Voice of America*, on 6,130, 9.455 or 9.775 kHz.

Wednesday: 0130 UTC. "Waveguide," BBC World Service, London, on 6.175 or 7.325 kHz.

Thursday: 0230 UTC. "Media Network," *Radio Nederland*, on 6.020, 6.165 or 9.590 kHz.

Friday: 0400 UTC. "World of Radio." WRNO, New Orleans, on 6.185 kHz.

Saturday: 2100 UTC. "SWL Digest," *Radio Canada International*, on 11.945, 15.325 or 17.820 kHz.

Sunday: 1240 UTC. "Talkback," *Radio Australia*, on 6.060 or 9.580 kHz.

Down the Dial

This is the place for your shortwave loggings. Spread the word. Drop a line telling me what you're hearing, the frequency (in kHz) and the time (in UTC, Universal Coordinated Time). If you have any comments or questions about SWLing, those are welcome too. The address is *Jensen on DX'ing*, **Hands-on Electronics**, 500-B Bi-County Blvd., Farmingdale, NY 11735.

(Continued on page 105)

Credits: Chuck Rippel, VA; Richard D'Angelo, PA; Wally Rhyne, NC; Rufus Jordan, PA; Art Harris, NY; Robert Zimer, NM; North American SW Association, 45 Wildflower Road, Levittown, PA 19057



By Marc Saxon

SAXON ON SCANNERS

Get instant weather reports with the latest scanner release from Regency.

□ THE REGENCY R1080 IS A NEW 30-channel programmable scanner that incorporates "instant" 162-MHz NOAA weather information. The unit covers all of the popular scanning ranges, including 30 to 50 MHz, 144 to 174 MHz, 440 to 512 MHz. The set comes factory programmed for 30 popular frequencies, so you can operate it just as it comes from the carton. But if you are so inclined, you can program in any combination of channels you choose.

The R1080 (with its active-frequency search capability) can locate new active frequencies. Also incorporated into the unit is a priority channel, which, when activated on your highest-interest channel, causes the unit to ditch any other signal it may be monitoring each time your priority channel has communications.

A numbered keypad and dual-level, vacuum-fluorescent display flashing visual messages make entering new frequencies as easy as using a pushbutton telephone. And, of course, there's that exciting and useful weather-scan feature. When you hit that particular button, the scanner automatically searches all of the NOAA 162-MHz weather channels and finds the one in use in your area.

Other nice features of the R1080 include channel lockouts (for skipping over channels that are not currently of interest), and slow/fast scanning speed. It comes in a decorator-styled woodgrain cabinet, with an AC power cord, a telescoping indoor antenna, and a well-written instruction manual.

Look for the Regency R1080 at most scanner dealers, or you can ask the *big boys* at Regency Electronics Inc. (7707 Records Street, Indianapolis, IN 46226) or circle No. 50 on the Free Information Card.

Wide Area Police Frequencies

In many areas of the nation, law-enforcement agencies find that it is of



Regency's R1080 covers all of the popular scanning ranges, including 30–50 MHz, 144–174 MHz, 440–512 MHz. Factory programmed for 30 popular frequencies, it features weather-scan and active-frequency search capabilities; a priority channel, numbered keypad, dual-level fluorescent display, channel lockouts, and slow/fast scanning speed. Housed in a decorative woodgrain cabinet, it comes complete with an AC-power cord, telescoping indoor antenna, and a well-written instruction manual. For more information, contact Regency Electronics Inc. (7707 Records Street, Indianapolis, IN 46226) or circle No. 50 on the Free Information Card.

genuine value to coordinate the efforts of different agencies. Therefore, *common-use* frequencies are often established so that base and mobile units of various agencies can contact one another on an intersystem basis.

Some states have established uncommon frequencies and networks for use within their boundaries—such as the Illinois State Police Emergency Radio Network on 154.68 MHz. Nationally, most of those systems operate on 39.46, 45.86, and 155.37 MHz. There's also the National Police Emergency Frequency (155.475), which (when fully implemented) is intended

to be a frequency on which mobile units and base stations of various agencies can contact one another during high-speed pursuits and other types of emergency situations.

In fact, just recently I was monitoring 155.475 MHz and I heard a deputy-sheriff's mobile unit calling for assistance. He wasn't in his home county and had the unhappy combination of a flat tire and two prisoners he was transporting to a penitentiary. He needed local police assistance in watching the prisoners while he changed his tire! It might be a good idea to punch up those

(Continued on page 97)

MASTER THE NEW ELECTRONICS WITH MCGRAW-HILL'S

Contemporary Electronics Series

The fast, easy and low cost way to meet the challenges of today's electronic innovations. A unique learning series that's as innovative as the circuitry it explains, as fascinating as the experiments you build and explore.

From digital logic to the latest 32-bit microprocessor, the McGraw-Hill Contemporary Electronics Series puts you into the electronic picture one easy step at a time. Fifteen unique Concept Modules, sent to you one every 4-6 weeks, give you a handle on subjects like optoelectronics, robotics, integrated circuits, lasers, fiber optics and more.

Each Concept Module goes right to the heart of the matter. You waste no time on extraneous material or outdated history. It's a fast, efficient, and lively learning experience... a non-traditional approach to the most modern of subject matter.

Unique Interactive Instruction

With each module, you receive a McGraw-Hill Action Audio Cassette. Each tape is a dynamic discussion that drives home the key facts about the subject. Your learning

With your first module, you get this solderless breadboarding system. You'll use it throughout the series to build electronic circuits and bring concepts to life.

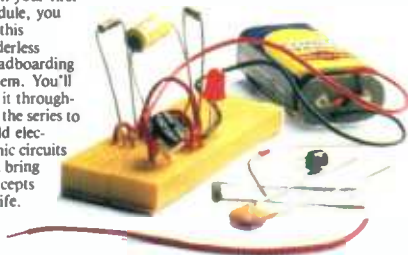

experience is reinforced through interaction with vividly illustrated text, audio cassettes, and actual electronic experiments. Indexed binders preserve backup material, notes, and tapes for convenient referral.

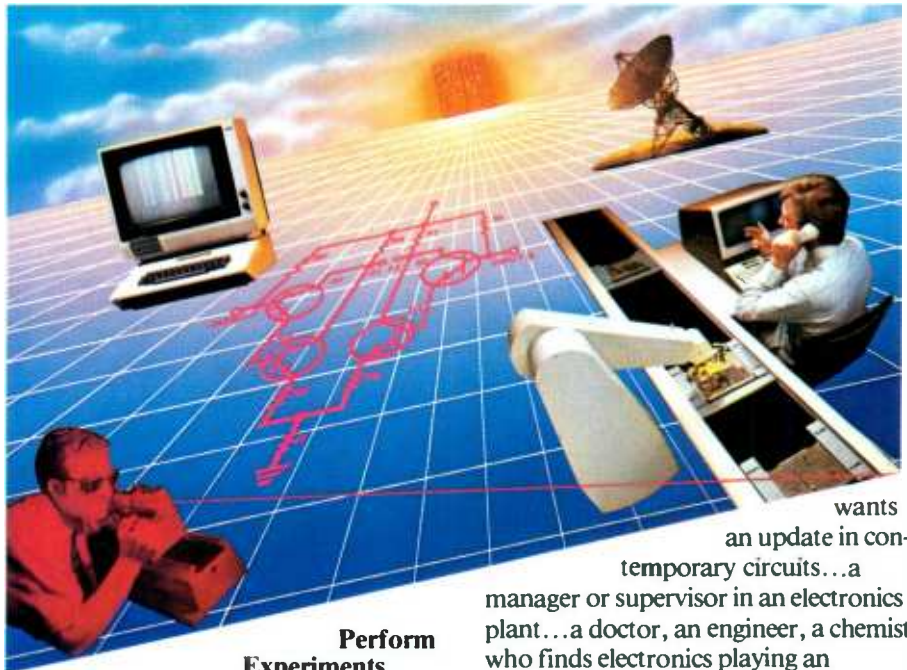

Perform Experiments in Contemporary Electronics

Throughout your series, laboratory experiments reinforce every significant point. This essential experience... dynamic, hands-on demonstrations of theory in practice... will help you master principles that apply all the way up to tomorrow's latest VLSI (Very Large Scale Integrated) circuitry.

In your very first module, you'll use integrated circuits to build a digital oscillator, verifying its operation with a light emitting diode (LED). You'll learn to identify passive and active components, understand concepts common to all electronic circuits.

For Anyone Interested in Electronics

The Contemporary Electronics Series is designed for anyone from hobbyist to professional. It's for you if you're looking for new fields of interest... if you're a teacher who

wants an update in contemporary circuits... a manager or supervisor in an electronics plant... a doctor, an engineer, a chemist who finds electronics playing an increasingly important role in your work. It's even for electronics engineers or technicians who feel their training needs freshening up. It's the quickest, most convenient, probably least expensive way to do it. And the only one that gives you hands-on experience.

15-Day No-Risk Trial

To order your first module without risk, send the card today. Examine it for 15 days under the terms of the order form and see how the Contemporary Electronics Series gets you into today's electronics. If card has been used, write us for ordering information.



McGraw-Hill
Continuing Education Center
3939 Wisconsin Ave.
Washington, D.C. 20016



By Charles D. Rakes

CIRCUIT CIRCUS

Electronic steppers take the drudgery out of sequencing circuits.

THIS MONTH OUR CIRCUS IS TAKING us in circles, around hypnotic spirals by stepping through the electronic jungle via a number of circuits that turn LED's on and off in a sequential manner. With a dab of imagination and a few *shekels*, it's possible to turn the following stepping circuits into a number of fun construction projects and hopefully, at the same time, answer a number of requests for this type of circuit.

Probably the simplest method of obtaining a stepping circuit would be to use a single-pole, multi-position rotary switch and have a tireless hand turning

the shaft to keep the sequence going. The second generation of the mechanical sequential generator would be the addition of an electric motor to drive the switch and let the little Dutch boy go on to better things. Since we are living in the computer and space age the above antiquated methods are only mentioned to illustrate the basic principle used in creating a stepping generator circuit.

Step It Up

Our first stepper circuit (see Fig. 1) uses a dandy low-cost CMOS decade counter/divider chip (CD4017) to take

the place of the mechanical rotary switch to march the LED's along in their light parade. An old friend, the 555 oscillator/timer, replaces the tireless hand to clock the counter at any desired rate without the slightest complaint or shift in cadence.

Since the 4017 is a smart chip, though not too strong in the output department, a transistor driver is required at each of the ten outputs to supply sufficient current to illuminate the LEDs. Only three LED output circuits are shown to simplify the schematic diagram and to conserve space; so just build and connect the remaining seven driver circuits to the 4017 in the same way.

The ten outputs of U2 are normally in the low state, with each output going high (one at a time) in sequence with each of the positive-going clock pulses. Each positive output turns on a transistor to light the appropriate LED. The physical layout of the LEDs can be arranged to display most any figure or pattern you desire.

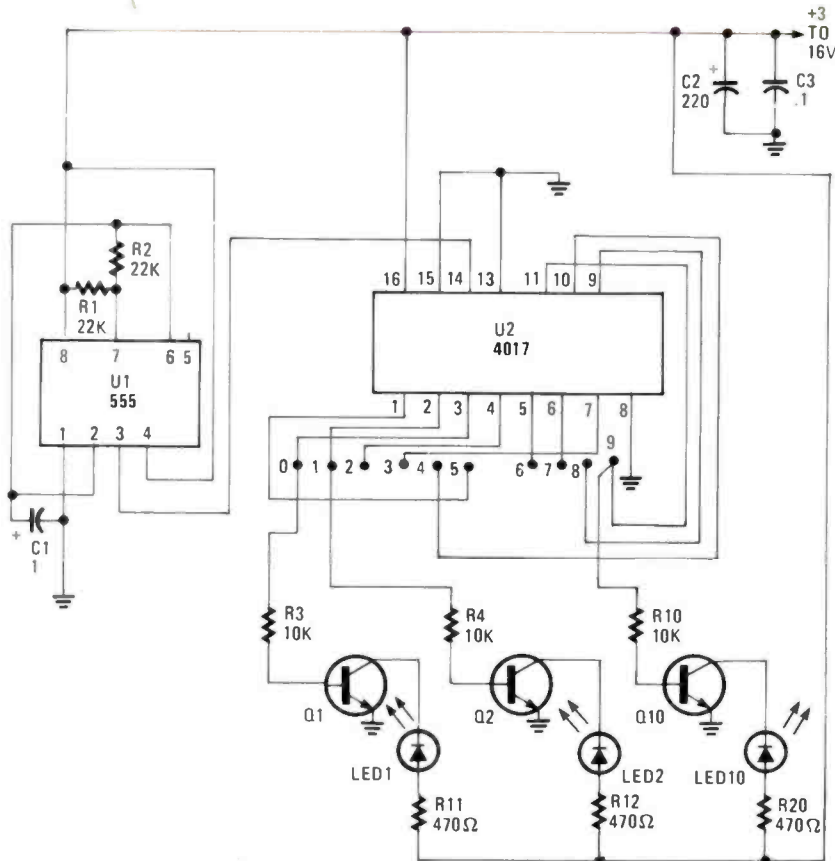

Fig. 1—The stepper circuit shown here, U1 (a 555 oscillator/timer) clocks the counter U2 (a CD4017 CMOS decade counter/divider) at any desired rate. The outputs of U2 are then used to turn on their respective driver transistors which have the task of providing sufficient current to turn on the LEDs.

PARTS LIST FOR FIG. 1

- C1—1- μ F, 25-WVDC electrolytic capacitor
 - C2—220- μ F, 25-WVDC electrolytic capacitor
 - C3—.1- μ F, 100-WVDC ceramic disc capacitor
 - LED1-LED10—Jumbo light-emitting diode (any color)
 - Q1-Q10—2N2222 general-purpose NPN silicon transistor
 - R1, R2—22,000-ohm, 1/4-watt 5% resistor
 - R3-R10—10,000, 1/4-watt 5% resistor
 - R11-R20—470-ohm 1/2-watt 5% resistor
 - U1—555 oscillator/timer integrated circuit
 - U2—4017 CMOS decade counter/divider integrated circuit
- Perfboard, IC sockets (8-pin and 16-pin) 3-to-16-volt DC power source, hookup wire, solder, etc.

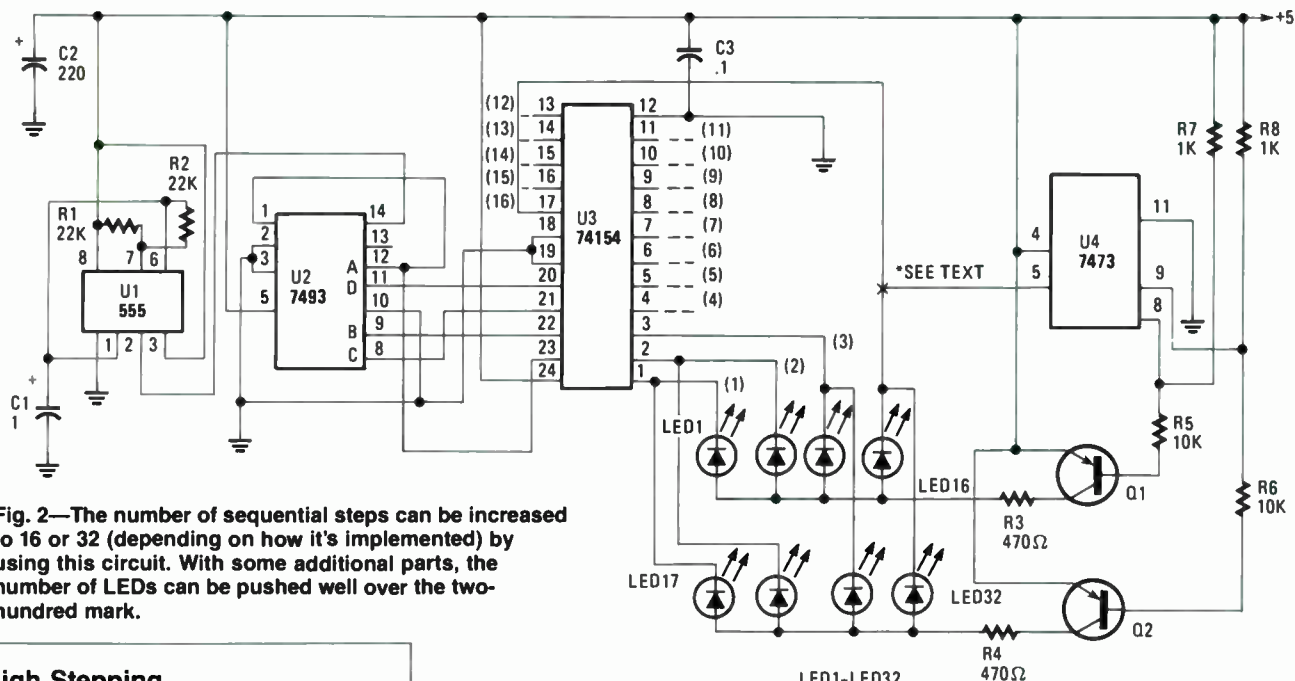

Fig. 2—The number of sequential steps can be increased to 16 or 32 (depending on how it's implemented) by using this circuit. With some additional parts, the number of LEDs can be pushed well over the two-hundred mark.

High Stepping

The circuit in Fig. 2 expands the number of sequential steps to 32 as indicated. And with some additional parts and the use of the old bean, the number of LEDs can be pushed well over the two-hundred mark. More about the expansion later. The 32-step circuit works like this: The 555 oscillator/timer (U1) sets the stepping rate and clocks U2 (a

7493 4-bit binary counter). The 4-bit binary output toggles U3 (a 74154 4-to-16 decoder/demultiplexer), to produce a sequential 1-to-16 stepped output. Transistors Q1, Q2, and a 7473 dual J-K flip-flop (U4) working together produce an additional group of 16-stepped outputs.

Whoa! I had better back-up a bit and explain how the circuit produces the first 16 steps before getting into the expanded version. If we disregard the two transistors (Q1 and Q2), the U4, and the second group of LEDs, (LED17-LED32), disconnect R3 from the collector of Q1 and connect it to the plus 5-volt bus, the circuit will operate as a 16-step generator.

The 4-bit binary counter (U2) is connected to produce a binary output that counts from 0 to 15. Take a look at the Truth Table in Fig. 3. With the first output pulse from U1 (the 555), U2 produces a 4-bit output for the binary number 1. Output A is high and B, C, and D outputs are low. That 4-bit output is decoded by U3 (the 74154 4-to-16 decoder/demultiplexer) to light LED 1. The second clock pulse changes the output of the 4-bit counter to supply a binary number 2, and so on through number 15. Yes, "0" counts toward making the total of 16 steps.

For a lesson in binary counting or if trouble occurs with the circuit, you can stop the clock by grounding pin 2 of the 555 and use your trusty voltmeter to

PARTS LIST FOR FIG. 2

- C1—1- μ F, 25-WVDC electrolytic capacitor
- C2—220- μ F, 25-WVDC electrolytic capacitor
- C3—.1- μ F, 100-WVDC ceramic disc capacitor
- LED1-LED32—Jumbo light-emitting diode (any color)
- Q1, Q2—2N3906 general-purpose PNP silicon transistor
- R1, R2—22,000-ohm 1/4-watt, 5% resistor
- R3-R4—470-ohm 1/2-watt, 5% resistor
- R5-R6—10,000-ohm 1/4-watt 5% resistor
- R7, R8—1000-ohm, 1/4-watt 5% resistor
- U1—555 oscillator/timer, integrated circuit
- U2—7493 4-bit binary counter, integrated circuit
- U3—74154 4-to-16 line decoder/demultiplexer, integrated circuit
- U4—7473 dual J-K master/slave flip-flop, integrated circuit
- Perfboard, IC sockets, 5-volt DC power source, hookup wire, solder, etc.

check the outputs of U2 and to determine which LED should be on. A low ("0") will measure zero, or very nearly so, and 1's will measure close to the positive-supply voltage. Another method you can use is to substitute a very large capacitor for C1, which will slow
(Continued on page 101)

TRUTH TABLE

555 PULSE #	7493 BINARY OUTPUT			
	D ↓	C ↓	B ↓	A ↓
0	0	0	0	0
1	0	0	0	1
2	0	0	1	0
3	0	0	1	1
4	0	1	0	0
5	0	1	0	1
6	0	1	1	0
7	0	1	1	1
8	1	0	0	0
9	1	0	0	1
10	1	0	1	0
11	1	0	1	1
12	1	1	0	0
13	1	1	0	1
14	1	1	1	0
15	1	1	1	1

Fig. 3—This Truth Table shows the sequence of events that occurs as the 7493 transforms the clock input to the 4-bit binary number that's fed to U3 (the 4-to-16-line decoder/demultiplexer) which, in turn, is used to provide sufficient drive to the LEDs through their respective driver transistors.



FRIEDMAN ON COMPUTERS

Now you can make color snapshots on your PC.

□ THE REAL STRENGTH OF ANY computer system lies not in the hardware, but in the software. All the boards, gizmos, and gimmicks that are the meat of most computer articles in the popular press are primarily faster and more convenient ways to run the *big gun* spreadsheets and databases, or yet another communications program "that finally allows you to use all the power built into your computer." Shucks, I've been getting all the power I've wanted since I got my Radio Shack TRS-80 Model I (which, by the way, is still running the best word processor ever written—and in only 48K of RAM). And I am still getting all the computer power I need for a database from an original CoCo (Color Computer) that still has the best multi-field search of any program, anywhere, anytime, on any machine.

As far as I'm concerned, the real strength of a computer is software that allows me to do something I haven't been able to do, and that's where Eastman Kodak comes in. Yes, the same Kodak of film and camera fame are now into unusual computer hardware and software applications, and we will shortly have a special feature on some of their electronic wonders. (Kodak is preparing some color "paintbox" photographs for me, because I left the ones I made for this issue at their New York show—my mind was numbed by the fantastic deserts they served).

Computer Photos

But I did remember to bring back some material on *digital photoimaging*, so that's what we'll cover this month.

Kodak's *Edicon* photoimaging system is a mug identification system; *mug* meaning a color photograph of a face, as in a "police mug shot." In fact, Kodak actually calls it a *Mug Identification System*.

Basically, the *Edicon* system is an IBM AT-type computer equipped with some proprietary boards, expanded

memory (about 3 MB), and Kodak's software. A small color video camera is interfaced to the computer through one of the proprietary boards. At the touch of a button, the computer freezes the action seen by the camera and digitizes a real-time 4-color photograph. The digital data representing the color snapshot is stored in RAM, or eventually on a disk. The disk storage can be anything from a floppy to a 364 GB Juke Box (many optical disks).

Although the storage capacity varies

according to the image size and data compression, just to give you some idea of what it all means in terms of the number of pictures that can be stored (for 25 percent screen coverage by a picture), a 30 MB Winchester drive can store 3300 images, while a 140-disk Juke Box can store 20,300,000 images.

You Tell It How

How the images are displayed is determined by the software. For example, you could fill the screen with, say, six

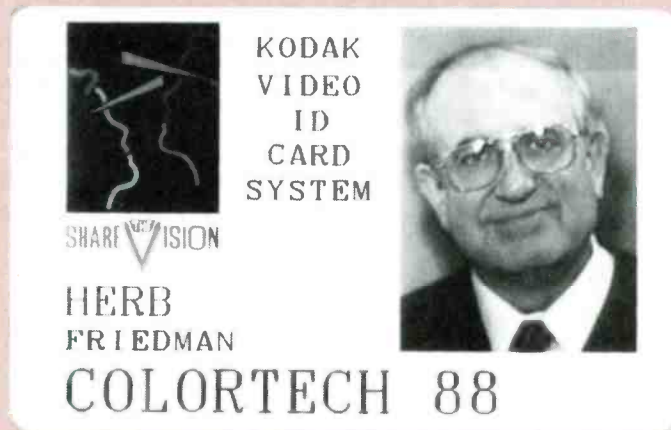

FIG. 1—Although this identification card is computer-generated, the photograph originated in a conventional TV camera, while the name and show ID was typed in.



FIG. 2—This copy of the next-made I.D. card proves there was no hanky-panky used in Fig. 1. This time out we not only changed the picture, but also the data, and even included the remainder of the operator's spelling error.

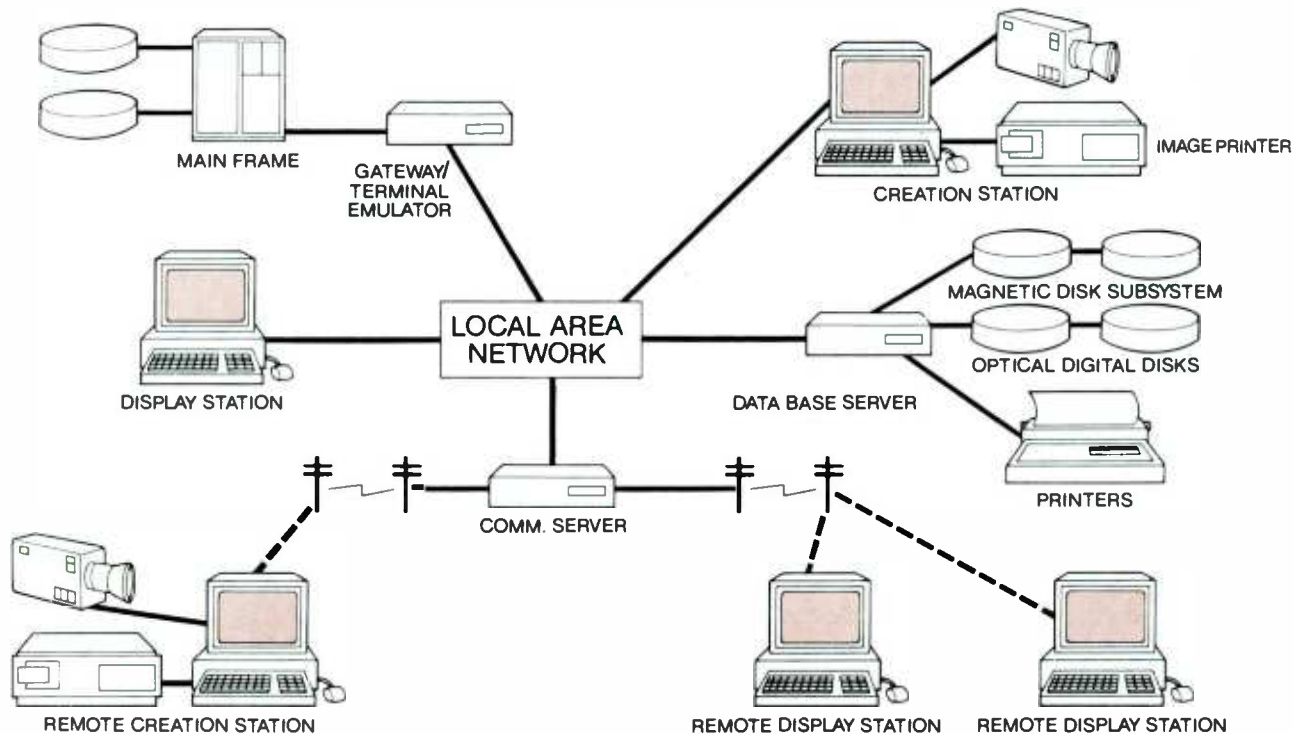

FIG. 3—As with other kinds of computer data, the digitized photographs can be stored and transmitted to many interlinking computer centers and work stations using the Kodak Edicon System.

mug shots. Alternately, you could load in a program using a game-type ROM module that will produce identification cards such as those shown in Figs. 1 and 2. (Yes, that's me.)

The program module used to make the I.D. cards preprogrammed the computer with the small graphics pattern in the left hand box, the title "KODAK VIDEO ID SYSTEM," space for the 4-color photograph, and room for three line of typographical information.

The picture and the descriptive type was generated by the operator. The fuzziness of the picture was caused by the operator trying to show me just how low a light level was needed to provide a usable image. Basically, when the picture was made there wasn't enough light by which I could comfortably read a newspaper, yet the picture quality is almost as good as that of a print made from 110 film. With more light the picture is almost "good photo" quality. I hope to be able to show you some high-quality digitized photographs the next time out.

My name and the *COLORTECH 88* I.D. was typed directly into indicated fields on the monitor screen.

Just to prove there was no hanky-panky, the operator made the I.D. card shown in Fig. 2. Even the error on the letter B in "Herb," which the operator didn't notice, was reproduced. Compar-

ing Fig. 1 with Fig. 2, you can easily see what data was preprogrammed and what was left free for real-time data.

Actually, anything or nothing can be preprogrammed. For example, the small box graphic on the left of the ID card could be a bar code for an optical scanner used to check the ID of the card holder, or even your company's logo, or your family's coat of arms. (What! Your family doesn't have a coat of arms? I'll bet you ten clams to five oysters that someone has a program that will "discover" your family's coat of arms.) And the "KODAK VIDEO..." imprint could be anything you want. You could even instantly change the entire design by simply plugging in a different or modified module.

Who Is That?

Because all data, including the photograph, is in digital form, the data can be easily exchanged using conventional computer networks. A typical system that might be used by regional, national, and international law-enforcement agencies (or, "the cops," as they were known in my younger days) is shown in Fig. 3. The telephone poles represent any kind of communications system, including international satellite radio, or yes, even telephone!

Notice that Fig. 3 shows both a conventional printer and an imageprinter in

use. The conventional printer can produce the usual dot-matrix, graphic print; which has never been known to justify any cheers. The Kodak imageprinter is something else; it's the gizmo that made the photo ID cards shown in Figs. 1 and 2. Someday, if Kodak releases sufficient info (they play everything close to the vest), we'll probably have a full-length feature on just the imageprinter, but meanwhile I'll give you the basics.

Keep in mind that the digital picture was stored as a color separation. Inside the printer is a roll containing small rectangles of black, yellow, cyan, and magenta dyes. The printer moves the yellow dye into position and the computer literally burns dots of the dye into a special paper. Then it does the same for the magenta, cyan, and black dots. The end result is an excellent color print that required no silver. Now that rates a few *huzzahs*.

The Future

Being able to store what is essentially a color-separation of any kind of picture—computer graphic or camera generated—opens up a whole new area of computer use. We'll be keeping you up to date on this new technology, because eventually it will end up as an electronic camera you can carry in your coat pocket. ■

BUILD A BCB TRAP

(Continued from page 74)

sible, then touch up the tuning by adjusting the corresponding coil in that circuit. Then repeat the process with another tuned circuit and another strong local signal. Finally, touch up all the coils a second time, since the tuned circuits may influence each other to some extent.

If one of the tuned circuits does its job too well, so that you completely lose a local signal that you only wanted to weaken a bit, try connecting a 1000-ohm resistor in parallel with the coil and capacitor. Resist the temptation to "weaken" a trap by mistuning it slightly; you may be blocking out a frequency on which you'll one day want to hear a distant station.

Practical Experience

Upon adding a BCB trap to my Bearcat DX-1000 receiver, I noticed a subtle improvement in reception on many frequencies, not just the ones on which I had noticed problems. Sound quality is better, and there is less noise. One of the BCB signals I'm blocking out is extremely strong (S9 + 80 dB), and it's quite possible that it was impairing the overall performance of the receiver.

Although I've included a toggle switch to take the trap

out of the circuit, I have never used it. Even for BCB DX'ing, I prefer to leave the trap on; although most of the broadcast band suffers some attenuation, this is more than made up by the elimination of noise from local stations. My parallel-tuned traps are set to 960 and 1340 kHz; there is no measurable attenuation below 600 or above 3500 kHz. ■

PARTS LIST FOR BCB TRAP

BP1, BP2—Multi-way binding post for antenna system and receiver connections

C1, C2—5-150-pF, trimmer capacitor (Radio Shack 272-1339)

L1, L2—0.63-millihenry, oscillator coil (Digi-Key TK201, or salvage from old pocket transistor radio)

S1—SPST, miniature toggle or slide switch

Plastic enclosure, perfboard or PC circuit board (Radio Shack 270-291), hardware, wire, solder, labels, etc.

Note: The oscillator coil is available as catalog number TK201 from Digi-Key Corporation, PO Box 677, Thief River Falls, MN 56701, for \$1.35, or ten for \$11.25, plus a service charge of \$2.00 for orders under \$10, or 75 cents for orders between \$10 and \$19.99. Minnesota residents must add 6% sales tax.

BOOKSHELF

(Continued from page 24)

imagine with the expert guidance of electronics expert Robert Iannini.

Here, you'll find plans for such fascinating devices as a high sensitivity laser light detector, a high voltage laboratory generator that's useful in all sorts of laser, plasma ion, and particle applications as well as for lightning displays and special effects, a solid-state gallium arsenide injection laser system capable of producing 4-to 30-watt peak power infrared pulses at 200 to 2500 pulses per second, an infrared viewer that has functions ranging for nighttime surveillance to viewing IR laser beams.

Interested in a project that shows how to modulate a laser beam for voice communication? Then you can build a voice modulation device for a helium-neon laser that's an ideal partner for the optical light detector and voice receiver projects.

The book contains 255 pages and costs \$15.95 from Tab Books Inc., Blue Ridge Summit, PA 17214.

Mastering Turbo Pascal Files By Tom Swan

The book demonstrates how to produce full-scale, integrated, power-user-type programs that use the graphics, database access, cursor control, editing, menus, and windows.

Swan's unique and often humorous writing style presents each programming

line with special "play-by-play" descriptions. Dozens of complete, tested, practical programs, including a disk mass duplicator, are covered in the book's 320 pages, as is Swan's personal collection of file programming packages.

Topics covered include: file fundamentals, in sequence and at random, text and the single character, files in the raw, directing the directory, problems of a sort, searches for tomorrow, multi-user mysteries.



CIRCLE 95 ON FREE INFORMATION CARD

Mastering Turbo Pascal Files retails for \$18.95 and is available at bookstores, electronics distributors or direct from the publisher SAMS, 4300 West 62 St., Indianapolis, IN 46206.

Free (and Almost Free) Software for the Macintosh By Robert C. Eckhardt

This book is an authoritative, comprehensive catalogue of public-domain, shareware, and user-supported software for the Macintosh. Robert Eckhardt, Macintosh author and expert, gives de-

tailed and informed descriptions of more than 1,000 programs, rates each in terms of quality and value, and explains where and how the programs can be obtained.

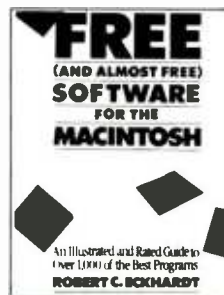

CIRCLE 68 ON FREE INFORMATION CARD

Here is the entire range of public-exchange software: desk accessories, graphics, animation, music, speech, games, education, business, utilities, and tele-communications.

Here too is a complete catalogue of the almost 300 text, display, and decorative fonts, including foreign-language fonts and a wide variety of picture fonts, that can be used in everything from personal correspondence to desktop-publishing.

It is illustrated with almost 600 representative screen shots, with a worldwide listing of Mac users groups and Macintosh-oriented computer bulletin boards, and it contains 394 pages. It is available for \$19.85 from Crown Publishers, Inc., 225 Park Avenue South, New York, NY 10003. ■

SAXON ON SCANNERS

(Continued from page 88)

intersystem frequencies on your scanner to see what they have to offer.

Trunked

Not only are elephants *trunked*, so are some of the newer 800-MHz communications systems. It's a word that's being heard with some regularity, and readers have written to ask for some idea of what it's all about.

So-called *trunked* systems use a block of several frequencies (maybe even a dozen, depending upon the number of mobile units in the system). The trunked system allows conversation between two stations, as it progresses, to hopscotch across several or all of the authorized frequencies licensed to the system—all of that at the direction of computers that select and shift the frequency of each individual transmission.

A municipal agency with a trunked system could well be using the same block of frequencies for mixing together various agencies from the police and fire people to the street-cleaning and dog-catching departments. While it does provide a measure of communications privacy, it is primarily intended to provide more efficient frequency usage. Monitoring trunked systems on a home scanner, as you might imagine, is hairy.

Winners

The folks at Regency Electronics have just announced the winners in their *Scanner Answer Giveaway Contest*. Some 25,000 entries were received, and although a bunch of secondary prizes were awarded, there was only one Grand Prize winner, and that was Charles Tenwick, El Cajon, CA. For answering all of the contest questions correctly and having his name randomly selected from all who sent in correct answers, Charlie won a complete monitoring package—consisting of a Regency Z-60 base scanner, a Regency HX-1500 handheld scanner, a Regency R806 mobile scanner, and a GDX-4 all-band scanner antenna.

Congratulations, Charlie! Lots of scanner enthusiasts wish they had your luck (along with your prizes).

Army-Type Question

Capt. Scott A. McFarlane, who is stationed overseas, asks if there is any equipment available that will enable him to monitor 55- to 88-MHz FM



The Regency "Scanner Answer Giveaway" winner, Charles Tenwick of El Cajon, California, was selected from more than 25,000 entries by: Ron Cooper (left), Vice President of Sales and Marketing for Regency Electronics; Marketing Services Assistant Elaine Lee (center); and Regency President and CEO Joseph E. Boone (right).

transmissions, a band that (in North America) is normally thought of as being used mostly for TV broadcasting and highway callboxes. Capt. McFarlane says those frequencies are also used for two-way communications by the U.S. Army.

Some of the newer breed of scanners cover those frequencies, in fact all frequencies from 25 MHz straight through to over 1000 MHz. In particular, we were thinking along the lines of the Realistic PRO-2004 and several others that seem to be able to pick up big chunks of the frequency spectrum.

Help

Bob Stout, Jr., PO Box 11611, Shorewood, WI 53211 asks our readers

to help him out. Can anybody give him information on a scanner that can interface with a home computer, such as a Commodore 64? He says he knows about the old Compuscan 2100, but that unit became available a while back. If anybody has any thoughts, please contact Bob directly.

For our own help request, we are always looking for your letters, questions, suggestions, photos, thoughts, ideas, comments, tips, and techniques. Write to the attention of Marc Saxon, *Saxon on Scanners, Hands-on Electronics*, 500-B Bi-County Boulevard, Farmingdale, NY 11735. And we do want to thank you all for your continuing enthusiasm and support for these pages! ■



"It's a good thing, John, I bought this book last week."

HAMSHACK NOSTALGIA

(Continued from page 61)



For the CW operator! The sounder and key on the left are from the wire-telegraph days. A McElroy and a J-5 flameproof are on the right. You can hook these up today.

little gem to get off-the-air code practice—which was all it was intended to do.

No shack is complete without a few old keys or bugs and some are shown in Photo 7. From left to right we have an old wire telegraph sounder, a "polechanger" key, a McElroy straight key, and a J-5 flameproof. None of these is especially rare or valuable and they can be found at many hamfests.

The device in Photo 8 is what I think was the first commercial electronic keyer, the Mon-Key. No self-completing dits or



The first commercial keyer, the Mon-Key from the early post-war years. Keyers have come a long way since then.

dahs on this one and the memory was between your ears.

Photo 9 shows a selection of old books and magazines. They make nice display items and are fun to read. They're dirt cheap at hamfests.

There are many other possibilities. If you're a 'phone person, how about a few old microphones?

If you're into solid-state, how about a board with some of the early transistors? The first low-cost transistor was the Raytheon CK722, introduced in 1953 for the give-away price of only \$7.50! Try and find one today!

Like the captain of a modern supertanker whose office is decorated with models of old sailing ships, a few mementos of radio's past is a nice addition to that special place, the hamshack.



A few old books and magazines can dress up the shack—and they're fun to read. You'll be surprised at how many non-hams will pick them up to look at.



\$350

NEW IDEAS

**42 PROJECTS
COMPLETE PARTS LISTS
ONE-EVENING PROJECTS
EASY TO BUILD**

■ **NEW IDEAS** is packed with 42 practical circuits for the Electronics Experimenter and Project Builder. In addition to the headlight alarm, the voltage freezer, and the remote telephone ringer, you get complete plans for a simple Tesla coil project that can generate 25,000-volts AC and draw one-inch sparks. Other interesting projects are: a sound-effects generator, a crystal tester, a stereo remote control, and much, much more! Each project was selected for its low cost of parts!

■ **WANT TO EXPAND** your knowledge of electronics? Build gadgets that only you can have on your block? Acquire a library of projects? **NEW IDEAS** is the gold mine of circuits you should own and read. You could start the first night building a project that will have others praising what it can do and admiring you for building it.

■ **THERE ARE PROJECTS** for everyone—automotive, household, test equipment, audio and hi-fi, and projects just for fun.

NEW IDEAS—Circuits for Experimenters and Project Builders!

Please send one copy of **NEW IDEAS** at \$3.50. First Class postage and handling \$1.00 (U.S. and Canada only). All other countries: \$2.00 for sea mail, \$3.00 for air mail.

Please send _____ copies of New Ideas. Total cost is sum of copy price and First Class postage and handling cost multiplied by number of issues ordered.

Please print

Allow 6-8 weeks for the material to arrive.

Detach and mail today:
HANDS-ON ELECTRONICS
Reprint Department
500-B BI-County Boulevard
Farmingdale, NY 11735

(Name) _____

(Street Address) _____

(City) _____

(State) _____

(Zip) _____

All Payment must be in U.S. Funds!

H-588

This will be coming to you when you subscribe to **Radio-Electronics**

- **HELPFUL CONSTRUCTION ARTICLES...**
 - Test Equipment
 - Hi-Fi Accessories
 - Telephone Accessories
 - Music Synthesizers
 - Computer Equipment
 - Automotive Equipment
 - Intruder Alarms- Home & Car
 - Video Accessories

- **NEWS ON NEW TECHNOLOGY**
 - Computers
 - Microprocessors
 - Satellite TV
 - Teletext
 - Automotive Electronics
 - Speech Synthesizers
 - IC Applications

- **FASCINATING "HOW TO DO IT" ARTICLES...**
 - Build Your Own Projects
 - Make Your Own PC Boards
 - Wiring Techniques
 - Soldering and Desoldering
 - Design and Prototyping



- **HOW YOU AND THE COMPUTER CAN BE FRIENDS...**
 - Getting Started
 - Programs, Circuit Design, Games
 - A/D-D/A Interfacing
 - Peripheral Equipment
- **NEW AUDIO DIMENSIONS FOR YOUR PLEASURE...**
 - Noise-Reduction Devices
 - How to Connect that Extra Add-On
 - Hi-Fi Accessories
 - New Technology
- **TV WONDERS FOR YOUR FUTURE...**
 - Latest Receivers and Circuits
 - The Home Entertainment Center
 - Projection TV
 - Satellite TV Receivers
 - Jack Darr's Monthly Service Clinic
 - Service Problems and Solutions
- **REGULAR MONTHLY FEATURES**
 - DESIGNERS NOTEBOOK by Robert Grossblatt
 - HOBBY CORNER by "Doc" Savage, K4SDS
 - STATE-OF-SOLID-STATE by Bob Scott
 - WHAT'S NEWS, new products, stereo news and NEW IDEAS, STEREO PRODUCTS, NEW COMPUTER PRODUCTS FOR HOME/JOB and MUCH MORE!

Radio-Electronics covers all aspects of the fast moving electronics field...featuring **COMPUTERS • VIDEO • STEREO TECHNOLOGY • SERVICE COMMUNICATIONS • PROJECTS**

Get it all!

Subscribe today to **Radio-Electronics**! Don't miss a single issue and...see subscription card in back of this issue for big savings.

When you select one of the subscription offers listed on the handy coupon—you'll be assured of having your copy reserved, even if it sells out on the newsstand. Make sure you get all the excitement in every issue of **Radio-Electronics**, every month, by filling in and mailing your subscription card today.

ANTIQUE RADIO

(Continued from page 85)

evident. Because of some unique electrical characteristics related to the construction of screen-grid tubes, tuned circuits using them (even very selective ones) often couldn't separate closely-spaced stations.

The problem (caused by an effect called "cross-modulation") was corrected by redesigning the wire coil forming the control grid so that spacing between turns was non-uniform. And the design change had a very useful side effect. The amplification of a tube with the new-style control grid could be smoothly controlled by varying the DC-bias voltage applied to the grid. Tubes of this kind are called *variable-mu*, *remote-cutoff*, or *super-control* amplifiers.

The variable-amplification feature paved the way for the design of efficient automatic-volume-control (AVC) circuits. Such circuits would reduce amplification when strong local stations were being received, preventing overloading of the radio, while making maximum gain available during reception of weak signals. Prior to the introduction of automatic volume control, overloading by local stations could be handled only by crude methods such as the use of a local-distance switch or a signal-control potentiometer wired into the set's first RF stage.

Incorporation of the variable- μ feature was the final stage of development of the screen-grid tube. The first variable- μ tetrodes hit the market in 1931. RCA called its version the type 35; other manufacturers produced a vir-

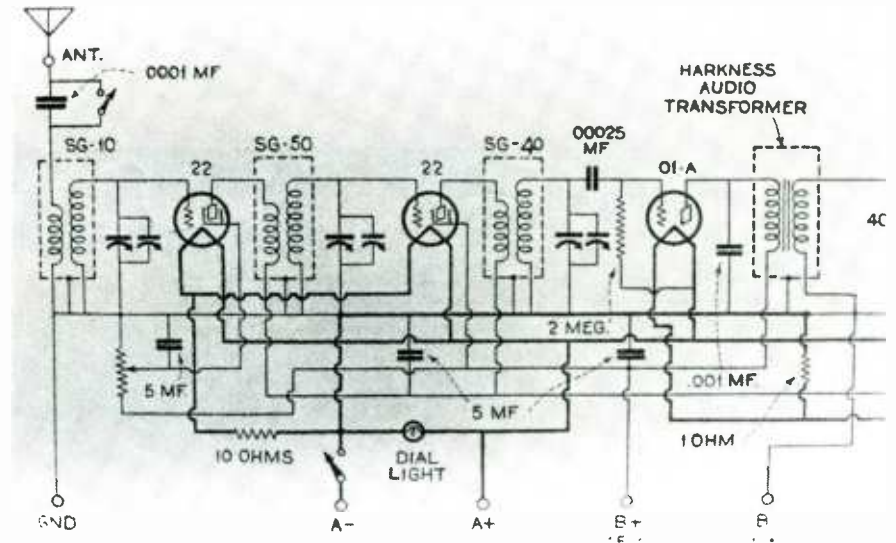

The Harkness battery-operated radio described in July, 1929 *Radio-Craft* used two type 22's in the front end. The detector vacuum tube was an 01-A.

tually identical tube, but called it the type 51. These were tubes with cathodes and 2.5-volt heaters like those of the types 27, 24, and 24A. The type 51 was discontinued not long after its introduction. But for many years, manufacturers of replacement tubes labeled the type as "35/51."

Advanced though it was, the 35, 51 or 35/51 is another tube that saw relatively limited use. Tetrodes as radio-frequency amplifiers were being made all but obsolete by the development of the *pentodes*, a new class of tubes that began to appear in the early 1930's. But that's a subject for another column!

See you next month and, as always, your comments and suggestions are most welcome. I use 80-90% of the letters I receive, so if you've asked a question or made a comment you'll

probably eventually see a response in print. But you may have to be patient. I usually don't handle the letters until a number have accumulated and I have room to accommodate them. On top of that, each issue of **Hands-On Electronics** is put together well ahead of the time it hits the streets. Regretfully, I can't send personal answers to individual letters. The volume of mail and my limited available time just don't permit it!

I have quite a few very interesting letters awaiting some attention right now, so don't be surprised if the next column turns out to be another "let's open the mailbag" session. In the meantime, please write to me Marc Ellis, c/o **Hands-On Electronics**, 500-B Bi-County Blvd., Farmingdale, NY 11735. ■

SERVICING GARAGE-DOOR OPENERS

(Continued from page 48)

switch and wiring when the manual operation does not seem to function.

Last Minute Tips

1. Check the batteries within the transmitter with weak or no operation of GDO. Replace with heavy duty batteries.
2. At least every six months oil the door hinges and pulleys, for easy operation.
3. Keep the short antenna of the receiver pointing downward so the transmitter can trigger the motor assembly.
4. If the garage door is found open, without the use of the transmitter, change the frequency code.
5. To prevent lightning or power-line outage damage to the motor control unit, plug the AC cord into an AC transient-surge protector or place metal-oxide varistors on the AC cord inside the motor control assembly.
6. When servicing the GDO assembly, always disconnect the

opener from the electrical power line.

7. If you cannot repair or service the GDO units, send the receiver board or transmitter to the dealer or service depot. Check the manufacturer's literature if in doubt.

8. Make sure the safety or vacation switch has not been switched off preventing the GDO from operating either manually or with the transmitter. ■



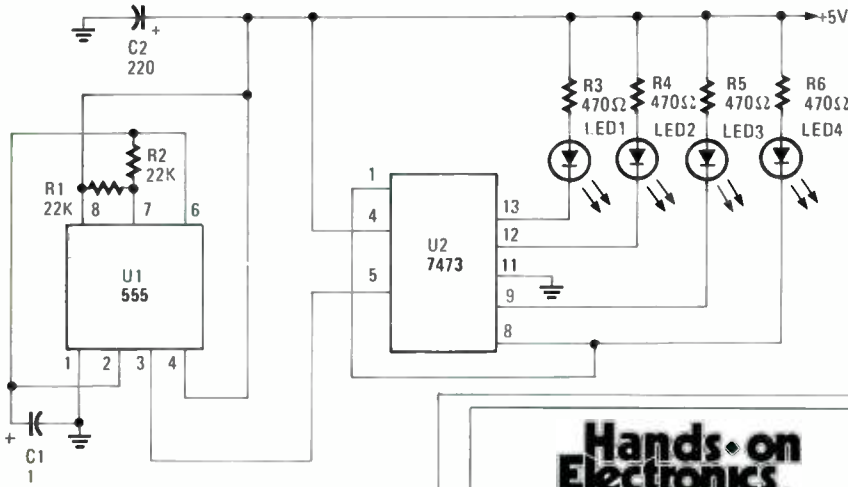

Fig. 4—Shown here is a simple LED dual-rate flasher circuit. The two LEDs, connected to pins 8 and 9 of U2 (a 7473 dual J-K master/slave flip-flop) will flash twice as often as the two LEDs connected to pins 12 and 13.

the clock down to a very slow crawl, giving you time to check the outputs of the U2 to determine the step position.

Now forward to 32 and back to Fig. 2. If we take the positive pulse from any one of the 1-to-16 outputs of U3 and connect it to the clock input of U4 (half of the 7473 J-K flip-flop) the outputs of the flip-flop would change state every 16 pulses. Since the two outputs of the flip-flop are always opposite, only one of the transistors (either Q1 or Q2) would be biased on at a time allowing a string of 16 LEDs to light in a row. After the first count of 16, the U4 receives another pulse that turns off the first transistor and turns on the second transistor to light the second row of 16 LEDs.

Only 8 of the LEDs are shown in the schematic diagram in Fig. 2, so you'll need to add the remaining LED's to the other outputs of U3.

Ideas on expanding the count. Here's where the fun really starts. If we added another 7493 IC and connect its clock input to one of the outputs of the 74154, to give an output change every 16 counts. Right! Now connect the output of the second 7493 to another 74154 and it will take 256 clock pulses to run through the 16 outputs of the second 74154.

Take 16 rows of 16 LEDs and connect them to the outputs of the first 74154. The outputs of the second 74154 will need to be connected to transistor switches, like Q1 and Q2 in Fig. 2, to turn on each string of the 16 LEDs. Try

it. It just might work. By the way, how many LEDs could be placed in a string if we added a 7473 to the circuit in the way it was done in Fig. 2?

Double Stepping

Figure 4 shows a simple LED dual-rate flasher circuit. The two LEDs that are connected to pins 8 and 9 of the 7473 will flash twice as often as the two LEDs connected to pins 12 and 13. If the four LEDs are located together in a small area, and the clock rate is made adjustable, it can be a real challenge to determine the sequence of events. ■

Hands-on Electronics

REPRINT BOOKSTORE

- | | |
|---|--|
| <input type="checkbox"/> SP1 Special Projects #1 (Winter 1980) . . . \$6.00 | <input type="checkbox"/> 106 Radio-Electronics back issues (1986) . . \$3.75 |
| <input type="checkbox"/> SP4 Special Projects #4 (Summer 1982) . . \$6.00 | Write in issues desired. |
| <input type="checkbox"/> SP5 Special Projects #5 (Winter 1983) . . . \$6.00 | <input type="checkbox"/> 105 Radio-Electronics back issues (1985) . . \$4.25 |
| <input type="checkbox"/> SP6 Special Projects #6 (Spring 1983) . . . \$6.00 | (Jan. 85 not available) |
| <input type="checkbox"/> SP7 Special Projects #7 (Summer 1983) . . \$6.00 | Write in issues desired. |
| <input type="checkbox"/> SP8 Special Projects #8 (Fall 1983) . . . \$6.00 | <input type="checkbox"/> 104 Radio-Electronics back issues (1984) . . \$5.25 |
| <input type="checkbox"/> SP9 Special Projects #9 (Winter 1984) . . . \$6.00 | (December 1984 issue is not available) |
| <input type="checkbox"/> SP10 Special Projects #10 (Spring 1984) . . \$6.00 | Write in issues desired. |
| <input type="checkbox"/> 111 Hands-On Electronics #1 . . . \$5.00 | <input type="checkbox"/> 103 Radio-Electronics back issues (1983) . . \$5.50 |
| <input type="checkbox"/> 112 Hands-On Electronics #2 . . . \$5.00 | (Jan., Feb., May are not available) |
| <input type="checkbox"/> 113 Hands-On Electronics #3 . . . \$5.00 | Write in issues desired. |
| <input type="checkbox"/> 114 Hands-On Electronics #4 . . . \$5.00 | <input type="checkbox"/> 102 Radio-Electronics back issues (1982) . . \$5.75 |
| <input type="checkbox"/> 115 Hands-On Electronics #5 . . . \$5.00 | (Jan., Feb.) is not available) |
| <input type="checkbox"/> 115A Hands-On Electronics #6 . . . \$4.50 | Write in issues desired. |
| <input type="checkbox"/> 116A Hands-On Electronics (Jan-Feb '86) . . \$4.50 | <input type="checkbox"/> 153 Etch your own PC boards . . . \$3.00 |
| <input type="checkbox"/> 116B Hands-On Electronics (Mar/Apr '86) \$4.50 | <input type="checkbox"/> 154 How to Repair VCR's . . . \$3.50 |
| <input type="checkbox"/> 116C Hands-On Electronics (May/Jun '86) \$4.50 | <input type="checkbox"/> 155 IBM Typewriter to Computer . . . \$3.00 |
| <input type="checkbox"/> 116D Hands-On Electronics (Jul/Aug '86) . . \$4.50 | <input type="checkbox"/> 125 Radio-Electronics Annual 1985 . . . \$5.95 |
| <input type="checkbox"/> 116E Hands-On Electronics (Sep/Oct '86) . . \$4.50 | <input type="checkbox"/> 126 Radio-Electronics Annual 1986 . . . \$4.95 |
| <input type="checkbox"/> 116K Hands-On Electronics (Nov '86) . . . \$4.00 | <input type="checkbox"/> 156 How to Make PC Boards . . . \$2.00 |
| <input type="checkbox"/> 116L Hands-On Electronics (Dec '86) . . . \$4.00 | <input type="checkbox"/> 157 All About Kits . . . \$2.00 |
| <input type="checkbox"/> 117 Hands-On Electronics (1987 back issues) . . . \$3.75 | <input type="checkbox"/> 158 Electro Importing Co. Catalog (1918) . . \$5.95 |
| Write in issues desired | <input type="checkbox"/> 159 Low Frequency Receiving Techniques |
| <input type="checkbox"/> 118 Hands-On Electronics (1988 back issues) . . \$3.50 | Building and using VLF Antennas . . . \$6.00 |
| Write in issues desired | <input type="checkbox"/> 160 New Ideas - 42 Circuits . . . \$3.50 |
| <input type="checkbox"/> 150 TV Descrambler . . . \$3.00 | <input type="checkbox"/> 161 Descrambling (Feb., 1984) . . . \$3.00 |
| <input type="checkbox"/> EH87 Experimenters Handbook . . . \$3.95 | <input type="checkbox"/> 162 Build Your Own Satellite TV Receiver \$7.00 |
| <input type="checkbox"/> 152 8-Ball Satellite TV Antenna . . . \$5.00 | <input type="checkbox"/> 163 Receiving Satellite TV . . . \$7.00 |
| <input type="checkbox"/> 108 Radio-Electronics (1988 back issues) . . \$3.00 | <input type="checkbox"/> 164 Modern Electrics (April, 1908) . . . \$3.00 |
| Write in issues desired | <input type="checkbox"/> 165 How to Repair CD Disc Players . . . \$5.00 |
| <input type="checkbox"/> 107 Radio-Electronics back issues (1987) \$3.25 | <input type="checkbox"/> 166 Collected Works of Mohammed Ulyses Fips (62 pages, April Fools Collection) . . . \$7.50 |
| | <input type="checkbox"/> 167 Designing With IC's . . . \$4.00 |

To order any of the items indicated above, check off the ones you want. Complete the order form below, include your payment, check or money order (DO NOT SEND CASH), and mail to Hands-on-Electronics, Reprint Department, P.O. Box 4079, Farmingdale, NY 11735. Please allow 4-6 weeks for delivery.

If you need a copy of an article that is in an issue we indicate is unavailable you can order it directly from us. We charge 50¢ per page. Indicate the issue (month & year), pages and article desired. Include payment in full, plus shipping and handling charge. Make checks payable to Gernsback Publications, Inc.

ARTICLE _____		
PAGES _____	MONTH _____	YEAR _____
TOTAL PAGES _____	@50¢ each	TOTAL PRICE _____

MAIL TO: Hands-on-Electronics
 Reprint Bookstore, P.O. Box 4079, Farmingdale NY 11735

SHIPPING CHARGES IN USA & CANADA

\$0.01 to \$5.00 \$1.00	\$30.01 to 40.00 \$4.75	SDRRY — We only ship to USA & Canada
\$5.01 to \$10.00 \$1.75	\$40.01 to 50.00 \$5.75	
\$10.01 to 20.00 \$2.75	\$50.01 and above . . . \$7.00	
\$20.01 to 30.00 \$3.75		

Total price of merchandise _____ \$
 Sales Tax (New York State Residents only) _____ \$
 Shipping Charge (see chart) _____ \$

Name _____ Total Enclosed _____ \$
 Address _____
 City _____ State _____ Zip _____

H5-88

TAME THE DOS TIGER

(Continued from page 76)

use it if your programs have trouble locating data and overlay files. (Incidentally, another program called DPATH is marketed commercially; the two programs are completely unrelated.)

Often when installing a new piece of software, you must change your path temporarily. You can always type in a complete new path specification, do whatever you have to do, and then re-type the old path. However, there's an easier way: PATHEDIT.COM, a path editor (included on the DOS Tool Kit disk). It allows you to use the normal DOS editing keys (F1, F2, F3, Ins, Del and the Left and Right arrow keys) to edit your path. To see how it works, invoke the program and press F3 (which displays everything from the current position to the end of the string). Used in conjunction with CED, COM, discussed next, PATHEDIT.COM makes path editing becomes a snap.

Command-line Editing

The next program in the AUTOEXEC.BAT file is called CED, for Command-line *ED*itor. (It's on the DOS Tool Kit disk.) You load the program once, normally in your AUTOEXEC.BAT file. Using the cursor-pad keys, you can move left and right by character, by word, and to either end of the line. You can also insert and delete characters anywhere on the command line, and clear to the end of the line from the current cursor position.

CED also maintains a stack of recently issued commands; you can scroll through the stack using the up and down arrow keys. CED makes entering, editing, and experimenting with long PROMPT strings (like that shown in Fig. 3) a snap. You only have to type the prompt in once; thereafter, you can scroll through the command stack to edit and re-edit the original prompt string until it's perfect.

REBUILD YOUR DOOR CHIMES

(Continued from page 36)

As shown in Photo D, remove the plungers by pulling them out on the same side as their springs. Notice that the top plunger has lost its rubber striker tip; which is the reason the front door was announced with a barely-heard "tink."

Photo E shows the difference between the new and the old. At the top is the old plunger, with one rubber striker missing. Below is its replacement, which has plastic long-life strikers. Notice how the springs are barely secured at one end. Make certain the new plungers are installed so that the springs are compressed when the electromagnetic pulls in the plungers.

Before installing the new plungers, as shown in Photo F, use a Q-tip soaked in cleaning fluid or alcohol to clean out the electromagnet's tubes: The black goo is years of accumulated dust and grease that can jam the plungers. Whatever you do, do not oil the plungers or their tubes, nor use an oil-based cleaner. Any kind of oil in the tubes will jam the plungers, or attract enough dust to cause the plungers to jam.

The plungers are not interchangeable. As shown in Photo G, make certain that the plunger having the flat striker tip is used for the rear door. (You'll see why shortly.) Place both plungers slightly into the electromagnetic assembly and replace the assembly by snapping it into the chime's base.

CED does some other nice tricks. For example, you can use it to define "synonyms" or abbreviations for often-used commands. You probably issue the command "CDIR A:" dozens of times per day. With CED you can define a short synonym—or several for different drives:

```
CCED SYN DA
DIR A:
CCED SYN DB DIR B:
CCED SYN DC DIR C:
```

Thereafter, when you type "CDA" you'll get a directory of drive A:, and, similarly, "DB" and "DC" will give you directories of drives B: and C:, respectively. A commercial version of CED (called PCED, Professional CED) with many enhanced features is being marketed; see the sidebar for information.

Disk Cache

The next line in our sample AUTOEXEC.BAT file sets up a disk cache. A disk cache is similar to a RAM disk, in that it retains disk information in RAM, in the hope that DOS will be able to retrieve it quickly from memory, rather than slowly from disk. But whereas a RAM disk emulates a disk at a high level, allowing you to copy and delete files, etc., a disk cache keeps copies of individual sectors in memory. Some sectors that are used often—the directory and FAT tracks of a hard disk, for example—would be kept in memory by a disk cache, whereas a RAM disk would have no effect. The disk cache program is included on the DOS Tool Kit disk.

Conclusions

In the process of booting, DOS uses two files, CONFIG.SYS and AUTOEXEC.BAT to set DOS parameters, load device drivers, and load RAM disk, disk cache, and other programs. Learning how to set up those two files will increase productivity, save computer time, and increase satisfaction. ■



A metal stop prevents the rear-door plunger from ever striking the second tone bar, thus you hear one tone.

The pointer in Photo H indicates that the striker of the front door plunger is actually resting on a tone bar. It returns and strikes the bar when the front bellswitch is released.

In Photo I, the pointer shows the metallic stop that prevents the rear door's plunger from striking the tone bar when the bellswitch is released. Notice that the flat striker tip rests against the stop. If the plungers are in their correct locations—and they should be—simply re-install the chime. ■

LETTER BOX

(Continued from page 6)

matching transformers suffice? Please advise.

—M.H., New York NY

While tape inputs adjust the equalization of a tape deck for flat frequency response, the auxiliary input on a stereo system does not. I would suggest you hook your Walkman up to the auxiliary input of your stereo and adjust its volume for clear sound without overdriving the stereo-input stage.

Some portable tape players boost the lower frequencies to compensate for poor bass reproduction in the earphones. Adjust the stereo bass control according to your unit and your ear.

Going Buggy

I am in need of some assistance in getting a program to run which I copied from the November 1986, **Hands-On Electronics**. It is on page 64 in the article entitled "Make Your Own Calendar" by Jeff Holtzman. Were there any errors in the original program? The program seems to form the calendar correctly, but the header is incorrect.

I am enclosing a copy of the top section of the calendar which my copy of the program is currently printing. As I am not a programmer, I don't know where to begin to play with the program. Everything seems to be typed correctly. My system is an IBM PC/XT with BASIC and BASICA available.

—J.G.B., San Jose, CA

Sometimes, the best way to debug is to re-enter. It takes far less time to type in suspect sections than to trace the trouble throughout a program. Since the article was printed a while ago I suspect you've probably spent more time trying to debug than necessary. Enter in the Format Header section first, and if the same problem results try the Format Name section. There is no simpler or more helpful advice we can give.

Bug off

When I received the February issue I just had to enter the "Date Calculation Software" program. When I gave it my leap year tests, it passed on one and failed on the other. The days between dates appears OK when passing through leap years, but the program doesn't reject the years 1700, 1800, 1900, 2100, 2200 and 2300 as leap years when the Day of the Week part of the program is used. Only the century years divisible by 400 are leap years. If the following line is added to the program, it will reject February 29 on those years also:

641 IF M = 2 AND D = 29 AND

(Y = 1700 OR Y = 1800 OR Y = 1900 OR Y = 2100 OR Y = 2200 OR Y = 2300) THEN PRINT Y; "IS NOT A LEAP YEAR" :GO TO 560

If anyone is planning a picnic further into the future than 2499 line 641 can be extended by adding OR Y = 2900, etc. in the parenthesis.

I know I'll get static on this statement but I'd like to see some BASIC computer programs in HOE that are electronic activist in nature. Like one that ties in with a Communication Receiver and converts Morse code to letters on the monitor.

—D.K.B., Snohomish, WA

Thanks for the correction. I'd like to see an addendum to the program that avoids the problem in the first place, rather than patch over it. If you've got one it would really make you a hit with the other readers.

Tube Tied

Your reply in the February issue to G.Y. may be correct, but it left a bit to be desired. First of all, an outfit which requires a \$50 minimum order is obviously trying to tell you that they do not want hobbyist business. I, for one, refuse to do business with such firms, and I would suggest that you do not encourage your readers to support such blackmail.

Electron tubes are still available from a number of sources which have much more reasonable order minimums. Since your magazine did not list them, I will. They include:

Antique Electronic Supply
688 W. First St.
Tempe, AZ 85281

FALA Electronics
PO Box 1376-2
Milwaukee, WI 53201

Cornell
4215 University
San Diego, CA 92105

Kirby
298 W. Carmel Dr.
Carmel, IN 46032.

It would be to your advantage to list those sources, and ask your readers to mention Hands-on.

—C.M., Memphis, TN

Consider them listed. By the by, there was another reader (K.S., Sandusky, OH) who supplied us with an address of yet another company with tubes:

Elmira Electronics, Inc.
PO Box 4230, Southside Station
Elmira NY 14904

Their telephone number for orders is 800/847-1695. Thanks to both of you, and as C.M. says, mention **Hands-on Electronics**.

BUILD-IT BOOKS FOR EXPERIMENTERS

Modern Op Amp Projects



◀ **BP106—MODERN OP-AMP PROJECTS . . . \$5.00.** Wide range of build-it projects that use op-amps. Easy to build board layouts provided for most. A variety of projects of all kinds are included.

◻ **# 223—PROJECTS USING THE CA3130 . . . \$5.00.** 50 different ways to put this op-amp to work including audio, RF, test equipment, household and miscellaneous projects.



IC 555 Projects



◀ **BP44—IC 555 PROJECTS . . . \$5.95.** Included are basic and general timer circuits, automobile and model railroad circuits, alarms and noise makers, as well as a section on 556, 558, and 559 timers.

◻ **# 224—50 CMOS IC PROJECTS . . . \$5.25.** These IC's are suitable for an extraordinary range of applications. This book shows you just how much you can do with them.



Second Book of CMOS IC Projects



◀ **BP59—2ND BOOK OF CMOS IC PROJECTS . . . \$5.00.** Still more ways to use these versatile devices. None of these projects overlap those in book # 224. The pair make a wonderful circuit reference set.

◻ **BP84—DIGITAL IC PROJECTS . . . \$5.25.** Both simple and more advanced projects to help the reader develop a knowledge of the workings of digital circuits. A number of board layouts are included.



MAIL TO: **Electronic Technology Today Inc.**
P.O. Box 240
Massapequa Park, NY 11762-0240

SHIPPING CHARGES IN USA & CANADA
\$0.01 to \$5.00 . . . \$1.00 \$30.01 to 40.00 . . . \$4.75
\$5.01 to \$10.00 . . . \$1.75 \$40.01 to 50.00 . . . \$5.75
\$10.01 to 20.00 . . . \$2.75 \$50.01 and above \$7.00
\$20.01 to 30.00 . . . \$3.75

OUTSIDE USA & CANADA

Multiply Shipping by 2 for sea mail
Multiply Shipping by 4 for air mail

Total price of merchandise . . . \$ _____
Shipping (see chart) . . . \$ _____
Subtotal . . . \$ _____
Sales Tax (NYS only) . . . \$ _____
Total Enclosed . . . \$ _____

Name _____
Address _____
City _____ State _____ Zip _____

HANDS-ON MARKETPLACE

FOR SALE

STRANGE stuff, complete items, plans, kits. Laser eavesdropping, hidden weapons, bugging and counter-measure sources, adult toys. Informational photo package \$3.00 refundable. **DIRIJO CORPORATION**, Box 212-H, Lowell, NC 28098. Information (704) 868-3408.

COMMODORE repair/chips. Oldest/largest Commodore Service Center in the U.S. eg. C-64 repair \$39.95 including parts/labor. Fast turnaround....Commodore chips at low prices. 6510-\$9.55, 6526-\$9.95, 6567-\$14.75, 6581-\$12.85, 82S100/PLA-\$12.85, 325572-\$10.95, 325302-\$12.95, 901 ROM Series—\$10.95, C128 upgrade ROMS \$37.95 and many others....."The Commodore Diagnostician." A complete diagnostic reference chart for fixing Commodore computers. Over 4,000 sold. \$6.95 plus \$1.00 postage....HD C-64 power supply \$27.95 + PP....VISA MC....**KASARA MICROSYSTEMS, INC.**, 31 Murray Hill Drive, Spring Valley, NY 10977, 1-(800) 248-2983 (nationwide) or (914) 356-3131.

Are you paying too much for electronics books? For the latest books from all publishers at low prices join the **ELECTRONICS AND CONTROL ENGINEERS' BOOK CLUB**. Call or write for free information **1-800-2-MCGRAW**

P.O. Box 582, Hightstown, NJ 08520-9959

TRANSISTORS-tubes: MRF421 \$24.00, MRF454 \$14.50, MRF455-MRF477 \$11.75, MRF492 \$16.00, SRF2072 \$12.75, SRF3800 \$17.50, 2SC2290 \$16.75, 2SC2879 \$22.00, 6LF6, 6LQ6, 6JS6, 8950, etc. Call. New **Ranger AR3500** all mode 10 meter transceiver \$319. Quantity discounts! Best prices on hard-to-find parts, antennas, mics, power supplies, & equipment! Catalog \$1.00 (refundable), or free with order. **RFPC**, Box 700, San Marcos, CA 92069. For information or same day shipment—call (619) 744-0728. Visa/MC/C.O.D.

BUY BONDS

PLANS/KITS

BUILD this five-digit panel meter and square wave generator including an ohms, capacitance and frequency meter. Detailed instructions \$2.50. **BAG-NALL ELECTRONICS**, 179 May, Fairfield, CT 06430.

PROJECTION-TV...Convert your TV to project 7 foot picture...Results comparable to \$2,500.00 projectors...Total cost less than \$30.00...Plans and 8" lens \$21.95...Illustrated information free. **MAC-ROCOMA-HI**, Washington Crossing, PA 18977. Creditcard orders 24 Hours. (215) 736-3979.

BUILD a 4 to 20 volt 1 or 2 amp power supply. Detailed plans and diagrams \$3.95. Plans with PC board \$6.95. **THIELE ELECTRONICS CO.**, 801 Rinzetta Dr., St. Louis, MO 63129.



TUBES - 2000 TYPES DISCOUNT PRICES!

Early, hard-to-find, and modern tubes. Also transformers, capacitors and parts for tube equipment. Send \$2.00 for 20 page wholesale catalog.

ANTIQUE ELECTRONIC SUPPLY
688 W. First St. • Tempe, AZ 85281 • 602/894-9503

CRYSTAL radio sets, plans, parts, kits. Catalog \$1.00. **MIDCO**, 660 North Dixie Highway, Hollywood, FL 33020.

VOICE disguisers! FM bugs! Telephone transmitters! Phone snoops! More! Catalog \$1.00 (refundable): **XANDI ELECTRONICS**, Box 25647, 32M, Tempe, AZ 85282.

DETECTIVES, experimenters. Exciting new plans. Hard to find micro and restricted devices. Large catalog \$5.00 refundable on 1st order. **WILSON**, P.O. Box 5264, Augusta, GA 30906.

CLASSIFIED AD ORDER FORM

To run your own classified ad, put one word on each of the lines below and send this form along with your check to:

Hands-on-Electronics Classified Ads, 500-B Bi-County Boulevard, Farmingdale, N.Y. 11735

PLEASE INDICATE in which category of classified advertising you wish your ad to appear. For special headings, there is a surcharge of \$10.00.

() Plans/Kits () Business Opportunities () For Sale
() Education/Instruction () Wanted () Satellite Television
()

Special Category: \$10.00

PLEASE PRINT EACH WORD SEPARATELY, IN BLOCK LETTERS.

(No refunds or credits for typesetting errors can be made unless you clearly print or type your copy.) Rates indicated are for standard style classified ads only. See below for additional charges for special ads. **Minimum: 15 words.**

1	2	3	4	5
6	7	8	9	10
11	12	13	14	15 (\$21.00)
16 (\$22.40)	17 (\$23.80)	18 (\$25.20)	19 (\$26.60)	20 (\$28.00)
21 (\$29.40)	22 (\$20.80)	23 (\$32.20)	24 (\$33.60)	25 (\$35.00)
26 (\$36.40)	27 (\$37.80)	28 (\$39.20)	29 (\$40.60)	30 (\$42.00)
31 (\$43.40)	32 (\$44.80)	33 (\$46.20)	34 (\$47.60)	35 (\$49.00)

We accept MasterCard and Visa for payment of orders. If you wish to use your credit card to pay for your ad fill in the following additional information (Sorry, no telephone orders can be accepted.):

Card Number

Expiration Date

PRINT NAME

SIGNATURE

IF YOU USE A BOX NUMBER YOU MUST INCLUDE YOUR PERMANENT ADDRESS AND PHONE NUMBER FOR OUR FILES. ADS SUBMITTED WITHOUT THIS INFORMATION WILL NOT BE ACCEPTED.

CLASSIFIED COMMERCIAL RATE: (for firms or individuals offering commercial products or services) \$1.40 per word prepaid (no charge for ZIP code)...**MINIMUM 15 WORDS**. 5% discount for same ad in 6 issues within one year; 10% discount for 12 issues within one year if prepaid. **NON-COMMERCIAL RATE:** (for individuals who want to buy or sell a personal item) \$1.15 per word, prepaid....no minimum. **ONLY FIRST WORD AND NAME SET** in bold caps at no extra charge. Additional bold face (not available as all caps) 25¢ per word additional. Entire ad in boldface, \$1.70 per word. **TINT SCREEN BEHIND ENTIRE AD:** \$1.75 per word. **TINT SCREEN BEHIND ENTIRE AD PLUS ALL BOLD FACE AD:** \$2.05 per word. **EXPANDED TYPE AD:** \$1.85 per word prepaid. Entire ad in boldface, \$2.20 per word. **TINT SCREEN BEHIND ENTIRE EXPANDED TYPE AD:** \$2.30 per word. **TINT SCREEN BEHIND ENTIRE EXPANDED TYPE AD PLUS ALL BOLD FACE AD:** \$2.70 per word. **DISPLAY ADS:** 1" x 2 1/4"—\$160.00; 2" x 2 1/4"—\$320.00; 3" x 2 1/4"—\$480.00. General Information: Frequency rates and prepayment discounts are available. **ALL COPY SUBJECT TO PUBLISHERS APPROVAL. ADVERTISEMENTS USING P.O. BOX ADDRESS WILL NOT BE ACCEPTED UNTIL ADVERTISER SUPPLIES PUBLISHER WITH PERMANENT ADDRESS AND PHONE NUMBER.** Copy to be in our hands on the 18th of the third month preceding the date of issue (i.e.; Aug. issue copy must be received by May 18th). When normal closing date falls on Saturday, Sunday or Holiday, issue closes on preceding work day. Send for the classified brochure. Circle Number 49 on the Free Information Card.

DJ beatmeter you can build. Organize your L.P.s by beats per minute like the pros do to make "mixing" faster and easier. Plans and instructions \$2.00. LERCOM, P.O. Box 2274, Sta.1, Kingsville, TX 78363.

DIGITAL oscilloscope. A unique project. Plans \$5.00. MIKE McGLINCHY, 214 Verano Dr., Los Altos, CA 94022.

GIANT displays (8" x 4") 7-segment red L.E.D. kit—\$25.00 plus \$3.00 S/H. Partially available! House numbers, clocks, readouts. Data \$2.00 refundable. Visa, M/C, Amex. ELVIS, Box 208, Parry Sound, P2A 2X3 Canada.

RADAR scrambler! X&K bands, car lighter hook-up. TV/radio scrambler! portable. Simple plans, \$5.00 each. Offer limited! NEWCASTLE, Box 7204(H) KC, MO 64113.

AWesome light sequencer with unbelievable sound sync. Plans, board, and Cpu \$39.95; complete and tested unit \$199.95. ELECTRONIC ARTS, 27 Linda, Colonia, NJ 07067.

PC boards made to order details—SASE. Eprom programmer plans. \$3.50 includes semiconductor bonus! GALLIUM JUNCTION, 540-C N.E. Northgate Way, Suite 542, Seattle, WA 98125.

CATALOG: hobby/broadcasting/HAM/CB: Cable TV, transmitters, amplifiers, bugging devices, computers, more! PANAXIS, Box 130-F(5), Paradise, CA 95967.

TESLA coils—Kirlian Electrophotography—Plasma Bulbs...free 1988 science plan catalog! SCIENTIFIC, Box 1054HHD, Duvall, WA 98019.

**CABLE T.V.
"BOXES"**

**Converters—Descramblers
Remote Controls—Accessories**

★ Guaranteed Best Prices ★
★ 1 Year Warranty—C.O.D.'s ★
★ Immediate Shipping ★
★ FREE CATALOG ★

Call or Write:
TRANS-WORLD CABLE CO.
HC 83, Box 531
Pequot Lakes, MN 56472
(218) 543-8871

BUSINESS OPPORTUNITIES

YOUR own radio station! AM, FM, TV, cable. Licensed/unlicensed. BROADCASTING, Box 130-F(5), Paradise, CA 95967.

SATELLITE TV

DISHES systems upgrades Chaparral, Drake, Houston, etc. Save \$\$\$\$ toll free (800) 334-6455. SKYVISION, 2066P Collegeway, Fergus Falls, MN 56537.

CABLE EQUIPMENT

CABLE-TV Secrets—the outlaw publication the cable companies tried to ban. HBO, Movie Channel, Showtime, descramblers, converters, etc. Suppliers list included, \$8.95. CABLE FACTS, Box 711-H, Pataskala, OH 43062.

WANTED

ASSEMBLERS. Assemble electronic musical accessories. No experience required. Materials supplied. \$8.00 per hour. Send self-addressed stamped envelope to YOUNG ELECTRONICS, Box 42, Kennedale, TX 76060.

EDUCATIONAL INSTRUCTION

ALL about meters. Learn development of electrical meters; build seven simple meters using common hardware. \$7.95 each, ppd USA. ALLABOUT BOOKS, Box 14155, Fremont, CA 94539.

REMOTE CONTROL KEYCHAIN



Complete w/mini-transmitter and +5 vdc RF receiver Fully assembled including plans to build your own auto alarm

\$19.95 Check, Visa or M/C 30 days return

VISITECT INC. (415) 872-0128
PO BOX 5442, SO. SAN FRAN., CA 94080

ALL about crystal sets. Theory and construction of crystal set radios. \$7.95 each, ppd USA. Allabout Books, Box 14155, Fremont, CA 94539.

CABLE TV DESCRAMBLERS

CABLE TV converters. Scientific Atlanta, Jerrold, Oak, Zenith, Hamlin. Many others. "New" Video Hopper "The Copy Killer." Visa, M/C & Amex 1-(800) 826-7623. B&B INC., 10517 Upton Circle, Bloomington, MN 55431.

SATELLITE &
CABLE T.V. HOE ←
DESCRAMBLERS

FOR CATALOG SEND \$2 TO:
DISTRIBUTORS
5078 SO. 108th
SUITE #333 DEPT. PM
OMAHA, NE 68137

TO ORDER CALL:
1-800-435-7057
1-402-330-7673

ADVERTISING INDEX

HANDS-ON ELECTRONICS magazine does not assume any responsibility for errors that may appear in the index below.

Free Information No.	Page
6	AMC Sales 18
5	All Electronics 15
—	Amazing Devices 12
—	Antique Electronic Supply 104
16	B&B Electronics 17
9	CIE 11
7	Cook's Institute 17
8	Digi-Key CV2
17	Electronic Parts Outlet 22
—	Electronic Tech. Today 14, 16
—	Electronic Tech. Today 24, 103
—	Electronic Tech. Today CV3
14	Electronics Book Club 3
15	Emco 18
—	Grantham Col. of Engineering 23
13	Hal-Tronix 22
—	HOE Reprint Bookstore 101
11	Heath 7
10	MCM Electronics 13
—	McGraw Hill Book Club 104
—	McGraw Hill (CED) 91
12	Mouser 12
—	NRI 21
—	Pacific Cable CV4
—	Telecom 105
—	Trans World 105
—	Visitect 105

JENSON ON DXING

(Continued from page 87)

Bulgaria—9,700 kHz. *Radio Sofia* broadcasts its English language programming from 2030 to 2100 UTC.

Chile—15,140 kHz. Because, by South American standards, it has few shortwave stations, Chile is among the most commonly heard country. But you should find *Radio Nacional de Chile*, in Spanish of course, evenings until 0400 UTC sign off.

Falkland Islands—3,958 kHz. The highly "DX-able" *Falkland Islands Broadcasting Service* at Port Stanley has been noted in eastern North America at 0645 UTC with a program of classical music.

Guinea—4,900 kHz. *Radiodiffusion Nationale* at Conakry can be heard with French programming and African music until sign off with Guinean national anthem at 0000 UTC.

Haiti—4,930 kHz. 4VEH in *Cap Haitien* is the only shortwave station operating from this country currently. Listen for programming in French around 1100 UTC.

Malta—6,110 kHz. *Radio Mediterranean*, which uses the same powerful "Cyclops" relay transmitters as West Germany's *Deutsche Welle*, but at different hours, has been heard in English at 2245 UTC.

South Africa—21,590 kHz. *Radio South Africa* is one of the handful of international broadcasters currently using the high shortwave frequencies. Look for it in English with news, commentary and "South African Panorama," beginning at 1400 UTC. And look for more stations in that frequency range in the next few years. ■



A HIGH VOLTAGE PULSE GENERATOR

(Continued from page 33)

bottom, and hold it together with one hand while installing the cabinet hardware with the other. Turn the five bottom screws snug, but not tight.

Cabinet assembly of the fence-charger version is easier cause you don't have to cope with the coil neck or connections to the front-panel potentiometer. For outdoor use, however, you will have to caulk seams against the weather. Silicone rubber is good for that purpose because it can later be peeled off if servicing becomes necessary. Acrylic rubber makes a better seal, but because it sticks more tenaciously, it makes later disassembly more difficult.

Carefully apply a very thin bead first along the inside edges of the opening in the top front, and install the front panel. Then, again very carefully and sparingly, apply a bead along the slot in the cabinet bottom; and finally, assemble the top and bottom. Depending on your skill in the application, there may be some squishing around the seams. Surplus material around the outside can be peeled off later, after the sealant has set.

Installation and Operation

For maximum safety, you should, if feasible, connect one side of the lab-generator power supply to Earth ground. If not, then be sure to provide a return path for the spark to one of the power-supply leads. Set the RATE control to get the desired rate, and the power-supply voltage to get the desired output potential. If the output is not excessively loaded, the small in-circuit neon lamp flashes with each pulse. The auto lamp may glow dimly when the rate is set near its upper limit, but otherwise it should never light during normal operation. It does light brightly to warn you when the power leads are reversed or if there is an internal short.

If you need one pulse at a time, or bursts of pulses, connect a pushbutton or momentary switch in series with one of the power-supply leads.

If you have trouble getting lower output voltages, but not higher, the spark-plug cable may have pulled loose. When that happens, high voltage settings give what appears to be normal performance because the spark path is completed by jumping within the neck of the coil; while at the lowest voltage settings it appears not to be working at all. If that difficulty is encountered, pull the cable out, inspect the solder joints, then simply push it back into the coil.

Fence Charger Ground

Using the author's cabinet and construction techniques, the fence-charger ground connection is made through the pipe fittings sticking out of the bottom end of the chimney. An Earth-ground means is provided by an ordinary 1/2-in. water pipe. The length should be chosen to permit the pipe to be driven at least 3 ft deep, but the deeper the better, depending on estimated conductivity of the soil; with enough pipe rising above ground to place the unit at a comfortable viewing level. Thus a pipe of at least 7 ft is required. A more effective ground can be had by adding salt to the soil.

Temporarily screw a pipe cap onto top end so as to protect the threads during hammering operation. Pound it into the ground, remove the cap, and screw the fence-charger assembly onto the end. Connect the fence and battery to the unit.

The neon lamp flashes with each pulse to assure you that everything is working okay, except in absolute darkness, since a few photons of light are necessary to prime the neon. That apparent drawback, however, has the definite earmarks of an advantage because when it's pitch black the unit cannot call itself to the attention of an interloper.

To test the battery it is only necessary to momentarily reverse the battery leads and observe how brightly the protective lamp lights. Again, however, don't leave it connected backward.

If you are cautious in building and using this project it can serve a wide variety of uses and provide many hours of service. Be careful and use common sense. ■



"On the contrary, I'm quite impressed that you can change channels with your toes."

Electronics Paperback Books

GREAT PAPERBACKS AT SPECIAL PRICES



BP173—COMPUTER MUSIC PROJECTS \$6.95. Shows how to use your home computer to produce electronic music. Many circuits. Mostly jargon free.



BP176—TV DXING FOR THE ENTHUSIAST.....\$6.95. Practical, authoritative intro to this unusual aspect of electronics. 812 x 11 in. 144 pp.



30 CUSTOMIZED MICROPROCESSOR PROJECTS \$14.95. Building instructions, detailed schematics and application programs for intriguing and useful coded CPU projects.



BP141—LINEAR IC EQUIVALENTS AND PIN CONNECTIONS \$12.50. 247 pages, 7 x 10 in. Shows equivs & pin connections for popular user oriented IC's.



BP140—DIGITAL IC EQUIVALENTS AND PIN CONNECTIONS \$12.50. 312 pages, 7 x 10 in. Shows equivs & pin connections for popular user oriented IC's.



BP146—THE PRE-BASIC BOOK \$6.95. A book on the BASIC programming for those who have not yet bought a computer as well as those who have trouble learning how to program.



BP108—INTERNATIONAL DIODE EQUIVALENTS GUIDE \$5.75. Full inter-changeability data and characteristics for diodes, including Zeners, LEDs, Diacs, Triacs and more.



BP135—SECRETS OF THE COMMODORE 64 \$5.00. Masses of useful info and programming tips not found in any user's manual.



BP143—INTRO TO PROGRAMMING THE ATARI 800 XL \$5.00. Perfect complement to the Atari user's manual. Even shows how to use animated graphics.



BP130—MICRO INTERFACING CIRCUITS—BOOK 1 \$5.75. Practical add-ons transform your computer into control or measurement equipment.



BP131—MICRO INTERFACING CIRCUITS—BOOK 2 \$5.75. Interfacing sound and speech generators, temperature and optical sensors, motor controllers, and more.



BP148—COMPUTER TECHNOLOGY EXPLAINED \$5.00. Explanations for computer terms often encountered. A dictionary for computer lingo.



BP152—INTRO TO Z-80 MACHINE CODE \$5.95. Speed up your programs. They may be harder to write, but it's worth learning how. Some demo programs are included.



BP105—ANTENNA PROJECTS \$5.00. Practical radio antenna designs that deliver good performance and are relatively simple and inexpensive to build.



BP198—AN INTRODUCTION TO ANTENNA THEORY \$6.95. Basic concepts relevant to receiving and transmitting antennas.



BP144—FURTHER PRACTICAL ELECTRONICS CALCULATIONS AND FORMULAE..... \$9.00. Companion volume to BP153. Book carries on with new data not found in earlier edition. 450 Pages.



BP125—25 SIMPLE AMATEUR BAND ANTENNAS \$5.00. All kinds of antennas for all kinds of amateur radio reception.



BP134—EASY ADD-ON PROJECTS FOR THE COMMODORE 64, ATARI 800, & ACORN ELECTRON \$6.95. Picture digitizer, light pen, model controller, and more.



BP179—ELECTRONIC CIRCUITS FOR THE COMPUTER CONTROL OF ROBOTS \$5.00. Data and circuits for interfacing the computer to the robot's motors and sensors.

Quality Paperbacks



BP183—AN INTRODUCTION TO CP/M \$5.75. To run and use programs operations under CP/M you need this book.



BP127—HOW TO DESIGN ELECTRONIC PROJECTS \$5.75. How to use standard circuit elements to make custom electronic projects.



BP110—HOW TO GET YOUR ELECTRONIC PROJECTS WORKING \$5.00. How to find the faults in your projects, repair them and get them working.



BP121—DESIGN & MAKE YOUR OWN PCB'S \$5.75. Everything you need to know before you make printed circuit boards for your projects.



BP85—INTERNATIONAL TRANSISTOR EQUIVALENTS \$7.50. Locates possible substitutes for a popular user-oriented selection of modern transistors. Japanese, European and American types.



BP117—PRACTICAL ELECTRONIC BUILDING BLOCKS, Book 1 \$5.75. Build the blocks and then combine them to form almost any custom project of your choice.



BP118—PRACTICAL ELECTRONIC BUILDING BLOCKS, Book 2 \$5.75. Amplifiers for all kinds to add to the circuits from Book 1 of this series.



BP169—HOW TO GET YOUR COMPUTER PROGRAMS RUNNING \$5.95. Have you ever written your own programs only to find that they do not work? This book shows you how to find errors.

Affordable Prices

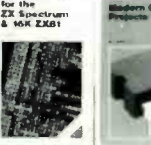

BP128—20 PROGRAMS FOR THE ZX SPECTRUM & 16K ZX81 \$5.75. All programs run on both machines. Include flow charts and info on how to modify to run on other computers.



BP106—MODERN OP-AMP PROJECTS \$5.00. Includes a Slide Timer, AF Signal Gen, Mike Pre-amp, Scratch Filter, and much more.



BP59—SECOND BOOK FOR CMOS PROJECTS \$5.00. Multivibrators, amplifiers; triggers & gates; special devices including reaction timer, simple electronic organ, and more.

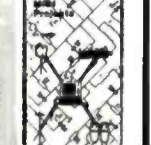

BP182—MIDI PROJECTS \$6.95. Details of how to interface many popular home computers with MIDI music systems.



BP65—SINGLE IC PROJECTS \$4.95. All projects in this book are based on one IC and are simple to construct. Great way to get started with IC's.

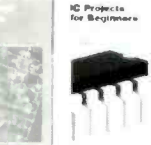

BP49—POPULAR ELECTRONIC PROJECTS \$5.50. A collection of a wide range of electronic projects and circuits for the experimenter.

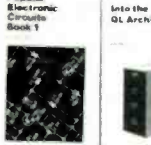

BP97—IC PROJECTS FOR BEGINNERS \$5.00. Written especially for the less experienced experimenter. Complete parts layouts and wiring diagrams.



BP161—INTO THE QL ARCHIVE \$5.95. Presents the powerful database for the Sinclair QL. Step-by-step approach includes practical examples.

CHECK OFF THE BOOKS YOU WANT

ELECTRONIC TECHNOLOGY TODAY INC.
P.O. Box 240, Massapequa Park, NY 11762-0240

SHIPPING CHARGES IN USA & CANADA

\$0.01 to \$5.00 \$1.00
\$5.01 to \$10.00 \$1.75
\$10.01 to 20.00 \$2.75
\$20.01 to 30.00 \$3.75
\$30.01 to 40.00 \$4.75
\$40.01 to 50.00 \$5.75
\$50.01 and above \$7.00

OUTSIDE USA & CANADA
Multiply Shipping by 2 for sea mail
Multiply Shipping by 4 for air mail

Total price of merchandise \$ _____
Sales Tax (New York State Residents only) \$ _____
Shipping (see chart) \$ _____

All payments must be in U.S. funds

Number of books ordered _____

Total Enclosed \$ _____

Name _____
Address _____
City _____ State _____ Zip _____

H588

