



**RADIO**

**HANDBOOK**  
**1946 EDITION**

- ★ THEORY • DESIGN • PLANNING
  - ★ INSTALLATION • OPERATION • SERVICE
  - ★ REGULATIONS • REFERENCE DATA
- for*
- ★ BROADCASTING • POLICE • FIRE
  - ★ RAILROADS • PUBLIC UTILITIES
  - ★ TRUCKS • BUSES • AMATEURS

*Edited by Milton B. Sleeper*

# Here's why **MYCALEX 410**

## is the "Last Word" in

### low loss insulation

For more than 27 years MYCALEX has consistently demonstrated its superiority as an insulating material — supplanting one old-fashioned material after another as electronic advancements have made insulating needs more exacting.

MYCALEX excels wherever high dielectric strength and extremely low loss factor are important . . . where resistance to arcing and high temperature is desired . . . where imperviousness to oil and water must be virtually 100%.

Latest and greatest of MYCALEX advancement is MYCALEX 410 (Molded Mycalex). This highly perfected insulation, together with our exclusive injection-molding techniques, now makes available a wide variety of unusual or intricate shapes . . . especially with metal inserts or electrodes molded in to form a perfect bond or hermetic seal.

Our engineers invite your inquiries on all insulating problems.

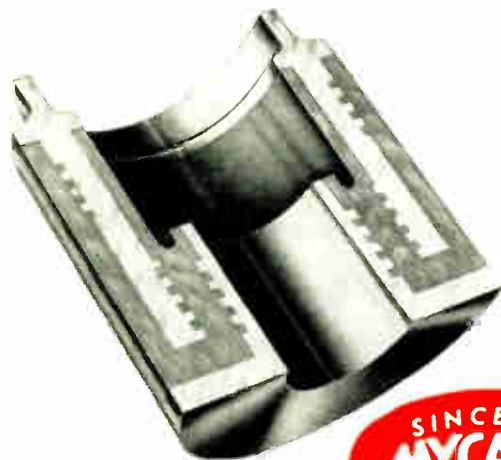
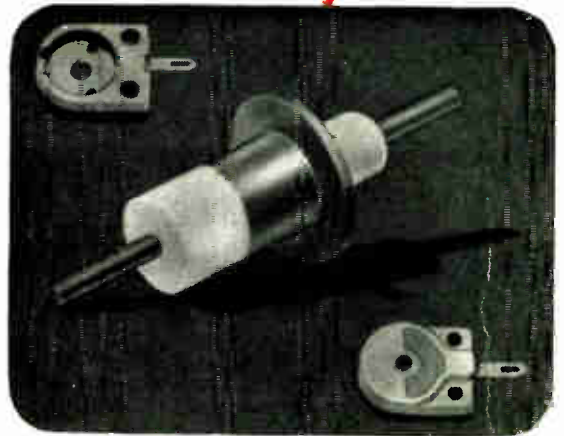

#### SOME PROPERTIES OF MYCALEX 410

##### Electrical Properties

Power factor, 1 megacyc e, dry . . . . .	0.0015
Dielectric constant, 1 megacycle . . . . .	8.3
Volume resistivity, ohm-cm . . . . .	$6.0 \times 10^{17}$
Arc resistance, ASTM seconds . . . . .	250
Dielectric strength, volts/mil . . . . .	400

##### Mechanical Properties

Flexural strength, psi . . . . .	13,000
Tensile strength, psi . . . . .	6,000
Compressive strength, psi . . . . .	20,000
Hardness, Brinell . . . . .	150
Modulus of elasticity, psi . . . . .	$8 \times 10^6$
Maximum safe operating temperature, °C . . . . .	400
Density, lb./cu. in. . . . .	0.136
Specific gravity . . . . .	3.8

## MYCALEX CORPORATION OF AMERICA

"Owners of 'MYCALEX' Patents"

Plant and General Offices CLIFTON, N. J.

Executive Offices, 30 ROCKEFELLER PLAZA, NEW YORK 20, N. Y.

# STANDARD FM HANDBOOK

## TABLE OF CONTENTS

- CHAPTER 1. Background of Frequency Modulation . . . . .** *Page 1*  
Testimony given by Major Edwin H. Armstrong on December 6, 1943, before the Senate Interstate Commerce Committee — Notes on the high points of FM history were prepared by Milton B. Sleeper.
- CHAPTER 2. Theory of Frequency Modulation . . . . .** *Page 12*  
By Rene T. Hemmes, former Assistant Editor of *FM AND TELEVISION* Magazine. Part 8, devoted to AFC circuits, was written by Burt Zimet, former project engineer, Freed Radio Corporation.
- CHAPTER 3. Frequency Modulation Broadcasting . . . . .** *Page 76*  
Answers to questions asked most frequently by those who are planning to enter FM broadcasting. By Milton B. Sleeper.
- CHAPTER 4. FM Broadcast Studio Techniques . . . . .** *Page 80*  
Pointing out some of the fundamental differences between AM and FM studio practices. By D. W. Gellerup, former Broadcast Technical Supervisor, WTMJ and WTMJ-FM, Milwaukee.
- CHAPTER 5. Coaxial Lines for FM Transmitters . . . . .** *Page 86*  
Data on the characteristics of coaxial transmission lines, and methods of installation. By C. Russel Cox, Chief Engineer, Andrew Company.
- CHAPTER 6. Audio Distortion and Its Causes . . . . .** *Page 94*  
Discussion of a subject which, in the past, has been all too frequently side-stepped, but which must be given serious consideration by designers of high-fidelity FM receivers. By Jerry Minter, Chief Engineer, Measurements, Inc.
- CHAPTER 7. High Fidelity Reproduction . . . . .** *Page 99*  
Description of coaxial speaker construction, combining separate units for low and high audio frequencies. By John K. Hilliard, Chief Engineer, Altex Lansing Corporation.
- CHAPTER 8. Antennas for Communications Frequencies . . . . .** *Page 104*  
Design data for antennas to operate on 30 to 44, 72 to 76, and 152 to 162 mc. By James A. Craig, Engineering Department, Link Radio Corporation.
- CHAPTER 9. Selective Calling Methods . . . . .** *Page 112*  
Presenting the results of tests in New York City, and a chart showing how calls can be made to individual stations, or to groups of stations. By Milton B. Sleeper.
- CHAPTER 10. Maintenance of Communications Systems . . . . .** *Page 116*  
How the Connecticut State Police handle the maintenance of 332 car installations and 11 main stations. By Frank Bramley, Supervisor of Radio Maintenance, Connecticut State Police.
- CHAPTER 11. Alignment of FM Receivers . . . . .** *Page 122*  
A fast, visual method for aligning broadcast and communications receivers. By Bernard J. Cosman, Chief Engineer, Harvey Radio Laboratories, Inc.
- CHAPTER 12. WWV Signals for Checking Frequency Meters . . . . .** *Page 125*  
Describing a receiver intended for the reception of WWV standard frequency signals, and its use in calibrating frequency measuring equipment. By Arthur Fong, Engineer, Browning Laboratories, Inc.
- CHAPTER 13. Railroad Radio Installations . . . . .** *Page 128*  
Details of some of the first radio installations made in railroad freight yards. By Arnold C. Nygren, former Chief Engineer, WFIL and WFIL-FM, Philadelphia.
- CHAPTER 14. Notes on Facsimile Equipment . . . . .** *Page 135*  
A review of postwar progress that is rapidly reaching the point where definite plans can be formulated for commercial home facsimile broadcast service. By Frank R. Brick, Assistant to the President, Finch Telecommunications, Inc.
- CHAPTER 15. FM Standards of Good Engineering Practice . . . . .** *Page 139*  
Complete text of the FCC standards, including revisions up to November 1st, 1946.

. . . FIRST EDITION . . .

## Editor's Introduction

**T**HE preparation of the Standard FM Handbook may have been an experience unique in the annals of technical literature. The work of planning and correlating the chapters was like trying to hold down a six-foot length of slippery eel with two hands.

That was because so many changes and so much progress have come to FM at such a rapid rate. For example, a chapter on FM transmitters was planned originally. At that time, we had data on RCA and REL equipment, representing reactance-tube and direct crystal-controlled circuits. Just when the text was ready to release, we realized that the chapter would not be complete without including the G.E. Phasitron. While we were wondering what to do, Federal and Westinghouse came out with their versions of FM transmitter circuits. Before we could meet that situation, we learned that Collins, Western Electric, and Raytheon were engineering something new.

At that point, we were faced with the choice of either having the chapter on transmitters incomplete, or holding up publication of the whole book for an indefinite length of time. We finally compromised by omitting the chapter entirely from this First Edition! It will appear in the Second Edition, however, and it will be complete, we hope.

Similar conditions confronted us in the chapters originally planned on communications equipment. Here, changes and impending shifts in frequencies were responsible. As for home receivers, very little data was available from manufacturers. The chief engineer of one company said: "We're going to hold up the release of complete data on our sets until more of our competitors have finished designing their first models!" We couldn't blame him.

In the end, we boiled down the chapters to those subjects which have jelled sufficiently to be used for reference purposes.

The net result will undoubtedly be subject to a certain amount of justified criticism. We aren't satisfied, either, so that makes it unanimous.

Looking back on this undertaking, we realize that a standard handbook on any subject has to grow up from year to year with the progress of the art to which it is devoted. Now, with Frequency Modulation set up on what should be an uninterrupted course of development and expansion, we can promise you, as we have promised ourselves, that future editions of the Standard FM Handbook will grow in usefulness as a reference work.

MILTON B. SLEEPER

September 11, 1946

COPYRIGHT 1946, BY MILTON B. SLEEPER

Published by FM Company, Great Barrington, Mass.

NEW YORK OFFICE, 511 FIFTH AVENUE

Price: Paper Bound \$2.00 — Lifetime Library Binding \$4.00



# Chapter 1

## Background of Frequency Modulation

Testimony by Major Armstrong before Senate Interstate Commerce Committee  
Reviews Early Struggles of FM for Recognition

ON December 6, 1943, Major Edwin H. Armstrong appeared before the Senate Interstate Commerce Committee which, under the chairmanship of Senator Burton K. Wheeler, was charged with investigating the need for new legislation to amend the Communications Act of 1934.

Taking part in this hearing, in addition to the Chairman, were Senators White, McFarland, Moore, and Hawkes. After the customary preliminaries, Major Armstrong was asked:

**THE CHAIRMAN:** You might give us, briefly, your experience in connection with the radio art.

**DR. ARMSTRONG:** My experience in the radio art began in 1906, and my connection with it has been continuous since that date.

I am the inventor of the regenerative circuit, the superheterodyne method of reception, the super-regenerative circuit, and the method of eliminating disturbances in radio signaling which has become known as Frequency Modulation, or FM.

For the sake of the record, I would like to say that the regenerative circuit invention, which was made in 1912, revolutionized the then existing means of radio communication and made possible overseas reception and radio broadcasting.

The superheterodyne principle is used in practically all receivers manufactured today.

The super-regenerative circuit is widely used in portable equipment and has been used extensively in military applications in the present war.

The FM system is also being used by the Armed Forces of the United States. Since March of 1941 I have waived all royalty payments under my patents for apparatus manufactured for this use, and this waiver continues for the duration of the war.

I am the recipient of the Medal of Honor of the Institute of Radio Engineers, the Holley Medal of the American Society of Mechanical Engineers, one of the National Modern Pioneer Awards on the occasion of the one hundred and fiftieth anniversary of the American Patent System, the Franklin Medal of the Franklin Institute, the Egleston Medal from Columbia University, the John Scott Medal awarded by the Board of City Trusts, City of Philadelphia; and the Edison Medal of the American Institute of Electrical Engineers. These awards I have listed only because there exists a difference of opinion between the scientific world and the

courts on a matter which may come up during the course of this hearing.

I served overseas in the Signal Corps of the A.E.F. from 1917 to 1919. With that exception, I have been continuously engaged in radio work in the Hartley Research Laboratory at Columbia University, where I am at present professor of electrical engineering.

It is my understanding that this committee is particularly interested, insofar as I am concerned, in any information which I have that bears upon the effects that the FM system may have upon post-war broadcasting and communications. There is not the shadow of a doubt but that the effect will be a revolutionary one. It has already been so, particularly in the field of broadcasting.

It seems to me, Mr. Chairman, that perhaps the best way to convey a picture of what is about to happen is to tell you something about the past history of this invention and explain how it has developed. There is, I believe, a lesson which is of great importance to the future development of the art. But I will, of course, proceed in any way which the committee would like to have me do.

**THE CHAIRMAN:** We wanted you to go ahead and explain something about the engineering problems of FM, and any other problems of the radio art you may see fit to talk about. In other words, some of us want to get a little education as we go along.

**DR. ARMSTRONG:** Well, Mr. Chairman, I will do my best to try to make clear a complex technical principle, and I will try to forecast as best I may what the effect of the invention and the system popularly known as FM may have on the future of the broadcasting and communications art.

I suppose in order to make clear what the FM principle is, I will have to go back quite a ways in the history of radio. Along about 1914, after the invention of the regenerating circuit, which revolutionized the radio art at that time, the problem of static interference became the great problem of the radio art. Practically everyone in the engineering part of radio undertook to try to solve it. The results were unsuccessful, and for a great many years the reason for the failure was unknown. Eventually it was understood that the reason static could not be filtered out from the radio waves was because static was practically identical in nature with the waves that we were using in trying to communicate with them.

Around 1924 the problem was practically given up as an insoluble one. I had started to work on this problem in 1914, and along about 1924, after I too had concluded it was an insoluble problem, I got an idea which led me into a line of research which resulted in the discovery of a new principle. That principle was that the way to overcome the effects of static was to produce a kind of wave which was different in character from the kind of wave which static disturbance could produce. But the way it was done was by the use of a method of modulation which was very old in the art.

This method of modulation dates back to the time when I was a student at Columbia University, but by using it in a new system and in a particular way, it became possible to generate a wave which was different from the static disturbance, and to make a receiver which was immune or refused to respond to waves of the ordinary kind, or to those waves produced by static, and which was responsive only to the new type of wave. Now that system has become known as Frequency Modulation or, for short, FM.

Compared to the existing system, or the system which was in use at the time this discovery was made, the static disturbances are reduced in power by an order of 500 to 1,000 times. I do not hesitate to say that that is beyond the wildest dreams of any inventor, to ever have had the good fortune to run into a discovery of that kind.

Around 1933 I had succeeded in setting up in my laboratory a complete demonstration of the system, with measuring equipment, to demonstrate the noise-reducing capabilities of the system.

Toward the end of 1933 this invention was brought to the attention of the executives and engineering department of the Radio Corporation of America. At that time no one credited any static eliminator which was demonstrated only in the laboratory, from one room to another. So the equipment was moved in the spring of 1934 to a station owned by the National Broadcasting Company, and located on the top of the Empire State Building in New York City. It was a relatively low power television station which was then not in operation, and I modified it to work as a frequency modulation system.

The original tests of the system were made in June 1934 over a distance of 70 miles. The results showed that, during periods of heavy static, a transmitter operating on power of only 2 kilowatts was

capable of outworking a 50-kilowatt standard broadcasting station.

For a period of about a year, I continued the demonstrations but was unable to persuade the Radio Corporation of America to take the next step, which was to build a high-power transmitter which would give a strong enough signal to wipe out the bad spots which occur in the broadcasting of ultra high frequency waves. I should like to add here that in the long series of tests which were conducted by the Radio Corporation of America, there were found certain bad spots in the coverage pattern, and the logical next step to overcome this difficulty was the erection of a higher power transmitter.

In the end of April 1935 I decided that I would have to take the job myself of erecting a high-power station, and I wrote to the Radio Corporation of America's manufacturing department asking them to give me a quotation on some power equipment. One week later the Radio Corporation of America announced that it was starting a series of field tests of television; that a million dollars would be spent toward putting television into use.

Now, from that point the story that the committee will be particularly interested in really begins.

SENATOR MOORE: When did you say the announcement was made that experiments with television would be made by the Radio Corporation of America?

DR. ARMSTRONG: May 6, 1935, at the annual meeting of the corporation's stockholders.

THE CHAIRMAN: When was your experiment completed, or substantially completed, with reference to FM?

DR. ARMSTRONG: With respect to demonstrating it for the Radio Corporation of America?

THE CHAIRMAN: Yes.

DR. ARMSTRONG: The equipment was left there until October of 1935. I turned the equipment over to their engineers to run further tests on it themselves.

THE CHAIRMAN: Why was it that FM was never adopted?

DR. ARMSTRONG: I believe there were two reasons, Senator Wheeler: 1) That the technical advantages of this system were underestimated at the time; and 2) That perhaps it meant too many new stations on new networks. As to which of these two reasons was controlling, I do not know at the present time.

In November 1935 I read a paper before the Institute of Radio Engineers and explained fully the capabilities of this system. No one questioned, either at that time or since, any of the statements which I made.

Toward the end of the year —

THE CHAIRMAN: What year was that?

DR. ARMSTRONG: That was in 1935, in November of that year, Mr. Chairman. I might say here that the principal objection which was raised against the system was that it could not work through the

man-made electrical disturbances, such as automobile ignition, or the great variety of noises which we have in cities, electrical machinery, power lines, or the like. The obvious answer to any of those criticisms was to build a high-power station and then demonstrate that the criticism was unfounded.

When I approached the Commission, which I did informally through an interview with the assistant chief engineer, he informed me that he was not satisfied I had done anything in the public interest that would warrant the granting of a

#### FM CAME UP THE HARD WAY

MAJOR ARMSTRONG'S story of his invention of Frequency Modulation, as told in the U. S. Senate records, is an inspiration to the thousands of pioneering spirits who have carried the radio art to its high level of achievement for peace and war in the United States.

As Major Armstrong told the Senators: "It isn't ignorance that causes the trouble in this world; it's the things that folks know that ain't so." That has been, indeed, FM's greatest stumbling block.

This testimony reviews the early efforts to eliminate static; the final acceptance of the static problem, in the 1920's, as being insoluble; the Major's discovery of a method by which static was reduced in power to an extent beyond the dreams of those who had quit trying; of newspaper accounts which acknowledged that reception from the 2kw. FM station he built from an NBC television transmitter on the Empire State Building was superior at 85 miles to reception from 50-kw. AM stations, yet "Major Armstrong's new system is utterly impractical — and the quest for static elimination must go on."

Fortunately, that quest did go on. When the assistant chief engineer of the FCC refused Major Armstrong's request for permission to build a high-power FM station, he still persisted, and a construction permit was finally granted. The station was built and its performance confirmed Major Armstrong's theoretical conclusions.

The story of the fight to overcome the obstacles of opposition and indifference to the advantages of FM, as disclosed in this testimony, is a fascinating story, and supplies background to the plans now being made for the postwar expansion of FM broadcasting.

The testimony published here is taken from the 1022-page record of "Hearings before the Committee on Interstate Commerce, United States Senate, Seventy-Eighth Congress, First Session, on S. 814, a Bill to Amend the Communications Act of 1934, and for Other Purposes."

license. Not even though I was spending my own money to demonstrate this principle. He suggested that I build a 1-kilowatt low-power FM transmitter and compare it with an AM transmitter. In other words, do exactly the same thing which I had already been doing for the past 2 years.

THE CHAIRMAN: Who was that?

DR. ARMSTRONG: Mr. Andrew Ring, who was then assistant chief engineer of the Federal Communications Commission.

THE CHAIRMAN: You may proceed with your statement.

DR. ARMSTRONG: About the same time also there appeared in the Boston papers an interview with Mr. Ring labeling this invention a visionary dream. I can supply the committee with a copy of the articles as they appeared in the press, such as the Boston Globe and the Christian Science Monitor, they being the two papers I saw.

SENATOR MCFARLAND: What was the substance of that interview? I did not catch what you said.

DR. ARMSTRONG: The interview was given by Mr. Ring to one of the editors of *Broadcast Magazine* who syndicated it through the press. How many other newspapers carried it I do not know, sir, but I did get copies of the Boston Globe and the Christian Science Monitor.

SENATOR MCFARLAND: What was the substance of the interview?

DR. ARMSTRONG: I will look it up.

THE CHAIRMAN: You can put it in the record later on if you do not have those clippings at hand.

DR. ARMSTRONG: I am sorry. I thought I had them right here.

THE CHAIRMAN: You can furnish them to the clerk of the committee later on to be inserted in the record.

DR. ARMSTRONG: The substance of the interview was that it was an impractical invention; that the receivers required too many tubes; that it would have to work in the ultra-high frequency range, and that that had not been made commercially possible by the Commission; and, in general, if it was of any interest it was years away.

THE CHAIRMAN: When was it that you gave a demonstration at Senator White's home which I attended?

DR. ARMSTRONG: I would say about February 1940, Mr. Chairman.

SENATOR MCFARLAND: What became of Mr. Ring?

DR. ARMSTRONG: Mr. Ring has not been with the Commission for several years. I believe he is in private consulting practice, engineering FM stations.

SENATOR MCFARLAND: That is rather surprising, Mr. Chairman, in view of the last answer by the witness I think the interview will be of especial interest to the members of this committee.

THE CHAIRMAN: Very well. It will be furnished by Dr. Armstrong when he can get opportunity to find them.

DR. ARMSTRONG: I will be glad to do that.

\* \* \* \* \*

Mr. Ring's interview, afterward furnished by Dr. Armstrong, is as follows: (From the *Christian Science Monitor*, November 18, 1935)

#### FINAL USE OF ULTRA-SHORT WAVES FOR STATICLESS RADIO FORECAST

A staticless era under ultra-short wave program radiocasting is foreseen by Andrew D. Ring, chief broadcast engineer of the Federal Communications Commission, after having viewed the new staticless transmitting system developed by Major Edwin H. Armstrong of

Columbia University. Major Armstrong was the inventor of the super-generative circuit which is employed by most radio amateurs in 5 meters.

If the time comes when ultra-short waves are used for program radiocasting, Major Armstrong's new staticless circuit will become of value. (Ultra-short waves are those below 10 meters.) The new circuit, however, is impracticable today on the present 200-500-meter radiocasting band. It is obvious, however, the crowded condition of the radiocast channels may one day cause entrance of radiocasters into the ultra-shorts where there will be room for many more hundreds of radio stations than there are at the moment on medium waves.

**FREQUENCY MODULATION**

Major Armstrong's new system, which employs frequency modulation, is too complex for the final answer, according to Mr. Ring, who

Major Armstrong's staticless circuit, the *Monitor* is indebted to Martin Codel, Washington radio writer, for a very clear description of the method the Major employs.

"Stripped of its technical ramifications," Mr. Codel says, "the system employs a multiplicity of so-called 'carrier waves' — the tracks along which radio impulses are conveyed — in lieu of the present single carrier wave. Assume that radio sounds are comparable to a high-speed train, traveling along a monorail (single carrier wave). Then liken the 'modulation' of the carrier wave (i.e., the superimposition of sound amplitudes on it) to the right-of-way of the railroad."

**OVER WIDER PATH**

"The Armstrong system," Mr. Codel concludes, "while utilizing only one carrier wave, spreads this carrier during modulation over a right-of-way of 200 kilocycles. The result is a

onstrated by his invention (during the war) of the superheterodyne circuit that makes modern radios so highly selective and sensitive, Mr. Ring sees two big obstacles in the way of "frequency modulation," which he calls a visionary development many years in advance of broadcasting's capacity to utilize it.

In the first place, it requires a 200-kilocycle path of frequencies for the transmission of its interference-free and noise-free signals — and such wide avenues of ether are simply not available today except among the plentiful ultra-short waves which are still labeled experimental. In the second place, it is so complex that it requires, at least in its present stage of development, a receiving set of 57 tubes, which is out of the question as a commercial and marketable possibility.

**IMPRACTICABLE AT PRESENT**

Major Armstrong has demonstrated quite

**Frequency Allocations between 40 and 129 Megacycles  
Oct. 1937 to 1940**

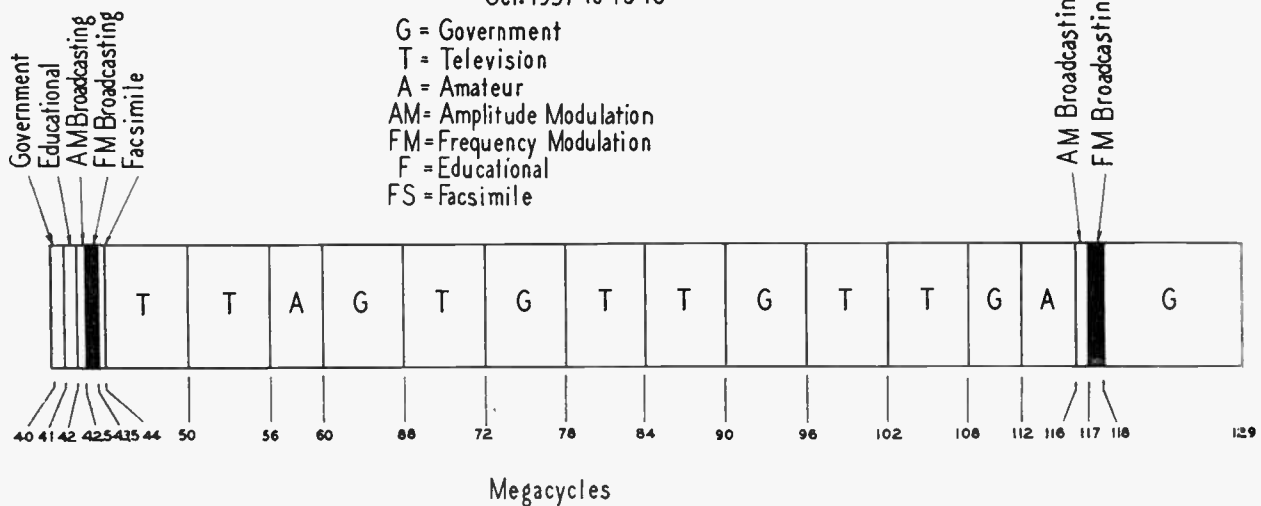

**FIG. 1. FREQUENCY ASSIGNMENTS AS ESTABLISHED BY THE FEDERAL COMMUNICATIONS COMMISSION, OCTOBER, 1937 TO MAY, 1940**

sees two obstacles in the way of this new radio circuit which he calls "a visionary development years in advance of broadcasting's capacity to utilize it."

First, it requires a 200-kilocycle path of frequencies for the transmission of its interference-free and noise-free signals — and such wide avenues of the ether are simply not available today except among the plentiful ultra-short waves which are still labeled "experimental." Second, in its present stage of development it requires a receiving set employing 75 tubes which is out of the question as a commercial and marketable possibility.

Major Armstrong has been experimenting with his new system from the R.C.A. experimental ultra-short-wave station atop the Empire State Building and he demonstrated quite satisfactorily how he transmitted high fidelity voice and music for distances up to 85 miles with low power and without a trace of the buzzing and frying sounds that are characteristic of lightning and other atmospheric interference. Indeed, the reception with his system was more satisfactory than that from 50,000-watt stations over the same distance. Hitherto it has been assumed that high power is the only way to override static — and the trend in radiocasting today is toward higher and higher powers.

While those familiar with radio circuits have not been able to get intelligible descriptions of

dissipation of the sound over a wider path and its transmission and reception with much greater clarity. That this is achieved by Armstrong is entirely admitted by radio engineers."

(From the Boston Sunday Globe, November 17, 1935)

**INVENTS RADIO WITHOUT STATIC**

If and when the ultra-short waves are adopted for program broadcasting, which will mean a plenitude of wave lengths for thousands of local stations as against 96 channels on which about 800 North American stations are now crowded, the new "staticless" transmitting system developed by Prof. Edwin H. Armstrong, of Columbia University, will provide a revolutionary new departure in radio. Under the present system of broadcasting on the intermediate waves between 550 and 1,500 kilocycles, Major Armstrong's new system is utterly impracticable — and the quest for static elimination must go on.

This is the conclusion of Andrew D. Ring, chief broadcasting engineer of the Federal Communications Commission, who saw the demonstration of Major Armstrong's new "frequency modulation" system before the Institute of Radio Engineers in New York last week. Though he pays high tribute to Major Armstrong's inventive genius, already dem-

satisfactorily how he transmits high-fidelity voice and music for distances up to 85 miles with low power and without a trace of the buzzing and frying sounds that are characteristic of lightning and other atmospheric interference. Indeed, the reception with his system is more satisfactory than that from 50,000-watt stations over the same distance. Hitherto it has been assumed that high power is the only way to override static — and the professor, one of the veterans of wireless, is highly enthusiastic about his system as the answer to the static problem, bane of most distant reception.

The Armstrong system, while utilizing only one carrier wave, spreads this carrier during modulation over a right-of-way of 200 kilocycles. The result is a dissipation of the sound over a wider path in its transmission and reception with much greater clarity. That this is achieved by Armstrong is entirely admitted.

The possibility, however, of securing ether paths as wide as 200 kilocycles is virtually nil under the present system of broadcasting. Used in the present broadcasting band, it would permit of only about 5 channels of transmission, or 1 where 20 are now available. It would render modern broadcasting entirely obsolete, quite aside from the fact that it would require brand-new types of receiving sets to pick up its signals.

On the ultra-short-wave lengths, which become more numerous and the use of which



can be duplicated about every 100 miles, it is very likely that the Armstrong system could be used to good advantage. The ultra-shorts, however, have practically no audience today even for the few experimental stations operating on them. It is improbable that they ever will have a substantial audience unless and until the Washington authorities decree that they shall be used for regular commercial broadcasting purposes. Even then entirely new audiences will have to be built up to tune them in — audiences equipped with entirely new types of receiving apparatus.

\* \* \* \* \*

THE CHAIRMAN: You may continue your statement, Dr. Armstrong.

DR. ARMSTRONG: I was unable to secure Mr. Ring's approval to construct a high power FM station, and during the early part of 1936 I made the acquaintance of Mr. Horace Lohues, who is an attorney practicing before the Commission, who succeeded in securing for me the necessary permission in July of 1936. I believe the chief engineer of the Commission at that time, Commander Craven, overruled

small black slices were all that were allocated to FM.

Now, this allocation was on an experimental basis. The theory on which the allocation was set up was a good one; it was that the Commission could not at that time fully determine the needs of the different services, but that as they developed this allocation would be revised, as one service developed faster than another and showed the need for greater space.

SENATOR McFARLAND: Mr. Chairman, I regret to have to leave this very interesting discussion but it is necessary for me to go to another committee. I do not want the witness to think that my leaving the room shows a lack of interest. I will read your testimony, Dr. Armstrong.

DR. ARMSTRONG: Thank you.

THE CHAIRMAN: You may continue your statement.

DR. ARMSTRONG: While this allocation to FM was ample for the purpose of making a demonstration, yet it had a very unfortunate effect. It had the effect of

I gave several hundred demonstrations, scores of lectures throughout the country, and gradually converted a large number of broadcasters to a belief that the FM system was the system of the future.

Now, those converts were not the major chains. They were the men who had small stations, who never could hope to get into the front row of broadcasting, as it were, with a 50-kilowatt station. But they were willing to go into this new development where they could get a seat in the front row.

About 150 applications had been filed in the beginning of 1940, when there was a hearing before the Communications Commission, set for mid-January of that year, to consider making permanent the television assignments shown in the chart and to make television commercial.

Had that been done FM would have been hamstrung for all time for lack of space. It would never have survived that. There was also set a hearing, for March 1940, in which the question of allocating more space to the service of FM broad-

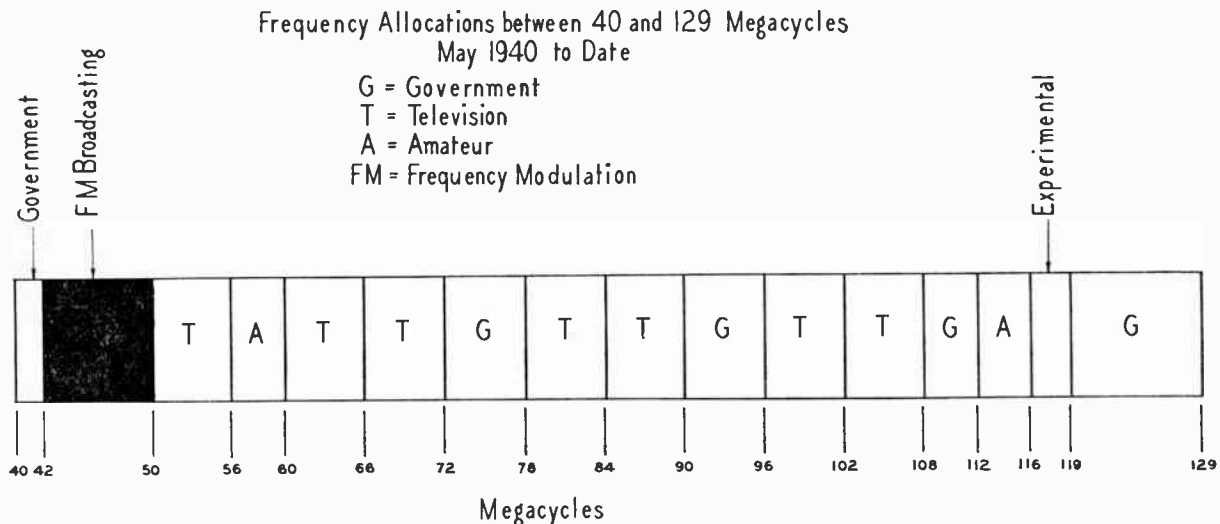

FIG. 2. FREQUENCY ALLOCATIONS, 40 TO 129 MC., AS THEY WERE SET UP BY THE FCC IN MAY, 1940

the position which the assistant chief engineer had taken.

In June 1936 there was held a hearing by the full Commission to determine how the high frequencies, that is, frequencies from 30 megacycles up, were to be allocated. At that time only two men spoke in favor of the FM system, myself naturally, and the chief engineer of the Yankee Network, a small network operating in New England, Paul de Mars. As a result of that hearing, in which the claims of television broadcasting were also considered, an allocation was made by the Commission, under I believe General Order 19, which as finally set up in the fall of 1937 resulted in the allocation which I have blocked out on the chart I now hand to you gentlemen. The squares marked "T" are, as I have indicated, television. The "G" represents space allocated to governmental purposes, the "A" represents amateurs, and the two

leading the rest of the broadcasting art to believe that the next major development of the art would be television, that it would not be Frequency Modulation broadcasting, and that there was really no place left in the spectrum for Frequency Modulation, because obviously in either one of these small blocks it would not be possible to set up a national service, and without a national service no new broadcasting system could hope to succeed.

THE CHAIRMAN: That diagram may be made a part of the record.

(The chart entitled "Frequency allocations between 40 and 129 megacycles, October 1937 to May 1940" is shown in Fig. 1.)

THE CHAIRMAN: You may resume your statement.

DR. ARMSTRONG: The obvious next step was to demonstrate to as many practical broadcasters as possible the capabilities of the FM system. And during the succeeding 3 years I undertook to do that.

casting was to be taken up. That question would have been moot had the purpose of the January 1940 hearing been carried through.

I appeared before the Commission at that time and pointed out what the situation was; and I think for the first time it was brought home to the Commissioners what the situation was that had really developed from the error of the June 1936 allocation.

The Chairman, Mr. Fly, stated that the Commission would hold over its decision on making the television assignments permanent, until they had been able to hear the FM case.

Now, shortly thereafter a very great effort was made in the commercial world to launch television, and to sell as many television receivers on the number 1 channel as could be sold, to block up the logical place for FM to expand.

At the hearing in March 1940 — well, I



want to add just one thing before I go into the March 1940 hearing. Television had been given a limited commercial status by an order of the Commission some 6 months prior to the time I am now talking about. That order was withdrawn when it became apparent that there was an attempt being made to fill up the No. 1 television channel with receivers, so that no change in the allocation could be made without working hardship on purchasers of those receivers.

Now, getting back to the March 1940 hearing, the facts of the case and the needs of FM for greater channel space, were presented to the Commission, and as a result of that the Commission took the No. 1 television band,<sup>1</sup> allocated it to FM and gave the band marked "Government" from 60 to 66, to television. So that television had exactly the same number of channels as before, but —

Electric Co., Mr. Chairman.

THE CHAIRMAN: You may resume your statement.

DR. ARMSTRONG: At this point I want to make this statement, that I have heard the chairman of the Commission has been accused of holding up FM. At this point he certainly did not hold up FM. Another chairman might well have done so, but at this point Mr. Fly gave FM its greatest boost. Later on regulations by the Commission did hold up FM, and they are still doing so.

THE CHAIRMAN: In what way?

DR. ARMSTRONG: The invention, Mr. Chairman, is 10 years old. There are still no channels assigned for relaying programs of FM about the country. It is one of the great developments which is surely coming, and that will be the relaying of FM broadcasting around the country without the use of connecting wires.

the allocation of these frequencies to television and Government, and that there is no space available.

Now, that reason was given a good many years ago, when allocations were based on the theory that everything about radio was known for all time; that there was a certain limited amount of spectrum, and that it had to be allocated among the different services. But I think the engineering department of the Commission has gained wisdom since that time.

SENATOR HAWKES: Has gained what?

DR. ARMSTRONG: I think the engineering department of the Commission since that time has acquired much wisdom.

SENATOR HAWKES: It is to be hoped so.

DR. ARMSTRONG: And I believe that we will in the future have much more sympathetic treatment of that particular request for relay channels.

SENATOR HAWKES: But their position

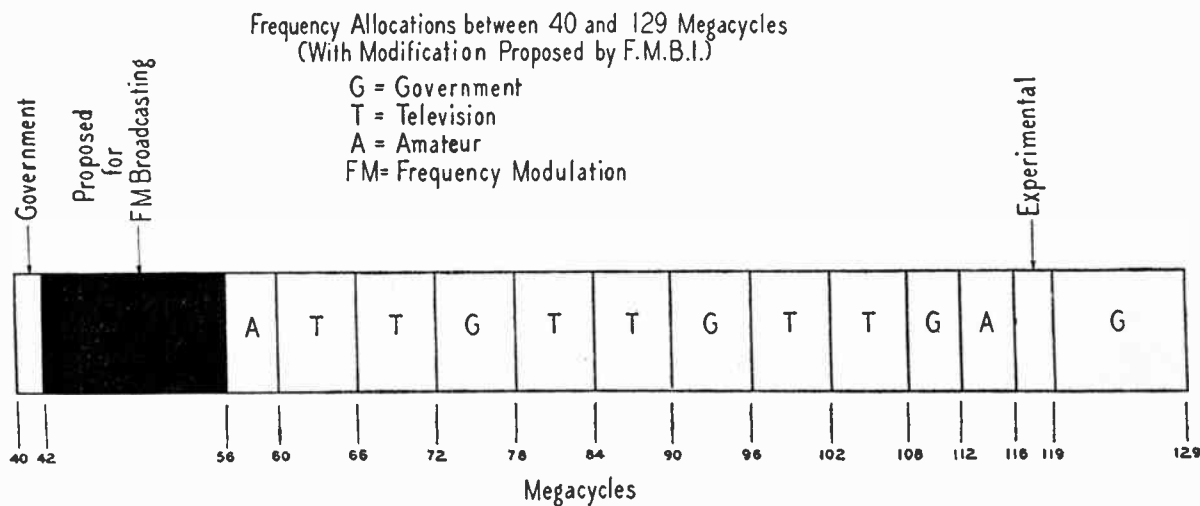

FIG. 3. REVISION OF THE FM BROADCASTING BAND, PROPOSED TO THE FCC BY FM BROADCASTERS, INC.

SENATOR WHITE: What do you mean by "the No. 1 television band"?

DR. ARMSTRONG: I am sorry, Senator White, as I should have explained that. The No. 1 television channel is from 44 to 50 —

SENATOR WHITE: You mean the first white block on the chart, to the left, bearing a "T," do you?

DR. ARMSTRONG: Yes. That was moved up into the position of 60 to 66, and the television bands were renumbered. The old No. 2 television band became the new No. 1 television band. And with that the enthusiasm to promote television subsided.

THE CHAIRMAN: When Mr. Ring left the Commission didn't he go with the General Electric Company?

DR. ARMSTRONG: I believe Mr. Ring is in private consulting practice. I believe that he formerly was with the General

THE CHAIRMAN: How did the Commission hold it up?

DR. ARMSTRONG: The Commission has never allocated a band of frequencies for that purpose, although the bands which could be utilized for relaying might be anywhere in a region as far up as 300 megacycles or more. They have had it under consideration, and perhaps if it had not been for the war there would have been something done about it, but nothing yet has been done.

SENATOR HAWKES: Dr. Armstrong, do you mean by that to say that they could have made these available to FM without interfering with the established channels at all?

DR. ARMSTRONG: Yes, Senator Hawkes. There are vast spaces up in the upper frequencies where, prior to the war, no stations whatsoever were operating.

SENATOR HAWKES: What have they given as a reason for not extending that privilege, or that license, to you for FM?

DR. ARMSTRONG: Informally that the existing allocations system provides for

was at that time, when this hoped-for wisdom you are speaking about had not been acquired, was that they could not make those assignments without interfering with other assignments already made; is that correct?

DR. ARMSTRONG: Yes. That is, assignments which had been made over large areas of the spectrum, where you could take a receiver and listen from morning until night and never hear a station. There was plenty of room to put relays in.

There was another reason why the relay broadcasting should have been put into use. It would have been years before any demand would have arisen for these channels for the purpose to which they were allocated, and by that time we would have learned how, through using these channels, to have moved the relay stations on up into the higher part of the spectrum, out of the way of the demands of some new service.

As this art develops you see more and more the impossibility of making progress under the rigid allocations of the past, for

<sup>1</sup> This band, 44 to 50 mc., was used by the R.C.A. station on the Empire State Building, New York City, when this station opened officially at the time of the World's Fair. (Editor's Note.)

they were made on the theory that there is a limited quantity or number of channels. That is the lesson I am trying to get across by relating the experience in FM, of getting it under way; and while at the present time FM has escaped that danger, the danger of being blocked off, I want to assure the committee that I as an inventor am not anxious to run the risks again that I ran in undertaking to put this thing into use.

THE CHAIRMAN: As Senator White has just suggested to me, at that time no one knew much about these ultra high frequencies, I take it.

DR. ARMSTRONG: Yes; that is true, Mr. Chairman. A few of us knew, but it was not possible by the use of the English language to convert people to your point of view. I haven't that power of speech. The only way that it could ever be done was to build a station, set it up, and wipe out by the demonstration of the things that people knew that were not so. (Laughter.)

SENATOR MOORE: If that could be applied to other activities of the Government, it would be very desirable.

DR. ARMSTRONG: I do not know of any other way of making progress in the radio art. I have been in the field of inventing since 1912.

SENATOR HAWKES: Your experience in proving what you knew yourself is very similar to the experience of anyone who has made a brand-new discovery in the mythical field; isn't that correct?

DR. ARMSTRONG: Yes; that is true. But in the ordinary type of human endeavor you are usually able to go ahead without being blocked in any way. Now, here was the case where if the engineering department of the Commission made a mistake, you never would get the opportunity to prove that you were right. That is the lesson of the development of FM. The history of all inventions is that most engineers are wrong; at the time the invention is made the only man who is right is the inventor, and everyone else is wrong. So that if you prevent him from developing what his idea is, he will never have the opportunity of making any converts. It is a tough problem.

THE CHAIRMAN: The inventor has to prove that the other fellows were wrong.

DR. ARMSTRONG: Invention is going ahead in the face of the established rules of scientific knowledge, and in showing that it either does not apply or it is being wrongly applied. As Josh Billings has said: "It isn't ignorance that causes the trouble in this world; it is the things that folks know that ain't so." (Laughter.)

SENATOR HAWKES: You will remember that at the end of the Civil War somebody suggested we ought to close the United States Patent Office because there was nothing new to be discovered.

DR. ARMSTRONG: Yes, Senator, I remember that very well.

I have a few copies of another chart

here which will illustrate the situation as it is at the present time, in the same frequency range of the chart I have already given you. I only have two or three copies of this chart.

SENATOR WHITE: Will you state again what this is.

DR. ARMSTRONG: That is the existing allocation between 40 megacycles and 129 megacycles, as it stands today.

THE CHAIRMAN: And it is your thought that that is not sufficient.

DR. ARMSTRONG: FM has developed so much more rapidly than the majority of people believed it could develop, that additional space will be required.

(The chart entitled "Frequency allocations between 40 and 129 megacycles May 1940 to date" is shown in Fig. 2.)

DR. ARMSTRONG: I have here a chart which indicates what additional space is now being asked for by the Association of FM Broadcasters. It is just the same as the charts which I have given you with the exception that the No. 1 television band is shown as allocated to FM broadcasting.

(The chart entitled "Frequency allocations between 40 and 129 megacycles (with modification proposed by F.M.B.I.)" is shown in Fig. 3.)

SENATOR HAWKES: You may have stated it before I came into the room, but how many FM broadcasting stations are there in the United States now?

DR. ARMSTRONG: Around 50, Senator. I do not know the exact number but it is of that order.

SENATOR HAWKES: And that is related to how many in the AM or standard broadcasting field?

DR. ARMSTRONG: Around 800, or perhaps even more than that. Under the present allocation there would be room for many thousands of FM stations scattered throughout the country, but in congested areas, such as New York, Chicago, and Los Angeles, the opinion is that there are not enough channels at the present time, and as this art develops at least an addition of the present number 1 television band<sup>2</sup> will be necessary.

You can see from looking at the charts what a really small part of the spectrum has been allocated to the service of FM broadcasting. The natural habitat of service such as television is in the higher frequencies, and I have a further chart which indicates that there is ample space for television to expand up into the higher frequencies.

(The chart entitled "Frequency allocations between 40 and 129 megacycles (with modification proposed by F.M.B.I.)" is shown in Fig. 4.)

SENATOR HAWKES: In order to use these higher spaces would it require a complete change in the apparatus now used for television?

DR. ARMSTRONG: It will require a

<sup>2</sup> That is, 50 to 56 mc. (Editor's Note.)

change in the transmitter principally. The difficulties of getting high power out at the higher frequencies were very much greater a few years ago than they are at the present time. The point I want to make, however, is that in order to get enough television channels to operate a national service, television must learn to work in the higher frequencies. So it makes very little difference whether television starts at 50 megacycles and winds up in the hundreds, or starts at 60 megacycles and winds up in the hundreds of megacycles. But it makes a very great difference to the full development of the FM system.

SENATOR HAWKES: In other words, the FM system can develop very much more rapidly and successfully in the lower frequencies.

DR. ARMSTRONG: I believe so. It can work in the higher frequencies, but I think the position it is now in is probably the best for it.

THE CHAIRMAN: Was it your idea that the industry engaged in AM broadcasting was blocking FM? Or, to be specific, that the Radio Corporation of America was blocking it? Was that your idea, as I gathered from your statement?

DR. ARMSTRONG: Senator Wheeler, I would like to answer that question this way: That if at the June 1936 hearing, that is, the hearing before the Commission which resulted in that very narrow allocation to FM (Fig. 1) the Radio Corporation of America as the recognized leader in the industry, had said one thing, and that is, that what Armstrong is saying as to the capabilities of FM is true, then we would never have had any of this trouble about allocations. I am quite sure the Commission would have had nothing left to do except to allocate a substantial band to FM.

THE CHAIRMAN: Wouldn't the Radio Corporation of America make more money with FM by reason of selling more equipment, than by not having it?

DR. ARMSTRONG: Yes, Senator Wheeler; and there is a difference of opinion within the Radio Corporation of America. One part, I believe, wants to go into FM, and another part does not.

SENATOR WHITE: I think everybody recognizes, Dr. Armstrong, that you are the final word in the development of this branch of the radio art. I am a little curious on this point, because I have no knowledge about it: What attention has FM attracted in England, or in Germany, or in other European countries? They have lagged far behind us, haven't they?

DR. ARMSTRONG: The British did not take it up as quickly as they should have. I believe the reason for that was that when they made inquiry to us through the established channels in this country, the possibilities were rather talked down to them. I got that impression from talking to some British engineers years later.

In Germany they fully appreciate the advantages of FM, as shown by some of

their technical publications which came to my hand just before the war started. But I have no information as to what they have done with it since that time.

SENATOR HAWKES: Has FM developed to any appreciable extent in any other country than the United States?

DR. ARMSTRONG: No; I believe that Canada is probably in second place, and they are just beginning to go into it, or were, prior to the war.

THE CHAIRMAN: Have you demonstrated FM in England, or in any other country? Have you tried to push FM in other countries?

DR. ARMSTRONG: No, Senator Wheeler. I have demonstrated it in this country after I completed the construction of the large station located at Alpine in 1939. That aroused a great deal of interest, as shown by the articles which subsequently appeared in the British technical press. I have no doubt that it will go into use throughout —

plemented by the spoken word in order to carry the point I wanted to make.

THE CHAIRMAN: Do I understand that the spectrum from 129 to 200 can be utilized in the future for FM broadcasting?

DR. ARMSTRONG: Yes; it can be utilized for FM, television, and various communication and relay circuits, all sorts of new forms of communication will arise in there.

THE CHAIRMAN: Your idea is that you will not have to use telephone wires, that you can communicate directly; is that correct?

DR. ARMSTRONG: No. I do not believe I have the imagination to go that far ahead at the present time.

THE CHAIRMAN: Then I misunderstood you.

DR. ARMSTRONG: I think that a great many point-to-point communications will be set up in there, and radio relays between broadcasting stations in different regions, and perhaps eventually we will

answer is, but should like to have it from you.

DR. ARMSTRONG: Yes. Of course, any program can be sent over FM. If, however, the program comes from one of the existing wire lines, while you will get the full benefit of the suppression of static, and will get a somewhat better quality than you would if the program was sent out over an AM station, you will not realize the full advantages of FM because the line transmission characteristics limit it.

SENATOR WHITE: As a practical matter any program that could be broadcast over the standard broadcast bands could be also transmitted by frequency modulation?

DR. ARMSTRONG: Yes; certainly Senator White. And a great many stations that are operating on FM now are doing that.

SENATOR HAWKES: It is your contention that the quality of these programs will be equal to or better than the quality

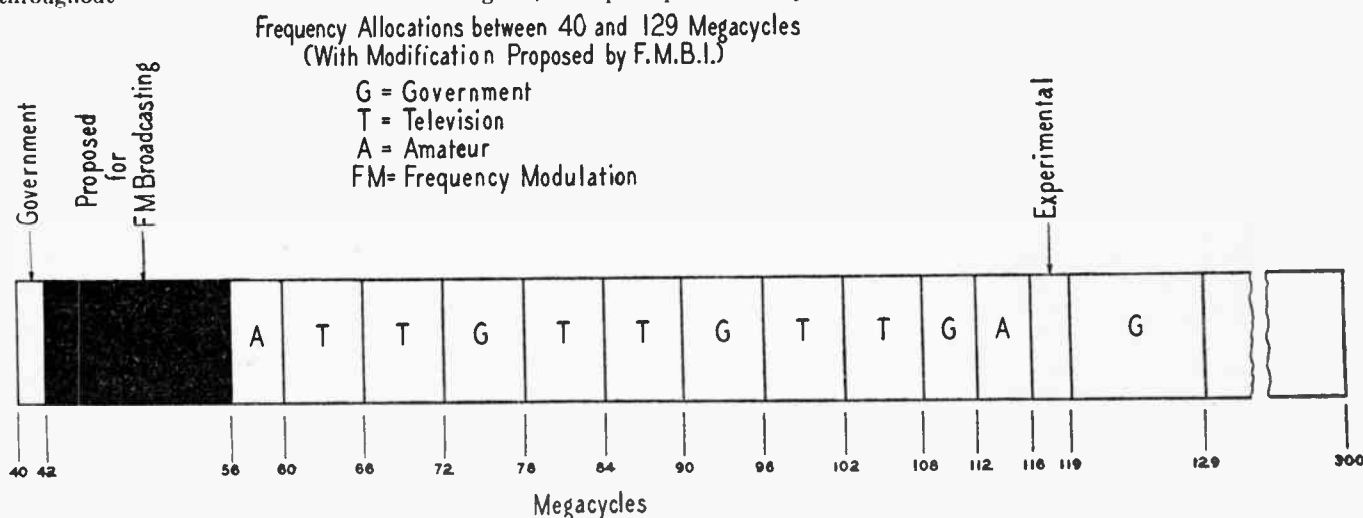

FIG. 4. AMPLE CHANNELS WERE MADE AVAILABLE FROM 129 TO 300 MC. TO COMPENSATE TELEVISION FOR GIVING 50 TO 56-MC. BAND TO FM

THE CHAIRMAN: In what State is that station located?

DR. ARMSTRONG: In New Jersey, just north of the George Washington Bridge.

SENATOR HAWKES: Do you mean that you demonstrated FM at the Alpine Station to the representatives of Great Britain and other countries?

DR. ARMSTRONG: Yes. I have given countless demonstrations during the first year or two after the station went into operation. And if it had not been for the war the thing would now be in operation in all parts of the world, and particularly in the tropics where static disturbances are very great.

SENATOR HAWKES: Do I understand that the Alpine Station went into operation in 1939?

DR. ARMSTRONG: The large station that I have referred to. I had a small station erected at the home of an amateur friend of mine, with which I gave demonstrations during the period of 1936 until the big station was ready. But that was the case where the demonstrations had to be sup-

see coast-to-coast networks. But I do not want to predict at the present time when that will be.

SENATOR WHITE: Will you state for the purpose of the record whether there is any difference in the type of program that can be sent over FM transmitters and received by FM receiving sets, than for standard broadcasting?

DR. ARMSTRONG: Yes; and I thank you very much, Senator White, for reminding me of that. I shouldn't have forgotten it.

SENATOR WHITE: I got the suggestion elsewhere. It was not original with me.

DR. ARMSTRONG: The quality of the transmission is very, very much superior to anything that can be done over the existing AM system.

SENATOR WHITE: That refers to the quality of the transmission. I was interested to have you put something in the record as to the type of program, whether you can send the same type of program by FM that you can send under standard broadcasting. I think I know what the

of the programs over AM; do I understand that from your statement?

DR. ARMSTRONG: Yes, Senator; but I would go further than that. I would say that they are much better, and that it is even possible on transcriptions to put out a program which is more pleasing than the program which comes over a line of the existing character and goes out on an AM station. I have very definitely gotten that reaction from the listeners to my Alpine transmitter.

THE CHAIRMAN: You are speaking of transcriptions. Is it possible to use a transcription today which will be as good as the voice coming over the radio from a distant point over AM?

DR. ARMSTRONG: Yes, Senator; I think you can do a better job.

THE CHAIRMAN: I was going to say I had been informed that as a matter of fact today you can do a better job on transcriptions than you can by getting it from the original point over the wire, because of the technical improvements in transcriptions.



DR. ARMSTRONG: Yes; if the transcriptions are sent out over FM, that is certainly so, and transcriptions will in the post-war period be very substantially better than they are at the present time.

THE CHAIRMAN: Then, so far as concerns the announcing that a certain program is a transcription, the need for doing it or the reason for doing it will be to some extent eliminated, will it not be — that is, announcing that "This is a transcription"?

DR. ARMSTRONG: I have seen transcriptions in the laboratory that, without such an announcement, would be mistaken for a direct pick-up.

THE CHAIRMAN: Yes. Some have contended that the transcription is better than the pick-up, that it can do a better job. I was wondering whether that was correct, in your opinion.

DR. ARMSTRONG: I would not go so far as to say —

THE CHAIRMAN: You would not go that far.

DR. ARMSTRONG (continuing): That the transcription is better than the direct pick-up, but I think it can be made so nearly equal to it that most people would not know the difference.

THE CHAIRMAN: Your idea is that the transcription from FM could be made better than the direct pick-up over AM today?

DR. ARMSTRONG: Yes; that is my statement, Mr. Chairman.

THE CHAIRMAN: The main thing, one of the principal things that you do, however, in FM is to eliminate this static which you get today in case of a thunderstorm or many other things that come up?

DR. ARMSTRONG: That is one of the advantages of the system, although a large number of the listeners who have been interrogated choose the better quality as the principal advantage of the system. I think it depends to a considerable extent where the listener is located with respect to the nearest AM station. If he is out on the fringes of the AM station's range, then FM comes through clearly and he thinks that the principal advantage is in the noise-reduction feature. If he is located near an AM station, where he doesn't get much static, then the better quality is the more striking difference between the two.

THE CHAIRMAN: Now, would you explain to the committee the difference between AM and FM?

DR. ARMSTRONG: Mr. Chairman, I will try my best. It is something that I have been trying to do from the lecture platform for the last 7 or 8 years, and it is difficult because there is no good mechanical analogy between the phenomenon which occurs in Frequency Modulation and anything with which we are familiar. But I will do my best.

THE CHAIRMAN: I should like to have you tell us what the difference is in the transmitter, too, and what the difference

has to be in your receiving set. Do it in simple terms so that we can understand it.

DR. ARMSTRONG: In order to explain Frequency Modulation, I have to explain modulation; and in order to explain modulation it is necessary to explain radio transmission.

Radio transmission is really a fairly simple thing. We have at the sending end an elevated conductor of some sort which is connected to an electrical pump at its base which pumps electricity up into this conductor and sucks it out again a great many times a second. The electrical pump is what we call the transmitter. The number of times that the electricity is pumped up and down may be in the hundreds of thousands or millions of times a second.

By a process that we need not inquire into, any other conductor located at a distance has set up in it a feeble electric current which likewise goes up and down in the wire or elevated conductor in the transmitter. Now, that is electrical transmission. It is not, however, electrical communication. To get communication you must do something at the transmitter; modulate the current in the transmitter so that the effect of that can be observed in the receiver. The oldest way of doing that is to change the strength of the current which is going up and down the antenna in accordance with the fluctuations of the voice. That is called amplitude modulation. The electrical pump continues to pump at a constant rate, the same number of times per second.

Now, in Frequency Modulation you do not change the strength of the current in the transmitting antenna, but you change the speed of the pump in accordance with the fluctuations of the voice. That is, you speed the pump up or slow it down; and you may, and in practical FM broadcasting you do, change the speed of the pump from, let us say, 39,900,000 times a second to 40,100,000 times a second, and that can be done very accurately in accordance with the fluctuations of the voice.

THE CHAIRMAN: Does it eliminate the fading that you get on radio at times, or not?

DR. ARMSTRONG: That is another of the advantages of the FM system, that it does not suffer within its service range from the present trouble which the AM system has, and the FM system will work beyond the fading range of our present day AM transmitters if it is constructed of high enough power and on a good elevation.

At the receiving end, we have for AM a particular kind of receiver, and for FM we have a different kind of receiver. The FM receiver must not respond to amplitude changes, nor must it respond to small frequency changes, but must respond only to the wide changes in the speed of the pump at the transmitter.

Now, I hope I shall be spared from the difficulty of undertaking to explain just

how that process is brought about. When I first explained it to the best men in the industry, it usually took a week or two before it sank in.

THE CHAIRMAN: We will not press you for that.

SENATOR WHITE: We know as much now as we ever will. (Laughter.)

SENATOR HAWKES: Dr. Armstrong, there is a converter that might be attached to the ordinary receiving set that has been receiving AM transmission, that will receive FM; is that correct?

DR. ARMSTRONG: Yes, Senator, there have been a number of devices which make use of the loudspeaking part of the AM set and which do it fairly effectively. The static-reducing features of FM are retained, but of course the quality is dependent on the excellence or otherwise of the loudspeaking system in the AM set.

SENATOR HAWKES: Is there any necessity of having anything other than this converter we are talking about, to use the ordinary set that people possess at the present time, in order to get the results you are talking about from the FM?

DR. ARMSTRONG: No. That can be done, provided there is a place to connect the translator, as it is called, into the loudspeaker system of the existing AM set.

SENATOR HAWKES: Is there a place to make that connection — that is the point I have in mind — in most of the sets that are now in existence?

DR. ARMSTRONG: If I had to hazard a guess, I would say that probably less than half of the sets now in existence would have a place where such a connection could be easily made.

SENATOR HAWKES: Thank you.

THE CHAIRMAN: You could, however, have a receiving set for AM and FM in the same cabinet, could you not?

DR. ARMSTRONG: Yes, Mr. Chairman. And I think that at the termination of hostilities the great majority of sets will be made that way. The manufacturers are already making plans to include an FM band on all sets selling beyond a certain minimum value.

THE CHAIRMAN: Now, with the development of FM can you have an unlimited number of wave lengths, so that you can have many more stations, or not?

DR. ARMSTRONG: Practically so, Mr. Chairman. I think that the number of wave lengths is so large that we are going to be limited by the number of stations which communities —

THE CHAIRMAN: Can support.

DR. ARMSTRONG: Can support, rather than by the lack of wave lengths to go around.

SENATOR WHITE: In your charts your top band to which you make reference is from 119, I think, to 129 megacycles. How much farther into what I will call the upper reaches of the spectrum do you think we can usefully go?

DR. ARMSTRONG: I hesitate to answer.

SENATOR WHITE: I do not know that



anybody can answer that definitely, but I thought I would like to have your notions about it.

DR. ARMSTRONG: Because I can remember when all the wave lengths above 1,500 kilocycles — that is  $1\frac{1}{2}$  megacycles — were considered so useless that they were given to the amateurs, I really do not know what the upper limit is going to be for broadcasting.

SENATOR WHITE: I do not suppose anybody really knows the answer with definiteness at this time, but I was just curious. How much above 129 megacycles are we now going in any branch of the radio industry?

DR. ARMSTRONG: The highest frequency that I know of that was used prior to the war was around 500 megacycles. Since the war that range has been exceeded many times.

SENATOR WHITE: What use, if any, is being made of the many bands between 129 megacycles and 500 megacycles? Is that area up in there being put to useful purpose now?

DR. ARMSTRONG: Prior to the war I do not believe there were many applications in there. Of course, now it is being put to all sorts of military uses.

SENATOR WHITE: The thing that impresses one with limited understanding of all this is the tremendous advances coming from day to day almost. I don't know whether I am right about it or not, but my recollection is that at the last international conference in '38 they went only to about 30,000 kilocycles in making their allocations of the spectrum. Am I right about that?

DR. ARMSTRONG: I am afraid my recollection doesn't serve me on that.

SENATOR WHITE: I do not say that is so, but my recollection was that we went only to about 30,000 or slightly above. All of this development beyond that really has come in 5 years of time.

DR. ARMSTRONG: Five or six years; yes.

SENATOR WHITE: Five or six years. So that makes one a little timorous as to speculating as to the future.

DR. ARMSTRONG: I agree, Senator.

THE CHAIRMAN: If phone lines are used to connect FM stations can any better tone quality be had on network programs over FM than is now secured on AM?

DR. ARMSTRONG: Senator, I am sorry. Would you repeat your question?

THE CHAIRMAN: I say, if phone lines are used to connect FM stations will the reception and the quality be any better than it is over AM, in your opinion, on network programs?

DR. ARMSTRONG: Yes; if the existing phones lines are used the quality is better than over the existing AM stations. However, the full advantage cannot be obtained.

THE CHAIRMAN: Does that complete your statement?

DR. ARMSTRONG: I think so, Mr. Chairman. I think that I ought to add just one

thing, perhaps; that if I have been too hard on the engineering department of the Commission in the past I want to say that the engineering department of the Commission at the present time is doing everything in its power to help this FM system get under way, and I think that we will have all the channels that we need when they have completed their studies of the situation.

THE CHAIRMAN: You think there will be a big development in FM after the war?

DR. ARMSTRONG: It will be the major development in the radio art. There isn't any question about that, Mr. Chairman. We will have television later. I am not prepared to say how long it will take to attain the same status as FM has now. There is no question at all but that we will have television, but the next development and the one which has been the logical development for the past 10 years is the FM system.

SENATOR WHITE: I was going to say, I don't know where either the Commission or the industry could find a better chief engineer than the present chief engineer of the Commission.

DR. ARMSTRONG: I would like to agree with you on that, Senator, if I may. Mr. Jett<sup>3</sup> has done a very fine job in a very difficult situation.

SENATOR WHITE: I think he has knowledge and ability and character.

DR. ARMSTRONG: I agree there also. (This concluded the taking of testimony, and the session was adjourned.)

## HIGH POINTS OF FM HISTORY

WHILE the technical details of Major Armstrong's invention of Frequency Modulation were told in his original I.R.E. paper, the story of his work was described only in terms of measurements and apparatus.

However, every engineer who has worked over the solution of problems that required original thinking knows that the facts of science are only the outward manifestations of the very human struggle by which they are produced.

Inventions are not created by mathematics and equipment. They are only tools. They are merely the means to the end sought by the man who uses them. They are of value only as he can relate what they show to other knowledge, and thus find the path which leads to ultimate success.

To many an inventor, there is satisfaction enough in finding the way to the solution of a problem. But that is purely selfish satisfaction for, if effort stops at that point, there is no benefit to society, and nothing real has been gained. Indeed,

<sup>3</sup> Mr. E. K. Jett was subsequently appointed a member of the Commission. (Editor's Note.)

the work is wasted, and the invention is lost if it is not carried on to a state of reality in which it can perform useful service.

It is very interesting to see how these two phases in the invention of the FM system were marked by log book entries in the records kept at Westhampton Beach, Long Island, and at Alpine, N. J.

The former was the location of the receiving equipment used for the first long-distance tests of FM transmission from the NBC station at the Empire State Building. Alpine was the site of FM broadcast station No. 1, set up by Major Armstrong.

The Westhampton tests, proving that the FM system did show a tremendous reduction of static over AM on the same frequency, represent the completion of the first phase of this invention.

Exactly what took place on this occasion is described in the entries reproduced here from the original log. The first part is in the handwriting of C. R. Runyon. Entries from 11:15 to 11:45 were made by George E. Burghard, at whose home the equipment was set up. The conclusion was written by Major Armstrong. Because the reproduction is not entirely clear, this record is set in type below:

### LOG —

Westhampton Beach, L. I.

June 9, 1934 — Daylight Saving.  
9:10 A.M. Received carrier from W2XDG (W2XFP) — on amplitude — 1,000 cycle tone.  
9:57 A.M. Frequency Modulation system on at Empire State no modulation.  
10:07 A.M. 1,000 cycle tone, frequency modulation.  
10:17 A.M. Music — freq — modulation.  
10:23.5 A.M. Perfect!  
11:15–11:30 A.M. Changing from frequency to amplitude modulation full carrier — half carrier — Hundreds or thousands (of times) more noise on amplitude.  
These tests made with half wave vertical pick up capacity coupled to 2nd rf stage. Also coupled same antenna to detector and still got perfect reception.  
11:45 A.M. Put on V antenna and listened to organ recital from chain. Low notes fully reproduced.  
1:00 P.M. W2XDG signed off. All tests performed exactly according to Hoyle. This experiment concludes just twenty years of work on this problem. It is with the deepest gratification that I record here that my two oldest friends, George Burghard and Randolph Runyon, old timers who saw the genesis of regeneration, took part in the culmination of this work. An era as new and distinct in the radio art as that of regeneration is now upon us.

After ten years of eclipse, my star is again rising.

Edwin H. Armstrong

The "culmination of this work" represented only the inventor's personal satisfaction over the evidence that he had truly overcome static and that, in so doing, had

not sacrificed but had improved the quality of reception.

He might very well have stopped at that point, for the system and its performance were received by the industry with complete indifference. Actually, on June 9th, 1934, while he was recording the conclusion of the first phase of his work, the log shows that he was preparing to bring about that "era as new and distinct in the radio art as that of regeneration."

The second phase extended over a period of five years, spent in laying the groundwork for the commercial application of FM in the service of public interest, convenience, and necessity.

A year's work at the Empire State Building transmitter brought no progress in the adoption of FM, and in the summer of 1935 he was asked to remove his apparatus to make room for television. Comments on Major Armstrong's paper at the November, 1935 meeting of the I.R.E. with a few exceptions, generally expressed the feeling that the system was "a visionary development many years in advance of broadcasting's capacity to utilize it."

The exceptions were limited to engineers whose experience dated back to the days before broadcasting began, for they had seen other revolutions take place. Those who had come into radio with the advent of broadcasting were unable to visualize a revolutionary change.

Some engineers expressed surprise that the man who had made such practical contributions to the art as regeneration, the superheterodyne, and super-regeneration should propose the use of a system so radical that it would require revision of the entire broadcasting structure. Nor did these engineers foresee that future circumstances would bring about the widespread use of FM in the police and emergency fields, or that it would serve on every front of a total war! Particularly notable was the use of FM relays for communications over the English Channel.

Since the demonstrations of transmission from the Empire State Building had reached an inconclusive end in the spring of 1935, so far as commercial application was concerned, Major Armstrong set about planning a 20 kw. FM transmitter of his own. During this period, he had recourse to amateur station W2AG, owned by C. R. Runyon, at whose home an FM transmitter was installed. This was used for the demonstration at the November, 1935 I.R.E. meeting, and for scores of other demonstrations up to the time Alpine went on the air. The log of W2AG is highly interesting, and its story may be told some day.

There was opposition to this idea in the engineering department of the FCC, but in July, 1936 he was granted a construction permit for such a station to be erected at Alpine, N. J. The permit did not become effective until the end of 1936. In the spring of 1937, construction was started.

Here were new difficulties to be overcome, but the log of station W2XMN was finally opened, and this entry was made on page 1:

April 10, 1938

4:10 P.M. Frequency — Carrier on — 43.7 mc/600 watts input to transmitter (Using temporary antenna).

This was not for purposes of transmission, but only to test for the proper termination of the antenna transmission line.

Subsequent entries were made during the further progress on the installation until, on page 132, the start of the first regular schedule of FM broadcasting was recorded:

Tuesday, July 18, 1939

First day — regular schedule on the air at 10:50 A.M. — 80-kw. input. Programs consisted of records played at Alpine.

4:01 P.M. WQXR programs 11:00 P.M.

Thus the second phase of the invention of FM drew to a close, for the performance of the Alpine station was conclusive and convincing evidence to broadcasters and manufacturers alike that a new era had come to radio.

The manner in which it came about, however, was not anticipated at that time. While the early commercial stations were being installed, and receivers for home use were started in production, a state-

Log -  
Westhampton Beach L.I.

June 9<sup>th</sup> 1934 -  
Subject Ser. -  
9:00 am - Received Collins from 12 X F - on  
amplitude 1000 cycles tone -  
9:57 Frequency Modulation system on Empire State  
no modulation  
10:02 1000 tone frequency modulation  
10:07 None - frequency modulation  
10:33 Perfect!  
11:50  
1:50 W 2 X D. Signed off. All tests performed exactly according to Hoyle. This experiment concludes just twenty years of work on this problem. It is with the deepest gratification that I record here that my two oldest friends, George Bingham and Randolph Runyon, old timers who saw the genesis of regeneration, took part in the

LOG ENTRIES DESCRIBING FIRST FM RECEPTION AT WESTHAMPTON BEACH

wide, 2-way FM communications system was going into service for the Connecticut State Police. Also, the performance of FM, successful even beyond the hopes of its sponsors, attracted the attention of the Signal Corps, and led to a gruelling series of AM vs. FM tests of communication with tanks. When the scores were added, FM was found to be far in the lead, and orders were placed for quantities of FM tank installations.

equipment in every type of military vehicle. FM equipment to the value of over ½ billion dollars was produced for our Armed Forces. Col. Grant A. Williams, Chief Signal Officer of the 1st Army, said this of its performance: "Wherever FM and AM equipments are used for the same purpose, FM proves distinctly superior."

Meanwhile, the evolution of FM broadcasting has continued steadily. Since

many ever knew, the cheerful predictions of some ten years ago that FM transmitters, and more particularly FM transmitters of the phase-shift type, were just too complicated for broadcast work in any practical sense of the word.

How strange and foolish today seem the statements accepted then that: "You can't get that much power on the ultra-high frequencies." Today it is a demonstrated fact that FM stations with up to 50 kw. can operate with the regularity and reliability of standard broadcast practice. For over five years the Alpine transmitter has met this standard, most of the time with 40-kw. operation.

The gap between the predictions of ten years ago and the performance of high power FM transmitters today means, of course, that someone must have done a great deal of very good and very hard work. The success of the operation of station W2XMN has depended on the work of two individuals. Major Armstrong gives Perry Osborn, the chief engineer, the full credit for working an experimental transmitter, giving a problematical 20 kw. for a short time, into a device capable of supplying 50 kw. in accordance with all requirements of broadcast station reliability. Charley Fowler, rigger, is given the credit for keeping in operation a complicated antenna structure through the severe storms of every kind, including one hurricane, which have been encountered since the station was erected.

The multitude of difficulties, expected and unexpected, and the manner of their solution, would make an interesting and instructive story.

Now, as his Alpine station enters its eighth year of scheduled transmission, FM's period of service to men at war has drawn to a close and its era of service to society at peace has begun in earnest.

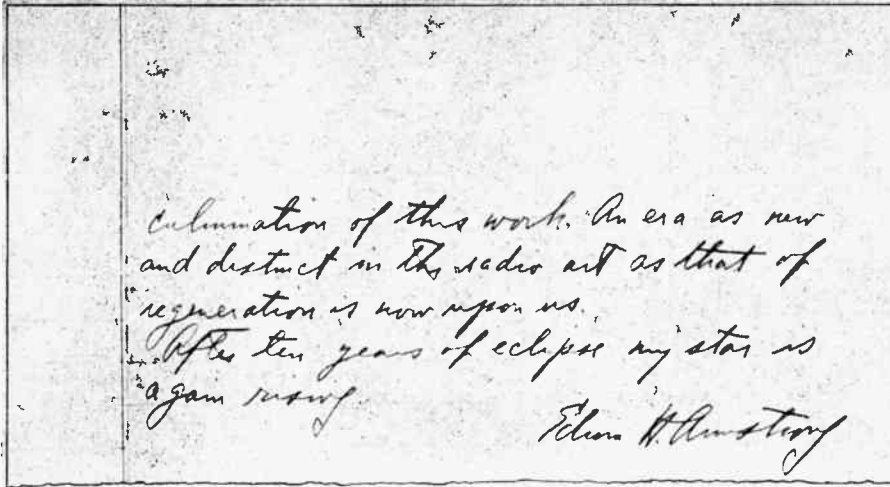

CONCLUDING REMARKS ON FIRST LONG-DISTANCE FM RECEPTION TESTS

In the midst of all this activity came the attack on Pearl Harbor, followed by the freeze order which stopped all production of civilian military radio equipment. This did not stop the progress of FM. On the contrary, it was accelerated immediately, for the war brought a heavy demand from police departments, particularly in cities along our coasts, for 2-way FM apparatus.

At the same time, the mobile nature of the fighting created the need for radio

Pearl Harbor nearly 800 applications have been filed with the FCC for construction permits to erect FM stations, and FM circuits will be provided in all but the cheap models of the new home radios.

All this has come about because Major Armstrong did not stop ten years ago when the radio industry merely shrugged its shoulders over an invention too far "in advance of broadcasting's capacity to utilize it."

Few people remember now, if in fact



# Chapter 2

## Theory of Frequency Modulation

### Section 1: Amplitude Modulated and Frequency Modulated Waves

**R**ECENT years have witnessed the growth of a new system of radio communication, which is having a revolutionary effect upon nearly all branches of the radio art. This system, invented by Major Edwin H. Armstrong, is sometimes referred to as "Wide-Band Frequency Modulation." More often, it is simply called "FM."

Not only does FM provide transmission in which distortion is reduced to a very low order, but it virtually eliminates noise at the receiver, whether this noise be of atmospheric or man-made origin. Furthermore, uncertainties due to interference between stations and changing propagation characteristics which affect AM circuits are overcome by FM. For these reasons, FM has gained a firm foothold in radiotelephone communications as well as in the broadcasting industry. Also, FM has made possible many new services, while others have been converted from AM to FM.

The highly desirable characteristics of FM are due in part to the nature of the frequency-modulated wave and in part to the design of the FM receiver. In order to gain an insight into the methods whereby the vast improvement in reception is obtained, it is necessary first of all to understand the basic differences between the amplitude and frequency modulation

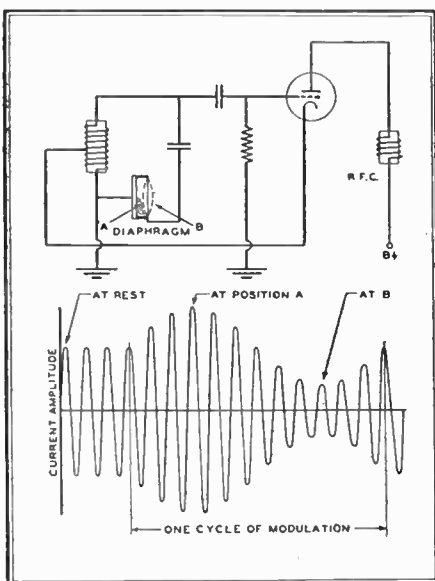

FIG. 1. ELEMENTARY AM TRANSMITTER

systems of radio telephone transmission and reception.

**Modulation** ★ The continuous transmission

of a radio wave of constant amplitude, or output power, and unvarying frequency conveys no information to the listener, other than that an unidentified station is on the air. It becomes possible to transmit intelligence on the wave only when one of the characteristics of the wave, such as its amplitude or its frequency, is subjected to a controlled variation at the transmitter. Modulation is the process of varying the amplitude or the frequency of the wave in accordance with the instantaneous variations of a control device, such as a telegraph key or a microphone.

**Amplitude Modulation** ★ When the power output of a radio transmitter is made to vary above and below an average level in keeping with the vibrations of a microphone diaphragm, as in Fig. 1, the transmitter is said to be amplitude-modulated.

The transmitter in Fig. 1 is of the most elementary type, but will serve to illustrate a method by which amplitude modulation can be accomplished. The circuit is that of a tuned-grid triode oscillator in which an inductive load in the plate circuit causes regenerative feedback by way of the plate-grid capacity of the tube. If the losses in the tuned circuit are compensated for by the transfer of energy from the plate to the grid circuits, a radio frequency current will be generated in the tuned circuit. The frequency of this current is determined by the values of inductance and capacity in the tuned circuit. The amplitude of the current will depend upon the resistance of the tuned circuit, assuming that the plate supply voltage and other factors remain constant.

Most of the resistance in the tuned circuit is introduced by the carbon-button microphone in series with the coil and the condenser. When the diaphragm is at rest, the resistance of the microphone limits the current to a definite level, and the transmitter sends out a wave of constant amplitude. As mentioned previously, the presence of the unmodulated wave can be detected in a receiver but the wave is incapable of transmitting intelligence in itself; it serves merely to establish a channel between the transmitter and the receiver, over which intelligence can be sent by modulation. The unmodulated wave, therefore, is termed the "carrier."

If a sound wave now strikes the microphone, the vibration of the diaphragm causes the carbon granules to be subjected alternately to increased and decreased pressure. The resulting respective decrease and increase of microphone resistance causes the output of the transmitter to

rise and fall in accordance with the volume and frequency of the sound, as shown in Fig. 1. The frequency of the wave remains the same since the inductance and capacity of the tuned circuit are not altered appreciably during modulation.

**Frequency Modulation** ★ An elementary circuit for the production of a form of frequency modulation is shown in Fig. 2. Here the carbon microphone of Fig. 1 has been removed and a condenser microphone is placed in parallel with the condenser of the tuned circuit. The oscillator generates a current of a frequency determined by the inductance of the coil and by the sum of the capacities across the coil. When a sound wave strikes the microphone, the diaphragm is first flexed toward the back plate, increasing the microphone capacity and hence also increasing the total capacity acting across the coil. This causes the oscillator to generate a lower frequency. Subsequently the diaphragm

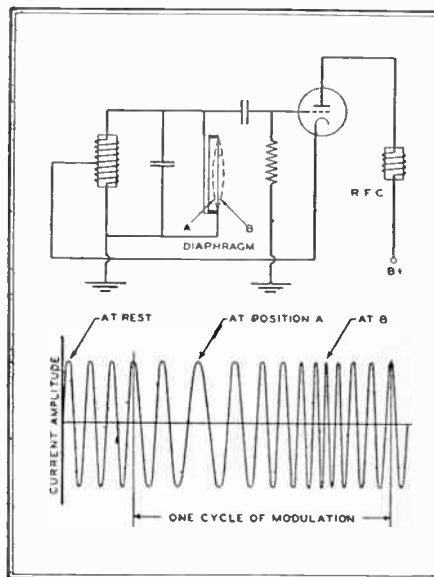

FIG. 2. ELEMENTARY FM TRANSMITTER

is flexed away from the back plate and the frequency of the oscillator is increased, because of the reduction in the amount of capacity in the tuned circuit. If a louder sound is made at the microphone, the diaphragm is flexed more in each direction, and the frequency is varied to a greater extent. In both cases, since the frequency of the generated wave has been varied above and below an average value by the action of sound waves on the microphone, a form of frequency modulation has been produced. Note that nothing



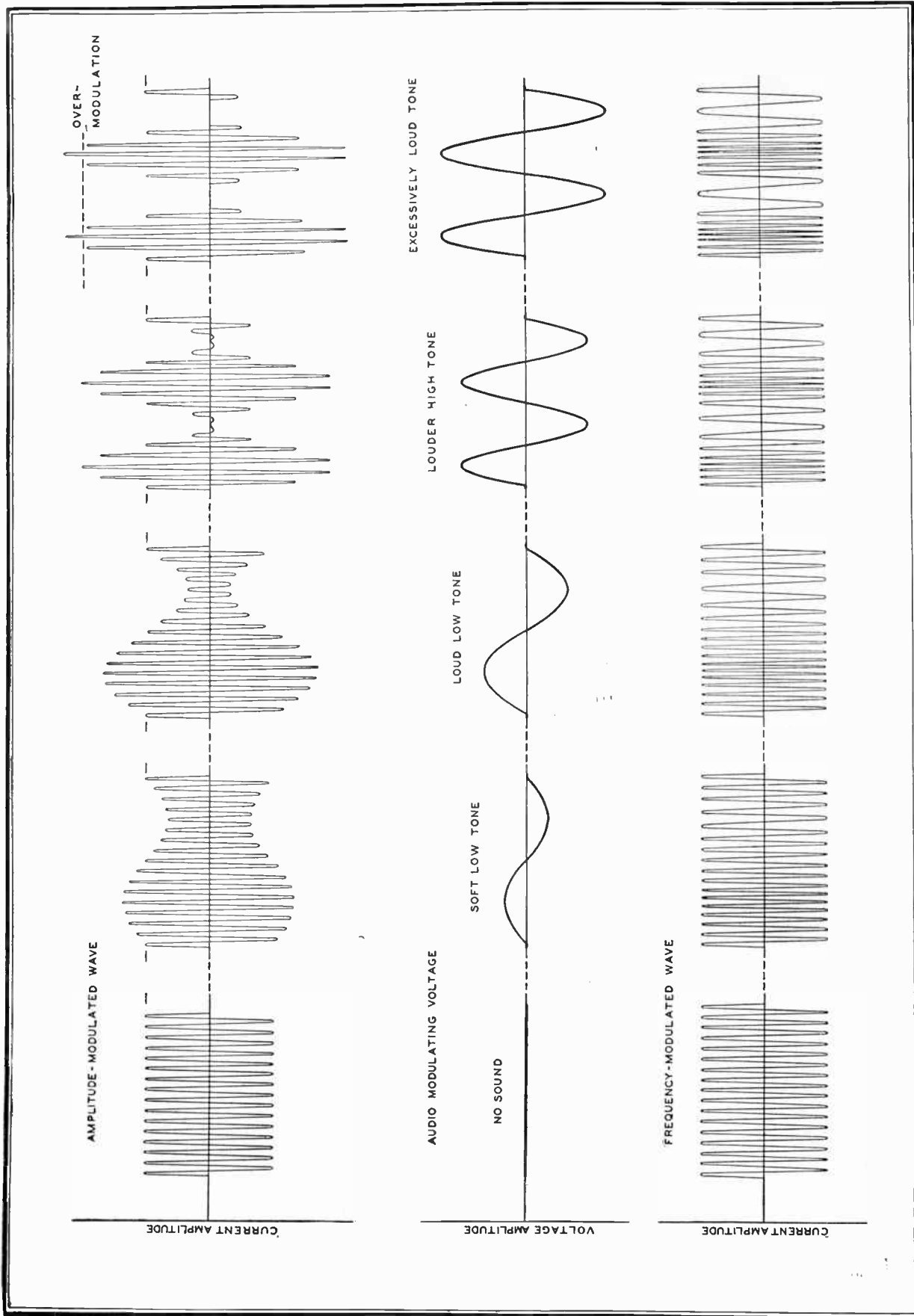

FIG. 3. CENTER, MODULATING VOLTAGE DUE TO AUDIO FREQUENCIES OF VARIOUS AMPLITUDES DIRECTED INTO THE MICROPHONE. TOP, RESULTING MODULATION OF AM TRANSMITTER OUTPUT, SHOWING THAT RF FREQUENCY IS CONSTANT, WHILE OUTPUT CHANGES. BOTTOM, RESULTING MODULATION OF FM TRANSMITTER OUTPUT. THE OUTPUT IS CONSTANT, BUT MODULATION CHANGES THE RF FREQUENCY

has occurred during modulation to affect the power output. Hence the amplitude of the generated wave is constant during modulation.

**Effects of Modulating Amplitude and Frequency ★**  
The contrast between the amplitude-modulated and frequency-modulated carrier wave will be emphasized by a consid-

eration of what occurs when the amplitude or the frequency of the modulating voltage is changed. In Fig. 3, the audio frequency modulating voltage and the resulting am-

plitude- and frequency-modulated carrier waves are plotted to equal scales of time.

At the extreme left is illustrated the condition of zero modulation. It will be observed that the outputs of the amplitude- and the frequency-modulated transmitters are exactly identical, both being of constant amplitude and unvarying frequency.

Next to the right is shown a condition of slight modulation at a low frequency, such as would occur when a soft, low-pitched note is sounded at the microphone. In the case of the amplitude-modulated wave, the output power rises and falls over a narrow range, in keeping with the very low level of the modulating voltage. In the case of the frequency-modulated wave directly beneath, there is no change in output, but the frequency is increased and decreased slightly, at a rate corresponding to the modulating frequency, and to an extent corresponding to the low volume level.

Next to the right in Fig. 3 is shown the effect of an increase in the amplitude of the modulating voltage, the frequency of the modulating voltage remaining unchanged. This condition would be caused when the same low-pitched note is sounded at the microphone with greater intensity. The successive radio frequency peaks of the amplitude-modulated wave vary over a greater range, in accordance with the increased amplitude of the modulating voltage, but the time taken to complete cycle of variation is the same.

The frequency-modulated wave is observed to rise to a higher frequency and to fall to a lower frequency than before, but going through this cycle of change at the same rate as before.

Further to the right are shown the forms of the modulating and the modulated waves when both the frequency and the amplitude of modulation are increased. This is equivalent to sounding a louder and higher-pitched note at the microphone. In the case of the amplitude-modulated wave, the modulation peaks and troughs are more pronounced, and are created at a higher rate. The frequency-modulated wave still has no variation of its amplitude, but shifts to higher and lower frequencies than before, and completes each cycle of frequency variation at a faster rate.

If the amplitude of the modulating voltage is increased still further, as shown at the extreme right in Fig. 3, so that the negative peak of modulation would tend to exceed the peak of the carrier amplitude, then the amplitude-modulated wave is rendered discontinuous and severe distortion of the wave form of the modulation results. This limitation upon the extent of modulation is inherent in the amplitude-modulated wave. Under the same condition of modulating voltage, the frequency of the frequency-modulated wave would simply increase and decrease over a still greater range, the limitations of the range

being set by the transmitting and receiving equipment rather than by the nature of the wave.

**Analysis of AM Wave** ★ From the above physical concepts of the two types of modulated waves, certain points of contrast are already evident. Other significant differences can be discovered when each of the waves is analyzed with a view to learning the nature of its components.

At the top of Fig. 4 is shown a wave of radio frequency  $F$  that is being subjected to amplitude modulation by a modulating voltage having a sine wave form and an audio frequency  $F_M$ .

In describing the extent of the modulation, it is customary to state the percentage relationship which the maximum variation from carrier amplitude bears to the carrier amplitude itself. For example, if the amplitude of the modulated wave on a positive modulation peak is twice the carrier amplitude, then the percentage of modulation is  $100(2 - 1)/1$  or 100 per cent. Similarly, if the amplitude rises to 1.5 times carrier amplitude at a positive peak of modulation, the modulation per-

centage is  $100(1.5 - 1)/1$  or 50 per cent.

However, in describing the extent of modulation in equations of the wave, it is more convenient to use the modulation factor symbol  $M$ , which is the decimal equivalent of the modulation percentage. The condition shown in Fig. 4 is that of 100 per cent modulation, equivalent to a modulation factor  $M$  of 1.0.

In writing the equation immediately beneath the diagram of the wave, it has been arbitrarily assumed that the modulated wave begins (when  $t$  equals zero) at the positive maximum of the modulation cycle. This assumption has been made solely to facilitate the construction of a clear drawing, and accounts for the difference between the equation shown and other equally correct forms which may be encountered in textbooks.

By using the trigonometric identity shown (for readers who are interested in the mathematical procedure) the equation is rewritten in the form which indicates that the amplitude-modulated wave may be regarded as the sum of three components: 1) A component of the same amplitude and frequency as the unmodulated

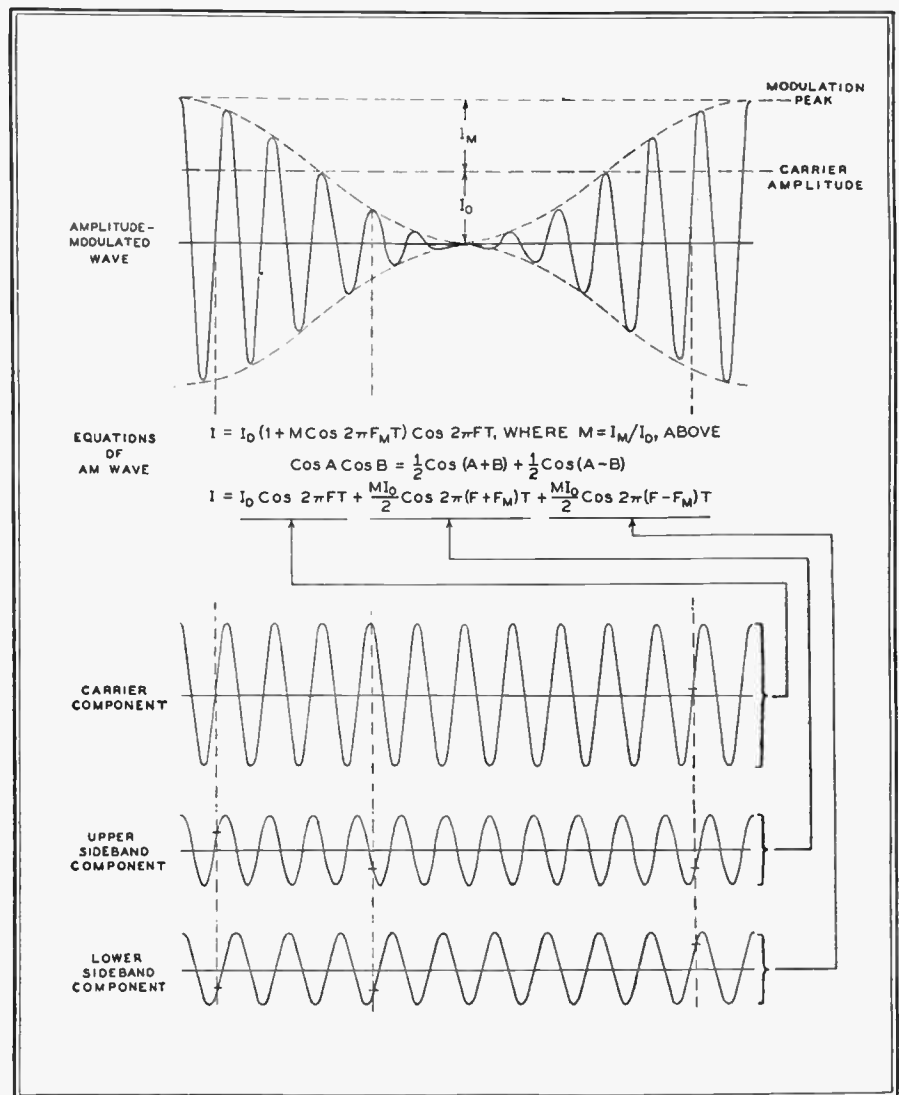

FIG. 4. THE AM WAVE AND ITS COMPONENTS AT 100% MODULATION

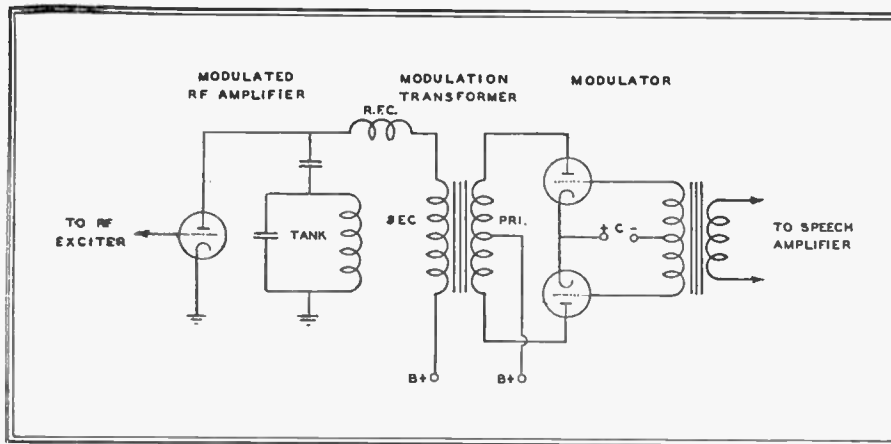

FIG. 5. THE CIRCUIT ELEMENTS OF AN AM TRANSMITTER

wave, usually termed the carrier component; 2) a component whose frequency is higher than that of the carrier by the amount of the modulation frequency, and whose amplitude is directly proportional to the modulation factor, but never exceeding half the carrier amplitude (called the upper sideband component); 3) a component whose frequency is lower than that of the carrier by the amount of the modulation frequency and whose amplitude is the same as that of the upper sideband component. This component is called the lower sideband.

The carrier and the sideband components have been drawn underneath the modulated wave to a common scale of time in order to facilitate graphical proof that the sum of the carrier and sideband components at any instant will equal the value of the modulated wave at the same instant. The vertical dotted lines representing several instants selected at random will aid in checking this point.

It may be remarked here parenthetically that many laymen unfamiliar with the methods of mathematical analysis doubt the reality of sidebands; others, acknowledging that sidebands may exist, are inclined to question the propriety of looking upon the amplitude-modulated wave as a single-frequency variable-amplitude affair in one instance and as the sum of three different frequency components of constant amplitude in another instance.

The cardinal principle that guides the mathematician in this matter is the axiom which states that the whole is equal to the sum of all its parts. Once it has been definitely established that a given whole is equal to the sum of certain components, thereafter the whole, or the expressed sum of all the components of the whole, can be used interchangeably. It is only necessary to observe all the laws of algebra and to account for all components. Whether the whole or the expressed sum of all the components of the whole will be employed is merely a choice of convenience for attacking the problem at hand.

This principle finds very wide usage in all mathematical work. For example,

to find the complement of an angle of  $25^\circ$ , one subtracts 25 from  $90^\circ$ . However, to find the complement of an angle of  $37^\circ 15' 22''$ , one subtracts from  $89^\circ 59' 60''$ .

Similarly, when describing the operation of a device that is responsive to voltage amplitude, such as a diode detector, the amplitude-modulated wave will be regarded as having a single frequency and a variable amplitude. On the other hand, when considering the effects of a tuned band pass circuit upon an amplitude-modulated wave, it is more convenient to consider the wave as the sum of a carrier component and sidebands, because the effects of the circuit upon the different frequency components may not be the same. To keep the amplitudes of the sideband components and the carrier in their original proportion with respect to each other, the band-pass circuit must pass all three frequencies with equal ease. This demands that the band width be twice the modulating frequency and that its tuning be centered on the carrier frequency. In the usual case where the wave is subject to amplitude modulation at various modulating frequencies, the band width must be twice the highest modulating frequency, in order that the amplitudes of the high audio frequency components of the reproduced sound at the receiver may have the same proportion with respect to the low audio frequency components as exists at the microphone.

From the analysis of the wave shown in Fig. 4, it is also evident that during modulation the amplitude of the carrier frequency component is unaffected, but two sideband components are added. This means that the power in an amplitude-modulated wave is greater than that in an unmodulated wave by the sum of the two  $I^2R$  products of the sideband currents. What is the source of this extra power? What is its significance in transmitter design?

The essential elements of a modern amplitude-modulated transmitter circuit are shown in Fig. 5. At the left is a radio frequency amplifier which is excited from an oscillator, either directly or through

one or more intermediate amplifiers. At the right in the diagram is an audio power amplifier or modulator whose output voltage is applied in series with the plate supply voltage of the radio frequency amplifier.

In the absence of modulation, the voltage across the secondary of the modulation transformer is essentially zero, and the amplitude of the radio frequency output is determined by the RF amplifier plate voltage. Power is drawn only from the DC plate voltage source and a portion of this power is converted to the RF carrier output of the amplifier.

When sound waves strike the microphone at the studio, the modulator is excited at audio frequency through a chain of speech amplifiers, and an audio modulating voltage appears across the secondary of the transformer. This voltage alternately adds to or subtracts from the plate supply voltage of the RF amplifier causing a proportionate increase and decrease in the RF amplifier plate current. The RF oscillations set up in the tuned circuit (tank) by the plate current pulses undergo the same audio frequency variation of amplitude.

During modulation the *average* plate current drawn from the DC plate supply of the RF amplifier remains unchanged, because for each pulse whose amplitude exceeds the unmodulated value by a certain amount, there is another pulse,  $180^\circ$  later in the modulation cycle, whose amplitude is less than the unmodulated value by the same amount. With both the average current and the voltage of the DC plate supply unchanged, this source furnishes the same amount of power as when there is no modulation. It follows that the extra power furnished to the RF amplifier for the generation of sidebands during modulation is the audio frequency power output of the modulator, derived from the DC plate supply of the modulator tubes.

Under a condition of complete or 100 per cent modulation, the amplitude of each sideband is one half that of the carrier. Since the power expended in a fixed amount of resistance varies as the square of the current amplitude, each of the sidebands represents one fourth as much power as the carrier. The total power in both of the sidebands may therefore be as great as one half that in the carrier. Furthermore, the modulator must also furnish the power dissipated in the radio frequency amplifier in the course of its generation of the sidebands. Suppose the rated carrier output of the transmitter is 1,000 watts, and the efficiency of the final radio frequency amplifier is 60%. At 100% modulation, the sideband power is 500 watts and the modulator is called upon to furnish  $500/.6$  or 833 watts of audio power, not including modulation transformer losses!

There are several stratagems available to the designer for reducing such large



audio power requirements. For example, the final stage may be modulated in the grid circuit rather than in the plate circuit, or the stage before the final may be modulated. However, it is not practical to attempt amplitude modulation at an early, low power stage, and to employ a chain of several linear amplifiers to bring the modulated wave up to a high power level; it is too difficult to adjust linear amplifiers for good linearity. Thus in transmitters of moderate or high power output employing amplitude modulation, the modulation is effected at or near the final amplifier stage. In general, therefore, tubes of the *power* rather than the *voltage amplifier* type are used in the modulator.

Of greater importance is the fact that on peaks of 100% modulation the radio frequency amplifier must deliver four times as much power as during carrier level condition. It is necessary that the tubes have adequate filament emission to supply a momentary two-fold increase in plate current over that occurring at carrier level. Also, the *average* power delivered during a cycle of 100% modulation is half again as great as the power furnished at carrier level. Thus the output obtainable from tubes in an AM final amplifier is only about two thirds that obtainable in an application where the amplitude is constant, as in FM. Hence tubes in AM final amplifiers operate at relatively low efficiency.

**Summary of AM** ★ The salient points about amplitude modulation, which will presently be contrasted with conditions found in frequency modulation, may be summarized as follows:

1. The amplitude of the wave, or the radiated power, is varied during modulation but its frequency is unchanged.

2. A higher modulating frequency increases the rate at which the amplitude is varied.

3. An increase in the amplitude of the modulating voltage causes the amplitude of the transmitted wave to vary over a wider range.

4. The limits of the range over which the amplitude can be varied is determined by the carrier amplitude. If the negative modulation peak tends to exceed the carrier amplitude, it is not reproduced and the wave is rendered discontinuous, which results in serious distortion.

5. When subjected to amplitude modulation at a single modulating frequency of sinusoidal wave form, the AM wave becomes the sum of three components, a carrier identical in frequency with the unmodulated wave, and a pair of sideband components of frequencies above and below the carrier by the amount of the modulation frequency.

6. The modulation factor is defined as the ratio of the maximum variation from carrier level during modulation to the unmodulated carrier amplitude. As the modulation factor is increased, the amplitudes of the upper and lower sidebands increase in the same proportion, reaching a maximum of half the carrier amplitude when the modulation factor is at its maximum value of 100 per cent. The amplitude of the carrier component of the wave is unchanged during modulation.

7. Since only one pair of sidebands is produced during amplitude modulation, a band width of twice the modulating

frequency is sufficient for satisfactory passage of the amplitude-modulated wave under any degree of modulation.

8. Inasmuch as amplitude modulation can only be effected in or near the final stage of the transmitter, a relatively large audio output is required to obtain the considerable increase in power output during modulation peaks.

9. In order to have the margin of safety necessary for handling the highest positive peaks of modulation, the tubes in the final stage of the radio frequency amplifier must be operated at considerably less than their normal ratings during carrier-level conditions; this tends to lower the overall efficiency of the transmitter.

**Analysis of FM Wave** ★ At the top of Fig. 6 is shown the form of a frequency-modulated wave. In the mathematical expression for the wave immediately beneath the diagram,  $F$  represents the carrier or mean frequency of the wave, and the audio modulating frequency is designated by  $F_M$ .

The amplitude of the FM wave, of course, is constant and the extent of modulation must be described in other terms than those of the amplitude-modulated wave.

When referring to a class of stations operating in the same service, a certain maximum frequency swing may be agreed upon by engineers as representing 100% modulation. For example, in the case of FM broadcast stations, a frequency swing of  $\pm 75$  kc. from the unmodulated center frequency is commonly considered as being the equivalent of 100% modulation.

However, the more widely applicable

**TABLE 1**  
**BESSEL FACTORS FOR FINDING AMPLITUDES OF CENTER AND**  
**SIDEBAND FREQUENCY COMPONENTS\***

$M$	$J_0(M)$ $F$	$J_1(M)$ $F \pm F_M$	$J_2(M)$ $F \pm 2F_M$	$J_3(M)$ $F \pm 3F_M$	$J_4(M)$ $F \pm 4F_M$	$J_5(M)$ $F \pm 5F_M$	$J_6(M)$ $F \pm 6F_M$	$J_7(M)$ $F \pm 7F_M$	$J_8(M)$ $F \pm 8F_M$	$J_9(M)$ $F \pm 9F_M$
0.0	1.000									
0.1	.9975	.0499								
0.2	.99	.0995								
0.3	.9776	.1483	.0112							
0.4	.9604	.196	.0197							
0.5	.9385	.2423	.0306							
0.6	.912	.2867	.0437							
0.7	.8812	.329	.0589	.0069						
0.8	.8463	.3688	.0758	.0102						
0.9	.8075	.4059	.0946	.0144						
1.0	.7652	.4401	.1149	.0196						
1.2	.6711	.4983	.1593	.0329	.005					
1.4	.5669	.5419	.2073	.0505	.0091					
1.6	.4554	.5699	.257	.0725	.0150					
1.8	.3400	.5815	.3061	.0988	.0232					
2.0	.2239	.5767	.3528	.1289	.034	.007				
3.0	-.2601	.3391	.4861	.3091	.1320	.0430	.0114			
4.0	-.3971	-.066	.3641	.4302	.2811	.1321	.0491	.0152		
5.0	-.1776	-.3276	.0466	.3648	.3912	.2611	.131	.0534	.0184	
6.0	.1506	-.2767	-.2429	.1148	.3576	.3621	.2458	.1296	.0565	.0212

To find the amplitude of any sideband pair, enter the table with the modulation index  $M$ , read the amplitude factor for the sideband pair and multiply the factor by the amplitude of the unmodulated carrier. The amplitude of the center frequency component is found in the same manner, taking the factor from the  $J_0(M)$  column.

\* Where no value is given, the actual value is less than .005 and the sideband pair is not important.



method of describing the extent of modulation lies in stating the value of the modulation index. This index ( $M$  in the equations of Fig. 6) is simply the ratio of the amount by which the transmitted frequency swings from its average frequency to the amount of the modulating frequency. For example, if the modulating voltage has an amplitude sufficient to swing the transmitted frequency over the range  $\pm 5$  kc., and the modulating frequency is 5,000 cycles, then the modulation index,  $M$ , is 5000/5000 or 1.

It is to be carefully noted, in describing the extent of frequency modulation, that the modulation percentage and the modulation index are defined in a different manner. The modulation percentage is proportional to the frequency swing. The modulation index is not only directly proportional to the frequency swing but also is inversely proportional to the highest modulating frequency. Thus, in contrast to amplitude modulation, the modulation index of a frequency-modulated wave is not the decimal equivalent of the modulation percentage. The modulation index of a frequency-modulated wave, for example, will exceed 1 by many times when the frequency swing is large and the modulating frequency is low.

By higher mathematics, it can be shown that the frequency-modulated output is the sum of a center frequency component and numerous pairs of sideband frequency components. The center frequency component has the same frequency as the unmodulated carrier. The two components of the first sideband pair have frequencies respectively higher and lower than the center frequency by the amount of the modulating frequency, just as in amplitude modulation. In frequency modulation, however, there are additional pairs of sideband components which can have appreciable amplitude. For example, the second pair of sidebands, having frequencies that are higher and lower than the center frequency by *twice* the amount of the modulating frequency, can also be important. The same can be true of the third pair of sidebands, which is removed from the center frequency by *three* times the modulating frequency, and of higher orders of sideband pairs whose frequencies differ from the center frequency by correspondingly greater amounts.

When the modulation is slight, only the pair of sidebands nearest in frequency to the carrier frequency component will have sufficient amplitude to be important. Under this condition, the band width required is no greater than for an amplitude-modulated wave.

As the frequency modulation is increased, however, more pairs of sidebands acquire appreciable amplitude and the band width requirements are greater than for amplitude modulation.

The actual amplitudes of the various components of the frequency-modulated wave, compared to an unmodulated car-

rier amplitude of 1, may be read directly from Table I for modulation indices up to 6.

Consider the case where the modulating frequency is 5,000 cycles and the frequency swing is  $\pm 5$  kc., making  $M$  equal to 5000/5000 or 1. For  $M$  of 1,  $J_0(M)$  is 0.7652, indicating that the amplitude of the center frequency component is 76.52% of the amplitude of the unmodulated carrier. Similarly, the relative amplitude of each of the first pair of sidebands, of frequencies  $F + 5,000$  cycles and  $F - 5,000$  cycles, is  $J_1(M) = .4401$  or 44 per cent. The second pair of sidebands, of  $F \pm 10,000$  cycles, has a relative amplitude of 11.5%; and the third pair, of  $F \pm 15,000$  cycles, has a relative amplitude of 1.96%. The fourth pair has an amplitude of less than .01 or 1%, and hence is considered unimportant.

The components have been plotted to a common scale of time in Fig. 6, so that graphical addition can be made to check the validity of the mathematical work.

Note particularly that the band width required depends upon the number of important pairs of sidebands as well as the modulating frequency; for this reason the band width required can be greater than the overall frequency swing resulting from modulation. In the case cited above, three pairs of sidebands are important. The frequencies of the third pair differ from the center frequency by the greatest amount and hence determine what band width will be needed. One of these sideband frequencies is higher than the center frequency by the amount of three times the modulating frequency of 5 kc., and the other sideband frequency is lower than the center frequency by the same amount. Thus the difference between the frequencies of the third pair of sidebands, which establishes the band width, is six times the modulating frequency of 5 kc., or 30 kc. The extent of the frequency swing is only  $\pm 5$  kc., or 10 kc. from peak to peak.

The values of  $J_0(M)$ ,  $J_1(M)$  and  $J_2(M)$  over the range  $M = 0$  to  $M = 16$  are plotted in Fig. 7. A study of these curves reveals some interesting facts about the composition of frequency-modulated waves.

$J_0(M)$  is less than 1 for all values of  $M$  greater than zero. This indicates that as sideband components appear with modulation, the amplitude of the center frequency component is less than its amplitude in the absence of modulation. The reasonableness of this fact is evident when it is remembered that the amplitude of the frequency-modulated wave is constant, so that the average power during each radio frequency cycle is the same as that during any other radio frequency cycle. In order that the power in the wave may not change when frequency modulation causes sideband currents to appear, the amplitude of the center frequency component must decrease sufficiently to keep the total of the  $I^2R$  prod-

ucts of *all* the components equal to the power of the unmodulated wave.

Fig. 7 also shows that at certain degrees of modulation the center frequency component disappears altogether. This fact is the basis of a certain method of modulation measurement to be discussed later. It will also be observed that at certain degrees of modulation the carrier component is negative, a reversal of phase.

When  $M$  is less than about .4, only the first pair of sidebands is important, and the relative amplitudes of sideband and carrier components can approach those of an amplitude-modulated wave. However, it should not be supposed that the two types of waves can be identical when both waves are slightly modulated. The sidebands of the FM wave are differently phased and add themselves to the carrier frequency component in a different manner from those of the AM wave.

Reference to Table I shows that for values of  $M$  between 0.4 and 3, the number of important sideband pairs is about  $2M$ . As  $M$  is made to exceed 3, the number of sideband pairs continues to increase but is somewhat less than  $2M$ . This information provides a useful rule of thumb for estimating the band width required, since the width needed is determined by the number of pairs of important sideband pairs that are present, as well as by the modulating frequency.

For example, if the amplitude of the modulating voltage of an FM station is such as to cause a frequency swing of  $\pm 20$  kc., and the frequency of the modulating voltage is 10 kc., then the value of  $M$  is 20/10 or 2. By the rule of thumb given above, the number of significant sideband pairs is  $2M$  or 4. The total band width required is  $4 \times 2 \times 10$  kc. or 80 kc. Again, the band width required (80 kc.) has been found to exceed the peak to peak frequency swing (40 kc.).

Suppose that while the frequency swing is maintained at  $\pm 20$  kc., the modulating frequency is reduced from 10 kc. to 4 kc. The modulation index becomes 20/4 or 5. The number of important sideband pairs can be expected to be somewhat less than  $2M$  or 10. Reference to Table I shows the values of the factors for the carrier and successively higher orders of sideband pairs to range from  $-.1776$  for  $J_0(M)$  to  $.0184$  for  $J_8(M)$ . For  $J_8(M)$  and higher order factors, the amplitude is less than .01; hence the ninth and higher orders of sidebands are unimportant.

It is evident that the reduction in modulating frequency has caused the number of important sideband pairs to increase from three to eight. However, the band width required is now  $2 \times 8 \times 4$  kc. or 64 kc., which is *less* than before.

In general, it can be said that for FM waves having the same frequency swing, the greatest spectrum area will be required by the wave having the highest modulating frequency. As the modulating frequency is lowered, more sidebands are

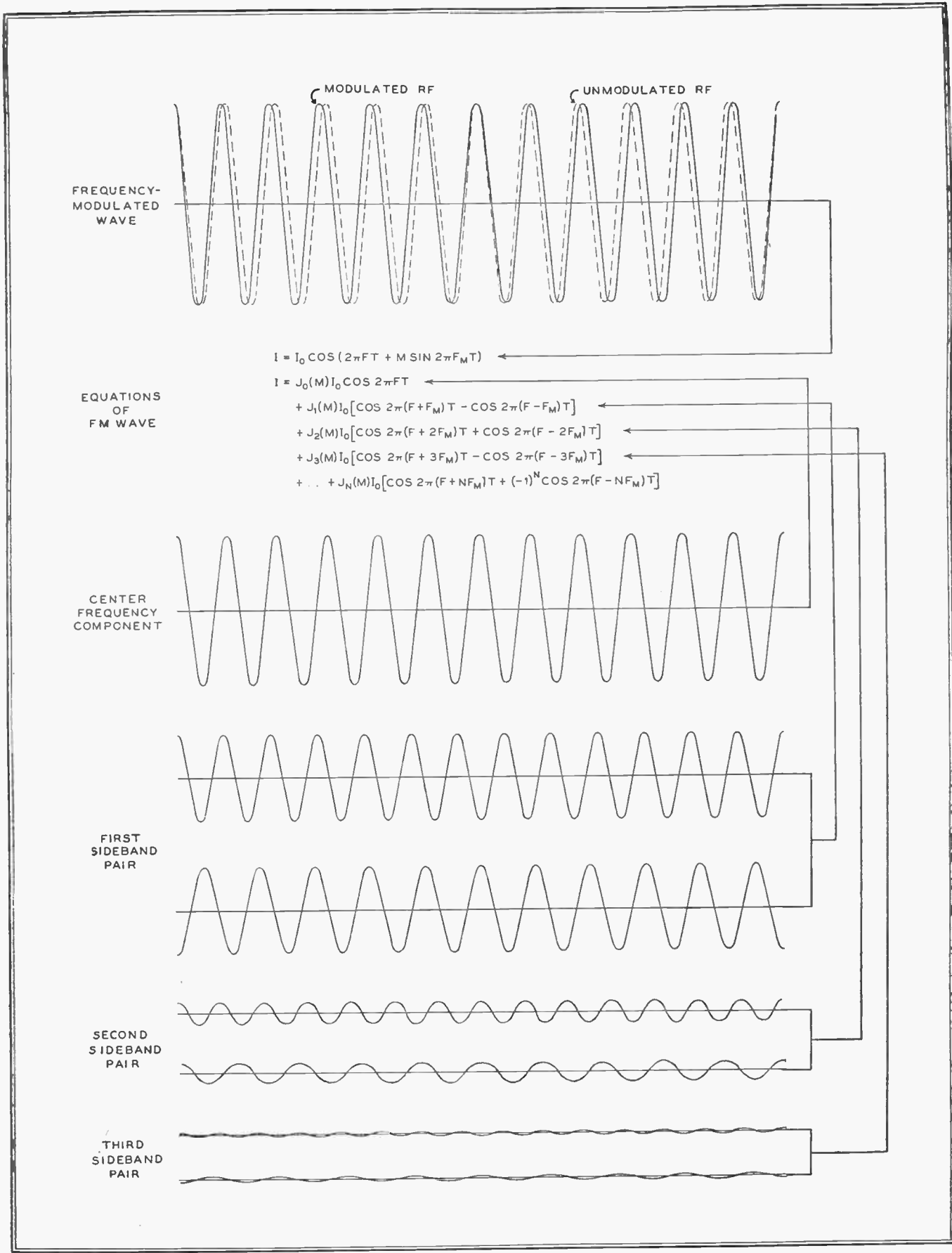

FIG. 6. THE FREQUENCY-MODULATED WAVE AND ITS COMPONENTS WHEN THE MODULATION INDEX IS 1

created, but the number of sidebands does not increase as rapidly as the frequency interval between the sidebands is reduced;

hence, the overall effect of lowering the modulating frequency while keeping the frequency swing unchanged is a reduc-

tion in the channel width.

If the modulating frequency is made very low, but the volume level is kept

constant to maintain the same frequency swing,  $M$  becomes quite high and a veritable multitude of sideband pairs are created; however, the band width required is reduced still more, although it can never be less than the peak to peak frequency swing nor twice the modulating frequency, whichever is the greater.

For example, consider the design of the output network of an FM broadcast transmitter whose maximum frequency swing is  $\pm 75$  kc. and whose maximum modulating frequency is 15 kc. The modulation factor  $M$  has a value of  $75/15$  or 5, indicating that eight important pairs of sidebands are present, as explained above. The band width of the output network theoretically should be  $2 \times 8 \times 15$  kc. or 240 kc. The actual width employed can be slightly less because the amplitude of the eighth sideband pair is quite small, being only 1.84% of the unmodulated carrier amplitude. The band width used may be in the order of 225 kc., or 50% greater, in this case, than the peak to peak frequency swing of 150 kc.

**Summary of FM** ★ Frequency-modulated waves differ from amplitude-modulated waves in the following respects:

1. During modulation the frequency is varied but its amplitude remains unchanged.

2. A higher audio modulating frequency increases the rate at which the radio frequency is varied.

3. An increase in the amplitude of the audio modulating voltage causes the radio frequency to be varied over a wider range.

4. The limits of the range over which the radio frequency can be varied is determined by the characteristics of the transmitter, rather than by the nature of the frequency modulated wave.

5. When subjected to frequency modulation at a single modulating frequency of sine wave form, the FM wave becomes the sum of a component at the center frequency, and numerous pairs of sideband components above and below the center frequency, at intervals equal to the amount of the modulation frequency. When the modulation is slight, the amplitude of the pairs of sidebands more remote from the carrier becomes so low that their presence may be ignored.

6. The extent of the frequency modulation can be described in two ways. A certain frequency swing is agreed upon as being equivalent to 100% modulation. The extent of modulation can also be specified by stating the modulation index. This index is the ratio of the maximum frequency swing (away from the center) to the highest modulating frequency. In the case of FM, therefore, the modulation index is not the decimal equivalent of the modulation percentage.

7. The band width required in FM depends upon the level of modulation and upon the modulating frequency. The

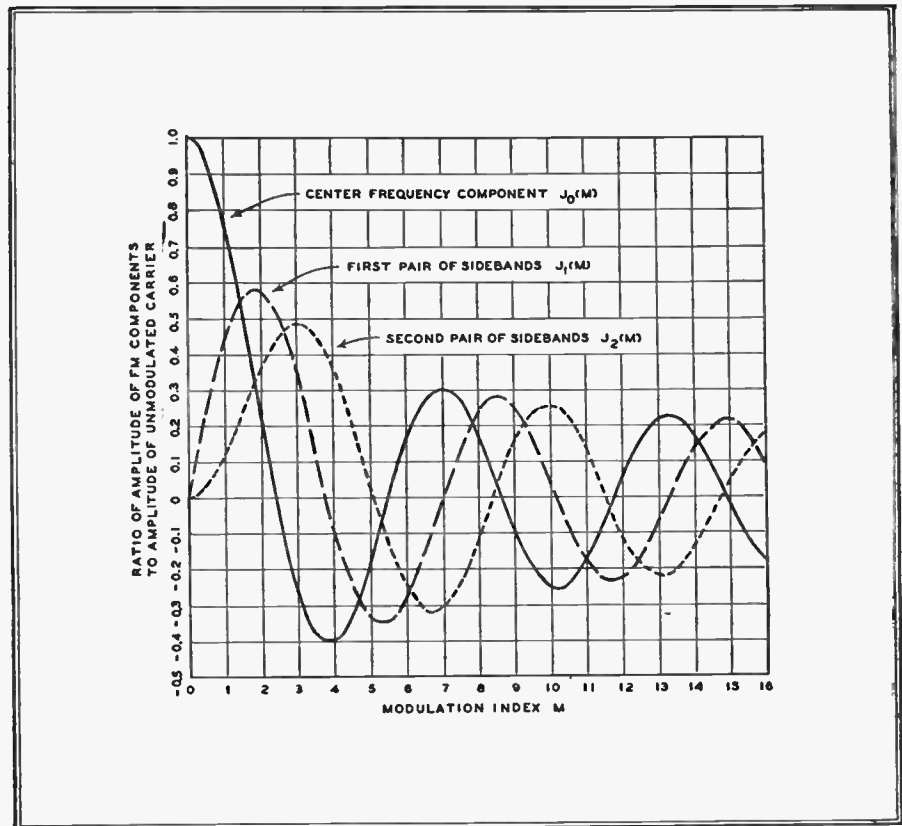

FIG. 7. HOW FM WAVE COMPONENTS VARY WITH THE DEGREE OF MODULATION

greatest channel width occurs when the wave is subjected to its maximum modulation at the highest modulating frequency; this band width may exceed considerably the peak-to-peak frequency swing. The least band width is required under a condition of slight modulation, but the channel width is never less than the amount of twice the modulating frequency.

8. Inasmuch as linearity of amplitude reproduction is not demanded of the amplifier stages of an FM transmitter, it is not necessary to introduce the modulating voltage at or near the last stage.

9. Since the RF power output of the FM transmitter is constant, modulation can be introduced in an early stage. Not only are the power output requirements for the modulator made extremely small, but also the tubes in all the stages of the transmitter subsequent to the modulated stage can be operated at their maximum Class C ratings, which makes for high overall efficiency.

## REFERENCE DEFINITIONS

**AMPLITUDE:** The amplitude of a quantity that is varying according to a sine wave form is the maximum value which the quantity attains; the peak value of the sine wave.

**AM, AMPLITUDE MODULATION:** The process whereby the amplitude of a wave is caused to vary according to the instantaneous variations of another wave.

**BAND-PASS CIRCUIT:** A circuit having filter characteristics such that frequencies within a certain range are passed while frequencies outside the range are blocked.

**BAND-WIDTH:** Range of frequencies passed by band-pass circuit.

**CARRIER FREQUENCY:** Frequency of an unmodulated AM transmitter.

**CENTER FREQUENCY:** Frequency of an unmodulated FM transmitter.

**CYCLE:** A complete course of change, at the end of which the original state is restored.

**FREQUENCY:** The number of cycles occurring in one second.

**FREQUENCY MODULATION:** The process whereby the frequency of a wave is caused to vary according to the instantaneous variations of a modulating frequency.

**FM:** Abbreviation for Armstrong system of Frequency Modulation.

**MODULATION:** The process whereby one characteristic of a wave, amplitude, frequency, or phase, is varied as a function of the variations of another wave.

**POSITIVE PEAK OF MODULATION:** In amplitude modulation, the maximum of that alternation of the modulation cycle which causes the amplitude of the wave to rise above carrier level.

**NEGATIVE PEAK OF MODULATION:** In amplitude modulation, the maximum of that alternation of the modulation cycle which causes the amplitude of the wave to fall below carrier level.

**SIDEBANDS:** Frequencies higher and/or lower than the carrier frequency, produced during modulation.

**TRIGONOMETRIC IDENTITY:** Statement of the equivalence of two trigonometric expressions which holds for every value of the angles involved.



# Theory of Frequency Modulation

## Section 2: The Operational Advantages of FM Circuits

**W**HEN Major Armstrong presented his original paper on Frequency Modulation before the Institute of Radio Engineers in November 1935, he referred to his invention as "A Method of Reducing Disturbances in Radio Signaling by a System of Frequency Modulation." This description is most appropriate, for an outstanding advantage of FM is its freedom from the various types of interference that beset AM reception.

FM also has a number of other important advantages, such as the economies in transmitter design and operation which have been explained, and the improvements in fidelity that will be discussed in the latter part of this chapter and in coverage, which will be taken up subsequently. However, the initial effort which led to the development of FM was directed primarily at the problem of overcoming static and other types of radio interference.

**Sources of Interference** ★ The principal disturbances to AM reception can be classified as follows: 1) Interference resulting from the reception of signals from stations other than the one whose program is desired. 2) Thermal agitation noise, arising from the small potentials set up by the random motion of electrons in the conductors of the first stage of the receiver. 3) Tube noise, caused by random fluctuations in the rate at which electrons arrive at the plates of the vacuum tubes in the early stages of the receiver. 4) Static, arising from electrical discharges in the atmosphere. 5) Man-made interference, which occurs when there is spurious radiation from such sources as electrical power equipment and automobile ignition systems. 6) Hum modulation of the signal, which can take place in the early stages of AC receivers, where alternating current is used to heat the cathodes, and where the rectified DC plate supply may be inadequately filtered.

All these types of interference can be practically overcome or at least greatly reduced by the use of frequency modulation in a particular way, provided that the voltage of the desired FM signal is somewhat greater than the voltage of the disturbance. The method by which the receiver is made unresponsive to disturbances can be understood from a knowledge of the various types of disturbances.

**Interference between Two Waves** ★ Consider first the simple case of the interference between two waves shown in Fig. 8. Here an undesired signal  $A$  is present at the receiver along with the desired signal  $B$ . The amplitude of the desired signal  $B$  is twice that of the interfering signal  $A$ , and the frequency of the interfering signal is

slightly less, in this case, than that of the desired signal.

The voltage at the grid of the first tube of the receiver is the resultant or sum of the two signal voltages. The wave form of the resultant voltage  $A + B$  is shown at the lower left of Fig. 8, and was obtained by adding the values of waves  $A$  and  $B$  from instant to instant.

It will be observed in Fig. 8 that the resultant signal has an amplitude variation between the limits of .5 and 1.5 times the amplitude of the desired signal taken alone. The form of the amplitude variation appears to approach that of a sine wave, although the negative peak is somewhat sharper than the positive peak. The frequency of the amplitude variation is the difference between the respective frequencies of the desired and the interfering signals.

In Fig. 8 it is noted that exactly the same amount of time is required for the completion of twelve cycles of the resultant as for the completion of twelve cycles of the predominant (desired) signal. Thus the *average* frequency of the resultant is the same as that of the predominant (desired) signal. However, Fig. 8 also shows that the curve of the resultant wave does not intercept its axis at equal time intervals, indicating that the resultant has a variation of frequency as well as a variation of amplitude. For example, in Fig. 8, the time taken to complete the first cycle of the resultant signal is somewhat greater than that required for the completion of the first cycle of the desired signal. To the lag acquired by the resultant during its first cycle is added a smaller amount of lag acquired during its second cycle, and so forth, until at instant  $T_1$  a maximum amount of lag has accumulated. Thereafter, and until instant  $T_2$ , the resultant signal shortens its time period per cycle, first diminishing the lag to zero and then causing the accumulation of a lead. At instant  $T_2$  the lead is at a maximum, and for the remainder of the wave shown in the diagram, the periods of the cycles increase, diminishing the lead to zero.

The amount of the *maximum* accumulated lead or lag of the resultant with respect to the predominant (desired) signal is called its *peak phase deviation*. The amount of the deviation is of interest because it plays a part in determining the effectiveness of the reduction of interference in the FM receiver, as will be shown presently. The amount of the deviation depends upon the ratio of the amplitude of the desired signal  $B$  to that of the interfering signal  $A$ ; in the present case, the ratio  $B/A$  is 2 to 1. It will be noted at instant  $T_1$  in Fig. 8 that with

$B/A = 2$ , the maximum lag occurs when the desired signal  $B$  has completed  $120^\circ$  more of its cycle than has the interfering signal  $A$  of its cycle. This agrees with the angular relationship of  $A$  to  $B$  in the vector diagram for instant  $T_1$ , also shown in Fig. 8, for readers interested in the mathematical procedure of determining the amount of peak phase deviation. It is found that the maximum lag or lead occurs when the resultant  $A + B$  is tangent to the circle described by the terminal point of vector  $A$  as it rotates about the terminal point of vector  $B$  as a center. In the present case, the side  $A$  opposite the deviation angle is equal to one-half the hypotenuse  $B$ , which makes the phase deviation equal to  $30^\circ$ , measured in terms of a cycle of the predominant (desired) signal as  $360^\circ$ . When the ratio of the amplitude of the desired signal  $B$  to that of the interfering signal  $A$  is greater than 2 to 1, the peak phase deviation is less than  $30^\circ$ .

It should be noted particularly that the amount of deviation depends solely upon the ratio of the amplitude of the desired signal to that of the interfering signal, and is independent of the frequencies of the two signals. As the difference between the frequencies of the two signals is made greater, the amplitude of the resultant pulsates at a higher frequency and the interval between the successive instants of maximum lag or lead is reduced; however, the *amount* of the deviation at these instants remains unchanged. For example, if the amplitude of the desired signal is twice that of the interfering signal, the resultant signal will alternately acquire lags and leads of only  $30^\circ$  with respect to the predominant (desired) signal, regardless of what the difference in frequency of the desired and interfering signals may be. This fact has an important bearing on the matter of how the effects of interference are overcome in the FM receiver, as will be explained later.

It has been mentioned previously that while the average frequency of the resultant is equal to the frequency of the predominant (desired) signal, the resultant is continually varying in frequency alternately above and below its average frequency value. The maximum amount of the frequency variation is called the *frequency deviation*. Unlike the phase deviation, the frequency deviation depends, in part, upon the frequencies of the desired and interfering signals. As a matter of fact, the frequency deviation is directly proportional to the amount of phase deviation, and also directly proportional to the rate at which the instants of maximum lag or lead recur, that is, to the difference of the two signal frequencies. This rela-

tionship is to be expected, for the extent to which the time periods of the cycles must be lengthened and shortened depends not only upon how much lag or lead is to be accumulated but also upon how many cycles occur during the process of accumulation.

For example, if the signal frequencies differ only slightly, then the amplitude of the resultant pulsates quite slowly and there is a long time interval between the instants of maximum lag or lead. Many cycles of the resultant wave occur during the process of accumulating the maximum lag or lead, and the amount by which the time period of any individual cycle is lengthened or shortened is quite small. Consequently, the frequency of the resultant is varied over a narrow range. On the other hand, if the signal frequencies differ considerably, the amplitude of the resultant pulsates rapidly, the time interval between the instants of maximum lag or lead is much shorter, and greater frequency deviation is required to give the same amount of phase deviation.

**Overcoming Effects of an Interfering Wave** ★ It has been noted that an interfering signal acts upon a desired signal of greater amplitude to create a resultant which differs from the desired signal by having variations of amplitude and frequency. It follows that to reduce the effects of the interfering signal, steps should be taken to minimize the amplitude and frequency variations of the resultant.

In the FM receiver, the amplitude variations are removed by the action of a limiter stage, located immediately after the last IF amplifier stage, as shown in the block diagram of Fig. 9. Previous to the limiter, the general arrangement of the receiver is like that of the conventional AM superheterodyne broadcast receiver, except that the tuned circuits are designed for higher RF and IF frequencies, and greater bandwidth. Thus the amplitude and frequency variations of the resultant signal voltage at the grid of the first tube of the receiver are transferred to the IF voltage at the input of the limiter.

If, for purposes of explanation, the voltage at the input of the limiter is assumed to have the wave form shown at the lower left in Fig. 8, then the output voltage of the limiter will have the wave form shown at the lower right in Fig. 8 (assuming that the limiter output impedance is constant at all frequencies). It will be observed that whenever the instantaneous voltage applied at the input of the limiter begins to exceed a predetermined level, the limiter operates to prevent its output voltage from increasing in a like manner. If the limiting action begins at a level below the least amplitude of the applied voltage at the limiter input, then the amplitude variations are practically absent in the limiter output. Thus the limiter overcomes one of the effects of the interfering wave. The use of a circuit that minimizes the effects

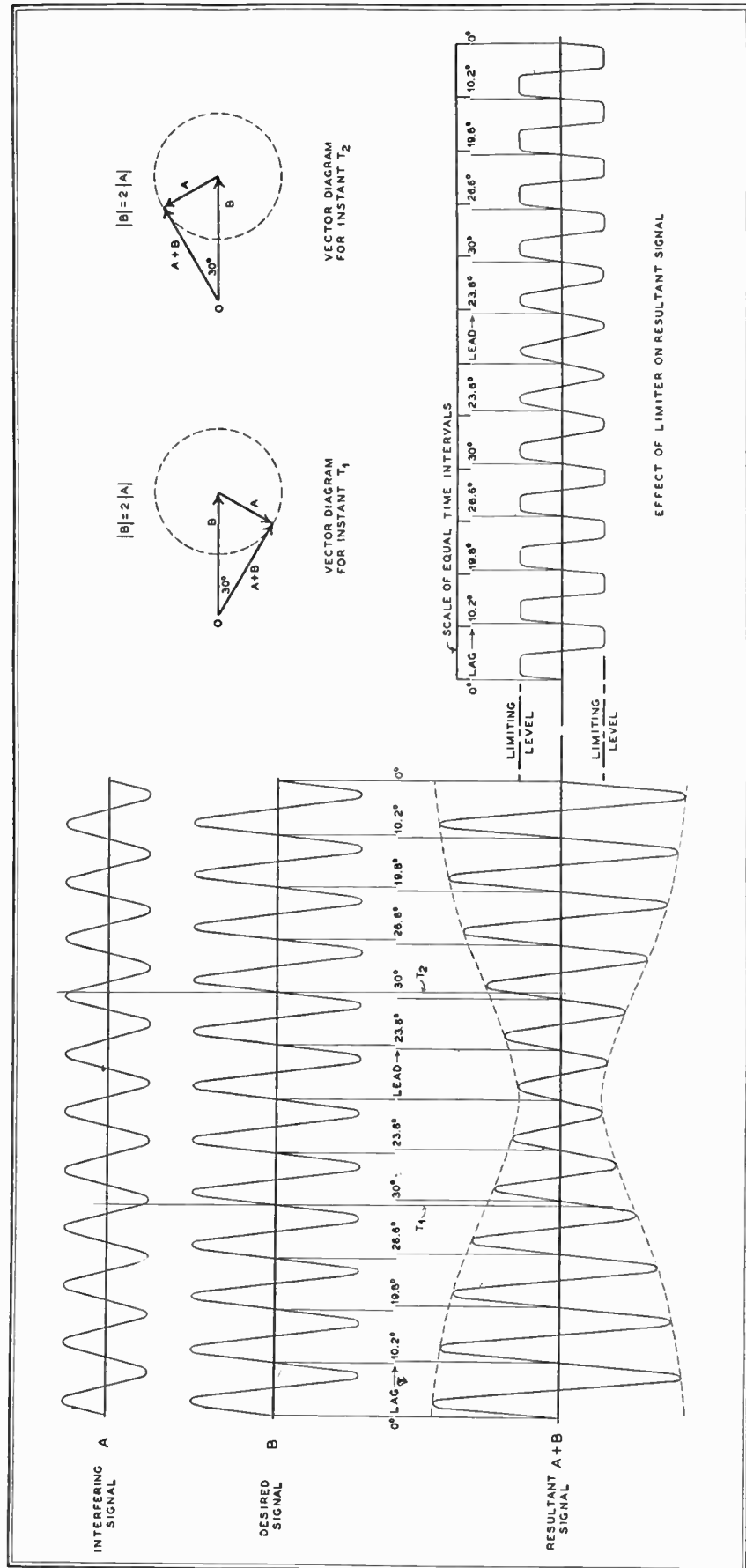

FIG. 8. EFFECT OF INTERFERING SIGNAL A UPON DESIRED SIGNAL B IS TO CREATE RESULTANT HAVING AMPLITUDE AND FREQUENCY VARIATIONS; THE LIMITER REMOVES THE AMPLITUDE VARIATIONS BUT THE FREQUENCY VARIATIONS ARE STILL PRESENT IN THE LIMITER OUTPUT

of the amplitude variation of the resultant wave, such as a limiter, is necessary for the reduction of interference in the FM receiver.

The frequency variations of the input voltage to the limiter, however, are carried over into the output, as indicated by the fact that the intercepts of the limiter out-

put voltage curve with its axis (Fig. 8, lower right) occur at unequal time intervals.

While the amount of frequency variation due to the interfering signal is not reduced in the limiter, the effects of such frequency variation can be minimized if wide-band frequency modulation is used for conveying intelligence on the desired signal. For example, if a sound wave striking the microphone at the studio causes the radio wave emitted by the FM transmitter to vary in frequency by thousands of cycles, then a supplementary frequency variation of, say, fifty cycles, in-

the phase deviation) of the limiter output voltage.

When the variation of frequency is sinusoidal, the frequency deviation in cycles is equal to the product of the phase deviation in radians and the number of times that a complete cycle of frequency variation recurs in one second. In the case of the FM wave mentioned above, having a phase deviation of 75 radians and a modulation frequency of 1,000 cycles, the frequency deviation due to modulation is  $75 \times 1000$  or 75,000 cycles.

In the case of the resultant of the interfering wave and the FM wave, whatever

ness of the reduction of interference, especially when it is remembered that the amplitudes of the desired and interfering signals are in the ratio of 2 to 1. If the ratio were greater than 2 to 1, the disturbance of reception by the interfering wave would be even less.

Fig. 10 shows, from left to right, the voltage at the limiter input, at the limiter output, and at the discriminator output when a wide-band frequency-modulated signal is being received in the absence of interference. Any amplitude variations caused by interfering signals are removed by the limiter and any frequency variations caused by interfering signals are rendered negligible by the fact of the much greater frequency variations caused by modulation. The discriminator creates a voltage whose amplitude at any instant is proportional to the amount by which the frequency of the output voltage of the limiter differs from the frequency to which the discriminator as well as the limiter and IF amplifier tuned circuits is aligned. The polarity of the discriminator output voltage at any instant depends upon whether the frequency at the limiter output is greater or less than the alignment frequency of the discriminator tuned circuits. When the variation of the frequency of the limiter output voltage is sinusoidal about its center frequency, the discriminator furnishes a sinusoidal alternating voltage for excitation of the audio amplifier, as shown in Fig. 10.

While the essential function of the discriminator is the demodulation of the FM signal, it also serves to supplement the action of the limiter. The discriminator tends to balance out the effects of any amplitude variations that are not completely removed in the limiter, providing the discriminator is correctly tuned. A properly aligned limiter and discriminator give a very marked reduction of the effects of amplitude variation of the sig-

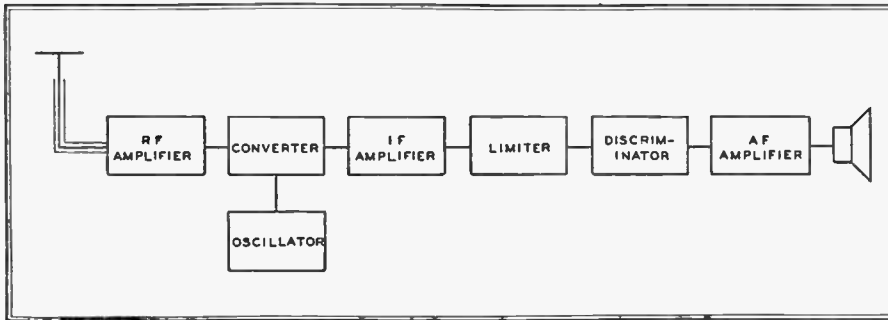

FIG. 9. BLOCK DIAGRAM OF A CONVENTIONAL FM RECEIVER

produced by the interfering signal at the receiver, is of negligible effect.

Consider the case of an FM broadcast transmitter. The maximum frequency swing away from the center frequency amounts to 75 kc., which is five times the highest modulation frequency of 15 kc. This is a wide-band FM system. Suppose that a 1,000-cycle note of sine wave form is sounded at the microphone with an intensity sufficient to cause the transmitter to be fully modulated. The frequency swing of the transmitter will be 75 kc. The modulation index is  $75000/1000$  or 75. The angle of phase deviation of the transmitter in radians is equal to its modulation index. Since one radian is equivalent to approximately 57.3 degrees, the phase deviation of the transmitter amounts to  $75 \times 57.3$  or about  $4300^\circ$  in this case!

Assume that at the receiver an interfering signal is present, having a frequency 100 cycles higher than the center frequency of the desired signal, and an amplitude one-half that of the desired signal. The ratio of the amplitude of the desired signal to that of the undesired signal is 2 to 1, making the phase deviation of the resultant with respect to the desired signal equal to  $30^\circ$ , regardless of the frequency of the desired signal, as explained previously.

The ratio of the phase deviation due to modulation to that caused by the interfering wave is  $4300/30$  or about 143 to 1. However, it must not be concluded from this that the intensities of the 1,000-cycle and 100-cycle tones at the speaker of the receiver will be in the ratio of 143 to 1. The discriminator stage which follows the limiter in Fig. 9 produces a voltage for exciting the audio amplifier that is proportional to the frequency deviation (and not

the frequency of the latter, the supplementary phase deviation caused by an interfering wave having one-half the amplitude of the desired FM wave is  $30^\circ$  or .52 radian. If the frequency variation of the resultant caused by the interfering signal is assumed to be sinusoidal, then the supplementary frequency deviation caused by the interfering signal is  $.52 \times 100$  or only 52 cycles!

(Strictly speaking, the value of 52 cycles must be regarded as an approximation, since neither the amplitude nor the frequency variation of the resultant caused by the interfering signal is sinusoidal. However, the variation of frequency caused by the interfering signal is suf-

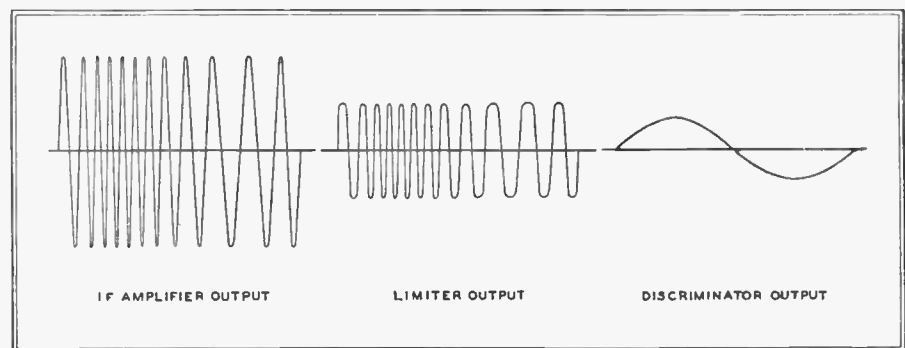

FIG. 10. WAVE FORMS OF LIMITER AND DISCRIMINATOR VOLTAGES IN RECEIVER

ficiently close to a sinusoidal form to justify the above assumption in making a rough estimate of the frequency deviation.)

A comparison of the frequency swing of 75,000 cycles caused by modulation to a swing of 50 or 100 cycles caused by the interfering wave emphasizes the effective-

ness of such variation be the result of noise, AM hum modulation in the early stages of the receiver, or an interfering wave.

It should be noted that the suppression of the frequency variation of an interfering wave is not always as effective as in the case for which figures were cited



above. For example, if the frequency of the interfering signal differs from the frequency of the desired signal by a greater amount, the phase swing remains unchanged but the frequency swing of the resultant is increased. Also, during much

same conditions are met, namely that: 1) The amplitude of the desired signal is two or more times the peak amplitude of the interfering signal, so that the supplementary phase swing caused by the interfering signal is never more than  $30^\circ$

ters. The general term applied to such disturbances is *noise*.

Noise voltages are made up of sharp pulses of various amplitudes occurring at irregular intervals. When the voltage peaks are infrequent and sharply defined, with successive peaks clearly separated, the noise is described as being of the *impulse* type. When the peaks follow one another in such rapid succession that there is overlapping, the noise is described as being of the *random* type. Both types of noise are usually present in varying degrees at any receiver.

Impulse noises usually originate in sources external to the receiver, such as automobile ignition systems, faulty power lines, and the sparking brushes of electric motors.

Random noise can be caused by the usual form of static, arising from a more or less continuous series of electrical discharges in the atmosphere. In addition, there is always an appreciable amount of random noise originating in the early stages of all radio receivers.

One source of such random noise is the thermal agitation voltage which is developed in all conductors at temperatures above absolute zero. It is the result of the

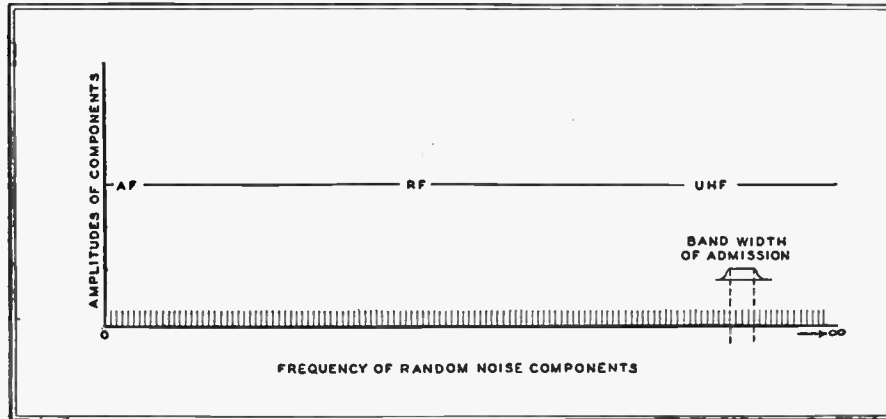

FIG. 11. APPROXIMATE REPRESENTATION OF SPECTRUM DISTRIBUTION OF RANDOM NOISE

of the time when a program is on the air, the transmitter is not fully modulated, so that its frequency swing does not overshadow the frequency deviation caused by interference at the receiver to as great an extent.

For example, if the difference in frequency of the desired and the interfering signals is increased from 100 to 10,000 cycles, the phase swing caused by the interfering signal remains at  $30^\circ$  or  $.52$  radian, but the frequency swing caused by the interfering signal is increased to  $.52 \times 10,000$  or 5,200 cycles. Such a swing is appreciable compared to a transmitter swing of 75,000 cycles. The situation is even less favorable at lower degrees of modulation where the swing of the FM wave is in the order of, say, 15,000 or 20,000 cycles. Since the higher frequency components of program material are generally of less amplitude than the lower frequency components, this characteristic might appear to be a serious obstacle to the achievement of high fidelity FM reception. However, the situation can be easily remedied by the use of pre-emphasis and de-emphasis, as will be explained later. Even without the use of emphasis networks at the transmitter and receiver, the interference is less noticeable than with AM.

When the frequency of the interfering wave differs from that of the desired signal only slightly, the disturbance is suppressed by the FM receiver more effectively than ever. This is in marked contrast to AM, where it becomes increasingly difficult to tune out the interfering signal as its frequency approaches that of the desired signal.

In the above discussion it was assumed that the interfering signal was unmodulated. Equally effective suppression of interference in the FM receiver occurs when the interfering wave is amplitude- or frequency-modulated, provided the

importance of high gain RF and IF amplifiers in the FM receiver. 3) The intelligence is conveyed on the desired signal by the use of wide-band frequency modulation, so that the frequency variations due to modulation will greatly overshadow the frequency variations due to the interfering signal.

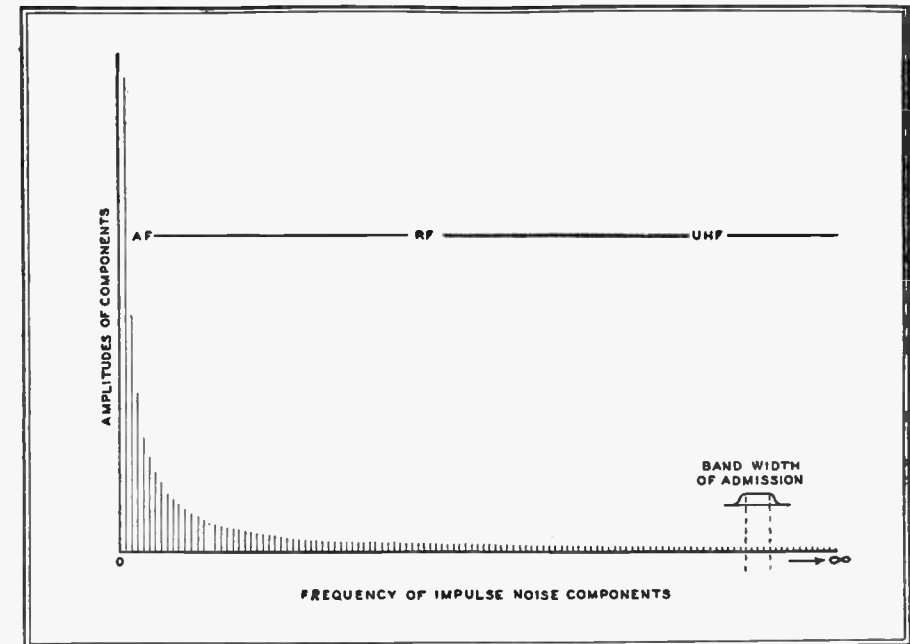

FIG. 12. APPROXIMATE REPRESENTATION OF SPECTRUM DISTRIBUTION OF IMPULSE NOISE

importance of high gain RF and IF amplifiers in the FM receiver. 3) The intelligence is conveyed on the desired signal by the use of wide-band frequency modulation, so that the frequency variations due to modulation will greatly overshadow the frequency variations due to the interfering signal.

**Noise Disturbances** ★ In addition to the interference caused by continuous signals picked up from undesired radio transmitters, there may be interference from voltages of a discontinuous nature arising from sources other than radio transmit-

ters. The general term applied to such disturbances is *noise*. haphazard motion of free electrons in the conductors, and depends upon the temperature as well as the resistance of the conductors. While thermal agitation is present in all the conductors of a receiver, only that present in the input circuit preceding the first tube is usually important because the signal voltage is at its lowest level at this point.

Another source of random noise within every receiver is a slight fluctuation in the rate at which the electrons arrive at the plates of the tubes. This fluctuation occurs continuously, regardless of whether or not there are larger variations of plate current

caused by the incoming signal. A certain amount of random fluctuation is inherent in the nature of plate current, which is a bombardment of the plate by a hail of separate particles rather than the smooth flow of a continuous fluid. This fluctuation creates a noise voltage across the output load of the tube, which is termed *shot effect*. Additional slight fluctuations of plate current are caused by variations in the rate at which electrons are emitted from the cathode of each tube and by variations of the ratio in which the electrons are divided among the collecting elements of the tube. The resultant of all these effects is called tube noise, and is of importance in the early stages of the receiver, where the signal voltage is still of relatively low amplitude.

**Analysis of Noise Voltages** ★ Since random noise voltages come from forces which act

equal to the sum of a component at the fundamental frequency, a component at twice the fundamental frequency having one-half the amplitude of the fundamental frequency component, a component at three times the fundamental frequency with one-third the amplitude of the fundamental, and an infinite series of higher harmonics each having an amplitude inversely proportional to the order of the harmonic. The spectrum distribution for impulse noise is approximately depicted in Fig. 12.

While noise voltages are made up of components at all frequencies, a radio receiver at any particular setting of the tuning dial responds only to frequencies within a comparatively narrow band of the spectrum. The center frequency of the band is the assigned frequency of the station to which the receiver is tuned; the width of the band, that is, the difference

From alternating current theory, it will be remembered that when two or more components of voltage, or current, at different frequencies are present in a circuit, the root mean square or RMS value of the resultant is equal to the square root of the sum of the squares of the RMS values of the components. If the components are all of equal amplitude, then the RMS value of the resultant is proportional to the square root of the number of components present. It was shown above that under conditions encountered in practice, the amplitudes of the components at different frequencies of both impulse and random noise tend to be uniform within the response band of the receiver. Thus the RMS values of random noise and of impulse noise can be expected to be proportional to the square root of the width of the radio frequency band to which the receiver is responsive at any particular

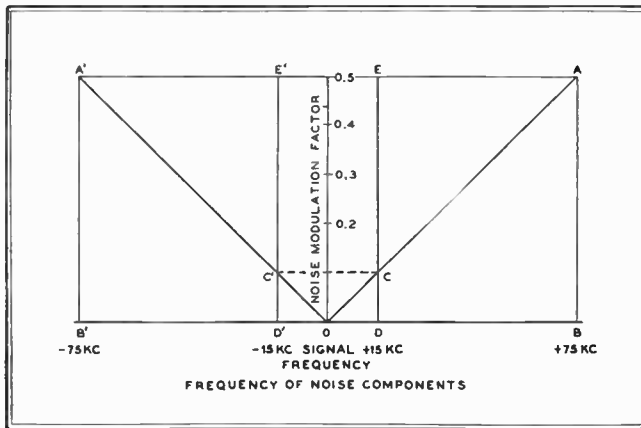

FIG. 13. CONSTRUCTION DIAGRAM OF AM AND FM RECEIVER NOISE

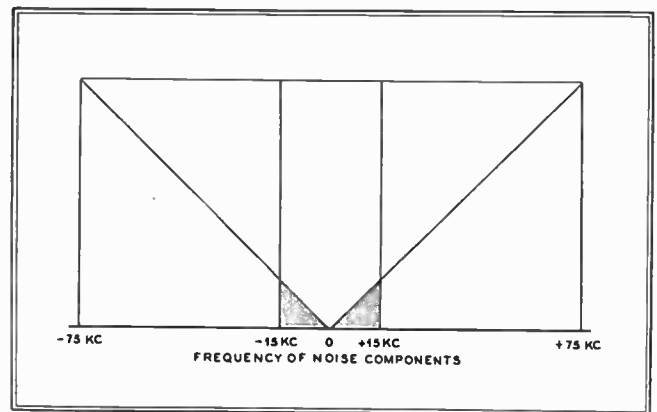

FIG. 14. SPECTRUM DISTRIBUTION OF FM RECEIVER NOISE, INDICATED BY THE SHADED AREA

in an uncontrolled and haphazard manner, it is to be expected that they will have no particular frequency. As a matter of fact, the energy of random noise is almost uniformly distributed over the spectrum from zero frequency to the highest of radio frequencies. True random noise voltage may be regarded, therefore, as consisting of an infinite number of components at different frequencies, each frequency differing from the next higher or lower frequency by an infinitesimal amount. The individual components have no specific time or phase relation with respect to each other, and the average amplitude of all the components in a frequency band in one portion of the spectrum is equal to the average amplitude of the components in a frequency band of the same width in any other portion of the spectrum. An approximation of the spectrum distribution characteristics for random noise is shown in Fig. 11.

Impulse noises are in the form of sharp peaks, occurring at irregular intervals. To analyze the spectrum distribution of energy received from a single pulse, the pulse may be regarded as one of a series of pulses recurring at a very low frequency. When a recurrent pulse of exceedingly short time duration is analyzed, it is found to be

between the highest and lowest frequencies of the band, is largely determined by the adjustments of the tuned circuits of the IF amplifier. In practice, the width of the frequency band to which the receiver responds at any particular dial setting is quite small compared to the center frequency of the band. For example, in FM broadcast reception, the band of frequencies to which the receiver is responsive when the receiver is tuned to a station is in the order of 200 kc. wide, while the frequency of the station (that is, the center frequency of the band) is in the order of tens of thousands of kilocycles. Thus the receiver band widths indicated in Figs. 11 and 12 are shown as narrow portions of the spectrum located well up the frequency scale. Note particularly that under such conditions, the amplitudes of components at different frequencies *within* the receiver response band are practically uniform. This is to be expected in the case of random noise, Fig. 11, but in the case of impulse noise, Fig. 12, the practically uniform amplitudes are the result of the location of the band in a region of the spectrum where the limiting frequencies of the band differ by only a small percentage from the frequency at the center of the band.

dial setting. That such is the case has been confirmed experimentally.

It is the peak value of a noise voltage rather than its RMS value, however, that largely determines the extent to which noise irritates the listener. In the case of random noise arising from thermal agitation, the ratio of the peak to the RMS value, called *crest factor*, is about 4 to 1. When random noise voltage arises from sources other than thermal agitation, the crest factor can assume a somewhat higher value, but will tend to be constant at that value in the presence of a strong signal. Thus the peak as well as the RMS value of random noise at the IF output of the receiver is approximately proportional to the square root of the band width of the receiver.

The peak value of the impulse noise voltage, however, varies directly as the band width, and not as the square root of the band width. The reason for this relationship is to be found in the fact that the components of the impulse noise are all in harmonic relation to the fundamental, and so timed with respect to each other that they are all in phase at the instants when the pulse starts or stops. Thus the peak value of the impulse noise voltage is the arithmetical sum of the

amplitudes of the components. In a receiver whose response band is located well up in the frequency spectrum, where the amplitudes of the impulse noise components are nearly uniform, the peak voltage is proportional to the number of components added. The number of components added varies, in turn, as the band width, since the components are located in the frequency spectrum at intervals equal to the fundamental frequency of the impulse. Therefore, the peak value of the impulse noise voltage is proportional to the frequency band passed by the receiver.

The distinction between the relationships of peak random and peak impulse

spaced at equal frequency intervals in the response band of the receiver, it follows that reduction of this noise as well as of the interfering signals can be expected in the FM receiver. Also, it is to be expected that the noise components at frequencies nearest the signal frequency will be most effectively suppressed while those components whose frequencies are more remote from the signal frequency will cause more disturbance in the receiver output.

These anticipated effects are found in practice, so that in Fig. 13 the curve  $A'O'A$  shows how the radio frequencies of the noise components at the receiver input determine the amplitudes of the audio frequency components of noise at the

receiver output. The diagram applies to the case of peak impulse noise and assumes that the ratio of carrier-to-noise is 2 to 1. While the amplitudes of the components of impulse noise are known to be practically uniform within the width of the receiver response band at the source, it is observed that the frequency modulation due to noise increases in direct proportion to the amount by which

are proportional to the highest frequency passed by the audio system of the receiver. These triangles are shown as shaded areas in Fig. 14, which represents the noise output of the FM broadcast receiver. As will be explained later, by the use of pre-emphasis and de-emphasis circuits at the FM transmitter and receiver, it is possible to reduce the already small amount of FM receiver noise represented by the shaded triangles still further.

In Fig. 13, if the perpendiculars  $CD$  and  $C'D'$  are extended upward until they intersect the horizontal line  $AA'$  at  $EE'$ , a means is afforded for visualizing the improvement in the signal-to-noise ratio that is effected in the FM receiver.

In an AM receiver, all the noise components at radio frequencies differing from the signal frequency by less than the highest audio frequency are amplified in the receiver equally as well as the intelligence of the signal being received. The peak impulse noise at the AM receiver output is therefore proportional to the area of rectangle  $E'EDD'$  of Fig. 13. This rectangle is shown as the shaded area of Fig. 15. The ratio of the area of the AM receiver noise rectangle of Fig. 15 to the total area of the FM receiver noise triangles of Fig. 14, called the *improvement ratio*, is the figure of merit of the FM system. The improvement ratio tells how many times the signal-to-noise ratio in the output of the FM receiver is increased over that in the output of an AM receiver, where both receivers have the same carrier strength and the same carrier-to-noise ratios at their inputs.

What determines the magnitude of the improvement ratio for peak impulse noise

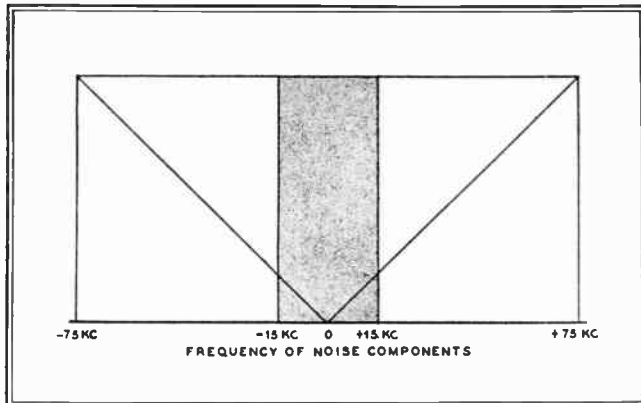

FIG. 15. SPECTRUM DISTRIBUTION OF AM RECEIVER NOISE, INDICATED BY SHADED AREA

noise to the band width accounts for a difference in the effectiveness of the FM receiver in reducing the noise, which will be explained presently.

**Comparative Noise in AM and FM Receivers** ★ In the discussion of Fig. 8, it was noted that the effect of an interfering signal upon a stronger desired signal is to create a resultant which has varying amplitude and varying frequency. The amplitude variation is largely removed in the limiter and the effects of any remaining amplitude variation in the limiter output are minimized in the discriminator. The frequency variation, caused by the interfering wave is not reduced in the limiter, but is rendered negligible by the much greater frequency swing of the desired signal during modulation. However, it was noted that as the frequency of the interfering signal differs from the frequency of the desired signal by an increasing amount, the frequency swing caused by the interfering wave (and hence the amount of interference in the receiver output) increases in direct proportion.

The above observations for the case of one interfering signal also hold with respect to two or more interfering signals, provided the peak value of the resultant of the interfering signals is not greater than one-half the amplitude of the desired signal. Since impulse noise can be analyzed as consisting of a series of components of practically uniform amplitude

the noise components are higher and lower in frequency than the signal.

The areas of triangles  $OAB$  and  $OA'B'$  therefore represent noise in the discriminator output. However, all of this noise may not be passed through the audio am-

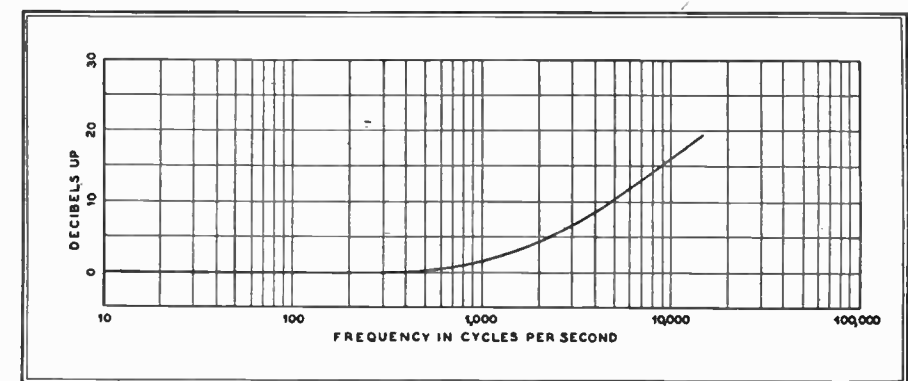

FIG. 16. STANDARD PRE-EMPHASIS CHARACTERISTIC FOR FM TRANSMITTERS

plifier. For example, in FM broadcasting the maximum frequency swing, as represented by  $OB$  and  $OB'$  is 75 kc., whereas the highest frequency that is passed through the audio system is in the order of 15 kc. The noise created in the discriminator output by noise components differing in frequency from the signal by more than 15 kc. is therefore prevented from reaching the receiver output. Thus, in the diagram of Fig. 13, the noise reaching the FM receiver output is represented by triangles  $OCD$  and  $OC'D'$ , whose bases  $OD$  and  $OD'$

reduction in the FM receiver? In other words, what determines the ratio of the area of rectangle  $E'EDD'$  in Fig. 13 to the area of the triangles  $OCD$  and  $OC'D'$ ? The construction line  $C'C$  aids in evaluating the ratio. The area of the large rectangle  $E'EDD'$  is greater than the area of the small rectangle  $C'CDD'$  by as many times as dimension  $ED$  is greater than  $CD$ , or as  $AB$  is greater than  $CD$ , or as  $BO$  is greater than  $DO$ . The ratio  $BO/DO$  makes the more useful reference, since it represents the ratio of the peak



frequency swing of the transmitted signal to the highest audio frequency handled by the audio channel of the receiver. This ratio is commonly called the *deviation ratio of the FM system*.

The ratio of the area of the large rectangle  $E'EDD'$  to the small rectangle  $C'CDD'$  is equal to  $BO/DO$  or to the deviation ratio of the FM system. The small rectangle  $C'CDD'$  in turn has twice the total area of the triangles  $OCD$  and  $OC'D'$ . Thus the improvement ratio of the FM system in the case of peak impulse noise is equal to twice the deviation ratio of the FM system. In Fig. 13 the deviation ratio  $BO/DO$  is 5 to 1, making the improvement ratio for the FM receiver on peak impulse noise equal to  $2 \times 5$  or 10 to 1. Thus the area of the shaded rectangle in Fig. 15 is 10 times the area of the shaded triangles in Fig. 14. The signal-to-noise ratio for peak impulse noise is ten times as great in this case at the FM receiver output than in the AM receiver output, assuming that both receivers operate with the same carrier strength and the same carrier-to-noise ratio at their inputs, and that the full noise reducing potentialities of the FM system are realized through careful design.

In the case of peak random noise, the diagram of Fig. 12 does not apply, because the components of random noise have no particular timing with respect to each other, and the peak value of random voltage is proportional to the square root of the band width, rather than to the width of the band. The improvement ratio for peak random noise is equal to the square root of the ratio of the areas that are created when each of the noise amplitudes of the triangles and rectangle is squared before plotting. By the use of calculus, the value of the improvement ratio for peak random noise is found to be the square root of 3 or approximately 1.73 times the deviation ratio of the system. Thus the improvement in the case of peak impulse noise is  $2/1.73$  or 1.16 times greater in the case of peak random noise. In both cases, however, the respective improvements are proportional to the deviation ratio of the FM system. That is why it is desirable to have as large a frequency swing at the FM transmitter as feasible with a due regard for the fact that the spectrum must be shared with other stations. It is why the audio channel of the receiver should accept and amplify frequencies up to the highest necessary in the particular type of FM service involved, and should reject frequencies that are higher. When these precautions are observed in setting up the FM transmitting and receiving system, the largest possible deviation ratio will be obtained and the greatest improvement in the signal-to-noise ratio can be achieved in a well designed receiver.

For example, in the FM broadcast service, for realistic reproduction of the studio program in the home, it is desirable that the full range of audio frequencies up to 15,000 cycles be amplified in the audio

system and converted to sound at the speaker. Frequencies higher than about 15,000 cycles are inaudible to the average human ear and the audio channel should therefore cut off at about 15,000 cycles. The frequency swing of the transmitter should be sufficiently in excess of the highest audio frequency of 15,000 cycles to give a satisfactory deviation ratio. Present practice is to provide for a frequency swing of  $\pm 75$  kc. at full modulation. This gives a deviation ratio of 75/15 or 5 to 1 with full modulation at the highest modulating frequency. Since the improvement ratio is from 1.73 to 2 times the deviation ratio, depending upon the type of noise, the signal-to-noise ratio in the FM receiver output will be 9 or 10 times greater in the FM receiver than in the AM receiver where both receivers have the same carrier-to-noise ratios and the same carrier strengths at their inputs. The background noise in the FM receiver will be of such low level as to be inaudible and the full quality of 15,000-cycle reproduction is enjoyed by the listener.

No such improvement of the signal-to-noise ratio is inherent in the AM receiver circuits. Even if AM broadcast stations transmitted with modulation frequencies as high as 15,000 cycles (most AM stations do not), the average listener could not enjoy 15,000-cycle reception, for he would be forced to use his tone control to bring the audio channel down to the order of 5,000 cycles or less in order to reduce the noise to a tolerable, but certainly not enjoyable, level!

Equally important as the frequency swing, in determining the deviation ratio, is the highest audio frequency which the receiver audio system is designed to handle. Suppose that while keeping the same frequency swing, the highest frequency transmitted by the audio system is reduced from 15,000 cycles to 5,000 cycles or in the ratio 3 to 1. The base of the AM noise rectangle  $E'EDD'$  will be narrowed in the ratio 3 to 1, but its altitude will remain unchanged. The area of the rectangle representing the AM receiver noise will have been reduced in the ratio 3 to 1. In the case of the triangles  $OCD$  and  $OC'D'$  however, both the bases and the altitudes will be reduced in the ratio 3 to 1, indicating that the areas of the triangles representing the FM receiver noise will have been reduced in the ratio 9 to 1. Thus narrowing the audio channel to one-third in both the AM and FM receivers reduces the noise in both receivers, but the improvement is  $9/3$  or 3 times as great with FM as with AM.

The increase of the improvement ratio with larger deviation ratios is of particular interest in FM communications work. Here the fact that an audio channel of 4,000 cycles or less will suffice for the transmission of intelligible speech permits operation with a signal frequency swing of only 40 kc., maintaining a deviation ratio for the system of 40000/4000 or 10 to 1,

which yields an improvement ratio in the order of 20 to 1 for FM over AM. It is not surprising that field tests of mobile FM communications equipment have exploded the idea that "AM can do everything that FM can do at the same frequency."

**Pre-emphasis and De-emphasis** ★ In the above discussion of the effects of interfering signals and noise components, it was observed that the noise and interference effects in FM systems are very much less than in AM systems. However, it was also noted that the residue of these disturbances that appears in the FM receiver output is concentrated in the upper audio frequency range. Since noise frequencies in the upper register are more irritating to the human ear, the noise concentrated at high frequencies is more objectionable than the same amount of noise energy uniformly distributed over the whole audio frequency range. This unfavorable situation can be easily corrected in FM circuits by the use of pre-emphasis and de-emphasis.

Pre-emphasis refers to the use of a simple network in the audio system of the transmitter for the purpose of causing the higher frequency components of the program to be amplified much more than the lower frequency components. The R.M.A. standard of pre-emphasis calls for a gain-versus-frequency characteristic that is flat to 500 cycles, then rising to +20 db at 15,000 cycles, as shown in Fig. 16. Since a 20 db increase represents a ten-fold voltage step-up, the frequency swing of the transmitter on a soft 15,000-cycle sound is ten times as great as without pre-emphasis, so that the intelligence of the modulation overshadows noise in the receiver output far more effectively. There is no danger of overmodulating the transmitter seriously on the high frequencies with pre-emphasis because the energy content of the high frequency components of program material is much smaller than that of the low frequency components.

In the receiver, a simple de-emphasis network is used to bring the highs down to proper relation with respect to the lows. Its gain-frequency characteristic is the inverse of that of the pre-emphasis network. For example, whereas pre-emphasis causes the amplitude of a 15,000-cycle component to be stepped up ten times prior to modulation of the transmitter, the de-emphasis network following the detector in the receiver reduces the 15,000-cycle component to one-tenth, thus restoring it to a proper proportion with respect to the low frequency components. At the same time, the high frequency noise is reduced to one-tenth of the amplitude that it would have without pre-emphasis and de-emphasis.

The marked benefit obtained by the use of the emphasis networks is shown by a comparison of Figs. 17 and 18. In Fig. 17, the triangular area under the curve

represents the amount and the frequency-distribution of the noise in an FM system not employing emphasis, corresponding to the sum of the triangular areas of Fig. 14.

signed to the same frequency must have a considerable geographical separation, and that adequate service to a continental area like the United States requires a large

the amplifier gain control on weak passages and reducing the gain on the strong passages. Such compression of the volume range is necessitated by the inherent sig-

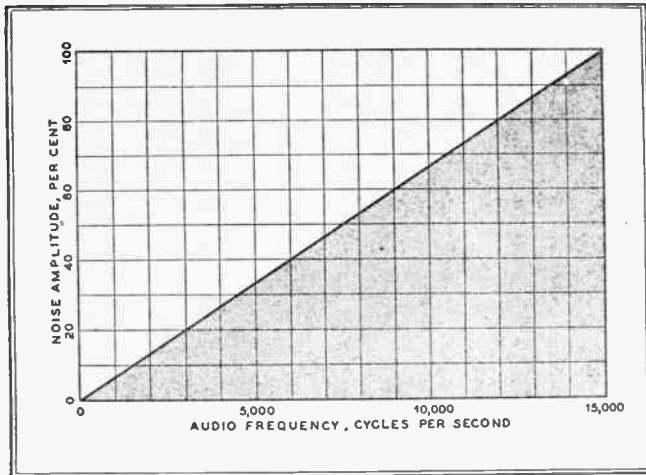

FIG. 17. FM RECEIVER OUTPUT NOISE WHEN DE-EMPHASIS IS NOT EMPLOYED

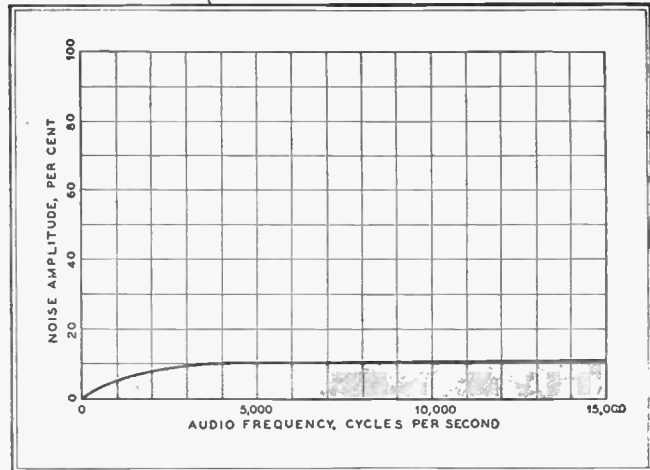

FIG. 18. REDUCTION OF NOISE INDICATED IN FIG. 17 WHEN DE-EMPHASIS IS EMPLOYED

The area under the curve of Fig. 18 represents the noise in the FM receiver when standard pre-emphasis and de-emphasis are employed. Note particularly that the greatest noise reduction occurs at the highest noise frequencies; in other words, the pre-emphasis and de-emphasis are most effective in reducing the amplitudes of the noise components at the frequencies where the noise is most likely to be annoying.

**High Fidelity** ★ In the discussion of noise reduction above, a typical value of 15,000 cycles was used for the highest frequency accepted by the audio amplifier of the FM receiver. This is in contrast to a value of the order of 5,000 cycles or less which is found in the typical AM receiver.

When it is remembered that the overtones of musical instruments such as the violin and flute are of appreciable amplitude in the frequency range from 10,000 cycles upward to the limits of human hearing, the importance of having noise-free reproduction of frequencies up to 15,000 cycles is evident. Why is it feasible to have an audio amplifier of greater frequency range with FM?

The reason is two-fold: 1) AM receiver circuits are not capable of increasing the signal-to-noise ratio at the receiver output over that at the input. The way in which noise can be reduced in an AM receiver is by narrowing the audio channel. In other words, the loss of the higher audio frequencies, which add so much realism to the reproduction, is the price that is paid for keeping the noise within tolerable levels. 2) AM receivers do not use a system which inherently reduces interference on frequencies very near to the frequency of the desired signal. In the AM service, the strength of the desired signal must be at least 100 times the strength of the interfering signal, if the effects of the interference are to be negligible in the receiver output. This means that AM stations as-

number of stations assigned to many different frequencies. As it has worked out, the separation between adjacent frequencies assigned to broadcast stations in the United States is only 10 kc., so that modulation at frequencies higher than 5,000 cycles produces sidebands outside of the assigned channel of the station. Receivers whose IF band width appreciably exceeds 10 kc. are therefore subject to interference whiskers from the sidebands of other stations.

The FM system, on the other hand, inherently reduces noise. It is possible therefore to widen the audio channel to 15,000 cycles and to obtain the resulting realism without raising the noise to an objectionable level. Also, in the case of FM, a 2 to 1 instead of a 100 to 1 ratio of the desired signal to the interfering signal overcomes the effects of interference, provided the FM receiver is well designed, so that the full potentialities of the FM system are realized. Thus in FM more stations can be operating simultaneously with wider (200 kc.) channels assigned to each, without creating a serious interference problem.

**Dynamic Range** ★ The term *dynamic range* refers to the difference in sound levels between the loudest and softest portions of program material. For symphonic music, the range may be in the order of 70 db, corresponding to a voltage ratio of about 3,000 to 1. The transmission of the full volume range makes it possible to reproduce at the receiving set the same relation between the loud and soft passages as would be heard at the studio — the relation, for example, between the spoken word and a pistol shot, or between a violin solo and the brilliant finale of a symphonic orchestra.

In AM broadcasting, the volume range is reduced by the control operator to the order of 35 db. This is done by advancing

nal-to-noise ratio in AM which, in best practice, seldom exceeds 40 db.

Even where the line characteristics are such that the full dynamic range of a symphonic program can be transmitted, the average AM receiver is incapable of giving a satisfactory reproduction of the full dynamic range because of the presence of hum and noise. If the volume control is adjusted to a setting where the loudspeaker is not overloaded on the loud passages, reception can be satisfactory at the high and medium levels of the music in spite of the presence of noise because the program energy greatly exceeds the noise energy and thereby renders the noise unnoticeable to the human ear. On the soft passages of the music, however, where the average amplitude of the music is about 1/3000th of that on the loudest passages, the hum and noise will be very apparent; in fact, the music amplitude may be well below the amplitude of the disturbances, so that the music is not even heard during the soft passages and the noise level appears to have risen. Only by narrowing the audio channel of the AM receiver to reduce the noise, and by operating with a reduced dynamic range at the AM transmitter so that the average amplitude on the weakest passages is not less than 1/50th or 1/100th of that on the strong passages, can tolerable reception be achieved in the AM receiver. Tolerable, perhaps, but not realistic!

In the FM system, the noise in a well-designed broadcast receiver is at such a low level that it is possible to hear the softer sounds satisfactorily without having the volume control advanced to the point where the speaker is overloaded on the stronger passages. Also, by employing a wide frequency swing at the transmitter, a sufficiently high deviation ratio for the FM system can be obtained to give a good improvement in the signal-to-noise ratio even with an audio channel extending as

high as 15,000 cycles. The inherent signal-to-noise ratio for best practice is 70 to 75 db. Thus full realism of reproduction can be achieved in the FM receiver.

The reproduction of the full dynamic range also adds *presence* to the program at the receiver output. The overtones of musical instruments in the frequency range above 10,000 cycles have already been mentioned. Most instruments have important overtones at lower frequencies, also — even at frequencies of less than 1,000 cycles. A listener seated near the orchestra in the studio hears these overtones better than a listener who is at a greater distance, because the soft overtones have a more favorable ratio with respect to the room noise when the listener is close to the orchestra. Similarly, a system which does not reduce the dynamic range appreciably in the course of transmission and reproduction makes the lis-

tener feel that he is present at the studio in a way that mere loudness of the reproduced sound can not accomplish.

The factor of dynamic range and high fidelity are so noticeable to the owners of well-designed FM receivers that they are able to state immediately whether a program is being originated and transmitted under circumstances that permit the realization of the full capabilities of the FM system, or whether the program has undergone a compression of its dynamic range and frequency range, as when it has been passed over an AM network line.

**Duplex Operation** ★ Another operational advantage of the FM system is the possibility of conducting two or more services to the public simultaneously over the same station while operating within its assigned channel width. While multiplexing of various unrelated transmissions is feasible,

the most frequent application of this feature of FM will probably come in the form of duplex operation, where a second service is offered that is complementary to the first.

For example, facsimile, the transmission of printed material and pictures, may complement the sound transmission. The broadcast receiver owner may receive his newspaper, complete with pictures, from facsimile equipment attached to his receiver, without interference to his favorite programs. Many newspaper publishers have already taken steps toward the establishment of facsimile services at a yearly cost to the listener comparable to that of a newspaper subscription.

Facsimile duplexed with sound may become an important auxiliary to the police radio systems. It is possible, for example, to transmit photographs and fingerprints rapidly.



# Theory of Frequency Modulation

## Section 3: Operational Advantages of Propagation at the FM Frequencies

THE two previous sections have explained the notable improvements that are obtained when a well-designed system of FM transmission and reception is substituted for AM. The advantages in the

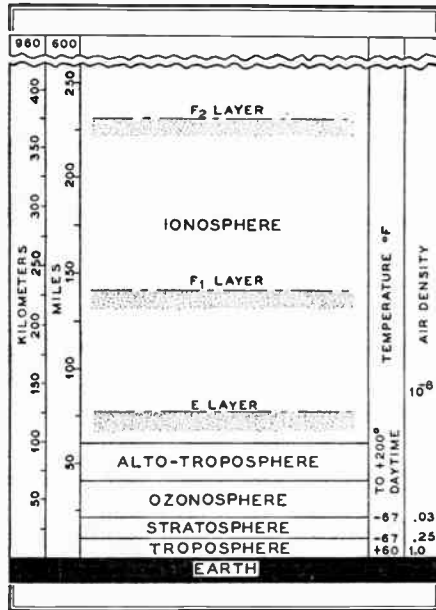

FIG. 19. ARRANGEMENT OF THE SHELLS OF THE EARTH'S ATMOSPHERE

favor of FM that were enumerated are inherent in the FM circuits, and are not dependent upon the signal carrier frequencies employed in the two systems.

As a practical matter, however, since FM requires a greater channel width than AM, FM stations must be assigned to a higher portion of the frequency spectrum,

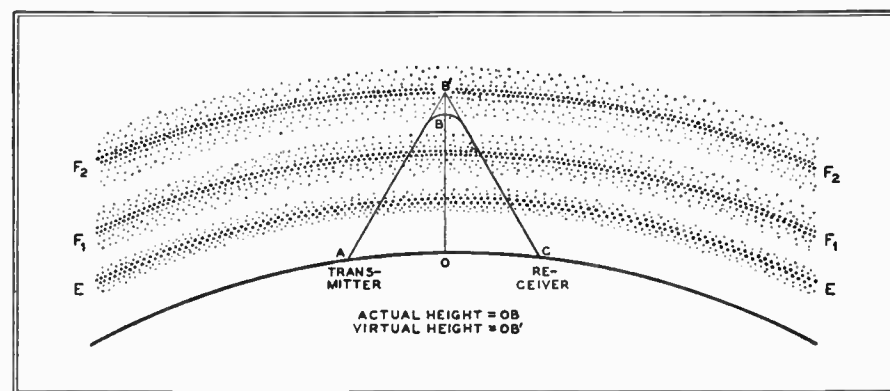

FIG. 21. TYPICAL PATH OF A WAVE RETURNED TO EARTH FROM THE F<sub>2</sub> LAYER

where a greater band of frequencies is available.

For example, the FM broadcast station channel width is 200 kc., while the channel width of the AM station is 10 kc. The present standard broadcast band, extending from 550 to 1,600 kc., provides 106 10-kc. channels for the AM stations but

could furnish only 5 channels 200 kc. wide. Hence it has been necessary to assign frequencies above 40 mc. to the FM broadcast stations. For the same reason, the frequencies allocated to police radio and other emergency communication systems are considerably higher in the case of FM than with AM.

This shift to a very high carrier frequency, incidental to setting up an FM system, introduces additional advantages in terms of improved signal coverage, as will be explained in this chapter.

In particular, the FM signals suffer less from the effects of the Ionosphere than AM signals at the lower carrier frequencies. With a view to understanding the difference between the propagation characteristics of the FM and AM frequencies, it is desirable to review briefly the nature of the Ionosphere and its effects upon radio signals.

**Nature of the Ionosphere** ★ The atmosphere of the earth can be regarded as consisting of a number of concentric shells or layers of various thicknesses above the earth's surface, as shown in Fig. 19. Each layer has its own distinguishing characteristics and certain of the layers exercise an influence upon radio waves, as will be shown presently.

The shell nearest to the earth's surface is called the *Troposphere*, extending upward about 10 miles. It is the weather belt of the earth, with fluctuating temperatures and barometric pressures.

Above the Troposphere in Fig. 19 is shown the *Stratosphere* or Isothermal layer of thin air, whose distinguishing charac-

teristic is a constant temperature of about  $-67^{\circ}\text{F}$ .

The *Ozonosphere*, a third layer about 18 miles in thickness above the Stratosphere, contains free oxygen which serves to absorb the actinic rays of the sun. Its temperature rises as high as  $200^{\circ}\text{F}$ . during the daytime but falls to  $-67^{\circ}\text{F}$ ., like that of

the Stratosphere, at night. Above the Ozonosphere is a layer about 20 miles thick, called the *Alto-troposphere*. This layer also absorbs sunlight and undergoes wide variations of temperature between day and night. The temperature varia-

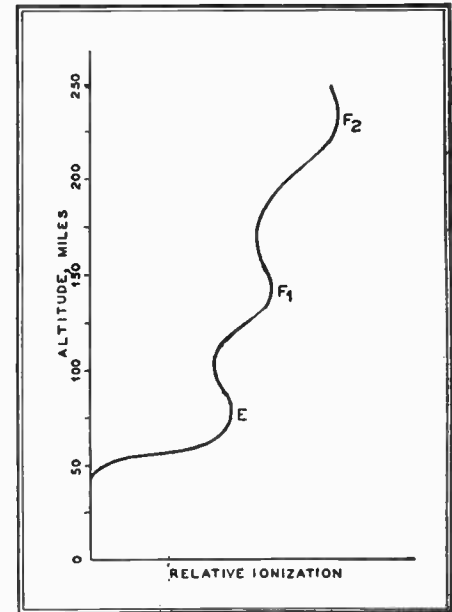

FIG. 20. DEGREE OF IONIZATION AS A FUNCTION OF HEIGHT ABOVE THE EARTH

tions cause changes in atmospheric pressure of an appreciable percentage, but the order of all pressures at these altitudes is, of course, quite low.

The fifth layer is the *Ionosphere*, beginning at a height of about 60 miles above the earth and extending upward for several hundred miles, at least. It is characterized by an air pressure as low as .00000001 of the normal pressure at the surface of the earth. The pressure within the Ionosphere is, therefore, in the order of that found within a vacuum tube.

Throughout the earth's atmosphere there is ionization, that is, radiation from the sun acting upon the molecules of the gases of the air causes the liberation of electrons and the creation of ions. The ionization is very slight in the Troposphere but tends to increase with altitude, because in regions of reduced atmospheric pressure the likelihood of a rapid recombination of electrons and ions diminishes. Particularly in the Ionosphere, where the pressure is extremely low, a liberated electron can travel for a relatively long time before encountering an ion. Thus comparatively large numbers of free electrons and ions exist at the high altitudes of the Ionosphere, as indicated by the curve of Fig. 20.

It will be noted that the ionization within the Ionosphere, Fig. 20, is not of

uniform density but is concentrated in at least three layers, designated  $E$ ,  $F_1$  and  $F_2$ , at various heights. This is believed to be due to a difference in the proportions of the several gases at various levels in the Ionosphere, since the gases differ in their ability to absorb energy from solar radiation.

When a radio wave from the earth approaches one of these layers of ionization, it will tend to be reflected or refracted back toward the earth, as shown in Fig. 21,

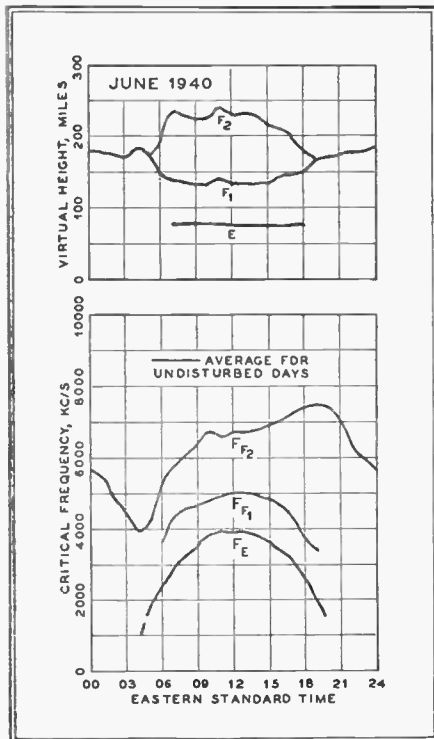

FIG. 22. VIRTUAL HEIGHTS AND CRITICAL FREQUENCIES OF IONOSPHERE LAYERS

provided the frequency of the wave is not too high. The mechanism of bending is explained as follows: When the wave enters the ionized region, its electric field sets the free electrons and ions into a vibratory motion. The movement of the heavy ions is so slight as to be unimportant, but the movement of the electrons is appreciable. The path of movement of the electrons is determined by the orientation and the direction of motion of the electric field, and by the magnetic field of the earth. The vibrating electrons represent a current that creates a reradiated field, which, together with the original field, causes a bending of the direction of motion of the wave, away from the region of more intense ionization.

As the frequency of the wave is lowered, the refraction or bending is greater. On the other hand, if the frequency of the wave is sufficiently high, the wave can penetrate one layer, but may be refracted by the next higher layer, which has a greater degree of ionization. It is also possible for the frequency of the wave to be so high that it will penetrate all layers and be lost in space. Whether or not the wave will be

bent back to earth depends, therefore, upon the frequency of the wave, the height of the refracting layer, and its density of ionization.

The density of ionization of a layer is measured by determining the highest frequency that can be returned to earth from the layer, when the wave enters the layer perpendicularly. This frequency is called the *critical frequency*.

The *virtual height* of a layer is that height at which reflection from a sharply defined plane, in the absence of ionization, would give the same transit time as is taken by the refracted sky wave in traveling over its curved path from the transmitter to the receiver. In other words, in Fig. 21, the same time would be taken to travel over the path  $AB'C$  at the velocity of light as is actually required by the wave in traveling its curved path  $ABC$  at a velocity which, in the vicinity of  $B$ , is less than the velocity of light.

$F_1$  layer during most of the daytime in the summer, but the difference in height is not as great in the winter. The critical frequencies of both the  $F_1$  and  $F_2$  layers are variable, being maximum at local noon in the winter and during the late afternoon in the summer.

With the approach of sunset, the height of the  $F_1$  layer increases while the height of the  $F_2$  layer approaches that of the  $F_1$  layer. At sunset, the layers merge to form a single  $F$  layer which remains throughout the night, rising to a maximum height of about 200 miles at local midnight. Shortly after sunrise, the  $F$  layer separates into the  $F_1$  and  $F_2$  layers previously mentioned, except on winter days during a year of great sunspot activity, when the layers do not separate appreciably.

While the virtual heights of the layers vary with the time of day and the season of the year, the cycle of variations of virtual height is repetitive with little change

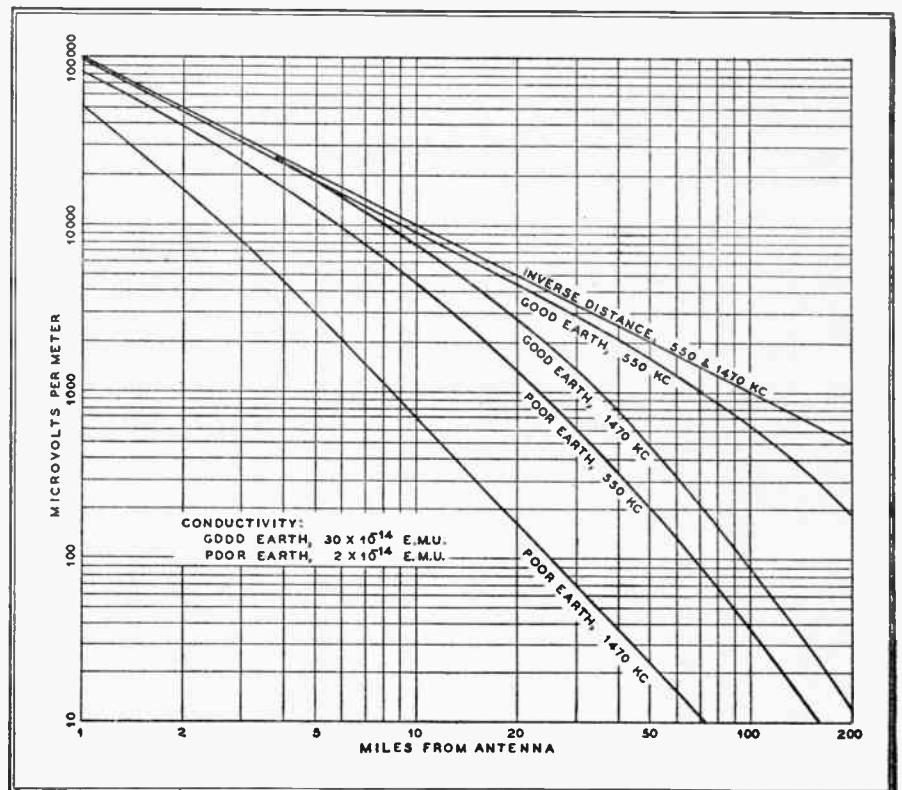

FIG. 23. AM FIELD STRENGTH AS A FUNCTION OF DISTANCE AT 550 AND 1470 KC.

The lowest important ionized layer within the Ionosphere is the  $E$  layer, whose virtual height remains practically constant at 70 to 75 miles throughout the daytime during every season of the year. As shown in Fig. 22, the critical frequency of the  $E$  layer is variable, with a maximum at local noon. The maximum is higher in summer than in winter.

The next higher daytime layer is designated the  $F_1$  layer, which, as shown in Fig. 22, has a minimum height of about 130 miles at local noon, with somewhat greater heights in the forenoon and afternoon.

The third important daytime layer is the  $F_2$  layer. It is much higher than the

from year to year. The critical frequencies of the layers, however, are affected by the sunspot numbers, and hence are subject to variation over the period of the 11-year sunspot cycle. In a year of large sunspot numbers, the critical frequencies of all layers, particularly that of the  $F_2$  layer at local noon in the winter, are very much higher than in the years of slight sunspot activity.

Sufficient knowledge of the general trends of the variations of the Ionosphere characteristics has been gathered during the past decade to permit the prediction of Ionosphere propagation characteristics in advance. The predictions have consid-

erable reliability, except for short periods of unusual sunspot activity.

**Effects of the Ionosphere** ★ It has been stated that the Ionosphere has more effect upon the radio waves of the standard AM broadcast frequencies than upon the radio waves at FM frequencies. The reason is quite simple. FM broadcast frequencies are in excess of 40 mc., and hence are greater than the maximum critical frequencies of all the ionized layers, with the exception of the  $F_2$  layer during short

sphere is caused by collisions between the free electrons that have been set in vibratory motion by the electric field of the wave and the drifting gas molecules. Within the Ionosphere, from the  $E$  layer upward, the absorption is quite small, because while many free electrons are present, the atmospheric pressure is so low that collisions of the electrons with gas molecules are relatively infrequent. On the other hand, when the intense radiation from the sun in daytime causes the ionization to be extended downward in the  $E$

tour, although in locations where man-made noise and interfering signals are at a minimum, it is possible to obtain satisfactory daytime service with lower field strengths.

The field strength at the receiver depends in part upon the power of the transmitter and upon the efficiency of the radiating system, since these factors determine the strength of the field that is initially established in the immediate vicinity of the transmitting antenna. However, the field strength at the receiver also depends

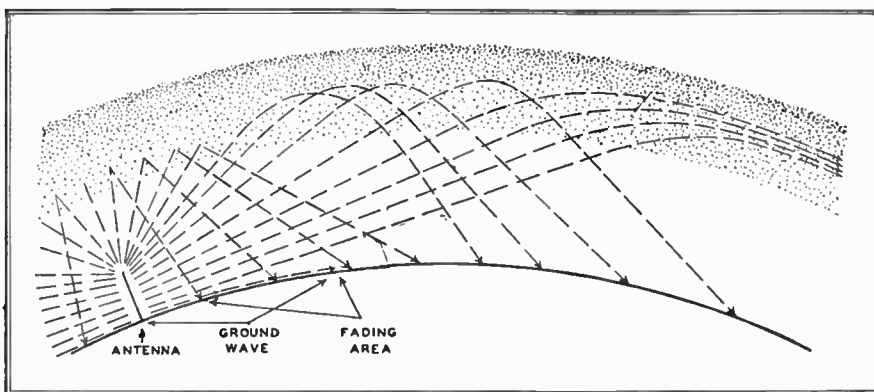
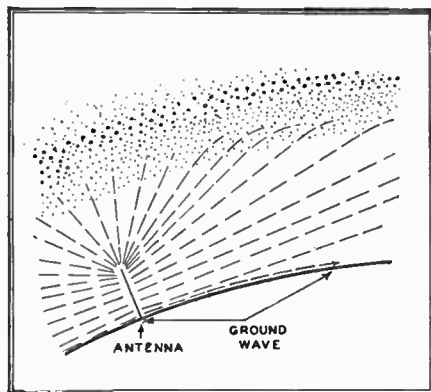

FIG. 24. LEFT: AM BROADCAST TRANSMISSION DURING DAYLIGHT HOURS IS BY MEANS OF THE GROUND WAVE. SKYWARD TRANSMISSION IS ABSORBED IN REGION BELOW E LAYER. RIGHT: AT NIGHT, SKYWAVES, RETURNED TO EARTH, GIVE LONG-DISTANCE COVERAGE, BUT CAUSE FADING IN THE OUTER PORTION OF THE AREA REACHED BY THE GROUND WAVE

periods around noon on winter days in the years of greater sunspot activity, when long distance transmission by  $F_2$  layer refraction can occur at frequencies somewhat in excess of 40 mc. In general, however, the skyward transmissions of radio waves at FM frequencies penetrate the ionized layers and do not return to earth.

On the other hand, the frequencies of the broadcast band, from 550 to 1,600 kc.,

layer, and even to regions in the Altosphere, just below the  $E$  layer, then an area of high absorption characteristics is created because of the higher pressure of the gases within the area. Since waves at AM broadcast frequencies would tend to make their refractive bend largely within this area, below the  $E$  layer, they are especially susceptible to absorption and very little skywave energy is returned

upon the loss sustained by the ground wave in traveling from the transmitter to the receiver. The amount of this loss depends upon the distance traveled, the conductivity of the ground, and the frequency of the transmitter.

The field strength would vary inversely as the distance if there were no ground losses, as shown by the straight-line inverse distance curve in Fig. 23. Actually, there is a continuous loss of energy as the wave passes over the ground, which is greater when the soil conductivity is poor and the frequency is high, as shown by the other curves of Fig. 23.

For example, when the inverse distance signal strength at one mile is 100 millivolts per meter, Fig. 23 shows that the distance to the 500 microvolt-per-meter contour would be 200 miles if there were no loss in the ground.

If the radio wave from the station mentioned above has a frequency of 550 kc. and is passing over ground having relatively good conductivity ( $30 \times 10^{-14}$  electromagnetic units), such as might be found in regions of rich soil and low hills, the distance to the 500-microvolt contour, by reference to Fig. 23, is about 115 miles. On the other hand, if the ground conductivity were rather poor ( $2 \times 10^{-14}$  electromagnetic units), as in the regions of steep hills and rocky soil, then the distance to the 500-microvolt contour would be only about 33 miles at the same frequency. If the frequency of the station in the latter case were increased from 550 to 1,470 kc., the distance to the 500-microvolt contour would be reduced to about 12 miles!

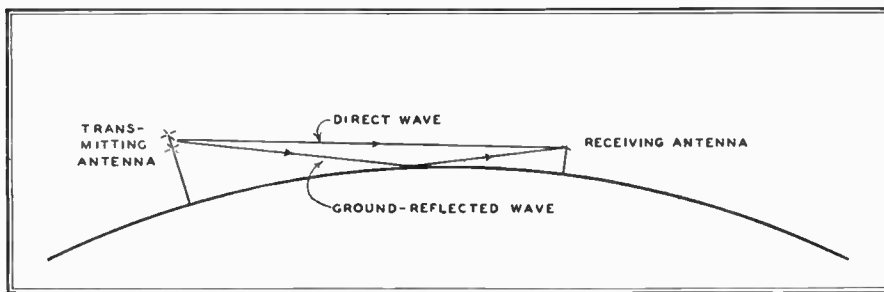

FIG. 25. TRANSMISSION AT VERY HIGH FREQUENCIES IS EFFECTED BY MEANS OF BOTH GROUND-REFLECTED WAVES AND DIRECT WAVES, AS THIS DRAWING SHOWS

are well below the critical frequencies of the  $F_1$  and  $F_2$  layers, and also somewhat below the critical frequency of the  $E$  layer. It would appear at first thought, therefore, that skywave transmission would occur at the standard broadcast frequencies at all times. Actually, such transmission occurs only at night because in the daytime the absorption of energy in the regions immediately below the  $E$  layer is so great at the AM broadcast frequencies that no appreciable energy from the skyward transmission returns to the earth.

The absorption of energy from the radio wave in the upper reaches of the atmos-

phere to the earth at these frequencies in the daytime.

**Daytime AM Broadcast Coverage** ★ Since skywave transmission is not feasible on AM broadcast frequencies during daylight hours, the area that is served by an AM broadcast transmitter is that which the radio wave traveling over the surface of the earth can reach with sufficient field strength for proper operation of the average broadcast receiver.

The area of usable signal strength in the daytime is commonly assumed to be that within the 500 microvolt-per-meter con-



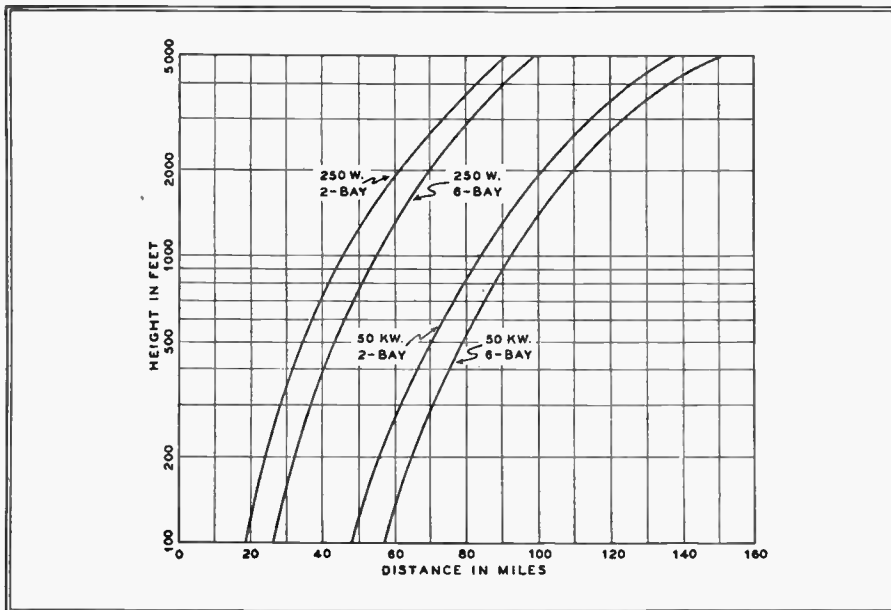

FIG. 27. RELATION OF HEIGHT, POWER, AND DISTANCE TO 50-MICROVOLT CONTOUR

Thus the range of usable signal in the daytime for broadcast stations at AM frequencies having the same field strength at one mile depends to a very great extent upon the conductivity of the earth and the frequency of the station.

**Night-time AM Broadcast Coverage** ★ The ionization in the region just below the *E* layer, where heavy absorption occurs during the day, is largely dissipated shortly after sunset. Thus energy transmitted skyward at night can be reflected back to earth with only moderate losses, as shown in Fig. 24.

Since the paths traveled by the skywave and the ground wave are unequal in length, it can be expected that they will be out of phase in the area where the sky wave returns to the earth and meets the ground wave. Furthermore, since the height of the ionized layer is not constant, the length of the skywave path is not constant. The result is a continuous change in the phase relationship between the ground wave and the returning skywave, which gives a resultant wave whose amplitude varies between the sum and the difference of the amplitudes of the two component waves. In other words, in the area where the ground wave and the sky wave are of nearly the same amplitude, the receiver responds as if it were receiving a signal of widely varying strength.

The phase relationship between the ground wave and the returning sky wave depends upon the wavelength as well as upon the difference in the lengths of the paths. Since the carrier and its two sidebands have slightly different wavelengths, different phase relationships between the ground wave and the skywave components at these three frequencies can occur at the receiving location. The cancellation or reinforcement being of unequal degree at the three frequencies, it is possible for the carrier and sideband components at the receiver to acquire a proportion, each

with respect to the others, that is quite different from that existing at the transmitter. This produces an effect which is called

selective fading, which appears as audio distortion at the receiver output.

The area of serious fading may begin at less than 75 miles from the broadcasting station and may extend to 125 miles or more, the location and the extent of the area varying with Ionosphere conditions. Thus in the case of night transmission from high-power broadcast stations, the skywave can actually reduce the area to which the ground wave delivers a good signal during the daytime.

The distance at which fading begins is somewhat greater when the frequency of the broadcast station is low and the ground conductivity is high, because the ground wave is stronger and overrides the skywave for a greater distance from the station. The use of transmitting antennas that minimize the radiation at high angles also tends to extend the distance at which fading sets in, because they diminish the strength of the skywave that returns to the earth fairly near the transmitter. However, the wavelengths at the AM broadcast frequencies are so long that it is physically impracticable to build an array

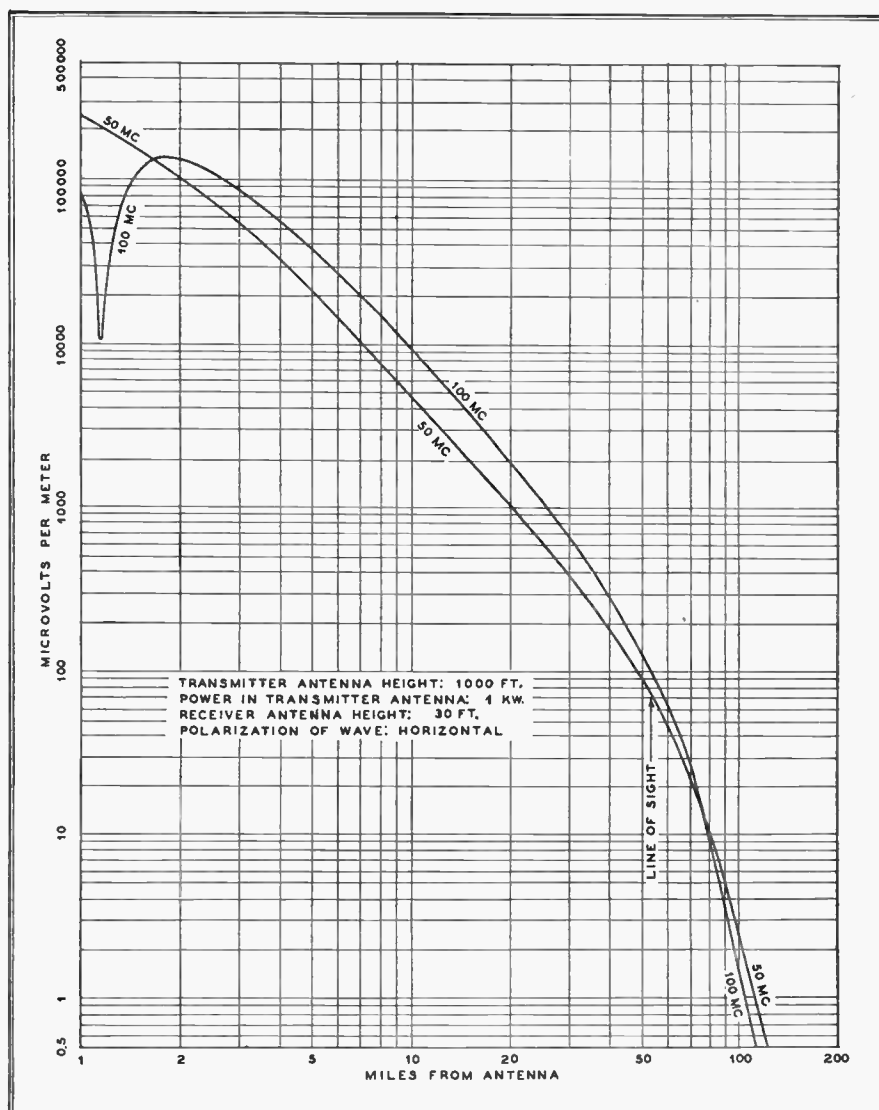

FIG. 26. FIELD STRENGTH AS A FUNCTION OF DISTANCE AT VERY HIGH FREQUENCIES

several wavelengths in height that would suppress skyward radiation altogether.

Beyond the zone of severe fading that is caused by ground and skywave interference, high-power broadcast stations are able to render a service extending over hundreds of miles at night by means of the skywave alone. This wave travels for considerable distances in the Ionosphere, where absorption is low, before it is bent back to the earth. Hence its signal strength is comparable to that of the ground wave of a nearby station.

The distant areas thus served by the skywave at night are referred to as the *secondary coverage* of the station. The quality of the service in these areas is distinctly inferior to the primary coverage by the ground wave, because the skywave is subject to slow fading and to selective

however, to cover distances more than twice the line-of-sight range when powerful FM transmitters are employed. This is due in part to the diffraction or spreading of the wave energy from a straight-line path as it passes from the transmitter to the receiver. It is also due in part to a slight bending of the path in the direction of the curvature of the earth, which is a result of the very slight decrease in the dielectric constant of the air that goes with an increase of height in the Troposphere.

It is particularly desirable to locate the FM transmitting antenna at a considerable height in order that the greatest distance to the optical horizon may be obtained. The height of the FM receiving antenna should also be made as great as practicable, in order to obtain good pick-up of signal energy, particularly if

antenna when the frequency is high, because any given change in the difference between the path lengths will then represent a larger fraction of a wavelength and a greater change in phase. In general, however, the minimum field strength in this area near the transmitter is more than adequate to operate the receiver, so that no dead spots are created.

The effect of frequency upon the field strength of stations of equal power is shown in Fig. 26. The curves represent the field strengths that will be obtained at frequencies of 50 mc. and 100 mc. from 1-kw. transmitters, using half-wave dipole antennas located at a height of 1,000 ft., and receiving antennas 30 ft. high.

In the case of the 100-mc. curve a fall and rise of signal strength with respect to distance is noted within a 2-mile radius of

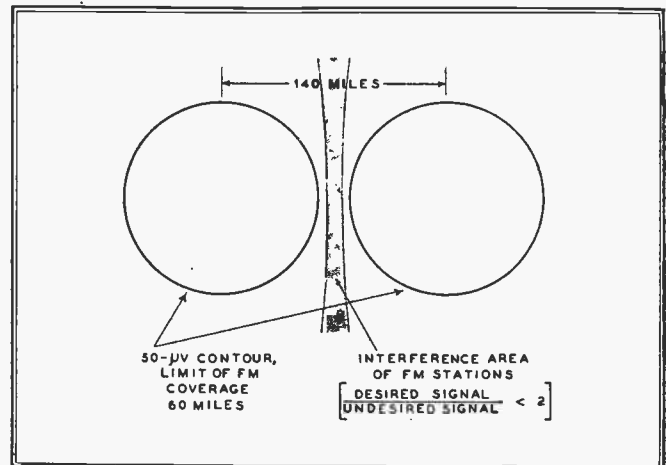
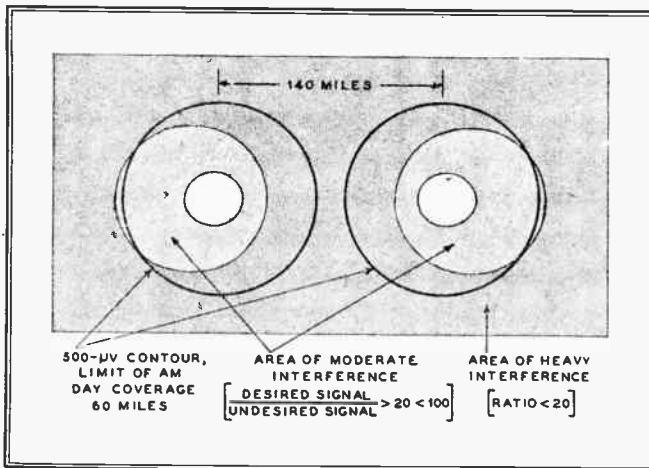

FIG. 28, LEFT: DAYTIME INTERFERENCE BETWEEN AM STATIONS 140 MILES APART, WITH 60-MILE RADIUS TO 500-MICROVOLT CONTOUR (MID-BAND FREQUENCY AND AVERAGE GROUND CONDUCTIVITY). FIG. 29, RIGHT: INTERFERENCE BETWEEN FM STATIONS 140 MILES APART, WITH 60 MILES TO 50-MICROVOLT CONTOUR (50-MC. FREQUENCY AND 1,000-FT. TRANSMITTING ANTENNA)

fading, as the radio waves follow different paths of varying length through the Ionosphere. In spite of the imperfection of sky wave propagation, however, it has been a means of serving many remote locations that are outside the primary coverage areas of all broadcast stations.

**FM Coverage** ★ It has been shown above that, except under special circumstances, radio waves at the FM frequencies are not returned from the ionized layers of the Ionosphere. It was noted also that the ground wave, which accounts for the primary coverage in broadcasting at the AM frequencies, is subject to increased loss as the frequency is increased. At the much higher frequencies of the FM band, the ground wave loss is so high that its intensity is negligible except in the immediate vicinity of the transmitter.

Transmission at the FM frequencies, therefore, is achieved by means of the direct wave and the ground-reflected wave. These waves tend to have straight-line paths rather than curved paths, as shown in Fig. 25.

The characteristics of propagation at FM frequencies therefore tend to approach those of light. It is entirely feasible,

the receiving location is somewhat beyond the optical horizon of the transmitter.

In general, the signal voltage induced in the receiving antenna varies inversely as the square of the distance from the transmitting antenna, and directly as the product of the heights of the two antennas, assuming that they are a fair distance apart but within line-of-sight. Beyond line-of-sight, the field strength falls off more rapidly than by the square of the distance, and it becomes especially important to have a high receiving antenna.

On the other hand, in the immediate vicinity of the transmitter antenna, where the ground-reflected wave strikes the earth at a relatively large angle, the field strength will alternately increase and decrease as a receiving antenna of fixed height is moved away from the transmitter. This rise and fall of signal strength with respect to distance is due to the relatively large change in the difference of the path lengths, whereby the phase of the reflected wave with respect to the direct wave is varied over such a wide range that alternate cancellation and reinforcement of the direct wave occurs. This effect is more pronounced and extends to a greater distance from the transmitting

the transmitter. At 50 mc., the variations are confined within a distance of one mile, so that they do not appear in Fig. 26.

It is also evident from Fig. 26 that within line-of-sight, the field strength is somewhat greater for the 100-mc. signal. For example, the distance to the 1-millivolt contour is 20 miles at 50 mc., but about 26 miles at 100 mc. The 50-microvolt contour occurs at 63 miles in the case of the 100-mc. signal and at 59 miles for the 50-mc. signal. This is slightly beyond line-of-sight for antenna heights of 1,000 ft. and 30 ft. At still greater distances, the higher frequency signal falls off more rapidly than the lower frequency signal, and at distances beyond about 78 miles, Fig. 26 shows the strength of the 50-mc. signal to be greater than that of the 100-mc. signal. It is important to note that the curves of Fig. 26 assume the existence of flat terrain. In hilly country, the signal strength suffers a much greater attenuation at 100 mc. than at 50 mc.

The signal strengths that are actually measured at various distances will vary from the values shown by mathematically derived curves of the type shown in Fig. 26.

While deviation between measured and calculated field strengths is found at the AM broadcast frequencies, the discrepancies are more often due to varying ground conductivity than to reflection or shadows. The dimensions of intervening objects in the path of a radio wave must be appreciable in terms of a wavelength before reflection from the object and reduced signal strength behind the object (shadow) will occur. Only objects of substantial dimensions, such as large buildings, power lines, or steep mountains, are capable of creating strong reflections at the low frequencies. For the most part, radio waves at AM broadcast frequencies

composed of crossed pairs of horizontal dipoles mounted above each other in layers or bays.

The concentration of the radiation in a horizontal plane by the use of an antenna of several bays is equivalent, so far as the field strength is concerned, to increasing the power radiated from a smaller, single-bay antenna. Hence multilayer turnstiles are often called *power gain* antennas. When a 2-bay antenna is employed, the same transmitter output gives a field strength at a given receiving antenna that is 1.12 times greater, equivalent to a power gain of 1.27 times. When a 6-bay antenna is employed, the field strength is

from the transmitter. For example, it has been mentioned that transmission of very high frequency signals beyond the line-of-sight is aided by the decrease in dielectric constant of the Troposphere with increase of altitude. The dielectric constant is not dependent upon altitude alone, however, but fluctuates with the weather, causing the range of the FM wave to increase and decrease.

Also, under certain conditions, a sharply defined region having an abnormal dielectric constant can be temporarily established at an altitude of 1 mile or more in the Troposphere. Such regions cause *Tropospheric reflections* of very high frequency waves back to earth. The strength of the tropospheric wave is variable, since it is related to the weather. Its general effect is to make it possible to detect signals from FM stations somewhat beyond their normal range at times, and to cause moderate variations of signal amplitude toward the outer limits of the normal range.

Another transmission vagary results from cloud-like areas of intense ionization floating within the *E* layer. These can cause sporadic skywave transmission to distant areas. Such sporadic-*E* transmission can occur at any time, but is more prevalent in the summer. Whether or not interference to local reception will be experienced in the distant areas will depend upon the ratio of the amplitudes of the desired signal from the local station and the interfering sporadic-*E* signal from the distant station. If the ratio is 2 to 1

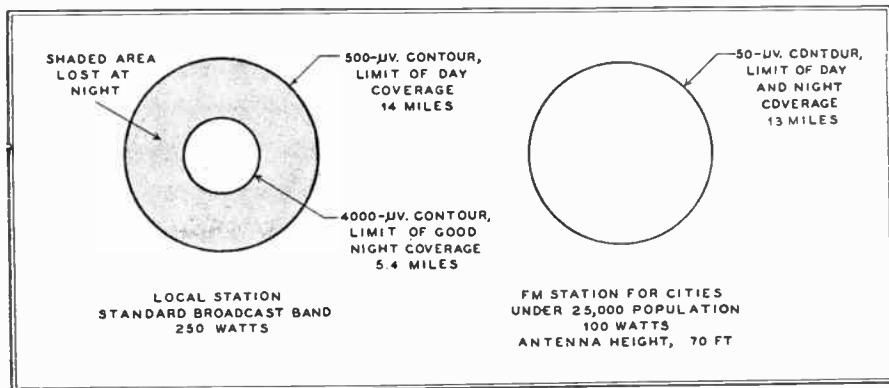

FIG. 30. DAY AND NIGHT COVERAGE OF LOW-POWER AM AND FM TRANSMITTERS

readily flow around intervening objects.

On the other hand, when the wavelength is in the order of a few meters, as at FM frequencies, reflections from objects are much more noticeable. Particularly in cities remote from the transmitter and over rough terrain, signal strength will vary over a wide range from one antenna location to another. Areas of shadow may also be created behind reflecting objects, although within city areas this is not a serious problem, if the transmitting antenna is high, because reflections from nearby buildings usually raise the signal strength within the shadow area.

While such multipath transmission is a source of concern in television reception, where differences in the path lengths cause multiple images to appear on the viewing screen, it is of little concern in FM under the receiving conditions usually encountered within cities, because the differences in the times required for the radio waves to reach the receiver via the various paths are small compared to the time of a cycle in the audio frequency range. Also, since the positions of the reflecting objects are fixed, multipath transmission of this type is not of itself productive of such fading.

The fact that the wavelength of a radio wave at FM frequencies is quite short makes it entirely practicable to build transmitting arrays of several wavelengths in height for the purpose of concentrating toward the horizon the power that otherwise would be radiated at very high and very low angles. An example of such an array is the multilayer turnstile antenna,

increased 2.04 times, equivalent to a power gain of 4.15 times.

The curves of Fig. 27 show the distance to the 50-microvolt contour for a 50-kw. transmitter when 2-bay, and 6-bay turn-

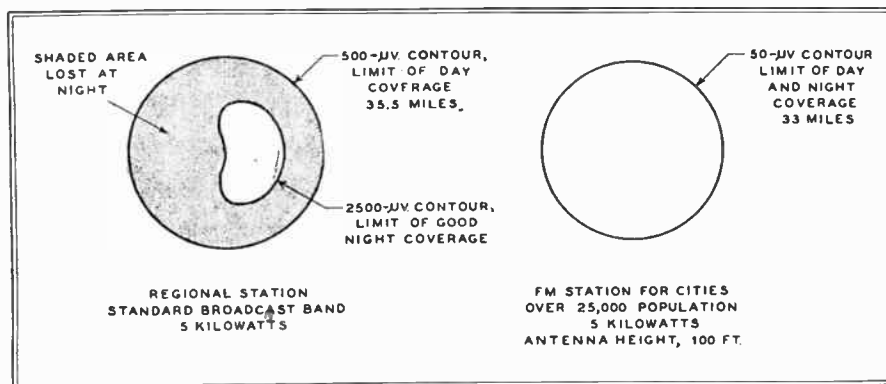

FIG. 31. DAY AND NIGHT COVERAGE OF MEDIUM-POWER AM AND FM TRANSMITTERS

stile antennas of various heights are employed. For example, when the transmitting antenna is located at a height of 1,000 ft., the distance to the 50-microvolt contour is 84 miles when a 2-bay antenna is employed, but is increased to 93 miles with a 6-bay antenna.

At considerable distances, for example, well beyond the 50-microvolt contour of an FM broadcast station, signals at very high frequencies are subject to fluctuation of amplitude. So long as the least amplitude is sufficient to operate the limiter of the receiver, satisfactory reception can be obtained.

Several factors operate to cause variation of signal strength at great distances

or greater, the interference will not be noted. Sporadic-*E* transmissions of appreciable strength are experienced for such a small fraction of the total time, that this type of interference is not considered important to FM reception.

Bursts, which are sudden increases in the signal strength of a distant station, lasting from a fraction of a second to one or two seconds, appear to be related to sporadic-*E* transmission, and are likewise of little concern. The average owner of a well-designed FM receiver, incorporating a limiter, is entirely unaware of the existence of these vagaries of propagation.



**Interference Considerations** ★ In this discussion of the effects of the propagation characteristics upon coverage, the presence of signals from stations other than the desired station was not considered. However, satisfactory radio reception depends not only upon having a signal strength at receiving location sufficient to operate the receiver. It is also necessary that the strength of signals from other stations on the same frequency be of such low amplitude that they are not heard by the listener.

In the matter of such interference, the FM system possesses a considerable advantage over the AM system, as explained in the previous chapter. The ratio of the amplitude of the desired signal to that of the interfering signal must be 100 to 1 for good AM reception, whereas a ratio of 2 to 1 is adequate in a well-designed FM system.

Fig. 28 shows the area of daytime interference between two AM stations of the same power and the same frequency, located 140 miles apart, each having a distance of 60 miles to its 500-microvolt contour. In other words, within the shaded area of Fig. 28, the field strength of one station is less than 100 times the field strength of the other. The loss of primary coverage for each station caused by the presence of the other station is shown by the portion of each circle that is shaded.

In Fig. 29 is shown the area of interference between two FM stations located 140 miles apart, having the same coverage as the primary coverage of the AM stations represented by Fig. 28. The interference area, in which the field strength of one FM station is less than twice that

of the other, lies entirely outside the 50-microvolt contours.

A comparison of Figs. 28 and 29 shows why, even if only daytime operation were to be considered, it would be possible to operate many more FM stations on the same frequency, with less geographical separation between stations, than in the case of AM.

With the advent of nightfall, the AM interference problem is vastly complicated by the presence of the sky wave, which causes the signals of AM stations to be heard for distances of hundreds of miles. On the other hand, the maximum range of the signals from an FM station is practically the same at night as during the daytime, so that no new source of interference is introduced. Every effort has been made to reduce the AM interference problem. Standard stations in the same locality have a frequency separation of at least four channels (40,000 cycles) to minimize adjacent channel interference; many local stations are required to reduce power after sunset; other stations are required to use directional antennas at night to minimize radiation in the direction of distant stations on the same frequency. In spite of these precautionary measures, the interference problem on the AM frequencies is serious, and a much stronger signal from the desired station is required at night to override interference than is necessary in the daytime. Since the power radiated from the desired station can not be increased, the area of satisfactory coverage of the station is reduced by the sky wave interference at night.

For example, the effects of night inter-

ference upon the typical local AM station operating with a power of 250 watts is shown at the left in Fig. 30. At night, a signal strength of at least 4,000 microvolts per meter is required to override the increased interference. This means that the effective range of service is reduced from 14 miles for the daytime limit of the 500-microvolt contour to about 5.4 miles for the nighttime limit of the 4,000-microvolt contour. An FM station operating on 100 watts with an antenna 70 ft. high can give essentially the same radius of coverage in the daytime, assuming flat terrain, with no reduction of coverage at night.

Fig. 31 shows the additional loss of coverage which occurs when a regional AM station is required to use a directional antenna after sunset. The 5-kw. AM station has a service range of about 35 miles in the daytime, but this range is severely curtailed after nightfall. An FM station of the same power with an antenna 100 ft. high gives the same radius of coverage in flat country by day or by night, and is less subject to the effects of interference from other stations.

Thus the use of FM at very high frequencies offers the solution for the interference problem encountered in AM broadcasting. With only about a thousand transmitters in operation, the present AM broadcast band in the United States is overloaded seriously. On the other hand, it is estimated that several thousand transmitters in continuous operation can be accommodated in the FM band, without requiring the range of any of the transmitters to be reduced during the night hours.

# Theory of Frequency Modulation

## Section 4: Introduction to FM Transmitter Circuits and Discussion of Reactance-Tube Modulators Mechanical Method for Control of Frequency Deviation

THE preceding Sections have described the differences that exist between FM systems operating at very high carrier frequencies and AM systems operating at frequencies of a much lower order. It was noted that FM has a number of distinct advantages over AM, the most important being the inherent ability of a well-designed FM system to reduce greatly the effects of interference and noise, provided that the strength of the desired signal at the limiter of the FM receiver is two or more times the strength of the disturbances.

Other important advantages of FM were also explained, such as the improved efficiency obtainable in the FM transmitter, and the greater realism of reproduction found in a properly engineered FM receiver. Moreover, it was shown that at the very high frequencies employed with FM, better and more consistent coverage is obtained within the intended service area than with AM, and that the FM service area is the same after nightfall as during the daylight hours.

It is proposed next to describe the actual methods whereby FM signals can be generated, transmitted, and detected. While the discussion to follow will give primary attention to the basic principles of different methods, additional details of circuit arrangements will be given in later chapters, where the features of commercial transmitters and receivers will be described. The present and following Sections will deal exclusively with methods for generating FM signals.

**FM Transmitter Design Considerations** ★ In order to obtain the full benefits of the FM system and to minimize the possibility of interference between stations, it is necessary that the FM transmitter output have a wide frequency deviation during modulation and a stable center frequency. Specifically, the output of the FM transmitter must have the following characteristics:

1. The amplitude of the output must remain constant during modulation.
2. The radio frequency of the output must be varied at a rate corresponding to the frequency of the audio modulating voltage.
3. The frequency deviation of the output must be proportional to the *amplitude* of the audio modulating voltage, but independent of the *frequency* of the audio modulating voltage.
4. The accepted compromise value for maximum frequency deviation of the output, occurring at the highest peaks of audio modulating voltage, is five times the

highest modulating frequency. In FM broadcast service, where the highest modulating frequency is 15,000 cycles, the FCC specifies a maximum frequency deviation of 75,000 cycles and, in communications services, where the highest modulating frequency used in speech transmission is 3,000 cycles, the specified maximum frequency deviation is 15,000 cycles. If the maximum frequency deviation is less than five times the highest modulating frequency, the channel assigned by the FCC is not entirely utilized, and full advantage is not taken of the noise and interference reduction made possible by the FM system. On the other hand, if the deviation exceeds five times the highest modulating frequency, there is danger of creating interference with stations on adjacent channels.

5. The frequency deviation must be symmetrical about the assigned carrier frequency and the center frequency stability must meet the following FCC requirements: For FM broadcasting the center frequency of the transmission shall at all times be within 2,000 cycles of the assigned carrier frequency of the station. For mobile communications transmitters, the maximum permissible drift of the center frequency from the assigned value is  $\pm .02\%$ , and for fixed communications transmitters,  $\pm .01\%$ .

In view of the fact that Frequency Modulation involves a continual variation of the frequency of transmission, the center frequency stability requirements mentioned above are quite exacting. However, an equally high degree of frequency stability is necessary with FM as with AM, in order that interference will not be created in adjacent channels, and that receivers, once they are tuned, will give satisfactory reception continuously, without requiring readjustment to compensate for center-frequency drift at the transmitter.

There are a number of methods whereby frequency-modulated signals can be generated. The methods in common use, however, may be divided into two distinct systems. The first, which involves the use of the reactance modulator, will be described in this Section. The frequency stability of this system in its most simple form is relatively poor, but the stability can be improved greatly by the use of auxiliary frequency-correction circuits. The second system employs the Armstrong phase-shift modulator, and will be described in Chapter 5. The Armstrong system has inherently good stability, since the center frequency is established by a crystal-controlled oscillator.

**Reactance Modulation** ★ In the reactance modulation method of generating FM signals, the frequency of the oscillator is varied by the direct action of an associated tube and circuit called the reactance-tube modulator. Before considering the manner in which the variation of the oscillator frequency is effected by the modulator, it is advisable to review briefly the factors which govern the natural frequency of an RF oscillator.

Strictly speaking, the operating frequency of an oscillator is not exactly the resonant frequency of its tuned circuit. However, there is only a slight difference between the resonant frequency of the oscillator tank and the actual frequency generated by the master oscillator circuit of a transmitter, where low-loss coils and condensers are used in the tank and where the load of the following buffer stage is relatively light.

It is customary, therefore, to speak of the inductance and capacity of the oscillator tank as comprising the *frequency-determining circuit*, and to regard the oscillator frequency as being the resonant frequency of the oscillator tank.

The resonant frequency of the oscillator tank depends on the product of the tank inductance and the tank capacity. If either the inductance or capacity is increased, the *LC* product is increased, and the period of oscillation is made longer, so that the oscillator operates at a lower frequency. On the other hand, if either *C* or *L* is decreased, the *LC* product is decreased, and the oscillator operates at a higher frequency.

The exact manner in which the resonant frequency is related to the *LC* product will now be examined, with a view toward finding a way in which the frequency of the oscillator can be varied without changing the inductance of the tank coil and without readjusting the capacity of the tank condenser.

At the resonant frequency, the opposition to the flow of alternating current offered by the tank coil, called the *inductive reactance*, is equal to the opposition to the flow of alternating current offered by the tank condenser, called the *capacitive reactance*.

Inductive reactance, the opposition found in coils, has the effect of limiting the current flow and causing the current to *lag behind* the voltage applied to the coil by  $90^\circ$ . Inductive reactance varies directly as the frequency and directly as the inductance of the coil, according to the relation:

$$X_L = 2\pi FL \quad (1)$$

in which  $X_L$  represents the inductive reactance in ohms,  $F$  the frequency in cycles, and  $L$  the inductance in henrys.

Capacitive reactance, the opposition found in condensers, also limits the current for any applied voltage, but causes the current to *lead* the applied voltage by  $90^\circ$ . Capacitive reactance varies inversely as the frequency and inversely as the capacity, as shown by the expression:

$$X_C = \frac{1}{2\pi FC} \quad (2)$$

in which  $X_C$  represents the capacitive reactance in ohms and  $C$  the capacity in farads.

At the resonant frequency, the inductive and capacitive reactances are equal.

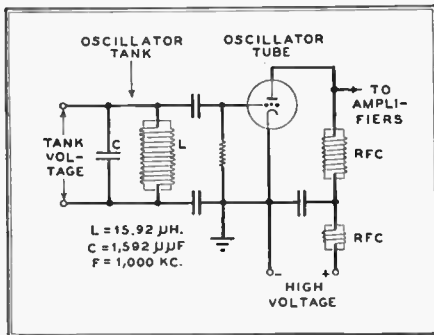

FIG. 32. CIRCUIT OF CONVENTIONAL UNMODULATED OSCILLATOR

That is, at the resonant frequency:

$$2\pi FL = \frac{1}{2\pi FC} \quad (3)$$

or

$$X_L = X_C \quad (4)$$

The resonant frequency, in terms of  $L$  and  $C$ , is found by solving equation (3) for  $F$ , which gives the familiar relation:

$$F = \frac{1}{2\pi\sqrt{LC}} \quad (5)$$

Thus, for any given values of circuit inductance  $L$  and capacity  $C$ , there is but one resonant frequency, regardless of whether large  $L$  is used with small  $C$  or small  $L$  with correspondingly large  $C$ .

Consider now the oscillator circuit of Fig. 32. The inductance of the tank coil in this particular case is 15.92 microhenrys (.00001592 henry) and the tank capacity is 1,592 micromicrofarads (.00000001592 farad). By the use of equations (1), (2), and (5), it is found that the resonant frequency of the tank is 1,000 kc., and that the values of capacitive and inductive reactance offered by the tank coil and condenser are 100 ohms each, as noted in Fig. 33.

Therefore, if voltage at a frequency of 1,000 kc. is present across the tank, the current in the inductive branch will be equal to the current in the capacitive branch of the tank. However, the current in the capacitive branch will lead the voltage by  $90^\circ$  while that in the inductive branch will lag by  $90^\circ$ , as shown by the small vector diagrams in Fig. 33.

Now suppose that a variable capacitive reactance of 1,000 ohms at 1,000 kc. is connected in parallel with the tank condenser, as shown in Fig. 34 at the left. The net capacitive reactance offered by two capacitive reactances in parallel can be determined by

$$\text{net capacitive reactance} = \frac{X_C \times X_{C_1}}{X_C + X_{C_1}} \quad (6)$$

This is similar to the procedure employed to find the net resistance offered by two resistors in parallel. It is found in this case that the equivalent capacitive reactance of 1,000 ohms in parallel with 100 ohms is 90.9 ohms.

Thus at 1,000 kc., the net capacitive reactance of the variable capacitive reactance in parallel with the tank condenser (90.9 ohms) is less than the inductive reactance of the coil (100 ohms). Also, the  $90^\circ$  leading current in the capacitive branch will be greater than the  $90^\circ$  lagging current in the inductive branch by the amount of current flowing in the extra path provided by the variable capacitive reactance. In short, when the variable capacitive reactance is connected across the oscillator tank condenser, the resonant frequency is no longer 1,000 kc., and the oscillator adjusts itself to a new frequency.

The frequency to which the oscillator adjusts itself in this case is 953 kc. At this frequency, the inductive reactance of the tank coil, which varies directly as the frequency, is decreased from 100 ohms at 1,000 kc., to  $953/1000 \times 100$  or 95.3 ohms at 953 kc. The combined capacitive reactances, which offer a net capacitive reactance of 90.9 ohms at 1,000 kc., vary inversely as the frequency and therefore assume a value of  $90.9 \times 1000/953$ , or 95.3 ohms at 953 kc.

Thus the oscillator, by adjusting itself to a lower frequency, brings the capacitive and inductive reactances into equilibrium, as shown in the right-hand diagram of Fig. 34. The total  $90^\circ$  leading current will equal the  $90^\circ$  lagging current and operation at the resonant frequency is maintained.

If the value of the variable capacitive reactance in parallel with the tank condenser is changed to less than 1,000 ohms at 1,000 kc., the oscillator will adjust itself to a frequency lower than 953 kc. to restore operation at the resonant frequency. On the other hand, if the value of the variable capacitive reactance is greater than 1,000 ohms at 1,000 kc., the oscillator will shift to a frequency higher than 953 kc.

Now, if the capacitive reactance shunted across the tank condenser is varied at an audio rate, the oscillator frequency will also vary at the same rate in order to maintain continuous operation at resonant frequency. In this manner frequency modulation of the oscillator output can be obtained.

The shunted capacitive reactance varying at an audio rate can be in the form of a condenser microphone upon whose dia-

phragm sound waves are impinging. Such an arrangement was mentioned in Section 1, but it is hardly practical for most applications because the microphone must be part of the oscillator circuit.

The effect of varying capacity can be produced artificially, without actually varying a condenser, by introducing a variable capacitive reactance across the oscillator tank condenser, as shown in the preceding paragraphs. Such a variable capacitive reactance can be furnished by the reactance-tube circuit, which is shown connected to the oscillator in Fig. 35.

The tube used in the reactance-modulator stage is of the variable- $\mu$  type, whose gain can be varied by changing the grid bias. The tank voltage of the oscillator is applied to the series network RC and also to the cathode and plate of the reactance tube. The capacitive reactance of  $C$  at the oscillator frequency is very much greater than the resistance of  $R$ . Hence the current through RC leads the tank voltage of the oscillator by  $90^\circ$ . The voltage across  $R$ , in phase with the current through it, also leads the tank voltage by practically  $90^\circ$ . Thus the grid of the reactance tube receives an excitation voltage from  $R$  that leads the tank voltage applied to the plate and cathode of the tube by practically  $90^\circ$ .

If the reactance tube were biased so negatively that no plate current whatever could flow in the tube, the frequency of

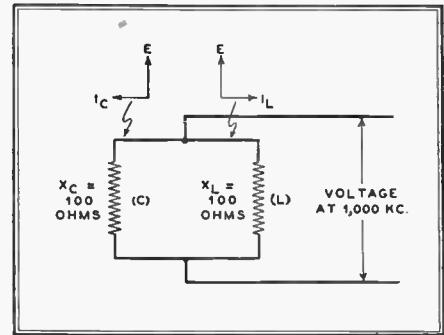

FIG. 33. REACTANCE RELATIONS OF CIRCUIT SHOWN IN FIG. 32

the oscillator would be unaffected by the presence of the reactance-tube circuit. (The impedance of the voltage-dividing phase-shift network RC is too high to affect the oscillator frequency appreciably.) Thus, the oscillator frequency would be determined by the tank coil inductance and the tank condenser capacity.

If the negative bias should be reduced sufficiently to permit a small plate current to flow in the reactance tube, and if there were no RF voltage on the grid of the tube, the effect would be that of shunting the plate resistance of the tube across the oscillator tank. Since the plate current of the pentode is relatively insensitive to small changes in plate voltage, the RF resistance shunted across the oscillator by the tube would be of relatively high order. The frequency of the oscillator would not be affected appreciably.



Actually, however, the resistor R of the RC network furnishes an excitation to the grid of the reactance tube at the frequency of the oscillator, but leading the oscillator tank voltage by 90°. Since the plate current is much more sensitive to a change in grid voltage than in plate voltage, the tube permits the flow of a 90° leading current through it with much greater ease than an in-phase current. Thus, with respect to the oscillator tank voltage, the reactance tube of Fig. 35 provides a capacitive reactance

current in C would lead the voltage across C by 90°. In other words, the voltage across C will lag the oscillator tank voltage by 90°, thus giving a 90° lagging current in the tube. The tube will therefore look like an inductive reactance to the oscillator tank voltage.

Whatever the type of reactance furnished by the reactance-tube circuit, the carrier frequency of the oscillator, in the absence of modulation, depends upon the constants of the oscillator tank, and the

to the oscillator, the oscillator frequency also becomes dependent upon the gain of the reactance tube, since it determines the magnitude of the RF component of plate current that is allowed to flow in the tube at a 90° angle of lead. The gain of the tube in turn depends upon its mutual conductance, upon the characteristics of the associated circuits, and especially upon the voltages applied to the tube elements. Thus the center frequency of the generated wave is affected by such factors as

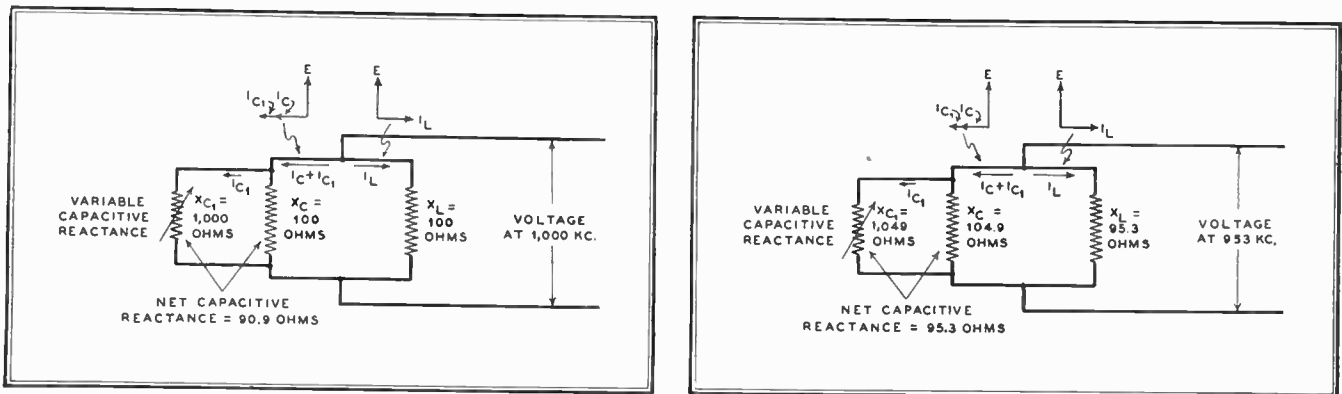

FIG. 34. EFFECT OF PUTTING VARIABLE CAPACITIVE REACTANCE ACROSS OSCILLATOR TANK CONDENSER. LEFT: NON-RESONANT CONDITION AT ORIGINAL FREQUENCY. RIGHT: CONDITION AFTER OSCILLATOR HAS SHIFTED FREQUENCY

across the oscillator tank condenser, the effect of which is to cause the oscillator to adjust itself to a lower frequency in order to maintain resonant operation.

Moreover, the magnitude of the 90° leading current allowed to flow in the reactance tube depends on the mutual conductance of the tube, that is, on the sensitivity of the plate current to a change in grid voltage. When the negative bias is reduced, the mutual conductance of the tube is increased, and a larger 90° leading current flows in the tube, so that the effective reactance of the tube is reduced. This causes the oscillator to adjust itself to a still lower frequency. Conversely, when the bias is made more negative, the 90° leading current is reduced and the effective reactance is increased.

It is feasible, therefore, to vary the reactance of the tube at an audio rate simply by introducing an audio voltage in the grid bias of the reactance tube from the output of an audio amplifier, as shown in Fig. 35. The varying reactance, in turn, causes the oscillator frequency to shift at an audio rate, giving frequency modulation of the oscillator output equivalent to actually varying the capacity of an auxiliary condenser across the tank condenser.

By a simple circuit rearrangement, the reactance tube circuit can be made to furnish a variable inductive reactance across the tank circuit for reactance-modulating the oscillator frequency. For example, suppose that the positions of R and C in the RC network are interchanged, and that the resistance of R is made very much greater than the capacitive reactance of C at the oscillator frequency. The current in RC would then be nearly in phase with the tank voltage of the oscillator. The

amount of reactance shunted across the tank by the reactance tube. The amount of reactance offered by the tube, in the absence of modulation, depends in turn upon the DC grid bias. Thus the center frequency of the FM signal generated by the oscillator can be adjusted to the assigned carrier frequency simply by an adjustment of the DC bias on the grid of the reactance tube.

the constants of the reactance tube and the voltage regulation of the power supply. In particular, a very slight variation in the grid bias of the reactance tube causes a considerable shift of the oscillator frequency.

In general, therefore, the primary difficulty that arises in the use of a reactance-tube modulator for the generation of FM signals is that the center frequency of the

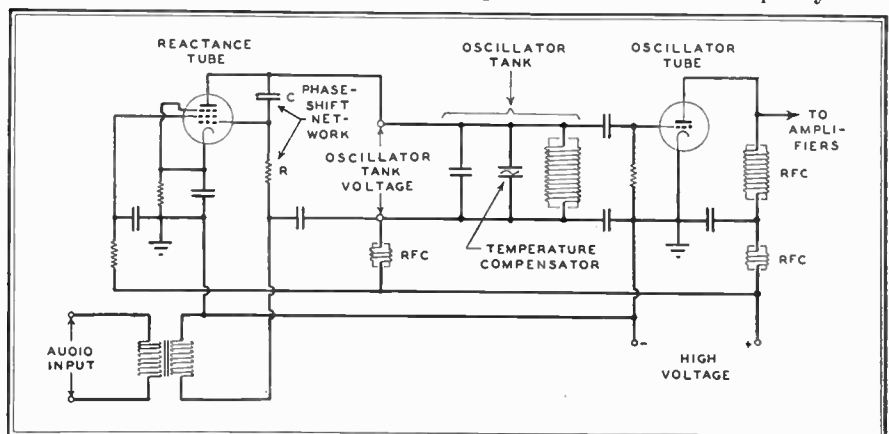

FIG. 35. THE VARIABLE CAPACITIVE REACTANCE SHOWN IN FIG. 34 IS HERE REPLACED BY A REACTANCE TUBE TO VARY THE OSCILLATOR FREQUENCY

The center frequency stability of the simple reactance modulator circuit of Fig. 35 is relatively poor. In the first place, the center frequency cannot be crystal-controlled. The natural frequency of the oscillator, even in the absence of the reactance tube, is affected by variations of the voltages on the oscillator tube elements, by the effects of temperature changes upon the inductance and capacity of the tank, and by the resistance reflected from the coupled load.

When the reactance tube is connected

generated wave depends upon the voltages on the reactance tube as well as upon the constants of the oscillator. The frequency stability can be improved by the use of a voltage-regulated power supply for the reactance modulator. However, even with this precaution, the drift at the very high frequencies is too great to meet the stability requirements of the FCC.

It is necessary, therefore, to employ auxiliary circuits to maintain the center frequency at the assigned value. The principle commonly employed is to compare

the center frequency of the transmitter output to that of a crystal oscillator. When the center frequency departs from its correct value, the stabilization circuits operate upon the reactance tube or the oscillator to bring the center frequency back to its correct value.

**The Crosby System** ★ The circuit diagram of a transmitter employing the frequency stabilization circuit developed by Murray G. Crosby is shown in Fig. 36. The oscillator in this particular case operates at one-ninth of the assigned transmitting frequency. In the circuit of Fig. 36 the 4.7-mc. oscillator frequency is passed through two tripler stages to produce a

to 1,800 kc.<sup>1</sup> The discriminator, in the absence of modulation, produces a DC voltage whose *magnitude* is proportional to the amount by which the frequency applied to the discriminator differs its resonant frequency. For example, if the discriminator produces 20 volts when the applied frequency is 1,820 kc., it will produce 50 volts when the applied frequency is 1,850 kc.

The polarity of the voltage at the discriminator output depends on whether the applied frequency is greater or less than the frequency of the discriminator circuit. Thus, when the applied frequency is 1,750 instead of 1,850 kc., the same voltage is produced but in opposite polarity.

change in frequency, whether in the form of a slow drift or a rapid variation, an audio voltage appears across the discriminator output during modulation in addition to the DC voltage. However, the *average* value of the voltage across the discriminator output will be proportional to the drift of the center frequency of the output, and the polarity of the average voltage will depend on the direction of frequency drift.

An example will serve to make this action clear. Suppose that the transmitter, having an assigned frequency of 42,300 kc., is actually operating at a center frequency of 42,350 kc., and that the frequency deviation during modulation is 75

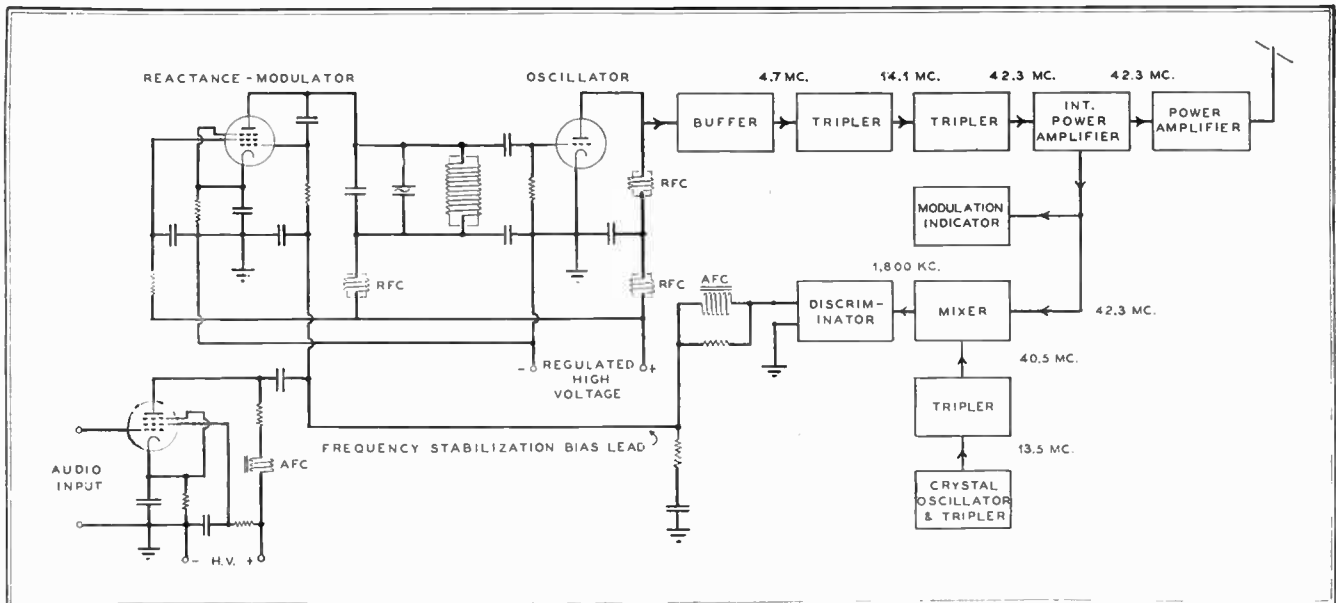

FIG. 36. FM BROADCAST TRANSMITTER EMPLOYING BIAS-CONTROL METHOD OF MINIMIZING FREQUENCY DRIFT

frequency of 42.3 mc. The oscillator is frequency-modulated by the reactance tube, a frequency deviation of  $75/9$  or 8.33 kc. being required at the oscillator for full modulation of the transmitter.

In the frequency stabilization circuits, a crystal oscillator operates at a frequency that differs from the correct center frequency of the reactance-modulated oscillator by a known amount. For example, the frequency of the crystal oscillator may be 4.5 mc. which, after being tripled twice, gives a reference frequency of  $4.5 \times 9$  or 40.5 mc.

The reference frequency of 40.5 mc. is applied to a mixer tube along with a voltage at the transmitter output frequency, taken from the intermediate power amplifier stage. If the center frequency of the transmitter output is correct, a beat frequency of  $42,300 - 40,500$  or 1,800 kc. will appear at the output of the converter. If the center frequency of the transmitter output is greater or less than 42,300 kc., the beat frequency will be greater or less than 1,800 kc. by the same amount.

The converter output is applied to a discriminator having a temperature-compensated circuit very accurately tuned

The voltage output of the discriminator is used for frequency correction and is applied to the grid of the reactance-modulator tube in addition to the bias contributed by the cathode resistor of the modulator tube. If the transmitter output frequency is exactly correct, the DC output voltage of the discriminator is zero, and the bias on the reactance tube is that developed by the cathode resistor alone. When the transmitter output frequency differs from the correct value, the discriminator produces a DC voltage of such polarity that the bias of the reactance tube is varied in a direction to shift the output frequency toward its correct value. When the frequency is very nearly correct, and only a very small correction voltage remains at the discriminator output, the frequency correction action ceases.

In the above explanation of the frequency stabilizing action, it has been assumed that no modulation is present. Actually, of course, a frequency-modulating audio voltage is being applied to the grid of the reactance tube during most of the time that the transmitter is on the air. Since the discriminator is responsive to

<sup>1</sup> The operating principle of the discriminator will be explained in a later chapter.

kc. The transmitter output frequency is varying between 42,425 kc., and 42,275 kc. The voltage applied by the mixer in the frequency correction circuit to the discriminator will vary in frequency between  $42,425 - 40,500$  or 1,925 kc., and  $42,275 - 40,500$  or 1,775 kc. This is 125 kc. above and 25 kc. below the 1,800 kc. reference frequency to which the discriminator is tuned. The voltage across the discriminator output will vary, therefore, between +125 and -25 volts, the average of which is +50 volts, the same voltage that would be obtained for an unmodulated transmitter output frequency of 42,350 kc. Thus the center frequency of the output during modulation can be corrected as easily in the absence of modulation, by employing the DC component of the discriminator output voltage.

Actually, the audio voltage of the discriminator is sometimes only partially filtered at the lower audio frequencies, in order to obtain some degenerative feedback at these frequencies. This gives the transmitter a pre-emphasis characteristic that improves the signal-to-noise ratio at the higher audio frequencies.

The stability of the carrier frequency in the circuit of Fig. 36 depends on: 1) the



stability of the reference crystal oscillator; 2) the gain of the mixer tube, and 3) the stability of the tuned circuits of the discriminator. Also, the frequency stabilization circuit does not remove all the drift of the output frequency, although the drift can be reduced by as much as 100 to 1 as compared to the drift of an unstabilized reactance-modulated transmitter.

**Western Electric System** ★ A different frequency stabilization system, developed by J. F. Morrison of Bell Laboratories, is employed in Western Electric transmitters. In this system, drift of the center frequency is automatically corrected by means of a small, reversible motor that readjusts the settings of variable condensers in the oscillator tank circuit. This motor, and the compensating condensers which it adjusts, are shown in Fig. 37.

A simplified diagram of the oscillator and reactance-tube modulator appears in Fig. 38. The oscillator is of the push-pull type, employing two tubes. Energy is fed back to the grids from the plate circuits through small coupling condensers  $C_C$  in such polarity as to sustain oscillation. The reactance-modulator also employs two tubes, the plates being connected in push-pull to opposite ends of the oscillator tank. The grids of the tubes in the modulator are connected in parallel, and are excited by a voltage taken from the oscillator tank through a  $90^\circ$  phase-shifting network.

Since the plates of the reactance tubes are connected to opposite ends of the oscillator tank, the direction in which the oscillator frequency will be shifted by the modulator depends on which of the tubes in the modulator passes the greater reactive current. By applying the audio voltage to the control grids of the reactance tubes in push-pull, during the first alternation of the audio voltage, the bias on one tube is reduced while the bias on the other tube is increased. Thus one tube is made to pass a greater reactive current than the other, so that the oscillator frequency is shifted. During the next alternation of the audio voltage, the grid biases are unbalanced in the opposite direction. The tube which passed the greater reactive current in the first alternation now passes the lesser current, and the oscillator frequency is shifted in the opposite direction.

As the audio voltage alternately favors the flow of reactive current first in one tube and then in the other, the oscillator frequency is increased and decreased at the same audio rate. Thus frequency modulation of the oscillator output voltage is obtained.

The balanced reactance-tube modulator circuit employed here has the advantage over single-tube modulators of balancing out the effects of ripples and fluctuations in the grid bias and plate voltages which are applied in parallel to the reactance-tubes.

The oscillator tank capacity consists of

fixed condensers  $C_F$  and variable condensers  $C_V$ . The variable condensers are ganged and mechanically linked to a synchronous motor, controlled by the frequency stabilization circuit. When the center frequency of the transmitter drifts away from the assigned carrier frequency, the motor rotates in the proper direction and to the extent necessary to readjust the tank capacity of the oscillator to the correct center frequency.

Fig. 39 shows, in block diagram form, the arrangement of this system of frequency stabilization. The frequency of the reactance-modulated oscillator in this case is  $\frac{1}{8}$  of the transmitter output frequency. For example, if the assigned carrier frequency is 42.3 mc., the oscillator operates at 5.2875 mc. The oscillator output is passed through a buffer and three doubler stages to give the assigned carrier frequency. It is then amplified to give the required power output.

A portion of the output voltage of the reactance-modulated oscillator is applied to the input of a chain of ten frequency dividers, each of which gives an output having one-half the frequency of its input. Thus the center frequency at the output of the last frequency divider is  $1/1,024$  of the frequency of the modulated oscillator. Hence, if the reactance-modulated oscillator is furnishing the correct frequency of 5.2875 mc., the frequency at the output of

the frequency-divider chain is  $5,287,500/1,024$  or 5,163.5 cycles. This is the frequency at which the reference crystal oscillator is designed to operate.

The output of the reference crystal oscillator and the output of the frequency-divider chain are combined in the motor-control circuit. This circuit determines the magnitudes of the currents that flow in the four windings of the synchronous motor that adjusts the oscillator tuning condensers.

If the output frequency of the transmitter has the correct value of 42.3 mc., the frequencies applied from the reference oscillator and the frequency-divider chain are the same. The resultant magnetic field set up between the poles of the motor by the currents in the windings is stationary, so that the armature of the synchronous motor does not rotate.

Suppose, however, that the output frequency of the transmitter drifts to 42.4 mc., so that the frequency at the output of the frequency-divider chain becomes 5,175.7 cycles. When this frequency is applied to the motor control circuits along with the reference frequency of 5,163.5 cycles from the crystal oscillator, the magnetic field set up between the motor poles is made to rotate at the difference frequency of 12.2 electrical cycles per second. Accordingly, the armature of the motor rotates and increases the capacity of the

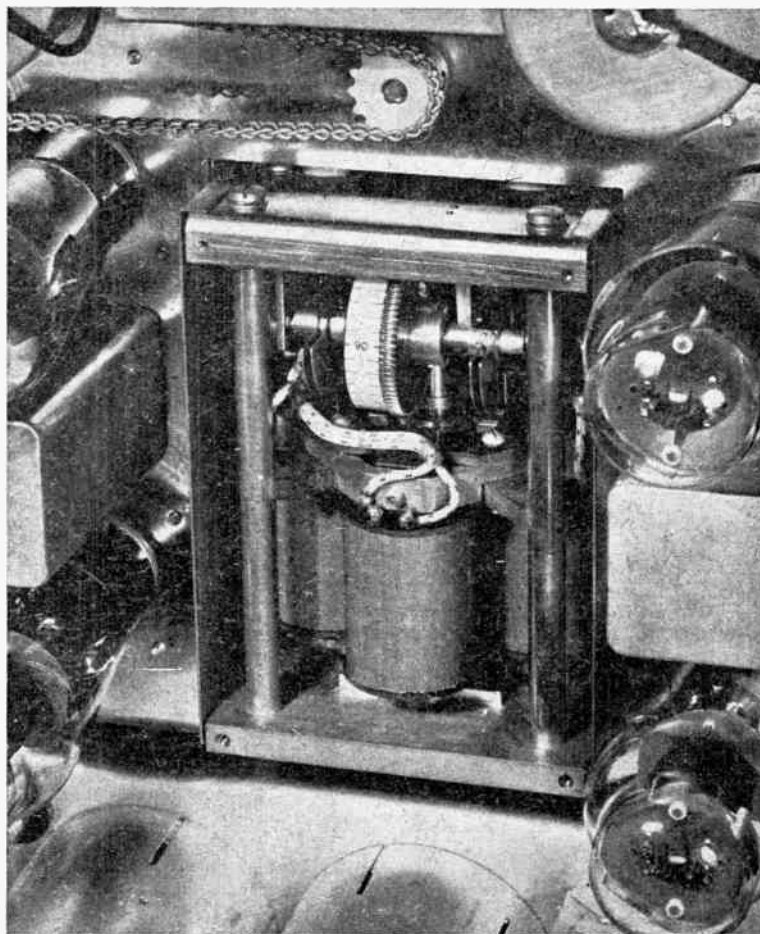

FIG. 37. CLOSE-UP OF WESTERN ELECTRIC FREQUENCY COMPENSATING CONTROL



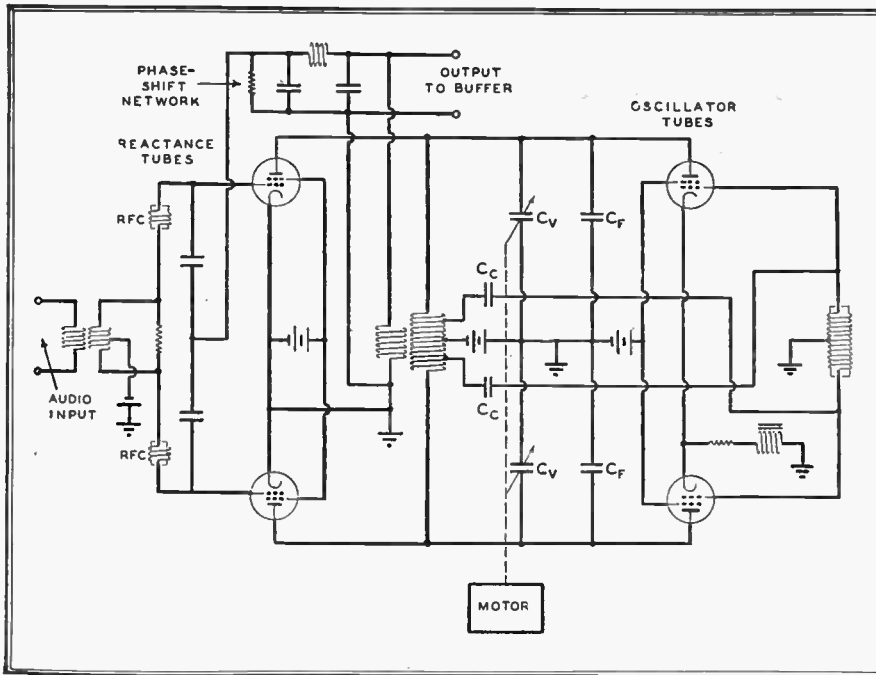

FIG. 38. REACTANCE-MODULATED OSCILLATOR OF WESTERN ELECTRIC FM TRANSMITTER, USING MOTOR-DRIVEN FREQUENCY-CORRECTION CONDENSERS

variable condensers,  $C_v$ , Fig. 38, thereby lowering the oscillator frequency toward the correct value. As the amount of the frequency drift is reduced, the difference frequency at the motor-control circuit is reduced, and the magnetic field rotates more slowly. The armature likewise revolves at a slower rate, in keeping with the field, and comes to rest when the field is stationary, that is, when the transmitter drift has been corrected, and the frequency at the output of the frequency-divider chain is exactly equal to that furnished by the reference oscillator.

If the transmitter output frequency should drift to a value lower than the assigned carrier frequency, then the rotation of the magnetic field is in the opposite direction.

In this way, the transmitter output frequency drifts, no matter how slowly, the magnetic field of the motor starts to revolve and the armature of the motor turns with the field, applying a correcting adjustment to the oscillator tank capacity.

The question naturally arises as to whether or not the frequency variations occurring during modulation will disturb the operation of the motor. Also, as explained in Chapter 1, in frequency modulation the center frequency component varies in amplitude and even disappears at certain percentages of modulation. What will be the effects of such variations in the center frequency component of the modulated oscillator output upon the operation of the motor-drive circuits?

Neither of these factors affects the operation of the motor. Each of the frequency-dividing stages halves the frequency deviation as well as the frequency of the voltage applied at the input. In the present case, when the transmitter output frequency is being fully modulated, the

frequency deviation is  $\pm 75$  kc. The frequency deviation of the reactance-modulated oscillator is  $\frac{1}{8}$  of the output deviation, or  $\pm 9.375$  kc. The frequency deviation at the output of the frequency-divider chain is  $9,375/1,024$  or  $\pm 9.14$  cycles. At the lowest audio frequency, say 30 cycles, the modulation index is  $9.14/30$  or about 0.3. Reference to the table of Bessel factors (Section 1) shows that, with this modulation index, the frequency-modulated voltage is composed of a center frequency component having 97.7% of the amplitude of the unmodulated carrier and only one important pair of sidebands, having an amplitude of less than 15% of the unmodulated carrier.

At modulating frequencies greater than 30 cycles, that is, over the entire audio range, the modulation index is still smaller, and the center frequency component is greater than 97.7%, while each of the two sideband components has an amplitude of less than 15%. Thus the

process of frequency division concentrates the energy of the frequency-modulated wave into the center frequency component. At the output of the frequency-divider chain, the amplitude of the center frequency component during modulation is never less than 97.7% of the amplitude of the carrier in the absence of modulation. Large variations in the amplitude of the center frequency component at the transmitter output during modulation, therefore, do not affect the operation of the motor-control circuits.

The FM voltage from the frequency-dividing chain, which has been described as having a frequency deviation of 9.14 cycles at full modulation, will cause a slight oscillation of the motor field at the modulating frequency. The angle in radians of alternate advancement and retardation of the field in the motor at the modulating frequency of 30 cycles per second would be equal to the modulation index, that is, to .3 radian or about  $17^\circ$ . In other words, the rotating or stationary field of the motor has a superimposed oscillation over a range of  $\pm 17^\circ$  when the transmitter is fully modulated at 30 cycles. That represents the most extreme condition of oscillation. When the modulating frequency is higher than 30 cycles and the transmitter is being modulated at less than 100%, the oscillation range is less than  $\pm 17^\circ$ .

For all the modulating frequencies from 30 to 15,000 cycles, the inertia of the armature element and the friction in the motor is sufficient to prevent any response to the slight, rapid oscillations of the motor field at the modulating frequency. The motor is only responsive to slow rotation of the mean position of the motor field, which occurs when the transmitter output frequency starts to drift from the correct value.

Since positive synchronism is maintained between the subharmonic of the transmitter output frequency and the reference crystal oscillator, the carrier frequency stability is that of the crystal oscillator. The stability is not affected by fluctuations of power supply voltages, nor

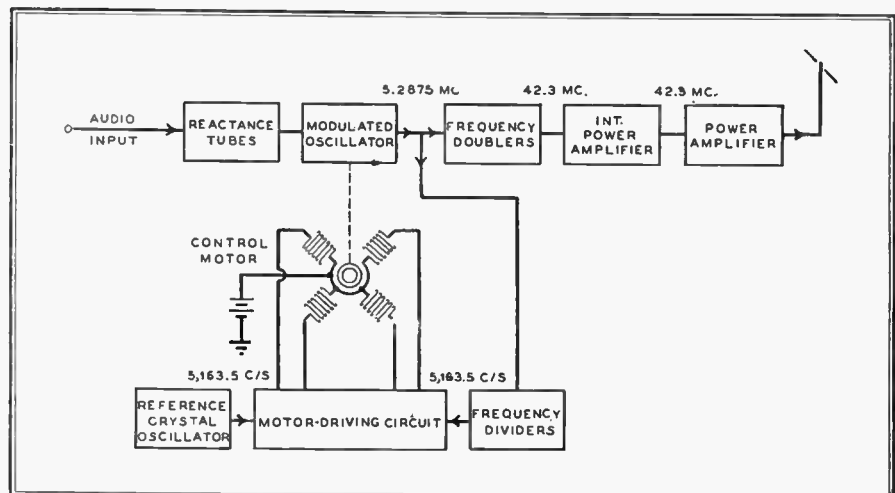

FIG. 39. BLOCK DIAGRAM OF W.E. SYNCHRONIZING MOTOR CONTROL CIRCUIT

does it depend on the maintenance of the constants of a tuned circuit, nor upon the stability of gain in any tube.

The frequency correction is applied in the oscillator by electro-mechanical means so that the design of the reactance-tube

modulator does not involve considerations of frequency stabilization, and failures in the frequency stabilization circuit cannot affect the process of modulation. If the frequency stabilization circuits fail, the motor ceases to revolve and the transmit-

ter frequency will drift slowly. There will not be a sudden change in the transmitter output frequency as would be the case where frequency stabilization is obtained by means of bias applied to the reactance-tube modulator.

# Theory of Frequency Modulation

## Section 5: Continuation of FM Transmitter Circuits—Description of Armstrong Modulator Modification of Original Armstrong Circuit—Pre-emphasis Networks

IN THE preceding section, the generation of FM signals by the use of reactance-tube modulators was discussed. It was noted that the reactance-modulated oscillator cannot be crystal-controlled because, during modulation, the reactance variation must cause the oscillator frequency to swing over a considerable range. Lacking crystal control or other means for frequency stabilization, the average or center frequency generated by the oscillator is subject to drift which may extend beyond the frequency stability limits established by the FCC.

The drift can be minimized by the use of frequency stabilization circuits in which the center frequency of the transmitter output, or a subharmonic thereof, is compared to the frequency of a reference crystal oscillator. When the center frequency drifts away from the assigned value, the stabilization circuits exert corrective measures upon the reactance-tube modulator, or upon the modulated oscillator, to bring the center frequency back to the correct value.

However effective, such circuit arrangements represent an indirect solution to the problem of maintaining the frequency stability, because the center frequency component is compared with the reference following its generation.

The direct solution lies in having the center frequency component of the signal under crystal control during its generation. With the stability of the center frequency established at the source, auxiliary frequency stabilization circuits, together with their potential troubles, are eliminated from the transmitter.

The Armstrong phase-shift modulator circuit provides a direct solution to the problem of maintaining the frequency stability of an FM transmitter. The center frequency component of the FM wave is generated by an oscillator that is crystal-controlled and therefore of very high frequency stability. Thereafter, the sideband components, which are generated in a modulator that is excited by the same oscillator, are combined in such phase with the center frequency component as to produce a voltage having a slight degree of frequency modulation. The frequency-modulated voltage is then passed through a multiplication system which increases the center frequency and the slight frequency deviation by such factors as will give the desired transmitter output frequency and frequency deviation. Finally, the voltage is used to excite a series of power amplifier stages to raise the

power to the required level for the transmitter output.

To present a clear picture of the operation of the Armstrong phase-shift modulation system, the creation of the frequency-modulated wave will be described graphically and with reference to the original simple form of the Armstrong modulator. Thereafter, the features of the new and improved Armstrong modulator circuit will be explained.

**Slightly Modulated AM and FM Waves** ★ Before considering the method by which FM waves are produced by the Armstrong modulator, it is well to review the points of similarity and difference of slightly modulated AM and FM waves.

In Section 1, AM and FM waves were analyzed and shown to be comprised of components at the carrier frequency and at sideband frequencies. The amplitudes of these components were found to depend upon the amplitude of the modulated

wave and upon the degree of modulation.

It was noted that with modulation at a single modulating frequency, the AM wave has only one pair of sideband components, regardless of the degree of modulation, up to 100%. The FM wave, on the other hand, can have a large number of sideband components, depending upon the modulation index. However, when the modulation index is less than 0.2, that is, with very slight frequency modulation, only one pair of sidebands has sufficient amplitude to be significant, and the amplitudes of these sidebands are proportional to the modulation index.

It was further pointed out, in Section 1, that the center frequency and sideband components of a slightly modulated FM wave can be the same in amplitude and in frequency as the components of a partially modulated AM wave. It was stated, however, that this does not mean that the two waves are identical. In the case of the FM wave, the sideband components are differ-

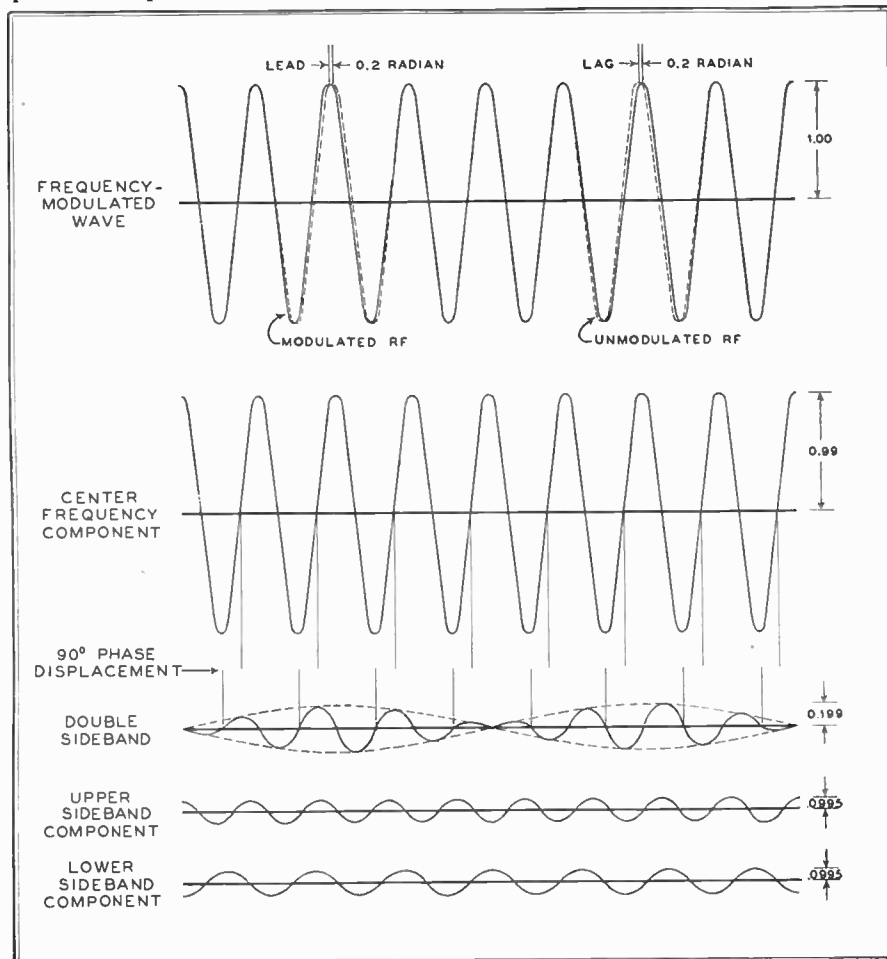

FIG. 40. COMPONENTS OF FM WAVE HAVING AMPLITUDE OF 1.00 AND MODULATION INDEX OF 0.2. NOTE 90° PHASE DISPLACEMENT OF DOUBLE SIDEBAND



ently phased with respect to the carrier, so that when they are added to the carrier, a wave of constant amplitude and varying frequency is produced, rather than a wave of varying amplitude and constant frequency.

Figs. 40 and 41 offer specific examples of the condition mentioned above. At the top of Fig. 40 is shown the wave form of an FM current having an amplitude of 1 ampere and a modulation index of 0.2. At the top of Fig. 41 is shown the form of an AM current having an average am-

sidebands are shown beneath the carrier frequency components in Figs. 40 and 41.

In spite of the fact that the amplitudes and the frequencies of the components of the wave in Fig. 40 are the same as the respective components of the wave in Fig. 41, it is found that the sum of these components produces a frequency-modulated wave in Fig. 40 and an amplitude-modulated wave in Fig. 41. Why?

The answer lies in the phase relationship of the sidebands with respect to the carrier. It will be observed that in the case

41. The double sideband current of Fig. 41 is created in a special type of AM modulator, excited at the carrier frequency but employing a circuit which suppresses the carrier frequency component in the modulator output. The double sideband is then displaced along the time axis, to the extent of one-quarter cycle, by a 90° phase-shift device. The phase relationship between the carrier frequency and the double sideband then becomes that shown in Fig. 40. If the double sideband component and carrier component are now combined in the proportions of amplitude shown in Fig. 40, the frequency-modulated wave at the top of Fig. 40 is produced.

Excellent frequency stability of the carrier component is assured by the use of a crystal-controlled oscillator for generating the original carrier frequency component.

Of course, only a slight degree of frequency modulation is obtainable, because only one pair of sidebands is added to the carrier. However, if the carrier frequency is made low, so that a sufficient number of frequency multiplying stages are employed in raising the frequency to the assigned transmitting frequency, the frequency deviation is increased by the same factor as the frequency is increased in each multiplier stage. Thus a large frequency deviation can be obtained from a frequency-modulated wave whose initial frequency deviation is quite small.

**Original Armstrong Phase-Shift Modulator** ★ A block diagram of original arrangement of the Armstrong modulator is shown in Fig. 42. The elements involved in the creation of waves having a slight frequency modulation at a given modulating frequency are enclosed within the dotted line. The circuit diagram for these elements is shown in Fig. 43.

It will be seen that the output of a crystal-controlled oscillator at a frequency in the order of 200 kc. is applied simultaneously to the carrier frequency amplifier stage and to both grids of the balanced modulator.

The balanced modulator serves to produce the double sideband illustrated in Fig. 41. The grids of the modulator tubes in Fig. 43 are connected in parallel to the oscillator, but the plates are connected in pushpull to the load circuit  $C_1L_1L_2C_2$ . The condensers  $C_1$  and  $C_2$  serve to neutralize the reactances of  $L_1$  and  $L_2$ , giving a purely resistive path for the RF components of the modulator plate current. This brings the RF components of the plate currents into phase with the common grid voltage, and hence into phase with each other.

Since the RF components of the plate currents flow toward the common junction of  $L_1$  and  $L_2$  from opposite ends of  $C_1L_1L_2C_2$ , it follows that when the tubes are well matched and operating with equal voltages on the tube electrodes, the RF voltage induced in coil  $L$ , equally coupled

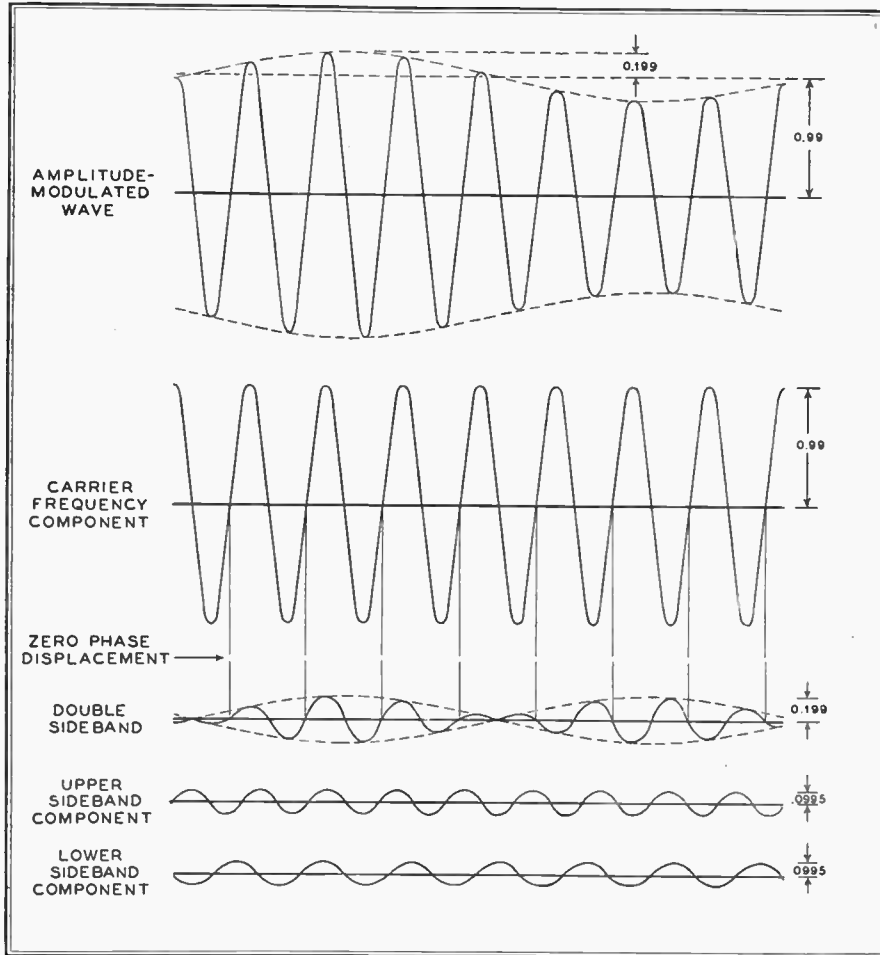

FIG. 41. AM WAVE HAVING SAME COMPONENTS AS FM WAVE IN FIG. 40. NOTE, HOWEVER, THE ZERO PHASE DISPLACEMENT OF DOUBLE SIDEBAND

plitude of 0.99 ampere and a modulation percentage of 20.1.

When these waves are analyzed by the methods given in Section 1, it is found that *both* waves have 1) a carrier frequency component with an amplitude of 0.99 ampere, 2) a lower sideband component, at carrier frequency minus modulating frequency, with an amplitude of .0995 ampere, and 3) an upper sideband component, at carrier frequency plus modulating frequency, also having an amplitude of .0995 ampere.

In Figs. 40 and 41 the carrier frequency components are shown immediately below the modulated waves. When the carrier frequency component is subtracted from the modulated wave, the remainder is the sum of the two sideband components, called the double sideband. The double

of the amplitude-modulated wave, Fig. 41, the intercepts of the double sideband wave with the time axis occur simultaneously with the intercepts of the carrier frequency component. On the other hand, in the case of Fig. 40, the intercepts of the double sideband occur at instants differing by one-quarter cycle from the instants of the intercepts of the carrier frequency component. In the case of Fig. 41 the summation of the components gives an amplitude-modulated wave. In Fig. 40 the summation of the *same* components, *but with the sidebands shifted 90° along the time axis*, gives a frequency-modulated wave.

**Principle of Armstrong Modulator** ★ The scheme of operation of the Armstrong modulator can be understood by reference to Figs. 40,

to  $L_1$  and  $L_2$ , will be zero, because the effects of the field created about  $L_2$  are cancelled by the effects of the field created about  $L_1$ .

However, if the tubes are not well matched, or if the voltages applied to the tubes are not equal, then the RF component of the plate current of one tube will be greater than that of the other tube. The net RF field set up around  $L_1L_2$ , which sweeps coil L, will then have a polarity dependent upon which tube has the larger RF component of plate current. The strength of the net RF field will vary as the degree of unbalance between the two tubes.

In the modulator of Fig. 43, the tubes are deliberately unbalanced during modulation by applying the audio modulating voltage at the primary of transformer T<sub>1</sub>.

the wave form of the double sideband illustrated in Fig. 41. Moreover, the field has the same phase relation with respect to the carrier voltage on the modulator grids as that shown for the double sideband with respect to the carrier frequency component in Fig. 41.

The voltage induced in coil L, however, has a phase displacement of  $90^\circ$  with respect to the inducing field. This is inherent in the process of induction. For example, the maximum induced voltage occurs at the instants when the inducing field is changing most rapidly. Similarly, the voltage induced in L is zero at the instant when the inducing field has reached a condition of maximum expansion and is stationary for an instant before contracting. Thus there is a  $90^\circ$  phase displacement between voltage induced in L and

The greater the ratio of the amplitude of the double sideband component to the amplitude of the carrier component, the greater the phase deviation of the wave created by combining the two components. However, if the amplitude of the double sideband is made greater than about one-fifth of the amplitude of the carrier, so that the phase deviation is greater than about 0.2 radian, then two undesirable effects will become evident. 1) The wave will have appreciable amplitude variation as well as frequency variation, and 2) the phase deviation will no longer be proportional to the amplitude of the double sideband, as determined by the amplitude of the modulating voltage.

Thus only a slightly modulated FM wave should be produced in the phase-shift modulator. As long as the amplitude

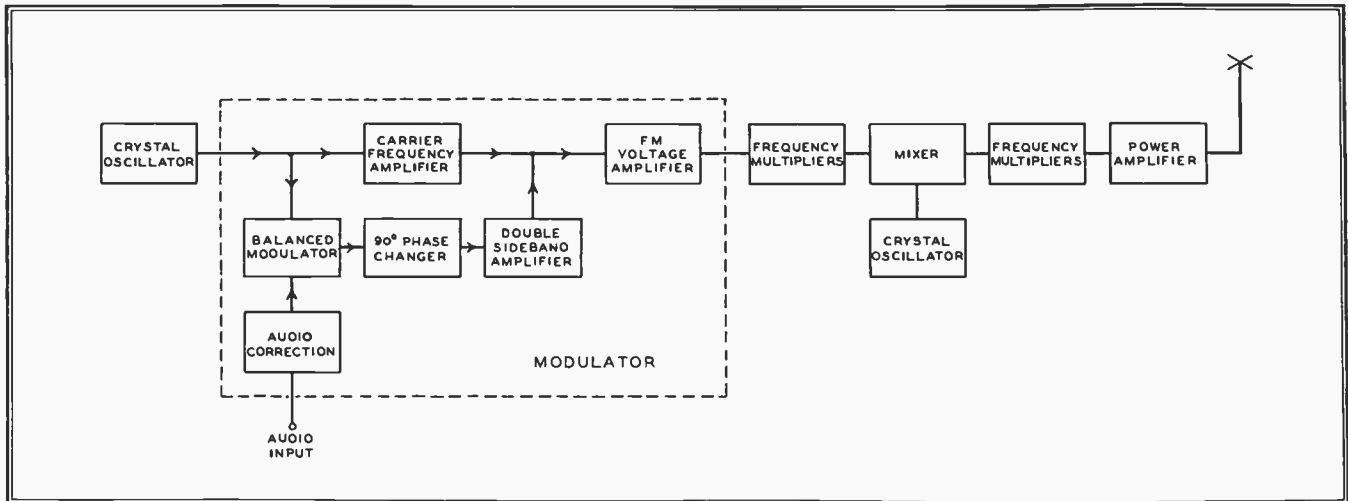

FIG. 42. A BLOCK DIAGRAM OF THE ORIGINAL ARMSTRONG PHASE-SHIFT MODULATOR CIRCUIT

The voltages appearing across the two halves of the secondaries of the transformer are inserted in opposite polarity in the screen grid returns of the two tubes. Thus during the first alternation of the audio modulating voltage, one screen is rendered *more* positive by the voltage across one half of the transformer secondary, while the other screen is rendered *less* positive by an equal voltage across the other half of the secondary.

This creates an unbalance such that the net RF field sweeping the coil L has a polarity determined by the predominant RF component of plate current, and a strength dependent upon the degree of inequality of the RF components of the plate currents of the two modulator tubes.

During the second alternation of the modulating voltage, the unbalance is shifted in the opposite direction, and the net RF field sweeping coil L is reversed in polarity.

In this way the net RF field sweeping coil L changes polarity as the audio modulating voltage changes its polarity, and the strength of the net RF field varies as the instantaneous value of the audio modulating voltage. Hence the balanced modulator produces a field about  $L_1L_2$  that has

the net RF field about  $L_1L_2$ . Since L is untuned, no further phase shift occurs before the voltage induced in L is applied to the grid of the sideband amplifier stage. In view of the  $90^\circ$  phase shift of the modulator output, the phase relationship of the RF components of plate current of the sideband amplifier and the carrier frequency amplifier, Fig. 43, will be that shown for the double sideband and center frequency components, Fig. 40. If the amplitudes of the RF currents are also in the proportion shown in Fig. 40, then when the currents are drawn through a common load resistor  $R_L$ , the voltage wave across  $R_L$  will have a slight frequency modulation as shown at the top of Fig. 40.

Comparison of the frequency-modulated wave in Fig. 40 with the dotted curve of an unmodulated wave of the same average frequency shows that the effect of adding the double sideband component (after  $90^\circ$  displacement along the time axis) to the carrier component is to create a wave that is alternately advanced and retarded in phase with respect to the carrier. Hence the circuit of Fig. 43 is called the Armstrong *phase-shift* modulator.

of the double sideband is less than one-fifth of the carrier amplitude, making the modulation index less than 0.2 and the phase deviation less than 0.2 radian, then the phase deviation will be proportional to the amplitude of the audio modulating voltage, and an essentially distortionless modulated wave will be produced.

**Alternate Circuit Arrangements** ★ There are a number of alternate arrangements of the Armstrong phase-shift modulator, all operating on the same principle of combining the double sideband with the carrier frequency component in *phase quadrature*, that is, after displacement by  $90^\circ$  along the time axis. For example, the *grids* of the balanced modulator tubes may be excited by voltages  $180^\circ$  out of phase with each other, while the *plates* are connected in parallel to a common load. The same suppressed-carrier double sideband output will be obtained. Another arrangement commonly employed is to insert the  $90^\circ$  phase-shift in the excitation of the modulator rather than at its output. Various other devices can be used for obtaining the  $90^\circ$  phase-shift.

A simple alternate arrangement of the Armstrong modulator is shown in Fig. 44.

Here the oscillator output is applied to three voltage dividers in parallel. The first of the dividers is purely resistive throughout and the portion of the oscillator voltage tapped off the divider is applied without shift of phase to the carrier frequency amplifier tube. The RF current passed through the plate load resistor  $R_L$  by this tube is therefore in phase with the oscillator voltage.

The second of the voltage dividers consists of an RC network in which the resistance of R very greatly exceeds the reactance of C at the oscillator frequency. The current in this branch therefore is practically in phase with the oscillator voltage applied to it but the small voltage across C lags the current by  $90^\circ$ . Hence it also lags the oscillator voltage by  $90^\circ$ . The voltage across C is used to excite one of the modulator tubes.

The third of the voltage dividers consists of an RL network in which the resistance of R very greatly exceeds the reactance of L. Again, the current in the network is practically in phase with the applied voltage from the oscillator but the voltage taken from L for excitation of the modulator tube leads the current and the oscillator voltage by practically  $90^\circ$ .

Thus the grids of the balanced modulator are excited by voltages which respectively lag and lead the oscillator voltages by  $90^\circ$ , and are therefore  $180^\circ$  out of phase with each other. In effect, the grids of the modulator tubes are excited in pushpull, while the plates are connected in parallel. If the tubes are balanced, the RF components of the plate currents are equal and opposite at every instant. Under a condition of balance, no RF current flows in the common lead of the two modulator tubes to the load resistor  $R_L$ , and the only RF voltage appearing across  $R_L$  is that created by the flow of the carrier frequency amplifier RF plate current.

On the other hand, if the modulator tubes are alternately unbalanced in one direction and then in the other by an audio voltage applied in pushpull to their screen grids, the flow of RF current is alternately favored in one tube and then in the other. The net RF current in the common lead from the plates of the modulator tubes to the load resistor  $R_L$  will no longer be zero. The net current will have a polarity dependent upon which of the modulator tubes has the predominant RF component of plate current, as determined by the polarity of the audio voltage. The net current will have an amplitude dependent upon the degree of unbalance existing between the tubes, as determined by the amplitude of the audio voltage. Thus the wave form of the net RF current of the two modulator tubes will be that of the double sideband illustrated in Fig. 40. In view of the  $90^\circ$  phase shift introduced in the excitation, the relation of the double sideband current in  $R_L$  to the carrier current in  $R_L$  will also be that shown in Fig. 40. If the peak amplitude of the

double sideband is one-fifth of the amplitude of the carrier, the voltage drop across resistor  $R_L$  will have the wave form of the frequency-modulated wave shown at the top of Fig. 40.

**Audio Frequency Correction** ★ In the preceding discussion, a single fixed modulating frequency has been assumed. During the transmission of speech and music, however, the modulating frequency is varied, and components at several frequencies are often present at the same time. What effect will a change in modulating frequency have upon the wave produced in the circuits of Figs. 43 and 44?

changing the amplitude, more cycles of the modulating voltage occur within any given time period, and the time interval between the successive instants of maximum lead and lag is reduced. This causes the time periods of the cycles of the FM wave to change by a greater amount from one cycle to the next so that the same maximum amount of lead or lag is produced in the shorter time interval.

Hence the modulator circuits of Figs. 43 and 44 have the characteristic of giving a frequency deviation that is proportional to 1) the amplitude of the modulating voltage applied to the screen grids of the modulator which determines the *maxi-*

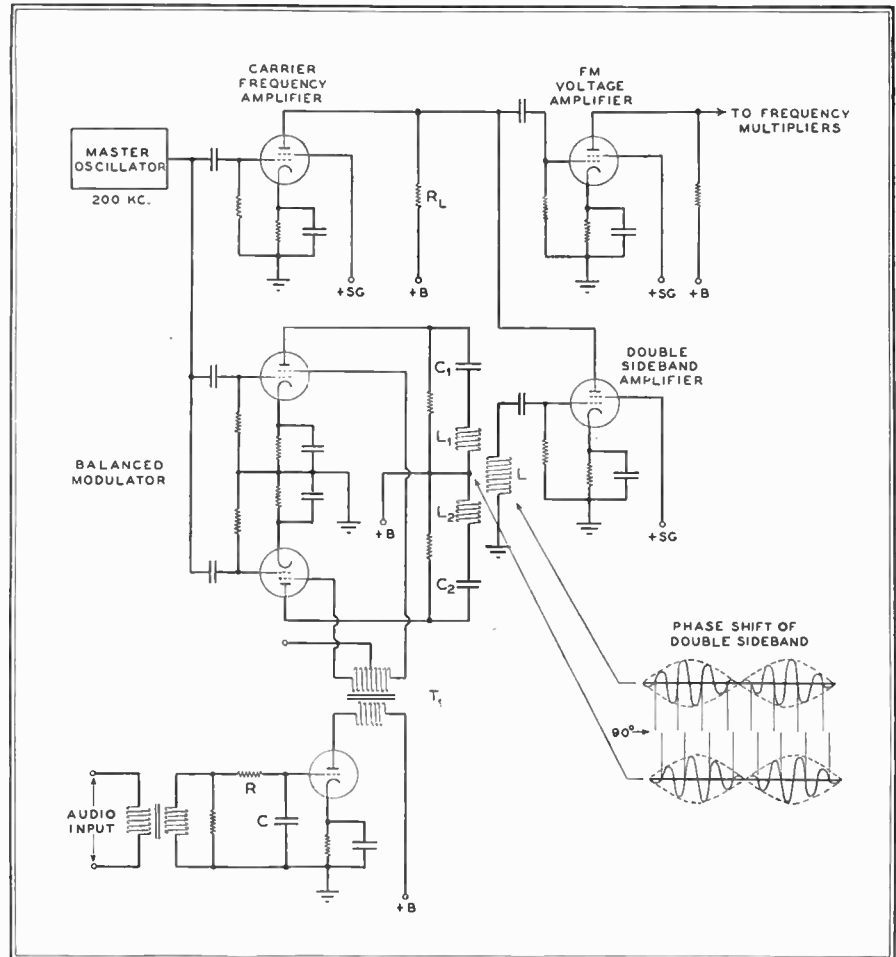

FIG. 43. CIRCUIT FOR PRODUCING SLIGHTLY MODULATED FM WAVES

It is noted in Fig. 40 that there are two instants of peak phase deviation for each cycle of the modulating frequency. In other words, during each cycle of the modulating frequency, the FM wave alternately acquires a maximum amount of lead and then a maximum amount of lag with respect to an unmodulated carrier of the same average frequency. The amount of the maximum lead or lag that is acquired depends upon the ratio of the peak amplitude of the double sideband to the amplitude of the carrier component, and does not depend on the modulating frequency.

When the frequency of the audio voltage at the modulator is increased without

maximum amount of lead and lag acquired, and 2) the frequency of the modulating voltage, which determines how many times per second the output wave alternately acquires the lead and lag.

In Section 4, however, it was stated that the FM wave must have a frequency deviation that is proportional to the amplitude of the modulating voltage but independent of its frequency.

To meet this specification for the transmitter output, it is necessary to counteract the characteristic of the modulator circuit whereby an audio modulating voltage of a given amplitude having a high frequency would cause a greater frequency deviation



than an audio modulating voltage of the same amplitude having a lower frequency.

The problem is handled quite easily by inserting an audio frequency correction network in the audio channel before the audio voltage is applied to the screen grids of the balanced modulator.

The circuit of a typical correction network is shown at the lower left of Fig. 43. In this case, a series RC network is connected across the loaded secondary of an audio transformer. The resistance of R is quite high compared to the reactance of C so that, for any given amplitude of the applied voltage, practically the same current flows in the RC network regardless of the frequency of the applied voltage. Since the reactance of C varies inversely as the frequency, the voltage taken from C for excitation of the correction amplifier tube is

FM waves that are modulated over a range of audio frequencies.

**Frequency Deviation Multiplication** ★ In order to obtain distortionless modulation from the phase-shift modulator, it has been stated that the maximum phase deviation of the FM voltage at the output should not exceed 0.2 radian. In other words, the modulation index of the FM voltage across  $R_L$  in Figs. 43 and 44 should not exceed 0.2.

A maximum modulation index of 0.2 for a transmitted FM wave would, of course, be quite insufficient to permit realization of the noise and interference reduction characteristics of the FM system. However, the modulation index of an FM signal can be increased, after generation and before transmission, by passing the signal through a series of frequency

and a maximum phase deviation of 5 radians.

However, the largest modulation index and phase deviation of the transmitted wave occur with full modulation at the lowest modulating frequency. For example, if the lowest audio frequency in the FM broadcast service is taken as 50 cycles, then with a deviation of 75 kc. at full modulation, the modulation index becomes  $75,000/50$  or 1,500, equivalent to a phase deviation of 1,500 radians.

Hence, in FM broadcast service, where the range of modulating frequencies is 50 to 15,000 cycles and the maximum frequency deviation is 75,000 cycles, the transmitter should incorporate sufficient multiplication to raise a maximum phase deviation of 0.2 radian at the output of the phase-shift modulator to 1,500 radians at the transmitter output. This calls for a multiplication of at least  $1500/.2$  or 7,500.

If doubler stages are used throughout the multiplication system, 13 stages are necessary, giving an overall multiplication of  $2^{13}$  or 8,192. A combination of 5 doubler and 5 tripler stages can be employed, giving an overall multiplication of  $2^5 \times 3^5$  or 7,776.

In the latter case, for a condition of full modulation at 50 cycles, the phase deviation at the output of the phase-shift modulator is  $1,500/7,776$  or .193 radian, corresponding to a modulation index of 0.193. At modulating frequencies higher than 50 cycles, the phase deviation at the transmitter output is less than 1,500 radians, making the phase deviation at the output of the phase-shift modulator less than 0.193 radian. Thus at all modulating frequencies in excess of 50 cycles, the phase-shift modulator is operated within the phase deviation limit of 0.2 radian, while at frequencies somewhat lower than 50 cycles, the maximum phase deviation of the modulator is not sufficiently in excess of 0.2 radian to cause serious distortion.

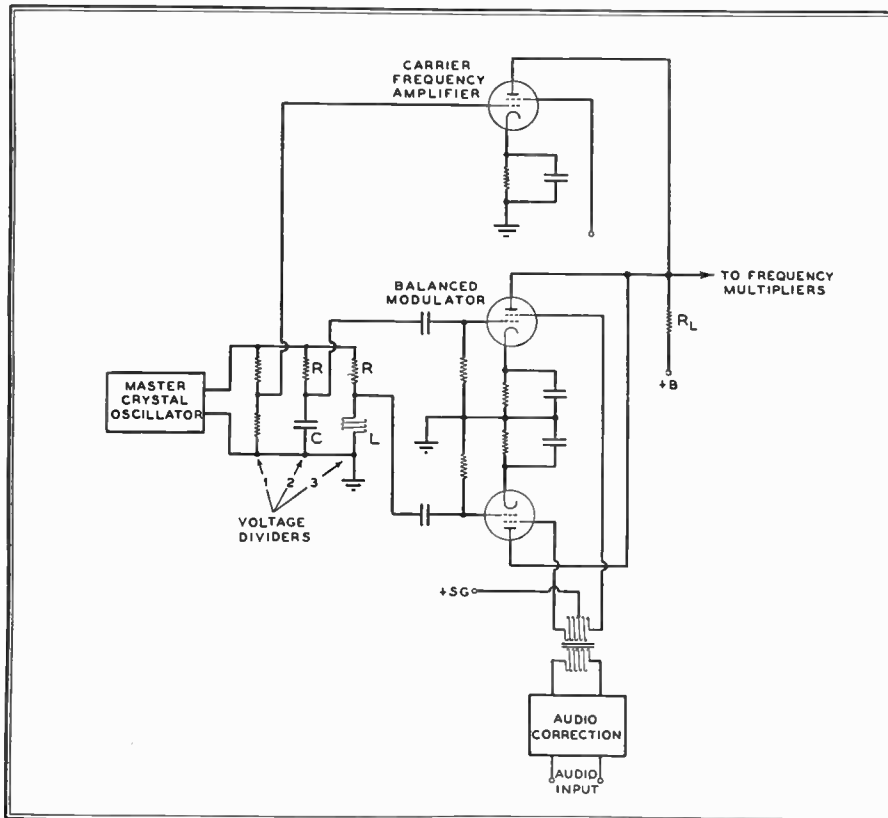

FIG. 44. AN ALTERNATE FORM OF THE ARMSTRONG MODULATOR

practically inversely proportional to the frequency.

By rendering the amplitude of the modulating voltage inversely proportional to its frequency before applying the voltage to the screen grids of the balanced modulator, the characteristic of the modulator, by which a greater frequency deviation is produced at higher modulating frequencies is *discounted in advance*.

Thus, the maximum frequency deviation of the output wave is made proportional to the amplitude of the audio modulating voltage before correction, but independent of the frequency of the modulating voltage. The audio frequency correction network is an essential element of the phase-shift modulator designed to produce

multipliers. Each multiplier stage increases the frequency deviation and the modulation index of the signal by the same factor as the center frequency is increased.

How much frequency multiplication will be required to obtain a frequency deviation at the transmitter output sufficient to realize the benefits of the FM system?

The accepted ratio of the maximum frequency deviation of the transmitter output wave to the highest modulating frequency is 5 to 1. For example, in FM broadcast service, the maximum frequency deviation is 75 kc. for a highest modulating frequency of 15 kc., equivalent to a modulation index of  $75/15$  or 5,

**Center Frequency Multiplication** ★ Where the highest modulating frequency is 15,000 cycles, as in FM broadcasting, the frequency of the crystal-controlled oscillator used to excite the modulator should be in the order of 190 to 200 kc. If a much lower oscillator frequency were employed, such as 50 kc., the sideband frequencies would differ from the carrier by such a large percentage that the modulator circuits would discriminate somewhat against one sideband or the other, thus causing distortion. In fact, sideband correction networks were required in some of the earlier modulators operating at frequencies considerably less than 200 kc., in order to overcome this effect.

If the oscillator frequency is taken at about 200 kc., and if straight frequency multiplication of at least 7,500 is employed to hold the phase deviation of the modulator within 0.2 radian, then the center frequency after multiplication will

be at least  $7,500 \times 0.2$  or 1,500 mc., or far beyond the band of frequencies assigned to FM broadcasting.

It is clear, then, that the center frequency can not be multiplied by as many times as the frequency deviation. Yet each multiplier stage increases the center frequency by the same factor as the frequency deviation.

The problem is easily solved by the use of a converter, or mixer stage, inserted in the chain of frequency multipliers, as shown in Fig. 42. The multiplied frequency at the point of insertion is applied to the mixer, along with a fixed frequency from a crystal-controlled oscillator, differing from the multiplied frequency by a known amount. The center frequency of the mixer output is the difference of the two frequencies at the input, producing a new center frequency of a much lower order. The frequency deviation at the mixer out-

If the master oscillator has a frequency of 200 kc., and if this frequency is multiplied 81 times before application to the mixer, then the multiplied frequency at the mixer input is 16,200 kc. To obtain a frequency at the mixer output of 440.6 kc., the frequency of the crystal-controlled oscillator should then be  $16,200 - 440.6$  or 15,759.4 kc.

While the frequency of the crystal-controlled oscillator used with the mixer is chosen with the thought of obtaining a particular output frequency from the transmitter, it must not be assumed that the frequency stability of the transmitter, Fig. 42, is determined by the second oscillator alone. As a matter of fact, the stability depends on the frequency stability of both oscillators.

The stability of the transmitter arrangement illustrated in Fig. 42 is less, theoretically, than if the frequency were

phase-shift network CRRC. At the applied frequency, about 200 kc., the reactances of CC very greatly exceed the resistances of RR, so that the current in CRRC leads the applied voltage from coil L by practically  $90^\circ$ .

The voltage drops across the resistors RR are therefore practically  $90^\circ$  out of phase with the voltage across the input coil L. The common cathode lead from the modulator tubes is connected to the common junction of RR, while the grids of the tubes are connected to the extremities of RR. Thus the grids are excited in opposite polarity by voltages across RR that have been shifted  $90^\circ$  along the time axis with respect to the voltage across the input coil L.

The modulator operates on the same principle as the modulator shown in Fig. 44, the carrier component being balanced out because the plates are connected in

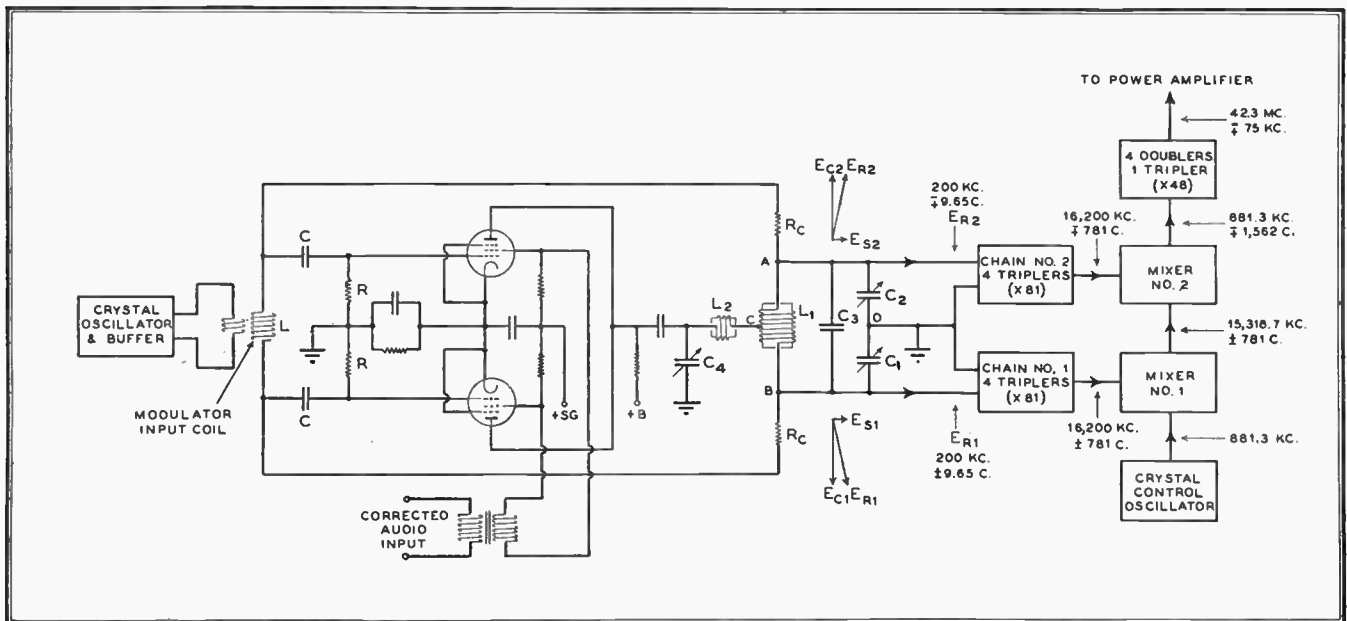

FIG. 45. CIRCUIT OF THE IMPROVED ARMSTRONG MODULATOR OF THE TYPE USED IN THE LATEST PHASE-SHIFT TYPE OF FM BROADCAST TRANSMITTER INSTALLATIONS

put, however, is just as great as that of the multiplied frequency fed to the mixer.

Thus, by the use of the mixer stage and crystal-controlled oscillator, it becomes possible to multiply the frequency deviation by more than 7,500 times, while multiplying the center frequency by a factor in the order of 200 or 250.

The frequency of the crystal-controlled oscillator is made such as to yield a beat frequency at the output of the mixer stage that can be multiplied to give the exact assigned carrier frequency.

For example, if the assigned frequency is 42.3 mc., and there is multiplication of 96 times between the output of the mixer and the input of the power amplifier, then the frequency at the output of the mixer is  $42,300/96$  or 440.6 kc. The frequency of the crystal-controlled oscillator must be 440.6 kc. less than the multiplied frequency applied at the mixer input.

determined by a single crystal-controlled oscillator. In practice, the output frequency drift with both oscillators under crystal control is a small fraction of that allowed under FCC regulations. Furthermore, a new Armstrong modulator circuit has been designed, in which the frequency stability is determined entirely by the crystal-controlled oscillator at the mixer.

**Improved Armstrong Phase-Shift Modulator** ★ The circuit of the improved Armstrong phase-shift modulator, employed in broadcast transmitters, is shown in Fig. 45.

The output of a crystal-controlled oscillator operating at a frequency in the order of 200 kc., is passed through a buffer amplifier whose tuned output circuit is inductively coupled to the input coil L of a balanced modulator.

The voltage appearing across the modulator input coil L is applied to the  $90^\circ$

parallel while the grids are excited in push-pull. The net RF current drawn by the modulator plates has an amplitude proportional to the amplitude of the audio modulating voltage and a polarity dependent on the polarity of the modulating voltage. The current drawn through the load by the modulating tubes has the wave form of the double sideband in Fig. 40. The phase relation of this current to the voltage across the input coil L is the same as that shown between the double sideband and the carrier component in Fig. 40.

The manner in which the double sideband current and the carrier current are combined in the improved modulator, Fig. 45, differs from that employed in the circuits of Figs. 43 and 44. It will be observed that no carrier frequency amplifier tube is employed in the new circuit. The center frequency voltage at the modulator

input coil is led through resistors  $R_C R_C$ , around the modulator, and is applied to the opposite terminals A, B of the tuned circuit  $L_1 C_1 C_2 C_3$ .

With respect to the center frequency voltage applied at points A, B, the tuned circuit  $L_1 C_1 C_2 C_3$  is at parallel resonance, so that the current drawn from the input coil  $L$  through  $R_C R_C$  is in phase with the input coil voltage. The center frequency voltage appearing across points A, B by virtue of the currents drawn through  $R_C R_C$  is therefore in phase with the voltage at the modulator input coil. By grounding the common junction of condensers  $C_1$  and  $C_2$ , equal center frequency voltages of opposite polarity are applied to the tripler grids, as shown by vectors  $E_{C1}$  and  $E_{C2}$  in the small vector diagrams.

The above condition occurs in the absence of modulation. Actually, of course, during most of the time the transmitter is on the air, audio voltage is applied to the modulator screen grids and a double sideband is created. The manner in which the double sideband is added to the carrier by way of network  $L_2 C_4$  will now be explained.

The coil  $L_1$ , Fig. 45, has two terminals and a center tap, and can be regarded as a 3-terminal network. This is illustrated in Fig. 46, at (A). Each half of coil  $L_1$  represents inductance in itself. This type of inductance is termed self-inductance, and is the amount of inductance offered by the turns in each half of the coil when the other half is disconnected. The self-inductances are denoted by  $L_A$  and  $L_B$  in diagram (B) of Fig. 46.

When both sections of the coil are connected in series, the field set up about each section sweeps across the turns of the other section. This effect is called mutual induction, and causes the inductance of the entire coil to be increased. The inductance of the coil becomes the sum of the self-inductances of its sections, increased by twice the amount of mutual inductance  $M$ . Thus, in diagram (B) of Fig. 46, the inductance offered by the coil between terminals A, B is  $L_A + L_B + 2M$ .

This leads to the three-terminal network of diagram (C), Fig. 46, which is the equivalent of the coil in diagrams (A) and (B). The equivalence can be easily checked by adding the inductances between each pair of terminals.

Between terminals A, C, the inductance is  $L_A + M - M$  or simply  $L_A$ , the self-inductance of the turns in the upper section. Between terminals C, B, the inductance is  $-M + L_B + M$  or simply  $L_B$ , the self-inductance of the turns in the lower section. Finally, between terminals A, B, the inductance is  $L_A + M + L_B + M$ , or  $L_A + L_B + 2M$ , that is, the sum of the self-inductances increased by twice the mutual inductance, or again the value to be expected.

Coil  $L_1$  of Fig. 45 can be replaced by the mathematically equivalent network of diagram (C) Fig. 46. This substitution

has been made in Fig. 47, in which the circuits to which the output of the balanced modulator is delivered have been redrawn. In Fig. 47, the generator represents the double sideband voltage developed by the modulator. The capacity across  $L_1$  of Fig. 45 has been assumed in Fig. 47 to reside entirely in two series variable condensers  $C_A$  and  $C_B$ , rather than in the form of a fixed capacity  $C_3$  and two variables,  $C_1$  and  $C_2$ , as in Fig. 45. This change has been made to simplify the explanation of circuit operation, since the fixed condenser  $C_3$  of Fig. 45 is employed solely to avoid the use of excessively large variable condensers.

The tuned circuit  $L_1 C_1 C_2 C_3$ , Fig. 45, is resonant to the center frequency voltage applied at terminals A, B. Thus, in Fig. 47, the total capacitive reactance of  $C_A$  and  $C_B$  in series is equal to the total inductive reactance of  $L_A + M$  in series with  $L_B + M$ . Because of the circuit

and  $C_B$  are equal to each other, and both of the voltages lag the branch currents by another  $90^\circ$ . Thus the double sideband voltages appearing across  $C_A$  and  $C_B$  are equal in magnitude, of the same polarity with respect to ground, with the phase of both voltages differing by  $90 + 90$  or  $180^\circ$  with respect to the sideband voltage at the balanced modulator output.

Since a  $90^\circ$  phase shift was introduced in the excitation of the balanced modulator which carried over into the modulator output, the subsequent shift of  $180$  degrees leaves the double sideband voltages appearing across  $C_A$  and  $C_B$  in phase quadrature with respect to the center frequency voltage appearing across the modulator input coil.

The center frequency voltage is applied in diminished amplitude at points A, B, causing center frequency voltages to appear across  $C_A$  and  $C_B$  in opposite polarity with respect to ground. The double side-

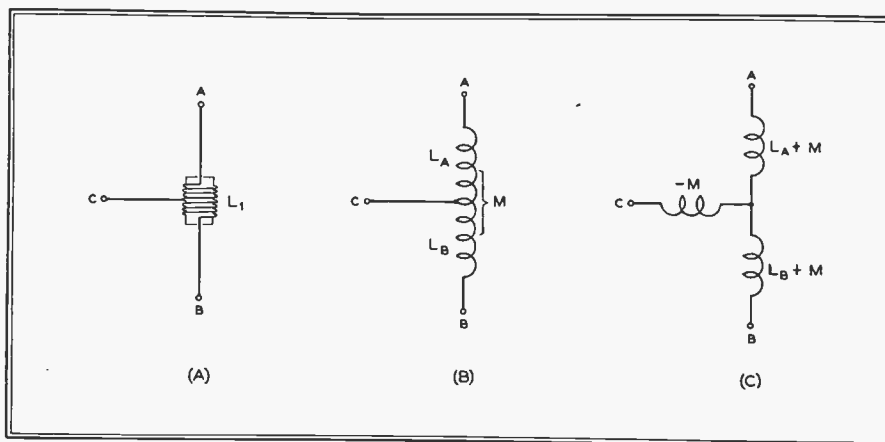

FIG. 46. COIL  $L_1$  OF FIG. 45, AND ITS EQUIVALENT NETWORKS

symmetry, the inductive reactance of  $L_A + M$  equals the capacitive reactance of  $C_A$ , and the inductive reactance of  $L_B + M$  equals the capacitive reactance of  $C_B$ . Therefore, between point E in Fig. 47 and ground, the parallel branches  $C_A$ ,  $L_A + M$  and  $C_B$ ,  $L_B + M$  are series resonant at the center frequency. The only opposition to current flow at the center frequency between point E and ground is the low resistance of the coil sections.

The inductance of coil  $L_2$  is sufficiently in excess of the negative inductance  $-M$  between points C and E to cancel  $-M$  and to leave a positive remainder of inductance that can be tuned to parallel resonance at the center frequency by means of condenser  $C_4$ . In this way, the balanced modulator delivers its output to a resistive load.

The current in the inductive branch, comprised of  $L_2$ ,  $-M$ , and the low resistances between point E and ground, lags the voltage applied from the double sideband generator by practically  $90^\circ$ . At point E, the current divides equally between the series resonant paths to ground. The voltages across the condensers  $C_A$

and  $C_B$  are in the same polarity with respect to ground. It follows that the phase difference between the carrier and double sideband voltages across one condenser will be in the form of a  $90^\circ$  lead at the same time as the phase difference across the other condenser is in the form of  $90^\circ$  lag.

This is illustrated by the small vector diagrams in Fig. 45. The sideband voltages  $E_{S1}$  and  $E_{S2}$ , created across condensers  $C_1$  and  $C_2$ , are in phase and equal. The center frequency voltages  $E_{C1}$  and  $E_{C2}$ , across the same condensers, are equal but of opposite polarity, each differing in phase from the sideband voltage by  $90^\circ$ .

The resultant frequency-modulated voltage  $E_{R1}$  appearing across  $C_1$  leads the center frequency component  $E_{C1}$  at the same time as the resultant voltage  $E_{R2}$  across  $C_2$  lags the carrier component  $E_{C2}$ . The resultants are therefore frequency-modulated voltages that are alike except for the fact that the frequency of one voltage is increasing at the same time as the frequency of the other voltage is decreasing.

Readers unfamiliar with vector diagrams will understand the situation by



considering what would happen if the center frequency component in Fig. 40 were reversed before being combined with the double sideband. The summation would give a frequency-modulated wave having its maximum lag at the instant when a maximum lead is shown in Fig. 40, and its maximum lead at the instant when the maximum lag is shown.

Thus the frequency-modulated voltage  $E_{R1}$  across  $C_1$  is increasing in frequency while the frequency-modulated voltage  $E_{R2}$  across  $C_2$  is decreasing in frequency. If the frequency deviation of the voltage is, say, 9.65 cycles, then the frequency-modulated voltage across  $C_1$  can be described as having the frequency  $200 \text{ kc.} \pm 9.65$  cycles, while that across  $C_2$  can be described as  $200 \text{ kc.} \mp 9.65$  cycles.

**Frequency Multiplication System** ★ Each of these two output voltages of the modulator, Fig. 45, is passed through its own chain of four triplers, giving a multiplication of both the center frequency and the frequency deviation by a factor of  $3^4$  or 81.

If the frequency at the input of tripler chain No. 1 is  $200 \text{ kc.} \pm 9.65$  cycles, then the output of the chain will have a frequency of  $16,200 \pm 781$  cycles. Because of the opposite frequency deviation of its

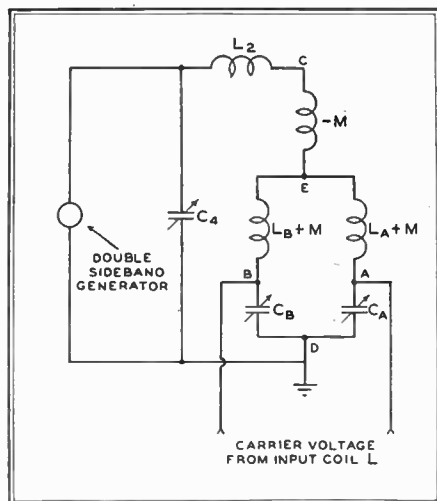

FIG. 47. OUTPUT OF BALANCED MODULATOR REDRAWN FROM FIG. 45

input, tripler chain No. 2 will deliver an output of  $16,200 \text{ kc.} \mp 781$  cycles.

The output of each tripler chain is applied to a mixer stage. Tripler chain No. 1 delivers a frequency of  $16,200 \pm 781$  cycles to mixer No. 1. This mixer also receives a voltage from the crystal-controlled control oscillator, which has a frequency equal to the assigned carrier frequency of the transmitter divided by the overall frequency multiplication that follows the mixer stages. In the transmitter shown in Fig. 45, four doublers and a tripler follow the mixers, giving an overall frequency multiplication of  $2^4 \times 3$  or 48. If the carrier frequency assigned to the transmitter is, say,  $42.3 \text{ mc.}$ , then the

frequency of the control oscillator is  $42,300/48$  or  $881.3 \text{ kc.}$

With the control oscillator frequency of  $881.3 \text{ kc.}$  applied to mixer No. 1 together with the output of tripler chain No. 1 at  $16,200 \text{ kc.} \pm 781$  cycles, the difference frequency appearing in the output of mixer No. 1 is  $15,318.7 \text{ kc.} \pm 781$  cycles. This frequency is applied to mixer No. 2 along with the output of the tripler chain No. 2 at  $16,200 \text{ kc.} \mp 781$  cycles. The difference of the center frequencies is  $16,200 - 15,318.7$  or  $881.3 \text{ kc.}$  The difference of the frequency deviations, which at any time are of opposite sign, is twice the deviation of each frequency, or  $2 \times 781 = 1,562$  cycles.

The frequency at the output of mixer No. 2 may therefore be described as  $881.3 \text{ kc.} \mp 1,562$  cycles. After passing through four doublers and a tripler, in which multiplication of 48 is obtained, the frequency becomes  $42.3 \text{ mc.} \mp 75 \text{ kc.}$ , which is suitable for excitation of the power amplifier of the FM broadcast transmitter.

**Advantages of the Improved Modulator** ★ The most notable differences between the improved modulator and the earlier types arise from the use of two chains of triplers excited by the voltages from the phase-shift modulator.

When the outputs of the chains of triplers are combined with the output of a crystal-control oscillator in the two mixers, as described above, the center frequency of the output of mixer No. 2 is the same as that of the control oscillator, regardless of any small variations in the frequency of the oscillator used to excite the modulator.

Suppose, for example, that the frequency of the oscillator which excites the modulator drifts from  $200$  to  $201 \text{ kc.}$ , that is, to a frequency  $1 \text{ kc.}$  too high. The center frequencies of the voltages at the inputs of the tripler chains will also be  $1 \text{ kc.}$  high, while at the output of the triplers, the voltages will be  $81 \text{ kc.}$  high. The output of mixer No. 1 will have a center frequency that is  $81 \text{ kc.}$  high, but the frequency at the output of mixer No. 2 will not contain the  $81 \text{ kc.}$  error, because it is the difference between two frequencies, each of which is  $81 \text{ kc.}$  high.

The frequency stability of the output frequency of the transmitter is therefore dependent on the stability of the control oscillator alone, and is independent of the first oscillator, used to excite the modulator. It is not imperative that the first oscillator be crystal controlled, although a crystal is usually employed as a matter of convenience, since it insures that the tripler chains will not be detuned by a large drift in the oscillator frequency.

Just as the effects of drift, or *slow* variation in the frequency of the oscillator used to excite the modulator, is balanced out, so also *rapid* variations are balanced out. Thus the improved modulator tends to overcome any slight noise or hum modulation that occurs in the first oscillator. Al-

though earlier types of Armstrong modulators were remarkably free from hum and noise as early FM listeners will remember, the noise level in the new Armstrong modulator is still lower, being in the order of  $-70 \text{ db.}$

The incorporation of sufficient multiplication to give frequency deviation equivalent to full modulation, while requiring a phase deviation of not more than  $0.2$  radian at the output of the phase-shift modulator at the lowest audio frequency, obviates the possibility of distortion in the modulator.

For a modulation index of  $0.2$ , the distortion inherent in the modulator is about  $1\%$ . This distortion occurs only with full modulation at the lowest audio frequency. At higher audio frequencies, and/or with less than full modulation, the modulation index is less than  $0.2$  and the inherent distortion disappears.

**Pre-emphasis Network** ★ It has been stated that the frequency deviation of the modulated wave should be proportional to the amplitude of the modulating voltage but

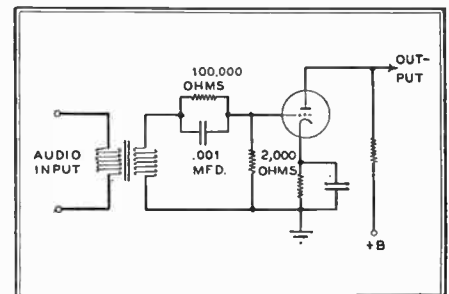

FIG. 48. NETWORK FOR INTRODUCING PRE-EMPHASIS

independent of its frequency. This is the basis upon which all FM transmitters are originally designed and upon which they are adjusted in service.

In the FM broadcast service, as explained in Section 2, it is desirable in the interest of noise reduction at the high frequencies to employ pre-emphasis networks so that the frequency deviation is increased when the modulating frequency is increased, assuming that receivers incorporate de-emphasis networks to bring the high frequency components of the detected signal back into proper amplitude relation with respect to the low frequency components.

Fig. 48 shows a circuit which will permit the correct amount of pre-emphasis to be introduced. A  $.001\text{-mfd.}$  condenser in parallel with a  $100,000\text{-ohm}$  resistance is inserted in series with the lead to the grid of the audio amplifier tube, and a  $2,000\text{-ohm}$  resistor is connected between grid and cathode. As the frequency is increased, a larger current flows through the condenser, producing a higher voltage across the  $2,000\text{-ohm}$  resistor, so that the amplitude of the audio modulating voltage at the transmitter is increased.

# Theory of Frequency Modulation

## Section 6: Introduction to FM Receivers and Discussion of FM Signal Amplifiers and Limiters

IN THE preceding Sections, it has been emphasized that the *amplitude* of an FM signal remains constant during modulation, while the *frequency* is alternately increased and decreased in accordance with the variation of the audio modulating voltage at the transmitter.

It follows that the first requirement to be met in the design of FM receivers is that the detector be capable of giving a change in its output voltage proportional

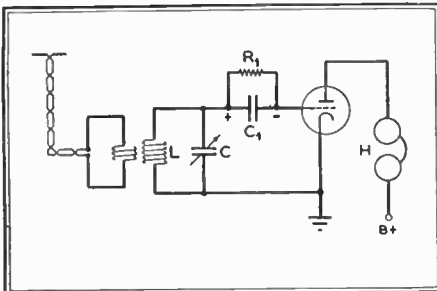

FIG. 49. ELEMENTARY TYPE OF FM RECEIVING CIRCUIT

to a change in the *frequency* of the input signal. When an FM signal is applied to a detector that meets this specification, the detector yields an audio output voltage having the same wave form and frequency as the audio modulating voltage at the transmitter.

**Elementary FM Receiver** ★ An FM receiver, in its simplest form, could consist of such a detector alone, as shown in Fig. 49. Here the input signal causes a voltage to be induced in coil L that sets up a radio frequency current in the tuned circuit LC. The current flowing in the tuning condenser C establishes an RF voltage across this condenser that is applied to the grid-leak and grid-condenser combination  $R_1C_1$  by way of the grid and cathode of the tube. The grid and cathode operate as a diode rectifier and cause a DC voltage to be established in grid condenser  $C_1$  very nearly equal to the amplitude of the RF voltage across tuning condenser C. The DC voltage established in grid condenser  $C_1$  acts as a negative bias on the grid of the tube and limits the flow of plate current.

If the amplitude of the RF voltage across tuning condenser C is increased, the negative bias developed across  $C_1$  is increased and the plate current of the tube is reduced. Conversely, if the RF voltage across C is decreased, the bias across  $C_1$  is decreased, and the plate current is increased. Now, if the amplitude of the RF voltage across C increases and decreases at an audio rate, then the bias established in  $C_1$  will vary in like manner. The resulting audio variation of the plate

current will cause the diaphragms of the headphones H to vibrate.

In fact, old timers will recognize the FM detector circuit of Fig. 49 as being exactly like that of a non-regenerative grid-leak detector for receiving AM signals. In the case of AM reception, the circuit LC is tuned exactly to the carrier frequency of the AM signal. This insures the maximum RF current flow in the tuned circuit LC and the maximum RF voltage across tuning condenser C. During modulation, the amplitude of the voltage across tuning condenser C is varied because the amplitude of the voltage induced in coil L by the AM signal is varied. The detector translates the amplitude variations of the voltage across C into variations of plate current, as explained.

For the reception of FM signals, however, the circuit LC is not tuned to exact resonance with the carrier or center frequency of the FM signal. In fact, the circuit LC is detuned until the amplitude of the voltage across C, produced by an unmodulated signal, falls off to about one-half that at resonance. A typical adjustment for the reception of FM signals is

frequency somewhat lower than the center frequency of the signal.

The waveform of the incoming FM signal is shown at the lower center in Fig. 50. Since the detector is responsive to a change in *frequency* of the signal, the frequency of the signal is plotted to the same scale of time, at the lower left in Fig. 50. The curve of the signal frequency variation is then projected upward against the selectivity curve of the tuned circuit, the area of impingement being centered about point A on the curve in Fig. 50.

It is noted that in the immediate vicinity of point A, the selectivity curve in Fig. 50 is steep and nearly straight. This means that when an FM signal is inducing voltage of constant amplitude but varying frequency in coil L, Fig. 49, the *amplitude* of the voltage built up across tuning condenser C will vary over a wide range, and the change in the amplitude of the voltage across C will be practically proportional to the change in the frequency of the voltage induced in L.

Thus a tuned circuit adjusted to a frequency somewhat higher or lower than the center frequency of an FM signal

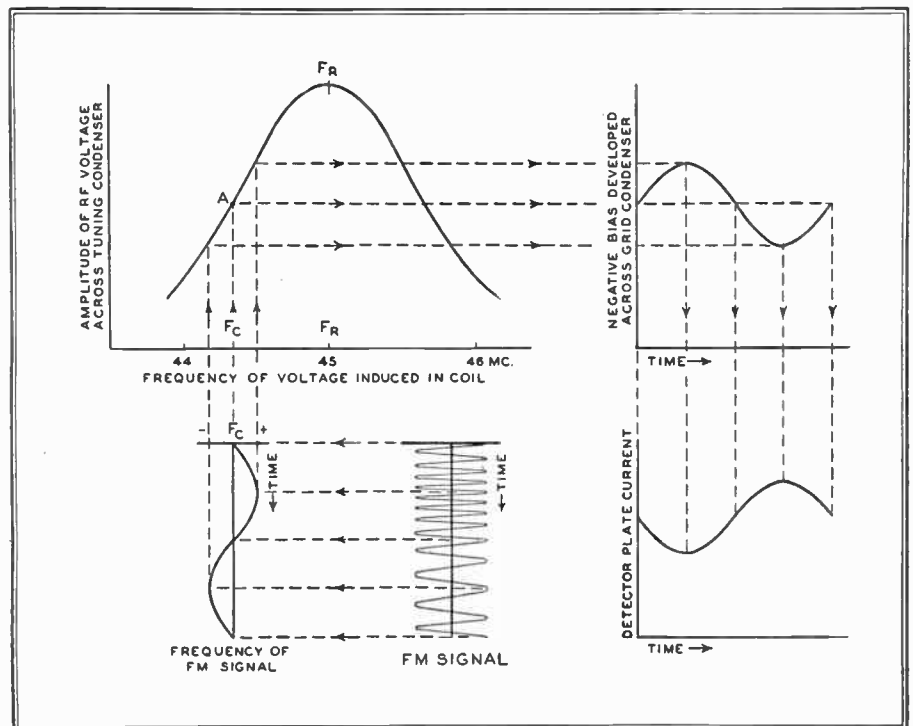

FIG. 50. TUNED-CIRCUIT DETECTION FROM ELEMENTARY RECEIVER, FIG. 49

indicated at point A on the selectivity curve of the tuned circuit, at the upper left in Fig. 50. In this case, the resonant frequency  $F_R$  of the tuned circuit is higher than the center frequency  $F_C$  of the signal. It would also be possible to obtain FM detection by tuning LC to a

has the property of translating the frequency variations of the signal voltage induced in the coil into amplitude variations of voltage across the tuning condenser. As the frequency of the signal swings toward the resonant frequency of the tuned circuit, the voltage across

the tuning condenser increases. As the frequency of the signal swings away from the resonant frequency of the tuned circuit, the voltage across the tuning condenser decreases. By careful adjustments, the amplitude variations of the voltage across the tuning condenser can be made nearly proportional to the variations of the signal frequency. The grid-leak detector converts the changes in amplitude of the voltage across the tuning condenser to corresponding changes in grid-condenser bias, as shown at the upper right in Fig. 50. The changes in grid-condenser bias, in turn, cause proportionate changes in plate current, as shown at the lower right in Fig. 50. Thus a voltage is built up across the load in the plate circuit having nearly the same wave form as the audio modulating voltage at the FM transmitter.

While an FM receiver can thus be constructed with a minimum of parts, it can hardly be claimed that such a single-tube detector would give satisfactory reception. The operation of this simple receiver has been described in order to illustrate the principle of an FM detector in terms familiar to all. It also explains why AM communications receivers, covering frequencies above 40 mc., can, with careful tuning, achieve poor but intelligible reception of FM signals. Finally, a consideration of the shortcomings of the simple circuit described will point out the characteristics required of a genuine FM receiver, capable of delivering the type of performance that distinguishes FM from AM.

**FM Receiver Design Considerations** ★ In the first place, the receiver of Fig. 49 would be very insensitive. The FCC considers the service area of usable signal of an FM station to extend to the 50-microvolt contour. Therefore, the receiver should incorporate sufficient RF gain to give satisfactory operation at input voltages in the order of 5 to 40 microvolts. This calls for high RF amplification before the detector, a requirement that can be met most satisfactorily by the use of the superheterodyne circuit, indicated in Fig. 51. The reduction of adjacent-channel interference (interference from FM stations operating on channels adjacent to the channel of the desired station) is made more effective by the use of the superheterodyne circuit.

Secondly, while the detector shown in Fig. 49, can be made to give an output nearly proportional to the change in frequency of the applied FM signal, it would still be responsive to changes in amplitude of the detector input voltage. Thus noise and other interference would not be eliminated nor reduced in the circuit of Fig. 49. In the superheterodyne, changes in amplitude due to interference and noise pass through the IF amplifier. In order to prevent these amplitude variations from being impressed on the

second detector, it is necessary to employ an effective amplitude limiter, as indicated in Fig. 51. The use of the limiter is required to reduce noise and interference, regardless of the type of detector employed. Sufficient gain must be provided in the receiver to insure that the weakest signal it is desired to receive without interference noises is amplified to a level sufficient to cause amplitude limiting action in the limiter.

A third deficiency of the detector shown in Fig. 49 is that in order to obtain reasonably linear conversion of input signal frequency variations into output voltage amplitude variations, the tuned circuit LC must be very carefully adjusted to the frequency at the mid-point of the straight portion of the selectivity curve, indicated by point A in Fig. 50. Even so, if the swing of the transmitter frequency is too great, operation in the curved portions of the curve will result, causing distortion of the detector output waveform. Also,

up discriminators, de-emphasis networks, audio systems and special FM circuit arrangements.

**Superheterodyne FM Receiver** ★ It will be observed in Fig. 51 that the arrangement of the superheterodyne FM receiver, from the antenna to the input of the limiter, resembles that of a conventional AM receiver. However, even in this area, there are certain important differences between FM and AM circuits.

For example, an automatic volume control acting upon all the RF and IF amplifier stages, as commonly employed in AM receivers, is neither necessary nor desirable in FM circuits. It is unnecessary because the FM limiter maintains the amplitude of the signals applied to the discriminator at a fixed level. It is undesirable because, in general, any system which reduces the RF gain preceding the limiter tends to lower the signal-to-noise ratio at the limiter. However, a few receivers

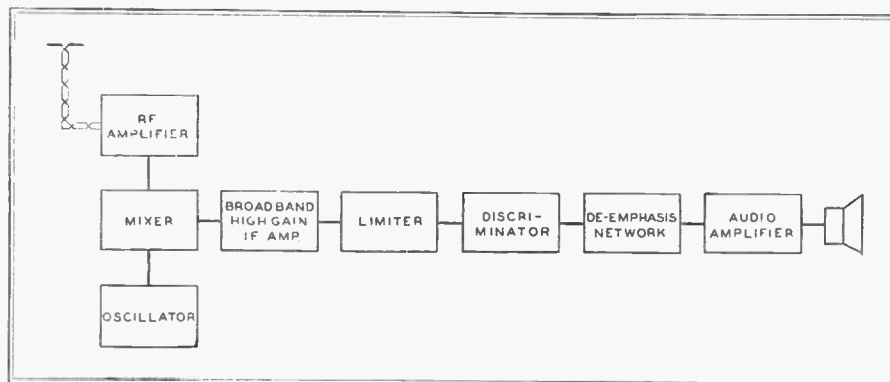

FIG. 51. BLOCK DIAGRAM SHOWING ELEMENTS OF A GENUINE FM RECEIVER

since the detector plate current decreases as the voltage across the tuning condenser increases, excessive input voltage may drive the plate current beyond cutoff, with resulting harmonic distortion. Genuine FM receivers have special FM detector circuits called *discriminators*, designed to handle large input voltage and to give essentially linear response over a wide frequency range.

It will also be noted that the circuit in Fig. 49 contains no de-emphasis to compensate for the pre-emphasis characteristic introduced at FM transmitters. Thus a de-emphasis network is inserted immediately after the discriminator, as indicated in Fig. 51.

Finally, if the full advantages inherent in FM broadcasting are to be realized, it is especially important to employ an audio amplifier having a wide frequency range and minimum harmonic and cross-modulation distortion. The noise and hum level of the audio amplifier should be very low. A high quality speaker system is also necessary, to obtain realistic reproduction.

In this Section, it is proposed to discuss only the circuits of the conventional superheterodyne that amplify and limit FM signals. The following Section will take

have been designed in which a limited amount of automatic or manually adjustable volume control is incorporated in order to prevent the signal amplifier grids from being driven positive on very strong signals.

Another difference between FM and AM superheterodyne receivers lies in the comparative band width of the IF amplifier system. In AM, at any one modulating frequency, there is but one pair of sideband components, having frequencies respectively higher and lower than the carrier by the amount of the modulating frequency. If the highest modulating frequency is 10 kc., a band width of 20 kc., centered at the intermediate frequency, will be adequate. On the other hand, in the case of FM signals, a large number of pairs of sideband components of appreciable amplitude may be present along with the center frequency component. As was noted in Section 1, the maximum band width is required when the FM signal is fully modulated at the highest modulating frequency. For example, in FM broadcasting, if the frequency is varying over the full range of plus or minus 75 kc., at 15 kc. per second, it was shown that eight important pairs of sidebands are present,



requiring a theoretical band width of  $16 \times 15$  or 240 kc., centered at the intermediate frequency. Actually, the band width is not made as wide as theoretically required, because 1) sideband components at frequencies near the limits of the theoretical band are of rather small amplitude and appear only when the transmitter is strongly modulated at the higher audio frequencies, 2) a worthwhile increase in RF gain per amplifier stage is obtained as the band width is decreased, and 3) with a somewhat narrower band, adjacent-channel interference is reduced.

form amplification of all sideband components on the other. As will be explained later, this comparatively narrow IF band width can cause appreciable distortion when the incoming FM signal is strongly modulated at high audio frequencies. Thus well-designed post-war receivers have IF band widths somewhat greater than those of pre-war receivers, in order to realize the full advantages of FM.

In general, FM receivers should have a higher overall RF gain than AM receivers. This is necessary in order that the weakest signal from which satisfactory reception

should amount to at least  $4/0.00001$  or 400,000. Such a gain at the high order of RF and IF frequencies involved, together with greater band width in the IF stages, makes the design of the signal amplification section of the FM superheterodyne considerably more difficult than that of AM receivers.

**The RF Amplifier** ★ All FM receivers should incorporate a radio frequency amplifier preceding the mixer or converter stage. The advantages gained more than justify the extra expense involved.

In the first place, the RF amplifier supplies additional RF gain. With a well-designed coil, the voltage step-up in the coil at resonance is in the order of 3 to 5. By careful circuit design and choice of the RF tube, the tube gain may be in the order of 6 to 10, thus giving an overall gain in the RF amplifier of about 20 to 50. While a really large gain is not obtainable in the RF amplifier at frequencies in excess of 40 mc., the gain of the RF amplifier does serve to reduce materially the amount of gain required of the mixer and IF amplifier stages.

The introduction of gain before the mixer stage is especially desirable because it serves to improve the signal-to-noise ratio of the receiver. Most of the noise due to tube hiss is introduced by the mixer. Thus if the amplitude of the signal can be raised before reaching the mixer grid, the usable sensitivity of the receiver can be improved.

As in the AM superheterodyne, the tuned input circuit of the RF amplifier also serves to reject signals on the image frequency which might otherwise cause serious interference. The image frequency is that frequency which differs from the signal frequency by twice the intermediate frequency and which lies on the same side of the signal frequency as the oscillator frequency.

For example, suppose that the intermediate frequency of the receiver is 4 mc., and that the desired signal has a frequency of 48 mc. If the receiver is one in which the oscillator frequency is higher than the signal frequency, the oscillator frequency would be  $48 + 4$  or 52 mc., and the image frequency would be  $48 + 8$  or 56 mc. If the receiver is one in which the oscillator operates at a frequency lower than the intermediate frequency, the oscillator frequency would be  $48 - 4$  or 44 mc., and the image frequency would be  $48 - 8$  or 40 mc. If the image frequency reaches the grid of the mixer tube, the mixer responds as readily to image frequency interference as to the desired frequency.

In receivers which do not have RF amplification before the mixer stage, signals at the image frequency are attenuated only in the one input tuned circuit of the mixer. If they are of sufficient strength at the mixer grid, they create a component at the intermediate frequency in the mixer output which interferes seri-

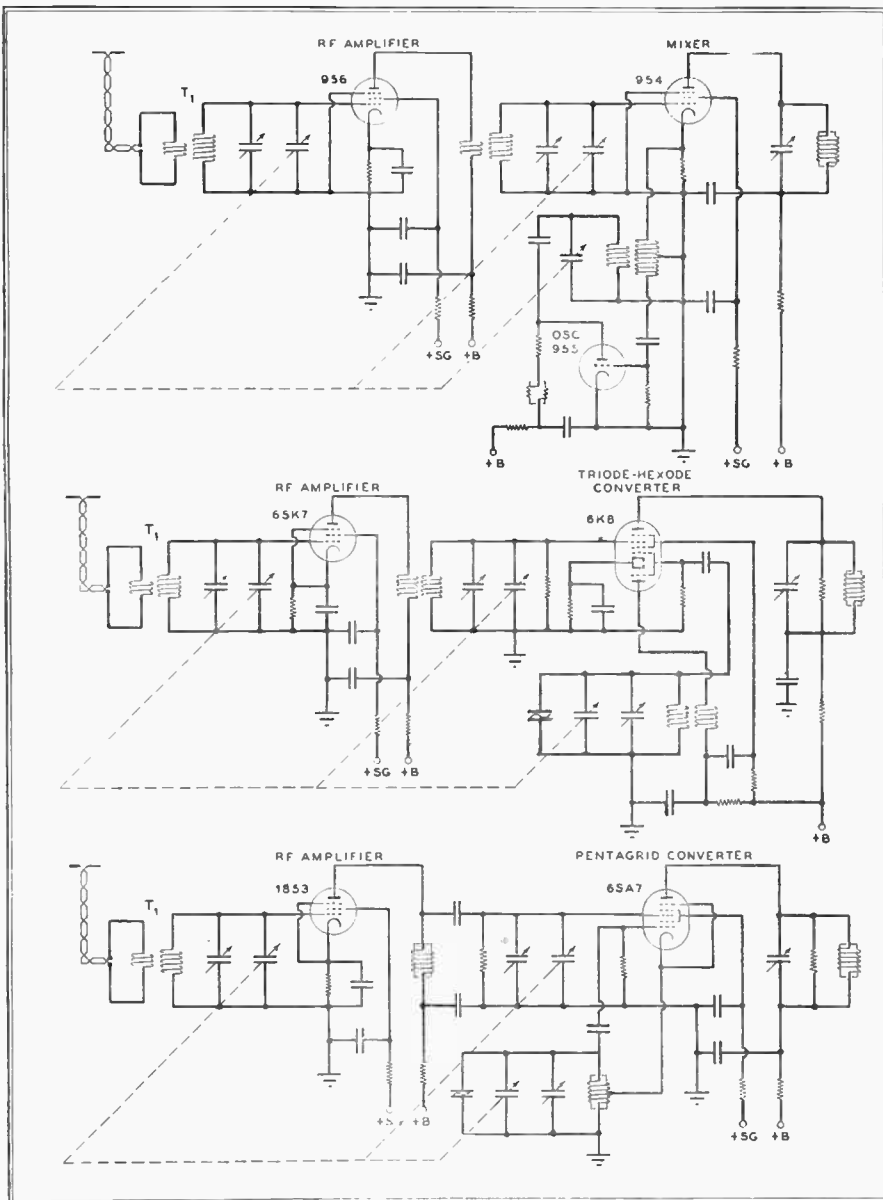

FIG. 52. THREE DIFFERENT TYPES OF MIXER CIRCUITS FOR FM RECEIVERS

The selectivity curves of IF amplifiers commonly employed in prewar FM broadcast receivers are down about 6 db at 75 kc. above and below the intermediate frequency. This represents a compromise between the opposing aims of obtaining maximum gain per stage and excellent suppression of adjacent-channel interference on the one hand, and of having uni-

is desired will be amplified sufficiently to permit amplitude-limiting at the limiter. For example, if the receiver is to operate satisfactorily on a signal voltage of, say, 10 microvolts (.00001 volt) at the antenna terminals, and if 4 volts are necessary at the limiter to obtain amplitude-limiting action, then the overall RF gain in the RF amplifier, mixer, and IF amplifier

ously with, or even over-rides, the component created by the desired signal.

On the other hand, if a tuned radio frequency amplifier precedes the mixer, signals at the desired frequency and the image frequency are passed through two independent tuned circuits and the rejection of the image frequency is more pronounced. For example, if one tuned circuit, resonant at the desired signal frequency, is capable of reducing the strength of signals at the image frequency by a ratio of 50 to 1, then two independent tuned circuits of the same characteristics will reduce the image frequency signal by the ratio of 2,500 to 1.

Similarly, the use of a tuned RF amplifier stage gives valuable additional protection against interference from strong signals at the intermediate frequency, which might otherwise reach the mixer grid in sufficient strength to cause serious interference at the mixer output.

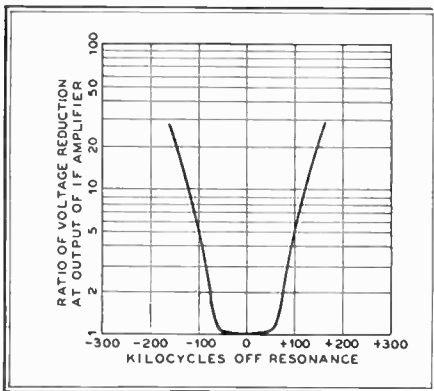

FIG. 53. TYPICAL CHARACTERISTIC OF IF CIRCUIT IN FM RECEIVER

Typical RF amplifier circuits are shown at the left of the circuit diagrams of Fig. 52. The input transformer  $T_1$  in each case is designed to permit the use of a dipole antenna for picking up signals. The low impedance input winding matches the low impedance line from the dipole, so that efficient transfer of signal energy to the tuned input circuit will be obtained.

A low-loss coil is employed in the tuned circuit and in view of the high frequencies involved, it is especially important to use short leads between the coil, condenser and tube. The tuned input circuit should be carefully shielded from the remainder of the receiver. A direct lead should be employed between the low-potential terminals of the coil and condenser, instead of grounding both terminals to the chassis to complete the circuit. It is best to make all grounds in the RF amplifier stage at a common point on the chassis. This minimizes stray inter-stage coupling, and helps to avoid regeneration or degeneration in the RF amplifier stage. Degeneration would result in loss of gain, while regeneration may lead to oscillation in the amplifier.

The tube employed in the RF amplifier should be one which will give high gain

at high frequencies. RF pentodes are usually employed for their high mutual conductance and low grid-to-plate capacity. The tube chosen should be one which has low input capacity and high RF resistance between the grid and cathode. Acorn and button type pentodes are especially suitable because of their high gain, low input capacity and short leads to the tube electrodes, but the less expensive conventional types of pentodes have often been used.

mechanically one grid is the extension of the other to the opposite side of the flat cathode, as previously explained. The FM signal voltage is applied to grid No. 3 of the hexode, which is shielded from the plate and from grid No. 1 by grids Nos. 2 and 4, both of which are held at ground RF potential by means of a bypass condenser. Thus both the oscillator and the signal voltages modulate the electron stream, while there is a minimum of electrostatic coupling between the oscillator,

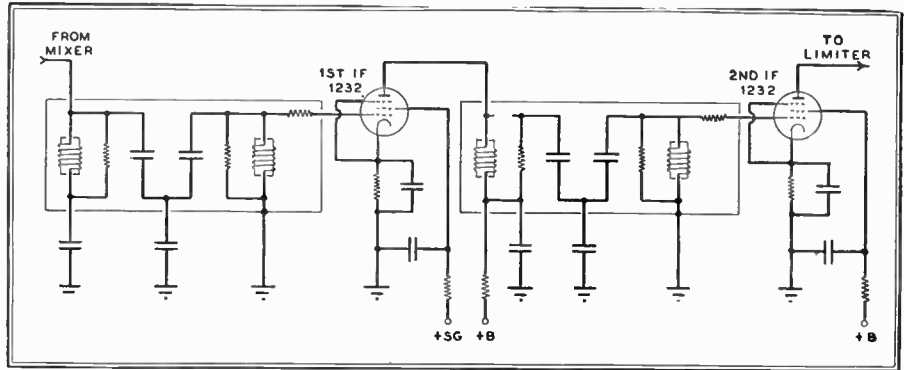

FIG. 54. CIRCUIT FOR TYPICAL TWO-STAGE IF AMPLIFIER FOR FM SET

**The Oscillator and Mixer** ★ In accordance with the superheterodyne principle, signal voltage from the RF amplifier and constant-amplitude RF voltage from a local oscillator are applied to separate control elements of the mixer tube. The component of plate current at the difference frequency is utilized to excite the high gain IF amplifier which follows the mixer stage.

Three types of circuit arrangements for mixer and oscillator are shown in Fig. 52. The circuit at the top employs acorn tubes throughout, with a separate tube for the oscillator. This arrangement permits each tube to be operated with maximum efficiency and good stability, and relatively high gain is obtained in the RF amplifier and mixer. The expense of this arrangement is high, however, because three special types of tubes are employed.

The circuit shown at the center of Fig. 52 is an alternate arrangement in which a triode-hexode converter tube is used. Hexode is the name applied to a six-electrode tube containing a plate, a cathode, and four grids, grid No. 1 being nearest the cathode and grid No. 4 nearest the plate. The triode-hexode tube contains the elements of a triode in addition to those of the hexode, within the same tube envelope. In the triode-hexode converter, the plate currents of the hexode and triode are taken from opposite sides of the flat rectangular cathode. Only one grid encircles the cathode, and this grid serves both as the control grid of the triode and as grid No. 1 of the hexode.

The constant-amplitude RF voltage is generated by the triode elements in a simple feed-back oscillator circuit. The RF voltage on the grid of the oscillator is likewise on grid No. 1 of the hexode, because

the signal input, and the mixer output circuits.

The third circuit arrangement, shown at the bottom of Fig. 52, employs a pentagrid converter tube, type 6SA7. This tube functions as both oscillator and mixer. Grid No. 1 serves as the grid for the oscillator while grid No. 2 serves simultaneously as the oscillator anode and as a shield between oscillator grid No. 1 and signal grid No. 3. For efficient shielding, grid No. 2 must be at ground RF potential, which requires that the oscillator cathode be operated at an RF difference of potential with respect to ground, as shown.

The 6SA7 is constructed with two deflecting plates connected to grid No. 2, so arranged that they collect most of the electrons which are repelled by voltage on the signal grid, No. 3, and which would otherwise fall back toward the cathode and affect the cathode current. The plates also serve to improve the shielding effect of grid No. 2 between the signal and oscillator circuits. These improvements of the 6SA7 over earlier pentagrid converters have made it possible to employ this simple, less expensive tube and circuit arrangement with reasonably satisfactory results at the FM frequencies.

Whatever tube and circuit arrangement is employed, it is important that the mixer tube furnish as much signal gain as possible and that there be a minimum of interaction between the oscillator and signal circuits. For example, adjustment of the trimmer condenser in the tuned signal input circuit should not affect the oscillator frequency.

The output voltage of the oscillator should be as large as possible without overloading the mixer and should be fairly constant over the frequency range. In the

design of the receiver, the frequency of the oscillator may be made either higher or lower than the signal frequency. Both arrangements were used in pre-war receivers.

With the oscillator frequency higher than the signal frequency, it is easier to obtain good tracking over the tuning range. In other words, it becomes possible to select coil and condenser values for the oscillator and signal circuits such that at all settings of the tuning dial the difference between the oscillator frequency and the resonant frequency of the signal circuits is equal to, or very closely approximates, the intermediate frequency of the receiver. When the oscillator frequency is lower than the signal frequency, deviation from perfect tracking is likely to be somewhat greater in a practical receiver design.

On the other hand, with the oscillator frequency lower than the signal frequency, it is easier to obtain good frequency stability from the oscillator. In broadcast reception, where the maximum transmitter deviation is 75 kc., it is found that the maximum permissible receiver oscillator drift, after the oscillator has completed its warm-up, is 10 kc. For an oscillator at a frequency of 45 mc., this represents a maximum percentage drift of .022%, whereas for an oscillator at 55 mc., 10 kc. represents a maximum drift of .018%. While the difference in these percentages appears small, it was found difficult to obtain a frequency stability in low-band receivers greater than .02%, even with temperature-compensated oscillators for home use. The majority of receivers were built with oscillators operating at the lower frequency for this reason.

A third factor which affects the choice between oscillator frequencies higher or lower than the signal frequency is the matter of image frequencies. The image frequency lies on the same side of the signal frequency as the oscillator frequency. Thus, if the factors of good tracking and high oscillator frequency stability are discounted against each other, the choice between a higher or lower oscillator frequency would be strongly influenced by the presence of interfering signals, immediately above or below the FM band.

**The IF Amplifier** ★ The intermediate frequency amplifier in an FM receiver, as in an AM receiver, contributes the major part of the RF gain and provides the selectivity necessary to avoid adjacent-channel interference.

From the standpoint of obtaining good selectivity and high gain per stage, a low intermediate frequency would be desirable. It would also give a more sensitive discriminator, since any given frequency deviation, such as 75 kc., becomes a comparatively large percentage of the IF frequency at the discriminator.

However, consideration of interference from signals at the image frequency demands that a fairly high intermediate fre-

quency be employed. The image frequency, which differs from the desired signal by twice the amount of the intermediate frequency, will then be effectively suppressed in the tuned RF amplifier and mixer circuits. The intermediate frequency should preferably be equal to at least one-half of the width of the FM receiver tuning band, so that all the image frequencies will lie outside the FM band. However, the intermediate frequency should not itself be a frequency on which strong signals are encountered.

In prewar broadcast receivers, the intermediate frequency most often employed was 4.3 mc. The width of the FM broadcast band, extending from 42 to 50 mc., was 8 mc., indicating that an intermediate frequency of 4 mc. would place all image frequencies outside the 42- to 50-mc. range. However, a frequency of 4 mc. was undesirable because of the possibility of interference from strong signals in the 80-meter phone band. The somewhat higher frequency of 4.3 mc. was, therefore, generally used.

Some receiver engineers have advocated the use of a still higher intermediate frequency in order to avoid any interference between two FM stations separated by the amount of the intermediate frequency. In such a case, each station may act as an oscillator for the other, and the two stations may be heard over the entire tuning range of the receiver. This condition has not been encountered frequently in the past, but may become more serious as

an intermediate frequency of 18 mc. or more would be required to obviate all possibility of experiencing this type of interference!

Whether or not such high intermediate frequencies will be employed eventually, the fact remains that the trend in receiver design is toward the use of higher intermediate frequencies.

**IF Amplifier Characteristics** ★ As previously explained in this Section, the band width required by FM signals is greater than that for AM signals. Fig. 53 shows a typical selectivity curve for the IF amplifier of an FM broadcast receiver. It is observed that at frequencies 75 kc. above and below resonance, the voltage reduction ratio is 2 to 1, equivalent to 6 db down. At frequencies 100 kc. removed from resonance, the ratio is 5 to 1 or about 14 db down.

This represents a considerable narrowing of the band width over the theoretical ideal of a band flat to 120 kc. above and below resonance. As previously explained, the narrowed band represents a design compromise in favor of greater gain per stage and improved adjacent-channel selectivity.

The argument in favor of such a compromise is that although the amplitude of a fully modulated FM broadcast signal will be cut down to one-half as the frequency of the signal swings toward the limit of plus or minus 75 kc., as long as the least amplitude of the signal is sufficient

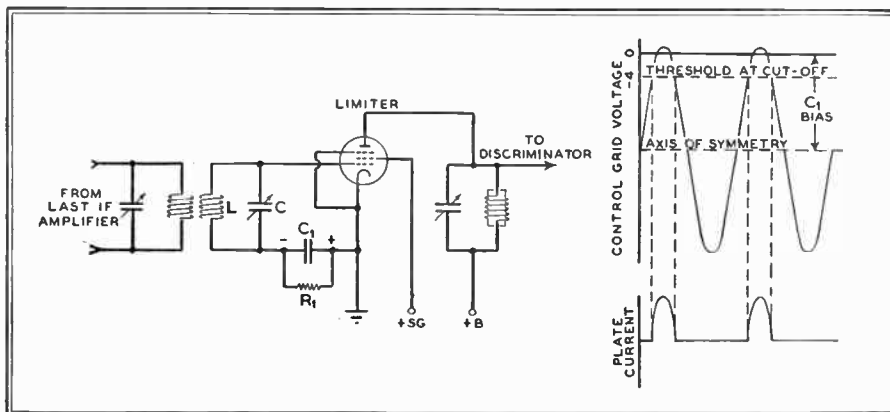

FIG. 55. ONE-STAGE AMPLITUDE LIMITER CIRCUIT, SHOWING HOW GRID LEAK BIAS ALLOWS GRID TO SWING TO ONLY A SLIGHTLY POSITIVE VALUE

additional stations are put into operation. While the use of a tuned RF amplifier and the choice of an intermediate frequency having an odd number of tenths of a megacycle will tend to minimize this type of interference, the more effective solution would lie in having the intermediate frequency equal to at least the entire width of the FM band, assuming that excessively strong signals are not present in the spectrum area adjacent to the band. For the 42- to 50-mc. band, an intermediate frequency of at least 8 mc. was found necessary to avoid this type of spurious response. With the wider band assigned to postwar FM broadcasting,

to saturate the limiter, the amplitude variations will be removed by the limiter.

A point not so frequently considered is the fact that as the frequency swings into the curved regions of the IF amplifier selectivity curve, the currents and voltages in the band pass circuits undergo a shift of phase as well as a variation of amplitude. For a given deviation of the signal frequency during modulation, the rate of change of phase in the band pass circuits is proportional to the modulating frequency. In other words, the band pass circuits introduce a variation in the frequency of the signal currents, in addition to the frequency variation due to modula-



tion, that is proportional to the modulating frequency.

This frequency variation is too small to be of consequence at low modulating frequencies, but as the modulating frequency is increased, the time rate of phase change in the tuned circuits is increased, meaning that the frequency variation superimposed on the FM signal by the tuned circuits is increased. These frequency variations produce amplitude distortion at the receiver output. For example, when the signal is fully modulated at 5,000 cycles, distortion in excess of 2% will be caused by phase shifts in an IF amplifier having a characteristic that is down 6 db at frequencies 75 kc. above or below resonance.

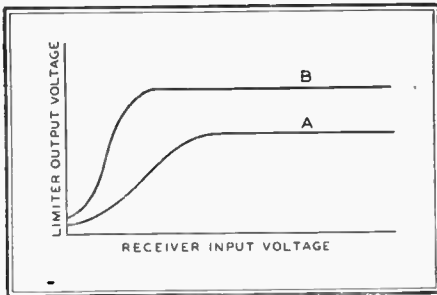

FIG. 56. CHARACTERISTICS OF ONE- AND TWO-STAGE LIMITERS

Set designers particularly interested in obtaining the highest degree of fidelity over the entire audio range are inclined to favor an IF characteristic in which the signal is down only 1 or 2 db at 75 kc. deviation, although it is more difficult to obtain adequate RF gain with the broader band. The broader selectivity curve also allows signals whose level is somewhat below limiting to be received without distortion, thus increasing the usable sensitivity of the set in locations where the noise level is very low.

As shown in Fig. 54, the wiring diagram of the IF amplifier of an FM superheterodyne is fairly conventional. It will be noted that loading resistors may be used across the coils to broaden the characteristics of the band pass circuits. These resistors may range in value from 10,000 to 100,000 ohms. Decoupling circuits are employed in both the screen and plate circuits to improve the stability of the high gain amplifier.

Two stages of IF amplification are all that can be used at these frequencies without encountering instability. Experience indicates that, from the production standpoint, the maximum gain that can be safely obtained in the mixer and IF amplifier is about 15,000. The RF amplifier is required to furnish the remainder of the RF gain necessary to bring the weakest signal it is desired to receive up to a level that will saturate the limiter.

**The Limiter** ★ From the standpoint of the reduction of noise and interference, the

limiter stage is the most important component of the FM receiver, because all types of FM detector circuits are responsive to amplitude as well as frequency variations of the detector input voltage, during the reception of FM signals.

With a really effective limiter located immediately ahead of the detector, and with sufficient RF amplification in the receiver to raise the signal level up to that necessary to obtain limiting action, amplitude variations due to noise and interference will be removed, and the detector output voltage will vary only in proportion to the frequency variation of the signal at the output of the IF amplifier.

Fig. 55 shows a simple one-stage limiter of the grid leak type, employing a 6SJ7 or similar tube. The tube is operated with low plate and screen grid voltages so that cut-off occurs with relatively small grid bias, such as -4 volts.

The control grid and cathode of the limiter tube act as a diode rectifier, so that with the grid driven only slightly positive with respect to the cathode, a charge is stored in the grid condenser  $C_1$ , Fig. 55, such that the DC voltage across  $C_1$  is very nearly equal to the amplitude of the IF voltage across the tuning condenser C. Thus the voltage set up by the charge in  $C_1$  increases and decreases with the amplitude of the input voltage across tuning condenser C, thereby biasing the grid negatively to the amount necessary to prevent the grid from swinging more than slightly positive, regardless of how the amplitude of the input voltage varies.

The characteristic curve of a single-stage limiter is shown at A in Fig. 56. It is essential that the horizontal portion of the input characteristic be flat, and it is desirable that the horizontal portion extend to a low value of input voltage, so that a more definite limiting action will set in at low signal levels. Curve B of Fig. 56 shows the improvement obtained by the use of a two-stage limiter, also known as the dual or cascade limiter.

The circuits of two types of two-stage limiters are shown in Fig. 57. Both stages in each of these limiters are of the grid-leak type, the grid leaks being shunted from grid to ground rather than across the grid condenser as in Fig. 55. The operation of each of the limiter stages is like that of the single-stage limiter, the second stage simply serving to remove any small residual amplitude variations remaining in the output of the first limiter, thus flattening the characteristic and extending it down to lower input voltages. The lower circuit differs from the upper by having a tuned circuit for coupling between the limiters rather than a resistor. This is a more expensive arrangement but gives somewhat improved performance.

The time constants of the grid-condenser and grid-leak combinations in the limiter are of considerable importance in the suppression of impulse noise. The time constant is a means of stating the rate at which a condenser will discharge through a resistance. Theoretically such a discharge continues indefinitely because as the discharge takes place the condenser

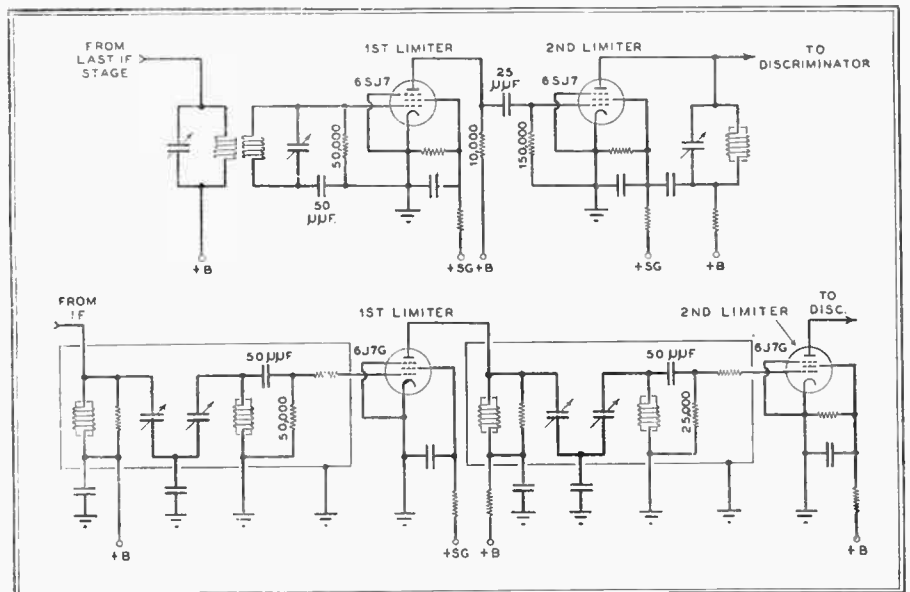

FIG. 57. CIRCUITS OF TWO TYPICAL TYPES OF DUAL LIMITERS

The result, as shown at the right in Fig. 55, is that the plate current varies between two fixed levels, namely, that corresponding to a slightly positive grid voltage and that of cut-off, regardless of variations in excitation voltage across tuning condenser C, assuming only that its peak amplitude is in excess of the 4 volts necessary to give cut-off.

voltage falls off, reducing the discharge current and prolonging the discharge period. Practically, in most RC circuits, the discharge current falls to a less than measurable value in a short period of time, the discharge time being greater when the condenser capacity is large or the resistance of the discharge path is high or both.

The time constant is defined as the amount of time required for the voltage of a condenser discharging through a resistance to fall off to 36.8% of its initial value. The time constant in seconds is equal to the product of the condenser capacity in farads and the grid leak resistance in ohms. The time constants in the limiter circuits should not exceed 10 microseconds, shorter time constants being indicated when automobile ignition interference is anticipated. The time constants of the grid-leak and grid-condenser combinations of the circuits in Fig. 57 range from 1.25 to 4 microseconds.

Short time constants make it possible for the grid bias to follow, almost instantaneously, an impulse so phased as to remove the signal voltage from the grid. Thus the time required to recover normal bias is less than the time of one cycle at the highest audio frequency, and the grid leak bias system does not increase the amplitude nor prolong the effect of an individual impulse. However, since the grid-leak limiter operates from an artificial threshold that is near the positive peak of the input signal, as shown in Fig. 55, it is sensitive to more and smaller impulses than would affect an ideal limiter whose threshold corresponds to the axis of symmetry of the signal voltage.

When two tubes are used in cascade, it becomes possible to rearrange the limiter circuit so that the condition of such an ideal limiter is approached. In Fig. 58, there is no self bias on the first 7C7, and the plate and screen voltages are so chosen that the plate current drops to cut-off when the instantaneous value of the input signal is more than 1 volt negative. The

positive voltage to the second tube. Thus both peaks are limited while the threshold is maintained near the axis of symmetry of the input signal, so that this limiter is responsive to but few small impulse peaks.

By a proper choice of the resistors  $R_1$  and  $R_2$ , it is also possible in this limiter circuit to obtain some decrease in the out-

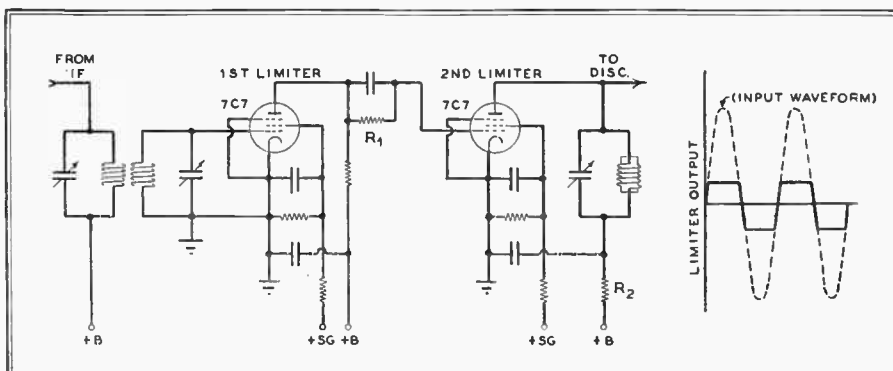

FIG. 58. CIRCUIT NOT EMPLOYING GRID LEAK IN THE FIRST STAGE. RIGHT, CURVES SHOWING THE INPUT WAVE FORM AND RESULTING OUTPUT

positive peak of signal voltage is reproduced without limiting in the first tube, but by means of resistance coupling, it is reversed in phase and applied as a nega-

put sensitivity when there are no input signals strong enough to suppress the noise, so that a partial squelch is obtained while tuning from one station to another.

# Theory of Frequency Modulation

## Section 7: Continuation of FM Receivers — FM Detectors, Audio Systems, and Special Receiver Circuits

IN THE preceding section, it was shown that a conventional triode AM detector can be made to respond to FM signals by detuning the tuned input circuit slightly, so that operation occurs on the steep and nearly linear portion of the selectivity curve of the input circuit, either above or below the resonant frequency. The principle involved is that as the frequency of the FM signal swings toward the resonant frequency of the tuned circuit, the current in the tuned circuit and the voltage across the tuning condenser increases, and as the frequency of the FM signal swings away from the resonant frequency of the tuned circuit, the current in the tuned circuit and the voltage across the tuning condenser decreases. In this way the selectivity characteristic of the tuned circuit serves to translate the frequency variations of the FM signal into amplitude variations of the voltage across the tuning condenser, so that the detector responds to the FM signal.

It was pointed out, however, that the detuned AM triode detector would not be suitable for use in a high fidelity FM receiver because 1) it is incapable of handling strong signal voltages without introducing distortion, 2) the detuning adjustment, for operation at the mid-point of the most nearly linear portion of the selectivity characteristic, is quite critical, and 3) even at the optimum detuning adjustment, there is some departure from true linearity in the detector output, causing harmonic distortion. This distortion would be particularly severe on strongly modulated FM signals, where the frequency swings over a wide range.

The problem of overloading encountered with triode detectors can be obviated by using a diode detector. In so doing, the advantage of obtaining amplification in the detector is lost, but the amplification can be readily made up in the stages preceding and following the detector. By using a detector which has the property of rectification only, a much higher order of signal voltages can be handled without introducing distortion. Practically all modern FM broadcast receivers employ diode detectors.

The problem of critical detuning adjustment, and the problem of distortion resulting from operation at the curved portions of the characteristic arise from the fact that the characteristic is practically linear over only a narrow range of frequencies. The solution to these problems would seem to lie either in 1) using a system of coupled tuned circuits in the detector that will give an overall characteristic that is approximately linear over a much wider frequency range, or 2) devising a system of FM detection which does

not depend in any way upon the selectivity characteristics of tuned circuits.

The solution which lends itself more readily to FM receiver design is that in which tuned circuits are coupled in such a way as to give a straight-line characteristic over a wide frequency range. Detectors of this type usually employ two diodes arranged to deliver an output voltage whose polarity depends upon whether the applied frequency is higher or lower than the mean frequency of the input tuned circuits, and whose amplitude depends on the extent by which the applied frequency differs from the mean frequency. Since these detectors are able to discriminate between frequencies above and below the mean frequency of the coupled tuned circuits, they are called *discriminators*.

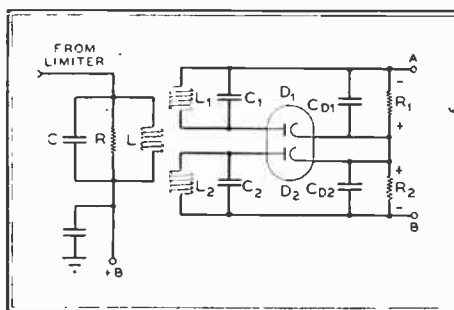

FIG. 59. DETUNED-CIRCUIT TYPE OF DISCRIMINATOR CIRCUIT

Two types of discriminator circuits have been employed in receiver design, namely the detuned-circuit discriminator and the center-tuned discriminator. Both of these types were employed originally in AM receivers for automatic frequency control, but since they can be adjusted to give an overall characteristic having a uniform slope over a relatively wide frequency range, they are especially suited for use as FM detectors.

**De-tuned Circuit Discriminator** ★ The circuit diagram of the detuned-circuit discriminator, or amplitude discriminator, is shown in Fig. 59. The limiter output circuit LC is tuned to the intermediate frequency  $F_C$  of the superheterodyne receiver. The input circuit  $L_1C_1$  for diode detector  $D_1$  is inductively coupled to LC but is resonant to a frequency  $F_{R1}$ , somewhat lower than the intermediate frequency  $F_C$  of the FM receiver. The input circuit  $L_2C_2$  for diode detector  $D_2$  is also inductively coupled to LC but is resonant to a frequency  $F_{R2}$ , somewhat higher than the intermediate frequency  $F_C$  of the FM receiver. The coefficients of coupling of circuits  $L_1C_1$  and  $L_2C_2$  to circuit LC are equal, and each circuit is detuned from the resonant frequency of LC by the same amount.

If a signal current, modulated or unmodulated, flows in the tuned circuit LC, the expanding and contracting field about L induces equal voltages in coils  $L_1$  and  $L_2$ , because of the equal degree of coupling.

When the signal is unmodulated and has a frequency equal to the resonant frequency of circuit LC, then the amplitude of the RF currents in the detuned circuits  $L_1C_1$  and  $L_2C_2$ , set up by the induced voltages, will be essentially equal and the RF voltages established across the tuning condensers  $C_1$  and  $C_2$  will also be equal. Thus, the DC voltages produced across  $R_1C_{D1}$  and  $R_2C_{D2}$  by the diodes, which are very nearly equal to the respective amplitudes of the RF voltages across  $C_1$  and  $C_2$ , will be essentially equal to each other. As shown in Fig. 59, the diode connections are such as to place the two DC output voltages of the diodes in opposite polarity between the discriminator output terminals A, B. Thus, zero net voltage is produced across terminals A, B of the discriminator when it is excited by an unmodulated signal at the resonant frequency of the tuned circuit LC, that is, at a frequency mid-way between the resonant frequencies of tuned circuits  $L_1C_1$  and  $L_2C_2$ .

When the signal is frequency-modulated, its frequency is alternately increased and decreased with respect to the average or center frequency. If the center frequency of the FM signal is equal to the resonant frequency of LC, then, during the period when the instantaneous frequency of the FM signal is greater than its center frequency, the RF voltage established across the tuning condenser  $C_1$  is decreased because the frequency of the voltage induced in  $L_1C_1$  circuit is farther from the resonant frequency of that circuit. Conversely, when the instantaneous frequency is less than the center frequency, the RF voltage across  $C_1$  is increased, because the applied frequency is nearer to the resonant frequency of  $L_1C_1$ .

This action is illustrated in Fig. 60. Here the FM signal is shown at the lower left and its frequency is shown as a function of time to the right of the signal. The frequency curve is projected upwards against the characteristic curve for the RF voltage across condenser  $C_1$ . Since the DC voltage established across  $R_1C_{D1}$  is very nearly equal to the amplitude of the RF voltage across  $C_1$ , this curve also represents the output voltage of diode  $D_1$  as a function of the input frequency. It is observed that as the frequency of the input signal is increased during the first alternation of modulation, the frequency of the voltage induced in  $L_1$  is farther from resonance and the DC output voltage across  $R_1C_{D1}$  is decreased. In the second



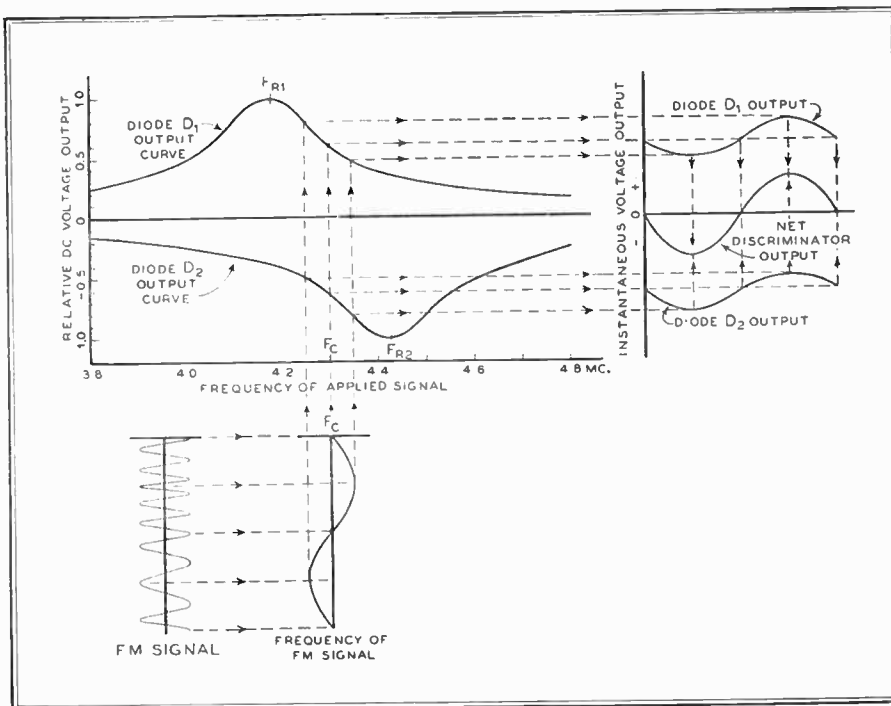

FIG. 60. DETECTION OF FM SIGNAL IN DETUNED-CIRCUIT DISCRIMINATOR. THE INDIVIDUAL DIODE OUTPUT VOLTAGES COMBINE TO PRODUCE AN AUDIO VOLTAGE HAVING THE SAME WAVE FORM AS THE MODULATING VOLTAGE AT THE TRANSMITTER

alternation of the modulation, where the instantaneous frequency of the voltage induced in coil  $L_1$  is nearer to the resonant frequency of  $L_1C_1$  than the center frequency, the DC output voltage across  $R_1C_{D1}$  is increased. The wave form of the output voltage variation of diode  $D_1$  is shown at the upper right in Fig. 60.

Since the tuned circuit  $L_2C_2$  of diode  $D_2$  is resonant to a frequency  $F_{R2}$  that is higher than the center frequency  $F_C$  of the input signal, the selectivity curve for the tuned circuit  $L_2C_2$  would occupy a position to the right of the curve for tuned circuit  $L_1C_1$  in Fig. 60. However, since the characteristic being plotted is that of the DC output voltage of diode  $D_2$  rather than the amplitude of the RF voltage across tuning condenser  $C_2$ , the curve is plotted in the negative direction from the horizontal axis to take into account the opposite polarity of the DC output voltage of diode  $D_2$ .

It is observed in Fig. 60 that in the case of diode  $D_2$ , an increase in the instantaneous frequency during modulation produces an increase in the magnitude of the negative voltage developed across  $R_2C_{D2}$ . A decrease in the instantaneous frequency during modulation produces a decrease in the magnitude of the negative voltage across  $R_2C_{D2}$ . The variation of the output voltage of diode  $D_2$  during modulation is shown at the right of the negative characteristic curve for diode detector  $D_2$ .

The output voltage of the discriminator is the algebraic sum of the positive and negative output voltages, respectively, of diodes  $D_1$  and  $D_2$  from instant to instant. The curve of the net discriminator output voltage is shown in Fig. 60 between the

curves for the individual diode output voltages. It is observed that the DC components of the individual diode voltages have been balanced out and that an audio

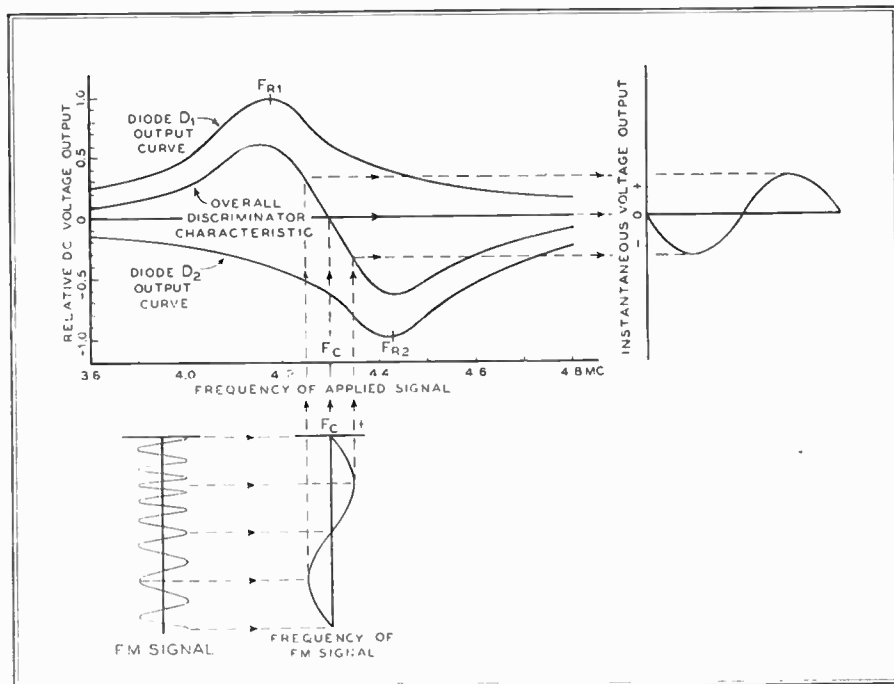

FIG. 61. THE OVERALL CHARACTERISTIC OF THE DISCRIMINATOR IS PLOTTED BY ADDING THE DIODE OUTPUTS ALGEBRAICALLY AT EACH FREQUENCY. THE COMPOSITE CHARACTERISTIC IS ESSENTIALLY LINEAR OVER A WIDE FREQUENCY RANGE

voltage is delivered by the discriminator which has an amplitude roughly twice that of the audio components of the individual diode output voltages.

The marked improvement in the quality of FM detection, obtained by combin-

ing the outputs of two detuned detectors in pushpull in the manner described above, is made evident by comparing the overall characteristic of the discriminator with the curves of the individual diode detectors, as shown in Fig. 61. Here the curves for the individual detectors are the same as those shown in Fig. 60, but the composite characteristic has been plotted by taking the algebraic sum of the positive and negative diode voltages at each frequency.

It is observed that the composite characteristic for the discriminator is essentially linear over a much wider frequency range than either of the individual diode detector characteristics. Thus the discriminator can be made to deliver essentially distortionless audio voltage on strongly modulated FM signals and requires only moderate care in tuning the receiver.

As shown in Fig. 59, the primary circuit LC should be loaded by means of shunt resistance  $R$  so that the effective ratio of reactance to resistance, or  $Q$ , of the primary is about one-third of the ratio of the resonant frequency of the primary circuit to the maximum frequency deviation of the signal to be detected. The  $Q$  of the secondary circuits  $L_1C_1$  and  $L_2C_2$  should be twice that of the primary circuits. The diodes serve to load the secondary circuits. The secondary coils  $L_1L_2$  are so placed that each has a coupling to the

primary coil  $L$  much greater than their coupling to each other.

It is evident from Fig. 61 that the linearity of the discriminator depends not only upon the sharpness of the selectivity curves of the tuned circuits, as deter-

mined by their respective  $Q$ 's, but upon the separation of the resonant frequencies of the circuits as well.

The condition for best linearity is that at which the resonant frequencies of the tuned circuits  $L_1C_1$  and  $L_2C_2$  are separated by 1.225 times the band width between the half-power points (or 70.7%-voltage points) on the curves of the tuned circuits. The band width between half-power points, in turn, is equal to the resonant frequency of each circuit divided by its  $Q$ . Fig. 61 illustrates the condition for best linearity.

**Center-Tuned Discriminator** ★ The circuit of the center-tuned or phase discriminator is shown in Fig. 62. In this circuit only two tuned circuits are employed and both are resonant to the intermediate frequency of the receiver. As will be explained presently, the signal voltage is conveyed from the limiter output circuit to the discriminator circuit by direct and inductive coupling. The diode detectors are connected in pushpull across the center-tapped secondary coil. By careful adjustment of the tuning and coupling it is possible to obtain the same overall characteristic as is shown for the detuned-circuit discriminator in Fig. 61.

The operation of the center-tuned discriminator depends upon the change that occurs in the phase relations of the voltages in the tuned circuits as the applied signal frequency varies from the resonant frequency of the tuned circuits during modulation. It is first necessary, therefore, to consider the phase relations of the voltages and currents in coupled tuned circuits for conditions of resonance and non-resonance.

Consider the coupled tuned circuits  $L_1C_1$  and  $L_2C_2$  at the upper left in Fig. 63. If an RF voltage  $E_1$  is present across  $L_1C_1$ , the resulting current  $I_1$  that flows in the turns of coil  $L_1$  will lag voltage  $E_1$  by nearly  $90^\circ$ , since the reactance of coil  $L_1$  very greatly exceeds its resistance.

This relationship is shown in the top row of three vector diagrams in Fig. 63, representing, from left to right, the conditions of operation at resonance, above resonance, and below resonance. The vector for voltage  $E_1$  serves as a reference, and is assigned the position representing  $0^\circ$  in each of the three diagrams. The vector representing current  $I_1$  is  $90^\circ$  clockwise from, or lagging, the applied voltage vector  $E_1$ .

The current  $I_1$  in the turns of coil  $L_1$  creates a magnetic field about  $L_1$  that expands, collapses, and changes polarity in phase with the increase, decrease, and reversal of the RF current in coil  $L_1$ . The vector for current  $I_1$  can, therefore, also be regarded as representing the field about coil  $L_1$ .

The expanding and collapsing field about  $L_1$  sweeps the turns of  $L_2$  and induces therein a voltage  $E_2$  proportional at every instant to the *rate* at which the

lines of force of the field above  $L_1$  are cutting the turns of coil  $L_2$ . When the field about  $L_1$  is changing most rapidly, that is, when the current in coil  $L_1$  is falling through zero, the voltage  $E_2$  induced in coil  $L_2$  is at a peak. On the other hand, at the instant when the field about  $L_1$  has reached a condition of maximum expansion and is about to contract, its *rate of change* is zero and zero voltage is induced in coil  $L_2$ .

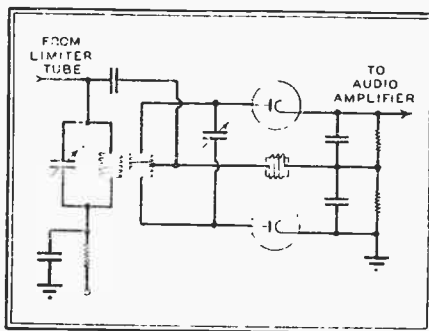

FIG. 62. CENTER-TUNED TYPE OF DISCRIMINATOR CIRCUIT

Thus the voltage induced in coil  $L_2$  is  $90^\circ$  out of phase with the inducing field and inducing current  $I_1$ . This is shown in the top row of vector diagrams in Fig. 63, where the vector for the induced voltage  $E_2$  appears at a position  $90^\circ$  clockwise from, or lagging, the vector for the inducing current  $I_1$ .

It is very important to note that the voltage  $E_{AB}$  which appears across the tuning condenser  $C_2$  is *not* the induced voltage  $E_2$ . As shown in the diagram of the equivalent circuit, the induced voltage  $E_2$  simply acts as a generator in series with coil  $L_2$  and tuning condenser  $C_2$ , causing a current  $I_2$  to flow in circuit  $L_2C_2$  which establishes a *reactive voltage drop*  $E_{AB}$  across the tuning condenser  $C_2$ . Since the condenser  $C_2$  offers a practically pure capacitive reactance, the voltage  $E_{AB}$  across condenser  $C_2$  will lag the current  $I_2$  by very nearly  $90^\circ$ , regardless of whether the circuit is resonant or non-resonant to the applied frequency.

At resonance, the reactances of  $L_2$  and  $C_2$  cancel each other and the current  $I_2$  in the secondary circuit is in phase with the induced voltage  $E_2$ . This is shown in the vector diagram for the resonant condition which appears just to the right of the tuned circuits at the top of Fig. 63. It should be observed that the vector for current  $I_2$  coincides with that for induced voltage  $E_2$ . The reactive voltage  $E_{AB}$  across tuning condenser  $C_2$  is  $90^\circ$  lagging the current  $I_2$ . As shown in the vector diagram, at resonance the voltage  $E_{AB}$  across tuning condenser  $C_2$  differs in phase by  $90^\circ$  with respect to the reference voltage  $E_1$  applied across circuit  $L_1C_1$ .

Consider next the phase relations which exist when the applied frequency  $F_A$  exceeds the resonant frequency  $F_R$  of the tuned circuits. At the higher frequency,

the inductive reactance of  $L_2$  exceeds the capacitive reactance of  $C_2$ , thereby causing the current  $I_2$  in circuit  $L_2C_2$  to lag the induced voltage  $E_2$ . This is shown in the center vector diagram at the top of Fig. 63. The vector for current  $I_2$  lags the vector for the induced voltage  $E_2$  by an acute angle. The reactive voltage  $E_{AB}$  across tuning condenser  $C_2$  lags current  $I_2$  by the fixed angle of  $90^\circ$ . As a result, the voltage  $E_{AB}$  differs in phase from the reference applied voltage  $E_1$  by *less than*  $90^\circ$ .

Conversely, when the applied frequency  $F_A$  of voltage  $E_1$  is less than the resonant frequency  $F_R$  of circuits  $L_1C_1$  and  $L_2C_2$ , current  $I_2$  in circuit  $L_2C_2$  leads the induced voltage  $E_2$ , as shown in the vector diagram at the top right of Fig. 63. This causes the voltage  $E_{AB}$  across condenser  $C_2$  to differ in phase with respect to the reference input voltage  $E_1$  by *more than*  $90^\circ$ .

Consider next the voltages that will be obtained when a center tap is placed on coil  $L_2$ , as shown in Fig. 63. Since the voltage at terminal A with respect to terminal B of the tuned circuit  $L_2C_2$  is shown by vector  $E_{AB}$  in the top row of vector diagrams, then the voltage at terminal A with respect to the center-tap terminal C is shown by vector  $E$  of half the length in the second row of vector diagrams. The angular position of vector  $E_{AC}$  in the second row of vector diagrams is the same as that of vector  $E_{AB}$  in the top row.

The voltage of the center-tap terminal C with respect to the lower terminal B or voltage  $E_{CB}$  could also be represented by a vector in the position of vector  $E_{AC}$ . However, the voltage of lower terminal B with respect to center-tap terminal C, or voltage  $E_{BC}$ , is a voltage taken in the opposite direction and must be represented by a vector having the opposite polarity from vector  $E_{AC}$ , as shown in the second row of vector diagrams.

As the next step, a condenser  $C_C$  is connected between the high potential terminal of circuit  $L_1C_1$  and the center-tap terminal C of tuned circuit  $L_2C_2$ , as shown at the left of the third row of vector diagrams in Fig. 63. At the same time, an RF choke RFC is connected between center-tap terminal C and terminal D. Terminal D is held at ground RF potential by condenser  $C_{D2}$ . The reactance of RFC at the applied frequency is too high to affect appreciably the tuning of circuit  $L_1C_1$  across which it is shunted. The reactances of  $C_C$  and  $C_{D2}$  are quite low at the applied frequency. Thus the voltage  $E_1$  across  $L_1$  also appears across RF choke RFC, with practically no change in magnitude or phase. Hence, the vector  $E_{CD}$  in the third row of vector diagrams is drawn in the same position as vector  $E_1$  in the first row.

The final step in the evolution of the discriminator circuit is the connection of two diode detectors at terminals A, D, B. The output circuits of the detectors are connected in pushpull as shown.

Diode  $D_1$  is connected to terminals A and D so that the voltage applied to the diode  $D_1$  is the sum of voltages  $E_{AC}$  and  $E_{CD}$ . The voltage applied to the lower diode  $D_2$  is the sum of voltages  $E_{BC}$  and  $E_{CD}$ , since this diode is connected to terminals B and D.

The sums of these respective pairs of voltages are obtained vectorally by completing the parallelograms and drawing in the diagonal resultants, as shown in the bottom row of vector diagrams in Fig. 63.

for  $E_{CD}$  than the vector for  $E_{BC}$ . As a result, the sum vector  $E_{AD}$  has a greater magnitude than the sum vector  $E_{BD}$ . Therefore diode  $D_1$  delivers a greater DC voltage than diode  $D_2$ . With the diode DC output voltages adding in opposite polarity, the net voltage delivered by the discriminator is positive when the applied frequency exceeds the resonant frequency.

Conversely, when the applied frequency is less than the resonant frequency, the voltage  $E_{AC}$  differs in phase from voltage

nately positive and negative. This is the case when an FM signal is tuned in, so that the discriminator produces an audio voltage having the same wave form as the audio modulating voltage at the FM transmitter.

Readers unfamiliar with vector diagrams will understand the operation of the discriminator by reference to the wave diagrams shown in Fig. 64. The left hand column of wave diagrams applies to the condition of resonance. The voltage  $E_{CD}$

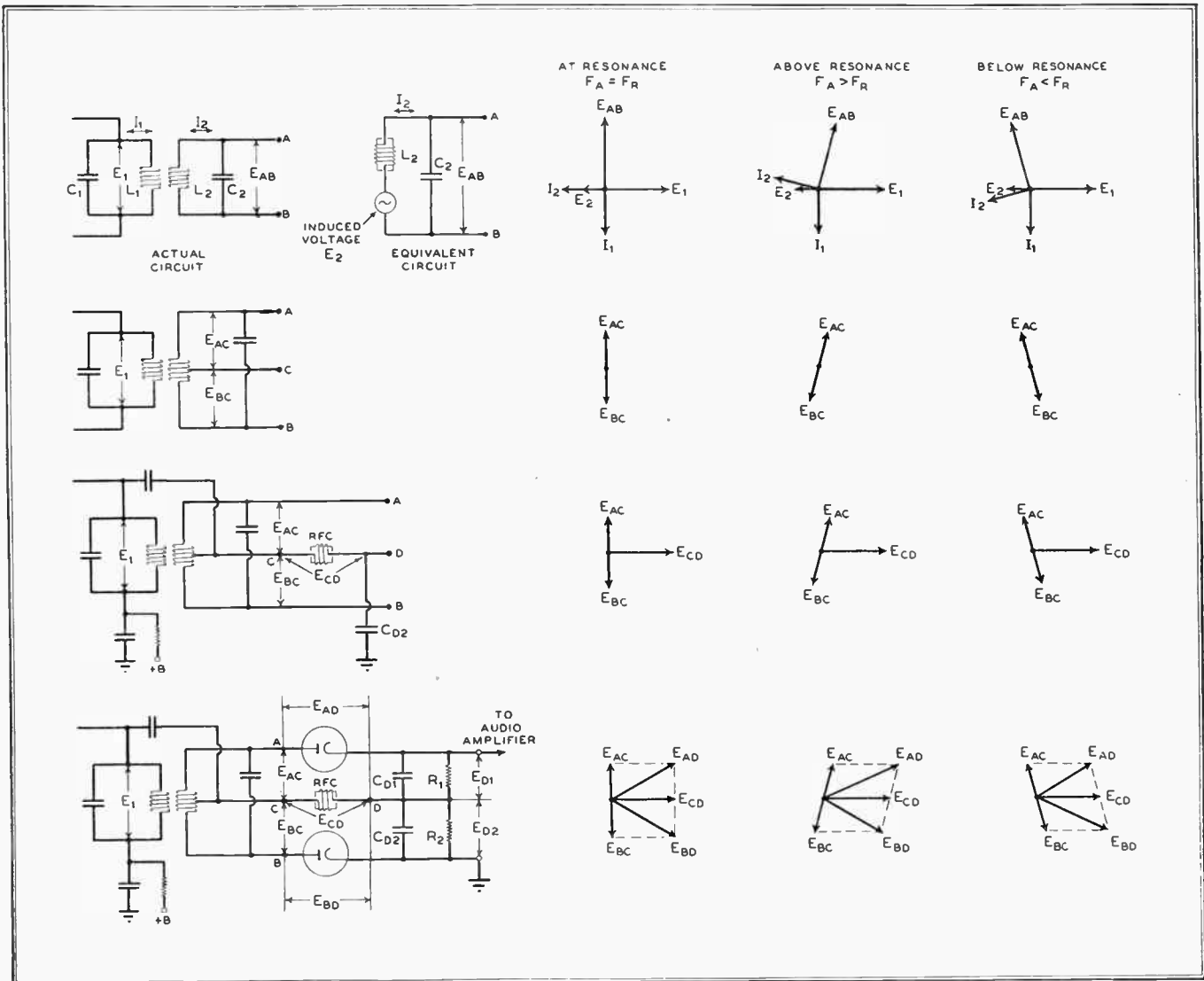

FIG. 63. EVOLUTION OF THE CENTER-TUNED DISCRIMINATOR CIRCUIT. STARTING WITH THE SIMPLE COUPLED TUNED CIRCUITS, TOP LEFT: CIRCUIT ELEMENTS ARE PROGRESSIVELY ADDED UNTIL THE COMPLETE DISCRIMINATOR CIRCUIT IS OBTAINED. PHASE RELATIONS OF VOLTAGES AND CURRENTS ARE SHOWN IN THE VECTOR DIAGRAMS TO THE RIGHT OF EACH CIRCUIT

At resonance, where a  $90^\circ$  difference of phase exists between the directly coupled voltage  $E_{CD}$  and the reactive voltages  $E_{AC}$  and  $E_{BC}$ , the resultant or sum vectors  $E_{AD}$  and  $E_{BD}$  are of equal magnitude. At resonance, therefore, the individual diode output voltages  $E_{D1}$  and  $E_{D2}$  are equal, and since they are added in opposite polarity the net output voltage of the discriminator is zero.

When the applied frequency  $F_A$  exceeds the resonant frequency  $F_R$ , the vector representing  $E_{AC}$  lies closer to the vector

$E_{CD}$  by more than  $90^\circ$ , while voltage  $E_{BD}$  differs in phase from voltage  $E_{CD}$  by less than  $90^\circ$ . As a result, the sum voltage  $E_{BD}$  has a greater magnitude than the sum voltage  $E_{AD}$ , as shown in the vector diagram at the lower right of Fig. 63. Diode  $D_2$  delivers a greater DC voltage than diode  $D_1$  and the net output voltage of the discriminator is negative.

If the frequency of the applied signal is alternately greater and less than the resonant frequency of the discriminator, the discriminator output voltage is alter-

at the center of the left hand column is the limiter output voltage which is transferred to terminals C and D of choke RFC in the discriminator circuit of Fig. 63.

Since the tuned circuit  $L_2C_2$ , Fig. 63, is operating at resonance, the reactive voltages  $E_{AC}$  and  $E_{BC}$  established across coil  $L_2$  will respectively lead and lag the limiter output voltage  $E_{CD}$  by  $90^\circ$ . The voltage waves of  $E_{AC}$  and  $E_{BC}$  are shown immediately above and below the wave of  $E_{CD}$  in Fig. 64. It is noted that the three waves have the same frequency but



there are 90° phase displacements between them. When the wave of  $E_{AC}$  is added to that of  $E_{CD}$  from instant to instant, the resultant is a wave  $E_{AD}$  of

greater amplitude than  $E_{AC}$ , shown at the top left in Fig. 64. Similarly,  $E_{BC}$  added to  $E_{CD}$  yields a wave  $E_{BD}$  of greater amplitude than  $E_{BC}$ , shown at the bottom left in Fig. 64. Since the two waves  $E_{BC}$  and  $E_{CD}$  added to  $E_{CD}$  are equally displaced in phase from  $E_{CD}$ , equal reinforcements of  $E_{CD}$  are obtained from the addition. The amplitude of the sum resultant voltage  $E_{AD}$  equals that of the sum resultant voltage  $E_{BD}$ . When these voltages are applied to diodes  $D_1$  and  $D_2$ , equal DC output voltages  $E_{D1}$  and  $E_{D2}$  are obtained. Since these diode output voltages of equal magnitude are added in opposite polarity, the discriminator out-

put voltage should be proportional at every instant to the frequency deviation of the signal being received. By careful circuit design and coupling adjustments, the characteristic of the tuned-circuit discriminator can be made linear over a wide frequency range, similar to the characteristic of the detuned-circuit discriminator shown in Fig. 61.

put voltage should be proportional at every instant to the frequency deviation of the signal being received. By careful circuit design and coupling adjustments, the characteristic of the tuned-circuit discriminator can be made linear over a wide frequency range, similar to the characteristic of the detuned-circuit discriminator shown in Fig. 61.

**Counter-Circuit FM Detector** ★ While the use of discriminator circuits, as described above, presents a convenient and practical means for detecting FM signals of relatively large frequency deviation with minimum distortion, there are a number of other methods for detecting FM signals.

For example, it has been suggested previously in this section that a solution to the problem of overcoming the inherent non-linearity of tuned-circuit detectors might lie in the use of a detection system whose operation does not depend in any way upon tuned circuits. The counter-circuit shown in Fig. 65 is an FM detector of this type. Because of its very low distortion, it has been employed in precision FM monitors for checking FM modulation systems.

The first tube in the circuit shown in Fig. 65 is a beam pentode, operating with a low value of load resistance,  $R_L$ , adjusted to give plate-current saturation when the excitation voltage is not quite sufficient to draw grid current. The excitation voltage has a center frequency in the order of 100 to 300 kc. and its peak-to-peak value is at least 20% greater than the cut-off bias of the beam pentode. The plate current of the pentode swings between cut-off and saturation level, as determined by the pentode characteristic. The pentode therefore squares off the positive and negative peaks of the plate current variation, and delivers a *square wave pulse of practically uniform amplitude* at the frequency of the excitation signal, regardless of any amplitude fluctuations that are present in the excitation signal.

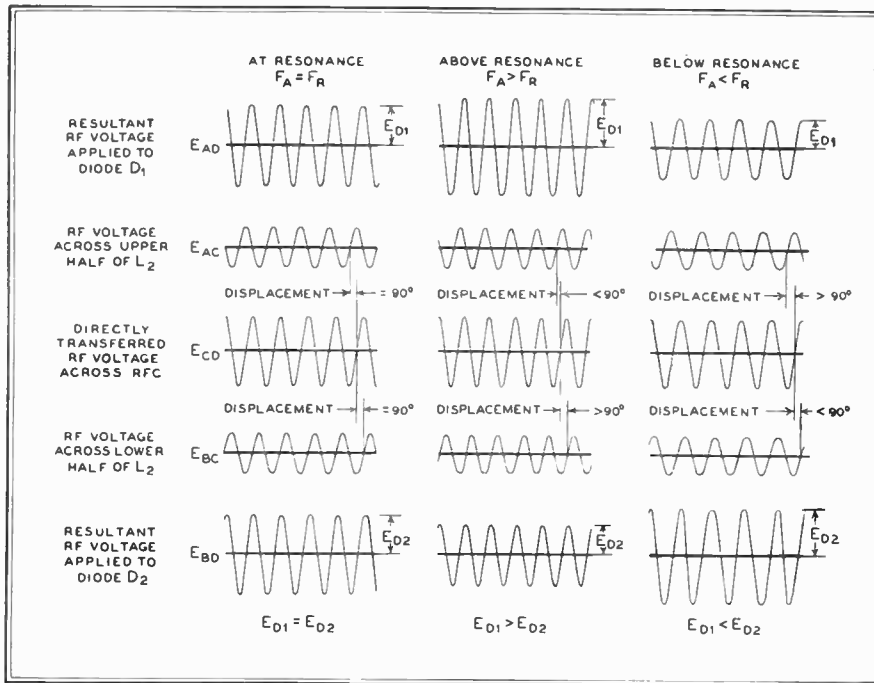

FIG. 64. WAVE DIAGRAMS OF VOLTAGES IN THE CENTER-TUNED DISCRIMINATOR CIRCUIT. THE VOLTAGES ARE TAKEN AT THE POSITIONS SHOWN IN THE CIRCUIT DIAGRAM: BOTTOM LEFT, FIG. 63

put is zero when the applied frequency  $F_A$  equals the resonant frequency  $F_R$ . The voltages for the condition of applied frequency  $F_A$  exceeding the reso-

$L_2C_2$  leads the directly coupled voltage  $E_{CD}$  by less than 90°, while the voltage  $E_{BC}$  across the lower half of the tuned circuit  $L_2C_2$  lags the directly coupled voltage  $E_{CD}$  by more than 90°.

When  $E_{AC}$  is added to  $E_{CD}$ , the amplitude of the sum voltage  $E_{AD}$  is found to be greater than the amplitude of the sum voltage  $E_{BD}$ , obtained when  $E_{BC}$  is added to  $E_{CD}$ . This is to be expected, since  $E_{AC}$  is more nearly in phase with  $E_{CD}$  than  $E_{BC}$  and, therefore, affords greater reinforcement of  $E_{CD}$  than  $E_{BC}$ . Since the voltage  $E_{AD}$  has a greater amplitude than  $E_{BD}$ , diode  $D_1$  delivers a greater DC output voltage than diode  $D_2$  and the net discriminator output voltage is positive.

Conversely, when the applied frequency  $F_A$  is less than the resonant frequency  $F_R$ , the phase displacement between  $E_{AC}$  and  $E_{CD}$  is greater than 90°, while that between  $E_{BC}$  and  $E_{CD}$  is less than 90°. This condition is shown in the right hand column of waves in Fig. 64.  $E_{BC}$  offers a greater reinforcement of  $E_{CD}$  than  $E_{AC}$ , so that  $E_{BD}$  exceeds  $E_{AD}$ . As a result, diode  $D_2$  delivers a greater DC voltage than diode  $D_1$  and the discriminator output voltage is negative.

During the reception of an FM signal whose center frequency equals the resonant frequency of the tuned circuits, the discriminator output voltage changes polarity as the frequency alternately exceeds or is less than the center frequency. The magnitude of the discriminator out-

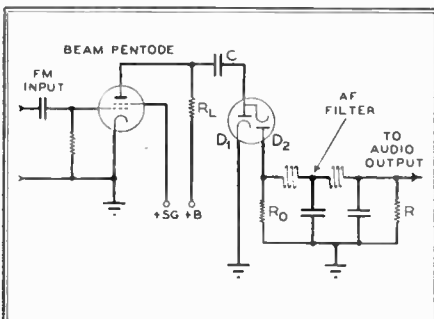

FIG. 65. COUNTER CIRCUIT TYPE OF FM DETECTOR

put is zero when the applied frequency  $F_A$  equals the resonant frequency  $F_R$ .

The voltages for the condition of applied frequency  $F_A$  exceeding the reso-

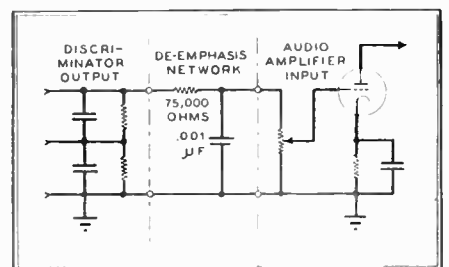

FIG. 66. POSITION OF DE-EMPHASIS NETWORK IN FM RECEIVER

The peak value of the output voltage pulse of the pentode is equal to the plate supply voltage, because there is zero drop in resistor  $R_L$  during the interval when the plate current is cut off. During the interval when the voltage pulse is maximum positive, condenser  $C$  therefore charges through the low cathode-to-plate resistance of diode  $D_1$  to a voltage very

nearly equal to the plate supply voltage. During the interval when the pentode output voltage is minimum positive, the charged condenser C cannot discharge through diode  $D_1$  because the cold plate of diode  $D_1$  does not emit electrons. Condenser C will discharge through the cathode-to-plate path of diode  $D_2$  and  $R_0$

frequency deviation is then a larger percentage of the center frequency. Moreover, a relatively low order of input frequencies is mandatory, since condenser C must very nearly acquire its full charge and must discharge to its residual voltage level, each within the half-cycle periods of the input voltage. The internal resistances

tems in transmitters, and studying the distortion produced by the tuned stages in FM receivers.

**De-emphasis Network** ★ As explained in Section 5, pre-emphasis can be introduced in the modulation at the FM transmitter in order to increase the amplitude of the high-frequency components of the audio modulating voltage. Such pre-emphasis will cause the high-frequency components of the audio voltage at the discriminator output to be considerably stronger with respect to high-frequency noise than if pre-emphasis were not employed.

With pre-emphasis at the transmitter, it is necessary to have de-emphasis at the receiver for the purpose of bringing the high frequencies down to the same proportion with respect to the low frequencies that exists at the studio microphone. At the same time, the de-emphasis network will reduce the high frequency noise picked up by the receiver antenna or from thermal agitation and shot effect to inaudibility.

The circuit constants for the de-emphasis network at the receiver will depend upon those of the pre-emphasis network at the transmitter. Where a 75-microsecond pre-emphasis characteristic is introduced at the transmitter, as in FM broadcasting, a 75-microsecond de-emphasis network should be connected between the discriminator and the audio amplifier of the FM receiver, Fig. 66.

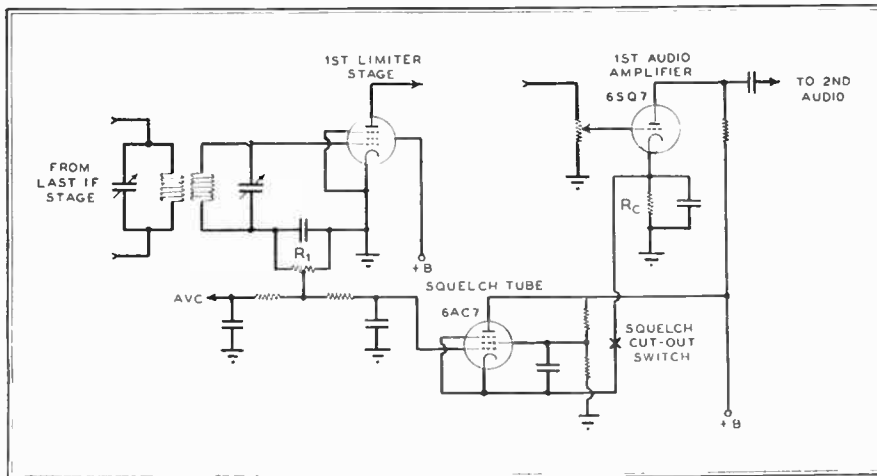

FIG. 67. CIRCUIT OF AN AUTOMATIC SQUELCH SYSTEM FOR SUPPRESSING INTERSTATION AND STANDBY NOISE IN FM RECEIVER

to ground. The capacity of the condenser C and the resistances of the charge and discharge paths are so small that the condenser acquires a voltage of at least 99.9% of the plate supply voltage by the end of the charge interval and discharges to within 0.1% of the minimum voltage at the pentode plate by the end of the discharge interval. Since the condenser voltage varies over a fixed range, the number of electrons moved through resistor  $R_0$  during each discharge period is fixed. The number of electrons passed through  $R_0$  per second is directly proportional to the number of discharge periods per second, that is, to the frequency of the excitation voltage at the grid of the pentode. Thus, it is said that this type of detector circuit counts the pulses and produces an average voltage across  $R_0$  directly proportional to the input frequency.

If the input frequency increases and decreases at an audio rate, then the voltage across  $R_0$  will increase and decrease at the same audio rate. The low-pass audio filter smooths out the RF fluctuations in the voltage across  $R_0$  and allows only the DC and audio components of the voltage across  $R_0$  to appear across the filter terminating resistor R. It is important that the filter be of the choke input type, so that no residual voltage will be maintained across  $R_0$ . Such a voltage would bias diode  $D_2$  and prevent condenser C from discharging completely on each cycle. The linearity of this detector, when properly adjusted, is said to be excellent.

It will be noted that the input frequencies at which this detector operates are of a low order. This permits the detector to deliver a larger audio voltage, since the

of the diodes limit the extent to which the time constants of charge and discharge can be shortened. In view of the low input frequencies required, and other practical considerations, the use of the counter type of FM detector has been limited to

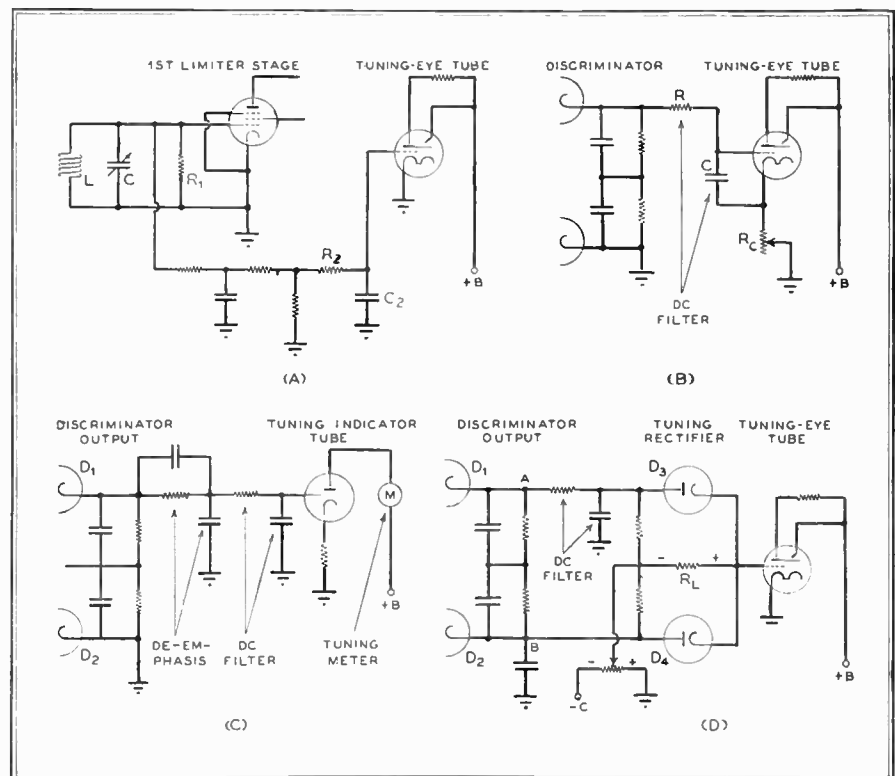

FIG. 68. FOUR TYPES OF TUNING INDICATOR CIRCUITS USED IN FM RECEIVERS

special applications, such as checking the performance of FM signal generators, monitoring frequency-modulation sys-

**The Audio System** ★ The theory of operation of the audio amplifier and loudspeaker system of an FM broadcast receiver does

not differ from that of an AM receiver. However, in view of the wider range of audio frequencies to be handled, greater care is required in the design of the amplifier. Not only should the amplifier give a flat response over a range of 50 to 15,000 cycles but the distortion in the amplifier must be of a very low order over the entire frequency range.

If appreciable distortion is present, cross-modulation will occur when two or more audio frequencies are simultaneously present at the input, creating additional components at the sum and difference frequencies in the output. Harmonics of the input frequencies will also be generated. In view of the wider range of audio frequencies reproduced in the FM system, it is especially important that such undesirable distortion be held to a minimum.

In view of the marked reduction of noise obtained in the FM system, the noise and hum level of the audio amplifier must be very low. This permits the receiver to deliver the dynamic range of the program at the studio and thereby to contribute to the realism of the reproduction.

No audio system is better than its loudspeaker. The wide frequency range to be reproduced by the loudspeaker system of an FM receiver creates a difficult problem in loudspeaker design. Unfortunately, the requirements of a loudspeaker for reproducing the high-frequency range most efficiently are opposed to the requirements of an efficient low-frequency speaker.

In general, low-frequency speakers demand a large diaphragm and comparatively heavy driving coil system to handle the large amplitudes of the audio currents, whereas high-frequency speakers should have a light cone and coil system capable of vibrating rapidly in response to high-frequency currents of much smaller amplitude.

In order to obtain efficient reproduction of both the high and the low frequencies, dual speaker systems are usually employed. The output of the audio amplifier is divided by means of an electrical network so that the low-frequency components are routed to a speaker designed for low frequencies, and the high-frequency components, say those above 1,500 or 2,000 cycles, are delivered to a high-frequency speaker.

The small high-frequency speaker, or *tweeter*, is usually mounted coaxially with and directly in front of the low-frequency speaker, or *woofer*. This simplifies the installation of the speaker system in the receiver cabinet.

**Squelch Circuits** ★ FM receiver circuits inherently have a high noise level when no signal is tuned in. In the FM communications services, where a receiver is tuned to a specific frequency for long stand-by periods in anticipation of signals that may appear at any time, the continuous roar of noise is highly objectionable to the listener on watch. In a communications

receiver, therefore, it is desirable that a *squelch system* be incorporated for the purpose of silencing the audio system during those periods when no signal is being received.

Similarly, in broadcast receivers, it is undesirable to have a large noise output when tuning from one station to another. A squelch system eliminates this undesirable interstation noise.

Most squelch circuits operate on the principle of applying a large negative

at zero grid voltage. Thus, in the absence of signal, the voltage across the cathode resistor  $R_C$  is about  $36/2$  or 18 times the normal bias of the first audio amplifier. A negative bias of  $-5$  volts is necessary to bring about complete cut-off of plate current in the 6AC7 squelch tube, restoring the normal bias of  $-2$  volts on the first audio amplifier tube. This voltage appears across the first limiter resistor  $R_1$  at relatively low signal level.

In locations where the noise level is very

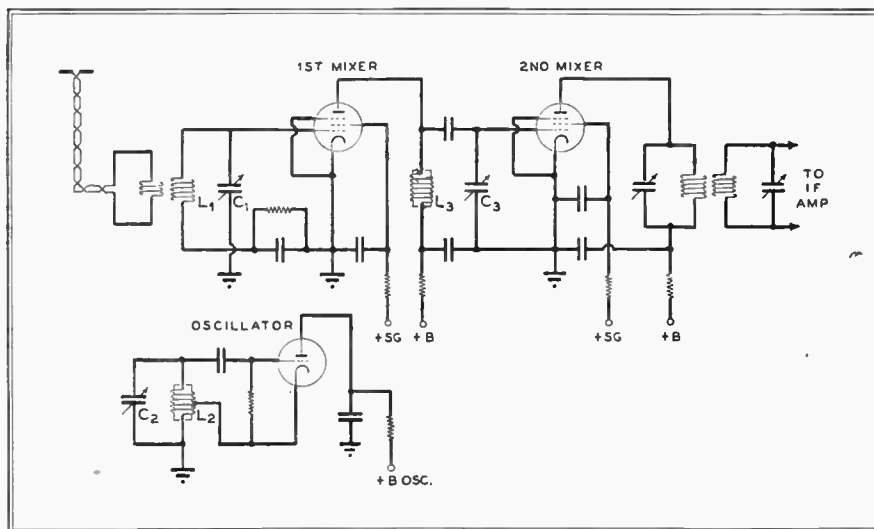

FIG. 69. FUNDAMENTAL CIRCUIT OF DOUBLE SUPERHETERODYNE RECEIVER, WHICH PROVIDES LARGE RF GAIN WITH GOOD STABILITY

bias on the grid of the first audio amplifier tube whenever the signal voltage is very low or entirely absent at the limiter input. The squelch bias must be sufficiently in excess of cut-off to prevent the noise output of the discriminator from causing a plate current to flow in the first audio amplifier tube, even momentarily on the noise peaks.

Figure 67 shows a typical squelch circuit. During the reception of signals, the first amplifier tube obtains its normal operating bias from cathode resistor  $R_C$ . The squelch tube is biased beyond cut-off by the negative voltage taken from the first limiter resistor  $R_1$ .

When the signal voltage at the limiter is removed, either through shutting down the transmitter or detuning the receiver, the rectified voltage across resistor  $R_1$  of the first limiter falls to a very low value. The squelch tube bias is, therefore, almost entirely removed and the tube draws a heavy plate current by way of cathode resistor  $R_C$ . The increased voltage drop across  $R_C$  biases the first audio amplifier tube beyond cut-off, until a signal is applied again at the first limiter grid.

In this typical case, the first audio-amplifier tube is a 6SQ7 which draws 0.9 milliamperes through the cathode resistor  $R_C$  of 2,200 ohms, and operates with a normal bias of 2 volts. The squelch tube is a 6AC7 which is operated without a plate load resistor and draws 36 milliamperes

low, the squelch system may shut off weak signals from which reasonably satisfactory reception could be obtained. It is desirable, therefore, that a switch be provided for stopping the squelch action. In the circuit shown in Fig. 67, this switch serves to disconnect the cathode of the squelch tube, and thus opens the circuit through which the squelch current is drawn.

**Tuning Indicators** ★ To avoid distortion in the discriminator, the center frequency of the voltage at the limiter output should equal the resonant frequency of the discriminator tuned input circuit. The discriminator will then be operated at the mid-point of its linear characteristic and will deliver an audio voltage having the same wave form as the audio modulating voltage at the transmitter.

When the center frequency of the signal applied to the discriminator approaches but does not equal the resonant frequency of the discriminator tuned circuit, operation occurs about a point off the center of the linear portion of the discriminator characteristic. Under such conditions the discriminator output contains 1) a DC component having a magnitude and polarity depending upon the extent and direction by which the applied frequency differs from the resonant frequency, 2) an AF component of the same frequency as that of the audio modulating



voltage at the transmitter and 3) harmonics of the AF component representing distortion resulting from operation on the curved portions of the discriminator characteristic.

In order to minimize such distortion, a device is needed to enable listeners to tune their receivers more accurately than is possible when depending upon the ear alone.

One solution of the tuning problem lies in the use of an AFC system actuated by the DC component of the discriminator output, which would automatically correct the oscillator frequency by means of a reactance tube whenever the receiver is slightly mis-tuned or the oscillator drifts. The theory of operation of the reactance tube has been already explained.

The other solution involves the use of a visual tuning indicator, such as a meter or tuning-eye.

Fig. 68 (A) shows a tuning-eye indicator circuit controlled by DC voltage taken from the grid leak of the first limiter stage. As the receiver dial is tuned *toward* the setting for the station, the beat frequency created by the signal and oscillator frequencies approaches the intermediate frequency of the receiver, to which the IF amplifier, limiter, and discriminator circuits are resonant. This causes the RF voltage across the limiter tuned circuit condenser C to rise, creating a large DC voltage across grid leak  $R_1$ . This DC voltage is applied by way of DC filter  $R_2C_2$  to the grid of the tuning-eye tube in negative polarity, and causes the shadow angle to diminish.

If the receiver dial is tuned beyond the setting for the station, the beat frequency created by the signal and oscillator frequencies draws away from the intermediate frequency of the receiver to which the tuned circuits are resonant. The RF voltage across the limiter tuning condenser C decreases, thereby reducing the negative bias applied by grid leak  $R_1$  to the limiter tube, and causing the shadow angle to increase.

At the correct tuning adjustment, the *maximum* negative voltage is developed in the limiter grid leak and applied to the grid of the tuning eye, so that the *least* shadow angle is obtained.

As stated previously, the condition to be satisfied for correct tuning adjustment is that the applied frequency at the discriminator be equal to the resonant frequency of the discriminator input circuit. The above method of tuning assumes that the alignment of the limiter, IF amplifier, and discriminator tuned circuits will be maintained exactly at the intermediate frequency of the receiver.

Actually, in view of the high order of the intermediate frequency involved, it can be expected that the circuits may be slightly out of alignment at times. Some set designers prefer to obtain the control voltage of the tuning eye from the discriminator, since this is the receiver stage

in which exact tuning is very important.

Fig. 68 (B) and 68 (C) show two tuning indicator circuits actuated by the DC component of the discriminator output, which appears whenever the center frequency of the signal applied at the discriminator differs from the resonant frequency of the discriminator tuned circuit.

In Fig. 68 (B), the DC component of the discriminator output voltage is isolated by means of a DC filter RC, and is applied to the grid of a tuning-eye tube. The tuning-eye is adjusted by means of a variable cathode resistor  $R_C$ , so that the eye just closes when there is zero voltage at the discriminator output. A convenient way to make this preliminary adjustment is to remove the last limiter tube temporarily, while adjusting  $R_C$  to make the eye close.

In the case of the circuit shown in Fig. 67 (B) it will be found that when no signal is tuned in, the eye is closed. When the dial is tuned past the setting at which a station is heard, the eye first opens and then closes and overlaps, or vice-versa, depending upon the direction in which the dial is turned. The correct tuning adjustment is at the transition point between an opening and an overlap, where the eye is just closed.

Fig. 68 (C) shows a circuit operating on the same principle as that of Fig. 68 (B), except that a tuning meter is employed instead of a tuning-eye. Tuning is accomplished by bringing the meter indicator to a reference mark on the meter scale.

While the indicator circuit in Fig. 68 (B) has the advantage of being operated from the discriminator stage, an ob-

jecting the eye open *above and below* resonance in his AM receiver. Thus the use of a tuning rectifier, as shown in Fig. 64 (D), is favored by some set designers.

In this circuit, when the applied frequency exceeds the resonant frequency and the voltage at the discriminator output terminal A is, say, positive with respect to ground, the current drawn through tuning rectifier diode  $D_2$  produces a voltage drop in the rectifier level resistor  $R_L$  of such polarity as to reduce the negative voltage on the grid of the tuning-eye, thereby opening the eye. When the applied frequency is less than the resonant frequency and terminal A is negative with respect to ground, then current is drawn in the *same* direction through  $R_L$  as before, but by way of diode  $D_1$ . Again a voltage is applied to grid of the tuning eye in such polarity as to open the eye. Therefore, the eye closes at the correct dial setting of the receiver and opens above or below the correct setting, similarly to tuning eyes in AM receivers.

**Double Superheterodyne FM Receivers** ★ In the preceding section, stress was laid upon the need for high RF and IF gain in FM receivers, in order that weak signal voltages can be brought up to a level sufficient to saturate the limiter. Moreover, it was stated that a gain of 15,000 represented about the maximum that could be obtained safely from the mixer and IF stages in the factory production of receivers without running serious risk of encountering instability in the IF amplifier because of regenerative coupling between

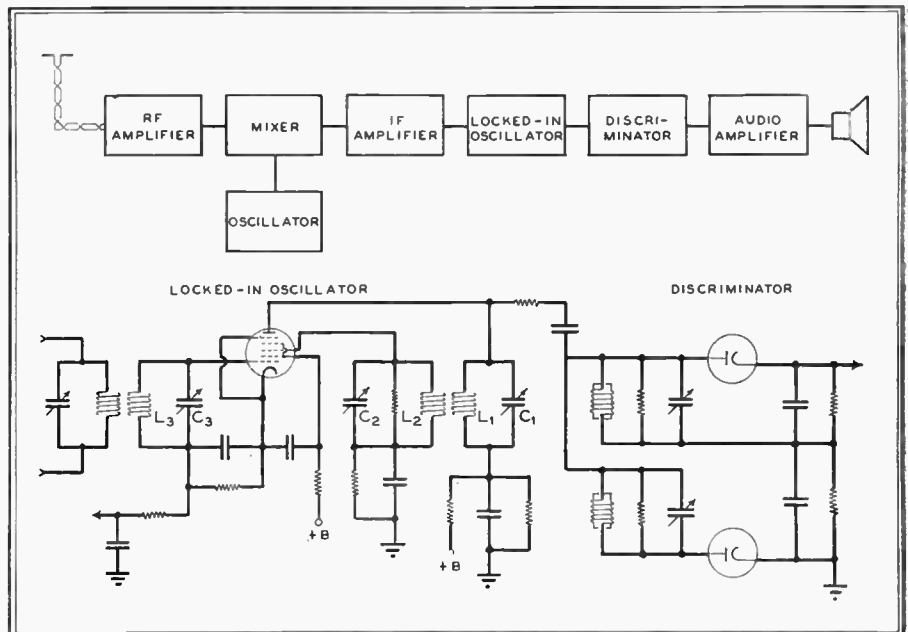

FIG. 70. BLOCK DIAGRAM OF BEERS FM RECEIVER WITH CIRCUIT DIAGRAM OF LOCKED-IN OSCILLATOR AND DISCRIMINATOR

jection may be raised because, during tuning, the shadow angle of the eye varies in a manner that may puzzle the uninformed operator who has been accustomed

stages. This condition demands a large gain in the first RF amplifier stage; in fact, a larger gain than can be obtained easily at FM frequencies.

One solution to this problem of obtaining large overall gain without requiring excessive gain at one intermediate frequency lies in the use of a special circuit arrangement called the *double superheterodyne* or *triple-detector superheterodyne*. Here, two intermediate frequencies are employed, thus reducing the amount of gain that is required at each frequency.

The logical circuit arrangement for a double superheterodyne would appear at first thought to include a variable-frequency oscillator to reduce the signal frequency to the first intermediate frequency in the first mixer, and another oscillator, of the fixed-frequency type, to lower the frequency to the second intermediate frequency in the second mixer. Actually, such an arrangement causes serious difficulty because of spurious signals produced by beating together the fundamentals and harmonics of the oscillator.

A practical circuit arrangement employed in FM receivers designed to tune over a range of frequencies is shown in Fig. 68. Here the oscillator frequency at any particular dial setting is half the difference between the signal frequency for that dial setting and the second IF.

For example, in Fig. 69, assume that the second intermediate frequency is 4.3 mc. and the signal frequency is 45.5 mc. The input tuned circuit of the first mixer is resonant at 45.5 mc. and the oscillator tuning circuit constants  $L_2C_2$  are such as to give an oscillator frequency of  $(45.5 - 4.3)/2$ , or 20.6 mc.

The oscillator is coupled inductively or capacitively to the first mixer and causes a beat component to appear in the output at the difference frequency of  $45.5 - 20.6$  or 24.9 mc. The tuned parallel circuit  $L_3C_3$  is resonant at this difference frequency, causing a voltage of the difference frequency to be established across  $L_3C_3$ .

The plate current of the first mixer also contains a strong component at the oscillator frequency. The impedance offered by  $L_2C_2$  to the oscillator frequency of 20.6 mc. is less than that offered to the first intermediate frequency of 24.9 mc. However, the strong component at the oscillator frequency of 20.6 mc. is able to build up an appreciable voltage across the small impedance of  $L_3C_3$ , and this voltage is applied to the grid together with the voltage at the first intermediate frequency of 24.9 mc. This, a difference frequency component at  $24.9 - 20.6$  or 4.3 mc. appears in the plate circuit of the second mixer, and serves to excite the IF amplifier.

Since the output circuit of each mixer tube is tuned to a frequency other than that of its input circuit, high-gain tubes can be employed in both mixer stages

without risking oscillation. Since the conversion transconductance of a tube used as a mixer is from one-third to one-half of the mutual conductance of the same tube used as an amplifier, reasonably good gain can be obtained in the two mixer stages. The use of a single oscillator for both mixer stages overcomes the difficulty with spurious responses that is encountered when two oscillators at different frequencies are employed.

Where still greater receiver gain is desired, as in FM mobile communications services, an additional stage of amplification at the first intermediate frequency may be employed. The selectivity of the IF amplifier between the first and second mixers would be too great to permit a component of voltage at the oscillator frequency to reach the second converter grid by way of the first converter as in Fig. 69. However, where reception at only one frequency is desired, the circuit can be designed so that only one crystal oscillator is employed. The fundamental of the oscillator is applied to the second mixer and a higher harmonic is coupled to the first mixer.

**The Beers Receiver** ★ Fig. 70 shows a block diagram of a special receiver circuit arrangement devised by G. L. Beers of RCA, in which the conventional limiter and discriminator are respectively replaced by a locked-in oscillator and a reduced-range discriminator. The circuit of the oscillator and discriminator are shown beneath the block diagram.

The locked-in oscillator employs a pentagrid-converter type of tube. The plate circuit  $L_1C_1$  of the oscillator is tuned to a frequency that is one-fifth of the nominal intermediate frequency of the receiver. For example, if the intermediate frequency is 4.3 mc., circuit  $L_1C_1$  will be tuned to  $4.3/5$  or .86 mc.

Energy is transferred by inductive feedback from the oscillator plate circuit  $L_1C_1$  to circuit  $L_2C_2$ , which is connected to grid No. 3. In order to accentuate the even harmonic content in the oscillator output, grid circuit  $L_2C_2$  is tuned to the second harmonic, 1.72 mc., instead of the oscillator fundamental, .86 mc.

The FM signal is applied to grid No. 1 by way of tuned circuit  $L_3C_3$ , which is coupled to the IF amplifier. Grids Nos. 2 and 4 are held at RF ground potential and serve to minimize electrostatic coupling between the signal input and oscillator circuits.

When no signal is being received, the oscillator operates at the frequency of its tank circuit, 860 kc. Under this condition the discriminator output voltage is zero.

If a signal voltage having a frequency near the intermediate frequency of 4.3 mc. is applied to grid No. 1 of the oscilla-

tor tube, it will modulate the electron stream and will combine with the fourth harmonic of the oscillator frequency, 3.44 mc., to give a component of oscillator plate current having the difference frequency of nearly  $4.3 - 3.44$  mc., or .86 mc. Such a component of plate current can produce a voltage across the tank circuit  $L_1C_1$  resonant to 860 kc. that is appreciable compared to the voltage set up across this circuit by the oscillator alone. The result is that the oscillator will *lock-in* at one-fifth of the signal frequency and *will follow any small variations in the signal frequency* that may occur. For example, if the FM signal at the oscillator input is  $4.3 \text{ mc.} \pm 75 \text{ kc.}$ , the signal at the oscillator output will be  $.86 \text{ mc.} \pm 15 \text{ kc.}$  The oscillator output signal is demodulated in the discriminator, which is designed to have a linear characteristic over a range somewhat in excess of  $2 \times 15$  or 30 kc.

The sixth harmonic of the oscillator frequency may also combine with the signal frequency to produce a component in the plate current having a frequency nearly equal to the natural frequency of the oscillator. Whether the fourth or the sixth harmonic will be the one which causes the locking-in effect will depend on which of the harmonics predominates. The end result is essentially the same. The oscillator operates at one-fifth of the instantaneous signal frequency at the IF amplifier output, and the amplitude of the oscillator output voltage is substantially independent of the amplitude of the signal.

The frequency range over which lock-in control of the oscillation frequency will be maintained is limited. In fact, the discriminator input circuit constants are so chosen as to tend to keep the oscillator tank circuit impedance essentially resistive over a wider range than would be obtained if the discriminator were not coupled to the oscillator. In this manner, lock-in operation can be obtained over a range of about  $\pm 110 \text{ kc.}$  with a 1-volt signal on the No. 1 grid of the oscillator. This is sufficiently in excess of the  $\pm 75\text{-kc.}$  deviation of an FM broadcast signal to allow for slight mis-tuning and for oscillator drift.

When the applied frequency differs from the intermediate frequency by appreciably more than 110 kc., say by 200 kc., a voltage very much in excess of 1 volt is necessary on the No. 1 grid of the oscillator to obtain lock-in operation. Thus the oscillator is prevented from responding to signals on channels adjacent to the one occupied by the desired signal. In fact, the improvement in the suppression of adjacent channel interference is the primary advantage claimed for the Beers receiver arrangement.

# Theory of Frequency Modulation

## Section 8: Principles of Automatic Frequency Control, and Applications to FM Receivers

UNLESS a radio receiver is tuned accurately to the frequency of the incoming signals, the audio quality is distorted and there may be heavy background noise. Slight mistuning may result from careless manual adjustment or lack of precise resetting in the mechanisms of automatic tuning devices. Even when the initial tuning is accurate, variations in line voltage or thermal drift in circuit components which are affected by changes in ambient temperature may result in mistuning.

Automatic frequency control circuits for AM receivers were introduced about 1936 on remote-controlled models to compensate for errors in the tuning mechanism. For this purpose, AFC proved highly satisfactory. It is doubtful, however, if the use of AFC is justified on manually-operated broadcast receivers as a substitute for accurate adjustment by hand.

**Application of AFC to FM Sets** ★ On FM receivers, AFC has two useful applications:

1. It is practically a requirement on broadcast receivers which employ automatic tuning of the mechanical type. At least, no mechanical device has been perfected so far to the point where it is accurate enough to reset a tuning condenser repeatedly at exact resonance. Also, in the band from 88 to 108 mc., it may prove less expensive to employ AFC than to compensate for drift due to thermal changes.

2. In communications services operating at 152 to 162 mc., and perhaps in the 70-mc. band, AFC will be used to compensate for drift in both mobile and remote relay installations.

Some engineers have expressed the opinion that AFC cannot be used successfully on FM receivers. However, such receivers were developed by Freed Radio Corporation early in the last war, and were produced in great numbers for the U. S. Navy.<sup>1</sup> The circumstances which called for this development are extremely interesting.

In 1942, engineers of the NDRC Underwater Sound Laboratory at New London, Conn., conceived the idea that sounds from a submarine could be picked up in patrol planes by parachuting a radio telephone transmitter down to the surface of the water. The plan was to equip the transmitter with a microphone and a length of cable to be released upon contact with the water. A crude model of the device was built at New London, and a

<sup>1</sup> It should be noted that this was one of the first, if not the very first, uses of FM in Navy radio equipment. Considerable pressure was brought to bear on the Underwater Sound Laboratories to use AM, but in exhaustive comparative tests, FM was found to be so much superior to AM in performance that the FM design was finally adopted.

contract was awarded Freed Radio to design and perfect the transmitter and a suitable receiver to pick up the signals.

Transmitters of several different frequencies were used, identified as to their frequency by colored bands. Corresponding color markings were put on the receiver dial to facilitate tuning.

Because the transmitters were not crystal-controlled, they drifted considerably in frequency after they were dropped into the water. And because the aircraft receiver could not be adjusted constantly to follow the transmitter drift, it was necessary to use AFC in the receiver.

The successful operation of this equipment is indicated by the high score of submarines sunk and captured through their use, particularly by planes from the baby flat-tops.

It was possible to observe the AFC action in the tuning eye with which this receiver was equipped. As the tuning was

heterodyne frequency produced by mixing the incoming signals with the local oscillator frequency.

2. A control circuit to which is applied the direct current or voltage from the discriminator, and which serves to shift the oscillator frequency enough to bring the heterodyne frequency into resonance<sup>2</sup> with the IF circuits.

The use of AFC in FM circuits is somewhat simplified, since the discriminator is an essential part of an FM receiver. This is illustrated in Fig. 71, which shows the elements of AM and FM superheterodyne receivers employing AFC. The chief difference, then, between the AM and FM systems is that the FM discriminator stage which is required to demodulate the incoming signals also furnishes the voltage to operate the AFC control on the oscillator.

**AFC Control Circuit** ★ Before discussing the

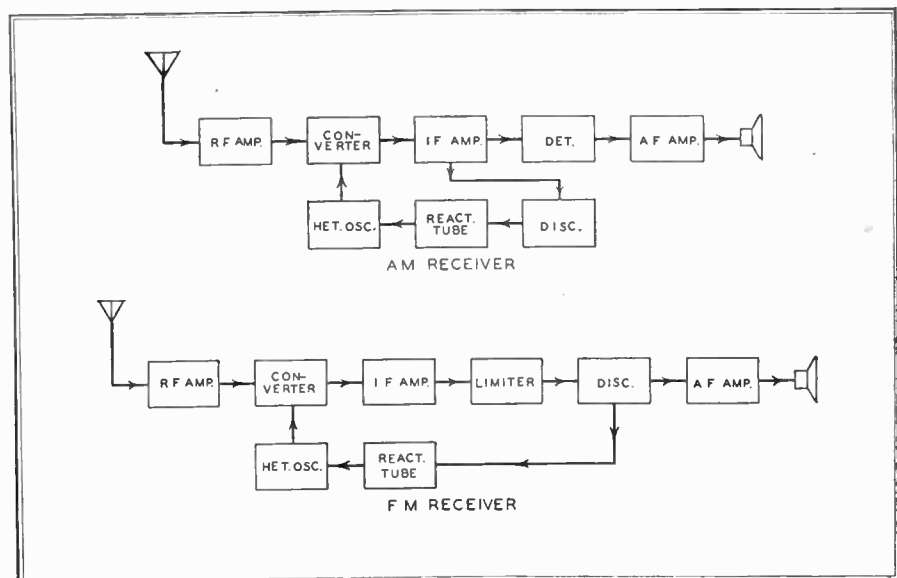

FIG. 71. BLOCK DIAGRAMS SHOWING THE DIFFERENCE BETWEEN AUTOMATIC FREQUENCY CONTROL CIRCUITS FOR AM RECEPTION, ABOVE, AND FOR FM, BELOW

varied, and the circuits were brought near the point of resonance with the incoming signals, the eye closed suddenly and remained closed even beyond the resonance point. There was no critical frequency adjustment, since the AFC action produced a response curve with steep sides and a relatively wide, flat top.

**Elements of the AFC System** ★ An automatic frequency system for AM receivers consists of two major networks. These are:

1. A frequency discriminator which produces a direct current or voltage whose polarity and magnitude are determined by the degree of difference between the nominal IF frequency of the receiver and the

control circuit itself, it might be well to consider first the heterodyne oscillator and to determine just how to best accomplish the desired control of its frequency adjustment. One commonly-used oscillator circuit is the Hartley type, shown in Fig. 72. The frequency of oscillation is determined by the tuned circuit LC. Grid excitation voltage of the proper phase is obtained by connecting the grid and plate of the tube to the ends of inductance L, and connecting the cathode to a tap on the coil. The ratio of the RF plate voltage  $E_p$  to the

<sup>2</sup> Absolute compensation is impossible because the correcting voltage results from off-resonance tuning. However, a correction ratio of 100 to 1 or better can be obtained in commercial practice.



grid exciting voltage  $E_G$  is determined by the position of the cathode tap on the coil.

To shift the frequency of oscillation, it is necessary to change the value of the inductance  $L$  or the capacity  $C$ . While it is possible to do this mechanically, such a method would not serve the purpose of AFC action. However, if we can cause a current which is out of phase with the circulating current to flow through the tank circuit  $LC$ , it will appear to the oscillator as though  $L$  or  $C$  has been varied, thereby causing the reactances to become unbalanced. The oscillator will then shift frequency until the capacitive and inductive reactances are in balance again.

What is necessary to produce AFC action, therefore, is a circuit or network which will produce a varying out-of-phase current flow through the oscillator tank circuit in response to variations in the DC output voltage from the discriminator. This can be accomplished most easily by using a simple vacuum tube circuit, such as is illustrated in Fig. 73. A pentode tube is used, with the plate-cathode circuit shunted across the oscillator tuned circuit, and the control grid bias supplied by a phase-shifting network across the tuned oscillator circuit. The grid voltage

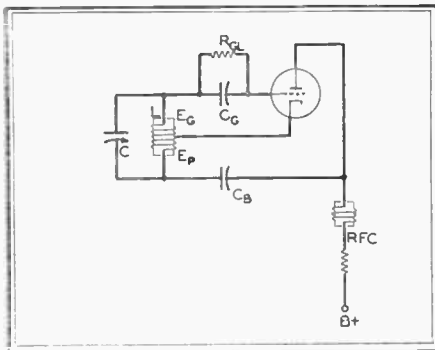

FIG. 72. HARTLEY OSCILLATOR USED FOR SUPERHETERODYNE RECEIVER

is  $90^\circ$  out of phase with the voltage across the tuned circuit, and the resulting plate current is likewise  $90^\circ$  out of phase with the tuned circuit voltage.

Thus the control tube appears as a shunting reactance, the value of which depends upon the transconductance of the pentode and, hence, upon the bias applied to the grid. The discriminator output voltage, applied as a bias on the control grid, varies the transconductance about a value determined by the bias obtained from the tuned circuit. The tube used in this manner is commonly called a reactance tube, since it appears as a reactance to the circuit across which it is connected.

In Fig. 73, the current  $I_T$  is in phase with voltage  $E_T$ . This voltage across the tuned circuit causes the current  $I_1$  to flow through the series combination of resistance  $R_1$  and capacitance  $C_1$ . The resistance of  $R_1$  is several times larger than the reactance of  $C_1$ , so that  $I_1$  will be in phase with  $E_T$ . Since  $C_1$  presents a practically pure reactance, the voltage  $E_C$  across  $C_1$

will lag  $I_1$  by  $90^\circ$ . This voltage is applied to the grid of the reactance tube  $T_R$ . The plate current  $I_P$  will be in phase with  $E_C$ , and thus will lag the tuned circuit voltage  $E_T$  by  $90^\circ$ . Plate current  $I_P$  will essentially flow only through the oscillator tuned circuit, since the impedance of every other possible path is considerably higher than that of  $LC$ . (The impedance presented at the operating frequencies is relatively high for the RF choke RFC, and relatively low for the blocking capacitors  $C_B$ .) To the oscillator, the lagging current flowing through its tuned circuit appears as a decrease in the inductive reactance of  $L$ . Therefore, the frequency of oscillation will increase until the inductive and capacitive reactances are balanced, and the oscillator is stable again.

plate current  $I_P$ . Current  $I_P$  depends directly upon the transconductance of the reactance tube, which is, in turn, controlled by the grid voltage  $E_C$ . The total static grid voltage locates the operating point on a linear portion of the transconductance characteristic, and the discriminator output voltage  $\pm E_M$  varies the transconductance about the operating point. Since there will be a certain amount of reactance added to the tuned circuit  $LC$  even when there is no frequency shift, i.e., when  $E_M = 0$ , it is necessary to take this into account when designing the tuned circuit, in order to have it cover the desired frequency range.

It is interesting to compare the use of the reactance tube for AFC with its application to frequency modulation for FM

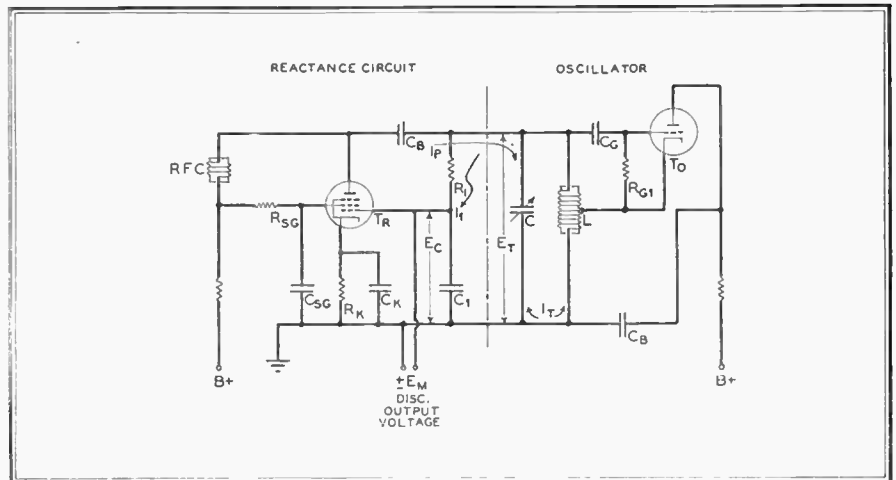

FIG. 73. FREQUENCY OF THE OSCILLATOR, RIGHT, IS VARIED BY THE REACTANCE TUBE, LEFT, WHICH APPEARS TO THE OSCILLATOR AS A VARIABLE REACTANCE

If an inductance is used in the phase-shifting network, in place of capacitor  $C_1$ , the excitation voltage would lead the current  $I_1$ , and current  $I_P$  would lead voltage  $E_T$ . This condition would appear as a decrease in capacitive reactance, and the oscillator frequency would decrease to restore stability.

However, it is preferable to use a capacitor at  $C_1$ , rather than an inductance, for a number of reasons. The  $Q$  of a capacitor is generally higher than that of an inductance, which would make the phase shift more nearly  $90^\circ$ . The distributed capacity of an inductance may resonate it within the frequency range used, causing the control action to disappear at the resonant frequency.

It is important that the plate current  $I_P$  and the tuned circuit voltage  $E_T$  be as nearly  $90^\circ$  apart in phase as is possible, in order that there will be no resistive component of  $I_P$ . If such a component exists, it will act as a resistance shunted across the tuned circuit  $LC$ , causing the amplitude of the oscillator output to vary with the magnitude of the frequency shift which the AFC circuit is correcting.

The magnitude of the apparent reactance shunted across  $LC$  by the reactance tube varies inversely with the

transmitters, the details of which were set forth in Section 4.

**Discriminator Circuits** ★ Either the detuned-circuit discriminator or the center-tuned discriminator can be used in conjunction with the AFC control circuit. Both types of discriminators are described in Chapter 7, together with an explanation of their functions.

From either type, a DC voltage can be obtained, the magnitude and polarity of which are determined by the extent of the difference between the heterodyne frequency and the nominal IF frequency of the receiver, as is required to operate the AFC control circuit.

**AFC Operation** ★ There are a number of other possible methods of controlling the frequency of oscillation, but the one discussed herein has proved to be highly satisfactory in commercial practice. Of course, in the practical application of the system to any particular receiver there will be considerable variation in details, but the basic circuit would be retained.

At this time it may be helpful to review briefly the sequence of operation of the entire system, from the input to the discriminator transformer to the final cor-

rection of the heterodyne oscillator frequency.

A complete circuit, combining a discriminator and control, is shown in Fig. 74. The discriminator transformer is tuned to the IF frequency, and the oscillator is adjusted to the proper frequency to produce the IF beat frequency when heterodyned with the incoming signal.

When the receiver is correctly tuned and there have been no changes in com-

as though an inductive reactance were shunted across its tuned circuit. However, these conditions are termed quiescent, or normal, stable conditions, and the apparent reactance produced by the reactance tube has already been taken into account in designing the tuned circuit for proper frequency range.

Now, if the receiver is tuned slightly below the desired frequency, so that the signal applied to the IF amplifier is slightly

capacitive reactance of  $C_S$  will predominate over the inductive reactance of  $L_S$ . Thus, the secondary voltages will lead, making the voltage across  $R_2$  the larger, and a negative bias will be applied to the reactance tube. The increase in negative bias reduces the reactive plate current, and therefore increases the apparent reactance shunted across the oscillator tuned circuit. To restore reactance balance and bring the IF frequency signal to the proper frequency, the oscillator will lower its frequency.

**Circuit Design Considerations** ★ For proper results an AFC system should not be considered as an accessory to be added to an existing receiver design. Rather, the receiver with the AFC system should be regarded as a unit to be designed for the desired end result.

An FM receiver in which an AFC system is to be used must have good stability of alignment in the various tuned circuits, as the proper operation of the control system depends upon the maintenance of alignment, especially in the discriminator network. It is desirable to include two IF amplifier stages, as well as two limiter stages, to obtain as much over-all sensitivity as possible. The IF stages must be designed in accordance with the best practice as to amplification, and band-pass characteristics.

Generally, it is desirable to supply the local heterodyne oscillator and the reactance tube with regulated plate voltage, to aid in controlling the oscillator. Tuning drift, due to thermal causes, should be made as small as possible by using temperature compensated components. The use of short leads is especially important in AFC systems, and the reactance tube and its associated components should be so installed that the coupling leads to the local oscillator will be as short as possible.

It may sometimes be desirable to use the second harmonic of the local oscillator for reasons of stability. Under this condition the reactance tube circuit would still be connected across the oscillator tuned circuit, but its holding action range would be doubled, since the plate circuit of the oscillator is tuned to the second harmonic. If insufficient reactive plate current is developed, it can be increased in the usual manner by means of an additional linear amplifier, as shown in Fig. 75.

**Discriminator Sensitivity** ★ In a discriminator of the Foster-Seeley type — that is, one using a center-tapped secondary with both primary and secondary tuned to the same frequency — the sensitivity of the device to changes in frequency of the applied signal is equivalent to the slope of the discriminator characteristic curve at resonance. The sensitivity of the discriminator is an important factor in the design of an AFC system, since it determines the control voltage developed for a given frequency shift. Foster and Seeley

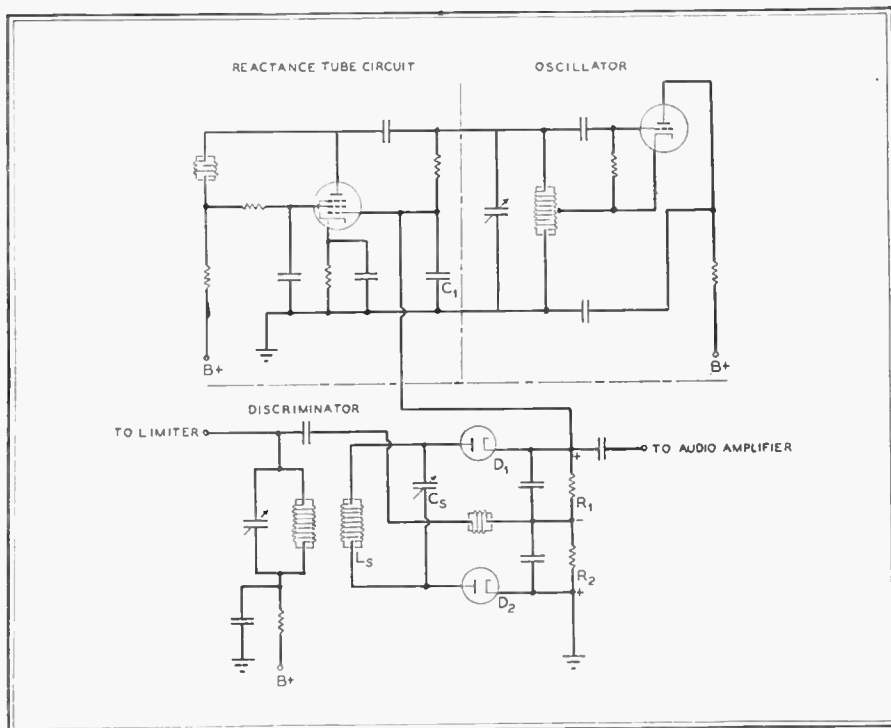

FIG. 74. COMPLETE AFC CIRCUIT, SHOWING THE FM DISCRIMINATOR WHICH SUPPLIES A VOLTAGE TO THE REACTANCE TUBE ACROSS THE OSCILLATOR CIRCUIT

ponents or adjustments due to thermal effects, the IF signal applied to the discriminator transformer primary produces equal and opposite voltages across the secondary. The primary voltage appears, with essentially the same magnitude and phase, across the RF choke. One secondary voltage leads this primary voltage by  $90^\circ$ , the other secondary voltage lags the primary voltage by  $90^\circ$ . The total voltage applied to each diode rectifier consists of the voltage across the RF choke, i.e., the primary voltage, plus the voltage across the corresponding half of the secondary. Since the secondary voltages are equal, and the primary voltage is common to both diodes, the DC output voltages across the load resistors are equal and opposite, hence, there is zero voltage applied to the grid of the reactance tube.

The quadrature voltage developed across  $C_1$ , due to the in-phase current flow produced by the oscillator tuned circuit voltage, is also applied to the grid of the reactance tube, in addition to the self-bias due to the voltage drop across the cathode resistor. This excitation causes a lagging current to flow through the oscillator tuned circuit. To the oscillator it appears

higher in frequency than the amplifier resonant frequency, it will be necessary for the AFC system to retune the oscillator. The same requirements would exist if thermal changes caused the oscillator to drift to a lower frequency.

With the applied frequency higher than the resonant frequency, the inductive reactance of  $L_S$  will exceed the capacitive reactance of  $C_S$ , hence the voltages across  $L_S$  will lag. The AC voltage applied to diode  $D_1$  will be greater than that applied to diode  $D_2$ , and the DC voltage across  $R_1$  will then be the larger, applying a positive bias to the reactance tube grid. A less negative total bias will cause an increase in the reactive plate current flowing in the oscillator tuned circuit, the total effective inductive reactance will be reduced, and the oscillator will increase frequency to balance the tuned circuit reactances and restore the IF signal to the resonant frequency of the amplifier.

If the receiver is off-tune on the high side of the desired signal, so that the signal is lower in frequency than the resonant frequency of the IF amplifier, or thermal changes in the oscillator circuit cause the oscillator frequency to increase, the ca-

give the following formula for calculating sensitivity:

$$S = 8\pi L Q^2 G_m \frac{(AK)^{1/2}}{(1 + K^2) (1 + \frac{AK^2}{4})^{1/2}}$$

- where  $L$  = primary inductance
- $Q$  = quality factor of primary
- $G_m$  = transconductance of tube preceding discriminator transformer
- $A$  = ratio of total secondary inductance to primary inductance
- $K$  = ratio of actual to critical coupling between primary and secondary.  $2\pi f M = K \sqrt{r_1 r_2}$ . ( $r_1$  = apparent primary series resistance, which includes the effect of the plate impedance of the tube, the natural primary series resistance, and any other resistive load other than the secondary, and  $r_2$  = apparent secondary series resistance.)

In deriving this formula the apparent  $Q$  values of primary and secondary (when in circuit) were assumed to be equal. It is apparent that the sensitivity is independent of frequency, proportional to  $L$ ,  $Q^2$  and  $G_m$ , and a function of the ratio of inductances and the percent of critical coupling. It can be shown that, for any ratio of secondary to primary inductance, the optimum coupling will be less than the critical value.

The separation of the two peaks of the discriminator characteristic may be increased to increase the band width, either by raising the value of coupling above optimum, or by reducing the  $Q$  of the circuits. In either case the sensitivity will be reduced; however, changing the coupling will affect the sensitivity the least for a given change in the peak separation. If the coupling between the primary and secondary of the discriminator transformer is not greater than 75% of the critical value, the peak separation of the discriminator characteristic will be approximately equal to  $f_0/Q_s$ , where  $f_0$  is the carrier frequency and  $Q_s$  is the effective  $Q$  of the secondary with diode loading considered.

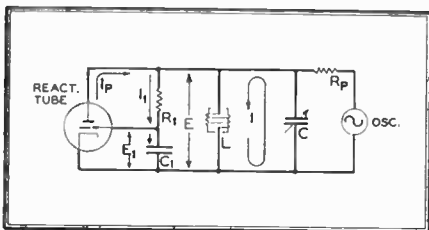

FIG. 76. RC PHASE-SHIFT NETWORK

**Time Delays** ★ Attention must be given to the relative time delays of the discriminator output filter system and the power supply filter. The discriminator filter should have a smaller time constant than that of the power supply, in order

that the AFC system may prevent changes in the oscillator frequency due to line voltage variations.

**Discriminator Filter** ★ It is necessary to insert a low-pass filter in the discriminator output line to the reactance tube, in order that the reactance tube will not be affected by low frequency audio voltages.

taken into account, ordinary coupled-circuit theory can be used in calculating the primary, secondary and output voltages.

**Reactance Tube** ★ The maximum amount of control or holding action is proportional to the product of the transconductance  $G_m$  of the reactance tube,

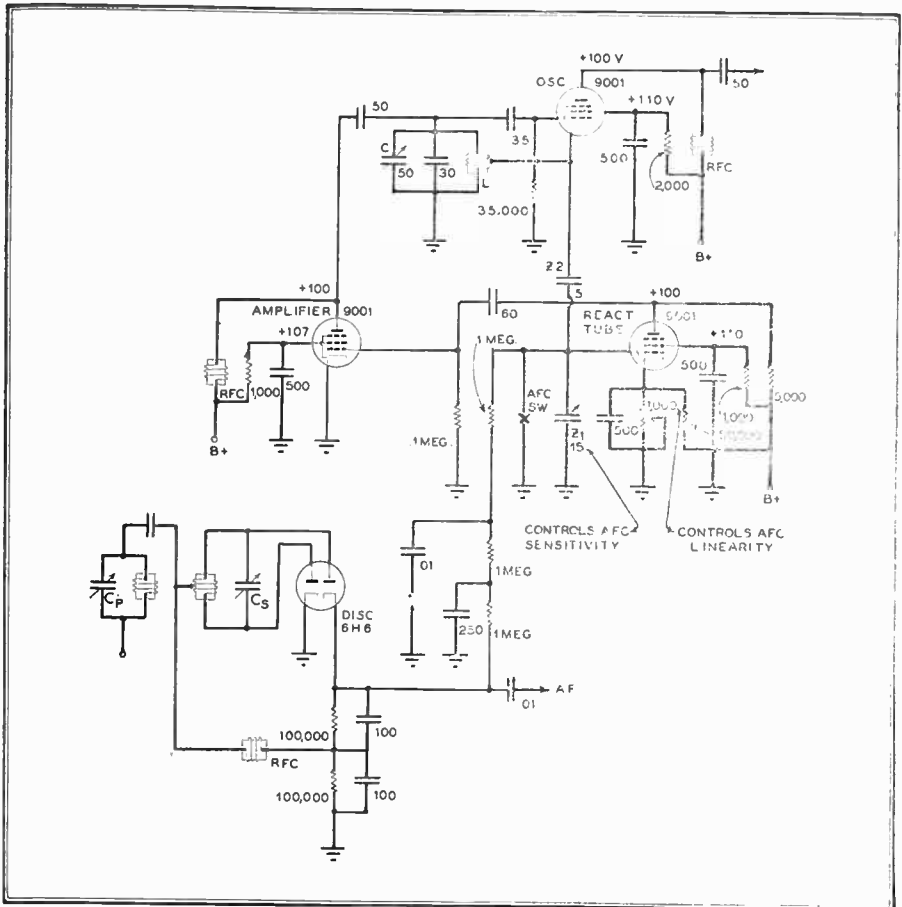

FIG. 75. WHEN THE SECOND HARMONIC OF THE LOCAL OSCILLATOR IS USED FOR STABILITY, A LINEAR AMPLIFIER MAY BE NEEDED TO INCREASE THE REACTIVE PLATE CURRENT

**Polarity** ★ The polarity of the voltage developed at the ungrounded output terminal of the discriminator network, with respect to ground, is determined solely by the sign of the coupling between the two tuned circuits. It is desirable to so phase the inductive coupling as to compensate for capacitive unbalances existing in the circuit. Then the polarity of the output voltage may be changed, when necessary, by interchanging the grounded and ungrounded terminals.

In the discriminator circuit shown in Fig. 75, the diode rectifiers produce a loading effect on the discriminator transformer. In the case of the primary, the load is equivalent to a shunt resistance equal to the diode load divided by four times the efficiency of rectification,  $R_1/4\eta$ . For the full secondary, the load is equivalent to a shunt resistance equal to the diode load divided by the rectification efficiency,  $R_1/\eta$ . Providing the effect of this loading on the  $Q$ 's of the circuit is

and the grid bias  $E_g$ . Since it is desired in practice that the range of holding action be as large as possible for a given change in bias, a sharp cutoff tube should be selected. The transconductance of the tube should change linearly with variations in grid bias. These requirements are satisfied by pentodes that produce substantial power amplification. Such tubes, besides having high transconductance, also isolate the plate current from the plate voltage, if the screen grid is operated at a lower voltage than the plate. In addition, since the plate current depends to a great extent upon the screen voltage, the discriminator output voltage can be impressed on the screen rather than on the control grid, thus reducing back actions.

By proper choice of the values of capacitor  $C_1$  and resistor  $R_1$  in the phase shift network, the amount of holding action obtained can be varied to meet requirements. The oscillator tuned circuit voltage is affected by the resistive branch of the



phase shift network; therefore, this resistance value should be selected first to give the proper tuned circuit voltage over the desired frequency range. The capacitive branch has little effect on the tuned circuit voltage; it does, however, govern the amount of holding action of the reactance tube, since it determines the alternating voltage applied between grid and cathode of the reactance tube. When the peak value of this alternating grid voltage exceeds the negative grid bias, the holding action ceases.

Therefore, the oscillator tuned circuit voltage appearing across the phase shift network limits the value of the resistive and capacitive branches which can be used without exceeding the negative grid bias. Reducing the tuned circuit voltage across the phase shift network increases the range of control, but the voltage must be sufficient to result in adequate translation. Since the impedance of the capacitive branch varies inversely with frequency, the tuned circuit voltage should vary reciprocally and directly with frequency, in order that a uniform holding range will be realized. The tuned circuit voltage should also remain as nearly constant in magnitude as possible over the entire frequency spectrum for best results.

The holding action limit is governed by reactance tube plate current cutoff with negative discriminator output voltage, and by reactance tube grid current with positive discriminator output voltage. The oscillator tuned circuit voltage affects the grid current cutoff point, but does not determine the plate current cutoff point. Hence, when the tuned circuit voltage does not vary inversely with the impedance across the reactance tube, the holding action range will not be symmetrical about the zero discriminator voltage axis.

A simple method of determining the relative merits of tubes, with regard to holding action, is shown in the tables following. The tables illustrate variations in control possibility, using four common pentodes that can be used to develop a reactive plate current. The tubes selected for the examples are the 9001, 6AK5, 1852, and 12SH7. Plate and screen voltages are based upon the manufacturer's recommended values; however, these values can be varied to satisfy particular requirements.

An RC type of phase shift network is used in the example, as shown in Fig. 76. The value of the resistive branch  $R_1$  is selected first so that the proper tuned circuit voltage  $E$  is realized over the desired range. The capacitive branch  $C_1$ , which has little effect on the tuned circuit voltage  $E$ , governs the amount of control. For purposes of illustration, an arbitrary peak value of 25 volts is assigned to the voltage  $E$ , which also appears across the phase shift network  $R_1C_1$ . The resistor  $R_1$  has a value of 50,000 ohms.

Cutoff in the positive direction can be

determined by using trial impedance values of 1,000 ohms and 5,000 ohms for capacitor  $C_1$ . When the capacitive reactance is 1,000 ohms, cutoff in the positive direction will be 0.5 volt; a capacitive reactance of 5,000 ohms will give a cutoff value of 2.5 volts.

The transconductance of a 9001 tube is approximately 2,000 at 0.5-volt bias, and 1,600 with a bias of 2.5 volts. Thus, for a change in the reactance of capacitor  $C_1$  from 1,000 ohms to 5,000 ohms, a change in transconductance from 2,000 micromhos to 1,600 micromhos occurs. This five-to-one change in bias, from 0.5 volt to 2.5 volts, results in a 25% change in the transconductance of the tube.

Using the 6AK5 tube, since its control possibility is highest, circuit values which result in a peak bias of 2.0 volts on the reactance tube will give maximum control. The normal operating bias applied to the reactance tube should be midway between the 2.0-volt  $I_{Xc}$  drop and the negative bias necessary for plate current cutoff. Since the cutoff bias is approximately -6.0 volts, the operating bias on the 6AK5, with zero discriminator voltage applied, should be about -4.0 volts.

#### VARIATION OF CONTROL POSSIBILITY WITH BIAS CHANGES

9001			6AK5		
$E_c$	$G_m$ micromhos	$G_m E_c$	$E_c$	$G_m$ micromhos	$G_m E_c$
-6.5	cutoff	0	-6.0	cutoff	0
5.0	300	1500	5.0	900	4500
4.0	800	3200	4.0	1500	6000
3.0	1400	4200	3.0	3000	9000
2.0	1800	3600	2.0	5000	10000
1.0	2000	2000	1.0	—	—
$E_p$ 250 volts, $E_{sc}$ 100 volts			$E_p$ 180 volts, $E_{sc}$ 120 volts		

12SH7			1852-6AC7		
$E_c$	$G_m$ micromhos	$G_m E_c$	$E_c$	$G_m$ micromhos	$G_m E_c$
-4.0	cutoff	0	-4.0	cutoff	0
3.0	900	2700	3.0	1000	3000
2.0	2700	5400	2.0	4000	8000
1.0	4000	4000	1.0	8000	8000
$E_p$ 250 volts, $E_{sc}$ 100 volts			$E_p$ 300 volts, $E_{sc}$ 100 volts		

**Holding Action** ★ Fig. 77 shows the holding action of a typical reactance tube circuit, where the shaded portion represents the area of instability. When the signal intensity decreases, due to fading, the control action is lost and is not regained unless the receiver is retuned. A sudden drop in line voltage could also reduce the holding action sufficiently that the desired signal would be completely lost. As shown in Fig. 77, the AFC circuit takes control at mid-frequency and holds the output substantially flat until the signal is detuned 200 kilocycles, at which point the AFC loses control and the output drops rapidly to zero. To regain the signal, the receiver must be retuned to nearly the mid-frequency, since the AFC system will not take control again to restore the signal unless this is done. This effect occurs both above and below the mid-frequency. The FM receiver should be tuned so that it is not operating at the outer edge of the control range, i.e., within the shaded areas shown. Whenever the receiver is tuned within this area it

is in an unstable condition and, in addition to possibly introducing unnecessary distortion, the signal may disappear abruptly.

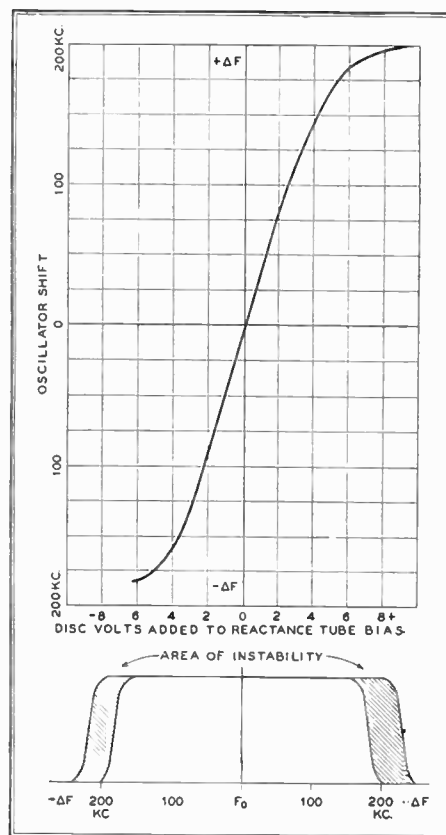

FIG. 77. HOLDING ACTION OF A TYPICAL AFC REACTANCE TUBE CIRCUIT

**Design Equations** ★ The maximum plate current developed by the reactance tube occurs when the discriminator output voltage reaches a positive maximum.

$$I_p \max = \omega CE + G_m E_m + G_m E_1$$

$$(\omega t = 90^\circ)$$

Minimum plate current occurs when the discriminator output voltage reaches a negative maximum,

$$I_p \min = \omega CE - G_m E_m + G_m E_1$$

$$(\omega t = 270^\circ)$$

These values are shown in Fig. 76, where the peak amplitude of the oscillator frequency voltage  $E_1$  applied to the grid of the reactance tube is fixed, since this value,

$$E_1 \text{ peak} = \omega CE + G_m E_m$$

exists with zero discriminator voltage  $E_m$ . In the circuit of Fig. 76, the grid exciting voltage  $E_1$  lags the small exciting current  $I_1$  by an angle of 90 degrees, and the resultant plate current  $I_p$ , flowing through the oscillator tuned circuit  $L-C$ , also lags the tuned circuit voltage  $E$  by the same angle. The total peak current  $I$  through the frequency-determining elements  $L-C$  is, therefore, no longer  $\omega CE$ , but for zero discriminator voltage  $E_m$  becomes

$$I_o = \omega CE - G_m E_1,$$

or approximately

$$I_o = \omega CE - G_m \frac{E}{\omega C_1 R_1},$$

since, for a 90-degree lagging current  $I_p$ , the phase shift network in the circuit shown consists of a capacitive branch

$$Z_1 = \frac{1}{\omega C_1}$$

and a resistive branch

$$Z_2 = R_1,$$

where, in practice the value of  $R_1$  is selected equal to or greater than five times the value offered by the capacitive branch  $Z_1$ , or

$$R_1 \geq \frac{5}{\omega C_1}.$$

The current  $I_1$  flowing through the phase shift network  $Z_1 - Z_2$  is practically equal to

$$I_1 = \frac{E}{R_1}.$$

The grid exciting voltage  $E_1$  applied to the reactance tube is

$$E_1 = \frac{I_1}{\omega C_1} = \frac{E}{\omega C_1 R_1},$$

and the resultant reactive plate current is

$$I_p = E_1 G_m = \frac{E G_m}{\omega C_1 R_1}.$$

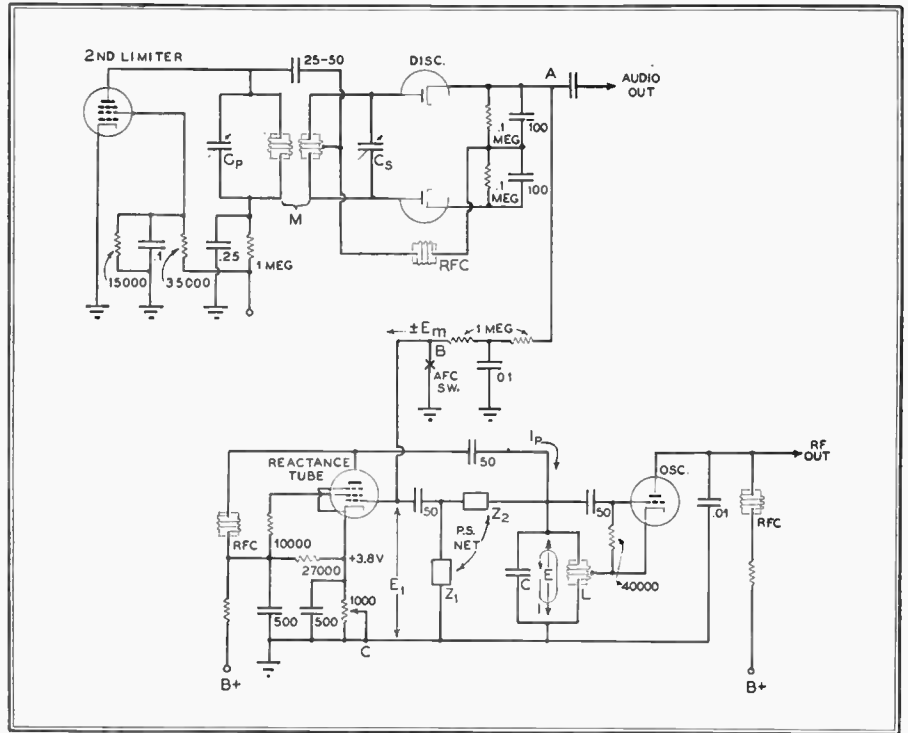

FIG. 79. COMPLETE AUTOMATIC FREQUENCY CONTROL SYSTEM FOR AN FM RECEIVER

The effective impedance applied to the oscillator tuned circuit  $L, C$  is then

$$Z_o = \frac{E}{I_p} = \frac{\omega C_1 R_1}{G_m} = \frac{E}{G_m E_1}.$$

Because this impedance varies directly with frequency, it appears as an in-

ductance  $L_o$ . This apparent inductance can be computed from the equation

$$L_o = \frac{C_1 R_1}{G_m} \text{ henrys,}$$

where the units are farads, ohms, and mhos. Consider, for example, the following values:

$$G_m = 5 \times 10^{-3} \text{ mho}$$

$$R_1 = 50,000 \text{ ohms or } 5 \times 10^4 \text{ ohms}$$

$$C_1 = 2 \times 10^{-12} \text{ farad.}$$

$$L_o = \frac{2 \times 10^{-12} \times 5 \times 10^4}{5 \times 10^{-3}} = 2 \times 10^{-5}$$

henrys,

or 20 microhenrys. The apparent inductance  $L_o$  developed by the circuit of Fig. 76 is shunted across the tuned circuit inductance  $L$ . Hence, the total effective inductance in the oscillator circuit becomes less as  $L_o$  is decreased, resulting in an increase of the oscillator frequency from its nominal value. The effective inductance in the oscillator circuit is

$$L_o = \frac{C_1 R_1 L}{C_1 R_1 + G_m L},$$

and the operating frequency  $f$  will be

$$f = \frac{1}{2\pi\sqrt{CL_o}}.$$

The oscillator frequency, if no inductance were introduced by the reactance tube circuit, would be

$$f = \frac{1}{2\pi\sqrt{CL}}.$$

These equations apply only to static conditions, which exist when zero discriminator voltage  $E_m$  is developed, i.e.,

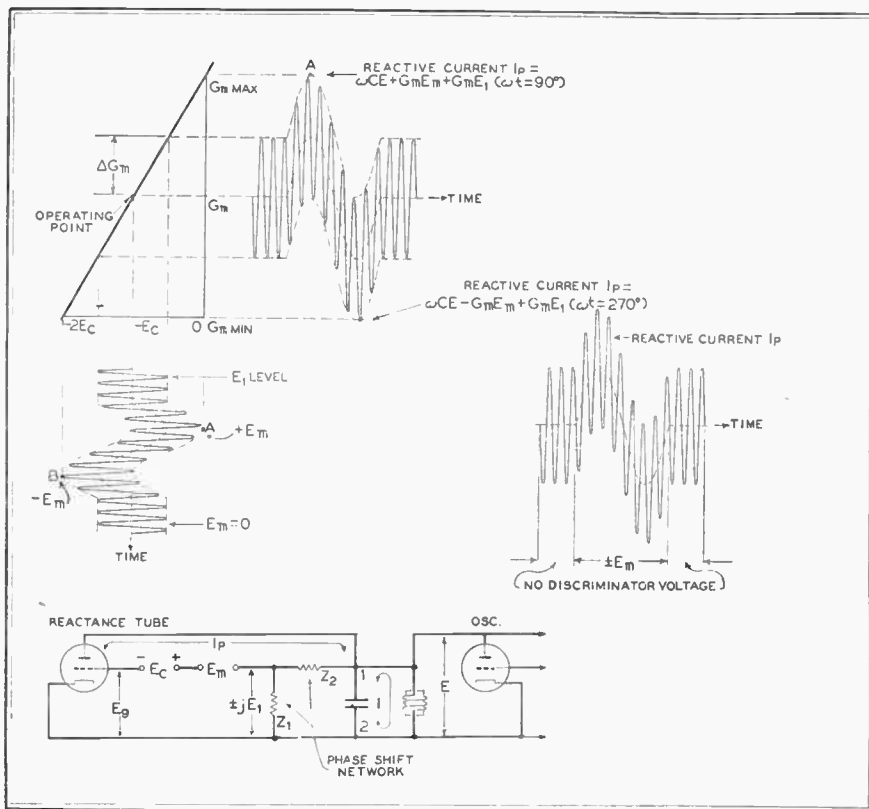

FIG. 78. GRAPHIC REPRESENTATION OF THE EFFECT OF VARIATIONS IN DISCRIMINATOR OUTPUT ON REACTANCE-TUBE PLATE CURRENT

intermediate frequency carrier at mid-frequency  $f_0$ . With changes in intermediate frequency, the discriminator develops direct voltages of  $\pm E_m$ , which cause variations of the inductive reactance about the quiescent value, as shown in Fig. 78. Since the phase shift network shown in Fig. 76 draws a current  $I_p$  which leads  $E$  by 90 degrees, the alternating voltage applied to the grid of the reactance tube is  $jE_1$ , i.e., the  $\cos \omega t$  function when the oscillator voltage  $E$  is a  $\sin \omega t$  function. Because of the linear transconductance curve, the variations in the plate current  $I_p$  caused by the discriminator voltage  $E_m$  no longer equal  $G_m E_1$ , but rather

$$I_p = G_m E_1 \pm G_m E_m$$

when maximum values of discriminator voltage are developed. Therefore, a peak voltage of

$$E_g = E_1 \pm E_m$$

appears on the grid of the reactance tube,

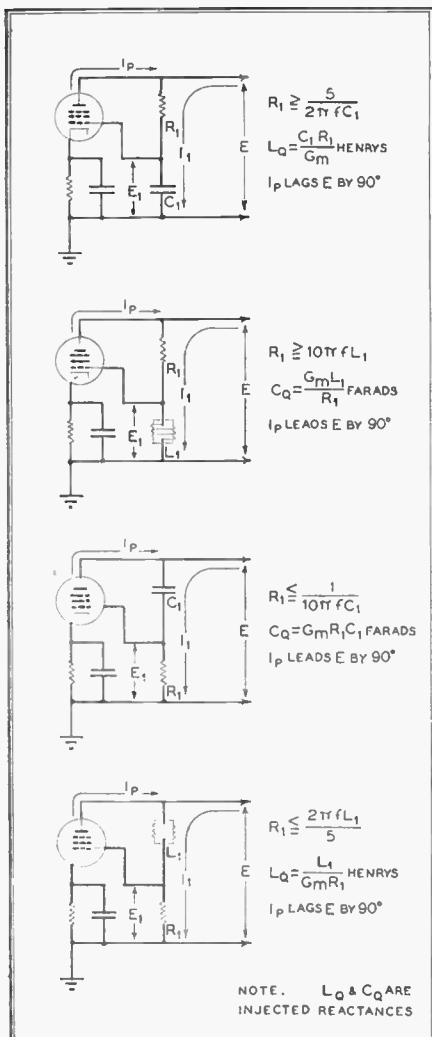

FIG. 80. REACTANCE TUBE ARRANGEMENTS

which causes the variation of the grid voltage time axis shown in Fig. 78.

Optimum conditions are realized when the alternating grid voltage  $E_1$  and the discriminator voltage  $E_m$  are each ad-

justed to one-half the grid bias  $E_0$ . This results in an effective total grid voltage  $E$  of  $1.5E_1$ , instead of  $E_1$ , when zero discriminator voltage  $E_m$  is developed. The total grid voltage  $E_g$  draws a plate current

$$\text{Peak } I_p = G_m E_1.$$

When an inductance is substituted for the capacitance in the phase shift network the following equation can be used to calculate the oscillator frequency when the discriminator voltage is zero:

$$f = \frac{1}{2\pi \sqrt{\left(C + \frac{G_m L_1}{R_1}\right)L}}$$

All values are in cycles per second, ohms, henrys and mhos. The effective oscillator frequency is governed not only by the  $L$ ,  $C$  branches, but also by the capacitance  $C_Q$  supplied by the reactance tube circuit and  $L_1$  in the phase shift network. The static value of  $C_Q$  is

$$C_Q = \frac{G_m L_1}{R_1}$$

When the oscillator frequency  $f$  shifts by an amount  $\Delta f$ , a voltage  $\pm E_m$  developed by the discriminator, causes the reactance tube to inject a reactance  $L_Q$  or  $C_Q$  into the oscillator tuned circuit  $L$ ,  $C$ , which returns the oscillator to the original frequency  $f$ . The pull-back action created by the injected reactance is then

$$f_p = f \pm \Delta f.$$

This change in frequency, or pull-back action, is caused by the voltage  $1.5E_1 - E_1$ , or  $0.5E_1$ , applied to the grid of the reactance tube. The current  $0.5G_m E_1$ , with respect to the normal circulating tuned circuit current

$$I = \omega CE,$$

represents the change of current for the shift of the frequency from the nominal value to its maximum deviation. The bandwidth equals twice the frequency deviation, or

$$W = 2\Delta f.$$

Since

$$\Delta f = 39.83 \frac{G_m E_1}{CF} \text{ kc./sec.},$$

$$W = 79.7 \frac{G_m E_1}{CE} \text{ kc./sec.}$$

$G_m$  is given in micromhos, and  $C$  in microfarads.  $E_1/E_0$ , being a numerical ratio, requires no units.

**Complete Circuit \*** The complete system shown in Fig. 79 is an application of the principles already discussed. The discriminator is of the conventional type, and the Hartley oscillator requires no special comment. The reactance tube, using a combination fixed- and self-bias circuit, merits mention. The self-bias is developed across the cathode resistor, while the fixed bias is obtained across the screen-to-

cathode resistor. The self-bias improves stability, and the fixed bias increases the sensitivity of the reactance tube action, because degeneration due to the voltage

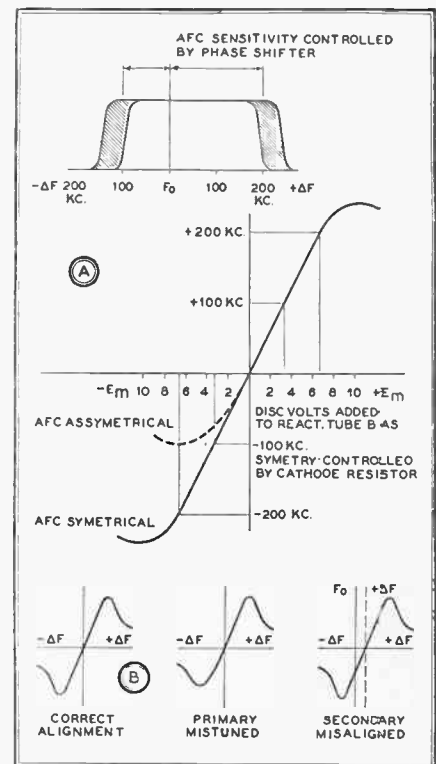

FIG. 81. EFFECTS OF CONTROL VOLTAGE

drop across the cathode resistor is reduced. Such a combined bias arrangement results in stable reactance tube action without sacrificing sensitivity.

The excitation voltage applied to the grid of the reactance tube is obtained from a phase shift network consisting of impedances  $Z_1$  and  $Z_2$ , where  $Z_1$  is 5 mmf., and  $Z_2$  is 50,000 ohms. Four different reactance tube arrangements and their design equations are shown in Fig. 80.

A variable cathode resistor is used in the reactance tube circuit to permit adjustment of the cathode voltage. The resistor is adjusted for an initial bias in the center of the reactance tube characteristic, so that a symmetrical oscillator frequency control is realized for equal positive and negative changes in discriminator control voltage. The effect of this adjustment is shown in Fig. 81A. When the discriminator develops a positive voltage, a limiting point is reached in which the reactance tube biases itself by grid current through the filter resistor system. The bias attained is nearly equal to the peak value of impressed oscillator frequency voltage. Since the tube may operate under this condition for long periods, the screen voltage must be reduced to avoid excessive plate current and consequent shortened tube life. When the discriminator develops a negative voltage, control action is limited by plate current cutoff. With sufficient signal input to the discriminator rectifiers, the total



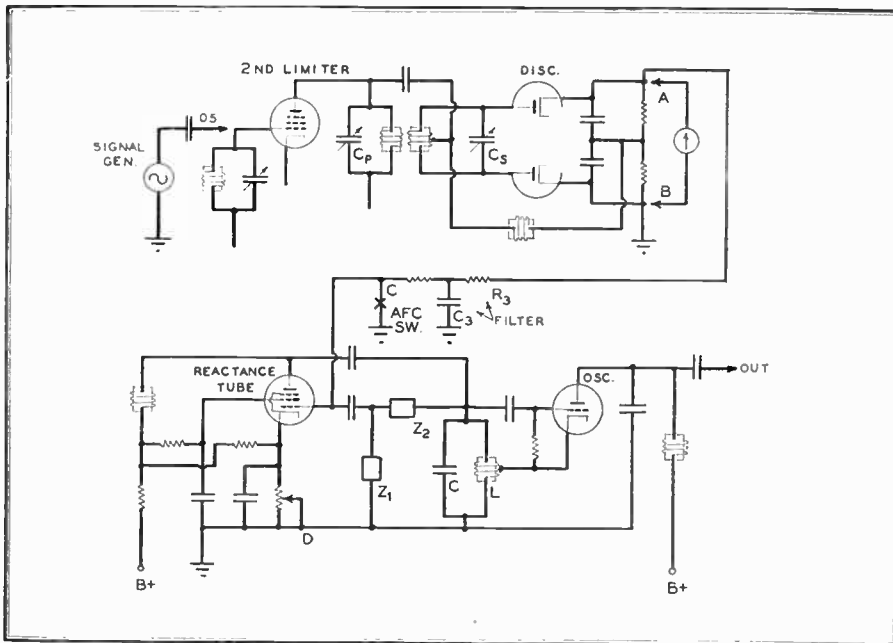

FIG. 82. SETUP FOR ALIGNING THE DISCRIMINATOR CIRCUIT FOR AFC

range of control is thus independent of the maximum value of voltage generated by the discriminator.

**Equipment for Aligning** ★ The process of aligning the discriminator and AFC networks in an FM receiver requires several pieces of equipment. A good signal generator which covers the frequency range with fundamental frequencies is necessary. In addition, a vacuum tube voltmeter with a center-zero scale, or some suitable substitute, such as a vacuum tube voltmeter with a left-zero scale combined with a polarity-reversing switch or a center-zero DC microammeter, must be at hand. If a DC microammeter is to be used, it should have an external series resistor of about 100,000 ohms to reduce the circuit loading. Visual alignment equipment, with a modulated signal generator, will facilitate the alignment process, but quite satisfactory results can be obtained with the equipment enumerated.

**Aligning Discriminator** ★ For aligning the discriminator circuit, the unmodulated output from the signal generator, adjusted to intermediate frequency, is applied to the grid of the limiter. The vacuum tube voltmeter, or microammeter, is connected to A and B, Fig. 82, and the signal generator is adjusted for maximum output. Adjust the secondary trimmer  $C_S$  of the discriminator transformer to exactly zero deflection. When making this adjustment, three positions of the trimmer will indicate zero deflection. One of these indications occurs when the trimmer capacity is at minimum; the second occurs at maximum capacity, while the third occurs at a position approximately midway between the first two. The minimum and maximum capacity adjustments of the trimmer are incorrect, and should be

avoided. The correct adjustment can always be recognized easily because of the fact that the indicator deflection changes rapidly from plus to minus, or vice versa, for a slight change in the trimmer setting.

When the secondary trimmer is adjusted properly, the primary trimmer  $C_P$  must be adjusted for maximum deflection of the meter. This is accomplished in the following manner: Increase the frequency of the signal generator to 75 kc. above the intermediate frequency. As this shift is being made, the meter will indicate an

not again be adjusted after the zero deflection is obtained.

The adjustment of the discriminator should now be tested for linearity. With the signal generator returned to the exact intermediate frequency, the indicating meter should again read zero if the secondary trimmer was not readjusted. Then tune the signal generator to 75 kc. below the intermediate frequency. As the signal frequency decreases, the meter will indicate an increasing negative voltage until the frequency shift is completed. At 75 kc. below the intermediate frequency, the indicated voltage should be exactly the same value as that at 75 kc. above the intermediate frequency, but of opposite polarity. If these voltages are unequal, it is necessary to retune the primary trimmer until the voltages are distributed equally on both sides of zero deflection. When this equality is achieved, the discriminator is properly aligned. Discriminator alignment curves are shown in Fig. 81B.

The alignment of the secondary branch of the discriminator network is very important, since the correct operation of the entire system depends upon it. The alignment determines the polarity and magnitude of the control voltage developed by the discriminator circuit. While the alignment of the primary branch is not critical and does not affect the phase relationship of the induced and coupled voltages across the secondary branch, it does determine the magnitude of these voltages. Hence it should be adjusted carefully. The tuning capacitor across the secondary winding controls the frequency at which zero control voltage occurs, and the primary tun-

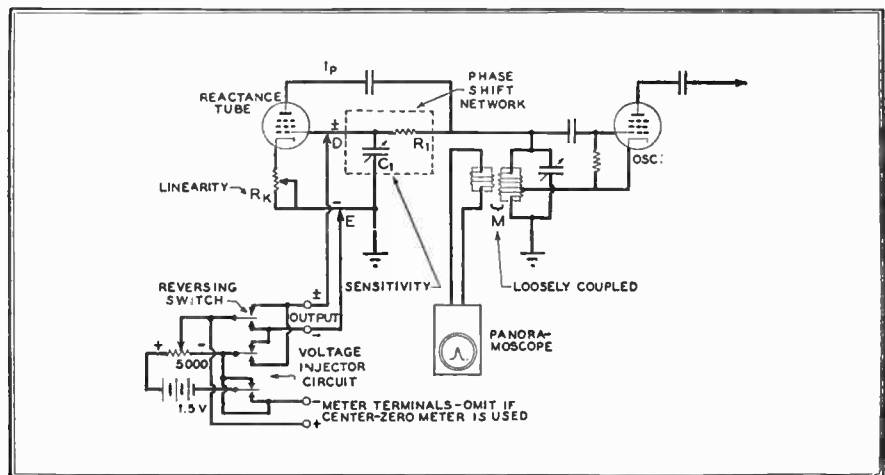

FIG. 83. CIRCUIT USED WITH PANORAMSCOPE FOR BALANCING THE AFC SYSTEM

increasing positive voltage until the frequency shift is completed. At the +75-kilocycle deviation, adjust the primary trimmer for maximum meter deflection. Should the meter pointer tend to move off-scale as this is done, it will be necessary to reduce the output from the signal generator. The adjustment of  $C_P$  is completed when the greatest deflection is obtained. The secondary trimmer  $C_S$  must

ing capacitor determines the amplitude and symmetry of the two peaks of the discriminator characteristic curve.

**Holding Action** ★ The holding action of the reactance tube can be ascertained in the following manner: Apply the signal generator output to the antenna terminals of the receiver, and adjust both the generator and receiver to the same frequency

in the desired spectrum. Short point C in Fig. 82 to ground so that no discriminator voltage will be applied to the grid of the reactance tube during this tuning adjustment. Leave the indicating meter connected to A and B, as for alignment of the discriminator.

Zero deflection of the meter should result when the signal generator and receiver are tuned to the same frequency. Then remove the shorting conductor from point C, so that the discriminator voltage will control the reactance tube. If the circuits are properly aligned the meter deflection will remain zero.

Increase the signal generator frequency by small increments, while noting the meter deflection. The meter will indicate an increasing positive voltage, until a point is reached where the indicator will abruptly return to a value slightly above zero. This near-zero deflection indicates that the reactance tube no longer controls the oscillator. The signal generator frequency should then be decreased slightly to the point of maximum meter deflection, i.e., just before control is lost, and the deviation in frequency from the center value should be noted. This frequency deviation represents the limit of the holding range in the positive direction.

Next, readjust the signal generator frequency to the original center value, decreasing it by small increments to the value which gives maximum meter deflection, as before. The frequency deviation at the point of maximum deflection, just before control is again lost, should be noted. This deviation represents the limit of holding range in the negative direction.

The positive and negative AFC holding limits should be symmetrical; however, any asymmetry can be corrected by varying the cathode resistor in the reactance tube circuit. The holding range will become broader as the signal input level is increased, as illustrated in the following table, data for which was taken on an experimental receiver using a 12SH7 reactance tube:

SIGNAL INPUT	AFC LIMIT
15 microvolts. . . .	$\pm 150$ kc.
50 microvolts. . . .	$\pm 250$ kc.
100 microvolts. . . .	$\pm 300$ kc.

**Balancing** ★ To balance the AFC system, when necessary, a simple circuit consisting of a battery and a double-pole, double-throw switch is very helpful. The circuit is shown in Fig. 83. The output terminals D and E are connected to the reactance tube grid and ground. When balancing is necessary, the receiver and signal generator are adjusted to the same frequency  $f_o$ , after shorting point C, Fig. 82, to ground. The meter across the discriminator output will indicate balance, or zero deflection. The artificial discriminator voltage supplied by the battery is applied between the reactance tube grid and ground. This battery voltage is adjusted by means of the potentiometer to deflect the meter to some positive value, for example, 100 kc. The switch is then snapped over, reversing the polarity of the voltage applied to the grid of the reactance tube. The meter will now be deflected in the opposite direction. If the positive and negative deflections are not symmetrical, the cathode resistor  $R_K$  in the reactance tube circuit is adjusted while alternately applying positive and negative voltages to the grid, until a point is reached where symmetrical deflection takes place. The battery circuit is then disconnected and the AFC holding action is determined as outlined in the preceding paragraphs. Should the AFC action be such that the reactance tube pulls away from the desired mean frequency  $f_o$ , it will be necessary to reverse the discriminator cathode leads.

**Linearity and Sensitivity** ★ The adjustment of AFC linearity and sensitivity will be facilitated if a panoramoscope is available. The output of the signal generator is reduced to zero and a voltage injector circuit, similar to the one shown in Fig. 83, is connected to the reactance tube. A

20,000-ohms-per-volt voltmeter, or a microammeter, is connected across the voltage injector as shown. The receiver is tuned to a desired frequency  $f_o$ , and the panoramoscope is loosely coupled to the receiver oscillator tuned circuit and adjusted to the frequency  $f_o$  of the receiver. This adjustment is made so that the resultant "pip" is centered on the screen of the panoramoscope, indicating that both equipments are tuned to the same frequency. The voltage injector is adjusted to 1 volt output, and the reversing switch is moved to the positive position. The pip on the panoramoscope screen will shift to the right of the center reference line, representing an actual shift in the oscillator frequency due to the action of the reactance tube. The injector switch is then reversed to apply 1 volt negative to the grid of the reactance tube. The pip on the screen of the panoramoscope will shift to the left of the center reference line, indicating a frequency deviation in the negative direction.

If an applied injector voltage of one volt is insufficient to deviate the receiver local oscillator  $\pm 75$  kilocycles, the sensitivity capacitor  $C_1$ , Fig. 83, must be adjusted with a non-metallic alignment screwdriver to add sufficient sensitivity to the AFC circuit to produce the required control range. The receiver tuning control is adjusted to give zero deviation, as indicated on the panoramoscope, each time the capacitor  $C_1$  is changed. The linearity of the AFC circuit can be determined by varying the injector voltage in steps of 0.25 volt from 0 to 1 volt. For a given voltage, the difference should not exceed 1 kc. between the positive and negative frequency deviations shown on the panoramoscope. If the AFC is non-linear, the cathode resistor  $R_K$  must be adjusted until equal positive and negative frequency deviations are obtained with a given injected voltage. The alignment of the receiver oscillator should be re-checked, since the adjustment of the AFC sensitivity capacitor  $C_1$  will vary the oscillator frequency.

# Chapter 3

## Frequency Modulation Broadcasting

Engineering Counsel—Rates and Potential Revenue—Building an Audience—Interesting Advertisers

IT IS not possible to set forth specific cost information for those without previous AM experience who are planning to enter the FM broadcast field. There are too many variable elements involved. A plan which would meet the conditions in one area would be completely misleading if applied perhaps 100 miles away. A plan for a commercial station, projected for the purpose of showing a profit, would not fit the needs of an educational station, or of a cooperative undertaking to be supported by a social or labor organization, or by popular subscription.

FCC regulations, and their interpretation by the Commission in the case of a specific application are controlling factors which must be considered in terms of the venture under consideration.

**The First Step** ★ Therefore, the first step to be taken by an individual or group planning to enter FM broadcasting without past experience in this field is to engage an engineering consultant.

The functions of an engineering consultant are:

1. To assist the principals in crystallizing their ideas concerning the purposes and policies of the proposed station.

2. To appraise the possible success of the venture as to available capital, capital investment required, operating expense, potential revenue, and contingencies.

3. To recommend the location of the studios and transmitter, and to relate the problems of antenna height, transmitter power, coverage, studio-to-transmitter connections, and FCC regulations.

4. To present the requirements for originating programs, building a record library, and making the necessary connections with a network.

5. To recommend and estimate the cost of studio facilities, transmitter, tower, incidental equipment, and a studio-to-transmitter connection if it is needed.

6. To outline the operating staff required, to estimate their salaries, and to explain the effects of union contracts which may be necessary.

7. Finally, to file an application for a construction permit, and to handle any problems which may arise at the FCC in connection with the application.

From this outline, it will be clear that a capable engineering consultant is not merely a radio engineer, nor is a man qualified in this capacity merely by having worked in a broadcast station. Few, if any, manufacturers' salesmen are equipped

with the necessary information and experience. But there are specialists who can measure up to the qualifications set forth here.

**Market Appraisal** ★ An approximate determination of potential income for any new broadcast station is extremely difficult to make for an independent FM station. In the case of FM, where the building up of an audience must be paced by the delivery and purchase of FM receivers, a time table estimate of potential income is difficult indeed. Furthermore, the availability of network programs is still an uncertainty.

The only basic information of real significance is that which can be obtained from the rate card of an AM station in a location comparable to that of the projected FM station. The coverage area and the audience of the AM station can then be compared to the population within the proposed area of the FM station. Here, FM offers a great advantage over AM, since the FM coverage is constant, day and night, while AM coverage is reduced greatly after sunset.

Figures on retail sales by counties are available from the Bureau of the Census, Washington, D. C. Studies of retail sales in the area under consideration will disclose additional pertinent facts. Also, the volume of local and national advertising carried by newspapers serving the area should be examined.

**Program Expense** ★ Radio programs, without benefit of network service, must be made up largely of local talent, recordings, and news. The first of these is of special, personal interest to an FM station's audience. Its composition will include contributions from members of social and political organizations, churches, schools, and colleges. Handled skillfully, these can be developed into an interesting and entertaining program source. As the station's audience increases, sponsors can be found for many of these programs. In other cases, expenses will be paid for remote pickups.

Very practical assistance will be rendered by any of the transcription services in connection with the choice of recordings. After the initial recordings have been obtained, comments from listeners will help to direct subsequent acquisitions. It is of paramount importance that the recordings do justice to FM broadcasting. No transcription should be accepted if it lacks sufficient fidelity to distinguish it from those heard on AM reception. Tran-

scriptions are now available which, when transmitted on FM, cannot be distinguished from live talent.

News reports can be obtained from any of the several news services. It will probably be possible to obtain news reports edited for radio broadcasting. These can be used as is, or further edited by the station's newscaster.

Plans for initial program composition must be made with the utmost care and thoroughness. The word will get around very quickly that the new station is excellent, if it is, or otherwise, if it is not. If the report is that "you must get an FM set to hear the new station," audience building will get off to a quick start. The comment that "I bought an FM set, but there's nothing good on the new station" can do inestimable damage.

**Building the Initial Audience** ★ When the first FM station is installed in any area, the management is confronted with the task of building an audience from scratch. It must be assumed that the only FM receivers are in the local radio stores.

Therefore, the station and the radio dealers have a common interest in the sale of FM sets. With only a few sets in the area, the station's immediate problem is to have the largest possible number of people listen to each receiver. As for the dealers, prewar experience showed that the most effective promotion on FM sets was the demonstration of FM reception.

Here is a promotion package for a new FM station to offer that will bring quick results in set sales for dealers, and will build an audience at the same rate of speed:

Offer each of several radio stores a 15-minute demonstration program, timed either to increase store traffic during an otherwise quiet period, or when traffic is heaviest, depending upon the conditions at the individual store. In return for the announcement of the dealer's name on the program, the dealer must feature the time of the demonstrations in his newspaper advertising, and in store-window banners, giving the station's call letters and frequency. These demonstration periods should include:

1. A very brief account of the station's plans to provide entertainment of superior quality.

2. Sound effects which take advantage of FM fidelity, such as breaking a glass tumbler, sawing wood, a ticking clock, ringing a telephone bell and a large gong,



hammering nails, firing a revolver, and blowing a police whistle.

3. High-fidelity transcriptions of familiar selections including a piano selection, a negro spiritual, and a brass band. Formal or unfamiliar music is not recommended for this purpose.

Several scripts, written to tie these elements together, will give enough variety that they can be repeated many times. No effort should be made in the scripts to "sell" FM. The contrast between the FM reception and what people have come to accept on AM is the most convincing argument for buying FM receivers!

Moreover, the sales made by the radio dealers as a result of these demonstrations will quickly justify a charge for station time, and thus bring in the first revenue.

Arrangements for these demonstrations should not be limited to a single store. They should be made with radio, furniture, department, record, and musical instrument dealers in various parts of the station's service area, and for both daytime and evening periods.

Nor are these the only opportunities to reach large numbers of people with individual sets. Business and service clubs, women's clubs, church organizations, and public schools welcome demonstrations and special programs with announcements in which the organization is mentioned. Music teachers welcome the opportunity to have their star pupils perform over the air, and without charge. This is also true of musical instrument stores which offer lessons to their customers.

**Proven Methods** ★ There is no intention to infer that these are original suggestions. They were used in 1940 and 1941 when the first FM stations went on the air. The methods described proved highly successful then. They are just as effective now.

Here, for example, is a detailed account of a series of demonstrations given in 1940 by the Yankee Network and the R. H. White department store in Boston. This text appeared in the November, 1940 issue of *FM Magazine*:

When Aaron Goldberg, manager of the radio department at R. H. White's in Boston, made up his mind to use Stromberg-Carlson receivers to push up his fall volume of radio sales, he determined to get the idea of extra-quality home entertainment across to his customers in a way that would wow them. And wow them he certainly did!

His primary purpose, of course, was to launch FM sales. There were other things he wanted to accomplish, also. He wanted to gain the prestige for his radio department of taking the lead in promoting a new radio development and to bring radio-minded people to the R. H. White store. Obviously, to address two groups, one in the afternoon and the other in the evening, would take less man-hours than talking to several hundred people individually. And finally, he wanted to get the names

and addresses of those who, after hearing an FM demonstration, were definitely prospects for FM sets.

Accordingly, the coöperation of the Yankee Network was enlisted. While their program department laid out the plan of a special demonstration to be broadcast from Paxton, and wrote the script, a dipole antenna of the conventional sort was erected on the roof of the store, and connected to the auditorium. This gave perfect, noise-free reception of WIXOJ, 43 miles distant, despite the fact that the store is in the DC section of Boston, where receiving conditions are unfavorable in the extreme. [WIXOJ is now WGTR.]

Announcements were run in the R. H. White newspaper advertisements, inviting the public to attend the demonstration in the afternoon or in the evening, when the radio and furniture departments are open until 9:00 P.M. On the stage of the auditorium, three Stromberg-Carlson FM-AM consoles were put on display, marked with prices and brief descriptions large enough to be read by the audience.

A piano was set up at the center of the stage. A microphone, connected by telephone wires to the broadcast studio, was located where it could pick up the piano. This completed the arrangement.

At both demonstrations, the auditorium, holding about 400 people, was filled. After brief remarks of introduction, one of the receivers was turned on, and Frequency Modulation spoke dramatically for itself.

The broadcasting of sound effects led up to the high spot of the performance: the Magic Piano. The announcement, "Now we return you to the auditorium of the R. H. White Company," was the cue for Harry DeAngelus, seated at the piano, to play "Stardust." Suddenly, in the middle of the piece, a stir went through the audience. People leaned forward in their seats, and others rose to see what had happened on the stage for, while the music seemed to be coming from the piano, Mr. DeAngelus was not playing. In fact, he had turned around and was looking into the wings. Then he swung back to the keyboard, and his hands picked up the music again.

The audience was mystified. Apparently this was a player piano, and he had been only making the motions of striking the notes. Again, he stopped playing, and the music continued. The next time he resumed, a spotlight was turned on him and, when he stopped, the spot was shifted to one of the FM receivers. Some of the people knew then what had been going on, but others did not understand until, at the end of the second selection, the announcer explained what had taken place.

The set-up was this: the pianist at the studio listened to the piano in the auditorium through the microphone wire connections. When he picked up the tune on the studio piano, the pianist at the auditorium stopped. Thus they alternated their playing without a pause. So perfect was the re-

production by FM, and the piano is a most difficult instrument to reproduce by radio, that the only way it was possible to determine the origin of the music was to watch the pianist on the stage.

The script which was used is presented through the courtesy of The Yankee Network. It can be changed readily and adapted to suit any similar occasion!

(*Organ Crescendo*)

**ANNOUNCER:**

Nights shall be filled with music — with songs and words, words, words, millions of them — bringing you news, drama, education, information, syncopation. . . . Radio — culmination of man's desire to conquer space. Radio — that leaps around the earth on waves of light — and brings the world within your touch. . . . Radio — that's everywhere at every time. . . . Radio — moving always forward, widening its scope — spreading its illuminating influence.

The story of radio is the story of man's progress, the story of his unending search for knowledge and expression. From the time of primitive smoke signals and the code of jungle drums to the red blast of trumpets heralding the approach of kings, to the time of Marconi and the first crude wireless key, radio has developed and perfected itself into a precious instrument of rare beauty.

Tonight, for the first time in Boston, Frequency Modulation is being demonstrated to the retail public. Tonight, The Yankee Network, in coöperation with the R. H. White Company, brings you a graphic demonstration of radio's newest and greatest achievement — Frequency Modulation. Signalizing this new era in the science and art of broadcasting, The Yankee Network and the R. H. White Company of Boston present to the general public and the retail trade a demonstration of this marvel called — Frequency Modulation. A glowing testimonial to man's mastery of the elements — for this great new Frequency Modulation conquers nature — eliminating static, minimizing interference — radio in its perfection — listen, as Frequency Modulation proves its birthright.

Clotilda Zappala, charming young New England coloratura soprano, sings one of the loveliest and most colorful arias in all of the world's great operatic literature — enjoy the complete perfection of reproduction afforded by FM as Miss Zappala, accompanied by Francis J. Cronin, sings —

(*The Bell Song from the Opera  
"Lakme" by Delibes*)

This afternoon it is our pleasure to present to you a man who has contributed much to the development and perfection of Frequency Modulation. Speaking from the auditorium on the third floor of the R. H. White Company store in Boston, where four hundred people have assembled to see as well as hear this demonstration, we present one of radio's pioneers, Paul

A. deMars<sup>1</sup>, Vice-President in charge of Engineering for The Yankee Network. Mr. deMars.

MR. DEMARS:

Ladies and Gentlemen —

In the fall of 1935, Major Edwin H. Armstrong, the scientific genius who had previously contributed the three outstanding inventions in radio, demonstrated his latest development to the Institute of Radio Engineers in New York City. Terminating a lifelong study to eliminate static from the radio, he disclosed a system of broadcasting virtually free from static and interference, and capable of transmitting programs with quality heretofore undreamed of. Called Frequency Modulation, as distinguished from the present method known as Amplitude Modulation, the system is now familiarly known as FM.

How FM differs in principle of operation from the present system is mainly of interest and concern to engineers and scientists and is too technical to discuss here. It is sufficient to say that new type transmitters and receivers are required.

Recognizing the outstanding capabilities of FM, the Federal Communications Commission, in May of this year, authorized commercial broadcasting on 40 new wavelengths in the high frequencies.

New FM broadcasting stations are under construction, or are being planned all over the country, and there are already about 20 in operation. [Note: this was 1940]

In this auditorium, you are listening to John Shepard, 3rd's pioneer FM station of New England. This station is the most powerful of its kind in the world and is located in the town of Paxton, Mass. — beyond Worcester — and broadcasts programs 16 hours daily from The Yankee Network, the Colonial Network, The Mutual Broadcasting System and NBC.

Although this is the only FM station that at present serves all of Massachusetts and Boston, other FM stations are planned for this region and there is no question that FM will not only broadcast present programs, but will also provide new services in this area.

The number of new stations technically possible is virtually unlimited, and the owner of an FM receiver is assured of not only better reception, but a greater variety of entertainment.

Now then, what specifically is offered to the owner of an FM receiver?

Reception without static — without noise — without interference.

Reception unmarred by crashing roars when lightning streaks the sky.

Reception free from the all-too-familiar buzzes, crackles and frying occasioned by your neighbor's electric razor, oil burner, kitchen mixer, or vacuum cleaner.

Reception without the chattering, the squawking, the unwanted programs in the background of your favorite station.

Reception with a naturalness and realism in the reproduction of music, speech and sounds beyond the capabilities of the present methods.

The program in the demonstration that follows originates in the studios of The Yankee Network in Boston, where it is transmitted by Frequency Modulation to Paxton and then broadcast to the listening audience.

You are listening here in this auditorium to reception of radio transmission transmitted twice over a distance of about 45 miles and received in one of the noisiest areas of Boston for broadcast reception.

But note the crystal-clear tone, despite the adverse local conditions. This is the quality of service that the owner of an FM receiver can expect in his own home.

The following demonstration is intended to convince you here in this auditorium of the merits of FM by letting FM speak for itself.

ANNOUNCER:

Thank you, Mr. deMars.

The perfection in the reproduction of sounds that is made possible through transmission by Frequency Modulation can perhaps best be demonstrated by producing a series of sounds frequently used in everyday radio programs. Notice in the following series of reproductions the great clarity in tone and the full range of sound that is clearly audible. First, the sound effects engineer will ring a ship's bell — the type in common use on sailing vessels — it is made of cast brass, is twelve inches in diameter, and will be struck with a clapper seven inches long. Listen —

*(Strike Ship's Bell)*

Our next sound effect is perhaps one of the most difficult in the sound engineer's entire repertoire to reproduce. Only through Frequency Modulation is it possible to recreate the wide tonal range of the sound of sawing wood.

*(Effect)*

Perhaps the next most difficult effect to convey over the radio is the accurate reproduction of a carpenter's hammer striking a three-inch flat-headed nail. Listen for the ping of the hammer — a sound which only Frequency Modulation can reproduce in all its naturalness.

*(Effect)*

We'll let you guess at this one!

*(Effect: Pouring Drink)*

Perhaps the smallest and most infrequently used instrument, yet one whose sound is most difficult to produce, is the triangle. Listen to it now.

*(Effect)*

Listen now to the rich tones of a large Chinese gong — made of hammered brass. Note particularly how long the aftertones

hang on. Frequency Modulation recreates this for you now.

*(Effect)*

The colorful and lively bolero, "Le Sevillana," by Guiseppe Ferraro, is a vertical transcription, made especially for broadcast purposes. It is a composition of brilliant tone patterns that, in unrestrained good spirits, employ the full instrumental range of Harry Horlick's orchestra. Listen to it now and notice the perfect reproduction to the full tonal range.

*(Le Sevillana 60-098)*

We now return you to the auditorium of the R. H. White Company store, where Harry DeAngelus is waiting to play a piano medley.

*(Stardust — Beer Barrel Polka)*

*(Piano at R. H. White auditorium and at studio alternate in playing this music.)*

Those in the R. H. White Company's auditorium have just witnessed a remarkable demonstration. We might have called those numbers the marvel of the Magic Piano, for the pianist in the auditorium and a pianist here in the studio alternated in playing the medley just completed — yet so wonderful is the reproduction made possible through transmission by Frequency Modulation that the studio audience could not tell whether they were listening to radio reception from the studio piano or to the piano on the stage before them, except by watching the pianist's hands — a further tribute to the perfection of this marvelous new system of broadcasting.

This evening's presentation is concluded as Francis J. Cronin, New England's premier organist, employs the full resources of the grand studio organ in playing a skillfully arranged medley of familiar overtures —

*(Medley of Overtures, organ)*

And so we conclude another "famous first" in the history of broadcasting. This afternoon for the first time in Boston, The Yankee Network, in cooperation with the R. H. White Company, has presented this broadcast, marking a new milestone in the development of radio — Frequency Modulation. And marking also the first time that Frequency Modulation has been demonstrated to the retail trade and the general public through a retail outlet — the R. H. White Company. Frequency Modulation, the sensational new perfection in radio reception, is the newest and greatest achievement of radio science — another forward step in man's mastery of the elements.

Noiseless, staticless, free from interference, Frequency Modulation brings you radio at its perfect best — doubling your enjoyment, ever widening and increasing the scope of your best form of entertainment — Radio!

You may see a complete line of the amazing new Frequency Modulation receivers on display at the R. H. White Company in Boston. Remember that the

<sup>1</sup> Now associated with Raymond Wilmore, consulting radio engineer, 1469 Church Street N. W., Washington 5, D. C.



world is at your finger tips when a radio is at arm's length and in radio reception, Frequency Modulation means perfection. (Station Break)

**Reaching Advertisers** ★ While efforts are under way to build the listening audience, it is also necessary to reach prospective sponsors. They, too, must be educated both as to the superiority of FM over AM broadcasting, and FM's greater impact on listeners.

One way to launch a drive for sponsors is to give prospective advertisers and agency executives an FM demonstration, and to follow that up with invitations to use the station facilities, without charge, for the actual broadcasting experimental programs.<sup>2</sup> The studio and program techniques of FM are completely different from AM practice. Producers, script writers, and performers have much to learn about FM. Specifically, the realism of FM reception makes possible the use of many effects, devices, and innovations that would fall flat on AM.

Since special FM techniques can be worked out only by trial and error, an "experimental FM workshop" period is of the greatest value to prospective sponsors, and offers listeners an interesting insight into program development.

In the December, 1940, issue of *FM Magazine*, there was published the following account of a luncheon at which the advertising fraternity of Boston was officially introduced to FM broadcasting. Here is the report:

On October 22nd (1940), at a Boston Advertising Club luncheon given in honor of John Shepard, 3rd, nearly 400 advertising managers and agency executives listened without moving or speaking during a demonstration of FM from Paxton. Not only that — they burst into applause when Clotilda Zappala, at the other end of the 90-mile circuit, finished singing Delibe's Bell Song!

When such a group of hard-boiled radio critics, accustomed to asking, "So what?" in response to the most enthusiastic proponent of a new idea, applaud something coming from a loudspeaker, it has to be a very extraordinary performance indeed. There is no doubt but that many a consultation followed this first formal introduction of FM to advertising executives, in which the question has been asked: "What changes will FM bring to the technique of radio broadcasting?" Certainly this demonstration left no doubt in any listener's mind that FM now, having reached the state of commercial perfection, performs a service distinctly superior to that of AM broadcasting.

When the demonstration was over, and John Shepard, 3rd had modestly accepted the ad men's sincere applause, some of

<sup>2</sup> This method was used with great success by the DuMont television station WABD. For details, see "Why the Other Five Letters Weren't Mailed" by Samuel H. Cuff, *FM AND TELEVISION*, Nov. 1944.

the more technically-minded went up to see just what kind of special equipment had been used. Expecting that the Yankee Network engineers had gone overboard in setting up some kind of super receiver that would be far beyond the means of the average home listener, they were almost

Here is the FM program policy set forth by Walter J. Damm, general manager of WTMJ and WTMJ-FM, owned by "The Milwaukee Journal".

1. If the public is going to buy FM sets, it needs an incentive — therefore, FM programs must be distinctly worth while and fill a genuine need.

2. It follows that FM program schedules must be entirely independent from AM schedules. FM's advantages of high fidelity reproduction and freedom from static are, alone, not enough in most cases to make people switch from AM to FM.

3. FM should be programmed to meet the radio desires of discriminating listeners who enjoy good music. Both sustaining and commercial programs should utilize the high fidelity advantage of FM to the utmost. In this respect, we believe that there is a place for electrical transcriptions, as well as live talent, on FM programs. Experience has shown that the new high-fidelity electrical transcriptions now available to the broadcasting industry are remarkably well adapted to FM. They will provide the means of presenting famous artists and musical groups which cannot otherwise be heard over individual FM stations until FM networks become feasible.

4. While music should be the basis of FM schedules, we recognize that drama, news, special events and children's programs have their place in the daily lives of radio listeners.

5. We believe that daily luncheon and dinner concerts of uninterrupted music should be scheduled, as these two periods will make it possible for the listener to enjoy the benefits of FM to the utmost. The dinner concert, particularly, should fill the wishes of many set owners who have hungered for a program of music and not one made up of 15-minute units, ranging from children's programs to dramatics, sports and news.

6. We believe that by concentrating on music during the afternoon, FM will attract set owners who do not care for the continuous procession of dramatic shows now on the air. Herein lies an opportunity for the FM broadcaster to awaken interest in daytime radio among set owners who do not listen to AM stations.

7. Lastly, we believe that the FM broadcaster should always model his programs according to the listening public's demands and should not permit himself to be swayed from his set course by the idiosyncrasies of the advertiser and the advertising agency. Steadfast adherence to a policy based on genuine public service can open up a listening field of unbelievable proportions.

disappointed at its simplicity. The receiver itself was just one of the new G.E. table model tuners, connected to a small amplifier unit, and a big Waite speaker, required to fill the enormous Georgian Room of the Statler Hotel.

As many a radio man knows, this is one of the world's worst spots to demonstrate radio reception, even from the nearby Boston stations. But here was the simplest, most elementary rig, bringing in

an actual reproduction of the original studio program with nothing added by way of noise or distortion, and nothing omitted through failure to transmit or receive the full audio range.

The announcement that John Shepard, 3rd, would be the guest of honor, and that he would provide a demonstration of FM reception, brought the largest attendance on record at a Boston Advertising Club luncheon. Many of the executives displayed the curiosity of people seeing television for the first time — but with this significant difference: Those who came to hear FM went away with the certain knowledge that this was not a scientific curiosity, but a newly perfected service now available to the public, in the form of an important improvement for which an immediate need already exists. Certainly, everyone who attended the luncheon was impressed with the conviction that FM provides a great advancement as a medium of advertising, as well as of home entertainment.

The first speaker was Linus Travers, vice president in charge of sales and production for the Yankee Network. He, in turn, introduced Paul A. deMars, Yankee's chief engineer, who conducted the demonstration from Paxton. The script followed the lines of the text published in *FM Magazine* for November, 1940, and included the use of the Magic Piano. In this case, a piano was set up at one end of the dining room. A spotlight was put on the floor, so that the shadow of the pianist was thrown up on the wall where it could be seen by those at the opposite end. When he stopped playing, and the music continued without interruption, people began to stand up to see what was taking place. A buzz of conversation went through the room, particularly noticeable because the audience had been so completely silent and attentive throughout the demonstration. The people were heard to remark: "Why, you can't tell when you're hearing the piano on the stage or the studio piano coming from the loud speaker!"

This was indeed the final and convincing evidence of FM's true and perfect reproduction at the loudspeaker of what goes into the studio microphone.

**The Postwar Period** ★ By using methods of the sort described here, interest in FM broadcasting was built up quickly to the point where, although FM sets were started in production very slowly, over 500,000 receivers were sold in 1941, most of them going into areas surrounding Boston, New York City, Philadelphia, Detroit, and Chicago. That figure will be exceeded many times in 1947. Therefore, new FM audiences and advertising revenue can be built rapidly by those stations which undertake carefully planned promotion, and back up their initial efforts with programs which provide the finer entertainment which FM makes possible.



# Chapter 4

## FM Broadcast Studio Techniques

Notes on the Special Techniques, Drawn from Experience at Station WTMJ-FM, Milwaukee

**L**OOKING back over some five years of experience with FM broadcasting, I still maintain that it is a difficult subject to discuss, because FM must be heard to be understood. I know this from having spent half an hour trying to explain effects that can be accomplished on FM programs which are impossible with AM, only to be told: "Well, I listened to FM once, and I couldn't see that it was much different from AM."

**That Horse Fly** ★ Some time ago, a horse-fly got into one of our studios where we were putting on an FM show and, to the consternation of the control room operator, the buzzing of that fly came over his monitor speaker just as clearly as if it had been making circles around the operator's head. The incident caused such a stir at the station that one of our enterprising publicity writers put out a story about it. Several radio magazines published the story, to my embarrassment, for I am sure that many of the technicians at AM stations read it and said: "Nuts!"

Within the limitations of their AM experience, I can imagine that it did seem absurd. They would have to *hear* the interference that a horse-fly can, and did, make on an FM program to believe it possible.

Back in 1941, W. A. Ready, president of the National Company, while in Roch-

ester, New York, heard that there would be an evening demonstration of FM in one of the rooms at the hotel where the Stromberg-Carlson studios are located. At the time he thought the demonstration was to take place, he went to the room and found the door locked, but he heard workmen sawing and pounding nails. On the assumption that preparations for the show had not been completed, he went away. Returning half an hour later, he found the audience coming out of the room. The show was over. The noise of hammering and sawing that he had heard were coming from the speaker of an FM set!

Yet people have said to me: "I think FM is very much over-rated. A friend of mine has a set that can tune FM, but he never uses the FM band." I haven't anything to say in reply to those who make such remarks, except when I can take them where they can hear genuine FM reception. Five minutes of listening enables them to understand what I couldn't explain if I talked myself blue in the face.

**FM Is a System** ★ AM broadcasting can be compared to playing catch with a baseball. One man throws the ball as best he can, and the other man tries to catch it. If the throw is good, the catcher will get the ball if he is skillful. However, the ball may go wild, or the catcher may fumble it.

There is no certainty, because there are several modifying conditions which affect the operations of throwing and catching, and the flight of the ball through the air, and there is no way to control the conditions in order to obtain consistent results.

In contrast, FM broadcasting provides a complete transmitting and receiving system which is the equivalent of a high-fidelity wire line between the transmitter and each listener's home within the service area. Whatever is transmitted can be heard consistently, and without modification except as reception may be affected by limitations of the receiver, amplifier, or loudspeaker design.

It is both possible and practical, therefore, to deliver the same quality of entertainment in each FM listener's home that he would hear at the studio provided, of course, that he lives within the station's service area.

However, FM puts new obligations on both the broadcaster and the listener, for poor program material sounds very bad indeed when heard from a high-quality FM receiver, and the best FM program, heard on a poorly designed receiver, may sound no better than AM from a \$9.95 midget.

That is why people who have good FM receivers are annoyed by the scratch from worn-out records. Others, who have listened

FIG. 2, RIGHT. THIS CONTROL ROOM SERVES TWO STUDIOS. ANOTHER VIEW OF THIS ROOM IS SHOWN IN FIG. 7

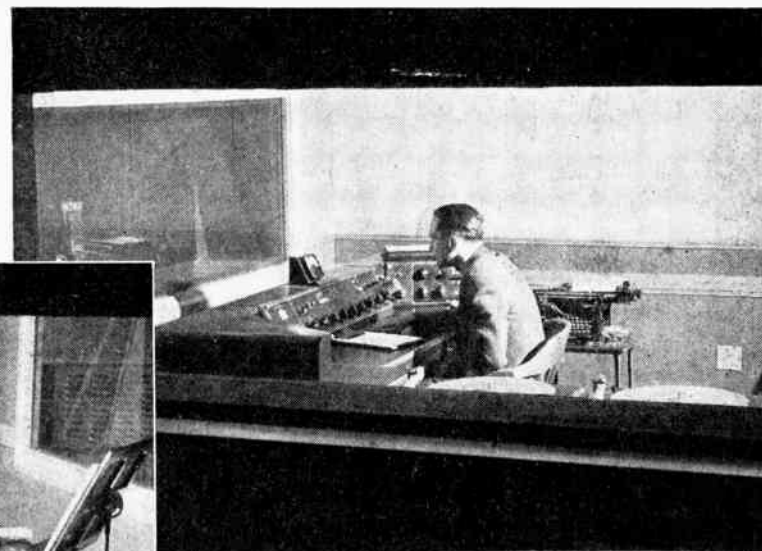

FIG. 1, LEFT. THE SAME CONTROL ROOM, LOOKING IN FROM THE OTHER STUDIO, OVER THE TOP OF THE OPERATOR'S CONSOLE

FIG. 3. ONE OF A PAIR OF SMALLER STUDIOS SERVED BY ONE CONTROL ROOM

to fine program material received on a makeshift receiver without a limiter circuit, are both honest and accurate when they say that they did not find FM in any way superior to AM, and no amount of explaining or theorizing will change their minds.

**Planning for FM** ★ In 1941, when *The Milwaukee Journal's* Radio City<sup>1</sup> was designed, it was determined to provide all the facilities required to give full effect to the capabilities of FM programming and transmission. The purpose was to assure our listeners of a quality of entertainment that would be limited only by the performance of the particular receiving sets they purchased.

Our Radio City installation was completed just as all new station construction was stopped. Therefore, it is still the last word in studios planned for FM broadcasting, both as to design and equipment. Experience over a period of nearly four years has confirmed the wisdom of our original planning.

It may be helpful to those who are now preparing to erect FM broadcasting facilities to point out some of the features of our installation, and to present a few notes on FM studio techniques which, although very different from AM practice, are, nevertheless, indicated by our experience in delivering the full capabilities of FM transmission.

**Fundamental Microphone Technique** ★ First of all, it is necessary to emphasize one fundamental point of difference between AM and FM microphone technique. It is this: Accepted AM practice is to play or speak directly into the microphone. FM practice, on the contrary, calls for locating the microphone at a point where speech or music can be heard to best advantage by the human ear.

Moreover, we have found that best results are obtained with a single microphone for FM program pickup. Any advantage that might be gained from two microphones is apt to be offset by phase displacement between them. Under some conditions, this is quite noticeable on high frequencies.

This eliminates one objectionable feature of the multiple-microphone AM practice, particularly in the case of orchestral music. When several mikes are in use simultaneously, the control room operator becomes an associate musical director and that frequently causes trouble. Besides, there have been occasions when musicians' wives listened

<sup>1</sup> See "FM Featured in \$500,000 Plant," *FM Magazine*, February, 1941 for plan drawing of the building, and construction details.

FIG. 4, CENTER. MIKE SET UP FOR FM BROADCASTING, IN CONTRAST TO ACCEPTED AM PRACTICE AS ILLUSTRATED IN FIG. 5, BELOW







FIG. 6. IN THIS SETUP FOR FM TRANSMISSION THE MUSICIANS' MICROPHONE IS APPROXIMATELY 15 FT. FROM THEIR INSTRUMENTS, IN WHAT WOULD BE A NORMAL LISTENING POSITION. NOTE HOW THE ANNOUNCER STANDS BACK FROM HIS MIKE



to their programs, and complained to their husbands that the placement of the mikes made the woodwinds so loud they couldn't hear the string section, for example.

If one microphone is located above and

Several studio setups are shown in the accompanying illustrations, to make clear the difference between conventional microphone technique and that employed for FM programming.



FIG. 7. THIS CONSOLE IS DESIGNED FOR THE CONTROL OF TWO STUDIOS

behind the director, the responsibility for the performance as it is heard over the air is not shared by the operator or the technicians, and the credit or the blame for the performance is the director's, as it should be.

Figs. 4 and 5 are typical. The usual placement for a microphone to pick up a soloist and piano accompaniment is seen in Fig. 5. The mike stand is directly at the side of the piano, and within easy arm's reach of the singer.

In Fig. 4, the mike is set up for FM broadcasting. It is well spaced from the piano and 6 to 8 ft. from the singer. This arrangement is not set forth as a rule. Modifying factors are the size and acoustics of the studio and the singer's voice. An obvious difference is that the setup in Fig. 4 very nearly corresponds to direct listening, but no one would enjoy the program if he stood where the mike is located in Fig. 5.

The same practice holds good for interviews and newscasting, as indicated in Figs. 8 and 9. Fig. 8 shows the usual AM set-up. While it can be used for FM, the arrangement of Fig. 9 gives a great improvement in voice quality. In some cases, speaking voices that have excellent quality and resonance when picked up for FM, as in Fig. 9, sound harsh and unpleasant when directed straight at the mike, as in Fig. 8, and transmitted by AM.

Still another setup is illustrated in Fig. 6. We generally use one of our large studios for such instruments as the harp and violin, or for piano solos, with the mike at a considerable distance from the performers. In this case, the separation is about 15 ft. The announcer stands well back from his microphone, too.

Here is something that may surprise you. We use mikes rated at 8,000 cycles for the high-fidelity transmission of frequencies which approach 15,000 cycles. While it is true that a microphone may be limited to 8,000 cycles when it is located immediately adjacent to the sound source, the response range is extended considerably under the conditions illustrated in Figs. 4, 6, and 9. This is another factor

FIG. 8, LEFT. CONVENTIONAL ARRANGEMENT FOR AM NEWSCAST. FIG. 9, RIGHT. REARRANGEMENT FOR FM TRANSMISSION

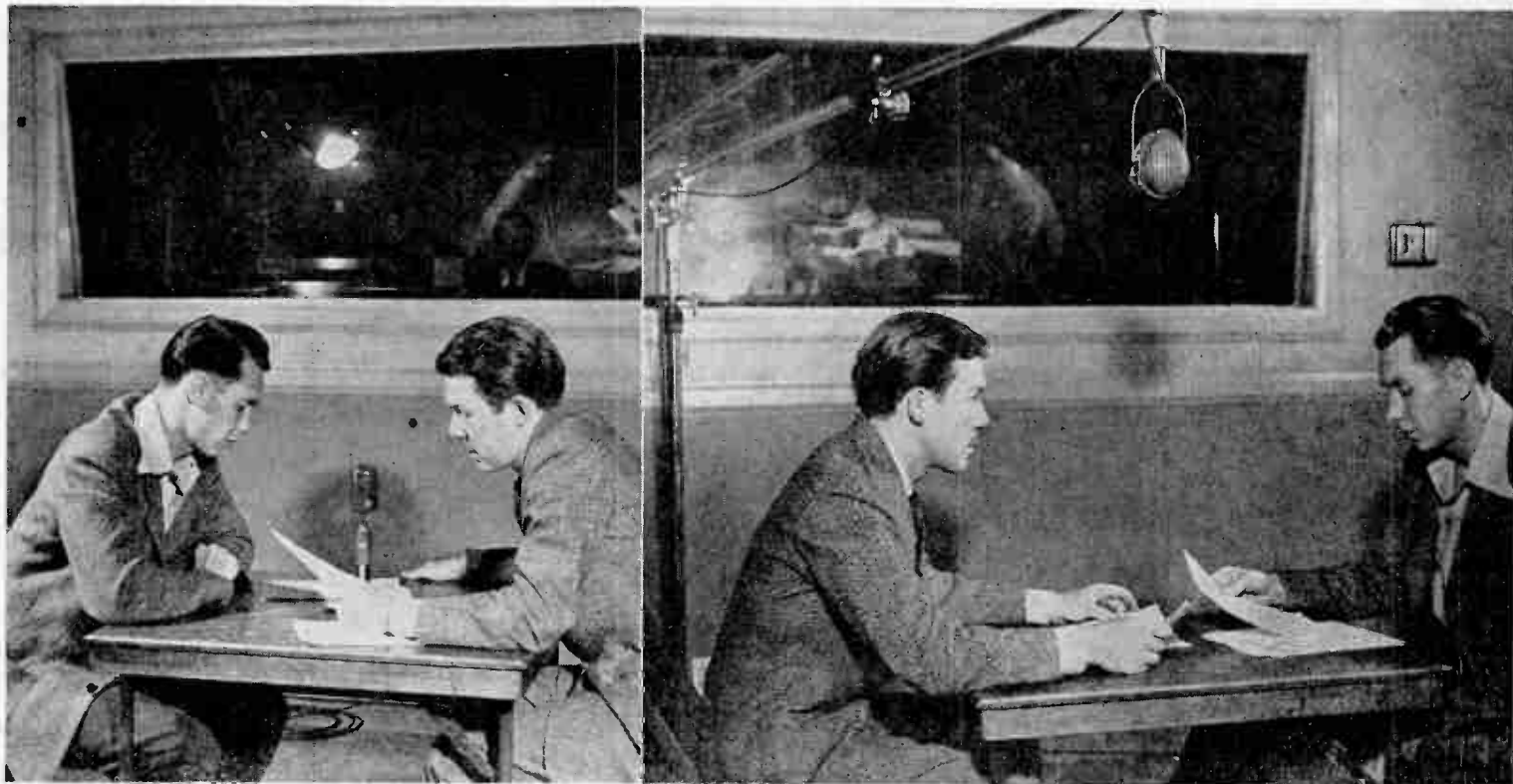
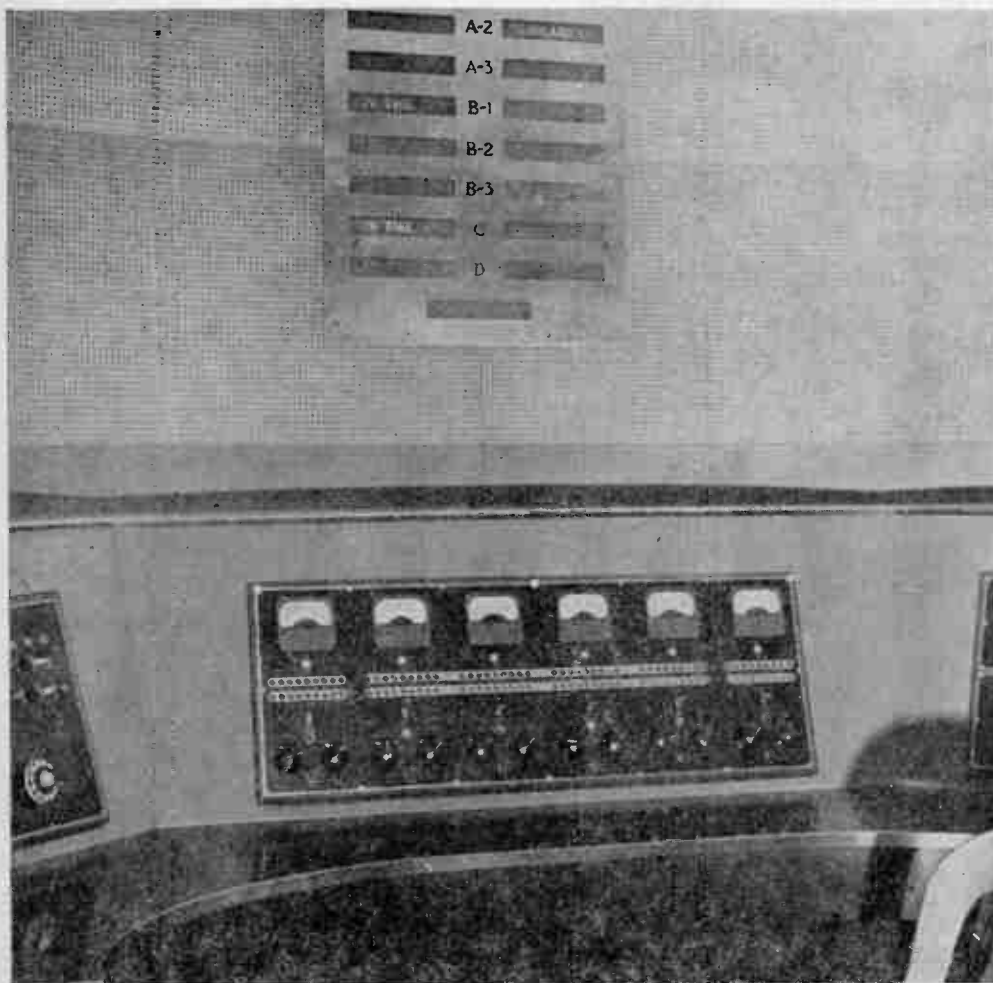



FIG. 10, ABOVE. THE AUDITORIUM AT WTMJ & WTMJ-FM SEATS 400. A ROOM AT THE REAR, WHICH CAN BE USED FOR RECEPTIONS OR SPONSORS AND THEIR GUESTS, LOOKS DOWN ON THE AUDITORIUM THROUGH A LONG WINDOW

FIG. 11. CONSOLE IN THE MASTER CONTROL ROOM. IF ANY STUDIO IS IN USE, THE ILLUMINATED BOARD ABOVE THE OPERATOR'S POSITION SHOWS WHETHER THE PERFORMANCE IS IN REHEARSAL OR ON THE AIR



that must be studied carefully by AM technicians when they undertake FM transmission.

You will notice that we use boom mike stands extensively. We have found that they reduce the microphone mortality by a considerable factor. Also, they are particularly useful in setting up for FM programs because of the ease with which they can be adjusted to proper microphone height and distance.

**Studios for FM** ★ In order to get the full audio range of voices, music, and sound effects for FM, brilliant acoustic characteristics are required in the studio in order to build up the overtones. We can hear a distinct difference when we use our auditorium, because overtones are absorbed by the audience. It is impossible to offset that effect. Therefore, when musical quality is the only consideration, we prefer not to have an audience.

I hope that, some day, we can have an outdoor band shell, designed for resonance at the high audio frequencies. Then we can obtain the desirable acoustic effects for FM, and have an audience, too.

We have succeeded in getting the noise down 60 db, although we had our troubles doing it. It may seem that we have gone to extremes in reducing the noise level in our studios, but the results justify the effort and expense.

Each studio is completely isolated from the building structure. The walls, ceiling, and floor are built within, and insulated from a steel framework which is suspended from steel beams on insulated hangers. Space between the studio and the building are filled with insulation, so that sound cannot reach the studio by radiation or by conduction.

A 60-db noise level is not easy to attain, even with this elaborate type of construction, and considerable sleuthing was required to discover the causes of noise which showed up in the beginning. We found, for example, that the studio floors were bonded to the corridors of the building by linoleum that extended past the thresholds of the doors. It was necessary to break that connection. Another cause was traced to the construction of the control room windows. The heavy frames were secured by spikes so long that they established a direct connection between the building and the studio walls.

These may seem to be extreme measures. Indeed, they would not show up on the average cheap AM receiver, but the results are made apparent on high-fidelity FM reception.

**Control Room Equipment** ★ Fig. 11 shows the master controls, and the board which indicates the status of each studio. There are views of one of the control rooms in Figs. 1, 2, and 7.

It will be seen that some of our control rooms are designed to handle two studios. For example, the photographs reproduced



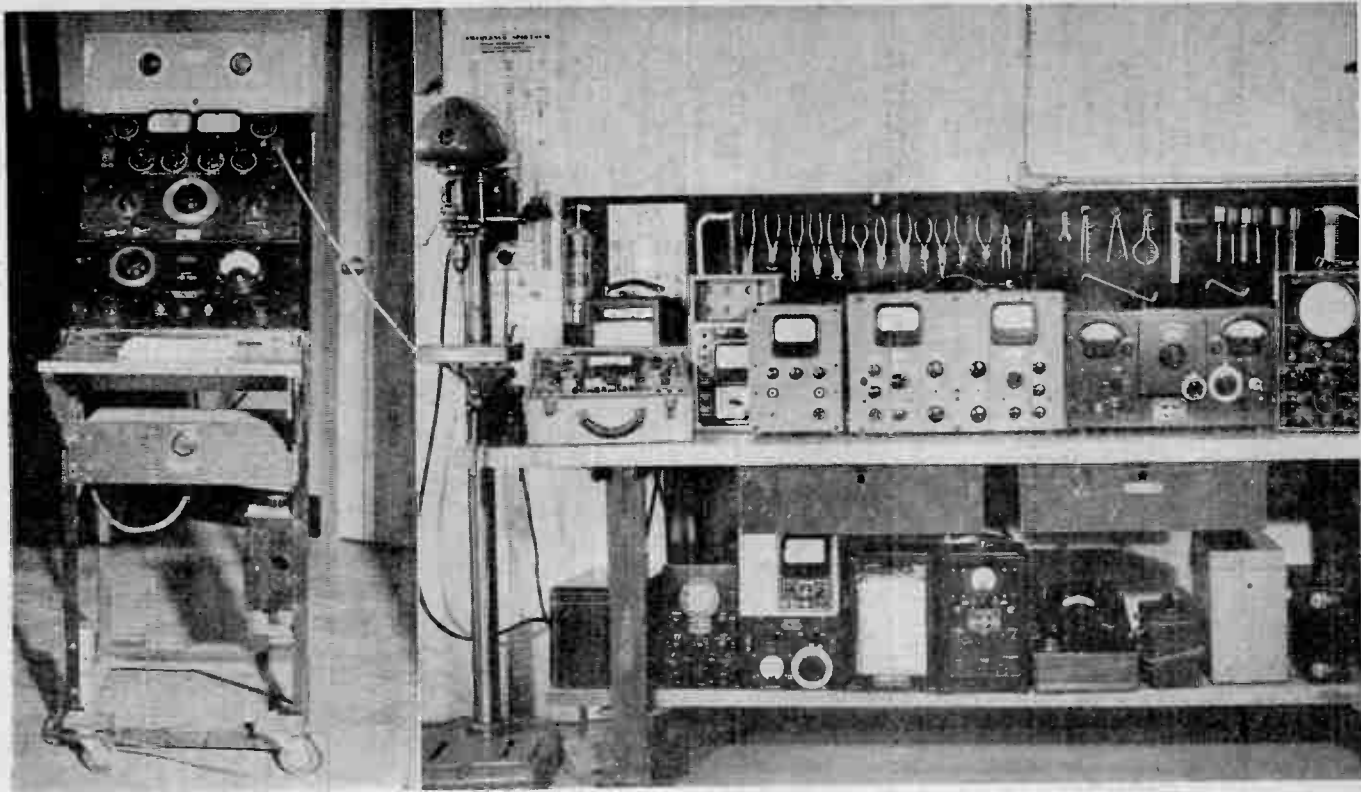

FIG. 12. PORTABLE TEST RACK FOR CHECKING AND MEASURING EQUIPMENT CHARACTERISTICS. FIG. 13. SERVICE INSTRUMENTS

in Figs. 1 and 2 are of the same control room, taken through the two studio windows.

In order to prevent the introduction of AC hum, the speech equipment is so arranged that there are no AC power transformers in the console. In fact, the only AC current carried in the console circuits is 6 volts, for the tube filaments.

All relay circuits are in their normal positions when they are set up for a program on the air. That is, there is no voltage on the coils. In case of a power failure, therefore, the program would not be interrupted. The microphones are not controlled by relays, but run to manually-operated keys. Duplicate rectifiers, located on the rear wall, can be seen in Fig. 1.

On the right-hand section of the console there is a switch for cutting in any of the other studios. Thus, a special news flash or an emergency broadcast can be originated in any studio and put on the air without interrupting the program in progress at that moment. This proved to be a great convenience during the war years.

In order to conserve floor space, the monitor speaker is mounted on the ceiling. It can be seen in Fig. 7, above the clock. Controls on the nemo panel, the left hand section of the console, permit the operator to monitor any incoming line, as well as the studio program.

**Office Monitors** ★ Our engineering offices are equipped with speakers and controls by which any studio or incoming line can be monitored. The selection is obtained with a conventional telephone dial, operating selector switches. In addition, there are two buttons to operate a volume control, which is driven by a reversible motor mounted in the speaker cabinet.

**Equipment Test** ★ A brief description of the test equipment most often used at our studios may be helpful to those planning new FM stations. Fig. 12 shows a test rack which we made up from standard instruments. Mounted on rubber-tired wheels, it can be pushed around the building wherever it is needed.

At the top of the rack is a square-wave generator, used in conjunction with the audio oscillator below and a cathode-ray oscilloscope, for studying wave shapes and checking equipment. Next on the rack is a transmission measuring set to check levels on various circuits, and for determining frequency response and maximum gain on various units of our equipment. Next, is an audio oscillator covering 30 to 20,000 cycles, and a distortion and noise measuring set. Below the shelf there is a set of filters for the distortion meter, so that we can get an accurate check on distortion at 50, 100, 400, 1,000, 5,000, and 7,500 cycles. The unit strapped to the leg of the supporting framework is merely

a voltage control by which we can get exactly 110 volts AC.

The equipment on the test bench illustrated in Fig. 13 includes, at the top, from left to right: tube checker, logarithmic vacuum-tube voltmeter, and 5-in. oscilloscope. On the lower shelf are: a 3-in. oscilloscope, microvolter, ohmmeter, Esterlino-Angus recording meter, vacuum-tube voltmeter, and multimeter test kit.

**Conclusion** ★ There is one suggestion I would like to offer those who are now making plans and preparations for new FM stations. It is perfectly natural for engineers of long AM experience to proceed along the lines of established practices, making only limited concessions to the special requirements of FM.

Such methods, however, will not produce the best end results in FM broadcasting. A much more effective method, and I say this because of our experience of *The Milwaukee Journal* station, is to study the special requirements of FM broadcasting, and base all plans for facilities and equipment on those considerations, without regard to AM practice.

Only in this way is it possible to anticipate the increasingly critical judgment of radio listeners which will result from widespread use of high-fidelity FM receivers, and to assure them of the full entertainment value which FM can deliver.



# Chapter 5

## Coaxial Lines for FM Transmitters

Coaxial Transmission Lines and Their Characteristics, and Methods of Installing Lines at FM Broadcast Stations

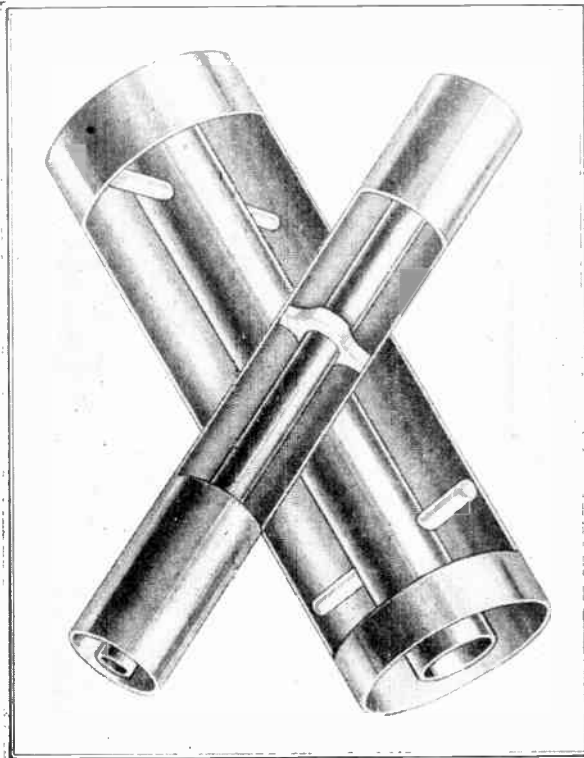

FIG. 1. INTERNAL CONSTRUCTION OF COAXIAL LINES

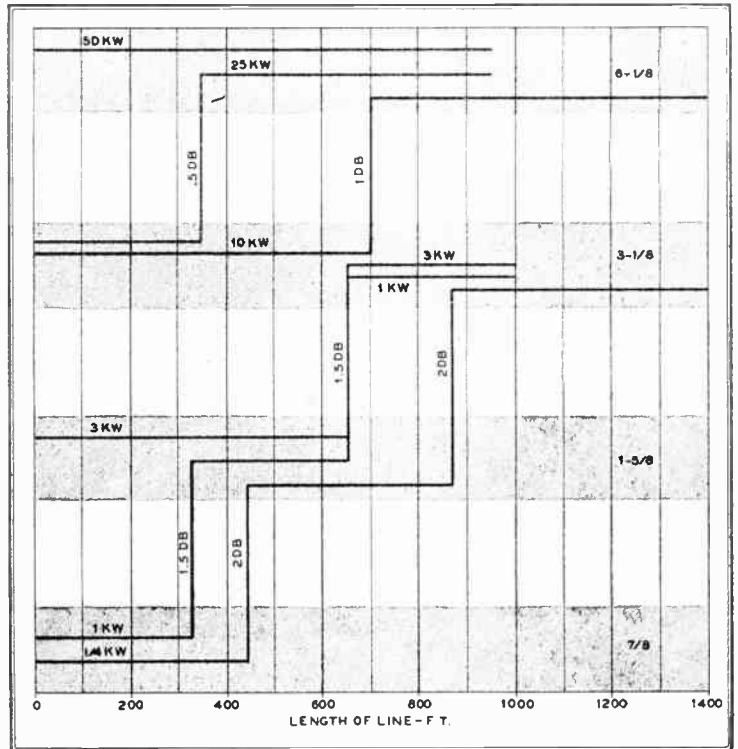

FIG. 2. DIAMETERS OF LINES FOR VARIOUS POWERS & LENGTHS

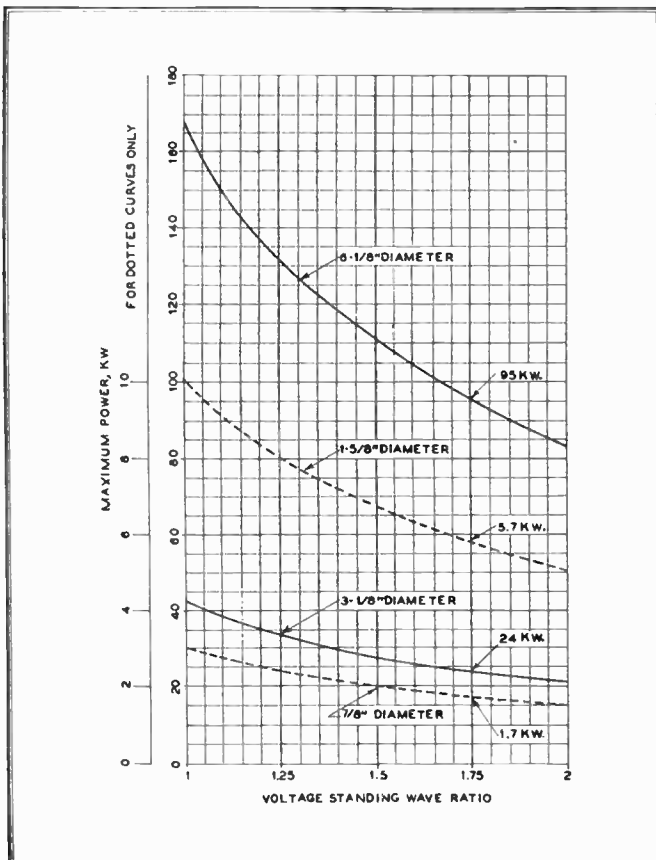

FIG. 3. MAXIMUM POWER RATINGS BASED ON SAFE TEMPERATURE RISE

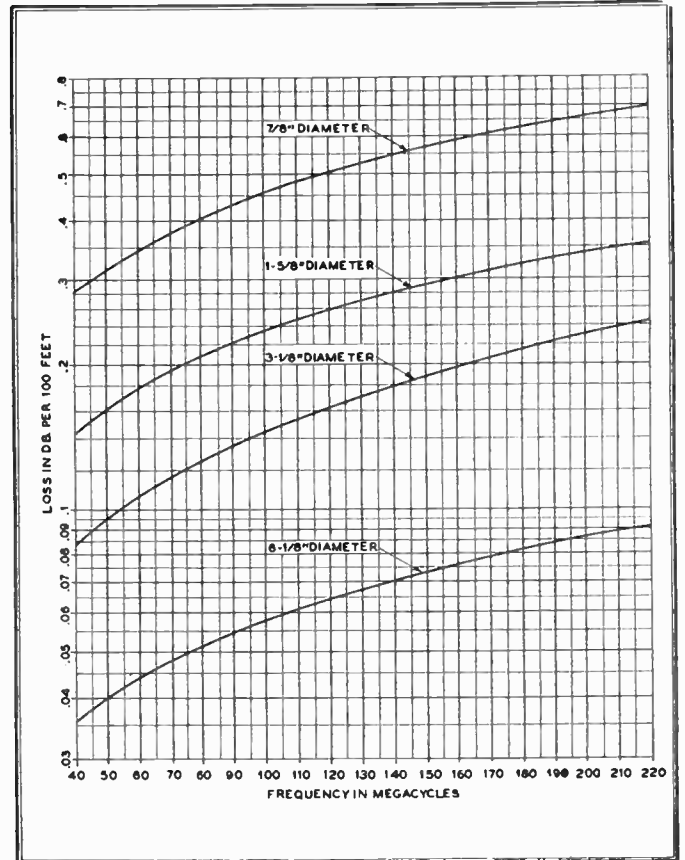

FIG. 4. ATTENUATION PER 100 FT. AT 40 TO 220 MC.

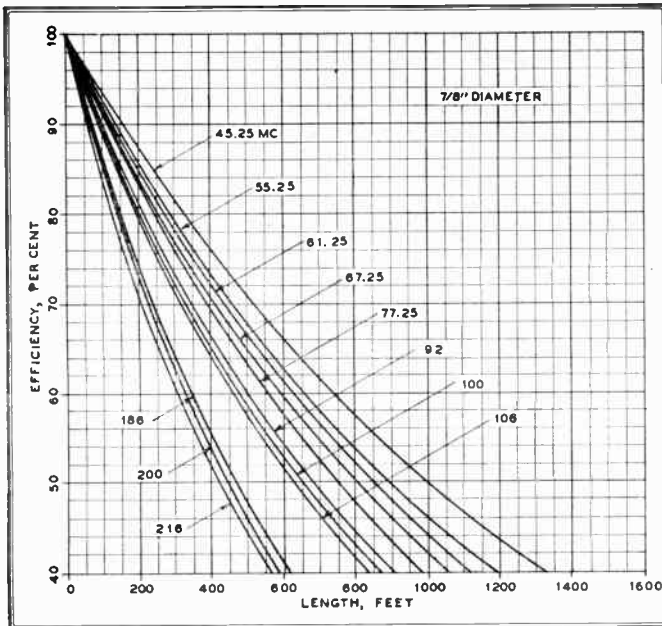

FIG. 5. EFFICIENCY OF 7/8-IN. LINE FOR LENGTHS TO 1600 FT.

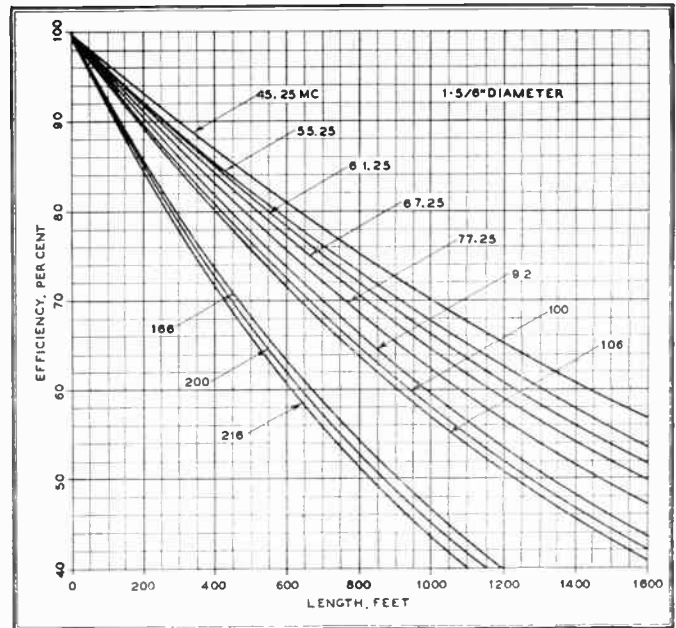

FIG. 6. EFFICIENCY OF 1-5/8-IN. LINE FOR LENGTHS UP TO 1600 FT.

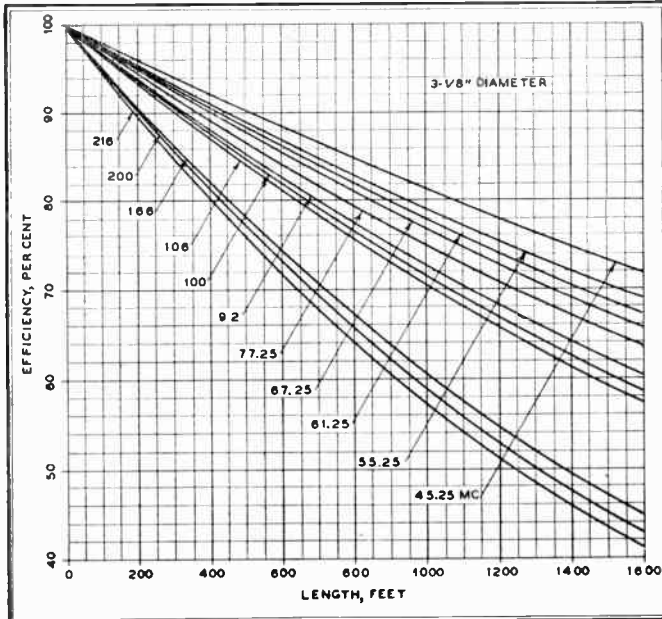

FIG. 7. EFFICIENCY OF 3-1/8-IN. LINE FOR LENGTHS TO 1600 FT.

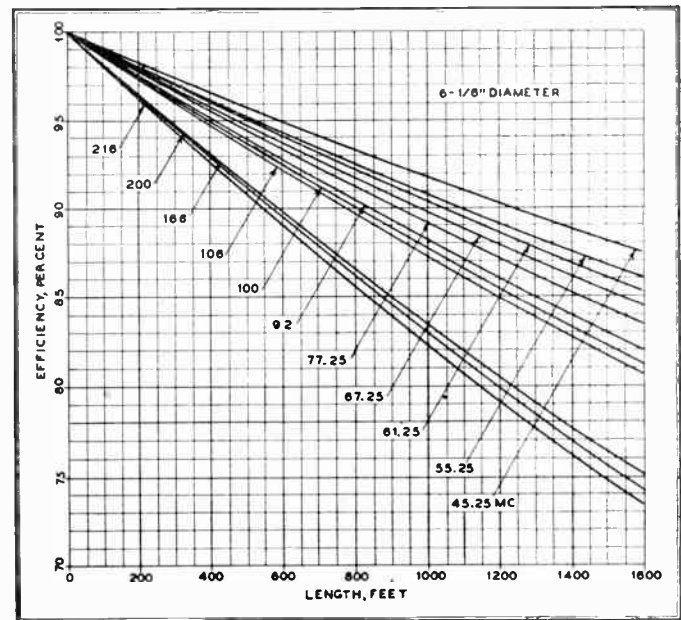

FIG. 8. EFFICIENCY OF 6-1/8-IN. LINE FOR LENGTHS UP TO 1600 FT.

EVERY FM or television broadcast transmitter, whether its power is 250 watts or 50,000 watts, must deliver energy to an antenna through some form of coaxial transmission line. Such coaxial lines must be installed with considerable care, because the mechanical problems of mounting large, heavy cables on towers or tall buildings are severe. No less important is the need for careful attention to electrical details, because freedom from reflections and from excessive attenuation is not easily achieved at 100 mc. Practices common in AM broadcasting would produce reflections and standing waves at 100 mc. far in excess of system tolerances.

Transmission lines which exhibit the required electrical properties at FM and television frequencies up to 216 mc. have been designed and are available. It is the purpose of this article to explain their use, and to describe the results obtained.

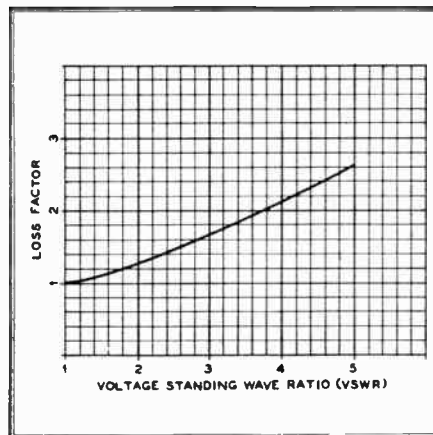

FIG. 9. LOSSES DUE TO STANDING WAVES

**Characteristic Impedance** \* For various reasons, a characteristic impedance of 51.5 ohms has become generally accepted as a standard transmission line impedance for

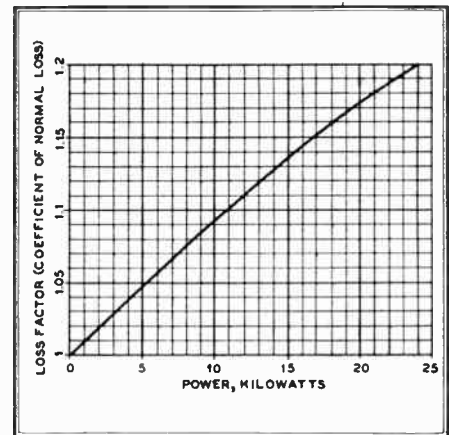

FIG. 10. RESISTANCE & INSULATION LOSS

FM and television. Most of the major manufacturers of transmitters and transmitting antennas are designing equipment around this value of impedance, and



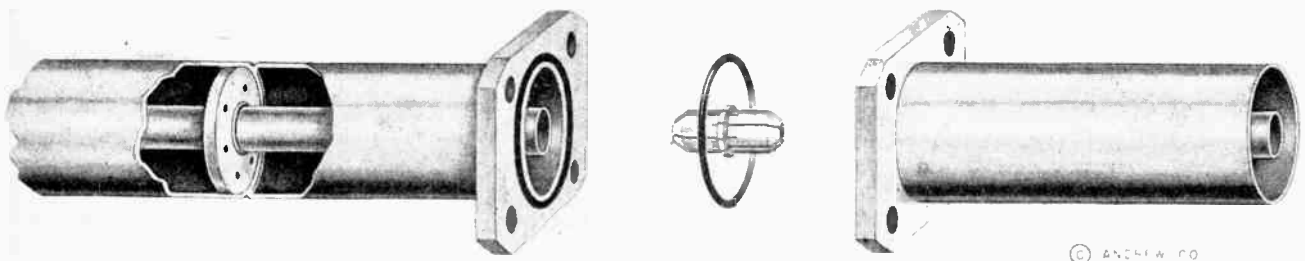

FIG. 11. CONSTRUCTION OF JOINTS FOR INNER AND OUTER CONDUCTORS, AND GAS SEAL BETWEEN 20-FT. LENGTHS

it is expected that the Radio Manufacturers Association will eventually lend its weight toward establishing an impedance of 51.5 ohms as standard. The 70-ohm transmission lines used for many years in AM broadcasting will continue to be available, but are not recommended for FM. Although entirely satisfactory at standard AM broadcast frequencies, such lines do not offer the required degree of electrical performance at 100 mc.

**Diameter** ★ Transmission line sizes have been chosen so that the diameter of each line is approximately twice that of the next smaller size. Four standard diameters are offered, as follows:  $\frac{7}{8}$ ,  $1\frac{1}{8}$ ,  $3\frac{1}{8}$ , and  $6\frac{1}{8}$ ". RMA standardization is also expected on these values of transmission line diameter; in fact, transmission line standards of very broad scope are being formulated and will help enormously in providing uniformity of electrical ratings and interchangeability of all components.

Unless the line is extremely short, the choice of a suitable diameter depends upon maximum permissible attenuation,

or minimum permissible efficiency. The latter factor may be determined by dividing the power required at the input terminals of the antenna by the maximum power output of the transmitter. The

rating should be checked against Fig. 3.

Fig. 2 shows recommended transmission line diameters for various transmitter output powers and line lengths, based on arbitrarily assigned maximum attenuation

FIG. 13. SOLDERLESS FLANGED COUPLING USED WHEN A 20-FT. SECTION MUST BE CUT OFF IN THE FIELD

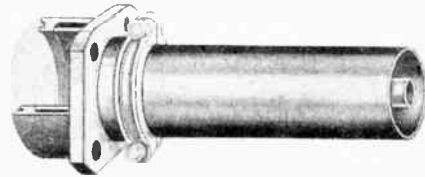

proper diameter for any specified length may then be determined by selecting from Figs. 5, 6, 7, or 8 a diameter which produces an efficiency equal to or greater than the quotient of these two powers. For very short lines, the procedure described above may lead to the selection of a diameter too small to carry the required amount of power, so the maximum power

values (2 db for 250 watts, 1.5 db for 1 and 3 kw, 1 db for 10 kw, and 0.5 db for 25 and 50 kw). The curves provide a graphical illustration of the importance of short transmission lines, because diameter and cost increase rapidly with the length.

The maximum power ratings shown in Fig. 3 for the four standard diameters are based on safe temperature rise, and should

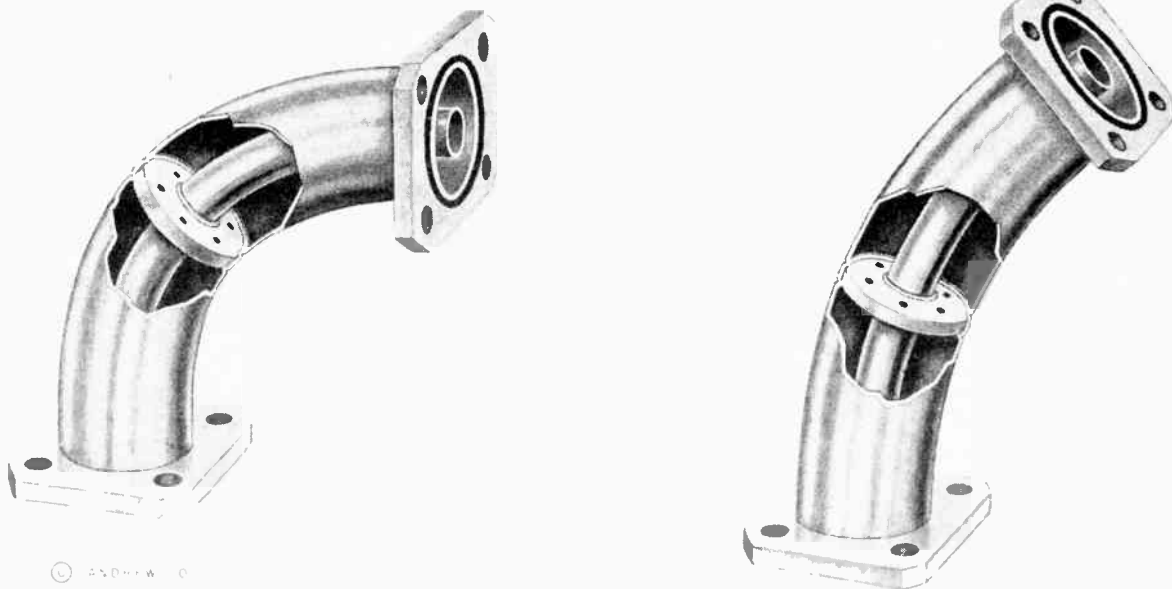
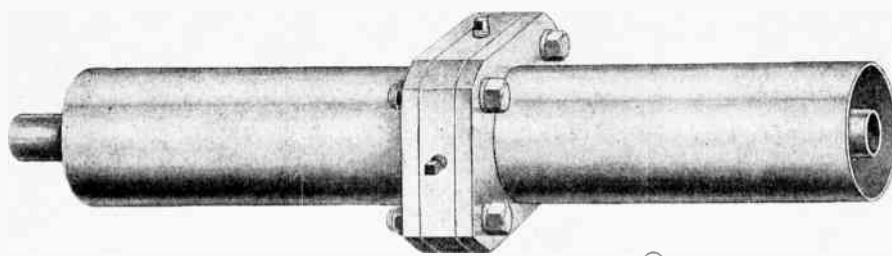

FIG. 12. 90° AND 45° ELBOWS, USING FLANGED CONNECTIONS, FOR CONSTRUCTION REQUIRING BENDS





© ANDREW CO

FIG. 14. A GAS INLET FITTING SET BETWEEN FLANGES ON THE ENDS OF 20-FT. SECTIONS OF COAXIAL LINE

not be exceeded. The standing wave ratio depends on impedance mis-match at the antenna, but since this factor should never exceed 1.75, the corresponding power ratings are suggested as maximum. At FM and television frequencies, only very short transmission lines are operated near

previously published data which fail to make full allowance for insulator and conductor losses. Actually, transmission loss in the new 51.5-ohm coaxial cables is less than that in any of the previously available commercial types. In making comparisons, it should be verified that both

**Mechanical Details** ★ Since FM antennas are usually mounted on towers or tall buildings where torch soldering is difficult, it was decided that all connectors and other accessories must be designed to permit a completely solderless installation. The connectors used for this purpose are gas-

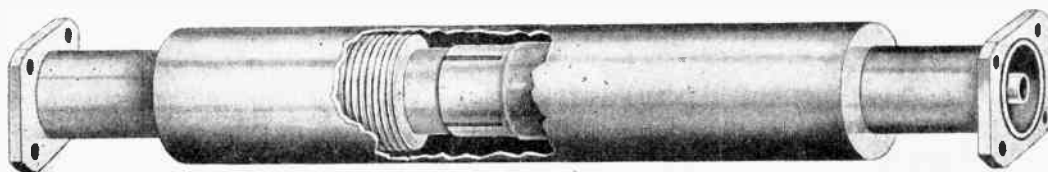

FIG. 15. THIS EXPANSION FITTING IS DESIGNED TO INTRODUCE ONLY NEGLIGIBLE REFLECTIONS IN THE LINE

the maximum power rating because, for even moderately long lines, the limitation of minimum permissible efficiency demands the choice of a larger diameter.

**Efficiency** ★ In calculating attenuation in the new FM and television lines, every effort has been made to determine precisely all the factors contributing to transmission loss. The result is that the attenuation and efficiency values presented in Figs. 4 through 8 appear more pessimistic than

sets of loss curves are calculated on the same basis.

Attenuation increases when standing waves are present, as shown in Fig. 9. Also, operation at maximum power rating or at excessive temperature rise causes an increase in attenuation, because resistivity of copper and loss factor of insulation both increase with temperature. Fig. 10 indicates the order of magnitude of this increase due to operation at high power levels.

keted brass flanges, silver brazed at the factory to both ends of each 20 ft. transmission line section. As shown in Fig. 11, successive sections are joined together by means of bolts passing through the flanges on adjacent ends. The gas seal is made with an "O" ring, a rubber gasket of circular cross section, and the inner conductor connection is made with a slotted spring-temper connector.

Fig. 12 shows 90° and 45° elbows using flanged connectors, and Fig. 13 illustrates

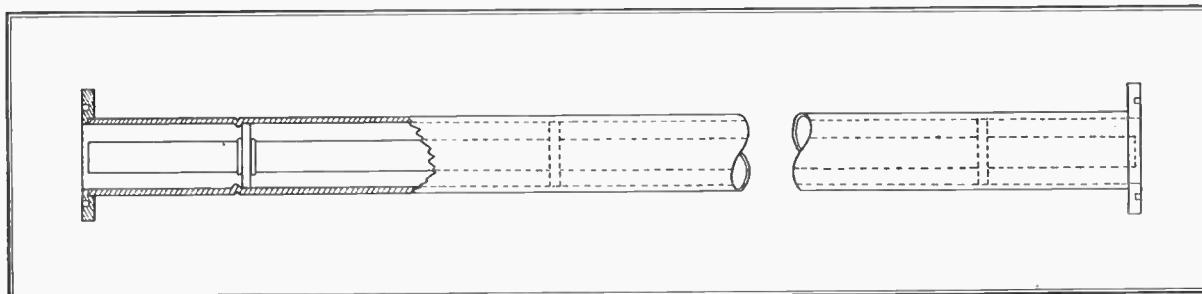

FIG. 16. THE ROLLED-IN GROOVE SUPPORTS THE INNER CONDUCTOR ON VERTICAL RUNS OF LINE

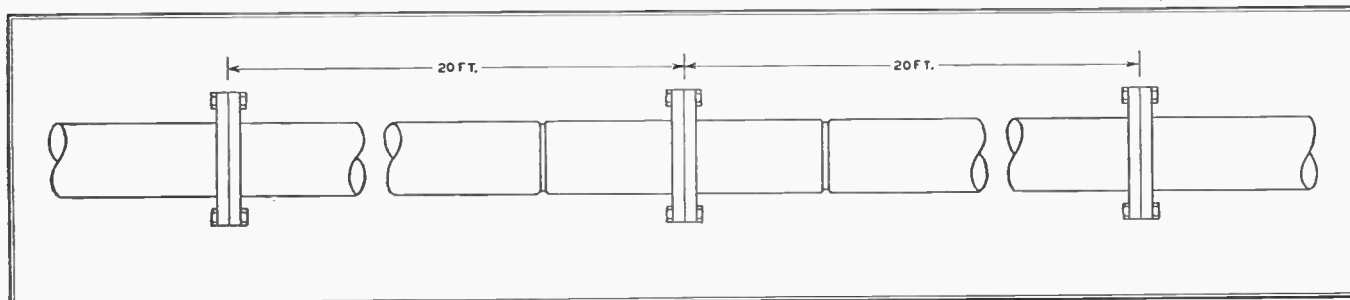

FIG. 17. ON HORIZONTAL RUNS, THE POSITION OF THE GROOVE IS REVERSED IN ALTERNATE 20-FT. LENGTHS OF LINE

a solderless flanged coupling device used when one of the 20-ft. sections must be cut in the field. Fig. 14 represents a gas inlet fitting which can be inserted between flanges on the ends of 20-ft. sections, while Fig. 15 shows a design for an expansion fitting. All these fittings are carefully designed to introduce only negligible reflections when inserted in a transmission line of 51.5 ohms impedance.

Since, in normal operation, the inner conductor develops some temperature rise, a means is required for absorbing its expansion with respect to the outer conductor. One satisfactory solution utilizes the inner conductor connector as a differential expansion joint. The design of this part, Fig. 11, permits variations in engagement with both inner conductors sufficient to accommodate any normal increase in length.

Inner conductor support on vertical runs is provided by a groove rolled into the outer conductor on one side of the bottom bead, as shown in Fig. 16. Each 20-ft. section of inner conductor then rests on its own bottom bead, and any motion due to differential expansion must be upwards. On horizontal runs, alternate 20-ft. sections are reversed, as shown in Fig. 17. This arrangement causes the motion due to differential expansion in successive 20-ft. sections of inner conductor to be alternated in direction, thereby preventing inner conductor creep.

The construction illustrated in Figs. 16 and 17 provides adequate mechanical support for the inner conductor, eliminating entirely the need for anchor joints.

**Overall Expansion** ★ Normal variations in temperature due to weather cause ex-

pansion and contraction in copper transmission lines, affecting the inner and outer conductors equally. For the extreme temperature range from winter cold to summer heat, the magnitude of this expansion is about 1¼ ins. per 100 ft. On a 400 ft. run, the total expansion is thus about 5 ins.

Although there are many successful installations in which soft-temper 7/8-in. coaxial cables have been attached to

mately 50% greater than that of steel, and enormous forces (several tons) may be developed in a structure if the two metals are held inflexibly together. Unless some form of stress relief is provided, these forces will inevitably cause failure of the supports, of the transmission line couplings, or possibly even of the tower itself.

Two methods of providing for expansion on vertical towers are illustrated in

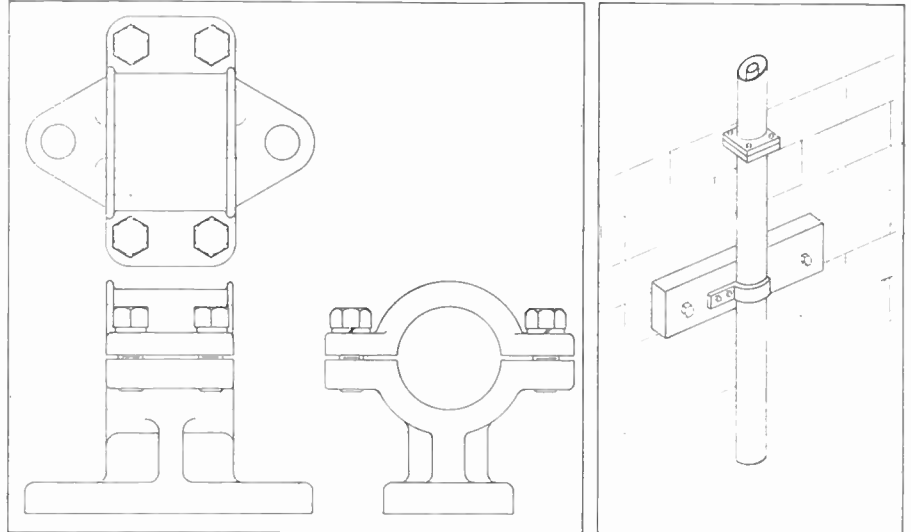

FIG. 18, LEFT. DETAIL OF RIGID SUPPORT TO CLAMP COAXIAL LINE. FIG. 19, RIGHT. PIPE STRAPS OR CONDUIT CLAMPS PERMIT LONGITUDINAL MOTION

vertical towers with no provision for expansion, the flexibility of these lines is entirely lacking in the rigid lines designed for FM, and the user is cautioned against installing such rigid lines with inflexible mechanical supports. The basic difficulty with inflexible supports is that the expansion coefficient of copper is approxi-

Fig. 21. The expansion joints in Fig. 21A are installed at 200-ft. intervals, and the bottom ends of each 200-ft. run are supported by brackets which anchor the line firmly to the tower. The remaining supports should be of a type which permit vertical motion (as from expansion or contraction) but prevent lateral motion.

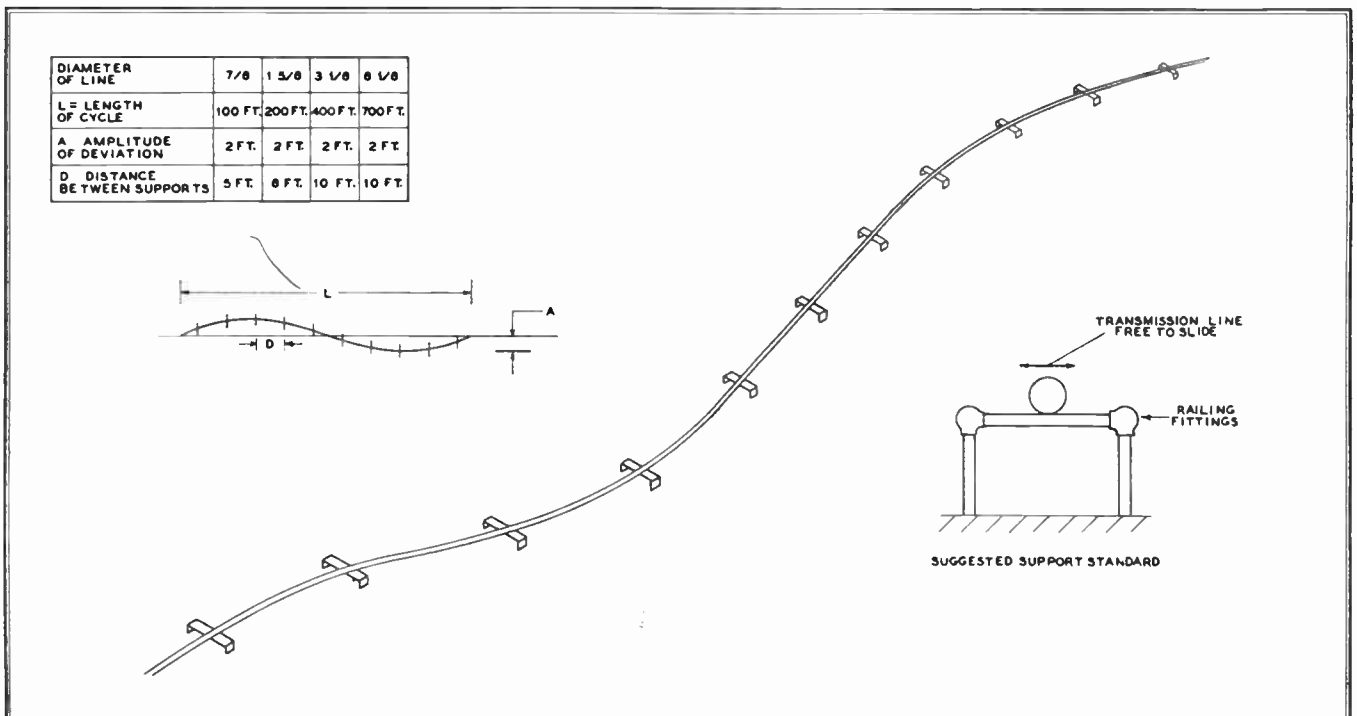

FIG. 20. IF THE LINE IS LAID IN A SINUOUS FASHION, AS SHOWN, EXPANSION FITTINGS ARE NOT NEEDED ON HORIZONTAL RUNS

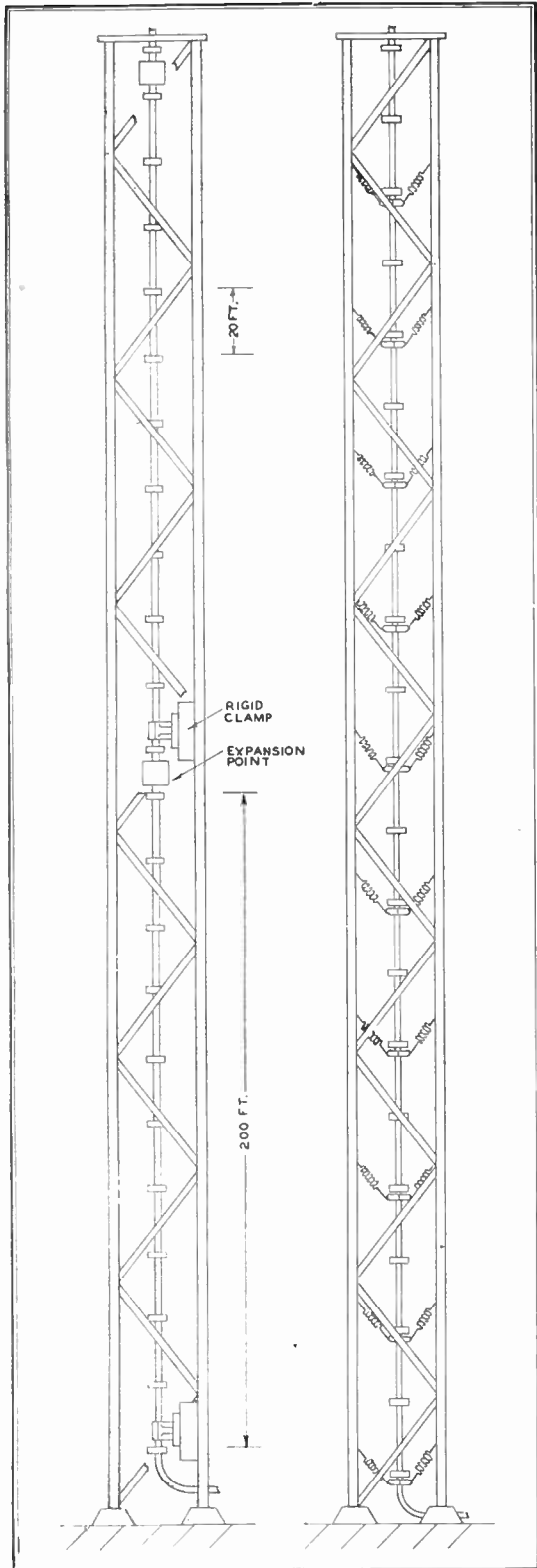

FIG. 21A, LEFT. RIGID LINE MOUNTING. FIG. 21B, RIGHT. SPRING SUSPENSION FOR VERTICAL RUN

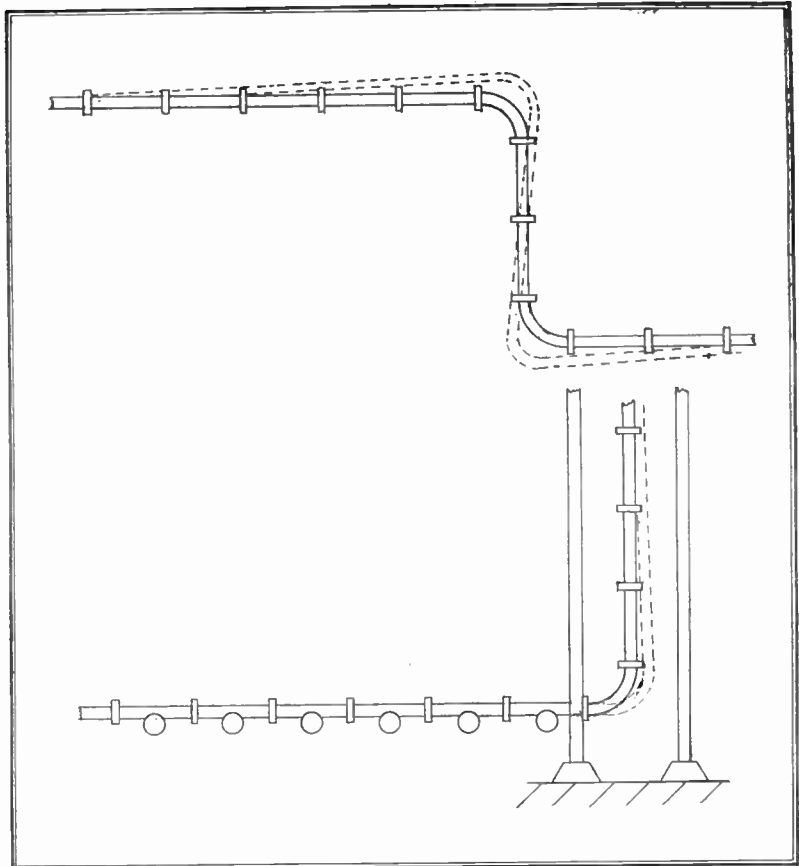

FIG. 22. PROPOSED ARRANGEMENT FOR A LONG HORIZONTAL RUN

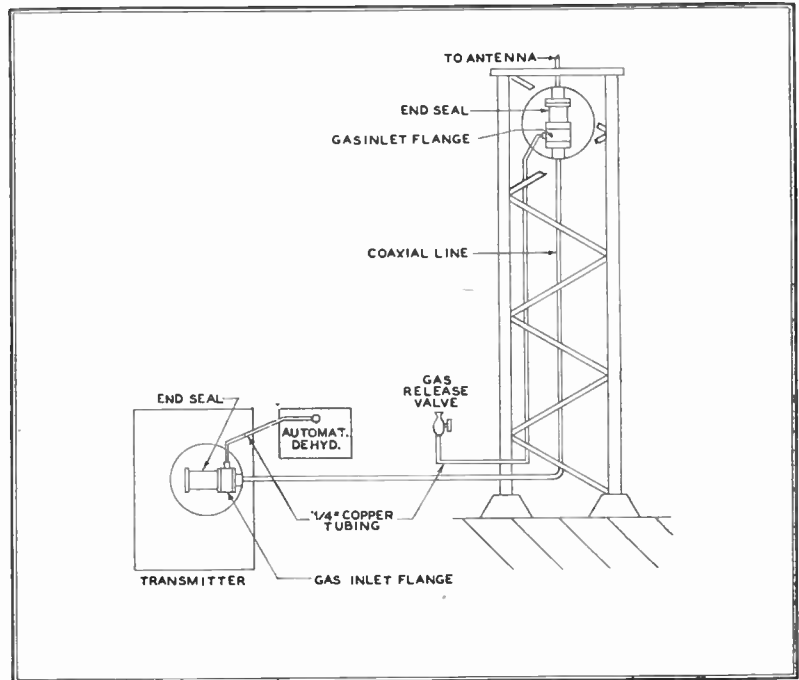

FIG. 24. DETAILS OF A PREFERRED METHOD FOR PROVIDING GAS CONNECTIONS ON TYPICAL FM LINE INSTALLATION

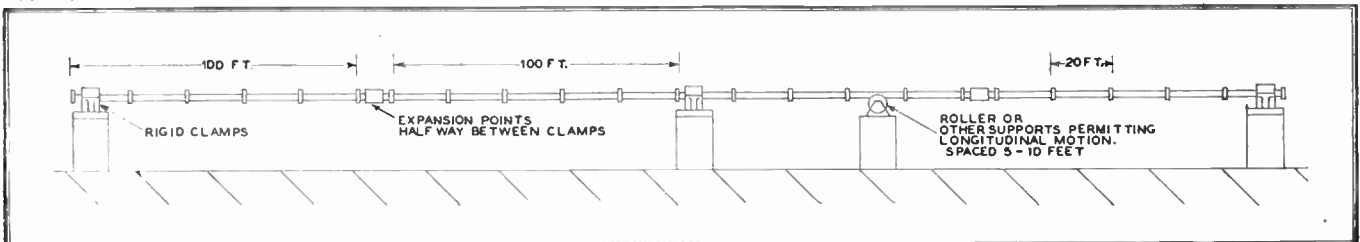

FIG. 23. PROPOSED CONSTRUCTION FOR A LONG LINE COMBINES RIGID AND ROLLER MOUNTS, AND EXPANSION JOINTS





FIG. 25A. MOTOR-DRIVEN DRY AIR PUMP

In making such an installation, the bottom section of transmission line should be installed first and subsequent sections added to it so that all sections are supported by the bottom one and all couplings are in compression, rather than tension. In connecting the expansion joint between the last section of the line and the antenna, it should be compressed slightly below its normal length for the temperature at the time of installation, to permit inserting the inner connector.

In Fig. 21B, spring supports allow expansion and contraction to occur freely, and expansion joints are not needed. Whereas the installation of Fig. 21A is made from the bottom up, this one is made from the top down. The spring supports should be added as the work progresses, so that tension on any one

flanged connector is never greater than that due to the weight of three or four lengths of line.

**Horizontal Runs** ★ Fig. 20 illustrates a horizontal run in which no provision for expansion is required because of the sinuous fashion in which the line is laid. Fig. 22 shows two other horizontal runs in which expansion joints are not needed. In both figures, the dotted lines indicate with some exaggeration the position of the line after expansion has occurred. Fig. 23 shows a long horizontal run with expansion joints.

If it becomes necessary to cut a 20-ft. length of line, the cut should be made only at the mid-point between insulators, to avoid disturbing the characteristic impedance of the line. The mid-points are marked on the outside of the outer conductor by means of yellow bands. In FM, one or two exceptions to this rule may be tolerated, especially if they occur near the transmitter rather than near the antenna. In television, however, if a cut is made any place other than at the mid-point, it becomes necessary to install a special section of inner conductor to introduce reflections compensating those due to the improper cut.

**Pressurization** ★ Pressurization with a dry inert gas is necessary if reliable operation is to be obtained. Although nitrogen was frequently used for this purpose before the war, dehydrated air is considered preferable because of its ready availability. So far as performance is concerned, there is no preference between the two gases.



FIG. 25B. MANUALLY-OPERATED DRY AIR PUMP FOR COAXIAL LINES

Fig. 25 shows two suitable sources of dry air, one manually operated and recommended for short lengths of line, the other motor driven, self-reactivating, and fully automatic.

The antenna end of a transmission line should be fitted with a valve to permit flushing the line with gas, a procedure especially recommended on new lines or after a line has been opened for repairs. Since the antenna end of the line is usually inaccessible, a length of copper tubing may be routed from a gas inlet coupling to some more convenient spot where the valve is located. Rubber hose may be used in place of copper tubing to by-pass the base insulator on insulated vertical towers. Fig. 24 shows typical gas connections.

**Isolation from AM Towers** ★ For owners of standard broadcast stations who are adding FM, it is often economical to use existing vertical tower radiators for support of the FM antenna. Two schemes for doing this without detuning the AM tower are illustrated in Figs. 26 and 27. Both methods attempt to provide a very high impedance between the base of the tower and the outside surface of the FM transmission line, by means of quarter wave resonant sections. In Fig. 26, the resonant section is on the tower and the tower itself forms the outer conductor. The transmission line must be insulated from the tower for a vertical distance of one-quarter wave up from the base. Fig. 27 shows an alternate scheme in which the resonant section is laid horizontally above ground.

In both methods described above it is possible to provide an exact adjustment to resonance by making the line slightly shorter than a quarter wave in length and connecting a variable condenser across the open end.

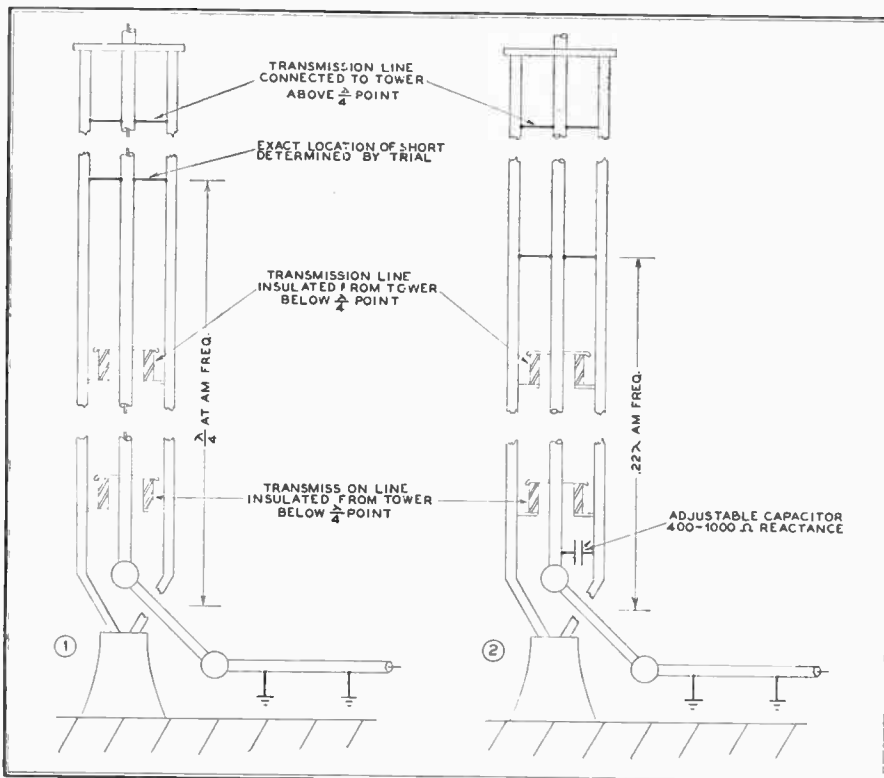

FIG. 26. TWO METHODS FOR ISOLATING FM LINE FROM AM RADIO TOWER

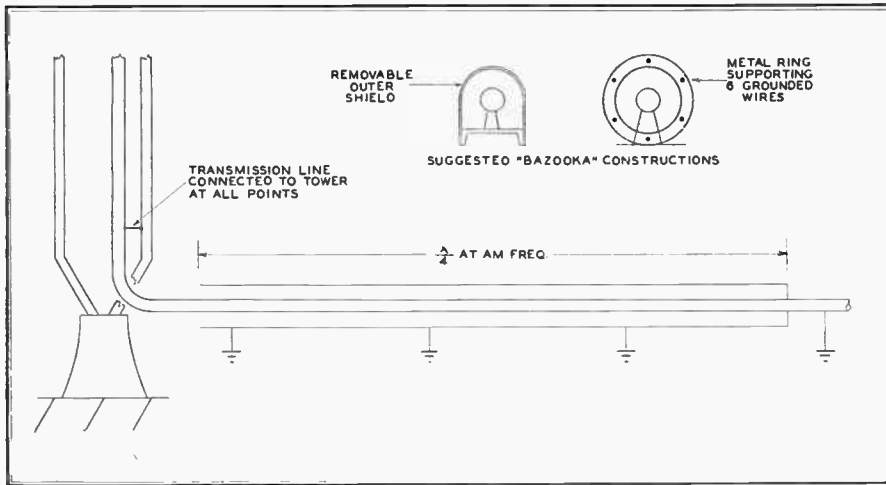

FIG. 27. RESONANT SHIELD USED TO ISOLATE FM LINE FROM AM TOWER

**Spare Lines** ★ The FCC engineering standards for FM require either an emergency antenna or an auxiliary coaxial transmission line to the main antenna. In most cases, it is cheaper to install an emergency antenna, as this may be an inexpensive device located on top of the transmitter building or at an intermediate level on a tower. Under emergency conditions operation at reduced power would then be necessary. Duplicate coaxial lines will undoubtedly be used in the larger stations, where the loss of revenue due to emergency operation with greatly reduced power is a more serious consideration than the cost of a duplicate line.

**Costs** ★ Fig. 28 shows the initial investment in transmission line materials only, exclusive of installation costs. Where steeplejacks are employed to work on towers, the installation labor may cost several times as much as the transmission line itself.

**Summary** ★ The data presented on specific antenna design problems has been drawn from such practices as have been adopted as standard, and from the author's very extensive experience in the installation of coaxial lines for FM and television antennas. In the former case, the organizations responsible for the adoption of

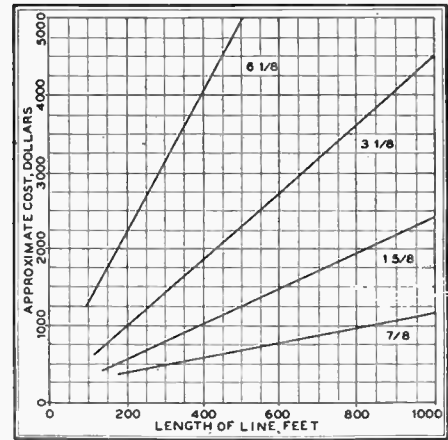

FIG. 28. THE APPROXIMATE COST OF LINE INSTALLATION, EXCLUSIVE OF THE LABOR, AS A FUNCTION OF LENGTH

standards were identified. Curves and data on line characteristics have been checked against actual practice, and afford a dependable basis for the design of new installations.

Correct design of antenna structures is emphasized not only because the cost is a substantial part of the total investment in any FM or television station, but because the efficiency of an antenna is directly related to coverage and, therefore, to the potential revenue to be derived from the station. Experiences which AM broadcasters have had with antenna problems shows the wisdom of thorough planning as a means of avoiding subsequent changes.

# Chapter 6

## Audio Distortion and Its Causes

The Best Reproduction Is the Exact Reproduction of the Original Studio Program

**T**HIS information represents the efforts of a hobby; it has no particular connection with the business interests of any company. The criticisms given in this paper are presented with the hope that they will further the best interests of the radio industry.

It has been customary to specify only the amplitude response and harmonic distortion of audio systems. There are two

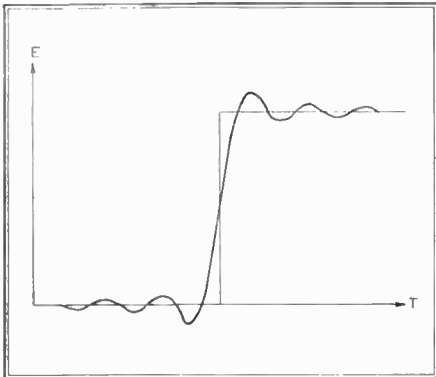

FIG. 1. EFFECT OF TOO SHARP CUTOFF

other important forms of distortion: poor transient response and cross modulation. This paper is concerned with these latter two, since the author feels that ignorance of their importance is chiefly responsible for the failure of many so-called "high fidelity" audio system tests.

**Transient Response** ★ The early connection of amplitude band-width with fidelity of re-

production can probably be attributed to the Bell Telephone Company. The fallacy of neglecting transient band-width of the audio system arose because it was cus-

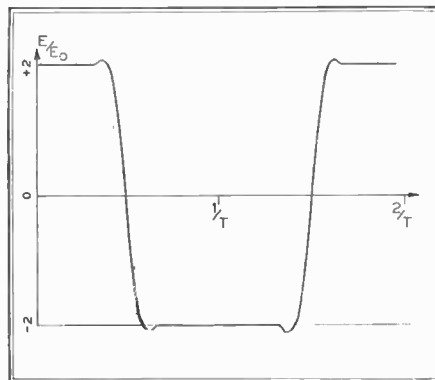

FIG. 2. CRITICALLY DAMPED RESPONSE

tomary to assume that speech and music are made up of continuous tones. We all know that audible sounds have transient character, since they must start and stop sometime. The percussion instruments and staccato score on the brasses particularly demand good transient response for realistic reproduction.

A characteristic ringing at the cutoff frequency results from insufficient transient band-width or too sharp a cutoff in the amplitude band-width response. Fig. 1 indicates the transient response resulting from the application of a unit or step func-

tion to a network having too sharp an amplitude cutoff. The Bell Telephone Company ignored this as long as sufficient damping was present to prevent continuous oscillation (which is called singing). The public has been forced to accept such "Johnny-One-Notes" because the Bell Telephone Company knows best what's good for us.

The transient response can best be

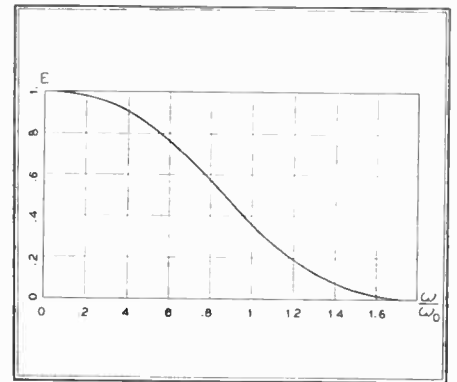
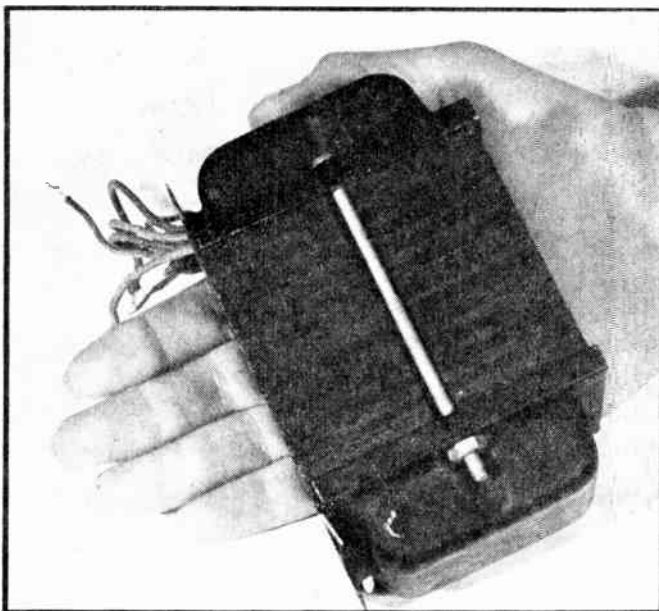
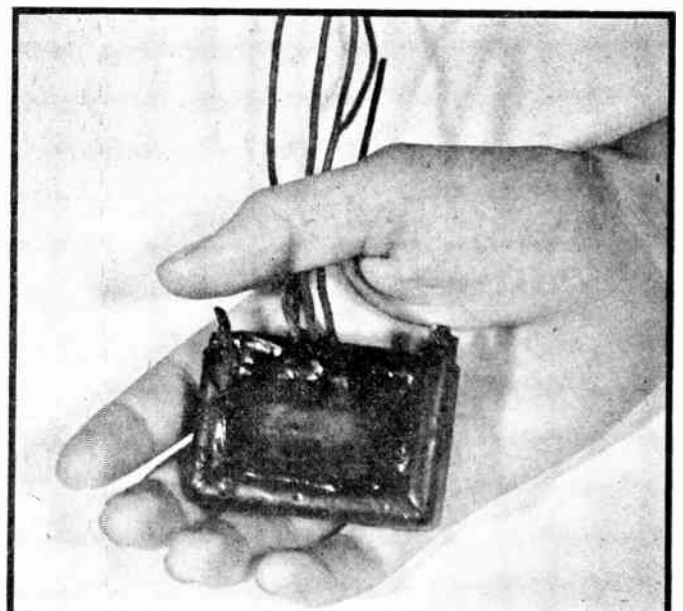

FIG. 3. NETWORK CHARACTERISTIC

measured by applying a square wave of 3 to 10 kc. to the audio system. If the cutoff is gradual and well damped, no Johnny-One-Notes will be observed. Usually output transformer resonance will cause slight oscillations well above the audio range which can be neglected, if well damped. Negative feedback generally accentuates these damped oscillations



ADEQUATE TRANSFORMER COSTS \$1.79, WEIGHS 5½ LBS.



79-CENT OUTPUT TRANSFORMER FROM RADIO SET, ¾ LB.



which may become continuous at a super-audible frequency and actually overload the amplifier.

Fig. 2 is taken from Kallmann's "Transversal Filters", *Proceedings of the Institute of Radio Engineers*, July, 1940. This represents a critically damped response of a network which has the optimum amplitude characteristic shown in Fig. 3. This curve represents the maximum rate at which the amplitude response can be allowed to drop without introducing ringing or Johnny-One-Notes.

Further acknowledgment of the importance of transient band-widths has come from Dr. Hanson in his recent paper before the 1944 National Electronics Conference in Chicago.

Emphasis is now placed on transient response in television applications, wherein it is obviously of great significance. However the principles apply with equal force to faithful audio reproduction and are perhaps the number one reason why the American public demands the tone control to cut out the Johnny-One-Notes created by our faithful servant the Bell Telephone System.

The advent of Frequency Modulation, with its inherent excellent transient response, has permitted my personal observation of sound reproduction free from these effects. The simplicity of direct FM relay offers great promise for reducing this and other forms of audio distortion, without the great expense involved in the installation and maintenance of equally satisfactory long lines and repeaters.

**Cross-Modulation Distortion** ★ Cross-modulation distortion is defined herein as the generation of sum and difference frequencies when two or more tones are applied simultaneously to a system. Since these sum and difference frequencies do not

necessarily bear any harmonic relation to the original tones, the resultant reproduction has a rather confused or muddled background accompanying it.

A test for the presence of such distortion is to note whether a solo instrument in the medium register must have only a soft or subdued accompaniment in order to sound clear. If rather heavy orchestral accompaniment tends to mask the solo instrument, this is probably due to cross-modulation in the system.

Another striking example is presented when the church choir is accompanied by heavy organ bass. Few systems are capable of justice to this combination because of cross-modulation defects.

Such distortions arise chiefly in iron cored transformers and reactors in the system. It has been a common experience for many people to say that FM does not give as much bass response as AM. I have personally observed this effect, since in the New York area several networks originating suitable program material frequently transmit simultaneously via both AM and FM. Invariably the AM seems to have more bass.

Since our Company manufactures a standard signal generator having AM type modulation, I decided to test its modulation system for cross-modulation effects. Fig. 4 indicates the connections and the resulting spectrum for 30% 50-cycle modulation. Only two sum and difference frequencies of 950 and 1,050 cycles are produced about 1,000 cycles, and their magnitude is less than 10 millivolts or 1%. Fig. 5 gives the spectrum for 40% 50-cycle modulation. It can be seen that a whole family of sidebands have been created about 1,000 cycles. Fig. 6 indicates about fifty different sum and difference frequencies for a 50% 50-cycle modulation.

The Model 65-B signal generator uses some negative feedback, and the frequency response is flat within 1 db or 10% to 50 cycles. It can be seen that only 10% of the second harmonic is present on Fig. 6. This amount of second harmonic is scarcely perceptible at such a low frequency because of the harmonic generation present in the human ear itself. The resultant spectrum about 1,000 cycles is definitely noticeable and tends to create the impression of much heavier bass because the human ear tends to react in a somewhat similar manner, and our senses cannot differentiate between synthetic and natural cross-modulation.

In properly designed FM systems, the cross-modulation is much less, since it is not necessary to use iron-core reactors. Hence the false impression of less bass. The absence of cross-modulation results in clean, distinct reproduction. One no longer shudders when the pipe organ hits a heavy bass note, for the choir seems to stand out as tho a screen or curtain had been drawn aside.

I issue a challenge to the AM broadcasters to measure and remedy the cross-modulation distortion in their transmitters.

I also invite the Bell Telephone Company to measure the cross-modulation on their transmission lines and repeaters between even Philadelphia and New York, not to mention Los Angeles and New York.

No wonder the American public doesn't like *high fidelity radios*. I hold in my hand the output transformer removed from a popular make of home receiver. This particular receiver sold for several hundred dollars, and its manufacturer has spent large sums on acoustical improvement but completely neglected the vital output transformer. Fig. 7 shows the cross-modu-

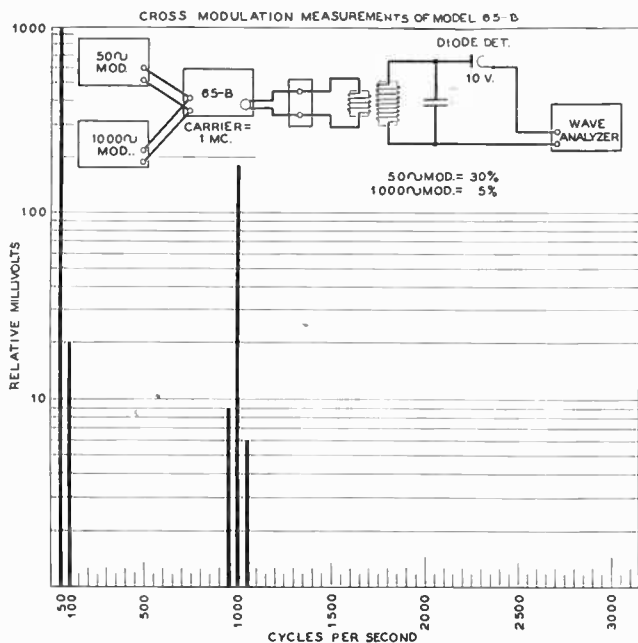

FIG. 4. 30% 50-CYCLE MODULATION AND 5%, 1000 CYCLES

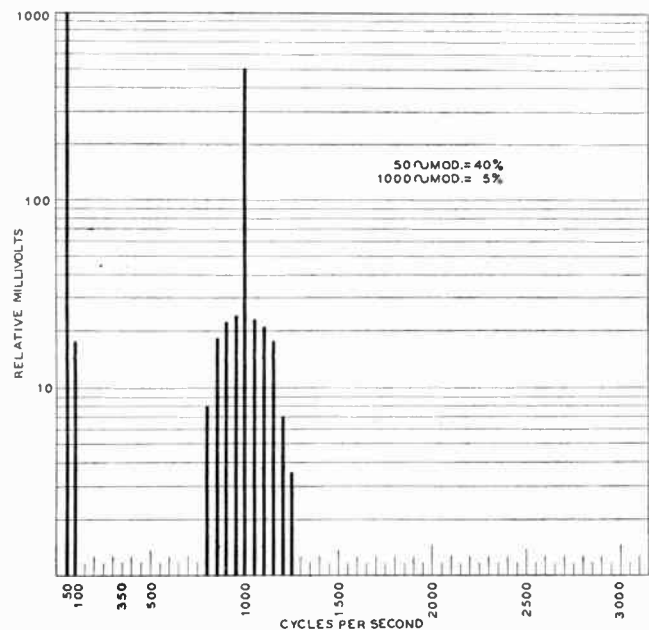

FIG. 5. 50-CYCLE MODULATION INCREASED TO 40%

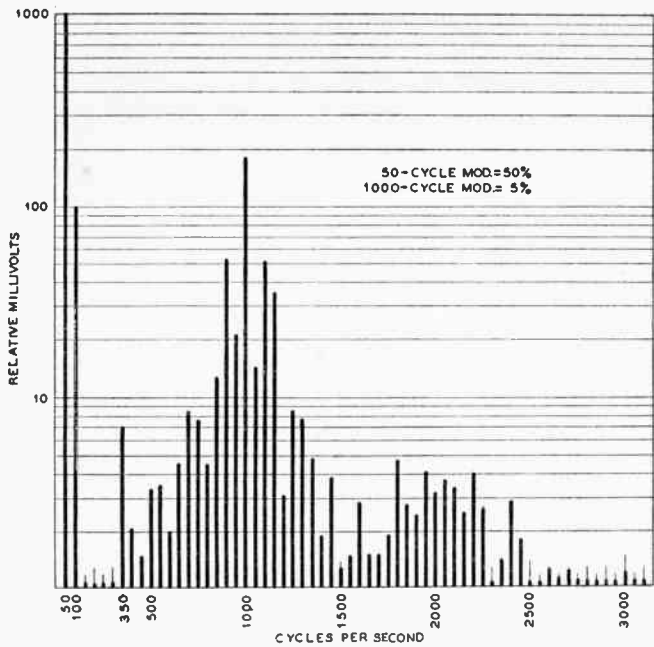

FIG. 6. 50-CYCLE MODULATION INCREASED TO 50%

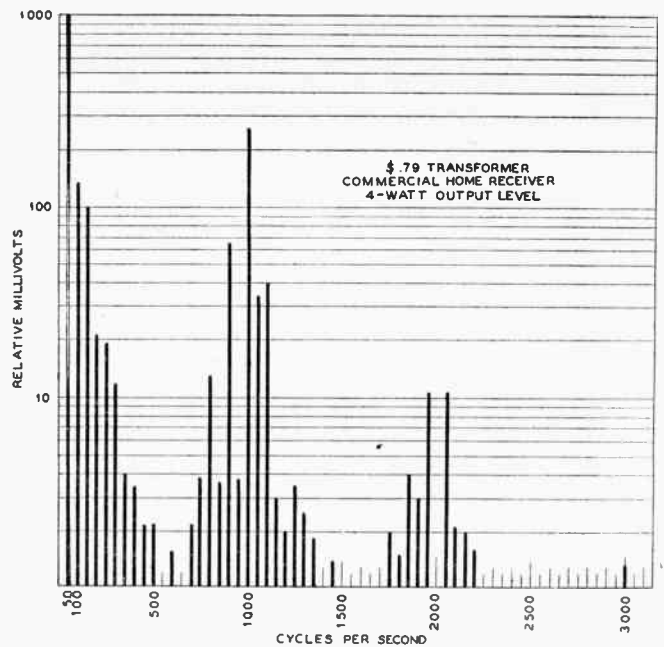

FIG. 7. CROSS-MODULATION IN COMMERCIAL RADIO SET

lation spectrum of this particular receiver with a *resistance* load in place of the speaker. The manufacturer used pentodes without feedback, and I didn't bother taking any overall acoustical data. You will note that the 79¢ output transformer yields a generous spectrum. This data was taken at a 4-watt level, since the pushpull 6V6 amplifier was not capable of supplying more power without serious harmonic distortion.

Fig. 8 was taken after a larger output transformer was substituted. This output transformer could probably be made for \$1.79, altho this particular transformer was designed for 25-cycle operation as a power transformer. The center-tapped, high-voltage winding was used for the plate-to-plate winding with the center tap for B+, while the 6-volt filament winding was used for the speaker voice-

coil winding. About 8 db of negative feedback was applied after the coupling capacitors in the audio had been increased from .005 to .1 mfd. This feedback helped damp the speaker by lowering the effective output impedance of the amplifier. More feedback would have been desirable if enough gain were available; however, this would have necessitated adding an extra audio amplifier. The 8 db of feedback has practically nothing to do with the improvement in cross-modulation distortion. Just using more iron with less flux density in the output transformer has done the trick. Incidentally the receiver sounds improved beyond expectations.

It may be noted here that John K. Hilliard reported in his article in the December, 1941 *Proceedings of the IRE* that 2% cross-modulation distortion was not objectionable. It can be seen that the

spectrum of Fig. 8 just meets this requirement. So much for the \$1.00 improvement. Let us hope that postwar receiver manufacturers will at least do this one thing in their more expensive models. Note that the improvement will be most noticeable in FM receivers when tuned to a program originating in the station's own studios and not transmitted via telephone lines.

**Good Audio Practice** ★ Necessary power output is all embracing, since this determines the amount of iron to be used in the output transformer, size of loudspeaker, acoustical enclosure, etc. Undoubtedly a 5-watt *average* electrical level into a good reproducer is ample for most homes with a reasonably low background or ambient noise level. This does not mean that the amplifier output is limited to 5 watts, but rather that the audio amplifier should

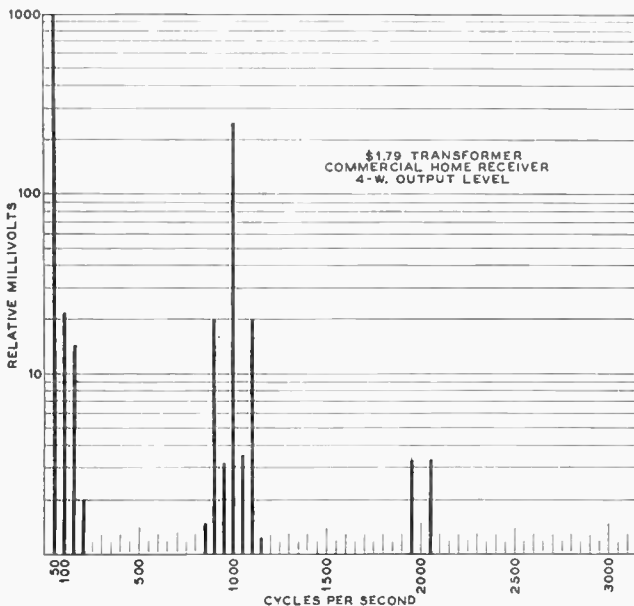

FIG. 8. RESULTS WITH AN ADEQUATE OUTPUT TRANSFORMER

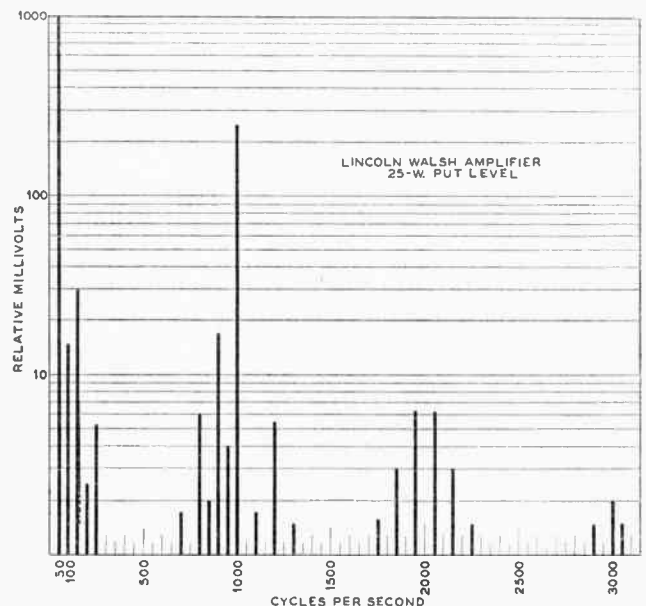

FIG. 9. L-W AMPLIFIER AT 25-WATT OUTPUT LEVEL

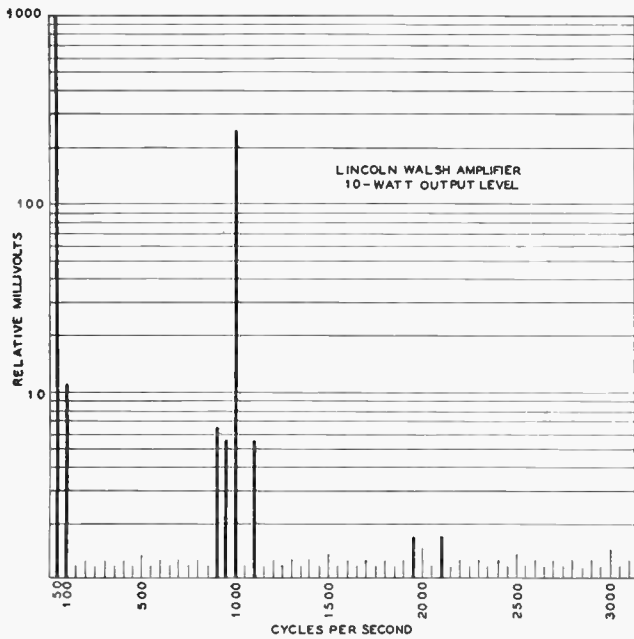

FIG. 10. L-W AMPLIFIER AT 10-WATT OUTPUT LEVEL

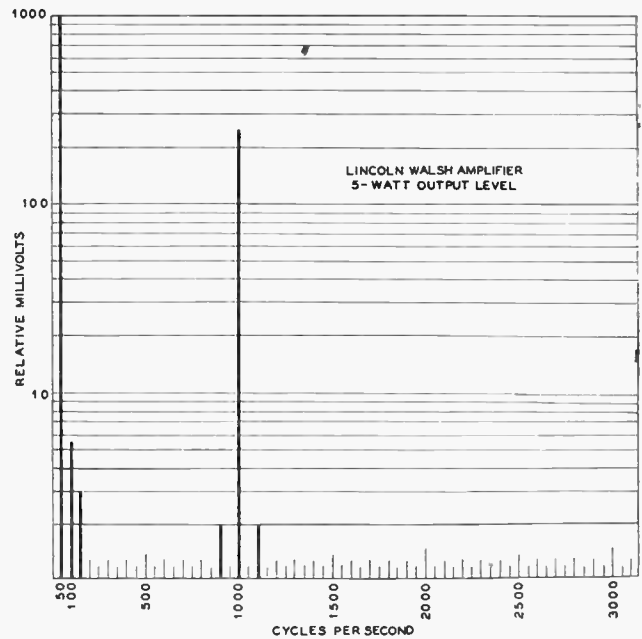

FIG. 11. L-W AMPLIFIER AT 5-WATT OUTPUT LEVEL

be capable of supplying in the neighborhood of 20 watts to take care of the peak power requirements which occur frequently in music. The peaks are of short duration and can be efficiently accommodated by an arrangement developed by Lincoln Walsh. Fig. 9 indicates the cross-modulation spectrum into a resistance load from a Walsh amplifier at the 25-watt level. At this level the two type 2A3 tubes are drawing rather heavy current and practically operating class B, but the output transformer is not generating cross-modulation components as high as 2%. Incidentally the output transformer in the Walsh amplifier resembles in size a 100-watt 60 cycle power transformer.

The Walsh amplifier contains a cathode follower driver and automatically adjusts the bias of the 2A3 tubes which allows

them to operate as fixed bias class A output tubes up to about 10 watts. Fig. 10 shows the distortion spectrum at the 10-watt level. Fig. 11 shows the results with the Walsh amplifier at 5 watts. It can be seen that the cross modulation products are less than 2 millivolts or 0.2%.

Of course, it is necessary to convert the electrical output into acoustical sound pressure, and Fig. 12 indicates the overall sound pressure spectrum with 5 watts fed into an HY-12-12 speaker with a QP-5 tweeter. The microphone was placed about 18 ins. directly in front of the speaker which was operated in my home as normally used. It is interesting to note that cross-modulation is present in the speaker, but the components do drop off rather rapidly with increasing frequency. Above 550 cycles, they are less than 2%.

Since natural resonance of the HY-12-

12 cone occurs around 45 to 50 cycles, another set of data was taken with 80 cycles substituted for the 50-cycle tone. This acoustical output spectrum is plotted in Fig. 13. It can be seen that the maximum overall distortion amplitude is less than 3%.

It is the consensus of most who have visited my home and listened to good, direct studio FM programs that faithful wide-range audio is truly different. Many have remarked that this doesn't sound like a radio set. Some say that it sounds like the orchestra that they may have heard in Radio City Music Hall or Carnegie Hall, and then I begin to realize that the average citizen has never really heard natural reproduction by radio. Since I have had approximately ten years experience as a musician, *natural* reproduction does not sound unreal to me. Re-

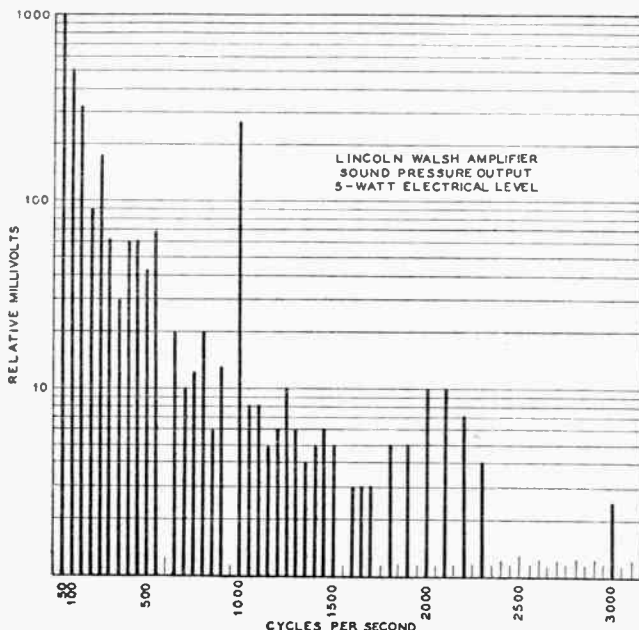

FIG. 12. ACOUSTICAL SOUND PRESSURE AT 5-WATT LEVEL

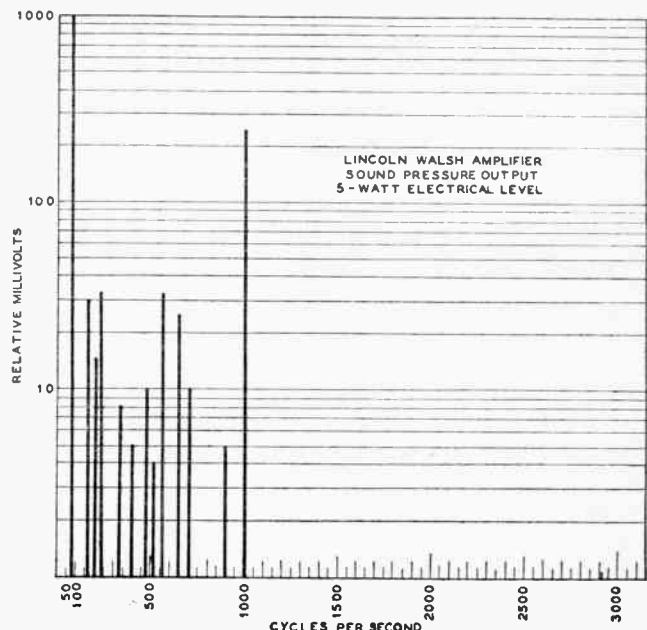

FIG. 13. 80 CYCLES SUBSTITUTED FOR 50 CYCLES USED IN FIG. 12



ardless of the Bell Laboratories, CBS, or NBC, with their fact-finding tests to contrary, I side with Major Armstrong and say: give the public wide-range audio up to 15,000 cycles. Better receivers will be accepted because there will be some reason to want them, if suitable programs are provided by the radio stations and their associated networks. Even programs involving no music, such as Abie's Irish Rose, become much more enjoyable with a wide range system. One gets a feeling of *presence* — after a moment of scientific reflection, this sensation of presence is natural, because the higher frequencies

are instinctively associated with nearby sounds since the higher frequencies are attenuated more rapidly as the distance is increased.

It is well known that one really *feels* low notes. At the higher sound levels, the ear does cross-modulate as previously mentioned, and this is interpreted as the sensation of bass. In November, 1941 Mr. Sheppard presented a paper on Synthetic Bass before the I. R. E. Rochester Fall Meeting which demonstrated how effectively artificial cross-modulation produced by vacuum tubes and associated circuits could simulate actual bass re-

sponse. The thing missing in his demonstration was the physical feeling that always accompanies such heavy bass response. If it were possible to use such a synthetic system in conjunction with a suitable direct-connected, floor-driving system, very effective bass sensations could probably be produced without the need for such large console cabinets. Such synthetic bass cross-modulation should necessarily be confined to the region below 500 cycles where it would not produce such objectionable masking as the usual type of cross-modulation mentioned herein.

# Chapter 7

## High-Fidelity FM Reproduction

A Duplex Loudspeaker and Associated Amplifier Designed to Give Effect to the Full Audio Range

**T**HE FCC's standards of good engineering practice for FM broadcast stations, requiring the transmission of frequencies of 50 to 15,000 cycles with very low distortion, will make available to radio listeners a degree of audio fidelity that has never been realized from AM transmission.

At FM broadcast studios, it will be necessary to use monitors with a frequency range up to 15,000 cycles in order to check transmitting line noises, telephone carrier cross-talk, and high-frequency disturbances that may overload the transmitter and produce intermodulation effects throughout the audible range.

There would be no reason to transmit frequencies up to 15,000 cycles unless reproducers of corresponding capability are available to radio listeners. Thus it is evident that loudspeakers and their associated amplifiers are the limiting factors, both at FM studios and in listeners' homes, in achieving the sense of presence that FM can provide.

These remarks may challenge the reader to reply: "If the speaker on my AM receiver could go up to 15,000 cycles, I still would turn down the tone control to cut off everything above 3,000 cycles. I don't like that shrill quality."

Audio reproduction is a personal mat-

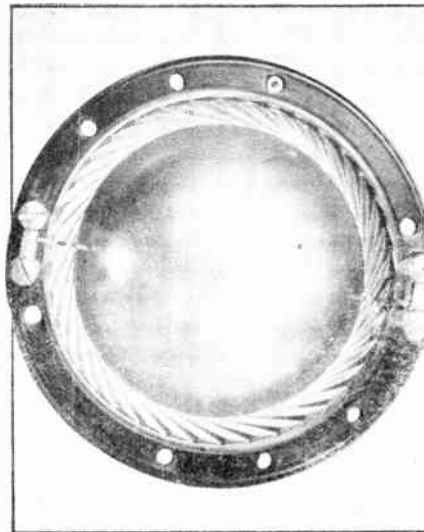

FIG. 2. HF DIAPHRAGM IS ALUMINUM

ter, and a matter of personal experience. Therefore, it is impossible to convince a listener that he will enjoy something he has never heard. It can only be said that listeners accustomed to AM reception, or wartime reception of recordings and network programs on FM, should reserve judgment until they hear full-quality FM on speakers that deliver undistorted repro-

duction up to 15,000 cycles. It has been the writer's experience that such a demonstration of FM reception invariably results in the question: "How can I get an outfit like that for my home?"

**Conventional Speakers** ★ Conventional single-unit loudspeakers furnished in radio receivers, phonographs, and even station-monitors have several limitations.

1. Intermodulation distortion produced when high frequencies are superimposed on low frequencies which cause large diaphragm excursions. (The lower the frequency, the larger the diaphragm movement for constant power output.)

2. The size of the diaphragm is limited by non-uniform radiation, due to the fact that the angle of distribution decreases as the frequency increases.

3. Requirements for best low-frequency reproduction are opposed to those for proper high-frequency radiation. Large diaphragms and heavy voice coils are needed for low frequencies, while very small diaphragms of extremely small mass are required for the highest frequencies.

4. The speed of propagation of sound in a paper cone does not permit efficient radiation of high frequencies.

In addition there are related factors of

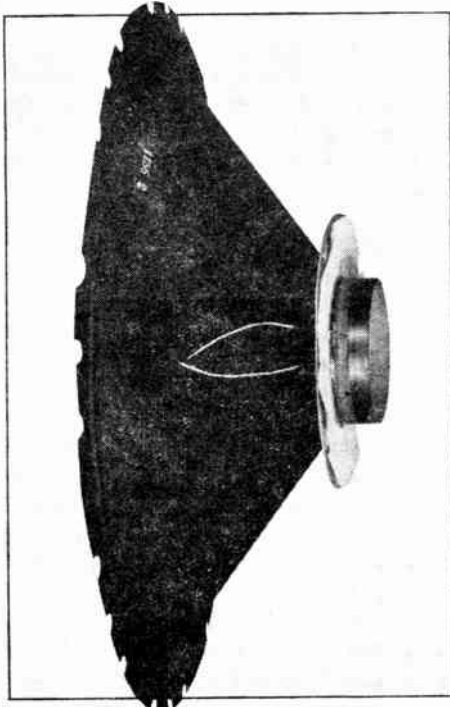

FIG. 3. LF DIAPHRAGM IS MOLDED PAPER

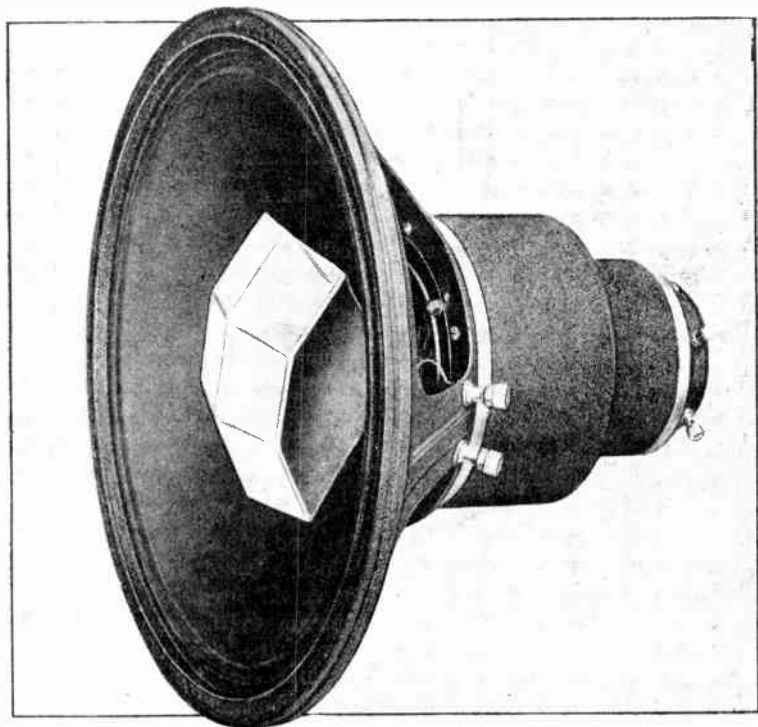

FIG. 1. THE ASSEMBLED DUPLEX SPEAKER, SHOWING POSITION OF THE DIFFUSER

amplifier design which will be discussed in the latter part of this paper.

It was recognized many years ago that great improvement in audio reproduction could be achieved by the use of two loudspeakers, one for low frequencies and another for the higher frequencies. Such a two-way loudspeaker, when properly designed, reduces the limitations listed above to a very marked degree.

**The Duplex Loudspeaker** ★ The Altec Lansing duplex loudspeaker, Fig. 1, is a permanent magnet speaker which incorporates several advanced design features and utilizes some of the newer materials which meet certain very special requirements. One unique feature is the concentric arrangement of the high- and low-frequency speaker units on a common horizontal axis. Both speaker units are mounted on a single 15-in. die cast frame. This provides compactness unobtainable in two-way

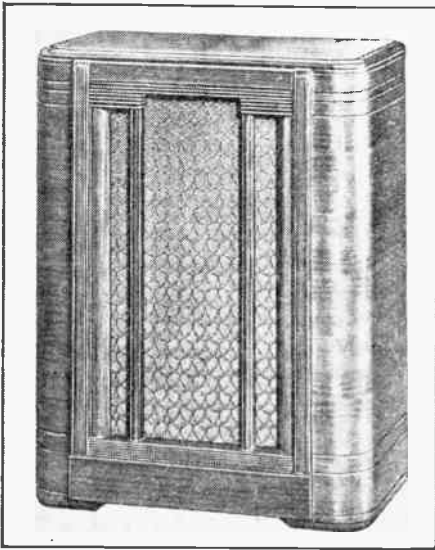

FIG. 5. SPEAKER CABINET OF 7 CU. FT.

speaker systems employing two separate horn assemblies. The die cast frame assures permanent alignment of the cone and voice coil. The rated capacity of this speaker is 25 watts, and it can be used safely up to this power without fear of damage to any of its parts.

**HF Speaker Unit** ★ The high-frequency speaker unit of this assembly utilizes a metal diaphragm, Fig. 2, having an active vibrating diameter of  $1\frac{3}{4}$  ins. It is designed to operate as a piston up to frequencies above the limits of audibility. It is made of aluminum alloy to obtain the required stiffness and a velocity of transmission three times as great as that of paper. The resulting light weight and high stiffness prevents it from breaking up and producing the intermodulation effects so common with paper diaphragms.

Tangential corrugations in the compliant portion surrounding the dome are used instead of the usual annular type. The tangential compliance permits three



FIG. 4. THE DIVIDING NETWORK UNIT

times as much movement as the annular type for the same stress. This results in an increased freedom of motion which allows the diaphragm to handle large stresses to the center of the dome.

If the diaphragm were made small enough to radiate sound directly, without having a sharp beam, it would be too small to handle the required power. This condition necessitated the selection of the multi-

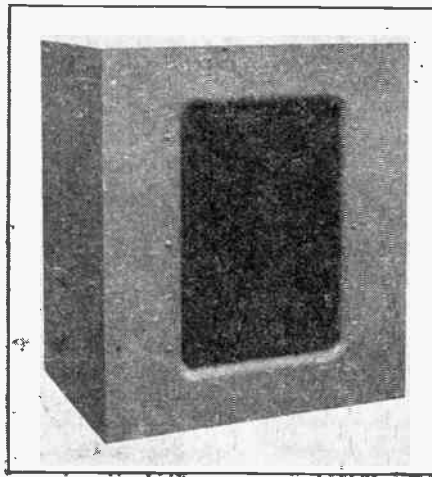

FIG. 6. THIS CABINET IS OF 6 CU. FT.

cellular high-frequency horn as a radiating medium.

As Fig. 1 shows, the horn has six cells, each cell having a  $20^\circ$  angle. Since the configuration is 2 by 3 cells, the maximum angles of radiation are  $40^\circ \times 60^\circ$ . The angles, size, and cut-off of the high-frequency horn were specifically selected to prevent interference from the low-frequency cone.

The high-frequency horn is mounted on the end of the low-frequency pole piece which is bored out to permit the passage of sound from the high-frequency diaphragm to the horn. The sound, as it leaves the diaphragm, passes through annular slits which effectively prevent destructive interference being set up within the chamber. This transducer is very necessary as, otherwise, unequal path

lengths from the diaphragm to the chamber would cause standing waves.

The voice coil of the high-frequency unit is constructed of edgewise wound aluminum ribbon. The use of this ribbon provides 27% more conductor material in the air gap, with the result that the efficiency is increased to the extent that approximately 22% more acoustic power is obtained.

The diaphragm is clamped to a cast bakelite ring which is held in position by three screws which secure it to the top plate. This can be seen in Fig. 2. By means of these screws, the diaphragm and voice coil assembly can be removed easily without special tools. Accurately positioned dowel pins in the top plate and corresponding holes in the bakelite ring assure proper alignment of the voice coil within the gap.

**LF Speaker Unit** ★ The low-frequency speaker unit, Fig. 3, employs a seamless, molded cone having an effective area of 116 sq. ins. The cone is moisture resistant and is mounted within the die cast frame concentric with the high-frequency speaker unit.

The low-frequency voice coil is constructed of edgewise wound copper ribbon to provide the maximum amount of conductor in the air gap. This greatly improves the efficiency. The voice coil is considerably larger than usual, being 3 in. in diameter. This results in an increased ability to handle higher power without undue temperature rise. It also permits a decreased cone depth with an increase in

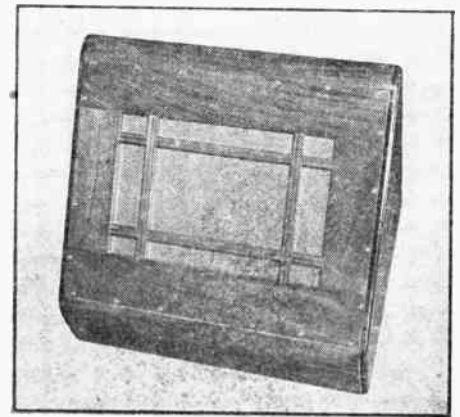

FIG. 7. WALL-MOUNTED CORNER CABINET

the effective stiffness of the cone, causing it to act more nearly as a piston. The impedance of the voice coil is approximately 20 ohms and the resonance of the cone and voice coil assembly is 40 cycles in free air. A clamping ring secures the outer rim of the cone to the frame. The inner spider assembly is held in place by screws so that it is a simple operation to remove the entire coil and cone assembly.

**Permanent Magnets** ★ There are two permanent magnets made of Alnico No. 5, one for each diaphragm. These magnets are of the center-core type, and the soft mag-



netic materials forming the path between the pole pieces are amply proportioned so that the magnetic flux is conducted through the outside walls and up to the air gap with little loss. The flux density is considerably higher than that ordinarily used in commercial units in the past. This provides better damping of the diaphragms which, in turn, materially increases their ability to handle transients having steep wave fronts. The design is such that the loss due to external leakage is extremely low. The magnets do not attract metal objects in the immediate vicinity, nor will they materially deflect the beam of a cathode ray tube operated in close proximity.

**Efficiency** ★ The Altec Lansing speaker has an overall efficiency in the region of 500 to 1500 cycles such that it produces 92 db (ref. 10-16 dynes per sq. in.) at a distance of 5 ft. with an input of 0.1 watt.

This increased efficiency minimizes distortion at all performance levels, and gives a much greater dynamic volume range. This can be demonstrated readily by placing a conventional loudspeaker alongside the duplex speaker and balancing them to give the same acoustic output at some medium level. It will then be observed that when the input is decreased to the point where output is zero on the conventional speaker, the duplex speaker will still be audible. Similarly, at high volume, as the input to both speakers is increased, it will be observed that the duplex speaker will deliver more acoustical energy. This is due to the increased linearity of the flux in the air gap.

**Dividing Network** ★ The cross-over point of the dividing network unit, Fig. 4, is approximately 2000 cycles. It was necessary to select this high cross-over frequency so that the size of the multi-cellular horn could be kept small because, mounted on

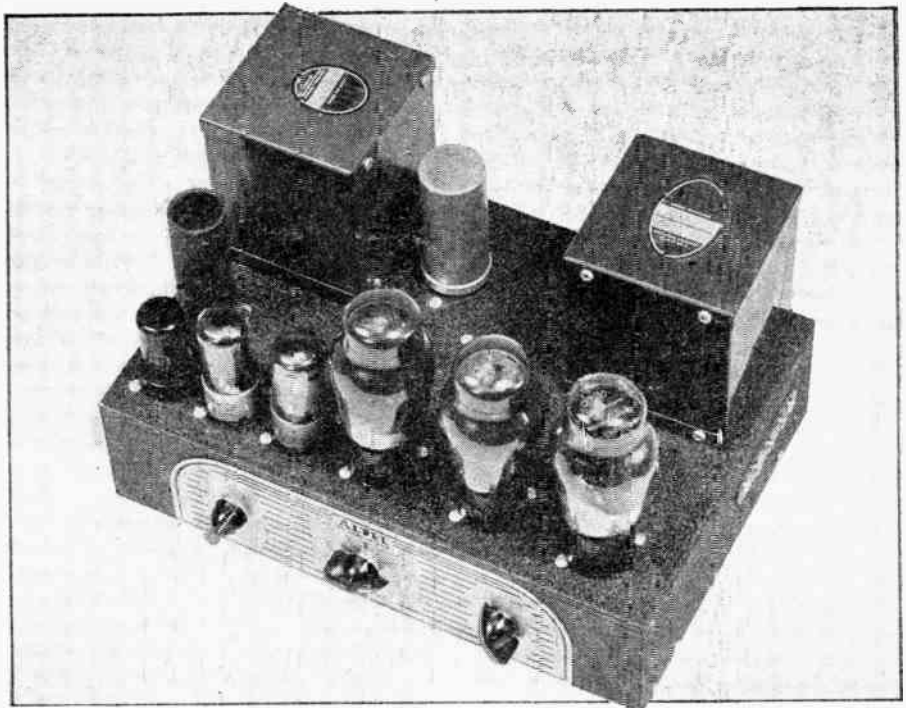

FIG. 8. THIS AMPLIFIER, DESIGNED FOR THE DUPLEX SPEAKER, USES 6L6'S

the face of the low-frequency horn, it would otherwise obstruct the low-frequency cone radiation.

**Distribution & Frequency Range** ★ The angle of distribution of sound energy is determined by the number and size of the cells in the high frequency horn. Each cell in the duplex loudspeaker has a distribution angle of 20°. Since the horn has six cells with a configuration of 2 by 3 cells, the angles of coverage are 40° by 60°. Provision is made for rotating the horn to give either of these angles of horizontal distribution with the corresponding angle of vertical distribution, as may be required.

The frequency range of the speaker is such that it will radiate efficiently over

the entire 40° by 60° area up to 15,000 cycles. The low-frequency range is limited only by the size of the cabinet used, down to its natural resonant frequency of 40 cycles. The deviation of impedance with frequency is considerably less than with less efficient loudspeakers, and for this reason it is possible to secure fundamental radiation at low frequencies provided proper loading is used.

**Speaker Mountings** ★ The duplex speaker is adaptable to many types of cabinets and enclosures. It is normally furnished in three standard cabinets, as follows:

1. The largest cabinet, Fig. 5, is 38 by 30 by 16 ins., and has a volume of approximately 7 cu. ft. A tuned port at the lower front of the cabinet has an opening

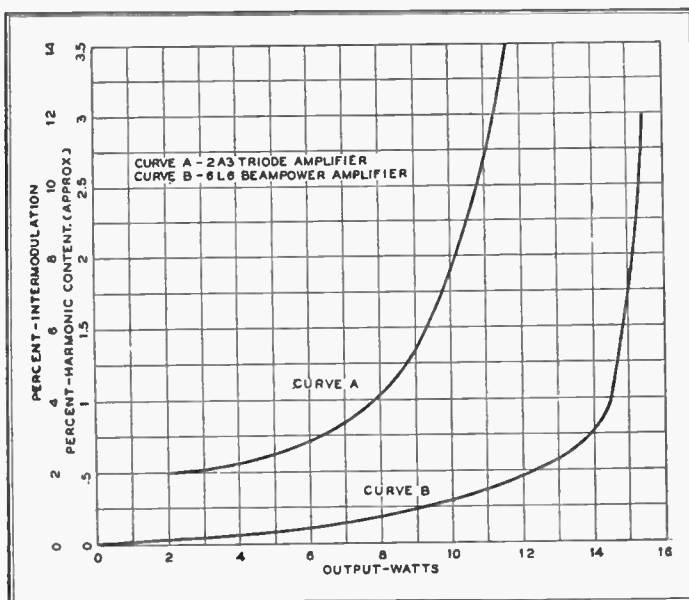

FIG. 9. COMPARISON OF INTERMODULATION WITH 2A3'S AND 6L6'S

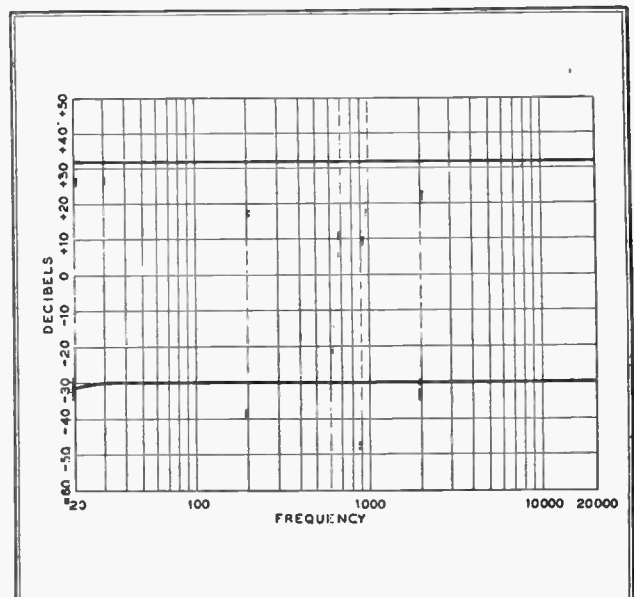

FIG. 11. FREQUENCY CHARACTERISTICS OF THE AMPLIFIER

of 90 sq. ins. This port maintains radiation down to 55 cycles.

2. The medium-size cabinet, Fig. 6, is 30 by 25 by 18 ins., with a volume of 6 cu. ft. Its port area is 60 sq. in. and it radiates down to 60 cycles.

3. The corner, or wall mounted cabinet, is triangular in shape, as shown in Fig. 7. It is intended for small studios where it is desirable to hang the speaker in a corner or on the wall. Its volume is  $5\frac{1}{2}$  cu. ft. and the port is adjusted to radiate down to 65 cycles.

A smaller cabinet, having a volume of 4 cu. ft. with a port area of 50 sq. in., will be efficient down to 70 cycles. Since the duplex loudspeaker resonates in free air at 40 cycles, it follows that the speaker will not produce a peak in any of the

vibration is permitted. Eliminating vibration of the cabinet walls or supports prevents dissipation of acoustic energy in friction, with its resultant decrease in the effective output. Rock wool pads, 1 in. thick, are placed on at least three of the sides to reduce slap or hang-over effects within the cabinet. Because the cabinet is subjected to vibration of large amplitude at low frequencies, it is not advisable to mount the amplifier in the cabinet with the speaker, since feedback may be generated.

Upon first hearing the duplex speaker, the listener may feel that more bass response is required. However, after more careful observation it will usually be agreed that true bass response is actually being heard. This is due to the lack of

speaker. By this method, the counter EMF generated by the speaker was high and the diaphragm had less tendency to "free-wheel" than when driven from a matched impedance.<sup>1</sup>

An analogy can be made to a meter movement. If the meter is terminated in a load which has a low resistance compared to the meter resistance, the meter movement will not overshoot on pulses but will be over-damped in its action. However, if the meter is terminated in a resistance greater than its critical resistance, the meter will overshoot and oscillate before coming to a steady reading.

Since the duplex speaker has a very high efficiency, due to greater flux density and low resistance, a very high internal damping is provided. This results in a

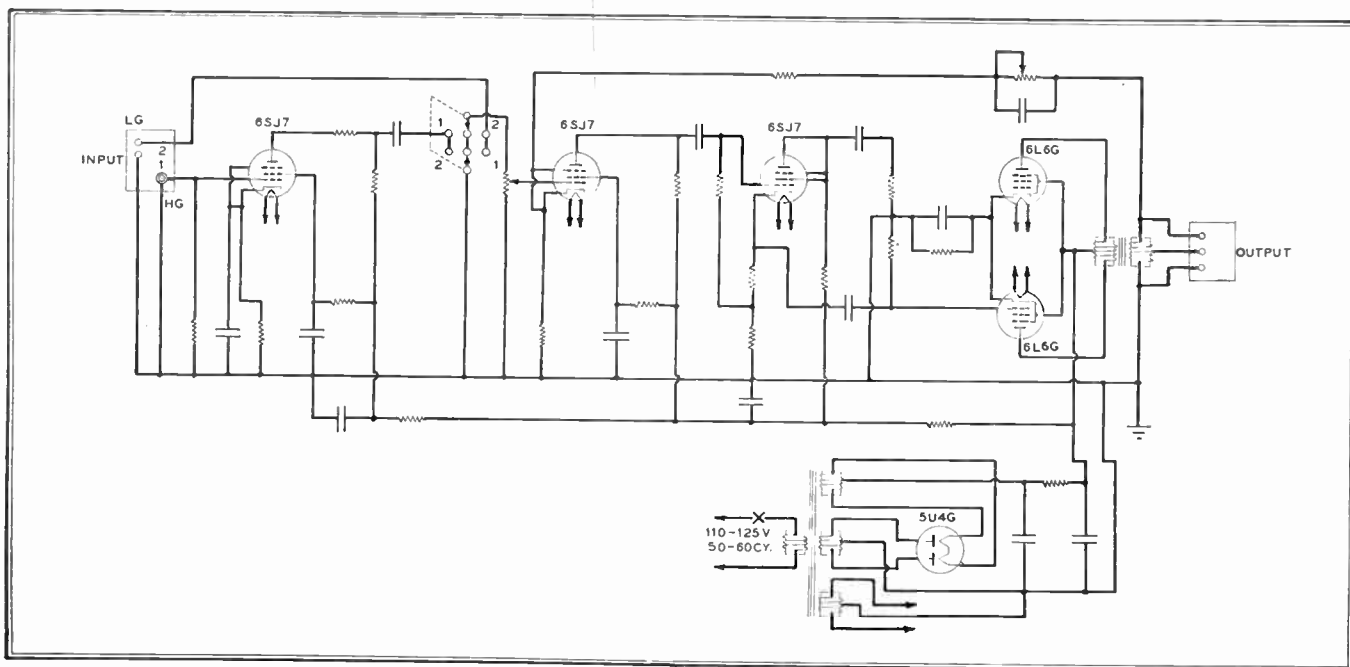

FIG. 10. SCHEMATIC DIAGRAM OF THE AMPLIFIER DESIGNED TO DRIVE THE DUPLEX TYPE LOUDSPEAKER

cabinets described. It should not be assumed that response in any of these cabinets is uniform down to the cut-off frequency. Actually, the response will be down at least 10 db. However, appreciable radiation can be obtained at fundamental frequencies down to the speaker resonant frequency.

It should be realized that there is no substitute for adequate cabinet size when good low-frequency performance is required. Accordingly large cabinets or enclosures having a volume of 8 to 10 cu. ft. are desirable for good performance down to 50 cycles. A wall can be used as an infinite baffle with good results if a minimum volume of 8 to 10 cu. ft. is provided at the rear. The large cabinet shown in Fig. 5 has a duplex speaker mounted in the top portion, with the port below. This is done so that high frequencies can be radiated directly, without having low obstacles blocking their path.

The internal bracing of the cabinets provides the equivalent of  $\frac{3}{4}$ -in. plywood, so that no appreciable amount of cabinet

cabinet and speaker resonance which, by generating harmonics, gives a false bass response.

**Input Requirements** ★ Where the source of input to the loudspeaker has distortion, as in the case of phonograph records, poor transcriptions, or over-modulated transmitters, it is advisable to provide a low pass filter ahead of the loudspeaker. Several taps should be included for adjustment in the 6,000 to 10,000 cycle area. By proper adjustment, input distortion can be made less objectionable than with unlimited response.

The amplifier output impedance determines to a great extent the amount and quality of bass response obtained from a loudspeaker. Heretofore, because of the low internal damping in loudspeakers, it has been necessary and customary to adjust the amplifier impedance much lower than the normal impedance of the loudspeaker. This mismatch of impedances was used purposely to provide a high degree of external damping for the

very constant impedance over a wide frequency range. For this reason the duplex loudspeaker can be operated from an amplifier having an output impedance equal to that of the loudspeaker without the free-wheeling effect mentioned above.

**The A-323 Amplifier** ★ The extremely wide frequency range of the duplex speaker makes necessary the use of an amplifier of very high quality, in order to give the best sound reproduction. In the past there has been a very decided preference for low-impedance output triodes, rather than beam power tubes, to operate loudspeakers. Apparently this preference was justified in a great many cases. However, the beam power tube has the advantages of high efficiency, greater power sensitivity, and its indirect heater gives less hum. Tests were made to determine how the beam power tube could be utilized to give overall quality equal to that of the low-impedance triode in this circuit.

<sup>1</sup> Elements of Acoustical Engineering, Olson, pages 140-141.

The outcome of this work was the A-323 amplifier which uses beam power 6L6 or 6V6 Tubes in the output stage. This unit is shown in Fig. 8, with the schematic in Fig. 10.

Early work indicated that the output transformer was the limiting factor. Therefore, an output transformer was designed for very low phase shift, high self-impedance, accurate balance between windings, low distributed capacity, and a high coupling factor to reduce leakage.

Intermodulation and harmonic distortion tests reveal that the A-323 amplifier has considerably less distortion with beam power tubes than with triodes of similar power rating. This decreased distortion exists regardless of whether or not feedback is used, thereby indicating that feedback is not necessary to reduce the distortion to a tolerable value. The feedback in the A-323 amplifier is used for the purpose of adjusting the effective output impedance to match that of the loudspeaker.

Intermodulation curves for this amplifier are shown in Fig. 9. Curve A was obtained from an amplifier using 2A3 triode tubes, whereas curve B is for the amplifier using beam power tubes. The same quality of transformer was used for each test. It will be observed that with the beam power tubes there was very low initial intermodulation distortion as compared to that obtained with the triodes. These curves represent the average of six pairs of tubes in each amplifier, so that they may be considered as average conditions with respect to the selection of tubes.

The intermodulation test frequencies were 60 cycles transmitted simultaneously with 1000 cycles, 12 db below the 60-cycle amplitude. The test is therefore representative of the 60-cycle distortion.

This amplifier has a gain of 104 db with an input impedance of 500,000 ohms. A selector switch is provided so that the amplifier can be switched to either the high gain position, Input No. 1, or to low gain, Input No. 2, which removes the first stage. On the low-gain setting, the amplifier has a gain of 74 db. An input transformer is also available which is tapped to work from 30-, 250-, or 500-ohm sources. This transformer has a 90 db shield so that, in the region of strong magnetic fields, shield will eliminate noise pickup.

The first stage has a 6SJ7 tube, pentode connected. The second stage has a 6SJ7 tube, pentode connected, driving a phase inverter of the cathodyne type, using a 6SJ7 tube, triode connected. This inverter is capable of supplying 30 volts of driver power to the last stage. Excellent balance over a long period of time is obtained with this type inverter. The output hum level is 30 db below the 0.001-watt reference in the high gain position, and 38 db in the low-gain position.

It is customary for manufacturers to rate the frequency range of their amplifiers without regard to maximum power capacity. This practice implies that an amplifier will have its rated frequency range up to its rated power. In virtually all cases, it will be found that the rated frequency range can only be obtained at some power output 6 to 10 db below the maximum power specified.

The frequency characteristics of the A-323 amplifier under two separate conditions are shown on Fig. 11. It will be noted that the lower curve is approximately 60 db below the upper curve. Since these curves are identical, it is obvious that the amplifier, and particularly the output transformer, are capable of operating over a 60-db range with no

change in frequency characteristics. Usually, output transformers will have considerably less bass response at low levels because of the decreased inductance for low current values.

If this amplifier is compared directly with another amplifier not meeting the foregoing specifications, it will be observed that, when driving a high quality speaker, the A-323 amplifier, with flat response, will have more actual bass energy at high levels than the comparison amplifier, even though the latter has been provided with considerable bass boost. The reason for this difference is due to the fact that the usual 15-watt amplifier will not develop more than two or three watts at the lower frequencies. As a result, no amount of boost can conceivably yield more bass power. The A-323 amplifier will deliver 15 watts at 400 cycles, and in the range from 40 to 10,000 cycles the output power will vary less than 1 db from the 400-cycle value. The output power will be flat within 1 db from 20 to 20,000 cycles over a 60-db volume range, subject to the power capacity stated above. The frequency range will be flat within 1 db from 20 to 20,000 cycles at 3 db below the rated power.

For best results, it is recommended that the duplex speaker be used with the A-323 amplifier or its equivalent. This amplifier has been designed expressly for operation with this loudspeaker along with its associated networks. The use of a conventional amplifier may result in poor overall quality since amplifier distortion is readily reproduced by the loudspeaker. Experience has shown that users have thought there was something wrong with the duplex speaker only to find out later that the cause was due to distortion in the amplifier, radio set or phonograph pickup.



# Chapter 8

## Antennas for Communications Frequencies

Design Data on Antennas to Operate at 30 to 44, 72 to 76, and 152 to 162 mc.

THE antennas described herein are not presented as being radically new or theoretically superior. Rather, an attempt is made to catalogue and explain the action of certain types of antennas which have proved successful in actual service, and are known to operate at high efficiency. Further, the presentation is planned in such a form as to be understandable to those with a limited knowledge of mathematics.

All too frequently, those who control the appropriation of funds for communications systems are inclined to discount the important function performed by the radio transmitting or receiving antenna. However, the efficiency of an antenna can mean the difference between the ability or failure of a radio system to span a point-to-point distance, or to provide the required coverage over a given area.

Many antenna designs are much easier to construct on paper than to put into actual practice. This may be due to difficulty in matching impedances, to the necessity for much-too-critical adjustments, or because the construction is mechanically unwieldy and will not withstand the elements.

This text is written with the following specifications in mind: The emergency

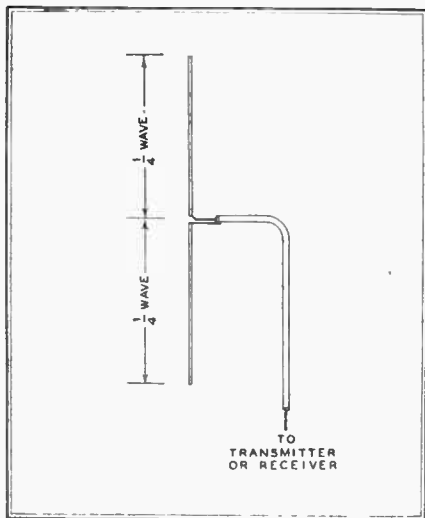

FIG. 1. SIMPLE VERTICAL HALF-WAVE DIPOLE

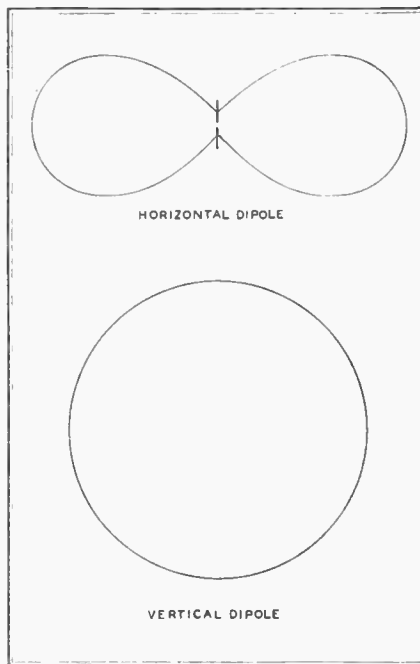

FIG. 2. RADIATION PATTERNS OF VERTICAL AND HORIZONTAL DIPOLE ANTENNAS

tenna that will not meet these specifications is unsuited for day-in and day-out use, regardless of how well it performs on paper.

**Antennas for Circular Coverage** ★ Where a fixed station is required to transmit to mobile units or to many scattered fixed points, the vertical half-wave dipole, Fig. 1, might be considered the most desirable antenna because of its simplicity. It is, however, difficult to mount. Since it is fed at its center point, the transmission line must be led away horizontally for at least a wave-length before descending to the transmitter, because the proximity of the line to the lower quarter-wave element would interfere with its characteristics as a dipole. Otherwise, it would not be a dipole, for it could not be considered to be operating in free space.

Horizontal half-wave dipoles can be used only in special cases, since they are bidirectional in the horizontal plane. Typical radiation patterns in the horizontal plane for vertical and horizontal dipoles are shown in Fig. 2.

Another point to be considered is the choice between vertical and horizontal polarization of the radiated waves. Tests have shown that horizontal polarization provides better propagation characteristics than vertical polarization over most types of terrain. However, the requirement that mobile antennas be vertical,

plus the fact that simple vertically polarized antennas are non-directional, dictates the choice of vertical polarization when communication with mobile units is involved.

If the lower half of a vertical half-wave dipole could simply be eliminated, there would remain nothing more than a quarter-wave whip antenna such as is used on mobile units. The difficulty here is that whereas the whip on a mobile unit has the body of the vehicle to work against as an RF ground or counterpoise, that condition does not prevail at the top of a fixed transmitting tower. The whip would then act as if it were floating, as far as an RF ground is concerned, and would not provide proper termination for the transmission line.

This can be overcome to a limited degree if some kind of counterpoise system of horizontal whips is used, as shown in Fig. 3. This antenna is popularly referred to as the "Whirling Joe" or ground-plane antenna.

A still better approach to the problem of mounting a half-wave vertical dipole would be to lead the transmission line, or coaxial cable, up inside the center of the

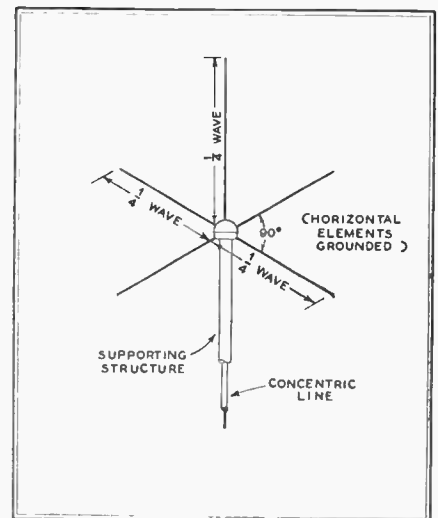

FIG. 3. THE GROUND-PLANE ANTENNA

lower half of the dipole. This is accomplished in the form of the half-wave coaxial or concentric antenna. Here the upper half of the dipole is called the whip, and the lower half is called the skirt. Reference to Fig. 4 shows that all elements have a common vertical axis, hence, the name "coaxial antenna." The support tube contains the transmission line, and is electrically common with the outer con-

- services require antennas or arrays that will provide high electrical efficiency and the required radiation pattern. At the same time, they must be simple, easy to match and adjust, and of mechanical construction that will withstand corrosion, icing conditions, and high winds. An an-

ductor of the line, both being at ground potential. The inner conductor of the coaxial line feeds the whip, which is insulated from the upper end of the support tube. The skirt, while directly connected to the top of the support, is insulated from it below this point by insulating rings which also keep it concentric with the support.

A coaxial antenna can be shunt-fed also. Then the whip is common electrically with

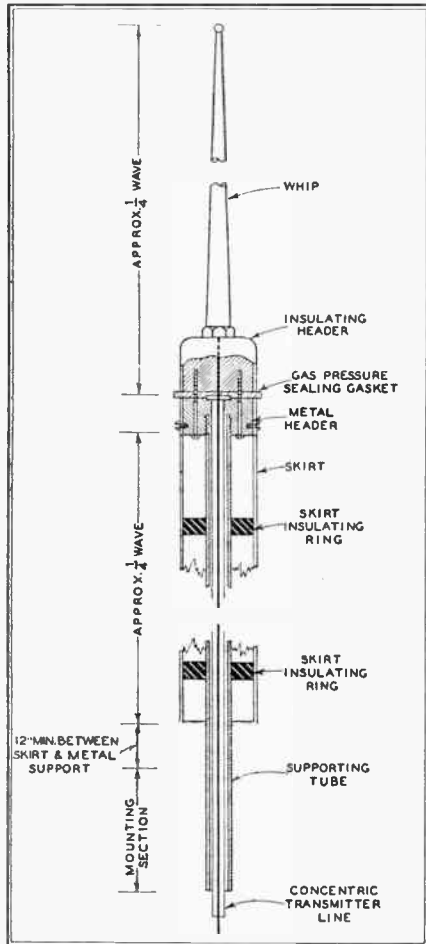

FIG. 4. SERIES-FED COAXIAL ANTENNA. THIS IS THE TYPE NOW MOST WIDELY USED

the support tube. Here the skirt is also grounded at its upper end as in the case of the series-fed coaxial antenna. To feed the antenna, it is necessary to take the center conductor of the transmission line through the support tube and connect it to the skirt at an impedance-matching point some distance down from its upper end, as in Fig. 5. Numerous reports from radio-men in the field attest to the fact that the correct location of this impedance point is rather difficult to determine, and that further adjustments may be required after installation to obtain maximum output.

About the only advantage that can be claimed for this arrangement is that the highest element, the whip, as well as the skirt, are at ground potential with respect to DC. It must be admitted that this fact provides a certain protection in case of a lightning strike.

Experience with several thousand series-fed coaxial antennas shows that lightning usually caused no structural damage to the antenna, but in the case of a heavy stroke, the coaxial transmission line suffers an arc-over or puncture within 6 or 8 ft. of the antenna header. Reports from the field show that the same thing occurs with shunt-fed coaxials, as would be expected. Our records show only three or four series-fed coaxial antennas that have sustained structural damage to the whip or the insulating header assembly. In these cases, the available evidence has led to the assumption that the antennas were subjected to particularly heavy and direct lightning discharges. With either series-fed or shunt-fed antennas, the usual damage is to the line alone, necessitating its replacement.

Thus it would seem that any advantage of the shunt-fed coaxial over the series-fed, as far as lightning is concerned, is more theoretical than practical.

It is felt, therefore, that the series-fed coaxial antenna, as shown in Fig. 4, provides the ideal antenna for a fixed location for this type of service and coverage. It is a relatively simple structure, and can be built strongly of lightweight aluminum alloys. Such an antenna, cut for an operating frequency of 30 mc., weighs less than 10 lbs., including the support tube.

The vertical radiation pattern of a coaxial half-wave dipole antenna is shown in Fig. 11. It should be noted that this pattern is produced in all horizontal directions and can be compared to a doughnut flattened on the bottom and resting on a table, with a toothpick, representing the antenna, in the center of the hole.

The most critical portion of a coaxial antenna is the length of the skirt. If it is not cut correctly for the operating frequency, the performance of the antenna may be impaired seriously. However, this exact length can be computed readily. Then the skirt length can be cut with the knowledge that the antenna will perform at peak efficiency, and will require no further adjustments after installation.

On a typical coaxial antenna fabricated of aluminum, it has been found that with 50- or 52-ohm transmission line, the proper active or effective skirt length is slightly under 98% of an electrical quarter-wave at the operating frequency. The effective skirt length is that distance measured from the bottom of the metallic skirt-supporting header to the bottom of the skirt tube. Stated another way, it is the length of the air column enclosed between the skirt and the support tube. This is made clear in Fig. 4.

The reason for accurate skirt length adjustment stems from the fact that the skirt, in conjunction with the whip, provides the proper termination for the transmission line. In order for an antenna to radiate most efficiently, it must be capable of utilizing, as radiation, the maximum amount of the power delivered to it by the

transmission line. This occurs when the impedance of the antenna, at its feed point, is equal to the characteristic or surge impedance of the transmission line. If the skirt length is not the proper value, the impedance presented by the antenna is not the characteristic impedance of the line. Consequently, some energy is not utilized by the antenna as radiation, but is reflected back down the line.

The skirt performs two important func-

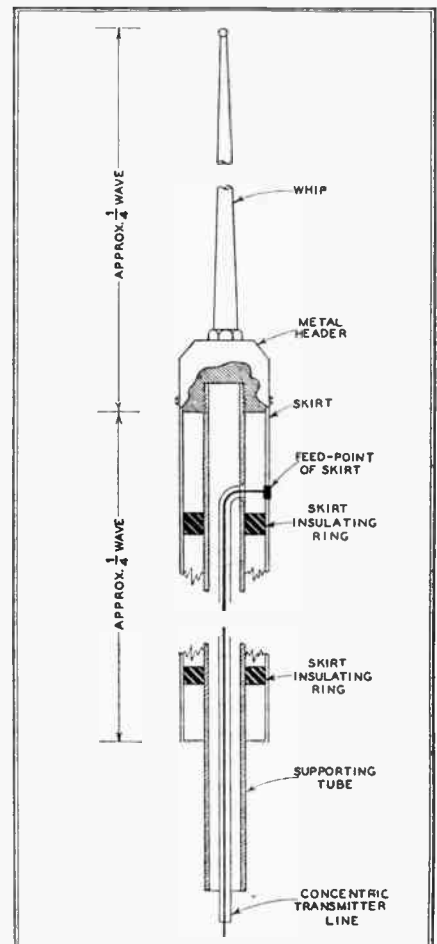

FIG. 5. SHUNT-FED TYPE OF COAXIAL, VERTICALLY POLARIZED ANTENNA

tions. The first is as a resonating stub to keep standing waves off the outside of the transmission line or the antenna support. This would destroy the desirable low-angle radiation pattern of the coaxial antenna as a half-wave dipole. In this manner, the skirt acts with the support tube as a metallic "insulator" to choke out the electrical continuity of the support pipe and antenna. Second, it is part of the half-wave dipole and, as such, must be a correct percentage of a quarter-wave. From the standpoint of its second function, the length of the skirt is less critical but, as a resonating stub, it is necessary to hold its length to a close tolerance.

Fig. 6 shows what is meant by standing waves on a line, and also how voltage and current are distributed along the antenna elements. This illustration also shows the effects of mismatched antenna elements.

In determining the correct values for the lengths of antenna sections, or elements, the presence of standing waves can be detected and their magnitude measured by means of a series of small holes drilled in the outer conductor of the transmission line. The probe of a vacuum tube voltmeter can be inserted and voltage readings taken along the line over at least a quarter-wavelength. A perfect line, perfectly terminated, would show the same voltage along its entire length, indicating that no standing waves were present. Then there would be no reflected energy and no power loss in the line other than that due to normal attenuation. In practice, it is possible to hold the ratio of maximum to minimum standing-wave voltage to a value of 1.1 with the series-fed coaxial antenna as described previously. This represents a power loss, due to reflections, of less than 1%. A relatively slight increase or decrease in skirt length from the proper value has a marked effect on the standing wave ratio as shown in Fig. 7.

For the same typical aluminum coaxial antenna mentioned above, the length of the whip has been found to be about 95% of a quarter-wave. This value includes the whip proper and that portion contained within the insulating header. In other words, it is that length from the point where the center conductor of the coaxial line merges from its sheath to the upper end of the whip. The length is not critical, as Fig. 8 shows. While the length of the whip has a definite effect on the performance of the antenna, it can be seen that a variation from 92% to 98% of a quarter-wavelength has very little significant effect on the performance.

The values for skirt and whip lengths given above are for 52-ohm transmission line. If 72-ohm line is used, the skirt length should be almost 99% of a quarter-wave,

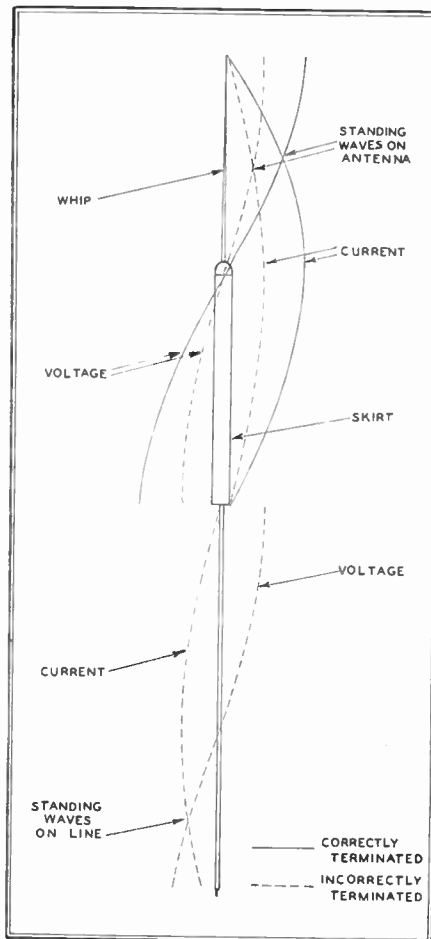

FIG. 6. EFFECTS OF CORRECT AND INCORRECT ANTENNA TERMINATIONS

and the whip, about 94% of a quarter-wave. For this typical antenna, as manufactured commercially, the values used are 98% of a quarter-wave for the skirt and 94% for the whip. The antenna can then be fed by 52- or 72-ohm coaxial transmission line, and the standing-wave ratio

in either case would not exceed 1.25, representing a power loss due to reflections of not over 3%.

Actually, the optimum lengths of the skirt and whip for any given coaxial antenna will depend upon the material from which the elements are fabricated, the type and number of insulating rings inside the skirt, end effects of the skirt, and the ratio of the diameters of the support tube and the skirt tubing.

**Colinear Coaxial Antennas** ★ An adaptation or extension of the coaxial antenna is known as the *colinear coaxial antenna*. Fig. 9 shows an exterior view of this antenna and the placement of the elements. In some variations of these antennas, the lower skirt element is not driven or fed any power. Parasitic excitation of this element is questionable, since the additional skirt is not within the main radiation pattern of the series-fed coaxial antenna located above it.

In comparison with a properly matched coaxial antenna, tests have shown that any gain in radiated signal strength was barely measurable, and so small as to be within the limits of observational error. Furthermore, with the length of this auxiliary skirt and its distance from the upper skirt at their optimum values, the antenna performed only as well as a simple, properly-matched coaxial antenna. But if the length of the auxiliary skirt, or its distance from the upper skirt, or both, were varied from their optimum values, the colinear coaxial antenna performance dropped below that of a standard series-fed coaxial antenna.

Actually, colinear antennas are not by any means a new development. Fig. 10 shows a conventional colinear antenna. It should be noted that such an antenna can be constructed of wires or metal rods as

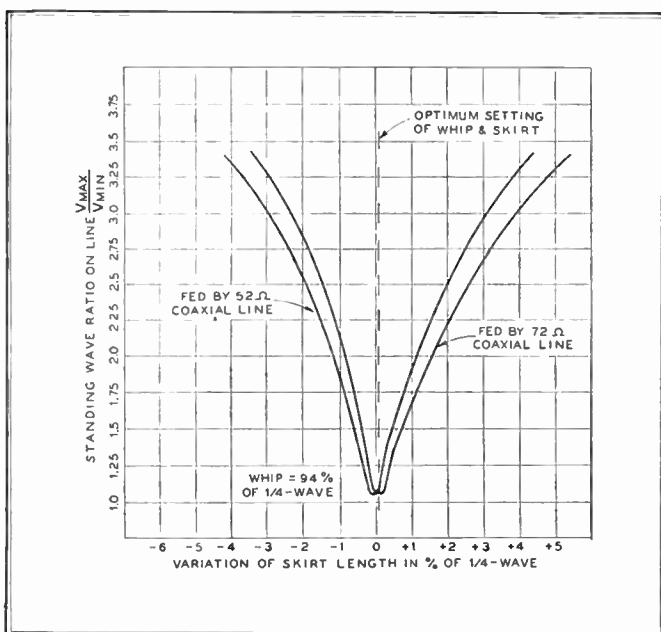

FIG. 7. EFFECT OF SKIRT LENGTH ON THE STANDING WAVE RATIO OF A SERIES-FED COAXIAL ANTENNA

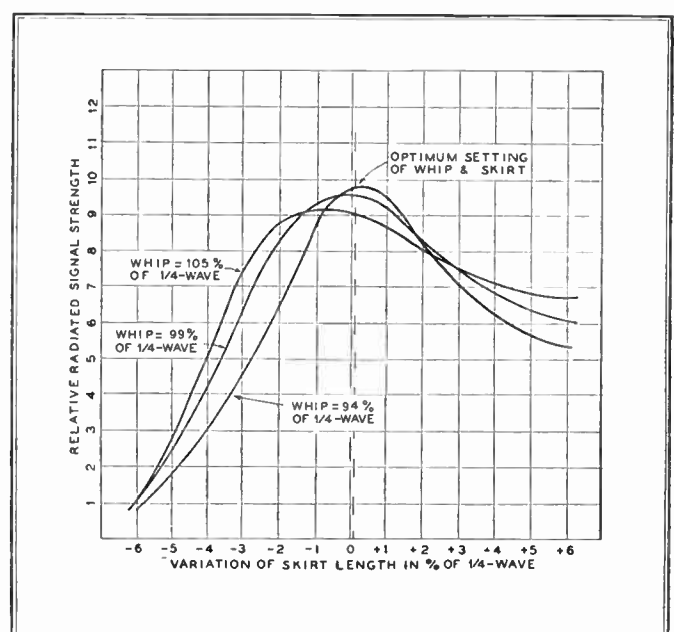

FIG. 8. EFFECT OF VARYING LENGTH OF WHIP FROM 92 TO 98 PER CENT OF ONE-QUARTER WAVE IS NOT CRITICAL



elements which are not necessarily coaxial. The theory behind this antenna array is sound, provided all elements are driven. The number of half-wave elements is not limited to two, and more can be used, up to practical limits.

Tests on a newly-designed series-fed

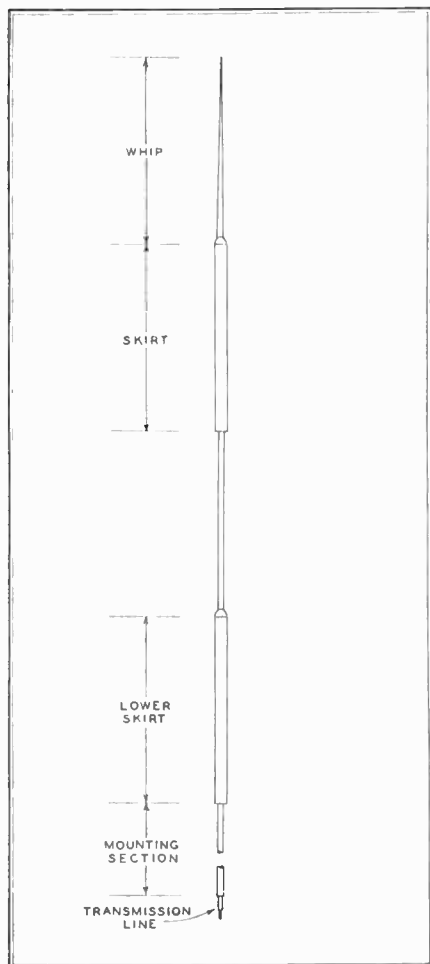

FIG. 9. NO POWER IS FED TO THE LOWER SKIRT OF THIS COLINEAR COAXIAL

colinear coaxial antenna, with all elements driven, indicate that a greatly improved signal can be radiated as compared with the standard series-fed coaxial. The design is extremely simple and workable for the 152- to 162-mc. band, and should prove highly advantageous.

As mentioned previously, a properly terminated coaxial antenna radiates almost 100% of the power delivered to it. The improvement in signal strength with a colinear coaxial, when all elements are driven, results from a lowered angle of radiation in the vertical plane and a compressed radiation pattern, as shown in Fig. 11. In any given plane, the area included within the radiation pattern boundaries is an expression of the power radiated by the antenna in that plane. It is seen that if the vertical pattern is narrowed, the radial coverage is increased. This provides greater coverage for the same antenna input power.

In the 30- to 42-mc. band, the overall length of the colinear coaxial would be as much as 33 ft., excluding support tube.

This would be an unwieldy structure. However, in the 152- to 162-mc. band, the length drops to less than 8 ft., and makes possible a mechanically sound structure.

**Directional Arrays** ★ In order to utilize antenna input power most effectively for communication between two fixed points, a beamed signal is desirable. Power radiated to other points serves no useful purpose. Directional antenna arrays can be used to boost the signal in any direction desired. This means that adequate signal strength can be delivered at a distant point with less transmitter power than would be required with a non-directional antenna. Another advantage is that the signal is not broadcast into areas where it might interfere with other services using the same or adjacent channels.

One of the oldest forms of directive antennas is the rhombic or diamond type. It is capable of substantial gain but, unfortunately, requires considerable space. Fig. 12 shows a full rhombic antenna.

Either vertical or horizontal polarization can be used for point-to-point transmission. That is because, at fixed locations, the receiving array can be made to match the polarization of the transmitting antenna. Although horizontally polarized waves generally travel over most types of terrain with less attenuation than those vertically polarized, a more important consideration is the structural advantage offered by one method of polarization over the other.

While a rhombic antenna can be arranged either horizontally or vertically, a vertical half-rhombic or inverted V antenna, Fig. 13, usually presents the least mechanical problems. The angle of tilt, designated  $A$ , is so chosen that the main radiation lobes 1 and 2 are horizontal. Lobes 3 and 4 then cancel each other and lobes 1 and 2 reinforce each other. The terminating resistor is used to eliminate the back radiation, indicated by dotted lines. With this resistance omitted, the array would be bidirectional, showing about

To realize the gain of which the rhombic is capable,  $L$  should be at least 3 times the wavelength. However, as  $L$  is increased, the gain increases but the beam becomes more narrow. In fact, at 6 times the wavelength, the beam is so highly concentrated that the orientation of the array for maxi-

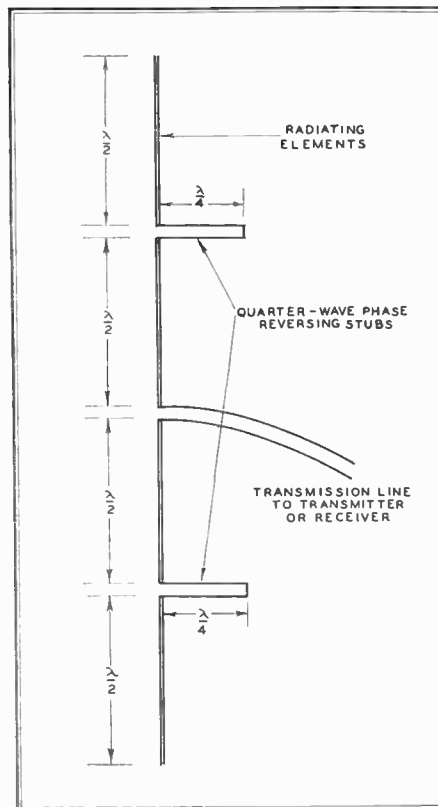

FIG. 10. SERIES-FED COLINEAR COAXIAL IS ADVANTAGEOUS AT 152 TO 162 MC.

imum signal at the receiving site becomes very critical, and must be done with great care. A gain of 8 to 10 db can be realized with a properly constructed rhombic having a leg length  $L$  equal to 6 wavelengths. This means a power gain of about 8 to 1 as compared to a standard half-wave dipole.

The trigonometric computation of the angles and sides of this array is beyond the

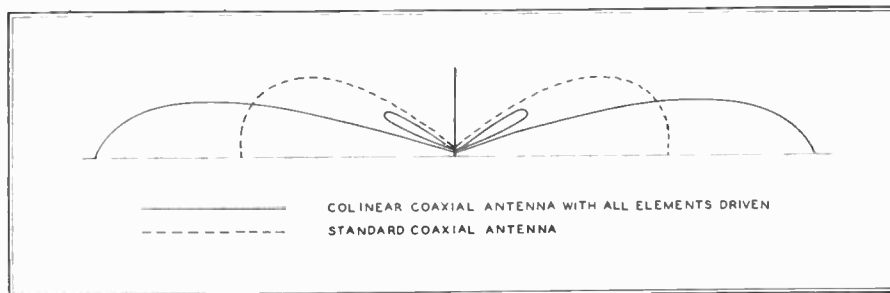

FIG. 11. LOWER ANGLE OF RADIATION GIVES COLINEAR COAXIAL GREATER RANGE

the same gain forward and backward. The angle of tilt may be adjusted by varying the height  $H$  or the length of the legs  $L$ .

The leg length is not critical, and can be 3 or more multiples of a wavelength at the operating frequency. While the antenna gain is increased with greater height, it is more dependent upon the leg length.

scope of this text. However, the following relations will produce rhombics that are efficient and will give very satisfactory performance.

Referring to Fig. 13, the proper tilt angle  $A$  is approximately  $66^\circ$ , and will be obtained if  $L$  is made 2.25 times the height  $H$ . Thus, if the operating frequency

is 30 mc., and available space permitted a leg length equal to 5 wavelengths,  $L$  can be found as follows:

$$L = \frac{300,000 \times 3.28}{30,000 \text{ kc.}} = 32.8 \text{ ft.} = L$$

$$5L = 5 \times 32.8 \text{ ft.} = 164.0 \text{ ft.}$$

$$H = \frac{164}{2.25} = 73 \text{ ft.}$$

At the same frequency, with legs equal to 3 wavelengths,  $3L$  would equal 98 ft. and  $H$  equal 43.5 ft. figuring as above.

At 50 mc. with  $L$  equal to 5 wavelengths,  $H$  becomes 43½ ft. and at 3 wavelengths for  $L$ ,  $H$  becomes only 26 feet. It is seen that, beyond about 50 mc., the value of  $H$  becomes so small that the effective height of the antenna is seriously cut down. This can be overcome at higher frequencies by going to a full rhombic antenna. As shown in Fig. 12, a single pole can be used to support this array without complicating the mechanical problems to any appreciable degree.

Here the distance  $B$  can be made 2 times  $H$  as computed above, and the same method used to figure the array. As a typical example, at 75 mc. with legs equal to 5 wavelengths:

$$L = \frac{300,000 \times 3.28}{75,000 \text{ kc.}} = 13.08 \text{ ft.} = L$$

$$5L = 5 \times 13.08 = 65.4 \text{ ft.}$$

$$B = 2H = 2 \times \frac{65.4}{2.25} = 58.2 \text{ ft.}$$

The full rhombic should be as high above the ground as possible, consistent with the space available for the end guys.

With the half-rhombic, it is necessary to employ a counterpoise system. This can be simply a wire on or just below the ground, directly under the antenna. One end is connected to the terminating resistor and the other end is connected to the second conductor of the transmission line. As an alternative, a section of metal screening or simply two wires, one at right angles to, and the other parallel with the antenna can be located on the ground under each end of the array. If the two crossed wires are used, they should be crossed at their mid-points. This point or the center of the screening should then be connected to the transmission line shield at one end of the antenna and to the terminating resistor at the other end of the antenna. If a full rhombic is used, no counterpoise is necessary.

With either the half or full rhombic the following considerations apply equally: The supporting mast must not be of metal. A wood pole, tubular plywood mast, or other non-metallic construction must be used. The mast can be guyed with wires, provided they are approximately at right angles to the direction of transmission. The terminating resistor should have a value of between 500 and 800 ohms. This is not critical. It should also be non-inductive, and must have a wattage rating ca-

pable of safely dissipating one-half of the transmitter output power, since its function is to eliminate the rear half of the radiation pattern.

Both rhombics exhibit the same characteristics of gain and directivity when used for receiving as well as for transmitting. The end guys used with the full rhombic, Fig. 12, can be metal without affecting the radiation pattern.

The input impedance of either the half- or full-rhombic at its feed point is about 600 ohms. If fed by a low impedance coaxial line, a serious mismatch would result. This can be overcome by the use of an impedance matching transformer, Fig. 14. It is properly adjusted when the loading of the transmitter is unaffected by sub-

In the majority of cases, these arrays can be so designed as to lend themselves readily to mounting on towers or pipe masts. They should be all metal for durability, preferably designed for single-point mounting, and should be self-supporting with no external braces.

Returning to Fig. 15, it is seen that the central portion is a half-wave dipole. It is usually fed by a coaxial transmission line with one quarter-wave element insulated from the central support and fed by the inner conductor of the line. The other quarter-wave element is grounded to the outer shield of the line and to the supporting structure. Minus the directors and reflectors, it has a radiation pattern as shown in Fig. 2.

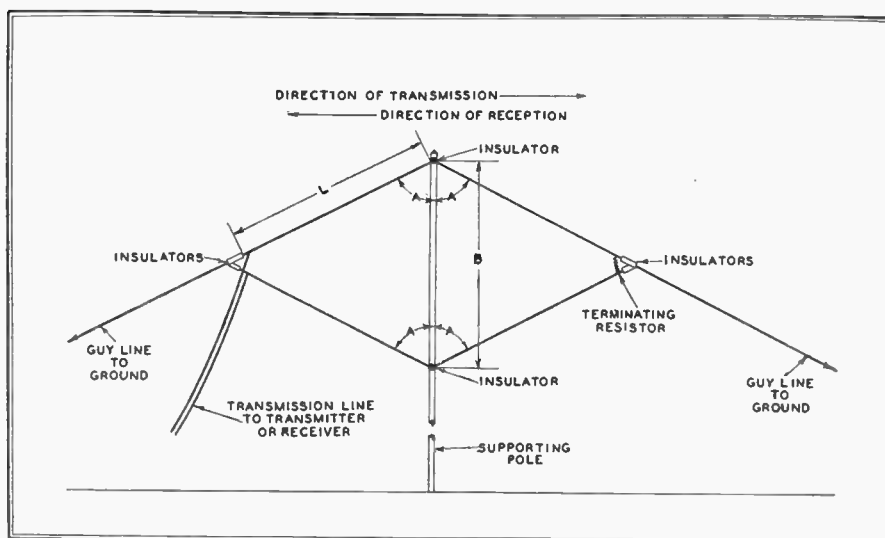

FIG. 12. FULL RHOMBIC IS FOR HIGHLY DIRECTIONAL TRANSMISSION OR RECEPTION

stituting for the rhombic antenna and impedance-matching transformer a dummy antenna having a resistance equal to the surge impedance of the transmission line. At this adjustment, the antenna current in either leg will also be at maximum.

If, in the case of a full rhombic antenna, it is desired to locate the impedance transformer at or near the ground, an open-wire 600-ohm line can be run from this point to the input end of the antenna. Such a line consists of two lengths of No. 12 wire, as might be used in the antenna, spaced 6 ins. apart by means of waxed wood, Lucite, or porcelain spreaders located every 2 ft. or so along the length of the line.

**Parasitic Directive Arrays** ★ Where space is not available for a rhombic antenna, or where a compact array is desired, a half-wave dipole with parasitic directors and reflectors can be used. Fig. 15 shows a horizontal dipole array.

These arrays present something of a structural problem in the 30- to 44-mc. band. Fortunately, while arrays for those frequencies have been built and are giving satisfactory service, most emergency service point-to-point work will be done on 72 to 76 and 152 to 162 mc.

When tuned elements such as the directors and reflectors are added, they are located directly in the radiation field of the driven dipole. The metal support arms for these elements have no effect on the radiation pattern either with or without the director and reflector. The supports, directors, and reflectors are all grounded to the hub assembly and to the mast structure, and are therefore at DC ground potential. A horizontal radiation pattern of such an array is shown in Fig. 16.

The function of the directors and reflectors is to absorb RF energy from the field of the driven dipole and to re-radiate it. By varying the lengths of these elements, or by varying their distance from the driven dipole, the re-radiated energy can be caused to reinforce the signal in the desired direction, and cancel it in the opposite direction.

Referring to Fig. 15, it is seen that the reflector is located slightly less than ¼-wavelength to the rear, and that the director is slightly less than ¼-wavelength ahead of the driven dipole.

Since both are directly in the path of the waves emanating from the driven dipole, each wave cuts across these elements. In doing so, a voltage is induced in the element which is opposite in phase to the in-

ducing voltage. Due to this voltage, the re-radiated wave from the parasitic element contains up to about 85% of the energy radiated to it by the driven dipole.

Considering the reflector only, the idea is to time this re-radiated wave so that, when it returns to the driven dipole, it is exactly in phase with the next wave being radiated by the driven dipole. Since the induced voltage in the reflector is 180° out of phase with the inducing field at the reflector, it is seen that about 90° in time are used for travelling to the reflector, 180° in time are added due to the reversal of phase at the reflector, and about another 90° are used in travelling from the reflector to the driven dipole. Thus the re-radiated energy from the reflector has undergone a 360°

ing directivity, but the addition of a director will provide additional gain in the desired direction by causing the beam to become narrower in the horizontal plane. More than one director can be used, each spaced about a quarter-wave ahead of the other. When one reflector and two directors are used, the result is the familiar Yagi array.

In the case of the director, a leading component of current must be introduced in order to preserve the phasing of the radiated and re-radiated fields, and to provide maximum reinforcement in the desired direction. This is accomplished by making the director elements less than a quarter-wavelength long. This causes them to have capacitive reactance.

the impedance presented to the transmission line will remain close to the value presented by a single half-wave center-fed dipole. This value will be in the neighborhood of 70 ohms.

It is possible to construct this same array with as little as 0.1- to 0.15-wave spacing between the driven dipole and the director and reflector. It will be found that the impedance presented by the array to the transmission line will have dropped to less than 20 ohms, which becomes a serious impedance mismatch. If the array were to be fed by commercial 50- or 70-ohm concentric cable, the loss due to mismatch and consequent standing waves on the line might more than offset any possible gain attributed to the array.

The array shown in Fig. 15 provides a beam having horizontal polarization. A typical horizontal radiation pattern for such an array is given in Fig. 16.

If the array were rotated 90°, using the parasitic support arms as an axis, it would then radiate a vertically polarized wave. Such an array is readily built about a coaxial antenna such as shown in Fig. 4. In fact, quite a number of these arrays are in use and give highly satisfactory performance. A vertical array based on a central coaxial antenna is shown in Fig. 17. It will be seen that the parasitic support arms are carried by a hub which is fitted around the metal skirt-supporting header of the coaxial antenna.

The gain and front-to-back ratio of this array compares very closely with that of the horizontal array shown in Fig. 16.

Typical figures for the vertical coaxial array are presented in terms of percent of a quarter-wavelength as follows: Whip length, 94%; skirt length, 98%; spacing from coaxial antenna to director and to reflector, 100%; reflector elements, 103%; director elements, 84%.

Both the vertical and horizontal arrays described must have the various lengths and spacings of the elements accurately fixed for optimum performance, but from another standpoint they allow a surprising amount of latitude. A certain amount of droop or sag in the support arms can be tolerated without serious effect on their performance of the array. Also, in both arrays, the director, reflector and driven dipole should all be parallel to the same plane. Yet, misalignment, so that the elements are crisscrossed when viewed in the direction of transmission, up to almost as much as 30°, has little practical effect on the characteristics of the radiated pattern. While such conditions are not desirable, the fact is brought out that these arrays are not as critical as many suppose them to be.

**Corner Reflector Antennas** ★ Corner reflectors can be used to direct the radiation from either a vertical or horizontal dipole, as shown in Fig. 18. While this type of antenna is mechanically more complicated than those previously discussed, it is a

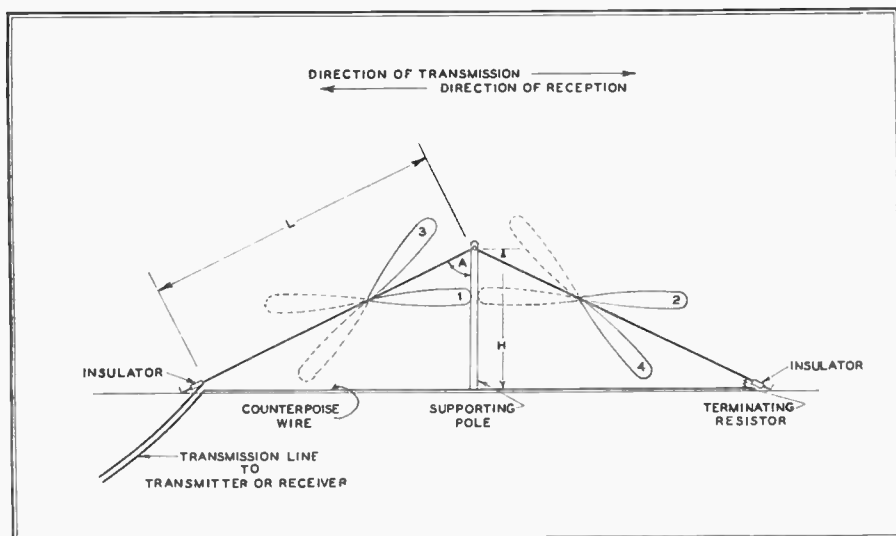

FIG. 13. THE HALF-RHOMBIC IS PREFERRED WHERE AVAILABLE SPACE IS LIMITED

change of phase by the time it returns to the driven dipole. Thus, it is in phase with the next wave radiated from the driven dipole. The net result is that two waves are involved, so timed in space that they tend to cancel at the reflector and become additive at the driven dipole. Therefore, the circular pattern of the dipole alone is altered, and is built up in the direction from the reflector toward the driven dipole, and reduced in the opposite direction.

Since the spacing between the parasitic elements and the driven dipole is slightly less than  $\frac{1}{4}$  wavelength, it becomes necessary to produce a lag at the reflector in order to obtain the 360° phase relationship of the two fields. This can be accomplished with reflector elements slightly longer than an electrical quarter-wave. This makes the reflector look inductive, and introduces a lagging component of current in the element. By adjusting the length of the reflector element, an optimum value is obtained where the phasing of the radiated and re-radiated fields provides the maximum front-to-back ratio. This is the ratio of the radiated energy in the desired direction to the energy radiated in the opposite direction.

In an array as illustrated in Fig. 15, the reflector does most of the work of provid-

While each added parasitic element increases the power gain in the desired direction, each one also takes away from the mechanical strength of the structure. Here again the choice must be reckoned in terms of power gain versus increased windage and ice loading on the structure. The array shown in Fig. 15 is capable of a 2.5 to 1 power gain and a front-to-back ratio of better than 4.5 to 1. This will be found adequate for most installations. Under conditions where more gain is necessary, additional parasitic elements may be required. In that case, more can be accomplished by additional directors located in the area of intensified field strength than by added reflectors in the area where the field strength has been purposely reduced.

While the following figures will be affected slightly by the type of construction, typical values for the lengths of horizontal dipole elements in terms of percent of a quarter-wave, are: Insulated driven dipole element, 95.5%; grounded dipole element, 95.5%; parasitic reflector and director spacing from driven dipole, 89%; reflector elements, 96%; director elements, 88%.

In an array consisting of a driven dipole with 1 director and 1 reflector with quarter-wave spacing, it should be noted that



relatively compact array. The central dipole is the only driven member, the other elements being used in place of two metallic sheets to form a corner reflector. Theoretically, each side of the angle should consist of a sheet of metal, which would simply be the ultimate case of having elements so numerous that they touched each other. Practically, if the spacing of the elements forming the sides is not over  $\frac{1}{2}\lambda_0$ -wave, the performance of the array would not differ appreciably from that obtained with metal sheets.

The characteristics of the array can be altered in two ways. As the angle between the sides of a vertically polarized array is decreased, the beam becomes narrower, mostly in the horizontal plane, but to a certain extent in the vertical plane also. For a horizontal array, the narrowing effect on the beam as the corner angle is reduced is more pronounced in the vertical plane, although the pattern in the horizontal plane is also narrowed, but to a lesser degree.

Referring to Fig. 18, the half-wave dipole is always located on a line bisecting the corner angle. The distance A, out from the corner to the point where the dipole is

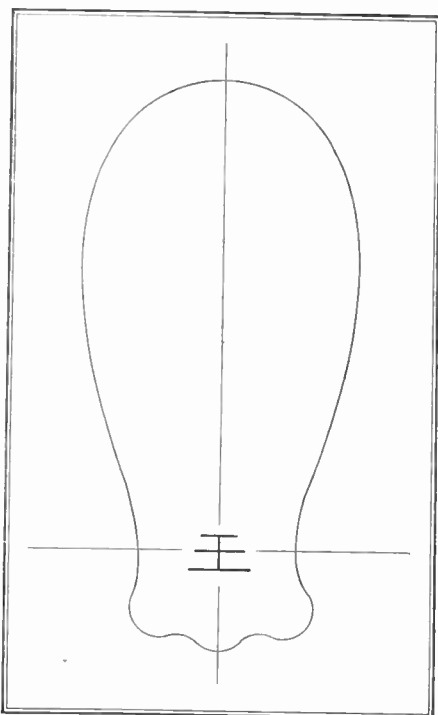

FIG. 16. RADIATION PATTERN OF THE HORIZONTAL REFLECTOR-DIRECTOR

located, controls the impedance of the array. The angle between the two sides can be varied between  $45^\circ$  and  $180^\circ$ . At  $180^\circ$  the result is a dipole located in front of a flat reflecting surface, which produces a very broad pattern forward. For any one angle however, there is a definite value for A which will produce a desired impedance. For 52-ohm transmission line, the antenna impedance will match the line at the following angles and values for A. For a  $180^\circ$  angle, A would be equal to 0.16 wavelength. At  $90^\circ$ , A becomes 0.3 wave-

length and at  $60^\circ$ , A becomes 0.45 wavelength. For smaller angles, the impedance of the array becomes more difficult to match regardless of how much A is increased. Smaller angles also produce a pattern that is broken up into multiple lobes and shows a decrease in gain.

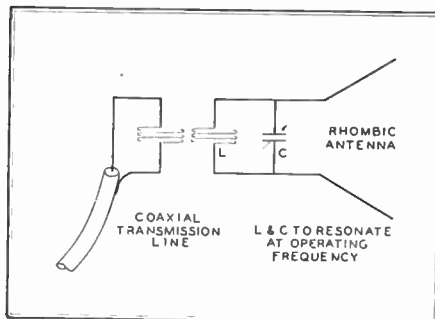

FIG. 14. SIMPLE MATCHING TRANSFORMER

To match a 72-ohm transmission line, the foregoing figures should be altered as follows. For angles of  $180^\circ$ ,  $90^\circ$  and  $60^\circ$ , the values for A become 0.21, 0.35 and 0.5 wavelength respectively.

At any of the usual angles given above, smaller values for A decrease the impedance of the array, and larger values increase the impedance.

The value of H, the length of the elements forming the sides of the angle, is not critical but should be held to a value not less than the overall length of the driven dipole. As a matter of fact, the elements forming the sides of the angle are not parasitic elements in the usual sense, since they are not tuned. They should be made long enough so that they appear to have unlimited length as far as their effect on the array is concerned.

The length L of the sides of the corner reflector is not critical as long as they are not less than 3 or 4 times the value of A, Fig. 18. The sides can be carried out farther than this minimum value, but the slight improvement in pattern is not worth the increased size of the array and the attendant mechanical problems introduced thereby.

Corner reflector antennas, while admittedly more cumbersome, are capable of greater gain than the simpler parasitic arrays. Properly designed corner reflectors can be expected to give a power gain of 10 to 13 db as compared to a single half-wave dipole. This means radiation in the desired direction of 10 to 20 times greater than that afforded by a simple dipole.

Referring to Fig. 18, it should be noted that the corner reflector antenna can be mounted vertically or horizontally. When mounted vertically, the driven dipole can be used to good advantage as a coaxial antenna. When a vertical half-wave dipole is used instead of the vertical coaxial, the transmission line should be led horizontally from the center of the driven dipole to the vertex of the corner reflector before it drops vertically to the transmitter or receiver.

**Mobile Antennas** ★ As mentioned earlier, vertical antennas are particularly adapted to mobile installations. A quarter-wave whip is most frequently used. The method of installation on the vehicle is important. A prime consideration is the use of maximum height relative to the vehicle. This is limited by the overhead clearances encountered in the area where the vehicles are required to operate.

The ideal location on a passenger car would be the center of the roof. In this position, the radiation pattern is most nearly non-directional. If such an installation is made in a station-wagon or on a truck body where the roof is made of wood, it is necessary to sheath the under side of the roof with light copper sheet or copper screening, securely bonded to the chassis at several points. This then becomes a ground plane immediately below the whip antenna, such as would be provided by the metal roof of a passenger car.

Usually, to provide overhead clearance, the antenna must be mounted toward the rear of the car, somewhere near the rear mudguard. In this position, the radiated pattern is no longer non-directional. With

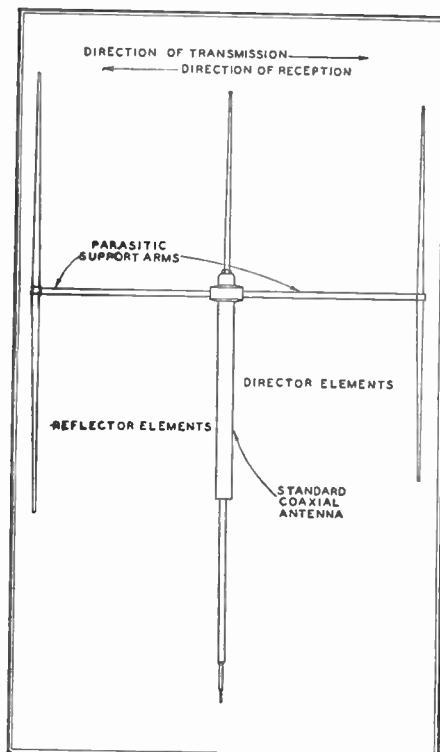

FIG. 17. REFLECTOR AND DIRECTOR ADDED TO A COAXIAL TYPE ANTENNA

a 30-mc. whip in the rear and at the left side of the car, it will be found that in most cases the greatest radiation and best reception will occur in a direction toward the right front corner of the car.

In the 72- to 76-mc. and 152- to 162-mc. bands, the center of the roof is the most logical location for the whip. At these frequencies the length of a quarter-wave whip is about 37 ins. and 18 ins. respectively, presenting no overhead clearance problem.

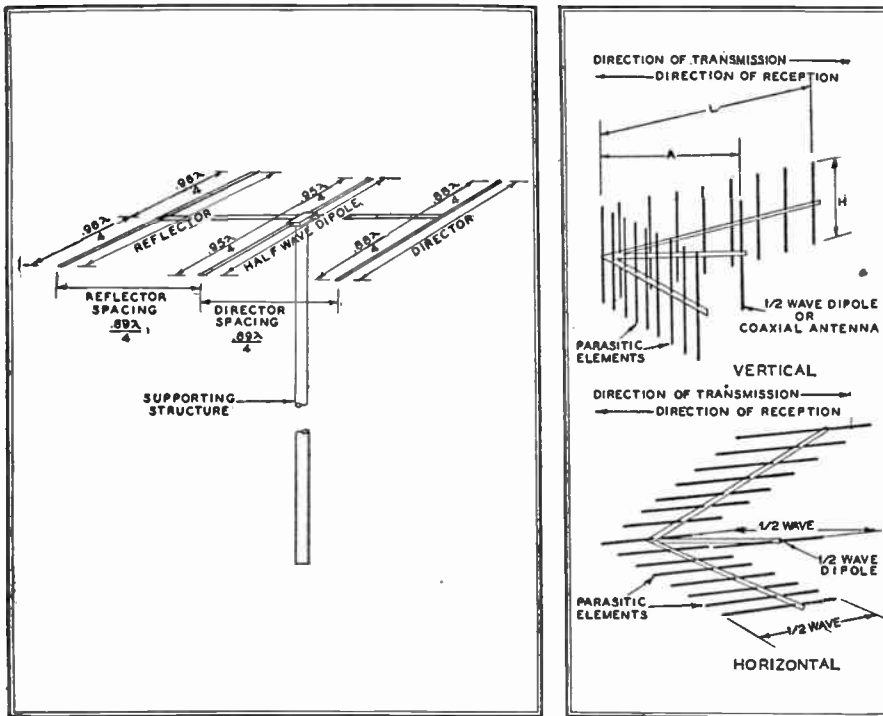

FIG. 15, LEFT: A HORIZONTALLY POLARIZED DIPOLE AND DIRECTIVE ARRAY. FIG. 18, RIGHT: VERTICAL AND HORIZONTAL TYPES OF CORNER REFLECTOR ANTENNAS

**Mechanical Considerations** ★ Obviously, all ferrous materials, unless heavily plated, should be ruled out for use in the construction of antenna arrays because of rust. Brass is easy to fabricate, withstands corrosion, and can be sweated for maximum electrical contact. Unfortunately, brass is a relatively heavy metal, and imposes a correspondingly heavier load on the array and on the supporting structure. Aluminum and its alloys are ideal because of their light weight. However, these materials are subject to corrosion from salt water and some acids. If this condition is

encountered in the locality where an aluminum antenna or array is contemplated, certain precautions must be taken.

Aluminum corrosion is largely self-inhibiting. That is, as corrosion attacks the aluminum surface, a scale or oxide is formed which progressively halts further corrosion. This is true on an unbroken surface, but does not hold true where tubular or other joints occur. Here, in severe cases, moisture finds its way into the joint and freezes the connection. This, together with the corrosion, expands the outer member of the joint and eventually weakens it,

causing poor electrical contact.

This can be overcome by using a vinylite sleeving or tape wrapped tightly over the joint, or by the application of some of the so-called stripping plastics used so successfully during the war to protect metal parts in ocean shipment. Where conditions necessitate this treatment, it is still worth the effort to take advantage of the lightweight, high-strength aluminum alloys.

The dead weight of the antenna or array is not the only factor to be considered. When high winds deflect an antenna, the moving mass of the system produces inertia effects that are proportional to the mass. Since windage increases with the exposed area of the elements, it is advantageous to keep the cross-section of the elements low. If the required strength can be realized in a given cross-section, it is wise to select the material that will give this strength with a minimum of weight.

Another important consideration is ice loading. In sections where this condition is likely to occur with some severity, it will be wise to decide on a vertical rather than horizontal antenna. This might not be the best choice from a radiation standpoint, but mechanically it would mean that heavily iced vertical members or elements would be subjected to compression or tension loads which are much more readily carried than the bending loads imposed by the same weight of ice on horizontal elements.

In every case, antennas for the emergency services should represent the best compromise between electrical efficiency and mechanical sturdiness. Above all, they must be dependable, since radio communication is of greatest value at times when weather conditions have put other means out of commission.

## ASSIGNMENTS IN THE 42- TO 44-MC. BAND

As of July 19, 1946

POLICE	42.78	GENERAL HIGHWAY MOBILE <sup>1</sup>
42.02	42.82	43.22
42.06	42.86	43.26
42.10	42.90	43.30
42.14	42.94	43.34
42.18		43.38
42.22		43.42
42.26		43.46
42.30	PROV. & EXPERIMENTAL	43.50
42.34	42.98	43.54
42.38		43.58
42.42		43.62
42.46		43.66
42.50	MARITIME MOBILE & GEOPHYSICAL	43.70
42.54		43.78
42.58	43.02	43.82
42.62	43.06	43.86
42.66	43.10	43.90
42.70	43.14	43.94
42.74	43.18	43.98

NOTE: To avoid interference with FM stations still operating in the band from 42 to 44 mc., each such FM station will be protected until January 1, 1947, by the provision of an 800-kc. guard band about its center frequency in the area in which it is located.

<sup>1</sup> May provide radio communication service to all types of mobile units such as marine, land vehicles, aircraft, etc. Pending final determination of the best method of operation of this service, these channels will be assigned on an experimental basis — 12 for development on a common carrier basis, 4 for trucks, and 4 for buses, except in those cases where it is shown that a different distribution is more desirable.

# Chapter 9

## Selective Calling for FM Communications

Report on Tests of Selective Calling on 157-Mc. Installation in New York City

**T**HE allocation of frequencies for police and other mobile services in the band from 152 to 162 mc. was originally greeted with little enthusiasm and much unfavorable conjecture. It was predicted that such high frequencies could be used only for police radio systems in small communities located in open country, and that even this limited use would be restricted by the high cost of the equipment.

All of which indicates that those who are too quick with their answers invite correction from those who do the work first and talk afterward for, during the I.R.E. Winter Conference, January 23rd to 26th, Link Radio gave an astonishingly successful demonstration of 2-way FM communication on 157 mc. in New York City, with the added feature of selective dial calling. And, it should be noted, the cost of the headquarters and mobile transmitters and receivers is about the same as similar equipment for 30 to 40 mc.

**Purpose of the Demonstration** ★ The purpose of the demonstration was twofold. First, the performance of the test setup showed that the 15-watt car installations, as illustrated here, could talk car-to-car upward of 2 miles despite the shielding effects of New York City's steel and concrete structures, or 15 to 18 miles in open country, while the one-way range of the 250-watt FM headquarters transmitter was at least 40 miles.

Second, the demonstration showed the simplicity and positive action of selective dial calling by which the squelch of the desired receiver could be opened, and a light or other signal actuated, without response from any other receiver in the system.

Following is a description of the test installation and its operation.

**Headquarters Installation** ★ For the purpose of this demonstration, a 250-watt transmitter, operating on 156.975 mc., was

installed at Madison Avenue and 53rd Street, where the DuMont television studios and station are located. A colinear coaxial antenna, with a gain of 2.7, was mounted on the television tower, 725 ft. above the street level. The transmitter, on the 42nd floor, was controlled remotely from television studio B, on the 2nd floor.

Fig. 6 shows the headquarters control console and the telephone instrument used for dialing. The latter is a standard type, except that the handset has a push-to-talk button. When the dial is operated, tone impulses are sent out on 570 cycles.

In addition, the headquarters receiver was equipped with a selector unit, so that the cars could call each other, the headquarters station, or another station set up at the Link factory on West 17th Street.

**Mobile Installations** ★ Figs. 2 to 5 show details of one of the mobile installations. The 157-mc. FM transmitter and receiver,

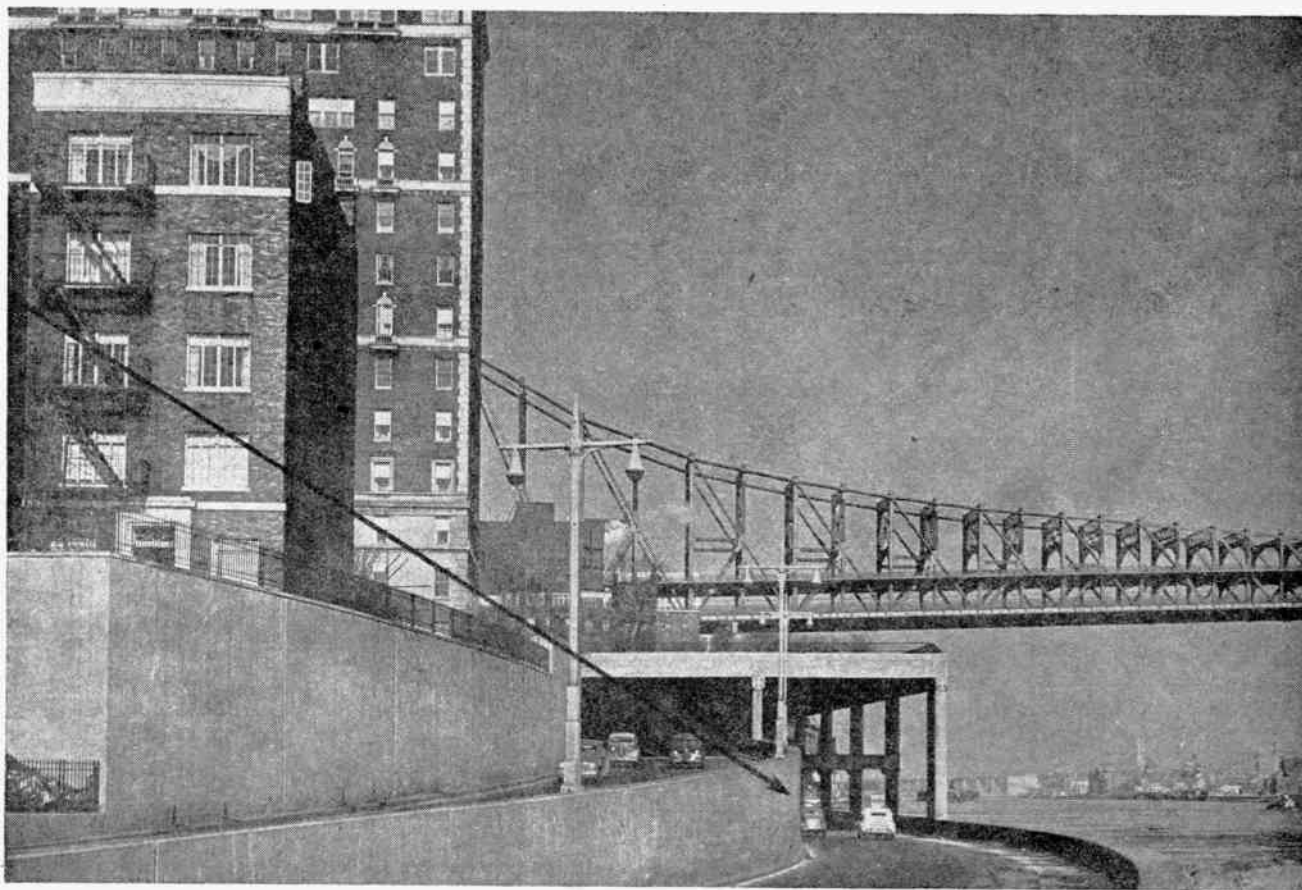

FIG. 1. EVEN UNDER THE EXTREME CONDITIONS ILLUSTRATED HERE, AT THE ENTRANCE OF THE EAST DRIVE UNDERPASS, WITH SIGNALS COMING FROM THE DIRECTION INDICATED BY THE ARROW, THERE WAS NO TROUBLE





FIG. 2. ACTING CHIEF INSPECTOR WILLIAM ALLEN, NASSAU COUNTY POLICE DEPARTMENT, TOURED NEW YORK'S WORST DEADSPOTS. EVERY TIME HE DIALED "HEADQUARTERS" THE OPERATOR SNAPPED BACK IN ANSWER TO HIS CALL.

Fig. 4, are of conventional appearance, and are designed for operation either with or without the dial system.

The selective calling circuits, in turn, are designed as an adjunct to any type of communications equipment for any frequency.

Fig. 2 illustrates the standard telephone dial and handset assembly used for the mobile installations. It should be noted, in this connection, that the handset is not removed from the hook until the number has been dialed.

Below the dash is the oscillator unit, containing two tubes and a voltage regulator. It also carries a red light which goes on when the car is called, and is only switched off when the handset is lifted.

The selector unit, Fig. 5, is mounted with the radio equipment, as shown in Fig. 4. It contains the checking relays and a stepping relay with a 10-point selector switch. Standby current drawn for the selector is 1 ampere at 6.3 volts, and 10 milliamperes at 180 to 250 volts. While selecting, there are current peaks of 3 amperes at 6.3 volts and 15 milliamperes at 180 to 250 volts. The selector unit used with the headquarters receiver is of similar design.

**Method of Dial Selecting** ★ Call numbers of 4 digits adding up to 10 are assigned to each receiver. There are 84 such call numbers possible, as 1-1-6-2, or 2-3-1-4. All the different combinations are listed on the

FIG. 3. THIS 18-IN. WIRE IS USED AS AN ANTENNA FOR 2-WAY COMMUNICATION



long side of the chart in Fig. 7. If there are more than 84 receivers in a system, additional audio calling frequencies can be employed, since the filter in each selector unit accepts only the operating impulses of its particular frequency. When a number is dialed, every receiver and corresponding selector unit responds, of course. If the number 4-2-1-3 is wanted, every stepping relay will first advance to the fourth contact. The position of the selector switch is immediately checked by a checking relay. At each receiver whose number begins with 4, the selector will remain at the 4th position. At all others, the selector switches will drop back to the normal position.

As number 2 is dialed, every selector switch will be advanced 2 points, its position will be checked again, and the switch held or released. Finally, when 1 and 3 have been dialed, only the switch in car 4-2-1-3 will have been advanced to its 10th position, at which point the receiver squelch is opened and a relay operated to turn on the red light or other indicating signal, such as a bell or horn.

In addition to calling individual receivers, groups can be reached simultaneously by the use of numbers with 1, 2, or 3 digits. The group combinations are indicated by the black squares in Fig. 7. If 0 is dialed, 10 impulses will be transmitted, and every receiver will respond. The number 1-9 will turn on all receivers from 1-1-1-7 to 1-7-1-1, while 1-2-7

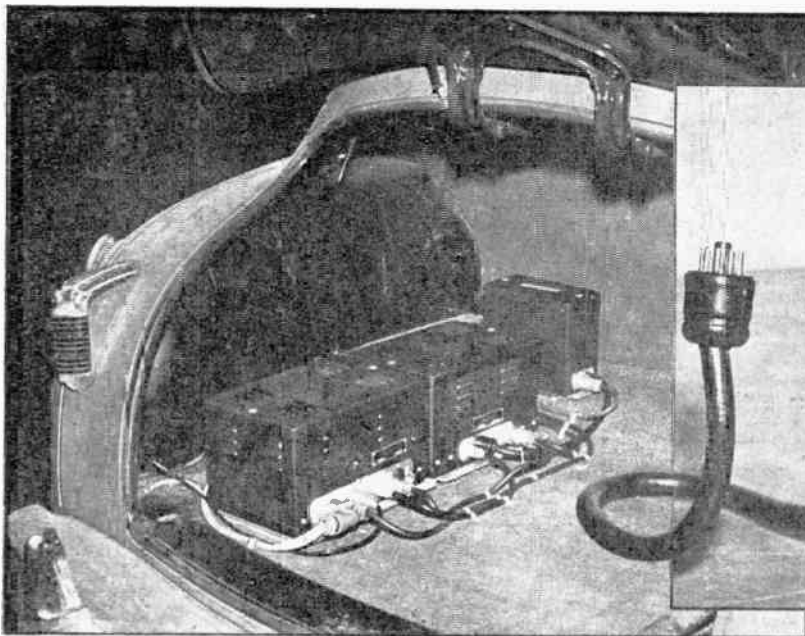

FIG. 4. THE 157-MC. TRANSMITTER AND RECEIVER. THE SMALL CASE AT THE FRONT CONTAINS THE RELAYS ACTUATED BY DIAL IMPULSES

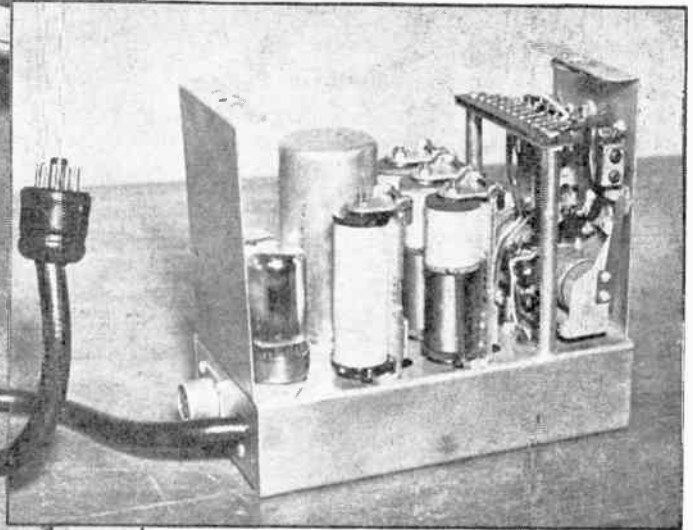

FIG. 5. CONSTRUCTION OF THE SELECTOR UNIT WHICH, IN RESPONSE TO THE PROPER SIGNALS, TURNS ON SPEAKER AND RED LIGHT

will actuate receivers 1-1-1-7 and 1-2-1-6 to 1-2-6-1.

It can happen that operators in two cars, or at headquarters and in one car, might dial simultaneously. In such a case, the stronger signals would prevail. This is likely to happen on only rare occasions, however. When a call is dialed from headquarters, the relays are actuated in all the cars, and clicks are caused in the speakers, even though the squelches remain closed except in the car called. Those clicks, therefore, serve as a warning that someone is putting in a call.

If a car calls another car or headquarters "while the line is busy," no interference is caused, since the relays are locked while the handset is off the hook. Furthermore, if a car is called while the operator is absent, the red signal light stays on, even though the receiver picks up other dial impulses in

the meantime. Altogether, the dialing system, simple as it is, operates in a fool-proof manner, and cannot be tricked into making mistakes, either by accident or intent.

**Performance of the System** ★ The experience of riding in one of the demonstration cars and operating the 157-mc. dial system was amazing for two reasons: 1) signals from headquarters were clear and clean and of constant volume level, and 2) the dial calling operation was as quick and certain as that of the familiar telephone.

One of the worst receiving conditions is illustrated in Fig. 1. This is at the East Side Drive underpass. With signals coming from the direction indicated by the arrow, there was no change in the speaker output level when the test car entered the up-town lane, or came out of the down-town lane. Yet the car antenna

was shielded not only by the steel construction of the underpass but by tall, adjacent buildings.

This does not mean that the field strength was constant everywhere, but that there was sufficient signal coming in to the receiver to operate the limiter. Therefore, the speaker output was constant even though the field strength varied.

Furthermore, it was possible not only to call and communicate with headquarters from the underpass, but with another car a mile away, on the other side of Manhattan.

Speech was of somewhat better quality than the ordinary telephone, both from the loudspeaker and the receiver in the handset. The only interference noise observed was in certain blocks where moderate background noise occurred. Link engineers identified this as diathermy interference.

This had no effect on the dial operation. In the course of a 2-hour drive through sections that are considered dead spots by New York City police radio engineers, there was not a single instance of failure in dial calls transmitted or received.

**Applications** ★ There are numerous applications for this new system among police departments, fire departments, public utilities, taxicabs, buses, remote pick-ups for broadcasters, and private telephone service in rural sections and from individual automobiles to central offices when this service is established.

Other services authorized to operate in this new frequency range, and for which the new dial-calling equipment is suited, include relay press services, forestry conservation groups, maritime mobile stations, urban mobile installations, rural subscriber telephone service, relay broadcast systems, and railroad communications particularly for freight and passenger yards.



FIG. 6. THE HEADQUARTERS CONSOLE IS OF CONVENTIONAL APPEARANCE, BUT THE ADDITION OF A DIAL PHONE IDENTIFIES THE SELECTIVE CALLING







# Chapter 10

## Maintenance of 2-Way FM Systems

The Connecticut State Police Set-up for Maintaining 332 Car Installations and 11 Main Stations

**T**HE Connecticut 2-way FM State Police installation was begun in 1939 and was completed in 1940. Since that time, the system has grown considerably, and now consists of eleven 250-watt main stations, and three hundred and thirty-two 25-watt, 3-way mobile units.

All of the 250-watt stations are situated on mountain tops and near the center of the serviced area. All are unattended and remotely controlled over telephone lines. The receiving and the transmitting equipments are housed in sheet steel buildings located on the mountain tops, with the control points miles away in police barracks.

A large system such as this is necessarily a 2-frequency system. All of the fixed stations transmit on 39.5 mc., but have receivers on 2 frequencies, 39.5 and 39.18 mc. All the cars receive on 39.5 mc. and normally transmit on 39.18 mc. but are also able to transmit on 39.5 mc., the so-called 3-way frequency for car-to-car communication. This system makes it

possible for several main stations to communicate with their cars at the same time, because signals received from the car are on a different frequency, and because, in an FM system, the stronger signal dominates at any one receiving point. The provision for use of a second transmitting frequency for the mobile units is necessary because all receivers in mobile units are tuned to the fixed station frequency of 39.5 mc. If car-to-car communication is desired, the car must change its frequency of transmission from the normal 39.18 to 39.5 mc., which all mobile units can receive also. Such a provision is absolutely essential in any large communication system and is highly desirable for all systems.

There has been some comment to the effect that Connecticut is using more main stations than is necessary to cover so small an area. In one sense this is true, but conditions require the Connecticut State Police to put noise-free signals from at least one station into every square

foot of the State, and also to provide secondary service from at least one other station. Then, in case the local station is off the air, satisfactory service can be obtained from at least one other station.

An adequate number of receiving points makes possible low-power mobile equipment with consequent freedom from battery trouble, lower maintenance costs, and greater reliability.

With certain modifications, the methods can be adapted to any type of 2-way system.

**Maintenance Organization** ★ Our maintenance organization consists of one Supervisor of Radio Maintenance, three radio technicians and one radio mechanic. In addition, a tower maintenance man is employed under contract to handle all tower and obstacle-light maintenance work.

The State is divided into three maintenance areas and a fairly complete radio shop and spare parts depot is maintained in each area. The whole maintenance organization is on duty during the usual

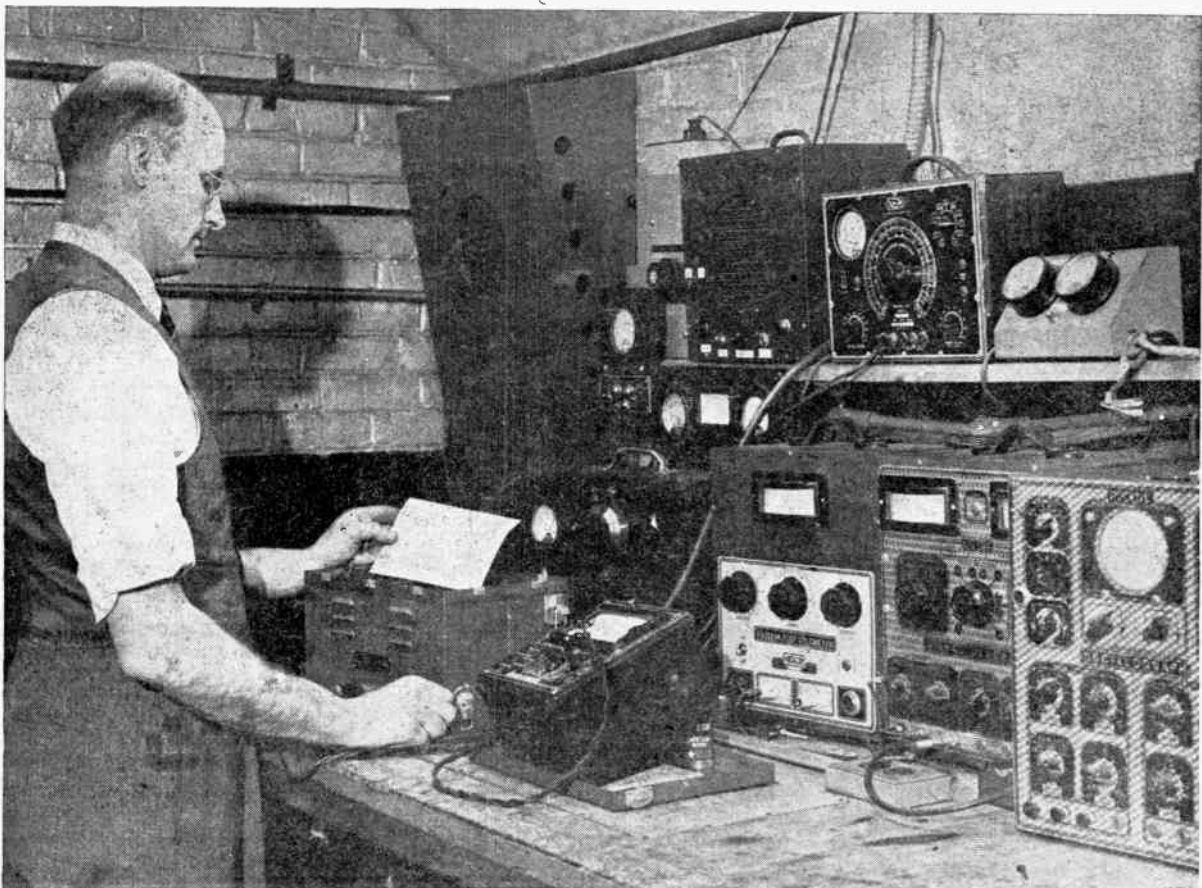

FIG. 1. FRANK BRAMLEY AT THE TEST BENCH IN THE STATE POLICE RADIO LABORATORY AT HARTFORD, CONN.

business hours and is on call at all other times.

**Selection of Personnel** ★ The selection of the personnel for an organization to maintain a communication system is not an easy proposition. There are many methods of doing it; all have their faults. Certainly, if the system is large, the group should be headed by a man of engineering caliber and one who has had extensive maintenance experience. The technicians under his supervision must also be experienced

training takes several years at least, and is only successful with men of special aptitude.

In a large system it will be found advisable to employ what may be called a radio mechanic to handle mechanical jobs involved in the installation, transfer, and reinstallation of the equipment. A rather versatile automobile mechanic with a good understanding of electrical principles could qualify for this job. He need not have any technical understanding of radio. Tower maintenance men are usually

- 1 microvolter
- 1 oscilloscope
- 1 audio oscillator
- 1 frequency meter
- 1 communications receiver
- 1 field strength meter
- 1 deviation meter

Next to the volt-ohm-milliammeter, the microvolter is probably the most useful piece of equipment. It is highly desirable that each radio technician have one at his disposal. The speed and accuracy

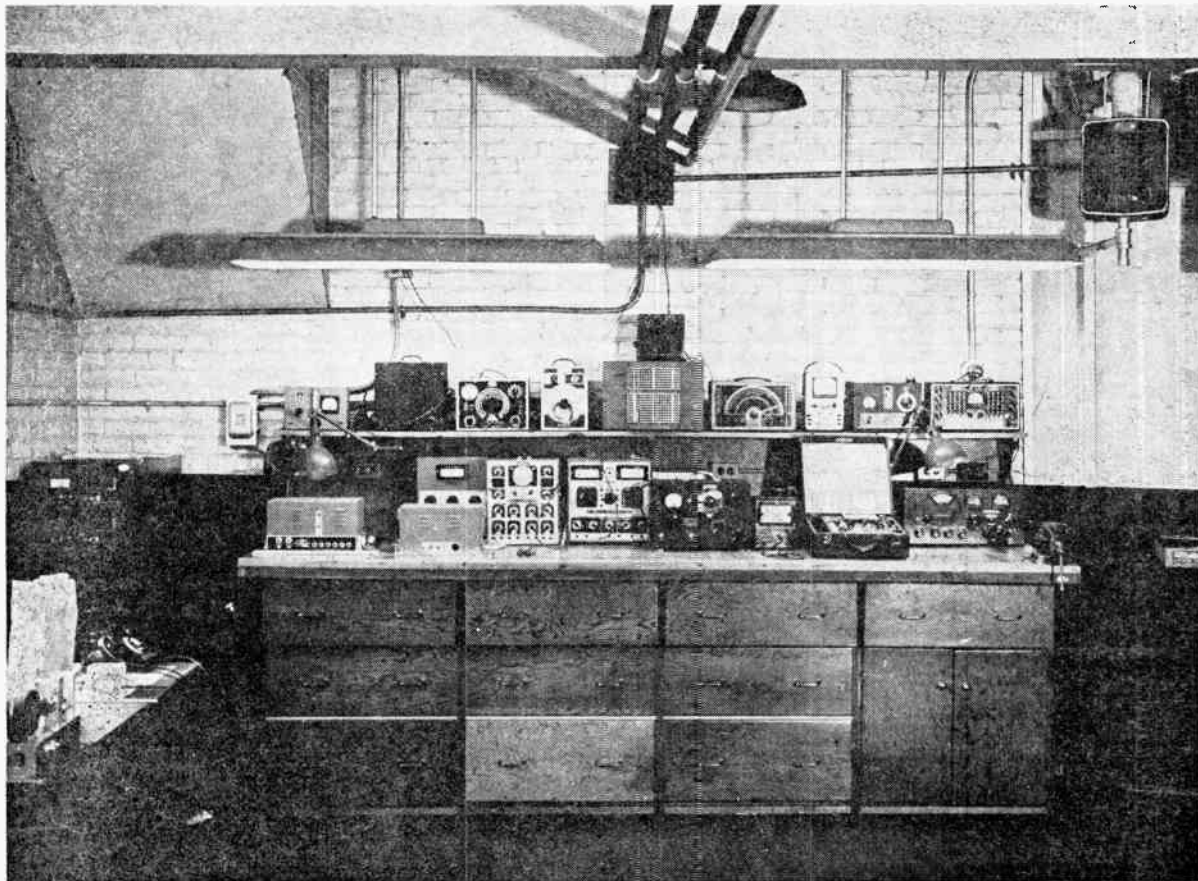

FIG. 2. SERVICE EQUIPMENT AND MEASURING INSTRUMENTS USED AT THE HEADQUARTERS LABORATORY

men able to obtain first grade operators' licenses, although this grade of license is not actually required.

Of even more importance than the training of the technicians is their mental attitude toward the equipment they will be required to maintain. It is of relatively little importance what make or type of equipment is used if the technicians thoroughly believe in its capabilities. A technician who expresses the opinion that the equipment he is to care for is "junk", had best be employed elsewhere.

In general, it will be found desirable to select men from outside the organization who have had extensive radio experience in the maintenance and repair field. Men of the self-trained type, such as develop through amateur radio, are especially desirable. Our experience indicates that it is not desirable to attempt to train men who are already members of the organization. Adequate radio maintenance

steplejacks, employed under separate contract to handle this work.

**Maintenance Equipment** ★ Each of our technicians is furnished with a car, a complete set of tools, spare parts, and tubes. His test equipment consists of:

- 1 volt-ohm-milliammeter
- 1 portable signal generator and frequency monitor
- 1 tube tester and analyzer
- 1 capacity bridge
- 1 portable decibel meter
- 1 vibrator tester
- 1 vacuum tube voltmeter

Each man has spare mobile and fixed station receivers, and spare mobile transmitters. At the Headquarters Radio Laboratory, views of which are given in Figs. 1 and 2, a somewhat larger stock of tubes, parts, and equipment is available. Here the following test equipment has been found necessary:

with which receivers can be checked for all-round performance with such an instrument makes it well worth the cost.

Our deviation meter, the only type available, does a good job when used within a few hundred feet of a main station, but its sensitivity is so low that it is totally inadequate for use with remote equipment. There is a great need for a deviation meter to monitor remote equipment on a state-wide basis, but such a device does not appear to be available at the present time.

**Maintenance Routine** ★ It was our original intention to check all equipment at regular intervals. This plan was used for a while but it became apparent that checks on units actually in good working order often produced trouble rather than prevented it. For instance, tube testing often indicated that certain tubes should be replaced. When this was done, often the







RADIO DIVISION  
CONNECTICUT STATE POLICE (1)

MAIN STATION RADIO EQUIPMENT INSPECTION RECORD

STATION \_\_\_\_\_ DATE \_\_\_\_\_  
 INSPECTED BY \_\_\_\_\_ AND \_\_\_\_\_

REMOTE EQUIPMENT:

Driveway \_\_\_\_\_ Entrance Wiring \_\_\_\_\_  
 Photocell \_\_\_\_\_ Relay Condition \_\_\_\_\_  
 Tower Lights \_\_\_\_\_ Emergency Switch \_\_\_\_\_  
 External Paint \_\_\_\_\_ Door Lock \_\_\_\_\_  
 Vent Covers \_\_\_\_\_ Vent Screens \_\_\_\_\_  
 Door Seal \_\_\_\_\_ Inside Paint \_\_\_\_\_  
 Phone Line Carbons \_\_\_\_\_ Phone Line Ruses \_\_\_\_\_  
 Housekeeping \_\_\_\_\_ Record Keeping \_\_\_\_\_  
 Heater \_\_\_\_\_ Trouble Light \_\_\_\_\_ Fan \_\_\_\_\_ Broom \_\_\_\_\_  
 Fan Thermostat \_\_\_\_\_ Mats \_\_\_\_\_ Cabinet \_\_\_\_\_ SVC. Notes \_\_\_\_\_  
 250th Filament Voltage \_\_\_\_\_

RECEIVER FOR 39.5 KC. : PLATE VOLTAGE \_\_\_\_\_  
 Squelch Adjustment \_\_\_\_\_ Audio Level \_\_\_\_\_ Decibels \_\_\_\_\_  
 Sensitivity \_\_\_\_\_ Overhaul \_\_\_\_\_

RECEIVER FOR 39.18 KC. :  
 Squelch Adjustment \_\_\_\_\_ Audio Level \_\_\_\_\_ Decibels \_\_\_\_\_  
 Sensitivity \_\_\_\_\_ Overhaul \_\_\_\_\_  
 Squelch Relay Mount \_\_\_\_\_ Plate Voltage \_\_\_\_\_

TRANSMITTER:

Tuning \_\_\_\_\_ Frequency \_\_\_\_\_  
 Neutralization \_\_\_\_\_ Power Output \_\_\_\_\_  
 Concentric Line Gas Pressure \_\_\_\_\_ lbs. \_\_\_\_\_  
 Line Voltage \_\_\_\_\_ 807 Plate Current \_\_\_\_\_ 250th Grid \_\_\_\_\_

RADIO DIVISION  
CONNECTICUT STATE POLICE

MAIN STATION RADIO EQUIPMENT INSPECTION RECORD

STATION \_\_\_\_\_ DATE \_\_\_\_\_  
 INSPECTED BY \_\_\_\_\_ AND \_\_\_\_\_

BARRACKS EQUIPMENT

Control Unit External Appearance \_\_\_\_\_  
 Meter Settings \_\_\_\_\_ Dial Lights \_\_\_\_\_  
 Loudspeaker Quality \_\_\_\_\_ Volume Control \_\_\_\_\_  
 Cars-Thru-Speaker Switch \_\_\_\_\_ Carrier Reading \_\_\_\_\_  
 Transmitted Audio Level \_\_\_\_\_ Decibels Average \_\_\_\_\_  
 Received Audio Level \_\_\_\_\_ Decibels Average \_\_\_\_\_  
 Receiver Minimum Volume Control Setting \_\_\_\_\_  
 General Overhaul of Apparatus \_\_\_\_\_

HANGUP BOX: HANDSET CORD \_\_\_\_\_

Micophone Quality \_\_\_\_\_ Output \_\_\_\_\_  
 Pushbutton Contacts \_\_\_\_\_ Switch Contacts \_\_\_\_\_

POWER SUPPLY: SQUELCH VOLTAGE \_\_\_\_\_ TRANSMIT VOLTAGE \_\_\_\_\_ OVERHAUL \_\_\_\_\_

SPECIAL BARRACKS RADIO EQUIPMENT: \_\_\_\_\_

GENERAL INSPECTION OF CARS:

CAR REG. \_\_\_\_\_ CONDITION \_\_\_\_\_  
 CAR REG. \_\_\_\_\_ CONDITION \_\_\_\_\_  
 CAR REG. \_\_\_\_\_ CONDITION \_\_\_\_\_  
 CAR REG. \_\_\_\_\_ CONDITION \_\_\_\_\_  
 CAR REG. \_\_\_\_\_ CONDITION \_\_\_\_\_

RADIO DIVISION  
CONNECTICUT STATE POLICE

MAIN STATION RADIO EQUIPMENT INSPECTION RECORD

REMOTE EQUIPMENT--

SPARE TUBES: 250TH (1); 866A's (2);  
 866 Jr's (2); 807's (2); 6L6 (1);  
 7C5 (1); 7C7's (2); 7A8's (2);  
 11717GT (1); 923 (1); 80's (2);  
 6J5 (1); 6K6G (1); 6K8's (2);  
 6AC7's (2); 6SJ7 (1); 6H6's (2);  
 6C3G (1); 6V6(g) (1);

RELAYS: Line Relay \_\_\_\_\_ Plate \_\_\_\_\_  
 Overload \_\_\_\_\_ Time Delay \_\_\_\_\_  
 Antenna \_\_\_\_\_ Squelch \_\_\_\_\_

NOTES: \_\_\_\_\_  
 \_\_\_\_\_  
 \_\_\_\_\_  
 \_\_\_\_\_

all day and turned off at night. After about three days of this, alignment is made. It is then left running continuously for 24 hours and a second alignment is made. This is final, and the receiver is then turned off and stored on the shelf. When it becomes necessary to use this spare, it is put in operation without being touched in any way. Operation will at first be poor, but will gradually come around to peak performance.

Equipment that has been running continuously for a long period, and then is turned off or goes out of service for any reason, is very likely to refuse to start or fail to operate properly when turned on again. Expansion and contraction of old equipment induce failure. Arbitrary replacement of paper and electrolytic condensers in old equipment is desirable for this reason.

Regular checks with a tube tester are made on fixed-station equipment, but replacements are made with caution because a certain percentage of all new tubes are likely to fail. We always stand by for a few hours to be certain the new tubes are going to be satisfactory.

**Control Units** ★ Headquarters control-unit troubles are confined to tube replacement, relay cleaning, and inspection of the microphone cord and control circuit. Again, the rectifier tube in the power supply is the item that should be checked most frequently. Next in importance are the microphone cord and the control circuit push button. These items must be checked frequently and replaced if they show any signs of wear.

If the control relays are not provided with dust covers, they should be added. We have traced many cases of trouble to this cause. After the installation of covers, relay trouble in the control units dropped to zero.

**Automatic Gain Control** ★ The use of automatic gain con-

trol circuits in control-unit speech amplifiers is highly important, even with an FM system. The widely varying levels of the dispatchers' voices, and the variable speaking distance from the microphone make a constant-output speech system highly desirable. For best operation, it should prevent overload and also bring up the volume of weak voices to a limited extent. Excessive build-up will increase background noise unduly. The slow, spaced, repetition of figures and letters so necessary in police announcements, places a stringent design factor upon any automatic gain system.

To prevent momentary overload, the automatic gain control circuit should be very fast-operating, but at the same time should not change the degree of amplification between spaced syllables. These two factors seem to be impossible to reconcile, and in the end a slower action must be chosen and momentary overloads tolerated.

Circuits having quick, original action and slow decay have been tried, but they introduce a warbling effect that is undesirable. Research along this line might be very helpful.

**Mobile Equipment** ★ The maintenance of the mobile equipment is the largest item. For the most part, no work is done unless the officer reports trouble, or monitoring indicates the need for service. This may seem to be a haphazard method, but experience indicates that modern FM equipment can be kept running quite reliably by this method, provided that servicing, when necessary, is quite thorough and complete. With two exceptions, it has not been found necessary to replace tubes or parts on an arbitrary basis. The exceptions have been the receiver coupling condenser and the vibrapack buffer condenser. These two condensers are always replaced whenever equipment comes in for service after two years of use.

Tubes or other parts are not replaced unless the performance indicates that it is necessary. Although we believe thoroughly in tube testers and tube testing, tube testers cannot be depended upon to indicate the performance of tubes at high frequencies. A much better indication of overall performance is given by the measurement of receiver sensitivity with a microvolter.

Transmitter output is indicated very satisfactorily by the ability to communicate between known points. Our technicians determine the efficiency of transmitting equipment in a car by attempting to communicate with a relatively distant station in the system. If the report from the dispatcher at the distant station is satisfactory for the distance concerned, we know the performance will be more than adequate for communication within the usual area.

**Installation** ★ There is no more important

FIG. 5. THIS VERY COMPLETE MAINTENANCE RECORD IS KEPT AT EACH MAIN STATION

item in the maintenance of a large group of cars than proper initial installation. We have found that control cables must be installed in conduit, and that all exposed cables must be fastened securely at intervals of 1 ft. or less, so that no parts can be set into destructive vibration. The equipment must be mounted so that there will be adequate ventilation and it will be kept free from moisture.

It is customary to mount the radio apparatus in the rear compartment. This compartment is seldom really water tight. If it does not leak in an ordinary rain-storm, it will usually leak when the car is washed. Auto mechanics seem to be unable to prevent this from happening, so the only alternative is to install the equipment so that the water will not be able to damage it. One of the best solutions to this problem is to mount the equipment off the floor slightly.

Loud speakers must be mounted so that the beam from the cone is directed at the operator. The speaker should never be mounted on the bulkhead, or with the cone facing the floor. Such a method of mounting makes for muffled reproduction rather than crisp, understandable speech.

The Connecticut State Police pioneered the roof-top aerial. It is still the best where maximum range and minimum noise are required. No other equivalent method has been found, but rear side and cowl-mounted aeriels are satisfactory where small areas are to be covered.

The Connecticut State Police use telephone type handsets, with signals reproduced both through the loudspeaker and the earpiece. If accurate, intelligible signals are required under the most adverse conditions, there is still no substitute for an earphone. Placing the handset to the operator's ear automatically insures close talking into the microphone, and correct modulation levels.

**Battery Maintenance** ★ Radio equipment cannot operate satisfactorily unless adequate power is delivered to it. Modern equipment requires at least No. 6 wire from the battery to the equipment. The voltage delivered to the operating equipment should not be less than 5.8 volts. With 25-watt transmitting equipment, it has not been found necessary to use heavy-duty batteries, but with the usual extra police equipment, a heavy-duty generator is required. It is of no use to have a heavy-duty battery without a heavy generator because no more can be taken out of a battery than is put into it, no matter how big the battery may be. A heavy-duty battery merely gives longer reserve operating time with the motor off.

Care must be taken to see that regulating equipment does not cut out before the battery is fully charged, and that the leads from the generator to the battery are large enough to allow the generator to deliver its full rate to the battery.

When over-size generators are installed, it is customary to leave the small wires in place that were intended for the original 10-to 15-ampere charging rate. Such wires are unlikely to be adequate for the 40- to 50-ampere charging rates of which a heavy-duty generator may be capable.

Some batteries have a tendency to deliver inadequate voltage after considerable use. They may be quite capable of starting the car and operating it satisfactorily in all respects except the radio apparatus. Radio tubes will not operate properly on low filament voltages, and

a boost while he is writing his reports, or is on duty at the station.

**Vibrators** ★ The maintenance of vibrator power packs is an important factor in keeping the system running at peak efficiency. We believe in replacing every vibrator that is at all questionable. If vibrator output voltages go 15% below normal, these units should be replaced. A new vibrator should always deliver full voltage. If the measured output of a new vibrator is less than normal, the pack must be examined for further trouble.

CONNECTICUT STATE POLICE  
RADIO DIVISION  
STATEMENT OF FREQUENCY MEASUREMENT

This is to certify that on \_\_\_\_\_  
at \_\_\_\_\_ A.M. P.M. the frequency of Station \_\_\_\_\_ was  
measured at Hartford, Connecticut and found to be \_\_\_\_\_  
kilocycles, which is equivalent to a deviation of \_\_\_\_\_ %  
from the assigned frequency of 39,500 kilocycles.

The above measurement was made by Radio Technician  
\_\_\_\_\_ using a  
Meter Type 105, Serial #29 which was previously calibrated  
against Station WWV.

Signed \_\_\_\_\_ Radio Technician  
Date \_\_\_\_\_

The above form shall be filed with and become a  
part of the regular radio log for the day specified.  
Also check and make sure that an entry was made  
in the original log at the time that the measurement was  
taken stating that a frequency measurement was made.

FIG. 6. THIS REPORT FOR FREQUENCY CHECKS MEETS FCC RULES

their ability to do so decreases rapidly with age.

Batteries which develop less than 6.0 volts at their terminals, with the radio equipment as the only load, should be replaced. It will be found less costly to replace a battery occasionally than to replace the tubes frequently to obtain full radio performance.

As an aid to maintaining fully charged batteries, the radio division of the Connecticut State Police has installed at each barracks a type of battery charger that simplifies battery upkeep for the officer. Six-ampere chargers are mounted on the wall of the garage and are provided with several wall outlets. Heavy, flexible leads from the outlets can be connected directly to the battery without removing it from the patrol car. A series arrangement is used, so that it is necessary to have all unused outlets shorted together. This has proven simple enough so that the uninitiated officer can give a weak battery

If none is found, the car battery or wiring must be suspected and appropriate action taken.

After 2 years of use we overhaul every power pack. All buffer condensers showing any oil leakage are arbitrarily replaced, and the filter condensers checked to see if capacity and power factor have changed.

**Equipment Life** ★ Vibrator life has been about one year. With the method of operation in the Connecticut State Police Department, this represents about 3,500 hours, because each car is in use about 10 hours per day.

Tube life has been long with a few exceptions. About 50% of the original tubes are still in use after 5 years. Power output and rectifier tubes are most frequently replaced, and are usually rejected because of low emission. Frequency converters in receivers, 6K8's, are commonly rejected because of high internal noise or low conversion efficiency, although they

may appear to be satisfactory on a tube checker.

Condenser failures, as has been mentioned, are chiefly buffer and audio coupling units. The dry type electrolytic condensers, used as high-voltage filter in receivers, have been very satisfactory. Low-voltage cathode bypass condensers and multiple RF and AF condenser blocks have been much less so. Low-voltage electrolytics seem to have very short life. We avoid their use. Paper condenser blocks also seem to be unsatisfactory unless they are of the oil filled can type.

**Antenna Maintenance** ★ The top-mounted antenna must be provided with a base spring. The flexible connection between the antenna rod and transmission line, terminating inside the spring, can be a service problem. The 1/4-in. braid usually provided is good for less than 10,000 miles. By using braid sold for generator brush leads, obtainable at auto supply stores, longer life has been obtained. It seems to be good for 100,000 miles. Rear side-mounted aerials must also be provided with springs or they will be subject to frequent breakage.

All main stations use coaxial antennas mounted on 180-ft. steel masts and fed with 7/8-in. concentric copper line. These lines are filled with dry nitrogen at about 25 lbs. pressure. There has been a tendency for these lines to develop slow leaks,

but no real trouble has occurred except in those cases where there has been severe icing or lightning damage. Why lightning damage should occur on grounded systems is difficult to explain, but it does. In one case, the 1/4-in. center conductor was melted in two and shorted to the tube. More frequently, lightning enters by way of the telephone or power lines. Damage to these facilities, and to the relays and transformers attached to them, has been common. Relays and transformers should be easily accessible, or of plug-in type, to facilitate quick repairs. Adequate fusing and heavy grounding of all equipment is essential.

**Remote-Control Telephone Lines** ★ The most frequent cause of failure of remote equipment is the power or telephone circuits. Telephone circuit failures are the most frequent of all. If an absolute maximum of dependability is required, relay circuits should be employed to control remote transmitters and receivers. Such equipment is now available, and will be installed in Connecticut as soon as possible.

**Frequency Measurements** ★ In Connecticut, where all main stations can be heard at our Hartford Headquarters, frequency measurements are made from that point once each month. A frequency meter is calibrated against WWV by the zero beat

method immediately before the measurement is taken. Signed reports of the results are mailed to each station and a copy to each technician. The form is shown in Fig. 6.

Each technician is provided with a portable frequency monitor that is checked against the Headquarters equipment. With this meter he can make the necessary checks on the mobile equipment in the field. Records of frequency measurements on mobile units are kept by the technician and notations are also made on the individual record card in each transmitter.

We would like to check our cars for off-frequency operation by means of an automatic frequency indicator installed at each of our fixed stations. Such an instrument should be operated by a radio receiver. Then we would be able to tell immediately if any car transmitter had drifted from its assigned frequency.

**Summary** ★ If some of the information presented here is not in agreement with practices followed by other systems, the reason lies in the fact that, either through trial-and-error or planned elimination, our procedures have been worked out over a period of years from the experience of handling a comparatively large number of fixed and mobile stations. Thus they are not based on the arbitrary opinions of any one individual.

## ASSIGNMENTS IN THE 72- TO 76-MC. BAND

As of July 19, 1946

FOR. & CONS.—URBAN TRANSIT	FOR. & CONS.—URBAN TRANSIT	73.94
72.02	72.62	73.98
SPECIAL EMERGENCY—PROV. <sup>1</sup>	SPECIAL EMERGENCY—PROV. <sup>1</sup>	74.02
72.06	72.66	74.06
72.10	FIRE	74.10
FOR. & CONS.—URBAN TRANSIT	72.70	74.14
72.14	72.74	74.18
PROV. & EXPERIMENTAL	72.78	74.22
72.18	72.82	74.26
72.22	72.86	74.30
FOR. & CONS.—URBAN TRANSIT	72.90	74.34
72.26	72.94	74.38
SPECIAL EMERGENCY—PROV. <sup>1</sup>	72.98	74.42
72.30	73.02	74.46
72.34	73.06	74.50
FOR. & CONS.—URBAN TRANSIT	73.10	74.54
72.38	73.14	74.58
SPECIAL EMERGENCY—PROV. <sup>1</sup>	POLICE	POWER—PETROLEUM <sup>2</sup>
72.42	73.18	75.42
72.46	73.22	75.46
FOR. & CONS.—URBAN TRANSIT	73.26	75.50
72.50	73.30	SPECIAL EMERGENCY—PROV. <sup>1</sup>
SPECIAL EMERGENCY—PROV. <sup>1</sup>	73.34	75.54
72.54	73.38	POWER—PETROLEUM <sup>2</sup>
72.58	73.42	75.58
<sup>1</sup> Includes Highway Maintenance.	73.46	75.62
<sup>2</sup> Including other classes of stations requiring similar radio service.	73.50	75.66
	73.54	FOR. & CONS.
	73.58	75.70
	73.62	75.74
	73.66	75.78
	73.70	75.82
	73.74	75.86
	73.78	75.90
	73.82	75.94
	73.86	75.98
	73.90	



# Chapter 11

## Alignment of FM Receivers

Visual Method for Aligning Home Broadcast Sets, as Well as Communications Receivers

**T**HE most useful tool for the adjustment and alignment of tuned coupling circuits is without doubt the visual alignment FM signal generator, in which the frequency response curve of the circuit under observation is presented on an oscilloscope screen. Changes in circuit adjustments can be evaluated quantitatively in a matter of seconds, whereas the old techniques of tuning for maximum audio output, in the case of receiver alignment, or tuning for maximum VTVM readings in some part of the circuit invariably lead to wholly improper alignment of the IF and discriminator circuits found in any FM receiver.

A visual alignment FM signal generator, designed for aligning both FM broadcast and communications receivers, has been developed by Harvey Radio Laboratories. This instrument is shown in Figs. 1 and 2, with a block diagram of the instrument in Fig. 3.

Several experiments have been conducted to determine the ability of first-class radio laboratory technicians to line up properly a number of FM receivers in various states of misalignment. Two of the receivers, of different manufacture, had IF circuits with band-widths at about 5 mc. In no instance was it possible to get proper alignment of these receivers by the meter and signal genera-

tor method. The errors were always characterized by such symptoms as improper band-width, unsymmetrical side-band response, insufficient adjacent-channel se-

lectivity, and reduced gain. Likewise, it was shown to be virtually impossible to get the same gain through both wide- and narrow-band responses. With the visual alignment FM signal generator, however, perfect response was obtained in from 2 to 10 minutes, depending on the nature and amount of the original mistuning. This is to be compared to 4 to 8 hours consumed by the far less accurate meter methods.

On another receiver, used for communications and equipped with a double superheterodyne circuit and triple-tuned IF stages, the results were similar, although the alignment problem was less complicated. Experienced technicians found it necessary to spend two hours trying to get perfect alignment, and they still fell far short of the results obtained from visual alignment made in 2 to 5 minutes.

In the case of a unit with only two IF stages of the slightly over-critically coupled type, the alignment problem seemed elementary, yet visual alignment cut the time by a factor of more than ten to one, as well as improving the band-pass characteristics of the system.

The conclusion to be drawn, therefore, is that alignment of FM receivers, and particularly their discriminators, can be accomplished satisfactorily only by a visual alignment technique which presents a

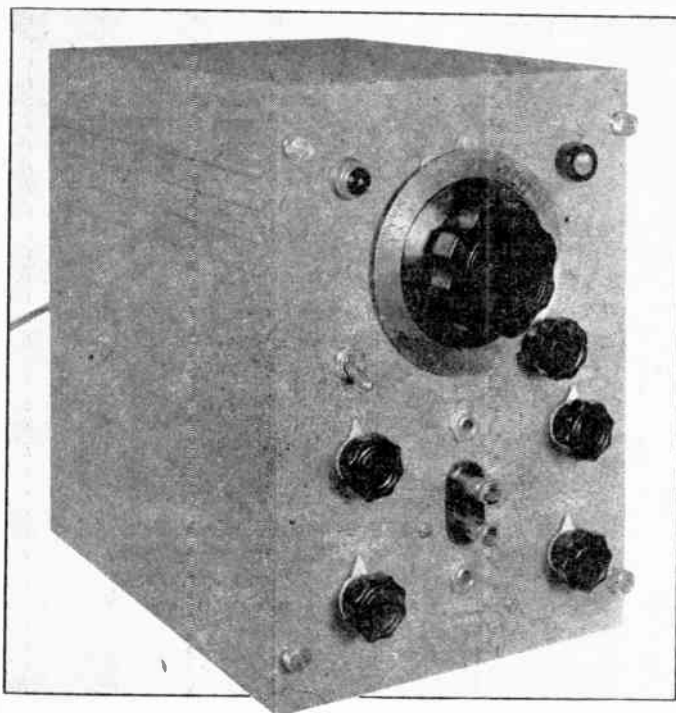

RIGHT: FIG. 1. THIS SIGNAL GENERATOR IS DESIGNED FOR FM ALIGNMENT

FIG. 2. COMPONENTS ARE ASSEMBLED ON A VERTICALLY-MOUNTED CHASSIS

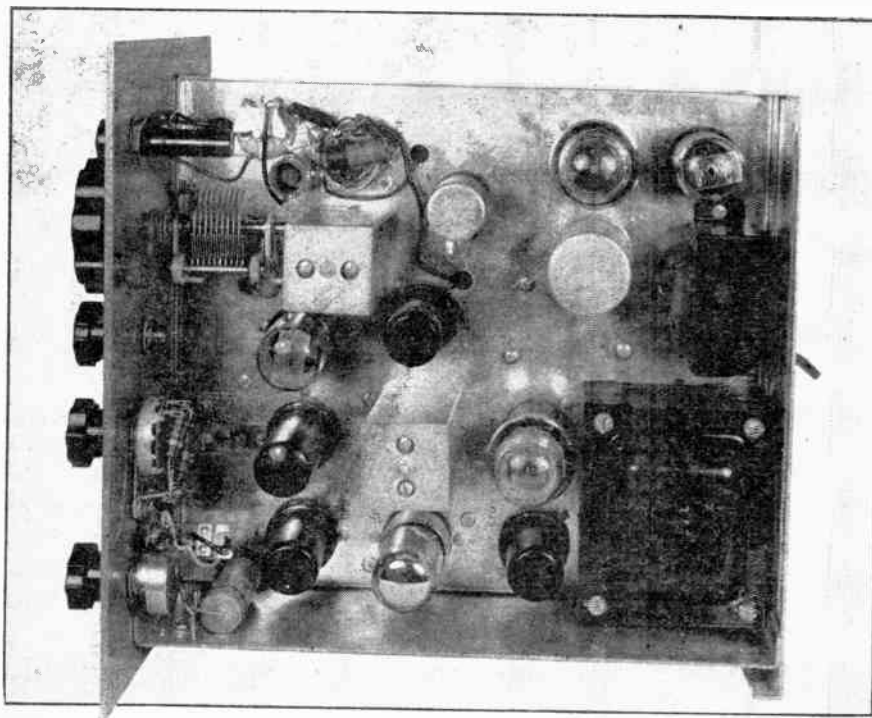

linear plot of the transmission characteristics of the circuits under observation on a cathode ray tube screen. This also implies that economical and accurate servicing of FM receivers can only be carried out through the practice of visual alignment. In the case of home receivers when one considers that FM broadcasting can supplant AM only when the general public can appreciate what advantage FM offers, it becomes significant that some of these advantages depend upon maintenance of proper circuit alignment. Because different methods are required for the new sets, many servicemen do not realize that FM circuits can be handled as simply and as quickly as AM. With the proper equipment, an FM set can be aligned perfectly, and at an absolute minimum expenditure of time and effort.

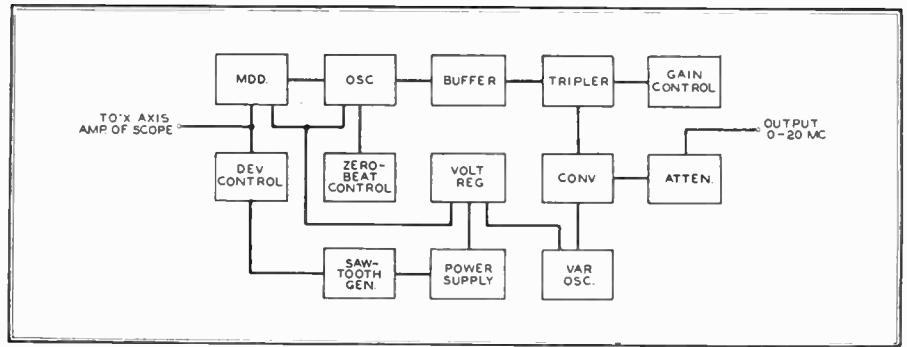

ABOVE: FIG. 3. BLOCK DIAGRAM OF THE VISUAL ALIGNMENT FM GENERATOR

put of the circuit being aligned, receives a signal only at such times as the instantaneous carrier frequency passes through the pass-band of the circuit. At all other times, the VTVM output is zero, or very

When the carrier is frequency modulated by a saw-tooth wave, the instantaneous carrier frequency is obviously varying at a constant rate from one frequency limit to another, and then flying back to repeat. The DC output of the VTVM thus varies in time exactly according to the transmission curve of the circuit, and is reproduced identically for every sweep of the saw-tooth modulation. If the same saw-tooth voltage which is sweeping the carrier frequency through the circuit under observation is also connected to the X-axis plates of an oscilloscope through the X-axis amplifier, then, obviously, the position of the spot on the screen is varying in the same linear fashion as the carrier frequency is being swept through the receiver circuit.

When the pulsating DC output of the VTVM is placed on the X-axis plates of the oscilloscope, the wave shape of the pulsating DC is shown directly, and since this is directly proportional to the transmission characteristic of the circuit, the circuit response curve is automatically traced out.

The signal generator is operated essentially as a beat frequency oscillator. A 21-mc. saw-tooth FM signal beats with a variable frequency, 21- to 41-mc. unmodulated oscillator to produce a fundamental output frequency range of 0 to 20 mc., with a controllable frequency swing up to 900 kc., peak-to-peak.

Several features have been incorporated

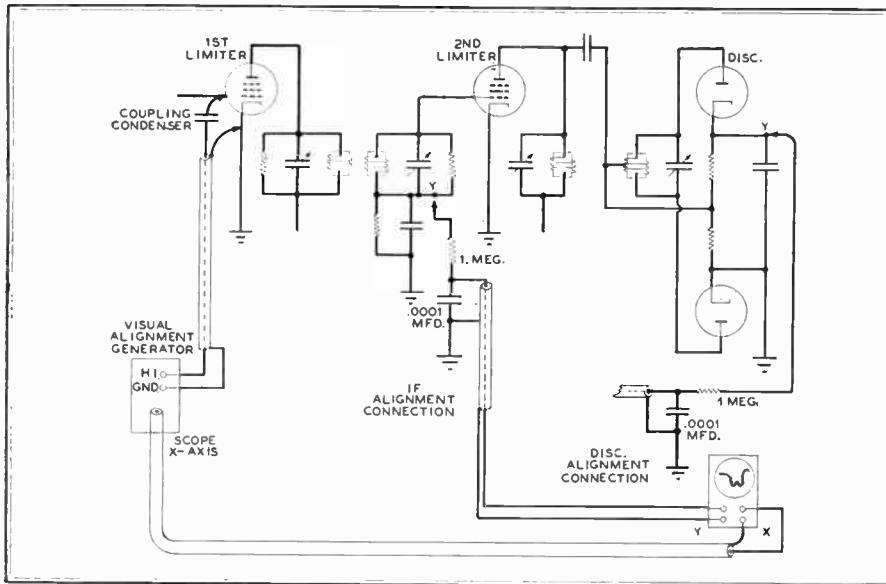

FIG. 4. ARRANGEMENT FOR TYPICAL IF AND DISCRIMINATOR CIRCUIT ALIGNMENT

The visual alignment FM signal generator has been devised to accommodate the needs not only of servicemen but of radio laboratories and factory production. It is stable, easily adjusted and operated, and widely applicable as a source of linearly-swept FM signals. Frequency "wobblers" to date have been characterized mainly by inflexibility and, in some devices, by extreme unreliability and inaccuracy. The function of the visual alignment FM signal generator is to produce frequency-modulated carrier signals for injection into any point in the IF or RF section of a set to be aligned.

This instrument is calibrated from 0 to 20 mc. By using harmonics of this range, it covers both communications and broadcast receivers. The deviations or excursions in the frequency modulation are sufficient to cover 3 to 5 times the bandwidth of receiver circuits. This means that as the carrier frequency is being modulated, the instantaneous frequency is sweeping completely through the entire pass-band of the receiver circuits. A vacuum tube voltmeter, placed on the out-

nearly so. If the VTVM output is rectified, the amount of DC voltage developed varies in time exactly proportional to the amount of instantaneous carrier frequency being transmitted through the receiver circuits.

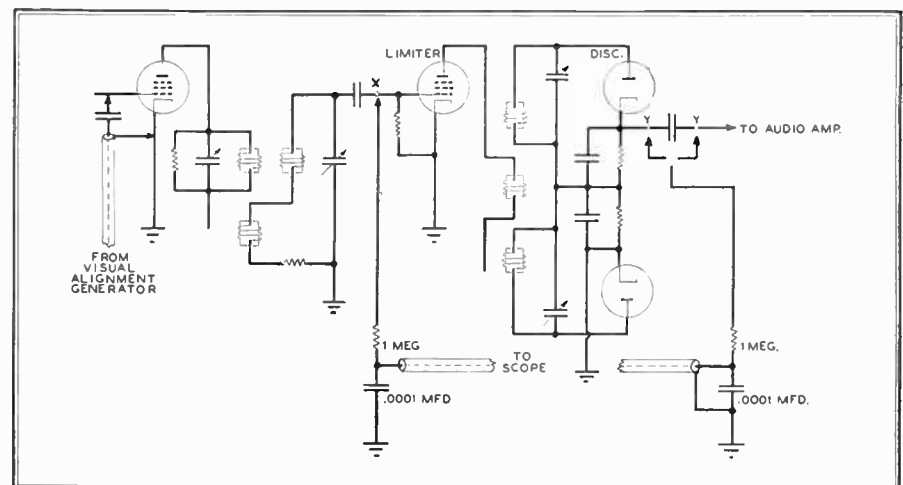

FIG. 5. TEST SETUP FOR OVER-COUPLED IF AND DISCRIMINATOR CIRCUIT ALIGNMENT

which make for extreme stability and reliability. They make the unit a little more complex than at first seems necessary. For example, the dial calibration indicates a zero frequency which is for zero beat between the two 21-mc. oscillators have proved responsible for a large measure of stability.

Two output gain controls are provided, one acting to change the conductance of the tripler stage, and the other acting to change the load resistance of the BFO out-

should start with the limiters, working back to the antenna. VTVM signals for the scope can be obtained by a number of methods, but the simplest is that of utilizing rectified grid current in the limiter circuits to align the IF stages. Once the IF system is aligned, the discriminator can be adjusted merely by taking signals off the audio output connection of the discriminator rectifier, without shifting the RF output connection of the signal generator in the set. Examples of typical connections for visual alignment are shown in Figs. 4, 5, and 6.

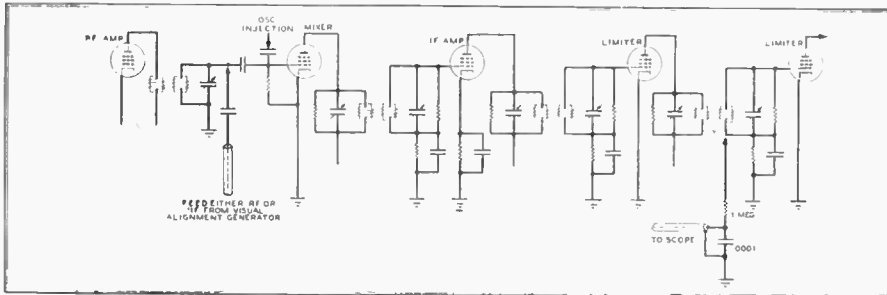

FIG. 6. CIRCUITS PRECEDING LIMITER SHOULD BE ALIGNED BACK TO ANTENNA

put circuit. This output circuit must obviously be resistance coupled in order to pass all frequencies from zero beat to harmonic output frequencies as high as 120 mc. The signal level of the harmonic RF output falls off rather rapidly, but still provides more than enough level to align RF sections up to 120 mc.

lators. This means that sufficient buffering is needed to prevent pulling and locking-in at some super-audible frequency, inasmuch as the unit was meant to be calibrated by merely plugging a pair of phones into the beat detector output and adjusting the fixed-frequency oscillator to zero audio beat. Locking-in occurs between 300 and 2,000 cycles audio beat, but this error is insignificant because the primary frequency range of the instrument is between 500 kc. and 20 mc. Buffering is accomplished primarily, as Fig. 3 shows, by incorporating a tripler stage after a 7-mc. reactance-modulated fixed oscillator. Saw-tooth voltage is generated by an 884 sweep tube, and is fed to the reactance tube through a cathode follower stage.

Drift is virtually eliminated by using a voltage-regulated supply to both oscillators and to the reactance tube. The similar thermal characteristics of the two

Fig. 4 shows typical connections for IF and discriminator alignment. Connections for aligning other types of over-coupled IF and discriminator systems are indicated in Fig. 5. Stages preceding the limiter should be tackled stage by stage, back to the antenna post, as shown in Fig. 6.

Five examples of results, as they appear in the cathode-ray tube, are given in Fig. 7. Perfect alignment of an IF system is shown at A. Trace B resulted from bad alignment. Complete misalignment of cas-

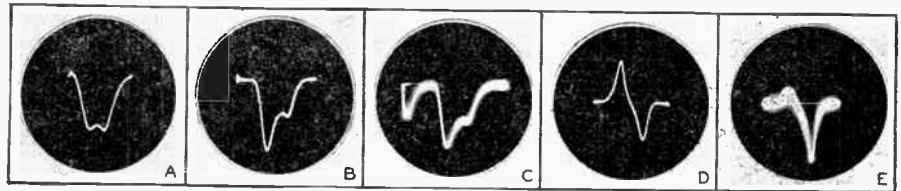

FIG. 7. TYPICAL EXAMPLES OF TRACES RESULTING FROM GOOD AND BAD ALIGNMENT

Use of the instrument is simple, as indicated by Figs. 4, 5, and 6. The RF output of the signal generator is capacity-coupled to the grid of the tube whose plate coupling circuit is to be aligned. Alignment

aded IF stages is indicated at C, with one stage badly aligned as at B. A correctly aligned discriminator produced trace D. Improper tuning of the discriminator resulted in trace E.



# Chapter 12

## WWV Signals for Checking Frequency

How to Make Frequency Measurements and Check Meters with the WWV Calibrator

**A**S THE USE of the radiospectrum moves to higher and higher frequencies, the degree of accuracy required of frequency measurements approaches that of primary standards. For example an error of .01% at 500 kc. amounts to only 50 cycles, or a small fraction of the 10,000-cycle broadcast channel. However, an error of .01% at 152 mc. is 15,000 cycles, or 50% of the total frequency swing of FM communications transmitters. Actually, FCC regulations require that transmitters in the band from 152 to 162 mc. must be maintained within .005% of their assigned frequencies.

In addition to setting transmitters within such close limits, accurate frequency measurements are essential to the study of frequency drift in FM broadcast and communications transmitters and receivers. There are also various uses for precision-calibrated oscillators at audio frequencies.

Since all secondary frequency standards are subject to drift beyond the limits imposed by laboratory needs and FCC requirements, both manufacturers and operators of radio equipment are confronted with the necessity of acquiring primary frequency standards or else a simple means of checking secondary standards against the standard frequencies transmitted from station WWV. The cost of the former runs into thousands of dollars, while the latter is quite inexpensive, while the degree of precision is about the same.

**WWV Services** ★ The National Bureau of Standards provides a 24-hour broadcast

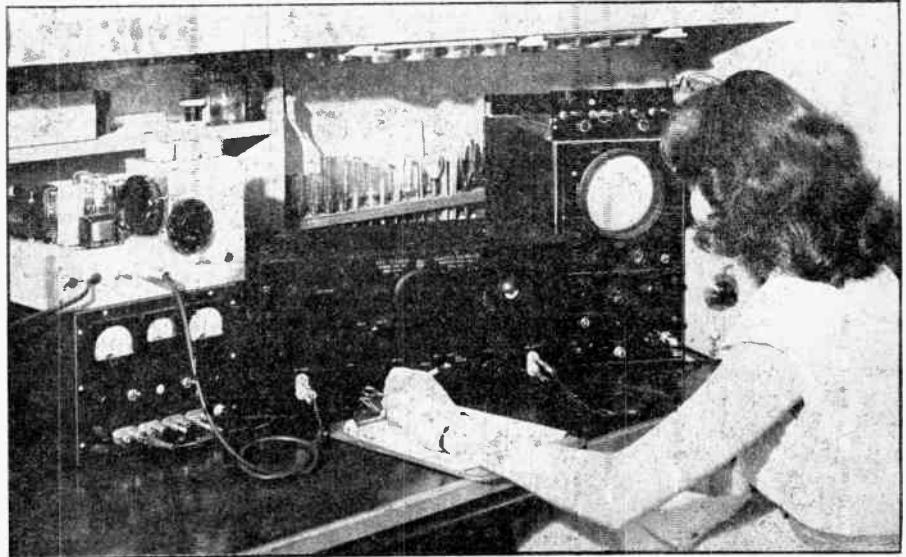

FIG. 1. THE CALIBRATOR SETUP FOR THE TEST POSITION OF A PRODUCTION LINE

service of standard frequencies from its radio station WWV at Beltsville, Md. Standard radio frequencies, standard audio frequencies, standard time intervals, standard musical pitch, and time announcements are available at all times. WWV's frequencies and time intervals are controlled by a 100-kc. standard frequency piezo crystal oscillator. The average frequency value is based upon and agrees with the average United States Naval Observatory time signals. All standards of frequency are ultimately referred to the period of rotation of the earth; this fundamental source might be referred to

as one cycle per day or one cycle per 86,400 seconds.

The accuracy of all frequencies, radio and audio, as transmitted, is better than one part in 10,000,000. Atmospheric conditions may cause slight fluctuations in frequencies as received, but of course the average frequency is as accurate as that transmitted. The time intervals marked by pulses at every second are accurate to 10 microseconds. Time intervals of 5 minutes or longer are accurate to a part in 10,000,000. Following is the complete schedule of WWV transmissions:

- 2.5 mc. — 7:00 P.M. to 9:00 A.M. EST (2400 to 1400 GWT) audio modulation 440 cps.
- 5.0 mc. — Continuous audio modulation only on hours indicated: 440 and 4000 cycles, 7:00 A.M. to 7:00 P.M.; 440 cycles, 7:00 P.M. to 7:00 A.M.
- 10.0 mc. — Continuous audio modulation, 440 and 4000 cycles.
- 15.0 mc. — Continuous audio modulation, 440 and 4000 cycles.

A .005-second pulse can be heard at every second except at the fifty-ninth second of each minute. Audio frequencies are interrupted precisely on the hour and each five minutes thereafter, resuming after an interval of precisely one minute. During

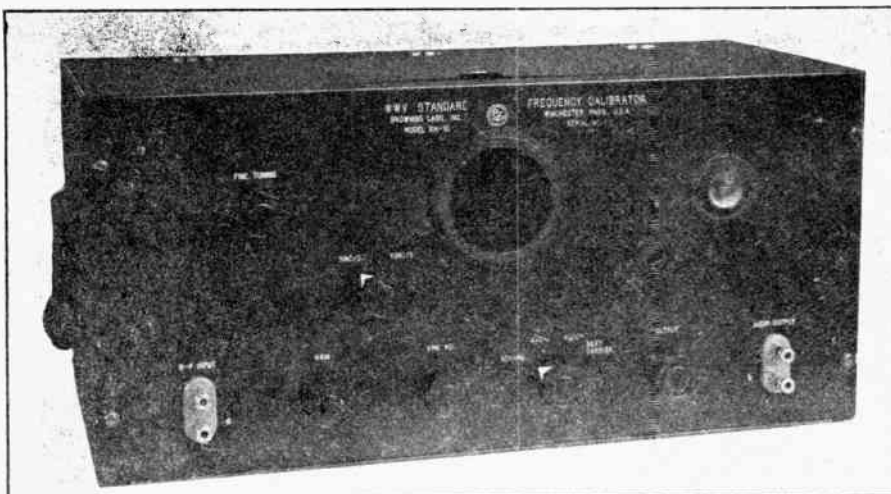

FIG. 2. RADIO CIRCUITS ARE PROVIDED FOR 2.5 AND 5 MC., 5 AND 10 MC., OR 10 AND 15 MC.

the one minute interval, Eastern Standard Time is given in telegraphic code. Voice announcements are made at the hour and half-hour.

**WWV Calibrator** ★ The Browning standard frequency calibrator has been designed to provide in a single package a receiver and associated circuits for making full use of the WWV transmissions. The Calibrator consists of a receiver with two RF inputs, audio filters of 440 and 4,000 cycles, a low pass filter with a cutoff frequency at 400 cycles, and a cathode-ray tuning indicator at the output.

Fig. 1 shows a typical setup for this instrument at the test position of a factory production line, while Figs. 2 and 3 show the construction in detail. Circuit elements are diagrammed in Fig. 4. Three different models are available, with circuits pretuned to WWV frequencies of 2.5 and 5 mc., 5 and 10 mc., or 10 and 15 mc.

The instrument is completely self-contained. Frequencies as low as 100 kc. can be inserted directly into the RF input

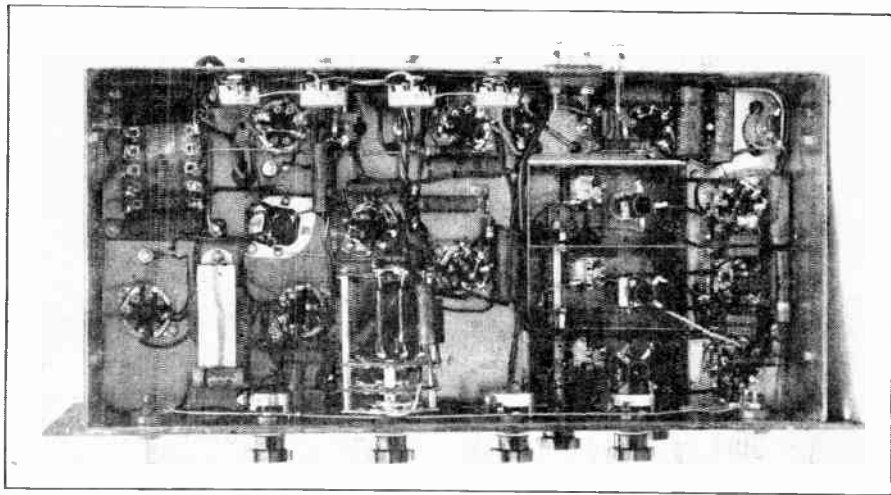

FIG. 3. INTERIOR VIEW OF THE CALIBRATOR, SHOWING UNDER SIDE OF THE CHASSIS

of precision. The method of measurement consists of obtaining a beat note between a harmonic of the signal under test and one of WWV's frequencies. A typical block diagram of the setup is shown in Fig. 5. The dotted lines indicate the

calibrated oscillator is at the same frequency of the beat note. The accuracy of measurement depends very much on the accuracy of the calibrated oscillator and the frequency of the beat note. Standard oscillators are usually made to operate on submultiple frequencies of WWV, for example, 10, 50, 100, 500 kc., etc. These are seldom off in frequency more than 10 or 20 parts per 10,000,000. Beat notes of this range can be determined very accurately by a beat counter, an audio-frequency meter, a frequency bridge, or a calibrated oscillator.

**Use of WWV Audio Frequencies** ★ By utilizing the modulation frequencies of WWV, one can compare or measure audio frequencies which are in fractional harmonic, subharmonic, or harmonic relation. This can be better expressed by the equation:

$$f = \frac{K_1}{K_2} 440 \text{ or } f = \frac{K_1}{K_2} 4000, \text{ where } K_1 \text{ and } K_2 \text{ are integers.}$$

It will be noticed from Fig. 6 that this scheme requires a band pass filter to eliminate the unwanted modulation frequencies. Filtering arrangements consisting of a degenerative type of selective amplifier has proved very satisfactory.

By observing the Lissajou figures<sup>1</sup> produced on the screen, the frequency relations can be determined immediately. A few examples are found in Fig. 7.

<sup>1</sup>The study of Lissajou's figures can be found in "Radio Engineers' Handbook" by F. E. Terman, and other texts.

(CONCLUDED ON PAGE 27)

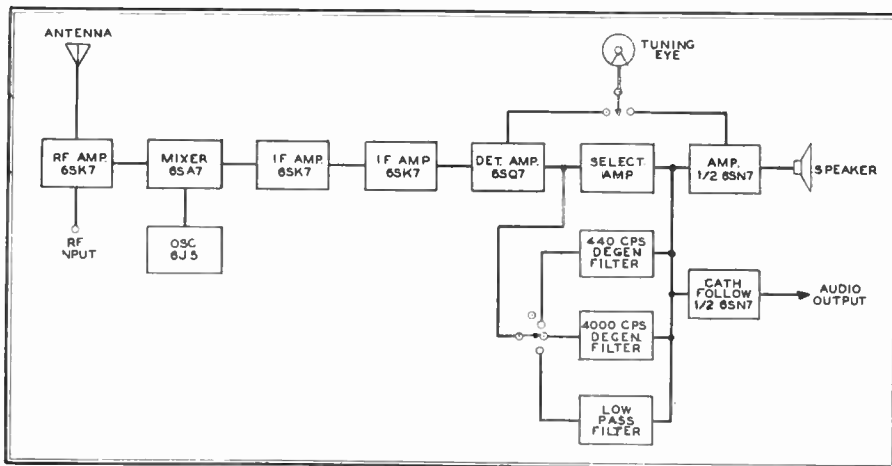

FIG. 4. BLOCK DIAGRAM OF THE CIRCUITS WHICH ARE INCLUDED IN THE INSTRUMENT

without the use of a harmonic generator if the amplitude is 100 microvolts or more. For audio and time interval measurements, the use of an audio oscillator and oscilloscope is necessary.

**Use of WWV Carrier** ★ Signals which are submultiple harmonics of any of WWV's carriers can be measured to a high degree

Browning Calibrator, with the 400-cycle filter cut in.

If the purpose is to set the local signal source to a subharmonic frequency of one of WWV's carrier frequencies, it is only necessary to adjust the local signal for zero beat frequency on the oscilloscope or for no flutter of the eye of the cathode ray tuning indicator. The use of a harmonic generator, Fig. 5, is optional, but the ratio of  $F_w/F_x$  is large and sufficient harmonic amplitude is not generated in the RF amplifier grid. High orders of harmonics can be obtained easily by saturating the grid of a sharp cutoff pentode. Spurious beats caused by modulation frequencies are eliminated by use of the low pass filter in the Calibrator.

In measuring a particular frequency whose harmonics are within 10 kc. of one of WWV's carrier frequencies, the addition of a calibrated audio oscillator is necessary. The calibrated oscillator should be connected to the horizontal plates of the oscilloscope shown in Fig. 5. A Lissajous pattern of an ellipse is seen when the

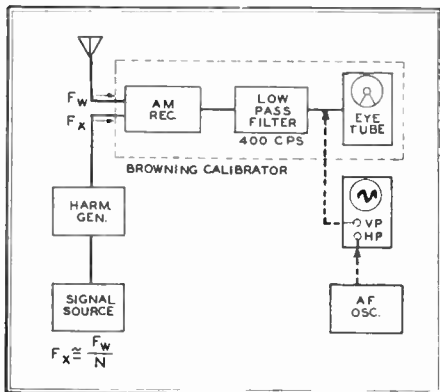

FIG. 5. SETUP FOR RF MEASUREMENTS

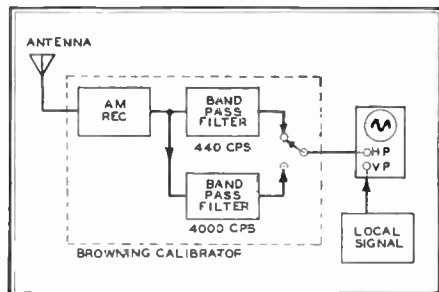

FIG. 6. SETUP FOR AF MEASUREMENTS

When the resulting pattern remains stationary, the ratio relations are exact. If the pattern drifts slowly, the ratio relation is not exact, but slightly higher or lower. By measuring the time required for a particular point on the pattern to travel one complete cycle along the horizontal axis, the exact ratio can be determined. The test frequency is as follows:

$$f = R \left[ F_m \pm \frac{F_m}{t F_m \mp 1} \right] \approx R \left[ F_m \pm \frac{1}{t} \right]$$

Approximately  
 $f$  = test audio frequency

where  $F_m$  = WWV's modulation frequency  
 $t$  = time in seconds for a particular point to complete one cycle along the horizontal axis.

$R$  = Ratio relation

To determine whether the local signal frequency is higher or lower than WWV's modulation frequency, the test frequency or its phase can be shifted slightly to note the direction of drift. A typical phase shift network is shown in Fig. 8. When  $R$  is increased, the direction of travel taken by the pattern on the cathode-ray tube will be that of a local signal frequency higher than WWV's modulation frequency.

**Time Interval Measurements** ★ The accuracy of the time interval marked by a pulse every second as transmitted by WWV is better than 10 microseconds. For intervals of 1, 4, or 5 minutes the accuracy is better than one part in 10,000,000. With appropriate chronograph or oscillographic recording equipment, the second pulses can be used to measure short or long time intervals. Second pulses can also be used to control a frequency source; whether it be an electrical oscillating system or a mechanical vibration system.

Measurements of low frequencies, from 1 to 200 cycles, can be made accurately by using the second pulses. For example, assume that a test frequency of approximately 100 cycles is applied to the horizontal plates of an oscilloscope and the

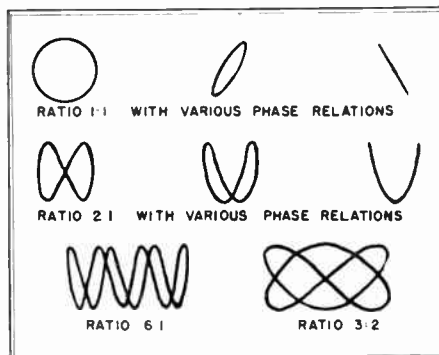

FIG. 7. TYPICAL LISSAJOUS FIGURES

WWV second pulse is applied to the vertical plates. If the pulse travels along the screen and returns to its original position after three hours, or 1,080,000 cycles later, the frequency is shown to be

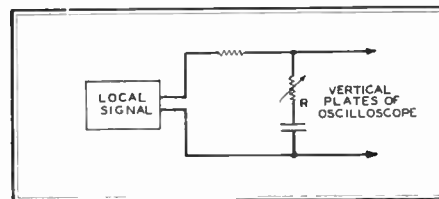

FIG. 8. SIMPLE PHASE SHIFT NETWORK

accurate to approximately 1 part in 1,000,000.

In the foregoing operation, it is always desirable to filter out the 400- and 4,000-cycle modulation frequencies by employing a low pass filter in the audio output of the receiver. The cutoff frequency should

be 400 cycles or less. Such a filter is provided in the Browning Calibrator.

**Standard Musical Pitch** ★ The modulation frequency of 440 cycles corresponds to pitch A above middle C (or A4) in the Equal Tempered Chromatic Scale as adopted by the American Standards Association in 1936.

To utilize the pitch A4 to its fullest extent, it would be advisable to filter out the second pulses, 4,000-cycle modulation frequency, and noise by employing the selective amplifier at 440 cps.

**Specifications** ★ Following is a summary of the specifications of the Calibrator:

All circuits, including the power supply, that are necessary for making WWV frequency measurements are provided.

Power Supply: 100 to 125 volts, single phase, 50/60 cycles.

Power Consumption: Approximately 85 volt-amperes.

RF Input Signal: Pretuned for 2.5 and 5 mc., or 5 and 10 mc., or 10 and 15 mc., with a sensitivity better than .5 micro-volt. Panel provision is made for test frequency input.

Selectivity: 10 db down at 5 kc. off resonance. Image rejection ratio and IF rejection ratio at least 50 db.

Cathode Ray Tuning Indicator: Audio indicator permits comparison between RF source and WWV transmission using zero beat method.

Audio Filters: Filter system allows selection of sharp band pass filter at 440 or 4,000 cycles, or low-pass filter with cutoff frequency at 400 cycles.

Dimensions: 9 ins. wide, 11 ins. deep, weight about 30 lbs.

The unit is supplied for rack mounting or in separate steel cabinet.



# Chapter 13

## Pioneer 2-Way Railroad Radio Installations

Notes on FM Installations at Miami and Jacksonville, and on the Rock Island and Reading Railroads



FIG. 1. A. C. NYGREN, COMCO ENGINEER RANSBURG, AND TRAINMASTER NORWOOD AT THE MIAMI TERMINAL, LISTENING TO SWITCHING CREW



FIG. 2. AT THE 29TH STREET YARDMASTER'S OFFICE RADIO AT THE PUMP HOUSE WAS REMOTE-CONTROLLED

EVER since 2-way FM equipment was made available to the railroads, more and more lines have been running tests to determine how, and to what extent, they can make use of this means of communication. It's beginning to look as if railroad officials have been criticized unfairly for their apparent lack of enthusiasm about making use of radio. At least the records show that, prior to the war, a number of roads carried on extensive tests with AM equipment, but the equipment simply failed to perform. So, if officials were too busy with war transportation problems to get very excited about new promises of FM performance, it's not surprising, particularly since the new equipment was not available until the last few months.

**Railroad Radio Tests ★**  
Now, as man-power is becoming available, the work of fitting together FM capabilities and railroad requirements is

progressing rapidly, and some installations are already going into regular service. One road after another has inaugurated FM tests between engines and cabooses, and between engines and wayside points. The author has personally visited some of the typical projects in order to present a review of the results obtained. Although these reports do not cover all the work done by the different roads and cooperating radio manufacturers, they do indicate

the general progress of railroad radio work in 1945.

**Miami Terminal ★** At the invitation of officials of the Florida East Coast Railway, I arrived at Miami on October 16th to observe the 160-mc. tests of FM equipment manufactured by Communications Company, Inc.,<sup>1</sup> of Coral Gables, for the Miami terminal. I was particularly anxious to attend as I had been unable to observe the tests at Jacksonville in September.

At Miami, equipment had been installed at the main station, Fig. 1; at the 29th street yardmaster's office, Fig. 2; and on one switching locomotive, Fig. 3. All the equipment was identical with that used earlier at Jacksonville.

Mr. Ransburg, of Communications Company, drove me

FIG. 3. RADIO ON LOCOMOTIVE 272 WAS INSTALLED DIRECTLY BELOW ANTENNA



<sup>1</sup>See "152-to-156 mc. Mobile Unit" by G. A. Leap, *FM AND TELEVISION*, May, 1945, for detailed description of this equipment.

to the main station for our first check. There, Mr. Norwood, Miami trainmaster of the F.E.C., showed us a map of the terminal area and outlined their communication problems. He explained: "As you probably know a yard engine conductor is given specific work at the beginning of his shift. During this period, it is only natural that numerous changes must be made to his original orders. Under our present system, it is necessary to have the conductor phone in at regular intervals to receive any changes, or have the yardmaster attempt to contact the conductor by telephone or messenger at some point in the yard. With two-way radio, we find that changes in orders can be made immediately and directly to the conductor without loss of time."

The trainmaster then picked up the radio handset and made a short call to engine 272, Figs. 3 and 5. The engineer on 272 promptly answered and asked for instructions. When he was asked his location, the engineer replied that he was switching in the vicinity of 27th street. Mr. Norwood then called the 29th street yardmaster's office, Fig. 2, asked for a



FIG. 4. TRAINMASTER NORWOOD SAT AT HIS DESK AND GAVE ORDERS TO LOCOMOTIVE 272 WITHOUT HAVING TO RAISE HIS VOICE OR LEAVE HIS CHAIR

FIG. 5. THE ENGINEER ON NO. 272 CAN GET HIS ORDERS WITHOUT TAKING HIS EYES OFF THE TRACK AHEAD



signal check on both transmitters, and received a "loud and clear" reply. The switching engine was then ordered to shuttle through the entire terminal area and for the next hour we were kept informed of its movements. Three-way com-

munication remained perfect throughout. even though, at times, we were told that the engine was alongside buildings, water towers and other trains. Mr. Norwood commented that with such satisfactory radio communication, terminal operations would be greatly simplified and speeded up.

What impressed me greatly was the simplicity of the installation, the lack of any elaborate antennas, and the excellent communication available throughout the terminal area. The transmitter and receiver in the locomotive had been installed above the engineer's head in the cab, as shown in Fig. 3. The fixed installations used similar, non-directional antennas, although the layout of the terminal would justify the use of directional arrays. I asked the radio engineer in charge of the installation what difficulties he had encountered. The answer was: "None! We had everything in operation the same day we began the work, and we have not found it necessary to make changes."

The following day, I had occasion to recall this remark. On very short notice, due to a change in engine and crew schedules, he was asked to remove the equipment from No. 272 and install it in No. 714. This required only a few hours.

Communications Company engineers had provided a loudspeaker at each location in addition to the handset receiver. Even with the unusually high ambient noise encountered in a locomotive, there never seemed to be any difficulty understanding a transmission. An additional handset and loudspeaker were installed at the rear of the tender for remote control of the equipment, and to allow operation without the necessity of climbing into the cab. This is shown in Fig. 6.

During all the tests, Communications Company had a receiver and 50-watt transmitter on the air at their Coral Gables plant, approximately 11 miles south of Miami. They answered all test calls from the Miami transmitters promptly, and without asking to have any messages repeated. To convince myself that the coverage was really solid, I took a turn at the microphone of each transmitter. After several hours, I began to feel as though I were operating an inter-office communication system, and not a 4-way radio system.

Officials of the Florida East Coast Railroad who had the opportunity of witnessing tests included C. V. Jelluson, supervisor of telephone and telegraph; W. A. Hoffman, superintendent of signals and telegraphs; J. W. Eddy, general foreman at the Jacksonville terminal; R. T. Jeffries, assistant general passenger agent; F. P. Oldfather, assistant general freight agent; and W. L. Zimpelmann, district superintendent for the Pullman Co.

Although the test requirements were for terminal coverage only, Communications Company installed an additional 15-watt transmitter and receiver at Homestead, Florida, approximately 32 miles distant, to check the maximum range. I had noticed that the antenna at the main station in Miami was fairly low, having been installed temporarily on the roof of the two-story main building. I was in-



formed that a similar antenna installation had been made on their Homestead station. With the engineer carrying out his normal switching orders between Miami and Homestead, the signals received in Miami and on the locomotive were excellent up to a distance of about 12 miles. Beyond this point it was usually necessary to cut out the squelch circuit to assure communication. Conversation with Homestead from the locomotive was also excellent up to 12 miles, with sufficient signal to operate the squelch up to this distance.

Thus communication was complete between the locomotive and Homestead except for a stretch of about 6 miles. This distance could have been covered, too.

**Rock Island Tests** ★ The Rock Island Lines are conducting very exhaustive tests on radio communications, under the direction of their electronics engineer, E. A. Dahl. At this time of writing, tests are still under way, so that no conclusions can be presented here.

However, through Mr. Dahl's cooperation, we have a report on the performance of 160-mc. Communications Company equipment for front-to-rear service on long freight trains. The tests were made on a run between Chicago and Silvis, Illinois, near Rock Island, on the night of July 10, and between Silvis and Council Bluffs, near Omaha, on the night of the 12th. The train between Chicago and Silvis carried 85 cars, and between Silvis and Council Bluffs, 98 cars. The tests were conducted between a caboose behind the engine, and the Rock Island Laboratory test car<sup>2</sup> which was adjacent to the caboose at the end of the train.

The transmitter output was approximately 10 watts. The receiver had a sensitivity of less than 1 microvolt at which point the audio output was in the neighborhood of 25dB (1 milliwatt base) and a signal to noise ratio of around 2 or 3. FM equipment was also used to talk from the laboratory car to the caboose up front, but no measurements were taken on transmission in that direction.

Mr. R. A. Clark, Jr., of Communications Equipment and Engineering Company, C. O. Ellis, Superintendent of Communications for the

<sup>2</sup> For details of the laboratory test car see "FM on the Rock Island," by Norman Wunderlich, FM and Television, June, 1945.

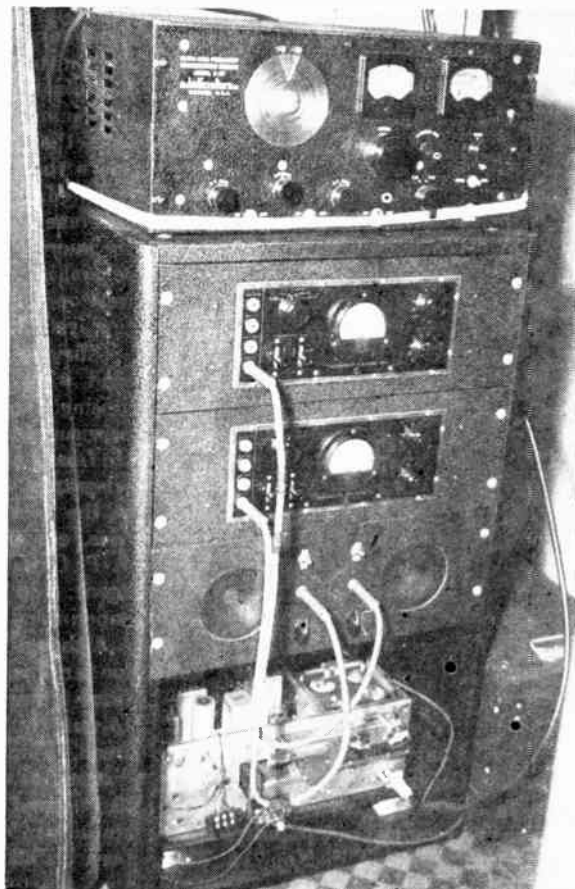

FIG. 6. A. C. NYGREN AND RUBE HOLSTROM OF THE F.E.C. TALK TO THE YARDMASTER FROM THE AUXILIARY SPEAKER AND HANDSET AT THE REAR OF NO. 272

Rock Island Lines, and E. A. Dahl, participated in these tests. The test equipment consisted of a recording milliammeter on the receiver connected to a vacuum tube voltmeter which, in turn, was connected to the DC circuit operating from the automatic volume control. A direct reading decibel meter was connected across the audio output, with a loud speaker placed across the DB meter. The loud

speaker impedance was high enough so that there was no effect on the accuracy of the DB meter. Tones were applied to the transmitter at levels well below the overloading point so that the variation in audio signal could be observed, also any noise or flutter. Figs. 7, 8 and 9 show the manner in which the equipment was installed. The 160-mc. type of antenna can be seen in Fig. 10.

FIG. 7. VISUAL AND AUDIO EQUIPMENT USED ON THE ROCK ISLAND TEST CAR FOR MEASURING RADIO RECEPTION



The run between Chicago and Omaha provided practically every type of right-of-way condition except mountainous terrain. There are numerous large cities on this route. In some of them, the tracks parallel the main streets. Other special conditions encountered were the Mississippi River Bridge and numerous small bridges and overpasses. In the vicinity of Bureau, Illinois, and between Atlantic and Council Bluffs, there are sharp curves, deep cuts, and heavy vegetation. While the train lengths were not the absolute maximum which may be encountered, they represented the average long freight trains. Heavy rain and lightning storms were encountered on the run.

Under conditions of straight right-of-way and clear ground, the signal strength was in the order of 1,000 microvolts. Under the worst conditions, the indicated average field strength dropped down to the order of 15 microvolts. Even under such conditions the signals were clear, with occasional hits or clicks. These were of very short duration, however, and did not affect the quality of the signal. Both antennas consisted of vertical quarter-waves with ground rods, shown in Fig. 10.

The variation in transmission at 160 mc. from the front to the rear of the train appeared to be in the order of 50 to 60 db. High losses occurred when the train rounded steep curves, and when there was heavy vegetation close to the right-of-way. The worst conditions were encountered in the vicinity of milepost 115,



Bureau, Illinois; milepost 185, Davenport, Iowa; milepost 237, Iowa City; milepost 445, Atlantic; and mileposts 476-95, Council Bluffs. While these represent typical bad conditions, there were also many other points where the signal strength dropped down to a 15 microvolt average.

There was no question but what FM on 160 mc. gave very satisfactory results. We did not observe a signal outage at any time, although the noise hits indicated that there was very little margin left under the worst conditions.

There is a possibility that higher frequencies will provide even better results, particularly in the mountainous areas which were not encountered in the tests described here. This would permit a reduction in antenna size so that beamed arrays could be utilized to obtain a considerable power gain. That is not practical on 160 mc. Tests are being made now in the region of 2660 mc., using Sperry FM equipment, to determine whether or not such high frequencies will prove even more satisfactory under all conditions.

**Jacksonville Terminal Installation** ★ The Jacksonville Terminal Company, Florida, is owned jointly by the Atlantic Coast Line Railway, Seaboard Airline, Southern, and the Florida East Coast Railroad. Two views of the yards are given in Figs. 12 and 13.

The Jacksonville Terminal Company operates a passenger station comprised of 25 platform tracks designed for handling passengers, mail and baggage; mail facilities of 6 tracks of 30-car capacity; a Railway Express Agency plant of 25 tracks and a 270-car capacity; coach yards of approximately 800-car capacity; and a freight interchange yard of 750-car capacity. The passenger operation of the Jacksonville Terminal is conceded to be one of the fastest switching operations of occupied passenger cars in the country, and it is believed that as many or more occupied passenger cars are switched from one line to another at this station than at any other station in the country.

In other words, it is not a terminal station for the majority of its trains but, on the contrary, the trains are mostly through connections, and must be switched from one railroad to another, or from one division of a railroad to another. The need for minimizing station margins between trains emphasizes the importance of instant communication. For over 15 years, the management of the terminal has been trying to work out a satisfactory method of meeting this need. In addition, it has been recognized that a great safety factor would be provided by a system with which the towermen could communicate directly with enginemen.

In the summer of 1945 the terminal made its first test of instant communication with improvised equipment of the AM type. While it was much better than nothing at all, it did not prove satisfactory

because of interference from static and other noise sources. Then, early in September, 1945, tests were made with FM equipment manufactured by Communications Company. Completely satisfactory service was obtained from units similar to those shown in Figs. 2 and 3.

The writer is indebted to John L. Wilkes, president and general manager of the Jacksonville Terminal Company, for the following account of the initial tests

In addition, it was felt that the system would not be complete unless radio communications from the Myrtle Avenue station, point 4, was provided by remote control so that Beaver Street Tower, point 1, could communicate with switching locomotives in its vicinity; The yardmaster in the coach yards point 2 could communicate with switch engines operating in what we call the non-interlocking territory in our coach and repair yards;

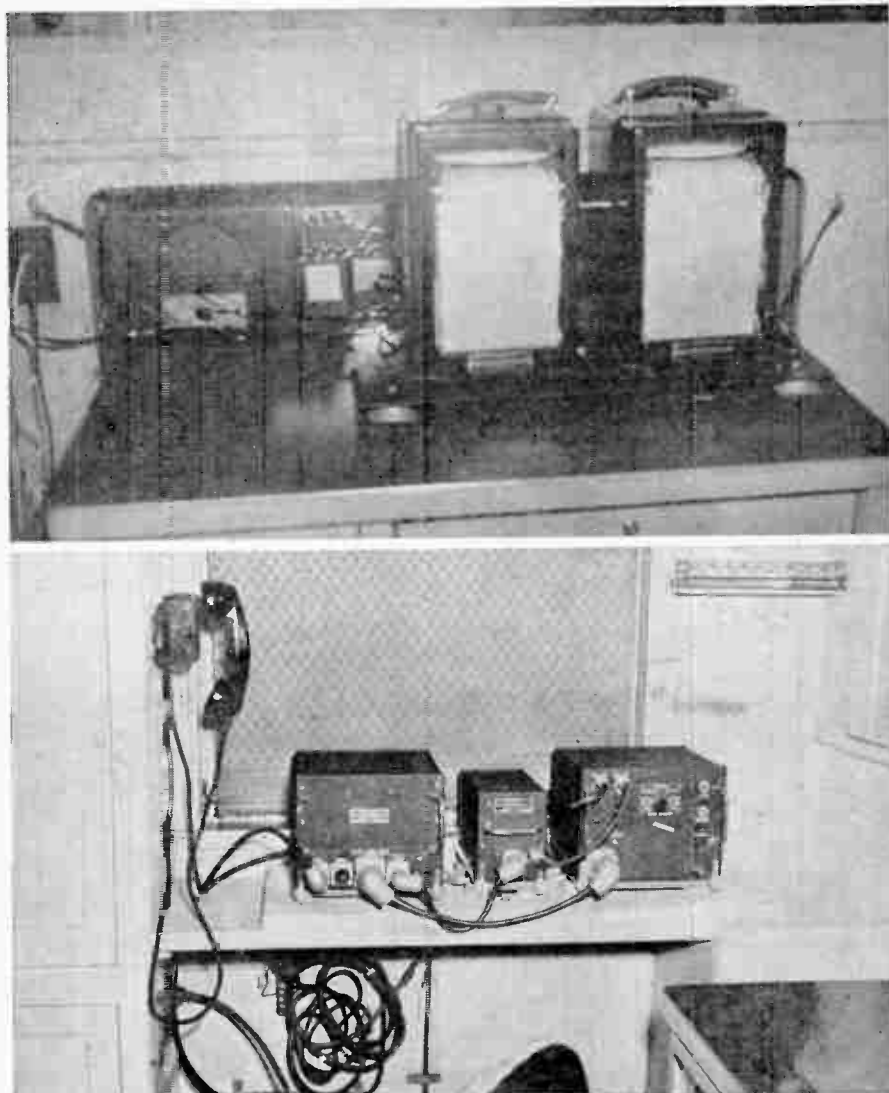

FIG. 8. ESTERLINE-ANGUS RECORDERS REGISTER RECEPTION CONTINUOUSLY. FIG. 9. COMMUNICATIONS COMPANY EQUIPMENT INSTALLED ON THE ROCK ISLAND

and subsequent plans for the permanent radio installation:

Because of the nature of the work in the Jacksonville Terminal, it was felt necessary to use one radio frequency for the east end of our terminal, point 5, Fig. 12, and a separate frequency for the west end of the terminal, point 4, Fig. 13, which controls operations completely separate and distinct from the east end. Operations are such that radio communications at both ends of the terminal are required simultaneously during peak movements and, therefore, provisions had to be made so that these points would not interfere with each other.

and the yardmaster in our Railway Express plant point 3, could communicate with engines operating in that territory, which is also non-interlocking.

To meet this situation, Communications Company designed a remote-controlled radio system between Beaver Street tower, the coach yard yardmaster, and the Railway Express plant yardmaster, which allows us to contact engines in these territories by remote control of the Myrtle Avenue radio installation without having to ask the train director in the Myrtle Avenue tower to handle the messages.

The management felt that they should

go one step further in relieving Myrtle Avenue tower and its radio transmitter of unnecessary traffic. Therefore a land-line intercommunication system between the points 1, 2, and 3 is being provided to handle traffic not requiring communication with switching locomotives. In addition to reducing traffic on the Myrtle Avenue radio transmitter, the land lines will provide faster communications between these three remote points as the regular telephone circuits are frequently busy.

As a result of the highly successful results obtained in the initial tests, we have committed ourselves to the purchase of 12 mobile radio units for switch engines, two complete dual-frequency radio units for tower equipment at Lee Street and Myrtle Avenue, and four remote-control inter-telephone equipments. It is expected that this equipment will be in operation before the end of 1945, and the management is looking forward to its operation with anticipation of greatly improved terminal communications.



FIG. 10. TWO 160-MC ANTENNAS MOUNTED ON ROCK ISLAND LABORATORY CAR

At the present time we are normally handling 110 passenger trains in and out of the terminal daily, approximately 40,000 passenger cars per month, and approximately 45,000 freight cars through its interchange per month. The Railway Express Agency is the largest plant of its kind in the Country, and throughout its peak season, beginning with November

15th, it transfers and loads out approximately 200 to 225 cars of perishable fruits per day, all moving by express trains. During the peak season 30 to 32 switching crews are working on this property, so that instant radio communications will be of the greatest value in maintaining satisfactory terminal operations.

Among the railway officials who ob-

FIG. 12. EASTERN PART OF THE TERMINAL AT JACKSONVILLE, FLA. POINT 5— LOWER LEFT CORNER — IS THE LOCATION OF ONE OF THE TWO TRANSMITTER-RECEIVER INSTALLATIONS NOW INSTALLED TO EXPEDITE MOVEMENT OF CARS

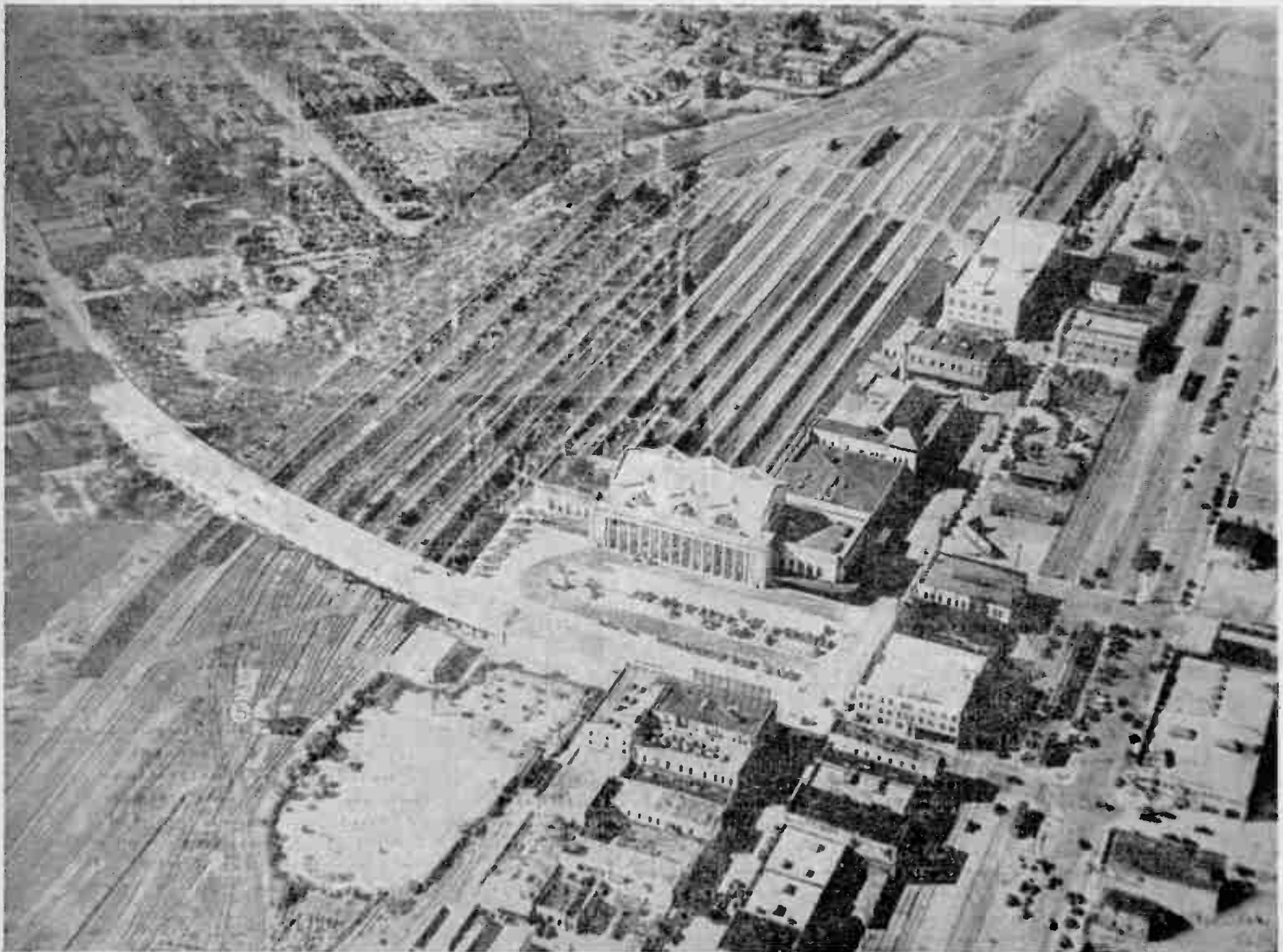



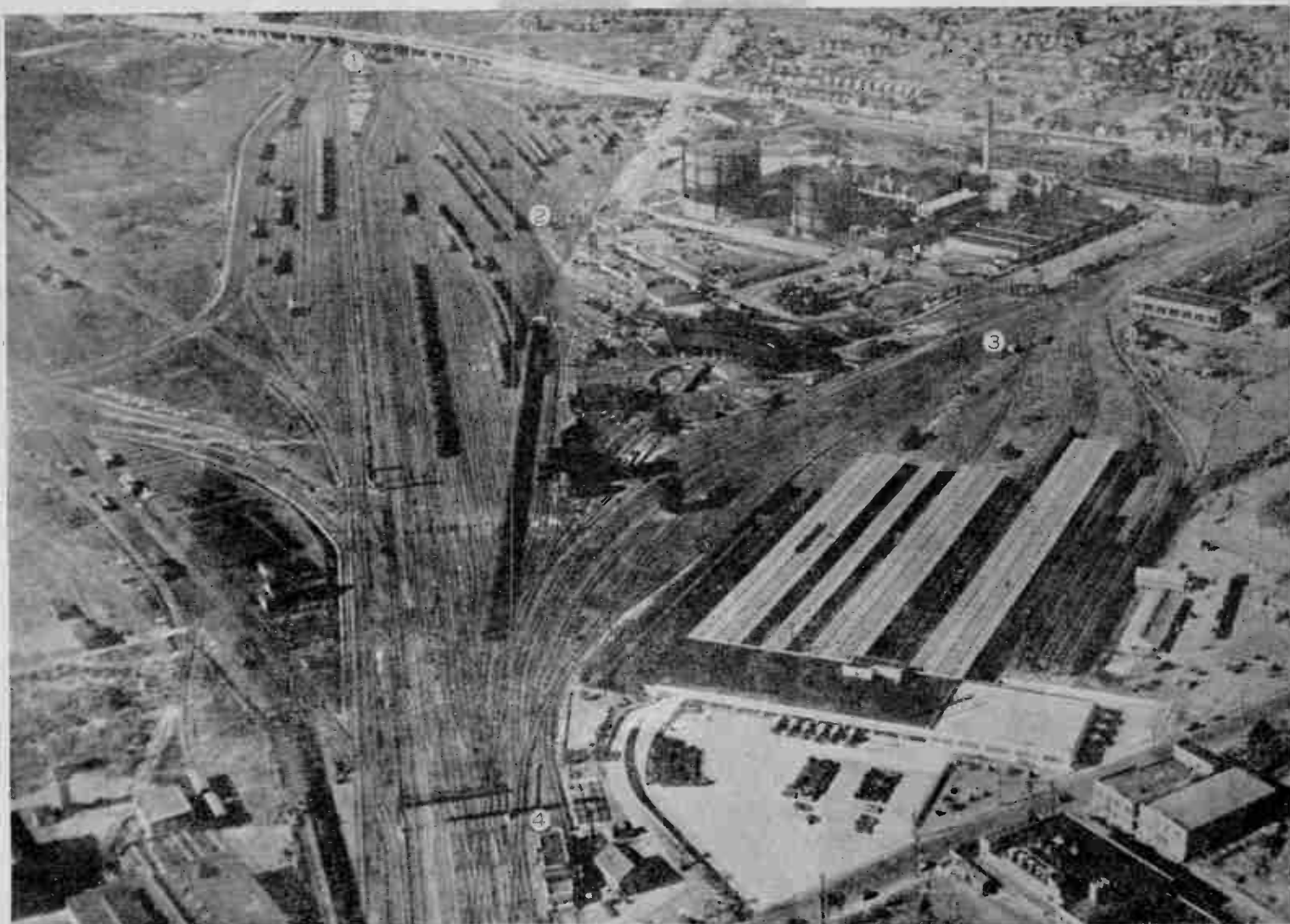

FIG. 13. WESTERN END OF THE TERMINAL. MYRTLE VENUE TRANSMITTER-RECEIVER, POINT 4, CAN BE OPERATED REMOTELY FROM BEAVER STREET TOWER, POINT 1; FROM YARDMASTER'S OFFICE, POINT 2, IN THE COACH YARD; OR FROM THE YARDMASTER'S OFFICE IN THE RAILWAY EXPRESS PLANT, POINT 3. ALL SWITCHING ENGINES ARE WITHIN RADIO RANGE OF 1 OR 2.

served the initial tests were J. P. Walker, General Superintendent, and E. B. Bush, Superintendent of Transportation of the Atlantic Coast Line Railway; S. B. Little, general foreman, Florida East Coast Railroad; T. W. Parsons, assistant general manager, Seaboard Airline Railway; and S. A. Gloff, superintendent of terminals of the Southern Railway.

**Reading Railroad Tests** ★ At Wayne Junction, Pa., the Reading Railroad is running tests in the 160-mc. band, using equipment manufactured by Maguire Industries, Inc., of Bridgeport, Conn. The work is under the direction of L. A. Moll, communications engineer for the Reading Railroad, with the assistance of Maguire engineer Nelson Wells.

E. W. Reich, superintendent of telegraphs and signals, explained that the Wayne Junction yard was selected because its maze of catenary structures, steel buildings, and tracks converging at various levels present communications diffi-

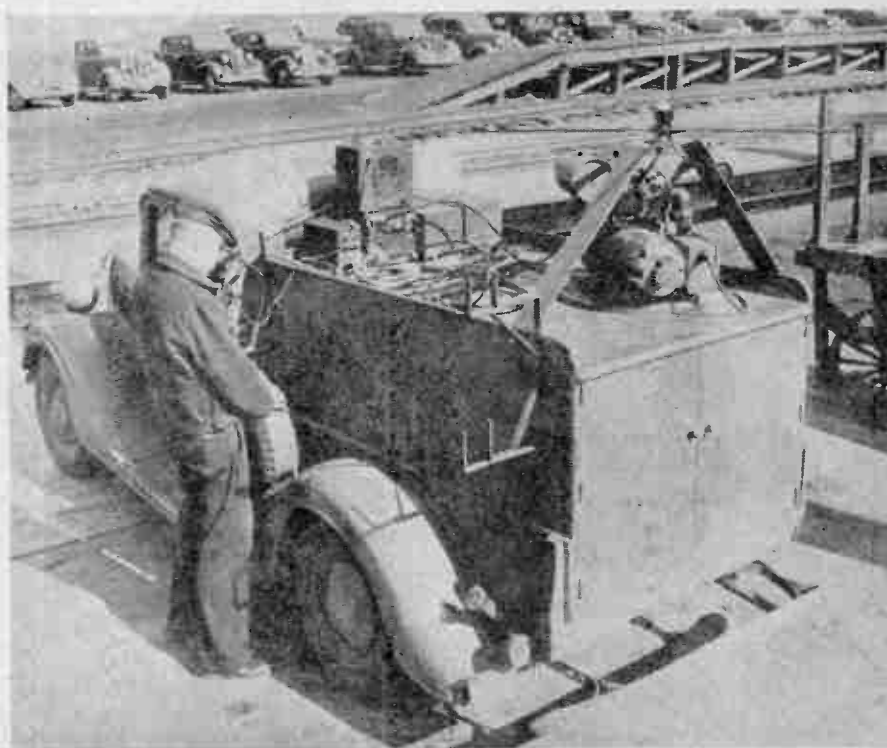

FIG. 11. 160-MC. TEST INSTALLATION ON ROCK ISLAND TELEGRAPH SERVICE TRUCK



culties that make it an ideal test spot. The 25-watt main station transmitter and receiver has been erected at the Wayne Junction yardmaster's office. This installation can be operated over remote-control wire lines across some trackage to the trainmaster's office, and to the yardmaster's office at Nicetown Junction, the next station to the north.

From any of these three points, it has proved possible to hold 2-way conversations with the crews of diesel-electric locomotives equipped with receivers and 15-watt transmitters. Three locomotives have been equipped already, and installations will be made in two more.

An interesting feature of this radio system is the use of automatic film recording to register 2-way conversations. A voice-actuated relay starts and stops the recorder. The voice-on-film will be used to check the performance of the system and its contribution to increasing the efficiency of yard operations.

**Conclusions** ★ The installations described here, and work being carried on by other roads with various makes of equipment indicate definitely that FM has contributed the interference reduction that was lacking in AM systems, tried by numerous

companies over a period of 20-odd years. In addition, the use of 160 mc. and even higher frequencies has reduced the mechanical dimensions of antennas to the point where they can be mounted on rolling stock without introducing any hazard to personnel, or interference with structures above the tracks.

There is much work to be done before radio communications can be set up for all railroad services, and integrated with railroad customs and practice. Officials who have taken part in the installation tests concede that radio can contribute much toward greater safety and speed of operations. It requires no great stretch of the imagination to see the present projects expanded, over perhaps five years, to the point where nearly all yards will handle switching operations by radio, and where most of the freight and passenger trains will be equipped for end-to-end communications. In addition, service will be provided between trains and signal towers or, in open country, relays along the right of way.

**Market for Railroad Radio** ★ The use of radio by the roads will, in no application, replace any present communications or signal systems. On the contrary it will

represent a source of employment for many ex-servicemen who have become expert in the operation and maintenance of military communications equipment.

As a new market for radio equipment, this is one of the largest created by wartime progress of the art. According to the Association of American Railroads, there were in service during 1943 a total of 45,210 locomotives, 38,485 passenger cars, and 1,780,000 freight cars operating on 229,174 miles of railroad with 399,627 miles of track. Railroads paid taxes in 1943 totalling \$1,870,880,000.

The total property investment of Class One<sup>1</sup> roads amounted to \$25,838,000,000 or an investment of \$113,000 per mile. This group, in 1943, carried 730,407,500,000 ton-miles of freight, and 891,790,000 revenue passengers representing 87,974,200,000 passenger-miles. They paid 1,376,000 employees \$3,564,330,000 in wages.

In contrast to the situation after the last war, the roads have entered the new peace with strong reserves for replacement and improvement of equipment and facilities.

<sup>1</sup> Class One roads are those with annual operating income of \$1,000,000 or more; Class Two, of \$100,000 or more; Class Three, of less than \$100,000.

## ASSIGNMENTS IN THE 152- TO 162-MC. BAND

As of May 16, 1946

URBAN MOBILE	POWER, PETROLEUM	155.49	157.47	159.33
152.03	153.59	155.55	157.53	159.39
152.09		155.61	157.59	159.45
152.15	RELAY PRESS	155.67	157.65	159.51
152.21	153.65	155.73	157.71	159.57
152.27	153.71	155.79	157.77	159.63
152.33	FIRE	155.85	157.83	159.69
152.39	153.77	155.91	157.89	159.75
152.45	153.83	155.97	157.95	159.81
152.51	153.89	156.03		159.87
152.57	153.95	156.09	MARINE MOBILE	159.93
152.63	154.01	156.15	158.01	159.99
152.69	154.07	156.21	158.07	160.05
	154.13	156.27	158.13	160.11
MARITIME MOBILE	154.19	156.33		160.17
152.75	154.25	156.39	PROV. & EXP.	160.23
152.81	154.31	156.45	158.19	160.29
152.87	154.37	156.51		160.35
	154.43	156.57	MARINE MOBILE	160.41
RELAY PRESS <sup>1</sup>		156.63	158.25	160.47
152.93	PROV. & EXP.	156.69		160.53
152.99	154.49	156.75	PROV. & EXP.	160.59
	154.57		158.31	160.65
POWER, PETROLEUM		POWER, PETROLEUM		160.71
153.05	POLICE	156.81		160.77
	154.65		MARINE MOBILE	160.83
RELAY, BROADCAST <sup>2</sup>	154.71	RELAY BROADCAST <sup>2</sup>	158.37	160.89
153.11	154.77	156.87		160.95
153.17	154.83	156.93	RAILROADS	161.01
	154.89	156.99	158.43	161.07
POWER, PETROLEUM	154.95	157.05	158.49	161.13
153.23	155.01		158.55	161.19
	155.07	POWER, PETROLEUM	158.61	161.25
RELAY BROADCAST <sup>2</sup>	155.13	157.11	158.67	161.31
153.29	155.19		158.73	161.37
153.35	155.25	RELAY BROADCAST <sup>2</sup>	158.79	161.43
	155.31	157.17	158.85	161.49
POWER, PETROLEUM	155.37	157.23	158.91	161.55
153.41	155.43		158.97	161.61
		URBAN MOBILE	159.03	161.67
RELAY BROADCAST <sup>2</sup>		157.29	159.09	161.73
153.47	<sup>1</sup> Shared with Forestry-Conservation, Geophysical.	157.35	159.15	161.79
153.53	<sup>2</sup> Shared with Forestry-Conservation, Geophysical, Motion Picture.	157.41	159.21	161.85
			159.27	161.91
				161.97

# Chapter 14

## Notes on Postwar Facsimile Equipment

Facsimile Is Approaching the Point Where Definite Plans Can Be Formulated for Commercial Service

**R**ECENT demonstrations of facsimile, particularly at the American Newspapers Publishers Convention held in New York, April 22-26, 1946, have served to focus the attention of broadcasters, publishers and communications officials on the importance and number of applications for this medium. The new facsimile equipment incorporates many refinements resulting from wartime development and field experience. As a result, the postwar status of facsimile indicates that it is now ready for adoption by many commercial services, and that an early resumption of experimental broadcasting is at hand. The latter will serve to pave the way for necessary engineering standards and operating regulations essential to a universal, nation-wide system of facsimile broadcasting.

Until very recently, the lion's share of publicity has been concentrated on Frequency Modulation and television. However, it still remains for facsimile to provide a system whereby a permanent record of any transmitted material can be received in its exact original form and retained for post-transmission purposes. To the broadcast station operator and advertiser, it is both a new public service and a new advertising medium, and it has the advantage of lower programming cost than sound or television broadcasting. For mobile communications and point-to-point services, it is a medium whereby information of any nature can be transmitted instantaneously for later analysis when convenient or desired, with a minimum of possible errors.

Prewar experimental facsimile broadcasting over AM facilities, conducted after the conclusion of regular aural programs, served to provide valuable operating and engineering data. It also demonstrated the futility of attempting to build facsimile into a healthy, competitive medium with the handicap of operation limited to early morning hours. The solution to this problem has been found in Frequency Modulation, which makes possible multiplex transmission, or the simultaneous transmission of sound and facsimile copy.

**Early System** ★ Facsimile communication is also referred to as wirephoto, radiophoto, telephoto picture transmission, and record communications.

The first record was sent over a telegraph circuit in 1842 by Alexander Baine,



FIG. 1. THE ORIGINAL FACSIMILE RECEPTION WAS BETTER THAN THIS REPRODUCTION

an English physicist. Professor Arthur Korn did a great deal of work on improving the method in the early part of this century. The most recent work has been done by Jenkins, Finch, Cooley, Ranger, Hogan, Ives, Bellin, and a number of others.

The first commercial facsimile system was placed in operation by the AT & T Company over regular telephone circuits. RCA operated a radio telegraph photo service in 1924 between New York and London.

The techniques employed in the trans-

mission of wire photographs and telephotographs are similar in general respects to those employed in the most recent facsimile systems. However, in the former, a light-sensitive film is required in the recording operation. This makes it necessary to go through the elaborate processes of film loading, developing, fixing, washing and drying to obtain the final copy. In contrast, facsimile requires no processing of the received copy, since it appears in a permanent, visible form during the recording operation. The present home-recording facsimile instrument prints the



received copy on a continuous sheet of special electro-sensitized paper. A full-size reproduction of a facsimile picture appears in Fig. 1. The reproduction does not do full credit to the original facsimile picture, for the latter is almost equal to the appearance of rotogravure.

**First Facsimile Broadcasting** ★ The first experimental facsimile broadcasting license, with the call letters W2XBF, was granted to Capt. W. G. H. Finch in September, 1937, and daily transmissions were immediately started in the New York area. Other radio stations soon expressed a deep interest in this new broadcasting medium. WHIO, Des Moines, KSPP, St. Paul and WGH, Norfolk applied for experimental licenses and were in operation before the end of the year.

To obtain technical data and determine the degree of public acceptance, a number of recorders were distributed in these areas, pre-tuned to the correct station frequency. Facsimile broadcasting was then conducted between midnight and 6:00 A.M., following the regular aural programs. These home recorders were automatically turned on and off by means of special time switches.

To obtain an acceptance evaluation of wide scope, the FCC approved the transmission of advertising copy to supplement the usual news programs. Thus, these early programs permitted the radio sta-

By early 1938, some twenty major radio stations were in operation with facsimile on an experimental basis. Many of these stations were affiliated with newspapers, Magazine, newspaper, and radio station

homes of individual subscribers.

The next logical step to improve facsimile broadcasting—the multiplex or simultaneous transmission of sound and program material was undertaken by

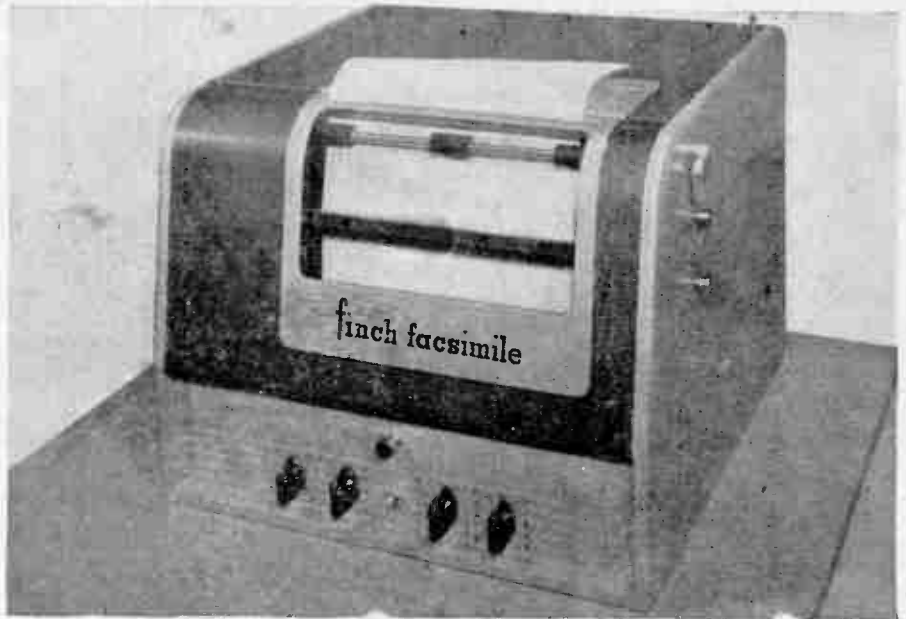

FIG. 2. THIS MODEL IS INTENDED FOR COMMERCIAL USE, NOT HOME FAX RECEPTION

reactions were mixed. Some publishers viewed facsimile as added competition, others believed it would prove to be a valuable supplement. All agreed, however,

Captain Finch in February, 1938. It was felt that multiplex transmission would greatly increase the value of facsimile broadcasting, and in some cases would increase the usefulness of facsimile to communications services. Multiplex experiments were successfully conducted by a series of daily transmissions to the New York World's Fair in 1938-39, and later through special tests before members of the FCC in Washington.



FIG. 3. INSIDE VIEW OF COMMERCIAL MODEL WHICH TRANSMITS AND RECEIVES

tions to investigate public reaction to its extended service and, at the same time, pioneer in what promised to be a fruitful source of added revenue. These first home recorders utilized a roll of specially treated paper, two newspaper columns in width. A speed of approximately five feet per hour was obtainable.

facsimile was destined to become a powerful medium for the dissemination of printed information, as it offered the added advantage of permanency to instantaneous reception, in contrast to the laborious and slow task of moving individual copies of newspapers from the printing plant to newsstands and the

**Scanning & Recording Equipment** ★ Figs. 2 and 3 show views of the dual transmit-receive facsimile unit designed for fixed station use. Fig. 4 is an interior view of a unit for mobile reception only.

Material for transmission is inserted into the TRANSMIT slot. Pressing the TRANSMIT button on the right side, Fig. 1, automatically loads and transmits the copy. After scanning, the copy is stripped from the drum and ejected by means of the EJECT button. Any black and white copy that is printed, typed, written, sketched, or photographed on ordinary paper 8½ ins. wide and not more than 11 ins. long can be used for transmission. When inserted, the copy is automatically wrapped around the surface of a metal cylinder. The cylinder rotates in front of a scanning head comprising a small electric bulb, a lens system, and a photo-electric cell. When the cylinder rotates, the scanning head is moved by means of a lead screw, parallel to the axis of the cylinder.

The electrical circuits of the scanner and recorder, Figs. 5 and 6, are relatively simple. In the scanner, light from the exciter lamp in the scanning head assembly is focused on the copy as it is moved



by the rotating cylinder. The light is reduced to a small spot 1/100 in. in diameter by means of an optical system. The light reflected from the copy is picked up by a

100 lines per inch. The output power of any unit is 0 db. (6 milliwatts) and is designed to feed into a 500 ohm circuit. The recorder unit will operate from any radio

pulses. This pulse is utilized to check the vibrations of a crystal which, in turn, controls the RPM of the recorder motor to drive and maintain the latter in correct phase relation.

If the recorder is out of frame with the scanner, the motor of the recorder is retarded by opening the circuit periodically once per revolution, causing the recording cylinder to lag. This is accomplished by having an open segment on a commutator that is attached to and drives the recorder cylinder. When both scanner and recorder cylinder are framed, the synchronizing or framing signal actuates a relay that closes the gap in the commutator locking the two cylinders in unison and maintaining them in frame as long as the signal (received by the recorder) is not interrupted.

**Present Facsimile Broadcasting** ★ Pending industry and FCC agreement on the necessary engineering standards for a common system of broadcasting, which will eventually provide for multiplex, experimental work is being resumed by a number of stations utilizing FM facilities. FM station WGHF in New York will be active in carrying out this phase of facsimile, and is now being used for specific demonstrations. Upon the availability of home recorders, a regular schedule of transmissions will be put into effect. WGHF operates on 99.7 mc.

Multiplex demonstrations to date have been conducted using a 20 kc. sub-carrier extending 10 kc. beyond the normal 150 kc. utilized for full modulation of an FM broadcast channel. A guard channel of 5 kc. is inserted between this sub-carrier

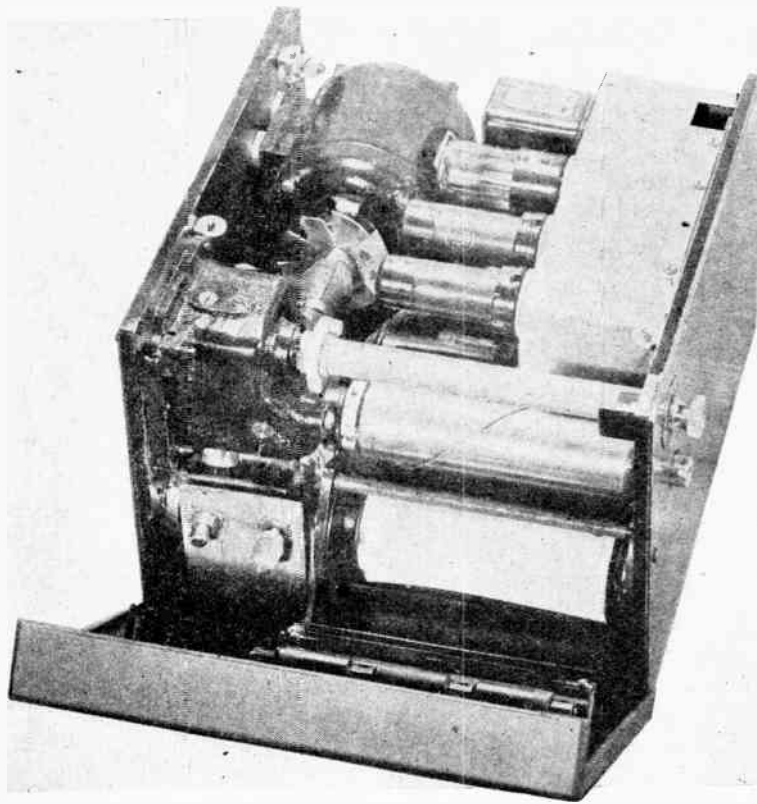

FIG. 4. COMPACT FACSIMILE RECEIVER SUITABLE FOR MOUNTING ON AUTO DASHBOARD

simple condenser lens and focused on the caesium cathode of the photoelectric cell. The amount of light reaching the cell depends upon the amount reflected from the copy. The white portions of the copy reflect the greatest amount of light and the dark portions the least. This changing amount of light controls the output of the photo-electric cell, and this output is used to modulate the radio transmitter.

At the receiving end, the facsimile signals are separated from the carrier frequency, amplified, and fed to the recorder mechanism. The program content is printed on a continuous sheet of electro-sensitive paper 8½ in. wide, fed by the receiving cylinder at identically the same rate as the transmitting cylinder. On the surface of the recorder cylinder is a spiral wire which contacts a metal blade parallel to the surface of the cylinder. In this manner, for each rotation of the cylinder the point of contact moves once along the length of the blade. The facsimile signal passes from the spiral wire to the blade, so that each line traced at the scanner is reproduced by a turn of the receiver cylinder on the sensitized paper. The paper, in turn, advances slowly between the cylinder and the blade. Fig. 6 is a simplified schematic of the recorder circuit.

The circumference of the scanning cylinder and the length of stroke of the recorder are both nine inches. Transmitted copy is scanned and recorded at a rate of

receiver of 5 watts rated output at 500 ohms, or from a wire circuit.

**Synchronizing & Framing** ★ A framing and syn-

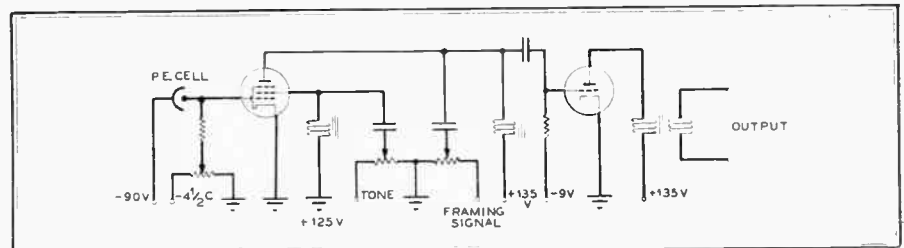

FIG. 5 ELEMENTS OF THE PHOTO-ELECTRIC CELL SCANNER AND AMPLIFIER CIRCUIT

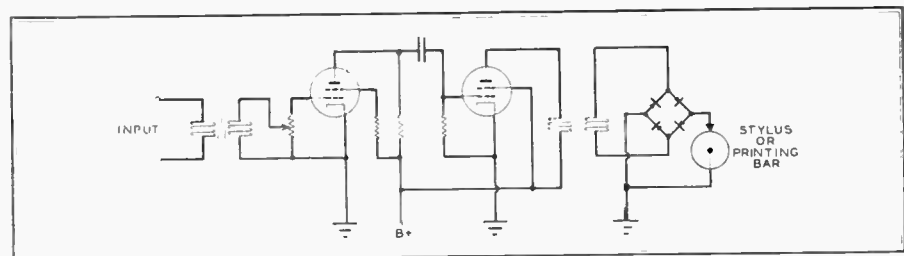

FIG. 6. AMPLIFIER AND FULL-WAVE RECTIFIER EMPLOYED FOR FACSIMILE RECORDING

chronizing pulse is transmitted at the start of each revolution of the scanning cylinder. The frequency of this pulse may be the same frequency as the sub-carrier or one that is higher or lower. When framing signals are above or below the carrier frequency, a filter is employed to separate the picture signals from the framing

and the extreme limits of the 150 kc. channel.

**Facsimile Applications** ★ Possibly the most dramatic application of facsimile will be its eventual use in broadcasting. The delivery of photographs, sketches, cartoons, maps, and advertising copy simultane-

ously with aural programs offers unlimited variations. The relatively small size of a home recorder unit permits it to be installed in an average radio cabinet as an additional unit.

The adoption of facsimile by newspapers to supplement their mechanical methods of distribution is a subject beyond the scope of this article. For those who are interested in this particular phase of facsimile, an article by Lieut. Col. Robert D. Levitt, former promotion director of the *New York Journal American* and circulation promotion manager of the *American Weekly*, appeared in the January 1945 issue of *FM AND TELEVISION*

which thoroughly and logically analyzed this field from the publisher's viewpoint.

One of the distinct advantages of facsimile is its relative immunity to static and other periodic forms of interference. In typewriter systems used to convey intelligence from one point to another via a radio circuit, interference of comparatively short duration with respect to the total intelligence being transmitted can cause a misprint under certain conditions, or possibly a complete loss of copy. In the page facsimile system, under similar adverse conditions, only a small portion of any letter or figure would be mutilated.

Similarly, no error can occur during transmission that is not already on the original copy. A final proofreading and approval is therefore satisfactory. The human element factor involving operators need not be considered. In the emergency services where hastily transcribed information is always a potential source of error, this feature is of particular importance.

Where stations or equipment are, of necessity, left unattended during certain periods, the facsimile receiver may be left in a standby condition so that complete copy is available upon the operator's return.

# Chapter 15

## Standards of FM Engineering Practice

FM Standards of Good Engineering Practice, Issued by the Federal Communications Commission on September 20, 1945, and Corrected to November, 1946

### 1. Definitions

**A. FM BROADCAST STATION:** The term *FM broadcast station* means a station employing Frequency Modulation in the FM broadcast band and licensed primarily for the transmission of radiotelephone emissions intended to be received by the general public.

**B. FREQUENCY MODULATION:** The term *frequency modulation* means a system of modulation where the instantaneous radio frequency varies in proportion to the instantaneous *amplitude* of the modulating signal (amplitude of modulating signal to be measured after pre-emphasis, if used) and the instantaneous radio frequency is independent of the *frequency* of the modulating signal.

**C. FM BROADCAST BAND:** The term *FM broadcast band* means the band of frequencies extending from 88 to 108 mc., which includes those assigned to non-commercial educational broadcasting.

**D. CENTER FREQUENCY:** The term *center frequency* means:

(1) The average frequency of the emitted wave when modulated by a sinusoidal signal.

(2) The frequency of the emitted wave without modulation.

**E. FREQUENCY SWING:** The term *frequency swing* means the instantaneous departure of the frequency of the emitted wave from the center frequency resulting from modulation.

**F. FM BROADCAST CHANNEL:** The term *FM broadcast channel* means a band of frequencies 200 kc. wide and is designated by its center frequency. Channels for FM broadcast stations begin at 88.1 mc. and continue in successive steps of 200 kc. to and including 107.9 mc.

**G. ANTENNA FIELD GAIN:** The term *antenna field gain* of an FM broadcast antenna means the ratio of the effective free space field intensity produced at one mile in the horizontal plane expressed in millivolts-per-meter for 1 kw. antenna input power to 137.6 mv/m.

**H. FREE SPACE FIELD INTENSITY:** The term *free space field intensity* means the field intensity that would exist at a point in the absence of waves reflected from the earth or other reflecting objects.

**I. MULTIPLEX TRANSMISSION:** The term *multiplex transmission* means the simultaneous transmission of two or more signals within a single channel. Multiplex

transmission as applied to FM broadcast stations means the transmission of facsimile or other signals in addition to the regular broadcast signals.

**J. PERCENTAGE MODULATION:** The term *percentage modulation* as applied to frequency modulation means the ratio of the actual frequency swing to the frequency swing defined as 100% modulation, expressed in percentage. For FM broadcast

**T**HERE are presented herein the Commission's engineering standards relating to the allocation and operation of FM broadcast stations. These standards also apply to non-commercial educational (FM) broadcast stations, except as noted herein. The Commission's Rules and Regulations contain references to these standards, which have been approved by the Commission and thus are considered as reflecting its opinion in all matters involved.

The standards set forth herein are those deemed necessary for the construction and operation of FM broadcast stations to meet the requirements of technical regulations and for operation in the public interest along technical lines not otherwise enunciated. These standards are based upon the best engineering data available, including evidence at hearings, conferences with radio engineers, and data supplied by manufacturers of radio equipment and by licensees of FM broadcast stations. These standards are complete in themselves and supersede previous engineering standards or policies of the Commission concerning FM broadcast stations. While these standards provide for flexibility and indicate the conditions under which they are applicable, it is not expected that material deviation from the fundamental principles will be recognized unless full information is submitted as to the need and reasons therefor.

These standards will necessarily be revised from time to time as progress is made in the art. The Commission will accumulate and analyze engineering data available as to the progress of the art so that these standards may be kept current with technical developments.

stations, a frequency swing of  $\pm 75$  kc. is defined as 100% modulation.

**K. EFFECTIVE RADIATED POWER:** The term *effective radiated power* means the product of the antenna power (transmitter output power less transmission line loss) times (1) the antenna power gain, or (2) the antenna field gain squared.

**L. SERVICE AREA:** The term *service area* as applied to FM broadcasting means the service resulting from an assigned effective radiated power and antenna height above average terrain.

**M. ANTENNA HEIGHT ABOVE AVERAGE**

### TERRAIN:

(1) For Class A stations the term "antenna height above average terrain" means the height of the radiation center of the antenna above the terrain 10 miles from the antenna.

(2) For Class B stations the term "antenna height above average terrain" means the height of the radiation center of the antenna above the terrain 2 to 10 miles from the antenna. (In general a different antenna height will be determined for each direction from the antenna. The average of these various heights is considered as the antenna height above average terrain for Class B stations.)

### 2. Engineering Standards of Allocation

**A. BASIS FOR FM ALLOCATIONS:** Sections 3.202 to 3.206 inclusive of the Rules and Regulations<sup>1</sup> describe the basis for allocation of FM Broadcast Stations, including the division of the United States into Areas I and II. Where reference is made in the Rules to antenna heights of Class A stations, Section 2 E (1) of these Standards should be consulted; for Class B stations, Section 2 E (2) should be consulted.

**B. FIELD INTENSITY CONTOURS:** In determining the predicted and measured field intensity contours of FM broadcast stations the following shall govern:

(1) Class A stations will normally not be required to determine their contours.

(2) Class B stations shall determine the extent of their 1,000  $\mu\text{v}/\text{m}$  and 50  $\mu\text{v}/\text{m}$  contours.

The above contours shall be determined in accordance with the methods prescribed in these standards.

**C. FIELD INTENSITY REQUIREMENTS:** Although some service is provided by tropospheric waves, the service area is considered to be only that served by the ground wave. The extent of the service is determined by the point at which the ground wave is no longer of sufficient intensity to provide satisfactory broadcast service. The field intensity considered necessary for service is as follows:

TABLE I

AREA	MEDIAN FIELD INTENSITY
City business or factory areas	1,000 $\mu\text{v}/\text{m}$
Rural areas	50 $\mu\text{v}/\text{m}$

<sup>1</sup>The revised text of Sections 3.202 to 3.206 is given in full on page 149.



A median field intensity of 3,000 to 5,000  $\mu\text{v}/\text{m}$  should be placed over the principal city to be served, and a median field intensity of 1,000  $\mu\text{v}/\text{m}$  should be placed over the business district of cities of 10,000 or greater within the metropolitan district served. The location of the main studio of a Class A station is specified in Section 3.203 of the Rules. A field intensity of 5,000  $\mu\text{v}/\text{m}$  should be provided over the main studio of a Class B station except as otherwise provided in Section 3.204 of the Rules.

These figures are based upon the usual noise levels encountered in the several areas and upon the absence of interference from other FM stations.

**D. SATELLITES:** A basis for allocation of satellite stations has not yet been determined. For the present, applications will be considered on their individual merits.

**E. SERVICE AREA:** The service area is predicted as follows:

(1) Class A stations: A map, topographic where obtainable, shall be submitted for the area within 15 miles of the proposed antenna site. On this map shall be indicated the antenna location and a circle of 10 miles radius with the antenna location as center. Representative points shall be picked on this circle 15 degrees apart and the elevation of these points determined. The average elevation of these points will be considered the average elevation of the circle. The difference between the elevation of the center of the radiating system and the average elevation of this circle shall be considered the height of the antenna over the terrain 10 miles from the transmitter. In cases where the applicant believes this method to be grossly in error due to peculiarities of the terrain, this method shall be used for determining the antenna height but a showing may be made, if desired, determining the height by other means and describing the method used. Calculations of the service contours of Class A stations are not required.

(2) Class B stations:

Profile graphs must be drawn for at least eight radials from the proposed antenna site. These profiles should be prepared for each radial beginning at the antenna site and extending to ten miles therefrom. Normally the radials are drawn for each 45° of azimuth; however, where feasible the radials should be drawn for angles along which roads tend to follow. (The latter method may be helpful in obtaining topographical data where otherwise unavailable, and is particularly useful in connection with mobile field intensity measurements of the station and the correlation of such measurements with predicted field intensities.) In each case one or more radials must include the principal city or cities to be served, particularly in cases of rugged terrain, even

though the city may be more than 10 miles from the antenna site. The profile graph for each radial should be plotted by contour intervals of from 40 to 100 ft. and, where the data permits, at least 50 points of elevation (generally uniformly spaced) should be used for each radial. In instances of very rugged terrain where the use of contour intervals of 100 ft. would result in several points in a short distance, 200- or 400-ft. contour intervals may be used for such distances. On the other hand, where the terrain is uniform or gently sloping the smallest contour interval indicated on the topographic map (see below) should be used, although only a relatively few points may be available. The profile graph should accurately indicate the topography for each radial, and the graphs should be plotted with the distance in miles as the abscissa and the elevation in feet above mean sea level as the ordinate. The profile graphs should indicate the source of the topographical data employed. The graph should also show the elevation of the center of the radiating system. The graph may be plotted either on rectangular coordinate paper or on special paper which shows the curvature of the earth. It is not necessary to take the curvature of the earth into consideration in this procedure, as this factor is taken care of in the chart showing signal intensities, Fig. 1.

The average elevation of the 8-mile distance between 2 and 10 miles from the antenna site should then be determined from the profile graph for each radial. This may be obtained by averaging a large number of equally spaced points, by using a planimeter, or by obtaining the median elevation (that exceeded for 50% of the distance) in sectors and averaging these values.

To determine the distance to a particular contour, Fig. 1, concerning the range of FM broadcast stations, should be used. This chart has been prepared for a frequency in the center of the band and is to be used for all FM broadcast channels, since little change results over this frequency range. The distance to a contour is determined by the effective radiated power and the antenna height. The height of the antenna used in connection with Fig. 1 should be the height of the center of the proposed antenna radiator above the average elevation obtained by the preceding method. The distances shown by Fig. 1 are based upon an effective radiated power of 1 kw.; to use the chart for other powers, the sliding scale associated with the chart should be trimmed and used as the ordinate scale. This sliding scale is placed on the chart with the appropriate gradation for power in line with the lower line of the top edge of the chart. The right edge of the scale is placed in line with the appropriate antenna height graduations and the chart then becomes direct reading for this power and antenna height. Where the antenna height is not one of those for

which a scale is provided, the signal strength or distance is determined by interpolation between the curves connecting the equidistant points.

The foregoing process of determining the extent of the required contours shall be followed in determining the boundary of the proposed service area. The areas within the required contours must be determined and submitted with each application for these classes of FM broadcast stations. Each application shall include a map showing these contours, and for this purpose Sectional Aeronautical charts or other maps having a convenient scale may be used. The map shall show the radials along which the profile charts and expected field strengths have been determined. The area within each contour should then be measured (by planimeter or other approximate means) to determine the number of square miles therein. In computing the area within the contours, exclude (1) areas beyond the borders of the United States, and (2) large bodies of water, such as ocean areas, gulfs, sounds, bays, large lakes, etc., but not rivers.

In cases where the terrain in one or more directions from the antenna site departs widely from the average elevation of the 2- to 10-mile sector, the application of this prediction method may indicate contour distances that are different from those which may be expected in practice. In such cases the prediction method should be followed, but a showing may be made if desired concerning the distance to the contour as determined by other means. Such showing should include data concerning the procedure employed and sample calculations. For example, a mountain ridge may indicate the practical limit of service although the prediction method may indicate the contour elsewhere. In cases of such limitation, the map of predicted coverage should show both the regular predicted area and the area as limited or extended by terrain. Both areas should be measured, as previously described; the area obtained by the regular prediction method should be given in the application form, with a supplementary note giving the limited or extended area. In special cases the Commission may require additional information as to the terrain in the proposed service area.

In determining the population served by FM broadcast stations, it is considered that the built-up city areas and business districts in cities having over 10,000 population and located beyond the 1,000  $\mu\text{v}/\text{m}$  contour do not receive adequate service. Minor Civil Division maps (1940 Census) should be used in making population counts, excluding cities not receiving adequate service. Where a contour divides a minor division, uniform distribution of population within the division should be assumed in order to determine the population included within the contour, unless a more accurate count is available.

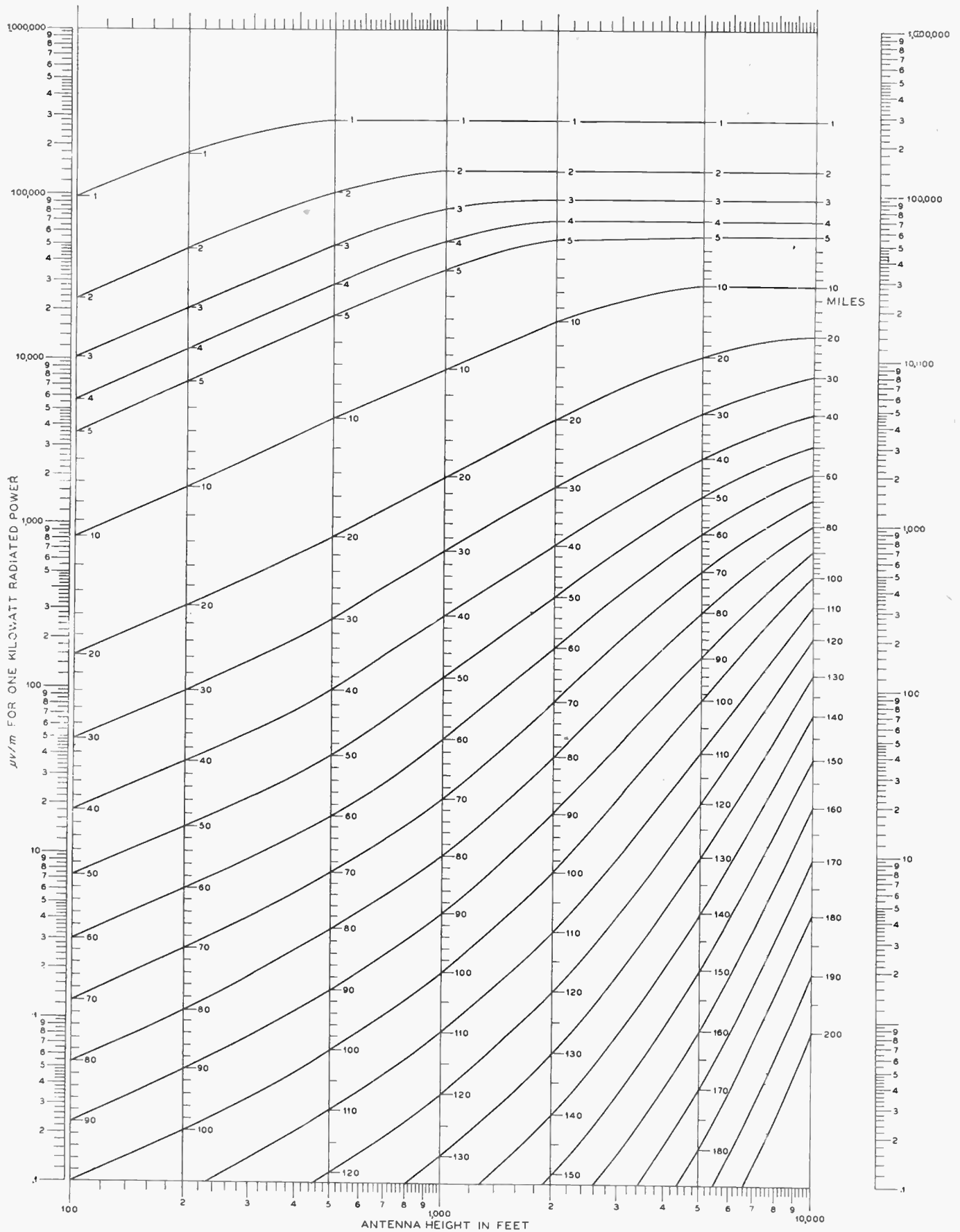

FIG. 1. GROUND WAVE SIGNAL RANGE FOR FM BROADCASTING: 98 mc,  $\sigma = 5 \times 10^{-14}$  e.m.u.,  $\epsilon = 15$ , RECEIVING ANTENNA HEIGHT 30 FEET. FOR HORIZONTAL (AND APPROX. FOR VERTICAL) POLARIZATION

### 3. Topographical Data

In the preparation of the profile graphs

previously described, the elevations or contour intervals shall be taken from the U. S. Geological Topographical Quad-

range Sheets for all areas for which such maps are available. If such maps are not published for the area in question, the next

best topographic information should be used. Topographic data may sometimes be obtained from state and municipal agencies. The data from the Sectional Aeronautical Charts (including bench marks), or railroad depot elevations and highway elevations from road maps, may be used where no better information is available. In cases where limited topographic data can be obtained, use may be made of an altimeter in a car driven along roads extending generally radially from the transmitter site.

The Commission will not ordinarily require the submission of topographical maps for areas beyond 15 miles from the antenna site, but the maps must include the principal city or cities to be served. If it appears necessary, additional data may be requested.

The U. S. Geological Survey Topography Quadrangle Sheets may be obtained from the U. S. Geological Survey, Department of the Interior, Washington, D. C., for 10 cents each. The Sectional Aeronautical Charts are available from the U. S. Coast and Geodetic Survey, Department of Commerce, Washington, D. C., for twenty-five cents each. Other sources of topographic maps or data will be furnished at a later date.

#### 4. Interference Standards

Field intensity measurements are preferable in predicting interference between FM broadcast stations and should be used, when available, in determining the extent of interference. (For methods and procedure, see Section 5.) In lieu of measurements, the interference should be predicted in accordance with the method described herein.

Objectionable interference is considered to exist when the interfering signal exceeds that given by the ratios of Table II. In Table II the desired signal is median field and the undesired signal is the tropospheric signal intensity exceeded for 1% of the time.

TABLE II

CHANNEL SEPARATION	RATIO OF DESIRED TO UNDESIRE SIGNALS
Same channel	10:1
Adjacent channel (200 kc. removed)	2:1

Objectionable interference is not considered to exist when the channel separation is 400 kc. or greater. Accordingly, FM broadcast stations in the same city or same area may be assigned channels 400 kc. apart. In the assignment of FM broadcast facilities the Commission will endeavor to provide the optimum use of the channels in the band, and accordingly may assign a channel different than that requested in an application.

In predicting the extent of interference with the ground wave service area of a station, the tropospheric signal intensity (from co-channel and adjacent channel

stations) existing for 1% of the time shall be employed. The 1% values for one kc. of power and various antenna heights are given in Fig. 2,<sup>2</sup> and values for other powers may be obtained by use of the sliding scale as for Fig. 1. The values indicated by Fig. 2 are based upon available data, and are subject to change as additional information concerning tropospheric wave propagation is obtained.

In determining the points at which the interference ratio is equal to the values shown in Table II, the field intensities for the two interfering signals under consideration should be computed for a considerable number of points along the line between the two stations. Using this data, field intensity versus distance curves should be plotted (e.g., cross-curves on graph paper) in order to determine the points on this path where the interference ratios exist. The points established by this method, together with the points along the contours where the same ratios are determined, are considered to be generally sufficient to predict the area of interference. Additional points may be required in the case of irregular terrain or the use of directional antenna systems.

The area of interference, if any, shall be shown in connection with the map of predicted coverage required by the application form, together with the basic data employed in computing such interference. The map shall show the interference within the 50  $\mu\text{v}/\text{m}$  contour.

#### 5. Field Intensity Measurements in Allocation

When field intensity measurements are required by the Commissioner's rules or when employed in determining the extent of service or interference of existing stations, such measurements should be made in accordance with the procedure outlined herein.

Measurements made to determine the service and interference areas of FM broadcast stations should be made with mobile equipment along roads which are as close and similar as possible to the radials showing topography which were submitted with the application for construction permit. Suitable measuring equipment and a continuous recording device must be employed, the chart of which is either directly driven from the speedometer of the automobile in which the equipment is mounted or so arranged that distances and identifying landmarks may be readily noted. The measuring equipment must be calibrated against recognized standards of field intensity and so constructed that it will maintain an acceptable accuracy of measurement while in motion or when stationary. The equipment should be so operated that the recorder chart can be calibrated directly in field intensity in order to facilitate analysis of the chart. The receiving antenna must be non-directional and of the same polarization as the transmitting antenna.

Mobile measurements should be made

with a minimum chart speed of 3 ins. per mile and preferably 5 or 6 ins. per mile. Locations shall be noted on the recorder chart as frequently as necessary to definitely fix the relation between the measured field intensity and the location. The time constant of the equipment should be such to permit adequate analysis of the charts, and the time constant employed shall be shown. Measurements should be made to a point on each radial well beyond the particular contour under investigation. The transmitter power shall be maintained as close as possible to the authorized power throughout the survey.

After the measurements are completed, the recorder chart shall be divided into not less than 15 sections on each equivalent radial from the station. The field intensity in each section of the chart shall be analyzed to determine the field intensity received 50% of the distance (median field) throughout the section, and this median field intensity associated with the corresponding sector of the radial. The field intensity figures must be corrected for a receiving antenna elevation of 30 ft. and for any directional effects of the automobile not otherwise compensated. This data should be plotted for each radial, using log-log coordinate paper with distance as the abscissa and field intensity as the ordinate. A smooth curve should be drawn through these points (of median fields for all sectors), and this curve used to determine the distance to the desired contour. The distances obtained for each radial may then be plotted on the map of predicted coverage or on polar coordinate paper (excluding water areas, etc.) to determine the service and interference areas of a station.

In making measurements to establish the field intensity contours of a station, mobile recordings should be made along each of the radials drawn in Section 2 E above. Measurements should extend from the vicinity of the station out to the 1,000  $\mu\text{v}/\text{m}$  measured contour and somewhat beyond (at the present time it is not considered practical to conduct mobile measurements far beyond this contour due to the fading ratio at weak fields, which complicates analysis of the charts). These measurements would be made for the purpose of determining the variation of the measured contours from those predicted, and it is expected that initially the correlation of the measured 1,000  $\mu\text{v}/\text{m}$  with the predicted 1,000  $\mu\text{v}/\text{m}$  contour will be used as a basis in determining adherence to authorized service areas within the 50  $\mu\text{v}/\text{m}$  contour. Adjustment of power or antenna may be required to fit the actual contours to that predicted.

In addition to the 1,000  $\mu\text{v}/\text{m}$  contour, the map of measured coverage shall show the 50  $\mu\text{v}/\text{m}$  contour as determined by employing Fig. 1 and the distance to the 1,000  $\mu\text{v}/\text{m}$  contour along each radial. The sliding scale shall be placed on the figure at the appropriate antenna height for the



radial in question and then moved so the distance to the 1,000  $\mu\text{V}/\text{m}$  contour (as measured) and the 1,000  $\mu\text{V}/\text{m}$  mark are opposite. The distance to the 50  $\mu\text{V}/\text{m}$  contour is then given opposite the 50  $\mu\text{V}/\text{m}$  mark on the scale.

In predicting tropospheric interference on the basis of the above measurements, such measurements shall be carried out in the manner indicated above to determine the 1,000  $\mu\text{V}/\text{m}$  contour. Using Fig. 1 and its associated sliding scale, the equivalent radiated power shall be determined by placing the sliding scale on the chart (using the appropriate antenna height) and moving the scale until the distance to the 1,000  $\mu\text{V}/\text{m}$  contour (as determined above), and the 1,000  $\mu\text{V}/\text{m}$  mark are opposite. The equivalent radiated power is then read from the sliding scale where it crosses the lower line of the top edge of the chart. Changing to Fig. 2 and using the equivalent radiated power just determined, the distance to the interfering contour under investigation is read in the usual manner.

In certain cases the Commission may desire more information or recordings and in these instances special instructions will be issued. This may include fixed location measurements to determine tropospheric propagation and fading ratios.

Complete data taken in conjunction with field intensity measurements shall be submitted to the Commission in affidavit form, including the following:

**A. MAPS:** Map or maps showing the roads or points where measurements were made, the service and/or interference areas determined by the prediction method and by the measurements, and any unusual terrain characteristics existing in these areas. (This map may preferably be of a type showing topography in the area.)

**B. DIRECTIONAL RADIATION:** If a directional transmitting antenna is employed, a diagram on polar coordinate paper showing the predicted free space field intensity in millivolts per meter at one mile in all directions. (See Section 7.)

**C. PROCEDURE:** A full description of the procedures and methods employed including the type of equipment, the method of installation and operation, and calibration procedures.

**D. SURVEY DATA:** Complete data obtained during the survey, including calibration.

**E. ANTENNA AND POWER:** Antenna system and power employed during the survey.

**F. PERSONNEL:** Name, address, and qualifications of the engineer or engineers making the measurements.

All data shall be submitted to the Commission in triplicate, except that only the original or one photostatic copy need be submitted of the actual recording tapes.

## 6. Transmitter Location

**A. ELEVATION:** The transmitter location should be as near the center of the pro-

<sup>1</sup> Not yet issued by the FCC.

posed service area as possible consistent with the applicant's ability to find a site with sufficient elevation to provide service throughout the area. Location of the antenna at a point of high elevation is necessary to reduce to a minimum the shadow effect on propagation due to hills and buildings which may reduce materially the intensity of the station's signals in a particular direction. The transmitting site should be selected consistent with the purpose of the station, i.e., whether it is intended to serve a small city, a metropolitan area or a large region. Inasmuch as service may be provided by signals of 1,000  $\mu\text{V}/\text{m}$  or greater field intensities in metropolitan areas, and inasmuch as signals as low as 20  $\mu\text{V}/\text{m}$  may provide service in rural areas, considerable latitude in the geographical location of the transmitter is permitted; however, the necessity for a high elevation for the antenna may render this problem difficult. In general, the transmitting antenna of a station should be located at the most central point at the highest elevation available. In providing the best degree of service to an area, it is usually preferable to use a high antenna rather than a lower antenna with increased transmitter power. The location should be so chosen that line-of-sight can be obtained from the antenna over the principal city or cities to be served; in no event should there be a major obstruction in this path.

**B. RELATION OF CONTOUR TO DISTRIBUTION OF POPULATION:** The transmitting location should be selected so that the 1,000  $\mu\text{V}/\text{m}$  contour encompasses the urban population within the area to be served and the 50  $\mu\text{V}/\text{m}$  or the interference free contour coincides generally with the limits of the area to be served. It is recognized that topography, shape of the desired service area, and population distribution may make the choice of a transmitter location difficult. In such cases consideration may be given to the use of a directional antenna system, although it is generally preferable to choose a site where a non-directional antenna may be employed.

**C. SITE TESTS:** In cases of questionable antenna locations it is desirable to conduct propagation tests to indicate the field intensity expected in the principal city or cities to be served and in other areas, particularly where severe shadow problems may be expected. In considering applications proposing the use of such locations, the Commission may require site tests to be made. Such tests should be made in accordance with the measurement procedure previously described, and full data thereon must be supplied to the Commission. Test transmitters should employ an antenna having a height as close as possible to the proposed antenna height, using a balloon or other support if necessary and feasible. Information concerning the authorization of site tests may be

obtained from the Commission upon request.

**D. BLANKET AREAS:** Present information is not sufficiently complete to establish *blanket areas* of FM broadcast stations, which are defined as those areas adjacent to the transmitters in which the reception of other stations is subject to interference due to the strong signal from the stations. Where it is found necessary to locate the transmitter in a residential area where blanketing problems may appear to be excessive, the application must include a showing concerning the availability of other sites. The authorization of station construction in areas where blanketing problems appear to be excessive will be on the basis that the applicant will assume full responsibility for the adjustment of reasonable complaints arising from excessive strong signals of the applicant's station. As a means of minimizing interference problems, it is expected that stations adjacent in location will generally be assigned frequencies that are generally adjacent. Insofar as is feasible, frequency assignments for stations at separated locations will also be separated.

Cognizance must, of course, be taken regarding the possible hazard of the proposed antenna structure to aviation and the proximity of the proposed site to airports and airways. In passing on proposed construction, the Commission refers each case to the CAA for its recommendations. Antenna painting and/or lighting may be required at the time of construction or at a later date.

## 7. Antenna Systems

**A. POLARIZATION:** It shall be standard to employ horizontal polarization. If the use of vertical polarization appears desirable in special circumstances, its use may be authorized upon a showing of need.

**B. SURROUNDING OBJECTS:** The antenna must be constructed so that it is as clear as possible of surrounding buildings or objects that would cause shadow problems.

**C. DIRECTIONAL SYSTEMS:** Applications proposing the use of directional antenna systems must be accompanied by the following:

(1) Complete description of the proposed antenna system.

(2) Orientation of array with respect to true north; time phasing of fields from elements (degrees leading or lagging); space phasing of elements (in feet and in degrees); ratio of fields from elements.

(3) Calculated field intensity pattern (on letter-size polar coordinated paper) giving the free space field intensity in millivolts-per-meter at 1 mile in the horizontal plane, together with the formula used, constants employed, sample calculations and tabulation of calculation data.

(4) Name, address, and qualifications of the engineer making the calculations.

**D. ADJACENT STATIONS:** Applications proposing the use of FM broadcast antennas in the immediate vicinity (i.e., 200 ft. or less) of (1) other FM broadcast antennas, or (2) television broadcast antennas for frequencies adjacent to the FM broadcast band, must include a showing as to the expected effect, if any, of such proximate operation.

In cases where it is proposed to use a tower of a standard broadcast station as a supporting structure for an FM broadcast antenna, an application for construction permit (or modification of construction permit) for such station must be filed for consideration with the FM application. Applications may be required for other classes of stations when their towers are to be used in connection with FM broadcast stations.

When an FM broadcast antenna is mounted on a non-directional standard broadcast antenna, new resistance measurements must be made of the standard broadcast antenna after installation and testing of the FM broadcast antenna. During the installation and until the new resistance determination is approved, the standard broadcast station licensee should apply for authority (informal application) to operate by the indirect method of power determination. The FM broadcast license application will not be considered until the application form concerning resistance measurements is filed for the standard broadcast station.

When an FM broadcast antenna is mounted on an element of a standard broadcast directional antenna, a full engineering study concerning the effect of the FM broadcast antenna on the directional pattern must be filed with the application concerning the standard broadcast station. Depending upon the individual case, the Commission may require readjustment and certain field intensity measurements of the standard broadcast station following the completion of the FM broadcast antenna system.

When the proposed FM broadcast antenna is to be mounted on a tower in the vicinity of a standard broadcast directional array and it appears that the operation of the directional antenna system may be affected, an engineering study must be filed with the FM broadcast application concerning the effect of the FM broadcast antenna on the directional pattern. Readjustment and field intensity measurements of the standard broadcast station may be required following construction of the FM broadcast antenna.

Information regarding data required in connection with standard broadcast directional antenna systems may be found in the Standards of Good Engineering Practice Concerning Standard Broadcast Stations.

In the event a common tower is used by two or more licensees for antenna and/or antenna supporting purposes, the licensee who is owner of the tower shall

assume full responsibility for the installation and maintenance of any painting or lighting requirements. In the event of shared ownership, one licensee shall assume such responsibility and advise the Commission accordingly.

**E. AUXILIARY ANTENNA:** It is recommended that an emergency FM broadcast antenna be installed, or, alternately, an auxiliary transmission line or lines if feasible in the particular circumstances. Data thereon should be supplied with the application for construction permit; if proposed after station construction, an informal application should be submitted to the Commission.

**F. PROTECTION OF AIR NAVIGATION:** When necessary for the protection of air navigation, the antenna and supporting structure shall be painted and illuminated in accordance with the specifications supplied by the Commission pursuant to section 303 (q) of the Communications Act of 1934, as amended.

These individual specifications are issued for and attached to each authorization for an installation. The details of the specifications depend on the degree of hazard presented by the particular installation. The tower paint shall be kept in good condition and repainted as often as necessary to maintain this condition.

General information regarding painting and lighting requirements is contained in the Obstruction Marking Manual available from the Civil Aeronautics Administration, Washington 25, D. C.

## 8. Transmitters and Associated Equipment

**A. ELECTRICAL PERFORMANCE STANDARDS:** The general design of the FM broadcast transmitting system (from input terminals of microphone pre-amplifier, through audio facilities at the studio, through lines or other circuits between studio and transmitter, through audio facilities at the transmitter, and through the transmitter, but excluding equalizers for the correction of deficiencies in microphone response) shall be in accordance with the following principles and specifications:

(1) Standard power ratings and operating power range of FM broadcast transmitters shall be in accordance with the table herewith:

STANDARD POWER RATING	OPERATING POWER RANGE
250 watts	250 watts or less
1 kw.	250 watts-1 kw.
3 kw.	1-3 kw.
10 kw.	3-10 kw.
25 kw.	10-25 kw.
50 kw.	10-50 kw.
100 kw.	50-100 kw.

Composite transmitters may be authorized with a power rating different from the above table, provided full data is supplied in the application concerning the basis employed in establishing the rating and

the need therefor. The operating range of such transmitters shall be from one-third of the power rating to the power rating.

The transmitter shall operate satisfactorily in the operating power range with a frequency swing of  $\pm 75$  kilocycles, which is defined as 100% modulation.

(2) The transmitting system shall be capable of transmitting a band of frequencies from 50 to 15,000 cycles: Pre-emphasis shall be employed in accordance with the impedance-frequency characteristic of a series inductance-resistance network having a time constant of 75 microseconds. (See Fig. 3.) The deviation of the system response from the standard pre-emphasis curve shall lie between two limits as shown in Fig. 3. The upper of these limits shall be uniform (no deviation) from 50 to 15,000 cycles. The lower limit shall be uniform from 100 to 7,500 cycles, and three db below the upper limit; from 100 to 50 cycles the lower limit shall fall from the three db limit at a uniform rate of one db per octave (four db at 50 cycles); from 7,500 to 15,000 cycles the lower limit shall fall from the three db limit at a uniform rate of two db per octave (five db at 15,000 cycles).

(3) At any modulation frequency between 50 and 15,000 cycles and at modulation percentages of 25%, 50%, and 100%, the combined audio frequency harmonics measured in the output of the system shall not exceed the root-mean-square values given in the following table:

MODULATION FREQUENCY	DISTORTION
50 to 100 cycles	3.5%
100 to 7,500 cycles	2.5%
7,500 to 15,000 cycles	3.0%

Measurements shall be made employing 75 microsecond de-emphasis in the measuring equipment and 75 microsecond pre-emphasis in the transmitting equipment, and without compression if a compression amplifier is employed. Harmonics shall be included to 30 kc.<sup>3</sup>

It is recommended that none of the three main divisions of the system (transmitter, studio to transmitter circuit, and audio facilities) contribute over one half of these percentages since at some frequencies the total distortion may become the arithmetic sum of the distortions of the divisions.

(4) The transmitting system output noise level (frequency modulation) in the band of 50 to 15,000 cycles shall be at least 60 decibels below the audio frequency level representing a frequency swing of  $\pm 75$  kilocycles. The noise-measuring equipment shall be provided with standard 75-microsecond de-emphasis; the ballistic characteristics of the instrument shall be similar to those of the Standard VU meter.

(5) The transmitting system output

<sup>3</sup> See Section 13 for measurement frequencies and other information.



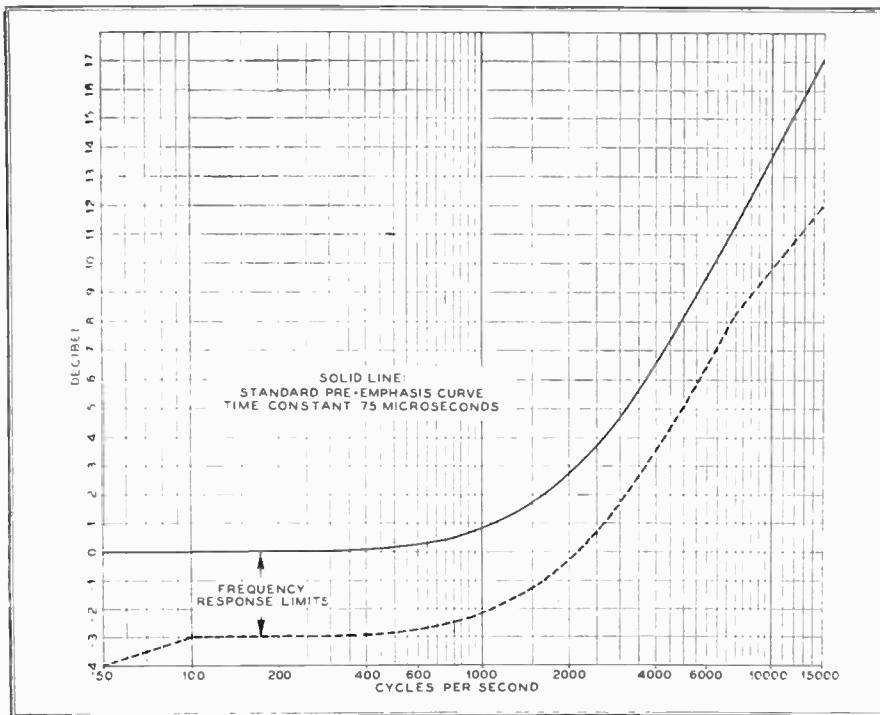

FIG. 3. STANDARD PRE-EMPHASIS CURVE. TIME CONSTANT 75 MICROSECONDS

noise level (amplitude modulation) in the band of 50 to 15,000 cycles shall be at least 50 decibels below the level representing 100% amplitude modulation. The noise-measuring equipment shall be provided with standard 75-microsecond de-emphasis; the ballistic characteristics of the instrument shall be similar to those of the Standard VU Meter.

(6) Automatic means shall be provided in the transmitter to maintain the assigned center frequency within the allowable tolerance ( $\pm 2,000$  cycles).

(7) The transmitter shall be equipped with suitable indicating instruments for the determination of operating power and with other instruments as are necessary for proper adjustment, operation, and maintenance of the equipment (See Section 9).

(8) Adequate provision shall be made for varying the transmitter output power to compensate for excessive variations in line voltage or for other factors affecting the output power.

(9) Adequate provision shall be provided in all component parts to avoid overheating at the rated maximum output power.

(10) Means shall be provided for connection and continuous operation of approved frequency and modulation monitors.

(11) If a limiting or compression amplifier is employed, precaution should be maintained in its connection in the circuit due to the use of pre-emphasis in the transmitting system.

**B. CONSTRUCTION:** In general, the transmitter shall be constructed either on racks and panels or in totally enclosed frames

protected as required by article 810<sup>4</sup> of the National Electrical Code and set forth below:

(1) Means shall be provided for making all tuning adjustments, requiring voltages in excess of 350 volts to be applied to the circuit, from the front of the panels with all access doors closed.

(2) Proper bleeder resistors or other automatic means shall be installed across all capacitor banks to lower any voltage which may remain accessible with access door open to less than 350 volts within two seconds after the access door is opened.

(3) All plate supply and other high voltage equipment, including transformers, filters, rectifiers and motor generators, shall be protected so as to prevent injury to operating personnel.

(a) Commutator guards shall be provided on all high voltage rotating machinery. Coupling guards should be provided on motor generators.

(b) Power equipment and control panels of the transmitter shall meet the above requirements (exposed 220-volt AC switching equipment on the front of the power

<sup>4</sup> The pertinent sections of article 810 of the National Electrical Code reads as follows:

"8101. General. — Transmitters shall comply with the following:

"a. Enclosing. — The transmitter shall be enclosed in a metal frame or grille, or separated from the operating space by a barrier or other equivalent means, all metallic parts of which are effectually connected to ground.

"b. Grounding of controls. — All external metallic handles and controls accessible to the operating personnel shall be effectually grounded. No circuit in excess of 150 volts shall have any parts exposed to direct contact. A complete dead-front type of switchboard is preferred.

"c. Interlocks on doors. — All access doors shall be provided with interlocks which will disconnect all voltages in excess of 350 volts when any access door is opened."

control panels is not recommended but is not prohibited).

(c) Power equipment located at a broadcast station but not directly associated with the transmitter (not purchased as part of same), such as power distribution panels, are not under the jurisdiction of the Commission; therefore Section 3.254 does not apply.

(4) Metering equipment:

(a) All instruments having more than 1,000 volts potential to ground on the movement shall be protected by a cage or cover in addition to the regular case. (Some instruments are designed by the manufacturer to operate safely with voltages in excess of 1,000 volts on the movement. If it can be shown by the manufacturer's rating that the instrument will operate safely at the applied potential, additional protection is not necessary.)

(b) In case the plate voltmeter is located on the low potential side of the multiplier resistor with the potential of the high potential terminal of the instrument at or less than 1,000 volts above ground, no protective case is required. However, it is good practice to protect voltmeters subject to more than 5,000 volts with suitable overvoltage protective devices across the instrument terminals in case the winding opens.

(c) Transmission line meters and any other radio frequency instrument which may be necessary for the operator to read shall be so installed as to be easily and accurately read without the operator having to risk contact with circuits carrying high potential radio frequency energy.

(5) It is recommended that component parts comply as much as possible with the component specifications designated by the Army-Navy Electronics Standards Agency.

**C. WIRING AND SHIELDING:**

(1) The transmitter panels or units shall be wired in accordance with standard switchboard practice, either with insulated leads properly cabled and supported or with rigid bus bar properly insulated and protected.

(2) Wiring between units of the transmitter, with the exception of circuits carrying radio frequency energy, shall be installed in conduits or approved fiber or metal raceways for protection from mechanical injury.

(3) Circuits carrying radio frequency energy between units shall be coaxial, two wire balanced lines, or properly shielded.

(4) All stages or units shall be adequately shielded and filtered to prevent interaction and radiation.

(5) The frequency and modulation monitors and associated radio frequency lines to the transmitter shall be thoroughly shielded.

**D. INSTALLATION:**

(1) The installation shall be made in suitable quarters.

(2) Since an operator must be on duty



during operation, suitable facilities for his welfare and comfort shall be provided.

**E. SPARE TUBES:** A spare tube of every type employed in the transmitter and frequency and modulation monitors shall be kept on hand at the equipment location. When more than one tube of any type are employed, the following table determines the number of spares of that type required:

NUMBER OF EACH TYPE EMPLOYED	SPARES REQUIRED
1 or 2 . . . . .	1
3 to 5 . . . . .	2
6 to 8 . . . . .	3
9 or more . . . . .	4

An accurate circuit diagram and list of required spare tubes, as furnished by the manufacturer of the equipment, shall be retained at the transmitter location.

**F. OPERATIONS:** In addition to specific requirements of the rules governing FM broadcast stations, the following operating requirements are specified:

(1) The maximum percentage of modulation shall be maintained in accordance with Section 3.268. However, precautions shall be taken so as not to substantially alter the dynamic characteristics of musical programs.

(2) Spurious emissions, including radio frequency harmonics, shall be maintained at as low a level as practicable at all times in accordance with good engineering practice.

(3) If a limiting or compression amplifier is employed, care should be maintained in its use due to pre-emphasis in the transmitting system.

**G. STUDIO EQUIPMENT:** Studio equipment shall be subject to all the above requirements where applicable except as follows:

(1) If properly covered by an underwriter's certificate, it will be considered as satisfying safety requirements.

(2) Section 8191 of Article 810 of the National Electrical Code shall apply for voltages only in excess of 500 volts.

No specific requirements are made with regards to the microphones to be employed. However, microphone performance (including compensating networks, if employed) shall be compatible with the required performance of the transmitting system.

No specific requirements are made relative to the design and acoustical treatment of studios. However, the design of studios, particularly the main studio, shall be compatible with the required performance characteristics of FM broadcast stations.

### 9. Indicating Instruments

An FM broadcast transmitter shall be equipped with suitable indicating instruments of acceptable accuracy to measure (1) the direct plate voltage and current of the last radio stage, and (2) the main transmission line radio frequency current or voltage.

The following requirements and specifications shall apply to indicating instruments used by FM broadcast stations:

**A. PLATE CURRENT AND VOLTAGE:** Instruments indicating the plate current or plate voltage of the last radio stage (linear scale instruments) shall meet the following specifications:

(1) Length of scale shall be not less than  $2\frac{3}{10}$  inches.

(2) Accuracy shall be at least 2% of the full scale reading.

(3) Scale shall have at least 40 divisions.

(4) Full scale reading shall not be greater than five times the minimum normal indication.

**B. TRANSMISSION LINE CURRENT AND VOLTAGE:** Instruments indicating transmission line current or voltage shall meet the following specifications:

(1) Instruments having linear scales shall meet the requirements of A (1), (2), (3), and (4) above.

(2) Instruments having logarithmic or square law scales.

(a) Shall meet requirements A (1) and (2) for linear scale instruments.

(b) Full scale reading shall not be greater than three times the minimum normal indication.

(c) No scale division above one-third full scale reading (in amperes) shall be greater than one-thirtieth of the full scale reading.

**C. RF INSTRUMENT SCALES:** Radio frequency instruments having expanded scales.

(1) Shall meet requirements A (1), (2), and (4) for linear scale instruments.

(2) No scale division above one-fifth full scale reading (in amperes) shall be greater than one-fiftieth of the full scale reading.

(3) The meter face shall be marked with the words "Expanded Scale" of the abbreviation thereof (E. S.).

**D. INSTRUMENT REPLACEMENTS:** No instruments indicating the plate current or plate voltage of the last radio stage or the transmission line current or voltage shall be changed or replaced without written authority of the Commission, except by instruments of the same maximum scale readings and accuracy. Requests for authority to use an instrument of different maximum scale reading and/or accuracy shall be made by letter or telegram giving the manufacturer's name, type number, and full scale reading of the proposed instrument and the values of current or voltage the instrument will be employed to indicate. Requests for temporary authority to operate without an instrument may be made by letter or telegram stating the necessity therefor and the period involved.

**E. ACCURACY:** No required instrument, the accuracy of which is questionable, shall be employed. Repairs and recalibration of instruments shall be made by

the manufacturer, or by an authorized instrument repair service of the manufacturer, or by some other properly qualified and equipped instrument repair service. In any event the repaired instrument must be supplied with a certificate of calibration.

**F. RECORDING INSTRUMENTS:** Recording instruments may be employed in addition to the indicating instruments to record the transmission line current or voltage and the direct plate current and/or direct plate voltage of the last radio stage, provided that they do not affect the operation of the circuits or accuracy of the indicating instruments. If the records are to be used in any proceeding before the Commission as representative of operation, the accuracy must be the equivalent of the indicating instruments and the calibration shall be checked at such intervals as to insure the retention of the accuracy.

**G. IDENTIFICATION:** The function of each instrument used in the equipment shall be clearly and permanently shown on the instrument itself or on the panel immediately adjacent thereto.

### 10. Auxiliary Transmitters

Auxiliary transmitters may not exceed the power rating or operating power range of the main transmitter, but need not conform to the performance characteristics specified by Section 8 A (2) to 8 A (5) inclusive. The subsequent portions of Section 8 apply to auxiliary transmitters.

### 11. Operating Power: Determination and Maintenance

**A. DETERMINATION OF OPERATING POWER:** The operating power of FM broadcast stations shall be determined by the indirect method. This is the product of the plate voltage ( $E_p$ ) and the plate current ( $I_p$ ) of the last radio stage, and an efficiency factor,  $F$ ; that is:

$$\text{Operating power} = E_p \times I_p \times F$$

The efficiency factor,  $F$ , shall be established by the transmitter manufacturer for each type of transmitter for which he requests FCC approval, and shall be shown in the instruction books supplied to the customer with each transmitter. In the case of composite equipment the factor  $F$  shall be furnished to the Commission by the applicant along with a statement of the basis used in determining such factor.

**B. MAINTENANCE OF OPERATING POWER:** The operating power shall be maintained as near as practicable to the authorized operating power, and shall not exceed the limits of 5% above and 10% below the authorized power except in emergencies. In the event it becomes impossible to operate with the authorized power, the station may be operated with reduced power for a period of 10 days or less provided the Commission and the In-

spector in Charge<sup>5</sup> of the district in which the station is located shall be notified in writing immediately thereafter and also upon the resumption of normal operating power.

## 12. Frequency and Modulation Monitors at Auxiliary Transmitters

Sections 3.252 and 3.253 require that each FM broadcast station have approved frequency and modulation monitors in operation at the transmitter. The following shall govern the installation of approved frequency and modulation monitors at auxiliary transmitters of FM broadcast stations in compliance with these rules:

In case the auxiliary transmitter location is at a site different from that of the main transmitter, an approved frequency monitor shall be installed at the auxiliary transmitter except when the frequency of the auxiliary transmitter can be monitored by means of the frequency monitor at the main transmitter. When the auxiliary transmitter is operated without a frequency monitor under this exemption, it shall be monitored by means of the frequency monitor at the main transmitter.

The licensee will be held strictly responsible for any center frequency deviation of the auxiliary transmitter in excess of 2,000 cycles from the assigned frequency, even though exempted by the above from installing an approved frequency monitor.

Installation of an approved modulation monitor at the location of the auxiliary transmitter, when different from that of the main transmitter, is optional with the licensee. However, when it is necessary to operate the auxiliary transmitter beyond two calendar days, a modulation monitor shall be installed and operated at the auxiliary transmitter. The monitor (if taken from the main transmitter) shall be reinstalled at the main transmitter immediately upon resumption of operation of the main transmitter.

In all cases where the auxiliary transmitter and the main transmitter have the same location, the same frequency and modulation monitors may be used for monitoring both transmitters, provided they are so arranged as to be readily switched from one transmitter to the other.

## 13. Requirements for Type Approval of Transmitters<sup>6</sup>

Section 3.254 of the Rules and Section 8 of these Standards concern the design, construction and technical operation of FM broadcasting station equipment. In order to facilitate the filing of and action on applications for construction permits specifying equipment of standard manufacture, the Commission will approve, as

complying with the technical requirements, such equipment by type, subject to the following conditions and in accordance with the following procedure:

**A. APPROVAL BY FCC:** Approval of equipment by the Commission is only to the effect that insofar as can be determined from the data supplied, the equipment complies with the current requirements of good engineering practice and the current technical Rules and Regulations of the Commission. The approval may be withdrawn upon subsequent inspection or operation showing the equipment is not as represented or does not comply with the technical Rules and Regulations of the Commission and the requirements of good engineering practice.

**B. PROGRESS OF THE ART:** Such approval shall not be construed to mean that the equipment will be satisfactory as the state of the art progresses and/or as the Rules and Regulations of the Commission may be changed as deemed advisable.

**C. APPROVED DESIGN:** Applicants specifying equipment of approved manufacture need not submit detailed descriptions and diagrams where the correct type number is specified provided that the equipment proposed is identical with that approved.

**D. PATENTS:** In passing on equipment, no consideration is given by the Commission to patent rights.

**E. APPLICATIONS FOR APPROVAL:** For approval of FM broadcast transmitters, manufacturers shall submit FCC Form 319 completed with respect to all pertinent sections (two sworn copies). In addition or included therein shall be the data set forth below, all of which shall be verified before a notary public.<sup>7</sup>

(1) Photographs or drawings, or any other evidence that construction is in accordance with the requirements of good engineering practice.

(2) Data and curves showing overall audio frequency response from 50 to 15,000 cycles for approximately 25, 50 and 100% modulation. Measurements shall be made on at least the following modulation frequencies: 50, 100, 500, 5,000, 10,000 and 15,000 cycles. This shall be plotted below a standard 75 microsecond pre-emphasis curve (see Fig. 3).

(3) Data on audio frequency harmonics for 25, 50 and 100% modulation for the fundamental frequencies of 50, 100, 400, 1,000 and 5,000 cycles. Data on audio frequency harmonics for 100% modulation for fundamental frequencies of 10,000 and 15,000 cycles. Measurements shall include harmonics to 30,000 cycles. (Measurements at 10,000 and 15,000 cycles at 25 and 50% modulation are not practical at this time, due to the de-emphasis in the measuring equipment.)

<sup>7</sup> In connection with its type approval of FM equipment, the Commission may send a representative to observe tests made by such equipment by the manufacturer.

(4) Carrier hum and extraneous noise (AM and FM) generated within the equipment and measured as the level below 100% modulation.

(5) Means of varying output power to compensate for power supply voltage variations.

(6) Data and curves on mean frequency stability for variations in ambient temperatures over the ranges encountered in practice.

(7) Data and curves on frequency stability for variations in power supply voltage from 85 to 115% normal.

(8) Net sale price.

**F. NON-LISTED POWER RATINGS:** In case any manufacturer decides to produce a 100-kw. transmitter and submit data on it for approval, or any power rating not listed as standard, he shall give notice to the Commission which will release by public notice the manufacturer's name and the standard power rating of the transmitter to be produced at least 6 months prior to the delivery date or completion of such transmitter.

## 14. Requirements for Type Approval of Frequency Monitors

Section 3.252 of the Rules requires each FM broadcast station to have in operation, at the transmitter, an approved frequency monitor independent of the frequency control of the transmitter. The frequency monitor shall be approved by the Commission and shall have a stability and accuracy of at least one-half ( $\pm 1,000$  cycles) of the permitted frequency deviation of the FM broadcast station. Visual indication of the operating frequency shall be provided.

**A. GENERAL REQUIREMENTS:** In general a frequency monitor for FM broadcast stations requires a stable source of radio frequency energy whose frequency is accurately known and a means of comparing the transmitter center frequency with this stable source. The visual indicator is calibrated to indicate the deviation of the transmitter center frequency from the frequency assigned.

Approval of a frequency monitor for FM broadcast stations will be considered on the basis of data submitted by the manufacturer. Any manufacturer desiring to submit a monitor for approval shall supply the Commission with full details (two sworn copies).

In approving a frequency monitor based on these tests and specifications, the Commission merely recognizes that the type of monitor has the inherent capability of functioning in compliance with Section 3.252, if properly constructed, maintained and operated. The Commission accepts no responsibility beyond this and further realizes that monitors may have a limited range over which the visual indicator will determine deviations. Accordingly, it may be necessary that adjunct equipment be used to determine major deviations.

<sup>5</sup> See Appendix 3 of Part I of the Rules and Regulations for addresses of Field Offices.

<sup>6</sup> Tentative Standard.



No change whatsoever will be permitted in the monitors sold under approval number issued by the Commission except when the licensee or the manufacturer is specifically authorized to make such changes. When it is desired to make any change, either mechanical or electrical, the details shall be submitted to the Commission for its consideration.

Approval is given subject to withdrawal if the unit proves defective in service and cannot be relied upon under usual conditions of maintenance and operation encountered in the average FM broadcast station. Withdrawal of approval means that no further units may be installed by FM broadcast stations for the purpose of complying with Section 3.252; however, this will not affect units already sold unless it is found that there has been an unauthorized change in design or construction or that the material or workmanship is defective.

**B. GENERAL SPECIFICATIONS:** The general specifications that frequency monitors shall meet before they will be approved by the Commission are as follows:<sup>9</sup>

(1) The unit shall have an accuracy of at least  $\pm 1,000$  cycles under ordinary conditions (temperature, humidity, power supply variations and other conditions which may affect its accuracy) encountered in FM broadcast stations throughout the United States, for any channel within the FM broadcast band.

(2) The range of the indicating device shall be at least from 2,000 cycles below to 2,000 cycles above the assigned center frequency.

(3) The scale of the indicating device shall be so calibrated as to be accurately read within at least 100 cycles.

(4) Means shall be provided for adjustment of the monitor indication to agree with an external standard.

(5) The monitor shall be capable of continuous operation and its circuit shall be such as to permit continuous monitoring of the transmitter center frequency.

(6) Operation of the monitor shall have no deleterious effect on the operation of the transmitter or the signal emitted therefrom.

**C. APPROVAL OF FREQUENCY MONITORS.** Tests to be made for approval of FM broadcast frequency monitors—The manufacturer of a monitor shall submit data on the following at the time of requesting approval:

(1) Constancy of oscillator frequency, as measured several times in one month.

(2) Constancy of oscillator frequency when subjected to vibration tests which would correspond to the treatment received in shipping, handling and installing the instrument.

(3) Accuracy of readings of the frequency deviation instrument.

<sup>9</sup> In connection with its type approval of FM equipment, the Commission may send a representative to observe tests made of such equipment by the manufacturer.

(4) Functioning of frequency adjustment device.

(5) Effects on frequency and readings, of the changing of tubes, of voltage variations, and of variations of room temperature through a range not to exceed 10° to 40° C.

(6) Response of indicating instrument to small changes of frequency.

(7) General information on the effect of tilting or tipping or other tests to determine ability of equipment to withstand shipment.

Various other tests may be made or required, such as effects of variation of input from the transmitter depending upon the character of the apparatus.

Tests shall be conducted in such a manner as to approximate actual operating conditions as nearly as possible. The equipment under test shall be operated on any channel in the FM broadcast band.

#### 15. Requirements for Type Approval of Modulation Monitors

Section 3.253 requires each FM broadcast station to have an approved modulation monitor in operation at the transmitter. This monitor may or may not be a part of the FM broadcast frequency monitor. Approval of a modulation monitor for FM broadcast stations will be considered on the basis of data submitted by the manufacturer. Any manufacturer desiring to submit a monitor for approval shall supply the Commission with full details (two sworn copies).

The specifications that the modulation monitor shall meet before they will be approved by the Commission are as follows:<sup>10</sup>

A. A means for insuring that the transmitter input to the modulation monitor is proper.

B. A modulation peak indicating device that can be set at any predetermined value from 50 to 120 per cent modulation ( $\pm 75$ -ke. swing is defined as 100 per cent modulation) and for either positive or negative swings (i.e., either above or below transmitter center frequency).

A semi-peak indicator with a meter having the characteristics given below shall be used with a circuit such that peaks of modulation of duration between 40 and 90 milliseconds are indicated to 90 per cent of full value and the discharge rate adjusted so that the pointer returns from full reading to 10 per cent of zero within 500 to 800 milliseconds. A switch shall be provided so that this meter will read either positive or negative swings.

The characteristics of the indicating meter are as follows: **SPEED**—The time for one complete oscillation of the pointer shall be 290 to 350 milliseconds. The damping factor shall be between 16 and 200. **SCALE**—The meter scale shall be similar in appearance to that of a standard

VU meter. The scale length between 0 and 100 per cent modulation markings should be at least 2.3 inches. In addition to other markings, a small mark for 133 per cent modulation and designated as such should be included for the purpose of testing transmitters with 100-ke. swing.

C. The accuracy of reading of percentage of modulation shall be within  $\pm 5$  per cent modulation percentage at any percentage of modulation up to 100 per cent modulation.

D. The frequency characteristic curve shall not depart from a straight line more than  $\pm \frac{1}{2}$  db from 50 to 15,000 cycles. Distortion shall be kept to a minimum.

E. The monitor shall not absorb appreciable power from the transmitter.

F. Operation of the monitor shall have no deleterious effect on the operation of the transmitter.

G. General design, construction and operation shall be in accordance with good engineering practice.

#### 16. Approved Transmitters.<sup>10</sup>

#### 17. Approved Frequency Monitors.<sup>10</sup>

#### 18. Approved Modulation Monitors.<sup>10</sup>

#### 19. FM Broadcast Application Forms

FCC Form No. 314—Application for Consent to Assignment of Radio Broadcast Station Construction Permit of License. (See Rules Section 3.223.)

FCC Form No. 315—Application for Consent to Transfer of Control of Corporation Holding Construction Permit or Station License. (See Rules Section 3.223.)

FCC Form No. 316—Inventory of Station Property to be submitted with Forms FCC No. 314 and 315.

FCC Form No. 319—Application for New FM Broadcast Station Construction Permit.

FCC Form No. 320—Application for FM Broadcast Station License.

FCC Form No. 322—Application for Construction Permit, Modification of Construction Permit, or Modification of License for an Existing FM Broadcast Station.

FCC Form No. 328—Income Statement to be submitted with Forms FCC No. 314 and 315.

FCC Form No. 340—Application for New Noncommercial Educational Broadcast Station Construction Permit.

FCC Form No. 701—Application for Additional Time to Construct Radio Station.

Additional forms and revisions of the above forms are being prepared. The appropriate forms to be employed may be obtained from the Commission upon request.

<sup>10</sup> Lists of approved equipment will be issued from time to time for incorporation in these Standards.



## RULES & REGULATIONS

On June 21, 1946, the FCC amended the Rules and Regulations, Sub part B of Part 3, concerning FM broadcast stations. This change is referred to in the footnote on page 139. Also, on August 22, 1946, provisions were made to withhold certain FM broadcast frequencies. The revised text follows:

**3.202 Areas of the United States** ★ For the purpose of allocation the United States is divided into two areas. The first area — Area I — includes southern New Hampshire; all of Massachusetts, Rhode Island, and Connecticut; southeastern New York as far north as Albany-Troy-Schenectady; all of New Jersey, Delaware, and the District of Columbia; Maryland as far west as Hagerstown; and eastern Pennsylvania as far west as Harrisburg.<sup>1</sup> The second area — Area II — comprehends the remainder of the United States not included in area I.

**3.203 Class A Stations** ★ (a) A Class A Station is a station which operates on a Class A channel and is designed to render service primarily to a community or to a city or town other than the principal city of an area, and the surrounding rural area. The transmitter power and antenna height of a class A station shall normally be capable of coverage equivalent<sup>2</sup> to a minimum of 0.1 kw. and a maximum of 1.0 kw. effective radiated power at 250 ft. antenna height, as determined by the methods prescribed in the Standards of Good Engineering Practice Concerning FM Broadcast Stations. Class A stations will not be authorized with more than 1 kw. effective radiated power. Standard power ratings of transmitters used for Class A stations shall be not less than 250 watts nor more than 1000 watts. A normal minimum separation for Class A stations of 50 miles will be provided on the same channel and 35 miles on adjacent channels.

(b) Twenty channels beginning with

<sup>1</sup> In some of the territory contiguous to area I, the demand for frequencies requires that applications be given careful study and consideration to insure an equitable distribution of facilities throughout the region. This region includes the remainder of Maryland, Pennsylvania, and New York, (except the north-eastern corner) not included in area I; Virginia, West Virginia, North Carolina, South Carolina, Ohio, and Indiana; southern Michigan as far north as Saginaw; eastern Illinois as far west as Rockford-Decatur; and southeastern Wisconsin as far north as Sheboygan. Other regions may be added as required.

<sup>2</sup> For the purpose of determining equivalent coverage, the 1000  $\mu\text{v}/\text{m}$  contour should be used.

104.1 mc. and ending with 107.9 mc. (channels 281 through 300) are designated as Class A channels. All of these channels are available for assignment in cities which are not the central city or cities of a metropolitan district. Ten of these channels are also available for assignment in central cities of metropolitan districts which have fewer than six Class B stations.<sup>3</sup>

(c) The main studio of a class A station shall be located in the city served and the transmitter shall be located as near the center of the city as practicable.

**3.204 Class B Stations** ★ (a) A Class B station is a station which operates on a Class B channel and is designed to render service primarily to a metropolitan district or principal city and the surrounding rural area, or to rural areas removed from large centers of population. The service area of a class B Station will not be protected beyond the 1000  $\mu\text{v}/\text{m}$  contour; however, class B assignments will be made in a manner to insure, insofar as possible, a maximum of service to all listeners, whether urban or rural, giving consideration to the minimum signal capable of providing service. Standard power ratings of transmitters used for class B stations shall normally be 1000 watts or greater. In the following subsections, antenna height above average terrain and effective radiated power are to be determined by the methods prescribed in the Standards of Good Engineering Practice Concerning FM Broadcast Stations.

(1) In Area I, class B stations will be licensed to operate with a service area equivalent<sup>2</sup> to a minimum of 10 kw. effective radiated power and antenna height of 300 ft. above average terrain, and a maximum of 20 kw. effective radiated power and antenna height of 500 ft. above average terrain.<sup>4</sup> In metropolitan districts in Area I with a population greater than 250,000, the minimum service area shall be the equivalent<sup>2</sup> of 20 kw. effective radiated power and an antenna height of 350 ft. above average terrain. Class B stations in Area I will not be licensed with an effective radiated power greater than 20 kw.

(2) In Area II, class B stations will be licensed to operate with a service area

<sup>3</sup> For the time being, until more FM broadcast stations are authorized, the Commission will not authorize Class A stations in central cities of metropolitan districts having four or more standard broadcast stations.

equivalent<sup>2</sup> to a minimum of 2 kw. effective radiated power and antenna height of 300 ft. above average terrain, and a normal maximum of 20 kw. effective radiated power and antenna height of 500 ft. above average terrain.<sup>4</sup> The use of greater power and antenna height will be encouraged in those portions of Area II where such use would not result in undue interference to stations already authorized or to probable assignments insofar as can be determined at the time of the grant. In such case, the power, antenna height and area will be determined on the merits of each application with particular attention being given to rural areas which would not otherwise receive service.

(b) Sixty channels beginning at 92.1 mc. and ending at 103.9 mc. (channels 221 through 280) are designated as Class B channels.

(c) For the period ending June 30, 1947, one out of every 5 Class B channels tentatively indicated as available to an area shall be withheld from assignment: Provided, however, that the withholding shall apply only to those areas to which at least 5 Class B channels have been so assigned.

**3.205 Station location** ★ (a) Each FM Broadcast station shall be considered located in the state and city where the main studio is located.

(b) The transmitter of each FM broadcast station shall be so located that satisfactory service is delivered to the city where the main studio is located, in accordance with the Standards of Good Engineering Practice Concerning FM Broadcast Stations; provided, however, upon special showing of need, authorization may be granted to locate the transmitter so that adequate service is not rendered to this city, but in no event shall this city be beyond the 50  $\mu\text{v}/\text{m}$  contour.

**3.206 Main Studio** ★ The term "main studio" means the studio from which the majority of local programs originate and/or from which a majority of station announcements are made of programs originating at remote points.

<sup>4</sup> In the determination of appropriate coverage, consideration should be given to population distribution, terrain, service from other FM stations, trade area and other economic factors. Among the recognized trade area authorities are the following: J. Walter Thompson (Retail Shopping Areas), Hearst Magazines, Inc. (Consumer Trading Areas), Rand McNally Map Co. (Trading Areas), and Hagstrom Map Co. (Four Color Retail Trading Area Map).

# *Notes*

## *Notes*



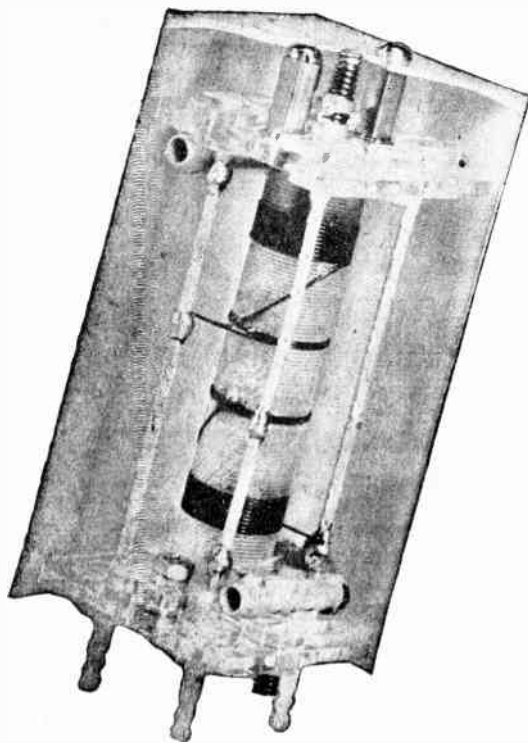

# NEW IF TRANSFORMERS

These new IF transformers are designed to meet the highest standards of performance in high frequency FM and AM. All operate at 10.7 Mc., making them ideal for the new FM band. Iron core tuning is employed and the tuning does not affect the bandwidth of 100 Kc. for the IFN or 150 Kc. for the IFM.

The discriminator output is linear over the full 150 Kc. output and remains symmetrical regardless of the position of the tuning cores.

Insulation is polystyrene for low losses. Mechanical construction is simple, compact and rugged. The transformer is 1 3/8 inches square and stands 3 1/8 inches above the chassis.



**NATIONAL COMPANY, INC., MALDEN, MASS.**

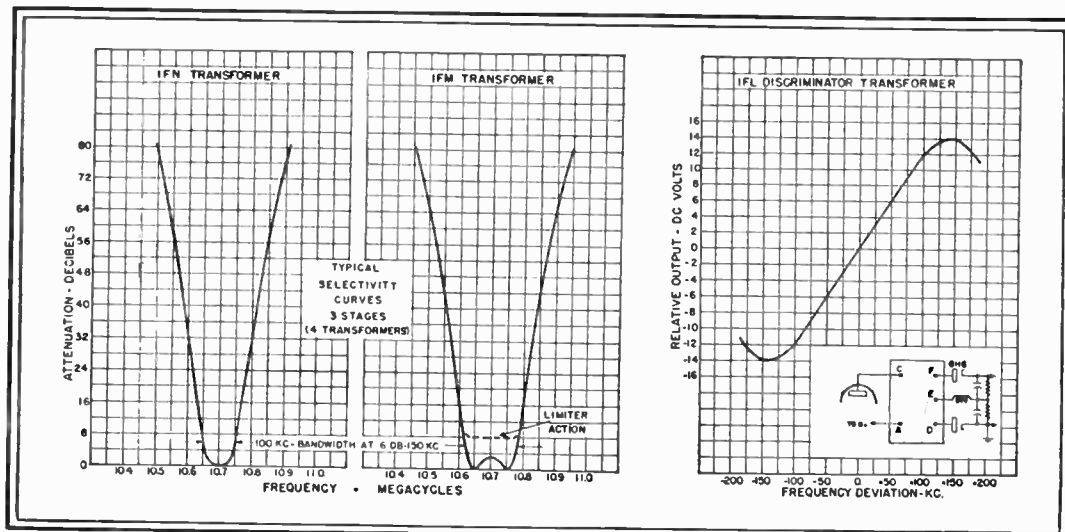

**W**e draw your particular attention to the comprehensive construction services we offer to Broadcasters, from selection of site, through the planning of buildings, the design of studios, the installation of equipment, to the finished station ready for operation.

*Raymond M. Wilmotte*

As Consulting Engineers we will furnish special or general engineering advice, information, and assistance in connection with the establishment of broadcast stations.

As Engineers and Constructors our services cover every detail of planning and supervision to the extent desired by the client in the construction of complete broadcast stations.

The head of this organization is Raymond M. Wilmotte, nationally known pioneer and consultant in radio. Associated with Mr. Wilmotte are:

Paul A. deMars, one of the foremost engineers and experimenters in radio, and nationally known for his pioneering in FM.

Jackson & Moreland, one of the leading firms in the electrical and construction fields.

We will welcome inquiries and will gladly furnish further details upon request.



**RAYMOND M. WILMOTTE Inc.**

CONSULTING ENGINEERS • RADIO & ELECTRONICS

1469 CHURCH STREET, N. W., WASHINGTON 5, D. C.

New York Laboratories: 236 W. 55th Street, New York 19, N. Y.

# Three Great BROWNING Achievements

**T**HE BROWNING FM-AM Tuner meets the individual needs of installations in the home, or in public halls and auditoriums, broadcast studios, audition rooms, and laboratories. Furnished without speaker, power supply, and amplifier, it can be used in the simplest or most elaborate audio systems and record players.

Genuine Armstrong circuits cover 88 to 108 mc. Full limiter action on 15 microvolts assures maximum distance and effective static elimination. AM tuning range, 535 to 1650 kc.

Prices: FM-AM Tuner, model RJ-12, illustrated, \$114.50. With rack panel mounting, model RJ-14, \$134.80. Power Supply for Tuner, model PF-12, \$14.75 (Plus 10% Federal Tax).

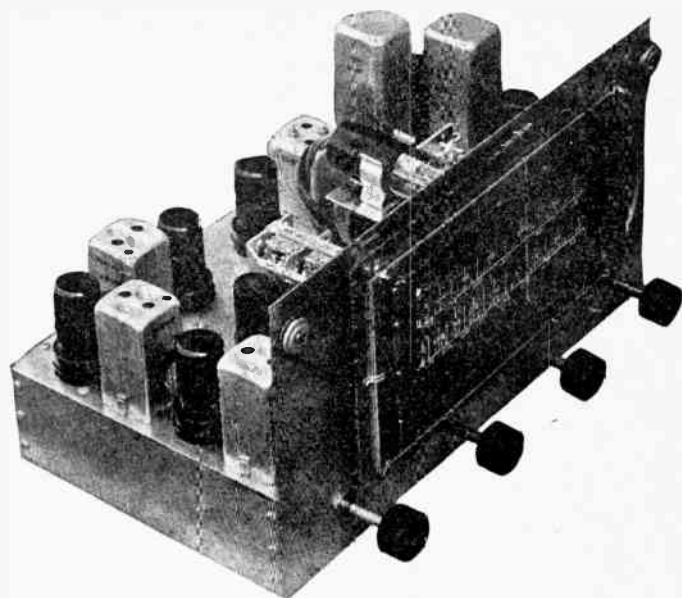

**T**HE BROWNING Frequency Calibrator is a WWV receiver, operating on 5 mc. or 10 mc., equipped with special circuits and filters for calibrating all types of RF and AF measuring equipment to WWV's accuracy of 1 part in 10,000,000. Thus, at small cost, it makes primary standards available in any laboratory. Price: with tubes, model RH-10, \$175.00.

**T**HE BROWNING Oscilloscope is intended for the observation of wave forms and transient phenomena requiring a variety of time bases, triggers, phasing and delay circuits, and extended-range amplifiers. It is suitable for studying extremely short pulses occurring at irregular intervals in television, communications, radar, and facsimile circuits. Further details on request. Price: Laboratory Oscilloscope, model OL-15, \$1275.00.

*For Technical Data, Write*

**BROWNING LABORATORIES, Inc.**

*Engineers and Manufacturers*

WINCHESTER

MASSACHUSETTS

CANADIAN REPRESENTATIVES:

MEASUREMENT ENGINEERING, LTD., 61 DUKE ST., TORONTO, CANADA

154

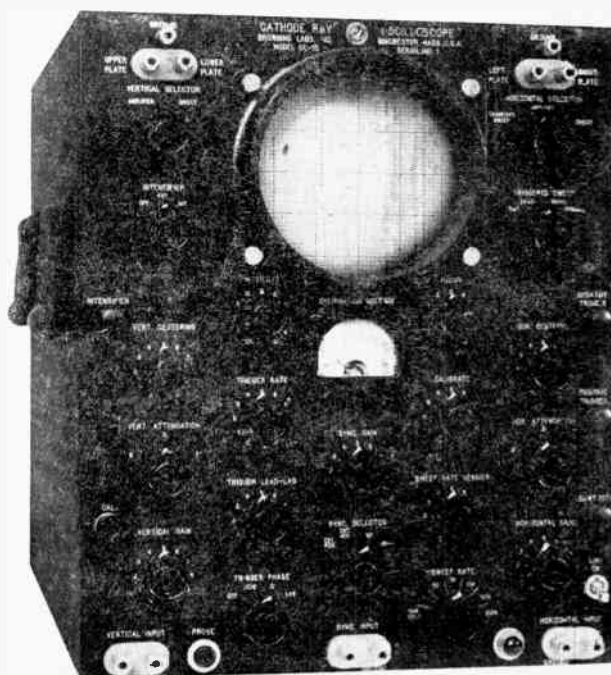



# Comco—ready first with FM

for (152-162) megacycle band

is now first to have had equipment—

**TESTED . . . BOUGHT . . . DELIVERED . . . INSTALLED**  
*for*  
**TAXICABS . . . RAILROADS . . . POLICE . . . TRUCK FLEETS**

**SOMEONE** asked "Why is Comco so far ahead in the VHF Field". The answer is that we pioneered before the War in developing VHF aeronautical equipment and continued during the War manufacturing equipment in this field. Hence our circuits were perfected, our models were fully developed, and our production lines were set up, ready to deliver when the FCC allocated the new bands. Hence we very naturally led the field in offering practical working tests . . . and as these tests proved the effectiveness of our equipments, they were bought and are doing their job well in all these fields.

We will be glad to discuss your mobile-unit communication and control problems, by mail or in person.

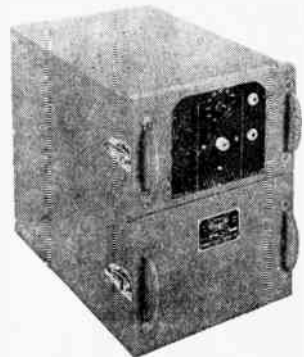

*COMCO Model 210, 15 Watt, FM VHF 152-162 Megacycles Mobile Transmitter Receiver for Taxicabs, Police Cars, etc. Size 10 $\frac{1}{4}$ " x 13 $\frac{1}{2}$ " x 14 $\frac{3}{4}$ ", weight 50 lbs.*

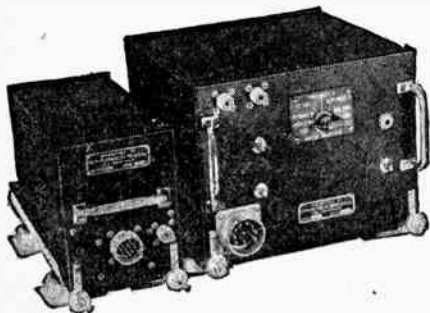

*Engineered for VHF mobile services for operation on 6, 32, 64 and 110 volts D.C. and 117 volts A.C. current. COMCO Model 172-T Transmitter provides 15 watts on 152-162 Mc band. Models for dual channel operation now available. Weight 12 $\frac{1}{2}$  pounds.*

*COMCO Model 173-R Receiver provides extreme sensitivity with 1 watt audio output. Dual channel operation. Weight 7 pounds.*

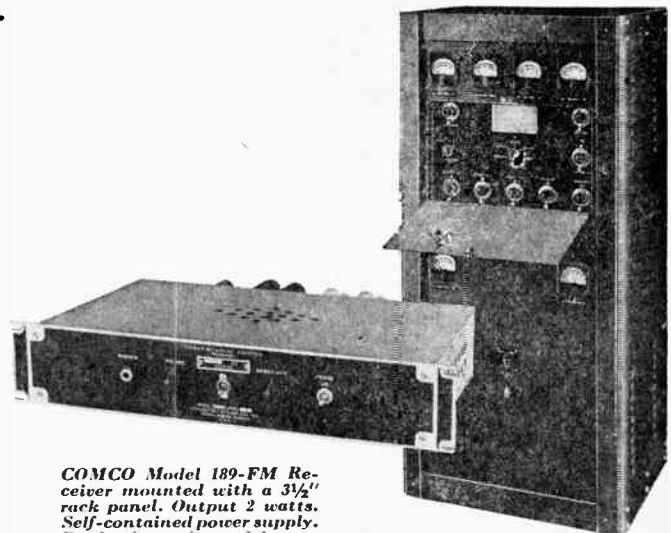

*COMCO Model 189-FM Receiver mounted with a 3 $\frac{1}{2}$ " rack panel. Output 2 watts. Self-contained power supply. Dual channel models are available, if desired.*

*COMCO Model 170-FM Transmitter, built for continuous duty, full 50 watts output. Entirely self-contained with complete metering provided. 48" x 23" x 18". Dual channel operation and remote control units available.*

*Write for Complete Details*

MANUFACTURERS OF RADIO  & ELECTRONIC EQUIPMENT

**COMMUNICATIONS COMPANY, Inc.**

CORAL GABLES 34, FLORIDA



# Westinghouse Electric Corporation

Plants in 25 Cities — Offices Everywhere

INDUSTRIAL ELECTRONICS DIVISION — BALTIMORE, MARYLAND

## WESTINGHOUSE FM TRANSMITTERS

Westinghouse 1, 3 and 10 kw FM transmitters are designed to meet the operator's requirements. A survey of 162 station managers, chief engineers and transmitter operators in 56 cities, plus the experience of operating five FM broadcast stations, has resulted in the new Westinghouse operator's FM transmitter. The development of a 50 kw transmitter is proceeding and deliveries will be scheduled for 1947.

The FM-1 and FM-3 transmitters use the same single cubicle construction with essentially the same arrangement of equipment. In the FM-3, two tubes each are used in the driver and amplifier stages, while in the FM-1 one each of the same tubes is used for these stages. Also, in the FM-3 six type 872-A rectifier tubes are used, as compared with two in the FM-1. The FM-10 transmitter comprises the FM-3 transmitter as the left end cubicle, with the high voltage rectifier cubicle in the center and the power amplifier cubicle at the right end.

### Roomy, easy-access design

Westinghouse 1, 3 and 10 kw FM transmitters are styled to allow the operator to reach all tubes quickly from easily-opened front panels, to check tubes visually through front and rear glass panels. Frequency modulated master oscillator unit and frequency control unit are built on standard relay rack chassis and equipped with plug-in connectors to allow easy removal.

The entire design permits easy access and roomy working space. From top to bottom on the front panels of the 1 and 3 kw cubicle are: (1) a hinged window that lifts up and locks in open position, making it easy to service; (2) a control panel which folds out of the way and a hinged panel which comes forward to permit inspection and cleaning; and (3) two lower doors which open to removable master oscillator and frequency control units, power switches and relays.

### Vertical, open arrangement for easy service of rear compartment

The vertical arrangement is continued in the rear compartments. In the lower left corner are two motor-driven voltage regulators and immediately to their right is the blower motor and air duct. Dust-tight covers are provided for the plug-in units. There are two complete crystal oscillators and their plug-in crystals.

On the upper panel, right to left, are the r.f. driver, concentric line-type tank circuits, variable coupling loop and P.A. concentric cathode line.

Outstanding features of the Westinghouse FM transmitters are:

1. Direct generation of the modulated carrier by a simple and straightforward circuit.
2. Crystal-derived center-frequency stabilization independent of circuit tuning.
3. Extremely conservative ratings on all power transformers.
4. Complete fuseless overload protection.
5. No oil-cooled components.
6. Supervisory control.
7. Low operating cost.
8. Ease of maintenance.
9. Lead covered wire used for all cubicle wiring where appropriate.
10. Conservative operation of tubes and components.

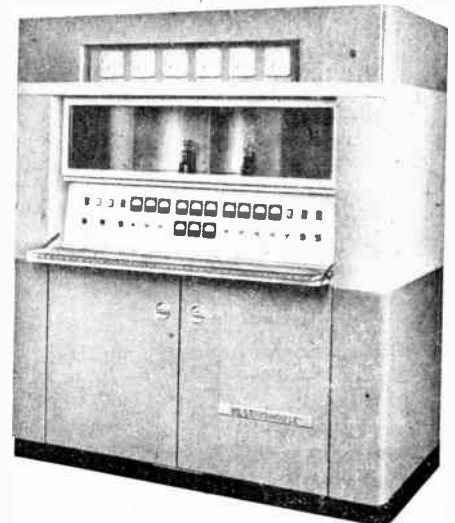

Centrally-located control panel is easily accessible through door that folds out of the way. Control panel includes power switches; electrically-driven tuning controls and their position indicating instruments; 6 meters in center panel associated with low power stages; controls for continuously variable line voltage and P.A. plate voltage and indicator lights.

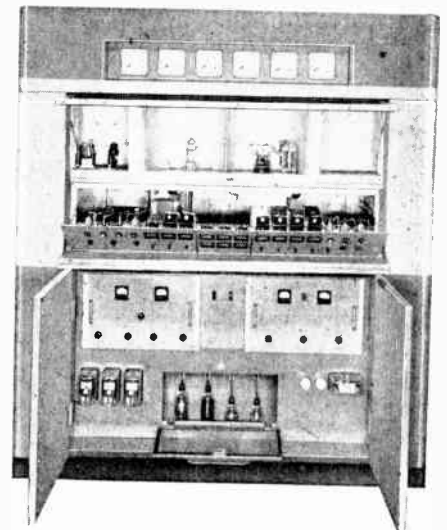

All openings to live circuits are equipped with interlocks and grounding switches. Aluminum cubicle provides excellent shielding at 100 mc. In lower section of cubicle are plug-in frequency modulated master oscillator and frequency control units, low-voltage rectifier tubes and high voltage rectifier tubes. Relays, left to right, are: 250, 400 and 2000-volt overload protection; bias protection for r.f. driver and P.A. tubes, and time delay relay to protect mercury vapor rectifier tubes.

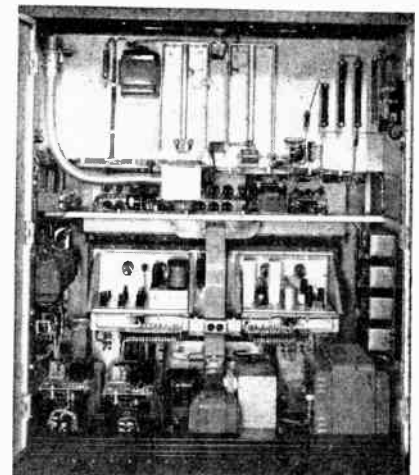

Large windows in rear doors permit inspection of interior. Flexible output transmission line can be seen at upper left. Note convenience power outlet, and lamp for lighting mounted at top of cubicle.

# WESTINGHOUSE ELECTRIC CORPORATION

## Electrical Specifications

Additional features of the 10 kw FM transmitter include:

1. Tetrode type tubes WL-479R, in the 10 kw power amplifier.
2. The use of only three cubicles makes alignment, installation, and inter-connection of the cubicles relatively simple and inexpensive.
3. Automatic sequence starting.
4. May be adapted easily for higher power by adding a 50 kw amplifier unit.

### Westinghouse Transmission Lines and Antennas

Westinghouse FM transmitters will operate into any suitable combination (r.f. output impedance, 40–80 ohms) of r.f. transmission lines and antenna within the 88–108 mcs band. The transmission lines are coaxial pressurized for 1, 3, and 10 kw transmitters.

The antenna is a horizontally-polarized turnstile system using folding dipoles. It is equipped to mount a standard 300 mm airways hazard beacon and has facilities for bolting to a supporting tower. The antennas are available with 1, 2, 4, 6, and 8 bays. Antennas can be supplied with or without sleet melting units.

	TYPE FM-1	TYPE FM-3	TYPE FM-10
Power Output	1000 watts	3000 watts	10,000 watts
Frequency Range (single specified frequency)	88–108 mc/s	88–108 mc/s	88–108 mc/s
Center-Frequency Stability	± 1000 cycles	± 1000 cycles	± 1000 cycles
Modulation Capability	± 100 kc	± 100 kc	± 100 kc
Audio-Frequency Response, 50 to 15,000 cps	± 1 db from 1000 cycle value without pre-emphasis; ± 1 db from 75 microsecond curve with pre-emphasis	± 1 db from 1000 cycle value without pre-emphasis; ± 1 db from 75 microsecond curve with pre-emphasis	± 1 db from 1000 cycle value without pre-emphasis; ± 1 db from 75 microsecond curve with pre-emphasis
Audio-Frequency Harmonic Distortion, ± 75 kc swing 50–15,000 cps 100–7,500 cps	Not greater than 1.5% rms 1.0% rms	Not greater than 1.5% rms 1.0% rms	Not greater than 1.5% rms 1.0% rms
Frequency Modulation Noise	At least 65 db below 75 kc swing	At least 65 db below 75 kc swing	At least 65 db below 75 kc swing
Amplitude Modulation Noise	At least 50 db below 100% amplitude modulation	At least 50 db below 100% amplitude modulation	At least 50 db below 100% amplitude modulation
Audio Input Level for 100% Modulation (75 kc swing)	+ 10 dbm ± 2 db	+ 10 dbm ± 2 db	± 10 dbm at 400 cycles
Audio Input Impedance	600/150 ohms	600/150 ohms	600/150 ohms
R.F. Output Coupling Impedance Range	40–80 ohms	40–80 ohms	40–80 ohms
Power Supply	208/230 volts, single-phase, 50 or 60 cycles	208/230 volts, 3-phase, 50 or 60 cycles	208/230 volts, 3-phase, 50 or 60 cycles; 115 volts, 50 or 60 cycles, single phase for crystal heaters
Power Input	3600 watts at 90% power factor	8500 watts at 90% power factor	31 kw at 90% power factor for full output

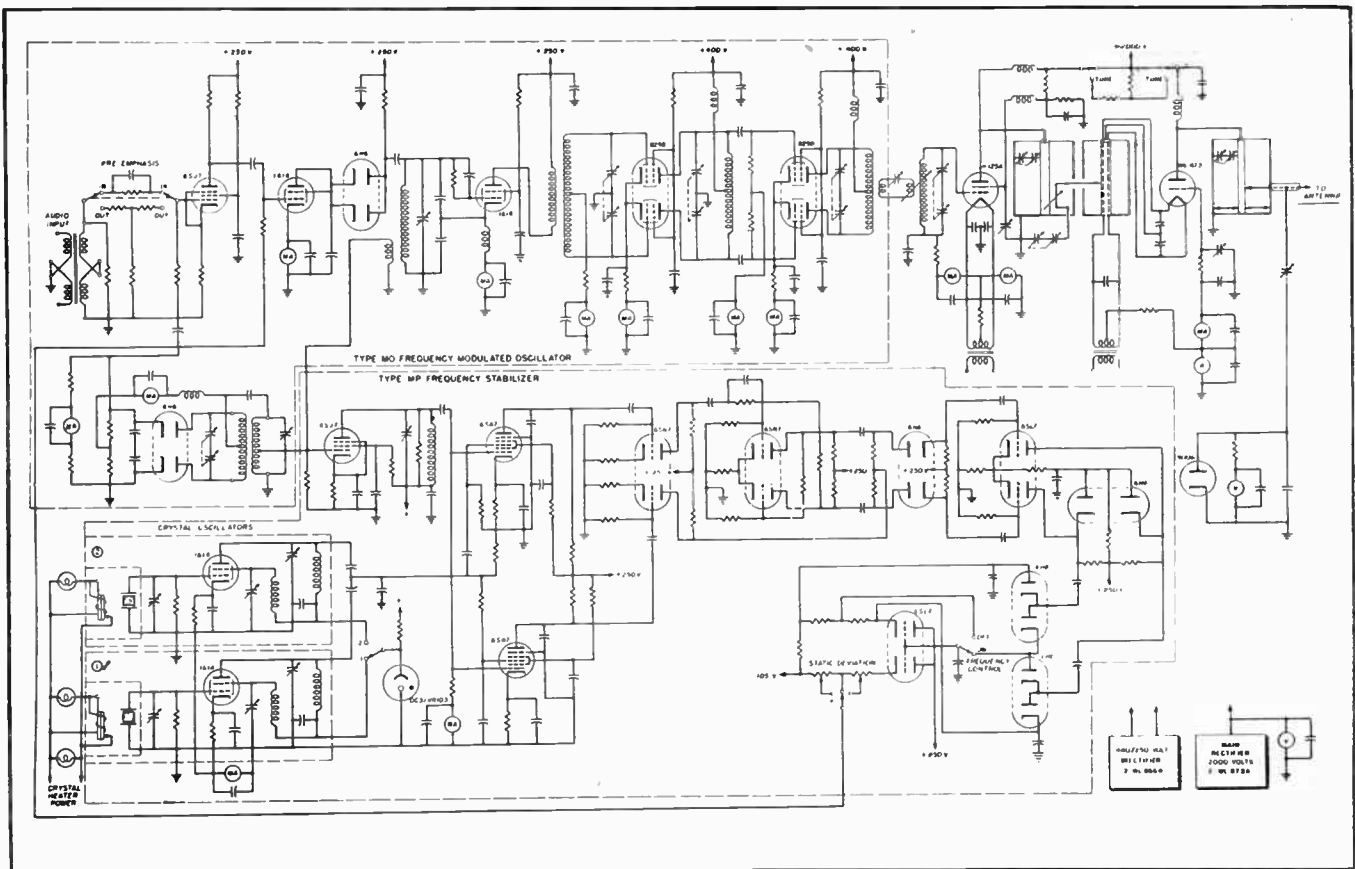

Schematic diagram of a 1-kw FM transmitter. In type FM-3 transmitter, the r.f. driver has two type 4-125A tubes, and the power amplifier uses two type WL-473A tubes, both in push-pull, and the h.v. rectifier uses six type WL-872A tubes.



## For FM and TV

NEW ANDREW COAXIAL CABLE WITH  
**51.5 OHMS IMPEDANCE!**

### Meets Rigid FM-TV Standards

A new coaxial cable, especially designed for FM and TV use, is now a reality at the Andrew Co. Scheduled for mid-June delivery to the first orders received, these new cables, in 4 sizes, introduce the following important engineering features:

1. Characteristic impedance of 51.5 ohms. (The regular Andrew cables for AM applications have a nominal impedance of 70 ohms.)
2. Connectors and associated fittings have been engineered with special care to avoid reflections and discontinuities. Being completely solderless, these fittings simplify installation and eliminate problems of flux corrosion and pressure leaks.
3. Insulators are spaced 12 inches apart in the 3 large size cables, and 6 inches in the 7/8-inch cable.
4. Improved low loss insulation material is used, having a dielectric constant of 6.0 and a maximum loss factor of .004 at 100 mc.
5. Close tolerances have been established on conductor and insulator dimensions, in order to maintain a constant characteristic impedance.

6. Inner and outer conductors are made of copper having a minimum conductivity of 95% IACS at 25° centigrade.

Your order now is the best assurance of early delivery on this new coaxial cable for your FM or TV installation.

Write or wire the Andrew Co., 363 East 75th Street, Chicago 19, Illinois, for complete information or engineering advice on your particular application.

#### ATTENUATION CURVE

Attenuation is calculated to provide for conductor and insulator loss, including a 10% derating factor to allow for resistance of fittings and for deterioration with time.

• The new 51.5 ohm air insulated coaxial cable for FM and TV comes in 4 sizes, priced tentatively as follows: 7/8", 42c per ft.; 1 1/8", 90c per ft.; 3 1/8", \$2.15 per ft.; 6 1/8", \$5.20 per ft. Andrew Co. also manufactures a complete line of accessories for coaxial cables.

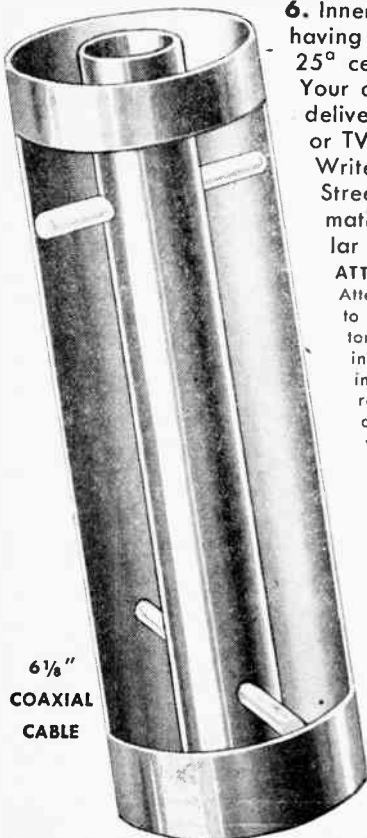
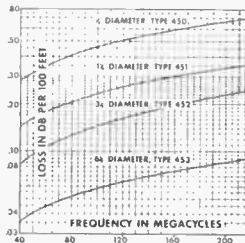

6 1/8"  
COAXIAL  
CABLE

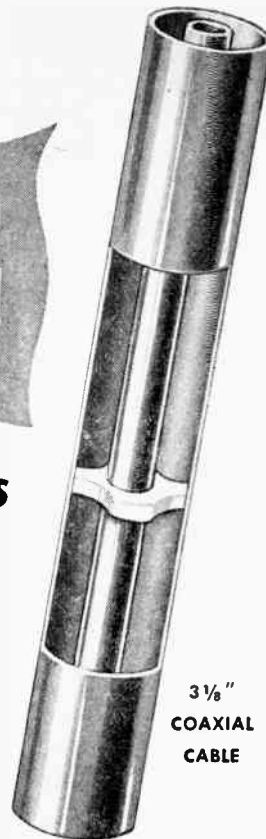

3 1/8"  
COAXIAL  
CABLE

## These Back Issues Give the Details of FM and Television Progress

### • 1941 •

- |                                   |                                    |
|-----------------------------------|------------------------------------|
| <input type="checkbox"/> January  | <input type="checkbox"/> July      |
| <input type="checkbox"/> March    | <input type="checkbox"/> August    |
| <input type="checkbox"/> April    | <input type="checkbox"/> September |
| <input type="checkbox"/> May      | <input type="checkbox"/> October   |
| <input type="checkbox"/> June     | <input type="checkbox"/> November  |
| <input type="checkbox"/> December |                                    |

### • 1942 •

- |                                   |                                    |
|-----------------------------------|------------------------------------|
| <input type="checkbox"/> January  | <input type="checkbox"/> June      |
| <input type="checkbox"/> February | <input type="checkbox"/> July      |
| <input type="checkbox"/> March    | <input type="checkbox"/> September |
| <input type="checkbox"/> April    | <input type="checkbox"/> October   |
| <input type="checkbox"/> May      | <input type="checkbox"/> November  |
| <input type="checkbox"/> December |                                    |

### • 1943 •

- |                                   |                                    |
|-----------------------------------|------------------------------------|
| <input type="checkbox"/> January  | <input type="checkbox"/> May       |
| <input type="checkbox"/> February | <input type="checkbox"/> June      |
| <input type="checkbox"/> March    | <input type="checkbox"/> September |
| <input type="checkbox"/> April    | <input type="checkbox"/> October   |
| <input type="checkbox"/> November |                                    |

### • 1944 •

- |                                   |                                    |
|-----------------------------------|------------------------------------|
| <input type="checkbox"/> March    | <input type="checkbox"/> August    |
| <input type="checkbox"/> April    | <input type="checkbox"/> September |
| <input type="checkbox"/> May      | <input type="checkbox"/> October   |
| <input type="checkbox"/> July     | <input type="checkbox"/> November  |
| <input type="checkbox"/> December |                                    |

### • 1945 •

- |                                   |                                    |
|-----------------------------------|------------------------------------|
| <input type="checkbox"/> February | <input type="checkbox"/> May       |
| <input type="checkbox"/> March    | <input type="checkbox"/> August    |
| <input type="checkbox"/> April    | <input type="checkbox"/> September |
| <input type="checkbox"/> December |                                    |

Take this opportunity to complete your files. There are only a few copies of many of the issues listed above. Order promptly, as these copies are offered subject to prior sale.

Price: 25¢ each, postpaid;

6 copies \$1.00

**FM AND TELEVISION**

CIRCULATION DEPARTMENT

Great Barrington, Mass.

**ANDREW CO.**

363 EAST 75th STREET  
CHICAGO 19, ILLINOIS

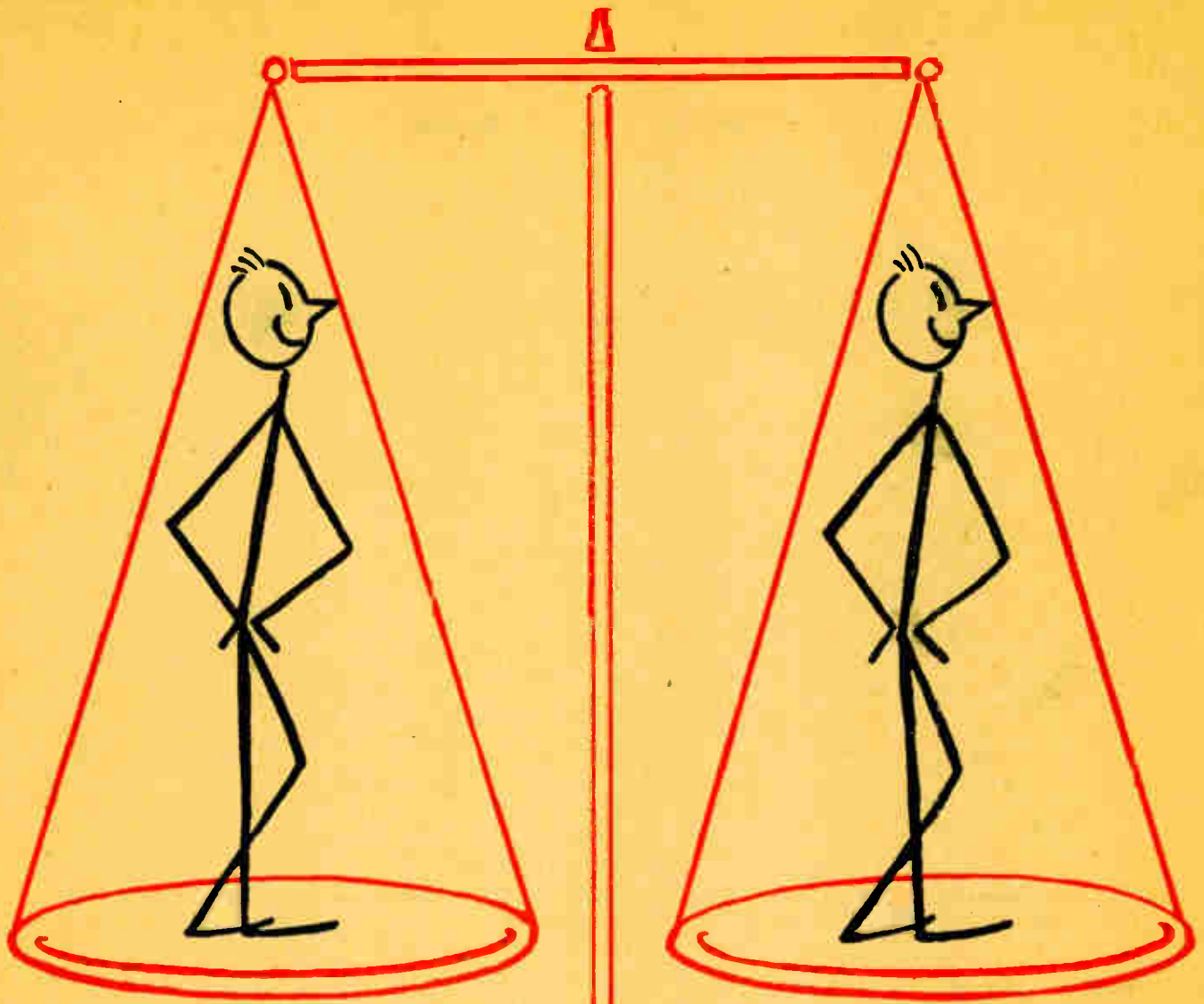

*don herold*

we  
believe  
in  
uniformity

Even through the war years, when conditions were difficult, we were able to maintain the uniformity of our thin gauge papers for important military equipment. We continue this ability for you for peace time products, including capacitors, coils, transformers and other insulating purposes, requiring thin gauge papers. Our grades range in thickness from .00025" to .004" with extremely low tolerance limits. Specify Schweitzer for thin gauge paper.

**SCHWEITZER PAPER CO.**

182 Cornelison Ave., Jersey City, N. J.  
Plants: Jersey City, Mt. Holly Springs, Pa.  
Research Laboratories: Chrysler Bldg.  
New York, N. Y.

**SPECIALISTS IN THIN GAUGE INSULATING PAPERS**



# NEW VARIACS with these 12 Features

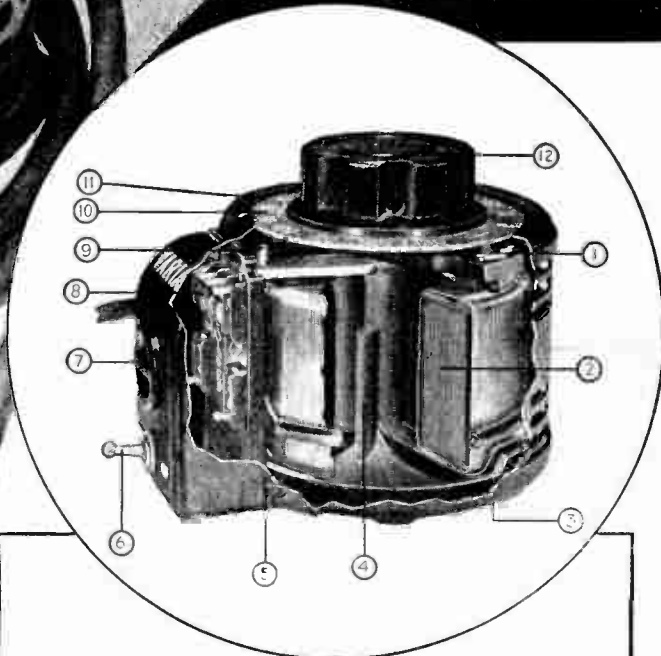

for  
Improved Performance  
Greater Convenience  
Longer Life

● This new Type V-5 VARIAC replaces the popular Type 200-C. Through entirely new design and radical changes in basic structure the new model is 25% lighter, with the same rating of 860 va. This is achieved both through improved magnetic performance of the core and less copper, and through use of aluminum in most of the structure.

Some of the new VARIAC's many features are listed at the right. Externally, the new VARIAC has been streamlined to eliminate all sharp corners. The cord on the mounted model is arranged to be wound around the VARIAC, plugged into the outlet, and then used as a carrying strap.

This is the first radical change in basic design of the VARIAC since it was introduced by G-R almost 15 years ago. These many changes were made not to dress up the VARIAC in a new case but to provide real improvements to better its performance, increase its convenience and lengthen its life, and to be sure that when you use a VARIAC you are using the best means possible for controlling any alternating-current operated device where perfectly s-m-o-o-th variation in voltage is desired.

### TYPE V-5 860 va VARIAC STYLE

TYPE	STYLE	PRICE
V-5	Basic (115-volt input) unmounted model	\$16.50
V-5M	Above with protective case around winding	17.50
V-5MT	A V-5 with protective case, terminal cover, 6-foot cord, switch and outlet	20.00
V-5H	Same as V-5, except for 115- or 230-volt input	21.50
V-5HM	Same as V-5M, except for 115- or 230-volt input	22.50
V-5HMT	Same as V-5MT, except for 115- or 230-volt input	25.00

WRITE FOR COMPLETE DATA

- 1 New G-R Unit Brush — low sprung weight reduces hammering and arcing under vibration — correct pressure provided by coil spring — holder cannot make contact with winding and cause short-circuit — brush changed quickly without tools.
- 2 New grain-oriented core of cold-finished silicon-steel with guaranteed maximum core loss — scrip wound.
- 3 Three rubber feet prevent marring table top and make it unnecessary to screw units down to prevent slippage.
- 4 Aluminum structure contributes to greatly increased output per pound.
- 5 Only two screws hold both case and terminal cover — a screwdriver or a spare dime remove each in a second.
- 6 Heavy-duty switch breaks both sides of the line, in mounted models.
- 7 Polarity indication provided in convenience outlet — useful if one side of line is grounded.
- 8 Improved molded terminal plate protected by a metal, fiber-lined cover — molded barriers between terminals prevent short-circuits from whiskers on stranded wire — both screw and solder terminals — engraved circuit diagram shows normal VOLTAGES between terminals — 2 extra terminals for use with auxiliary transformers.
- 9 New resilient stop allows brush arm to bounce instead of break if you are too vigorous in rotating knob.
- 10 BIG calibration figures and extra points on dial — easy to read at a distance — easier to reset — pointer provided for panel mounting.
- 11 A single screw, readily accessible under dial, loosens shaft for reversing dial and knob to change from table to panel mounting without affecting brush or stop settings.
- 12 Newly designed, larger knob — easier to hold — easier to turn.

# GENERAL RADIO COMPANY

Cambridge 39,  
Massachusetts

90 West St., New York 6 920 S. Michigan Ave., Chicago 5 950 N. Highland Ave., Los Angeles 38





PRINTED AND ILLUSTRATED MESSAGES BY WIRE OR RADIO



*Finch Teletax Duplex Unit*

# finch facsimile

Finch Telefax equipment transmits and records exact facsimiles of written or printed messages — as well as drawings, photographs, signatures, etc. at a speed by telephone of 900 square inches per hour — or

by radio of 2760 square inches per hour, equivalent to 30,000 words! This provides a fast, flexible, accurate and economical new service to solve your communication problems. Write for full particulars.

## **FINCH TELECOMMUNICATIONS, INC.**

*Address all inquiries to Sales Office*

**10 EAST 40th STREET • NEW YORK 16, N. Y.**

Makers also of Facsimile Broadcast Transmitting Equipment, Facsimile Home Recorders, Facsimile Duplicating Machines, and Finch Rocket Antenna for all FM stations.

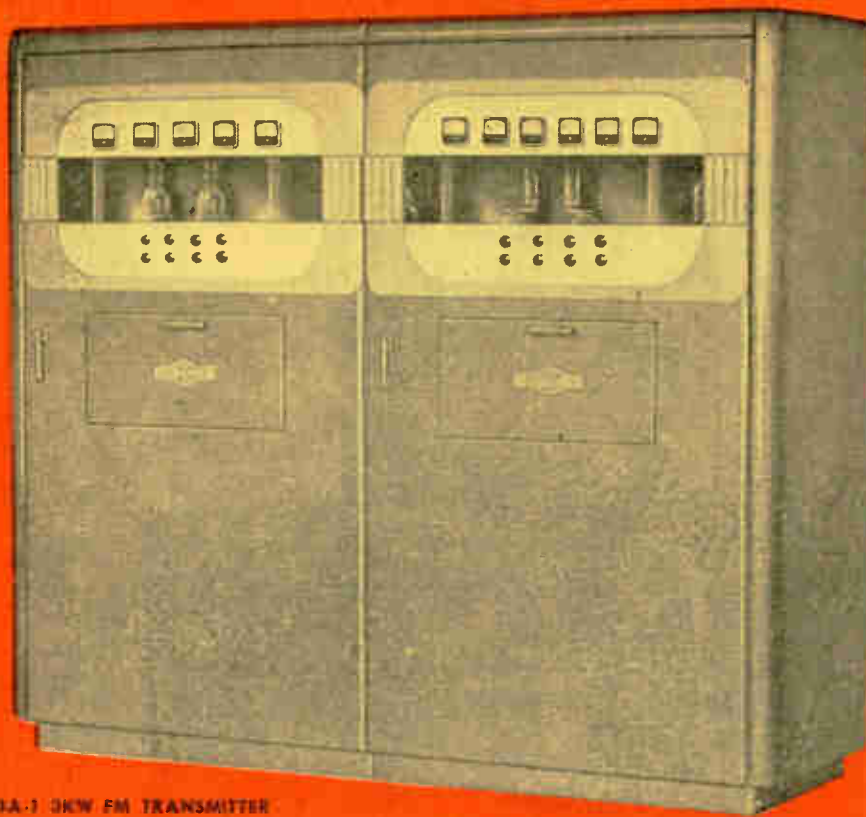

THE COLLINS 733A 30KW FM TRANSMITTER

THE COLLINS 5P PREAMPLIFIER



## You Want the Best in FM

The traditional high quality and superior performance of Collins equipment have been proved over the years in AM broadcast stations all over the world. At the beginning of the recent war, 10% of all the AM broadcast stations in the United States were using Collins transmitters and a larger percentage was using Collins speech amplifiers. That these equipments performed dependably and with a minimum of maintenance is a tribute to the advanced engineering standards to which they were produced.

### TRANSMITTERS

Collins FM transmitters are designed and manufactured to these same high standards of performance and reliability. Circuits are straightforward and clean. The radically new and simpler Phasitron modulator is

employed, eliminating as many as ten different tubes and accompanying circuit components, compared with earlier and more complicated methods.

A frequency multiplication of only 486 produces the carrier frequency. Stability is easily and positively achieved by temperature control, and is better than  $\pm 1,000$  cps. Audio frequency response is constant within 1.0 db from 30-15,000 cps, and distortion is less than 1.5% over the same range. The noise level is more than 65 db below the program level.

Collins FM transmitters are designed as units, to which higher power amplifiers can be added as desired. The complete installation has an integrated appearance in an attractive three-tone gray finish. The series of six transmitter types covers a power range of 250 watts to 50,000 watts output.

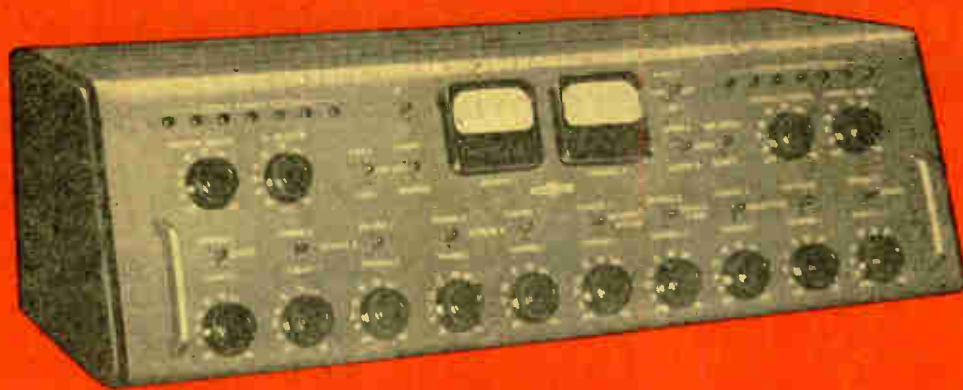

THE COLLINS 212A-1 SPEECH INPUT CONSOLE



THE COLLINS 6X LINE AMPLIFIER AND MONITOR



THE COLLINS 12Z REMOTE AMPLIFIER



THE COLLINS 6M PROGRAM AMPLIFIER

## ... Collins Can Supply It

### SPEECH EQUIPMENT

Foreseeing the coming importance of FM and the need for tremendously improved fidelity in speech equipment performance, Collins has designed its new post-war audio units to meet the most exacting FM requirements. The operational characteristics of these equipments fully equal those of Collins FM transmitters. Convenience, accessibility, reliability, and versatility mark Collins speech amplifiers and consoles as ideally suitable for FM.

In this audio equipment series you will find units to fill every requirement. Let our engineers assist you in determining your needs. Specialists experienced in all phases of broadcasting will work with you from the time your application is being prepared and will help you effect an early completion and operation.

### DESCRIPTIVE BULLETINS

Send for descriptive bulletins, "Collins FM Broadcast Transmitters" and "Collins Broadcast Speech Equipment and Accessories." They will be mailed to you immediately with no obligation to you. In them you will find complete information about the Collins equipment you need For The Best in FM.

**Collins Radio Company, Cedar Rapids, Iowa**  
11 West 42nd Street      458 South Spring Street  
New York 18, N. Y.      Los Angeles 13, California

IN RADIO COMMUNICATIONS, IT'S ...





# Everything for the Emergency Radio Services!

## COMPLETE MATCHED **FM** and **AM** RADIO COMMUNICATION EQUIPMENT

BY *Doolittle*

**Mobile Receivers • Station Receivers • Frequency Monitors  
Mobile Transmitters • Station Transmitters • Station Control Units  
Concentric Transmission Line • Mobile Antennae • Station Antennae**

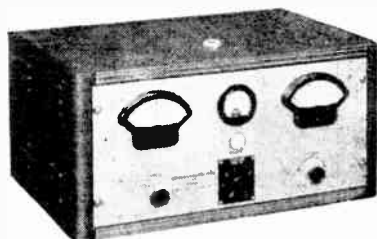

### FREQUENCY MONITORS (FM and AM)

Direct reading. No charts or complicated calculations necessary. Available for all the frequencies used by the Emergency Services, including the new 152-162 mc. band. Designed for operation on 110 V. AC 60 cycles.

*Also available for the New 88-108 mc. FM Broadcast Band.*

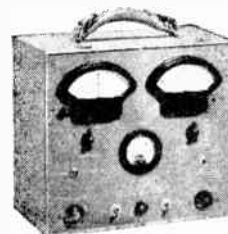

### PORTABLE FM MONITOR

Model FD-10A is similar to the FD-9A except operates on 6 Volts D.C. Designed for checking FM Mobile Transmitting Equipment at point of operation. Supplied for operating on one or two frequencies between 30-44 mc.

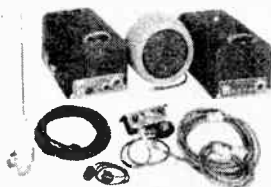

### MOBILE EQUIPMENT (FM and AM)

Models up to 60 watts output. Crystal controlled. Complete with Transmitter, Receiver, Power Supply and all Accessories.

Emergency services function with increased speed and effectiveness through FM and AM equipment *completely engineered, built and matched by DOOLITTLE*. Individual units or complete systems . . . standard or special equipment . . . high or low power . . . in MF, HF or VHF . . . for old and new bands.

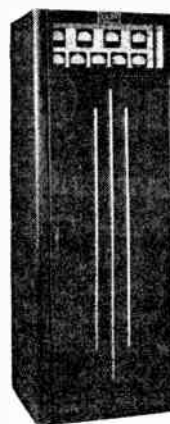

### STATION TRANSMITTERS (FM and AM)

18 available models. Power output up to 1000 watts. Assure maximum efficiency, absolute reliability and economical maintenance. Station Receivers, Control Units and Accessories to meet your needs.

Outstanding features of DOOLITTLE equipment include: Noise operated squelch. Low power consumption. Maximum coverage. Latest electrical and mechanical design. Compact, easy to install. Very accessible, simple to service. Aluminum construction throughout. Highest quality components.

*Equipment engineered and built by DOOLITTLE  
years ago still serves efficiently today.*

*Doolittle*

**RADIO, INC.**

7421 S. LOOMIS BLVD., CHICAGO 36, ILLINOIS

*Builders of Precision Radio Communication Equipment  
for Police, Fire, Government, Forestry, Railroad, Public  
Utility and other emergency services.*



# **BLAW-KNOX** will design, fabricate and erect your antenna towers

Station Engineers take a load off their shoulders when their antenna problem is turned over to Blaw-Knox.

Thousands of installations, ranging from 66 ft. to 1000 ft., are ample proof that you can rely on

Blaw-Knox for complete responsibility in the fabrication and erection of complete antenna systems.

## **BLAW-KNOX DIVISION**

of Blaw-Knox Company  
2046 Farmers Bank Building  
Pittsburgh, Pa.

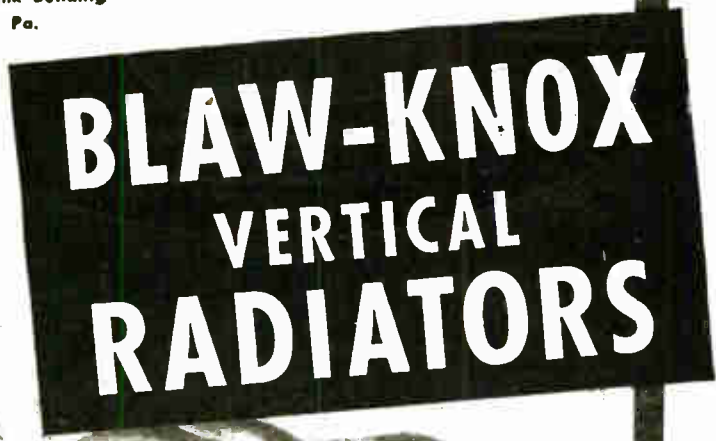

# **BLAW-KNOX VERTICAL RADIATORS**

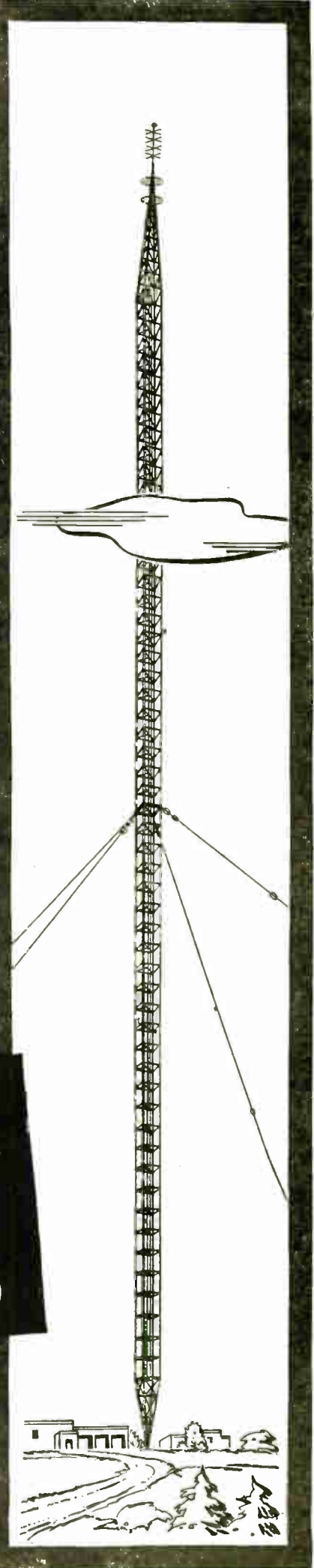

# Laboratory Standards

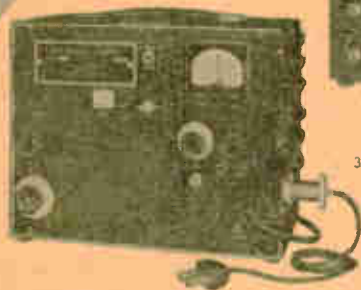

**MODEL 78 - FM STANDARD SIGNAL GENERATOR**  
86 to 108 megacycles. Output: 1 to 100,000 microvolts



**MODEL 8+**  
**U.H.F. STANDARD SIGNAL GENERATOR**  
300 to 1000 megacycles, AM and Pulse Modulation



**MODEL 62**  
**VACUUM TUBE VOLTMETER**  
0 to 100 volts AC, DC and RF

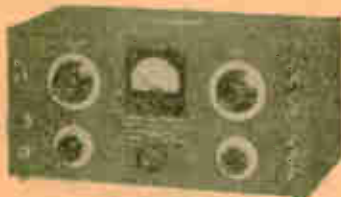

**MODEL 71 SQUARE WAVE GENERATOR**  
5 to 100,000 cycles  
Rise Rate: 400 volts per microsecond



**MODEL 58 U.H.F. RADIO NOISE AND FIELD STRENGTH METER**  
15 to 150 megacycles

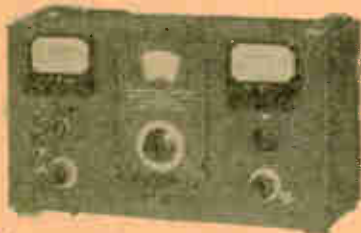

**MODEL 65-B**  
**STANDARD SIGNAL GENERATOR**  
75 to 30,000 kilocycles  
M.O.P.A., 100% Modulation

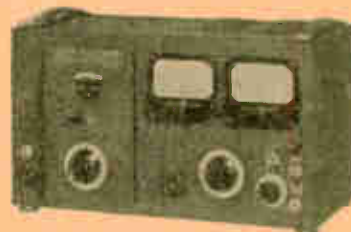

**MODEL 80**  
**STANDARD SIGNAL GENERATOR**  
2 to 400 megacycles  
AM and Pulse Modulation



**MODEL 79-B PULSE GENERATOR**  
50 to 100,000 cycles  
0.5 to 40 microsecond pulse width

Standards are only as reliable as the reputation of their maker.

**MEASUREMENTS CORPORATION**  
BOONTON · NEW JERSEY



# FM BY FEDERAL

## COVERS THE FIELD FROM ANTENNA DOWN!

Federal can provide your new FM station with the finest transmission equipment available—complete in every detail, from microphone to antenna. This outstanding "one-source" service means completely matched components for the entire system—all precision engineered, all of the highest quality, all designed to work together as a single perfected and coordinated FM system.

## 8 SQUARE-LOOP FM ANTENNA WITH NOMINAL POWER GAIN of 9!

This remarkable new antenna, with the highest power gain ever available in FM service, provides 90-kw effective output with a 10-kw transmitter . . . 130-kw with a 20-kw transmitter . . . 450-kw with a 50-kw transmitter.

Antenna is built for use over entire FM range—from 88 to 108 mc. A single adjustment per loop tunes for any frequency in this band. Coaxially-fed loops radiate power in every direction of the *horizontal* plane, with very little power lost to sky or ground waves. Complete antenna and rugged supporting tower designed to withstand high wind velocities and heavy icing loads. Blaw Knox, Ideco, Wincharger towers available to mount the FTR Square-Loop array.

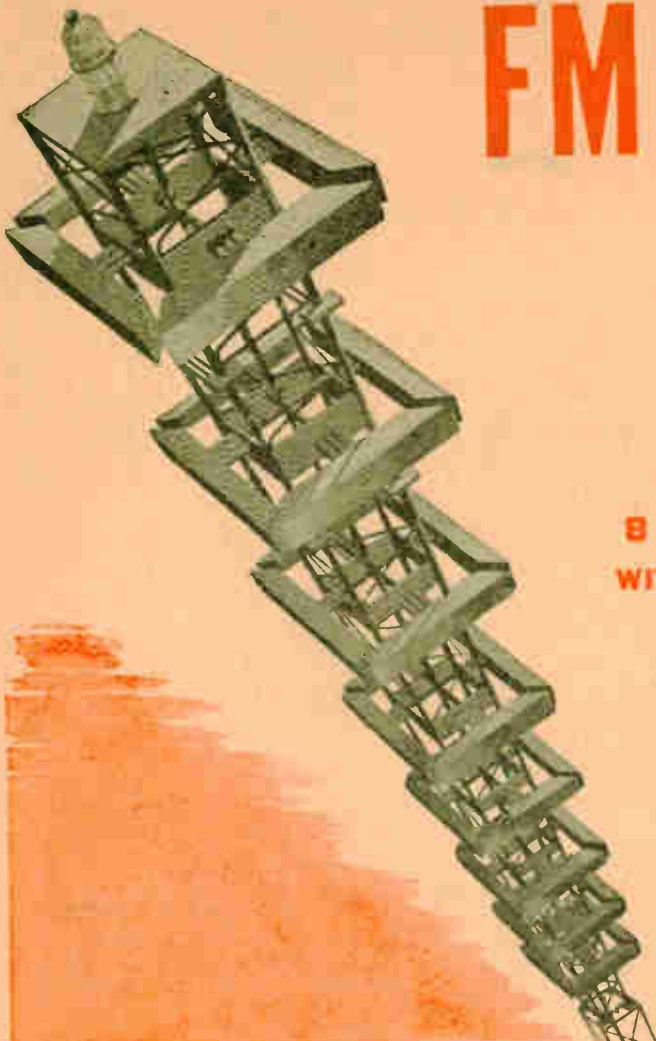

### FM TRANSMITTERS—1, 3, 10, 20 & 50 KW

WITH THE NEW

## "FREQUEMATIC" MODULATOR

The new "FREQUEMATIC" modulator—an exclusive feature of Federal's complete line of FM transmitters—assures outstanding fidelity and mean carrier stability, with unsurpassed dependability and economy.

• Maintains center-frequency stability within .001% • Signal-to-noise ratio reduced to 5600-to-1 • Linear modulation of all signals between 50 and 15000 cycles • Uses simple all-electronic circuits with standard receiver tubes • Extreme ease of initial alignment and minimum maintenance.



Federal gives you complete service, too—providing factory-trained engineers to supervise installation, tune the equipment, and instruct your personnel in its operation and maintenance—all without extra charge.

**NEW POWER TRIODES**, developed by Federal, especially for FM service, are used in the power amplifier stages of the Transmitter, contributing to long life and stable operation.

® Trade mark

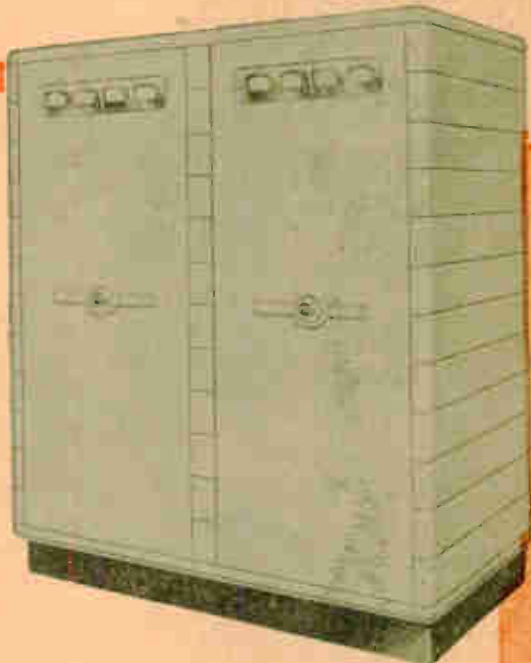

For information on Federal's complete FM equipment, write: Federal Telephone and Radio Corporation, Newark 1, New Jersey.

# Federal Telephone and Radio Corporation

Export Distributor:  
International Standard Electric Corporation

Newark 1, New Jersey



# Frequency CONTROL by VALPEY

Insure perfection in your products — use VALPEY CRYSTALS in vital spots . . . Our experienced engineers and craftsmen are equipped to solve your commercial crystal problems. Quotations furnished without obligation.

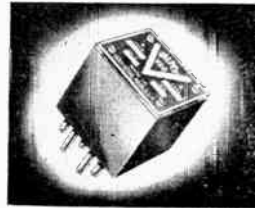

Type VD-0 is a compact unit utilizing two crystals within same holder. Five-pin mount for standard five-prong tube socket. Designed for transceiver equipment where both transmitter and receiver channels are crystal controlled. Furnished with or without heater—case of low-loss phenolic—electrodes, high nickel content stainless steel—hermetically sealed. Recommended frequency range, 1000 Kc. to 10,000 Kc.



**TYPE A-1**  
Compact unit designed for builders of aircraft and commercial equipment where permanent installation in the oscillator is required. Case of low loss phenolic—lug terminals . . . Xtal is spring mounted between two high nickel content, stainless steel electrodes. Size—1-7/16" x 1-1/8" x 7/16" not including lugs. Recommended frequency range: 1,000-4,000 Kc.

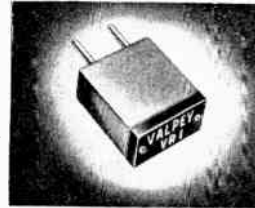

The VR-1, compact, rectangular, vertical mounting, especially designed for aircraft and marine equipment, permits grouping of several units in small space. Holder of low-loss phenolic—measures 1-3/16" long by 1-1/8" by 13/32" deep. Pins are 1/8" diameter with .486 spacing between centers. Neoprene cover gasket insures perfect seal from air, dust and moisture. Electrodes of stainless steel. Recommended frequency range of from 2000 Kc. to 10,000 Kc.

The CM-1, of similar design to the CM-5 but proportionately larger—equipped with standard spaced P-K pins. Body of low-loss phenolic. Unit measures 1-3/16" x 1/2" x 1-7/16" not including pins which extend 5/8". Crystal pressure mounted between stainless steel electrodes. Recommended frequency range from 1200 Kc. to 4000 Kc. Fits standard 5-prong tube socket.



The CM-5, a rectangular, vertical mounting type unit, incorporates the sound engineering and rugged design of the VP-3, and is normally furnished in the same frequency range. Holder of low-loss phenolic measures 13/16" x 7/16" x 1-1/8" not including pins, which are spaced to fit standard 1/2" octal or crystal socket mounting. Crystal pressure mounted

between two stainless steel electrodes. Frequency range 3500 to 30,000. Supplied to within .01% or .02% frequency tolerance.

The VP-3 Unit is designed to meet requirements, when weight and compactness are important factors. Excellent for mobile installations. Molded of low-loss phenolic, it measures 1" x 1/2", not including pins. Crystal pressure mounted between two stainless steel electrodes. Pin spacing, standard 3/4". Unit normally furnished in the frequency range from 3.5 megacycles to 30 megacycles.



The VM-2 is of similar design to the VP-3 but proportionately larger. Molded of low-loss phenolic, the case measures 1-3/8" diameter by 5/8" high, not including pins which extend 5/8" from base. Standard P-K pins provide for 5-prong tube socket or crystal socket mounting. Crystal mounted in a horizontal plane. Recommended for use where overhead space is limited. Crystals in the frequency range from 1200 Kc. to 4000 Kc. can be mounted in this holder, which employs stainless steel electrodes. The crystal is spring pressure mounted.



The CBC Crystal Holder—a variable air gap holder designed for application where maximum stability and accuracy must be maintained in fixed equipment such as frequency standards, broadcast stations, etc. Holder of low-loss phenolic—metal parts, monel metal or nickel-plated brass. Measures 2-1/4" x 1-1/8". Contact pins extend 1/2". Frequency range, 60-10,000 Kc.



The Type CBC-0 Crystal Oven is designed for the same applications as the Type CBC Crystal Holder. It incorporates the CBC in a unit which has a temperature-controlled oven. Can be supplied with VALPEY Crystals in the frequency range from 60 Kc. to 10,000 Kc. Unit measures 3-5/16" x 2-1/4". Furnished in heater voltages of 6, 8, or 10 volts—6 watts.



The VS-1 Crystal Holder is intended primarily for application in police, marine and general communication frequencies where space is not of primary importance. Holder of low-loss phenolic, has stainless steel electrodes with adjustable spring pressure variable from 1 ounce to 1 lb. Best adapted to frequencies of from 1000 Kc. to 4000 Kc. Contact pins of machined brass spaced 3/4" for a 5-prong tube socket or crystal socket mounting. Measures 1-3/4" diameter x 1/2" high including pins.

The VS-5 Crystal Holder—identical with the VS-1, with exception of a unique mechanical design which provides for clamped crystal mounting with adjustable air gap. Allows for exact setting of frequency by the operator.



Type XL-100 Crystal Unit consists of a low temperature coefficient 100 Kc. crystal bar mounted in a Type XL-100 Holder of the same design as the XLS, except that it has slightly smaller dimensions. Unit is designed for frequency standard application and incorporates a crystal cut to produce frequency oscillations of extreme stability. The frequency temperature coefficient will not exceed 3 cycles per megacycle per degree of centigrade. Crystal is furnished so that when used per diagram furnished it can be set to exact frequency.

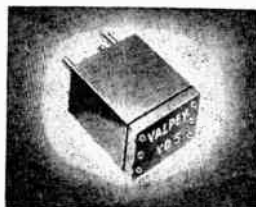

The VD-5 Dual Crystal Unit—especially recommended for use in aircraft, marine or police equipment. This model facilitates the use of a transmitter and receiver Xtal in the same unit. Holder of low-loss phenolic, measures 2-1/16" long by 1-9/16" wide, by 1-3/16" deep. Three pins 5/32" diameter—one pin contacts each crystal and the third is ground to both. Recommended frequency range of from 1000 Kc. to 6000 Kc.

Type XLS incorporates a rugged mechanical structure to eliminate all frequency instability and variations due to vibration or shock. The crystal bar is silvered and spring-clamp mounted at its nodal line. Unit hermetically-sealed and tropicalized for any climatic condition. Base of black bakelite with threaded nickel-plated brass cover with glyptal seal. All internal parts of silver-plated brass or stainless steel. Pins are standard 1/8" plated brass designed to fit standard 5-pin tube socket or crystal socket. Frequency range of from 80 Kc. to 1000 Kc. Frequency tolerance .01%. Crystals guaranteed within specified frequency tolerances over standard temperature range of 50°C.



Type VD-8, similar unit as VD-5 but fits an octal socket—supplied with and without oven. Frequency range 1500-6000 Kc.

**TYPE VT-1**  
Metal tube type similar to J-5. Fits octal base. Supplied with or without oven. Vacuum hermetically-sealed unit insures the finest in modern crystal design. Frequency range 1000 Kc. to 10,000 Kc. Featured is a special offer for 1000 Kc.

**TYPE CF-1**  
A small round compact I.F. filter unit measuring 3/4" in diameter by 3/8" thick and having lug terminals. Supplied to .01% at 455-456-465 Kc. Especially adaptable to commercial equipment manufacturers. A special adapter to fit a 5-pin tube socket can be furnished at a slight additional cost.

VALPEY Precision Lapping, Polishing and etching to final frequency produces these Special Quartz Crystals to your Exact Requirements. Cabinet Compensators, Re-ardation Plates, Polished Crystals and Bertrand Plates made to customer's exact specifications.

# Valpey CRYSTALS

VALPEY CRYSTAL CORP., HOLLISTON, MASS.



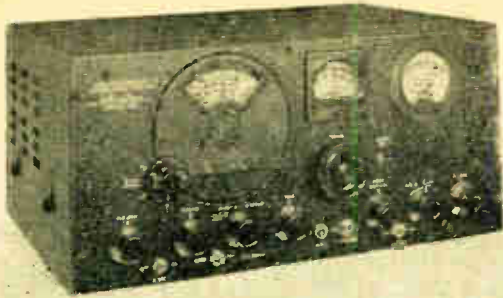

**Model S-36A**

The Model S-36A is probably the most versatile VHF receiver ever designed. Covering a frequency range of 27.8 to 143 Mc it performs equally well on AM, FM or as a communications receiver for CW telegraphy. Equipment like this was introduced by Hallicrafters more than 5 years ago, clearly anticipating the present trend toward improved service on the higher frequencies.



**Model S-37**

Model S-37 FM-AM receiver is an outstanding example of Hallicrafters pioneering work in the upper regions of the spectrum. Covering the frequencies between 130 and 210 Mc, the S-37 provides superior VHF performance. An indispensable instrument for all engaged in FM experimentation.



**Model SX-42**

With the introduction of the new Model SX-42 Hallicrafters further strengthens its foremost position in FM. The SX-42 offers the greatest continuous frequency coverage of any communications receiver . . . from 540 kc to 110 Mc. Tremendous frequency range made possible by new "split-stator" tuning system and the use of dual intermediate frequency transformers.

FIRST...

FOREMOST

IN FM RECEIVERS

By experience and accomplishment Hallicrafters is a factor to be reckoned with in FM. This brief summary shows how models like the S-36A and the S-37 were developed more than 5 years ago—five years in advance of other commercially developed receivers. The new

Model SX-42 and other FM receivers now in development will continue to maintain Hallicrafters foremost position in the highly specialized FM field. Hallicrafters will have high quality FM equipment available in every price bracket.

COPYRIGHT 1946 THE HALLICRAFTERS CO.



**hallicrafters RADIO**

THE HALLICRAFTERS CO., MANUFACTURERS OF RADIO AND ELECTRONIC EQUIPMENT, CHICAGO 16, U. S. A.





AMPHENOL

COMPONENTS FOR

FM and

TV

FREQUENCIES



Now that the emphasis in communications is turning more and more toward the FM and Television frequencies, there is a great demand for quality components made to increasingly critical specifications. Amphenol products have kept abreast of developments and are available now—in quantity—to manufacturers of equipment operating in these frequencies and to amateurs.

In addition to the long line of standard parts, Amphenol engineers announce the following new products particularly adaptable to FM and Television:

**Radio Frequency Cable and Connectors** and a new line of low-capacitance microphone cables. Also, new cables especially developed for Television color cameras and for Facsimile work.

**Hi-Q Tube Sockets.** Standard, miniature and sub-miniature. Also new sockets for cathode ray viewing tubes and similar applications.

**Twin-Lead.** This Amphenol-developed parallel transmission line is widely used as antenna lead-in and, in addition, has become standard for built-in folded dipole antenna construction.

**FM Antennas.** New Amphenol designs for standard reception that deliver the greatest gain, particularly in low signal areas. Write for complete information.

**Plastic Components,** in a wide variety, adaptable where this superb dielectric is an integral part of the engineering of critical circuits.

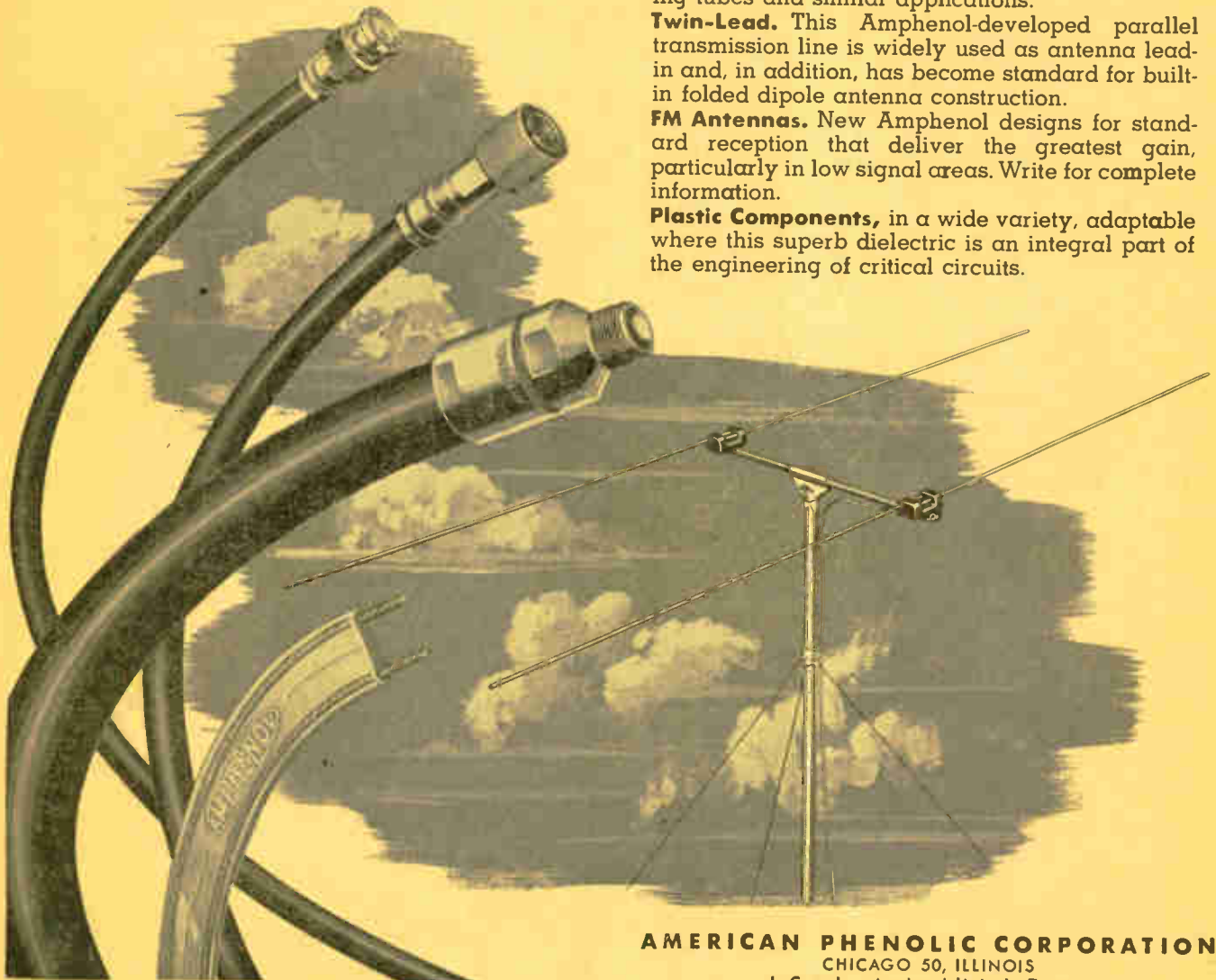

AMERICAN PHENOLIC CORPORATION

CHICAGO 50, ILLINOIS

In Canada • Amphenol Limited • Toronto

COAXIAL CABLES AND CONNECTORS • INDUSTRIAL CONNECTORS FITTINGS AND CONDUIT • ANTENNAS • RADIO COMPONENTS • PLASTICS FOR ELECTRONICS

# An extensive line of A.R.C. radio and electronic components

Precision Built to Aircraft Standards



Since 1928 the Aircraft Radio Corporation has devoted its engineering and production facilities to the design and manufacture of high-quality radio equipment for aircraft use. Components similar to those listed here proved their worth in the A.R.C. receivers and transmitters used in nearly all military aircraft during the war.

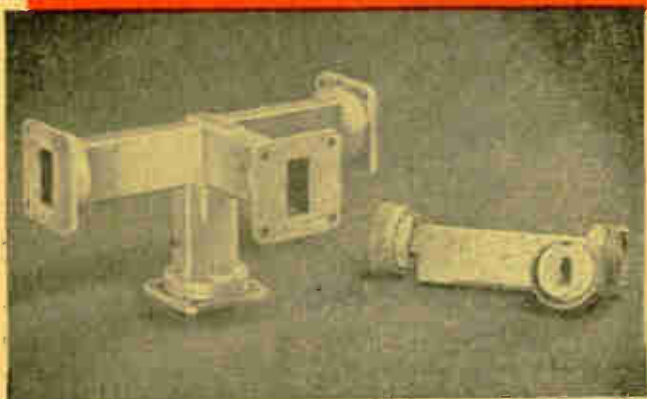

ARC "Magic Tee" and Microwave Coupler

**MICROWAVE PLUMBING AND ACCESSORIES**—A complete line of Microwave Plumbing and Accessories, engineered to A.R.C. precision standards, is now available. With the increasing emphasis on microwave transmission in modern aircraft navigation and control, A.R.C. has pioneered in the design of equipment for this type of operation. Typical of A.R.C. Microwave Accessories are the "Magic Tee" and Directional Coupler illustrated. Other items, such as the 24,000 megacycle attenuator, use the unique "split plate" construction developed by A.R.C.



Miniaturized D.C. Relay by ARC

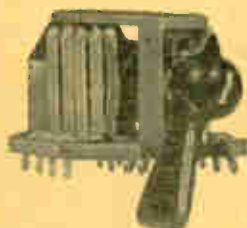

Precision Built "Music Box" Type Switch

**RELAYS AND SWITCHES**—Compact, lightweight relays designed by A.R.C. have had years of use under the extreme conditions of vibration, humidity and temperature encountered in military aircraft operation. Available in several types and sizes, they meet rigid requirements for reliability and specified performance.

A.R.C. Precision-built Switches are made in Drum-Type, "Music-Box" Type, and special Toggle and Push Types, and are available in various contact combinations. All are designed to stand up under the hardest usage, and are manufactured to the highest standards of the aviation industry.



ARC Multi-contact Connector with Ceramic Inserts

**MULTI-CONTACT CONNECTORS WITH CERAMIC INSERTS**—A.R.C. has developed a line of Ceramic-Insulated Multi-Contact Plugs and Receptacles to combat carbon-tracking due to flashover. Floating, self-aligning female contacts and replaceable pin-plugs mean ease of maintenance and assembly as well as efficient service. Completely interchangeable with A.R.C. Bakelite insulated Plugs and Receptacles, the Ceramic type is provided in all types and sizes for use with shielded or unshielded cable, or with open wiring.

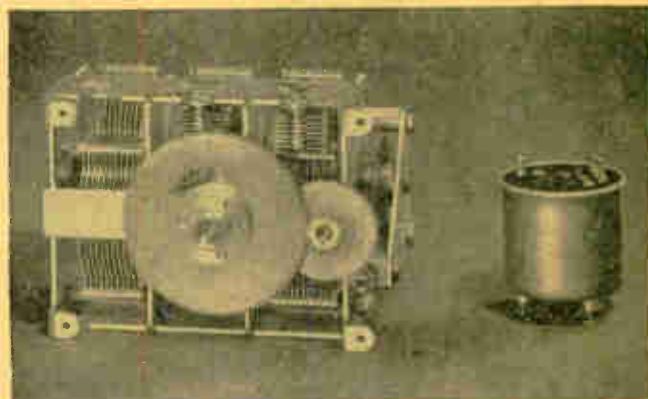

ARC Variable Air Condenser and Sealed, Oil Paper Type

**CONDENSERS — VARIABLE, ADJUSTABLE, AND SEALED**—Variable and adjustable air condensers by A.R.C., designed for use in both receivers and transmitters, are available in both single and multiple sections. Features of this equipment include the use of forked springs to provide positive grounding of rotor shafts, a special glass-ball method of stator support which keeps dielectric losses to a minimum, and cadmium plating of rotor and stator assemblies.

A complete line of Sealed Oil Paper and Dry Electrolytic Condensers have been designed by A.R.C. in both cylindrical and rectangular types, sealed in cadmium-plated brass cans. Minimum leakage path to ground is approximately 1/16th inch, good for a breakdown test of 2000 volts D.C.

Sealed Chokes and Transformers are also available in the cylindrical design.

For complete Parts Catalog, or specific information, write

## AIRCRAFT RADIO CORPORATION

BOONTON, NEW JERSEY







## *Continuing Our Pioneering Leadership in Quality FM Radio Manufacture*

WITH the current introduction of the first postwar line of Freed-Eisemann Radio-Phonographs, the Freed Radio Corporation once again demonstrates its pioneering leadership in the manufacture of quality radio receivers with FM. This new Freed-Eisemann line is the *first* postwar line in which every instrument is equipped with authentic Armstrong Wide-Swing FM. This carries on the tradition established before the war, when Freed-Eisemann Radio-Phonographs were the *only* line in which all receivers were FM-equipped.

Enhanced by wartime experience, Freed-Eisemann engineering and craftsmanship represent highest achievement in FM, as well as in standard radio, shortwave and reproduction of recorded music. Together with period and modern cabinets of outstanding design, the Freed-Eisemann continues to live up to its reputation as *one of the world's great radio-phonographs*. Freed Radio Corporation, 200 Hudson Street, New York 13, N. Y.

*Freed-Eisemann*  
with FM

ONE OF THE WORLD'S GREAT RADIO-PHONOGRAPHS



# Reminder for FM BROADCASTERS

Here are the equipment ABC's for a top quality station

**A.** YOU NEED A TRANSMITTER....



that will keep on frequency. In Western Electric Synchronized FM, the "Frequency Watchman" keeps your transmitter precisely on frequency—constantly and automatically.

**B.** YOU NEED AUDIO FACILITIES....



that combine finest transmission performance with maximum operating flexibility. The Western Electric 25B console has these plus other features and handles two programs at once.

**C.** YOU NEED MICROPHONES....



that can handle every type of pick-up. Western Electric offers you the famous "Salt Shaker," the 3-way and 6-way Cardioids and the new 640 Double-A for highest fidelity pick-ups.

**D.** YOU NEED AN ANTENNA....

that will enable you to really cover your service area. The high gain Western Electric CLOVER-LEAF antenna which radiates horizontally polarized waves in a circular azimuth pattern will do this for you.

**Yes** ... you can count on Western Electric for your *complete* FM broadcasting equipment. And you can *depend* on the equipment itself for high quality, trouble-free, economical performance.

It's designed by Bell Telephone Laboratories—world's largest organization devoted exclusively to research and development

in all phases of electrical communications. It's manufactured by Western Electric—supply unit of the Bell Telephone System and the nation's largest producer of communications equipment.

For full technical and delivery information, get in touch with your nearest Graybar Broadcast Equipment Representative today.

## Western Electric

QUALITY COUNTS

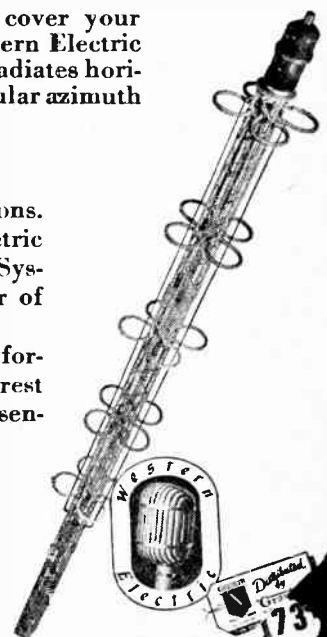



**C**apacitor

**Q**uality...

**T**o Solar, "CQ" means *Capacitor Quality* because Solar lives up to its by-word, "Quality Above All."

That's the whole Solar story in one sentence.

We *could* show pictures of departments in our up-to-the-minute plants, depicting the modern machines and skilled workers who build outstanding quality into each Solar capacitor that comes off the lines. Or photos of our laboratories where tests insure that every Solar capacitor will live up to Solar's "Quality Above All" standards.

We *could* quote unsolicited letters of praise from hundreds of manufacturers who've used Solar "Quality Above All" capacitors . . . letters which verify Solar's claim to the most dependable line of capacitors on the market!

We *could* say all this, but Solar capacitor performance speaks for itself—proves "Quality Above All" is more than just a phrase.

**SOLAR MANUFACTURING CORPORATION**  
285 Madison Avenue • New York 17, New York



**ELECTROLYTIC, PAPER AND MICA CAPACITORS FOR THE ELECTRONIC INDUSTRY**

Ⓢ 1075B

*Announcing*

THE REMOVAL OF  
THE ENGINEERING OFFICES  
AND LABORATORIES

*to New and Larger Quarters*

LOCATED AT

1339 WISCONSIN AVENUE, N.W.  
WASHINGTON 7, D. C.

*Telephone: Adams 2414*

*These expanded facilities will be dedicated to service to our clients,  
advancement of the art of broadcasting, and to research and develop-  
ment in the field of radio engineering*

**EXECUTIVE OFFICES WILL REMAIN AT  
970 NATIONAL PRESS BUILDING**

**JANSKY & BAILEY**

CONSULTING RADIO ENGINEERS



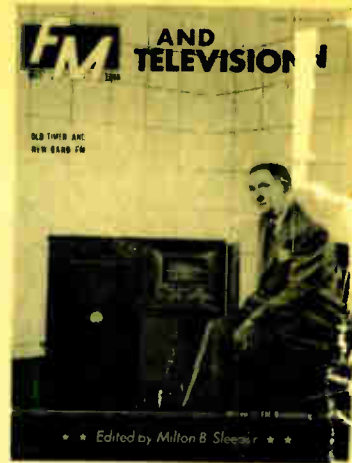
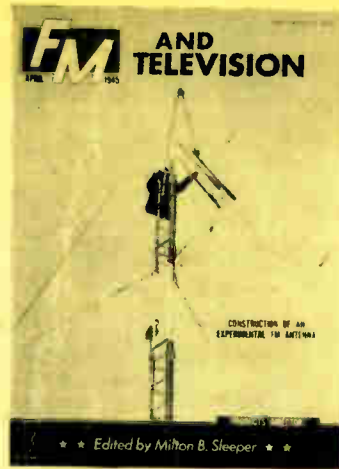
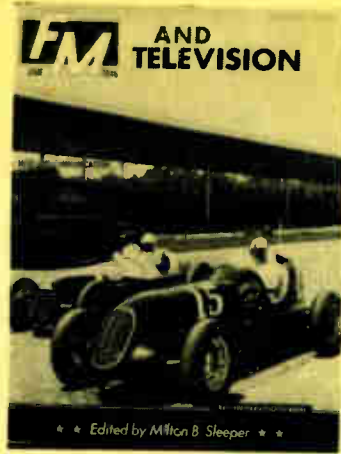
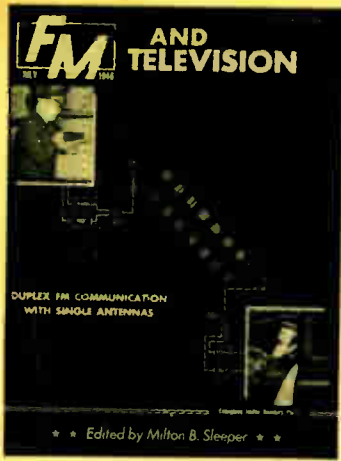

*FM AND TELEVISION is published for the top-level bracket of those engaged in manufacturing, broadcasting, communications, sales, and maintenance—"the Men Who Set the Pace the Industry Follows"*



**Subscription Price: \$5 per year — \$10 for 3 years**  
 Add 50c per year for Canadian postage, or \$1 per year for foreign postage

*Published at*

**GREAT BARRINGTON, MASSACHUSETTS**

NEW YORK OFFICE, 511 FIFTH AVENUE

CHICAGO OFFICE, 360 N. MICHIGAN AVENUE

