

Price 25 Cents

Oct. '49

FMA-TV

★ Edited by ★
Milton B. Sleeper



OFFICERS OF THE AUDIO ENGINEERING SOCIETY

9th Year of Service to Management and Engineering

World Radio History



FM BROADCAST MONITOR

MODEL 335B



**CONTINUOUS, ACCURATE
MEASUREMENT OF FREQUENCY
AND MODULATION LEVEL**

(No Adjustment During Operation)

SPECIFICATIONS

FREQUENCY MONITOR

Frequency Range: Any channel, 88 to 108 mc.

Deviation Range: +3 kc to -3 kc mean deviation.

Accuracy: Better than $\pm 1,000$ cps ($\pm .001\%$).

Power Drive: Approximately 2 watts.

MODULATION METER

Modulation Range: 100% at 75 kc deviation; 133% at 100 kc deviation.

Accuracy: Within 5% over entire scale.

Characteristics: Meter damped in accordance with F.C.C. regulations.

Frequency Response: Flat within $\pm 1/2$ db, 50 to 15,000 cps.

External Meters: Circuit provided to operate remote modulation meter.

PEAK LIMIT INDICATOR

Peak Limit Range: 50% to 120% modulation (75 kc = 100%).

AUDIO OUTPUT

Frequency Range: 20 cps to 20 kc. Response flat within $\pm 1/2$ db.

Distortion: Less than 0.25% at 100% modulation.

Output Voltage: 10 v into 20,000 ohms.

Noise: 75 db or more below audio output level resulting from 100% modulation (low frequencies).

Monitoring Output: 1.0 mw into 600 ohms, balanced, at 100% modulation (low frequencies).

Size: Front panel 10 1/2" x 19" x 13" deep.

Power: 115 v 50/60 cps primary power. Requires approximately 150 watts.

Data subject to change without notice

EASY TO OPERATE • HIGH STABILITY

REMOTE MODULATION METER • LOW DISTORTION

LOW NOISE LEVEL • INDEPENDENT OF SIGNAL LEVEL

MEETS F. C. C. REQUIREMENTS

The *-hp-* 335B FM Monitor is a Frequency and Modulation Meter combined. It monitors FM broadcast transmitters accurately, reliably, day after day. It doesn't depend on a tuned circuit for accuracy, so it is never necessary to re-set the carrier level.

The instrument is independent of signal level, tube characteristics or tube voltages; and requires adjustment only at infrequent intervals. It gives continuous indication of broadcast frequency and modulation level at all times.

An audio output signal of less than 0.25% residual distortion is provided for measurement purposes. A high-quality 1 mw demodulated signal is also provided for remote or local aural monitoring. The instrument includes provision for external or remote modulation meters, as well as a remote peak

modulation indicator lamp. An amplitude modulation noise detector permits measurement of transmitter AM noise.

The compact *-hp-* FM Monitor can be supplied in a cabinet, for relay rack, or in special panel colors matching station installations. Construction throughout is in accordance with engineering practices proved satisfactory for broadcast equipment. Components are rigidly mounted on bakelite cards; bathtub, mica and oil-filled condensers are used where voltages exceed 50 volts.

For complete details, see your local *-hp-* representative, or write direct to factory.

HEWLETT-PACKARD CO.

1877-F Page Mill Rd., Palo Alto, Calif.

Export: FRAZAR & HANSEN

301 Clay Street, San Francisco, California, U.S.A.
Offices: New York, N. Y.; Los Angeles, Calif.

hp laboratory instruments
FOR SPEED AND ACCURACY

He finds trouble by ear

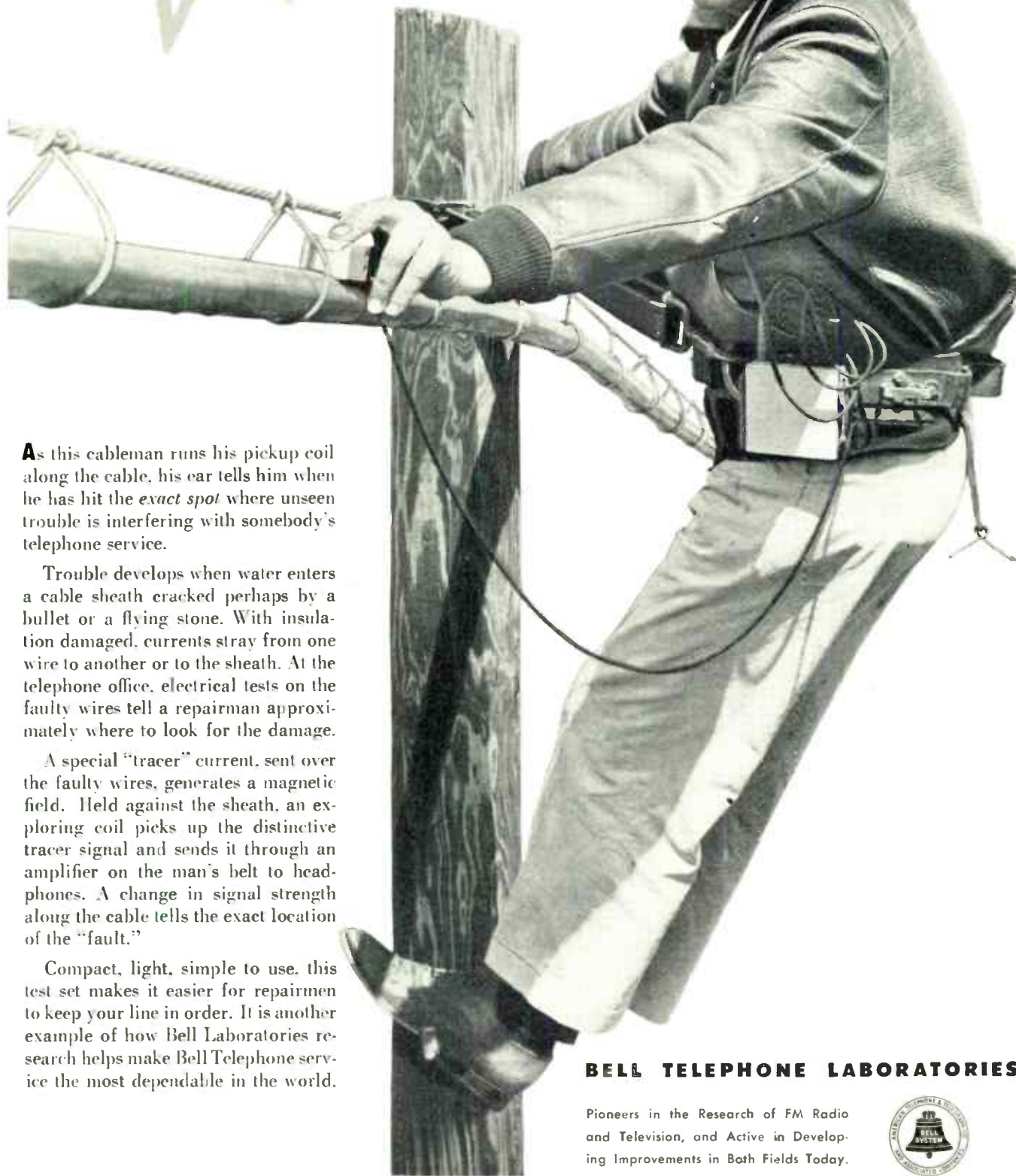

As this cableman runs his pickup coil along the cable, his ear tells him when he has hit the *exact spot* where unseen trouble is interfering with somebody's telephone service.

Trouble develops when water enters a cable sheath cracked perhaps by a bullet or a flying stone. With insulation damaged, currents stray from one wire to another or to the sheath. At the telephone office, electrical tests on the faulty wires tell a repairman approximately where to look for the damage.

A special "tracer" current, sent over the faulty wires, generates a magnetic field. Held against the sheath, an exploring coil picks up the distinctive tracer signal and sends it through an amplifier on the man's belt to headphones. A change in signal strength along the cable tells the exact location of the "fault."

Compact, light, simple to use, this test set makes it easier for repairmen to keep your line in order. It is another example of how Bell Laboratories research helps make Bell Telephone service the most dependable in the world.

BELL TELEPHONE LABORATORIES

Pioneers in the Research of FM Radio and Television, and Active in Developing Improvements in Both Fields Today.



Another Zenith TV "first"!

MIRACULOUS NEW *Easy-on-the-Eye* GLARE-BAN "BLACK" TUBE TELEVISION

Relieves eyestrain
by reducing glare, yet
increasing picture clarity
60% in lighted rooms!
Medical authorities
recommend this way
to view television!

Old Way — Conventional "White" Tube

All conventional television tube faces are practically white. Television "paints" its pictures on them with millions of tiny pin points of light. When viewed in a lighted room—the way medical authorities say television should be viewed—the resulting pictures look faded, washed-out. They lack sharp contrast—like drawing on a white board with white chalk. Your eyes squint and strain to make up for this lack of clarity. This is a major cause of television eyestrain.

New Way — Zenith Glare-Ban "Black" Tube

Television's greatest picture improvement! Gives you pictures with depth and quality never seen before on any television set. Its special built-in Oxide lens intensifies the dark parts of the picture, reduces glare, and actually increases picture clarity 60% in lighted rooms. The result is a far clearer, sharper picture—with amazingly lifelike quality and depth. The difference in viewing pleasure and freedom from eyestrain is *unbelievable* until you experience it.

A "natural" for store demonstration! The lighter your showroom, the more startling the difference between this greatest of all picture improvements and conventional television receivers!

— **PLUS**

Zenith Giant Circle Screen with New Picture Control Switch!



Zenith Television Receivers give you either of these two picture shapes at the flick of a switch.

Zenith's Giant Circle "C" Screen gives you up to 165 sq. in. picture. And New Picture Control Switch gives you choice of the circular or rectangular type picture—lets you prove to yourself how much bigger, better, the Giant Circle picture really is!

Another sales-closing exclusive Zenith demonstration! Show your customers how Zenith gives either the Giant Circle picture or the Rectangular type—at the flick of a finger!

SEE YOUR ZENITH DISTRIBUTOR
ZENITH RADIO CORPORATION, CHICAGO 39, ILL.

*Conventional
Shape — much
smaller picture.*

Zenith One-Knob Simplified Automatic Tuning

One twist, there's your station, picture, sound!
Does automatically what on many other sets
takes up to 5 or 6 manual tuning operations!
Ends repeated re-tuning nuisance!

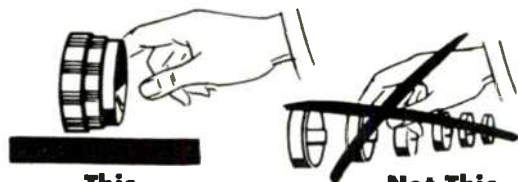



Formerly, FM MAGAZINE and FM RADIO-ELECTRONICS

VOL. 9 OCTOBER, 1949 NO. 10

COPYRIGHT 1949, by Milton B. Sleeper

CONTENTS

INDUSTRY NEWS

TV-FM-AM Set Production
Compiled from figures released by the RMA 4

New Catalogs & Design Data
Review of new products and equipment 5

What's New This Month

1. RMA reports on TV shipments
2. More information from telephone polls
3. Changes for provisional stations
4. Do you remember the OPA? 6

TELEVISION

RCA's Color Television System
E. W. Engstrom 11

FREQUENCY MODULATION

A New Type of VHF Tank Design
B. E. Parker 14

MOBILE RADIO

Mobile Radio News & Forecasts
Jeremiah Courtney 18

Specifications for Equipment
Official manufacturers' data 19

Radio Communications Services, Conclusion
Rules & allocations for the transportation services 21

AUDIO DEVELOPMENTS

Design of Recording Systems
Leon A. Wortman 24

SPECIAL DEPARTMENTS

Professional Directory 8

Special Services Directory 9

Spot News Notes 16

News Pictures 17

THE COVER DESIGN AND CONTENTS OF FM AND TELEVISION MAGAZINE ARE FULLY PROTECTED BY U. S. COPYRIGHTS, AND MUST NOT BE REPRODUCED IN ANY MANNER OR IN ANY FORM WITHOUT WRITTEN PERMISSION

MILTON B. SLEEPER, Editor and Publisher

CHARLES FOWLER, Business Manager
LILLIAN BENDROSS, Circulation Manager
SOPHIE FORTY, Production Manager
Published by: FM COMPANY

Publication Office: 264 Main St., Gt. Barrington, Mass. Tel. Gt. Barrington 500
FM-TV Magazine is issued on the 10th of each month.

Single copies 25c—Subscription rate: \$6.00 for three years, \$3.00 for one year in the U. S. A.—Canada, add 50c per year postage—foreign, add \$1.00 per year postage.

Contributions will be neither acknowledged nor returned unless accompanied by adequate postage, packing, and directions, nor will FM-TV Magazine be responsible for their safe handling in its office or in transit.

Entered as second-class matter August 22, 1946, at the Post Office, Great Barrington, Mass., under the Act of March 3, 1879. Additional entry at the Post Office, Boston, Mass. Printed in the U. S. A.



CIRCULATION AUDITED BY
H. R. SYKES
CERTIFIED PUBLIC ACCOUNTANTS
PITTSFIELD, MASSACHUSETTS

1. Undistorted fundamental tones, clear down to the 16-foot bourdon pipe
2. undistorted full range, demonstrated by comparison with the original sound
3. rugged design, executed with unequalled quality of craftsmanship.

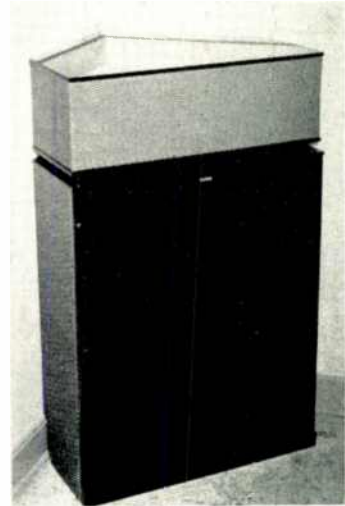

Just 3 reasons why the
KLIPSCHORN
surpasses all other

For details on the world's finest
sound reproducers, write

KLIPSCH AND ASSOCIATES
DEPT. F, HOPE, ARKANSAS

CAN YOU USE A ROTARY SWITCH

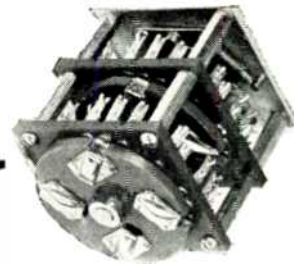

WITH

- A tamper-proof rotor arm (patented)
- Extra long life
- Low and uniform contact resistance
- Minimum thermal noise
- High resistance to leakage
- Trouble-free operation

A complete line of standard switches is offered. Consult our engineering department for your special switch problems. Write for Bulletin SW-1, Dept. FM-10 for complete information on standard switches.



THE **DAVEN** CO.
191 CENTRAL AVENUE
NEWARK 4, NEW JERSEY

THE NEW Improved MODEL 3HW-A Workshop Antenna will . . .

More than triple the effective power of the transmitter.

Increase the effective power of the mobile transmitter.

Increase the operating a.e.a.

Permit the use of low power, low cost equipment.

Workshop High-Gain Beacon Antennas are designed specifically for the 152-162 megacycle band—taxicab, fire, police, and private fleet communications.

Design Features

- Low angle of radiation concentrates energy on the horizon.
- Symmetrical design makes azimuth pattern circular.
- Can be fed with various types of transmission lines. Special fittings are available for special applications.
- Enclosed in non-metallic housing for maximum weather protection.

Available for immediate delivery through authorized distributors or your equipment manufacturer.

—THE—
WORKSHOP ASSOCIATES
INCORPORATED

Specialists in High-Frequency Antennas

65 NEEDHAM STREET
Newton Highlands 61, Mass.



PAT. APP. FOR

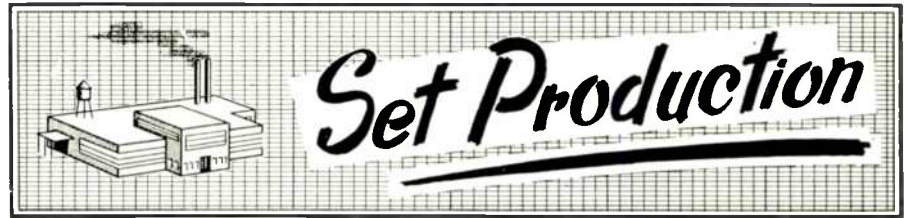

UNLESS the trend in set production takes a sharp upward turn this fall, a considerable number of manufacturers who, at the end of '48, looked forward to Big Business in '49 aren't going to be in business come next January.

Just as the broadcasters have been financing their TV losses from AM profits, so many set manufacturers expected that AM receivers would carry them through a brief transition period to all-out TV production. But things just haven't worked out that way because TV promotion and lack of FM-AM promotion have hurt audio set sales.

Since the war, production has always been lowest in July. Shipments for that month in '47, however, were 1,074,000 AM sets. The corresponding figure in '48 was 552,000. But July '49 shipments fell to 318,000.

In 7 months, 993,000 TV sets have been shipped by RMA members. This is far below the level predicted last fall.

The steady rise during '48 came to a halt in December, when TV sets hit 161,179. In 4 months of '49, production was below that figure, and only in March was it higher by an appreciable amount, when the all-time record of 182,361 was reached.

These figures reflect conditions resulting from the TV freeze, chief of which are inferior programs on the air. The freeze has been on for a year, and the prospects are that it may be July or August, 1950, before the hearings can be completed and a final plan worked out for the future expansion of television broadcasting.

July receiving tube sales by RMA members totaled 10,118,000, up 481,000 over July '48. Of these 72 per cent went into new equipment, 24 per cent for replacements, 3 per cent for export, and 1 per cent for U. S. Government agencies. Average monthly production this year has been at the rate of 13,111,000 tubes.

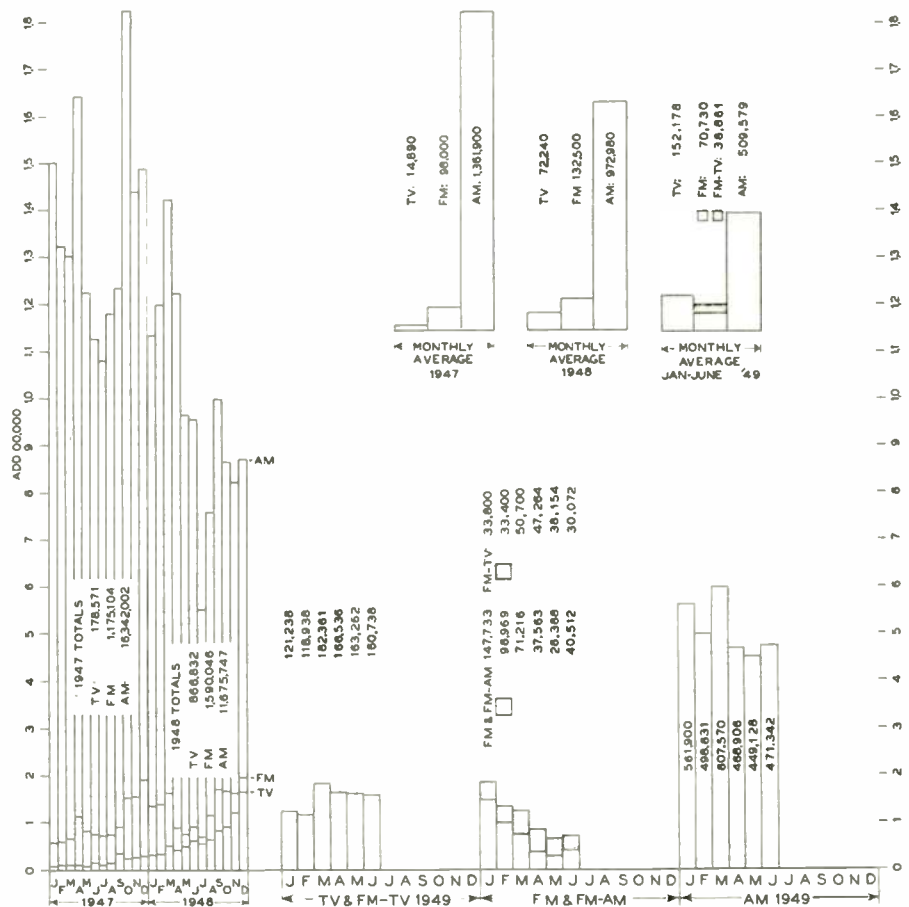

TV, FM, and AM Set Production Barometer, prepared from RMA figures

NEW CATALOGS & DESIGN DATA

THE products listed here are described in new catalogs and bulletins now available. Unless otherwise noted, they will be sent on request, without charge.

Vacuum Pump:

Oil-diffusion type rated at 67 liters per second, with attainable vacuum 4×10^{-7} mm. Hg. Requires no liquid cooling or charcoal trap. *Eitel-McCullough, Inc., San Bruno, Calif.*

Voltage Regulator:

Tube-operated, output 0 to 250 volt-amperes. Stabilized for input and load variations to 25%. For input changes only, change in output voltage is rated at not more than 1%, with speed of correction 3 to 6 cycles. *Superior Electric Co., Bristol, Conn.*

Technical Bulletin:

Publication of the monthly *Aerovox Research Worker* has been resumed. Contents is devoted to technical information for radio and electronic engineers. Mailed without charge to those requesting that they be put on the subscription list. *Aerovox Corp., New Bedford, Mass.*

TV Tube Beam-Benders:

Permanent magnet mountings clamp on tube neck, to minimize burned spot on screen. *Clarostat Mfg. Co., Dover, N. H.*

Antenna Handbook:

A 48-page book detailing the construction of rotary beam transmitting antennas, also presenting data on transmission lines and coupling methods. Price 60c. *E. F. Johnson, Waseca, Minn.*

Standard Signal Generator:

Combines two oscillators, one covering 20 cycles to 200 kc., with an output of 0 to 50 volts across a resistance of 7,500 ohms, and another covering 80 kc. to 50 mc. with an output of .1 microvolt to 1 volt. The latter can be modulated by the low-frequency oscillator. Model 82. *Measurements Corp., Boonton, N. J.*

Wiring Harnesses:

Flexible and rigid wiring assemblies, using armored, molded-on, laced, and braided units, with caps, switches, sockets, and connectors soldered to leads and ready for chassis mountings. *Cornish Wire Co., Inc., 15 Park Row, New York City.*

Secondary Frequency Standards:

Moderately priced model 100D provide sine waves at 5 frequencies and rectangular waves at 4 frequencies, accurate to 2 parts in 1 million. Timing pips at intervals of 100, 1,000, and 10,000 microseconds can be used with a built-in oscilloscope. Model 100C delivers sine waves only at 4 frequencies, with an accuracy of .001%. *Hewlett-Packard Co., Palo Alto, Calif.*

Tube Data:

Revised manual of 418 pages gives basic application data for 637 receiving and cathode-ray tubes. Price 85c. *Sylvania Electric Products, Inc., Emporium, Pa.*

TV Replacement Guide:

Revised edition lists replacement transform-

Floating Action! for all TV Cameras

"BALANCED" TV TRIPOD

Pat. Pending

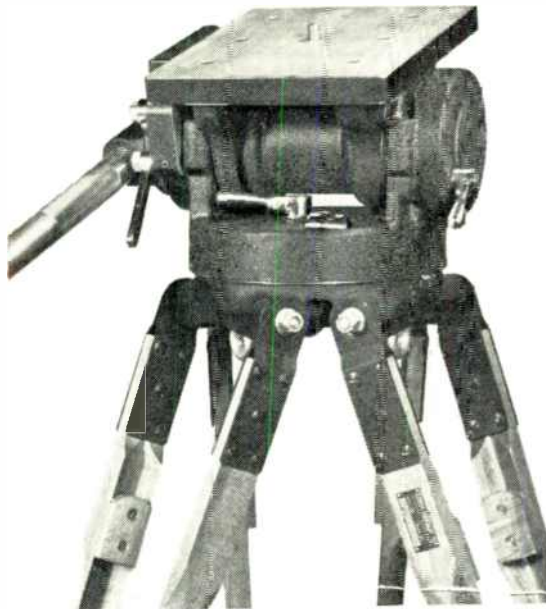

This tripod was engineered and designed expressly to meet all video camera requirements.

Previous concepts of gyro and friction type design have been discarded to achieve absolute balance, effortless operation, super-smooth tilt and pan action, dependability, ruggedness & efficiency.

Below:

3-wheel portable dolly with balanced TV Tripod mounted.

Complete 360° pan without ragged or jerky movement is accomplished with effortless control. It is impossible to get anything but perfectly smooth pan and tilt action with the "BALANCED" TV Tripod.

Quick-release pan handle adjustment locks into position desired by operator with no "play" between pan handle and tripod head. Tripod head mechanism is rustproof, completely enclosed, never requires adjustments, cleaning or lubrication. Built-in spirit level. Telescoping extension pan handle.

Write for further particulars



CAMERA EQUIPMENT CO.
FRANK C. ZICKLER
1600 BROADWAY NEW YORK CITY

ers, chokes, deflection yokes, and focus coils for 108 of the most popular TV receivers. Bulletin DD338B. *Standard Transformer Corp., 3580 Elston Ave., Chicago 18.*

Film-Processing Unit:

Theatre TV equipment produces 24 pictures per second from 30-picture TV transmission, and processes the film, ready for projection, in 20 seconds. *Paramount Pictures, Inc., 1501 Broadway, New York 18.*

Insulation Tester:

Portable instrument, operating from 115 volts 60 cycles can be used for laboratory or field measurements of resistance from .1 to 50,000 megohms. Four ranges provide voltages up to 10,000 volts, with constant voltage regulated to .5%. Elaborate pro-

visions are made for safe operation. *Radio Frequency Laboratories, Boonton, N. J.*

Noise-Generating Diode:

Miniature type 5722 tube generates noise for measurement purposes up to 500 mc. Plate voltage is 150 volts. Noise output is controlled by regulating the filament voltage from 2 to 5.5 volts. *Sylvania Electric Products, Inc., 500 Fifth Ave., New York 18.*

System of Absolute Units:

Very complete information on the new system of electrical measurement using absolute units, adopted January 1, 1948, by the International Conference of Weights and Measures. Circular C475. Price 25c. *Superintendent of Documents, U. S. Government Printing Office, Washington 25, D. C.*



Broadcasters

Are you planning to establish your remote pick-up in the NEW F.C.C. approved 450-460 mc. band?

Link has now designed and put into production, in this new band, a mobile remote broadcast transmitter and a sensitive and selective receiver.

Link U.H.F. Mobile Transmitter Type 25 MRB. Power output 25 Watts F.M. crystal controlled with ± 45 kc. modulation swing with broadcast fidelity. For operation from either 12 V. D.C. or 110 V. A.C. power supply.

Link U.H.F. Fixed station Receiver Type 2340. F.M. crystal controlled single frequency superheterodyne. For operation from 110 V. A.C. power supply. This unit has been designed for mounting in standard 19" racks.

Link is famous for easy to install, dependable equipment. These units are no exception and merit careful consideration when purchasing a remote pick-up system.

Design Leader

in F.M. Communications

Since 1932

Link Radio Corporation

125 W. 17th St., New York 11, N. Y.

Write for details!

THIS MONTH'S COVER

Heartiest congratulations are due the officers of the Audio Engineering Society. They have done an excellent job of building the membership and extending the influence of the AES, and now they have set up the first New York convention to be devoted to the interests of those concerned with audio developments. The officers, as they were photographed for this month's cover, are: Seated, left to right, executive vice president C. A. Raekey, NBC; president C. J. LeBel, Audio Devices; secretary Norman Pickering, Pickering & Company; standing, publicity committee chairman George Daniel, Western Electric; and treasurer Ralph Schlegel, WOR Recording Studios.

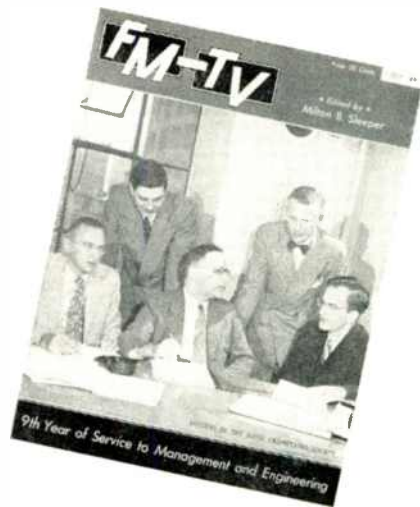

WHAT'S NEW THIS MONTH

1. RMA REPORTS ON TV SHIPMENTS
2. CHANGES FOR PROVISIONAL STATIONS
3. MORE INFORMATION FROM TELEPHONE POLLS
4. DO YOU REMEMBER THE OPA?

1. The geographical breakdown of TV set shipments by RMA members during the first six months of '49 discloses some interesting information, particularly when the figures for this year are checked against the number of local TV stations, and the sets sold prior to January 1st of this year.

A list of the 10 largest TV areas shows that New York and Boston, respectively in 1st and 6th place last year, maintained the same positions in 1949. Chicago, Los Angeles, Detroit, and Cleveland advanced over their positions last year, while Philadelphia, Newark, Washington, and Baltimore dropped down in the list.

The number of sets sold in '49 is not related to the number of local stations at all, but to the relative standings of the areas as to total retail sales. Here are the RMA figures:

AREA	TV STA.	SETS 1949	SETS PRIOR TO '49
Albany, N. Y.	1	9,801	12,779
Albuquerque, N. M.	1	71	246
Atlanta, Ga.	2	3,184	4,831
Baltimore, Md.	3	21,158	28,101
Birmingham, Ala.	2	2,199	23
Boston, Mass.	2	49,286	38,947
Buffalo, N. Y.	1	12,092	9,104
Charlotte, N. C.	1	1,718	231
Chicago, Ill.	4	77,278	79,416
Cincinnati, O.	3	19,196	14,087
Cleveland, O.	2	31,406	21,308
Dallas, Tex.	—	2,016	6,287
Davenport, Iowa	—	473	448
Detroit, Mich.	3	36,535	26,336
Erie, Pa.	1	690	303
Greensboro, N. C.	—	562	—
Houston, Tex.	1	2,106	2,259
Huntington, W. Va.	—	30	—
Indianapolis, Ind.	1	5,704	572
Jacksonville, Fla.	—	95	—

Kansas City, Mo.	—	4,549	549
Los Angeles, Cal.	6	60,407	76,925
Louisville, Ky.	1	2,042	3,119
Memphis, Tenn.	1	1,970	3,102
Miami, Fla.	1	2,800	843
Milwaukee, Wis.	1	10,439	12,939
Minneapolis, Minn.	2	4,711	6,236
Nashville, Tenn.	—	58	55
Newark, N. J.	—	59,978	103,526
New Haven, Conn.	1	10,733	17,072
New Orleans, La.	1	1,691	3,983
New York City	7	152,619	273,029
Oklahoma City, Okla.	1	2,810	28
Omaha, Neb.	1	1,109	37
Philadelphia	3	75,222	129,239
Phoenix, Ariz.	—	22	—
Pittsburgh, Pa.	1	15,185	6,138
Portland, Ore.	—	425	134
Richmond, Va.	1	2,879	3,221
St. Louis, Mo.	1	12,944	16,252
St. Petersburg, Fla.	—	51	44
S. Lake City, Utah	2	861	1,001
San Antonio, Tex.	—	87	—
San Francisco, Cal.	2	7,897	12,297
Seattle, Wash.	1	2,591	4,569
Syracuse, N. Y.	1	2,196	2,403
Toledo, O.	1	7,378	5,630
Tulsa, Okla.	—	203	—
Washington, D. C.	4	22,709	30,596
Miscellaneous	—	—	5,961

Totals 742,166 964,206

2. In a public notice dated August 9, the FCC called attention to the fact that the new rules effective last July 1st abolished the provisional radio station classification. However, all licenses for such stations expiring between July 1 and November 1, 1949, were automatically extended to November 1, 1949, in order to allow time for filing applications for reclassification.

(Continued on page 8)

FM and TELEVISION

RADIO-TELEFAX UNITS WITH SYLVANIA TUBES

SPREAD THE NEWS OF INCOMING SHIPS!



Pilot boat Captain sending written message of arrival of the big ship through link unit equipped with Sylvania tubes, and in short order . . .

★ ★ ★

. . . message arrives in Western Union Marine News room as facsimile reproduction, then is transmitted by an operator and simultaneously appears on tickers at offices of newspapers, customs, postal and immigration authorities, taxi, steamship companies and many others.

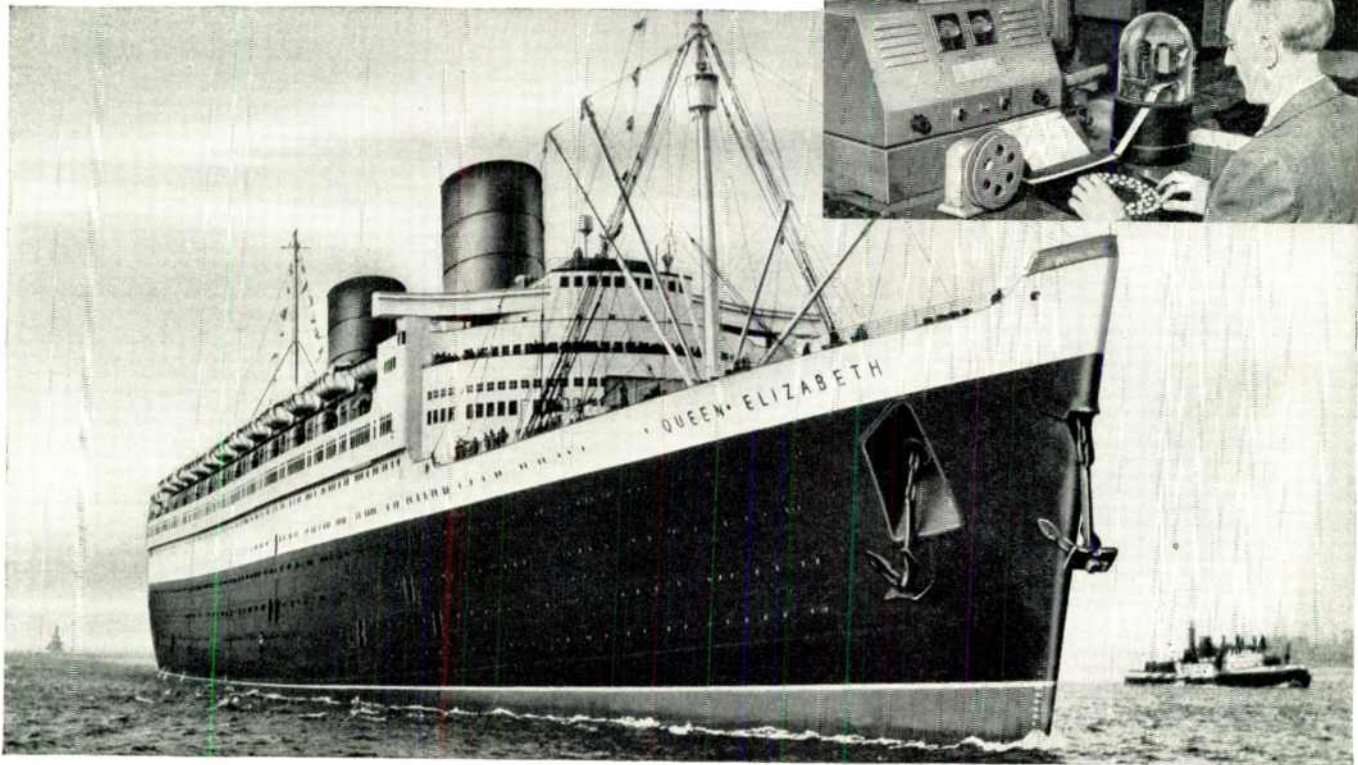
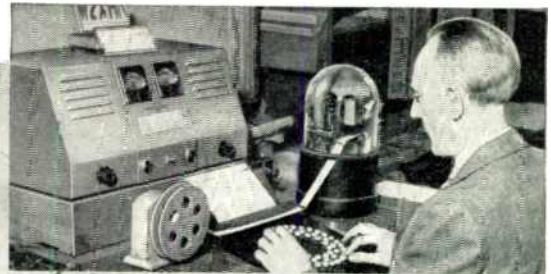

Link radio equipment used in Western Union Marine Reporting Service

RADIO-TELEFAX, a new type of telegraph communication, reports ship arrivals as part of Western Union's Marine Reporting Service.

Out at sea, the captain of the New York Pilot Boat spots incoming liners, writes a message such as "SS QUEEN ELIZABETH INCOMING AT 1644" on a telegraph blank and inserts it in an automatic Telefax transmitter. The unit then transmits it to Western Union over a VHF radio channel. It arrives as a *facsimile* of the sent message!

And inside this Link equipment, rugged Sylvania tubes, operating smoothly, do their part in this

important marine reporting service. Find out more about the complete Sylvania line of Radio Tubes . . . see your Sylvania Distributor or write Radio Tube Division, Emporium, Pa.

SYLVANIA ELECTRIC

RADIO TUBES; CATHODE RAY TUBES; ELECTRONIC DEVICES; FLUORESCENT LAMPS, FIXTURES, WIRING DEVICES; LIGHT BULBS; PHOTOLAMPS

October 1949—formerly FM, and FM RADIO—ELECTRONICS

Professional Directory

Jansky & Bailey

AN ORGANIZATION OF
Qualified Radio Engineers
DEDICATED TO THE
SERVICE OF BROADCASTING
National Press Bldg., Washington, D. C.

GARO W. RAY

CONSULTING RADIO ENGINEERS
Standard, FM and Television Services

HILLTOP DRIVE
STRATFORD, CONN. Tel. 7-2465

ANDREW ALFORD

Consulting Engineers
ANTENNAS & RF CIRCUITS

Laboratory and Plant:
299 Atlantic Ave., Boston 10, Mass.
Phone: HAncock 6-2339

DALE POLLACK

FREQUENCY MODULATION

development and research
transmitters, receivers
communications systems

352 Pequot Avenue New London, Conn.
New London, 2-4824

GEORGE C. DAVIS

Consulting Radio Engineers

501-514 Munsey Bldg.—Sterling 0111

Washington 4, D. C.

AMY, ACEVES & KING, INC.

*Specialists in the
Design and Installation of*

**HIGH-GAIN
AM, FM, and TELEVISION
ANTENNA SYSTEMS**

LOngacre 5-6622
11 West 42nd St., New York 18, N. Y.

WHAT'S NEW THIS MONTH

(Continued from page 6)

The Commission suggests that provisional stations may be able to qualify for operation in one of the industrial services¹ or the special emergency service.²

Such licensees are urged to apply for reclassification at the earliest date possible. Information required must include a detailed description of the licensee's business operations, and the manner in which radio facilities are being used now. Those found ineligible for reclassification may be able to obtain the service they require by subscribing to a common carrier³ radio system.

3. Right now, when FCC is being damned from all sides because of the TV allocations proposal, we are happy to report one very realistic and practical piece of thinking from that source.

It was contained in a letter commenting on the first item which appeared in this department last August—the one suggesting that members of the FCC should do more listening to audio programs around the country in order to acquaint themselves more fully with the relative merits of FM and AM broadcasting.

In the case of one Commissioner, at least, our comments seem unnecessary, for he wrote us:

"I gained the impression last year while in New England, and more particularly of late as a result of reports which reached my desk, that FM is gaining ground slowly but steadily in the urban and rural areas of the country, and particularly in the local and regional stations.

Then he offered this very sound suggestion: "Perhaps if one of the polling agencies were to expend a few cents for long-distance calls, they might find a different audience reaction than they receive within a city."

We haven't seen that thought expressed anywhere before, and we pass it on because it merits very careful consideration by AM and FM broadcasters, and by time-buyers, also.

Not that we think any AM station manager would disclose the results of a survey of listeners outside the 5-cent-call radius. However, there's no doubt but what 10- and 15-cent calls would give them some very important information, and an entirely new, factual slant

¹See "Radio Communications Services, Part 3" *FM-TV* Magazine, September, 1949, for complete details for requirements and available frequencies.
²See "Radio Communications Services Part 2" *FM-TV* Magazine, July, 1949.
³See "Radio Communications Services, Part 1" *FM-TV* Magazine, June, 1949.

(Continued on page 9)

Professional Directory

McNARY & WRATHALL

CONSULTING RADIO ENGINEERS

906 National Press Bldg. DI. 1205
Washington, D. C.

1407 Pacific Ave. Phone 5040
Santa Cruz, California

KEAR & KENNEDY

Consulting Radio Engineers

1703 K St., N.W. STerling 7932
Washington, D. C.

GEORGE P. ADAIR

Consulting Engineers

Radio, Communications, Electronics

1833 M St., N.W., Washington 6, D.C.

EXecutive 1230

McINTOSH & INGLIS

Consulting Radio Engineers

710 14th St. N.W., Wash. 5, D. C.
MEtropolitan 4477

RATES FOR PROFESSIONAL CARDS IN THIS DIRECTORY

\$12 Per Month for This Standard
Space. Orders Are Accepted
for 12 Insertions Only.

COMMUNICATIONS RESEARCH CORPORATION

System Planning—Engineering
Research & Development
FM—TV—Facsimile
VHF—Communications

60 E. 42nd St., New York 17, N. Y.
Mu 2-7259

Professional Directory

RAYMOND M. WILMOTTE Inc.

*Consulting Engineers
Radio & Electronics*

1469 Church St. N. W. Decatur 1232
Washington 5, D. C.

WELDON & CARR CONSULTING RADIO ENGINEERS

Washington, D. C.

1605 Connecticut Ave. MI. 4151

Dallas, Texas

1728 Wood St. Riverside 3611

RUSSELL P. MAY

CONSULTING RADIO ENGINEERS

★ ★ ★

1422 F Street, N. W. Wash. 4, D. C.

Kellogg Building Republic 3984

Member AFCEE

HAROLD M. HEIMARK

Communication Engineers

Specialists in the design of low power portable & mobile two-way radio equipment.

MANUFACTURING FACILITIES

734 N. Austin Blvd. Chicago phone
Oak Park, Illinois Estebrook 8-7047

LYNNE C. SMEBY

*Consulting
Radio Engineers*

820 13th St., N.W. EX 8073

WASHINGTON 5, D. C.

Winfield Scott McCachren

AND ASSOCIATES

Consulting Radio Engineers
TELEVISION SPECIALISTS

2404 Columbia Pike 410 Bond Bldg.
Arlington, Va. Washington, D.C.
GLEbe 9096 District 6923

WHAT'S NEW THIS MONTH

(Continued from page 8)

on the relative quality and effectiveness of FM and AM coverage.

Certainly the practice of sampling with 5-cent calls and applying the result to what an AM station claims as its primary service area is misleading to the station management, and completely false as a basis for selling coverage to time-buyers.

We once asked the chief engineer of a Philadelphia FM-AM station whether, if he should build a station of his own, it would be FM or AM. He answered promptly: "FM, of course." When we asked why, he said: "Did you know that, five miles from this AM transmitter, there is severe interference from a Chicago station?" It is doubtful, however, if the AM coverage claimed and sold by the Philadelphia station reflected that Chicago interference. And we'd be much surprised if the sales department has ever found out how much better coverage is delivered by the FM transmitter. They probably never will know until they use 10- and 15-cent calls to find out.

4. You may or may not favor Government control over the radio industry. But in case you have forgotten the conditions which prevailed when set manufacturers operated under Government controls exercised by OPA, here is a report published by RMA at that time from one of its members:

"An industry increment factor of 9% was announced as the permissible increase in Loud Speaker prices over the October 1, 1941, base price. OPA was advised that Loud Speakers could not possibly be manufactured on this basis and again we demonstrated severally and individually where and how the formula itself was defective. A new increment factor of 13.5% was then announced and again it was shown that no operations could possibly result, and the industry remained stalled.

"In October of 1945, with industry still stalled, OPA adopted a liberal interpretation of Sections 9 and 10 of RMPR 136 which had the effect of permitting to a great extent the use of actual producing and operating costs in determining the price of a Loud Speaker. The industry, with some exceptions, started at once. But Amendment 22 was issued as of December 3, 1945—which prevented this liberal interpretation and, for all practical purposes, the industry was right back where we started in June, 1945, when Loud Speaker manufacturers demonstrated that the formula was defective. Production stopped abruptly to avoid heavy operating losses and on December

Special Services Directory

METHODS ENGINEERS

Materials & Methods engineers in America's leading manufacturing plants use Topflight's Printed Cellophane, Self-Adhesive Tape to meet A-N specs. - assembly line - follow through - instruction labels. Easy to Apply.
TOPFLIGHT TAPE CO. YORK PA.

RANGERTONE

TAPE RECORDERS

HIGH-FIDELITY EQUIPMENT FOR
BROADCAST & RECORDING STUDIOS

RANGERTONE, INC.

73 Winthrop St. Newark 4, N. J.
Tel. Humbolt 5-2550

THE WORKSHOP ASSOCIATES

INCORPORATED

*Specialists in
High-Frequency Antennas*

66 Needham St., Newton Highlands, Mass.
Bigelow 3330

FACSIMILE

Systems developed to your special order—

EMERGENCY COMMUNICATIONS
POINT TO POINT
FM BROADCAST

—any size—any speed—using Alfax electro-sensitive paper (Write for new brochure on Alfax Papers).

ALDEN PRODUCTS CO.

117 North Main Street, Brockton 55, Mass.

15, Amendment 27, RMPR 136 was issued, relaxing somewhat the restrictions imposed by Amendment 22, but the only substantial effect was to formally legalize the use of prices to which some manufacturers had become obligated during the period of liberal interpretation of Sections 9 and 10 prior to Amendment 22. Amendment 27 created further confusion and inequity by: 1) giving OPA approval to 2 different prices on the same product and 2) permitting some manufacturers to operate with satisfactory prices (those who had applied under Section 9 and 10 in the brief period prior to December 3) while denying these same prices to others."

Installing a 25B is easy, fast, inexpensive!

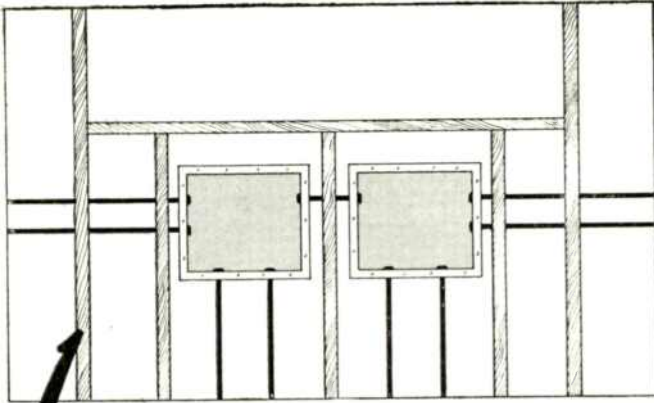

1 No need to design, buy and wait for junction boxes. They're furnished with the 25B! Your electrician just takes the shells of the boxes (with terminal and cable assemblies removed), mounts them in place and runs conduit to them—all in a minimum of time.

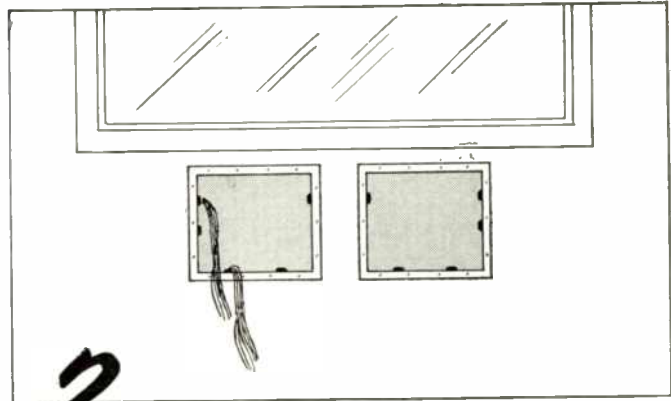

2 While the plasterer is doing his work, there's no equipment in the room to be damaged. When plastering is finished, it's an easy matter to pull wire through the conduit. The electrician works freely—unhampered by the presence of terminal assemblies or console.

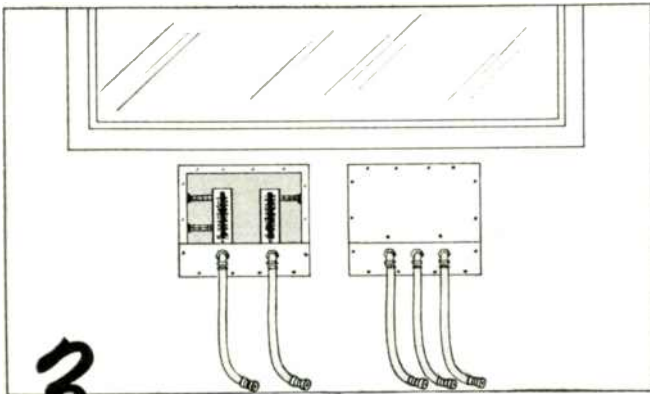

3 The two completely wired terminal and plug-in cable assemblies are mounted in the shells in a few minutes' time. External wiring is then connected—easily and neatly—to terminal strips. Cover plates are then attached (box at right is shown with cover in place).

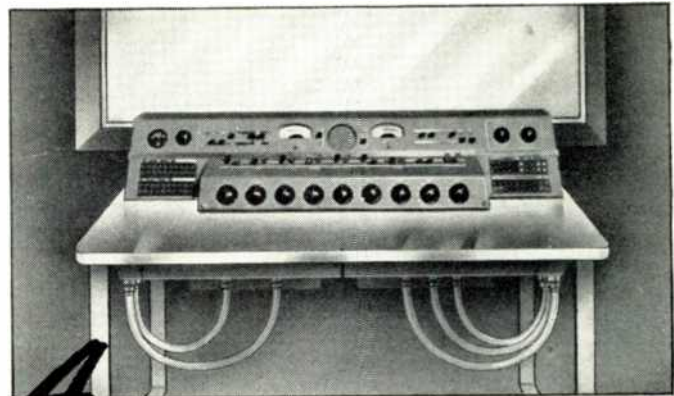

4 When workmen have finished, and you're ready for operational tests, unpack your 25B and plug the cable assemblies into the receptacles on the console. Note that the 25B remains out of the room till rough work is over—it stays free from scratches, dirt and paint drippings.

The 25B saves you time and money in installation because it's the *only* standard Speech Input Console supplied complete with wall junction boxes, terminal assemblies and plug-in connectors.

Here are some *other* reasons why you'll find the 25B a mighty good buy!

It provides highest quality studio control for AM, FM, and TV audio—has high signal-to-noise ratio and exceptionally low distortion. The wide fre-

quency range of the 25B exceeds FM requirements.

It handles two programs simultaneously without interference.

It's easy to operate, easy to maintain—all components are readily accessible.

For full information on the 25B—or for *immediate delivery*—call your nearest Graybar Broadcast Representative. Or write Graybar Electric Company, 420 Lexington Avenue, New York 17, N. Y.



— QUALITY COUNTS —

Western Electric

DISTRIBUTORS: IN THE U.S.A.—Graybar Electric Co.
IN CANADA—Northern Electric Company, Ltd.

HOW RCA'S COLOR TV WORKS

AN EXPLANATION OF THE RCA ALL-ELECTRONIC SYSTEM OF COLOR TELEVISION WHICH CAN BE RECEIVED ON MONOCHROME SETS AS WELL — By E. W. ENGSTROM*

THE color system which we will describe and demonstrate at the FCC television hearings has its roots in the simultaneous method first disclosed by RCA on October 30, 1946. This method was described in detail at the hearing in Docket No. 7896. The new system includes, however, later developments which accomplish transmission of a high definition color picture in a 6-mc. channel.

There is no degradation of the quality of the received picture. The system is completely compatible, so that present receiving sets need no modification or converter in order to receive color transmissions in monochrome.

The RCA letter dated August 25, 1949, pointed out that this new color system has the following characteristics:

1. 6-megacycle channel
2. Fully compatible
3. 525 lines
4. 60 fields per second
5. Field interlaced
6. Picture dot interlaced
7. 15 color pictures per second
8. Time multiplex transmission
9. All electronic operation

The transmitted signal is entirely consistent with the "Standards of Good Engineering Practice Concerning Television Broadcast Stations." This is the fundamental basis for compatibility, and means that a current monochrome receiver will respond in the same way as it would if a standard black-and-white camera originated the picture signal.

A block diagram of the broadcasting station for this RCA color system is shown in Fig. 1. The color camera related equipment, and the synchronizing generator are the same as for the wide-band simultaneous system.¹

This studio apparatus provides three signals, one for each of the primary colors: green, red, and blue. Each of these signals may contain frequency components out to a maximum of 4 mc., and in addition an average or DC component. For one signal routing of Fig. 1, each color signal passes through a low-pass filter which eliminates frequency com-

ponents above 2 mc. The green-channel signal coming out of its particular low-pass filter is designated as G₁ on Fig. 1, indicating that at this point the signal contains the DC component and AC components with frequencies of 2 mc. or less. The three low-frequency signals, G₁, R₁, and B₁, are then sent into an electronic commutator or sampler.

The manner in which this sampler functions will be discussed in detail later. In essence, however, at this point in the circuit each color signal is sampled for a very short time, 3.8×10^6 times per second for each color. Current investigations are aimed at determining whether this rate is optimum or whether a slight deviation from this value is desirable.

The sampling pulse generator is an integral part of the electronic commutator, and makes use of the trailing edge of the horizontal synchronizing pulse to time the sampling of each of the color signals.

From the sampler, the signals pass to an electronic combining device called Adder No. 1 in Fig. 1. Standard synchronizing signals from the synchronizing generator are also applied at this point.

The principle of "mixed highs," described by RCA in Docket Nos. 7896 and 8976, is also utilized. For the second signal routing of Fig. 1, the three color signals from the camera are combined in electronic Adder No. 2, and then passed through a band-pass filter. The output of this filter contains frequencies between 2 and 4 mc., with contributions from each of the three color channels. The signal at the output of the band-pass filter is designated as M₁, the mixed-highs signal. The mixed-high frequencies are fed to Adder No. 1 which is already receiving the signals from the sampler and synchronizing generator.

The signal resulting from the addition of these three signals, namely, the sampler output, the mixed highs, and the synchronizing pulses, then goes to a low-pass filter which cuts off at 4 mc. The signal from this filter is applied to the modulator of a conventional VHF or UHF television transmitter. No change in the normal transmitter equipment is required. The transmitter is used just as existing VHF transmitters are used, with the same vestigial sideband filter, sound transmitter, diplexer, and transmitting antenna.

The functioning of the electronic sampler will now be considered in more

detail. Fig. 2 illustrates the action of the system in any large uniform polychromatic areas, with the three primary colors represented by three different signal strengths. Fig. 2A shows the output of the sampler due to the green signal only. The green channel signal is sampled every 0.263 microsecond ($0.263 = 1/3.8$). At a time 0.0877 microsecond after a green sample, a sample is taken of the red signal. This time delay is one-third of the time between successive green samples. The red samples continue to be taken 0.263 microsecond apart as shown in Fig. 2C. The blue samples are taken at the same rate and follow the red samples by a time of 0.0877 microsecond, as indicated in Fig. 2E. The composite output of the sampler consists of a superposition of the green, red, and blue trains of pulses or samples. Fig. 2G shows the state of affairs in the circuit between the sampler and Adder No. 1, and, except for the synchronizing pulses and the mixed highs, represents the signal feeding into the low-pass filter. Since only large area color is under consideration for the moment, the mixed-highs signal need not be included. The narrow green pulses of Fig. 2A, occurring at a rate of 3.8×10^6 pulses per second, are smoothed by the low-pass filter to give the result shown in Fig. 2B. This wave consists of a DC component, which is the average of the pulse sample, plus a sine wave which has a frequency of 3.8 mc. (the filter having removed the higher order harmonics). The 3.8-mc. sine wave and the DC component change together, as the green signal changes in strength, in such a way that the signal of Fig. 2B always passes through zero at the same interval of time after the peak, regardless of the strength of the green signal. The smoothed sample of the green signal may be ex-

$$\text{pressed as: } \frac{G(t)}{3} [1 + 2\cos(2\pi ft)]$$

where $G(t)$ is the green signal as a function of time, and f is the sampling frequency, namely 3.8 mc. A study of this expression reveals that the smoothed green sample goes through zero, 120, and 240 electrical degrees after the signal has reached its maximum value.

The red samples of Fig. 2C are smoothed by the filter to yield the result shown in Fig. 2D. This again is made up of a DC component and a sine wave with a frequency of 3.8 mc.

* Vice President in Charge of Research, RCA Laboratories Division, Princeton, N. J. This text was transmitted to the Federal Communications Commission on September 6, 1949, as an engineering statement supplemental to comments of the Radio Corporation of America, in response to paragraph 14(a) of the notice of the FCC, issued July 11, 1949, in Docket Nos. 8736, 8975, 9175, and 8976.

¹ These were described by RCA in Dockets No. 7896 and No. 8976. See also: *RCA Review*, Vol. VII, No. 4, pp. 459-468, December, 1946; *Proc. I.R.E.*, Vol. 35, No. 9, pp. 861-875, September, 1947.

Smoothing of the blue sampling pulses results in the contribution shown in Fig. 2F. It should be noted in Figs. 2B, 2D, and 2F that when any one color signal out of the filter reaches its maximum value, the other two responses are crossing the zero axis.

While the curves of Figs. 2B, 2D, and 2F have been shown separately for illustrative purposes, it should be remembered that the pulse train of Fig. 2G goes into the low-pass filter. Thus the composite signal of Fig. 2H comes out of the smoothing filter. In this figure, the DC component is the sum of the DC components of the green, red, and blue signals, while the 3.8-mc. sine wave is the sum of three sine waves, resulting in a 3.8-mc. sine wave with a new amplitude and phase position superimposed on the composite DC component.

The signal of Fig. 2H is applied to the modulator of the transmitter. As has been explained, the signal at this point for large and small picture areas contains frequency components up to the limit of the low-pass filter or up to 4 mc.

The action of the system in the presence of a varying color may be illustrated by means of Fig. 3. In Fig. 3A, the three color signals are shown as they enter the sampler, with the appropriate sampling pulses as they come out of the sampler indicated by vertical lines. These same pulses are shown in Fig. 3B, with the envelope indicating the result of smoothing in the filter. This envelope may also be regarded as the envelope of the transmitted radio-frequency signal, neglecting the contribution of the mixed-highs signal.

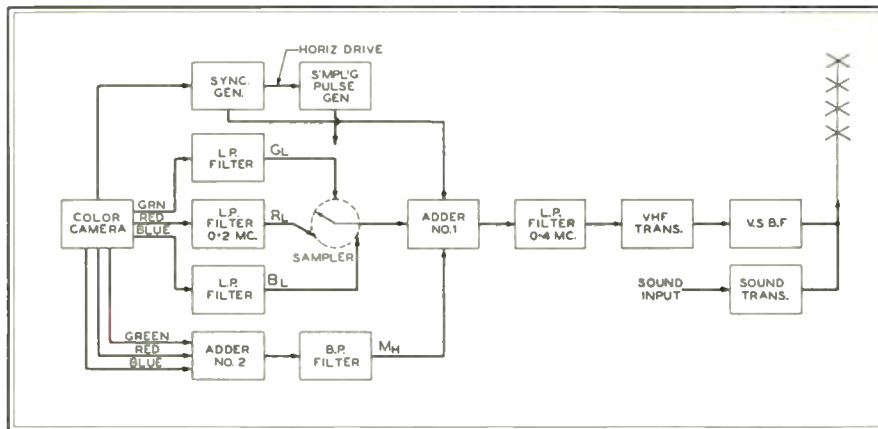

Fig. 1. The RCA TV color system is designed to feed a conventional VHF transmitter

A few words of explanation regarding mixed-highs is appropriate. First, we have demonstrated that the mixed-highs procedure is successful and satisfactory in a wide-band simultaneous system. In the RCA color television system, the sampling process by itself is sufficient to carry high-frequency components of each color signal so that when combined the resulting band width is below 4 mc. (the sampling frequency determines the highest frequency which will be passed). However, the choice has been made to sample for the lower half of the video band (up to 2 mc.) and to use the mixed-highs principle for the upper half of the video band because this has technical advantages.

Fig. 4 is a block diagram of one type of color television receiver. The radio-frequency circuits, the picture intermediate-frequency amplifiers, the second detector, the sound intermediate-frequency amplifiers, the discriminator, and the audio circuits are identical with those of a conventional black-and-white receiver. The composite video and synchronizing signals from the second detector enter an electronic device called the sync separator, which removes the

video and sends the synchronizing pulses to the deflection circuits and to the sampling pulse generator. The sampling pulse generator utilizes the trailing edge of the horizontal synchronizing pulse to actuate the receiver sampler in synchronism with the transmitter sampler.

The signal from the second detector also enters the sampler. It has the same form as the composite signal of Fig. 2H, or as the solid envelope of Fig. 3B. For ease of reference, Fig. 2H has been reproduced on Fig. 5A. The electronic commutator samples the composite signal every 0.0877 microsecond, producing the short pulses shown on Fig. 5A. The amplitude of each of these pulses is determined by the amplitude of the composite wave at that particular instant.

The commutator feeds these pulses into three separate video amplifiers which, in turn, control three cathode-ray tubes or kinescopes having appropriate color-producing phosphors.²

The video amplifiers have a flat re-

² This method for portraying the single color picture with three kinescopes in a projection system is similar to that demonstrated to the Commission during the hearing on Docket No. 7896. (See also: *RCA Review*, Vol. VII, No. 4, pp. 459-468, December, 1946; *Proc. I.R.E.*, Vol. 35, No. 9, pp. 861-875, September, 1947.)

Fig. 2. Action of the system in large, uniform polychromatic areas. Fig. 3. Action of the system in the presence of a varying color

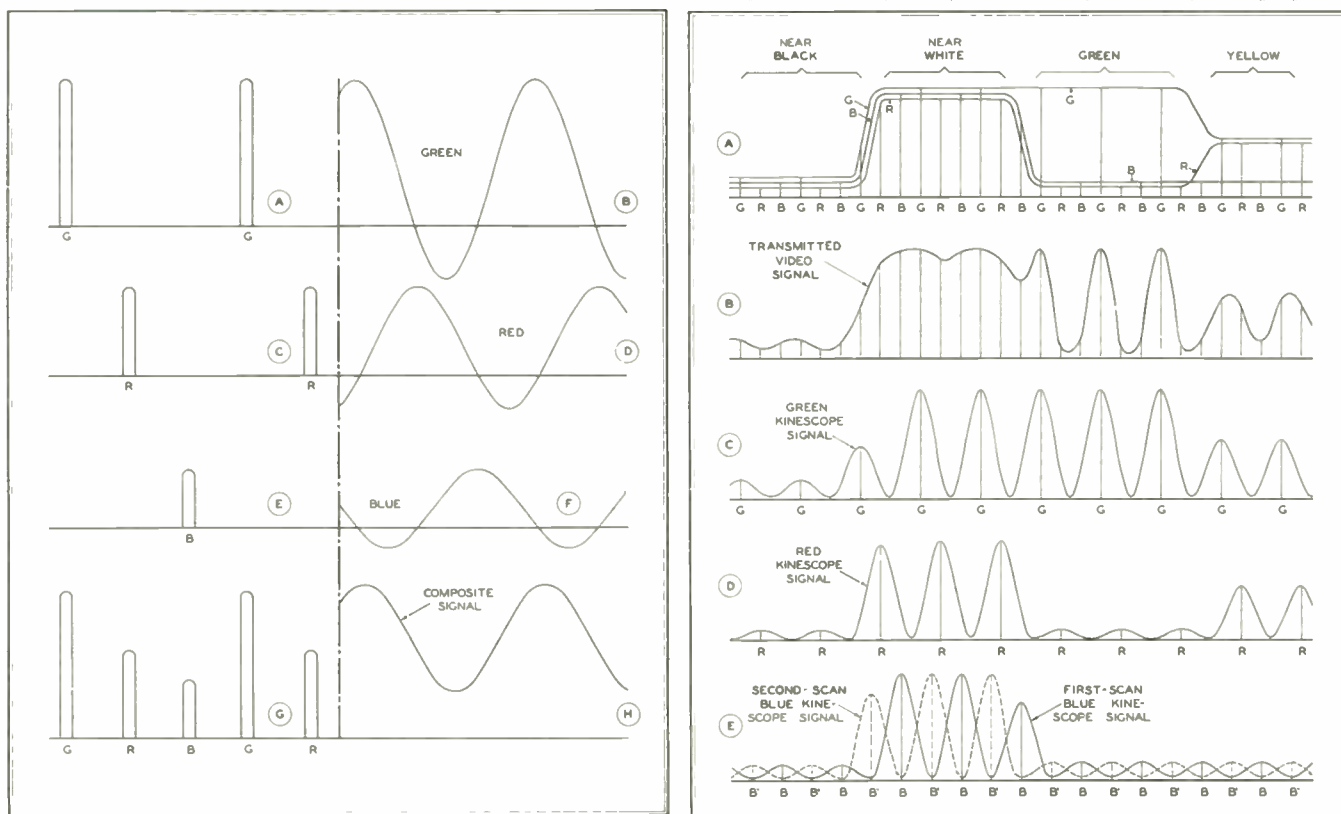

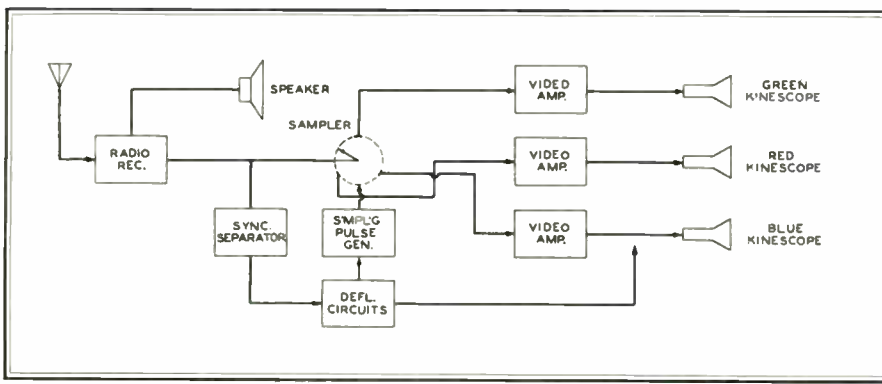

Fig. 4. The block diagram for one type of RCA color television receiver

sponse to 4 mc., gradually drop off in response from that frequency to 7 mc., and have great attenuation above 7 mc. (We are discussing here the frequency response of the video amplifiers only, and not channel requirements.)

The sampler sends the pulses to each of the video amplifiers and its attendant kinescope in succession. For instance, as illustrated in Fig. 5A, the first pulse goes to the green kinescope, the next pulse goes to the red kinescope, while the third pulse is sent to the blue kinescope. The green kinescope receives the fourth, seventh, tenth, and so on. Thus, while the individual pulses coming out of the sampler are 0.0877 microsecond apart, the green pulses going to the video amplifier for the green kinescope repeat every 0.263 microsecond. The green channel pulses of Fig. 5A, passing through the video amplifier, lose all frequency components except the fundamental frequency of 3.8 mc. and the DC component. The resultant smoothed signals are shown in Fig. 5B. The green, red, and blue signals are shown in superposition on this figure for illustration. It should be remembered that at this point the green signal shown is that fed to the green kinescope, while the red and blue signals are applied to their individual kinescopes.

Examination of Figs. 2B, 2D, 2F, and 2H, has already revealed that, when the green signal is maximum, the red and

blue signals are passing through zero. Hence, since the composite signal is sampled for green, by a narrow pulse at the receiver at this exact instant, the receiver sampling pulse is a true measure of the green signal and includes no dilution from the red or blue signals. Likewise, the red and blue samples are each taken at points on the composite signal where no cross-talk is contributed from the other two color signals.

Assuming that the kinescope actually cuts off with negative applied signal, and neglecting the non-linearity of the input control-voltage vs. the light-output characteristic of the kinescope, the solid lines of Fig. 5C may be regarded as the effective light intensity along one line scan on the screen of the green kinescope. Figs. 3C, 3D, and 3E show the effective signals on the green, red, and blue kinescopes, again for a single-line scan.

Returning now to Fig. 5C, it may be seen that a single line scan on the green channel lays down a series of green dots on the screen as shown by the solid lines. As was indicated above, these dots occur at a 3.8-mc. rate. If fine detail were involved to such an extent that two adjacent pulses in the green channel in a single line scan were of different amplitude, it is basic that the highest frequency component of use in establishing picture detail would be a sine wave which went from a crest to a trough in the time between the two

adjacent green pulses. This sine wave would then have a frequency of 1.9 mc. The fact that each pulse has a rise equivalent to twice this frequency allows the use of picture-dot interlacing to secure full detail up to 3.8 mc. This is accomplished by shifting the sampling pulses the next time that the same line is scanned so that the dots are then laid down between the dots that were laid down in the first scan. This second series of green dots is shown by the broken curves in Fig. 5C. In this figure, the dots shown by broken curves are the same amplitude as the dots shown by the solid curves. For resolution of very fine detail, the dots laid down in the first scan would differ in amplitude from the dots laid down in the second scan of this same line. Fig. 3E shows the signal at the blue kinescope for the first scanning of the line, with the dotted line showing the kinescope voltage for the second scanning of the same line.

Inspection of Fig. 5B reveals that while a single line scan lays down a series of green dots on the screen with space between dots, this space is completely filled at the same time by red and blue dots, with great overlapping of the dots.

The scanning sequence used in the RCA color television system is illustrated in Fig. 6. Here each square represents a dot on the screen. Because of the overlapping of dots, each square should be approximately 50% longer than shown.

During the first scanning field, illustrated by the upper diagram in this figure, the odd-numbered lines are scanned in order. That is, the three colored dots are laid down in order along line 1 as shown. Next, line 3 is scanned with a displacement of one and one-half squares for each color. The remaining odd lines

(Continued on page 15)

Fig. 5 The signal from the second detector, as it enters the sampling device. Fig. 6. Dot patterns created by the four fields

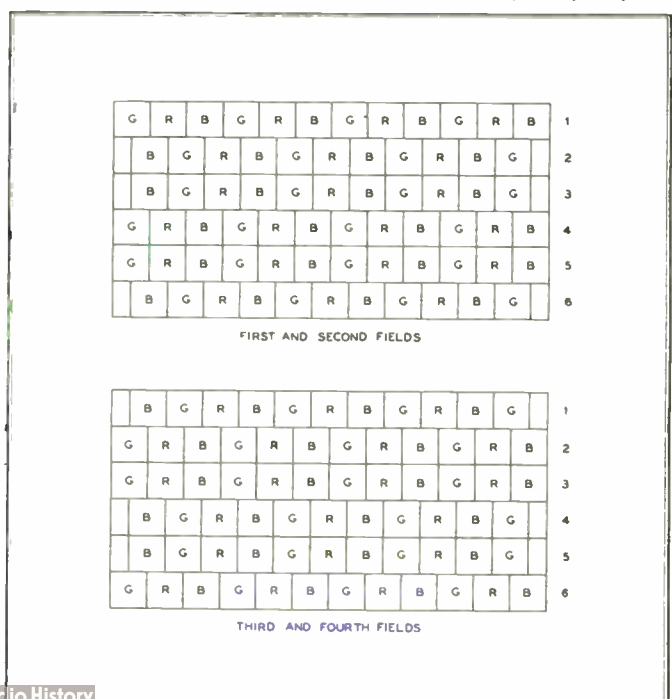
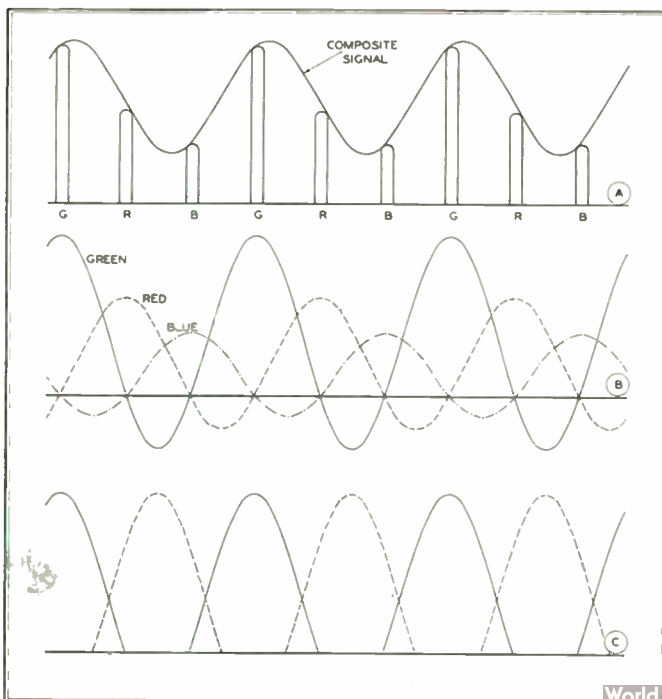

A NEW TYPE OF VHF TANK DESIGN

GROUND-PLANE TUNING OF FLAT TANK ELEMENTS AFFORDS MECHANICAL AND ELECTRICAL ADVANTAGES IN A PUSH-PULL OUTPUT CIRCUIT — By B. E. Parker*

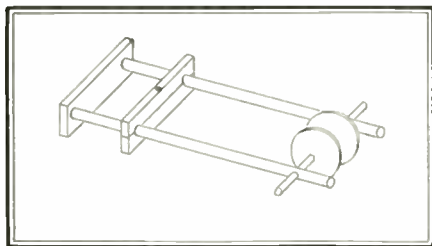

Fig. 1. Usual 2-wire, quarter-wave section

FOR FM broadcast frequencies, linear parameters are used almost without exception as the tuning elements in transmitters, consisting usually of quarter-wave sections of transmission line shorted at one end. In single-ended stages, coaxial conductors can be used to advantage. For push-pull operation, however, the balanced two-wire section of trans-

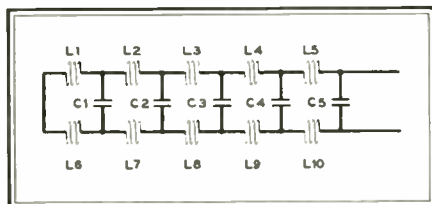

Fig. 2. Components of transmission line

mission line is more desirable. The following describes the evolution of a new method of tuning such a section which results in several basic improvements over conventional methods, and provides a basis for further development or variation in this direction. One specific application is illustrated here.

When two-wire, quarter-wave sections are used, tuning is commonly accom-

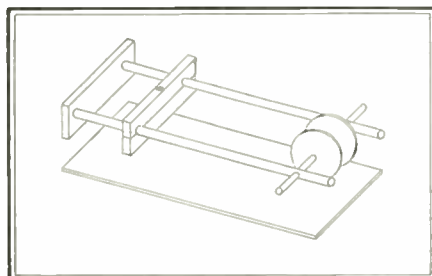

Fig. 3. Method of changing surge impedance

plished by means of a small variable shunt capacity across the open end or by the use of a movable shorting bar, as shown in Fig. 1. Occasionally, a combination of these two methods is employed.

Using the variable shorting bar pre-

* Engineering Department, Gates Radio Corp., Quincy, Ill.

sents difficulties with sliding fingers and wiping contacts. These are subject to wear and arcing, since they are at a high-current point. The shunt-capacity method of tuning is no less troublesome. High-voltage design problems enter the picture here, since the highest RF potentials exist at this point. The capacitor insulation must be excellent to minimize RF losses. It is extremely difficult, also, to maintain complete circuit symmetry and balance in the legs of the tuning parameters, since some mechanical means must be provided for varying the capacitor. The addition of this extra shunt capacity to that of the tubes reduces the effective physical length of the tank by an undesirably large amount. Efficiency is then reduced.

The lower the surge impedance of a quarter-wave section, the less pronounced is the effective physical shortening effect of the variable shunt capacity. Take, for example, a typical situation in which the tube capacity is 10 mmf., the operating frequency is 100 mc., and the line surge impedance is 200 ohms. Since $X_L = X_C$ for resonance, and the capacitive reactance of the tube is 159 ohms, then the line must present an inductive reactance of 159 ohms. By substitution in

$$\text{the following equations}^1 \quad \tan \Theta = \frac{jZ_0}{Z_{in}}$$

we obtain a value of 38.5° for Θ where

Θ = length of the line in degrees

Z_0 = characteristic surge impedance

Z_{in} = input impedance in ohms.

A line 38.5° long corresponds to a physical length of approximately 12.6 ins. at this frequency.

If, in this example, the line surge impedance is changed by some means from 200 to 100 ohms, the line length becomes 57.9° electrically, or about 19 ins. long. Thus, by changing the surge impedance we have in effect changed the physical length of the tank by 5.4 ins. to maintain the same resonant frequency of 100 mc. From the above, it is obvious that tuning can be accomplished by varying the surge impedance; for we would have increased the resonant frequency appreciably by considering the length of the line to be constant, as it would be, rather than considering it to increase in length to maintain the same 100 mc. resonant frequency.

A transmission line is often considered as being made up of a network of series

¹ F. E. Terman, Radio Engineering Handbook, pgs. 146-148, 183.

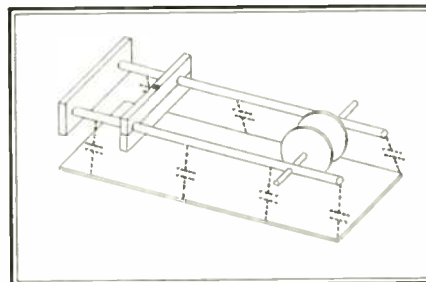

Fig. 4. Effect of using flat conductor

inductive and shunt capacitive components as shown in Fig. 2. To change the surge impedance it is necessary to vary either the series inductance or the shunt capacity of the line.² A tuning arrangement based on Fig. 3 will do both. As the flat conductor is brought closer to the line, the capacity of the section increases and the inductance decreases. This is indicated in Fig. 4. The increase in the shunt capacity is due simply to the effective increase in surface area, and eddy currents induced in the vane set up an opposing magnetic field to reduce the useful inductance.³ The net result is a decrease in surge impedance according to the following equation:⁴

² W. L. Everitt, Communications Engineering, pg. 74.

³ MIT Radar Staff, Principles of Radar, Sec. 7-10.

⁴ Marchand, Ultrahigh Frequency Transmission and Radiation, pg. 288.

Fig. 6. Detail of VHF tank construction

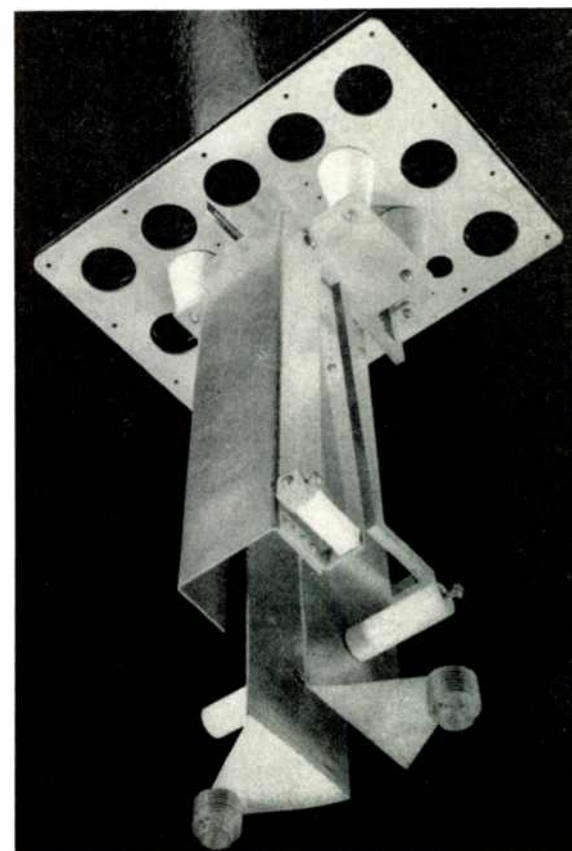

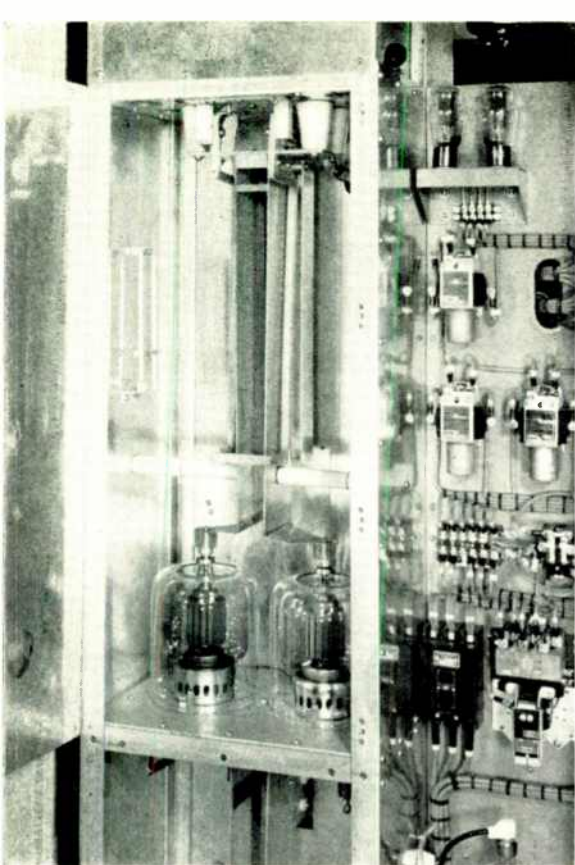

Fig. 7. Tank assembly in FM transmitter

$$Z_0 = 276 \log_{10} \left[\frac{2h}{a \sqrt{1 + \left(\frac{2h}{d}\right)^2}} \right]$$

where

a = radii of the conductors.

d = center to center distance between conductors.

RCA COLOR TELEVISION

(Continued from page 13)

are scanned in order with the color dot pattern shown. This scanning of the first field takes place in one-sixtieth of a second. During the second field, the even lines are scanned, first line 2 with the colors laid down in overlapping dots as shown, then line 4 and so on. The dot pattern laid down during the third field is shown by the lower diagram, where the odd lines are scanned in succession. During the fourth field, the even lines are again scanned in succession with the color dot pattern shown.

Thus, in the RCA color television system, the odd lines are scanned during the first field, but dots of the same primary color are separated by spaces. The even lines are scanned during the second field, again with spaces between like color dots. During the third field, the odd lines are again scanned but with the color dots displaced so that the spaces are filled. The even lines are scanned during the fourth field, with the color dots displaced to fill in the spaces left during the second field scanning. Four scanning fields are required to completely cover the picture area, with all spaces filled, with say, green dots. Simultaneously, the area is being cov-

erred with red dots and with blue dots. Since there are 60 fields per second, it may be said that there are 15 complete color pictures per second. It should be remembered that the effective field rate for large-area flicker is 60 per second, the same as for current black-and-white receivers. At viewing distances such that the picture line structure is not resolved, the effect of small-area flicker due to line interlace and picture-dot interlace is not visible.

When the radio signal from the RCA color television system is received on a current black-and-white receiver, in good adjustment, the output of the second detector is represented by Fig. 2H, or, when the picture is of varying color, by the envelope of Fig. 3B. With mixed highs also transmitted as shown in Fig. 1, the black-and-white receiver then develops on its kinescope a black-and-white picture with full resolution. The 3.8-mc. sine wave superimposed on the picture signal produces a dot pattern on the kinescope, but due to interlace and line structure the dots are not visible at normal viewing distance.

In our laboratory setup, using the standard wedge pattern to test horizontal resolution, we have obtained the same resolution figure when reproducing the color transmission on an unchanged

l = distance from the tuning vane to conductor centers.

It seems evident that an efficient method of tuning can be based on this, having the following desirable characteristics:

1. Freedom from sliding-finger wear and arcing, since the tuning element can be placed readily at RF ground potential.
2. The tank efficiency is increased due to the added effective physical length.
3. Complete symmetry in the circuit is maintained.
4. VHF high-voltage insulation problems are non-existent, since the tuning element is at ground potential.
5. The RF field is concentrated in the tank proper, lessening radiation losses.

The effectiveness of the tuning vane can be increased by forming the vane as shown in Fig. 5. A plane of this nature was used at Gates Radio in the first laboratory experiments during our initial FM transmitter development. Tests indicated that the theoretical approach was basically correct. In the first model and since, one end of the vane was fastened to the shorted end of the tank by means of a pivot arrangement which allowed the other end, close to the tubes and at the high impedance end of the tank, to swing toward and away from the linear elements.

Flat-surface transmission line was used rather than wires or rods because low

surge impedance is more easily obtainable with this type of construction, in addition to these other advantages:

1. Higher voltage capabilities without arcing between elements for equivalent spacing.
2. Better distribution of RF current on the inner surfaces.
3. Coupling is more easily accomplished.

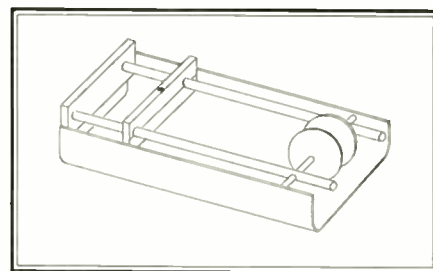

Fig. 5. Final design of VHF tuning vane

4. Layout is simplified, and manufacture is facilitated.

A closeup view of the tank is shown in Fig. 6, and the complete tank assembly in Fig. 7.

FM transmitters employing this design repeatedly show average efficiencies of 75% on performance tests. This construction will become increasingly advantageous where tank elements grow shorter physically, and wherever it is essential to obtain the highest possible degree of circuit symmetry and efficiency.

current-model black-and-white receiver as one may obtain with the same receiver on a well-designed, well-adjusted black-and-white system using present broadcast standards. We have also obtained the same resolution figure when reproducing the color transmission on a color receiver.

For color transmissions received on a color receiver, band-saving is accomplished for the radio channel, first by the sampling process wherein the color signals are transmitted in time-multiplex fashion. The second aspect of the band-saving process is through picture-dot interlacing. At the receiver the effect of the greater band width is restored by the inverse sampling and by circuit arrangements to scan so as to picture-dot interlace.

For color transmissions received in monochrome on a current black-and-white receiver, no band-saving is involved, but because the transmitted signal contains all the resolution which a black-and-white signal of the same scene would have, the resulting monochrome picture will have the full resolution of the current standards.

To adapt a current black-and-white receiver to receive color transmissions in color will require the addition of circuits

(Continued on page 30)

SPOT NEWS NOTES NOTES AND COMMENTS ABOUT SIGNIFICANT ACTIVITIES OF PEOPLE & COMPANIES

424 TV Receiver Models:

A study of current TV receivers shows that 87 companies are now offering 424 different models. The list is comprised of 4 chassis, 6 kits, 8 portables, 57 consolettes, 174 consoles, and 175 table types. Of the consoles, 10 have FM tuning, 8 provide for both FM and AM, while 70 are FM-AM-phono models. Of the consolettes, 9 have FM and 2 have FM-AM tuning. Of the table types, 14 have FM and 10 have FM-AM tuning. This gives a total of 124 TV models with FM circuits and 300 without.

\$12.95 Record Changer:

To spearhead a new promotion drive on 45 RPM records, RCA has cut the retail price of its model 9JY changer from \$24.95 to \$12.95. Prices of other models remain unchanged.

TV for Movie Theatres:

The Society of Motion Picture Engineers has asked the FCC to provide 50-mc. channels in the band of 5.925 to 7.125 mc. for radio distribution of TV shows to theatres. SMPE thinking is that equipment to use 50-mc. bands will be developed by progressive improvement over a period of years. FCC allocations table of July 1, 1949 list these assignments: common carrier fixed 5.925-6.425 mc.; non-government fixed and mobile 6.425-6.575 mc.; international control, operational fixed 6.575-6.875 mc.; TV pickup, TV S-T link 6.875-7.125 mc.

FM for Forestry Service:

Michigan Conservation Department will install a network of 20 FM stations for communication with fire towers and mobile units. Control of the system will be located at the state office building in Lansing, connected by a point-to-point system to a repeater at Stanton. This will re-transmit messages to the fixed stations.

FM-TV Circulation Audit:

Will be made by the firm of H. R. Sykes, Certified Public Accountants, Pittsfield, Mass. Reasons for the shift from the Audit Bureau of Circulations are to make 6-month reports available more promptly, to permit complete auditing of each report instead of issuing them as ABC sworn publisher's statements, and to provide additional audited information not disclosed by ABC.

The New TV Plan:

Anything can happen by the time TV is unfrozen, but some of the best-informed opinion stacks up this way: 1) There will



"Travis, unless your company's engineers adopt a more realistic approach, we must seek elsewhere for our requirements"

be no color on VHF, 2) The VHF channels will be released first, 3) Finalizing of a UHF plan will be deferred, pending further investigation, 4) When standards are set for UHF, they will be for a high-definition system. If the first three of these predictions prove correct, VHF construction may be resumed very early in 1950, and volume of receiver sales will take another jump.

Wider Band for Cable:

In a report to the FCC on the bandwidth of its coaxial cables, AT & T stated that all except the prewar routes are capable of carrying the full frequency range now required for TV pictures, and that new developments already underway will make it possible to increase the bandwidth to 8 mc.

Harold M. Heimark:

Former chief engineer for Doolittle has set up a laboratory at 734 N. Austin Boulevard, Oak Park, Ill., where he will handle the development of low-power transmitters and high-sensitivity receivers for railroad, forestry, and other communications services.

3-Watt Mobile Units:

Fast-selling newcomer in communications field is the small, light, 3-watt unit, authorized by the FCC for "any person engaged in a commercial activity or an industrial enterprise." Motorola and Doolittle are producing them now. Others will have models soon. There are a thousand uses for them, and they work beautifully on exclusive channels of 27.51, 33.14, 35.02, and 42.98 mc., and on the 154.57-mc. shared channel.

Low-Temperature Batteries:

Storage batteries capable of cranking engines in tanks and trucks at -65° F. are being produced by Willard Storage Battery Company, Cleveland, Ohio. These would meet requirements of emergency power plants for remote communications transmitters on mountain-tops.

Markets for FM and TV Sets:

Broadcast stations create markets for receivers. Among the 150 largest retail markets in the U. S. there are 43 TV markets with a total of 74 stations, and 138 FM markets with a total of 488 stations. Experience has shown that two stations are required in a given area to build set sales in substantial volume. In the 150 largest markets, 16 have 2 or more TV stations to a total of 49, while 109 have 2 or more FM stations to a total of 459, and 12 have neither.

Howard V. Carlson:

Formerly of Doolittle, and an old-timer in mobile radio, has joined Communications Equipment & Engineering Company, Chicago 44.

Peace on 34th Street:

Full-page advertisement of Du Mont TV receivers over Macy name in *The New York Times*, September 18, signaled resumption of friendly franchise relations, following dust-up over Macy's cut-price promotion last July.

WGKV-FM Charleston, W. Va.:

NBC outlet is now operating on 98.5 mc. Transmitter is a 3-kw. REL Serrasoid installation.

Color vs. Monochrome Pictures:

If the detail in VHF color TV compares favorably with that of present black-and-white reception, the inference can be drawn that the optical quality of monochrome television can be improved substantially within the limits of existing standards. Or, to put it differently, if good color reception is possible now, why can't we have better black-and-white service? The answer to this question will probably come out in the FCC hearings, which are now under way.

New Plant Facilities:

North American Philips is installing automatic equipment for mass production of Protelgram and direct-view tubes at their Dobbs Ferry plant. Associated television components will also be manufactured there, to be announced later, and a new magnetic core material called Ferrocube.

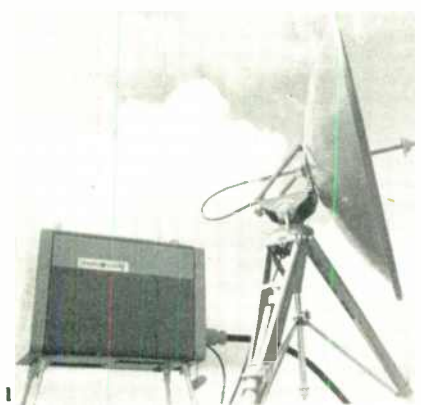

1

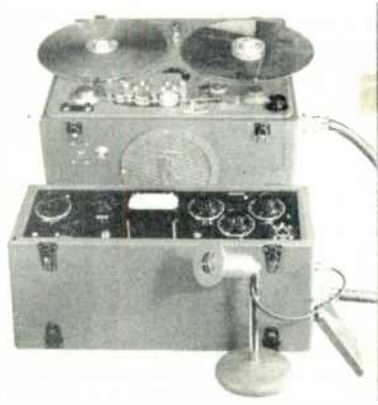

2



3



4

NEWS PICTURES

1. General Electric has a semi-portable TV relay transmitter, with the controls and power supplies assembled in four cabinets, each 24 by 13½ by 20 ins. The photograph shows the transmitter unit and 4-ft. tripod-mounted reflector and antenna. Similar equipment is available for permanent installations.

2. This new Ranger tape recorder is designed to provide lip-synchronized recordings in conjunction with motion picture film. Synchronization is obtained by putting a sync signal on the tape while a recording is being made. During play-back, the signal is applied to a variable-frequency power generator (thyatron) which controls the speed of the driving motor.

3. A number of mechanical and electrical refinements have been incorporated in the Audiograph tape recorder. Rated response is flat within 2 db from 50 to 10,000 cycles at 7½ ins. per second. Harmonic distortion in the equipment chain is rated at less than 1% at 10 db

above normal level, and the signal-to-noise ratio 50 below the 2.5% tape distortion point. Response can be extended at the 15-ft. speed.

4. Dr. H. F. Olson, acoustics authority at the RCA Laboratories, has developed a new, low-cost 15-in. speaker that has interesting possibilities for custom installations. Designed for high sensitivity between 40 and 12,000 cycles, it is capable of handling 25 watts. Dr. Olson will describe the speaker at the Syracuse Fall Meeting, November 2.

5. Motorola's commercial version of the Handie-Talkie is a remarkably compact assembly containing 11 receiving and 8 transmitting tubes. FM receiving circuit includes 2 RF stages and 2 limiters. Power output of transmitter is .5 watt at 25 to 50 mc. Weight is 9.8 lbs., including A and B dry cells.

6. For demonstrations, tests, and temporary installations, this tripod-mounted antenna is most convenient. This design is suitable for field tests of mobile radio equipment, for the mast

and base are strong enough to carry any conventional type of radiator such as is used for communications purposes. The manufacturer is Universal Products Company, Racine, Wis.

7. The strength of lightweight welded tower construction is indicated in this photograph. This 30-ft. tower, strong enough to carry the weight of three men, weighs only 70 lbs.

8. Walco Products, Inc., East Orange, N. J., by using aluminum construction, is producing 120-ft. towers that weigh only 1 lb. per foot. Sections are 6 ft. long, making the assembly work very easy. Three sets of guys are required for the full height of 120 ft.

9. Station WMBO-FM, now on the air at Auburn, N. Y., is a new G.E. installation. The 248-ft. tower is located high in the hills near Scipio Center. Programs from the studio are carried over a microwave link. The receiving dish can be seen about two-thirds of the way up the tower.



5

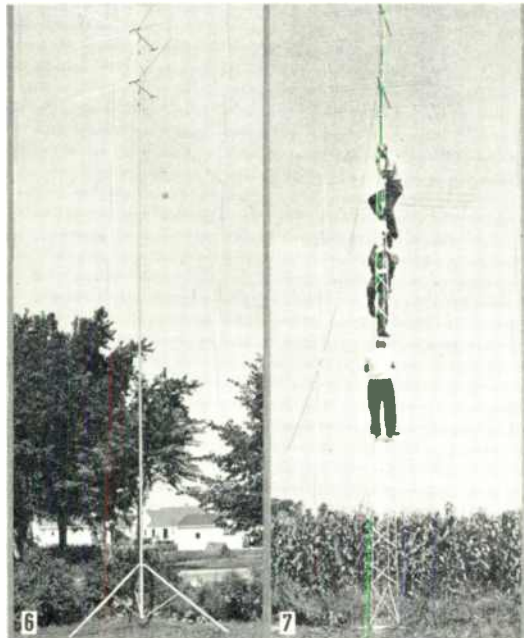

6

7

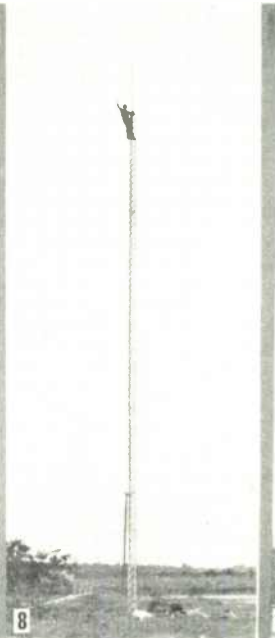

8

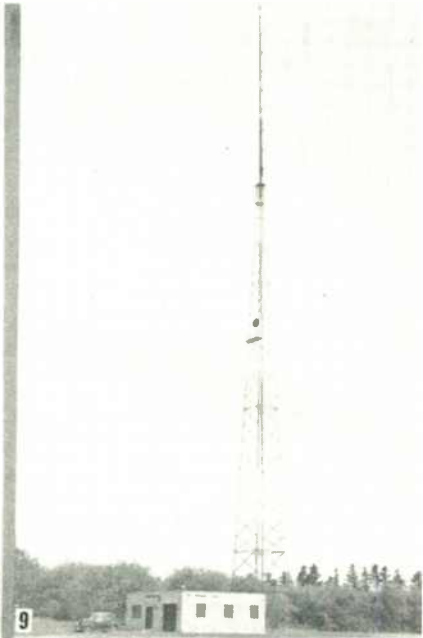

9



JEREMIAH COURTNEY'S* MOBILE RADIO NEWS and FORECASTS

SHORTLY, taxicab licensees will be able to install mobile radio units in tow, repair, and maintenance vehicles serving their taxis. The FCC has issued a proposed Rule to permit such use, following petitions to that effect by the two national taxicab trade associations, the American Taxicab Association and the National Association of Taxicab Owners.

However, portion of Association petitions requesting permission to install mobile units in company supervisors' cars was denied. The proposed Commission Rule is subject to comment by the industry, however, and the importance of supervisors' radio use will probably result in an industry request for oral argument before full Commission. Denial action reported here was taken by board of three Commissioners.

Police Radio Bands:

Eastern States Police Radio League, in pushing the use of 44 to 50 mc. by new police radio systems in preference to the 152- to 162-mc. band, is to be commended. The upper band has been overloaded in the haste to join the rush to 152 to 162 mc. Five years ago, everyone wanted the 30-mc. band. The trend has been so completely reversed today that unless checked, police officials may soon regret overlooking the 44- to 50-mc. area.

Intra-City Trucking:

American Trucking Association has petitioned the FCC to modify highway truck radio service Rules to permit a very small but highly important segment of the trucking industry to use radio within metropolitan areas. Present Rules limit trucking radio use to those "engaged in the operation of trucks, on a route basis, outside of metropolitan areas." Modification recommended by ATA would extend eligibility to cover truck operators serving inter-city truck lines, railroads, steamships and airlines.

ATA petition stated that the recommended modification would affect only 2 to 15% of all intra-city truck operations. The petition also indicated that very light frequency utilization would result

from the modification recommended, with little or no interference to inter-city route operators now eligible to use radio. Air Cargo, Inc., which handles land transportation of air cargo for all certificated air carriers, joined in the ATA petition because of the demonstrated value of radio to truckers serving air lines, where speedy transportation is particularly of the essence since most cargo shipped by air is either highly valuable or highly perishable.

Radio Flash Petition Denied:

Through two unfortunate errors, Radio Flash Corporation in particular and the taxi industry in general lost an opportunity to move forward to greater taxicab frequency use. Radio Flash has 194 radio-equipped units in operation in Chicago. Prior to moving to the new taxi channel 3, Radio Flash wanted some assurance that this costly move would not be followed by the assignment of additional systems to its channel. Since Radio Flash would have more mobile units in operation on channel 3 than would be left on any other channel, it asked for the exclusive assignment of channel 3. That was error No. 1. The "exclusive" label made shared-use taxi frequencies sound too much like a regular AM broadcast request.

Error No. 2 was not due to the direction Petitioner had first taken, since before Commission consideration was finally made on the exclusive request, it was amended so that it requested merely Commission assurance that the expensive move to channel No. 3 would be protected at least at the outset. This was done by a Radio Flash letter notification to the Commission that the exclusive assignment requested was to continue only so long as it was serving more mobile units on Channel 3 than were being served on the other channels.

Unfortunately, the Commission compounded error upon the petitioner's original error by confining its attention solely to the first, ill-cast, exclusive request. The Commission Rule (Section 16.57), they said, provides for shared use of all frequency assignments in land transportation radio services and "petitioner's

proposal to reverse this policy is one of such fundamental import as to necessitate further public hearings." Commission held that such further hearings were not now indicated prior to operating experience under the new Rules which only became effective last July 1.

Commission consideration of the entire record, which included Radio Flash's request for mere assurance no additional units would be licensed on its channel while a considerably less number of units were assigned to other channels, would have gone a long way to clarify present coordination plans of industry. Members of the taxi industry are still wary of better frequency-utilization plans until the Commission announces its policy on channel assignments when the channel-loading situation in individual areas is brought to its attention.

Common Carrier:

Customer priorities for mobile radio service by telephone companies and limited common carriers have been finally established by FCC, effective September 19, as follows: 1) public safety and health; 2) public service; 3) quasi-public service; 4) physically handicapped; 5) industrial; 6) traveling public; and 7) all others. Any customers now being served may retain service. Once channel saturation is reached, new customers thereafter come on, as old ones drop out, in the order of priorities. Low-priority customers, if they wait too long, may therefore go without mobile radio service in congested city areas.

Congestion in the Los Angeles area, where several limited common carriers are all working on the same pair of frequencies, did not move the Commission to grant request of largest—Robert C. Crabb serving 90 units—for temporary use of a new LCC mobile frequency, not now in use there and not capable of use by any other service.

Search for merit in two reasons assigned by Commission to support its denial has been fruitless. First reason was that "it appears reasonable to conclude that the assignment of such frequency to you at this time would carry with it the strong probability that your subscribers would oppose any frequency shift which might later appear necessary." This argument assumes that the individual subscriber is going to protest a small crystal expense. Notwithstanding, this argument cuts both ways. By its denial, the Commission made it absolutely necessary for every new subscriber to Crabb's service to make a frequency change because the present LCC mobile frequency has to be given up by November 1. Moreover, Crabb was standing the entire expense on his leased mobile units. (In anti-

(Continued on page 28)

* Courtney, Krieger, and Jorgensen, Washington 6, District of Columbia.

for 40 kc channel width. G.E. crystal G61A; Mallory 534C vibrator; 6 a. *Tubes:* 6BH6 RF; 12AT7 1st osc, 1st conv; 6BH6 1F, 12AT7 2nd osc, 2nd conv; 6BH6 1F; 6BH6 1F; 6BH6 1F; 6AQ7 disc & noise amp; 12AX7 sq amp & AF; 6AQ5 output; 6AL5 noise rect.

Fixed: 152-162 Mc.

Transmitter: 50 w. to 50-70 ohm line; AC input 300 w. *Tubes:* 6AU6 osc; 6BA6 doub; 6BA6 trip; 6AQ5 doub; 2E26 doub; 829B output; 6C4 mod; 12AX7 mod lim; 2J5R1GY rect; G.E. crystal G61.

Fixed: 152-162 Mc.

Transmitter: 250 w. to 50-70 ohm lines; AC input 1,300 w. *Tubes:* 6AU6 osc; 6BA6 doub; 6BA6 trip; 6AQ5 doub; 2E26 doub; 829B amp. 2JGLHD21/4-125A output; 6C4 mod; 12AX7 mod lim.; 2J5R1GY rect; 2J866A or 3B23 rect; G.E. crystal G61.

Mobile: 152-162 Mc.

Transmitter: 20 w. to RG58U line; 6 v. input, 3 a. stby; 30 a. trans. *Tubes:* 6AG5 osc; 6AG5 quad; 2E30 doub; 2E30 trip; 2E30 doub; 2J2E24 output; 6AG5 mod. *Notes:* G.E. dynamotor; Shure military mike or handset; 2-freq. operation available. 12AX7 modulation limiter available.

Receiver: double superhet.; 6.1-6.7 & 2 mc. IF; G.E. crystal G61A; vibrator power supply. *Tubes:* 6AK5 RF; 6AK5 RF; 6GH6 1st mix; 2J6BJ6 1F; 6BH6 2nd mix; 6BJ6 1F; 6BH6 1F; 6BH6 1F; 6AQ7 disc & noise amp; 6BJ6 osc & trip; 6J6 trip & doub; 6AL5 noise rect; 6SL7 DC amp & AF; 6AQ5 output.

HARVEY RADIO LABS., INC.

Cambridge, Moss.

Fixed: 30-44 Mc.

Transmitter: 25 to 250 w. to 72-ohm line. *Tubes:* 7C7 osc; 7A8 mod; 7AG7 quad; 7C7 doub; 7C5 doub; 7C5 doub; 2J807 output; plus 2J100th for 250 w.

Mobile: 30-44 Mc.

Transmitter: 25 watts to RG8U line; 6 v. input, 2.4 a. stby; 35 a. trans. *Tubes:* same as fixed transmitter, but with one 807 output. *Notes:* W.E. military mike or F3WE3 handset; Carter dynamotor 620-VS; 2-freq. operation available.

Receiver: double superhet.; 4.5 & 1.6 mc. IF; Radiart vibrator 5515, 5.4 a. *Tubes:* 7AG7 RF; 7AG7 1st mix; 7AG7 1F; 7A8 2nd mix; 7AG7 1F; 7AG7 1F; 7AG7 1F; 7A6 det; 7AG7 osc; 7AG7 noise amp; 7N7 AF & noise rect; 7F7 AF & control; 7C5 output.

Fixed: 152-162 Mc.

Transmitter: 30 or 250 w. to 72-ohm line. *Tubes:* 6AQ6 osc; 6AQ6 speech amp; 6AQ6 mod; 6AK5 trip; 6AQ5 quad; 6AQ5 doub; 2E26 doub; 2J2E26 output; plus 2JWL4D21-4-125A for 250 w.

Mobile: 152-162 Mc.

Transmitter: 30 w. to RG58U lines; 6 v. input; 2.4 a. stby; 35 a. trans. *Tubes:* same as 30 w. fixed transmitter, but with 2J5516 output. *Notes:* Shure mike 101B or W.E. F3WE3 handset; Carter dynamotor 620-VS *Receiver:* double conversion single crystal; 1st IF 7.3-11.5 mc; 2nd IF 1.7 mc; Radiart vibrator 5515; crystal FT-213. *Tubes:* 6AK5 RF; 6AK5 RF; 6AK5 mix; 6BJ6 1F; 6BJ6 1F; 6BJ6 2nd mix; 6BJ6 1F; 6BH6 1F; 6BH6 1F; 6AL5 disc; 6BH6 noise amp. 12AV7 1st & 2nd AF; 12AX7 noise rect; 6BJ6 osc; 6AK5 mult; 6AQ5 output.

KAAR ENGINEERING CO.

Palo Alto, Calif.

Fixed: No. FM-50A, 30-44 Mc.

Transmitter: 50 w. to 30-70 ohm line; AC input 350 w. *Tubes:* 6V6GT osc; 6V6GT mod; 6V6GT mod; 6V6GT amp mod; 6V6GT trip; 6V6GT quad; 6V6GT quad; 2J807 out-

put; 2J5R1GY rect. *Notes:* Kaar mike G-635; Kaar crystal E.

Fixed: No. FM-100A, 30-40 Mc.

Transmitter: 100 w. to 30-70 ohm line. *Tubes:* same as FM-50A, but with 4D22 instead of 2J807 output tubes.

Fixed: No. FM-250A, 30-40 Mc.

Transmitter: 250 w. to 30-70 ohm line. *Tubes:* same as FM-50A, plus 4-250A output.

Mobile: No. FM-50FX, 30-44 Mc.

Transmitter: 50 w. output; 6 v. input, 0 a. stby; 40 a. trans. *Tubes:* 5618 osc; 5618 mod; 5618 mod; 5618 amp mod; 5618 quad; 5618 quad; 2E25A trip; 2JHY69 output. *Notes:* Kaar mike 4C or Conn. handset 2060-W; Carter dynamotor; 2-freq. operation available.

Receiver: double superhet.; 5.1-5.9 mc. & 455 kc. IF; Oak vibrator; Kaar crystal E; 5.8 a. *Tubes:* 6SS7 RF; 6SS7 RF; 6SS7 1st conv; 6G6G osc; 6SS7 1F; 6SS7 2nd conv; 6SJ7 1F; 6SJ7 1F; 6H6 disc; 6SZ7 noise amp & rect; 6SZ7 AF & sq; 6G6G output.

Mobile: No. FM-100X, 30-44 Mc.

Transmitter: 100 w. output; 6 v. input; 0 a. stby; 70 a. trans. *Tubes:* same as FM-50X except 2JHY69 output.

Fixed: No. FM-70A, 72-76 Mc.

Transmitter: 25 w. to 50-70 ohm line; AC input 350 w. *Tubes:* 6V6GT osc; 6V6GT mod; 6V6GT mod; 6V6GT amp mod; 6V6GT quad; 6V6GT quad; 2E26 doub; 2J807 output. *Notes:* Kaar mike G-635; Kaar crystal E.

Mobile: No. FM-70X, 72-76 Mc.

Transmitter: 20 w. output; 6 v. input, 0 a. stby; 40 a. trans. *Tubes:* 5618 osc; 5618 mod; 5618 mod; 5618 amp mod; 5618 quad; 5618 quad; 2E25 trip; 2J807 doub-output. *Notes:* Kaar mike 4C or Conn. 2060-W handset; Carter dynamotor; 2-freq. operation available.

Receiver: double superhet.; 5.1-5.9 mc. & 455 kc. IF; Oak vibrator; Kaar crystal E; 5.8 a. *Tubes:* same as 30-44 receiver.

Fixed: No. FM-176A, 152-162 Mc.

Transmitter: 50 w. to 50-70 ohm line; AC input 350 w. *Tubes:* 6V6GT osc; 6V6GT mod; 6V6GT mod; 6V6GT amp mod; 6V6GT quad; 6V6GT trip; 6V6GT doub; 2E26 doub; 829B output. *Notes:* Kaar mike G-635; Kaar crystal E.

Fixed: No. FM-252A, 152-162 Mc.

Transmitter: 250 w. to 50-70 ohm line. *Tubes:* same as FM-176A, plus GL-591 output.

Mobile: No. FM-177X, 152-162 Mc.

Transmitter: 15 w. output; 6 v. input; 0 a. stby; 25 a. trans. *Tubes:* 3A4 osc-mod; 3A4 quad; 3A4 trip; 3A4 doub; 2E24 doub; 2E24 output. *Notes:* Kaar mike 4C or Conn. handset 2060-W; Oak vibrator; Kaar crystal E or H; 2-freq. operation available.

Receiver: double superhet.; 5.3-5.7 mc. & 455 kc. IF; Oak vibrator; Kaar crystal E or H; 4 a. *Tubes:* 6AK5 RF; 6AK5 RF; 6AK5 1st mix; 6AK5 osc; 6BH6 mult; 6BH6 1F; 6BH6 2nd mix; 6BH6 1F & lim; 6BH6 1F; 6AL5 disc; 6BH6 noise amp; 6AQ6 AF & noise rect; 2J6AK6 output.

Mobile: No. FM-179X, 152-162 Mc.

Transmitter: 50 w. output; 6 v. input, 0 a. stby; 55 a. trans. *Tubes:* same as FM-177X except 4-65A output and Westinghouse dynamotor.

LINK RADIO CORP.

New York, N. Y.

Fixed: No. 2365, 25-50 Mc.

Transmitter: 30 w. to 50-70 ohm line; AC input 245 w. *Tubes:* 12AT7 osc & mod; 6BJ6 doub; 6BJ6 quad; 2E30 doub; 2E30 doub; 2J2E24 output. *Notes:* W.E. mike F3; Biley crystal FM8.

Receiver: double superhet.; 5 mc. & 456 IF;

Biley crystal. *Tubes:* 6BJ6 RF; 12AT7 mix & osc; 6BJ6 1F; 6BE6 conv; 6BJ6 1F; 6BJ6 1F; 6BJ6 1F; 6AL5 disc; 12AX7 noise amp & rect; 12AX7 AF & sq; 6AQ5 output.

Fixed: No. 50-UF5, 25-50 Mc.

Transmitter: 50 w. to 50-70 ohm line; AC input 275 w. *Tubes:* 7A4 AF; 7F7 osc-mod; 7W7 doub; 7C5 doub; 7C7 quad; 7C5 doub; 2J807 output. *Notes:* W.E. mike F3; Biley crystal FM8.

Receiver: same as No. 2365.

Fixed: No. 250-UF5, 25-50 Mc.

Transmitter: 250 w. to 50-200 ohm lines; AC input 1100 w. *Tubes:* same as No. 50-UF5 plus final amp.

Receiver: same as No. 2365.

Mobile: No. 2365-LR, 25-50 Mc.

Transmitter: 30 w. to RG58U line; 6 v. input, 1.9 a. stby 25 a. trans. *Tubes:* same as No. 2365. *Notes:* vibrator pwr. supply; W.E. handset, 2-freq. operation available.

Receiver: double superhet.; 5 mc. & 456 kc. IF; Biley crystal MC9 or FM11; Mallory 1501/94 vibrator; 6.3 a. *Tubes:* same as No. 2365.

Fixed: No. 2210, 152-174 Mc.

Transmitter: 7-10 w. to 50-70 ohm line; AC input 190 w. *Tubes:* 7F7 osc & mod; 6AK5 quad; 6AK5 trip; 2E30 doub; 2E30 doub; 2E24 output. *Notes:* W.E. mike F3; Biley crystal FM10 or FM10H; available for 75 w. operation.

Receiver: double superhet.; 10.7 mc. & 456 kc. IF; Biley crystal MC9 or FM11. *Tubes:* 6AK5 RF; 6A1T6 osc; 6AK5 mix; 7AG7 1F; 7AG7 1F; 7A8 conv; 7AG7 1F; 7C7 1F; 7A6 disc; 7A6 noise rect; 7F7 AF & sq; 7B5 output.

Relay: No. 50 MRB, 150-220 Mc.

Transmitter: 50 w. to 50-100 ohm line; AC input 400 w. *Tubes:* 6J5; 6SL7; 3J6SJ7; 3J6V6; 2E26; 2J829B. *Notes:* VPI crystal DC-12A; 12 v. dynamotor for DC operation available.

Fixed: No. 1907, 152-174 Mc.

Transmitter: 50 w. to 50-70 ohm line; AC input 250 w. *Tubes:* 7A4 AF; 7F7 osc & mod; 7AG7 quad; 7W7 doub; 2E26 trip; 2E26 doub; 829B output. *Notes:* W.E. mike F3; Biley crystal FM10 or FM10H.

Receiver: same as No. 2210.

Fixed: No. 1908, 152-162 Mc.

Transmitter: 250 w. to 40-150 ohm line; AC input 1200 w. *Tubes:* same as No. 1907 plus final amp. *Notes:* W.E. mike F3; Biley crystal FM8.

Receiver: same as No. 2210.

Mobile: No. 2210 L-R, 152-174 Mc.

Transmitter: 7-10 w. to RG58U line; 6 v. input, 2 a. stby; 18 a. trans. *Tubes:* same as No. 2210. *Notes:* W.E. handset; vibrator pwr. supply; 2-freq. operation available.

Receiver: double superhet.; Biley crystal MC9 or FM11; Mallory vibrator 1501; 7 a. *Tubes:* same as No. 2210.

Fixed: No. 2340-TR, 450-460 Mc.

Transmitter: 10 w. to 50-100 ohm line; AC input 200 w. *Tubes:* 7A4 AF; 7F7 osc & mod; 7AG7 quad; 7W7 doub; 2E26 trip; 2E26 doub; 4X150A trip; 829B output.

Notes: VPI crystal DC-12A; narrow, medium or wide bandwidths; 100 w. operation available.

Relay: No. 25-PRB, 450-460 Mc.

Transmitter: 25 w. to 50-100 ohm line; AC input 400 w. *Tubes:* 6J5 AF; 6V6 doub; 2E26 doub; 4X150A trip; 6V6 trip; 829B trip output; OD8/VR-150 reg.

Fixed: No. 2048-TR, 940-962 Mc.

Transmitter: 20 w. to 50-100 ohm line; AC input 240 w. *Tubes:* 7A4 AF; 7F7 osc & mod; 7W7 doub; 2E26 trip; 2E26 doub; 4X150A trip; 4X150A doub; 829B output.

Notes: VPI crystal DC-12; narrow, medium or wide bandwidths.

What the New FCC Allocations and Rules Mean to the

RADIO COMMUNICATIONS SERVICES

A QUICK-REFERENCE GUIDE TO THE FREQUENCY ASSIGNMENTS AND TECHNICAL REQUIREMENTS FOR THE VARIOUS CLASSES OF MOBILE RADIO SERVICE — Part 4

INTERCITY BUS SERVICE

Persons eligible to operate intercity bus radio service are those regularly engaged in offering to the public a scheduled common carrier passenger land transportation service over public highways and primarily between established city terminals. An organization may be considered eligible for this service, although not directly engaged in the operation of intercity buses, provided that all persons who are members or shareholders of the organization would themselves be eligible for authorization.

Only one base station will be authorized to serve a particular portion of a highway, and such a station will be required to provide service without discrimination, but on a cooperative maintenance basis, to all bus common carriers eligible for authorization in the intercity bus radio service. A licensee rendering such service may accept contributions to capital and operating expenses on a cost-sharing basis from persons to whom such service is furnished.

Frequency Assignments:

Available frequencies are listed in the accompanying table, subject to qualifications set forth in the footnotes.

Technical Information:

FCC Rules specify that each frequency or band of frequencies assigned to stations in the land transportation radio services is available on a shared basis only, and will not be assigned for the exclusive use of any one applicant. All applicants for, and licensees of, stations in these services shall cooperate in the selection and use of the frequencies assigned, in order to minimize interference and thereby obtain the most effective use of the authorized facilities. In the event that two or more licensees are unable to make an equitable division of transmission time, the Commission, at its discretion, may specify a time-sharing arrangement. The use of any of these frequencies may be restricted to one or more geographical areas.

EMISSION LIMITATIONS: Bandwidth for AM phone is 8 kc.; for FM phone, 40 kc. The specified band shall contain those frequencies on which 99% of the radiated power appears, extended to include any discrete frequency of which the power is at least .25% of the total ra-

INTERCITY BUS FREQUENCIES

FREQ.	CLASS	NOTES	FREQ.	CLASS	NOTES	FREQ.	CLASS	NOTES
43.70	Base, Mob.	1	44.26	Base, Mob.	1	3500 to		
43.74	"	1	44.30	"	1	3700	Base, Mob.	5
43.78	"	1	72.02 to			6425 to		
43.82	"	1	75.98	Fixed	2	6575	"	5
43.86	"	1	952 to			6575 to		
43.90	"	1	960	"	3	6875	Op. Fixed	3
43.94	"	1	1850 to			11700 to		
43.98	"	1	1990	"	3	12200	Base, Mob.	5
44.02	"	1	2110 to			12200 to		
44.06	"	1	2200	"	3	12700	Op. Fixed	3
44.10	"	1	2450 to			16000 to		
44.14	"	1	2500	Base, Mob.,		18000	"	3, 4
44.18	"	1	2500	Op. Fixed	3, 4, 5	26000 to		
44.22	"	1	2500 to			30000	"	3
			2700	Op. Fixed	3			

¹ Available for assignment to base and mobile stations in the intercity bus radio service only.

² Assignable frequencies spaced by 40 kc., beginning with the frequencies 72.02 and 75.42 mc. and ending with the frequencies 74.58 and 75.98 mc., respectively, are available on a shared basis to operational fixed stations in the intercity bus radio service on the condition that no harmful interference will be caused to the reception of television stations on Channels 4 or 5.

³ Available for assignment to fixed stations in

diated power. Radiation in excess of these limits is considered unauthorized emission. Emission appearing on any frequency removed from the carrier frequency by at least 50% but not more than 100% of the maximum authorized bandwidth must be attenuated not less than 25 db below the unmodulated carrier. Spurious or harmonic emission appearing on any frequency removed from the carrier frequency by at least 100% of the maximum authorized bandwidth must be attenuated below the unmodulated carrier by not less than:

40 db with maximum plate power input to the final stage of 3 watts or less.

60 db with more than 3 watts and including 150 watts.

70 db with more than 150 watts and including 600 watts.

80 db with more than 600 watts.

MODULATION: Maximum audio frequency required for speech intelligibility is considered 3,000 cycles. Transmission of higher frequencies will not be authorized. On FM, deviation due to modulation must not exceed plus and minus 15 kc. from the unmodulated carrier.

Each transmitter authorized or installed after July 1, 1950, must be provided with a device which will automatically prevent modulation in excess of that specified above, except that this

the intercity bus service on a shared basis with other services, under terms of a developmental grant only.

⁴ Use of frequencies in the 2,450- to 2,500-mc. band and the 17,850- to 18,000-mc. band is subject to no protection due to the operation of industrial, scientific, and medical devices on 2,450 and 18,000 mc.

⁵ Available for assignment to base and mobile stations in the intercity bus service on a shared basis with other services, under terms of a developmental grant only.

shall not apply to mobile transmitters using a maximum plate power input to the final RF stage of 3 watts or less.

MAXIMUM POWER: Maximum plate power input to the final RF stage shall not exceed 500 watts at 30 to 100 mc.; and 120 watts at 100 to 220 mc. Power at frequencies above 220 mc. will be specified in the FCC authorization.

TRANSMITTER MEASUREMENTS: Frequency and modulation measurements on each fixed and mobile unit must be made and entered in the log every 6 months, or whenever an adjustment is made that might affect frequency or modulation. Mobile units may be checked on the bench if they are operated under load conditions. The use of automatic frequency monitors is approved for frequency checking.

Any independent, qualified engineering measurement service may be employed, provided the log entries show the name and address of the firm, and the name of the person making the measurements.

OPERATOR'S LICENSE: While unlicensed persons may operate the transmitters, all adjustments or tests for installation, service, or maintenance which may affect the proper operation of such a station, shall be made under the immediate supervision and responsibility of a person holding 1st or 2nd class commercial

radio operator license, either radiotelephone or radiotelegraph, who shall be responsible for the proper functioning of the station equipment."

At radiotelegraph stations, adjustments affecting frequency must be made by an operator holding a 1st or 2nd class commercial radiotelegraph license.

CHECKING LIGHTS: The licensee shall make a daily check of the tower lights "either by visual observation of the tower lights or by observation of an automatic indicator to insure that all such lights are functioning properly."

Any observed failure of a code or rotating beacon light not corrected within

30 minutes must be reported immediately by telegraph or telephone to the nearest Airways Communication Station or CAA office regardless of the cause of the failure, and notice given immediately on resumption of illumination. Light and light controls must be inspected at least once every three months.

HIGHWAY TRUCK SERVICE

Only persons regularly engaged in the operation of trucks, on a route basis, outside metropolitan areas, are eligible for authorizations in the highway truck radio service. This service is not available for truck routes within a single metropolitan area. An organization may be considered eligible for this service, although not directly engaged in the operation of trucks, provided all persons who are members or shareholders thereof would themselves be eligible for an authorization.

Technical Information:

The same requirements apply to highway truck radio service as are listed under technical information for intercity bus service.

Frequency Assignments:

Available frequencies are listed in the accompanying table, subject to qualifications set forth in the footnotes, and in

HIGHWAY TRUCK SERVICE			HIGHWAY TRUCK FREQUENCIES		
FREQ.	CLASS	NOTES	FREQ.	CLASS	NOTES
35.74	Base, Mob.	1	1850 to		6575 to
35.78	"	1	1990	Fixed	5 6875
35.82	"	1	2110 to		11700 to
35.86	"	1	2200	"	5 12200 Base, Mob.
35.90	"	1	2450 to		12200 to
35.94	"	1	2500	Op. Fixed,	12700
35.98	Mobile	2		Base, Mob.	4, 5, 6 16000 to
72.02 to			2500 to		18000
75.98	Fixed	3	2700	Fixed	5 26000 to
952 to			3500 to		30000
960	Fixed	5	3700	Base, Mob.	6
			6425 to		
			6575	"	6

accordance with a geographical assignment plan.

¹ Available for assignment to base and mobile stations in the highway truck radio service in accordance with a geographical assignment plan.

² Available for assignment in all states to mobile stations only.

³ Assignable frequencies spaced by 40 kc., beginning with the frequencies 72.02 and 75.42 mc. and ending with the frequencies 74.58 and 75.98 mc., respectively, are available on a shared basis to operational fixed stations in the highway truck radio service on the condition that no harmful

interference will be caused to the reception of television stations on Channels 4 or 5.

⁴ Use of frequencies in the bands 2,450 to 2,500 mc. and 17,850 to 18,000 mc. is subject to no protection from interference due to the operation of industrial, scientific, and medical devices on 2,450 and 18,000 mc.

⁵ Available for assignment to fixed stations in the highway truck service on a shared basis with other services, under the terms of a developmental grant only.

⁶ Available for assignment to base and mobile stations in the highway truck service on a shared basis with other services, under the terms of a developmental grant only.

TAXICAB RADIO SERVICE

Those eligible to operate stations in the taxicab radio service are persons regularly engaged in furnishing to the public a non-scheduled passenger land transportation service not operated over a regular route or between established terminals. An organization may be considered eligible for an authorization, although not directly engaged in the operation of taxicabs, provided that all persons who are members or shareholders would themselves be eligible.

Frequency Assignments:

Available frequencies are listed in the accompanying table, subject to qualifications set forth in the footnotes.

Technical Information:

Requirements are the same for the taxi-

TAXICAB RADIO SERVICE			TAXICAB RADIO FREQUENCIES		
FREQ.	CLASS	NOTES	FREQ.	CLASS	NOTES
152.27	Base, Mob.	1	452.15	Base, Mob.	2 2450 to
152.33	"	1	452.25	"	2 2500 Base, Mob.
152.39	"	1	452.35	"	2 3500 to
152.45	"	1	452.45	"	2 3700
157.53	Mob. only	1	452.55	"	2 6425 to
157.59	"	1	452.65	"	2 6575
157.65	"	1	452.75	"	2 11700 to
157.71	"	1	452.85	"	2 12200
452.05	Base, Mob.	2	452.95	"	2

cab radio service as are listed under technical information for intercity bus service. Mobile units in the taxicab radio service may be installed only in vehicles used for the carriage of passengers.

¹ Available for assignment to base and mobile stations in the taxicab radio service only. Not more than one mobile station frequency and one

base station frequency will be assigned to a licensee, unless clearly shown in a supplement to a license application that the grant of an additional frequency would be in the public interest.

² Available for assignment to base and mobile stations only under terms of a developmental grant.

³ Available for assignment to base and mobile stations on a shared basis with other services under the terms of a developmental grant only.

⁴ Use of frequencies in the 2450-2500 mc. band is subject to no protection from interference due to the operation of industrial, scientific, and medical devices on the 2450 mc. frequency.

AUTOMOBILE EMERGENCY SERVICE

Those eligible to operate stations in the automobile emergency radio service are: 1. associations of owners of private automobiles which provide emergency road service, and 2. public garages operating emergency road service vehicles.

Stations licensed under this service may transmit only the following types

of communications: any communication

Frequency Assignments:

The frequency of 35.70 mc. is available for assignment to base and mobile stations in the automobile emergency radio service only. The following frequencies are available for assignment to base and mobile stations in the automobile emergency radio service, under the terms of

a development grant only: 453.85 mc. (available to automobile associations only) and 453.95 mc. (available to public garages only).

Technical Information:

The same requirements apply to automobile emergency radio service as are listed under technical information for intercity bus service.

RAILROAD RADIO SERVICE

Persons regularly engaged in offering to the public a passenger or freight transportation service by railroad common carrier are eligible for authorizations to operate stations in the railroad radio service. Although not directly engaged in railroad operation, an organization may be considered eligible for this service, provided that all persons who are members or shareholders of the organization would themselves be eligible for an authorization.

Frequency Assignments:

Available frequencies are listed in the accompanying table, subject to qualifications set forth in the footnotes.

Technical Information:

The same requirements apply to railroad radio service as are listed under technical information for intercity bus service, excepting those affecting operators. These are listed in FCC Rules and Regulations, Sec. 16.354.

¹ Assignable frequencies spaced by 40 kc. beginning with the frequencies 72.02 and 75.42 mc. and ending with the frequencies 74.58 and 75.98 mc., respectively, are available on a shared basis to operational fixed stations in the railroad radio service on the condition that no harmful interference will be caused to the reception of television stations on Channels 4 or 5.

² (a) Available for assignment to base and mobile stations used for end to end, fixed point to train, or train to train communications used in connection with the operation of railroad trains over a track or tracks extending through yard and between stations upon which trains are operated by timetable, train order, or both, or the use of which is governed by block signals. May also be used on a secondary basis for inter-communi-

RAILROAD RADIO FREQUENCIES

FREQ.	CLASS	NOTES	FREQ.	CLASS	NOTES	FREQ.	CLASS	NOTES
72.02 to			160.89	Base, Mob.	2	453.75	Base, Mob.	4
75.98	Fixed	1	160.95	"	2	952 to		
159.51	Base, Mob.	2	161.01	"	2	960	Op. Fixed	5
159.57	"	2	161.07	"	2	1850 to		
159.63	"	2	161.13	"	2	1990	"	5
159.69	"	2	161.19	"	2	2110 to		
159.75	"	2	161.25	"	2	2200	"	5
159.81	"	2	161.31	"	2	2450 to		
159.87	"	2	161.37	"	2	2500	Base, Mob.,	
159.93	"	2	161.43	"	2		Op. Fixed	5, 6, 7
159.99	"	2	161.49	"	2	2500 to		
160.05	"	2	161.55	"	2	2700	Op. Fixed	5
160.11	"	2	161.61	"	2	3500 to		
160.17	"	2	161.67	"	2	3700	Base, Mob.	6
160.23	"	2	161.73	"	2	6425 to		
160.29	"	2	161.79	"	2	6575	"	6
160.35	"	2	161.85	"	2, 3	6575 to		
160.41	"	2	161.91	"	2, 3	6875	Op. Fixed	5
160.47	"	2	453.05	"	4	11700 to		
160.53	"	2	453.15	"	4	12200	Base, Mob.	6
160.59	"	2	453.25	"	4	12200 to		
160.65	"	2	453.35	"	4	12700	Op. Fixed	5
160.71	"	2	453.45	"	4	16000 to		
160.77	"	2	453.55	"	4	18000	"	5, 7
160.83	"	2	453.65	"	4	26000 to		
						30000	"	5

cation between adjacent base stations, providing interference is not caused to communications of radio stations aboard rolling stock. (b) All these frequencies may be assigned to base and mobile stations to be operated within railroad yards or terminal areas, or for communications which are of a practical necessity for railroad operation or maintenance, provided no interference is caused stations eligible under (a). Applicants requesting assignment of 159.57, 159.81, 160.53, 161.01, 161.31, or 161.67 mc. must show proof of non-interference of stations authorized under (a).

³ Available for assignment in Chicago area only.
⁴ Available for assignment to base and mobile stations on a shared basis with stations in the

urban transit radio service, under the terms of a developmental grant only.

⁵ Assignable to fixed stations on a shared basis with other services under terms of a developmental grant only.

⁶ Available for assignment to base and mobile stations on a shared basis with other services under the terms of a developmental grant only.

⁷ Use of frequencies in the 2,450- to 2,500-mc. band and 17,850- to 18,000-mc. band is subject to no protection from interference due to operation of industrial, scientific, and medical devices on 2,450 and 18,000 mc.

URBAN TRANSIT SERVICE

Persons eligible to operate stations in the urban transit radio service are those regularly engaged in furnishing scheduled common carrier public passenger land transportation service along fixed routes primarily within urban or suburban communities. Although not directly engaged in operating an urban transit system, an organization may be considered eligible for this service provided that all members or shareholders of the organization would themselves be eligible for authorization.

Frequency Assignments:

Available frequencies are listed in the accompanying table, subject to qualifications set forth in the footnotes.

Technical Information:

The same requirements apply to urban transit radio service as are listed for intercity bus service.

¹ Available for assignment to base and mobile stations in the urban transit radio service, on a shared basis with other services.

² Available for assignment to base and mobile stations in the urban transit radio service only.

³ Assignable frequencies spaced by 40 kc. beginning with the frequencies 72.02 and 75.42 mc.

URBAN TRANSIT RADIO FREQUENCIES

FREQ.	CLASS	NOTES	FREQ.	CLASS	NOTES	FREQ.	CLASS	NOTES
30.66	Base, Mob.	1	44.54	Base, Mob.	2	2450 to		
30.70	"	1	44.58	"	2	2500	Base, Mob.,	
30.74	"	1	72.02 to				Op. Fixed	5, 6, 7
30.78	"	1	75.98	Fixed	3	2500 to		
30.82	"	1	453.05	Base, Mob.	4	2700	Op. Fixed	5
30.86	"	1	453.15	"	4	3500 to		
30.90	"	1	453.25	"	4	3700	Base, Mob.	6
30.94	"	1	453.35	"	4	6425 to		
30.98	"	1	453.45	"	4	6575	"	6
31.02	"	1	453.55	"	4	6575 to		
31.06	"	1	453.65	"	4	6875	Op. Fixed	5
31.10	"	1	453.75	"	4	11700 to		
31.14	"	1	952 to			12200	Base, Mob.	6
44.34	"	2	960	Op. Fixed	5	12200 to		
44.38	"	2	1850 to			12700	Op. Fixed	5
44.42	"	2	1990	"	5	16000 to		
44.46	"	2	2110 to			18000	"	5, 7
44.50	"	2	2200	"	5	26000 to		
						30000	"	5

and ending with frequencies 74.58 and 75.98, mc., respectively, are available on a shared basis to operational fixed stations in the urban transit radio service on the condition that no harmful interference will be caused to the reception of television stations on Channels 4 or 5.

⁴ Available for assignment to base and mobile stations in the urban transit radio service on a shared basis with the railroad radio service, under the terms of a developmental grant only.

⁵ Available for assignment to fixed stations in the urban transit radio service on a shared basis

with other services, under the terms of a developmental grant only.

⁶ Available for assignment to base and mobile stations in the urban transit radio service on a shared basis with other services, under the terms of a developmental grant only.

⁷ Use of frequencies in the 2,450- to 2,500-mc. band and the 17,850- to 18,000-mc. band is subject to no protection due to the operation of industrial, scientific, and medical devices on 2,450 and 18,000 mc.

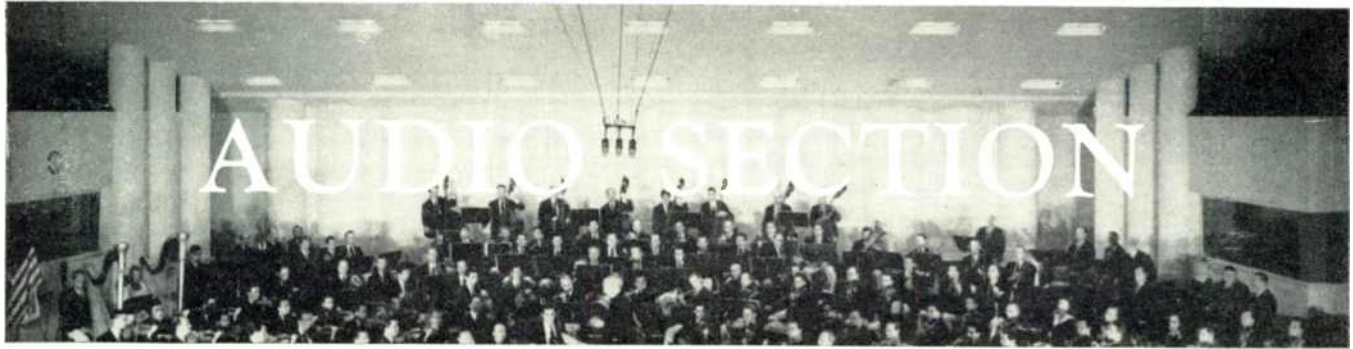

DESIGN OF RECORDING SYSTEMS

THIS DETAILED STUDY REVEALS THAT 14 BASIC UNITS CAN MEET THE INITIAL & FUTURE REQUIREMENTS OF ANY RECORDING STUDIO — *By* LEON A. WORTMAN*

IT is costly to the point of being impractical to design an initial audio recording installation so complete and versatile that it will meet the many special needs that may arise in the course of time. And it is expensive for recording engineers to build their own equipment, even though individual studio requirements vary so widely that custom design is highly desirable.

Recognizing this situation, Fairchild engineers have made an exhaustive study of recording installations now in use, and have consulted a great number of engineers as to their needs and preferences. A subsequent analysis of the information obtained disclosed the fact that recording equipment can be reduced to a series of basic, standardized units which can be combined in accordance with the needs of simple or elaborate systems, offering the advantages of custom design at production-level prices.

Our study showed that any installation, small or large, can be built from combinations of some or all of 14 basic units.

Basic Units of Equipment:

While there might be a difference of opinion concerning some of the units listed below, it must be borne in mind that our selection was weighted by consideration of two important factors. These are the desirability of avoiding 1) obsolescence of initial units as studio facilities are expanded, and 2) loss of initial investment resulting from such obsolescence.

Here is the list of units drawn up at the conclusion of our study:

1. Power Amplifier
2. VU Panel
3. NAB Equalizer

4. Input Switching Panel
5. Output Switching Panel
6. Mixer Panel
7. Preamplifier
8. Auxiliary Power Supply
9. Line Amplifier (booster and monitor applications)
10. Diameter Equalizer
11. Pickup Preamplifier-Equalizer
12. Cuing Amplifier
13. Bridging Device-Isolation Amplifier
14. Variable Equalizer

To check the versatility of installations made up from these units, let us examine the needs of typical recording studios.

Basic Studio Requirements:

For purposes of explanation let's assume that our first requirements are for single-channel recording from a line level source such as a radio tuner. The unit common to all installations is the amplifier supplying power to the cutterhead. Many amplifiers deliver insufficient power at frequencies below 70 cycles and above 1,000 cycles. In order to gain driving power at these important low and high frequencies, some amplifiers have been designed with as high as 50 watts output *at the middle frequencies*. A 30-watt amplifier with constant power output over *all the frequency range* is adequate and is much more desirable from the economy standpoint. The power amplifier should have its own gain control for setting audio levels, or for riding gain on a single channel. Such a fundamental installation, including a means for measuring the audio level fed to the cutterhead, is indicated in Fig. 1.

Now, if it is desirable to record from a low-level source, such as a microphone or pickup, an input switching panel with a built-in preamplifier is recommended because of its versatility. This can be

a compact, rack-mounted device containing a preamplifier with a switch to select audio from a variety of sources. These inputs would include microphones, pickups, and a zero-level line. When the input selector switch is in the LINE position, the preamplifier is bypassed.

Purpose of NAB Equalization:

The materials of which the recording disk are composed include relatively rough particles. The effect of these particles in contact with the reproducer stylus is one of objectionable noise. The characteristics of constant-velocity recording are such that the energy put on a disk decreases as the frequency of the recorded signal increases. As a consequence, the ratio of signal to inherent noise decreases at the higher end of the audio spectrum. If the sound energy put on a disk is deliberately increased in direct proportion to the frequency of the recorded signal, it is possible to maintain a nearly constant ratio of signal-to-noise over the entire audio spectrum. The NAB Recording and Reproducing Standards Committee proposed that, in order to produce disks with a high signal level above the inherent noise, the frequencies above approximately 1,000 cycles have a rising characteristic. It was proposed that a 10,000 cycle signal be 16 db higher than a 1,000 cycle signal. With the adoption of this standard, it was possible to design a simple and inexpensive equalizer that can be inserted in the audio line to produce this characteristic curve automatically. By recording with this rising characteristic and playing back with a complementary equalizer to attenuate the high frequencies between 10,000 and 1,000 cycles by a like amount, the signal-to-noise ratio is maintained at higher frequencies and the recorded program material is reproduced exactly as the

* Technical Data Division, Fairchild Recording Equipment Corporation, Whitestone, Long Island, New York.

original. An NAB equalizer, inserted ahead of the power amplifier, meets this standard. The equalizer can be quite compact, mounting in a rack panel space as small as 1 3/4 in. A switch is needed to permit instantaneous insertion and removal of the equalizer from the electrical circuit. Passive equalizers necessitate insertion losses. If this insertion loss cannot be tolerated, an additional booster amplifier is required.

Adding Another Channel:

Let's now expand our facilities to feed two recorder channels, for simultaneous and segue (continuous) recordings. Figs. 2A and 2B diagram two installations which accomplish these objectives. Fig. 2A is the more elemental. It can be expanded to the installation shown in Fig. 2B with some interesting advantages. The second installation allows complete control of the audio levels and of the program material being fed to the separate recorders. Two completely different programs or an original and a safety disk of the same program can be cut at the same time. Installation 2A limits the facilities to recording one program at a time. The output switch panel indicated in Fig. 2A serves the functions of the VU panel in Fig. 1. A four-position switch permits instantaneous transfer of audio from the power amplifier to cutterheads 1 and 2 singly, cutterheads 1 and 2 simultaneously, or to a line. The output switch panel includes a VI meter, meter attenuator and vernier calibrator, a gain control for the monitor loudspeaker fed from an auxiliary winding on the output transformer of the power amplifier, and a phone jack mounted on the panel. Plugging a headset in the jack automatically silences the loudspeaker.

Many recording installations require the simultaneous operation of multiple input channels. Adding a mixer panel provides for combining audio from any desired number of signal sources. A separate gain control is used on each signal source for mixing and balancing the separate signals. A master gain control for setting the over-all level and fading is part of the unit.

Multiple-Channel Mixing:

A representative installation for multiple-channel mixing is shown in Fig. 3. The number of channels can be increased or decreased to suit the individual requirements. The input channels may be wired for impedances of 50, 150, 250, 500, or 600 ohms. Each preamplifier consists of a 2-stage, single-ended, fixed gain amplifier.

To allow complete and rapid interchangeability of preamplifiers, audio and power wiring should terminate in multi-contact connectors, with one part se-

cured to a fixed mounting tray and the other on the amplifier assembly. To eliminate hum, the power supply for the preamplifiers should be external to the units. An auxiliary power supply, designed as a basic unit for our recording

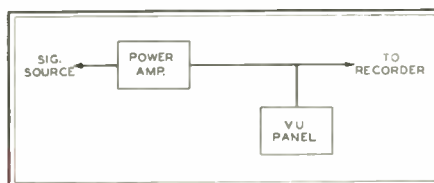

Fig. 1. The basic single-channel circuit systems, should deliver 300 volts DC up to 210 ma., 6.3 volts up to 8 amps., and a bias of 12 volts DC on the filament supply for further hum reduction. A selenium rectifier is recommended because it eliminates the danger of a vacuum tube rectifier filament burn-out which would disable the entire system. This calls for a three-section, heavy-

15,000 cycles. About 8 watts output is needed for the monitor speaker. By using the same type of amplifier for line and monitor functions, one of these units can act as a spare for both purposes.

The output switch panel specified for Fig. 2A is ideally suited to the type of installation shown in Fig. 4. The control room operator can select any one of three lines for audio feed. A practical example: one line feeds the recording room, a second line feeds a monitor speaker in the studio, and the third line feeds a monitor speaker in the audition lounge. Two of the lines can be fed simultaneously. When checking a playback recording, simply selecting the proper position on the output switch automatically feeds the audio to the audition lounge for sponsor's appraisal, and to the studio loudspeaker for artists' appraisals. The control room monitor speaker is operative at all times and has its own gain control. The monitor

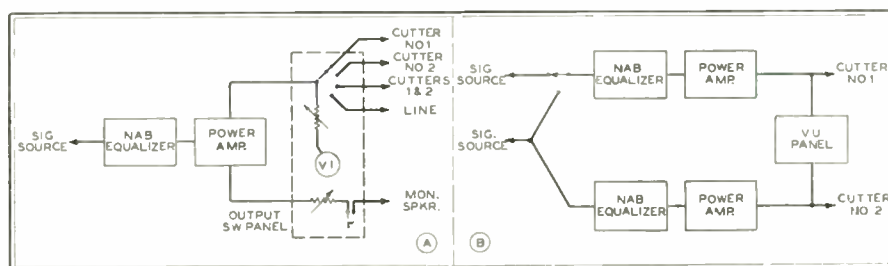

Fig. 2. Here are alternate arrangements for feeding two recorder channels

duty filter to provide virtually pure DC output from the high voltage rectifier.

In installations using line connections between the points of origin and the studio, Fig. 4, experience demonstrates that hum and noise pickup in the line may cause a severe reduction in dynamic range. In such cases, suitable pads and

gain control, headset jack, VI meter and meter attenuator are all mounted on one panel with the output selector switch.

Diameter Equalization:

In recording from outside to inside of a disk, losses in reproduction increase as the diameter decreases. This effect increases at the higher frequencies and varies with disk velocity, making diameter/frequency equalization desirable at 33 1/3 RPM. By increasing the high-frequency input as the cutterhead moves toward the inside diameter, this loss can be overcome. A 10,000 cycle signal should be 8 db higher than a similar 1,000-cycle signal at the inner diameter.

An automatic device with predetermined correction is included in the list of basic units for the recording system.

The proper place to insert the diameter equalizer in the recording channel is shown in Fig. 5.

Equalizing Pickups:

The professional recording installation includes playback equipment for auditions, dubbings and special effects. With the numerous types of pickups needed to reproduce the present variety of commercial and instantaneous disks, the cost of supplying each pickup with an equalizer has increased equipment costs

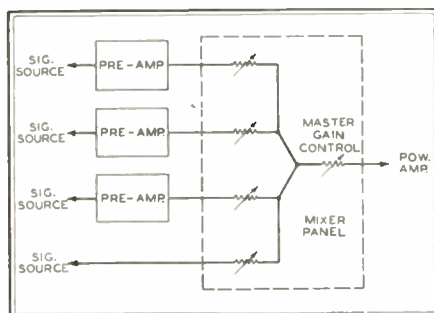

Fig. 3. Setup for multiple channel mixing

booster amplifiers are indicated. Such boosters, or line amplifiers, must have sufficient gain to overcome line-pad losses, and sufficient power-handling capabilities to accommodate program peaks without overloading.

These units, indicated as line and monitor amplifiers in Fig. 4, should have over-all gains of 50 db in order to feed +22 db into the program line with less than 1% distortion from 30 to

heavily. Equipment investments can be reduced by eliminating the need for separate equalizers, and making one equalizer serve all the pickups.

A preamplifier and equalizer that are independent of source impedance can be combined in one basic unit. Any constant-velocity pickup vertical, lateral, microgroove, or standard regardless of its impedance, can be operated directly into the input of such a unit without affecting the frequency characteristics of the pickup itself. Equalization can be accomplished after a built-in stage of preamplification, isolating the pickup from the equalizer itself. Since equalization is achieved at comparatively high audio level, hum pickup often encountered in passive-losser equalizers is avoided. The output of this basic unit should be at mixer level to eliminate the danger of hum and noise pickup in the audio wiring between the pickup and the mixer console. It is best to mount it inside the turntable cabinet, upright, with the equalization selector switch protruding through the turntable deck in a position convenient to the operator. If properly designed, there is no danger of hum pickup from the turntable drive motor. The use of DC filament voltages overcome another common source of hum pickup. RC equalization results in smooth curves, free from resonant peaks within the usable audio spectrum. A 6-position selector is adequate to give a

Patching Circuits:

It is often necessary to feed more than one circuit from a signal source. It may also be desirable to lift one of the circuits at will. This lifting and inserting, or patching, of one or more circuits can be accomplished without upsetting audio levels or impedances by the simple expedient of bridging or circuit-isolating pads. The diagram of a control room installation in Fig. 4 shows such a

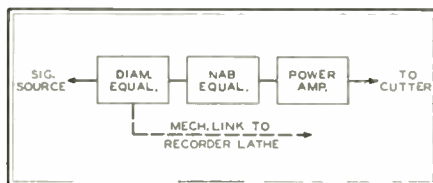

Fig. 5. Inserting a diameter equalizer

pad between the input to the monitor amplifier and the output of the mixers. Since it may be desirable to patch the monitor amplifier for some other purpose, the output impedance of the mixers should be matched to the input impedance of the line amplifier, the more important of the two circuits. The pad absorbs an extremely small amount of power from the audio circuit and affords electrical isolation between the monitor and recording channels.

Bridge pads are lossier circuits. Losses of 25 db in such pads are not unusual. If the requirements of the system are such

the process. For example; a record manufacturer obtains a stock of old originals and masters from another company, and decides that time is opportune to re-issue them. However, the disk originals were made in the infant days of the recording art, and may have poor total quality, poor bass response, or deficient high response.

Each dubbing presents an individual problem to the recording engineer whose conscientious ambition is to make the new release as perfect as the state of the art will permit.

Also, in recording original music, the recording engineer, musical director, or other person supervising the audio quality may desire heavier bass or middle register, or more brilliance than is obtained by natural studio acoustics. These conditions all indicate the need for a versatile equalizer that can selectively boost or attenuate various portions of the audio band simultaneously. Such a variable equalizer is not required to deliver power or voltage amplification. It is essentially a zero gain device. All signal amplification is achieved by other elements in the recording system. The variable equalizer must deliver, through continuously variable controls, a broad peak at any of the bass frequencies from 20 to 100 cycles and at any of the treble frequencies from 4,000 to 10,000 cycles. Not only must it be possible to select the frequencies at which equalization is to take place, but the degree of equalization must be adjustable in amplitude from zero (flat response) to a maximum boost of 16 db. Separate controls are needed for roll-off of low and high frequencies, and there must be no interaction between the high and low frequency controls. Such a basic unit finds wide application in professional recording.

Vertical and lateral NAB standards, private standards, broadcast audio line equalization, elimination of distorted and noise spectra, pre-emphasis and de-emphasis are all controllable for recording and playing back with the one variable equalizer unit. By mechanically linking the cutterhead with a potentiometer that is electrically connected to the variable equalizer, this unit can be used as an automatic diameter-equalizer. This technique provides the unusual control of both equalization frequencies and maximum boost level. Input and output gain controls allow for handling signals of various levels, and a magic eye on the front panel makes it possible to set the optimum input level for distortionless operation.

EDITOR'S NOTE: The next part of this series will discuss and illustrate specific professional recording installations, and how they have made use of the unitized amplifier system.

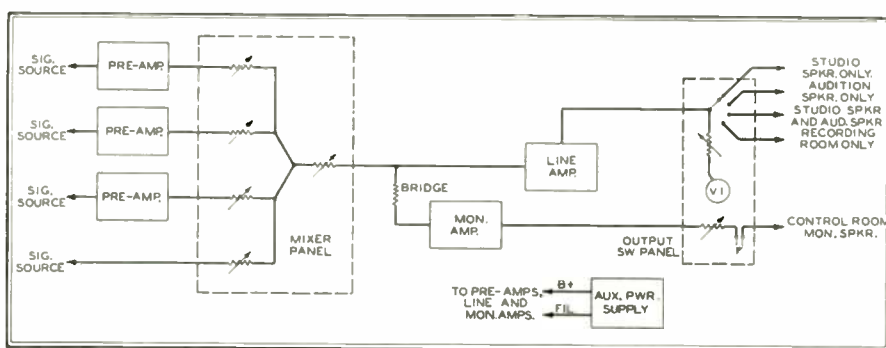

Fig. 4. An installation which provides for the use of three incoming audio lines

wide choice of vertical and lateral equalization curves.

To provide a means for cuing the disks on the playback turntable, a small 2-stage, push-pull amplifier capable of feeding 3 watts of audio to a loudspeaker is more than adequate. With a 10,000-ohm input impedance through a bridging transformer, it can be connected across any low impedance line, such as the output of the preamplifier-equalizer, without reflecting a mismatch. A popular custom is to mount the cuing loudspeaker on the front access panel of the turntable cabinet. A switch in series with the voice coil is required to silence the loudspeaker during the actual playback.

that the loss cannot be tolerated, the use of another basic unit, a bridging device, is indicated. This is a single-stage, push-pull, fixed-gain, isolation-bridging amplifier. It must operate from source impedances of 600 ohms or less without reflecting a mismatch. The gain of the amplifier compensates for the loss in the bridge. Both the bridging and amplifying components can be combined in one very compact assembly.

Dubbing Methods:

Dubbing has always been a bugaboo that most recording engineers would rather not have to face because of the unusual equalization problems often involved in



TYPE 1001-A

Standard-Signal Generator

- MODERATE COST THROUGH SIMPLIFIED DESIGN
- UNUSUALLY LOW LEAKAGE

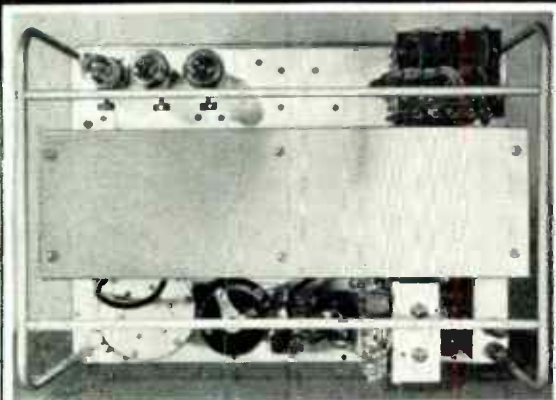

Rear view, removed from metal cabinet. Semi-unit construction with power supply along top, completely enclosed shielded and filtered carrier oscillator in center, and attenuator, carrier control, audio oscillator and modulation control at bottom.

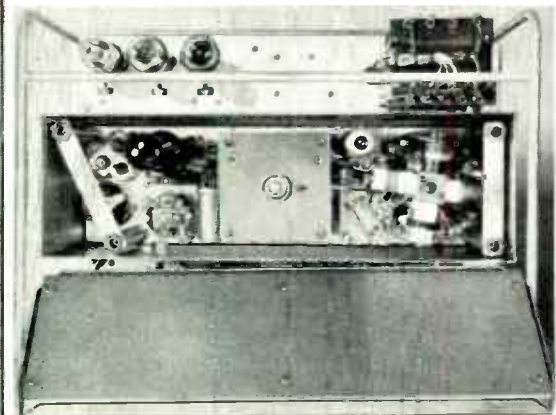

Cover removed from oscillator compartment. Note two-piece construction of cover, each being insulated from the other and making contact with both surfaces of the metal box housing the oscillator. All leads to this box are carefully filtered to prevent leakage.

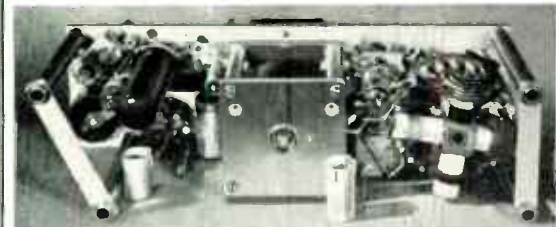

The complete oscillator plugs in and out of the metal box shown above, making testing and servicing particularly easy. The oscillator can be operated when removed from its shielding box. Extra precautions have been taken to insure excellent contact between the pre-loaded contact springs and the cylindrical contacts on the oscillator coil turret shown at extreme right.

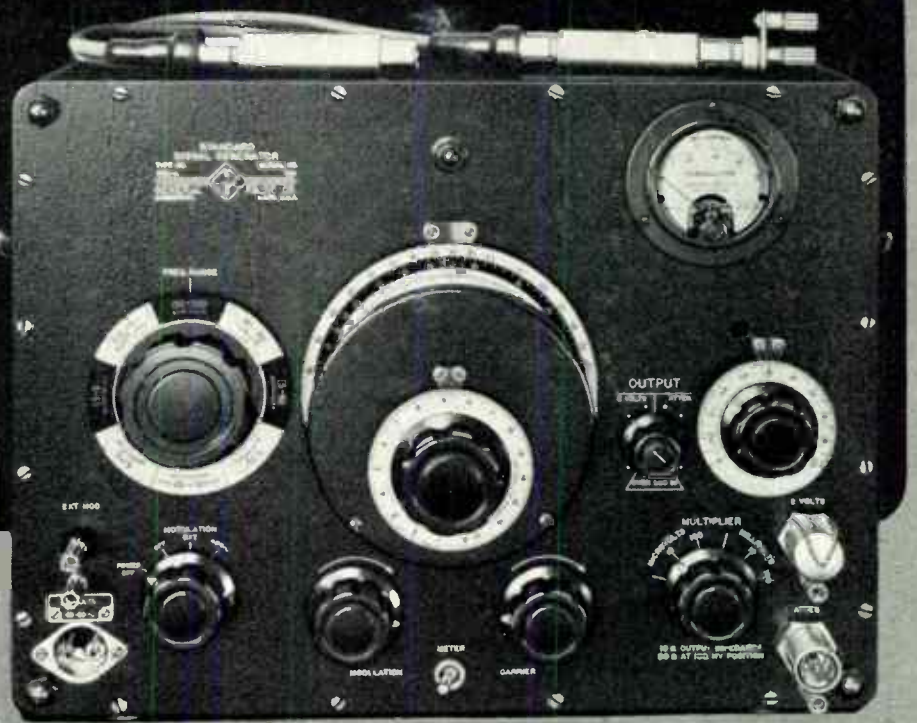

With many mechanical and electrical improvements, the Type 1001-A Standard-Signal Generator replaces the once-popular Type 605

Ruggedly designed, with unique mechanical construction and simplified circuits, this generator has exceptionally low leakage. Through the elimination of a number of circuit frills it has been possible to keep its cost to a moderate figure.

ABRIDGED SPECIFICATIONS

CARRIER-FREQUENCY RANGE: 5 kc to 50 Mc in eight logarithmic, direct-reading ranges.

FREQUENCY CALIBRATION: accurate to $\pm 1\%$.

INCREMENTAL-FREQUENCY DIAL: indicates increments of 0.1 per cent of frequency per division up to 15 Mc.

OUTPUT VOLTAGE: open-circuit voltage adjustable from less than 0.1 microvolt to 200 millivolts. Two-volts output available from a second jack.

AMPLITUDE MODULATION: adjustable from 0 to 80% either with 400-cycle built-in source, or over 20 to 15,000 cycles from an external source.

LEAKAGE: stray fields are substantially less than 1 microvolt per meter two feet from the generator.

INCIDENTAL FREQUENCY MODULATION: varies from 10 to 100 parts per million, at 80% a.m., over each range except 15-50 Mc where it may be three times this amount.

ENVELOPE DISTORTION: about 6% at 80% modulation.

NOISE LEVEL: carrier noise level corresponds to about 0.1% modulation.

Fully 90 per cent of the needs for a standard-signal generator for general laboratory use are adequately met in this carefully designed G-R instrument, where the ultimate in accuracy and stability is not required.

TYPE 1001-A STANDARD-SIGNAL GENERATOR..... \$595.00

GENERAL RADIO COMPANY

Cambridge 39, Massachusetts

NEW YORK

CHICAGO

LOS ANGELES

FM

SIGNAL GENERATORS



MODEL 78-FM 86 Mc.—108 Mc.

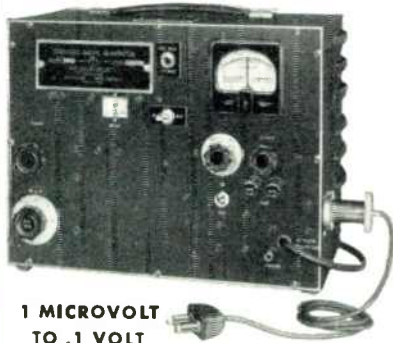

1 MICROVOLT
TO .1 VOLT

DEVIATION: Directly colibrated diol. Two ranges, 0 to 30 kc., 0 to 300 kc. Internal 400 cycle oscillator. Con also be modulated from external source.

DIMENSIONS: 10"x13"x7". Weight 20 lbs.

POWER SUPPLY: 117 volts, 50-60 cycles. 36 watts.

• SPECIAL GENERATORS

One-band Model 78-FM generators, with a tuning ratio of approximately 1.2 to 1, are available for use within the limits of 30 to 165 megacycles.

MODEL M-275 I. F. CONVERTER

For Use With Model 78-FM.



CARRIER FREQUENCIES: 4.5 Mc.; 10.7 Mc.; 21.7 Mc. (Provision for one extra frequency).

OUTPUT: When used with Model 78-FM the output voltage is variable from 10 microvolts to 1 volt.

POWER SUPPLY: 117 volts, 50-60 cycles, 45 watts.

MEASUREMENTS CORPORATION
BOONTON NEW JERSEY

MOBILE RADIO NEWS

(Continued from page 18)

pation of favorable Commission action. Crabb had already bought crystals and equipments for new LCC frequency requested.) This argument cancels out, therefore.

Second reason assigned was that "the grant of your application could logically be expected to provoke similar applications from your competitors in the Los Angeles area, as well as from other licensees similarly situated in other areas. If your application were granted, the Commission could not, in good conscience, deny similar applications of other licensees." Why Crabb's competitors with much fewer units in operation should follow his 90 units to the new frequency—instead of celebrate his departure—must remain a mystery, as the Commission's view on the matter was not elaborated further.

As to the difficulties of denying the similar requests of other licensees in other areas, they are no greater or less than those in Crabb's case. The fact that others may be entitled to the same relief is hardly a reason for denying the first petitioner if his request presents a meritorious case for grant. And the merits of the Crabb request were inferentially acknowledged by Commission in the final paragraph of its denial order:

"It is recognized that the miscellaneous common carriers operating in the general mobile service have, for a long time, suffered the disadvantage of sharing a common frequency pair, and it is the Commission's desire that this handicap may be removed at the earliest possible date. To achieve that objective, it appears that the interests of all will be better served by the maintenance of status quo for an additional period of time which, we hope, will be not unreasonably long."

Miscellaneous Intelligence:

Bill Irvin, maestro of the FCC's Commercial License Section, is snowed under. Recent FCC form letter reminder to taxi licensees of need for filing regular license applications before experimentals expire November 1 brought him an avalanche of application business . . . Bill claims that the queerest application to hit his section was that for a radio authorization in a sail plane used to follow the flight of gulls, for aeronautical design purposes . . . Don Haynes, the man-in-the-sealed-car on a cross-country endurance tour, comes in close second with a recent request for a Handie-Talkie unit . . . Tom Daniels, former Chief of FCC Aviation Section, and Joe Wofford, ditto Industrial Section, are active as engineering consultants in Austin and Houston, Texas, respectively.



TYPE
BH6



TYPE
TCO-1
OPER. TEMP. 75°C.
RATING 6.3V. - 5.5W



But A COMPLETE
KNOWLEDGE OF
FREQUENCY CONTROL

Type BH6 . . . Miniature size crystal unit. Frequency range . . . 1 MC to 100 MC . . . Tolerances meet all commercial or military specifications . . . hermetically sealed . . . in demand where space limitations are a problem . . . precision performance based on Bliley's complete knowledge of frequency control applications.

Type TCO-1 . . . Temperature control oven . . . for performance $\pm .0001\%$ between -55°C and $+70^{\circ}\text{C}$. . . specify BH6 crystal units with TCO-1 temperature control ovens. (For dual units specify TCO-2). Precision performance based on Bliley's complete knowledge of temperature control ovens.

* **"First . . . For 20 Years"**

Bliley
CRYSTALS

BLILEY ELECTRIC COMPANY
UNION STATION BLDG., ERIE, PA.

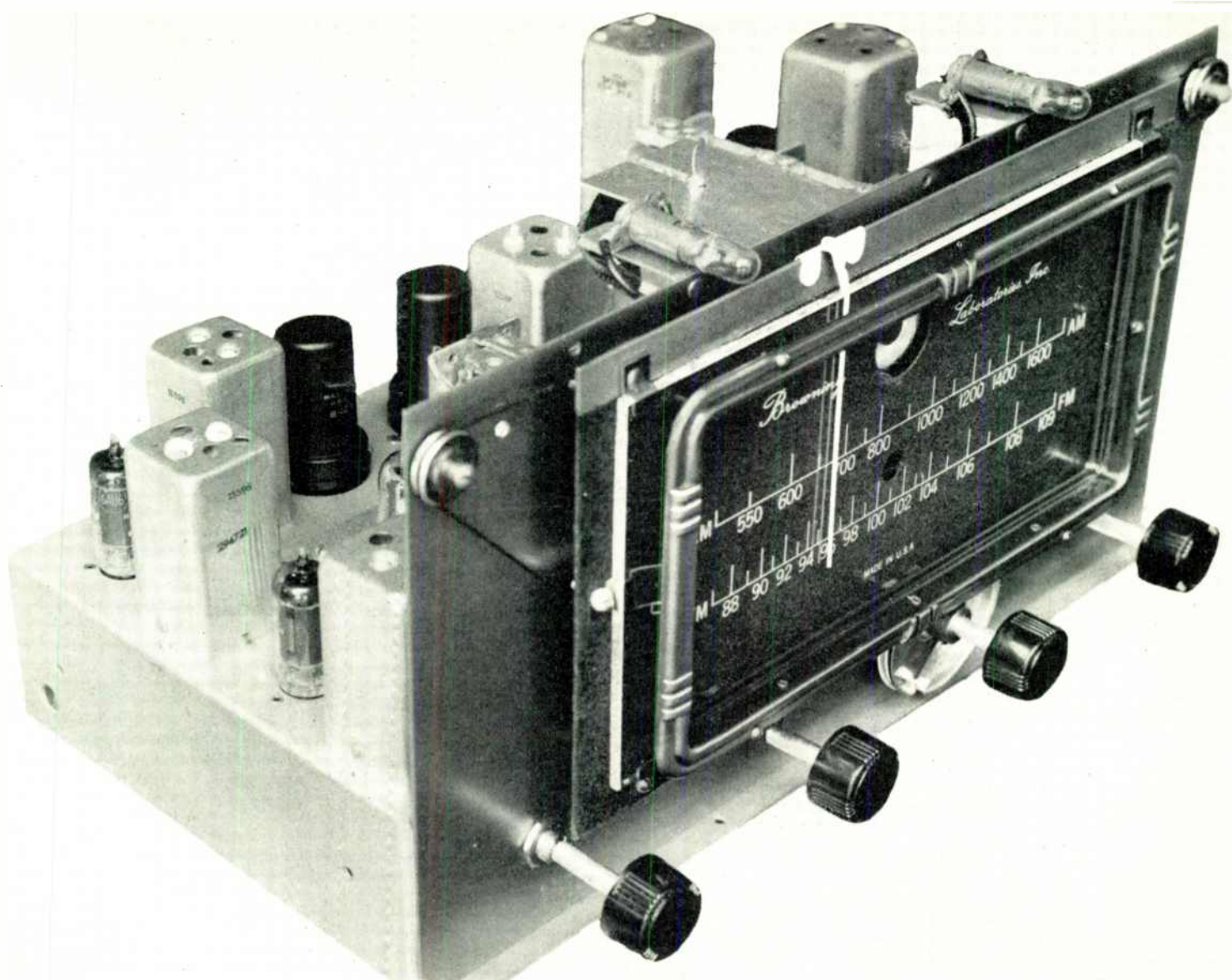

THE GENUINE ARMSTRONG FM CIRCUIT IN THIS RJ-12A FM-AM TUNER GIVES THE FINEST OVERALL PERFORMANCE OF ANY CIRCUIT AVAILABLE TODAY

IT'S EASIER TO INSTALL— AND MORE PROFITABLE TO SELL

THERE can be more profit in selling a BROWNING RJ-12A FM-AM tuner installation than in any cabinet-type audio or video receiver. That's a broad statement, but remember this: With every RJ-12A you sell a fine amplifier, a high-quality speaker, record player, and an FM antenna. And you won't dissipate your profits with repeated, free, service calls!

Today, more than ever before, there is a demand for fine audio entertainment. People who only used their old sets for time signals and weather reports are discovering new pleasure in noise-free FM reception on the BROWNING RJ-12A.

In almost any section east of the Mississippi, the RJ-12A will bring in at least 8 or 10 FM stations with full noise limiting. There are 25 FM stations in metropolitan New York, Chicago has 15, Los Angeles 14, Philadelphia 9, and Boston 7. The RJ-12A will bring them in at distances of 50

to 100 miles with beautifully clean, clear quality, free of all interference.

Maybe you don't realize how many FM stations can be heard with full limiting on the RJ-12A in your particular area. Better check up on this. You will find all the information, including frequencies, network affiliations, and other data in a 64-page FM Directory which will be sent you on request, without charge, together with a set of MT-10 data sheets, describing the BROWNING RJ-12A and RJ-20 FM-AM tuners, and the RV-10 FM tuner. *You'll profit by doing this today!*



IN CANADA, ADDRESS:
MEASUREMENT ENGINEERING, LTD.
ARNPRIOR, ONT.

IN THE PROFESSION, AN HONORED NAME

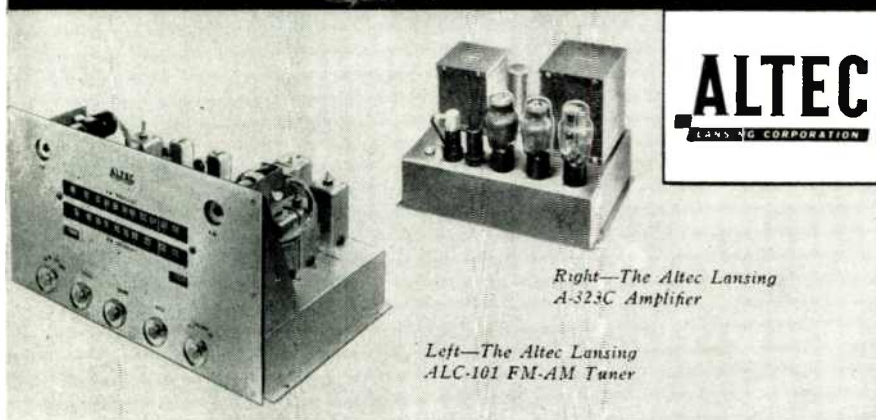

Right—The Altec Lansing A-323C Amplifier

Left—The Altec Lansing ALC-101 FM-AM Tuner

ENGINEERED FOR THE HIGHEST POSSIBLE PERFORMANCE REGARDLESS OF COST

This superb two-unit Altec Lansing combination was designed in accordance with a single directive: "They are to be the finest. No component, no circuit, is to be chosen with price in mind. They must be able to realize the full resources of the finest AM and FM programs; they must be capable of receiving and delivering these resources undisturbed to the finest loudspeaker in the world,

the Altec Lansing 604B Duplex." The AM section is an improved tuned radio frequency circuit recognized as the best for high quality reception. The distortion-free circuits of the FM section re-create all of the life-like reproduction possible with FM. The A-323C Amplifier transmits to the loudspeaker the signal delivered by the tuner, changed only in power level. This two-unit-com-

ination is available with special accessories to permit rack mounting for professional monitoring. Phonograph and television inputs and required switching are provided.

Technical folder describing ALC-101 Tuner and A-323C Amplifier sent on request. Write Altec Lansing Corporation, 1161 North Vine Street, Hollywood 38, Calif., 161 Sixth Avenue, New York 13, N. Y.

GRAY

BETTER REPRODUCTION FOR BROADCASTING ...



GRAY TRANSCRIPTION TURNTABLE 304T with exclusive RECORD LIFT

The Gray Transcription Turntable 304T assures you virtually perfect reproduction with 78 rpm or 33-1/3 rpm transcriptions. It features . . .

- Absolute synchronism at 78 and 33-1/3 r.p.m.
- Instant speed change
- Single control for starting and speed change
- Filters building vibrations
- Record Lift lever-operated
- No record slipping, flutter, wow
- Record Lift guarantees exact timing
- Maximum simplicity and SPEED of operation

Mounted in all metal cabinet 27" square. Price \$450 f.o.b. Hartford (Pickup, Equalizer, casters extra)



GRAY STYLUS FORCE GAUGE 901

Preserve your record library. Check stylus force with this new gauge. Accurate to grams. As simple as it is important to use!

Please ask for descriptive bulletins

THE GRAY RESEARCH & DEVELOPMENT COMPANY, Inc.
16 ARBOR STREET • HARTFORD 1, CONN.

RCA COLOR TELEVISION

(Continued from page 15)

to accomplish the inverse sampling, a picture-tube viewing arrangement or combination, and associated power supplies. For the demonstrations at the time of the hearing, we will have several setups available to illustrate and to demonstrate what may be done with this equipment.

We have described an embodiment of this RCA color television system which we will demonstrate in Washington at the time of the hearing. The studio equipment will be installed in the NBC station WNBW at the Wardman Park Hotel. The system operates within the framework of the present standards and is consistent with the "Standards of Good Engineering Practice Concerning Television Broadcast Stations." The transmitted signal contains sufficient information within the 6-mc. channel to enable a color receiver of the type shown in Fig. 4 to display a color picture of high definition. At the transmitter, time multiplex sampling has been used together with bypassed mixed highs. In the receiver shown in Fig. 4, the total signal consisting of the sampled signal plus the mixed highs has been inserted in the receiver sampler and picture-dot interlacing has been used to achieve high definition. Other arrangements of the receiver are possible, one of which is currently under investigation at RCA Laboratories. The result of this investigation will be presented at the time of the hearing. In this alternate receiver, the entire signal is fed into the sampler as before. However, in this case, low-pass filters with cut-off frequencies of approximately 2 mc. are inserted between the sampler and the kinescopes. The low-frequency filters smooth out the pulses of Fig. 5C so that the adjacent light spots of a single color in one line scan now almost completely overlap. Because the pulses have been broadened by the 2-mc. filters in this receiver, horizontal resolution will not be increased by picture-dot interlacing at the receiver. Full resolution, however, is restored by obtaining mixed highs from the signal ahead of the receiver sampler, and bypassing the mixed highs through a band-pass filter to the green, red, and blue kinescopes.

The color television receiver of Fig. 4 and the alternate receiver just described are but two examples of many possible designs, and indicate the flexibility afforded a receiver designer. For the color transmitter the same flexibility of circuit arrangement is possible. For both receivers and transmitters this flexibility exists within the framework of the current television standards.

Advertisers' Index

Adair, George P.	8
Alden Products Co.	9
Alford, Andrew	8
Allied Radio Corp.....	31
Altee Lansing Corp.	30
Amy, Aceves & King, Co. Inc.	8
Bell Telephone Labs.	1
Bliley Electric Co.	28
Boonton Radio Corp.....	31
Browning Radio Labs. Inc.	29
Camera Equipment Co.	5
Communications Research Corp.	8
Daven Co., The	3
Davis, George C.	8
Eitel-McCullough, Inc.	32
Electrical Reactance Corp.	
Inside Front Cover	
FM-TV	31
General Radio Co.	27
Graybar Electric Co.	10
Gray Research & Development Co... ..	30
Heimark, Harold M.	9
Hewlett-Packard Co.	
Inside Front Cover	
Jansky & Bailey	8
Kear & Kennedy	8
Klipsch & Associates.....	3
Link Radio Corp.	6
May, Russell P.	8
McCachren, Winfield Scott	9
McIntosh & Inglis	9
McNary & Wrathall.....	8
Measurements Corp.	28
Pollack, Dale	8
Radio Engineering LabsBack Cover	
Rangertone, Inc.	9
Ray, Garo W.	8
Smeby, Lynne C.	9
Sylvania Electric Pldts., Inc.....	7
Topflight Tape Co.	9
Weldon & Carr.....	8
Western Electric Co.	10
Wilmotte, Raymond M.	9
Workshop Associates, Inc.	4, 9
Zenith Radio Corp.....	2

FM SIGNAL GENERATOR

MODEL 202-B

FREQUENCY RANGE
54 to 216 MEGACYCLES

The model 202-B is specifically designed to meet the needs of television and FM engineers working in the frequency range from 54-216 mc. Following are some of the outstanding features of this instrument:

RF RANGES—54-108, 108-216 mc. $\pm 0.5\%$ accuracy. Also covers 0.1 mc. to 25 mc. with accessory 203-B Univerter.

VERNIER DIAL—24:1 gear ratio with main frequency dial.

FREQUENCY DEVIATION RANGES—0-24 kc., 0-80 kc., 0-240 kc.

AMPLITUDE MODULATION—Continuously variable 0-50%; calibrated at 30% and 50% points.

MODULATING OSCILLATOR—Eight internal modulating frequencies from 50 cycles to 15 kc. Available for FM or AM.

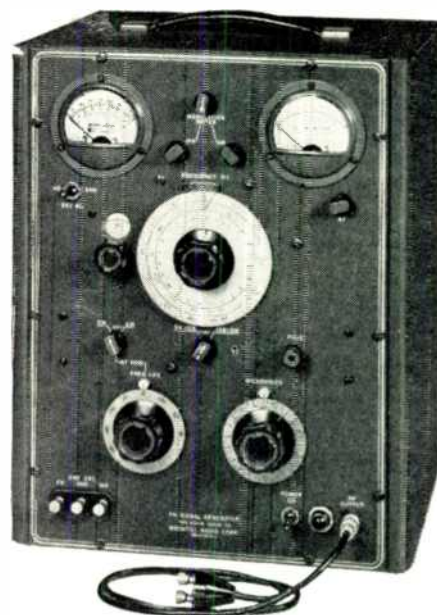

RF OUTPUT VOLTAGE—0.2 volt to 0.1 micro-volt. Output impedance 26.5 ohms.

FM DISTORTION—Less than 2% at 75 kc deviation.

SPURIOUS RF OUTPUT—All spurious RF voltages 30 db or more below fundamental.

Write for Catalog F

BOONTON RADIO



BOONTON · N · J · U · S · A

DESIGNERS AND MANUFACTURERS OF
THE Q METER · QX CHECKER
FREQUENCY MODULATED SIGNAL GENERATOR
BEAT FREQUENCY GENERATOR
AND OTHER DIRECT READING INSTRUMENTS

LIST

Just released: a Who's Who of the FM broadcast industry. Book includes names and titles of 3,300 top management and operating staff, such as president, general manager, station manager, program director, chief engineer, and many others. Also shown for each of over 700 stations are:

- Call letters
- Frequency
- Name of licensee
- Network
- AM and TV affiliates
- Location

This reference book has been compiled from data furnished by the stations themselves and is the most accurate such list now available. For maximum convenience and usefulness, it is arranged both geographically by location and alphabetically by call letters.

68 pages, 5½ by 8½, sturdily bound. \$2.00 per copy. Order direct from the publishers: FM - TV, Great Barrington, Mass.

FREE! Send for it NOW!

**ALLIED'S NEW
1950 CATALOG!**

**196 PAGES—
Everything in
Radio and
Electronics**



**GET RADIO'S
LEADING BUYING GUIDE**

Service Technicians and Engineers: ALLIED'S 1950 Buying Guide brings you all the new releases and money-saving values—from the world's largest stocks of test instruments, amplifiers, P.A. systems and equipment, tubes, parts, tools, books and accessories—ready for instant expert shipment. Send today for your FREE new 196-page ALLIED Catalog.

ALLIED RADIO CORP., DEPT. 20-K-9
833 W. Jackson Blvd., Chicago 7, Ill.

Send FREE New ALLIED Catalog.

FREE

Name.....

Address.....

ALLIED RADIO

Follow the Leaders to

Eimac
REG. U. S. PAT. OFF.
TUBES

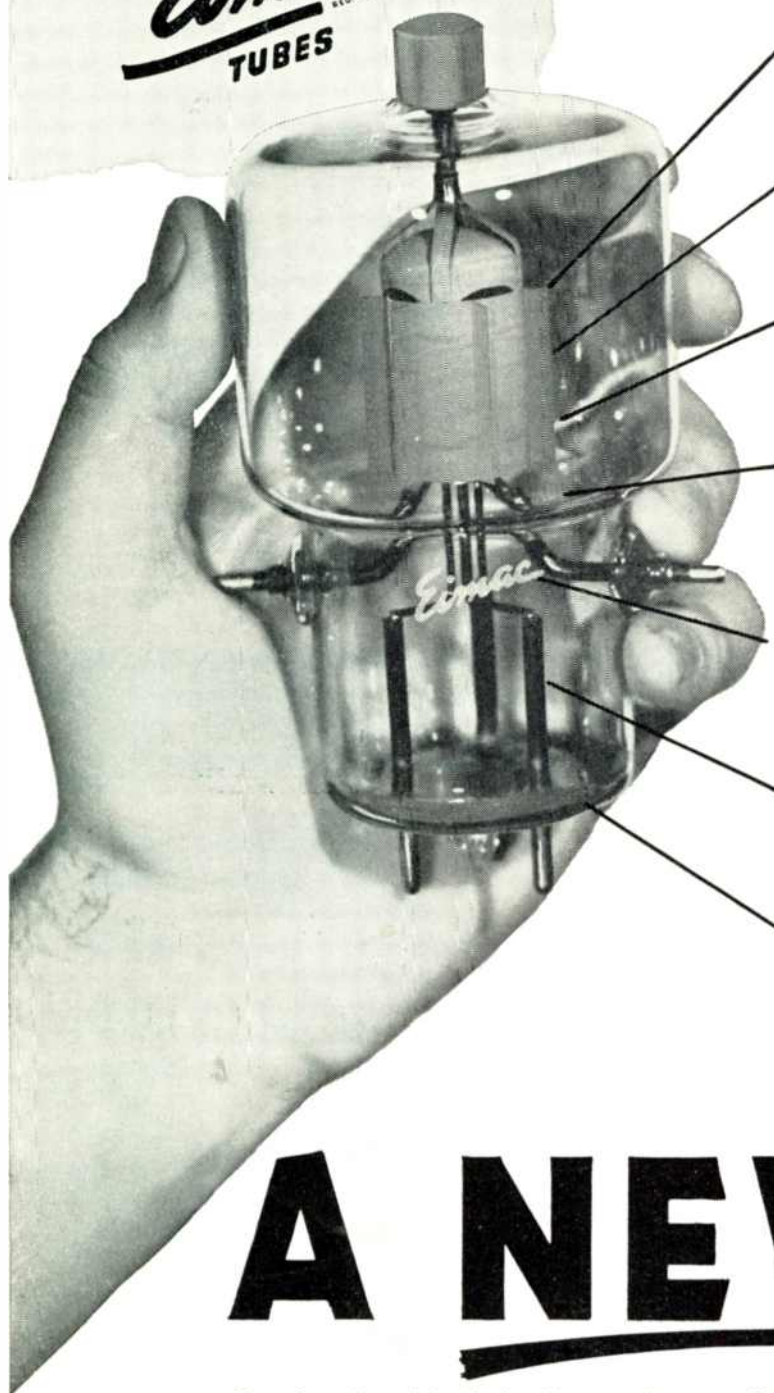

★ Pyrovac plate . . . for long life and to withstand momentary overloads.

★ Eimac non-emitting grid . . . for stability of operation.

★ Component materials are chemically stable . . . insuring long filament life.

★ Mechanical design of internal structures produces a high degree of rigidity and resistance to physical abuse.

★ Trade-marked "Eimac" . . . your assurance of superior performance and continuing service.

★ Tungsten leads . . . for low R-F resistance.

★ Eimac moulded glass base and precision aligned base pins.

A NEW 592

Developed and built by Eimac, the new 3-200A3/592 is directly interchangeable with existing tubes marked 592 without equipment modification.

The structural features indicated above impart to this new triode a long life span and rugged construction customarily associated with Eimac tubes.

Further information may be had by writing the Application Engineering Department of:

EITEL-McCULLOUGH, INC. SAN BRUNO, CALIFORNIA

Export Agents: Frazer & Hansen, 301 Clay St., San Francisco, California

FM and TELEVISION

Electronic Manufacturers

Specify



COMPONENTS-

for Dependable Performance

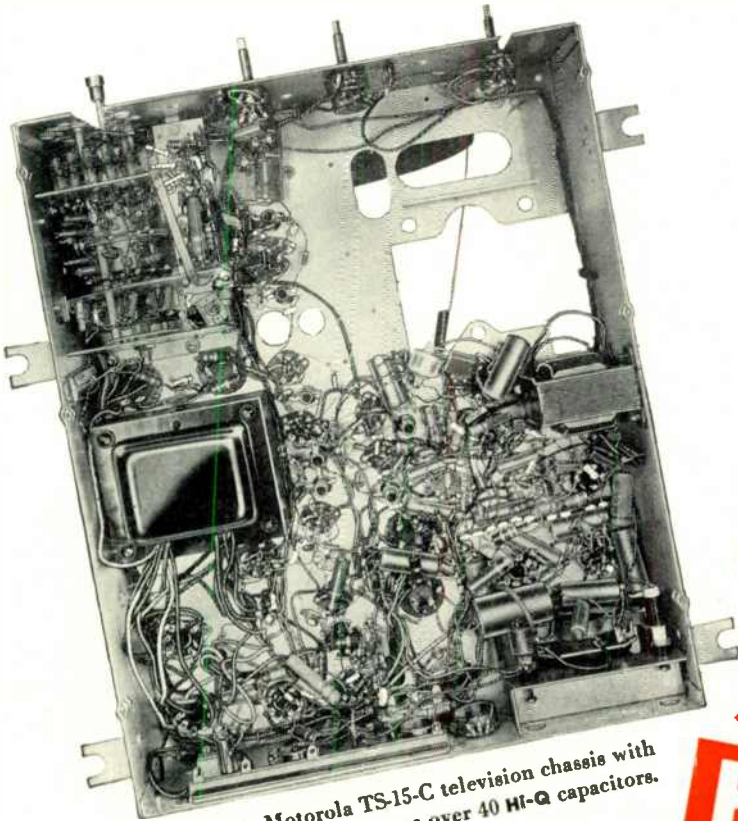

This Motorola TS-15-C television chassis with 12" picture tube uses over 40 Hi-Q capacitors.

● Motorola and practically all the rest of the industry's big names are among the more than 200 users of Hi-Q Components. They know from experience that they can depend upon Hi-Q for fine quality and strict adherence to ratings and tolerances . . . that Hi-Q contributes to the performance and long life of any electronic circuit.

Our engineers are always available to work with you in the development and production of capacitors, trimmers, resistors and choke coils to meet your specific needs. Write, wire or phone whenever you have a question concerning them.



Hi-Q general purpose ceramic capacitors have proven superior to mica and paper condensers of corresponding values. They are available in ratings of 5 mmf to 33,000 mmf. Hi-Q disc capacitors are high dielectric by-pass, blocking or coupling capacitors designed for use where their physical shape is more adaptable than tubular units.

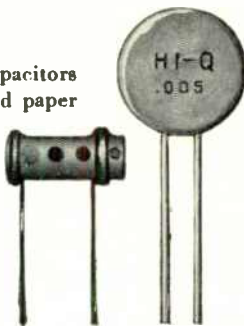

Hi-Q COMPONENTS
BETTER 4 WAYS

PRECISION Tested step by step from raw material to finished product. Accuracy guaranteed to your specified tolerance.

UNIFORMITY Constancy of quality is maintained over entire production through continuous manufacturing controls.

DEPENDABILITY Interpret this factor in terms of your customers' satisfaction . . . Year after year of trouble-free performance. Our Hi-Q makes your product better.

MINIATURIZATION The smallest BIG VALUE components in the business make possible space saving factors which reduce your production costs . . . increase your profits.

JOBBERS—ADDRESS: ROOM 1332
101 Park Ave., New York, N. Y.

Hi-Q

Electrical Reactance Corp.

FRANKLINVILLE, N. Y.

Plants: Franklinville, N. Y.— Jessup, Pa.— Myrtle Beach, S. C.
Sales Offices: New York, Philadelphia, Detroit, Chicago, Los Angeles

ACKNOWLEDGED STANDARD OF FM PERFORMANCE

This FM Receiver Has No Tone Control!

JHAT'S right! You see, the REL model 646-B is used as a relay receiver for 15,000-cycle FM broadcast networks. So it has to have the sensitivity and limiting action necessary to pick up signals from one transmitter and deliver an undistorted, noise-free output to the next transmitter in the chain.

In the REL 646-B, noise, distortion, and intermodulation have been reduced to the point where FM networks use a series of these receivers as repeaters.

No conventional home receiver compares with this model. It is so distinctly superior that you can actually recognize its performance wherever you hear it.

That's why, as FM station managers and chief engineers became accustomed to reception on the 646-B, they began to order these receivers for their own use at home.

Their friends came to listen, and they said: "I had no idea radio reception could sound like that! Can you get *me* one of those receivers?" Then some of the dealers who specialize in custom installations wrote to ask if they could buy the 646-B.

Because all our equipment is priced for sale to broadcast stations and communications systems, we had to charge them the standard price of \$345, but they were glad to pay it, for there is no other receiver of equivalent performance.

The volume of orders continued to grow. Still, we limited production to releases of 100 units until, gradually, we came to recognize that two important changes have taken place in the home radio market:

First, while the public has stopped paying fancy prices for mediocre performance, there is a growing demand

for the superlatively fine performance of this REL model.

Second, the day of radio furniture is nearly over. People are learning that it's much easier to eliminate radio cabinets than to find acceptable furniture designs. They like the simple metal case of the 646-B because this set looks like what it really is—a piece of fine radio equipment. And it is small enough to be inconspicuous.

So we found a market we hadn't anticipated, a market large enough that we are now justified in setting up a trade discount on this receiver.

Not every dealer can handle it, of course. But many can. Quite a number are doing so very successfully right now. These are dealers who are experienced in custom work. They know how to mount and install speakers, turntables, and tape recorders which are generally specified in 646-B installations. Also, they know how to put up FM antennas.

If you are handling business of this sort, write for technical data on the 646-B, and information as to the trade discount and deliveries. You'll find it an exciting experience to demonstrate and sell an FM receiver of such distinctive performance that listeners exclaim: "I had no idea that radio reception could sound like that!"



RADIO ENGINEERING LABORATORIES, Inc.

35-54 36th STREET,
LONG ISLAND CITY 1, N. Y.