

Price 25 Cents

June '49

# FM-TV

★ Edited by ★  
Milton B. Sleeper

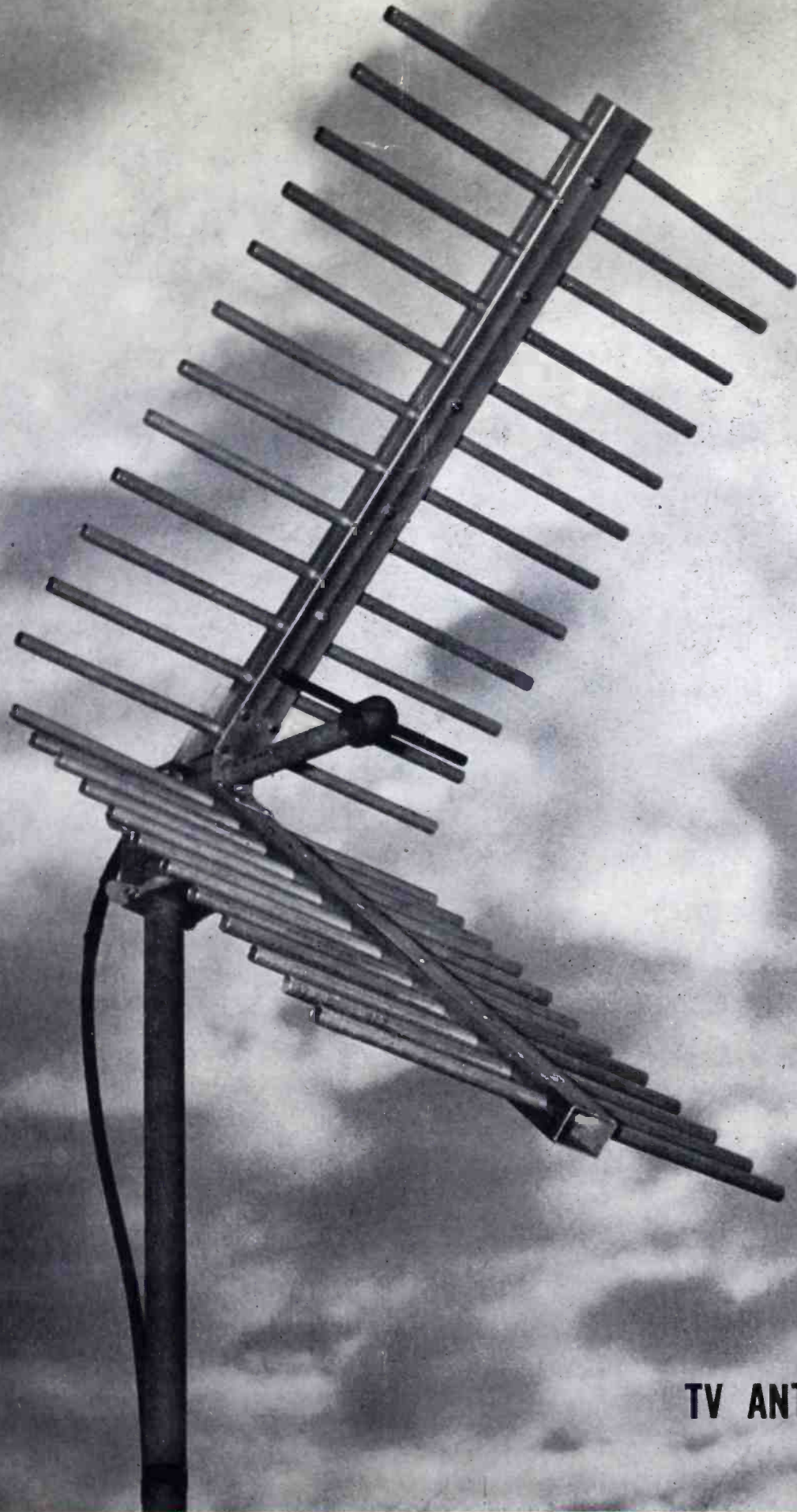

TV ANTENNA FOR 600 MC.

9th Year of Service to Management and Engineering



# LOW DISTORTION SIGNAL SOURCE FOR BROADCAST MEASUREMENTS

**-hp- 201B AUDIO OSCILLATOR**



**EASY TO USE  
INEXPENSIVE  
HIGH OUTPUT  
LOW DISTORTION**

## SPECIFICATIONS

**Frequency Range:** 20 cps to 20 kc, in 3 bands  
X1—20 to 200 cps  
X10—200 to 2,000 cps  
X100—2,000 to 20,000 cps.

**Frequency Calibration:** Direct in cps for lowest band. Effective scale length for 3 bands is 47 inches.

**Stability:** Better than  $\pm 2\%$ , including warm-up drift.

**Output:** 3 watts or 42.5 volts into 600 ohm load.

**Frequency Response:** Within  $\pm 1$  db over entire frequency range.

**Distortion:** Less than 1% at 3 watts output.  
Less than 0.5% at 1 watt output, at frequencies above 50 cps.

**Hum Level:** Less than 0.03% of maximum amplifier output voltage.

Data subject to change without notice.

**Broadcast stations** across the country find this high-fidelity *-hp-* 201B Audio Oscillator an ideal signal source for broadcast measurements, including new station performance data now required by the F. C. C. It meets every FM or AM requirement for speed, ease of operation, accuracy and purity of wave form. It enables you to quickly, easily and accurately make such measurements as high fidelity amplifier tests, overall station frequency response, overall station distortion, studio-transmitter line characteristics, etc.

### 3 WATTS OUTPUT

The *-hp-* 201B provides 3 watts of output power into a 600 ohm resistive load, sufficient to drive almost any kind of broadcast, laboratory or production equipment. Distortion may be limited to less than 0.5% at power of 1 watt or less. Hum level and output level can be attenuated together, and hum level is held 70 db under signal level for accuracy in working with small test signals.

### 20 TO 20,000 CPS

The instrument has a frequency range of 20 to 20,000 cps, covered in 3 bands. Frequencies can be tuned directly or by a 6:1 vernier control.

Effective scale length is about 47" and the no-parallax tuning dial has 95 calibration points occupying 300 degrees of the scale. The entire instrument is rigidly constructed for long service; sturdy, light weight and easy to handle. It is completely powered from any 115 volt ac power source.

Get complete details. See your nearest *-hp-* representative or write direct.

### HEWLETT-PACKARD CO.

1878-F Page Mill Road, Palo Alto, California

Export: FRAZAR & HANSEN, LTD.  
301 Clay Street, San Francisco, California, U. S. A.  
Offices: New York, N. Y.; Los Angeles, Calif.

**FREE**

**HOW-TO-DO-IT MANUAL  
FOR F. C. C. MEASUREMENTS**



**Broadcast Engineers:** Write for new, 37-page manual. Detailed instructions for making F. C. C. station performance measurements. Recommended circuits, step-by-step procedures, charts for calculating data, recommended forms for characteristic curves. Limited quantity. Write on station letterhead—today!

Recommended circuits, step-by-step procedures, charts for calculating data, recommended forms for characteristic curves. Limited quantity. Write on station letterhead—today!

**hp laboratory instruments**  
FOR SPEED AND ACCURACY



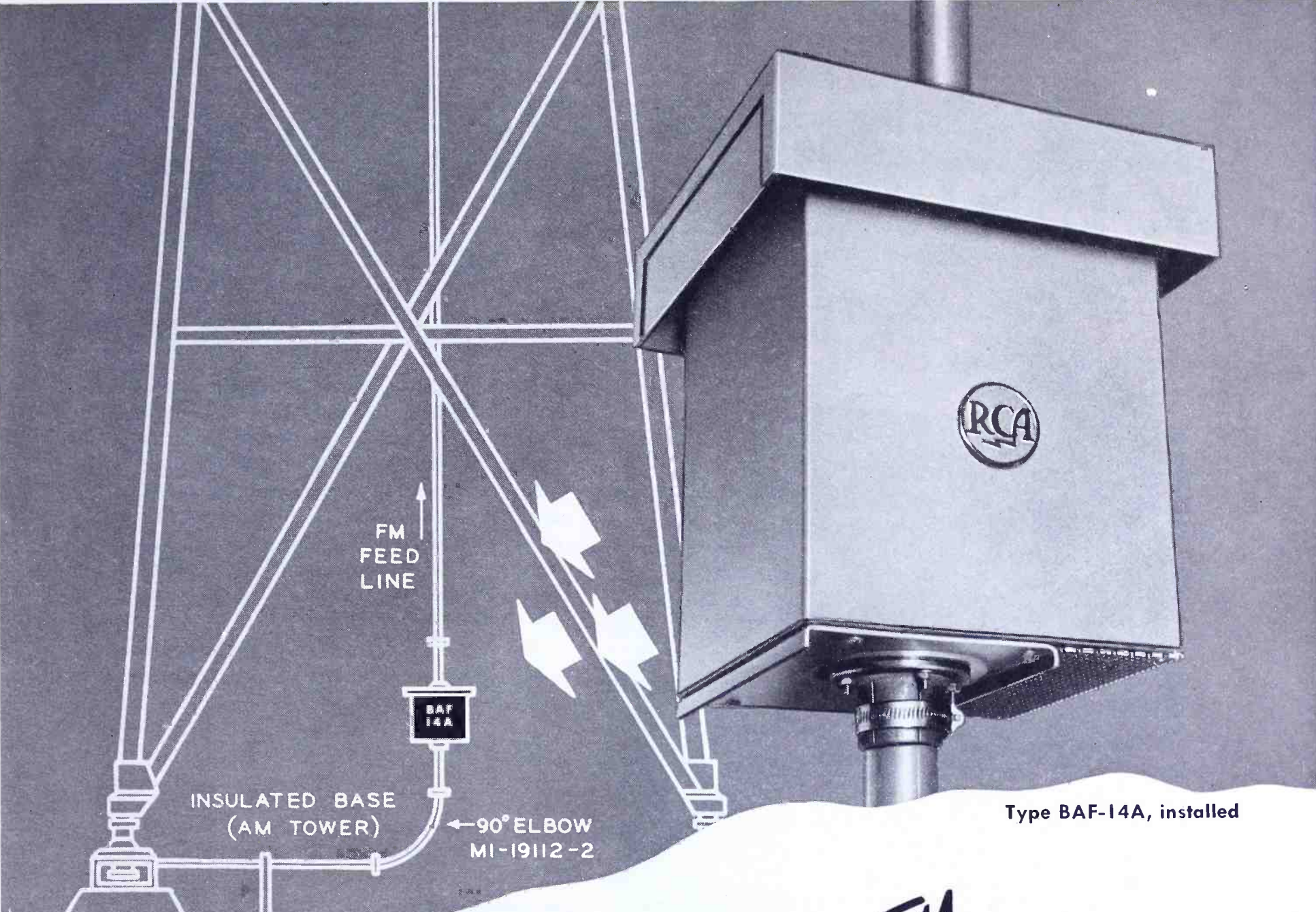

Type BAF-14A, installed

...isolates the **FM** feed from  
 your **AM** tower ... *the easy way*

Close-up view of the BAF-14A with the shield removed.

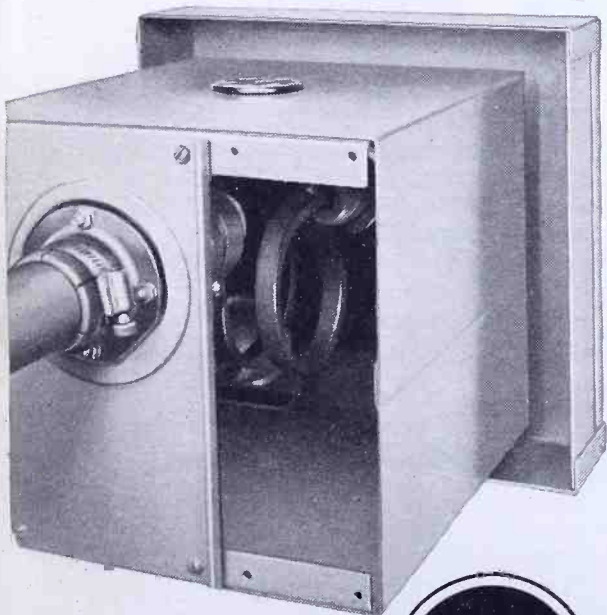

**New design—New low price\***

• The new RCA Type BAF-14A Isolation Unit enables you to transfer FM power effectively across the insulating zone of your AM tower . . . and makes it possible to completely isolate the FM and AM signals from each other. The unit maintains a low standing wave ratio on any FM channel and has minimum effect on AM tower impedance. Type BAF-14A will handle up to 10 kilowatts of FM power—with AM base insulator voltages up to 14 kv, peak!

In this Isolation Unit, two series-resonant circuit loops are coupled to each other in such a way as to provide excellent band-pass characteristics over the range of 88 to 108 Mc. Each circuit connects directly to its respective input or output transmission line—terminating

in an end-seal. Provision is made to carry the gas pressure line across the unit.

It's a simple matter to connect up the BAF-14A . . . because the input and output terminals are both equipped with special swivel flanges that eliminate expensive special coaxial fittings.

Built in a weatherproof metal box, only 12" x 12", the BAF-14A Isolation Unit is delivered ready to go. No tuning or adjustments to go through after installation.

Ask your RCA Broadcast Sales Engineer how the BAF-14A can solve your tower coupling problem. Or write Dept. 38F, RCA Engineering Products, Camden, N. J.

\*Ask your Broadcast Sales Engineer



**BROADCAST EQUIPMENT**  
**RADIO CORPORATION of AMERICA**  
**ENGINEERING PRODUCTS DEPARTMENT, CAMDEN, N.J.**

In Canada: RCA VICTOR Company Limited, Montreal



# NOW — A COMPLETE LINE! ZENITH TELEVISION

WITH  
GIANT CIRCLE SCREEN *and* BULLS EYE AUTOMATIC TUNING

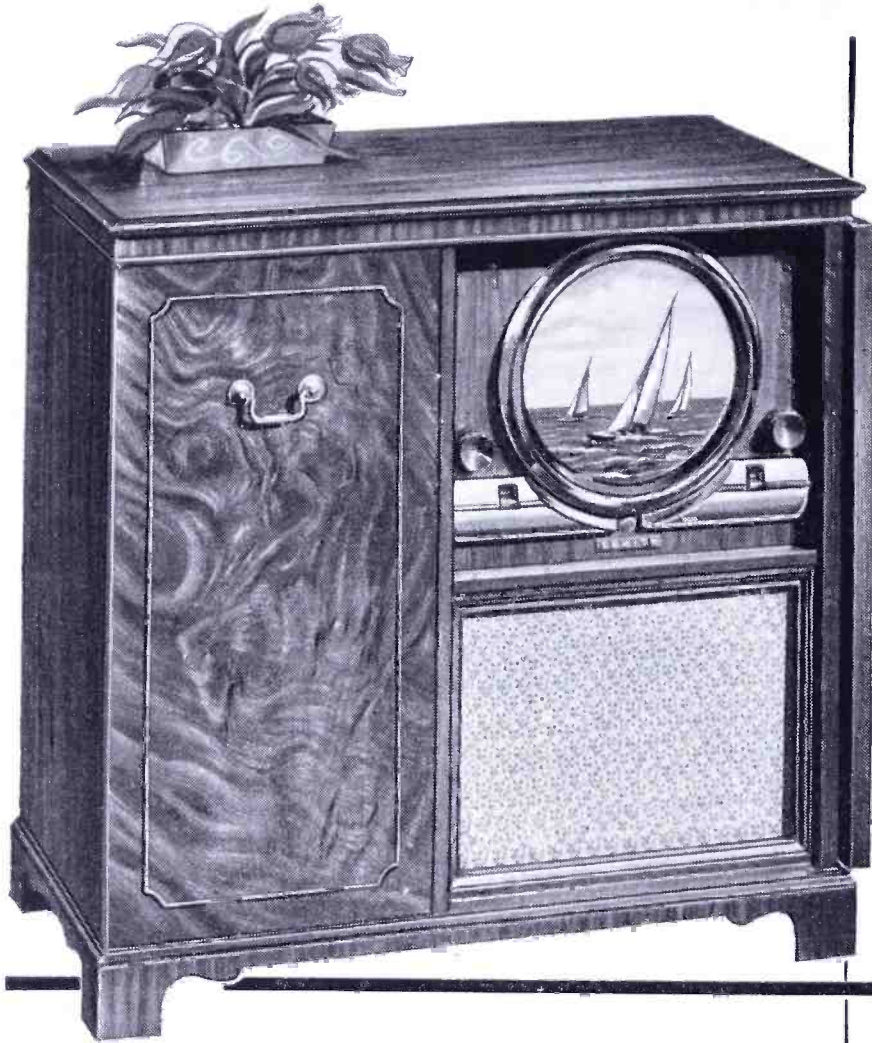

**THE ZENITH GOTHAM.** Zenith Television with "Big B" Giant Circle Screen; "Twin Cobra"† Tone Arms; Genuine Zenith-Armstrong FM and Zenith long distance AM radio; all superbly combined in a console of breathtaking beauty in imported mahogany veneers. **\$695\***  
*(plus Federal excise tax.)*

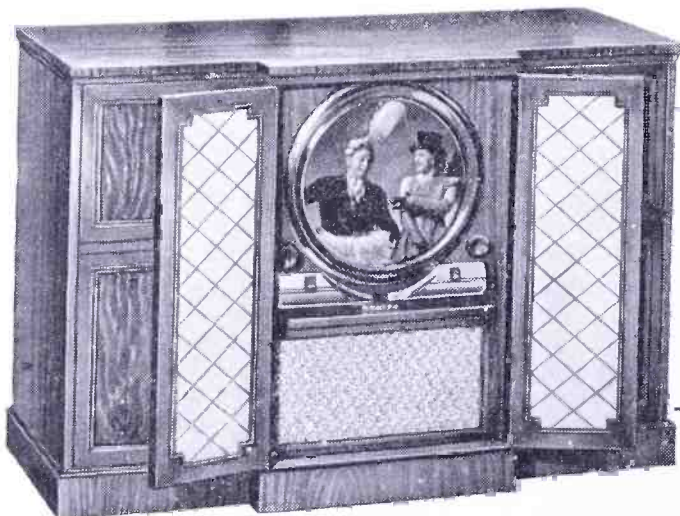

**THE ZENITH MARLBOROUGH.** Super deluxe! Zenith Television with "Giant C" Giant Circle Screen. Plus "Twin Cobra" Record Player; FM-AM and Short Wave Radio. In an authentic Regency console of hand glazed Honduras mahogany veneers, a masterpiece of the furniture craftsman's art. **\$1150\***  
*(plus Federal excise tax.)*

From the ultra-magnificent combinations to the beautifully streamlined table models, every Zenith† Television set hits the "bulls eye" for sales appeal. Every one has the sensational Zenith advancements found in *no* other television set... the Giant Circle Screen for a bigger, brighter, clearer picture... and Bulls Eye Automatic Tuning—one knob, one twist, there's your station, your giant picture, your sound... automatically pre-tuned to perfection!

Yes, Zenith has what it takes to assure the ultimate in customer satisfaction and bring you the most beautiful profit picture in television.

## SEE YOUR ZENITH DISTRIBUTOR

ZENITH RADIO CORPORATION  
6001 Dickens Ave., Chicago 39, Ill.

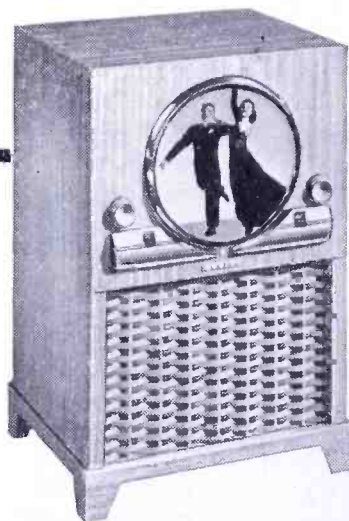

**THE ZENITH WALDORF.** Modern television console of imported Afara veneers in blonde finish. With "Big B" screen. **\$489.95\***

WILSHIRE model with "Super A" screen, \$449.95. \* Both models also available in mahogany finish.

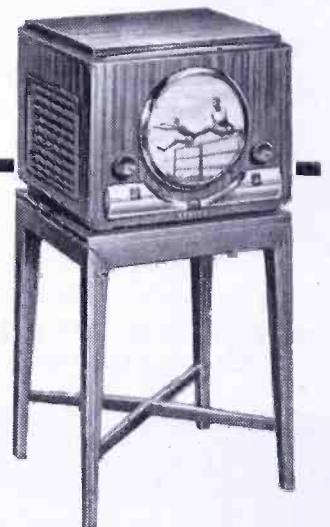

**THE ZENITH MAYFLOWER.** Period table set in mahogany-finished veneers of imported Afara. Has "Super A" television screen. **\$389.95\***

Matching table, 26 inches high, available at \$29.95. \* Receiver and table also in blonde finish.

**ZENITH HAS THE GREAT VALUES**  
**TELEVISION**  
*and long distance* **RADIO**

†®

*\*Suggested retail price.  
West Coast prices slightly higher.  
Prices subject to change  
without notice.*





Formerly, FM MAGAZINE and FM RADIO-ELECTRONICS

VOL. 9 June, 1949 NO. 6

COPYRIGHT 1949, by Milton B. Sleeper

# CONTENTS

## INDUSTRY NEWS

**TV-FM-AM Set Production**  
Compiled from figures released by the RMA ..... 4

**What's New This Month**

1. FCC's new TV plans
2. Jeremiah Courtney's Page
3. Optical Service for TV
4. Motorcycle Radio Equipment ..... 8

## FREQUENCY MODULATION

**Equipment for Remote Pickups**  
Frederick T. Budelman ..... 13

**Radio Communications Services, Part 1**  
New FCC rules and allocations ..... 17

## TELEVISION

**TV Operation in Small Cities**  
E. J. Meehan ..... 24

**Choosing the Right Antenna**  
Notes on improved designs ..... 27

## APPARATUS DESIGN

**Carbonyl Iron Powders**  
George O. Altmann ..... 29

## AUDIO DEVELOPMENTS

**Generator for AF Measurements**  
W. Noel Eldred ..... 31

## SPECIAL DEPARTMENTS

*Television News* ..... 6

*Special Services Directory* ..... 9

*Professional Directory* ..... 10

*Spot News Notes* ..... 22

*News Picture* ..... 23

THE COVER DESIGN AND CONTENTS OF FM AND TELEVISION MAGAZINE ARE FULLY PROTECTED BY U. S. COPYRIGHTS, AND MUST NOT BE REPRODUCED IN ANY MANNER OR IN ANY FORM WITHOUT WRITTEN PERMISSION

**MILTON B. SLEEPER, Editor and Publisher**

CHARLES FOWLER, Business Manager  
LILLIAN BENDROSS, Circulation Manager  
Published by: FM COMPANY

Publication Office: 264 Main St., Gt. Barrington, Mass. Tel. Gt. Barrington 500  
FM-TV Magazine is issued on the 20th of each month.  
Single copies 25c — Yearly subscription in the U. S. A. \$3.00; foreign \$4.00.

Contributions will be neither acknowledged nor returned unless accompanied by adequate postage, packing, and directions, nor will FM-TV Magazine be responsible for their safe handling in its office or in transit.

Entered as second-class matter August 22, 1945, at the Post Office, Great Barrington, Mass., under the Act of March 3, 1879. Additional entry at the Post Office, Boston, Mass. Printed in the U. S. A.

MEMBER,  
AUDIT  
BUREAU OF  
CIRCULATIONS

# ★ POLIC FM ALARM ★

FOR  
POLICE CALLS  
TAXI CABS  
AND OTHERS

## Radio Receiver Tunes Emergency Communications Band . . . 152-162 Megacycles

NEW IMPROVED MODEL PR-7

True F.M. superhetrodyne, 6 miniature tubes, including rectifier. 110 volts, AC-DC, 5-inch speaker, highest quality components.

Attached Antenna →

- \* Clear Vision dial
- \* Size 10½" x 6¾" x 6"
- \* Discriminator detector

# \$39.95



LIST PRICE includes excise tax, F.O.B. Indianapolis. \$10. cash with order, balance C.O.D.

Deluxe CA-2 outside coaxial antenna for best \$5. reception, list price only

See your DEALER first, or write Dept. FM-1.

**RADIO APPARATUS CORP.**  
303 FOUNTAIN SQUARE THEATER BLDG.  
INDIANAPOLIS 3, INDIANA

# DO YOU NEED..?

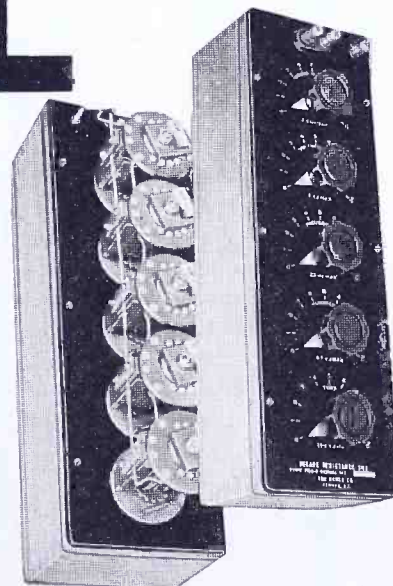

Rugged, accurate  
**RESISTANCEBOXES**  
for use in testing  
laboratory work, and  
as components in  
bridge work?

If you do, write DEPT. FM-10 for further information.



THE **DAVEN** CO.  
191 CENTRAL AVENUE  
NEWARK 4, NEW JERSEY



NEVER BEFORE  
AT ANY PRICE



SUCH VHF  
VERSATILITY!

THE NEW  
NATIONAL HFS  
\$142  
(power supply extra)

**Complete Coverage  
27 mcs-250 mcs!**

Covers all mobile communication services, as well as fixed services. Receives CW, AM OR FM! Superheterodyne with superregenerative 2nd detector.

**Mobile, Portable  
or Fixed!**

Operates from standard 110 volt, 60 cycle National 5886 power supply, National 686S 6-volt vibrator-type power supply or batteries! Built-in speaker. Light.

See your nearest National dealer listed in the classified section of your 'phone book.



RMA set production figures for April were not available up to June 1st due, we were told, to delay by one of the larger manufacturers in making his report.

April marked the beginning of price reductions on receivers, and the end of a period when RCA was the principal source for components. It will be remembered that RCA not only made the design of its first TV production model available to licensees, but also the individual parts. Thus manufacturers could start their own set production quickly. No doubt, RCA priced their components at a level which returned some of their heavy investment in engineering and tools. In the light of costs developed since the licensees got going on their own, RCA prices proved high, but initial assistance served its purpose.

Only disturbing cloud on the horizon is the UHF question. Probably the large producers will be able to add UHF tuning and keep the cost down at the level already established for VHF sets.

Others won't be able to absorb the expense and troubles involved.

Last January, we said: "FM is going to be the safest bet profit-wise for conservative-minded manufacturers and retailers." With AM sagging at the knees, and TV faced with allocations problems, FM has the advantage of a stable base. It's the only prop for audio broadcasters who have just discovered that the high-power promotion employed by TV operators is selling the foundations from under their towers.

Commander McDonald seems, at this moment, to be the only major producer to play both FM and TV to the middle. Thus, while Zenith is going along with the television parade, it is carrying an FM egg-basket on the other arm, thereby winning the active support of the audio broadcasters. Also Zenith dealers in rural areas have something superior to sell where there is no television, and those in the cities have something to offer people who don't buy TV sets.

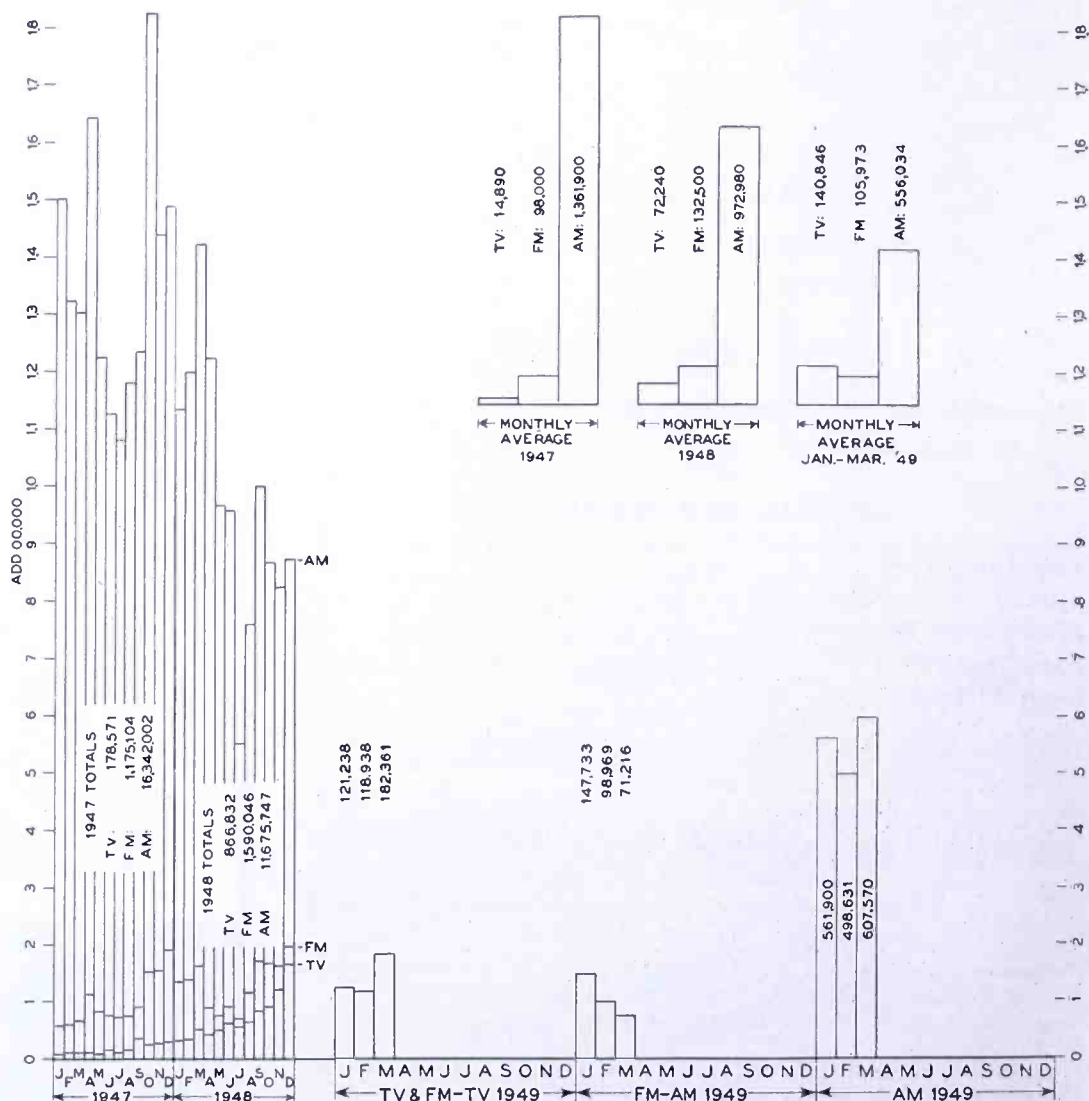

TV, FM, and AM Set Production Barometer, prepared from RMA figures



**CITIZENS RADIO  
TRANSCIVER USES**

*Sylvania  
sub-miniature  
tubes!*



The farmer in the field and his wife at home will be able to converse with ease by using these new, lightweight transceivers equipped with Sylvania sub-miniature tubes!

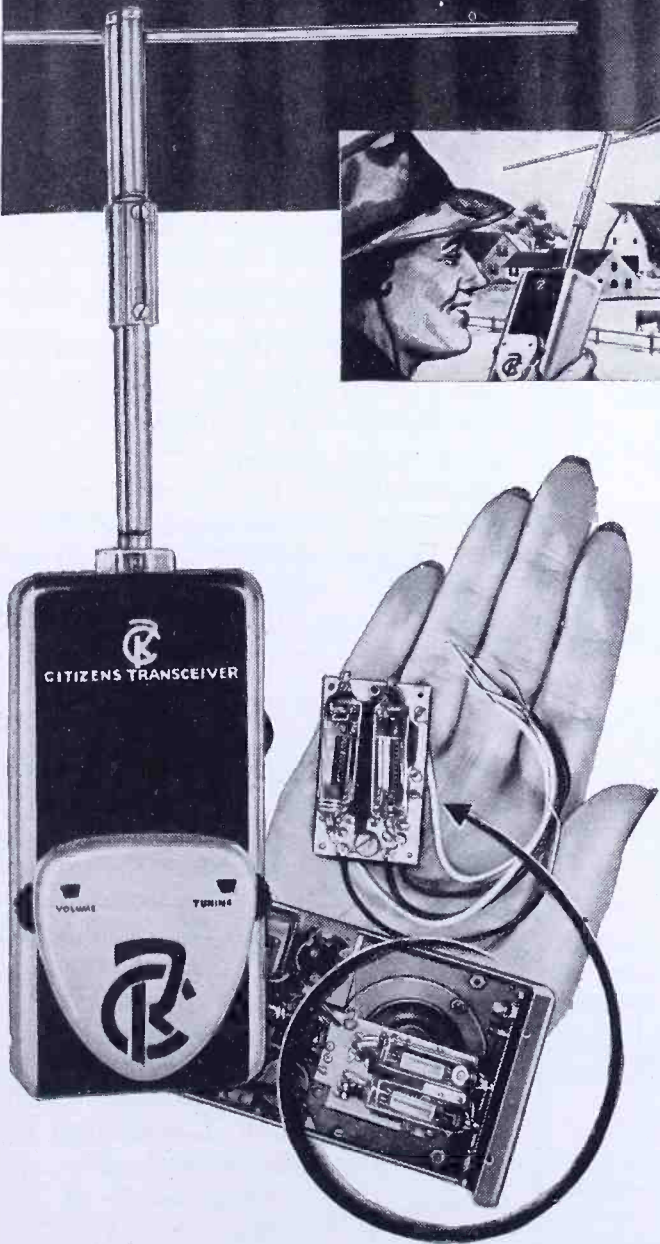

Tiny Sylvania sub-miniature radio tubes, smaller than a lady's little finger, are big reasons why the Citizens Radio Transceiver measures only 6" long, not quite 3" wide, 1 1/4" deep, and weighs only eleven ounces!

Sold in sets of two, these tiny two-way transceivers with a range of several miles are tuned to 465 mc. Among the many who want these handy units are police and fire departments, surveyors, farm-

ers, hunters, industrial users, rangers and those who wish boat-to-home and auto-to-home communications.

Sylvania's extensive radio tube research and manufacturing skill have made Sylvania sub-miniature tubes the choice of Citizens Radio Corporation, Cleveland, for this revolutionary, civilian transceiver. Sylvania Electric Products Inc., Radio Tube Division, Emporium, Pennsylvania.

# SYLVANIA ELECTRIC

RADIO TUBES; CATHODE RAY TUBES; ELECTRONIC DEVICES; FLUORESCENT LAMPS, FIXTURES, WIRING DEVICES; LIGHT BULBS; PHOTOLAMPS



## *A Message to Operators of*

# MOBILE RADIO SYSTEMS

COINCIDENT with the release of new FCC rules and allocations for mobile radio, *FM-TV Magazine* is expanding its editorial service to communications supervisors and engineers, and to owners of mobile radio systems. . . . For the past nine years, *FM-TV* has been the leading publication in this field. In fact, it has consistently devoted more space to mobile radio equipment and systems than all other magazines combined. . . . It is natural that this should be so, not only because the real expansion of mobile communications began with the development of 2-way FM equipment, but because the Editor of *FM-TV* was one of the pioneer engineers in the communications field, and has had an active part in the development of mobile radio since 1934. . . . Since that time, the narrow low-frequency band originally used only for police radio has grown to a total of 616 channels between 25 and 470 mc., used by many services. The total bandwidth is 32 mc., 36 times the bandwidth occupied by AM broadcast stations! . . . New allocations and rules mean new FCC actions affecting present and future operations. These will be discussed each month by Jeremiah Courtney, former FCC Assistant General Counsel. . . . Problems of adjacent-channel assignments, reduction of interference, combined operations, limitations on frequency stability and modulation, planning new systems in accordance with FCC rules, and the use of operational fixed stations will all be covered in detail by men who are specialists in these subjects. . . . And, of course, we shall continue the semi-annual *Directory of Mobile Radio Systems*, an exclusive *FM-TV* feature, available from no other source. July presents the newly-revised list of all systems operated by police, fire, forestry, railroads, and petroleum companies. All other systems, including taxis, public utilities, trucks and buses, are listed, with up-to-date revisions, in January. . . . In short, *FM-TV* provides, in one magazine, complete operational and technical information on present and future applications of mobile radio for all services. The cost is \$6 for three years, or \$3 for one year. If you are not already a subscriber, use the order blank attached.

## *FM-TV* MAGAZINE

GREAT BARRINGTON, MASS.



### **Paid TBA President:**

May be FCC Chairman Coy, if he will accept the post. Proposal was submitted by committee comprising Jack Poppele, Dr. Du Mont, Lawrence Lowman, and G. Emerson Markham. Salary would be \$25,000 to \$35,000. Purpose would be to develop public relations and represent TBA in technical, regulations, and legislative matters.

### **Pressure on TV Permittees:**

FCC has refused additional construction time to WJAX-TV and WPDQ-TV, Jacksonville, and WEEK-TV, Peoria. Also, WMBR-TV, Jacksonville, and WAFM-TV, Birmingham, were turned down on requests for permission to operate on interim power of 500 watts.

### **First TV Anniversary in Boston:**

WBZ-TV, Boston's first station, started transmission on May 29, 1948. Since that time, 81,390 receivers have been installed in the Boston service area.

### **Add These TV Stations:**

Since the list of TV stations on the air was published last month, KFMB-TV, San Diego, has started regular programs, using channel 8, and KGO-TV, San Francisco, is now operating on channel 7. These bring the total to 63 stations.

### **West Coast Rebroadcast:**

When KFMB-TV, San Diego, went on the air May 16, the Hoffman Hayride program was rebroadcast by direct pickup from KTLA, Los Angeles, and Klaus Landsberg, general manager of KTLA, sent his greetings to the San Diego audience. The distance between KTLA's transmitter on Mt. Wilson and KFMB-TV's pickup receiver on Mt. Soledad is 125 miles.

### **ATS Officers Elected:**

David Hale Halpern, vice president of Owen and Chappel, Inc., has been elected president of the American Television Society, succeeding Charles J. Durban of U. S. Rubber. New vice president is Donald E. Hyndman, Eastman Kodak; secretary, Reynold R. Kraft, N. B. C.; treasurer, Archibald V. Braunfeld. Directors are Charles J. Durban; George Shupert, Paramount; Ralph Austrian, Ralph Austrian, Inc.; Maurice Strieby, A. T. & T.; Edgar P. James, MBS; Halsey V. Barrett, Du Mont; and Jerry A. Danzig, CBS. Headquarters of ATS are at 11 E. 45th Street, New York 17.



## NEW CATALOGS & DESIGN DATA

THE products listed here are described in new catalogs and bulletins now available. Unless otherwise noted, they will be sent on request, without charge.

### Transmitting Tubes:

Quick reference data on 9 types of tetrodes, 25 triodes, 8 rectifiers, and associated components. Included are multiple triode assemblies for high power at VHF. *Eitel-McCullough, Inc., San Bruno, Calif.*

### Broadcast Equipment:

Four separate brochures describe: an FM broadcast transmitter of 1 to 5 kw. output for stations authorized to use up to 60 kw. effective radiation a super-power FM transmitter of 10 to 50 kw. output; a universal control console of flexible design which can be used at FM, AM, and TV stations and an isolation unit to transfer FM power across the insulating zone of an AM tower. Complete technical data is given on this equipment. *RCA Victor Division, Engineering Products Department, Camden, N. J.*

### Service Signal Generator:

Covers all frequencies used for mobile communications, as well as the upper TV channels, with over 100 ins. of calibrated scales, accurate to .05%. Modulated and unmodulated output from 1 to 100,000 microvolts. Self-contained crystal oscillator. Model 292X. *Hickok Elect. Inst. Co., 10530 Dupont Ave., Cleveland 8, Ohio.*

### JAN-Type Capacitors:

Complete specifications and dimension drawings are presented in quick-reference form in a 32-page catalog. *Cornell-Dubilier Electric Corp., South Plainfield, N. J.*

### 6AB4 Miniature Triode:

For use as a grounded-grid RF amplifier and local oscillator for TV sets. Heater is designed to reduce microphonics and hum level. *General Electric Co., Tube Division, Schenectady, N. Y.*

### Data on Lucite:

Entitled "DuPont Lucite Acrylic Resin," a new 32-page book presents application data and information on handling and fabricating this versatile material in cast sheet form. *E. I. DuPont De Nemours & Co., Wilmington 98, Del.*

### Filament Transformers:

Type 203T1 is designed for the 5771, and type 203T2 for the 5786 power tubes. No auxiliary current-limiting reactor is required. The former, limiting the filament starting current to 800 amperes, has 6 taps for line voltages of 195 to 250 volts. The latter limits the starting current to 50 amperes, and is tapped for 105, 115, and 125 volts. *RCA Tube Department, Harrison, N. J.*

### Subminiature Tubes for Portables:

Four new types have 8-pin leads for sockets or printed-circuit connections. Seated height is 1½ ins., diameter .4 in. The series comprises: 1AD5 sharp-cutoff RF pentode; 1E8 pentagrid converter; 1T6 diode-pentode; and 1AC5 output pentode. Plate potentials range from 30 to 67.5 volts, plate current 3 to 2 milliamperes. *Sylvania Electric Products, Inc., 500 Fifth Ave., New York 17.*

# Floating Action! for all TV Cameras

## "BALANCED" TV TRIPOD

Pat. Pending

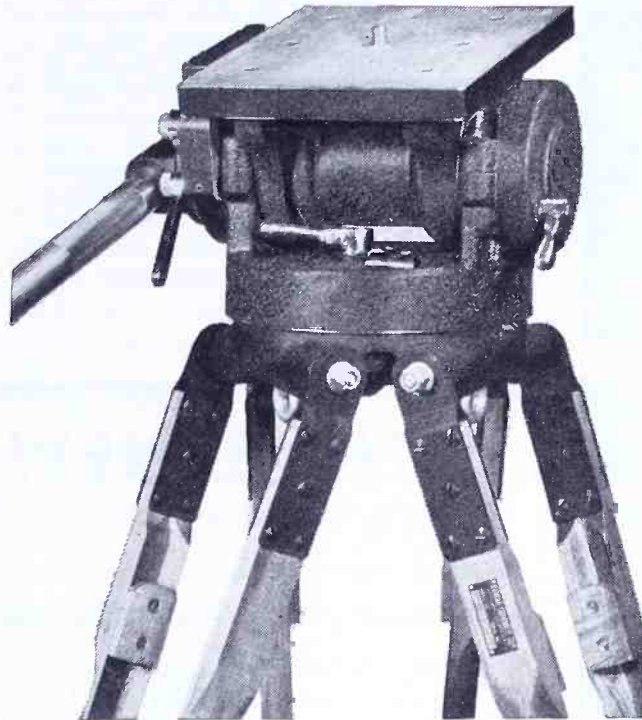

This tripod was engineered and designed expressly to meet all video camera requirements.

Previous concepts of gyro and friction type design have been discarded to achieve absolute balance, effortless operation, super-smooth tilt and pan action, dependability, ruggedness & efficiency.

Below:

3-wheel portable dolly with balanced TV Tripod mounted.



Complete 360° pan without ragged or jerky movement is accomplished with effortless control. It is impossible to get anything but perfectly smooth pan and tilt action with the "BALANCED" TV Tripod.

Quick-release pan handle adjustment locks into position desired by operator with no "play" between pan handle and tripod head. Tripod head mechanism is rustproof, completely enclosed, never requires adjustments, cleaning or lubrication. Built-in spirit level. Telescoping extension pan handle.

Write for further particulars

FRANK C. ZUCKER  
**CAMERA EQUIPMENT CO.**  
1600 BROADWAY NEW YORK CITY

### 811-A Power Triode:

Improved version of the 811 features a zirconium-coated plate with radial fins for greater dissipation, reduced RF loss from grid and plate leads, and strengthened top-cap assembly with ceramic collar. *RCA Tube Department, Harrison, N. J.*

### Circuit Markers:

Self-adhesive tabs, ⅜ in. square, for identifying terminals, harnesses, and switches. Furnished 40 to the card, they are numbered 1 to 10, 1 to 20, or 1 to 40, and in letter series A to Z. *Western Lithograph Co., 220 Rose St., Los Angeles 54.*

### Deflection Amplifier Tubes:

Moderately-priced types 6BQ6GT and 25BQ6GT are intended to reduce the cost of deflection circuits. *Hytron Radio & Electronics Corp., Salem, Mass.*

### NAB Equalizer:

Modifies the frequency characteristics of a recording system to conform with NAB recommendations for lateral transcriptions. Mounted on a 19-in. rack panel 1¾ ins. high. If 22-db insertion loss is too high, equalizer is supplied with a preamplifier booster, making panel 3½ ins. high. *Fairchild Recording Equipment Corp., Whitestone, N. Y.*

### Remote TV Control:

Control with 50-ft cable turns set on or off, tunes stations, and controls contrast and brightness. Operates with any type of TV set. *Transvision, Inc., New Rochelle, N. Y.*

### Stylus Force Gauge:

Gauge calibrated 0 to 40 grams shows stylus force when needle is set in an indentation on test arm. *Gray Research & Development Co., 16 Arbor St., Hartford, Conn.*



# Link Transonic F.M. Receiver

for  
Buses, Streetcars  
Supermarkets  
Stores, Hotels  
Restaurants  
and  
Public Buildings

- **FIXED FREQUENCY**  
Crystal Controlled
- **EXTREME SENSITIVITY**  
Better Than 1 Microvolt
- **HIGH AUDIO OUTPUT**  
Full 8 Watts
- **NEGLECTIBLE DISTORTION**  
Less Than 5 Percent
- **HIGH FIDELITY**  
Essentially flat 50-15,000 cycles
- **tone CONTROL**  
Bass and Treble Control
- **VOICE ACCENTUATION**  
10 db Rise for Commercial Announcements
- **REMOTE CONTROL**  
Audio Silencing under Control of Broadcasting Station
- **TAMPER-PROOF ASSEMBLY**  
Equipment Sealed in Locked Cabinet

THESE AND MANY OTHER FEATURES ASSURE OUTSTANDING PERFORMANCE WITH A MINIMUM OF MAINTENANCE AND A MAXIMUM OF SERVICE. THERE IS A REALLY GREAT RECEIVER IN THE TRUE LINK TRADITION OF QUALITY THAT HAS MADE LINK COMMUNICATIONS EQUIPMENT "PREFERRED THE WORLD OVER."

**Link Radio Corporation**

125 W. 17th St., New York 11, N. Y.

## THIS MONTH'S COVER

This month's cover is not a picture of something to strain minnows from the ether waves. Rather, it shows what is coming by way of housetop antennas for UHF television. Dr. Goldsmith, of DuMont Laboratories, has been using this antenna to pick up images from station WIOXKT, located at the site of WABD. Details of Dumont transmission on 600 mc. were presented in *FM-TV* last month.

Now that the FCC has announced definite plans to make commercial TV assignments in the UHF band when the present freeze ends, we can expect to see a new crop of antenna designs.



## WHAT'S NEW THIS MONTH

1. FCC'S NEW TV PLANS
2. JEREMIAH COURTNEY'S PAGE
3. OPTICAL SERVICE FOR TV
4. MOTORCYCLE RADIO EQUIPMENT

**1.** As we had anticipated, research during the period of the television freeze brought to light the fact that the 12 VHF channels will not accommodate the 459 TV stations originally planned by the FCC.

The first official word from the Commission was released on May 26, in an announcement which puts the industry on notice that it must prepare for the 6-mc. transmission and reception on UHF. The further implication is that some present VHF applicants are going to get UHF assignments, and that, if there are going to be VHF channels still open anywhere, they'd better be gobbled up quickly.

Here is the exact and complete text of the Commission's announcement released on May 26:

The Federal Communications Commission announced today that, in accordance with plans adopted Friday, May 20, 1949, it will institute further proceedings looking toward, 1) lifting the freeze on the present VHF television band, 2) providing a substantial number of UHF channels for commercial television broadcast service, 3) affording an opportunity for the submission of proposals looking toward the optional use of 6-mc. color in all channels in such a way as to permit reception on an ordinary television receiver with relatively minor modifications, and 4) adopting a nation-wide assignment plan covering commercial operation in both bands.

The Commission finds that these problems are so closely related that it is not feasible to lift the present TV freeze without first having more channels available and an overall allocation plan. Accordingly, it proposes to utilize ap-

proximately one-half of the lower portion of the UHF band for regular television operation on 6-mc. channels. This band has been available for operation on an experimental basis. The upper portion of the band will be kept open for television research such as stratovision, polycasting, and high-definition monochrome and color.

The Commission also proposes to afford an opportunity for the submission of proposals looking toward utilization of all television channels for 6-mc. monochrome or color on an optional basis in such a way as to permit reception on the ordinary television receiver with relatively minor modifications.

The Commission desires to emphasize that if, as a result of these proceedings, it is shown that color television can be operated satisfactorily within a 6-mc. channel in such a way as to permit reception on the ordinary television receiver with relatively minor modifications, the commission will make provision for licensing stations both in the VHF and UHF bands when it is shown that sufficient receivers and parts are available to permit adapting monochrome receivers for color reception.

The combined schedule calls for proposed rule making proceedings as required by the Administrative Procedure Act. A Notice of Proposed Rule Making will be issued within approximately six weeks from this date. The proposed rules will not only cover the contemplated use of channels in the UHF band but will also contain a revised allocation table for the present VHF band, taking into consideration the propagation studies of the ad hoc committee.

(Continued on page 9)

FM AND TELEVISION



## Special Services Directory

### METHODS ENGINEERS

Materials & Methods engineers in America's leading manufacturing plants use Topflight's Printed Cellophane, Self - Adhesive Tape to meet A-N specs. - assembly line - follow through - instruction labels. Easy to Apply.  
**TOPFLIGHT TAPE CO. YORK PA.**

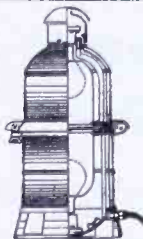

### "H & P"

300 MM. Code Beacons  
Obstruction Lights  
Code Flashers  
Packaged Lighting Kits

Send for Catalogue

### HUGHEY & PHILLIPS

326 North La Cienega Blvd.  
Los Angeles 36, Calif.

### THE WORKSHOP ASSOCIATES

INCORPORATED

Specialists in  
High-Frequency Antennas

66 Needham St., Newton Highlands, Mass.  
Bigelow 3330

### RATES FOR SPECIAL SERVICE CARDS

IN THIS DIRECTORY

\$12 Per Month for This Standard Space. Orders Are Accepted for 12 Insertions Only

### RADIO-MUSIC CORP.

REPRODUCERS **R** TURNTABLES

**M**

AMPLIFIERS **C** SPEAKERS

F. M. broadcast quality for custom sound installations for the studio and the home.

PORT CHESTER, NEW YORK

### KAY ELECTRIC CO.

INCORPORATED

Manufacturers of:

Television Test Equipment  
Laboratory Instruments  
Electronic Devices

14 Maple Avenue, Ridge Brook, N. J.  
Tel. CAldwell 6-3710

## WHAT'S NEW THIS MONTH

(Continued from page 8)

Upon issuance of the proposed regulations, approximately thirty days will be allowed for submission of comment or alternative proposals by those interested. A hearing will follow within ten days or two weeks. Within two weeks after the hearing, the Commission will hold oral argument preparatory to a final decision which will be given priority consideration.

The Commission will attempt to conclude the proceedings as soon as practicable after a fair opportunity is given for hearing all interested persons and allowing for due consideration of the matters presented. In view of the above required procedure, it does not appear that a final decision can be made before late fall. However, the ultimate decision will not only involve lifting the freeze but, at the same time, resolve other closely related problems.

It should be noted that Commissioner Freida B. Hennock, did not approve of releasing the foregoing announcement at this time. Her dissenting opinion was expressed by a separate statement, in accordance with FCC practice. The complete text follows:

I am keenly aware of the intense interest in the progress of television shared by members of the public generally, and especially the families contemplating purchase of television sets, by manufacturers, and by station licensees. But I am aware also of the many problems that exist as to the future status of black-and-white television, color television, both in the present VHF bands and the proposed UHF bands, and the multitude of other questions which must be solved to insure the finest development of this great new art for as many people as possible. I feel strongly that these questions must be carefully deliberated and thoughtfully answered in the manner which Congress has prescribed, by the orderly conduct of rule-making proceedings in accordance with the Administrative Procedure Act, 5 U. S. C. Sec. 1003. We are now in the midst of such proceedings, in which all interested persons are being afforded a full opportunity to participate, present their views, and offer technical information, and are in a position to issue a further notice of proposed rule making, looking toward an early solution of these difficult problems which confront us. And I feel that we must patiently continue to move forward in this orderly manner with confidence that we are performing our duty conscientiously and in a way which will, in the end, supply the fullest answers with the most adequate protection for the inter-

(Continued on page 10)

## Professional Directory

### AMY, ACEVES & KING, INC.

Specialists in the  
Design and Installation of

HIGH-GAIN  
AM, FM, and TELEVISION  
ANTENNA SYSTEMS

Longacre 5-6622

11 West 42nd St., New York 18, N. Y.

### RANGERTONE

TAPE RECORDERS

HIGH-FIDELITY EQUIPMENT FOR  
BROADCAST & RECORDING STUDIOS

RANGERTONE, INC.

73 Winthrop St. Newark 4, N. J.  
Tel. Humbolt 5-2550

Collins Custom Components

*The Very Finest*

FM TUNERS FM/AM TUNERS  
FM RECEIVERS

Custom Matched Components

*Collins*

Audio Products Co., Inc.

P. O. Box 368 Westfield, N.J.

## It's Alden — for . . . facsimile dispatching equipment

designed for your specific purposes.  
It may be for wire or for radio circuit.  
A pilot operation — or in quantity  
production

Our engineering provides for messages to be automatically picked up at scanner with recorder starting, stopping, and framing automatically, controlled by transmitter.

Alden Engineering experience covers the range of operations from low speed for narrow bandwidth wire lines to high speed large area equipment.

So whether you are dispatching a memo from office to office — or a full size weather map across the country — Alden has the system and will make to special order equipment that fits your needs. **For instance—**

200 cycle bandwidth	15KC bandwidth
Memo	Newspaper
Map	
with 4" width—50 LPI	with 18" width—100 LPI
2 in./min.	9 in./min.



OR



### Alden engineering opens new fields in impulse recording

Filling the gap between indicating instruments and the Cathode Ray Oscilloscope.

Giving a permanent record directly without photographic processes.

Alden Recording Equipment operates with Alfax Electro-sensitive Recording Paper producing permanent recordings. Alfax is a sensitive high speed paper that does not require special packaging. It is stable in storage, and is permanent in its recording.

To solve that facsimile or impulse  
recording problem — write now to

**ALDEN PRODUCTS CO.**

Brockton 64FD, Massachusetts



## Professional Directory

### Jansky & Bailey

AN ORGANIZATION OF  
*Qualified Radio Engineers*  
DEDICATED TO THE  
**SERVICE OF BROADCASTING**  
National Press Bldg., Washington, D. C.

### GARO W. RAY

**CONSULTING RADIO ENGINEERS**  
*Standard, FM and Television Services*  
HILLTOP DRIVE  
STRATFORD, CONN. Tel. 7-2465

### ANDREW ALFORD

Consulting Engineers  
**ANTENNAS & RF CIRCUITS**

Laboratory and Plant:  
299 Atlantic Ave., Boston 10, Mass.  
Phone: HAncock 6-2339

### DALE POLLACK

**FREQUENCY MODULATION**

development and research  
transmitters, receivers  
communications systems  
352 Pequot Avenue New London, Conn.  
New London, 2-4824

### REFERENCE DATA

Bound volumes of *FM* and *TELEVISION* contain a wealth of engineering and patent material. Each volume contains 6 issues, starting with January or July. They are available back to July 1941. Price \$5.50. By mail, 25c extra.

### GEORGE C. DAVIS

*Consulting Radio Engineers*  
501-514 Munsey Bldg.—Sterling 0111  
Washington 4, D. C.

## WHAT'S NEW THIS MONTH

(Continued from page 9)

ests of the public. We should not falter in that purpose. I therefore believe that this public notice is premature.

**2.** Beginning with our July issue, *FM-TV* adds a new columnist to its staff. He is Jeremiah Courtney, probably the country's outstanding legal authority in the two-way radio field. Mr. Courtney will edit a regular monthly column on developments in this field under the heading *Mobile Communications—Past and Forecast*.

Jerry is no stranger to *FM-TV* readers or communications people generally. He has been writing articles in his chosen field at the rate of one every two months since leaving his post in 1946 as FCC Assistant General Council in charge of safety and special service mobile radio matters. He consented to step up his production rate to one a month for *FM-TV* upon the understanding, as he modestly put it, that he would not have to answer the reader complaints.

Although he worked his way through Columbia college and law school, among other things writing for two New York City newspapers, Jerry maintains that the law lays a heavy hand on style. His explanation: "The lawyer who is paid to develop a facility for disentangling elaborate provisions is sooner or later deluded into thinking that the layman will have a similar patience. As a check against this, I keep writing those magazine articles. When they stop taking them, I'll know the jig is up."

Our new columnist's style we leave to our readers to judge. But we cling tenaciously to the view that there is no keener student of mobile communication developments, no one better equipped to weigh and report what has happened, and may happen, in this dynamic field he has done so much to shape both with in and without the FCC.

**3.** A few months ago, in the course of watching a television program, genial Gene Levy leaned forward suddenly and squinted critically at the image on the picture tube. Then, as the scene shifted and the focus changed, he relaxed. But from time to time, during the course of the program, he saw again the condition that had first caught his eye.

Next morning, he called the station and asked for the chief engineer. "I was watching your show last night," he said. "It looks to me as if one of your camera lenses is not mounted correctly, because each time it was used, the image was fuzzy at the top." As a result of this

(Continued on page 11)

## Professional Directory

### McNARY & WRATHALL

**CONSULTING RADIO ENGINEERS**

906 National Press Bldg. DI. 1205  
Washington, D. C.  
1407 Pacific Ave. Phone 5040  
Santa Cruz, California

### KEAR & KENNEDY

*Consulting Radio Engineers*  
1703 K St., N.W. STerling 7932  
Washington, D. C.

### GEORGE P. ADAIR

*Consulting Engineers*  
Radio, Communications, Electronics  
1833 M St., N.W., Washington 6, D.C.  
EXecutive 1230

### FRANK H. McINTOSH

*Consulting Radio Engineers*  
710 14th St. N.W., Wash. 5, D. C.  
MEtropolitan 4477

### WELDON & CARR

**CONSULTING RADIO ENGINEERS**

Washington, D. C.  
1605 Connecticut Ave. MI. 4151  
Dallas, Texas  
1728 Wood St. Riverside 3611

### COMMUNICATIONS RESEARCH CORPORATION

System Planning—Engineering  
Research & Development  
FM—TV—Facsimile  
VHF—Communications  
60 E. 42nd St., New York 17, N. Y.  
Mu 2-7259



## Professional Directory

### RAYMOND M. WILMOTTE Inc.

**Paul A. deMars**

Associate

*Consulting Engineers  
Radio & Electronics*

1469 Church St., N. W. Decatur 1234  
Washington 5, D. C.

### RUSSELL P. MAY

CONSULTING RADIO ENGINEERS

★ ★ ★

1422 F Street, N. W. Wash. 4, D. C.  
Kellogg Building Republic 3984

Member AFCCE

### LYNNE C. SMEBY

*Consulting  
Radio Engineers*

820 13th St., N.W. EX 8073  
WASHINGTON 5, D. C.

### Winfield Scott McCachren

AND ASSOCIATES

Consulting Radio Engineers

TELEVISION SPECIALISTS

2404 Columbia Pike 410 Bond Bldg.  
Arlington, Va. Washington, D.C.  
GLebe 9096 District 6923

### RATES FOR PROFESSIONAL CARDS

IN THIS DIRECTORY

\$12 Per Month for This Standard  
Space. Orders Are Accepted  
for 12 Insertions Only.

**NATHAN  
WILLIAMS**  
FM TV AM  
*Consulting Engineer*

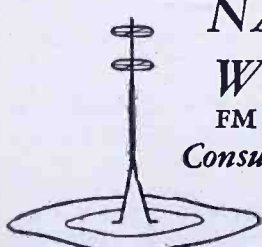

20 Algoma Blvd.  
Oshkosh, Wis.

Phone: Bl'khawk 22

## WHAT'S NEW THIS MONTH

(Continued from page 10)

conversation, the chief engineer sent the lens in question to Gene Levy, at Camera Equipment Company, 1600 Broadway, New York. Using a special setup built for checking lens mountings, it was found that the plane of the lens in question was not set to be exactly parallel with the plane of the camera tube. The error was slight, but the out-of-focus effect was sufficient that a trained eye could identify the cause.

When a lens is received from the manufacturer, it is mounted in a barrel. The barrel, in turn, must be mounted to fit the camera on which it is to be used, and this must be done with great precision in order to use the complete focusing range.

As television programming develops, the engineers are calling more and more on movie equipment and techniques to solve their problems. Thus Gene Levy at Camera Equipment has expanded his services to TV stations. Because optical equipment is so expensive, and the engineers cannot always tell what they should buy until they try it, Gene has set up a rental arrangement for lenses of focal length from 35 mm. to 20 ins., tripods, lighting gear, and both 16 and 35 mm. cameras and editing equipment. The service has proved so helpful to the TV engineers that it's being used by nearly all the stations on both sides of the Mississippi.

4. Out California way, police departments generally prefer motorcycles to four wheeled patrol cars. That probably explains why Vertric, Inc. of Los Angeles, went to such length to develop radio equipment for motorcycle use. The Vertric unit can be used on either a Harley-Davidson or Indian bike without any modification except, on the Indian, to convert the generator from 6 to 12 amperes by changing one pulley. Stand-by drain of the radio equipment is only 3½ amperes. Standard models cover 1,500 to 2,500 kc. and 30 to 50 mc. on AM, and 30 to 50 and 150 to 160 mc. on FM.

This spring, Vertric, Inc., was purchased by Link Radio. The Los Angeles plant is now operated as a division of Link, and also serves as a West Coast service depot for all Link mobile radio equipment. Just recently, the Los Angeles Police Department ordered 425 Vertric motorcycle units, to provide AM reception on 1,700 kc. and FM transmission in the 30- to 40-mc. band.

Bill Hamilton, who was sales manager of the old company, is now handling Link sales engineering for the entire southwest area.

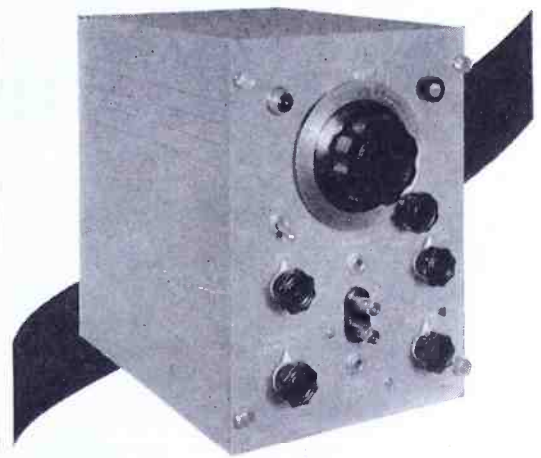

VISALGEN MODEL 205TS

## FASTER, MORE ACCURATE VISUAL ALIGNMENT

Use the HARVEY Visual Alignment Signal Generator for IF and RF circuits in FM and AM mobile and broadcast receivers. With any oscilloscope, the HARVEY Visalgen shows overall frequency response on the screen. Speeds factory production tests, service work, and keeps mobile communications equipment at peak efficiency. *Write for Bulletin 53.*

**HARVEY RADIO LABS., INC.**  
449 Concord Ave., Cambridge 38, Mass.

## DIRECTORY OF COMMUNICATIONS SYSTEMS

Copies of **FM-TV** for January, 1949, containing the directory of radio systems operated by taxis, public utilities, and special services are still available.

This issue also contains the complete specifications of all makes of communications equipment.

**PRICE 25c**

**FM-TV MAGAZINE**  
Great Barrington, Mass.



# Two BIG reasons why you'll want...

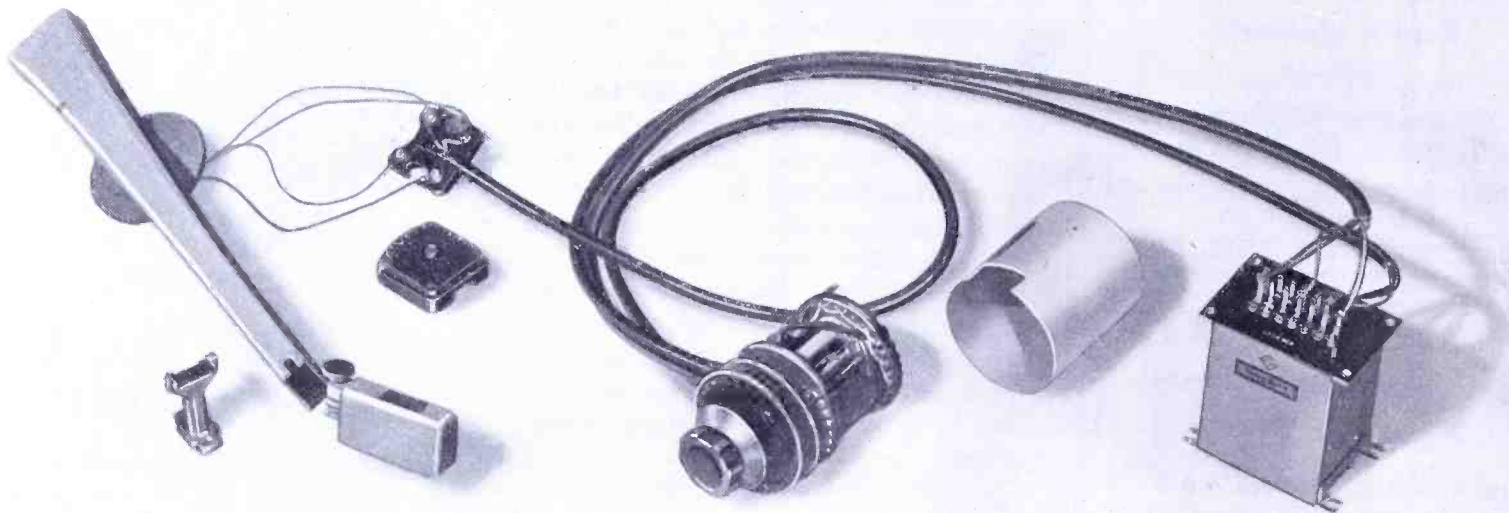

## ...the 109 Type Reproducer Group!

### 1. Low intermodulation distortion

Naturally, the Western Electric 109 Type Reproducer Group gives you extremely low harmonic distortion. But here's a still more important point—its advanced design practically eliminates *intermodulation* distortion.

Intermodulation distortion is one of the important factors that cause the "fuzziness" so often heard in the reproduction of the higher frequencies. Tests *prove* that the moving coil principle of reproduction, used in the 9 Type Reproducer, introduces far less intermodulation distortion than other currently used methods. That's *one* reason why the 109 gives exceptionally "clean" reproduction!

### 2. Wide, uniform frequency response

The combination of the 9 Type Reproducer and the equalizer used in the 109 Group is carefully designed for uniform frequency response—and this 7-position equalizer permits correction for any of the more commonly used recording characteristics. With the 109 Group, you can match within close tolerances all vertical and most lateral transcriptions and 90% of phonograph records.

The 109 Type Reproducer Group is *available from stock*—place your order with your local Graybar Representative, or write Graybar Electric Company, 420 Lexington Avenue, New York 17, N. Y.

## — QUALITY COUNTS —

### Immediate replacements on 9 Type Reproducers

If your 9 Type Reproducer needs repairs, send it to your Graybar District Warehouse — you can get a *factory-rebuilt* replacement immediately from stock.

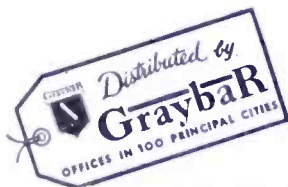

# Western Electric

DISTRIBUTORS: IN THE U. S. A. —  
Graybar Electric Co. IN CANADA  
—Northern Electric Co., Ltd.



# EQUIPMENT FOR REMOTE PICKUPS

TRANSMITTERS AND RECEIVERS DESIGNED FOR THE REVISED VHF CHANNEL ASSIGNMENTS, AND THE NEW 450-TO 452-MC. BAND—By FREDERICK T. BUDELMAN\*

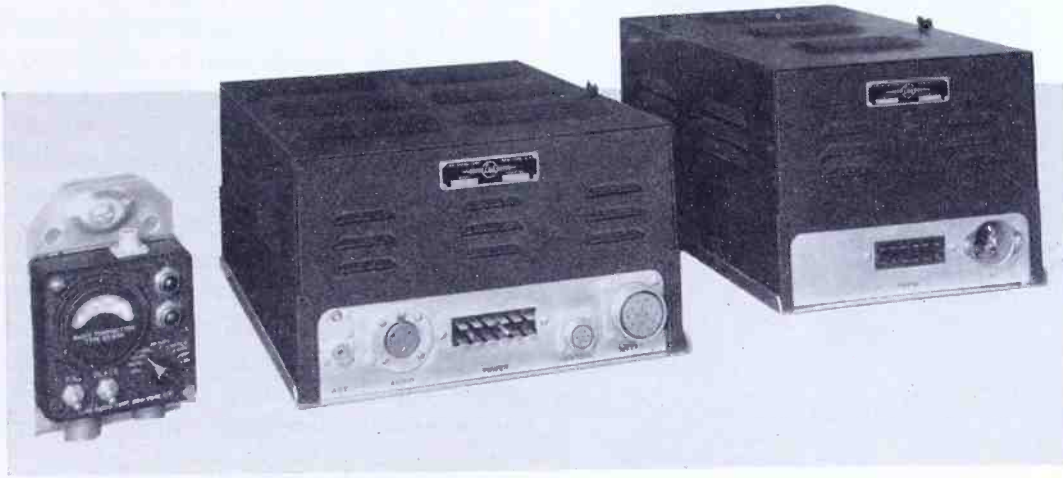

Fig. 1. Mobile units for 50 watts VHF, or 25 watts UHF, with remote control head, transmitter, and AC power supply. For DC, dynamotors are in transmitter case

THE new FCC frequency assignments which become effective on July 1, 1949, change the set up for mobile equipment in remote pickup (relay broadcast) service. In its proposal of May 5, 1948, the FCC indicated that it planned to cancel the remote pickup channels originally assigned to this use by the 1945 allocations in the 152- to 162-mc. band. Various networks, the NAB, and Link Radio, while admitting the future possibilities of channels in the region of 450 to 460 mc., objected vigorously to the deletion of channels which had proved so successful in the 152- to 162-mc. band. Moreover, pickup equipment for that band had been developed commercially, and was giving excellent service because of the favorable characteristics of those channels.<sup>1</sup>

## New Remote Pickup Channels:

It is gratifying to learn, therefore, that the new FCC allocations plan released on May 6, 1949, permits the remote broadcast pickup service to retain the use of 9 channels from 152.87 to 153.35 mc. These channels, as before, are to be shared with certain industrial radio services which are not normally operated in urban areas where the demand for remote broadcast pickup is greatest.

Specifically, frequencies 152.87, 152.93, and 152.99 are shared with the special industrial and motion picture services, while the remaining six, from 153.05 to 153.35 are shared with forest products.

In addition, two 100-kc. channels at 166.25 and 170.15 mc. have been made available to the remote pickup service except within a radius of 150 miles from

\* Vice President and Chief Engineer, Link Radio Corporation, 125 W. 17th Street, New York City.  
<sup>1</sup> "Remote Pickup Relays" by Frederick T. Budelman, *FM AND TELEVISION*, June, 1948.

New York City, and in the Tennessee Valley Authority area, where these channels have been otherwise assigned by the Interdepartmental Radio Advisory Committee (IRAC).

Finally, twenty 100-kc. channels have been assigned exclusively to remote pickup service for base and mobile operation, from 450.05 to 451.95 mc. Anticipating this, we have been developing additional equipment at Link Radio for operation on these new channels.

## Mobile Pickup Transmitters:

The Link VHF and UHF mobile transmitters are similar electrically, and are mechanically interchangeable, with 50 watts output on 152 to 174 mc., and 25 watts output on 450 to 470 mc. They are FM types with a normal swing of  $\pm 45$  kc. at the carrier frequency, although a deviation of only  $\pm 25$  kc. is now authorized on the 60-kc. channels in the 152.87- to 153.35-mc. band. It is expected that the full swing of  $\pm 45$  kc. will be authorized on 166.25 and 170.15 mc., and at 450.05 to 451.95 mc., with a corresponding improvement in signal-to-noise ratio.

Both the VHF and UHF transmitters are available in two models, and for operation from 12 volts DC or 115 volts, 50-60 cycles AC. The MRB series is of mobile design, with two built-in dynamotors for 12-volt operation, or a separate AC power supply. Fig. 1 shows the rear of the MRB design, with a remote control head and the AC power supply.

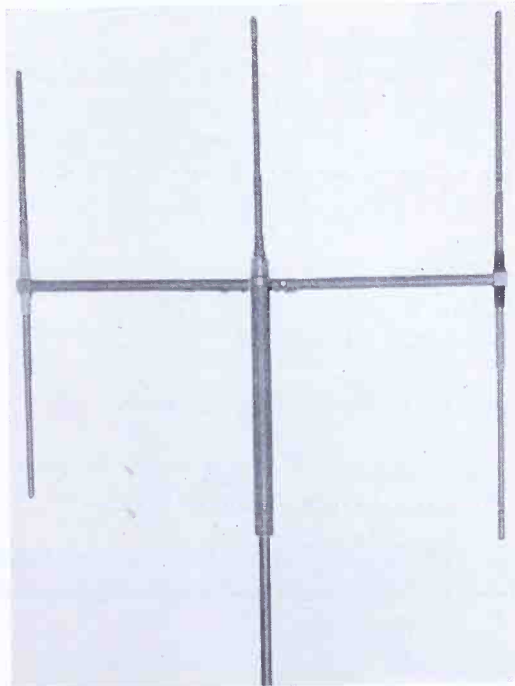

Fig. 2. The 50-watt VHF chassis with dynamotors for 12 volts DC. Fig. 3. Directional array for 160 mc. Removing side members gives circular pattern

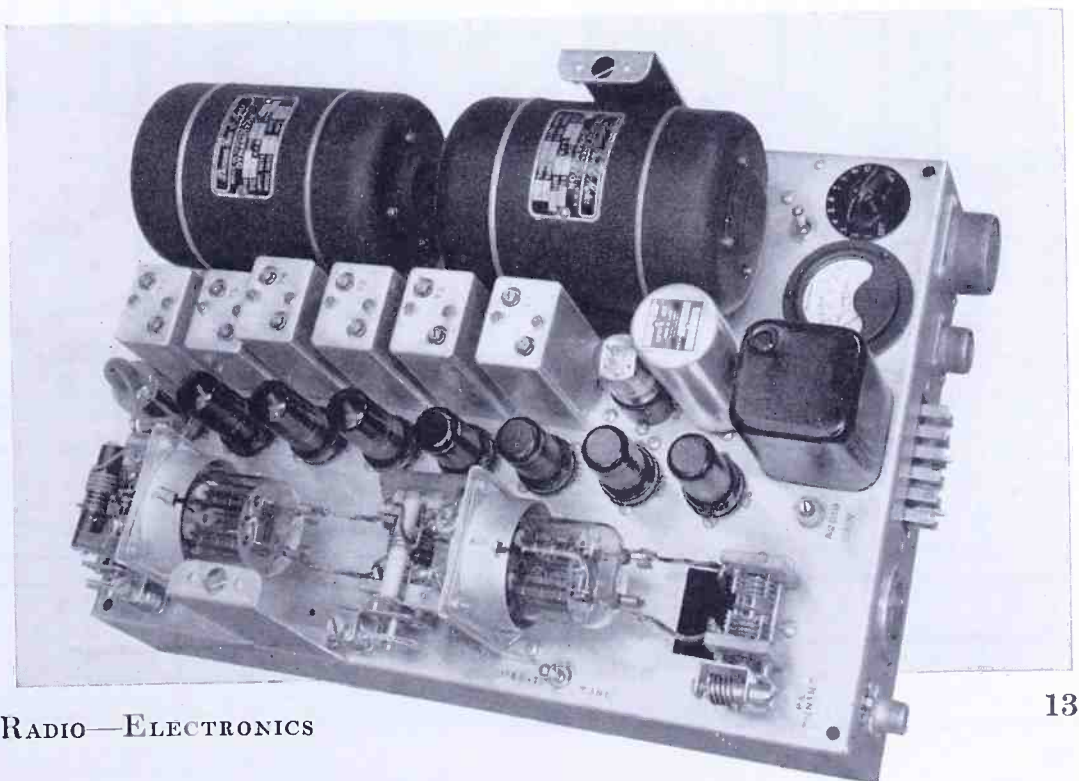





Fig. 4. Portable transmitter has pre-amplifiers, monitoring and switching circuits

Fig. 2 is a view of the 50-watt VHF chassis with the 12-volt dynamotors.

The transmitter is 18 ins. long, 13 ins. deep, and 10 ins. high, weighing 36 lbs., while the AC power supply, 18 ins. long, 10 ins. deep, and 10 ins. high, weighs 52 lbs.

Mechanically, the equipment has been designed to permit ease of installation and operation in mobile units. For this reason, although complete metering of all transmitter circuits is provided on the transmitter chassis as can be seen in Fig. 2, metering of all essential circuits and radiated power is also provided on the remote control unit, Fig. 1. The remote control is the only portion of the mobile installation that need be accessible to the operator. It provides complete control of filament and plate power,

as well as metering of the transmitter circuits. Provision is made at the remote control unit for connection to a probe antenna by means of which the radiated power of the transmitter can be indicated on the test meter.

The following essential specifications apply to the 50-MRB with 50 watts output on 152 to 174 mc., and the 25-MRB with 25 watts output on 450 to 470 mc.:  
**ANTENNA LEAD:** Coaxial line, 50 to 100 ohms.

**DC INPUT:** 30 amperes at 12 volts, or  
**AC INPUT:** 400 watts at 115 volts  
**FREQUENCY STABILITY:**  $\pm 0.005\%$  at  $-30^\circ$  to  $+60^\circ\text{C}$ .

**FREQUENCY DEVIATION:**  $\pm 45$  kc. maximum

**AUDIO RESPONSE:** within 2 db of 100-microsecond pre-emphasis curve.

**FM NOISE:** 50 db below  $\pm 45$ -kc. swing  
**AM NOISE:** 40 db below 100% modulation.

**DISTORTION (Including Receiver):** less than 3%

**AUDIO INPUT LEVEL:** +8 dbm

**AUDIO INPUT IMPEDANCE:** 500/600 ohms

Phase-shift modulation is employed, with direct crystal control and a frequency multiplication of 1,296 times. The 50-MRB and 25-MRB models are almost identical except for the RF output stage. In the former, there is a conventional push-pull power amplifier, using an 829-B. The 25-MRB, however, has an output stage in which a 4X-150A tetrode operates as a tripler into a cavity-type tank circuit. This tube requires forced-air cooling.

#### Portable Pickup Equipment:

At the request of the Columbia Broadcasting System, to whose engineers goes the credit for instigating several of the phases of our developmental program, two other models of remote pickup transmitters are being produced. These are the 50-PRB and 25-PRB units, respectively similar to the two models just described, except that the dynamotors have been displaced by the installation of a 2-channel remote pickup pre-amplifier and the associated monitoring and switching circuits.

In addition, the conventional mobile type of housing has been exchanged for one better suited to portable use. Fig. 4 shows the front of the 25-PRB, the circuit of which is given in Fig. 5. In the

Fig. 5. Schematic wiring diagram of the 25-watt UHF pickup transmitter illustrated in Figs. 4 and 6. Essentially, it follows

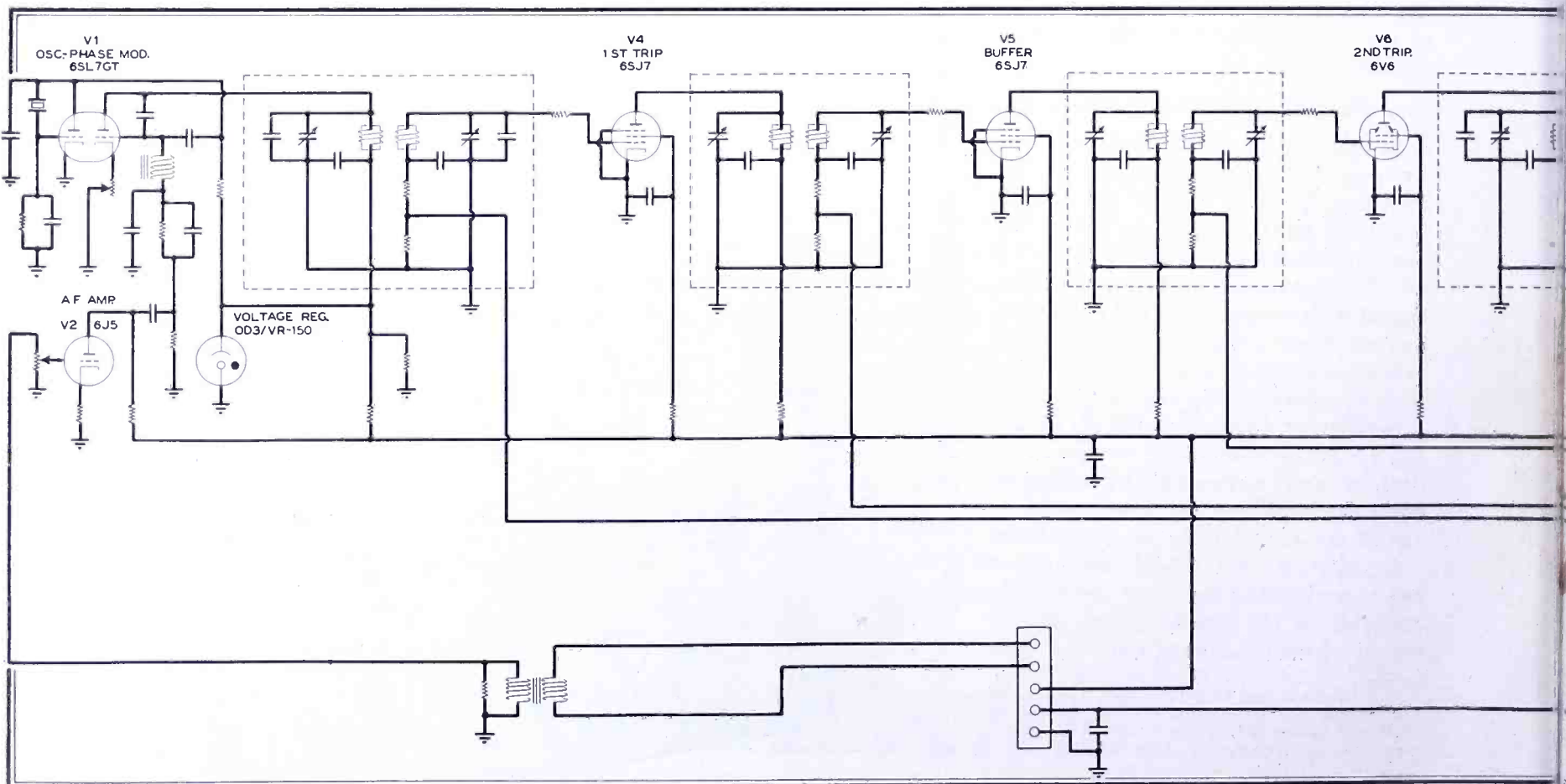



interior view, Fig. 6, the cover has been removed from the pre-amplifier section. The under side of the chassis can be seen in Fig. 7.

Power is supplied by a separate 12-volt unit carrying two dynamotors and the necessary filters, or an AC unit operated from 115 volts, 50 to 60 cycles. No remote control is provided, since the operator is always at the transmitter location. Instead, the controls, meter, and meter switch are mounted on the lower front panel.

The pre-amplifier has two 150-ohm microphone inputs, two 600-ohm line inputs, two mixers, VU meter, monitoring jacks, and provisions for feeding audio either to a telephone line or the radio transmitter, or both.

**Pickup Receivers:**

The pickup receivers used in conjunction with the transmitters are high-sensitivity, double-conversion superheterodynes, utilizing two limiters and a conventional discriminator detector. Both are designed for relay rack mounting, since it is expected that they will be normally installed at a studio or transmitter location in standard equipment racks. For portable application, however, the receivers can be mounted in such a case as is shown in Fig. 8.

The portable receiver, either for VHF or UHF, is designed to meet the emergency conditions generally encountered when its use is required. A meter, loud-speaker, control switches, and connectors for headphones are all located at the top

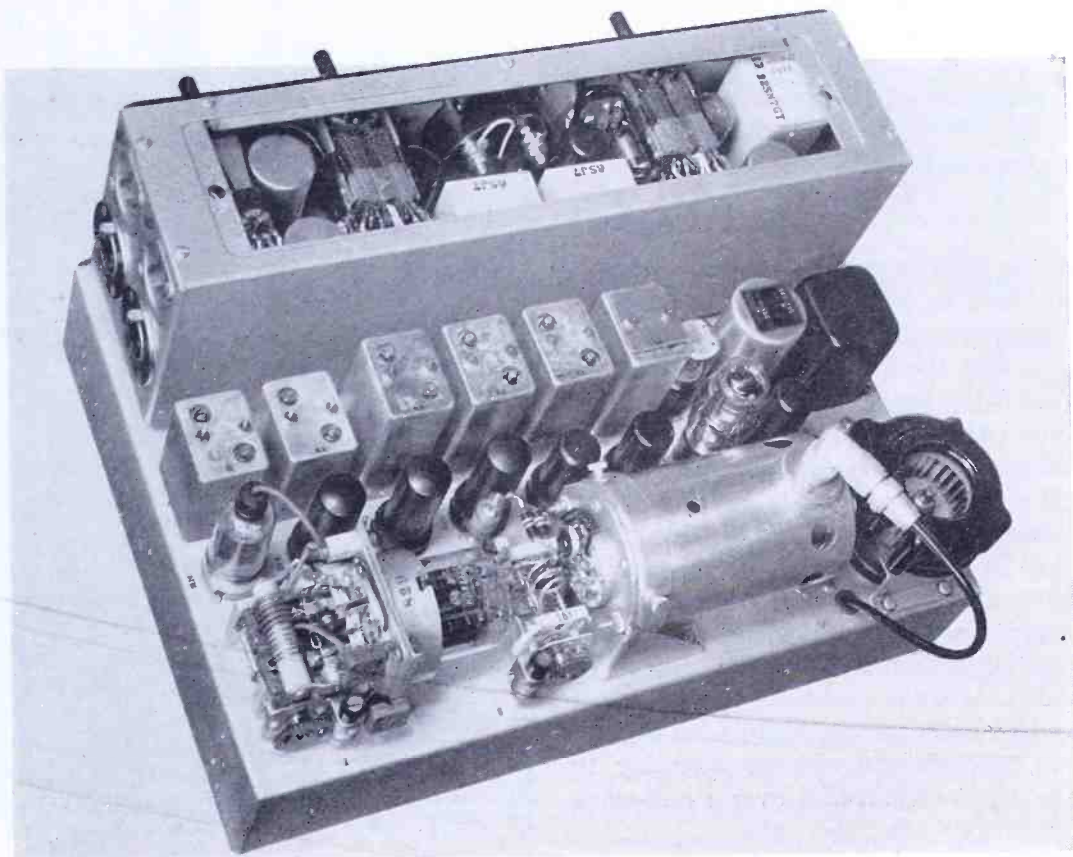

Fig. 6. Chassis of the portable UHF unit, with cover removed from the preamplifier

across the side of the case. Terminals for the external circuits are flush-mounted at the right, and for the antenna at the left. The receiver chassis can be removed readily.

Model 1927 covers 152 to 174 mc. The circuit has a noise figure of better than 6 db and, in many typical installations, has provided usable broadcast signals at a range of 25 miles when used in conjunction with one of the 50-watt remote pickup transmitters.

Model 2340-R, covering 450 to 570 mc., has features similar to the VHF receiver. Exhaustive performance tests in both urban and rural areas are planned, and will be reported in full detail at a future time.

Both receivers are equipped with carrier-off squelch circuits and, when required, carrier-operated relays for signalling circuits. Standard 500/600 ohms output impedance is provided for feeding telephone lines or studio equipment. The

straightforward FM transmitter design practice. Circuit of the 4 X 150A output tube is made more clear by referring to Fig. 6

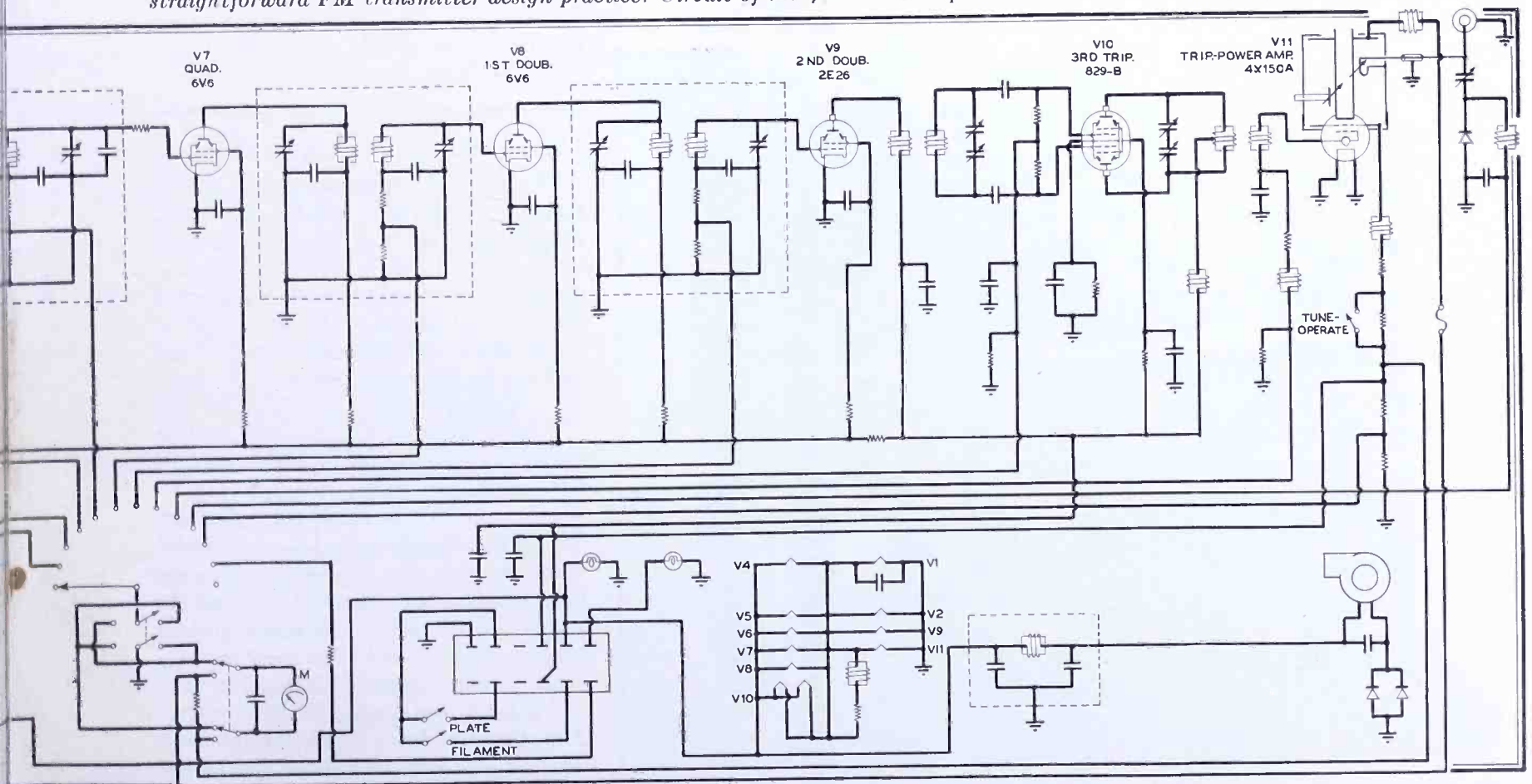



performance of the receivers is included in the overall figures listed under transmitter characteristics.

#### Types of Antennas:

It has been found that various antenna types are useful in meeting the problems encountered in remote pickup broadcasting. For the 160-mc. band, a quarter-wave whip antenna is usually installed. This simple arrangement provides excellent signals over the primary coverage area and has the advantage of being permanently installed and capable of use while in motion. For extended coverage there is a three-element demountable array, Fig. 3, which weighs only a few pounds, and can be erected quickly. The basic antenna is a coaxial type which can be used alone, or combined with a parasitic reflector and director assembly to give a power gain of 4 over a half-wave dipole.

At the receiving location, a greater variety of antennas is available. For the permanently-installed receiver, a vertically polarized stacked array, giving a non-directional power gain of 4 times over a dipole, is generally used. Where the normal origin of pickup is in one general direction from the receiver, or when it is convenient to orient directional antennas for extended coverage, a 3-element array with a power gain of 6 db over a dipole, and a 5-element array with a power gain of 9 db over a dipole are available. If the pickup receiver is used as a portable unit, a simple coaxial antenna is used ordinarily, because of its light weight and portability.

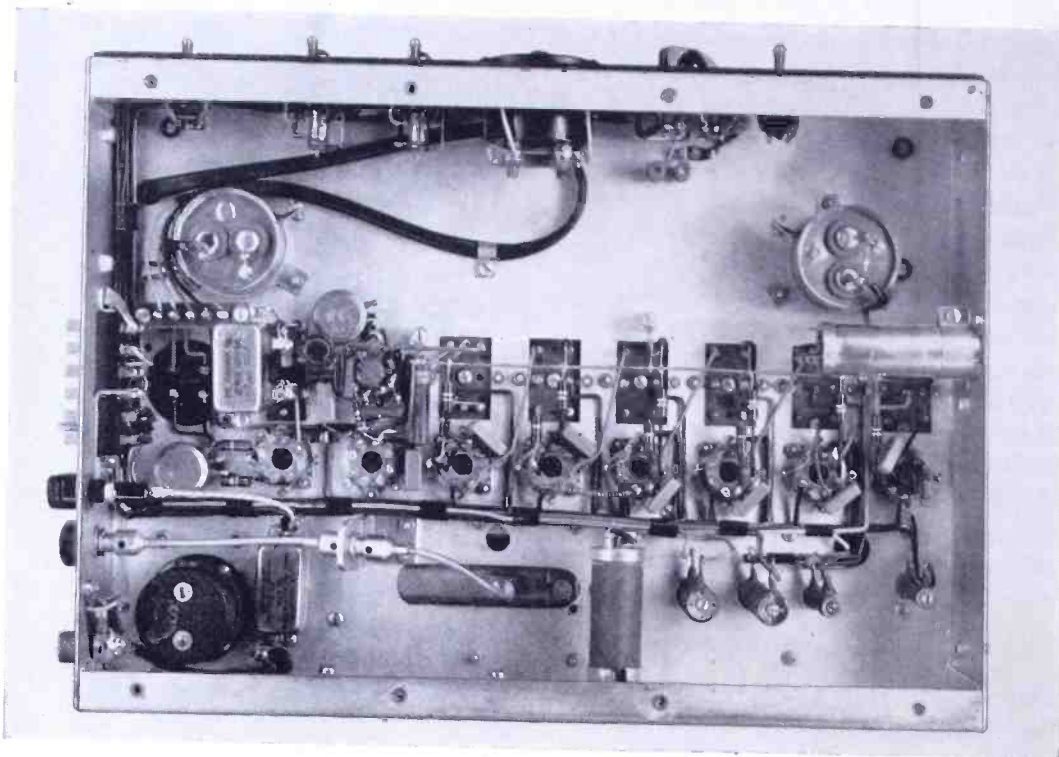

Fig. 7. This is a view beneath the chassis of the 25-watt portable UHF transmitter

Various types of mobile, portable and fixed antennas are being tested for 450 to 470 mc., but it is too early to form definite conclusions as to the types that will prove most useful in mobile service at these frequencies. Those showing the greatest promise at the present time for general coverage are a coaxial J antenna for the transmitter, and vertically-polarized, stacked arrays with power gains of 4 to 8 db for fixed or portable receivers. Yagi arrays with 10 db gain are effective for longer ranges and semi-fixed pickups. These frequencies are considered too low for parabolas.

#### Cue-Circuit Equipment:

No description of the radio equipment used for cue circuits is given here, since it is of standard FM communications design, long used on the 25- to 30-mc. band. The new allocations provide 19 exclusive channels for this purpose, from 26.1 to 26.47 mc. Greater propagation range at these lower frequencies usually provides cue circuits that will carry beyond the effective broadcast-quality range of the program transmitter. However, the narrower band width, of 20 kc., and the higher noise level encountered make these channels less suitable for program transmission than the wider bands at higher frequencies.

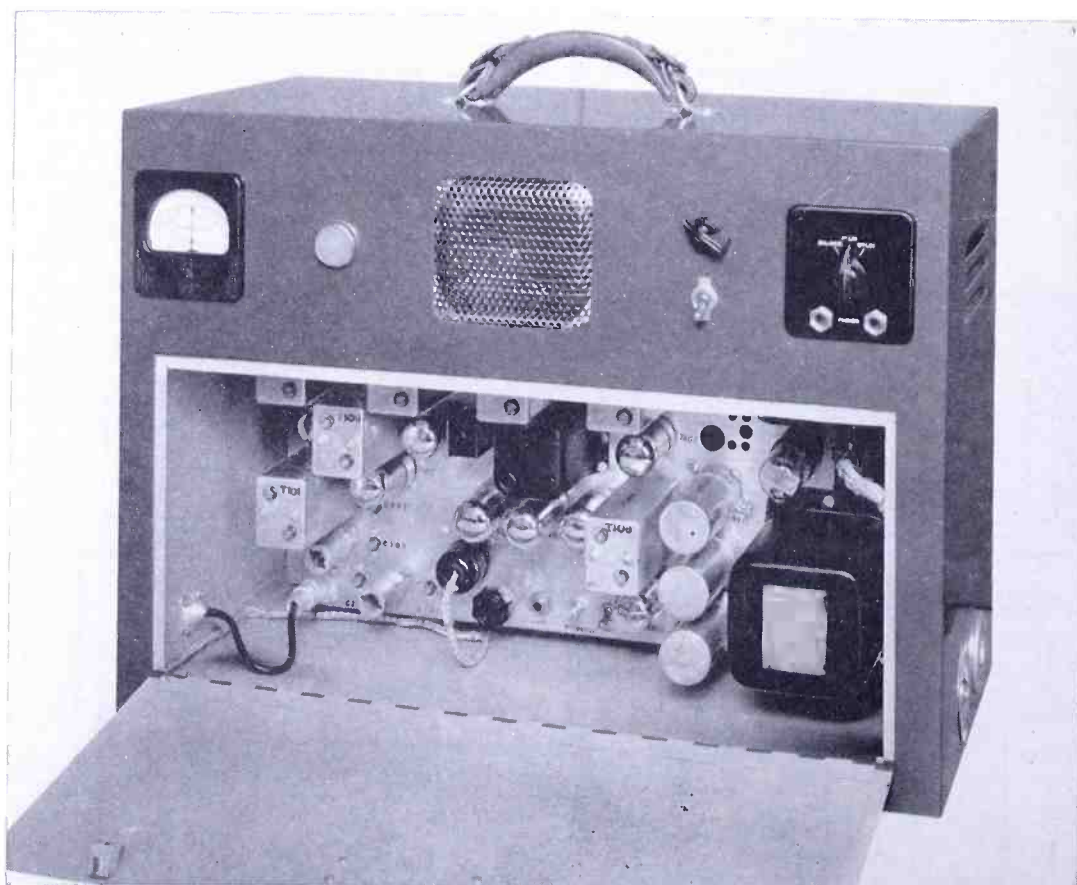

Fig. 8. For portable use, the UHF remote pickup receiver is mounted in this manner

#### CHICAGO PARTS SHOW

The plan and program of this year's Chicago Parts Show didn't quite click, despite the fact that the management went to great pains to effect improvements over preceding years. Most complaints were directed at the schedule under which attendance in the exhibition hall was limited to specific hours for each class of visitor.

Typical criticism ran this way: "I had other business to do while I was in Chicago for the Show. I wasn't able to get there when they would let me in, and when I had time free, they kept me out."

Because of the admission schedule, most manufacturers found it necessary to engage display rooms, in addition to their booths. Some found their show expense nearly doubled, because they had to take out enough men to handle both places. Also, the attendance was below the 1949 figure. This may have been due to the exclusion of servicemen.



What the New FCC Allocations and Rules Mean to the

# RADIO COMMUNICATIONS SERVICES

A QUICK-REFERENCE GUIDE TO THE FREQUENCY ASSIGNMENTS AND TECHNICAL REQUIREMENTS FOR THE VARIOUS CLASSES OF MOBILE RADIO SERVICE — Part 1

THE new FCC allocations and rules for radio communications systems, effective July 1, 1949, introduce so many changes and open the way for such expansion of present services and the inauguration of new ones that everyone concerned with mobile communications must equip himself with this new information.

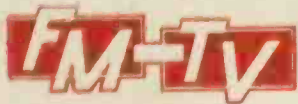

☆ Edited by Milton B. Sleeper ☆  
GREAT BARRINGTON, MASSACHUSETTS

## INDUSTRIAL RADIO SERVICES

1. Power
2. Petroleum
3. Forest Products
4. Motion Picture
5. Relay Press
6. Special Industrial
7. Low-Power Industrial
8. Developmental

## AND TRANSPORTATION RADIO SERVICES

1. Intercity Bus
2. Highway truck
3. Railroad
4. Taxicab
5. Urban Transit
6. Automobile Emergency
7. Developmental

## COAST GUARD MOBILE RADIO SERVICES

1. Boat and Tugboat

An examination of the Rules shows some confusion in the arrangement of information on these services, but the listing above follows the FCC text.

## FIXED PUBLIC SERVICES (Docket No. 9046, Part 6)

FIXED PUBLIC SERVICES include point-to-point radio communication by telephone, telegraph or facsimile transmission between stations handling 1) public correspondence, 2) press dispatches for newspapers, and 3) agricultural market information. No information is given as to operating frequencies.

RURAL SUBSCRIBER SERVICE is only referred to in Part 6 by a footnote stating that rules governing this point-to-point service will be promulgated at a later date. However, it is specified that all frequencies assigned to domestic public land mobile services between 152 and 162 mc. are available for rural subscriber service.

SHORT-HAUL TOLL TELEPHONE SERVICE is only referred to in Part 6 by a footnote stating that rules governing this point-to-point service will be promulgated at a later date. However, it is specified that all frequencies assigned to domestic public land mobile services are available for short-haul toll telephone service provided that no interference is caused to the land mobile service.

DOMESTIC CONTROL STATIONS are defined as "a fixed station in the fixed public control service, associated directly with the domestic public radio communication

service." No further details of this service are given, except to specify that all frequencies assigned to domestic public land mobile services between 152 and 162 mc. are available for domestic control stations provided no interference is caused to the land mobile, short-haul toll telephone, or rural subscriber telephone services.

## DOMESTIC PUBLIC LAND MOBILE RADIO SERVICE (Docket No. 9046, Part 6)

### COMMON CARRIER SERVICE

Common carrier mobile systems are those operated by companies "which are also in the business of affording public landline message telephone service."

### Frequency Assignments:

The following frequencies are available, some of which are to be assigned on the zone plan detailed below:<sup>1</sup>

BASE STATIONS Mc.	MOBILE, AUXILIARY TEST, OR SUBSCRIBER FIXED STATION, Mc.		
35.22 <sup>2</sup>	152.51	43.22 <sup>2</sup>	157.77
35.26	152.57	43.26	157.83
35.30	152.63	43.30	157.89
35.34	152.69	43.34	157.95
35.38	152.75	43.38	158.01
35.42	152.81	42.42	158.07
35.46 <sup>2</sup>		43.46 <sup>2</sup>	
35.50		43.50	
35.54		43.54	
35.58		43.58 <sup>3</sup>	
35.62		43.62	
35.66		43.66	

<sup>1</sup> All frequencies listed between 152 and 162 mc. are available for assignment to the rural subscriber and short-haul toll telephone services on a geographical or frequency separation basis, provided that no interference is caused to the land mobile service. Rules to govern these point-to-point services will be promulgated at a later date.

All frequencies listed are available for assignment to developmental stations provided no interference is caused to the mobile services.

All frequencies listed between 152 and 162 mc. are available for assignment to domestic control stations, provided no interference is caused to the mobile, short-haul toll telephone, or rural subscriber services.

<sup>2</sup> These frequencies are also designated for assignment to base and mobile stations using facsimile as an integral portion of common carrier telegraph message handling or delivery procedure.

<sup>3</sup> This frequency is also designated for assignment to common carriers offering only a one-way signalling service to mobile receivers, for actuating a signalling device in the mobile unit.

### Zone Allocation Plan:

Certain base and mobile station frequencies will be assigned as follows:

Please enter my  new  renewal subscription for

3 years (36 issues) for \$6.00  
(you get one year free)

One year at the regular rate of \$3.00

My remittance is enclosed.  Remittance will be sent promptly when bill is received.

FOREIGN POSTAGE: Add 50¢ per year for Canada.  
\$1.00 per year elsewhere.

Name.....

Street.....

City & Zone.....State.....

IMPORTANT: The following information is required so that your subscription can be classified correctly by industry and position.

Company.....

Product or Service.....

Your Title.....

SAVE \$3.00 SEND \$6 FOR THREE YEARS

## DOMESTIC PUBLIC LAND MOBILE SERVICES

1. Common carrier
2. Limited common carrier

## PUBLIC SAFETY RADIO SERVICES

1. Police (phone, and zone and inter-zone telegraph)
2. Fire
3. Forestry-Conservation
4. Highway Maintenance
5. Special Emergency
6. Developmental



performance of the receivers is included in the overall figures listed under transmitter characteristics.

**Types of Antennas:**

It has been found that various antenna types are useful in meeting the problems encountered in remote pickup broadcasting. For the 160-mc. band, a quarter-wave whip antenna is usually installed. This simple arrangement provides excellent signals over the primary coverage area and has the advantage of being permanently installed and capable of use while in motion. For extended coverage there is a three-element demountable array, Fig. 3, which weighs only a few pounds, and can be erected quickly. The basic antenna is a coaxial type which can be used alone, or combined with a parasitic reflector and director assembly to give a power gain of 4 over a half-wave dipole.

At the receiving location, a greater variety of antennas is available. For the permanently-installed receiver, a vertically polarized stacked array, giving a non-directional power gain of 4 times over a dipole, is generally used. Where the normal origin of pickup is in one general direction from the receiver, or when it is convenient to orient directional antennas for extended coverage, a 3-element array with a power gain of 6 db over a dipole, and a 5-element array with a power gain of 9 db over a dipole are available. If the pickup receiver is used as a portable unit, a simple coaxial antenna is used ordinarily, because of its light weight and portability.

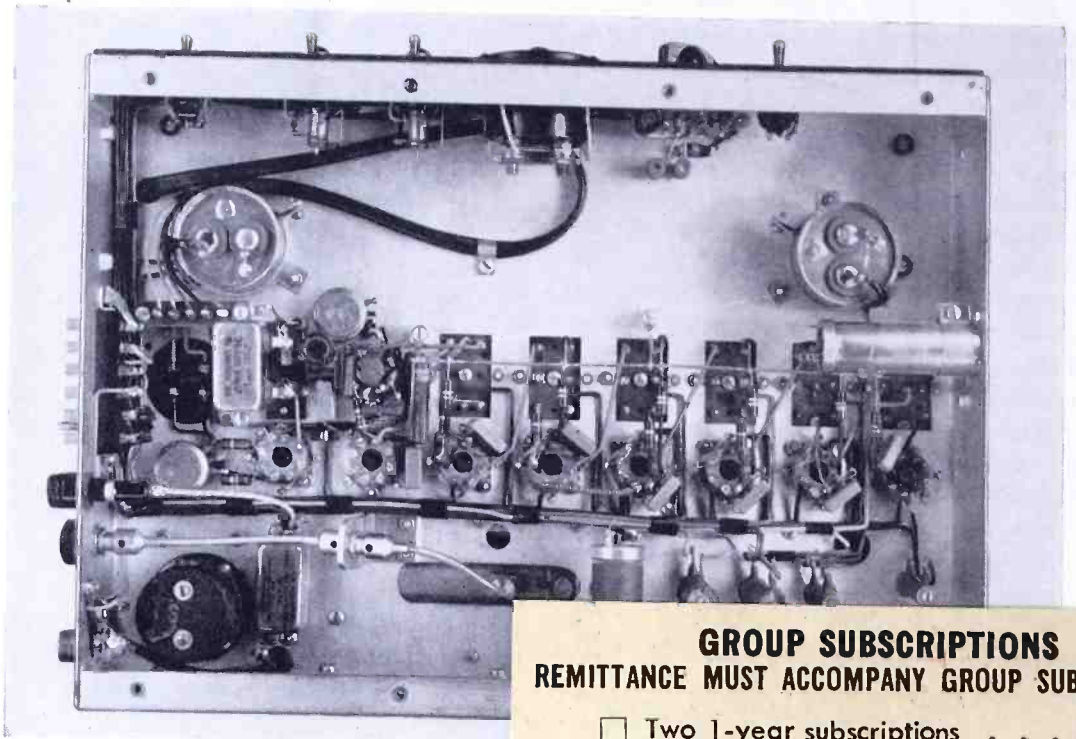

Fig. 7. This is a view beneath the chassis.

Various types of mobile, portable and fixed antennas are being tested for 450 to 470 mc., but it is too early to form definite conclusions as to the types that will prove most useful in mobile service at these frequencies. Those showing the greatest promise at the present time for general coverage are a coaxial J antenna for the transmitter, and vertically polarized, stacked arrays with power gains of 4 to 8 db for fixed or portable receivers. Yagi arrays with 10 db gain are effective for longer ranges and semi-fixed pickups. These frequencies are considered too low for parabolas.

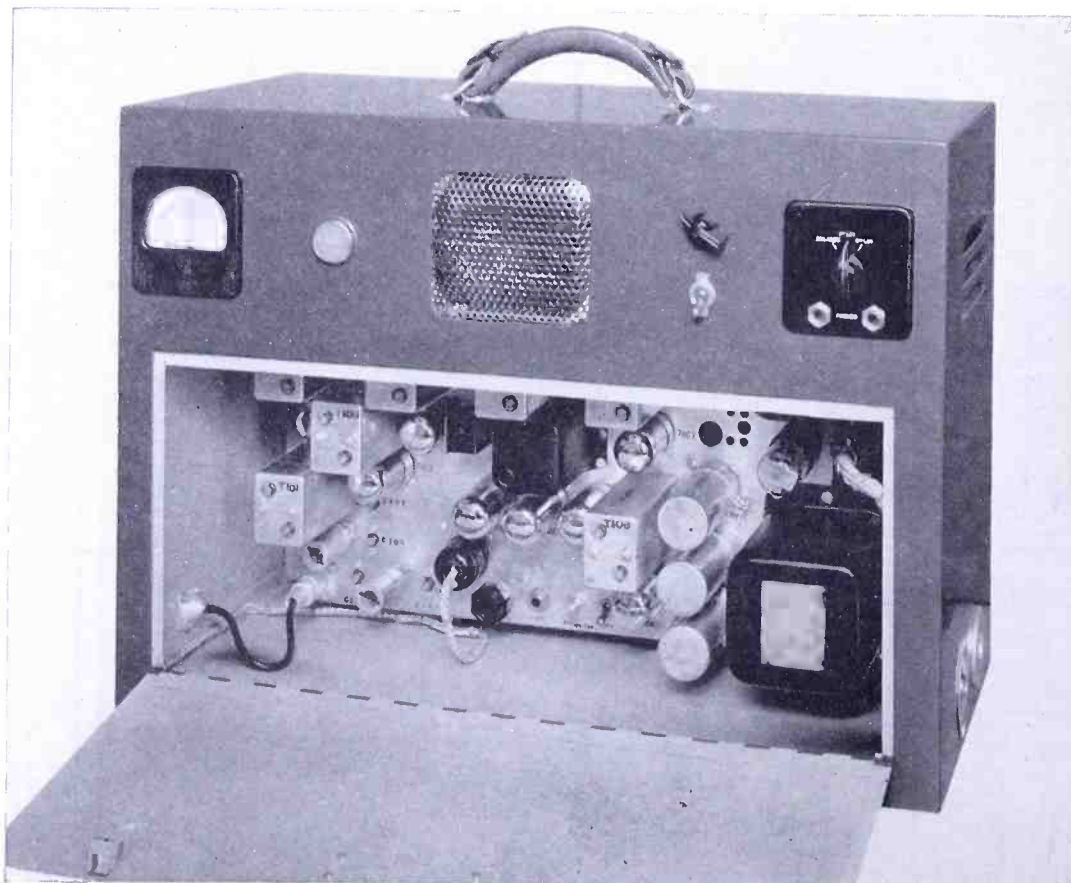

Fig. 8. For portable use, the UHF remote pickup receiver is mounted in this manner.

**GROUP SUBSCRIPTIONS**  
**REMITTANCE MUST ACCOMPANY GROUP SUBSCRIPTIONS**

- Two 1-year subscriptions . . . \$5.00
- Three 1-year subscriptions . . . \$6.00
- Four 1-year subscriptions . . . \$7.00
- Five 1-year subscriptions . . . \$8.00

Six or more subscriptions, \$1.60 per year each.

New Sub  
 Renewal

NAME.....  
 STREET.....  
 CITY & ZONE..... STATE.....  
 Company.....  
 Product or Service.....  
 Your Title.....

New Sub  
 Renewal

NAME.....  
 STREET.....  
 CITY & ZONE..... STATE.....  
 Company.....  
 Product or Service.....  
 Your Title.....

New Sub  
 Renewal

NAME.....  
 STREET.....  
 CITY & ZONE..... STATE.....  
 Company.....  
 Product or Service.....  
 Your Title.....

New Sub  
 Renewal

NAME.....  
 STREET.....  
 CITY & ZONE..... STATE.....  
 Company.....  
 Product or Service.....  
 Your Title.....

other business to do while I was in Chicago for the Show. I wasn't able to get there when they would let me in, and when I had time free, they kept me out."

Because of the admission schedule, most manufacturers found it necessary to engage display rooms, in addition to their booths. Some found their show expense nearly doubled, because they had to take out enough men to handle both places. Also, the attendance was below the 1949 figure. This may have been due to the exclusion of servicemen.



# RADIO COMMUNICATIONS SERVICES

A QUICK-REFERENCE GUIDE TO THE FREQUENCY ASSIGNMENTS AND TECHNICAL REQUIREMENTS FOR THE VARIOUS CLASSES OF MOBILE RADIO SERVICE — Part 1

THE new FCC allocations and rules for radio communications systems, effective July 1, 1949, introduce so many changes and open the way for such expansion of present services and the inauguration of new ones that everyone concerned with mobile communications must equip himself with this new information. It is contained in the *Federal Register* of May 6, 1949, copies of which can be ordered from the Superintendent of Documents, Government Printing Office, Washington 25, D. C., at 20c.

You will find that a basic understanding of the 95 fine-print pages calls for many hours of serious study. To save your time, a thorough analysis of the allocations and rules is presented here. In this simplified form, you will be able to locate the essential information on any type of service. Then, you can use the full FCC text for more detailed information. The following analysis is taken directly from the FCC Rules and Regulations. However, it must be emphasized that this is only a short form of the full text. Every effort has been made to assure the accuracy of presentation, but further modifications may be made subsequently by the FCC.

## The Service Classifications:

Various existing types of communications services have been reclassified, and others have been added. It is necessary, therefore, to understand the new major classifications, and the types of services grouped under each heading. As set up now, they are:

### FIXED PUBLIC SERVICES

1. Fixed Public
2. Fixed Public Press
3. Agricultural
4. Rural Subscriber
5. Short-Haul Toll Telephone
6. Domestic Control

### DOMESTIC PUBLIC LAND MOBILE SERVICES

1. Common carrier
2. Limited common carrier

### PUBLIC SAFETY RADIO SERVICES

1. Police (phone, and zone and inter-zone telegraph)
2. Fire
3. Forestry-Conservation
4. Highway Maintenance
5. Special Emergency
6. Developmental

### INDUSTRIAL RADIO SERVICES

1. Power
2. Petroleum
3. Forest Products
4. Motion Picture
5. Relay Press
6. Special Industrial
7. Low-Power Industrial
8. Developmental

### LAND TRANSPORTATION RADIO SERVICES

1. Intercity Bus
2. Highway truck
3. Railroad
4. Taxicab
5. Urban Transit
6. Automobile Emergency
7. Developmental

### MARITIME MOBILE RADIO SERVICES

1. Boat and Tugboat

An examination of the Rules shows some confusion in the arrangement of information on these services, but the listing above follows the FCC text.

### FIXED PUBLIC SERVICES (Docket No. 9046, Part 6)

FIXED PUBLIC SERVICES include point-to-point radio communication by telephone, telegraph or facsimile transmission between stations handling 1) public correspondence, 2) press dispatches for newspapers, and 3) agricultural market information. No information is given as to operating frequencies.

RURAL SUBSCRIBER SERVICE is only referred to in Part 6 by a footnote stating that rules governing this point-to-point service will be promulgated at a later date. However, it is specified that all frequencies assigned to domestic public land mobile services between 152 and 162 mc. are available for rural subscriber service.

SHORT-HAUL TOLL TELEPHONE SERVICE is only referred to in Part 6 by a footnote stating that rules governing this point-to-point service will be promulgated at a later date. However, it is specified that all frequencies assigned to domestic public land mobile services are available for short-haul toll telephone service provided that no interference is caused to the land mobile service.

DOMESTIC CONTROL STATIONS are defined as "a fixed station in the fixed public control service, associated directly with the domestic public radio communication

service." No further details of this service are given, except to specify that all frequencies assigned to domestic public land mobile services between 152 and 162 mc. are available for domestic control stations provided no interference is caused to the land mobile, short-haul toll telephone, or rural subscriber telephone services.

### DOMESTIC PUBLIC LAND MOBILE RADIO SERVICE (Docket No. 9046, Part 6)

#### COMMON CARRIER SERVICE

Common carrier mobile systems are those operated by companies "which are also in the business of affording public landline message telephone service."

#### Frequency Assignments:

The following frequencies are available, some of which are to be assigned on the zone plan detailed below:<sup>1</sup>

BASE STATIONS Mc.	MOBILE, AUXILIARY TEST, OR SUBSCRIBER FIXED STATION, Mc.		
35.22 <sup>2</sup>	152.51	43.22 <sup>2</sup>	157.77
35.26	152.57	43.26	157.83
35.30	152.63	43.30	157.89
35.34	152.69	43.34	157.95
35.38	152.75	43.38	158.01
35.42	152.81	42.42	158.07
35.46 <sup>2</sup>		43.46 <sup>2</sup>	
35.50		43.50	
35.54		43.54	
35.58		43.58 <sup>3</sup>	
35.62		43.62	
35.66		43.66	

<sup>1</sup> All frequencies listed between 152 and 162 mc. are available for assignment to the rural subscriber and short-haul toll telephone services on a geographical or frequency separation basis, provided that no interference is caused to the land mobile service. Rules to govern these point-to-point services will be promulgated at a later date.

All frequencies listed are available for assignment to developmental stations provided no interference is caused to the mobile services.

All frequencies listed between 152 and 162 mc. are available for assignment to domestic control stations, provided no interference is caused to the mobile, short-haul toll telephone, or rural subscriber services.

<sup>2</sup> These frequencies are also designated for assignment to base and mobile stations using facsimile as an integral portion of common carrier telegraph message handling or delivery procedure.

<sup>3</sup> This frequency is also designated for assignment to common carriers offering only a one-way signalling service to mobile receivers, for actuating a signalling device in the mobile unit.

#### Zone Allocation Plan:

Certain base and mobile station frequencies will be assigned as follows:



ZONE I, Base 35.66 mc., Mobile 43.66 mc.  
 Maine New Jersey  
 New Hampshire Pennsylvania  
 Vermont Delaware  
 Connecticut Maryland  
 Massachusetts District of Columbia  
 Rhode Island Virginia  
 New York West Virginia

ZONE II, Base 35.34 mc. Mobile 43.34 mc.  
 North Carolina Alabama  
 South Carolina Mississippi  
 Georgia Louisiana  
 Florida

ZONE III, Base 35.42 mc.,  
 Mobile 43.42 mc.  
 Tennessee Illinois  
 Kentucky Wisconsin  
 Ohio Michigan  
 Indiana

ZONE IV, Base 35.54 mc.,  
 Mobile 43.54 mc.  
 Minnesota Nebraska  
 Iowa Montana  
 North Dakota Wyoming  
 South Dakota

ZONE V, Base 35.30 mc., Mobile 43.30  
 Missouri Oklahoma  
 Kansas Texas  
 Arkansas

ZONE VI, Base 35.38 mc., Mobile 43.38  
 Colorado Arizona  
 New Mexico Nevada  
 Utah California

ZONE VII, Base 35.26 mc.,  
 Mobile 43.26 mc.  
 Oregon Idaho Washington

#### Technical Information:

**EMISSION LIMITATIONS:** Bandwidth for AM phone is 8 kc.; for FM phone, 40 kc. The specified band shall contain those frequencies upon which a total of 99% of the radiated power appears, extended to include any discrete frequency upon which the power is at least 25% of the total radiated power. Radiation in excess of these limits is considered unauthorized emission. Any emission appearing on any frequency removed from the carrier frequency by at least 50%, but not more than 100% of the maximum authorized bandwidth shall be attenuated not less than 25 db below the unmodulated carrier. Spurious or harmonic emission on any frequency removed from the carrier by at least 100% of the maximum authorized bandwidth shall be attenuated below the unmodulated carrier by not less than:

40 db with maximum plate power input to the final RF state of 3 watts or less  
 60 db with more than 3 watts and including 150 watts

70 db with more than 150 watts and including 600 watts

80 db with more than 600 watts

**MODULATION:** AM or FM phone or tone-signal modulation is authorized, with a maximum modulation of 3,000 cycles. On

FM, deviation due to modulation must not exceed plus or minus 15 kc. from the unmodulated carrier.

Each transmitter authorized or installed after July 1, 1950, must be provided with a device which will automatically prevent modulation in excess of that specified above, except that this shall not apply to mobile transmitters using a maximum plate power input to the final RF stage of 3 watts or less.

**FREQUENCY STABILITY:** Frequency tolerance of the carrier frequency shall be .01% below 50 mc., and .005% from 50

#### ALLOCATIONS TABLE Effective July 1, 1949

ON the opposite page, the new FCC table of frequency allocations and the voluminous footnotes have been reduced to a quick-reference form. The original table in the *Federal Register* occupies 19 pages.

It should be noted that the general classifications shown do not indicate the specific service or services that are assigned to a given band. The heading "Public Safety" does not show whether the band is to be used by police, fire, or forestry, for example.

That information cannot be conveyed in this short-form table because many of the individual channels are shared by two or more types of services, or they are shared under certain circumstances.

That detailed information will be presented, however, in *FM-TV*. In this issue, details are given for Fixed Public Services and Domestic Public Land Mobile Services.

The July issue will contain the list of channels, corresponding footnotes, and technical information for the Public Safety Services. In August, the same data will be presented on Industrial and Land Transportation Services.

to 220 mc. Stability above 220 mc. will be specified in the FCC authorization.

**MAXIMUM POWER:** Maximum plate power input to the final RF stage shall not exceed 500 watts at 25 to 100 mc., and 600 watts at 100 to 220 mc. Higher power will be authorized if a clear showing of need is made to the Commission. Power above 220 mc. will be specified in the FCC authorization. Power and antenna height shall be no more than the minimum required for satisfactory technical operation commensurate with the area to be served and local conditions which affect transmission and reception.

**TRANSMITTER MEASUREMENTS:** Frequency and modulation measurements on each fixed and mobile unit must be made and entered in the log every 6 months, or whenever an adjustment is

made that might affect frequency or modulation. Mobile units may be checked on the bench if they are operated under load conditions. The use of automatic frequency monitors is approved for frequency checking.

Any independent, qualified engineering measurement service may be employed, provided the log entries show the name and address of the firm, and the name of the person making the measurements.

**OPERATOR'S LICENSE:** While unlicensed persons may operate the transmitters, all adjustments or tests for installation, service, or maintenance "which may affect the proper operation of such a station, shall be made under the immediate supervision and responsibility of a person holding a 1st or 2nd class commercial radio operator license, either radiotelephone or radiotelegraph, who shall be responsible for the proper functioning of the station equipment."

**CHECKING LIGHTS:** The licensee shall make a daily check of the tower lights "either by visual observation of the tower lights or by observation of an automatic indicator to insure that all such lights are functioning properly." Any observed failure of a code or rotating beacon light not corrected within 30 minutes must be reported to the nearest Airways Communication Station or CAA local office immediately regardless of the cause of the failure, and notice given immediately on resumption of illumination. Lights and light controls must be inspected at least once every three months. Station records, which must be signed and dated, are specified in detail in the Rules. These records must be retained for one year.

#### LIMITED COMMON CARRIERS

Eight channels have been assigned to "communication common carriers which are not in the business of providing a public land line message telephone service."

#### Frequency Assignments:

The frequencies assigned to limited common carriers are:

BASE STATIONS MC.	MOBILE AUXILIARY TEST, OR SUBSCRIBER FIXED STATIONS, MC.
152.03	158.49
152.09	158.55
152.15	158.61
152.21	158.67

#### Technical Information:

The same provisions apply to limited common carriers as are listed above for common carriers.

*Part 2, covering the Public Safety Services, will appear in July, with the concluding data in August.*



**FCC ALLOCATIONS**  
Effective July 1, 1949

	megacycles						
<b>INDUSTRIAL</b>	<b>25.01-25.33</b>	<b>INDUSTRIAL</b>	<b>42.96-43.00</b>	<b>PUBLIC SAFETY</b>	<b>154.62-156.25</b>	<b>TV PICKUP —</b>	
16 20-kc. channels		24 40-kc. channels		27 60-kc. channels		TV S-T LINK <sup>19</sup>	1,990-2,110
<b>GOVERNMENT</b>	<b>25.33-25.85</b>	<b>INDUSTRIAL</b>	<b>43.00-43.20</b>	<b>MARITIME MOBILE —</b>	<b>156.25-157.15</b>	<b>INTL. CONTROL —</b>	
<b>INTL. BROADCASTING</b>	<b>25.85-26.10</b>	1 40-kc. channel		(PUB. SAFETY) <sup>10,11,12</sup>		<b>OPERATIONAL FIXED</b>	2,110-2,200
<b>REMOTE BCST. PICKUP</b>	<b>26.10-26.48</b>	<b>INDUSTRIAL —</b>	<b>43.20-44.00</b>	9 100-kc. channels		<b>GOVERNMENT</b>	2,200-2,300
19 20-kc. channels		<b>MARITIME MOBILE</b>	<b>43.00-43.20</b>	<b>GOVERNMENT</b>	<b>157.15-157.35</b>	<b>AMATEUR</b>	2,300-2,450
<b>GOVERNMENT</b>	<b>26.48-26.95</b>	5 40-kc. channels		<b>MARITIME MOBILE —</b>	<b>157.35-157.45</b>	<b>NON-GOVT. FIXED &amp;</b>	
<b>INTL. FIXED PUBLIC</b>	<b>26.95-26.96</b>	<b>DOMESTIC PUBLIC —</b>	<b>44.00-44.60</b>	(PUBLIC SAFETY)		<b>MOBILE</b>	2,450-2,500
1 10-kc. channel		<b>LAND TRANSPORT</b>	<b>43.20-44.00</b>	1 10-kc. channel		<b>INTL. CONTROL —</b>	
<b>AMATEUR</b>	<b>26.96-27.23</b>	20 40-kc. channels		<b>TAXICABS</b>	<b>157.45-157.74</b>	<b>OPERATIONAL FIXED</b>	2,500-2,700
<b>INDUSTRIAL, SCIENTIFIC</b>		<b>LAND TRANSPORT.</b>	<b>44.00-44.60</b>	4 60-kc. channels		<b>AERO. NAVIGATION METEOR-</b>	
<b>MEDICAL EQUIPMENT<sup>1</sup></b>	<b>27.12</b>	15 40-kc. channels		<b>DOMESTIC PUBLIC</b>	<b>157.74-158.10</b>	<b>OLOGICAL AIDS</b>	2,700-2,900
<b>EXPERIMENTAL</b>	<b>27.23-27.28</b>	<b>PUBLIC SAFETY</b>	<b>44.60-47.68</b>	6 60-kc. channels		<b>NAVIGATION</b>	2,900-3,246
<b>INDUSTRIAL</b>	<b>27.28-27.54</b>	77 40-kc. channels		<b>INDUSTRIAL</b>	<b>158.10-158.46</b>	<b>RACON</b>	3,246-3,266
13 20-kc. channels		<b>INDUSTRIAL</b>	<b>47.68-50.00</b>	6 60-kc. channels		<b>NAVIGATION</b>	3,266-3,300
<b>GOVERNMENT</b>	<b>27.54-28.00</b>	58 40-kc. channels		<b>DOMESTIC PUBLIC</b>	<b>158.46-158.70</b>	<b>AMATEUR</b>	3,300-3,500
<b>AMATEUR</b>	<b>28.00-29.70</b>	<b>AMATEUR</b>	<b>50.00-54.00</b>	4 60-kc. channels		<b>NON-GOVT. FIXED &amp;</b>	
<b>INDUSTRIAL</b>	<b>29.70-29.80</b>	<b>TELEVISION BCST.</b>	<b>54.00-72.00</b>	<b>PUBLIC SAFETY</b>	<b>158.70-159.48</b>	<b>MOBILE</b>	3,500-3,700
5 20-kc. channels		<b>OPERATIONAL FIXED —</b>	<b>72.00-74.60</b>	13 60-kc. channels		<b>COMMON CARRIER</b>	
<b>AERO. FIXED —</b>		(DOM. FIXED PUBLIC) <sup>3,4</sup>		<b>LAND TRANSPORT —</b>	<b>159.48-161.85</b>	<b>FIXED</b>	3,700-4,200
<b>INTL. FIXED PUBLIC</b>	<b>29.80-29.89</b>	65 40-kc. channels		(PUBLIC SAFETY) <sup>13</sup>		<b>ALTIMETER</b>	4,200-4,400
8 10-kc. channels		<b>AERO. MARKER</b>	<b>74.60-75.40</b>	39 60-kc. channels		<b>GOVERNMENT</b>	4,400-5,000
<b>GOVERNMENT</b>	<b>29.89-29.91</b>	<b>BEACON<sup>5,6</sup></b>	<b>75.40-76.00</b>	<b>MARITIME MOBILE</b>	<b>161.85-162.00</b>	<b>AERO. NAVIGATION</b>	5,000-5,250
<b>AERO. FIXED —</b>		<b>OPERATIONAL FIXED</b>	<b>75.40-76.00</b>	<b>COAST</b>		<b>NAVIGATION</b>	5,250-5,440
<b>INTL. FIXED PUBLIC</b>	<b>29.91-30.00</b>	15 40-kc. channels		(2 channels:		<b>RACON</b>	5,440-5,460
8 10-kc. channels		<b>TELEVISION BCST.</b>	<b>76.00-88.00</b>	(161.9 & 162.0) <sup>10,14</sup>		<b>NAVIGATION</b>	5,460-5,650
<b>GOVERNMENT</b>	<b>30.00-30.56</b>	2 6-mc. channels		<b>GOVERNMENT<sup>15,16</sup></b>	<b>162.00-174.00</b>	<b>AMATEUR</b>	5,650-5,925
<b>INDUSTRIAL</b>	<b>30.56-30.64</b>	<b>FM BCST.<sup>7</sup></b>	<b>88.00-108.00</b>	(REMOTE BCST.		<b>INDUSTRIAL, SCIENTIFIC,</b>	
2 40-kc. channels		100 200-kc. channels		<b>PICKUP)<sup>17</sup></b>		<b>MEDICAL EQUIPMENT</b>	5,850
<b>INDUSTRIAL —</b>		<b>AERO. LOCALIZER</b>	<b>108.00-112.00</b>	<b>TELEVISION BCST.</b>	<b>174.00-216.00</b>	<b>COMMON CARRIER</b>	
<b>LAND TRANSPORT.</b>	<b>30.64-30.84</b>	39 100-kc. channels		7 6-mc. channels		<b>FIXED</b>	5,925-6,425
5 40-kc. channels		<b>AERO. RADIO RANGE</b>	<b>112.00-118.00</b>	<b>GOVT. TELEMETER<sup>8</sup></b>	<b>216.00-220.00</b>	<b>NON-GOVT. FIXED &amp;</b>	
<b>LAND TRANSPORT.</b>		59 100-kc. channels		<b>AMATEUR</b>	<b>220.00-225.00</b>	<b>MOBILE</b>	6,425-6,575
<b>PUBLIC SAFETY</b>	<b>30.84-31.16</b>	<b>AIRDROME CONTROL</b>	<b>118.00-121.40</b>	<b>GOVERNMENT</b>	<b>225.00-328.60</b>	<b>INTL. CONTROL —</b>	
8 40-kc. channels		33 100-kc. channels		<b>AERO. GLIDE PATH</b>	<b>328.60-335.40</b>	<b>OPERATIONAL FIXED</b>	6,575-6,875
<b>PUBLIC SAFETY</b>	<b>31.16-32.00</b>	<b>AERO. MOBILE</b>	<b>121.40-121.60</b>	<b>GOVERNMENT</b>	<b>335.40-400.00</b>	<b>TV PICKUP —</b>	
21 40-kc. channels		<b>AERO. UTILITY</b>	<b>121.60-122.00</b>	<b>RADIOSONDE</b>	<b>400.00-406.00</b>	<b>TV S-T LINK</b>	6,875-7,125
<b>GOVERNMENT</b>	<b>32.00-33.00</b>	2 200-kc. channels		<b>GOVERNMENT</b>	<b>406.00-420.00</b>	<b>GOVERNMENT</b>	7,125-8,500
<b>PUBLIC SAFETY</b>	<b>33.00-33.12</b>	<b>PRIVATE AIRCRAFT</b>	<b>122.00-123.00</b>	<b>AMATEUR</b>	<b>420.00-450.00</b>	<b>NAVIGATION</b>	8,500-9,800
3 40-kc. channels		5 200-kc. channels		<b>REMOTE BCST.</b>		<b>NON-GOVT. FIXED</b>	9,800-9,900
<b>INDUSTRIAL</b>	<b>33.12-33.40</b>	<b>FLIGHT TEST —</b>	<b>123.00-123.60</b>	<b>PICKUP</b>	<b>450.00-452.00</b>	<b>GOVERNMENT</b>	9,900-10,000
7 40-kc. channels		<b>FLYING SCHOOL</b>	<b>123.00-123.60</b>	20 100-kc. channels		<b>AMATEUR</b>	10,000-10,500
<b>PUBLIC SAFETY</b>	<b>33.40-34.00</b>	3 200-kc. channels		<b>LAND TRANSPORT</b>	<b>452.00-454.00</b>	<b>INDUSTRIAL, SCIENTIFIC,</b>	
15 40-kc. channels		<b>AERO. MOBILE</b>	<b>123.60-132.00</b>	20 100-kc. channels		<b>MEDICAL EQUIPMENT<sup>20</sup></b>	
<b>GOVERNMENT</b>	<b>34.00-35.00</b>	42 200-kc. channels		<b>PUBLIC SAFETY</b>	<b>454.00-456.00</b>	<b>COMMON CARRIER</b>	
<b>INDUSTRIAL</b>	<b>35.00-35.04</b>	<b>GOVERNMENT</b>	<b>132.00-144.00</b>	20 100-kc. channels		<b>FIXED</b>	10,700-11,700
1 40-kc. channel		<b>AERO. MOBILE<sup>8</sup></b>	<b>140.58</b>	20 100-kc. channels		<b>NON-GOVT. FIXED &amp;</b>	
<b>INDUSTRIAL —</b>		<b>AMATEUR</b>	<b>144.00-148.00</b>	<b>DOMESTIC PUBLIC</b>	<b>458.00-460.00</b>	<b>MOBILE</b>	11,700-12,200
<b>MARITIME MOBILE</b>	<b>35.04-35.20</b>	<b>GOVERNMENT</b>	<b>148.00-152.00</b>	20 100-kc. channels		<b>INTL. CONTROL —</b>	
4 40-kc. channels		<b>DOMESTIC PUBLIC</b>	<b>152.00-152.24</b>	<b>CITIZENS RADIO</b>	<b>460.00-470.00</b>	<b>OPERATIONAL FIXED</b>	12,200-12,700
<b>DOMESTIC PUBLIC —</b>		4 60-kc. channels		<b>FACSIMILE BCST.</b>	<b>470.00-475.00</b>	<b>TV PICKUP —</b>	
<b>LAND TRANSPORT</b>	<b>35.20-36.00</b>	<b>TAXICABS</b>	<b>152.24-152.48</b>	<b>BROADCASTING</b>	<b>475.00-500.00</b>	<b>TV S-T LINK</b>	12,700-13,200
20 40-kc. channels		4 60-kc. channels		<b>TELEVISION BCST.</b>	<b>500.00-890.00</b>	<b>GOVERNMENT</b>	13,200-16,000
<b>GOVERNMENT</b>	<b>36.00-37.00</b>	<b>DOMESTIC PUBLIC</b>	<b>152.48-152.84</b>	<b>BROADCASTING</b>	<b>890.00-940.00</b>	<b>NON-GOVT. FIXED &amp;</b>	
<b>PUBLIC SAFETY</b>	<b>37.00-37.44</b>	6 60-kc. channels		<b>INDUSTRIAL SCIENTIFIC,</b>		<b>MOBILE</b>	16,000-18,000
11 40-kc. channels		<b>INDUSTRIAL —</b>	<b>152.84-153.38</b>	<b>MEDICAL EQUIPMENT<sup>9,15,00</sup></b>		<b>INDUSTRIAL, SCIENTIFIC,</b>	
<b>INDUSTRIAL</b>	<b>37.44-37.88</b>	(REMOTE BCST.		<b>FM BCST. S-T LINK<sup>18</sup></b>	<b>940.00-952.00</b>	<b>MEDICAL EQUIPMENT<sup>21</sup></b>	
11 40-kc. channels		<b>PICKUP)<sup>9</sup></b>	<b>152.84-153.38</b>	<b>INTL. CONTROL —</b>		<b>GOVERNMENT</b>	18,000
<b>PUBLIC SAFETY</b>	<b>37.88-38.00</b>	9 60-kc. channels		<b>OPERATIONAL FIXED</b>	<b>952.00-960.00</b>	<b>AMATEUR</b>	18,000-21,000
3 40-kc. channels		<b>INDUSTRIAL</b>	<b>153.38-153.74</b>	<b>AERO. NAVIGATION</b>	<b>960.00-1,215</b>	<b>GOVERNMENT</b>	21,000-22,000
<b>GOVERNMENT</b>	<b>38.00-39.00</b>	6 60-kc. channels		<b>AMATEUR</b>	<b>1,215-1,300</b>	<b>GOVERNMENT</b>	22,000-26,000
<b>PUBLIC SAFETY</b>	<b>39.00-40.00</b>	<b>PUBLIC SAFETY</b>	<b>153.74-154.46</b>	<b>SURVEILLANCE RADAR</b>	<b>1,300-1,365</b>	<b>NON-GOVT. FIXED &amp;</b>	
25 40-kc. channels		12 60-kc. channels		<b>AERO. NAVIGATION</b>	<b>1,365-1,660</b>	<b>MOBILE</b>	26,000-30,000
<b>GOVERNMENT</b>	<b>40.00-42.00</b>	<b>INDUSTRIAL</b>	<b>154.46-154.62</b>	<b>RADIOSONDE</b>	<b>1,660-1,700</b>	<b>EXPERIMENTAL —</b>	
		2 80-kc. channels		<b>GOVERNMENT</b>	<b>1,700-1,850</b>	<b>AMATEUR</b>	30,000 Upward

<sup>1</sup> Emissions from industrial, scientific, and medical equipment using the frequency 27.12 mc. must be confined to the band 26.96-27.28 mc.

<sup>2</sup> Emissions from industrial, scientific and medical equipment using the frequency 40.68 mc. must be confined to 40.66-40.70 mc.

<sup>3</sup> Operational fixed stations may be authorized to use frequencies in this band on the condition that harmful interference will not be caused to the reception of television stations on channels 4 or 5. In any area in the continental United States, the aviation service and marine service may each be authorized to use four of the frequencies in the band 72-76 mc. listed for operational fixed stations in these services.

<sup>4</sup> Fixed stations in the domestic fixed public service may be authorized to use any of the frequencies in the band 72-76 mc. on the conditions that a) harmful interference will not be caused to the reception of television stations on channels 4 or 5, and b) that harmful interference will not be caused to operational fixed stations.

<sup>5</sup> The frequency 75 mc. is designated for aeronautical marker beacons. In Region 1, the guardband is  $\pm 0.2$  mc; in Regions 2 and 3,  $\pm 0.4$  mc.

<sup>6</sup> The use of the frequency 75 mc. by aeronautical marker beacons is temporary and may be authorized until they are moved to a frequency band allocated for the aeronautical radionavigation service, or until they are no longer required.

<sup>7</sup> Facsimile broadcast may be authorized in the band 88-108 mc.

<sup>8</sup> The frequency 140.58 mc. may be authorized on an interim basis to civil aviation as a common simplex frequency for emergency and distress communications, available to all stations operating in or with the aeronautical mobile service.

<sup>9</sup> The use of the frequencies in the block 152.87-153.35 mc. may be authorized, in any area, to remote pickup broadcast base and mobile stations on the condition that harmful interference will not be caused to the industrial radio services.

<sup>10</sup> The use of the frequencies 156.27, 156.33, 156.39, 156.45, 156.51, 156.57, 156.63, 156.69, 156.75, 156.87, 156.93, 156.99, 157.05, 157.11, 157.41, 157.47, 161.85, 161.91 and 161.97 mc. may be authorized to base and land mobile stations in the public safety radio services on the condition that no harmful interference will be caused to the maritime mobile service. Public safety service operations at points within 150 miles of coastal areas and navigable gulf, bays, rivers and lakes, may be authorized only after a factual finding indicates that, on an engineering basis, no harmful interference will be caused to the maritime mobile service.

<sup>11</sup> The international port operational service, on a simplex basis, has priority on this frequency.

<sup>12</sup> The frequency 156.80 mc. has been designated for world-wide use for safety, calling and intership and harbor control communications in the maritime mobile service.

<sup>13</sup> The use of the frequencies in the block 159.51-161.79 mc. may be authorized to base and land mobile stations in the public safety radio services, in any area, on the condition that harmful interference will not be caused to stations in the railroad radio service.

<sup>14</sup> In the Chicago area, only the frequencies 161.85 mc. and 161.91 mc. may be authorized to base and land mobile stations only for train communications in the railroad radio service.

<sup>15</sup> The government frequencies, 170.425, 170.475, 170.575, 171.425, 171.475, 171.575, 172.225, 172.275, and 172.375 mc. may be authorized to fixed, land and mobile stations owned and operated by non-Federal forest fire fighting agencies, in certain areas, on the condition that no harmful interference will be caused to any government stations.

<sup>16</sup> In order to provide for inter-communication for safety purposes between government and non-government stations in the maritime mobile service, the frequencies 157.2 and 157.3 mc. are allocated exclusively in all areas, to government stations in the fixed and mobile services, and the frequencies 173.225, 173.275, 173.325, 173.375 mc. are allocated exclusively, in all areas, to non-government stations in the fixed and land mobile services.

<sup>17</sup> The use of the frequencies 166.250 and 170.150 mc. may be authorized to non-government remote pickup broadcast base and land mobile stations and to non-government base fixed and land mobile stations in the public safety radio services (the sum of the band width of emission and tolerance not to exceed 60 Kc.) in Continental U. S. only, except within the area bounded on the west by the Mississippi River, on the north by the parallel of latitude 37° 30' N., and on the east and south by that arc of the circle with center at Springfield, Ill., and radius equal to the airline distance between Springfield, Ill., and Montgomery, Ala., subtended between the foregoing west and north boundaries, on the condition that harmful interference will not be caused to government stations present or future in the government band 162-174 mc. The use of these frequencies by remote pickup broadcast stations will not be authorized for locations within 150 miles of New York City; and the use of these frequencies by the public safety radio services will not be authorized for locations within 150 miles of New York City.

<sup>18</sup> Interim FM relay stations may be authorized to use the band 940-952 mc. on the condition that harmful interference will not be caused to stations operating in accordance with the table of frequency allocations.

<sup>19</sup> Interim television relay stations may be authorized to use frequencies in this band on the condition that harmful interference will not be caused to stations operating in accordance with the table of frequency allocations.

<sup>20</sup> Emissions from industrial, scientific and medical equipment using the frequency 10,600 mc. must be confined to the band 10,500-10,700 mc. Sharing by radio-communication services is to be determined at a later date.

<sup>21</sup> Emissions from industrial, scientific and medical equipment using the frequency 18,000 mc. must be confined to the band 17,850-18,150 mc. Radiocommunication services operating within the band 17,850-18,150 mc. must accept any harmful interference that may be experienced from the operation of industrial, scientific and medical equipment.



# Motorola meets the challenge!

## announces the new "RESEARCH LINE" solves the ADJACENT CHANNEL PROBLEM

Today! The modern, the scientific, the ideal mobile radio communications equipment is here.

Research, experimentation, development, and field testing in systems operation produced this scientific answer to the adjacent channel operations problem.

The minor problem of super-precision selectivity was solved in six months, but two years of research and the creation of five major inventions were required to solve the major problem of intermodulation before same-area adjacent channel operation became practicable.

Here is equipment that is new all through, with the new amazing circuit inventions which provide a new standard of performance for the industry.

Here is equipment to give you the most modern communications system you can own—actually anticipating the standards of good engineering practice for the future. This startling departure from the conventional, offering new simplicity of maintenance, and a new standard of reliability—this engineering and scientific achievement is the new MOTOROLA "Research Line":





these "8" essential *Motorola* inventions make  
**ADJACENT CHANNEL OPERATIONS** practicable . . .

- SENSICON CIRCUIT (PAT. PENDING)
- ISO-Q CAVITIES (PAT. PENDING)
- STATOMIC OSCILLATOR (PAT. PENDING)
- PERMAKAY FILTER (PAT. PENDING)
- BRIDGE BALANCED OVEN (PAT. PENDING)
- CAPACITANCE DISCRIMINATOR (U.S. PAT. 2,404,359)
- DIFFERENTIAL SQUELCH (U. S. PAT. 2,343,115)
- I. D. C. SLOPE FILTER (PAT. PENDING)

**The Sensicon Circuit**

A radical departure from conventional receiver design to achieve control of intermodulation, the major barrier to successful adjacent channel operation. The Sensicon Circuit is the name given to the practicable embodiment of an invention which will change profoundly all future communication receiver design. The Sensicon Circuit is a **MOTOROLA** "first" (Patents Pending).

**The Permakay Filter**

The super-precision selectivity of the Sensicon receivers, 100 db. down at the edge of the adjacent channel, is achieved by the Permakay Filter (Patent Pending). Cast in a solid block of polyester styrene, sealed against moisture, vibration and change, this unit is guaranteed for the life of the equipment.

**I.D.C.**

Consider the Sensicon Circuit, the Permakay Filter, the Statomic Oscillator, and the Iso-Q Cavities, and then add to all these the Instantaneous Deviation Control (Patent Pending) to keep the modulated transmitter radiation within the channel boundaries and you have the formula which answers the adjacent channel problem. Not one, but all of these inventions are necessary for practicable, trouble-free systems operation.

**The Statomic Oscillator**

Single-cycle frequency control provided by the stable automatically compensated crystal circuit, stops drift and holds the signal perfectly.

**ISO-Q Cavities**

Silver plated, sealed, thermally compensated Iso-Q Receiver Cavities (Patent Pending) freeze the selection of the desired signal.

Remember! Selectivity alone is not the answer to adjacent channel operation. The integrated systems combination of these new inventions is the modern engineering answer to full channel utilization.

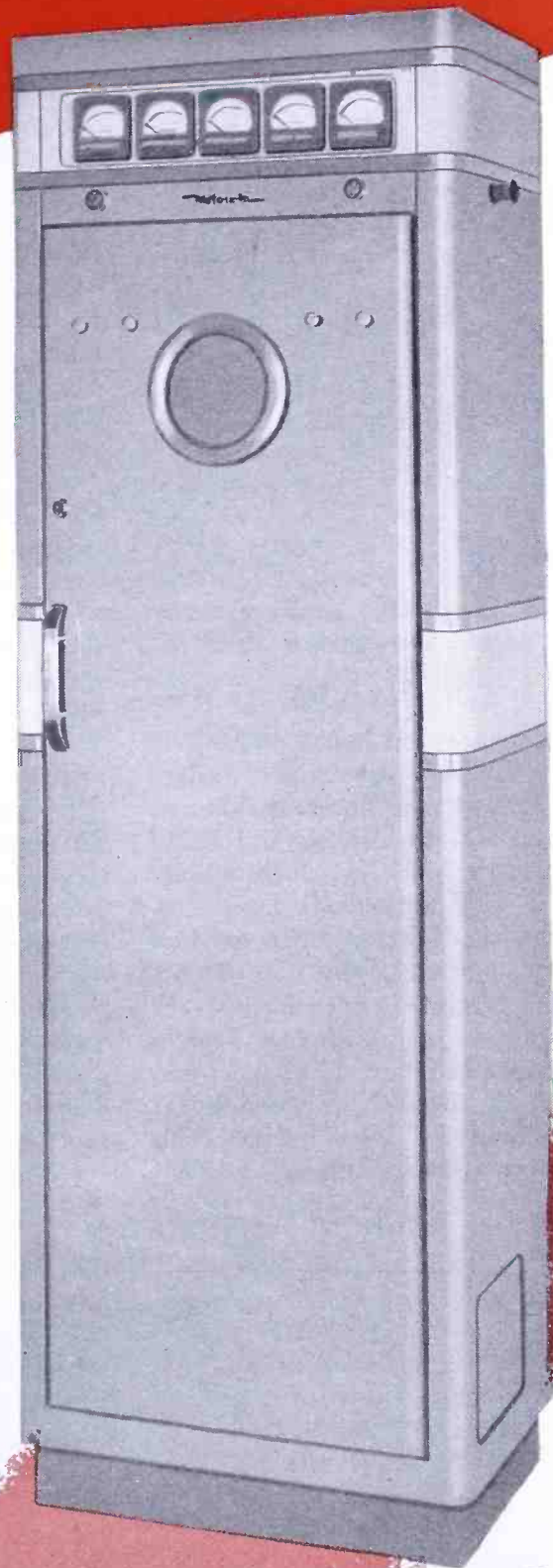

the **BEST** is now **BETTER**  
 than ever before . . .

**COMPARE** feature for feature with any other equipment on the market . . . **GET THE COMPLETE STORY . . . MAIL THIS COUPON TODAY**

MOTOROLA INC., Communications Division  
 4545 Augusta Blvd., Chicago, Ill. Dept. FM&T-Jun

Name .....

Position .....

Firm .....

Address .....

City .....Zone.....State.....

**Motorola FM 2-WAY RADIO**



# SPOT NEWS NOTES NOTES AND COMMENTS ABOUT SIGNIFICANT ACTIVITIES OF PEOPLE & COMPANIES



"He's a communications engineer, sir. . .  
Been like this since May 6, 1949"

## FCC Opens TV Ice Box:

Official announcement issued on May 26 promises a TV plan providing a "nation-wide assignment plan covering commercial operation in both [VHF and UHF] bands." This will include a "substantial" number of VHF authorizations, plus 6-mc. channels in "approximately one-half of the lower portion of the UHF band," the balance being kept open for research on "stratovision, polycasting, and high-definition monochrome and color." Complete text of the FCC announcement will be found in What's New This Month, of this issue.

## Give-Away Programs:

They will collapse, one of these days, from sheer weight of their gargantuan proportions. When they do, sponsors and listeners will discover to what an extent they have crowded out genuine entertainment. Any third-rate advertising agency can handle them without using brain-power above the copy-boy level. They represent the shoddiest effort on the part of the producer, and the lowest grade of program material. As such, they are of no credit to the sponsor or to radio broadcasting.

## TV Picture Size:

The practice of rating TV pictures in square inches is misleading to the point of justifying an investigation by the FTC or the BBB. The number of square inches claimed for a given picture-tube diameter now runs from that obtained with a rectangle of standard RMA 3-to-4 aspect ratio with or without the corners cut off, to the total area of the tube face.

Thus, it is impossible to relate picture area in square inches to the size of the tube with which a set is equipped.

## Report on the FCC:

Everyone in the industry should read Senator Edwin C. Johnson's speech of April 20, when he discussed the problems of broadcasting, and the manner in which they are being handled by the FCC. It's a masterful, non-partisan presentation. If you haven't read it, get a copy, by all means. Reprints are available without charge from the FM Association, 526 DuPont Circle Building, Washington 6, D. C.

## TV Operation on UHF:

NBC has been authorized to operate an experimental station at Bridgeport, Conn., on a frequency in the neighborhood of 500 mc. Transmitter will probably have 1 kw. output, with a high antenna gain. It is expected that RCA will produce suitable receivers.

## Help for Communications:

After wading through the 95 pages of the Federal Register required to print the revised allocations, rules, and regulations on mobile communications, we are prepared to agree with Jeremiah Courtney's remarks published in our previous issue. Operators of communications systems certainly are going to need legal and engineering counsel. We can't even figure out how the consultants can understand what FCC means in some cases.

## TV Microwave Relay Design:

It has been standard practice to mount the microwave relay transmitter or receiver unit directly behind the antenna dish. On permanent, outdoor installations, exposure to the weather has disadvantages. The New York Telephone Company uses a different arrangement. They mount the microwave unit within the building, and run up to 30 ft. of 2-by 1-in. Titeflex flexible waveguide to the outdoor antenna. Attenuation in the waveguide is rated at less than .05 db per foot.

## Transitcasting in Boston Area:

WLYN-FM, at Lynn, Mass., is furnishing programs for 300 buses operated by the Eastern Massachusetts Street Railway Company in Medford, Malden, Lynn, and Salem. Station manager is A. M. Morgan.

## Tests of FM vs. AM for TV:

Prewar tests conducted by RMA's National Television System Committee are

quoted frequently to show that FM has been found inferior to AM for picture-signal transmission. Text of the report appears on page 260 in "Television Standards and Practice" (McGraw-Hill). What seems to be forgotten is the fact that, according to the report: "No FM limiter was used." What the report does not state is that the receiver employed was an AM model! It was on the basis of such a test that NTSC decided: "The contrast between the two systems was very marked, and decidedly in favor of FM." FCC engineers are currently checking FM vs. AM for video, and have obtained encouraging results on FM.

## Future of FM Broadcasting:

Pros and cons of FM's future have been argued hotly of late. Fact is that video broadcasting has an advantage in point-of-sale appeal because it offers a completely new and novel feature as compelling as reception of audio programs back in 1920. Then, the fact of hearing *something* was more important than *what* was heard. Now, the fact of *seeing* something, is more important than what is seen. But it won't be long until programs will be as important on TV as they are now on FM. Then, the two services will compete on an even footing. Not arguments but programs and promotion will give us the answer.

## CBS Lists No FM Affiliates:

In the annual report to CBS stockholders, 179 owned and affiliated AM stations are listed, but there is nothing to show that any of these operate FM transmitters. Seems surprising, for the only way many listeners can hear CBS programs is on FM.

## Radio's Customer, Too:

We've always admired the realistic attitude of Bell Telephone Laboratories toward the business of giving telephone users what they want. Particularly, we like the caption in current Bell Labs advertising: "The Ear Is Our Customer." We thought of that when, on May 15, we snapped off the Lucky Strike program. We don't remember the exact part when there was so much yelling and confusion, but we do remember our annoyance at the sponsor, Jack Benny, and the whole program staff for presuming to think that they were entertaining us by making such an infernal racket come out of our loudspeaker. Maybe its just blind faith, but we still hope to see the day when both broadcasters and set manufacturers discover that the ear is the radio industry's customer, too.



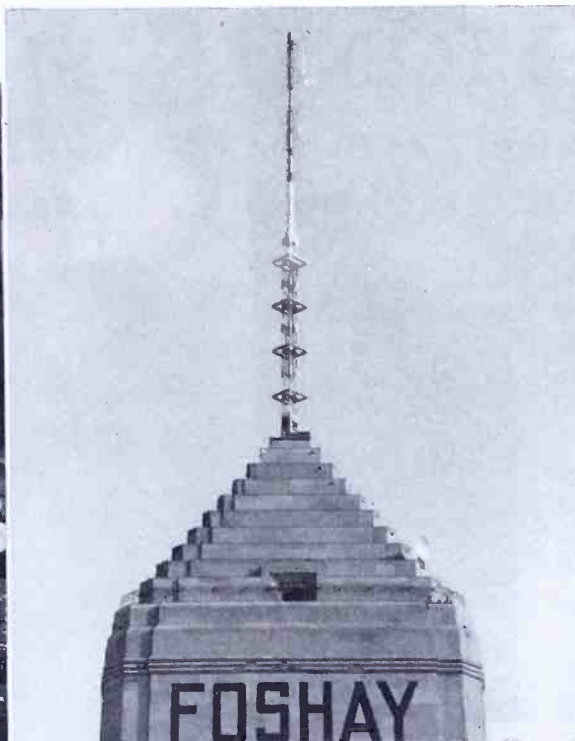
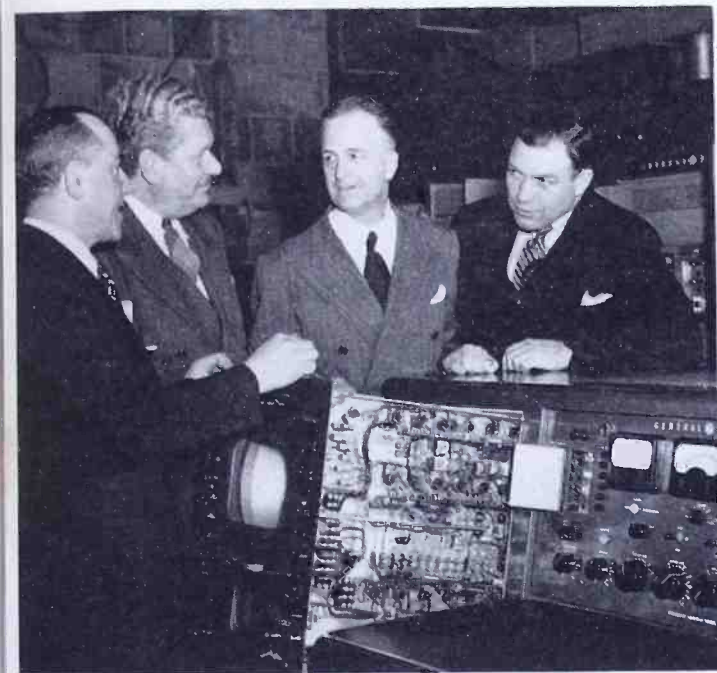

1. WOR-TV moves toward completion 2. Seven antennas on WTCN tower 3. TV engineers from Brazil, Cuba, Italy

## NEWS PICTURES

1. With WOR-TV shaping up as the television show-place for New York visitors, Jack Poppele, third from left, as engineering vice president for WOR, and assistant chief engineer Charles Singer, left, have made this their pet project. Paul Chamberlain and Grady Rourke of G. E. are in there pitching, too.

2. John Sherman, technical director of WTCN Minneapolis, says his station holds the record for antennas on a broadcast tower. They are for 1) high-power FM on 97.1 mc.; 2) high-power video; and 3) audio for TV on channel 4; 4) mobile FM remote pick-up transmitter or 153.53 mc., and 5) AM talk-back and

cue circuits and, finally, 6) two parabolas for the mobile TV unit on 6,950 mc.

3. Fifteen engineers from foreign countries attended RCA's recent TV training program. Among them were, left to right, W. Obermiller, Brazil; V. Montes and Antonio Zamarano, Cuba, and Dr. Edoardo Cristo Faro, Italy.

4. Jewel Store manager Roy Martin and James Hyde, of Consumers Aid, help WMOR manager Ralph Wood check store speakers in preparation for starting FM music service for the Jewel chain.

5. During the convention of the American Wood Preservers Association, St. Louis station KSD-TV sent its mobile

unit into the Monsanto Chemical plant where chemists demonstrated the use of various equipment and processes.

6. In Providence, R. I., the Journal-Bulletin has created tremendous listener interest with public-service features from its FM station WPJB. Here, publisher Servellon Brown presents scholarships to music contest winners Joyce Mangler, Martha Butler, John R. Pandolfi, and a certificate to Jean Porter.

7. CBS is using tiny induction telephone units developed by Link Radio, for TV studio communication. They provide 2 channels on 100 to 175 kc. Use of three subminiature tubes keeps total weight to 2¼ lbs.

4. Storecasting readied in Chicago 5. TV cameras tour factory 6. WPJB awards scholarships 7. Radio for TV studios

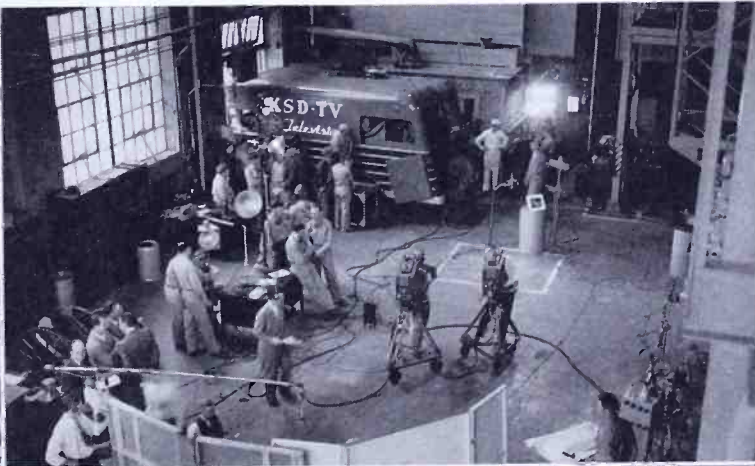



# TV OPERATION IN SMALL CITIES

DESCRIBING THE EQUIPMENT LAYOUT AND OPERATION FOR A COMMERCIAL PRACTICAL, MINIMUM-COST SECONDARY TV INSTALLATION—By E. J. MEEHAN\*

EARLY in 1949, with the inception of coaxial interconnecting service between the eastern seaboard and the mid-west, network-fed, low-power television stations became a practical, commercial reality. The impact of the situation thus created has provoked a need for "secondary stations" to make network programs available in the smaller cities.

Secondary stations, as defined by FCC Chairman Coy in his address at the NAB convention last spring, "must be simple in construction and operation, to give minimum investment and operating cost. The stations must be, as nearly as possible, automatic in operation, thus requiring a minimum staff." To meet the need for a practical low-cost, minimum operation, RCA has worked out a new overall plan for such an installation, capable of handling both network and film programs.

## Essential Operating Functions:

The accompanying illustrations show a suggested layout for a secondary station, and the equipment necessary. The prime requisite is that such an operation be workable from the economic point of view. To this end, specific items of equipment has been selected to make up what we call the Basic Buy.

\* Engineering Products Department, Radio Corporation of America, Camden, N. J.

Fig. 2. Floor plan of the transmitter building, laid out for simplicity of operation

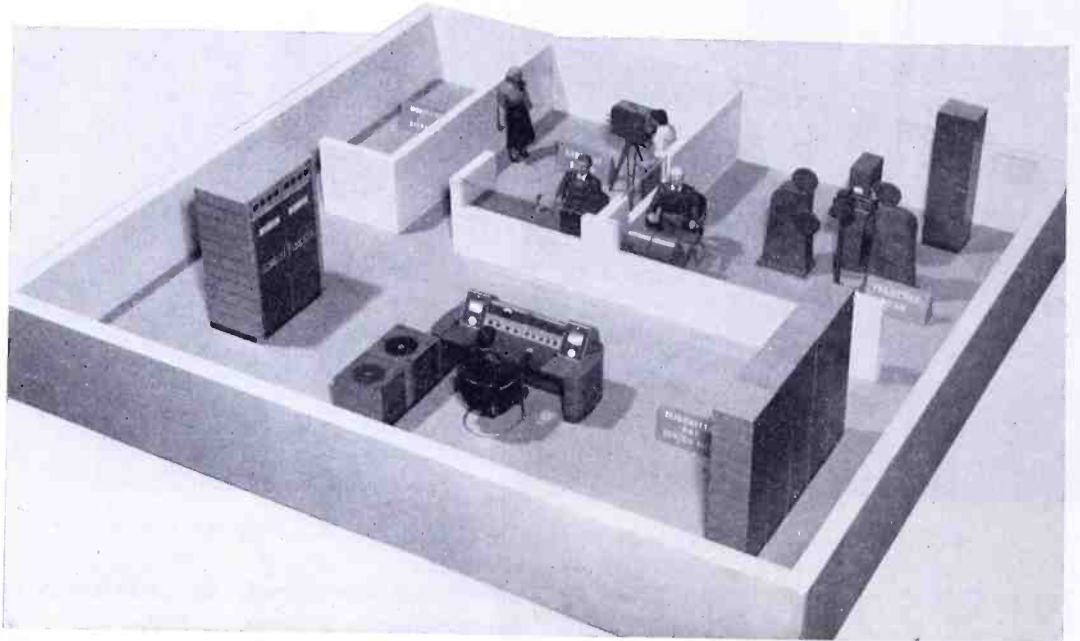
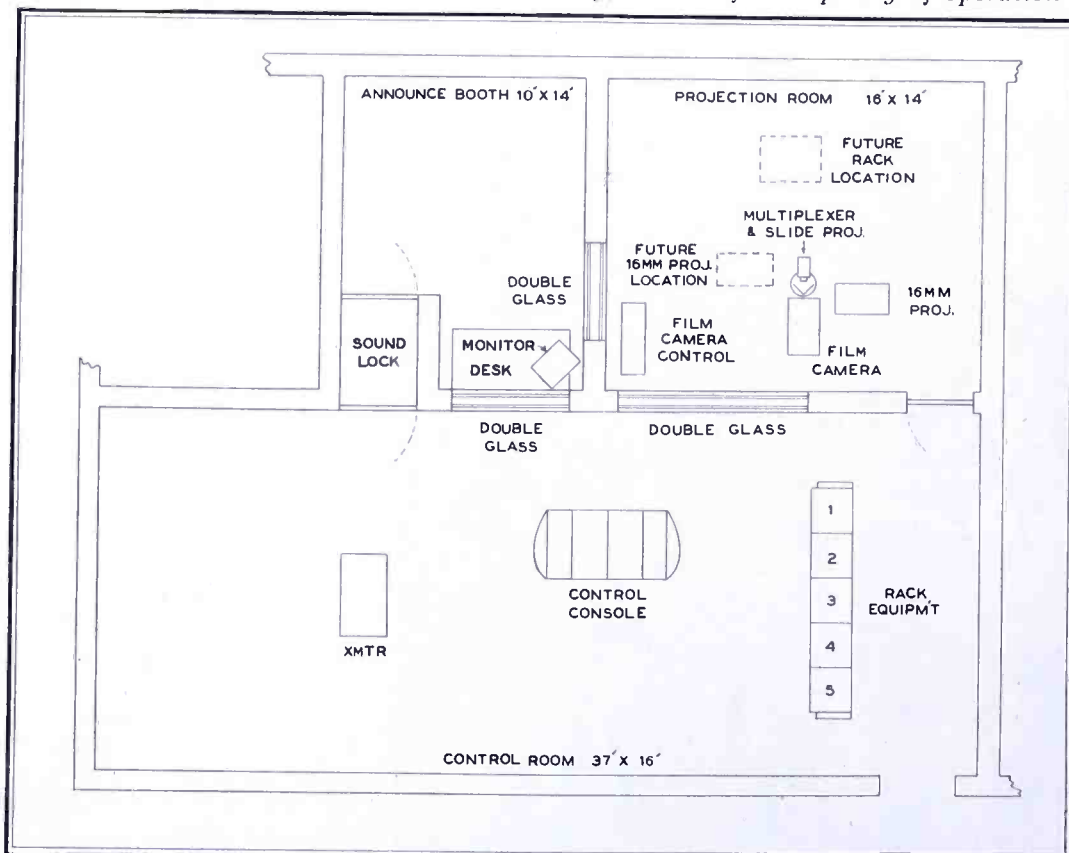

Fig. 1. Model of a TV station equipped with the units comprising RCA's Basic Buy

To make the proper selection of equipment, and to plan its arrangement to best advantage, it is important to understand the four separate functions to be performed in the operation of a secondary station. These are:

1. TRANSMITTER CONTROL requires transmitter monitoring, maintaining proper levels of sync and modulation, and responsibility for getting the cleanest picture from the incoming network through proper use of the stabilizing amplifier. Maintenance of the proper

level of sound transmission is also a function of transmitter control.

2. PROGRAM SWITCHING involves the selection of proper picture and sound channels, previewing programs before their transmission, cueing film and transmitter operation and switching, and fading and superimposing video and audio signals being fed into the transmitter control. Operation of turntables also falls in this operation.

3. FILM CONTROL is that function which is charged with responsibility for maintaining proper shading of the picture output of the film camera. Most motion picture film varies greatly in average picture brightness from one scene to another, and it is essential that continuous monitoring and shading be performed during film transmission.

4. FILM PROJECTION calls for the proper operation and feeding of the television film projector, and correct sequential feeding of slides to the slide projector. This operation also involves pre-running all film, timing film programs, and adjustment of optical equipment.

It is possible, and quite likely in many operations, for several of these technical functions, together with that of announcing, to be combined in various methods. The relation between types of program being shown, degree of personnel training, cost, local regulations, and other factors all contribute to the particular requirements of each individual operation.

Certain operating functions lend themselves to combination with others in this system, due to physical and operational



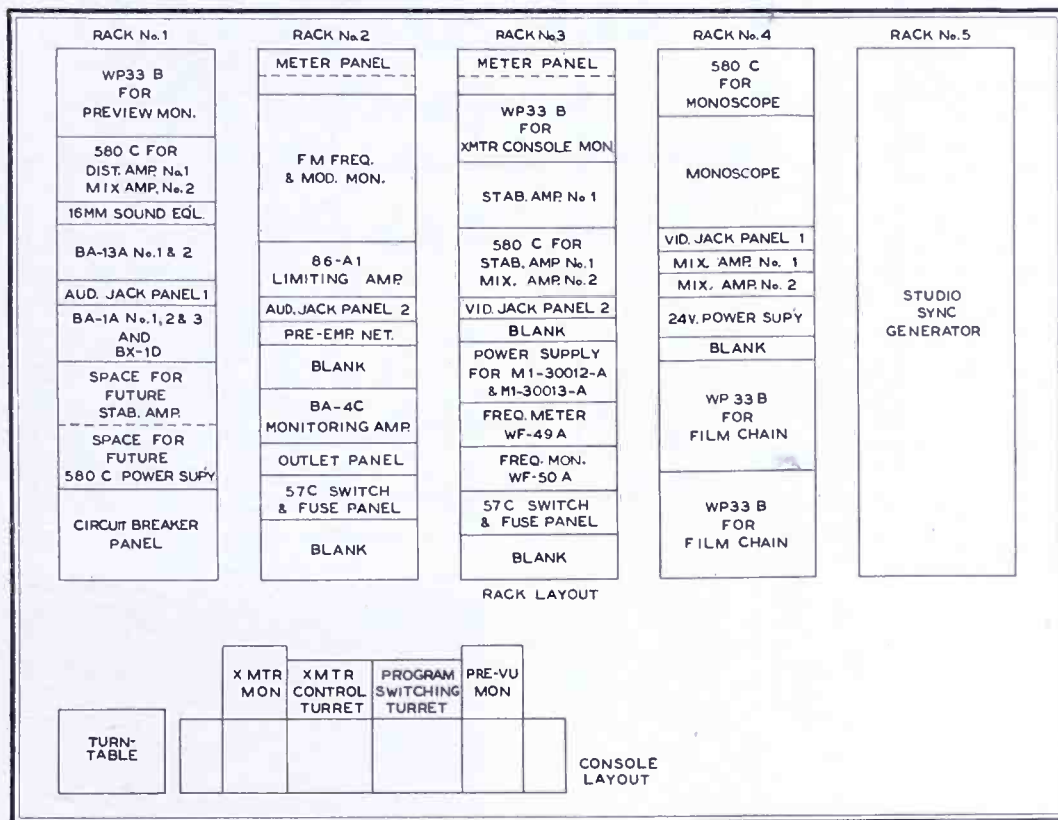
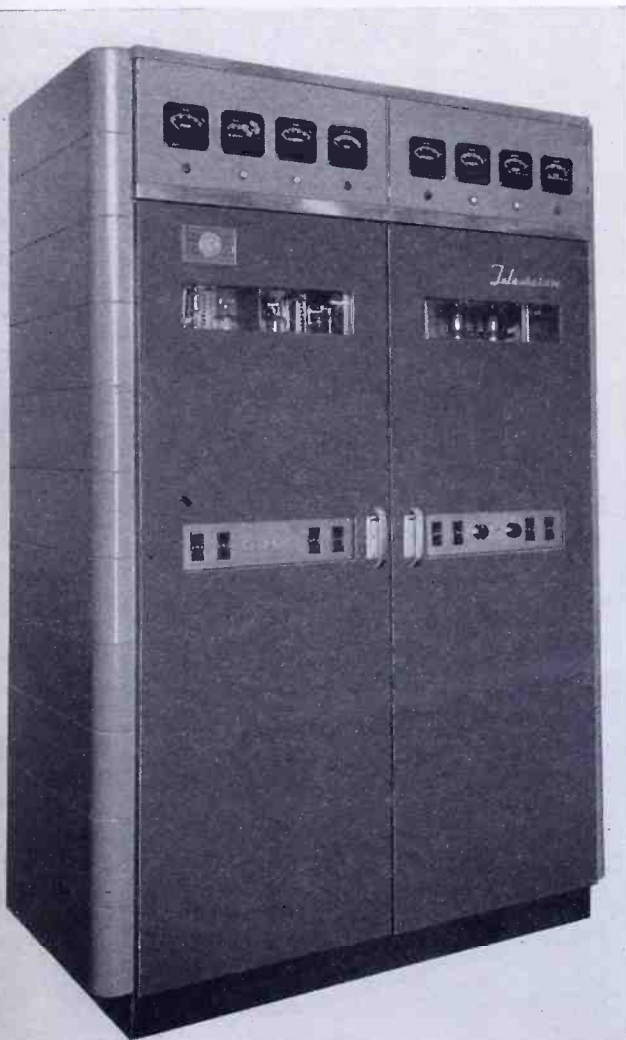

Fig. 3. Details of the equipment carried in the five racks and in the control console

proximity. Transmitter control and program switching are both performed at a combination console and, except in operations where close program timing and equipment supervision is desired, may usually be performed by one versatile operator.

Film control and film projection are

Fig. 4. The video and audio transmitter



performed in the film projection room and, to some degree, can be paired or combined, again depending on local circumstances. For an all-film operation, greater requirements would be placed, for example, on film personnel, while the program switching function would be correspondingly simplified.

It is felt, however, that whatever combination of functions be assigned to individual operating personnel, it is desirable, due to the variety of applications for this type of layout, that each principal function be separated for the purposes of this discussion.

#### Transmitter Building Plan:

The model photographed in Fig. 1, and the floor plan in Fig. 2 show how facilities enumerated above are provided in combination with a type TT-500 television transmitter. In addition to the main transmitter-control room there is a film projection room at the rear right, an announce booth where a camera can be set up for interviews, and auxiliary space at the left for power equipment, storage, and a maintenance shop.

Equipment in the transmitter-control room comprises the transmitter, at the left, ceiling-mounted vestigial sideband filter, diplexer, input, and monitoring units, the console combination and turntables, and five racks carrying the video and audio power, and equalization, stabilization, and distribution circuits.

Ample space is provided in the floor area 37 by 16 ft. Utmost personnel efficiency is afforded, since one operator at the console can attend the transmitter and perform the necessary program switching, at the same time maintaining

proper sound and picture levels. He also commands a view of the announce booth and film projection room, which facilitates cueing and program coordination.

The individual items of equipment and their functions are described in detail in the sections which follow, with a basic diagram of the complete installation in Fig. 3.

#### Television Transmitter:

The transmitter, Figs. 4 and 5, provides an output from the sideband filter of 500 watts for the picture and 250 watts for the sound. Effective radiated power depends, of course, on the antenna, which may have a gain of 1.2 up to approximately 7.2. A 6-section superturnstile, for example, would provide radiation of 3.6 kw. on the picture signals. Dimensions of the transmitter cabinet are 84 ins. high, 56 ins. wide, and 31 ins. deep.

#### Film Chain and Facilities:

A 16-mm. television film projector, with film multiplexer, slide projector, and film camera chain, together with control equipment and monitor, are located in the film projector room. A standard television receiver with de-sensitized input, operating directly off the air, enables the projectionist to obtain accurate cueing.

This station plan was designed primarily for film-network operation. The availability of live video signals for network programming, while desirable, is not essential. Network kinephoto service is now available in quantity and may,

Fig. 5. Interior of the 500-watt design

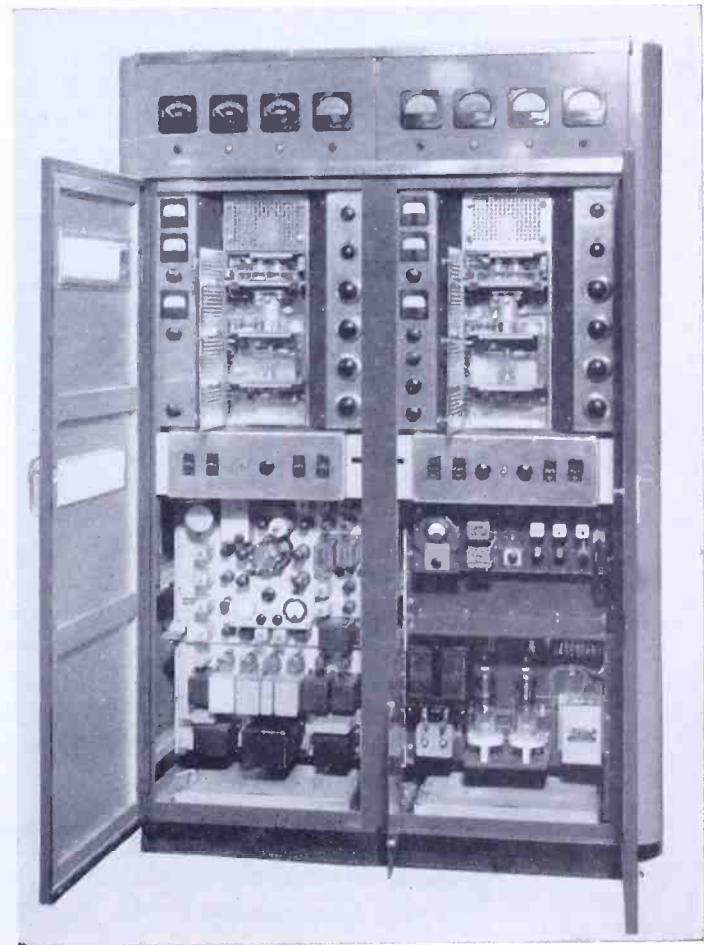



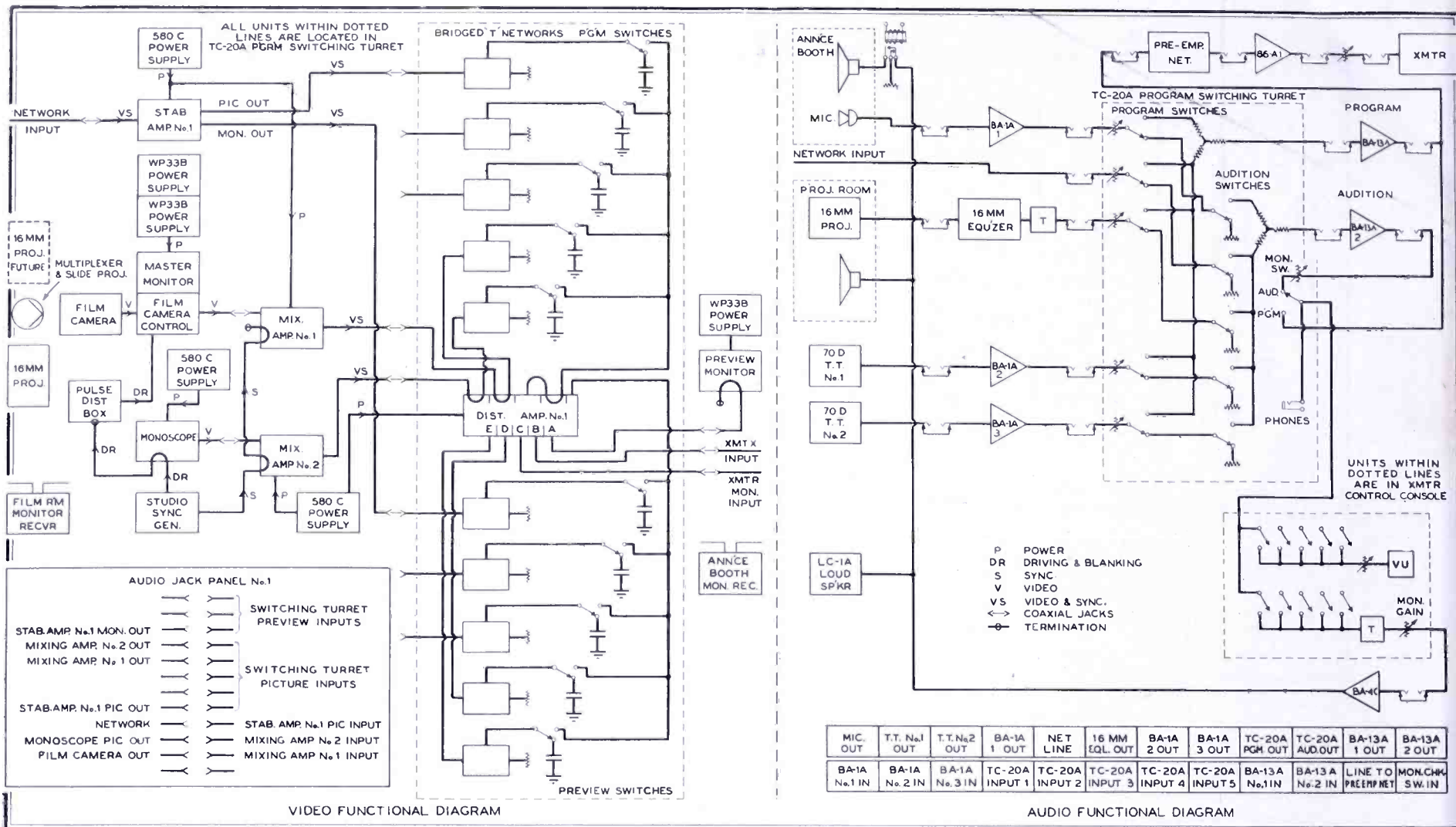

Fig. 6. Functional diagrams of the audio and video controls and switching facilities which are provided in the control console

in large measure, be substituted for live network in areas where such facilities are not available. Operation of this type would consist initially of film programming entirely.

For this reason, space has been provided for the addition of a second 16-mm. television film projector, which would be necessary to maintain continuous programming with this system. Recent improvements in the quantity and quality of off-the-kinescope film serve to emphasize the significance of this type of programming, and the increasing role it must play in small TV station operation.

The film camera control unit contains all operating controls for the film camera. Used in conjunction with a 10-in. picture monitor and a 5-in. waveform scope, it enables the operator to adjust and maintain within close tolerance the quality and level of the picture produced. The camera control is mounted in a standard console section which matches the other equipment.

A separate projection room, as shown in Figs. 1 and 2, is recommended for the control unit. The camera control monitor will then provide the projectionist with a means of monitoring the output of his film camera constantly.

**Announce Booth:**

For local news, commercials, and station breaks, an announce booth is provided.

Equipment in this booth consists of another de-sensitized off-the-air receiver for monitoring purposes, a microphone, and a loudspeaker. The television receiver enables the announcer to coordinate his announcements with the transmitted picture.

**Switching Equipment:**

The switching section of the combination console, Fig. 6, utilizes rack mounted equipment for audio and video amplification and distribution, plus the

power supply. There are individual gain controls for both sound and picture channels, so that levels can be adjusted at any time. Separate rows of buttons are provided on the turret, in order that picture and sound can be switched simultaneously or sequentially, as programming requires. This offers considerably more flexibility than could be obtained from simultaneous single-button switching.

A stabilizing amplifier is used with the  
(Concluded on page 38)

Fig. 7. This console combines transmitter controls and program switching facilities

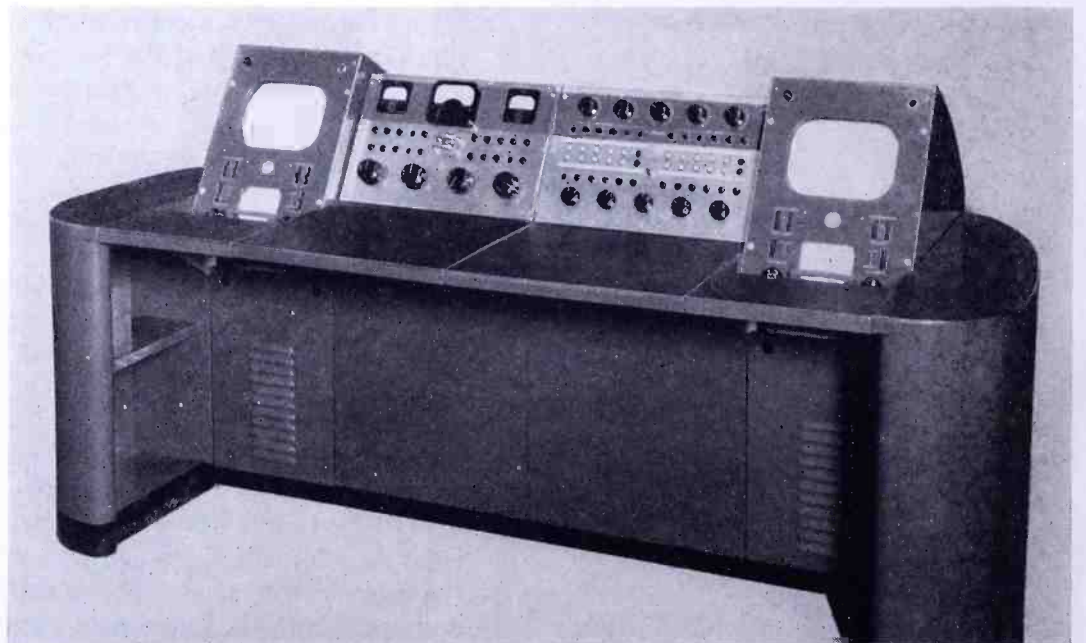



# CHOOSING THE RIGHT ANTENNA

AN INFERIOR SET WITH A GOOD ANTENNA WILL ALWAYS OUTPERFORM A BETTER SET WITH A POOR ANTENNA. HERE ARE HELPFUL NOTES ON IMPROVED DESIGNS

SELLING antennas for reception at FM and TV frequencies calls for settling two basic questions. First: will the customer be satisfied with the performance he can get from the least expenditure, or is he willing to pay the cost of the best possible performance? Second: what type of antenna will give him the best results?

Antenna designs start with wires run

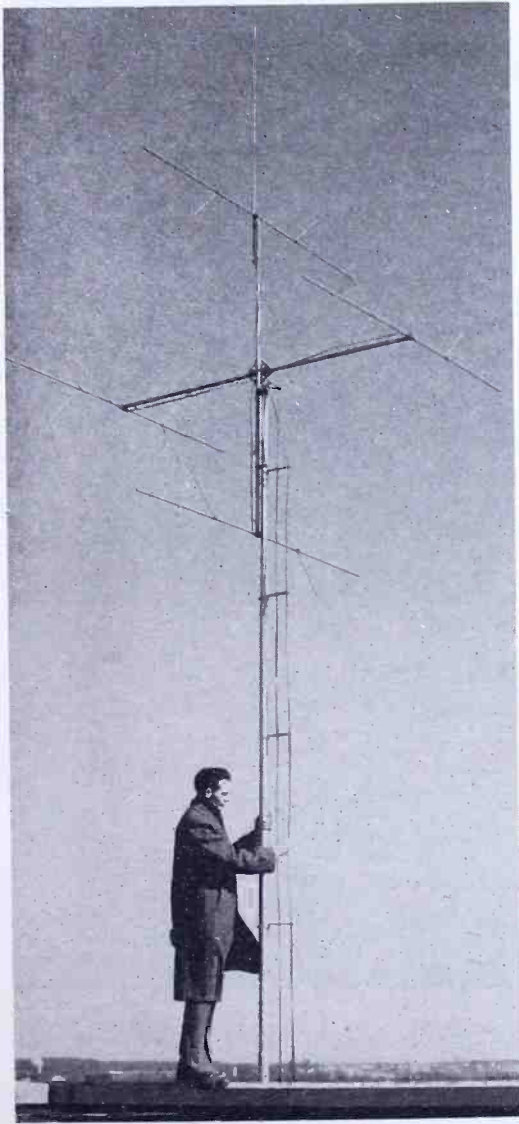

in dipole-fashion on walls or under carpets, or dipole rods that can be mounted on a console cabinet. But the range of such rigs stops at a short distance from the transmitters. If a customer insists on the cheapest thing, it's generally a good idea to let him have it. He'll convince himself that it isn't good enough.

If the transmitting stations lie in one direction, and are not separated widely in frequency, or if there is only one station to pick up, that's easy. The headaches multiply with added directions and an increased frequency spread to be covered.

In borderline cases, the best antenna is the safest, for an inferior set with strong signals will outperform a better set operating on weak signals! So the surest way for the man who makes the installation to protect his reputation, and

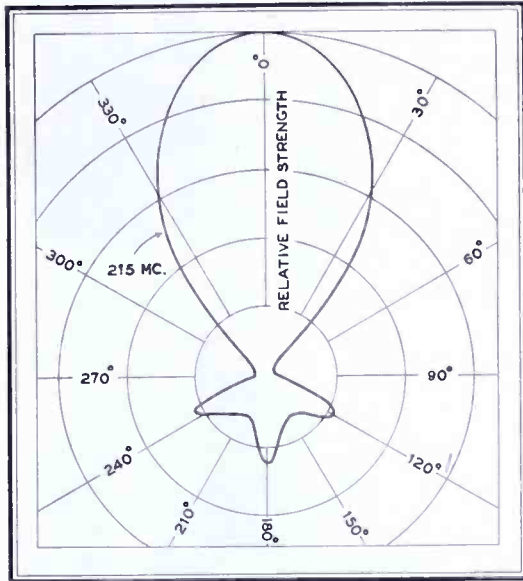
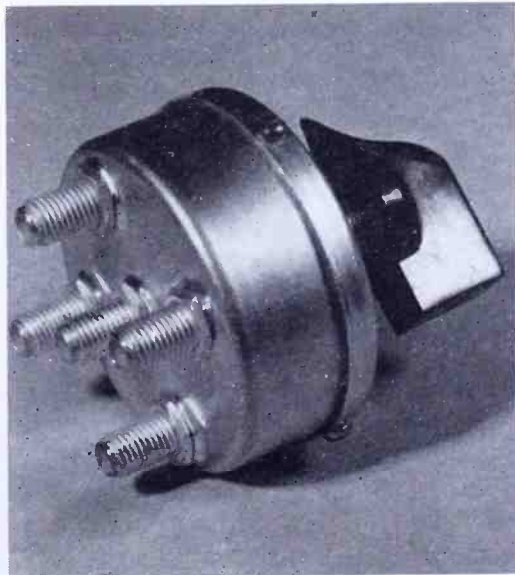

Fig. 1, left. O. M. Woodward with his reversible-beam antenna. Fig. 2, above. Pattern at 215 mc. Fig. 3, right. One of the antenna types assembled from standard components. Fig. 4, below. Switch designed to take coaxial leads



assure the customer of satisfaction from his investment is to sell the importance of a high-efficiency antenna and a mounting that will withstand year-round weather conditions.

Special antennas are now available in quite a range of designs. Some of these are shown in the accompanying illustrations.

One of these is the reversible beam antenna, developed by O. M. Woodward,

Jr., at RCA's Princeton Laboratories. This is illustrated in Fig. 1. The array consists of four dipoles arranged in the form of a square, and interconnected through a diplexing network to the television receiver. Diagonally-opposite dipoles are jointed to form broadside and end-fire pairs, respectively. The mid-points of the two joining lines extend down to the supporting mast to a diplex-

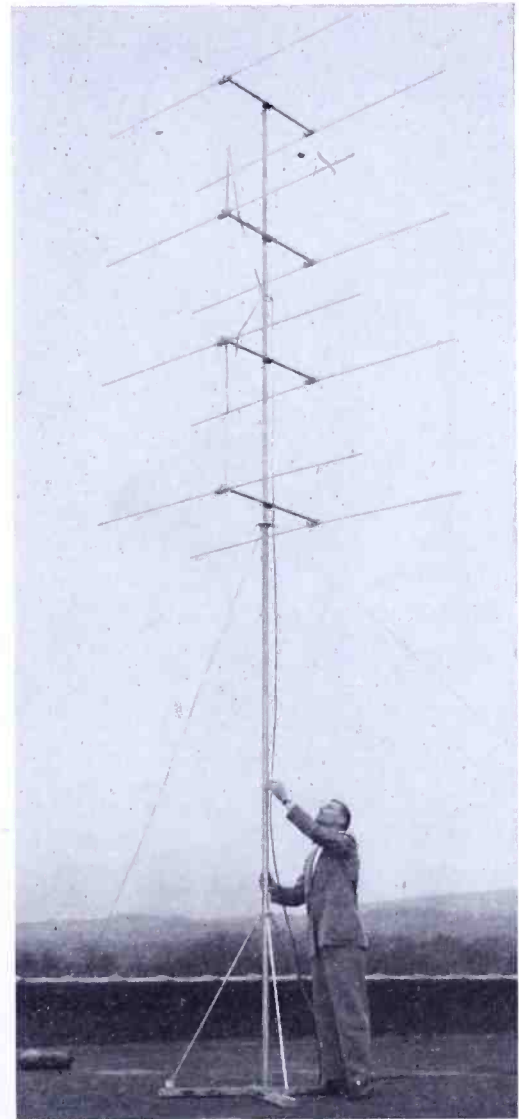

ing network, which may be located near the receiver. A beam-reversing switch is provided at the receiver to transpose one of the two lines leading to the array. All lines used in the array and diplexer are the standard 300-ohm balanced transmission lines.

A very high front-to-back ratio is obtained on all 12 TV channels. At 65 mc., the back lobe almost disappears, while at 215 mc. the front directional pattern becomes sharper, but there are 3 slight lobes, Fig. 2, at the rear. It is important to note that the directional effect does not shift in at the higher frequen-



cies, as is the case with some designs.

Westinghouse Electric Corporation, Pittsburgh, has developed a new idea in supplying component parts so designed that they can be assembled in any arrangement from a simple dipole to the high-gain array, as shown in Fig. 3. Thus, an antenna can be custom-made on the spot, to suit any local condition. Such parts as are used on a job can be replaced from stock when the truck returns to the service shop.

Arrays which can be made up from the elements used in the assembly illustrated in Fig. 3 include:

1. Low-frequency or high-frequency di-



pole and reflector,

2. A combination of low- and high-frequency dipoles and reflectors,

3. Stacked array with two low- or high-frequency dipoles and reflectors,

4. Stacked array with four low- or high-frequency dipoles and reflectors.

Workshop Associates, Newton Highlands, Mass., have specialized in antenna construction which feature high electrical efficiency and rugged design. A Workshop antenna can be recognized readily by the circular, molded housing which supports the elements and protects the connections from smoke acids and rain. Also, they recommend the use of RG8/U coaxial cable used with silver-plated, solderless connections.

The Workshop plan is to cut and orient a separate antenna for each channel required if a 6-element array is used,

or for each group of three adjacent channels if the antenna has 3 elements. Separate leads are brought to a coaxial switch, Fig. 4, to select the proper antenna for a given station.

When signals are not strong enough at a given location, the sure solution is to raise the height of the antenna. There

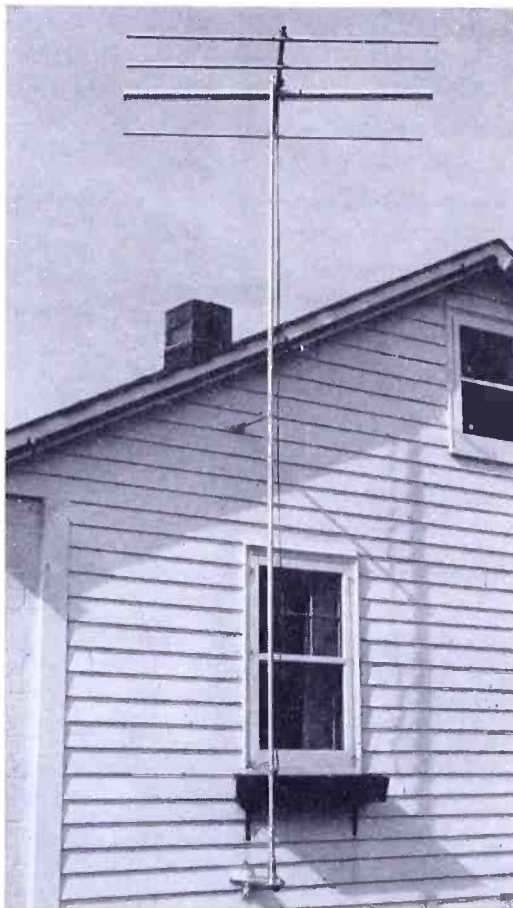

Fig. 5, left. This tower permits the mast to be slid up and down. Fig. 6, right, welded steel tower can be pushed up like a ladder. Fig. 7, above. Bevel gear is used to orient this antenna manually. Fig. 8, below. Two types of heavy 300-ohm line



are some very handsome tower installations around the country, but some look like accidents that are about to happen.

Wincharger has a convenient design, illustrated in Fig. 5. It is light, but strong enough to carry a man's weight, and needs no guy wires. The base mounting is suitable for a flat roof, or for fastening on both sides of a ridgepole. As Fig. 5 shows, the tower is intended to carry a 1 1/4-in. pipe. The pipe is put

in place before the antenna is fastened to it. Then, when the antenna and lead have been made secure, the pipe is run up and clamped at the top of the tower.

For greater height, there is the type shown in Fig. 6, made by the Easy-Up Tower Company, Racine, Wis. Three 10-ft. welded sections weigh only 65 lbs., and carry a 10-ft. mast. When the hinged mounting feet are secured, it can be raised as easily as a ladder.

A simple method for orienting an antenna is offered by LaPointe Plascamold,

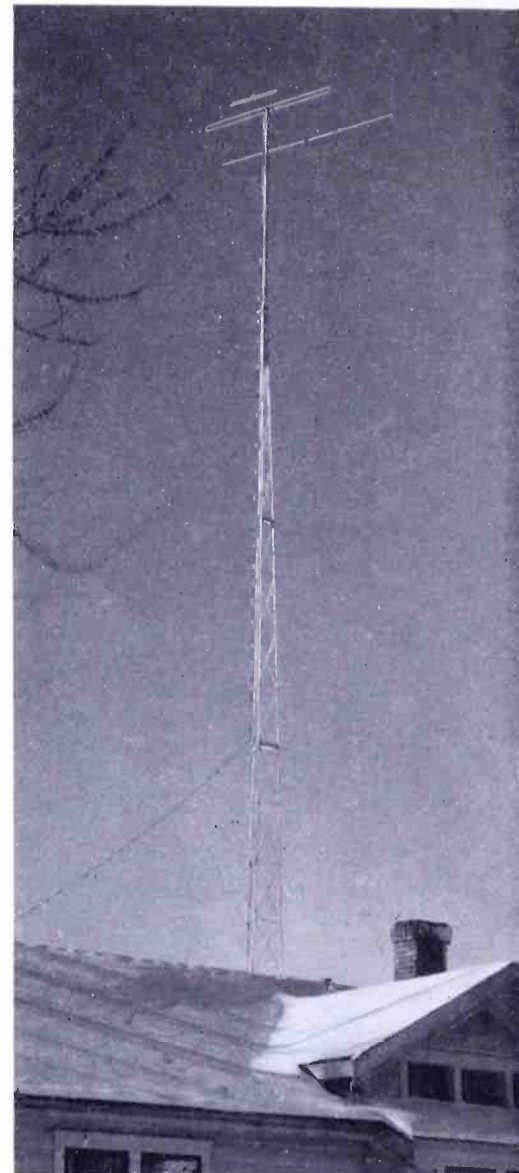

Unionville, Conn. This is shown in Fig. 7. The iron pipe carrying the antenna is supported on the side of the house, just below the eaves, but the weight is carried by a heavy casting at the bottom. This contains a bevel gear with a shaft that goes through to a control handle inside, by which the mast can be rotated in any direction.

To satisfy those who feel that ordinary twin-line is not strong enough mechanically, or may deteriorate electrically, American Phenolic Corporation, Chicago, has brought out the heavier types shown in Fig. 8. One has solid, flat insulation of increased thickness. The other is a tube of plastic insulation with extra wall thickness to carry the two wires.



# CARBONYL IRON POWDERS

A DESCRIPTION OF THE MANUFACTURING TECHNIQUES USED TO REDUCE IRON TO POWDER FORM FOR HIGH-FREQUENCY CORES — By GEORGE O. ALTMANN\*

THE use of powdered iron cores at VHF and UHF frequencies is now an established and well-known fact. The cores are used in transformers and inductance coils of every description and shape. They are used to boost  $Q$  values, to vary coil inductances, or to reduce the size of coils. Other functions are to confine stray fields or to increase transformer coupling factors. The work they do may be very specific, as in wave traps and deflection yokes. Their uses are manifold. Up to about 1940 it was generally believed that iron powder had no place at frequencies above 10 mc. except in the oxidized, low-permeability form. That this situation has changed so radically is due, largely, to successful research on very small particle size iron powders with advantageous properties. These belong to the family of carbonyl iron powders.

## Early Work on Iron Powders:

The history of carbonyl iron powders<sup>1</sup> goes back to the year 1890, when the British chemist Ludwig Mond discovered compounds resulting from a reaction between a metal and carbon monoxide gas. The first was Ni (CO)<sub>4</sub> nickel tetracarbonyl, a highly poisonous liquid, and then followed the crystalline Fe<sub>2</sub> (CO)<sub>9</sub> iron ennea (or nona) carbonyl. When distillation at 100 deg. C was attempted in an atmosphere of carbon monoxide, the iron ennea-carbonyl instead enriched itself with CO to form iron pentacarbonyl Fe(CO)<sub>5</sub>, a yellowish liquid with a boiling point of 101.5° C. These reactions presented considerable difficulties, but it was soon recognized that their intricacies could be turned to an advantage. The carbonyls that do form are not stable at elevated temperatures but decompose, under suitable conditions, into CO and the original metal. Here was a way to obtain metals in very pure form.

The British scientists and engineers investigated this field systematically. Particular attention was paid to high pressure and high temperature. After 1920 these developments were followed up in Germany. They led to the first large-scale industrial production of iron-pentacarbonyl for use as an anti-knock, and later to the manufacture of pure iron by means of continuous dissociation of this

compound. At first, up to about 1928, this purified iron was manufactured without attention to grain shape and structure, for the chemical and metallurgical industries. Then, however, the influence of heat and pressure on the finished powder was examined<sup>2</sup>.

The discovery was made that carbonyl iron powder, when properly controlled, possessed excellent sintering properties. When it was made in the form of particles of spherical shape with diameters of less than 20 microns, such particles had a very strong tendency to adhere to each other with surprising firmness after the usual heat treatments. The sinter-blocks formed in this way had greater strength and hardness than those made from other iron powders, and were often superior to articles made by way of fusion *i.e.* at very much higher temperatures.

In due course, this powder was examined for use in electromagnetic cores where other powders, notably of electrolytic origin, were used before. In view of its high mechanical hardness, it came as a surprise to discover a very low hysteresis loss or narrow hysteresis loop. This is a very attractive feature for Pupin coils in the loading of telephone lines and the powder was immediately put to use for that purpose.<sup>3</sup>

Soon thereafter the powder was used for radio frequencies. New techniques of core making had to be developed. Among them, Polydoroff's<sup>4</sup> was probably the most successful. A main feature is the efficient coating of the individual particles with insulating matter before compounding. A plastic binder is used which hardens at relatively low temperatures. In this way, insulation between particles remains undestroyed. Eddy currents develop only inside each particle and not over groups of them. Since eddy currents are proportional to the area over which they are produced, and are also proportional to the square of the frequency, these innovations were highly important.

An earlier creation was the material Ferrocart by H. Vogt.<sup>5</sup> It was essentially a combination of iron powder and paper. Other companies in several countries followed these developments and

began production of molded powdered iron cores. According to Pfeil<sup>1</sup> "there is little doubt that the main reason for the success of the development was the use of carbonyl iron powder."

Among the important publications of the 1930's in this field was A. Crossley's<sup>6</sup> description of an iron-core IF transformer. Also F. Colebrook<sup>7</sup> wrote the first comprehensive treatise on magnetic materials at radio frequencies. A theoretical discussion of the power losses of carbonyl iron powders then in use was published by Kornetzki and Weis<sup>8</sup> in 1936.

By 1941, a carbonyl iron plant<sup>9</sup> had been built in the United States by the General Aniline & Film Corporation. Electronic equipment for warfare demanded large quantities of powdered iron cores, the majority of which was made with carbonyl iron powders produced in this plant.

New grades of carbonyl iron powders were developed, particularly suitable for high frequencies. The production of these grades went hand in hand with improvements in core fabrication and coil design, such as were described, for example, by Martowicz<sup>10</sup> in 1945.

The key to an understanding of the interesting properties of these powders is furnished by a consideration of the way they are prepared.

## Preparation of Iron Powders:

Carbon monoxide is passed at elevated temperatures over crude metallic iron. Fe(CO)<sub>5</sub> is formed as a vapor and carried away with the gas current from which it is separated by cooling, and is collected.<sup>11</sup>

The decomposition of the iron pentacarbonyl is accomplished in a large cylindrical vessel heated to a temperature above 200° C. The starting materials, iron and carbon monoxide, are re-formed. The liberated iron atoms grow to spherical particles. These are removed from the gas stream and processed into the final carbonyl iron powders.

The growth of a particle is a somewhat complicated matter. Ordinarily, iron arranges itself in a cubic crystal lattice which should lead to angular particles instead of spheres, as is the case of nickel, for example. The actual mech-

Rep. No. 14 London 1934.

<sup>8</sup>M. Kornetzki & A. Weis, *Wissenschaftl. Veroff. Siemens Wke.* 15 95-111 (1936).

<sup>9</sup>G. J. Comstock, *Steel* 108, 88 (1941).

<sup>10</sup>C. T. Martowicz, *Electronic Ind.*, June 1945.

<sup>11</sup>U. S. Patent 1,783,744.

<sup>2</sup>Schlecht, W. Schubardt & F. Duftschmid, *Zs. Elektrochemie* 37, 485-492 (1931).

<sup>3</sup>W. Deuschmann, *Tele. Fernsp. Tech* 20 (1931) Heft 6.

<sup>4</sup>W. J. Polydoroff, *Proc. IRE*, 21, May 1933.

<sup>5</sup>H. Vogt, *Wireless World* 31, 272-273 (1932).

<sup>6</sup>A. Crossley, *Electronics*, Nov. 1933.

<sup>7</sup>F. Colebrook, Dept. Sci. & Indust. Res.—Spec.

\*Physicist, Carbonyl Iron Powder Plant, General Aniline & Film Corporation, 444 Madison Avenue, New York 22, N. Y.

<sup>1</sup>B. Pfeil, "Symp. Powder Met." Special Report No. 38, p. 47-51, The Iron & Steel Inst., London, 1947.



anism, according to Pfeil<sup>1</sup> and others, appears to be as follows:

The particle proceeds from a tiny cubic nucleus of iron. The surrounding gas film becomes impoverished in iron penta-carbonyl and enriched in CO. At the same time, heat is used up because the decomposition reaction is endothermic. Consequently, further decomposition and growth are temporarily slowed. At this point, another decomposition reaction is favored with the iron as a catalyst. This is the dissociation of carbon monoxide according to the equation  $2\text{CO} = \text{C} + \text{CO}_2$ , an exothermic reaction. Its effect is three-fold. 1) The concentration of CO in the neighborhood of the particle decreases, making room for new supplies of iron penta-carbonyl, 2) the particle regains heat it had lost, which it can use for further growth, and 3) carbon has been chemically absorbed which reduces the catalytic action of the iron for further CO dissociation. The particle is ready to receive some more iron and repeat the cycle. The end results are clearly not homogeneous particles, but particles whose carbon content radially, alternately increases and decreases. Simultaneously, the particles also reduce some CO<sub>2</sub> they have helped form to CO, and absorb most of the oxygen.

Crystal growth is seemingly hampered by the presence of these other elements, although each amounts to less than 1% by weight. The crystals do not exceed about one-hundredth of the particle diameter, and thus contain perhaps only a few hundred atoms in each direction.<sup>2</sup> This smallness, together with formation in free space, is responsible for random growth of the particles and, hence, their spherical shape. Under a high-powered microscope, with a magnification of 500 times or more, the spherical shells can be observed as circular concentric rings alternately darker and lighter hue, provided the particle has been mounted, etched with nitric acid, and polished. Usually between 5 and 10 of these rings can be seen, but the indication is that there are actually many more. The crystal size and type are deduced from X-ray diffraction patterns.

#### Mechanical Characteristics:

It is easily seen that in a particle of such a structure, plastic flow will be impossible. The particles retain their shape even under the highest practically possible pressures in hydraulic presses. Their hardness values are high. Pfeil<sup>1</sup> reports a Vickers diamond hardness of the order of 850. This is an advantage when efficient insulation is required, for the coating applied to a particle before molding will not have to stretch over a deformed particle after molding, as can

very easily be demonstrated in practice by comparing with non-carbonyl iron powders. Secondly, grinding and machining is very easy. The core surfaces appear, and are in fact, very smooth because the cutting tool can pry loose and remove the separate spheres much better than deformed and possibly interlocking grains. However, reports from core makers indicate that, in spite of hardness, wear on dies is not greater, probably due to the roundness of the particle surfaces.

There is a drawback to the incompressibility. The air spaces remaining between the particles even after molding prevent the available core volume from being filled with iron by more than about 65%. This restricts permeabilities to values of about 15 or lower. Since there are usually large gaps in the magnetic circuits at the higher frequencies, low permeabilities are quite permissible, but higher permeabilities can be obtained through further treatment of the powder.

#### Soft Carbonyl Iron Powders:

The essential feature of this softening treatment is, as would be expected, the removal of the carbon and oxygen, with concurrent crystal growth inside the particles. This reduction is usually achieved by means of hydrogen and the application of heat. The powder emerges from the oven in the form of soft chunks which break easily into single spheres and, occasionally, into clusters of two or more spheres. The spheres have lost their exact curvature. The electron microscope reveals them to have surfaces of small, flat facets which are, no doubt, the end faces of the various crystals inside the particle.

These compressible particles permit much better use of a given volume. The air space within the core can be reduced from 35% to 5% and even less. Permeabilities can be increased from 15 to 60 and more.<sup>12</sup> However, as stated above, insulation is harder to maintain and, for that and other reasons, these powders do not find application above 5 mc. as a rule.

#### Size Distribution:

The factor that most seriously limits the use of iron powder at higher frequencies is the power loss due to eddy currents. The magnitude of the eddy currents in every particle is proportional to the square of the diameter of the particle all other things being equal. The particle size distribution of any given powder is thus of paramount importance for the performance of that powder in a high-frequency core. A powder having half the average particle size of another

one might possibly exhibit *Q* values 4 times as high. On the other hand, if the particles are too small, the required insulating matter may take up too much space, crowding out magnetic matter and lowering permeability. In some cases it is better to have particles of fairly uniform size, while in other cases a great variety of sizes seems indicated as, for example, in the compressible powders whose cores should have most of their gaps filled.

The carbonyl process permits control of particle size distribution by shifting, to some extent, the balance between the formation of new particles and the growth of those already existing.

The size distribution of the soft carbonyl iron powders can be altered by changing the conditions of the reducing treatment, and also by breaking down the lumps into small particles more or less severely.

#### Summary:

From the information presented, it can be seen that there are two different kinds of carbonyl iron powders: those obtained directly from the decomposition of the iron penta-carbonyl vapor, and the others which have been softened by an additional reduction treatment. Both are manufactured by the Antara Products Division of General Aniline and Film Corporation.

The "straight" carbonyl iron powders are composed of particles of about 0.5 to 15 microns in diameter. The particles are spherical, built up of concentric shells, and possess no porosity. They are made up of hundreds of small crystals, mechanically hard and practically incompressible. The hysteresis loss is very low. They are easy to insulate efficiently, so that eddy currents can be kept very low. Consequently they are very well-suited for high-frequency applications.

The soft carbonyl iron powders are composed of particles which are spheres at first glance, but have many small, flat facets. A number of particles are clusters. The particles are homogeneous and are easy to deform. Hence, high densities can be attained which result in high permeabilities.

---

Some 700,000 shoppers in 150 Chicago supermarkets within a 40-mile radius will hear FM music and announcement under a new arrangement between WMOR and Consumers Aid, Inc. Three-minute newscasts will be given on the hour, with time signals every quarter hour. Transcribed commercials will feature such entertainers as Bing Crosby and Jim Ameche. Survey shows 95% approval of store programs by shoppers.

<sup>12</sup>G. O. Altmann and H. Beller, *Electronic Ind.*, Nov. 1945.



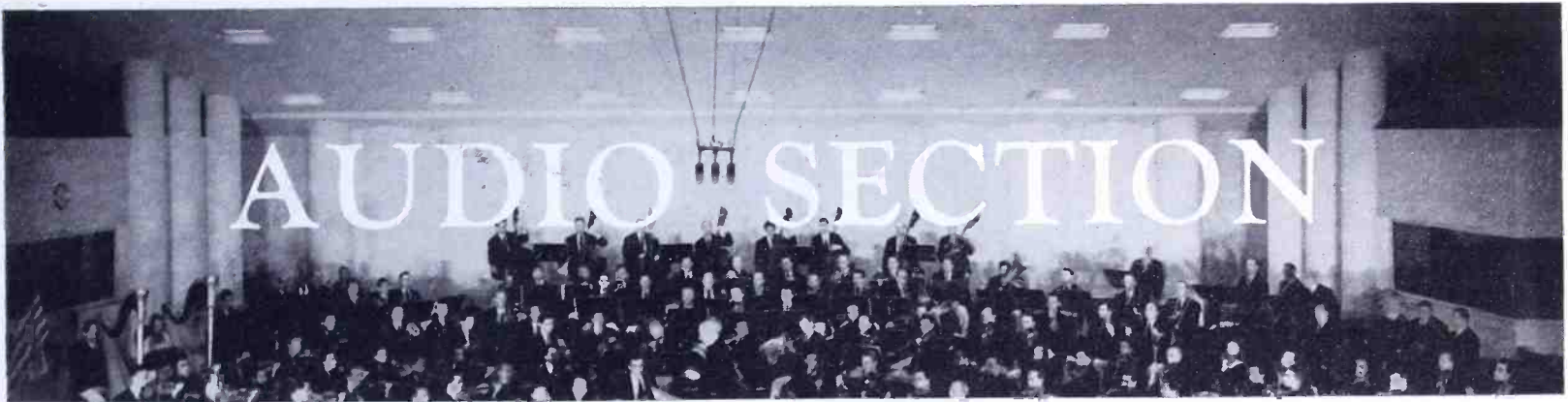

# GENERATOR FOR AF MEASUREMENTS

A PRECISION AUDIO FREQUENCY SIGNAL GENERATOR WITH A CONTROLLED OUTPUT VOLTAGE AT A KNOWN IMPEDANCE LEVEL — *By* W. NOEL ELDRED\*

THE improvement of audio frequency quality, possible with modern FM transmission, has caused broadcast engineers to reexamine and tighten up on their fidelity requirements. Microphones, audio facilities, and transmitters are today meeting much higher performance standards than ever before. Measuring equipment, too, must meet higher standards, for it is necessary that the performance of these systems be more carefully

\*Sales Manager, Hewlett-Packard Company, 1877-F Page Mill Road, Palo Alto, Calif.

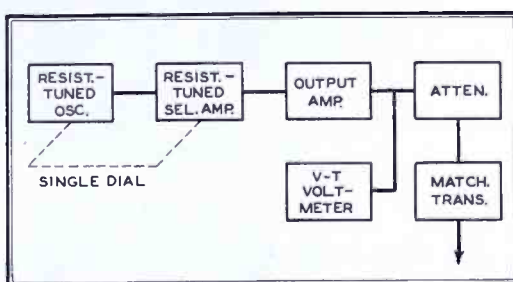

Fig. 1. This block diagram shows the separate circuit elements combined in the 206A audio signal generator

maintained. Along with these higher standards, then, modern measuring equipment should be easy and quick to operate.

Ideally, the test signal source should emit an exact frequency having a pure wave of exactly known amplitude, and at the proper impedance level. Further, the frequency of this source should be continuously variable over its complete range. The Hewlett-Packard 206A audio signal generator is an instrument designed to meet these idealized require-

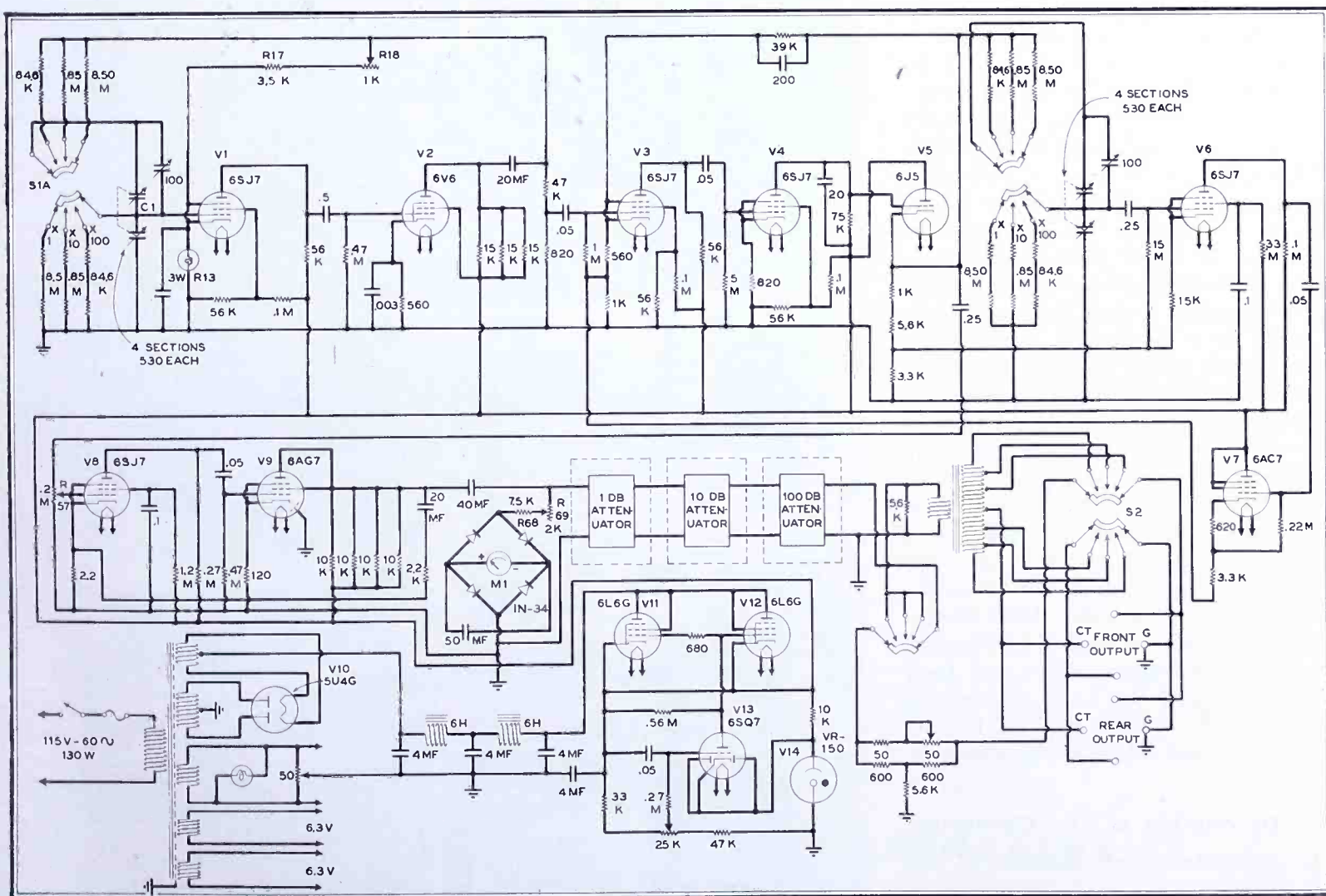

Fig. 2. Wiring diagram of the AF generator, showing the single-control resistance-tuned oscillator and selective amplifier



ments. The term *signal generator* is used here because this instrument has an exactly controlled output voltage which is transmitted at a known impedance level. A simple audio oscillator or test oscillator, on the other hand, delivers a signal at a known frequency but usually there is no mechanism for determining the exact amplitude or power level of the test signal.

In the generator to be described, it has been possible to keep the distortion below 0.1% over most of the frequency range. This has been accomplished with a circuit which combines a resistance-tuned oscillator with a resistance-tuned selective amplifier. The two units are tracked in such a way as to cause rejection of the harmonics generated by the oscillator, but amplification of the fundamental voltage. Following the selective amplifier, there is an output amplifier whose level is monitored by a vacuum tube voltmeter. The output amplifier delivers its voltage to an attenuator system which is coupled to an impedance-matching transformer. This transformer is arranged to give a variety of output impedances, and is completely balanced to ground. The impedances available are: 50, 150 and 600 ohms. The arrangement of the signal generator is shown by the block diagram in Fig. 1.

The equipment necessary to make the complete gain and frequency response measurements is thus consolidated in one unit. The only additional equipment required is an appropriate load for the instrument under test to work into, and some sort of an indicator which will show power in this load either on a voltage or a current basis. This indicator need not have any absolute accuracy. The only requirement is that it be capable of revealing a small change in level. It may be a simple AF vacuum-tube voltmeter, a copper oxide VU indicator, or the like. It is feasible, in making a test of this kind, to maintain the vacuum tube voltmeter in the signal generator at a standard value and, likewise, the indicator at the load at a standard value. The variation in gain as the various test frequencies are selected can be taken up by revising the adjustment of the attenuator system in the audio signal generator. Thus, the errors of the indicating meters are completely eliminated from the circuit, and the basic accuracy of measurement depends only on the attenuator system, which is better than  $\frac{1}{2}$  of 1%.

#### Description of the Generator:

The complete wiring diagram of the

*Fig. 3, above. Interior of the AF signal generator. Fig. 4, center. Tuning condenser assembly. Fig. 5. Bottom of chassis*

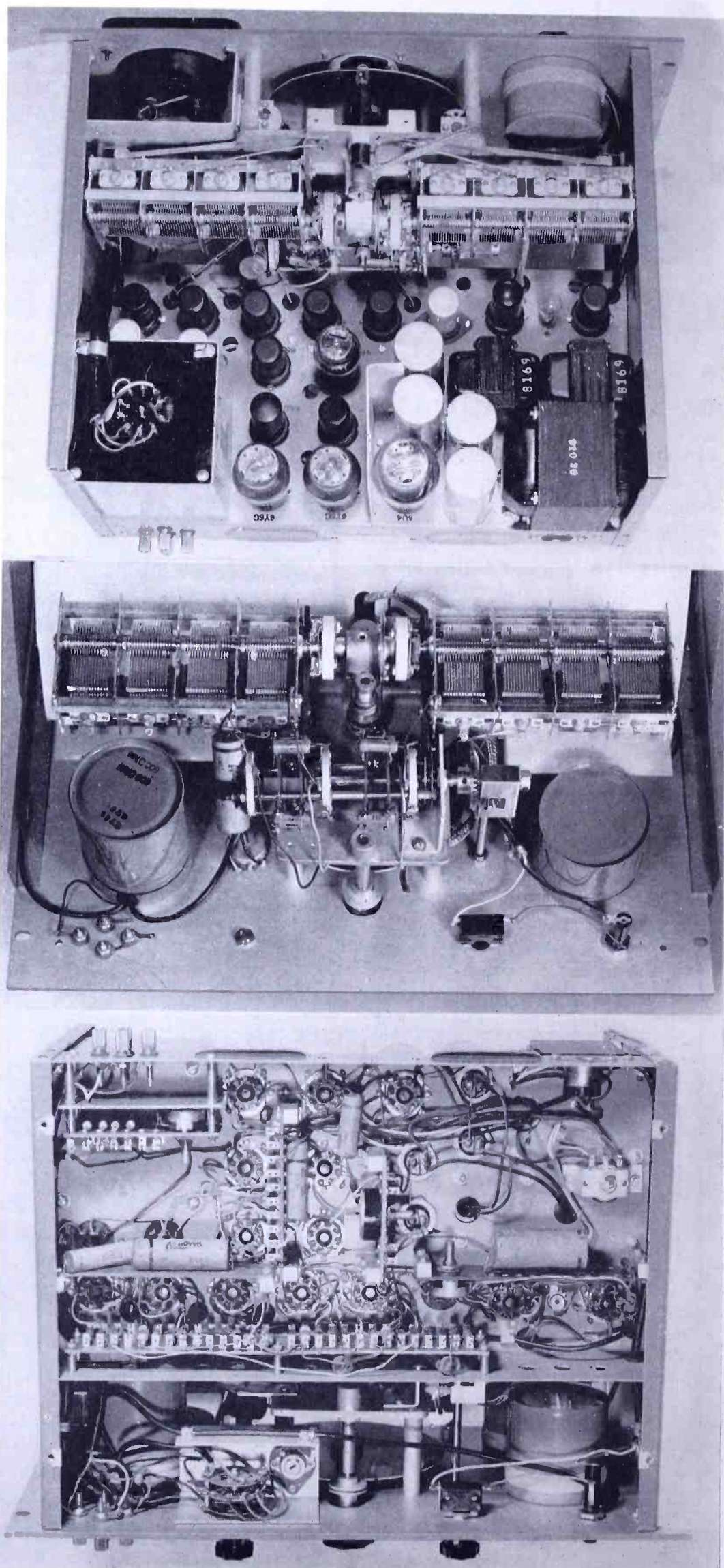



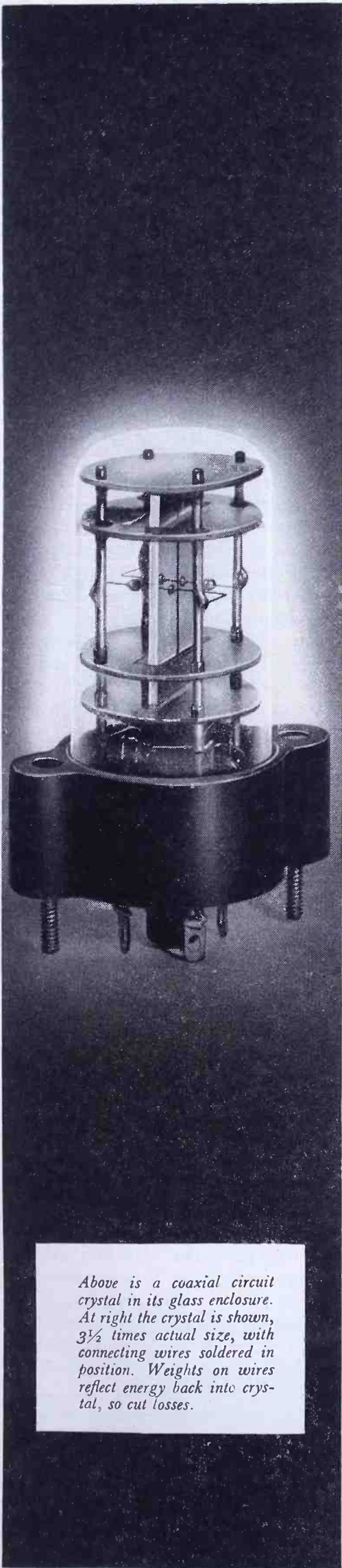

*Above is a coaxial circuit crystal in its glass enclosure. At right the crystal is shown, 3½ times actual size, with connecting wires soldered in position. Weights on wires reflect energy back into crystal, so cut losses.*

## Key to a Crystal Gateway

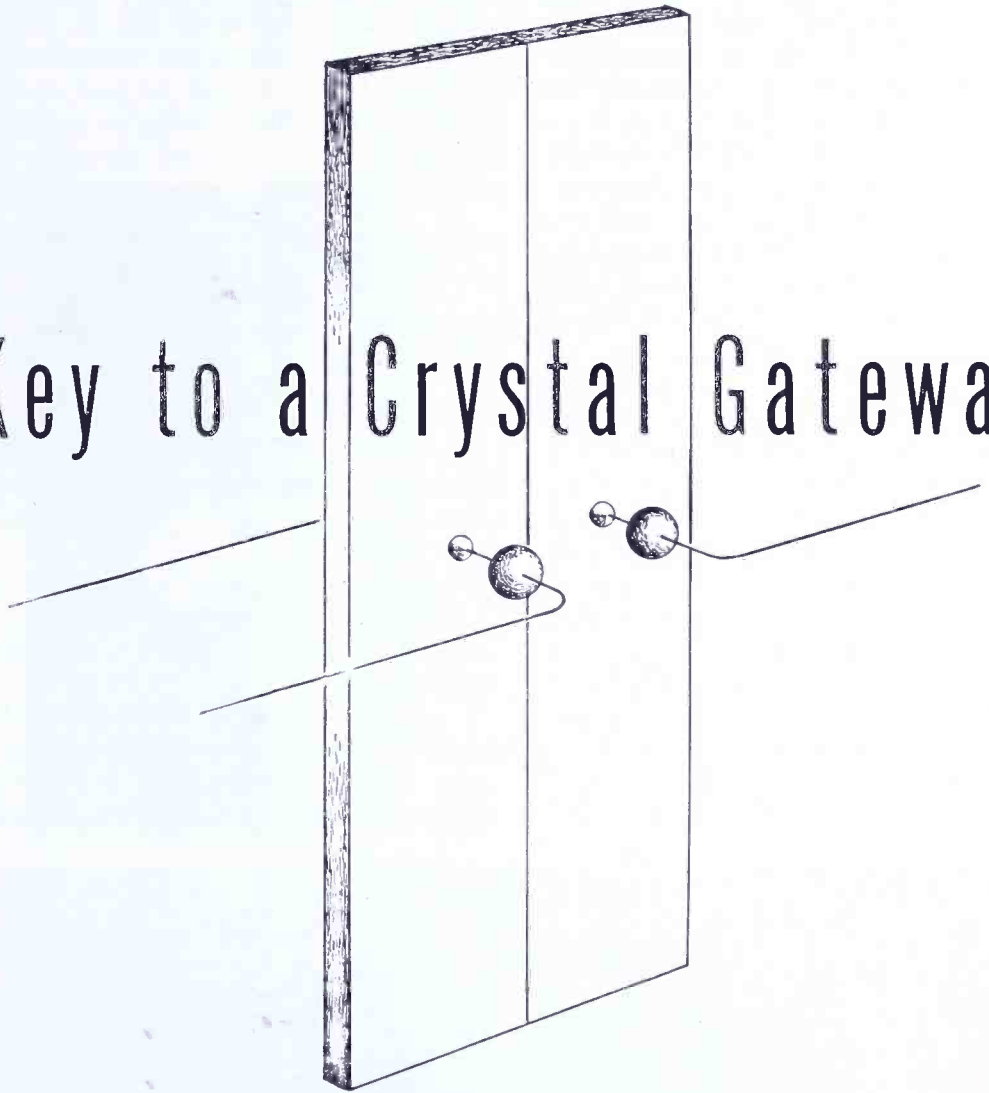

How would you solder a wire to a crystal? This must be done for most of those wafer-thin plates of quartz used in electrical circuits. They play a big part in the myriad-channel telephone system that utilizes coaxial cables.

This is how Bell Laboratories scientists solved the problem: A spot of paste containing silver is deposited on the crystal and bonded to it by oven heat. The crystal is then vapor-plated with a thin layer of silver. Then a fine wire is soldered to the spot by a concentrated blast of hot air. The result

is a rugged electrical connection to the surface of the crystal which does not interfere with its vibrations.

Sealed in glass tubes, the crystals are precise and reliable performers in the telephone system. Each is a crystal gate to a voiceway, separating *your* conversation from the hundreds of others which may be using a pair of coaxial conductors, at the same time.

This spot of paste, this tiny wire, this puff of air are among the tremendous trifles which concern Bell Telephone Laboratories in finding new ways to improve your telephone service.

### **BELL TELEPHONE LABORATORIES**

PIONEERS IN THE RESEARCH OF FM RADIO AND TELEVISION, AND ACTIVE IN DEVELOPING IMPROVEMENTS IN BOTH FIELDS TODAY





audio signal generator is shown in Fig. 2, with details of the design in Figs. 3, 4, and 5. The resistance-tuned oscillator section consists of the tubes V-1 and V-2. These tubes operate as a resistance-coupled audio amplifier over which there is both positive and negative feedback. Positive feedback is directed through the resistance-capacity network in connection with the switch S1A. These resistors, in conjunction with the variable capacitor C<sub>1</sub>, are the frequency-determining network. This network will, at a single frequency, give a phase shift of exactly 180°. Since the phase shift through the tubes V-1 and V-2 is exactly 360°, then, the entire unit will oscillate at the frequency determined by the resistance-capacity network. The circuit elements are especially designed resistors of low temperature coefficient, having a maximum long-time stability. This results in a fundamental accuracy of approximately 1% over reasonable periods of time, and a long-time accuracy better than 2%.

The negative feedback loop consists of resistors R-18, R-17 and R-13. The latter is a 3-watt, 120-volt incandescent lamp. It is a non-linear element which acts as an automatic amplitude limiter, and maintains the system at an optimum op-

erating point. The lamp provides flat frequency response over the entire range, and also assures that the tubes V-1 and V-2 operate on the linear portion of their characteristics. The negative feedback feature also reduces hum and distortion in the circuit.

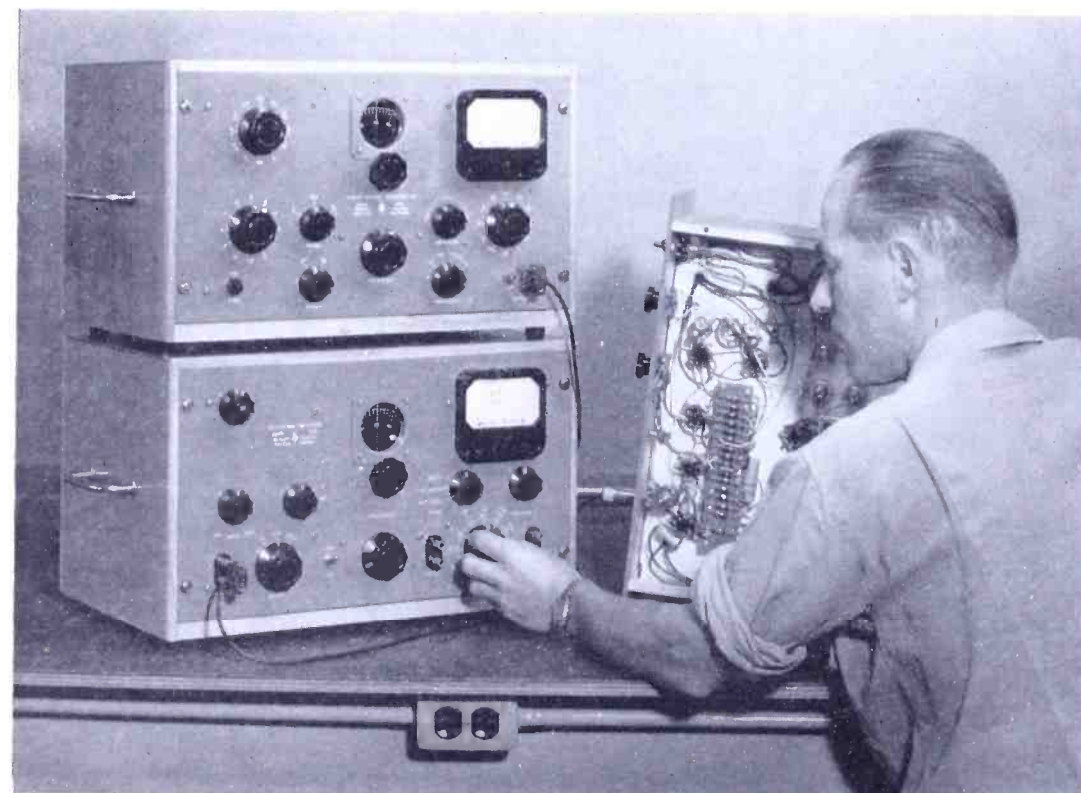

Fig. 7. Setup for measuring frequency response, gain, or total harmonic distortion

erating point. The lamp provides flat frequency response over the entire range, and also assures that the tubes V-1 and V-2 operate on the linear portion of their characteristics. The negative feedback feature also reduces hum and distortion in the circuit.

**TUNED AMPLIFIERS:** The distortion generated in the oscillator circuit is somewhat in excess of the required 0.1%, and a selective amplifier is arranged to track

the oscillator circuit so that it is responsive to the fundamental frequency and rejects the harmonic components. This amplifier consists of tubes V-3 through V-7. Tubes V-3 and V-4 are conventional voltage amplifiers, but V-5 is a cathode follower which has a Wein bridge, tuned to null at the fundamental frequency, in the output as part of its circuitry. This Wein bridge is another resistance-capacity network identical to that in the oscillator section previously

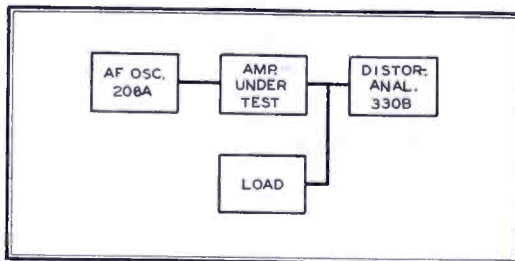

Fig. 6. Measuring gain or AF distortion

described. The tuning condenser is ganged with the oscillator tuning condenser, and the range switch is similarly ganged.

This ganged tuning arrangement is shown in Fig. 4. One four-gang condenser controls the oscillator frequency, while the other controls the selective

lower whose cathode circuit is returned to the cathode of V-3. This arrangement results in negative feedback for the harmonics but not for the fundamental frequency to which the bridge is balanced. The output for the circuit is taken ahead of the bridge circuit. Thus, this circuit amplifies the fundamental frequency and rejects the harmonic frequency. A harmonic rejection of more than 10 db is obtainable by this process.

**OUTPUT AMPLIFIER:** Tubes V-8 and V-9 comprise the output amplifier. There is negative feedback over the whole so as to reduce distortion to a minimum, and the output of V-9 is connected as a triode so that the tube can work directly into the load of the attenuator system. Variable resistor R-57 serves an amplitude control.

**VACUUM-TUBE VOLTMETER:** The voltmeter uses a DC, 0-1 millimeter, M-1. It is connected into the circuit through a full-wave bridge rectifier, with four 1N34 germanium crystals as rectifier elements. The meter is calibrated both in volts and in dbm (zero dbm = 1 milliwatt in a 600 ohm load). The series resistances R-68 and R-69 are provided for calibration.

**ATTENUATOR:** The attenuator gives a range of 111 db, variable in 0.1-db steps. It consists of three separate decade attenuator elements, the first one variable in 0.1-db steps and having a maximum attenuation of 1 db; the second section is variable in 1-db steps and has a maximum attenuation of 10 db; while a third section has 10-db steps and a maximum attenuation of 100 db. The 1-db attenuator also serves to pad out the internal impedance to match the load impedance.

**IMPEDANCE-MATCHING TRANSFORMER:** The impedance-matching transformer for this generator represented a major design problem. It was necessary that this transformer have very low distortion and at the same time that its frequency response be flat over the range from 20 to 20,000 cycles, even at extremely low levels. The resultant transformer is very large physically compared to its power-handling capacity. It is wound on a special high-permeability core, with particular attention paid to the matter of output balance, shielding, and hum pickup. The secondary in the transformer is center tapped, and free from ground. The center tap is brought to the front panel so that the transformer can be operated with a center tap, grounded on either end, or completely free of ground connection.

The overall design of the attenuator and impedance matching transformer is such that, beyond the vacuum tube voltmeter, the frequency response of the unit is accurate from 30 to 15,000 cycles within 0.2 db at all levels. Switch S-2

amplifier frequency. Located centrally between the two condensers is the ganged range-switch which selects the proper frequency-determining resistors.

Tuning the Wein bridge to a null eliminates the fundamental frequency without appreciably affecting the harmonics present. These are amplified in V-6, a conventional voltage amplifier connected across the center of the bridge. This voltage is then fed to V-7, a cathode fol-



# Facts about Frequency Meters for

# MOBILE COMMUNICATIONS

**E**VERYONE is agreed that, under the new FCC allocations for the mobile services, and with the advent of adjacent-channel operation, all fixed and mobile transmitters must be kept more closely to their assigned carrier frequencies than ever before.

But no matter how accurately a meter is calibrated at the factory, its effective precision depends on the accuracy with which you can read the scale.

A BROWNING Frequency Meter can be set with greater precision because of the big dial and easy-reading vernier. They eliminate guesswork and assure the accuracy required by the FCC.

Then, there's the matter of drift. It's one thing to calibrate a meter at the factory, but you want to know how long the meter will retain that calibration. After all, meters used by communications services can't be coddled like laboratory instruments.

When you specify a BROWNING Frequency Meter, you get a design that has gone through ten



Model S-4 and S-7 Frequency Meters

years of improvement and refinement. In addition, you get a basic advantage that is found in no other communications-type meter at any price. It is this:

Over a period of time, any make of meter will drift. The only way to determine if a meter has drifted beyond the limits specified by the FCC is to check it against the standard-frequency signals from the Bureau of Standards' station WWV.

But do you realize that BROWNING meters are the only communications-type instruments that can be checked against WWV in the field. To check a meter directly against WWV, the crystal must be a sub-multiple of a WWV frequency. Every BROWNING meter, at whatever point it is calibrated, uses a 100-kc. crystal. With meters having crystals ground to a submultiple of the calibration frequency, you can't find out how much they have drifted.

Still, a BROWNING Frequency Meter is very reasonable in price. Model S-4 can be furnished with calibrations at 1 to 5 points in the band from 1.0 to 70 mc., accurate to .0025%, or model S-7 at 1 or 2 points between 72 to 76 and/or 152 to 162 mc., accurate to .0025%. The model S-5, with temperature-controlled crystal, can be calibrated at 1, 2, or 3 points from 30 to 500 mc., accurate to .0025%.

Use the coupon below to get detailed information promptly.



IN CANADA, ADDRESS:  
Measurement Engineering, Ltd., Arnprior, Ont.

EXPORT SALES  
9 ROCKEFELLER PLAZA, Room 1422  
NEW YORK 20, U. S. A.

BROWNING LABORATORIES, Inc.

750 Main St., Winchester, Mass.

Please send me technical details and prices on the following Browning precision products:

- S-4 Frequency Meter       S-7 Frequency Meter  
 S-5 Frequency Meter       WWV Frequency Calibrator

Name .....

Address .....

Company Connection .....



selects the desired output impedance and also provides for a 600-ohm single-ended operation, eliminating the output transformer from the circuit for minimum distortion and frequency response error.

The calibration of the output meter and attenuator are applicable only when the instrument is operating into a matched, resistive load, and the volts calibration applies only when operating into a matched, resistive 600-ohm load. The internal impedance of the generator is always equal to the load impedance into which the instrument is designed to operate, and thus it is possible to calculate directly the voltage impressed across loads having impedances other than the standard values of 50, 150 or 600 ohms.

Very careful shielding of the output transformer results in a hum level that is at least 70 db below the output level, or more than 100 db below zero level, whichever hum voltage is the larger.

**POWER SUPPLY:** The complete unit is powdered by a full-wave rectifier, consisting of a single 5U4G followed by a conventional filter. A voltage regulation system keeps the plate voltage constant on all the tubes and thus contrib-

within the limits specified after a brief warmup although a 30-minute interval is necessary if greatest accuracy is required.

The frequency is selected by a combination of the range switch and the frequency control dial previously described. In order to keep hum at a level as far below the output voltage as possible, it is desirable to set the amplitude control such that the reading on the vacuum

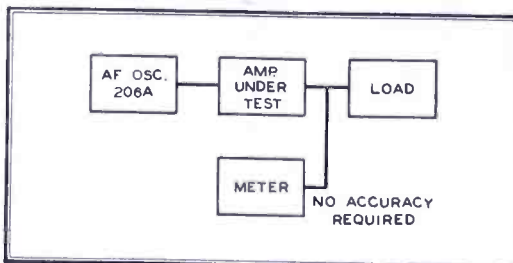

Fig. 8. Measurement of frequency response

tube voltmeter is +15 dbm. This is the maximum output level obtainable. Lower levels are obtained by inserting the necessary amount of attenuation. The level across the load is calculated as the algebraic readings of the vacuum tube voltmeter and the attenuator (considering the attenuator readings as minus). For

put voltage approximately 3 to 1, or an attenuation of 1 db reduces the voltage approximately 12%. Keeping these figures in mind, it is possible to calculate quickly the amount of attenuation required to obtain the exact output voltage desired without reference to charts or tables. For example, to select an output voltage of .005 volts the vacuum tube voltmeter should be set to 5.0 volts and the 10 db step attenuator should be set to 60 db.

Voltages at the 150-ohm impedance level and 50-ohm impedance level can be calculated by applying the proper multiplying factor. The factor for 150 ohms is 0.5 of the indicated voltage, and for 50 ohms it is 0.29.

It must be remembered that the output attenuator works properly and the calculated voltages are correct only when the instrument is matched to the proper resistive load. Before making any series of measurements, it is well to investigate the type of load into which the signal generator is operating. If the load is a resistive network, it may be possible to determine its value by the use of a simple ohmmeter. Usually, however, this is not the case, and it is necessary that the load be measured under dynamic conditions, that is, when operating with an AC voltage. The value of the load may be roughly checked by measuring the output voltage across the signal generator with a high impedance vacuum tube voltmeter under the condition of no load. Then, connect the load. This should cause the voltage to drop to exactly one-half of its original value. Normally, a test of this kind is made at a standard frequency of 1000 cycles.

In the event that it is not possible to supply a matched load, then it is necessary to calculate the actual voltage impressed across the input of the equipment. This is calculated by the formula:

$$E_L = \frac{E_o \times R_L}{R_L + 600}$$

Where:

$E_L$  = voltage across load

$E_o$  = measured open circuit load or VTVM reading  $\times 2$  (at 600 ohm level)

$R_L$  = load resistance

600 = the selected generator output impedance

This formula can be used for other settings of switch  $S_2$  by substituting the proper impedance for 600, i.e., either 150 or 50 ohms.

To estimate the load impedance, this formula can be rewritten as:

$$R_L = \frac{600 \times E_L}{E_o - E_L}$$

These formulas apply only when the load is resistive. There will be some error if a reactive component is present.

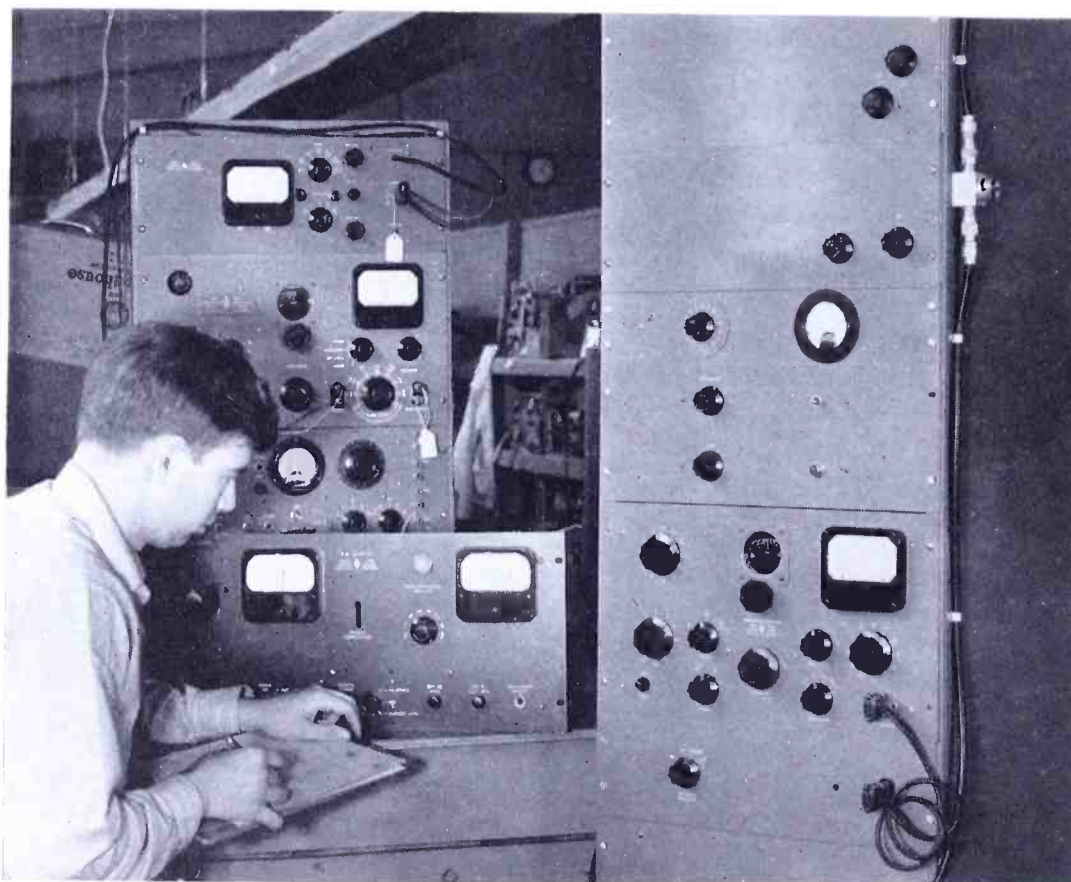

Fig. 9. Using the 206A generator to check modulation percentage on an FM monitor

utes to the frequency stability of the instrument, as well as reducing of the hum in the power supply voltage.

#### Application Data:

The instrument is ready for operation as soon as it is connected to 115 volts, 50-60 cycles, and after it has been allowed to warm up for a few minutes. The frequency calibration will be well

example, if a level of -20 dbm is required, the output attenuators should be set at 35 db (+15 -35 = -20).

For calculation of the voltage applied to 600-ohm loads, it is convenient to recall that attenuation of 20 db reduces the output voltage to 1/10. An attenuation of 40 db reduces it to 1/100, 60 db reduces it to 1/1000, and so on. Further, an attenuation of 10 db reduces the out-



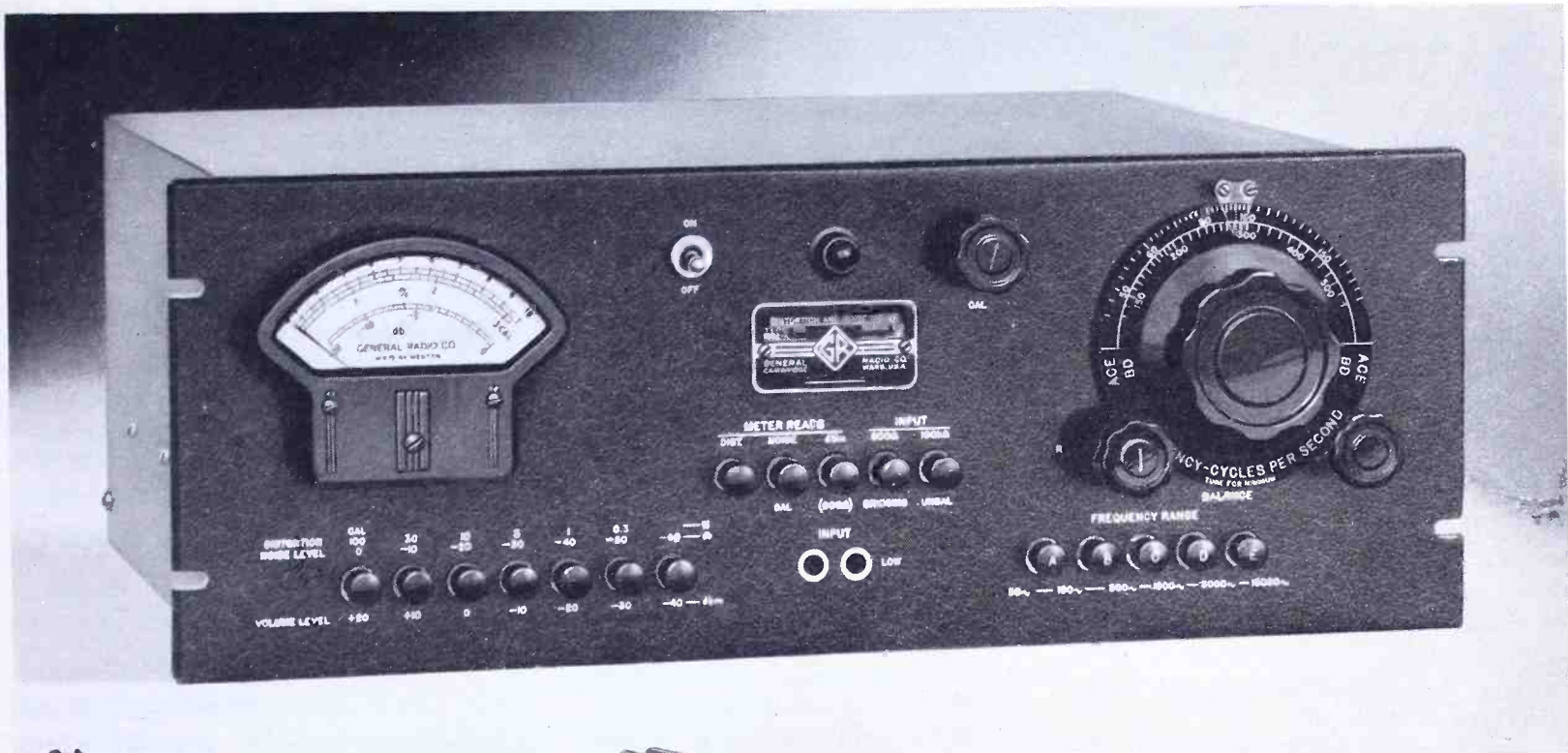

Type 1301-A Low-Distortion Oscillator

## Here's Your "PROOF-OF-PERFORMANCE"

AS ANNOUNCED by the Federal Communications Commission,\* effective August 1, 1949 all a-m and f-m broadcast stations will be required to make proof-of-performance checks of over-all noise and distortion of the complete station at least once a year.

Many stations already make these measurements at frequent intervals as routine operating maintenance to insure the continuous high-quality service the modern transmitter system is capable of supplying.

General Radio instruments for these measurements have been available for some time, and are in regular use by the leading stations where this equipment has given accurate, convenient-to-use and trouble-free service.

The G-R Type 1932-A Distortion and Noise Meter meets all of the F.C.C.'s requirements for measurements of this type for both a-m and f-m services; the Type 1301-A Low-Distortion Oscillator is the ideal companion unit for use with the Type 1932-A. Both of these instruments are relay-rack mounted and can be supplied in panel finishes to match most existing installations.

### TYPE 1932-A DISTORTION & NOISE METER

For measurements of sine-wave voltages, distortion and noise throughout the audio range. Over-all pass-band of the voltmeter circuit extends to 45,000 cycles, thus including all

\*F.C.C. Rules and Regulations, Sections 3.254 and 3.46, as amended



# GENERAL RADIO COMPANY

Cambridge 39, Massachusetts

90 West St., New York 6    920 S. Michigan Ave., Chicago 5    1000 N. Seward St., Los Angeles 38

noise and distortion products contained in this range; particularly the 3rd harmonic of a 15,000-cycle test is included.

This instrument is continuously adjustable and can be set to any frequency quickly since it has only one main tuning control plus a small trimmer. With it measurements can be made on a-f distortion in radio transmitters, line amplifiers, speech amplifiers, speech input equipment to lines; noise and hum levels of a-f amplifiers, wire lines to the transmitter, remote pick-up lines and other station equipment.

Full-scale deflections on the large meter read distortions of 0.3, 1, 3, 10 or 30 per cent; range for carrier noise measurements extends to 80 db below 100% modulation, or 80 db below an a-f signal of zero dbm level. The a-f range is 50 to 15,000 cycles, fundamental, for distortion measurements and 30 to 45,000 cycles for noise and hum.

Type 1932-A Distortion and Noise Meter: **\$575.00**

### TYPE 1301-A LOW-DISTORTION OSCILLATOR

Especially designed for rapid measurements, this highly-stable oscillator has exceptionally low distortion. By means of push buttons, 27 fixed frequencies between 20 and 15,000 cycles may be selected in logarithmic steps. Any frequency between steps can be obtained by plugging in external resistors. The distortion over the entire range will not exceed the following percentages: with 5,000-ohm output, 0.1% from 40 to 7,500 cycles; 0.15% at other frequencies. With 600-ohm output 0.1% from 40 to 7,500 cycles; 0.25% from 20 to 40 cycles and 0.15% above 7,500 cycles.

The oscillator is calibrated to within  $\pm(1\frac{1}{2}\% + 0.1 \text{ cycle})$ ; the calibration is not affected by changes in load or plate supply voltage; drift is less than 0.02% per hour after a few minutes operation. The operation of the oscillator is unaffected by ordinary climatic changes.

Type 1301-A Low Distortion Oscillator: **\$395.00**

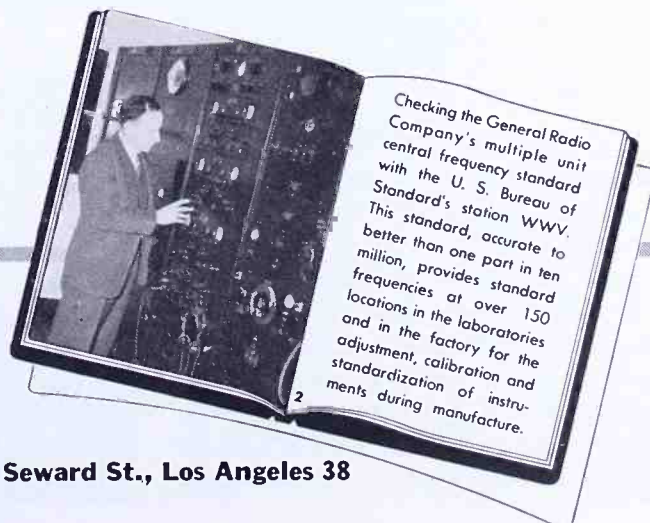

Checking the General Radio Company's multiple unit central frequency standard with the U. S. Bureau of Standard's station WWV. This standard, accurate to better than one part in ten million, provides standard frequencies at over 150 locations in the laboratories and in the factory for the adjustment, calibration and standardization of instruments during manufacture.



### Gain and Distortion:

Fig. 6 shows a typical setup to measure gain or audio distortion, with a photograph of the equipment in Fig. 7. Here, the model 206A is used in conjunction with a Hewlett-Packard 330B distortion analyzer. The only additional equipment required is an appropriate load on the amplifier or equipment under test. This usually is a simple resistance. To measure gain, only the vacuum tube voltmeter section of the 330B is employed. Then gain is simply calculated as the ratio of the output to input voltages, taking into account the impedance ratios. If the impedances are both the same, the gain is the simple ratio of output to input voltages. Where impedance levels differ, a correction should be made. In many cases, gain of the equipment is stated without reference to the impedance level, although this is not strictly a correct procedure.

### Frequency Response:

A typical test setup for measuring frequency response is shown in Fig. 8. The frequency is controlled by means of the main tuning dial and an auxiliary range switch. The total range covered is 20 to 20,000 cycles. The tuning dial is calibrated in cycles for the lowest frequency range, 20 to 200 cycles. The second range provides a 10 times multiplier and the frequency covered is 200 to 2,000 cycles, while the third range provides a multiplier of 100 and the frequency covered is 2,000 to 20,000 cycles. Thus, the instrument covers the complete audio spectrum continuously. It is possible to study in complete detail the frequency response, audio distortion, and transient response of a particular audio system. Hence, peaks or transient responses can be detected which might possibly go unnoticed if the analysis were limited to discreet steps of frequency.

The use of a continuously-variable generator is also valuable in the measurement of unknown frequencies. For example, a spurious frequency of oscillation occurring in an audio system can be compared with the audio signal generator frequency by means of an oscilloscope. This type of a measurement frequently gives a clue to the source of the spurious oscillation.

### Percentage of FM Modulation:

Measurements of the percentage modulation of an FM transmitter to calibrate the reading of the station modulation monitor, may be made employing the 206A. Fig. 9 shows the setup. The FM carrier in unmodulated condition is detected by means of a communications receiver, employing a beat frequency oscillator to give a beat note of a suitable pitch. This may be done at the carrier

frequency, or frequently it is more convenient to detect the carrier at the intermediate frequency employed in the discriminator circuit of the modulation monitor.

As sine-wave modulation is gradually applied to the transmitter. The amplitude of the transmitter carrier, and hence the receiver beat note output, will go through successive amplitude nulls. The combinations of nulls can be computed using the following relation:

$$\text{Mod. index} = \frac{\text{modulating frequency}}{\text{frequency swing}}$$

These values of modulation indices are given in the table below:

NULL NO.	MOD. INDEX
1	2.405
2	5.520
3	8.654
4	11.792
5	14.931
6	18.071
7	21.212
8	24.353
9	27.494
10	30.635

Thus, by selecting the proper frequency of the signal generator, a calibration point can be selected for any desired percentage of modulation, thereby checking exactly the calibration of the modulation monitor.

## TV IN SMALL CITIES

(Continued from page 26)

first video input in the switching system. This is to remove disturbances in the signal obtained from the network line, and to re-establish the proper sync-to-picture ratio before feeding the incoming remote into the transmitter. This amplifier utilizes clamp circuits to establish fixed levels for peak-of-sync and for black level. Other video inputs are equipped with mixing amplifiers to control gain of local video signals and to mix sync with these signals. Two inputs not used in this switching unit allow the subsequent addition of local studio or remote field pickup equipment, or both.

Facilities are provided in the turret for switching and monitoring any of the five audio channels. Gain controls are provided for each channel, with direct level-reading on the VU meter in the transmitter control section. Provision is made to permit the microphone channel to be mixed with any other of the four input channels.

By pressing the microphone button and the network button, for example, the microphone can be used to override the network for a station break. The audition switching bank of the turret is arranged in a similar manner. Audio signals contemplated for this system include the microphone in announce booth,

network sound, film sound, turntable, and one open input.

The system is quite flexible, due to accessibility of the audio and video jack panels. If an expansion of facilities is contemplated at some future time, provisions are available for switching two additional video inputs by adding stabilizing amplifiers and their power supplies. Fig. 3 shows the functional operation of both video and audio signals in the switching unit. Open provision for additional video can be seen in this diagram.

Five racks are used to provide entire video and audio power, equalization, stabilization and distribution, as shown in Fig. 7. The equipment contained in this bank of racks is so arranged as to leave space for the addition of one incoming video signal without additional rack requirements.

### Minimum Layouts:

The system layout for a secondary type television station which has been described represents a maximum of operating and programming flexibility at low cost.

However, this is by no means the minimum in equipment requirements for television operation. Many broadcasters have visualized virtual slave-station operations which would originate no local video signals, but only serve as repeaters for existing stations. Such a network-only operation would require merely the transmitter and antenna portions of the system described here. Operation of a film-only video outlet would also require less terminal equipment and program switching facilities.

It is considered, however, that in general the additional variety provided in a film-and-network operation will find wider acceptance than either an exclusive film or network type of operation. The Basic Buy, as outlined here, is a minimum operation as regards equipment and initial investment in a station for both film and network programming.

### Future Expansion:

The switching and distribution portion of the control system has open provisions for two additional video inputs to accommodate a very large degree of growth on the part of the individual station.

Similarly, the output of a standard two-camera image-orthicon chain can be fed into the existing system, either from a local studio or from a remote location, such as a ball park, civic auditorium, etc. Remote pickups are generally carried to the transmitter via microwave relay equipment but, in many cases, the use of an equalized-pair telephone line will further serve to follow the keynote of economy upon which this entire design has been based.



## Advertisers' Index

Adair, George P.....	10
Alden Products Company.....	9
Alford, Andrew .....	10
Altec Lansing Corp.....	39
Amy, Aceves & King, Co. Inc.	9
Bell Telephone Labs.....	35
Boonton Radio Corp.....	39
Camera Equipment Co.....	7
Collins Audio Products.....	9
Communications Research..... Corp .....	10
Daven Co., The.....	3
Davis, George C.....	10
Eitel-McCullough, Inc.....	40
Electrical Reactance Corp..... Inside Back Cover	
FM-TV .....	6, 11
General Radio Co.....	37
Graybar Electric Co.....	12
Harvey Radio Labs., Inc.....	11
Hewlett-Packard Co..... Inside Front Cover	
Hughey & Phillips Co.....	9
Jansky & Bailey.....	10
Kay Electric Co.....	9
Kear and Kennedy.....	10
Link Radio Corp.....	8
May Russell P.....	11
McCachren, Winfield Scott....	11
McIntosh, Frank H.....	10
McNary and Wrathall.....	10
Motorola, Inc.....	20, 21
National Co.....	4
No. American Philips Co. Inc. Back Cover	
Pollack, Dale.....	10
Radio Apparatus Corp.....	3
Radio Corp. of America.....	1
Radio Music Corp.....	9
Rangertone, Inc.....	9
Ray, Garo W.....	10
Smeby, Lynne C.....	11
Sylvania Electric Pdts., Ins....	5
Topflight Tape Co.....	9
Weldon & Carr.....	10
Western Electric Co.....	12
Williams, Nathan .....	11
Wilmotte, Raymond M.....	11
Workshop Associates, Inc.....	9
Zenith Radio Corp.....	2

**ALTEC  
LANSING**

*has the correct  
answers to your  
sound problems*

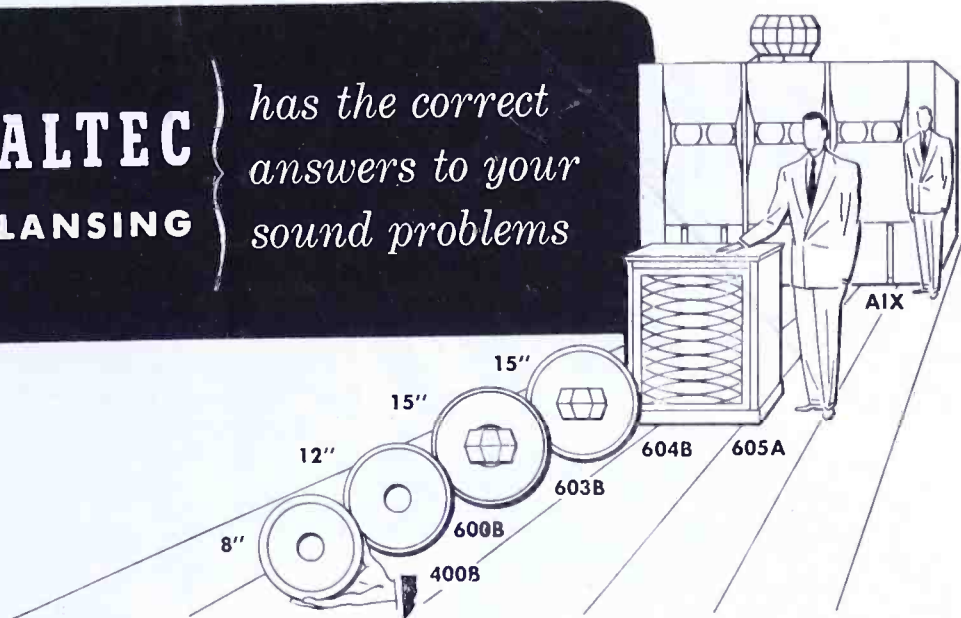

Regardless of your problem of high quality sound reproduction and distribution, you will find the solution with one or a combination of the highest quality units in the Altec Lansing line. From a small, efficient, 8-inch speaker to a huge industry approved theatre loudspeaker system, Altec Lansing manufactures over 25 different types and sizes of speakers and speaker systems. Each unit has been especially designed to adequately solve a specific sound problem. Thousands of Altec Lansing speakers are now in use in the motion picture, public address and radio in-

dustries. If your problems are sound, consult Altec Lansing. You will find the right answer to your sound problems.

*Write for descriptive brochure*



1161 N. Vine St., Hollywood 38, Cal.  
161 Sixth Ave., New York 13, N. Y.

## MEASUREMENT • TEST • CONTROL

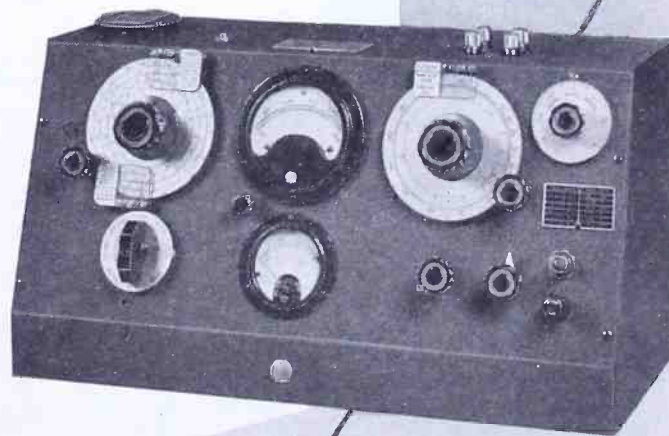

### 160-A Q METER

The 160-A Q-Meter is unexcelled for laboratory and development applications, having received world wide recognition as the outstanding instrument for measuring Q, inductance, and capacitance at radio frequencies.

Frequency Range: 50 kc. to 75 mc. (8 ranges)  
Q Measurement Range: 20 to 250 (20 to 625 with multiplier)  
Range of Main Q Capacitor: 30-450 mmf.  
Range of Vernier Q Capacitor: +3 mmf., zero, -3 mmf.



**BOONTON RADIO**

BOONTON • N. J. • U. S. A.

*Corporation*

*For further specifications and descriptive details, write for Catalog F*



Follow the Leaders to

**Eimac**  
TUBES  
The Power for R-F

# Skill

## HELPS BUILD BETTER VACUUM TUBES

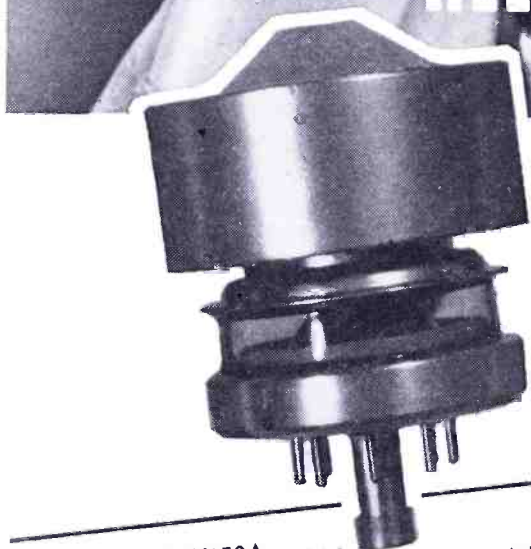

Skill in the form of old fashioned individual dexterity, teamed with modern manufacturing techniques, plays a very important part in the manufacture of better vacuum tubes . . . Eimac tubes.

Craftsmanship of Eimac employees is the result of years of training at one specific art . . . vacuum tube assembly . . . and the degree of proficiency they have attained is manifest in the quality of the product they produce.

Illustrated is the screen-grid assembly operation of the Eimac 4X150A tetrode. Precise geometric alignment of these parts provides the excellent electron beam action in the 4X150A. This operation is but one of over a hundred similar operations in the construction of this tube requiring the painstaking abilities of the Eimac craftsman.

### ABOUT THE 4X150A . . . . .

This extremely compact external anode type tetrode is capable of relatively high-output power at low plate voltage. It is intended for use as an r-f amplifier or oscillator. The 4X150A is used extensively as a wide-band amplifier for video and in single or multi-tube high-power ultra-high-frequency equipment. Good operational characteristics are maintained up to 950-Mc.

#### ELECTRICAL CHARACTERISTICS

Cathode: Coated Unipotential	6.0 volts
Heater Voltage	2.6 amperes
Heater Current	5.0
Screen-Grid Amplification Factor (Average)	
Direct Interelectrode Capacitances (Average)	
Grid-Plate (without shielding)	0.02 uuf.
Input	16.1 uuf.
Output	4.7 uuf.
Transconductance ( $i_b = 250$ ma., $e_b = 500$ v., $E_{c2} = 250$ v.)	12,000 umhos.

#### CLASS-C TELEGRAPHY OR FM TELEPHONY Maximum Ratings; (Frequencies up to 500 Mc.)

D-C Plate Voltage	1250 Max. Volts
D-C Screen Voltage	300 Max. Volts
D-C Grid Voltage	-250 Max. Volts
D-C Plate Current	250 Max. Ma.
Plate Dissipation	150 Max. Watts
Screen Dissipation	15 Max. Watts
Grid Dissipation	2 Max. Watts

Complete data available on request.

## EITEL-McCULLOUGH, INC.

728 San Mateo Ave., San Bruno, California

Export Agents: Frazar & Hansen, 301 Clay St., San Francisco, California



# HI-Q

## COMPONENTS

*Specified by*

The Leaders in Radio-TV & Communications

Emerson

FADA

Bendix Radio

Motorola

RAYTHEON  
BELMONT

Admiral

RCA VICTOR

Packard-Bell

Magnavox

Farnsworth

CROSLEY

Andrea

Tele-tone

DUMONT

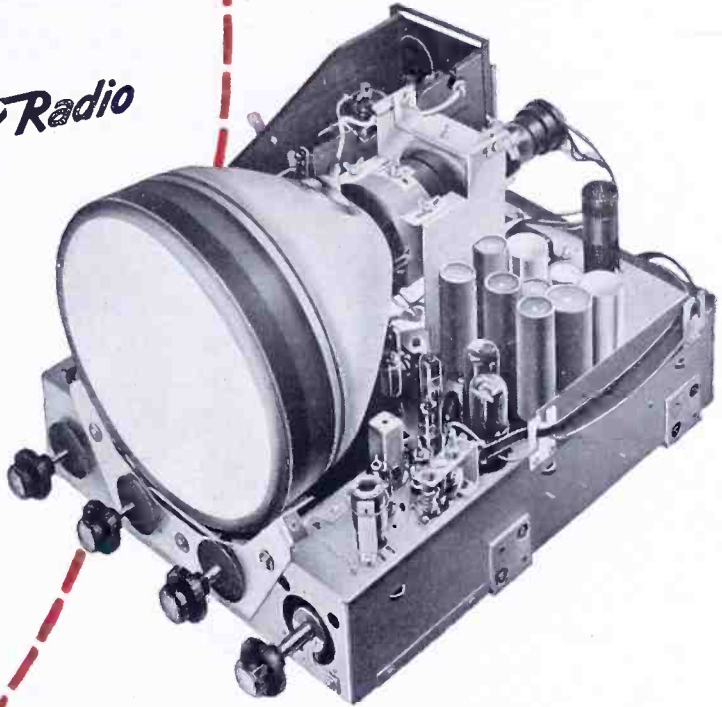

Chassis of the popular EMERSON Model 611 Television set. HI-Q components contribute their part to dependable operation.

—and many others too numerous to list in this limited space.

# HI-Q COMPONENTS

## BETTER 4 WAYS

**PRECISION** Tested step by step from raw material to finished product. Accuracy guaranteed to your specified tolerance.

**UNIFORMITY** Constancy of quality is maintained over entire production through continuous manufacturing controls.

**DEPENDABILITY** Interpret this factor in terms of your customers' satisfaction . . . Year after year of trouble-free performance. Our Hi-Q makes your product better.

**MINIATURIZATION** The smallest BIG VALUE components in the business make possible space saving factors which reduce your production costs . . . increase your profits.

Look at the leaders in Radio, Television and Communications, and you'll find they look to HI-Q for quality components.

HI-Q engineers have worked closely with many of these companies in the development of electronic components demanded by the ever changing circuits of modern electronics.

These same engineers with their wide experience are available to your company for confidential consultation. Write—wire—or phone. Three (3) plants exclusively devoted to the manufacture of ceramic capacitors, resistors and choke coils assure prompt delivery of your orders.

# HI-Q

## Electrical Reactance Corp.

FRANKLINVILLE, N. Y.

Plants: FRANKLINVILLE, N. Y.—JESSUP, PA.—MYRTLE BEACH, S. C.  
Sales Offices: NEW YORK, PHILADELPHIA, DETROIT, CHICAGO, LOS ANGELES



# Norelco PROTELGRAM

**LIFE-SIZE**  
*MORE*  
**LIFE-LIKE**  
*Television!*

... from this 2½" tube

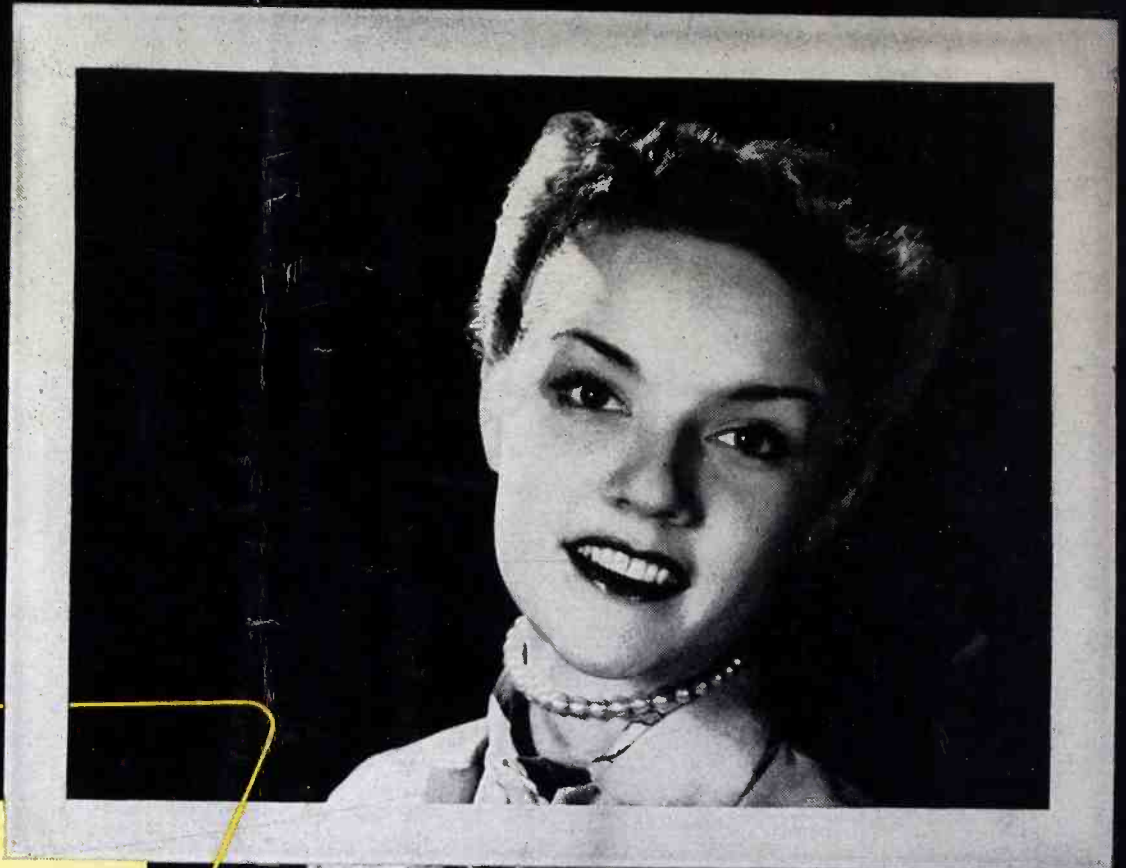

Chosen by these famous makers of quality projection TV receivers

**ANSLEY • EMERSON  
FADA • FISHER  
PILOT • SCOTT  
STEWART WARNER  
INTERNATIONAL  
TELEVISION  
BRUNSWICK**

*and others soon to be announced*

PROTELGRAM is the result of nearly fifteen years of research by the world's greatest electronics laboratories. This scientifically designed, optically correct projection system makes possible, for the first time, a life-size distortion-free picture of nearly 200 square inches (20" diagonal) ... a more life-like picture without glare or eyestrain. And from a tiny long-life, low-cost picture tube!

PROTELGRAM-equipped sets provide your finest profit opportunity for 1949 because they offer your customers what they want—a bigger, clearer picture that is easier on the eyes. Get the facts today from the above manufacturers on the outstanding sales and profit advantages of their PROTELGRAM-equipped receivers. Or write to Dept. PC-6, North American Philips Company, Inc., 100 East 42nd St., New York 17, N. Y.

**PROTELGRAM**

for  
life-size,  
more  
life-like  
television



*An Exclusive Development of*

**NORTH AMERICAN PHILIPS**