



# AND TELEVISION

Price 25 Cents

Oct. 1948

★ ★ *Edited by Milton B. Sleeper* ★ ★

**NEW TECHNIQUE FOR  
FM AND TV SHOWS**

SEE PAGES 8 AND 30



*8th Year of Service to Management and Engineering*

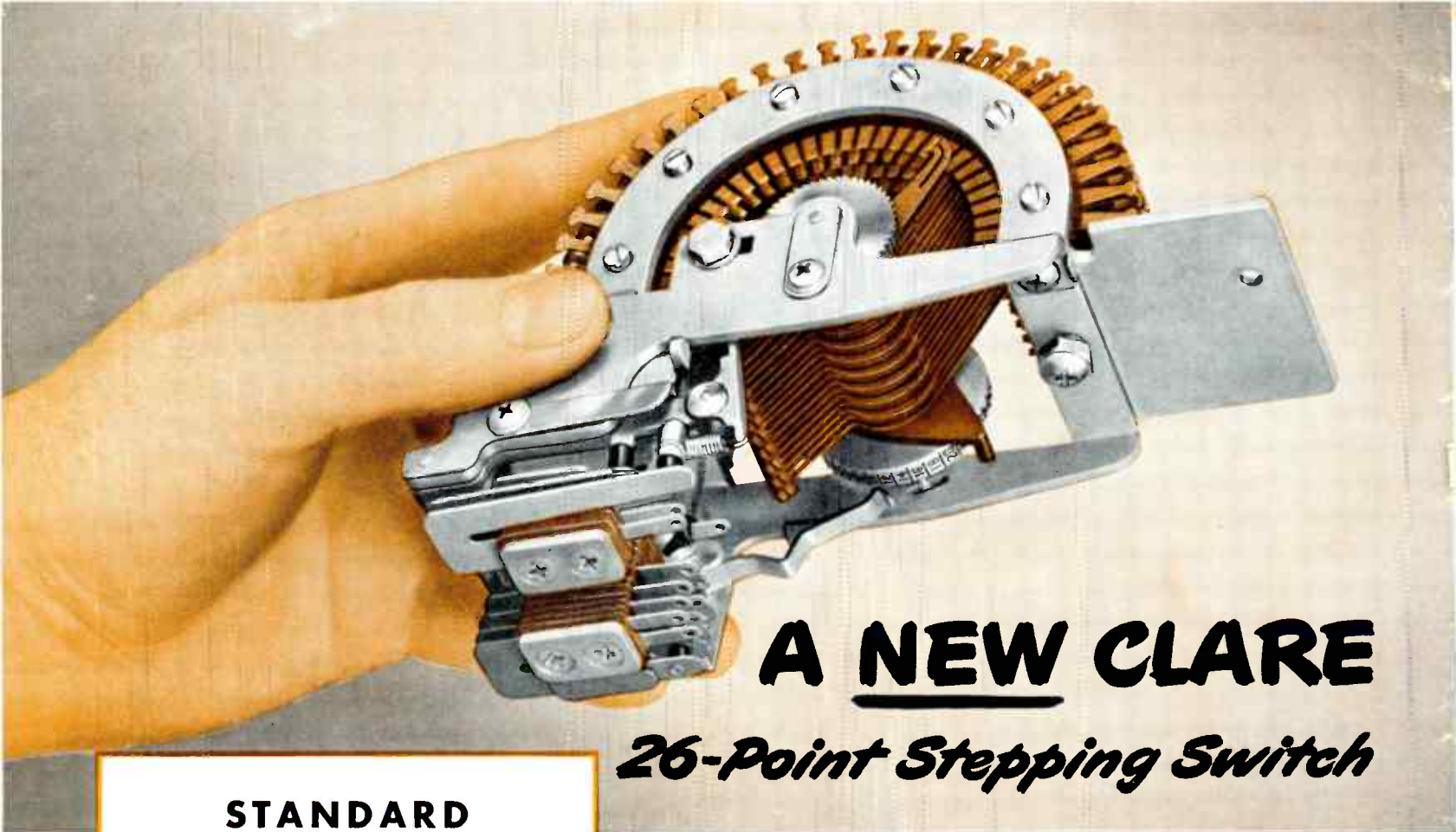

# **A NEW CLARE**

## *26-Point Stepping Switch*

### **STANDARD SPECIFICATIONS**

#### **OPERATION:**

Automatic (self-interrupting) or remote controlled.

#### **WIPERS:**

One to ten, traversing individual contact levels.

#### **INTERRUPTER SPRINGS:**

Form IB (to open the operating circuit at the end of each step). Contacts are single platinum-iridium.

#### **OPERATE SPEED:**

Remote controlled operation: maximum 30 steps per second. Self cycling operation: average 60 steps per second, with 48-volt power supply.

#### **FINISH:**

Framework and armature: cadmium; Bank contacts and wipers: phosphor bronze.

#### **MOUNTING:**

Frame drilled and tapped at each end to accommodate No. 8-32 mounting screw.

#### **DIMENSIONS:**

Overall length: 6-9/16 in.; width: 2-3/8 in.; height: 4-5/8 in.

#### **NET WEIGHT:**

27 oz., approximately.

#### **SHIPPING WEIGHT:**

4 lbs., approximately.

Write for Clare Bulletin 101 on complete details.

### **For Selection - Sequence Control - Counting - Totalizing**

Selection of any channel or circuit path from a total of 26 or 52 circuits is provided by this new CLARE Stepping Switch.

This selection may be at the rate of 30 steps per second on remote control—up to 60 steps per second on self-cycling operations. Operating at these speeds, the switch gives a minimum life of 5 million half-revolutions or 130 million stepping operations.

Each of the ten levels possible for the Type 26 Switch, or the five levels of the Type 52 Switch, is unit-molded in Bakelite. Hand positioning of individual contacts is thus eliminated, and each bank level is easily replaced if a contact becomes damaged in service.

In operation, a pair of double-ended wiper springs is stepped over each bank level of 180 degrees. One end of the wipers is engaged with the bank contact at all times, one end is always free of the bank. The stepping magnet may be remotely controlled or wipers may be stepped automatically by interrupting the magnet circuit through a pair of interrupter springs. As many as eight auxiliary interrupter springs may be provided for other control or signal functions.

Like many other CLARE developments, this new stepping switch was designed to meet a specific requirement . . . has provided an answer to others. Whatever your relay problem, it will pay you to submit it to CLARE. Sales engineers are located in principal cities for your convenience. Look in your classified telephone directory . . . or write to C. P. Clare & Co., 4719 West Sunnyside Ave., Chicago 30, Illinois. In Canada: Canadian Line Materials Ltd., Toronto 13. Cable address: CLARELAY.

## **CLARE RELAYS**

### **First in the Industrial Field**

... hallicrafters  
*proudly presents*  
the **SX-62**



Communications - type  
Broadcast Receiver  
540 KC to 110 MC

**\$289<sup>50</sup>**  
(slightly  
Higher West  
of Rockies)

**Beats Any Broadcast Receiver on Any Frequency.**

For discriminating listeners on all wave bands (FM/AM) . . . who appreciate the thrill of superior performance . . . who want dependability of reception with high-fidelity audio . . . who want a few extra controls but not too many.

An "SWL" version of our Famous SX-42. Two stages RF, three stages IF amplification. Temperature compensated, voltage regulated. Crystal filter. Built-in calibration oscillator. 14 tubes plus rectifier and voltage regulator.

WATCH FOR IT AT YOUR LOCAL HALLICRAFTERS DEALER  
. . . OR WRITE TO THE FACTORY BULLETIN S-215

**the hallicrafters co.**

4401 W. Fifth Avenue, Chicago 24, Illinois

**World leading manufacturers of precision radio and television equipment**

# AM · FM · TV RAYTHEON SPEECH EQUIPMENT

For the last word in complete, up-to-the-minute facilities  
... or simple, low-cost equipment to suit your limited requirements ...

## Look to RAYTHEON for All Your Needs

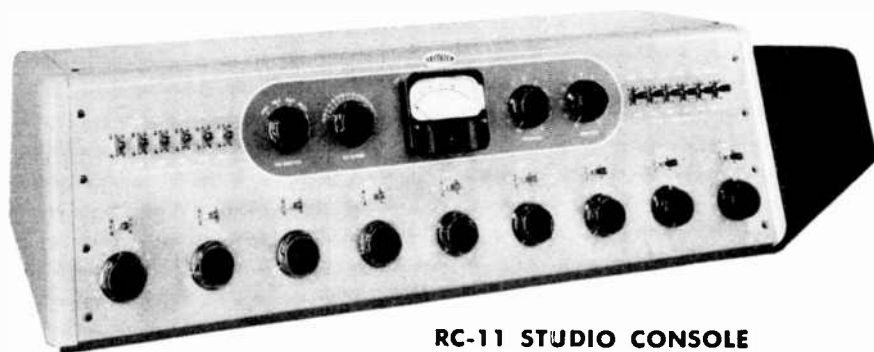

**RC-11 STUDIO CONSOLE**

**NOW WITH CUE POTS FOR TWO TURNTABLES**

Provides complete high-fidelity speech input facilities with all control, amplifying and monitoring equipment in one cabinet. Seven built-in pre-amplifiers, nine mixer positions, cue attenuators for two turntables. Simple, positive controls reduce operational errors. Frequency response—2 DB from 30 to 15,000 cycles; Distortion—less than 1% from 50 to 10,000 cycles; Noise Level—minus 65 DB's or better. Meets all FCC requirements for FM.



**RPC-40 PORTABLE CONSOLE**

Ideal for remote pickups yet complete enough to serve as a studio console. Four input channels for microphones or turntables, high level mixing, two output lines. Two RPC-40's interconnected provide 8-channel mixing—a feature of special interest to new TV stations planning future expansion.

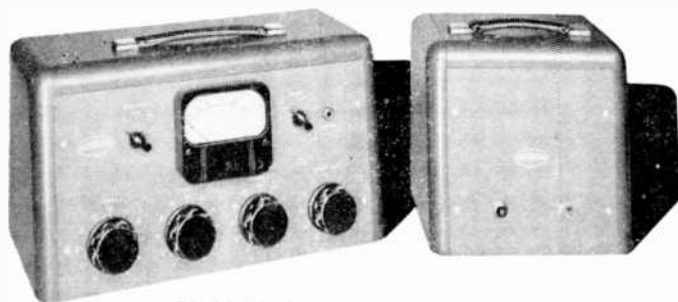

**RR-30 REMOTE AMPLIFIER 3 CHANNEL**

A lightweight, easy-to-carry combination of amplifier and power supply—simple and quick to set up. Provides three high-fidelity channels, excellent frequency response, high over-all gain.

**RR-10 REMOTE AMPLIFIER  
SINGLE CHANNEL**

A complete, self-contained unit with built-in power supply. An excellent low-cost amplifier for remote pickups requiring only one high-fidelity channel.



**RL-10 VOLUME LIMITER**

Engineered for high-fidelity AM, FM or TV speech input. Increases average percentage modulation without distortion.

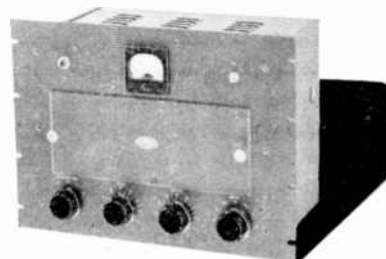

**RZ-10 FOUR-CHANNEL PRE-AMPLIFIER**

Four plug-in pre-amps plus a plug-in power supply, all in one handsome cabinet, provide maximum flexibility for a wide variety of high fidelity uses ... with turntables, high level microphones, as a booster amplifier, etc.

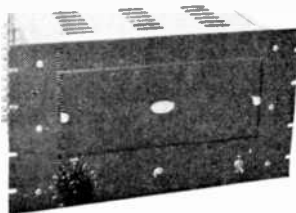

**RP-10 PROGRAM AMPLIFIER**

A high-fidelity, single-unit amplifier and power supply. Over-all gain, 65 db; frequency response flat from 30 to 15000 cps; distortion less than 2% at +30 vu. Designed for rack or cabinet mounting.

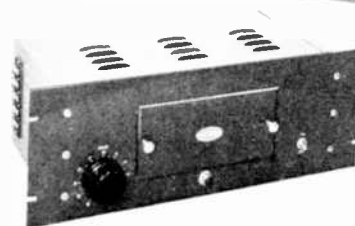

**RPL-10 LINE AMPLIFIER**

A single-control, two-stage amplifier featuring wide frequency response, low distortion, low noise level, freedom from RF pickup. Push-pull throughout. Mounts in standard rack or cabinet.

**RAYTHEON MANUFACTURING COMPANY**  
WALTHAM 54, MASSACHUSETTS

**EXPORT SALES AND SERVICE IN FOREIGN COUNTRIES**

Raytheon Manufacturing Company  
50 Broadway, New York 4, N. Y., WH. 3-4980



# AND TELEVISION

★ ★ Edited by Milton B. Sleeper ★ ★

Formerly, FM MAGAZINE and FM RADIO-ELECTRONICS

VOL. 8 OCTOBER, 1948 NO. 10

COPYRIGHT 1948, by Milton B. Sleeper

## CONTENTS

FM AND TELEVISION IS INDEXED REGULARLY BY ENGINEERING INDEX, INC.

### INDUSTRY NEWS

FM-AM-TV SET PRODUCTION BAROMETER <i>Compiled from figures released by the RMA</i> .....	4
WHAT'S NEW THIS MONTH	
1. FM AND TELEVISION starts its ninth year	
2. RCA'S merchandising setup for television .....	8

### FM BROADCASTING & COMMUNICATIONS

FCC VIEWS ON FUTURE PROGRESS <i>The Hon. Wayne Coy — An address at the annual convention of the FMA, at Chicago</i> .....	17
WHY FM PRODUCTION IS GOING UP <i>Lee McCann — Discussion of set production problems, explaining why more FM sets will be made in 1949</i> .....	19
CIRCUITS FOR SELECTIVE CALLING <i>C. M. Backer &amp; P. J. Breuster — Method of increasing efficiency of mobile telephone systems</i> .....	20

### TELEVISION

RCA-NBC VIEWS ON TV ALLOCATIONS <i>Elmer W. Engstrom — Statement presented at the FCC hearing on television allocations problems</i> .....	24
DU MONT PLAN FOR UPPER-BAND TV <i>Dr. Allen B. DuMont — Testimony at FCC hearing presents a plan to expand television service</i> .....	25
CUSTOM-BUILT PROJECTION RECEIVER <i>Gerard R. Francoeur — Description of a set assembled from wired and tested units</i> .....	26

### APPARATUS DESIGN

STEPPING-SWITCH OPERATION, Part I <i>T. L. Sipp — Data on the use of stepping switches for remote-controlled radio installations</i> .....	28
---	----

### AUDIO DEVELOPMENTS

30-10,000 CYCLES ON 16-MM. FILM <i>A. J. Maurer — Precision film recorder to give improved tone on programs filmed for television</i> .....	30
FUNCTIONAL DESIGN FOR REALISM <i>H. S. Morris — Improved audio quality eliminates problems of cabinet cost and styling</i> .....	32
FM FOR STORECASTING <i>Bernard J. Sullivan — Method of reaching captive audiences opens new market for equipment sales</i> .....	34

### SPECIAL DEPARTMENTS

Telenotes .....	6
Special Services Directory .....	10
Professional Directory .....	14
Spot News Notes .....	22
News Pictures .....	23
Classified Advertising .....	46

THE COVER DESIGN AND CONTENTS OF FM AND TELEVISION MAGAZINE ARE FULLY PROTECTED BY U. S. COPYRIGHTS, AND MUST NOT BE REPRODUCED IN ANY MANNER OR IN ANY FORM WITHOUT WRITTEN PERMISSION

MILTON B. SLEEPER, *Editor and Publisher*

CHARLES FOWLER, *Business Manager*      RICHARD H. LEE, *Advertising Manager*  
STELLA DUGGAN, *Production Manager*      LILLIAN BENDROSS, *Circulation Manager*

Published by: FM COMPANY

Publication Office: 264 Main St., Great Barrington, Mass. Tel. Great Barrington 500  
Advertising Department: 511 Fifth Avenue, New York 17, Tel. VA 6-2483

FM Magazine is issued on the 20th of each month.  
Single copies 25¢ — Yearly subscription in the U. S. A. \$3.00; foreign \$4.00. Subscriptions should be sent to FM Company, Great Barrington, Mass., or 511 Fifth Avenue, New York 17, N. Y.

Contributions will be neither acknowledged nor returned unless accompanied by adequate postage, packing, and directions, nor will FM Magazine be responsible for their safe handling in its office or in transit. Payments are made upon acceptance of final manuscripts.

Entered as second-class matter August 22, 1945, at the Post Office, Great Barrington, Mass., under the Act of March 3, 1879. Additional entry at the Post Office, Concord, N. H. Printed in the U. S. A.

MEMBER,  
AUDIT  
BUREAU OF  
CIRCULATIONS



World Radio History

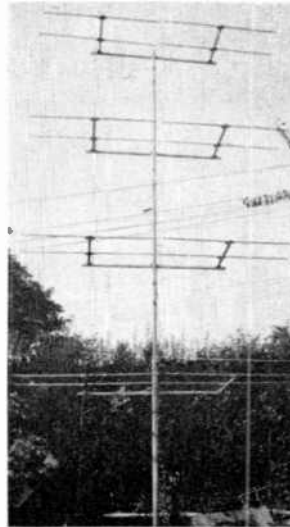

## 8, 16, 32 ELEMENTS for FM & TV BANDS

UP TO 91 TIMES  
POWER GAIN  
OVER A SINGLE  
FOLDED DIPOLE

Special beams peaked  
to order at any fre-  
quency, 30 to 500 mc.

Having trouble with a tele-channel? Install a Hoisington 16 or 32-element beam and see the improvement. Receives only in a narrow cone out front.

All-duralumin construction. No soft aluminum used. Extremely light. The 8-element beam on 150 mc. weighs only 4 pounds.

WRITE FOR ILLUSTRATED LITERATURE

**W. F. HOISINGTON**

U. H. F. RESONATOR COMPANY

GUION ROAD

RYE, NEW YORK

## A Message to Manufacturers of COMMUNICATIONS EQUIPMENT

YOUR advertising in the January Communications Directory issue of FM and TELEVISION will produce extra results per dollar because:

★ Over 1,500 additional circulation among purchasers of communications equipment.

★ It is the ONLY Directory of taxi, public utility, bus, truck, pipe line, highway maintenance, and geophysical communications systems.

★ These Directory issues are used throughout the communications field by owners, engineers, and supervisors.

NOTE: By permission, this Directory is newly compiled every year from FCC records, assuring up-to-date listings with addresses, frequencies, call letters, number of mobile units, and make of equipment used.

MAKE YOUR SPACE RESERVATION EARLY.  
ADVERTISING FORMS CLOSE DECEMBER 15

## FM and TELEVISION

Advertising Office

511 Fifth Avenue, New York 17, N. Y.

**NEVER BEFORE  
AT ANY PRICE**



**SUCH VHF  
VERSATILITY!**

**THE NEW  
NATIONAL HFS  
\$125**  
(power supply extra)

**Complete Coverage  
27 mcs-250 mcs!**

Covers all mobile communication services, as well as fixed services. Receives CW, AM OR FM! Superheterodyne with superregenerative 2nd detector.

**Mobile, Portable  
or Fixed!**

Operates from standard 110 volt, 60 cycle National 5886 power supply, National 6865 6-volt vibrator-type power supply or batteries! Built-in speaker. Light.

See your nearest National dealer listed in the classified section of your 'phone book.



# Set Production

AFTER a sharp drop in July as compared to June, set production in all categories made a substantial recovery during August. TV went up to the June level, FM climbed 20% above, and AM showed a gain, although lagging 20% below June. The exact figures appear on the Production Barometer here, compiled from data released by the RMA.

There is general agreement in the industry that the day of expensive AM receivers is over. From this time forward, \$29.95 will be the top list price for AM models other than automobile and portable types. In August, only 424,000 AM sets were produced for home use, and a considerable part of those went into the export trade. By the end of this year, it is considered probable that production of FM-AM and straight FM receivers will exceed that of AM sets.

As to dollar volume of sales, TV is probably in the lead at this time, with FM in second place, and AM following closely in third place. The net result

is a gain in dollar volume over 1947, but the actual figures are not disclosed by RMA.

No adverse effect on TV production is expected to result from the FCC's decision on September 29 to withhold action on pending TV applications until the completion of a new allocations study. Present markets can absorb all the sets for which picture-tubes will be available.

However, this situation, plus the waning demand for straight AM sets, is sure to encourage manufacturers and the dealers to put more emphasis on FM receivers. At the same time, broadcasters will work with the dealers to weed out models of inferior performance.

Meanwhile, manufacturers who have the necessary research facilities will be working feverishly on upper-band TV development. Considerable progress in that direction must be made, of course, before hearings can start on setting upper-band standards.

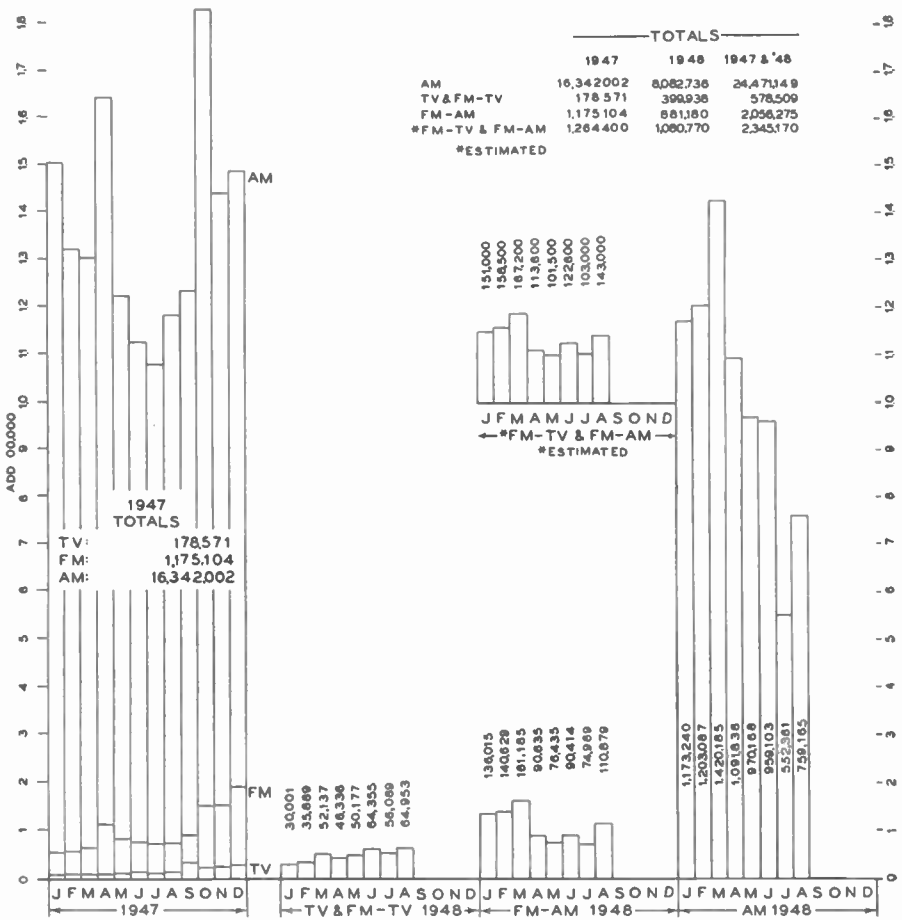

FM-AM-TV Set Production Barometer, based on monthly figures compiled by the RMA

Recommended for use under stringent conditions such as encountered in television, auto radio applications, and sets for export use.

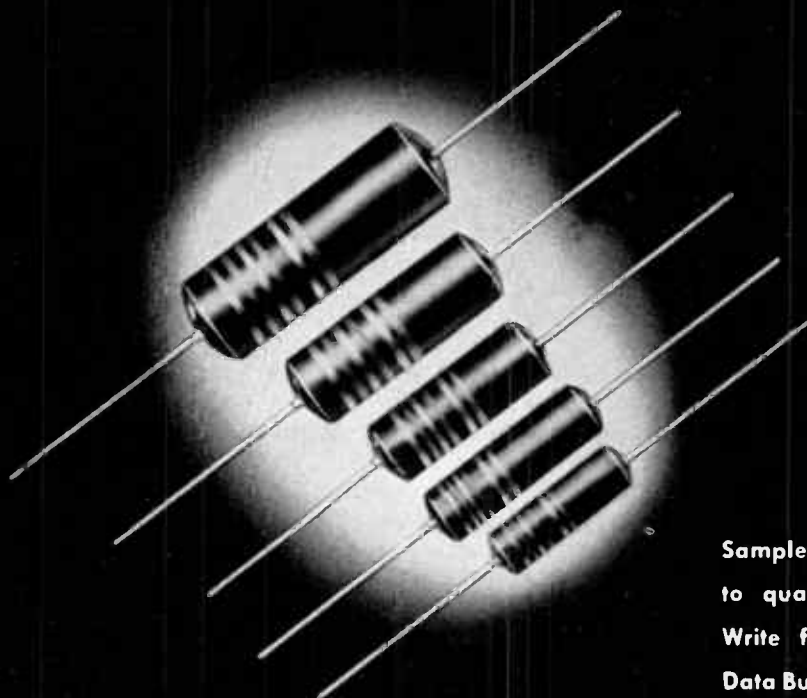

Samples on request to quantity users. Write for Sprague Data Bulletin 210 A.

**W**herever small, paper capacitors are required to operate under exacting conditions of heat, moisture or vibration, Sprague Phenolic Molded Tubulars are setting new, higher standards of efficiency.

SPRAGUE ELECTRIC COMPANY, NORTH ADAMS, MASS.

# SPRAGUE

PIONEERS OF

• Trademark Reg. U. S. Pat. Office

ELECTRIC AND ELECTRONIC PROGRESS

CAPACITORS • KOOLOHM RESISTORS

Want the  
MOST EFFICIENT  
TRANSMISSION LINE  
for Your Station?

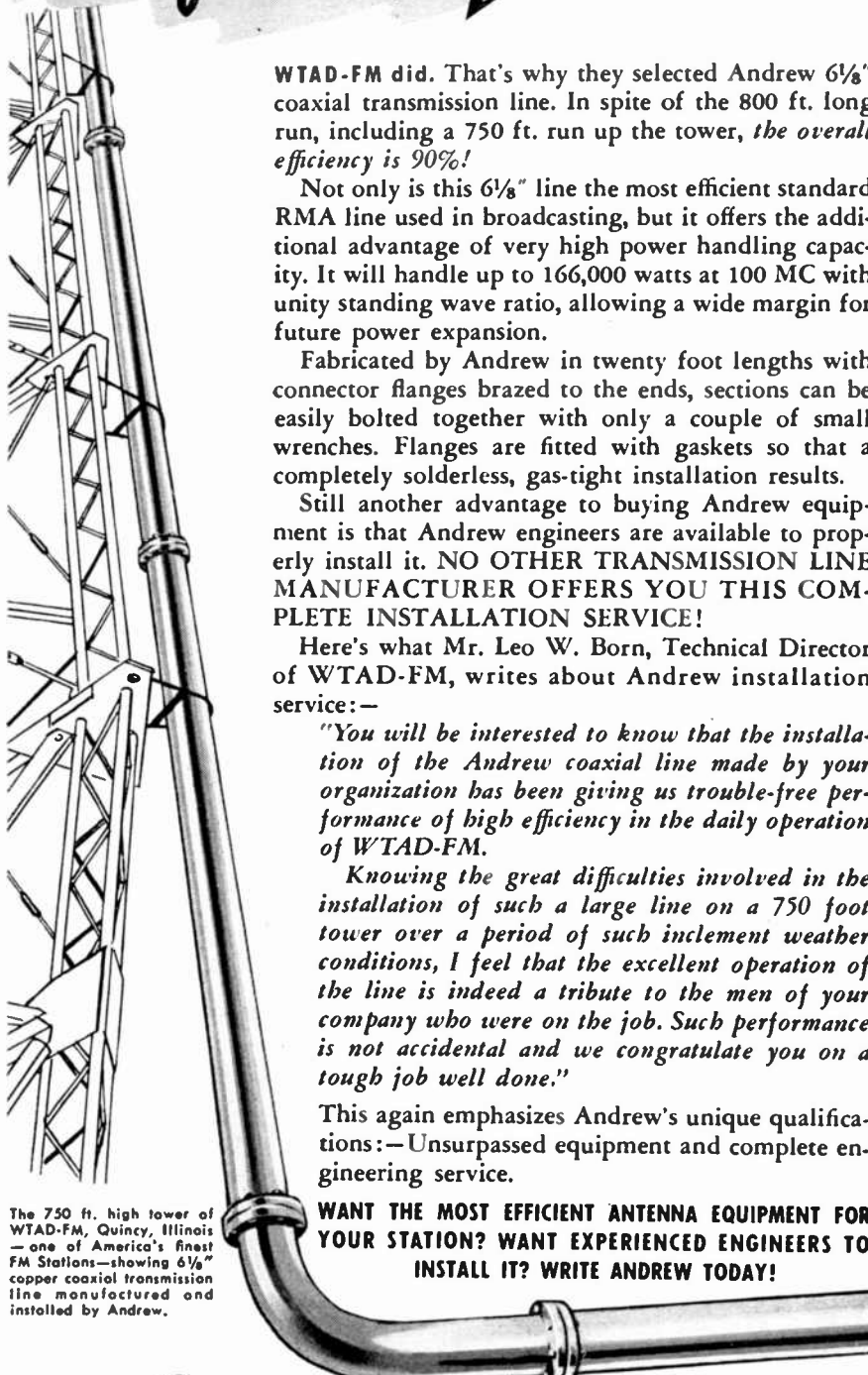

The 750 ft. high tower of WTAD-FM, Quincy, Illinois — one of America's finest FM Stations—showing 6 1/8" copper coaxial transmission line manufactured and installed by Andrew.

WTAD-FM did. That's why they selected Andrew 6 1/8" coaxial transmission line. In spite of the 800 ft. long run, including a 750 ft. run up the tower, the overall efficiency is 90%!

Not only is this 6 1/8" line the most efficient standard RMA line used in broadcasting, but it offers the additional advantage of very high power handling capacity. It will handle up to 166,000 watts at 100 MC with unity standing wave ratio, allowing a wide margin for future power expansion.

Fabricated by Andrew in twenty foot lengths with connector flanges brazed to the ends, sections can be easily bolted together with only a couple of small wrenches. Flanges are fitted with gaskets so that a completely solderless, gas-tight installation results.

Still another advantage to buying Andrew equipment is that Andrew engineers are available to properly install it. NO OTHER TRANSMISSION LINE MANUFACTURER OFFERS YOU THIS COMPLETE INSTALLATION SERVICE!

Here's what Mr. Leo W. Born, Technical Director of WTAD-FM, writes about Andrew installation service:—

*"You will be interested to know that the installation of the Andrew coaxial line made by your organization has been giving us trouble-free performance of high efficiency in the daily operation of WTAD-FM.*

*Knowing the great difficulties involved in the installation of such a large line on a 750 foot tower over a period of such inclement weather conditions, I feel that the excellent operation of the line is indeed a tribute to the men of your company who were on the job. Such performance is not accidental and we congratulate you on a tough job well done."*

This again emphasizes Andrew's unique qualifications:—Unsurpassed equipment and complete engineering service.

**WANT THE MOST EFFICIENT ANTENNA EQUIPMENT FOR YOUR STATION? WANT EXPERIENCED ENGINEERS TO INSTALL IT? WRITE ANDREW TODAY!**

**Andrew**  
CORPORATION

TRANSMISSION LINES  
ANTENNA EQUIPMENT

363 EAST 75TH STREET, CHICAGO 19 • EASTERN OFFICE: 421 SEVENTH AVENUE, NEW YORK CITY



**TBA Approves FCC Action:**

President Jack Poppele has announced approval by the directors of Television Broadcasters Association of the FCC decision to hold up new CP's until a new study of frequency allocations can be completed. Opinion is that "The study will undoubtedly result in better, interference-free reception by the ever-growing television audience."

**Full Daytime Schedule:**

WABD New York is now on the air from 7:00 A.M. to 6:00 P.M., Monday through Friday, from the Madison Avenue studio. Evening programs will originate at the Wanamaker studios. In addition to giving extra service to the TV audience, this will benefit dealers, since they can demonstrate sets at any time.

**New Studios:**

Television Workshop has moved into its new studios at 1780 Broadway, at 57th Street, New York City. Primarily intended for use by students, they will also be available to TV package groups, advertising agencies, and the local TV stations.

**New TV Service Plan:**

Effective October 15, RCA's owner contract for installation and service has been made optional. RCA service will still be available, but the contract modification affords dealers and service organizations trained and equipped for this work the opportunity of handling it when desired by the customer.

**WHTM, Rochester, N. Y.:**

Construction has been started on Stromberg-Carlson's TV transmitter on Pinnacle Hill. Transmission will start next June. New tower, located on best available spot in Rochester area, is designed to carry three TV antennas plus the WHFM radiator. Since two other TV channels have been allotted here, Stromberg is planning to share the use of its structure.

**Unauthorized Use TV Broadcasts:**

Very interesting analysis of legal status of TV reception in public places is presented in *Columbia Law Review*. Written by David M. Solinger, New York attorney, this piece reviews typical situations applying to taverns, hotels, and theatres where TV programs are presented without charge. There are 197 foot-note references to pertinent decisions and situations. Reprints can be obtained from *Columbia Law Review*, Columbia University, New York City.

FM AND TELEVISION



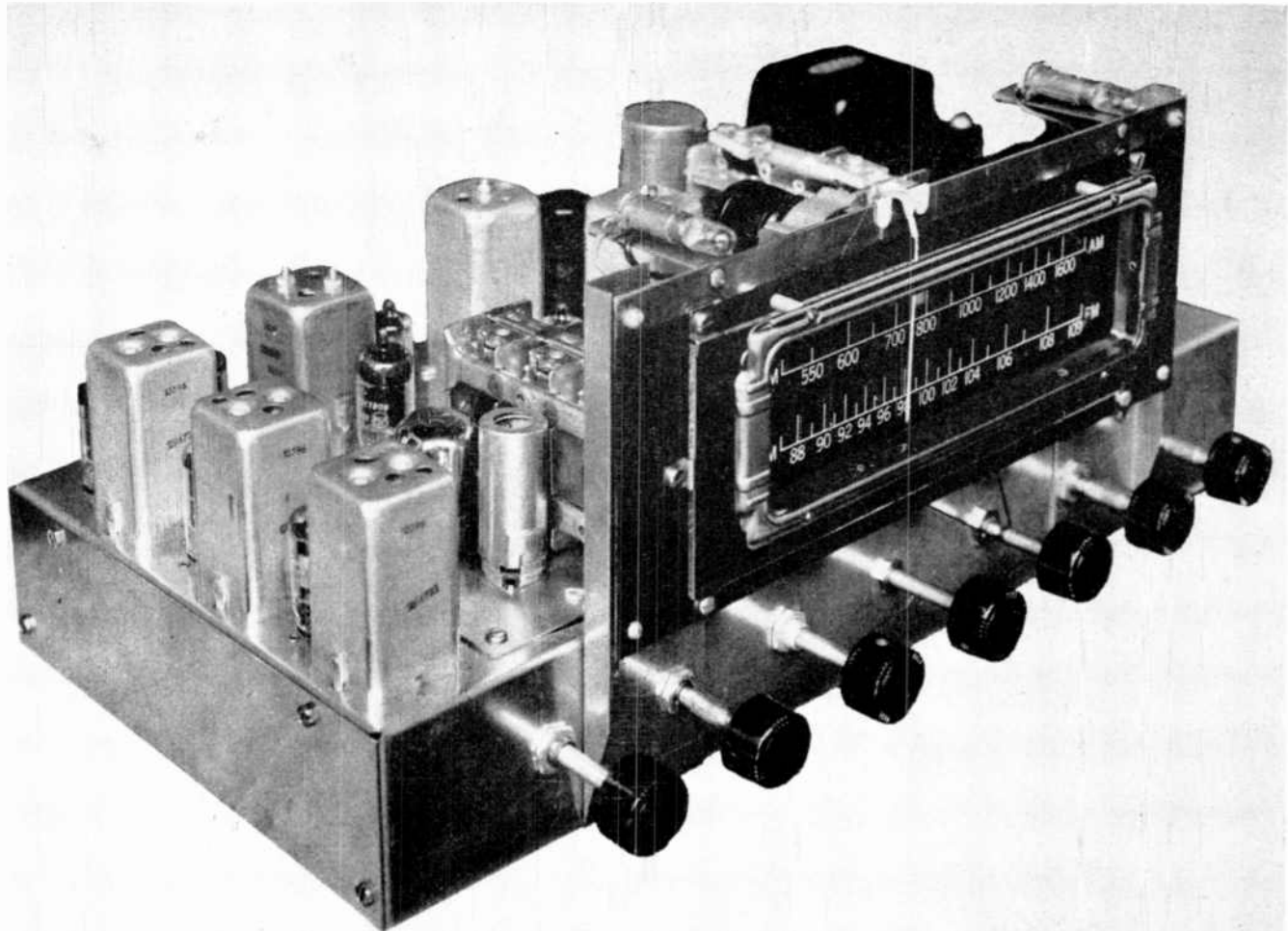

MODEL RJ-20 FM-AM TUNER WITH 2-STAGE AUDIO AND BUILT-IN POWER SUPPLY

## You Can Depend on **BROWNING** Tuners for **FM SENSITIVITY** and **STABILITY**

This completely new Model RJ-20 Tuner takes the lead in advanced FM-AM engineering. It embodies not only the latest refinements in RF, IF, and AF circuits, but the two paramount features of FM performance: *extreme sensitivity* and *absolute frequency stability*!

**SENSITIVITY** of the Model RJ-20 gives full FM noise-limiting action on signals of  $6\frac{1}{2}$  microvolts. This compares to 250 to 500 microvolts required for noise-limiting on some receivers now on the market.

**STABILITY** of the Model RJ-20 eliminates perceptible drift completely in less than one minute after the tuner is turned on.

To give you FM-AM performance at its very best, **BROWNING LABORATORIES** add such features as:

- ★ Separate RF and IF systems. No coil-switching is used to change from FM to AM.

- ★ Genuine Armstrong FM circuit, with dual limiters. This provides maximum protection against noise.

- ★ Variable IF bandwidth on AM gives selectivity adjustment of 4 kc. to 9 kc.

- ★ Two-stage audio system gives separate bass and treble boost controls up to 20 db.

- ★ Precise FM tuning is made easy, even on weak stations, by the use of the new 6AL7 tuning eye.

In short, if you are one of those supercritics, or if you have customers of that hard-to-please variety, the **BROWNING RJ-20** is the answer to every requirement of fine FM-AM performance. Instrument tests show this. Listening tests confirm it.

For complete circuit data and performance curves, write for Data Sheet FMT-10.

If you want to feed a separate high-fidelity system, use the **BROWNING RJ-12A** for FM-AM, or the **RV-10** for straight FM reception.



IN CANADA, ADDRESS:

MEASUREMENT ENGINEERING, LTD., ARNPRIOR, ONT.

# Crystals for the Critical

## STABILIZED CRYSTALS TO MEET EVERY NEED

Whatever your crystal needs, James Knights Co. is equipped to satisfy them quickly and economically.

To effect greater savings for you on short runs, a special production system has been established.

We are also equipped to quickly build "Stabilized" crystals to your exact specifications. In addition, James Knights Co. fabricates a complete line of "Stabilized" crystals to meet every ordinary need—precision built by the most modern methods and equipment.

For quality—speed—economy, contact the James Knights Co. You'll be glad you did!

*New James Knights Catalog on Request*

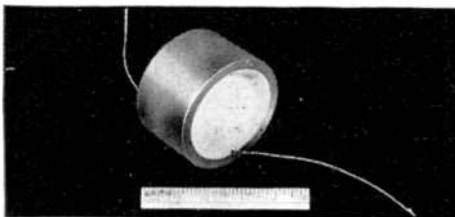

A university physicist wanted a 2" supersonic X-cut crystal. The James Knights Co. made it promptly and has since delivered many other special crystals for the same university.

**The JAMES KNIGHTS Co.**

SANDWICH, ILLINOIS



## THIS MONTH'S COVER

With the characteristic movie flicker eliminated on reception of TV film transmission, only the difference in audio tone quality distinguishes it from live programs. That movie-tone kind of audio is poor at best, and sometimes positively objectionable.

Now, however, TV may be on the way to correct that defect in the case of programs filmed for television broadcasting. At least, the new Maurer film-recording equipment promises to deliver sound-on-film quality that listeners will not be able to distinguish from original speech and music. This month's cover shows Mr. A. J. Maurer and his precision film recorder. For details, see page 30.



## WHAT'S NEW THIS MONTH

1. FM AND TELEVISION STARTS ITS NINTH YEAR
2. RCA'S MERCHANDISING SETUP FOR TELEVISION

1 With the next issue, this Magazine will start its ninth year of publication. That isn't such a long time, yet the radio industry's greatest progress occurred during that period. In November, 1940, when our first issue appeared, FM broadcasting had made a bare beginning. The first FM communications system had just been completed for the Connecticut State Police. Television was at a standstill, following its World's Fair debut.

Expansion in these three fields grew to record proportions in 1948. This year also marked our greatest increase in circulation. According to the Audit Bureau of Circulations, FM AND TELEVISION showed the highest gain of any ABC publication in our group.

Next month, as we start down the home stretch of our first ten years, you will note the addition of the new Audio Section. Also, you will see a change on the front cover, for we shall use TV in place of TELEVISION in the name of this Magazine. Henceforth, it will be FM AND TV.

Now, we would like to say a word of appreciation to our readers and advertisers for their loyal support of our efforts. In return, we shall undertake to make this Magazine of still greater usefulness during the coming months.

2 If you are interested in television, get a copy of *Fortune* for October, and read the article entitled "R.C.A.'s Television". This review of the \$50 million investment that RCA has made in television is well-written, accurate, and highly informative. Specifically, there is the account of RCA's merchandising plans: "It is in television too deeply to rely on its income from patent royalties and a median position in the sale of its own manufactured products. Its intentions may be judged from the fact that, of its total investment, about \$20 million has been spent for

plant and machinery that will turn out R.C.A. television receivers, tubes, and telecasting equipment.

"But then, R.C.A.'s manufacturing division never did lack machines. What it seemed to suffer from in radio's great days was a lack of men with merchandising flair. To correct this weakness, President Sarnoff, about five years ago, went off the reservation for a new kind of man to head up the R.C.A. Victor Division. He picked Frank M. Folsom, a square-built, plain-speaking extrovert with years of tough merchandising experience behind him. Folsom, then just finishing a tour of duty as Chief of Procurement for the Navy, knew the rudiments of manufacturing, but selling was his forte. He once was merchandising manager of Hale Brothers Stores in San Francisco, and he has a proud place among the bloody but unbowed alumni of Sewell Avery's Montgomery Ward & Co., where he was Vice President in charge of merchandising."

Our industry has a record of nearly thirty years of merchandising which, judged by the standards of other lines, has been consistently bad, and all of it based on the single formula of price competition. This has so pervaded the industry that the quality of AM radio reception has deteriorated steadily from year to year, and to those who have protested the deterioration, manufacturers have only offered the solace: Never mind. It may be worse, but it's cheaper!

This attitude has become so universal that, with the advent of FM as a means to overcome all the faults that have plagued radio listeners since the beginning of broadcasting, most of the manufacturers have kicked it around price-wise and otherwise until the FM performance of most models is hardly on a par with AM.

That is a dark inheritance for television. Probably no one appreciated the

*Continued on page 10*

FM AND TELEVISION



**for  
TV, -FM, and AM  
servicing**

**- your 3 finest basic testers**

On Model 266 Vacuum Tube Voltmeter, note these distinguishing Simpson features: the 1 volt range for full scale deflection, necessary in low R.F. voltage measurements, the zero center switch provided for discriminator circuit alignment, a feature which embraces all D.C. voltage ranges, D.C. volt input resistance ranges from 50 megohms to 200 megohms, A.C. volt input impedance at 60 cycles is 40 megohms. The low input capacitance of the probe (approximately 4 micro-microfarads) insures the accuracy essential for the high frequencies encountered in servicing FM and television receivers.

**Model 266  
Vacuum Tube  
Voltmeter  
for TV, FM, AM**



- RANGES:** Volts: (A.C. and D.C.) 0-1, 5, 10, 50, 100, 250, 500, 1000, 5000  
 Milliamperes: (D.C.) 0-1, 5, 10, 50, 100, 250, 500  
 Amperes: (D.C.) 0-10
- Ohms:** 0-100 (10 ohms center)  
 0-10,000 (100 ohms center)  
 0-100,000 (1000 ohms center)  
 0-1 megohm (10,000 ohms center)  
 0-10 megohms (100,000 ohms center)  
 0-100 megohms (1 megohm center)  
 0-1000 megohms (10 megohms center)

Size: 8 1/2" x 9 1/2" x 8" Dealer's Net Price complete with Operator's Manual..... **\$94.50**

Ask your jobber or send for literature.

**SIMPSON ELECTRIC COMPANY**  
 5200-5218 W. Kinzie St., Chicago 44, Ill.  
 In Canada: Bach-Simpson, Ltd., London, Ont.

**Simpson**  
 INSTRUMENTS THAT STAY ACCURATE



The Simpson Model 330 tests tubes in terms of PERCENTAGE of rated DYNAMIC MUTUAL CONDUCTANCE, a direct indication of tube performance with reference to the manufacturer's STANDARD MICROMHO rating. Shows tubes as good, fair, weak or definitely bad. When you have finished a tube test ONE BUTTON returns all switches to the normal position ready for the next test.

Size: 15 1/2" x 9 1/2" x 6 1/4"  
 Dealer's Net Price, complete with Operator's Manual. **\$132.50**

**Model 330 RCP  
Mutual Conductance  
Tube Tester  
for TV, FM, AM**



**Model 415-A Signal Generator for FM and AM.** Incorporates built-in sweep circuit for modern FM servicing. Frequency modulated signal with a sweep of 1 megacycle, more than adequate for all FM alignment. Internally modulated at either 60 cycles or 400 cycles or modulated from an external source. A 120 cycle saw-tooth voltage is available as scope synchronization or as actual scope sweep. AM bands cover complete frequency range from 75 KC to 130 MC.  
 For 105-130 volts, 50-60 cycle  
 Size: 5 5/8" x 11 3/8" x 15 1/8"  
 Dealer's Net Price, complete with Operator's Manual..... **\$145.00**



## Special Services Directory

### METHODS ENGINEERS

Materials & Methods engineers in America's leading manufacturing plants use Topflight's Printed Cellophane, Self - Adhesive Tapeto meet A-N specs, - assembly line - follow through - instruction labels. Easy to Apply.  
**TOPFLIGHT TAPE CO. YORK PA.**

### KAY ELECTRIC CO. INCORPORATED

Manufacturers of:  
 Television Test Equipment  
 Laboratory Instruments  
 Electronic Devices

14 Maple Avenue Pine Brook, N. J.  
 Tel. CAldwell 6-3710

### Custom-Built

### SPEECH INPUT EQUIPMENT U. S. Recording Co.

1121 Vermont Avenue  
 Washington 5, D. C.  
 District 1640

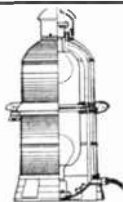

### "Guardian"

300 MM. CODE BEACONS  
 OBSTRUCTION LIGHTS  
 CODE FLASHERS  
 PACKAGED LIGHTING KITS

Send for Catalogue

**HUGHEY & PHILLIPS**  
 326 North La Cienega Blvd.  
 Los Angeles 36, Calif.

### HIGH QUALITY REPRODUCTION



ENGINEERING and PRODUCTION  
 The KLIPSCH SPEAKER SYSTEM  
 Standard and Custom Built Types for Private  
 Homes, Auditoriums, Hotels, Theatres

**BROCINER ELECTRONICS LABORATORY**  
 REgent 7-6794  
 1546-F SECOND AVENUE, NEW YORK 28

### RATES FOR PROFESSIONAL CARDS IN THIS DIRECTORY

\$12 Per Month for This Standard  
 Space. Orders Are Accepted  
 for 12 Insertions Only

## WHAT'S NEW THIS MONTH

Continued from page 8

situation better than David Sarnoff. Very likely, that is why he broke an RCA tradition and brought in an outsider to set new standards for TV merchandising. Here is *Fortune's* account of Frank Folsom's administration:

\* Not all of its present preeminence is due to its running start. Folsom is engaged in a real competitive merchandising program even though, in the industry's first flush, television receivers of all kinds appear to be walking off dealers' floors as fast as they can be produced. For one thing, Folsom is the kind of fellow who would be ashamed to be caught, at some future time, with a "dog" in his line. But more than that, RCA's basic merchandising policy in television is to produce, at the very outset, a sound, durable instrument that will make friends for television and will not be obsolescent the day after tomorrow.

The distinctive thing about television selling is the manufacturer's respect for the customer. It is a rare ear that is sensitive to the full register and tonal nuances of recorded or broadcast music, but any citizen with average eyesight is a first-class critic of television receptivity. If nothing else, the American's cultural heritage from Hollywood would have seen to that. So the minimum acceptable quality on a television receiver is very high compared with a radio receiver. This is only one of a dozen different ways in which the television business differs from the radio business. Indeed, Frank Folsom felt that his people had to unlearn almost everything they knew about merchandising radios and break away to a clean start in the art of tele selling.

RCA's view is that a television set is a complicated piece of precision machinery and that this point must not be lost sight of in the attempt to accommodate the product to mass-merchandising methods. Around the Camden shop today one hears more automobile than radio jargon. RCA speaks of its ten-inch model as the Ford of the television industry. When it gets into production, perhaps early next year, with its sixteen-inch metal-tube job, it believes it will have the Buick of the trade; and it has a big projection model, a la Cadillac, for prestige.

When the television market begins to level out, RCA will undoubtedly have to change some of its thinking and some of its models. When it started in television production, RCA had an idea that the seven-inch set might be the Ford, but it has now discontinued the model, although it still makes the tubes for other manufacturers. RCA has also tried to throw a block at lower-priced com-

Continued on page 14

## Special Services Directory

### FREQUENCY MEASURING SERVICE

Exact Measurements - at any time



RCA COMMUNICATIONS, INC.  
 64 Broad Street, New York 4, N. Y.

### THE WORKSHOP ASSOCIATES

INCORPORATED

Specialists in  
 High-Frequency Antennas

66 Needham St., Newton Highlands, Mass.  
 Bigelow 3330

### ELECTRONIC ENGINEERING MASTER INDEX

CONTAINS the most complete bibliography available on Frequency Modulation, Television, UHF, Broadcasting, Radar, and over 400 other topics.

1925-1945 edition.....\$17.50  
 1935-1945 edition.....\$ 7.50

Descriptive literature on request

ELECTRONICS RESEARCH PUBLISHING CO.  
 Dept. A 161 West 18th St., N. Y. 11

### COLLINS CUSTOM COMPONENTS

*The Very Finest*  
 FM TUNERS FM/AM TUNERS  
 FM RECEIVERS

Custom Matched Components

★ Collins ★

AUDIO PRODUCTS CO., INC.  
 P. O. Box 368 Westfield, N. J.

### RADIO-MUSIC CORP.

REPRODUCERS **R** TURNTABLES  
**M**  
 AMPLIFIERS **C** SPEAKERS

F. M. broadcast quality for custom sound  
 installations for the studio and the home.

PORT CHESTER, NEW YORK

### AMY, ACEVES & KING, INC.

Specialists in the  
 Design and Installation of

HIGH-GAIN  
 AM, FM, and TELEVISION  
 ANTENNA SYSTEMS

LONGacre 5-6622  
 11 West 42nd Street, New York 18, N. Y.

**This is actual  
SOUND-ON-FILM  
RECORDING  
performance**

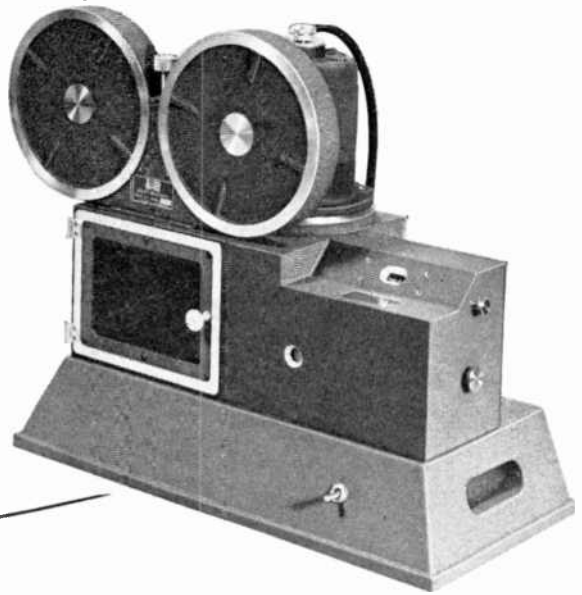

When you can secure the quality of results shown in these graphs, can you afford to use any recording equipment that does not approach such a standard?

On the basis of definite performance, the Maurer 16-mm Recording Optical System — the only postwar designed equipment of its kind on the market — is unrivaled in its field regardless of price.

And the Maurer 16-mm System has already been selected by two of the four major radio networks for their television requirements.

• • •

Anticipating a demand for finer quality of recording, including the higher frequencies, the Maurer Recording Optical System was designed to produce an extremely fine line image that makes possible the recording of frequencies beyond 10,000 cycles, with very low distortion. The galvanometer of the postwar Maurer Model 10 System is tuned to 12,000 cycles. This is the model that has been sold to the trade for two years.

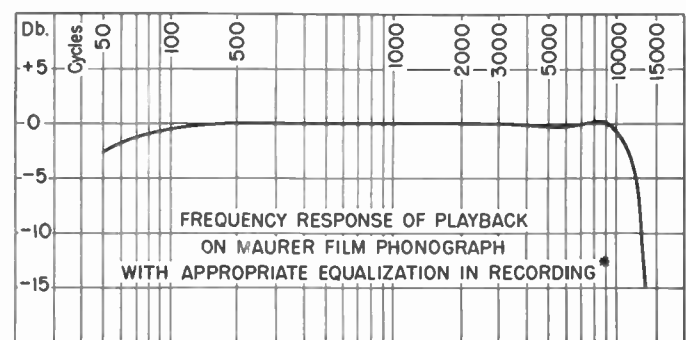
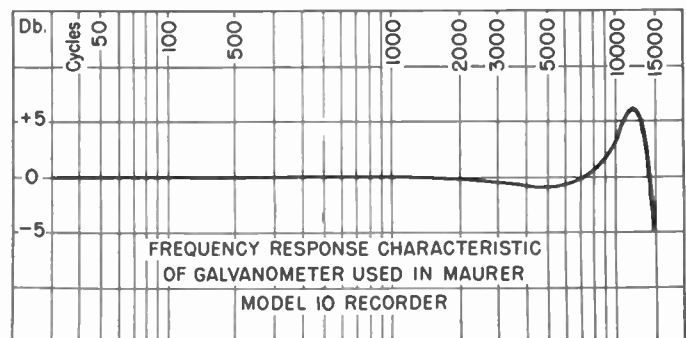

\*For those who may have been educated to believe that such a result is not possible with 16-mm film, we shall be glad to demonstrate that it not only is possible, but practical commercially NOW.

**16mm  
maurer**

**J. A. MAURER, INC.**

37-07 31st Street, Long Island City 1, N. Y.

Professional Motion Picture Cameras and Recording Equipment for the Production of Industrial, Educational and Training Films

a new family joins the sangamo tribe...



## New Dependability, New Long-Life Performance

Meet Sangamo Electrolytics, the newest family to become linked with the Sangamo Tribe. Introducing, from left to right on the opposite page, are illustrations of the "Chieftain", "Tomahawk", "Warrior", "Apache", and "Mohican". These newcomers now join the established tribe of Sangamo Micas, Silver Buttons, Papers, and Plastic Tubulars. Their heritage of dependability and long-life

performance stems from being built in a factory which was constructed *especially* and *exclusively* for the manufacture of contamination-free electrolytics. Their performance will meet and exceed the most stringent requirements of electronic applications. Yet, these new, high-quality capacitors are competitive in every respect from a standpoint of design, construction, and price.

Your own trial-use will convince you that new standards of dependability and longevity have been built into Sangamo Electrolytics. Order from the new Sangamo Electrolytic Capacitor Catalog No. 825F, which is yours for the asking, and without obligation.



Micas

Silver Buttons



Papers

Plastic Tubulars





SANGAMO

# electrolytic

## CAPACITORS

*Chieftain*



*Tomahawk*



*Warrior*



*Apache*



*Mohican*



# SANGAMO

ELECTRIC COMPANY

SPRINGFIELD, ILLINOIS

## Professional Directory

**Jansky & Bailey**

AN ORGANIZATION OF  
*Qualified Radio Engineers*  
DEDICATED TO THE  
**SERVICE OF BROADCASTING**

National Press Bldg., Washington, D. C.



**Andrew Corporation**

*Consulting Radio Engineers*  
**363 EAST 75th STREET, CHICAGO 19**  
Triangle 4400

**GARO W. RAY**

*Consulting Radio & Television Engineers*

991 BROAD STREET  
BRIDGEPORT 3, CONN.  
Phones — 5-2055 & 7-2465

**ANDREW ALFORD**

*Consulting Engineers*  
**ANTENNAS & RF CIRCUITS**

Laboratory and Plant:  
299 Atlantic Ave., Boston 10, Mass.  
Phone: Hancock 6-2339

**DALE POLLACK**

**FREQUENCY MODULATION**

development and research  
transmitters, receivers  
communications systems

352 Pequot Avenue New London, Conn.  
New London, 2-4824

Preliminary surveys, management and operational consulting service based on practical experience with AM, FM and Facsimile.

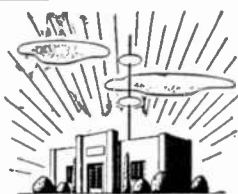

Phone: Executive 3929

**RADIO CONSULTANTS, Inc.**  
1010 VERMONT AVE., WASHINGTON 5, D. C.

## WHAT'S NEW THIS MONTH

Continued from page 10

petitors by bringing out for \$325 a ten-inch model that has only twenty-one tubes compared with the \$375 receiver's thirty. But the cheaper model sometimes fails to present a good picture if the sending station is more than twenty or twenty-five miles away. This points up another striking difference between video and radio: manufacturers like RCA and Du Mont claim that you can't, at this stage of the game anyway, cheapen a television receiver to any extent without coming down the scale rather dangerously in quality. They don't believe that the corner cutters can do in television what they did in radio. Like everybody else, RCA has made some mistakes, but the important thing is that it displayed imagination and intelligence in gauging an unknown market, and shot into mass production on a product worthy of the monogram. If it meets subsequent challenges as well, it will do all right.

Perhaps the boldest feature in Frank Folsom's program is the RCA service contract. Believing that the best television receiver in the world may prove a bust if the delicate installation job isn't done properly, RCA insists that its own service company, and not the dealer, perform this function and also service the instrument for the duration of the year's warranty. The dealer may dislike this arrangement, but it is almost impossible for him to escape it. He pays the service fee when he pays the distributor for the set. This fee starts at \$55 for a standard table-model installation, with added charges for larger sets and special installations in more difficult or distant zones where it is hard to get a strong signal.

Naturally, this upsets tradition in the radio-servicing field. Most competitors of RCA think it will put a brake on sales. They point to the fatal delays in installation and repairs that might occur when the RCA Service Co. is forced to attempt this job on a nationwide scale. And they predict that dealers will eventually resent the loss of contact with the customer that the system entails. But RCA responds that thus far the plan has been greatly appreciated by consumers and by dealers as well, and that it is helping to lay a sound foundation for the television industry. Such service is particularly required in these early days of telecasting when the introduction of each new station, or channel, usually requires a skillful adjustment of the antenna to assure complete reception free from interference. RCA has hiked its television-service personnel to 2,200 men, and claims to be able to install within three days of purchase. As a

Concluded on page 15

## Professional Directory

**RAYMOND M. WILMOTTE Inc.**

*Paul A. deMars*  
Associate

*Consulting Engineers*  
*Radio & Electronics*

1469 Church St., N. W. Decatur 1234  
Washington 5, D. C.

**RUSSELL P. MAY**

**CONSULTING RADIO ENGINEERS**

★ ★ ★

1422 F Street, N. W. Wash. 4, D. C.  
Kellogg Building Republic 3984

**LYNNE C. SMEBY**

*Consulting*  
*Radio Engineers*

820 13th St., N.W. EX 8073  
WASHINGTON 5, D. C.

CONSULTING  
RADIO ENGINEERS

**DIXIE B. MCKEY**  
&  
**ASSOCIATES**

1820 JEFFERSON PLACE, N.W. Republic 7236  
WASHINGTON 6, D. C. Republic 8296

**RATES FOR  
PROFESSIONAL CARDS  
IN THIS DIRECTORY**

\$12 Per Month for This Standard  
Space. Orders Are Accepted  
for 12 Insertions Only

**NATHAN  
WILLIAMS**  
FM TV AM  
*Consulting Engineer*



Phone: Bl'khawk 22

20 Algoma Blvd.  
Oshkosh, Wis.



## Professional Directory

**FRANK H.  
McINTOSH**

Consulting Radio Engineers  
710 14th St. N.W., Wash. 5, D. C.  
MEtropolitan 4477

### WELDON & CARR CONSULTING RADIO ENGINEERS

Washington, D. C.  
1605 Connecticut Ave. MI. 4151  
Dallas, Texas  
1728 Wood St. Riverside 3611

### COMMUNICATIONS RESEARCH CORPORATION

System Planning—Engineering  
Research & Development  
FM—TV—Facsimile  
VHF Communications

60 E. 42nd St., New York 17, N. Y.  
Mu 2-7259

### REFERENCE DATA

Bound volumes of *FM* and *TELEVISION* contain a wealth of engineering and patent material. Each volume contains 6 issues, starting with January or July. They are available back to July 1941. Price \$5.50. By mail, 25c extra.



Radio Engineering Consultants,  
Frequency Monitoring

### Commercial Radio Equip. Co.

International Building • Washington, D. C.  
603 Porter Building • Kansas City, Mo.

### WINFIELD SCOTT McCACHREN AND ASSOCIATES

Consulting Radio Engineers  
TELEVISION SPECIALISTS

PHILADELPHIA: 410 BOND BUILDING  
809B Windemere Ave. Washington, D. C.  
Draxel Hill, Pa. District 6923  
Sunset 2537-W

## WHAT'S NEW THIS MONTH

Continued from page 14

matter of fact, every responsible television manufacturer realizes that top-flight service is all-important in television selling. Philco, for example, has set up a school for training its dealers' service personnel. Philco believes that this will answer the need for proper installations now, and that in two or three years' time the dealer will be happy to be in a position to capitalize on the service business that will be available.

Time will tell who is right on this issue. RCA may want to step away from the practice after the industry has passed its growing pains and technical knowledge is more widespread. And then again it may not. The system is a strong one for creating brand loyalty among consumers, and ties in with Folsom's long-range aims for merchandising his television sets along the lines of Detroit automobile selling. As far as practicable, RCA is trying to project its merchandising methods right on through the distributors and dealers. The latter are urged to carry the RCA line in its entirety - to cash in on RCA's heavy advertising and promotional program, and to gun for profits on volume sales of RCA television rather than scatter their efforts on a variety of lines. \*

That is *Fortune's* summary of TV merchandising as set up at RCA by Mr. Folsom. It presents a brand new kind of competition for the rest of the industry. It is competition based on "the manufacturer's respect for the customer", a relation that is as old as selling, but completely new to radio.

But there is a statement in the *Fortune* piece that calls for special consideration: "So the minimum acceptable quality on a television receiver is very high compared to a radio receiver."

Now, as we have learned from movie-audience reaction, minimum acceptable picture quality is essentially that which permits the spectator to feel that he is witnessing the original action.

Should the standard of audio reception be lower than that which permits the listener to feel that he is hearing the original speech and music? Audio, like video broadcasting, is an entertainment service. Should we respect the eyes and offend the ears? As the quality of audio reproduction is debased, its entertainment value diminishes to the point where the program ceases to amuse. Then radio becomes a dam' nuisance, as it is known in many homes today.

Frank Folsom has pointed the way to revitalizing audio entertainment, and to reorienting industry attitude toward radio listening. The public *should* have the best the industry can produce in both FM and TV.

## Professional Directory

### McNARY & WRATHALL CONSULTING RADIO ENGINEERS

★ ★ ★

983 National Press Bldg. DI. 1205  
Washington, D. C.

### KEAR & KENNEDY

Consulting Radio Engineers

1703 K St. N.W. STerling 7932  
Washington, D. C.

### GEORGE P. ADAIR

Consulting Engineers

Radio, Communications, Electronics  
1833 M St., N.W., Washington 6, D.C.  
EXecutive 1230

### GEORGE C. DAVIS

Consulting Radio Engineers

501-514 Munsey Bldg. — District 8456  
Washington 4, D. C.

WATKINS 9-9117-8-9

### S. A. Barone Co.

Consulting Engineers

MECHANICAL—RADIO—ELECTRONIC  
PRODUCT DEVELOPMENT & RESEARCH

Development Specialists In Circuits, Part  
Lists, Models, Manufacturing Drawings.

143-145 W. 22ND STREET, NEW YORK 11

### RATES FOR PROFESSIONAL CARDS IN THIS DIRECTORY

•  
\$12 Per Month for This Standard  
Space. Orders Are Accepted  
for 12 Insertions Only

T W X

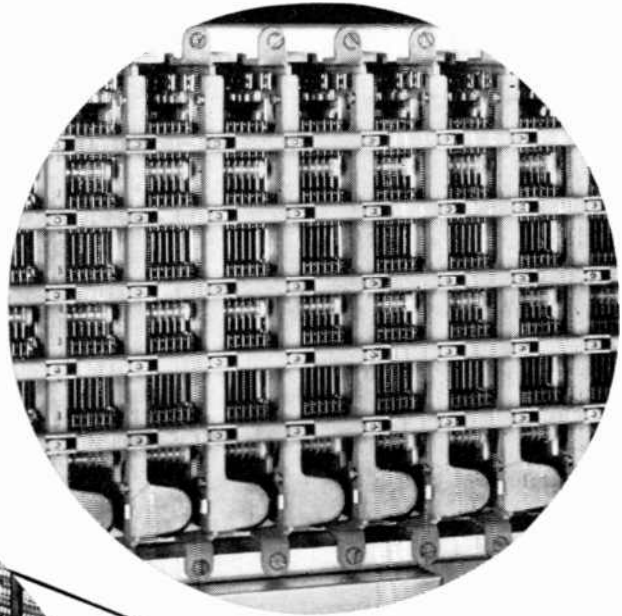

*Switches in small offices do a distant operator's bidding.*



## IT TALKS WITH FINGERS

For those who want to talk, Bell Laboratories scientists developed the telephone. For those who prefer the typewritten message, they developed TWX — Teletypewriter Exchange Service.

Fingers on a keyboard send your message to be typed by one or scores of other teletypewriters selected at your request from the 21,000 instruments connected to the Bell System's nationwide TWX network.

As in telephone service, your TWX connection is set up through switching systems, manual or mechanical, as best may serve. And over long distances your message travels economically with many others on the same pair of wires. All these technics are products of Bell Telephone Laboratories research in the telephone art.

TWX is today a vital link in the nation's chain of communication. And year by year it benefits from the steady growth of the telephone system which carries it.



### BELL TELEPHONE LABORATORIES

PIONEERS IN THE RESEARCH OF FM RADIO AND TELEVISION, AND ACTIVE IN DEVELOPING IMPROVEMENTS IN BOTH FIELDS TODAY.

# A VIEW OF THE FM-TV SITUATION

HERE IS AN UP-TO-DATE APPRAISAL OF THE FM AND TV SITUATION, PRESENTED AT THE CHICAGO CONFERENCE OF THE FM ASSOCIATION — *By* THE HON. WAYNE COY \*

A LOT of my friends have asked me why I ever took this job as Chairman of FCC. I tell them that I do not know. At this point, after some nine months of service in that job, I know even less about why I took it.

I was asked the other day, in a meeting when I was talking off the cuff, where FM fits in with future broadcasting. As in the answer to the question of why I took over the Chairmanship of FCC, I don't know the answer to this one either. Any answer I give to that question must of necessity be my own opinion. Any opinion that I would have about this subject would probably not be shared by others; and I take it from what I have heard expressed by some of you in attendance at this meeting that you are no more certain than I.

I think it can correctly be stated that it is the future of broadcasting itself that we are uncertain about, not just where FM fits into the picture. When you ask me to answer the question, I remind you that you are asking me to supply you with clear-cut, definitive answers about a situation which, as far as I am concerned, is bristling with question marks. Certainly I know no more than you; sometimes I am sure that I know less, and you will probably agree with me on that latter statement.

There is no blueprint for the future; in fact, we may not be able at this moment to prepare such a blueprint, but in doing the preparatory work that goes in the blueprint we can, I believe, find the answer to FM's role in our future broadcasting system.

What will be the ingredients of our future broadcasting system? Certainly they will be sight, sound and the printed message; television, sound broadcasting and facsimile.

The need for all your people to have a broadcasting service with choices of program service, if possible, must be paramount in our planning for any future broadcast service, and we cannot ignore the economics, the question of support for these stations, if we are to serve all our people.

If people were distributed equally throughout the country, the problem might be easier to answer, but I doubt it very much. They would just turn around and move back to the cities.

The impact of television on our future broadcasting system will be grave: how grave, I do not know and I do not know anyone who does, but it will be terrific.

\* Chairman, Federal Communications Commission, Washington, D. C.

I am quite sure that you broadcasters are just as concerned about this creature of science as are the motion picture producers, sports promoters, and newspaper publishers.

Today, there are only thirty-seven television stations on the air. There is every indication, however, that two years from now there will be in the neighborhood of three hundred to four hundred stations on

## ARE WE HEADED FOR AN FM BOOM AND BUST?

FCC Chairman Coy doesn't think the current FM boom will end in a bust. He seems to feel that FM broadcasting has already proved, in coverage and program quality delivered to listeners, definitely superior to AM. And coverage and program reception quality are the two commodities for which sponsors pay money. This means that the real competition that is building up between video and audio broadcasting lies between TV and FM, with AM headed toward becoming an also-ran.

So if we say that there is going to be an FM bust, we are predicting the end of audio broadcasting. We don't believe anyone expects that, particularly when FM can increase the radio audience during periods of bad-weather static, and reach new listeners by such special services as transiasting and storecasting.

There's plenty of room for both FM and TV. With the progress of both, competition will become keener, and both services will benefit as they vie to give the public better programs.

the air, and they will cover 140 metropolitan communities and many other areas of the country. These transmitters will be available to a potential audience of 70 million people; roughly half the population of the United States. They will reach the most populous areas where people have the most money to spend for the advertisers' dollar.

It is true that as of today there are only 630,000 receiving sets, but they are being produced now at the rate of 16,000 per week and there is a steady increase in the rate of production. That rate of production will be doubled and tripled and quadrupled within the next two to three years, and at that rate you can see that it will not be too long before the manufacturers will have television receiving sets in most of the homes in the range of television broadcasting stations.

You are wondering how you can compete with a screen in the living room that miraculously produces musical comedy, drama, opera, grand opera, soap opera, circuses, prize fights, football games, world series games, news, and history in

the making and, sometimes with it all, produces nausea.

Under our present system of allocation, with only twelve channels, many people in many areas are being deprived, and will continue to be deprived, of television service, but the Commission has committed itself to a truly nationwide competitive system of television. We cannot have that under the present available number of channels.

Back in 1945, the Commission announced that the channels for a truly nationwide and competitive system of television and for color television would have to be found upstairs in the spectrum. In view of the inadequacies of the present allocation, the Commission has been holding a public hearing in Washington to determine what can be done. We want to know what progress has been made in developing equipment that will operate in the upper part of the spectrum and what standards ought to be set.

The first stage of this hearing has been recessed. I see people in this room who participated in that hearing, and I know all of you have been following it with great interest. When the Commission will be able to arrive at a decision as to the utilization, I do not know. We have a sizable record compiled of these hearings, with the industry cooperating with the Commission and furnishing to the Commission all the technical data resulting from their experiments.

I can assure you this: that it is the intention of the Commission to see that every measure possible is taken to provide this country with a truly competitive system of television. I hope that the uncertainty as to time and the standards for that service will not be long. This I can assure you: that the best planning of which the commission is capable is going into this effort. We have the support of the industry in this regard, and I know that you all hope we don't take too long at the job.

I am confident that sound radio will try to meet this coming competition from the video screen by improving its service, and by developing those particular services for which it is especially well adapted.

I am not here today to make a speech about television, but I note that many of you talk about it, and loudly. I wish some of you could have been with me at dinner last night and heard the argument that we had with Ben Strouse, David Taft, Miss Claire and others participating.

I have said what I have about television to lay the groundwork for thinking out loud with you about the future of

aural broadcasting. I do not want to talk about the problems of the service—I want to talk about signals: where they can be heard satisfactorily and where they cannot.

I need not labor the point of the need for service: the highly complex directional antenna structures, the hundreds of daytime-only stations, amply attest this need for satisfactory signals and, more important, the need for a medium of local expression. What kind of a service do we have now?

First, I should say that we have a lot of it: some 2,000 standard broadcasting stations on the air; some 625 to 640 FM stations on the air—I haven't checked it with Cy Braum since I saw him today at lunch to find out the exact number.

Second, we have services in the metropolitan areas which are predominantly good day and night.

Third, services in the suburban areas, immediately adjacent to our large metropolitan areas, run from poor to good. Some stations in our metropolitan areas do not serve all the suburban areas immediately adjoining. If they do, they serve with signals of inadequate strength, and it is only the tenacious soul who wants to hear the world series games or the political conventions who gets any benefit from his AM receiver.

Fourth, you go from this to the rural areas, where the groundwave service of our regional stations is fair. Some parts of the rural areas of the United States have excellent skywave service but with a limited choice of programs. And there are still large numbers of people living in the rural sections who do not have any radio service.

It is a hard thing for me to believe that there are some twenty-odd million people in the United States who, at night, have next to nothing in the way of radio service; but in the rural areas about the only service they have is skywave service, or what I should call a degraded service.

There are many cities (call them small if you like) which should have and will have in the future their own service to meet their own needs. The skywave service from clear-channel stations is fine, but inadequate as a medium for the discussion of local controversial issues, sports events, and local religious programs, and does not afford opportunity for local talent.

Daytime stations in such areas have tried to meet the need of some of these communities by what used to be called an STA operation of daytime stations. STA operation is now prohibited because of the interference which it caused. In several cities (some represented at this convention) FM broadcasters are showing how these needs can be met. And more can be done as equipment is improved and more signals provided for less cost.

I welcome such developments in this

field. Can we use your technical know-how to improve this situation? I think we can. I think we can find the answer to the question of how FM fits into the future broadcasting system.

I see no reason why we must think of aural broadcasting as an AM service, or an FM service. I see no reason why we should not recognize the capabilities of these two different methods of transmitting the signal, utilizing each in accordance with those capabilities.

There would be a lot of disagreement about how to so utilize FM and AM. I think it is perfectly clear that FM cannot begin to cover the areas that are served by clear-channel AM radio stations. I think it is equally clear that ninety per cent of all the other classes of AM broadcast stations would serve larger areas by employing FM; would serve those areas with better signals; and would provide service more days and more hours out of the year than you are now providing in the maze of regional and local and daytime AM channels.

I said this spring at the NAB in Los Angeles that some of these days the broadcasters will realize that they can better serve the people of this country with FM and, at that time, the growth of FM in terms of its popularity will be what we have all been expecting of it.

I urged all broadcasters to speed that time by recognizing that they can better serve the people of their communities through FM. We have learned that a radio service is not built in a day; but we have built tremendously since the war in the FM field, with more than 600 stations on the air, approximately 400 more now being built, and another 100 applications pending before the Commission. If I could keep Cy Braum at home long enough, we would get action on those.

A large part of the physical plant for a future FM broadcasting system has already been built. It now remains to provide the service to the American people through that plant.

I am reminded of a story. It is a true story that happened during the war. Donald Nelson of Chicago was appointed to head up the War Production Board. He knew nothing about this until the President called him to the White House. He hurried back to the War Production Board to tell that great American, Bill Knudsen (now dead), that he had been appointed to succeed him.

Bill Knudsen had already read it on the ticker, and when Mr. Nelson came into his office, he said: "Yes, Don, I know what has happened. I read it on the ticker. You take it now. You run it a while. My job was to build the plant, Don. It is your job to produce the goods."

I think it is a fair statement to say that FM is a technical service. In terms of the number of stations required to provide real service to the American people, FM has arrived at the point where the plant

has been built. The job now is to develop FM broadcasting to serve more people in this Country than we are now serving.

I am satisfied that today aural radio program service is, on the whole, good. It can always be improved, but the biggest improvement in it will be in the use of FM to deliver steady, interference-free signals of high fidelity to a greater number of people.

FM will not be sold first to people already getting serviceable signals from their AM transmitters. FM will be sold to those who are getting inadequate signals, if any at all.

Is that an audience of any size? Is the total radio audience increasing? I think so. Is that extra audience worth the advertiser's attention? I am sure of it. In making it your business to reach this added audience, you are providing for the transition from your AM transmitter to your FM transmitter.

Even the city folks will recognize an improved service when they hear it, but they are not the easiest ones to sell at the present time because of the difficulties of delivering to them signals of higher fidelity than the wire lines which carry the programs to your stations.

The Commission is seriously concerned over the delays at some stations in moving up from low-power interim operation to full-power operation. As you all know, interim operation was granted to speed up FM, not to delay it. The Commission is mindful of this problem and should it develop that this device no longer serves its purpose, it will be ended.

I understand there is some discussion of that problem among those attending this convention. Requests for extension of time for constructing FM stations are carefully checked, and are being granted only where there is a bona fide reason for such extension. As long as there are stations on the air in interim operation with an inferior service considerably below the standards required by the Commission, the public is going to get an erroneous and unfair impression of FM capabilities.

The manufacturers have a most important role to play in building the FM structure. Until we have FM sets in quantity and quality we are not giving FM a square deal. This has been one of FM's worst growing pains. As more stations go on the air and duplicate network programs, making it possible for listeners to hear all their favorite network shows over FM sets, we can see a rapidly growing demand for FM-only receivers. Such sets should be much cheaper than the best AM-FM sets on the market today. As the people become more aware of FM, and when the demand for sets increases, we can hope for more benefits of mass production.

But the real kingpin of the whole FM movement is the broadcaster himself. All the other parties in the field must look  
(Continued on page 44)

# WHY FM PRODUCTION IS CLIMBING

A PIONEER RADIO MANUFACTURER EVALUATES FM AND TV RECEIVER PROBLEMS, AND EXPLAINS WHY FM SET PRODUCTION WILL BE HIGH NEXT YEAR — *By* LEE McCANNE \*

OVER four years ago, RMA established a School Equipment Committee to work with the U.S. Office of Education of the Federal Security Agency toward the establishment of acceptable standards for classroom radio sets, educational broadcast transmitters and studios, recording equipment, centralized sound systems, and all the tubes and parts and maintenance policies needed for schools. In the fall of 1946, after two years of blood, sweat and tears to get the different manufacturers to pool their individual differences into one set of specifications acceptable to the long-haired educators selected to work with us, we came out with our first brochure or pamphlet on "Central Sound Systems for Schools", more familiarly known as the blue book, published at RMA expense and mailed under Post Office frank to school administrators and architects by the U.S. Office of Education. This was hailed as an amazing example of cooperation between a government agency and a trade association. Naturally, it prescribed FM radio reception for any school sound system. Last fall we produced another brochure, known as the brown book, on "School Recording and Play-Back Equipment". Next month our third literary effort will come off the press. It will have a green cover, and the title will interest you: "Classroom Radio Receivers." Those of you who have read in the papers about the "commie" investigations in Washington, notice the careful avoidance of any red cover in our series!

This third pamphlet from our joint committee will have more circulation than the first two combined. The initial print order is 100,000 copies. Naturally this booklet stresses the importance of FM in any radio for classroom use. Most of it is written in simple language for those of grade-school level, but it includes a careful explanation of the differences between AM and FM which, if I do say so, would be valuable to Consumer's Research and Consumer's Union, or to any radio dealer, any prospective consumer, and certainly to the promotion department of any FM station. You can get single copies free of charge by writing either to RMA at the American Building, 1317 F Street in Washington, or to the Office of Education, Federal Security Agency, 4th and D Streets.

So much for why I am here. It's a pleasure to be here. Of course, Bond

\* Vice President and General Manager, Stromberg-Carlson Company, Rochester, N. Y. An address before the FMA Chicago conference, Sept. 28, 1948.

Geddes may have remembered in the back of his mind that Stromberg-Carlson was one of the stalwarts who helped Dr. Armstrong put FM on the map back in 1939, with the fifth FM station in continuous operation and the first complete line of FM sets including phonograph combinations. We were leaders then. We're still leaders in quality FM sets, like

## WHAT ABOUT THE PRODUCTION OF FM SETS?

For the fifth consecutive month, fewer AM sets were made than in the lowest month of 1948. TV receivers are gaining slowly, but the quantity is still bottle-necked by picture tubes. This state of affairs could mean a sharp loss in sales volume this winter, and much idle capacity in radio plants.

It won't, though, according to Stromberg-Carlson's general manager, Lee McCanne. As he told FMA members at Chicago, radio set manufacturers will follow the obvious course of promoting FM receivers, for which a national market has been created by more than 600 FM stations now on the air. Right now, at least two companies are readying production of moderately-priced FM-only receivers.

Under these conditions, it doesn't make sense to start a TV vs. FM fight. The smart thing is to build sales volume by playing both markets for all they are worth! And that will be the policy of the smart manufacturers. Here is the complete text of Lee McCanne's address.

the new 1409 series models introduced last month. But when it comes to hanging out quantities of AM-FM table models at low prices, we bow to Zenith, General Electric, and others who have larger factories. It may also interest you to know that we are distracted in our factory by the growing volume of our dial telephone switchboard business and, when your telephone company has put up a new building constructed expressly for a dial exchange, has sold the public service commission in your state on higher rates to start with dial service, they just don't listen considerably when we say it will take up to a year to design a switchboard tailor-made for your town, and then another year to produce it because we'd rather make FM radio sets. Some of you who have had the experience of waiting for equipment can appreciate their point of view. If you like a three-ring circus, come up and see us in Rochester, N. Y.

In behalf of all the radio manufacturers, I can tell you that the production of FM radio models picked up nicely in August. It certainly should remain high through the Christmas season and probably all winter. August production of

110,879 sets was a 7.95% improvement over the average month of the first seven months. The total for the first eight months is 881,180 FM sets. This compares with 399,938 television sets for the eight months, and 9,363,854 sets of all types, including automobile and portable radios.

These figures do not include those television models which likewise can tune in FM stations. RMA still does not know how to break out those television sets which can receive FM programs from the total of television sets reported to it. This has little to do, if anything, with the way in which RCA collects its data. To add confusion (or to compound it, in an already confused situation) it is impossible to correlate RCA license figures against the totals reported to RMA's audit because there are important manufacturers who report to RCA but will not report to RMA, and there are other producers of sizable quantities who report to RMA but will not report to RCA, while the majority submit their figures in confidence to both. For the most part, the television models which can receive FM radio broadcasts are of two types: either they have continuous variable tuning through all twelve television channels and thereby cover the FM broadcasting band while going from television channel 6 to television channel 7, or they have both a television chassis and a separate AM-FM radio chassis or tuner installed in the console or phono combination cabinet. Stromberg-Carlson is one of the larger producers of television receivers of the first type mentioned, having continuous variable tuning past all television channels and the FM radio reception. I would venture a guess, based on information and impressions that I have gathered, that the total sets reported as television sets but also capable of receiving your FM stations will run at least 110,000 units this year. That's equivalent to adding a thirteenth month of FM production to the quantities that will be reported for the twelve months of this year.

So far the peak month in 1948 for production of FM sets was last March. Sales of AM sets, FM sets and television sets fell off in April. The sales of AM sets are still badly off, television sets made a quick recovery, and FM set sales have just begun to climb back into six figure quantities per month. Why the sharp drop in all kinds of sets last March, especially when we know that the demand for portable sets was on the upturn at that season?

Analyzing this situation, I think it's  
(Continued on page 42)

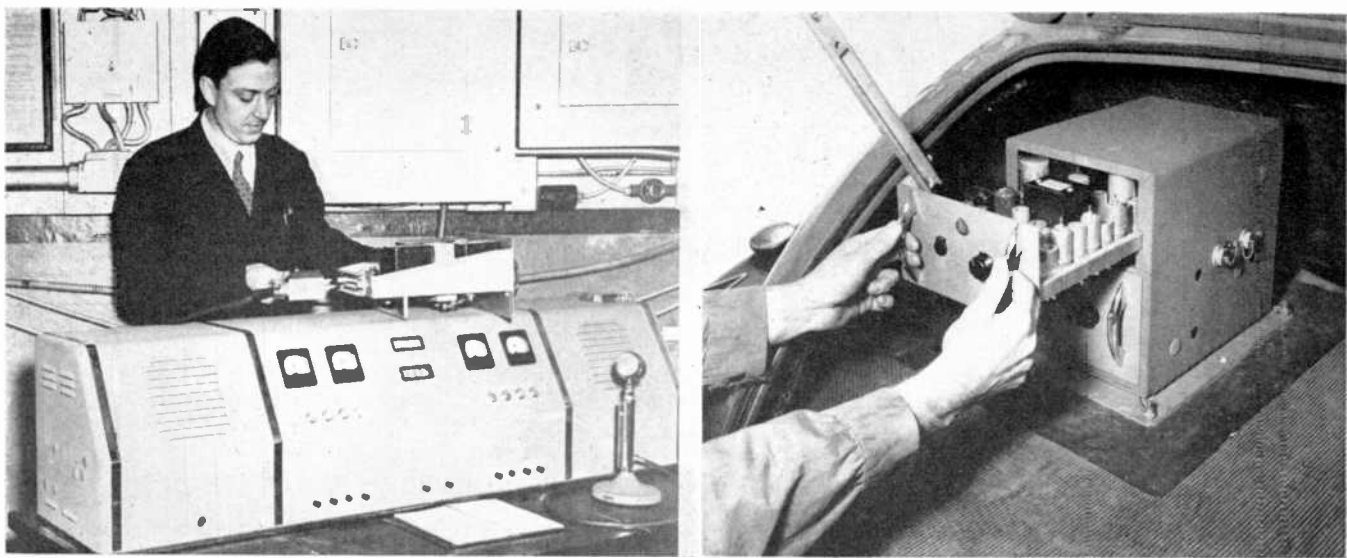

FIG. 2. Low-voltage supply section of headquarters console carries selector. FIG. 3. Selector plugs into mobile receiver chassis

## CIRCUITS FOR SELECTIVE CALLING

APPLICATION DATA ON FEDERAL SELECTO-CALL, DESIGNED TO INCREASE OPERATING EFFICIENCY OF MOBILE TELEPHONE SYSTEMS — *By C. M. BACKER & P. J. BREWSTER\**

THE development of efficient, compact, and highly reliable FM mobile communications equipment has tremendously expanded the use of radio telephony in many new fields.

Obviously, with many receivers tuned to one frequency, a point is reached — as the number of receivers on one channel is increased — where the mobile units pick up so many unnecessary calls that the efficiency of the system is impaired. Hence the requirement for some means of selective calling, such as Federal's Selecto-Call system. The equipment to be described is intended to give four selections, although the number can be increased as desired.

### Applications of Selective Calling:

The Selecto-Call circuit enables a suitably equipped control station to contact, at will, any one mobile unit or any particular group of units to the exclusion of the others in the system, despite the fact that all receivers are tuned to the same frequency. This is accomplished in the mobile receivers by frequency sensitive decoders, each of which responds to a particular frequency within the range of 150 to 442 cycles. In the normal or standby operation, the audio system of the receiver is silenced. Only reception of the proper decoder signal turns on the audio circuits.

The Selecto-Call can be added to Federal mobile receivers by merely plugging in a decoder unit. No additional space is required. Where provision for Selecto-Call has not been included in the receiver, selective calling may be obtained by adding a unit  $4\frac{3}{8}$  by 5 by  $12\frac{13}{16}$  ins.

The Selecto-Call is utilized advantageously in many applications. One of

these is where the operation of many receivers on the same frequency introduces an excessive degree of interference. For example, in Nashua, N. H., the Wheeler and Nutting Taxicab Company employs Selecto-Call to not only limit reception of each call to the cab wanted, but to eliminate reception of calls from two other radio-equipped systems in Nashua and from others operating on the same frequency in the Boston-Lowell area.

### Principles of Operation:

As previously indicated, the system makes use of a frequency-selective decoder. The decoder is essentially a single-pole, single-throw switch, normally open, which closes only when an audio signal of suitable frequency is impressed across the driving coil. The receiver circuit is arranged so that, when in Selecto-Call position, the audio amplifier is inoperative until the decoder contacts close. When the decoder is energized by the proper audio signal, the audio system is made operative. Once it has been turned on, it will continue to operate as long as the RF carrier comes in. If carrier transmission stops, the receiver shuts off and can be turned on only when the proper decoding signal is received again.

A carrier alone, or a carrier with voice or any other type of modulation, will not turn on the receiver. Hence the operator at the fixed station can call any particular mobile unit by selecting and transmitting the audio tone to which the desired mobile receiver responds. No other receiver, when in Selecto-Call position, and equipped with decoders tuned to any other frequency, will respond.

The audio frequencies to which the decoders are sensitive lie between 150 and 442 cycles. Direct phase modulation of

the RF carrier with frequencies as low as 150 to 442 cycles produces only slight deviation on standard mobile transmitters and is, therefore, not practical. Instead, a sub-carrier system is used in which the low-frequency audio signal amplitude-modulates a 7,000-cycle sub-carrier which, in turn, frequency-modulates the carrier.

### Circuit Details:

Briefly, the chain of action is as follows: The tone is transmitted only at the beginning of the fixed-station transmission. The station equipment automatically provides the proper time duration of about one second, by use of a delayed action relay. Reception of the tone signal energizes the audio circuit in the mobile receiver, the squelch and Selecto-Call circuits of which are shown in Fig. 1.

In this circuit a switching relay K1, which turns the audio on or off, is held closed by the plate current flowing through a 2D21 thyatron when the receiver is in standby condition. This relay is in series with the 2D21 thyatron. The relay opens, energizing the audio system through a set of relay contacts, when plate current through the thyatron is stopped.

The method of controlling the flow of thyatron plate current is the key to the entire operation of the squelch circuit. When the hook switch is in Selecto-Call position, reception of the proper tone signal actuates the decoder which, in turn, causes a negative voltage to be applied to the grid of the thyatron (pin 3 of decoder, Fig. 1), cutting it off and opening relay K1. Opening of this relay places a B+ voltage on the screen grid of the audio power tube through contact B, thereby permitting it to conduct. After the mobile unit is alerted, the operator removes the microphone or handset from the hook switch, automatically placing

\* Mobile Communications Engineers, Federal Telephone & Radio Corporation, Nutley, N. J.

unit in carrier position so that the signal does not have to be repeated to maintain the two-way conversation.

In the carrier position, the operation of the squelch circuit is as follows: Control grid bias, which controls the flow of plate current, is applied to the thyatron oscillator from the second limiter grid bias resistor, and the output of the second limiter plate. The second limiter grid bias is always saturated on either noise or on-frequency signals and is negative. The voltage from the second limiter plate when no signal is present, on the other hand, consists of continuous noise pulses, the positive peaks of which exceed the steady negative voltage derived from the second limiter grid, changing the instantaneous grid voltage to a positive value and permitting the 2D21 tube to fire, draw plate current, and close the plate relay. The thyatron is extinguished after the first cycle of oscillation, and fires again when another noise pulse is applied to the grid, the random effect keeping the receiver audio cut off.

Two effects occur, one with on-frequency signals, and the other with strong, near-frequency signals. When an on-frequency signal is received, there is no change in second limiter grid voltage, but the level of the positive peaks of noise is reduced and cannot keep the thyatron in operation. Therefore the plate relay opens and turns on the audio tube.

When an adjacent channel or other signal of sufficient strength is present, the early RF and IF stages of the receiver tend to saturate and reduce the noise signal on the limiter grids. With sufficient input signal, the second limiter grid bias will go to zero. At the same time, the discriminator output voltage is reduced to zero because of the absence of noise signal. Hence the thyatron grid bias is continuously maintained at zero potential thus permitting the tube to remain fired. In this way the audio stages are main-

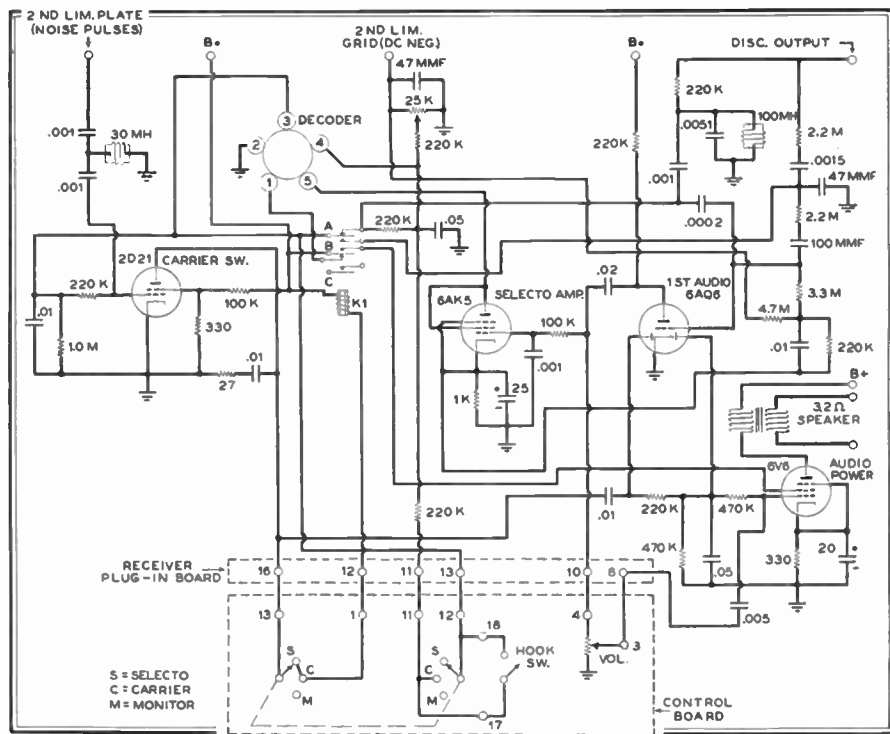

FIG. 1. Schematic diagram of Federal Selecto-Call system for mobile communications

tained in the silenced condition. This effect is compensating for all values of adjacent-channel or near-frequency input signals. However, as in any receiver, interference with an incoming on-frequency signal may be present if the interfering signal is of sufficient strength.

It should be noted that it is possible to by-pass the decoder unit or the entire squelch circuit by means of switches provided in the control box. In the carrier position, as previously indicated, the audio is turned on whenever an on-frequency signal is received. This position is used whenever simultaneous communication with all groups is desired. The decoder circuit is also by-passed through the operation of the hook switch so that once the desired party has been contacted, it is not necessary to repeat the Selecto-Call signal to actuate the receiver. In the monitor position, the audio is on at all times.

The decoder unit, as shown in Fig. 3, is inserted in the circuit by merely plugging it into a conventional tube socket. Thus it is a simple operation to transfer a mobile unit from one group to another by merely replacing the decoder.

An external unit, Fig. 4, is also available for installation on receivers in which selective calling has not been included. This unit, installed on the firewall behind the dashboard, connects into the control-box and can be installed in a matter of minutes. It consists of a high-pass filter to select the 7,000-cycle signal, a detector, low-pass filter, and decoder. A switch is inserted in the loud-speaker circuit so that the speaker is normally disconnected.

In addition to reconnecting the speaker, actuation of the decoder also turns on a have-been-called light which remains on until the call is answered, or the horn relay of the vehicle can be connected to give warning of a call.

FIG. 4. External selector unit can be added to any mobile installation. FIG. 5. Most Federal receivers have socket for selector

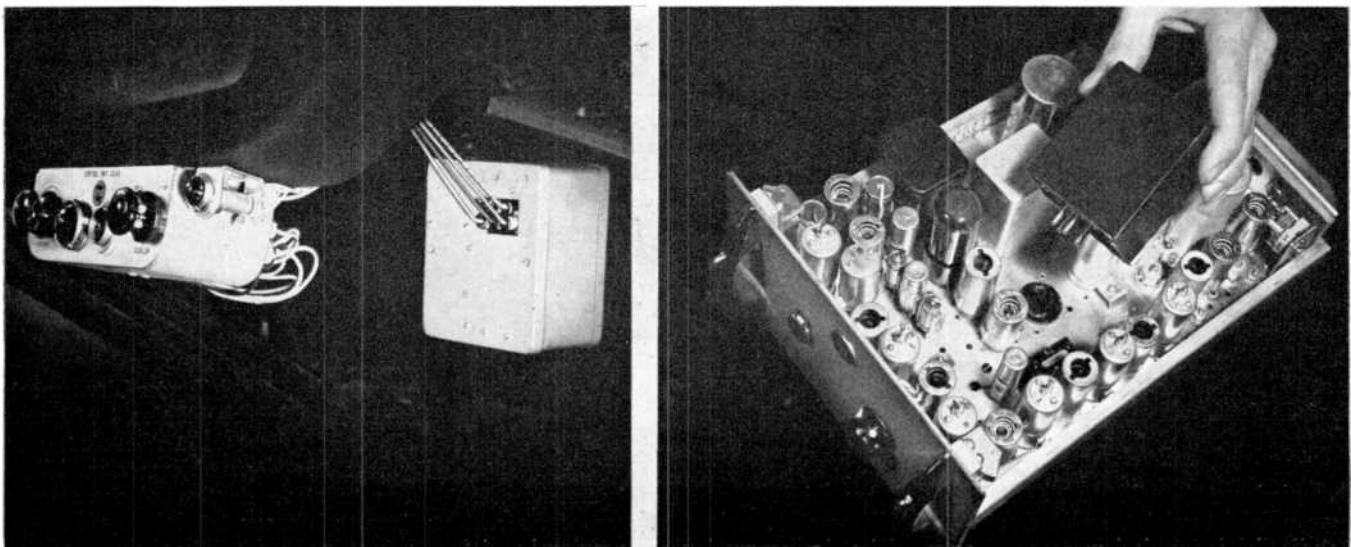

# SPOT NEWS NOTES

ITEMS AND COMMENTS, PERSONAL AND OTHERWISE, ABOUT MANUFACTURING, BROADCASTING, COMMUNICATIONS, AND TELEVISION ACTIVITIES

## Set Prices Increased:

The idea that prices of video and audio sets are going to drop is proving to be a snare and a delusion. Stromberg-Carlson has just joined the general upping with increases on all their models.

## Long Distance TV Reception:

Floyd Murphy of Thompson, Ohio, reports reception of WPTZ on channel 3. The airline distance is 380 miles. Program held from 7:45 to 8:30 p.m.

## FMA's Chicago Convention:

FM and the FMA did it again! There were more enthusiasm and interest at the 3-day meeting, more new ideas and information exchanged, and a stronger feeling of accord expressed than at any trade association affair we have ever attended. And when treasurer Tom McNulty asked for help to make up a deficit, he received \$4,800 in checks and pledges within a few minutes. For information about joining FMA, address executive director Bill Bailey, 101 Munsey Building, Washington 4, D. C.

## Joshua Sieger:

Appointed director of research and development for Freed Radio Corporation. Mr. Sieger was engineering chief of Great Britain's wartime radar program, and previously headed design and development for Scophony's projection system.

## Lush Times, Rich Relations:

A lot of broadcasters and manufacturers are sorry now that they didn't attend the FM Association meeting at Chicago. Many of those who went were expecting to hear only bad news, but they left with the conviction that, as one broadcaster put it, the only trouble with FM is due to lush, postwar thinking, and rich relations. Too many people went into FM because they had easy money to spend. And too many stations are owned by wealthy newspapers and AM'ers. They could afford to just kick FM along, and they have done just that. That situation has started to change. FM'ers are beginning to go to work!

## Mail Order Merger:

Radio Wire Television and Concord Radio have been merged into Lafayette-Concord. Branches at New York, Newark, Boston, Atlanta, and Chicago will all be continued. President is S. J. Novick, with Louis Perlstein vice president.

## Michigan State Police:

Commissioner Donald S. Leonard has approved Motorola's new version of the Handie-Talkie for his department. Range

between these units is reported to be about 1½ miles, and up to 8 miles with a main station.

## Transitcasting & Storecasting:

Two of the most interesting papers at FMA Chicago conference dealt with FM developments in fields not covered by AM. These were a discussion of transitcasting, by Hurlbert Taft, Jr., president of Transit Radio, Inc., Cincinnati, and another on storecasting, by Stanley Joseloff, president of Storecasting Corporation of America, New York City. We expect to publish both of these papers in our November issue.

## Cartwheel Antennas:

On page 32 of our August issue, the caption under the photo of a tugboat refers to the cartwheel antenna as identifying a Bendix installation. We were mistaken about that. John Sloane, of Westinghouse, just sent us a picture of an Erie tug with a Westinghouse installation and that same type of cartwheel antenna.

## Orrin E. Dunlap, Jr.:

We like this line in his new book *The Future of Television*: "Marconi made a whispering gallery of the heavens. Television turns the world into a Hall of Mirrors." It's a very readable volume of 196 pages, discussing the progress of TV as observed by a man for whom, we suspect, television has had a paramount interest ever since, as radio editor of *The New York Times*, he reported the first demonstrations. Now as RCA vice president in charge of advertising and publicity, he is in a position to present the whole panorama of TV's unfoldment. Publisher is Harper & Brothers, 49 E. 33rd Street, New York 16. Price \$3.

## FMA Elects Officers:

New officers elected at Chicago convention are: president William E. Ware, KFMY Council Bluffs; vice president E. Z. Jones, WBBB-FM Burlington, N. C.; secretary Emil J. Hodel, WCFC Beekley, W. Va.; and treasurer Thomas F. McNulty, WMCP Baltimore. Directors elected are: M. H. Bonebrake, KOCY-FM Oklahoma City; R. F. Wolfe, WFRO-FM Fremont, Ohio; E. A. Wheeler, WEAW Evanston, Ill.; Lee McCanne, vice president of Stromberg-Carlson; Frank Gunther, vice president of REL; Marion Claire, WGNB Chicago; and Morris Novik, Unity Broadcasting Corp., New York City.

## Daniel E. Harnett:

New chief engineer for Emerson Radio. He was formerly president of Harnett Electric Corporation, and previously chief

engineer at Hazeltine Electronics Corporation.

## FM Transmitting Equipment:

Special feature of exhibits at the FMA conference was the new transmitting equipment displayed by REL, shown for the first time with the Serrasoid modulator. Its extreme simplicity not only marks a new step in FM development, but it takes a deep cut out of transmitter prices since, at low powers, the cost of the modulator has been a substantial item.

## New TV Receiver Line:

Now in production by National Company. This is the first National equipment offered in general consumer market. Among other interesting features is 37.3-mc. IF system.

## Organization Changes:

Will Whitmore, Western Electric advertising manager since 1945, has been appointed radio advertising manager of AT&T. His former post has been filled by Walter M. Reynolds, who has been publications manager at Western Electric since he moved over from AT&T in 1946.

## Everett L. Dillard:

Retiring FMA president, addressing the Chicago convention on September 27: "Certainly TV and FM are in competition with each other. For that matter, so are AM and TV, and it goes without saying that the phonograph attachment is also in competition with aural and video broadcasting as far as the use of the set is concerned."

## Standards of Set Performance:

Complaint voices at FMA conference: We hear a lot about the need for cheap FM receivers, but we aren't getting decent FM performance from many expensive FM-AM models now being sold! One broadcaster suggested that stations blacklist inferior FM sets. Another stated that he had paid servicemen over \$2,000 to fix FM sets in his area. FMA resolutions committee, under chairman R. B. German, adopted a resolution directing FMA liaison committee to discuss with RMA the establishment of minimum standards for FM receivers to assure that the full capabilities of FM broadcasting will be made available to the public.

## KSBS Storecasting:

Harry Butler, KSBS Kansas City, reports that storecasting installation for Charles Ball Supermarket sold 11 other stores during first two days of operation. KSBS plans to start commercial storecasting programs January 1st. Electronic Sound Engineering equipment is being used.



## NEWS PICTURES

Left: KDFC Sausalino is on the air, covering the bay area with 33 kw. on 102.1 mc. In this photograph, San Francisco can be seen in the background, within easy range from the 1,100-ft. elevation of the FM antenna. According to reports, KDFC is doing an outstanding program job.

Largest installation of TV sets ever made was set up by RCA for the Gillette Company on Boston Common during the World Series baseball games. Special stands with shadowboxes were erected for 100 receivers, enabling 10,000 people to see the games at any one time. AC power line was run in because downtown Boston has DC.

Expansion of transit radio was planned at American Transit Association convention in Atlantic City by T. Frank Dolan, president of Omnibus Corp., Syracuse, W. R. Pollard, president of Virginia Transit Company, Richmond, and G. F. Metcalf, GE specialty division manager, Syracuse.

Harry J. Stentiford, vice president of Aldens, Inc. has OK'd listing of this Hallicrafters TV model in his company's latest mail order catalog, now being mailed to 2 million customers. This is the first time that TV sets have been listed in a general catalog. A portable TV antenna is offered at \$12.75.

Right: To assure perfect reception of remote TV pickups, antennas installed on the Empire State building by NBC and the N. Y. Telephone Company are now protected by Plexiglas igloos. Each is 7 ft. in diameter, of material  $\frac{1}{2}$  in. thick. Plexiglas is expected to protect the antennas from ice that will fall from the tower, 300 ft. above. The igloos were fabricated by Ranger-Tennere, Inc., New York City.

WFIL-FM Philadelphia is using the Hogan system for duplexing sound and facsimile programs. At a demonstration attended by FCC officials, duplexing was operated without the slightest audible trace of facsimile interference. Photo shows picture-transmitting console at WFIL-FM studios.

The Kimble Glass plant, Toledo division of Owens-Illinois Glass Company, is now producing 12-in. envelopes for cathode-ray tubes. Preparation required the installation of special machinery, and the training of more than 500 employees.

First television station in South America will be at Rio de Janeiro, using GE equipment. It is hoped that this will lead to the adoption of U.S. standards for TV in South America. Photo shows Cesar Ladavia, one of the founders of Radio Televisao do Brazil, with C. A. Priest, manager of GE's transmitter division.

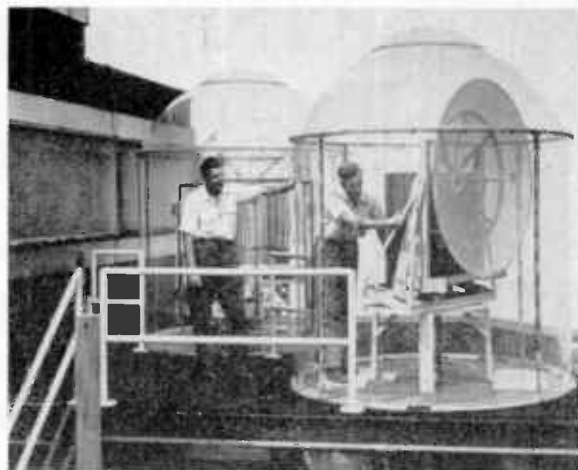

# RCA-NBC VIEWS ON TV EXPANSION

A DISCUSSION OF THE NEED FOR ADDITIONAL TV BROADCAST CHANNELS, AND A SIX-POINT SUMMARY OF RCA-NBC THINKING ON THIS SUBJECT — *By* ELMER W. ENGSTROM

**T**HE views of RCA and NBC were presented to the FCC in a statement on September 21 by Elmer W. Engstrom, vice president in charge of research of RCA Laboratories. The following is the complete text, except for an introductory review of TV growth prior to 1948:

As of June 30, 1948 television receivers were being produced at the rate of approximately 65,000 a month, and currently over 50 manufacturers are engaged in their production. Cathode-ray tubes are being manufactured by about 10 companies. Television transmitters and studio equipment are being sold and installed on all twelve frequencies assigned to television. These receiver, transmitter, and tube manufacturers have made a large capital investment in manufacturing space and equipment devoted to television production.

In the case of television receivers, it is of interest to note that the total post-war unit production at June 30 was more than 460,000 receivers and that these had a value in terms of the manufacturer's sales price of approximately \$122,000,000. This, in turn, represents an investment by the public of approximately \$228,000,000.

At the end of 1945, there were six commercial television stations with licenses and an additional three with construction permits. Such programs as there were consisted almost entirely of sports events and mediocre films. Two years later, in December 1947, there were sixteen stations on the air, 55 additional construction permits had been granted by the Commission, and 76 applications for stations were pending. Programs had improved markedly and included such items as drama, news, variety, quiz, public service, motion picture, political, educational, and sports programs.

As of mid-1948, television station activity more than doubled over a brief six months period. Thirty-one stations were on the air, with an additional 78 construction permits granted and 285 applications pending. In terms of actual investment and avowed intent to invest, this represents many millions of dollars outlay on the part of television broadcasters.

Programs have continued to improve, both in quality and quantity; many large concerns have helped along these lines with increasing support through advertising. The networking of television programs is also developing as rapidly as connection facilities are made available. Several networks are already in operation on the eastern seaboard. Additional networks will be in operation in the midwest

before the end of this year. It is expected that on or about Christmas of this year the east coast will be linked with the midwest.

NBC now operates two television stations, WNBT New York and WNBW Washington, and has three more stations under construction — WNBK Cleveland, WNBQ Chicago, and KNBH Los Angeles,

## FCC TO REVIEW TV ALLOCATIONS PLAN

Based on testimony presented at the FCC-industry conference on September 13 and 14, and at the subsequent TV hearing, the Commission announced on September 29 that evidence presented raises serious questions as to the validity of the basis upon which the present allocations table was constructed. Accordingly, until a new study is completed:

1. Applications pending before the Commission and those hereafter filed for permits to construct television stations on channels 2 through 13 will not be acted upon by the Commission, but will be placed in the pending files.

2. Applications pending before the Commission, and those hereafter filed for modification of existing permits or licenses will be considered on a case-to-case basis, and Commission action thereon will depend on the extent to which they are affected by the issues to be resolved in the proceedings bearing Docket Nos. 8975 and 8736.

3. No hearing dates will be scheduled with respect to applications for construction permits which have been designated for hearing, and in cases in which hearings have been commenced or completed but decisions have not been issued, no further action will be taken.

4. This procedure does not apply to construction permits or other television authorizations heretofore issued by the Commission.

all of which will be conducting test transmissions by the end of this month. In addition, NBC supplies network programs to stations in Boston, New York, Schenectady, Philadelphia, Baltimore, Washington, and Richmond, and makes kinescope recordings of many of its programs available to other NBC-affiliated stations not yet linked by coaxial cable or radio-relay systems.

Such, then, is the background and brief outline of the phenomenal rise of television from a small service at the time of the Commission's 1945 Allocations Decision to the important public service and major industry which it is today. It has caught the enthusiasm of the public, the broadcaster, the advertiser and the entertainment world. It is growing by leaps and bounds.

It is well, however, to pause at this

point and reflect on this phenomenal rise. It has been made possible because: the Commission's decisions crystallized the standards and allocations thus providing a stable basis for planning; because the radio industry expedited conversion to peacetime manufacturing and took maximum advantage of wartime developments; and because the broadcasters had the vision and courage to go ahead, in the face of monetary losses, with faith in the future of television as a public service. Commercial television service is today a reality, and this reality has been built upon the bed-rock of the twelve channels allocated to television by the Commission. In our opinion the further development and expansion of television must continue to be built upon the basis of these 12 channels.

RCA-NBC agree with the Commission that more channels are necessary for commercial television. It is our desire that as many people as possible in the United States have an opportunity to receive television service. We are willing and anxious to work with the Commission and the industry to advance this objective as rapidly as possible. In so doing, there are several possible avenues of approach.

RCA-NBC feel that the Commission should authorize the use of higher power for television stations. We feel that it is only by the use of higher power that improved reception can be provided for the public throughout the service area of a television station. This higher power would make possible the simplification of the receiving antennas and the installation of television receivers. Accordingly, we recommend that the Commission authorize increases in power where such increases would be consistent with the standards which it may determine relating to tropospheric propagation and protected contours.

The performance of frequencies below 300 mc. is better understood and equipment is available for the use of these frequencies now. We believe the Commission should examine thoroughly the allocations below 300 mc. to determine whether some additional channels could be made available to television in this part of the spectrum. If that should prove possible there could be an immediate, if moderate, expansion of television there. We believe that the band 88-108 mc. assigned for FM broadcasting should not be included in this examination because the present allocation should be definitely retained for that service. Many of the remaining frequencies are used by the Government for  
*(Concluded on page 36)*

# DU MONT OFFERS UPPER-BAND PLAN

A NEW SLANT ON ALLOCATION OF UPPER-BAND TV CHANNELS, WITH A PROMISE OF TRANSMITTERS AND RECEIVERS IN A YEAR'S TIME *By* DR. ALLEN B. DU MONT

*THE following transcript of testimony by Dr. Allen B. Du Mont at the FCC on September 20 presents the views of the Du Mont Laboratories, and summarizes the work done on upper-band TV by this Company:*

DR. DU MONT: I have no prepared statement to make in connection with this hearing, but I would like to express our ideas on some of the subjects that have been up for discussion.

We operate two television stations at the present time along the Eastern Seaboard, and we also distribute television receivers throughout the various cities now having television stations. I simply mention that because in our experience we find that the present allocations in our estimation have worked out quite satisfactorily. Of course, along the eastern coast we do have quite decent spacing between the various cities. I mean, between Washington and New York, between New York and Boston, and so forth. In other words, the spacing is well above the 150 miles which we feel is on the ragged edge to provide real good service.

The one thing that bothers us more than anything else is the ability of the present number of channels to provide a really nationwide service. We have brought up at various conferences in the past the necessity for additional channels in order to provide service throughout the whole country. Recommendations have been made by us that some other channels between 100 and 180 mc., and also slightly above 216 mc. be utilized for television if it were possible to get the Government to give them up. It doesn't seem that much can be done along these lines.

We have come to the conclusion that now is about the time to consider a different allocation scheme than we have at the present time, utilizing the UHF frequencies for some of the bad spots in our present allocation picture. The VHF frequencies would be retained pretty largely as they are except in these bad areas.

I have no detailed specific plan to submit at the present time, but we probably will have something reasonably concrete to submit at the hearing next week.

The particular spots that we consider bad in the present allocation plan, of course, are the allocations of less than 150 miles. We also consider it a bad commercial practice and a bad practice from the standpoint of public service as regards to the cities with either only one or two assignments. We feel that it is possible to keep our present VHF assignments in a large number of cities but utilize the

UHF assignments in the cities, as I have just mentioned, that either haven't enough channels or where the allocations are too close together.

To give you an example of our thinking, such cities as Bridgeport, Waterbury, Hartford, Springfield, Worcester, and Providence have very few channels assigned to them. With the congestion in

## A PROPOSAL FOR OPENING THE UPPER TV BAND

There is general agreement that the upper TV band must be put to use in order to accommodate all the projected TV stations and, ultimately, a number sufficient to provide a choice of programs in all service areas.

Now the industry wants to know when upper-band transmitters and receivers will be available, how two-band operation will affect the merchandising of sets, and if the opening of the upper band will disturb the groundwork already completed.

To give you some of the test thinking on these subjects, we present here the testimony given by Dr. Allen B. Du Mont before the FCC on September 20. His frank discussion sheds much light on the possible course of events in 1949.

Dr. Du Mont did not refer to matter of withholding action on pending TV applications, since that decision was not reached by the FCC until the 29th. However, best-informed opinion is that this action may prove to be a blessing in disguise. The reason is that new stations have created new markets for receivers at a faster rate than set production can be stepped up to meet the demands. This condition may prevail for another twelve months.

Altogether, much benefit and no hardships will result from the low-band revisions and the upper-band planning now being done by the FCC in cooperation with the broadcasters and manufacturers.

that particular area under our present scheme, very little relief can be expected. In addition, if these stations go ahead on the present channels, they may run into some interference problems.

There are other areas where this same thing applies. For instance, out in the area around Canton, Youngstown, and that general area.

We feel that by utilizing the ultra high frequencies, where you have 69 channels available, it is possible to set up a nationwide television system utilizing both the present VHF and the proposed UHF, so that all the major cities in this country would have at least four or five channels.

We have found that it is very difficult in a city with a single television station, or even two, to create real interest, and also to supply a real public service to those people. They want a choice of pro-

grams, and I feel that at least four channels should be available.

Now, as far as the ability of these UHF frequencies to take care of such conditions, a considerable amount of work has been done in the past year. We have convinced ourselves that they are practical. It is possible to build receivers. It is possible to build transmitters for UHF. We do not, right at the moment, know how to build real high-power transmitters, but we feel that transmitters can be built today that would serve adequately the cities in question.

To give you just a little idea of how this thing may work out: It would not be necessary to interfere with any existing station on the air. UHF allocations would fit into the present allocation picture, and no station now on the air would be required to change frequency. However, of all the construction permits out at the present time, it looks that a few of them probably should be changed to UHF, but I think that the ones in question have only recently received their CP's, and I doubt that any work has been done in connection with them. But it would mean that out of the first 50 cities 39 would be in the VHF band, whereas 11 cities would be in the UHF band. I don't think it is necessary to read this list.

THE CHAIRMAN: What is the population, what is the lowest population, in the first 50 cities?

DR. DU MONT: I haven't the population figures here. The fiftieth city is San Antonio. I didn't mean to imply that that should apply to the first 50 cities. It should be carried down.

THE CHAIRMAN: Yes, I understand. Did you make the same analysis on the basis of the 140th?

DR. DU MONT: We haven't yet, but expect to have it ready for next week if the Commission would like to take a look at it.

MR. PLOTKIN: Mr. Chairman, the population of San Antonio, from the 1940 census, is 253,954.

DR. DU MONT: There is another thing about going ahead with a scheme such as this, and that is you may be able, in a number of cases, to increase the spacing between stations on the VHF band, and thereby set up power standards based on the separation between the stations and get much better rural coverage than is possible with the present system.

I think that is about all I have. If there are any questions I will try to answer them. Dr. Goldsmith has looked into this

*(Continued on page 36)*

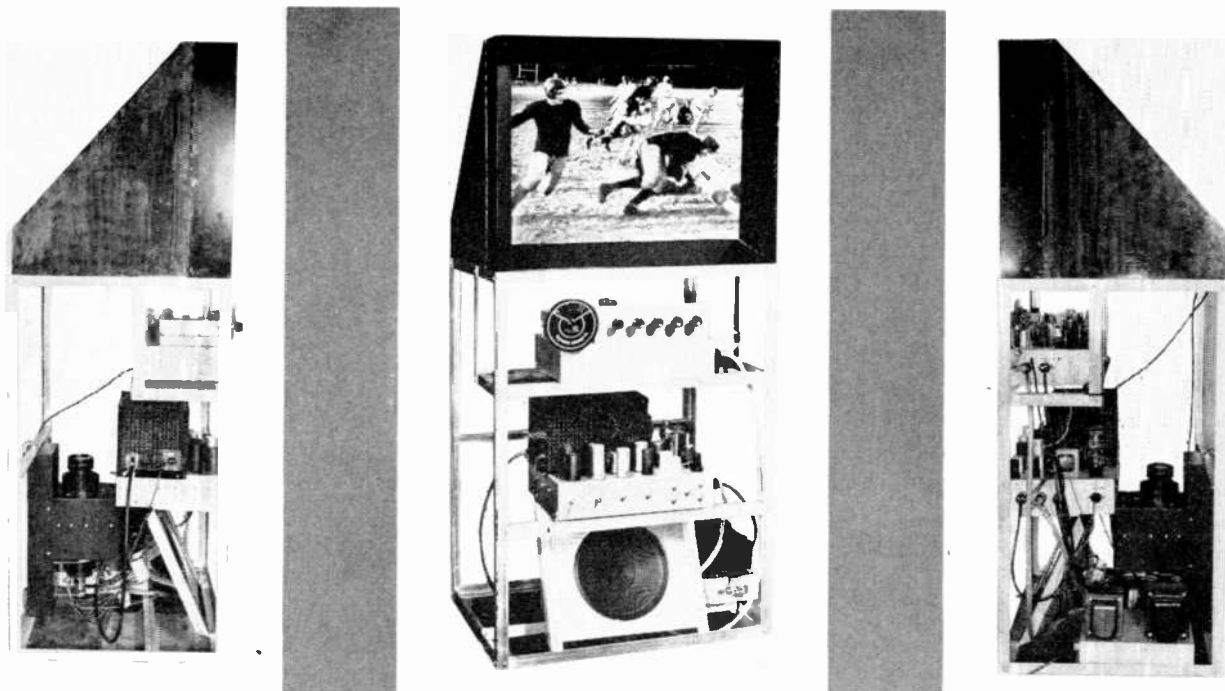

FIG. 1. Three views of the Television Assembly units put together and ready for operation. All the parts shown are supplied

## CUSTOM-BUILT PROJECTION MODEL

THIS PROJECTION MODEL PRODUCES A PICTURE 20 BY 26 INCHES, WITH CRITICAL CIRCUITS WIRED AND ALIGNED, THE ASSEMBLY IS EASY — *By GERARD R. FRANCOEUR \**

ALL the surveys of those who own or plan to buy television receivers indicate that people want large images. In fact, this desire generally extends to big-picture receivers at prices many can't afford to pay. Now, the largest single item of cost in a projection-type receiver is the cabinet. Its cost is not represented as a single item of the selling price, but is reflected down the line in packing, shipping,

\* Chief Engineer, Television Assembly Co., 540 Bushwick Avenue, Brooklyn 6, N. Y.

refinishing, handling, re-packing, re-shipment, and ultimate installation.

The obvious way to reduce the cost of projection receivers, and to meet the demand for big pictures at the price of a small cabinet model, is to eliminate the cabinet. This has the added advantage of eliminating the factor of cabinet design, and letting the individual customer decide how he wants to set up the assembly in his own home.

It was from this angle that we, at Tele-

vision Assembly Company, undertook to design the model P-520 projection receiver, by which we arrived at a suggested list price of \$1,299 for the complete parts, giving a picture size of 20 by 26 ins.

### Design for Custom Builders:

Television has produced a great revival of interest in custom building. That applies both to those who want to build sets for their own use, and to those whose business it is to build sets for others. This repre-

FIG. 3. For the head end, a DuMont Inputuner is furnished. FIG. 2. Block diagram of the four units, and the complete tube line-up

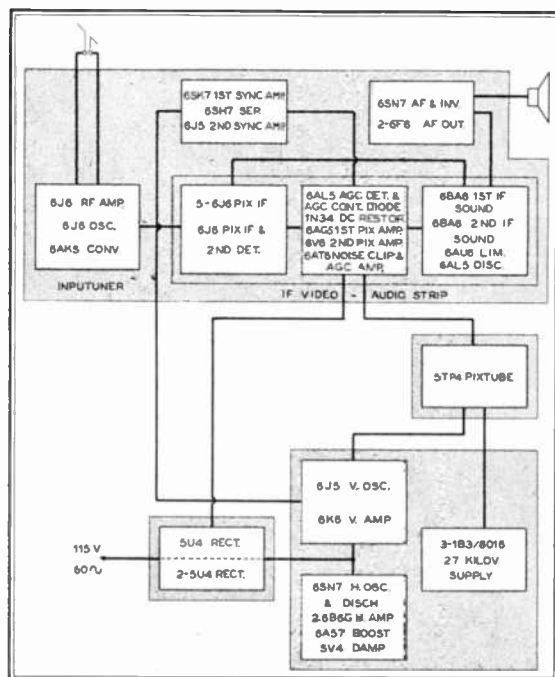
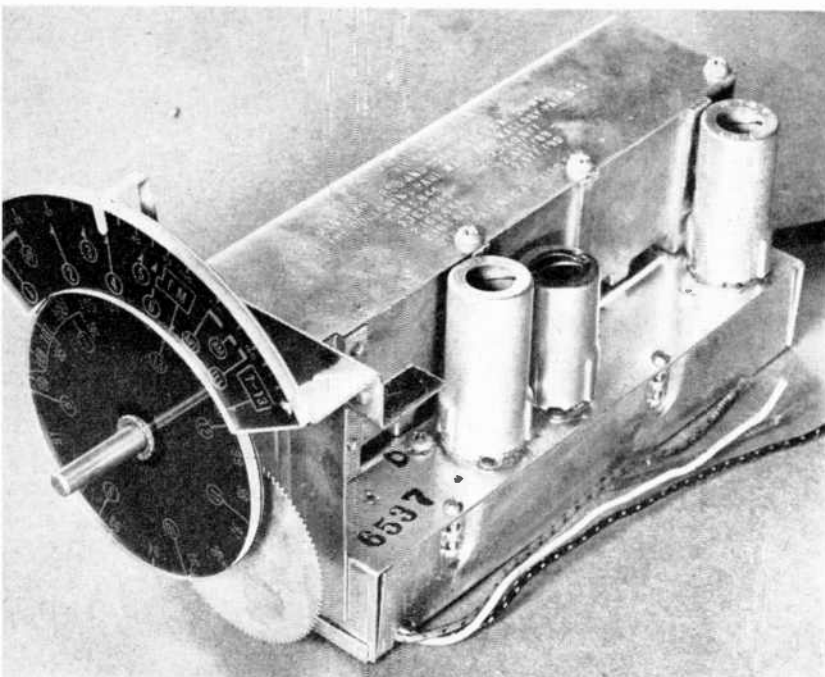

sents a saving to the former, and additional profit for the latter. The end result depends upon the precision with which the vital circuit elements are assembled, wired, and adjusted.

Accordingly, the plan of the model P-520 was laid out with great care to strike the proper balance between the work that requires special skill and equipment, and the work that can be just as well handled in the custom set-builder's shop.

Thus the circuits were distributed between four separate chassis. These, as shown in Figs. 1 and 2, are the video-audio unit, low-voltage power supply, high-voltage power supply, and the projection tube and lens assembly. The rack mounting is drilled accurately, so that it fits together in a sturdy, rugged mounting for the equipment and the mirror and viewing screen. When assembled, the complete installation is in every way equivalent, both in design and performance, to a factory-built receiver.

#### Video-Audio Chassis:

All RF and IF circuits for video and audio signals, plus the audio amplifier, are assembled on one chassis, Fig. 4. This includes the Du Mont Imputuner, Fig. 3, and the IF strip, Fig. 5. The tuner covers a continuous band from 44 to 216 mc., including all TV channels, FM broadcasting, and some of the communications services. It is furnished all wired and adjusted.

The IF strip, indicated in Fig. 2, is also wired and aligned, leaving only straight-forward assembly and wiring to be completed by the set-builder. Fig. 2 gives the tube line-up. IF frequency is 21.9 mc. for the audio circuits and 26.4 mc. for the video circuits. Audio output is 12 watts from two 6F6's in class AB2 push-pull. A 12-in. RCA speaker is furnished.

#### High-Voltage Supply:

All danger from handling the high-voltage supply is eliminated, for this chassis, Fig. 6, is factory-assembled. A Plexiglas cover permits examination of the parts without exposure to shock. This circuit furnishes 27,000 to 30,000 volts for the second anode of the picture tube. Three 1B3/8016 tubes are used in a tripler circuit.

Also carried on this chassis are the vertical oscillator and amplifier, and the horizontal oscillator and amplifier, booster, and damper.

#### Low-Voltage Supplies:

Two low-voltage supplies are mounted on the third chassis, as shown in Fig. 7. Designed for continuous service and good regulation, the full-wave rectifier with two 5U4G's delivers 500 volts to the horizontal and vertical deflection circuits. This rectifier is cut off when the FM-TV switch is in the FM position.

FIG. 4. Video and audio chassis. FIG. 5. The IF strip assembly. FIG. 6. High-voltage supply. FIG. 7. Low-voltage supply chassis

A second rectifier, using a single 5U4G in a full-wave circuit, furnishes 400 volts for the RF, IF, AF, and sync tubes.

#### Picture Projection System:

The images are formed with great brilliance on a 5-in. RCA 5TP4 projection-type picture tube, focused on an aluminum-coated mirror by a sturdily-mounted Bausch & Lomb lens. Characteristics of this lens are: speed F/1.9; EF 5 ins. or 127 mm.; length 7 ins.; diameter 4¼ ins.

Finally, the images are reflected from the mirror to the back of an Eastman Kodak rear-projection screen. The net result is a high-quality black-and-white

picture that is pleasant to watch over a wide viewing angle.

#### Rack Mounting:

An important effect of the mechanical arrangement of the rack assembly is that the center of the screen is approximately 56 ins. above the floor. This extra height, about 20 ins. greater than in the average console cabinet, not only enables the viewers to look up rather than down on the screen, but makes it possible for a much larger audience to see the pictures. This feature is particularly important in public places where the conventional, low cabinet brings the tube where it can be seen only by those at the front.

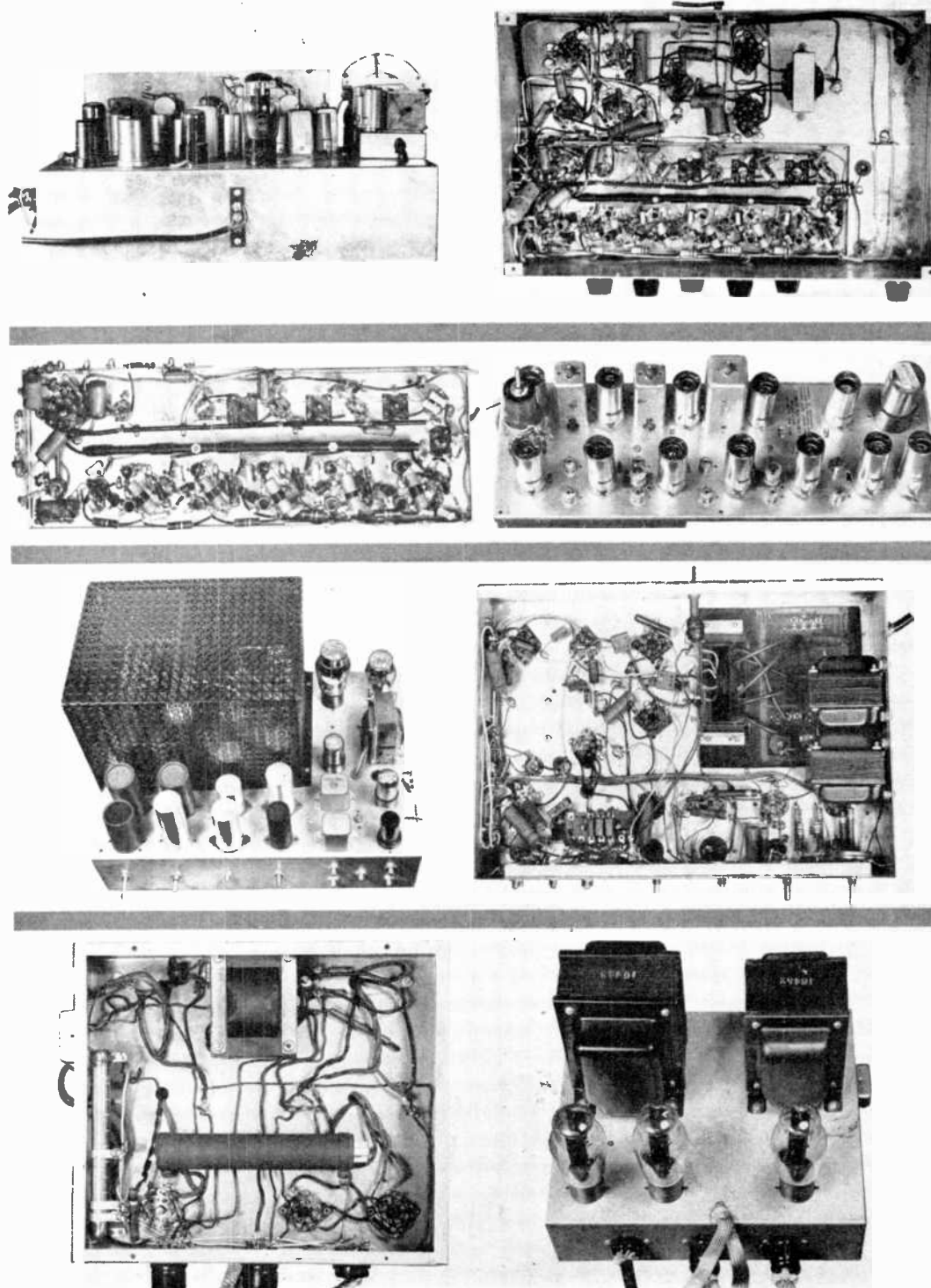

# STEPPING-SWITCH OPERATION

## PART 1: STEPPING SWITCHES PERMIT NOT ONLY THE REMOTE CONTROL OF RADIO EQUIPMENT, BUT UNLIMITED CONTROL OF REMOTE DEVICES BY RADIO—By T. L. SIPP\*

THE design of remote control equipment must meet the general requirements of simple, fast, and reliable operation. Apparatus must be held to the minimum, and yet be sufficient to perform all necessary control functions.

These requirements do not differ from those met with in step-by-step automatic telephone switching systems since they are in effect, remote control applications.

### Direct-Drive Stepping Switch:

Fig. 1 illustrates a Clare direct-drive stepping switch. This is a 10-position switch, since 10 fixed contacts are mounted on a 90° arc. One to three independent circuits can be closed by using a bank of one, two, or three levels. Associated with each level is a pair of rotating fingers, or wipers, mounted on a shaft which carries a ratchet. A magnet-driven pawl engages the ratchet and advances the wipers forward a given number of steps, determined by the number of current impulses applied to the rotary or stepping magnet. When current is not flowing in the magnet, the wipers are maintained in position by a detent. To reset the switch, the release magnet is energized. This disengages the detent from the ratchet, and allows the wipers to return to the normal or home position under the influence of a coiled restoring spring.

\* Engineering Department, C. P. Clare & Company, 4719 Sunnyside Avenue, Chicago 30.

### Spring-Driven Switch:

The 20-point spring-driven stepping switch shown in Fig. 2 is also very popular in remote control work. It provides a semi-circular bank having 20 fixed contacts molded into each level, up to the maximum of 8 levels. This allows up to 8 independent circuits to be closed for each position. Associated with each level is a double-ended pair of wipers mounted on a shaft together with a ratchet wheel and a position-indicating number wheel. There being no separate reset magnet, the wipers can rotate in only one direction over the bank level contacts. One end of a wiper pair will traverse the 20 contacts in a half-revolution. As one end is leaving the 20th contact, the opposite end is approaching the first contact. Connection to each insulated wiper pair is accomplished through a brush spring which is also molded into the bank levels, and provides a terminal of the same form as the fixed contacts.

The rotary magnet, upon operating, deflects a leaf-type spring. A pawl, driven by this spring, engages a ratchet, causing the switch to advance upon cessation of the current impulse in the magnet. A detent maintains the wipers in position. It will be noted that this action differs from that of the direct-drive switch, and accounts for this being called a spring-driven switch. In addition to deflecting the driving spring, the magnet armature

also actuates certain contact springs at the side, as shown in Fig. 2. They can be used for any desired control or signal operations. Most important among these is the operation used to advance the switch to a normal or home position (usually the 20th point) after it has been stepped to a given position. A pair of normally closed interrupted contacts is connected between the magnet coil and the wiper of one level used for homing the switch. By connecting together all contacts of this level, except the 20th, and completing the circuit to the magnet coil through an appropriate voltage source, the switch is made to rotate in a self-interrupted or buzzer-type manner until it reaches the unconnected bank contact. This arrangement will be discussed in details in a subsequent section.

An interesting method is employed to double the number of positions for this type of switch. By using single-ended wiper pairs and connecting two adjacent pairs together, a 40-point switch can be obtained. The first wiper pair traverses 20 contacts in the first half-revolution, and the adjacent wiper pair traverses its level in the second half-revolution. Although not shown, similar switches are available which have a maximum of 10 levels of 26 points each, or 5 levels of 52 points each.

Both the direct-drive and the spring-driven stepping switches are designed to

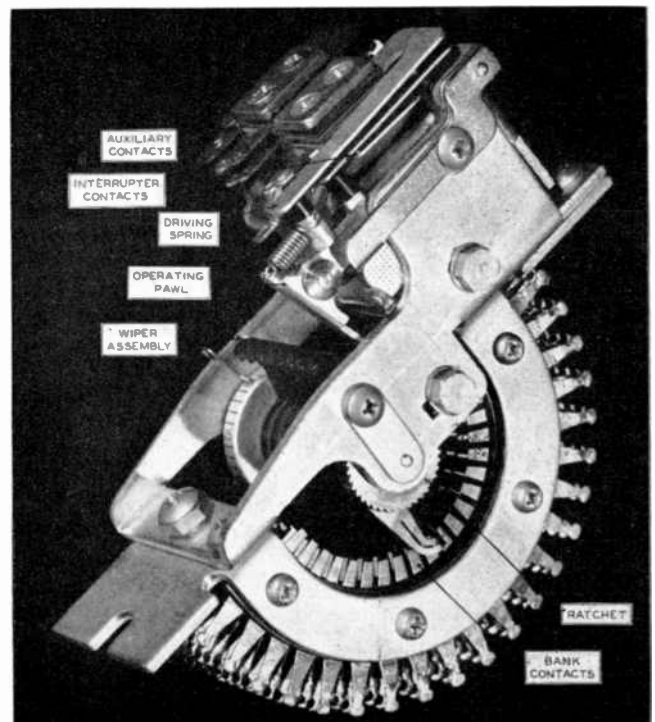
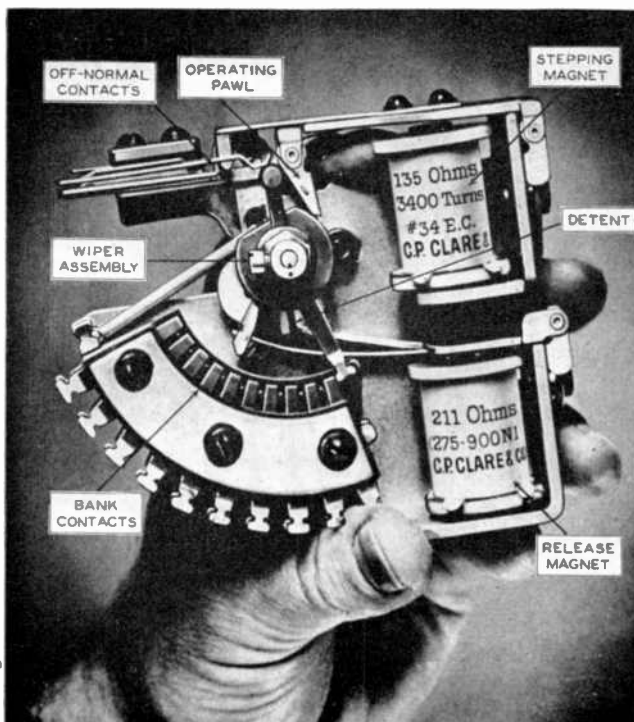

FIG. 1. The 10-contact, direct-driven stepping switch. FIG. 2. The 20-contact, spring-driven type. Both are made by C. P. Clare

operate on 6 to 115 volts DC. For direct-drive switches, when the operating voltage is over 48 volts, it is common practice to use 48-volt coils and proper series resistors. This results in more satisfactory performance characteristics than would be obtained with high-voltage coils.

#### Speed of Operation:

When operation of remote control equipment must occur rapidly, the speed of switch-stepping is an important factor. Both types of switches will respond to rates as high as 30 impulses per second when the circuit is closed 50 to 70% of the complete impulse period for the direct-drive switch, and 45 to 80% for the spring-driven switch. At lower rates, such as 10 impulses per second, the direct-drive switch will advance when the periods have a 25 to 85% make impulse. The spring-driven switch will rotate on 20 to 90% make impulses. When the spring-driven switch generates its own impulses, as is the case for self-interrupted operation, it rotates at the rate of approximately 65 steps per second. The foregoing values for speed of operation are those that can be expected with 48-volt power sources. At lower voltages, the maximum impulse rates and self-interrupting speeds are slightly less.

#### Auxiliary Relays:

It is only in rare instances that stepping switches can be used alone for remote control applications. Certain routings of the operating impulses and sequence-switching actions must be performed by auxiliary relays. For example, when selecting a circuit by a stepping switch, it is generally required that the circuit be closed only after the wipers have come to rest upon the bank contacts. If this were not the case, all the other selective circuits connected to switch bank contacts between the home position and the selected contact would receive short impulses as the wipers traverse the intermediate contacts. Another important reason for keeping open the wiper circuits or bank contact circuits open during switch operations is that the wipers are not designed to open or close circuits carrying more than approximately .1 ampere at 110 volts. Even with these values, such operation is not recommended. When at rest, currents as high as 3 amperes can be carried.

Relays are used to perform routing, sequence-switching, and other operations. They are generally of the telephone type, Fig. 3. A great variety of operating circuits can be employed because of the adaptability of this type of relay. As many as 28 contact springs can be provided, arranged in a variety of switching forms.

A standard single-winding coil is capable of providing relay operation on less than one-tenth the current that it can carry continuously without overheating.

The wide variation in the time required for a relay to operate or release can be

employed to advantage. Fast-action relays pull in and drop out at times varying from .005 to .05 second, the actual value depending upon such factors as circuit voltage, coil inductance, operating power, and relay adjustment. By providing a low-resistance copper ring on the coil adjacent to the movable armature, delays in relay operation up to .1 second can be obtained.

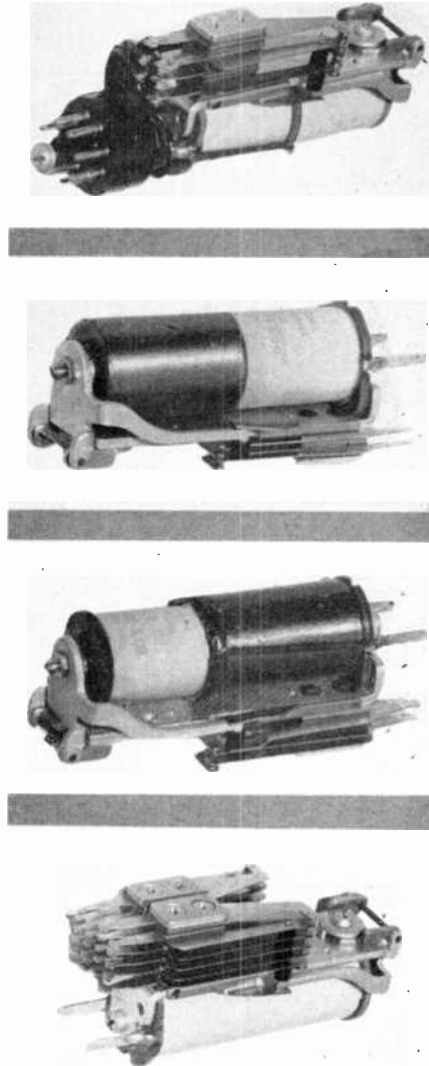

FIG. 3. Typical Clare telephone relays, top to bottom: Plug mounted, slow-to-operate, slow-to-release, and fast-action types

Similarly, the placement of such a ring at the opposite end of the coil provides delay in releasing the relay up to .35 second.

#### Switch-Operating Impulses:

The operation of stepping switches requires a series of impulses, transmitted over the link between the control point and remote points. The number of these impulses determines the function performed. In certain cases, they may be sent in one or more groups. Suitable means must be provided to generate the impulses. An electronic generator of the multi-vibrator type, with suitable means

for controlling the number of impulses produced, is one form. Also practicable is a relay-type generator, comprising two relays, arranged so that when one relay operates it closes a circuit to the other. The second relay has a pair of normally closed contacts which, when operated, opens the circuit of the first relay. By using proper copper rings on the coils, these relays will alternately operate and release so as to provide impulses (taken from a pair of normally open contacts on one of the relays) of the required rate and characteristics to operate the switches.

Probably the most widely used form of mechanical impulse-generator is the telephone dial. During the restoring motion of the dial, after it has been operated, it will produce from 1 to 10 impulses at a normal rate of 10 per second. The actual number of impulses corresponds to the dial number selected. Two common forms are used: One provides impulses representing momentary openings of a normally closed circuit; the other form produces impulses representing closures of a normally open circuit. A standard dial impulse has 38½% make. That is, the dial contacts are closed during 37½%, and open during 62½% of the total impulse period.

#### Remote Control Circuits:

The media by which control impulses are transmitted from the control point to the remote point vary, depending upon the circumstances of the application. The simplest form is a 2-conductor line. Using DC on the line, the remote equipment would be operated by impulses of direct current from the impulsing device. Generally, the impulses are not applied directly to the switches, but are used to actuate a pulsing relay at the remote end which, in turn, repeats the pulses for stepping the switches with a local DC source. This method allows the use of small conductors, which may be of any length provided the total loop resistance does not exceed approximately 1,000 ohms. Leased telephone lines are often used when it is impractical to construct private lines. In many cases, however, telephone operating companies restrict the use of direct current in its lines since, if distances are long, repeating equipment may be employed which cannot pass direct current. It then is necessary to use alternating current on the lines, and to rectify it at the remote end before it is applied to the pulsing relay.

Another medium is an RF carrier. The carrier, or signal-frequency modulating the carrier, is controlled by the impulsing equipment at the transmitter. A receiver at the remote end provides a rectified output of the transmitted signal sufficient to operate the pulsing relay.

EDITOR'S NOTE: Part 2, the conclusion, will present typical operating circuit diagrams, and describe methods now in use for the remote control of radio equipment.

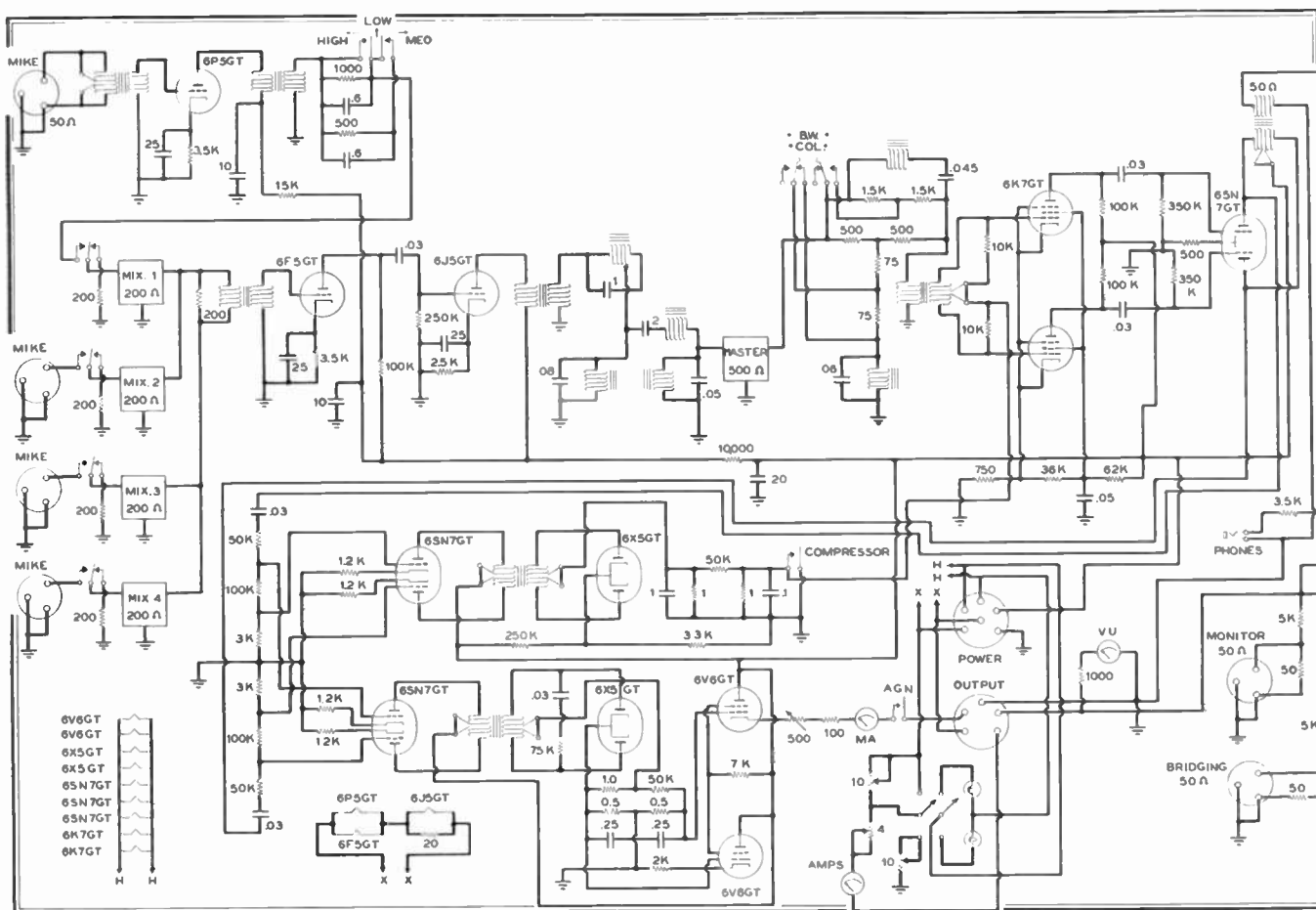

FIG. 1. Circuit of the 4-channel amplifier illustrated in Figs. 2 and 3. This unit is used to feed the sound-on-film recorder

## 30-10,000 CYCLES ON 16-MM. FILM

THE USE OF A .0001-IN. RECORDING LINE AND A PRECISION SOUND TRACK PRINTER GIVE SOUND-ON-FILM QUALITY SUITABLE FOR TELEVISION STUDIOS—*By J. A. MAURER\**

UNTIL very recently, 16-mm. motion picture film has not been regarded as a high-fidelity sound recording medium. In fact, the general impression has been that 16-mm. sound films were limited to an upper frequency range of 5,000 to 6,000 cycles, and a volume range of little more than 30 decibels. Most projection equipment currently being supplied for use in television broadcasting stations has been engineered to those standards.

The nearly universal use of reproducing equipment designed for the mass market, in which quality has been severely limited by cost considerations, is chiefly responsible for the mediocre performance generally obtained from sound film. Because very little high-quality reproducing equipment has been in existence, there has not been an incentive to develop high-quality recording and film-printing equipment. Thus most of the film which has been commercially available has not contained recorded frequencies much beyond 6,000 cycles. No particular care has been taken to minimize distortion in the film prints because system noise and distortion in the low-priced reproducing sys-

tems were nearly always sufficient to mask distortion in the sound track.

The recent announcement of the availability of Maurer 16-mm. sound-on-film recording equipment, capable of handling the frequency range of from 30 to 10,000 cycles with low distortion and a signal-to-noise ratio in excess of 45 decibels has created considerable interest with respect to its application to television programs recorded on film.

Prior to the end of the last war, our engineers had established the fact that the grain and resolving power of 16-mm. films available for sound recording and printing were such that the recording and reproducing of frequencies up to and beyond 10,000 cycles was principally a matter of the accuracy of the equipment used. In this respect, the major requirement was accuracy of the optical systems used to form the narrow-line images by means of which the sound track is recorded and reproduced. In most of the equipment used in the past, the recording-line image has been approximately .00025 in. in width, and the reproducing image for 16-mm. film has been .0007 to .0008 in. wide. Since the wave length on the film is .0007 in. at 10,000 cycles, it can be seen

that ordinary reproducing systems will give no response at that frequency.

The new Maurer recording equipment produces a recording line of light very nearly .0001 in. wide, and the film phonograph used for reproduction utilizes a scanning light beam .0003 in. wide. It is advantageous to make the recording image narrower than the one used for reproduction because the scattering of the light by the tiny, sensitive silver bromide crystals in the film adds somewhat to the effective width of the recording image. This effect, however, is by no means as serious as is generally believed. Failure to obtain good high-frequency response in the past has been due primarily to optical limitations, and to insufficiently accurate printing of the sound track.

The present Maurer 16-mm. recording equipment was engineered immediately following the close of World War II. At that time, it was foreseen that the arrival of television broadcasting on a large scale would create a demand for 16-mm. film records of substantially higher fidelity than any that were then available. In order to provide in advance for this higher standard of quality, the optical system used in the recorder was designed

\* President and Chief Engineer, J. A. Maurer, Inc., 37-01 31st Street, Long Island City 1, N. Y.



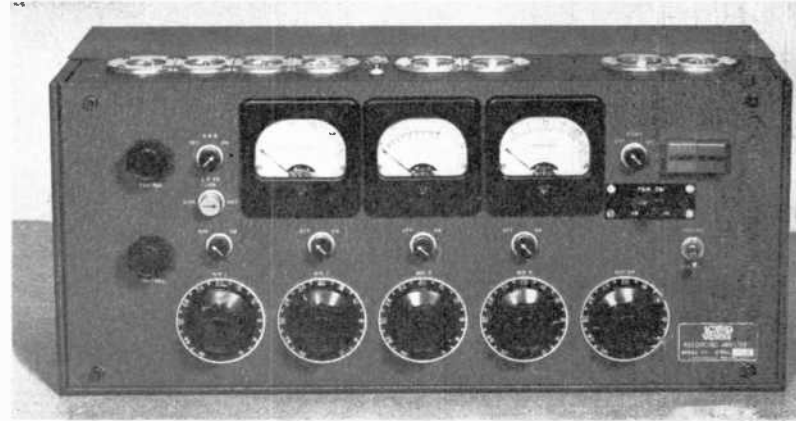
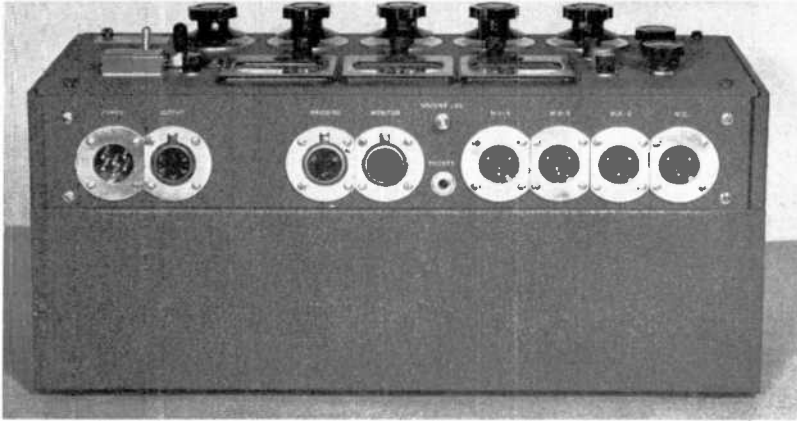

FIG. 2. Top view, and FIG. 3 front view, of the 4-channel amplifier. It is provided with a carrying case, or mounted on a rack

to provide a line of light sufficiently narrow to meet all foreseeable requirements, and the system was equipped with a carefully standardized mirror galvanometer tuned to 12,000 cycles. Following general industry practice, the sound input equipment provided with the recorder is equalized for a range of 90 to 6,000 cycles, but provision is made for simple replacement of this equalizer by others designed for wider frequency ranges.

emphasis necessary to overcome this reduced film-loss is approximately the same as is used above 1,000 cycles in recording discs, according to the standard NAB characteristics. Since the amplitudes of naturally-occurring high-frequency components of speech and music fall off with increasing frequency more rapidly than this equalization curve rises, this amount of equalization introduces no new problems in recording. The recording amplitude that is practical to employ is still determined by components in the neighborhood of 1,000 cycles, or at lower frequencies on which the equalizer has no effect.

equally simple adjustment allows the selection of either a positive- or a negative-recorded track. Direct-positive sound tracks are extremely useful when a record must be processed and used for reproduction within a time too short to permit the usual printing procedure. The movement of the film past the recording light beam is maintained at the constant speed of 24 frames per second by a synchronous motor drive, mechanically filtered by a heavy, accurately balanced fly-wheel on the sound shaft, driven by a fluid transmission. Flutter content is less than .05%.

Distortion in the system has been held within the limits necessary for the satisfactory utilization of a wide frequency range. Though the recording galvanometer is a moving iron device, the content of odd-order harmonics is less than 0.5%, and second harmonic is less than 1%. Photographic effects in variable-area recording do not add appreciably to the odd-order harmonic distortion. They may introduce appreciable second harmonics, but with properly controlled film processing, the overall harmonic content of the sound track print can be held to the order of 2% on a commercial basis.

Film magazines supplied with the equipment are of 400-ft. and 1200-ft. capacity. The latter provides an uninterrupted recording time of 33 minutes.

The 4-channel portable amplifying equipment, Fig. 1, is usually supplied with the recorder, it is equipped with variable high-frequency pre-emphasis and variable low-frequency attenuation for convenience in meeting the acoustical problems ordinarily encountered in motion picture production. It is also provided with a compressor which can be used to give about 8 db of compression when operating under conditions such that the material to be recorded cannot be rehearsed adequately. Signal level, recording lamp current, and the bias current for noise reduction are controlled at the amplifier.

FIG. 4. Power supply for the amplifier

During the two years since this recording equipment was developed, our efforts have been concentrated mainly on sound track printing equipment, and the details of film processing. The result of this work is an optical 1-to-1 ratio sound track printer which overcomes the problems of imperfect contact and slippage, long recognized as impairing the quality of sound track prints. The sharper definition resulting from the use of this printer improves the response of 16-mm. prints by 8.5 decibels at 10,000 cycles. The net film transfer loss at this frequency is thus reduced from its former value of 24 decibels to 15.5 decibels. The high-frequency pre-

Our recorder produces either variable-area or variable-density records. The change from one type of recording to the other is made by rotating a turret, moving one lens into or out of the recording optical system. The function of this lens is to focus widthwise the image of the sound track when recording by the variable area system. Removing it from the system permits exposure of the full track width to the varying total amount of light reflected through a slit by the oscillating galvanometer mirror. The change can be made in a few seconds. An

To meet the requirements of stations where this equipment for television program recording, a special rack-mounted amplifier system, including the noise reduction control circuit and the proper equalization for the 10,000 cycle frequency range, is now in production, and will be available shortly. This system is designed to work from normal program lines at signal levels of 0 to +10 vu.

FIG. 5. Fly-wheel recorder. FIG. 6. Recording galvanometer, track selector, and motor-reversing switch. FIG. 7. Recording galvanometer

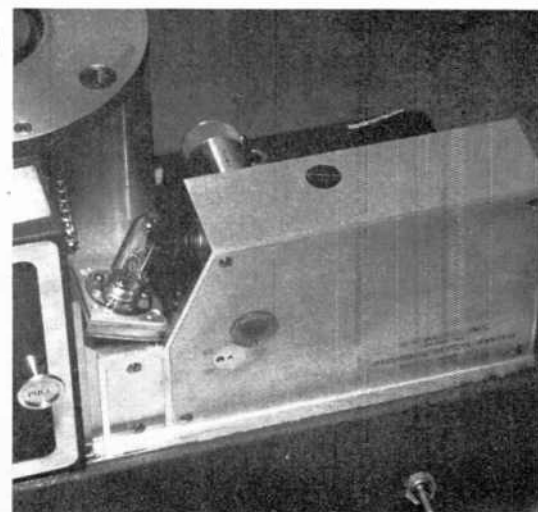
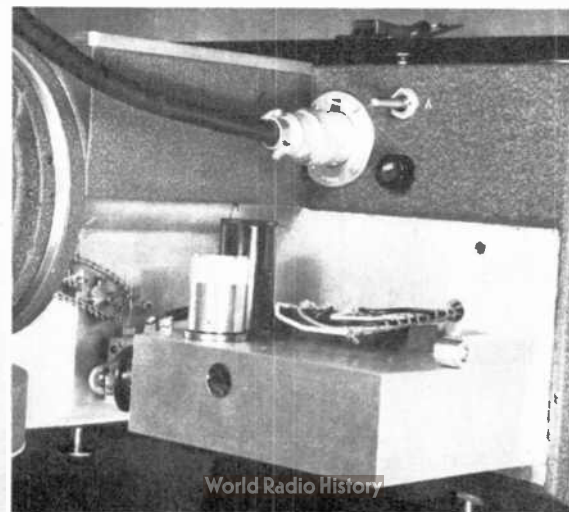
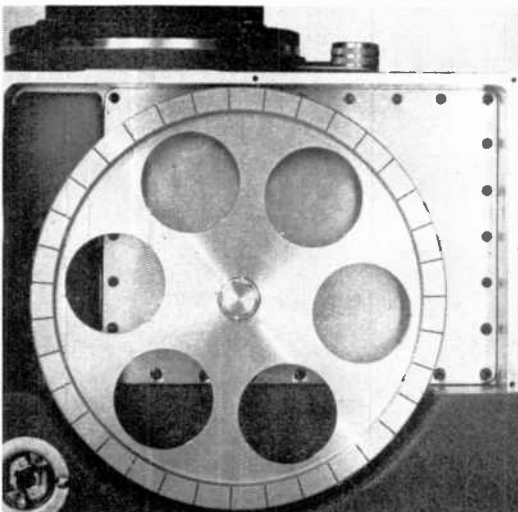

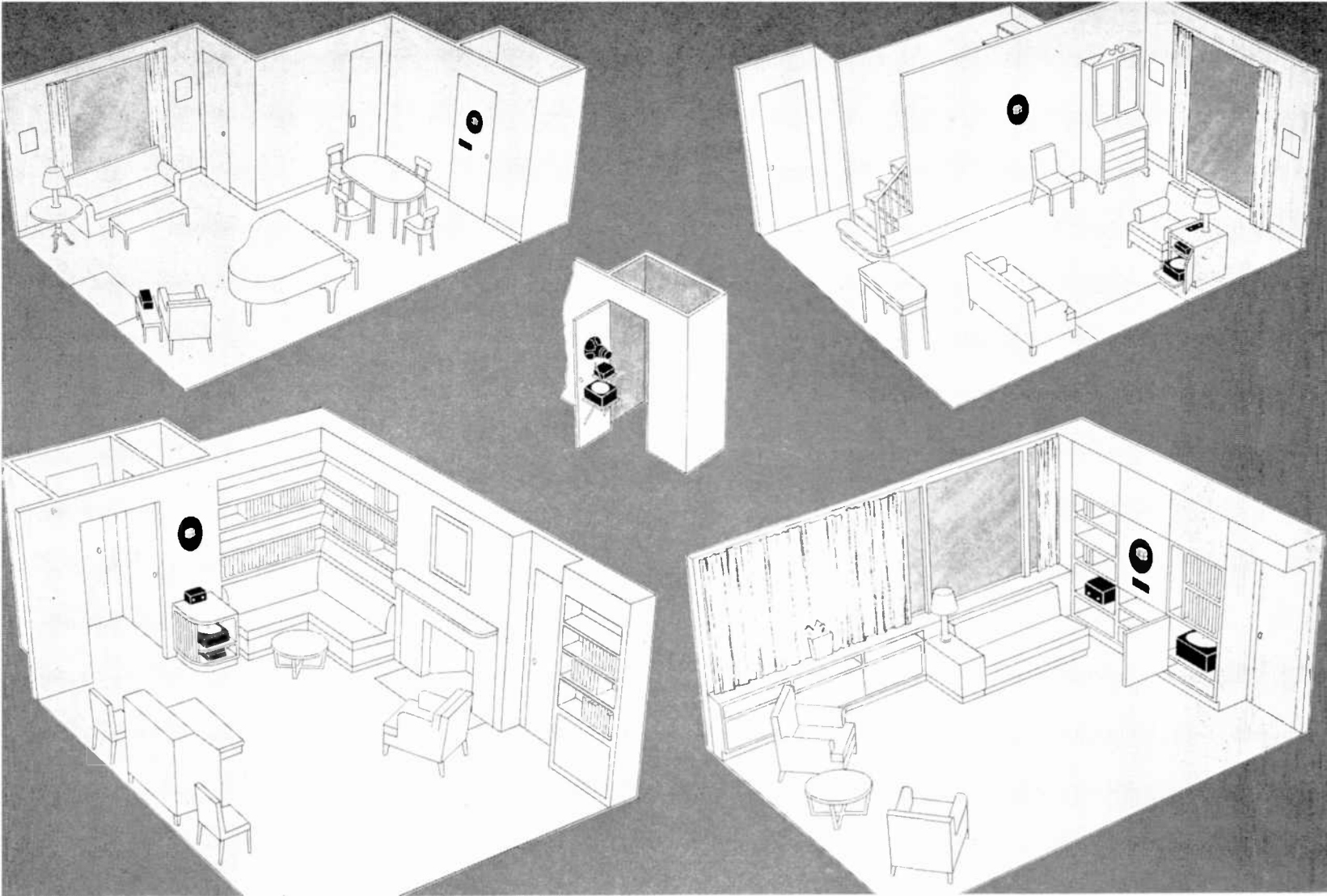

*In these arrangements, all the investment goes into fine audio reproduction. Cabinet cost and style problems are eliminated*

## FUNCTIONAL DESIGN FOR REALISM

SINCE MUSIC IS HEARD AND NOT SEEN, RADIO-PHONOGRAPH DESIGN SHOULD START WITH LOUDSPEAKER ACOUSTICS, AND ELIMINATE THE FURNITURE — *By H. S. MORRIS\**

**M**MUSICALLY perceptive men and women who are accustomed to hearing music in the concert halls have long been aware that their radio-phonographs, even the expensive ones, do not give them the illusion of live performances.

### Simulation Vs. Reproduction:

This awareness of fastidious musical listeners is becoming accelerated, and more widespread as a result of the discovery that the professional type of loudspeaker presents, when fitted into the structure of a living room, an illusion of live music in a way that has never been created in the home before. The contrast between this professionally-produced illusion of reality, and the simulated tones that issue from the conventional radio-phonograph is only too marked.

For the industry which produces conventional radio-phonographs, the implica-

tions of this contrast are nothing short of revolutionary. This article will explore some of those implications, and asks the provocative question: Are conventional radio-phonographs designed *backward*?

### To Be Seen — Not Heard:

The commercial maker of radio-phonographs begins not with circuits and components, which are his *métier*, but with a piece of furniture. His first preoccupation is that of a carpenter, or cabinet-maker. Knowing the complexity and capriciousness of taste and preference that the American home owner brings to the choice of furniture, the radio-phonograph maker must first undertake research to find out whether the modified 18th Century cabinet, or the blond moderns — or which of the periods in between — will be acceptable to the opinionated department store stylists whose judgment is sought by the buyers before orders are placed for what we call "home radios."

### The Last Is Least:

The manufacturer knows that the tuner and the phonograph record changer have got to be located as high up in the cabinet as possible. People are allergic to stooping any lower than necessary to work the dials or the changer. The speaker, therefore, the only element which does not *need* to be accessible, goes into the bottom of the cabinet, in whatever space is left!

The manufacturer has, moreover, something else to consider beside the compromises he must make to the physical limitations of furniture design. He must consider costs. He is in a competitive price market when he bids for customer-acceptance of his cabinet designs. By the time he has worked out his costs for the furniture, and has added the tuner, the amplifier, and then the record changer, he becomes panicky, and looks about for ways to save every possible penny on the rest of the equipment. This brings him to the speaker, and because the speaker is

\*Audio Engineer, Altec Lansing Corporation, 161 Sixth Avenue, New York 13, N. Y.

permanently concealed, this is the item on which he feels safe in making drastic economies. So he chooses the smallest, cheapest, minimum-performance speaker that can be related to the performance of the other elements.

Thus the speaker, the mechanism for the creation of sound, is, by the very nature of things, the orphan, the waif-and-stray, the step-child of the best cabinet-type radio-phonograph models.

### One-Note, Beer-Barrel Boom:

Reproduction from store-model radio-phonographs is most egregiously bad in the lower frequencies. That is not merely because economic considerations relegate the speaker to the what's-left-if-any position as to size and price. It also results from conflict with simple laws of physics, against which the speaker cannot win.

Anyone with a knowledge of music can understand that. Consider the bass viol, or the double bass. To produce the resonant low notes characteristic of the bass viol, the instrument is made of sufficient size to provide an air cavity of about ten cubic feet. Without that air cavity, the instrument would simply not produce the low frequencies we are accustomed to hear when a bass viol is played.

Because of the size and space limitation of the ordinary radio-phonograph, the air cavity behind the speaker is, like the speaker itself, grossly inadequate in size. The loss of low-frequency sound waves, as generated from an air cavity of incorrect size (to be adequate, it must be not less than 7 cubic feet) affects not merely the bass viol, but every instrument<sup>1</sup> which has any low-frequency components.

Manufacturers have resorted to various expedients to create the impression that bass notes are present. Such devices as baffles and labyrinths, trick mountings, and resonant pipes are well-known to those who look behind the cabinets. Some makers resort to other subterfuges, such as resonating the speaker and its air cavity at a frequency in the low register between 75 and 200 cycles. These are the radios that have the beer-barrel boom or juke-box bass.

Critical listening will disclose the presence of this artificial resonance; the bass will have a one-note characteristic, resulting from shock excitation. That is, any bass frequency reasonably close to the artificial resonance point will excite the speaker-cabinet at that resonant frequency, setting up that single boom-boom note. In a system having a *true* bass response, the resonant frequency is below frequencies common in musical instruments, so that the one-note effect is not created. A high-quality system can always be distinguished by the fact that the bass actually plays a tune.

<sup>1</sup> For the frequency range of each musical instrument, see the Frequency Range chart published in *FM AND TELEVISION*, December, 1947.

### The Built-in Music System:

Now, let us turn, with a sigh of relief, from that conventional musical monstrosity, the radio-phonograph, whose performance is crippled and hobbled by the very nature of its design.

The maker of the built-in music system can be as innocent of furniture design as the babe unborn. He doesn't have to know what pleases the department store stylist, or what, in consequence, is supposed to please the ultimate consumer.

Remembering what has been said about the air cavity in the double bass, it is clear that the loudspeaker must be located where it will have behind it an air space of at least eight cubic feet. If the speaker is placed in a wall, the back of the wall must be a stairway, or a clothes closet, where dead air space exists, free of echo from reverberation-producing surfaces. In practically every living room there is a choice of several such locations. The location should be so chosen that the sound waves are directed toward the part of the room where the family usually sits. Since the high-frequency waves from a speaker with an exponential high frequency horn, such as the Altec Lansing Duplex for example, will beam out in an arc of 40° vertically and 60° horizontally, the listeners need not sit in the direct path of the speaker, but they *should* sit within the 60° arc.

In the conventional radio-phonograph, the speaker is usually less than a foot above the floor, simply because that is the only place left for it in the cabinet. Built-in systems, completely emancipated from such limitations, permit location of the speaker at the height at which normal listening processes occur.

There is literally no living room of conventional design in which the speaker cannot be located to conform to the individual preferences of the home owner, and still afford the quality of reproduction necessary to create the illusion of artists actually playing in the room.

Placing of the other elements of the built-in system can be resolved in various simple ways that eliminate the awareness to mechanical adjuncts,<sup>2</sup> which would otherwise detract from the pleasure of listening to music. Several arrangements are indicated in the accompanying illustrations. Stir these examples up with a small quantity of ingenuity and imagination, and you can come up with a solution to fit any combination of circumstances.

*Altec-Lansing version of a radio-phonograph installation is the last word in audio quality, convenience, and low cost*

<sup>2</sup> Editor's Note: The use of flat, 2-conductor line intended for FM and TV antenna lead-in is suggested for connecting the equipment, as it is easy to conceal under rugs, and can be tacked inconspicuously on baseboards. American Phenolic Corporation manufactures multi-wire cables in flat plastic tape.

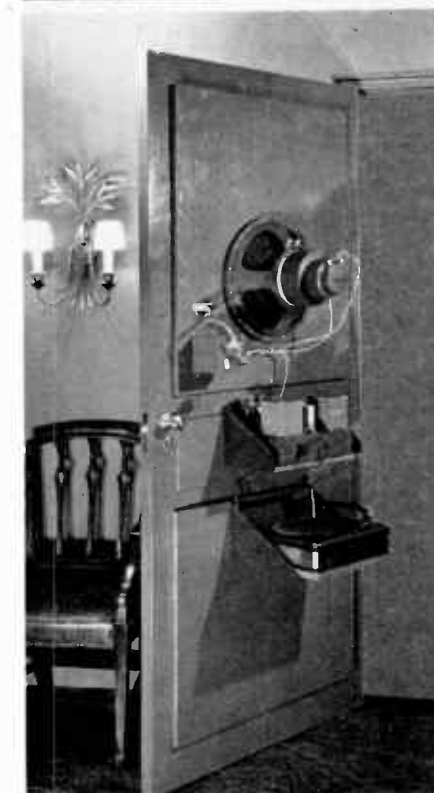

Right: In Chicago, the I.G.A. chain has sixty storecasting installations in use. Below: The single FM unit is fully automatic



## FM FOR STORECASTING

IT REACHES CAPTIVE AUDIENCES, AND OPENS A NEW MARKET FOR EQUIPMENT—By BERNARD J. SULLIVAN\*

FM BROADCASTERS are frequently challenged with the question: "What can FM do for sponsors that AM isn't doing already?" This was discussed at length during the September FMA conference, together with the complaint: "FM doesn't add to the listening audience."

As was brought out at the conference, there are a number of things that FM can do that AM can't, in the process of which guaranteed audiences can be reached. Storecasting is one of them. It is impossible to use AM for program reception in large grocery stores during busy shopping hours, because the speakers would roar every time the coffee grinder is turned on, or a fluorescent light sputters. But not with FM to provide protection against sources of man-made static interference.

There is a tremendous field of new business in storecasting, both as to the sale

of time and the sale and installation of equipment. The grocery chains are recognizing that just as music increased factory production, so it is effective in creating an agreeable atmosphere and customer goodwill in their stores.

The I.G.A. chain in Chicago, for example, is putting FM receiver and speaker systems in 60 of their stores. The accompanying illustrations show one of these installations, and details of the equipment, manufactured by Electronic Sound Engineering Company.

A single cabinet, 5 by 16 by 20 ins., contains the three basic operating units, comprising an FM receiver, high-quality amplifier, and automatic time-control mechanism. The receiver is particularly noteworthy because it is equipped with automatic frequency control. This is considered more practical than the use of temperature-compensating devices for storecasting service. Since the equipment must be fully automatic, AFC is necessary to eliminate off-frequency reception at all times, even during the warm-up period. Thus, no manual adjustment is required at any time.

The Polyphonic amplifier is designed to deliver the full quality of live FM programs. Harmonic distortion is rated at less than 2% with 20 watts output. While it may seem that an amplifier of lower quality would be adequate, experience has proved that distortion is an important psychological factor that produces a reaction of irritation. The difference in cost, therefore, is amply justified by public response to more agreeable reproduction.

The automatic timing mechanism is an interesting departure from other devices of this sort. It not only turns the radio equipment on and off, but it adjusts the

volume level in accordance with periods of greater and less store traffic. This is an essential feature, for ambient noise changes greatly during the day. A level set when a store is crowded would be objectionable when there are only a few customers, while if the level were adjusted under the latter condition, the music would hardly be heard during busy periods.

As for the loudspeakers, two of the type shown in I.G.A. photograph above are entirely adequate for a store 50 ft. wide by 80 ft. deep. These are 360° speakers, assuring uniform sound distribution in all directions.

It should be noted that this type of service is by no means limited to grocery stores. Many other types of retail establishments can use broadcast music with equal effectiveness, as well as restaurants, bus stations, and other places where people can listen without being distracted from other activities.

Two doors give access to the wiring of the FM receiver and the audio amplifier

\*General Manager, Electronic Sound Engineering Company, 4344 W. Armitage Avenue, Chicago 39.

The entire radio equipment and the clock control mechanism swing out on the door

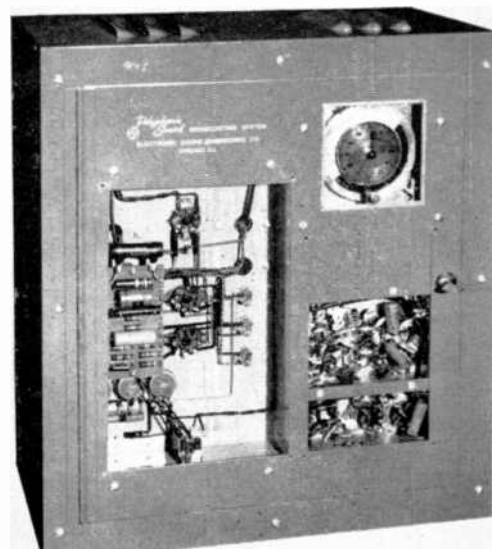
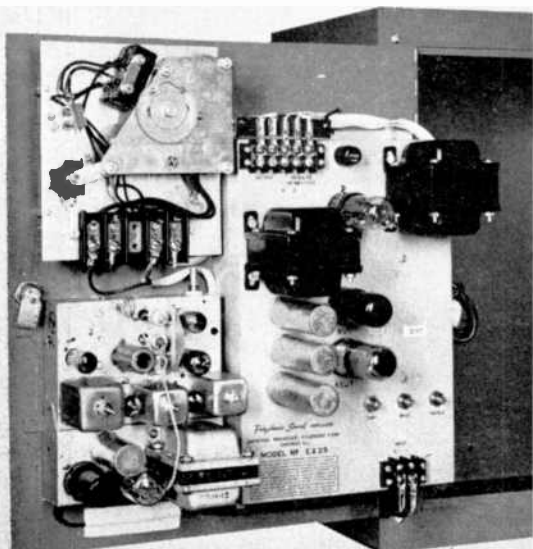

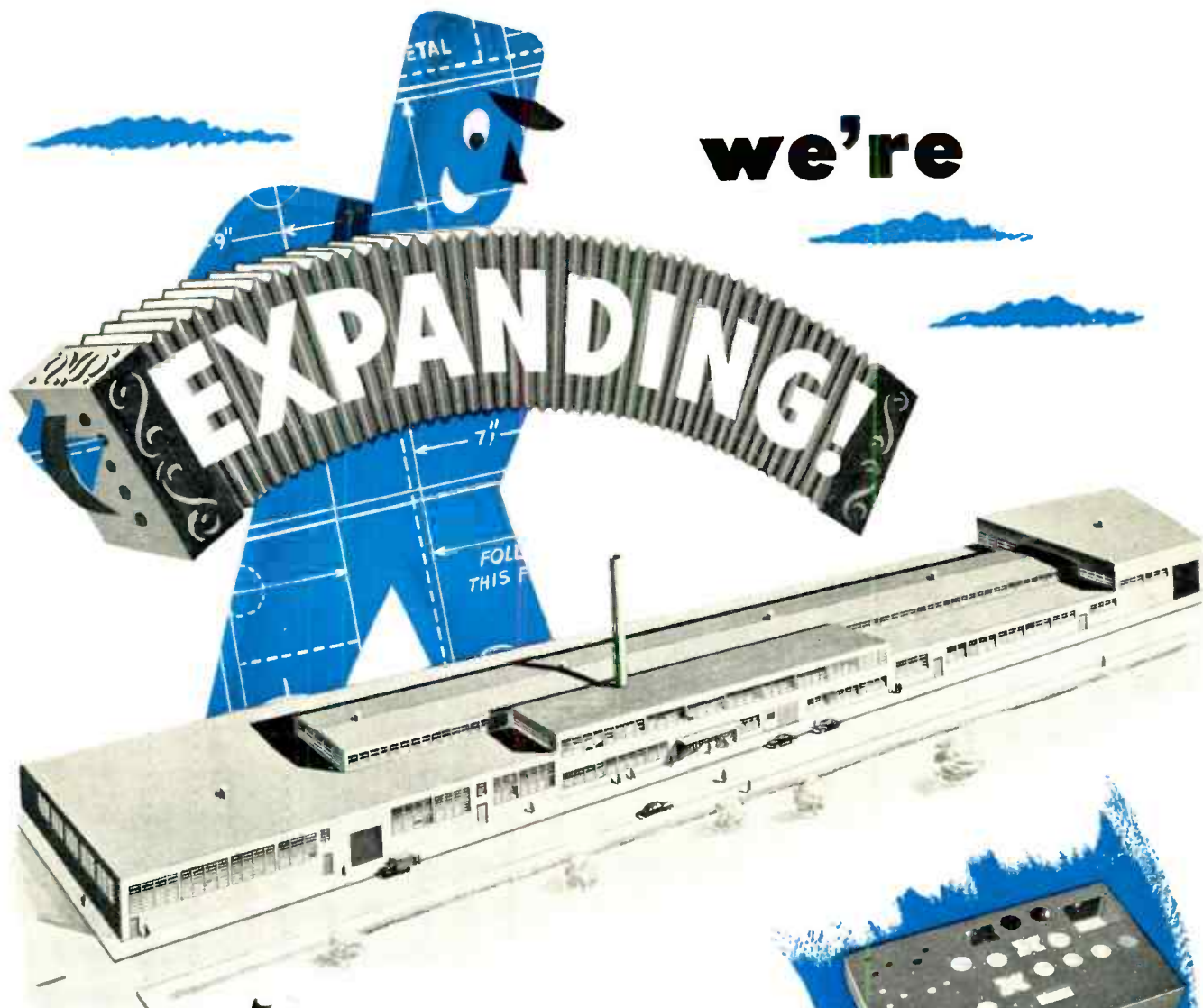

**we're**

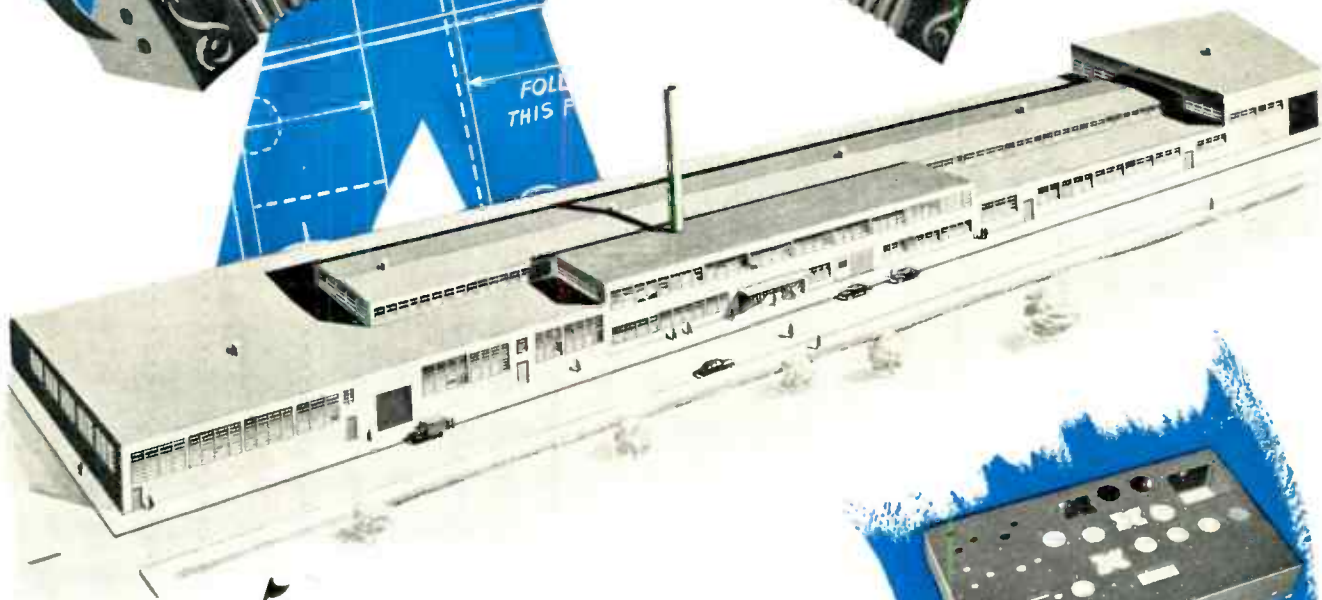

It's sweet music to us...and to our customers, we think, to know that Karp Metal Products Co., Inc., this month will move into a brand new streamlined building of 70,000 square feet of space, with a 600 foot frontage.

Our new plant will be the last word in modern manufacturing quarters, equipped with the newest and most efficient machinery and facilities, including the most complete and **up-to-date paint and finishing department**, scientifically air conditioned and dustproof. These advancements will enable us to extend the scope of the precision service we render the leaders of the radio, television and electronics industries.

Your loyal patronage has helped make possible this expansion, and you may be sure the favor will be returned in the form of greater production and better-than-ever Karp service... from the simplest chassis to the most elaborate console.

Ask For Our Informative New Catalog



# **KARP METAL PRODUCTS CO., INC.**

217 - 63rd Street, Brooklyn 20, New York

*Custom Craftsmen in Sheet Metal*

## RCA-NBC VIEWS ON TV

(Continued from page 24)

services concerning which RCA has little information, and it would appear that the FCC is the only agency that can make this determination.

As a matter of realism, we recognize of course that the possibility of finding a substantial number of additional channels for television below 300 mc. is remote, and that therefore the Commission should, as it is now doing, explore the characteristics of the 475- to 890-mc. band to determine whether it is feasible to provide space there for the expansion of black-and-white television.

The problem of using this frequency space is of course a complicated one which must be approached cautiously, with a full understanding of both the capabilities and limitations of this band.

For many years RCA has carried out research on the generation, propagation and use of frequencies in the upper reaches of the radio spectrum. As technical developments have made it possible to open up new areas, we have investigated the problems and contributed to the store of knowledge relating to the behavior of radio in the higher frequencies. This research has included extensive experimentation in television. During the hearing on certain standards proposed for color television (Docket No. 7896) in December, 1946, we presented testimony as to our knowledge at that time of the possibilities of generating and using frequencies above 500 mc. The allocation by the Commission of frequencies above 475 mc. for the future use of television and our research with respect to color television have stimulated our study of this area of the frequency spectrum.

When the Federal Communications Commission visited RCA Laboratories at Princeton on April 11-12, 1948, we discussed this subject at some length and gave the Commission copies of a technical report, "Comparative Propagation Measurements: Television Transmitters at 67.25, 288, 510 and 910 Megacycles". This report is published in the quarterly technical journal, *RCA Review*, June 1948.

As we told the Commission during its visit, our work on color television was leading up to a field test involving transmissions on frequencies in the vicinity of 500 mc. We planned at that time to install a color television transmitter on the Empire State Building and obtain further experience in transmitting color television on these frequencies. The studies indicated that more information is desirable on propagation using a wide-band signal such as television. In order to expedite obtaining this information, we planned preliminary tests in New York using one television transmitter with black-and-white pictures, later expanding to the full simultaneous color system.

With the announcement of this hearing, our plans were altered and it was decided to shift some of the propagation tests from New York to Washington. By expediting the work of installation we were able to get on the air with transmissions at a date prior to the beginning of these hearings. The present transmissions will be continued for a suitable period of time in order to permit persons who so desire to make investigations, and in particular to give the Commission ample opportunity to make such studies as it requires. The information on propagation which is being obtained in the Washington experiment will be useful in our subsequent color investigations. However, we would like to discontinue this present black-and-white experiment as soon as it has served its purpose in order that we may continue with our color television research.

In conclusion I shall now present, in summary form, the position of RCA-NBC. The supporting data for many of these points will be given by other witnesses.

1. RCA-NBC believe that the present twelve channels should continue as the backbone of television's service to the public.

2. RCA-NBC feel that, where consistent with such rules relating to tropospheric propagation and protected contours as the Commission may adopt, the Commission should authorize the use of higher power for television stations.

3. RCA-NBC believe that additional channels should be assigned to commercial black-and-white television.

4. RCA-NBC urge the Commission to make an exhaustive survey of the frequencies below 300 mc. to determine whether additional channels for television can be found in that part of the spectrum.

5. RCA-NBC believe that the Commission should complete its studies of the band 475 to 890 mc. and then prepare plans for the use of a part of that band for the expansion of commercial monochrome television. We feel that these plans should provide for the use of the same standards, in so far as they relate to interchangeability of operation, as those in use on the present 12 channels. While of course the opening of these higher frequencies to commercial service would not immediately produce a solution to the problems which the Commission and the industry face, it would serve to stimulate the commercial development of equipment and shorten the time until the problems of this region would be solved.

6. RCA-NBC urge that the Commission recognize that what it does in this case may have a substantial bearing on the ultimate development of a nationwide color television service. We believe that the encouragement of color development is one of the factors the Commission should bear in mind in making any allocation of additional channels to monochrome television. The band 475 to 890

mc. is, for the foreseeable future, the only one available for the development of color. If that entire band were taken for the expansion of monochrome, the effect on color would be obvious. On the other hand, we recognize that one of the major considerations now is to provide an adequate and nationwide commercial monochrome television system. In balancing these factors, we urge that the Commission, in fixing the number of additional channels which may be allocated to monochrome, reserve enough space in the band 475 to 890 mc. to encourage continued work in color.

## DU MONT UPPER-BAND PLAN

(Continued from page 25)

scheme, and he can probably give some information on it.

THE CHAIRMAN: I have a few questions to ask you, Dr. Du Mont. You made reference to the fact that cities with only one or two assignments now might get assignments in the UHF band, and I believe that a little later you said that there should be at least four channels available in each community on the basis of program choice.

DR. DU MONT: That is right.

THE CHAIRMAN: I take it you have given consideration to this question of a nationwide competitive system of television, and you conclude that competition is on the basis of the number of program services available?

DR. DU MONT: That is right. Generally, I would like to see a minimum of five stations in all, well, certainly the first 140 cities, and possibly carry it down further. You may not be able to get the five, but I think there is a good chance you can get four with the additional 69 channels.

THE CHAIRMAN: As I understand the situation now in the first 140 cities under our present allocation rule, Network A could have 140 affiliates, presumably.

DR. DU MONT: That is right.

THE CHAIRMAN: Network B, 90; Network C, 60; and Network D, 50; and E in the order of 36 or 37.

DR. DU MONT: Of that order, that is correct.

THE CHAIRMAN: And you are saying that to have a nationwide competitive system there should be parity between Network E and A in terms of the number of affiliates?

DR. DU MONT: I think yes, that is very definitely true, to have a competitive system. I think you also have to look at it from the standpoint of the public. It certainly is a benefit to them to have a choice of four or five programs rather than having to listen to just one or two programs. I think it works both ways.

THE CHAIRMAN: Have you given consideration to how many channels it would

(Continued on page 38)

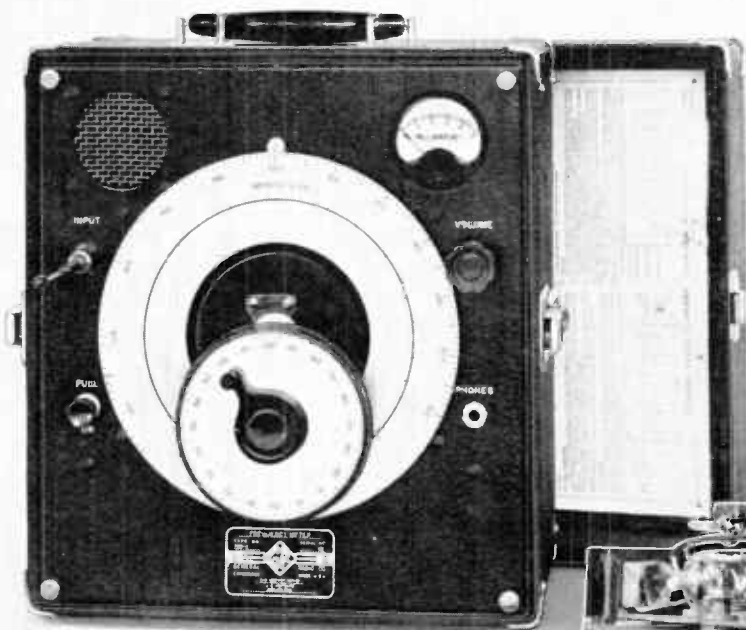

## FREQUENCY MEASUREMENTS TO 3,000 Mc

FULL advantage of the simplicity of the heterodyne method of frequency measurement is taken in this frequency meter. With a fundamental range of 100 to 200 megacycles, accurate frequency measurements may be made between 10 and 3,000 megacycles.

The tuning circuit is our butterfly type with no sliding contacts, obviating many of the difficulties encountered in the usual tuning elements used in u-h-f-equipment.

A standard plug-in silicon crystal is used as the detector, followed by a three-stage audio amplifier. The band width of the amplifier is 50 kc to permit visual beat indication even if the signal under measurement is unstable.

For very strong signals beat indication may be obtained either aurally from the built-in dynamic loud speaker or visually from the panel meter. For weak signals a telephone jack is provided for headset detection.

Normally no direct connection to the signal under measurement is required, the retractable 'antenna' providing the necessary coupling. On weak signals, terminals are provided for additional pick-up if necessary.

This instrument is finding wide application both in the laboratory and in the field where a portable, self-contained, stable and accurate heterodyne frequency meter is needed for measurements over a very wide range of high and ultra-high frequencies.

**TYPE 720-A HETERODYNE FREQUENCY METER \$340**

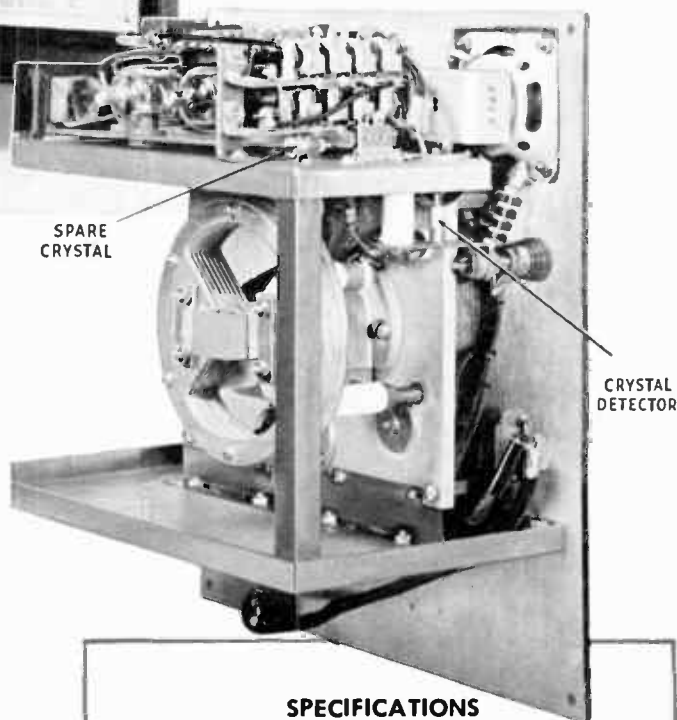

### SPECIFICATIONS

**FREQUENCY RANGE** — fundamental range of instrument is 100 to 200 Mc; by harmonic methods measurement range is 10 Mc to 3,000 Mc.

**CIRCUIT** — our butterfly tuning unit used in the oscillator; crystal detector (with spare); 3-stage audio-frequency amplifier.

**BEAT INDICATORS** — built-in dynamic loud speaker and panel meter for aural and visual beat indication; telephone jack for headset indication from weak signals.

**ACCURACY** — over-all accuracy is  $\pm 0.1\%$

**CALIBRATION** — main dial calibrated in frequency, each division being 1 Mc; one-half turn of vernier dial corresponds to approximately 1% change in frequency over entire tuning range.

**PORTABILITY** — instrument weighs only 27½ pounds complete with batteries. Separate a-c power supply may be ordered for a-c operation.



**GENERAL RADIO COMPANY** Cambridge 39, Massachusetts

90 West St., New York 6

920 S. Michigan Ave., Chicago 5

950 N. Highland Ave., Los Angeles 38

## DU MONT UPPER-BAND PLAN

(Continued from page 36)

take to equalize E and A networks under the 140-city allocation plan?

DR. DU MONT: I haven't the figures to give you right now. We should have those next week. But from the preliminary work we have done, we are reasonably sure that there will be more than enough channels in the UHF band to take care of it. In other words, what we are proposing is that you use the same standard in the UHF 6 mc. band as you use today in the VHF. That will allow slightly over 69 channels. We don't think 69 will be necessary. And we would recommend that whatever additional space is left in the UHF band be employed for relay purposes, where there is a tight situation.

THE CHAIRMAN: Under your thinking you would have the VHF and the UHF frequencies comingled in the various communities?

DR. DU MONT: No, we are not.

THE CHAIRMAN: If you are going to equalize the number of assignments in the 140 cities, we will say, it seems you would have to, or you would propose to delete some VHF frequencies, one or the other.

DR. DU MONT: That is correct. We are not proposing, and fortunately, after all, television is relatively new, and you have had your stations and your c.p.'s in the larger cities, so that most of them are in cities that you would not want to delete, but there may be some cities where you would definitely want to delete VHF frequencies in order to smooth this thing out.

Our thinking is that it would be better to have UHF in one city and VHF in another city for a number of reasons. One, for competitive purposes they would be all more nearly on the same basis. Secondly, it allows for a cheaper television receiver and cheaper antenna installation. If we have to provide television receivers that cover the entire band, and we have to provide an antenna and a lead-in that covers the entire band, it will be somewhat more expensive than if we can build receivers for either the UHF or VHF. Ultimately it may not make any difference. You may have one antenna, one receiver, everything, to cover the whole band. We thought at the start, and our plan is, to try and lay this out on the basis that you either have one or the other, UHF or VHF, in a particular city.

THE CHAIRMAN: In connection with that, have you given consideration to the kind of terrain you are going to run into in these cities which would be UHF and the plan you would lay out? I am thinking of your statement about Worcester and Providence.

DR. DU MONT: I don't know whether you have seen the report we have given to the Commission —

THE CHAIRMAN: I have not.

DR. DU MONT: We have taken some contours over some rough terrain and the shadow effect, according to our tests that we have made, is not nearly as bad as we had anticipated. We don't think that you have to give that very much more consideration than you have to give it in the present band. Furthermore, we can see, and we not only can see but we have accomplished certain results in the way of receivers for the UHF that will operate at a lower microvolt than they will in the VHF, which means that in the shadow area, where the signal is very low, you still can get an excellent picture without noise. We are not saying the whole thing is solved. We are saying that the results we have had look good enough to us to go ahead on the UHF and we certainly have held back a long while on this because we wanted to be sure that we had something we could use commercially.

THE CHAIRMAN: You spoke in your statement, Dr. Du Mont, about a transmitter for the UHF frequencies. I assume you meant the entire band.

DR. DU MONT: That is correct.

THE CHAIRMAN: It could be built today, you said.

DR. DU MONT: Well, I said today, we couldn't make delivery today, we could make delivery in maybe six to nine months, something like that. That is to say, it would be a low-power transmitter, somewhere between 500 and 1,000 watts, at the present time. But you can use an antenna that will step that up considerably.

THE CHAIRMAN: What kind of gain can you get out of that antenna?

DR. DU MONT: Certainly a gain of three or four, and probably a lot more.

THE CHAIRMAN: Would you say it was your judgment that equipment could be available within 12 months?

DR. DU MONT: I think that the equipment could be available in limited quantity within 12 months.

THE CHAIRMAN: Are you delivering transmitters now on VHF?

DR. DU MONT: Oh, yes.

THE CHAIRMAN: Within what period from the time of placement of the order?

DR. DU MONT: We normally run through a certain number of transmitters, and we will have a certain number of them in stock so we can make immediate delivery.

THE CHAIRMAN: Do you have some in stock in the VHF?

DR. DU MONT: Yes.

THE CHAIRMAN: Are there any other questions of Dr. Du Mont.

MR. COTTONE: Dr. Du Mont, I think you indicated that you would provide 69 channels in UHF for utilization.

DR. DU MONT: I said I didn't know whether the 69 would be necessary. I don't think it would be necessary to use the full 69, but they are available for filling in.

MR. COTTONE: You are talking about black and white only?

DR. DU MONT: That is correct. The way I look at it, in order to get a nationwide service for color, if you take the whole band and utilize it just for color, you are going to be in the same mess we are in now with the VHF, so why not do a good job and find other frequencies some day for the color situation.

MR. COTTONE: Would that utilization of the 69, or whatever figure comes out, for black and white commercial, permit of any experimentation for color in UHF?

DR. DU MONT: I think it would. I think you will have extra frequencies available after you allocate.

MR. COTTONE: In reference to your proposal for allocation of channels on the VHF, proposed allocation, you feel that the Commission should get back to the minimum 150-mile co-channel separation and 75-mile adjacent channel separation?

DR. DU MONT: I would like to see the minimum of 150, and would like to see that spread as far as you can past that point where you can do it without causing conflict. The 75, I am not so worried about. I think you may be able to shade that. Seventy-five is certainly a good working distance. But that isn't as serious as the co-channel.

MR. COTTONE: You recognize certain problems with respect to possible existing grants?

DR. DU MONT: Yes. As I say, we have looked this over. When you do you will find you won't have to touch any of the present stations.

MR. COTTONE: You mentioned c.p.'s.

DR. DU MONT: There are a few in c.p.

MR. COTTONE: What would you do with them?

DR. DU MONT: That is something I would want to think about, but there are very few that have been affected. I think it is a question of whether a very few, just a handful of people, might suffer some inconvenience at the moment, and get a decent system for all time, or whether you go ahead with the present system we have, which definitely is not adequate, and end up three or four years from now and find out you have to make a change, and then it will hurt a lot of people.

MR. COTTONE: You don't believe any of the existing stations should be required to modify in any way?

DR. DU MONT: No, I don't think they should. By and large I think there may be some slight modifications that might be all right.

MR. PLOTKIN: Dr. Du Mont, is it feasible to build a combination television receiver to operate both on VHF and UHF?

DR. DU MONT: Yes.

MR. PLOTKIN: Will it be, in effect, two television receivers on the RF stages?

DR. DU MONT: It looks to us, with some work we have done, just giving a

(Continued on page 40)



**ALL  
NEW**

P. R. MALLORY & CO. Inc.  
**MALLORY**  
Midgetrol

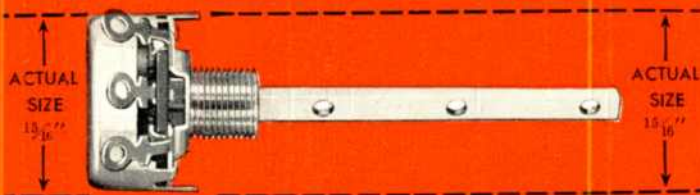

*The Little Volume Control  
with BIG Advantages*

**Bigger  
Market**

The small size of the Mallory Midgetrol lets you service portables, auto radios and small AC-DC receivers which require  $1\frac{5}{16}$ " controls.

**Simpler  
Installation**

The unique shaft design of the Mallory Midgetrol saves installation time with *all* types of knobs.

**Simpler  
Stocking**

Electrical characteristics let you use the Mallory Midgetrol to replace  $1\frac{1}{8}$ " as well as  $1\frac{5}{16}$ " controls. Stocks are further reduced because no special shafts are needed.

The Mallory Midgetrol is quietest by actual tests — and tests prove it stays quiet, too. In addition, it has nine big features that are *all new*.

- NEW SIZE
- NEW DESIGN
- NEW SHAFT
- NEW EXTENSION
- NEW SWITCH
- NEW ELEMENT
- NEW CONTACT
- NEW TERMINAL
- NEW TWO-POINT SUSPENSION

*It's the NEW Standard in Carbon Controls. See your Mallory Distributor.*

P. R. MALLORY & CO. Inc.  
**MALLORY**

CAPACITORS . . . CONTROLS . . . VIBRATORS . . .  
SWITCHES . . . RESISTORS . . . RECTIFIERS . . .  
VIBRAPACK\* POWER SUPPLIES . . . FILTERS

\*Reg. U. S. Pat. Off.

**APPROVED PRECISION PRODUCTS**

**P. R. MALLORY & CO., Inc., INDIANAPOLIS 6, INDIANA**

# Bliley- CRYSTALS



with type **BH6**  
Bliley engineering  
has anticipated  
your **VHF**  
requirements...

Type BH6 is available up to 100 MC and can be furnished to meet all standard specifications, military or commercial. This means your design considerations can be simplified by elimination of unnecessary multiplier stages. Write for information covering latest recommended oscillator circuits and associated crystal data.

# Bliley- CRYSTALS

BLILEY ELECTRIC COMPANY  
UNION STATION BLDG. • ERIE, PA.

## DU MONT UPPER-BAND PLAN

(Continued from page 38)

look ahead, it looks like we might be able to make a combination receiver that would be cheaper than our present receiver, by an entirely different method. So it isn't unsurmountable. We have one section of it working today.

Mr. PLOTKIN: You stated that it would take about 12 months to get equipment out, you think, in the UHF band?

Dr. Du MONT: Somewhere around that time.

Mr. PLOTKIN: Would that require extensive retooling of your present assembly lines?

Dr. Du MONT: We don't run assembly lines on the transmitter.

Mr. PLOTKIN: Oh, you were talking about transmitters. How about receivers?

Dr. Du MONT: Minor. Just a tuning head.

Mr. PLOTKIN: You think you could do that in 12 months?

Dr. Du MONT: Yes.

Mr. PLOTKIN: What do you think would happen in the meantime to sets?

Dr. Du MONT: Present sets, it won't affect your present system. You are not going to change, by and large, any of your present set-up. Your receiver will go ahead. There are very few stations that — there is no city in operation that will be affected, and very few where you have construction permits. This is looking several years ahead when these cities open up, like Springfield, Worcester, Providence, those cities.

Mr. PLOTKIN: You are going into greater detail in next week's hearing, are you not?

Dr. Du MONT: Yes.

Mr. PLOTKIN: One further thing: You say with respect to propagation the data shows that shadow is not a particularly difficult problem?

Dr. Du MONT: The only thing I can tell you — you have a copy, you can look at it yourself — they are honest results, we didn't try to make it look one way or the other. When you take a look at them, it is amazing it fills in as well as it does.

Mr. PLOTKIN: Are you familiar with the evidence introduced in color television on test in New York?

Dr. Du MONT: Yes.

Mr. PLOTKIN: Are these latest results consistent with those results?

Dr. Du MONT: I think that the results we have show better for the UHF than they did with the color, very definitely.

Mr. PLOTKIN: Color has nothing to do with propagation?

Dr. Du MONT: That is right. There is a problem, as you mentioned, on bandwidth, on receivers, that it is a lot tougher job to build a receiver to receive color than it is black and white, on account of the wide bandwidth and the lower gain and the much more noise.

THE CHAIRMAN: Are there other questions of Dr. Du Mont? Mr. Norton?

Mr. NORTON: Dr. Du Mont, did you have an opportunity to look at the curves in my statement yesterday?

Dr. Du MONT: I just had a casual look at it. I didn't get a chance to study it very much.

Mr. NORTON: I wonder if you would mind taking a look at it now (handing document to the witness).

Dr. Du MONT: Yes.

Mr. NORTON: On Fig. 4 I estimate the percentage of the total area of the country which could be covered when stations are separated by 150 miles. You note for a thousand-foot antenna it would be possible to cover 27 percent of the area of the country, whereas if that spacing between the stations, minimum spacing between stations, were increased to 280 miles it would be possible to cover almost 15 percent of the area of the country with a single channel, which means that with this channel we would get twice as much area coverage, by having a minimum spacing of 280. I realize that the assumptions that I have made are up for consideration in the engineering conference, but assuming that these are correct would you still be willing to limit the minimum separation to 150 miles or would you like to see it extended so that greater areas could be covered?

Dr. Du MONT: I think you will find when you see what we are able to show you here that in a large number of cases you will be able to have a very much greater spacing than 150 miles. I think there will be a few instances where you have to go that low. However, I don't think it would be advisable at the present time to upset the entire allocation scheme along the East Coast. Roughly, we have an average of 200 miles between stations. I feel that is quite satisfactory. It has worked out in practice that way. You are going to find a lot of your other stations will be well over 150 miles and probably well over 200 miles in your spacings.

Mr. COTTONE: Dr. Du Mont, do you think it is possible to get much more separation than 150 miles without upsetting the apple cart?

Dr. Du MONT: There is no sense going past 250, 300 miles.

Mr. NORTON: If it were possible to have complete coverage of the United States with the present 12 low-band channels by the use of stratovision, for example, would you feel that the present allocation on the Eastern Seaboard might be upset to advantage in order to accomplish that?

Dr. Du MONT: I would say it should be upset if I thought stratovision was a proper proposition. I personally do not think it is. I do not think it will ever be, and why disturb a set-up that has worked very well and is working very well for

(Concluded on page 42)

F.M. AND TELEVISION



**Towering**

**Above**

**Pittsburgh's**

**Civic**

**Center**

**F**or KDKA — "America's Pioneer Station" — Blaw-Knox—America's pioneer builder of radio towers recently furnished this 500 ft. H-40 heavy duty tower.

The location of the tower on a rise overlooking Pitt Stadium and adjacent to buildings of the University of Pittsburgh made it imperative that station engineers select a structure of sufficient built-in strength to provide a high factor of safety in this congested area.

The Blaw-Knox heavy duty H-40 tower, supporting an FM and television antenna is not only adequate to meet these provisions but is also rugged enough to take care of any reasonable changes in equipment which might arise in the future.

**BLAW-KNOX DIVISION**  
*of Blaw-Knox Company*  
2017 Farmers Bank Building  
Pittsburgh 22, Pa.

**BLAW-KNOX** *Antenna*  
**TOWERS**

## ALTEC LANSING NOW "PACKAGES" ALL COMPONENTS FOR A COMPLETE HIGH FIDELITY RADIO-PHONOGRAPH SYSTEM TO BUILD INTO YOUR HOME

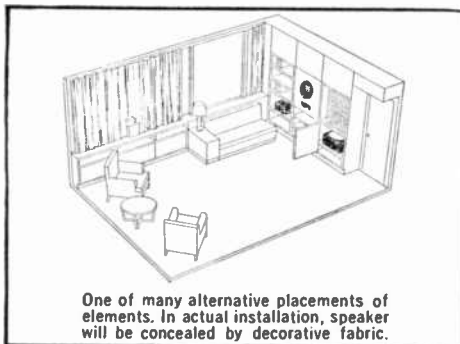

One of many alternative placements of elements. In actual installation, speaker will be concealed by decorative fabric.

The Altec Lansing Custom-in-Built Music System consists of the famous Altec Lansing Duplex speaker, a special Altec Lansing amplifier, a newly designed TRF Altec Lansing AM-FM tuner, and the Webster 70 record changer with GE variable reluctance pick-up. Integrated with the structure of your room, this system transcends completely the inherent acoustical and electronic limitations of conventional radio-phonographs, eliminates radio "furniture," and reproduces the

161 Sixth Avenue,  
New York 13, N. Y.  
1161 N. Vine Street,  
Hollywood 38, Calif.



full range of sound (35 to 16,000 cycles). It achieves the highest faithfulness to living sound now known to science. Built-in Altec Lansing Daylight Television can also be included. Complete installation instructions come with each system.

*A brochure will be sent on request.*

# ALTEC

LANSING  
custom-in-built  
home music system

### DU MONT UPPER-BAND PLAN

*(Continued from page 40)*

something that is not practical. I think you probably have seen the results, as I have, the number of difficulties that have to be overcome. I can't see it from an economic standpoint, either. It is just too expensive.

THE CHAIRMAN: Thank you very much, Dr. Du Mont.

### FM PRODUCTION INCREASE

*(Continued from page 19)*

safe to say that the public was upset by the sudden interest, publicity, and rash of advertisements about television, and decided to take a breather, or wait a while to see what television would be like and where they would want it in their homes before buying any radio or television set.

It's perhaps safe to say also that FM radio sales are recovering now because people are beginning to realize that at least a good many of them will be better off to have a television table model in the den or junior's room or some place where dad and the boys can slip off to see prize fights and ball games, and still have a radio in every bedroom and a radio-phonograph combination in the living room where the rest of the family can enjoy music and other radio programs.

Some of the people who have bought table model television sets do say that later on they will want a complete radio-phonograph-television combination, but a great many are deciding that they will keep the television separate from the radio. And many will still want several radios in the home. With well over 60,000,000 radios in use that don't have FM, naturally a lot of these radios can be replaced by AM-FM models.

It is getting progressively harder and harder to sell radios or radio-phonograph combinations that don't have FM, especially with good AM-FM table models coming onto the market at prices in the \$50.00 bracket and AM-FM-phonograph combinations now offered at prices under \$200.00.

Television production is strictly limited by the bottleneck in blowing the glass, settling the phosphorescent chemicals, and in high-vacuum pumping and sealing of cathode-ray tubes. There will definitely be a shortage of these tubes until after Christmas and a number of manufacturers are having to cancel or reduce production authorizations for television sets. Moreover, it takes so long to set up high vacuum pumping facilities, make or procure machinery, and train labor to produce these picture tubes that the outlook for next year is not too encouraging in television set production capacity. Most of the better informed stat-

isticians seem in agreement that 1,600,000 sets are conservative for 1949 television production, but few will hazard a guess that more than 3,000,000 can be made in 1949. In making this statement, I am aware that the *Wall Street Journal* for Friday, September 24, says Charles Denny, the former FCC Commissioner and Executive Vice President of NBC, stated in Sun Valley that 2,500,000 television sets will be in use in the nation by the end of 1948. In my opinion, either the *Wall Street Journal* misquoted Mr. Denny as to the end of which year, or else Mr. Denny got his television sets mixed with his shmoos, the little beasties introduced to humanity by Little Abner, which multiply faster than they can be devoured. It seems safe to predict that 800,000 television sets will be about the limit for 1948, two or three times that for 1949, and that there may be 15,000,000 television sets produced in five years, through 1952.

Will the radio industry, which produced over 20,000,000 sets of all kinds in 1947 and has produced 9,363,854 sets of all kinds in the first eight months of 1948, be content to shrink its production to a mere 1,600,000 television sets in 1949 or even 3,000,000 at the outside, plus a few million AM table radios under \$25, and portable sets and auto radios? That would be a calamity. That would be a colossal drop in employment and use of machine load capacity. The answer is No! The factories must turn their energies in some other direction and, unless there is a war, FM radios will be produced and promoted by companies who never seriously promoted FM before. Manufacturers are having to make their plans two ways, of course, on the assumption that there will or will not be a war. Let us hope there is not. It is only good business to make FM our big business in 1949.

The radio manufacturing industry could turn out up to half a million FM sets a month in 1949, and all the AM sets it can sell, as well as all the TV sets it will have tube supply for, without overstraining its capacity.

If FM broadcasters will really go to work to promote the reliable service coverage of FM day or night, winter or summer, and the freedom from summer-time thunder storm static, they can go a long way to make FM a big business. In promoting reliable day-or-night coverage you can point to clear reception without interference from distant stations in the assigned audience areas of the FM stations. I think this is far more important than talking up high fidelity or separate programming or even more variety of program fare, though these are important to the audience, of course.

Not many months ago, we were thinking of FM as being limited to purely local, big-city service. Well, I have a summer home down in the Bristol Hills just west

*(Continued on page 43)*

## FM PRODUCTION INCREASE

(Continued from page 42)

of the Finger Lakes in New York State. That's wild and wooly country that never had decent AM radio reception. Along comes the Rural Radio Network which you will hear about on your program and for which Milton Sleeper went overboard in his magazine this month, and my farm neighbors are getting excited about radio for the first time. Good reception is a new experience to them. I am convinced that we have underestimated the suburban and rural regional market being developed by FM stations, some of them beyond the telephone lines and hard to survey for a Hooper rating.

Although FM sets were introduced to the public in 1939, the war caused so much interruption that our engineers and factories are still using tubes that were developed primarily for AM circuits without FM in mind. Sure, we can use the same audio tubes and IF amplifiers, but tubes designed for FM detection and FM's tuning range are still few in number. In 1949 the tube factories and tube designers will begin to introduce new tubes developed expressly for FM to simplify limiter action and improve RF gain. The day may not be too far away when low drain tubes will make FM practical in portable sets and cars. Since these are used extensively in summer when thunder

(Concluded on page 44)

STATEMENT OF THE OWNERSHIP, MANAGEMENT, CIRCULATION, ETC., REQUIRED BY THE ACTS OF CONGRESS OF AUGUST 24, 1912, AND MARCH 3, 1933

OF *F.M. AND TELEVISION*, published monthly at Great Barrington, Massachusetts, for October 1, 1948

State of Massachusetts } ss.  
County of Berkshire }

Before me, a Notary Public in and for the State and county aforesaid, personally appeared Milton B. Sleeper, who, having been duly sworn according to law, deposes and says that he is the owner, publisher, and editor of the *F.M. AND TELEVISION Magazine* and that the following is, to the best of his knowledge and belief, a true statement of the ownership, management, etc., of the aforesaid publication for the date shown in the above caption, required by the Act of August 24, 1912, as amended by the Act of March 3, 1933, embodied in section 537, Postal Laws and Regulations, to wit:

1. That the names and addresses of the publisher, editor, managing editor, and business manager are: Publisher, Milton B. Sleeper, Great Barrington, Massachusetts; Editor, Milton B. Sleeper, Great Barrington, Massachusetts; Managing Editor, none; Business Manager, Charles Fowler, South Egremont, Massachusetts.

2. That the owner is: Milton B. Sleeper, db/a FM Company, Great Barrington, Massachusetts.

3. That the known bondholders, mortgages, and other security holders owning or holding 1 per cent or more of total amount of bonds, mortgages, or other securities are: None.

4. That the two paragraphs next above giving the names of the owners, stockholders, and security holders, if any, contain not only the list of stockholders and security holders as they appear upon the books of the company but also, in cases where the stockholder or security holder appears upon the books of the company as trustee or in any other fiduciary relation, the name of the person or corporation for whom such trustee is acting, is given; also that the said two paragraphs contain statements embracing affiant's full knowledge and belief as to the circumstances and conditions under which stockholders and security holders who do not appear upon the books of the company as trustees, hold stock and securities in a capacity other than that of a bona fide owner; and this affiant has no reason to believe that any other person, association, or corporation has any interest direct or indirect in the said stock, bonds, or other securities than as so stated by him.

(Signed) MILTON B. SLEEPER, Owner  
Sworn to and subscribed before me this Seventeenth day of October, 1948.

[Seal] LILLIAN BENDROSS, Notary Public  
Commission expires July 1, 1954.

# Flexibility makes

## "the Service Man's Line"

Brach antennas . . . long known for dependability . . . maximum reception . . . trouble-free operation . . . durability and ease of installation . . . now feature an added extra . . . Flexibility. Unique construction features aid the service man in making a more rapid installation to which future additions or modifications can be easily made.

**1. FLEXIBILITY** A complete line designed with basic antenna parts which are convertible to more complex arrays as required by location and reception problems.

**2. COMPLETE KITS** Each antenna model is independently designed and furnished in a completely packaged kit containing all necessary hardware, download (when desired) and the Universal Base Mount . . . ready for installation.

**3. PRE-ASSEMBLY** Each antenna is factory pre-assembled as far as possible, ready to erect. Complete and simple installation instructions. Saves valuable man-hours on the roof.

**4. MECHANICAL STRENGTH** Weather - tested for durability, Brach Antennas feature a husky steel mast, rigid connections, sturdy base mount, neat appearance. All parts corrosion resistant.

**5. SUPERIOR RECEPTION** Designed with engineering "know-how". All Brach antennas are factory pre-tuned, matched for 300 ohm transmission line with large diameter aluminum elements for better signal pick-up. Directivity patterns and standing wave ratios available upon request.

## New! Tops in TV! HI-LO ROTATABLE Antenna

Here it is! A rotatable antenna to provide peak performance with any station at any time. Brach introduces the new "Superview" Rotatable, covering both high (174 MC to 216 MC) and low (88 MC to 108 MC) TV bands. High band extension available for easy addition to standard dipole array for separate orientation. No more multiple images. No more "weak" stations. Brach's Superview HI-LO assures television reception that's tops. Make sure and investigate the new Superview line today.

Write for Free Brach catalog showing complete line of TV and FM antennas and accessories.

SEND FOR CATALOG NO. FMT304



**L. S. BRACH MFG. CORP.**

200 CENTRAL AVENUE, NEWARK, N. J.

WORLD'S OLDEST AND LARGEST MANUFACTURERS OF RADIO ANTENNAS AND ACCESSORIES

# MEASUREMENT • TEST • CONTROL

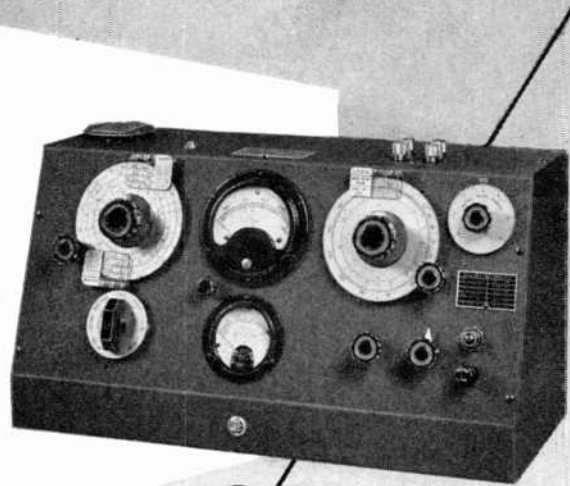

## 160-A Q METER

The 160-A Q-Meter is unexcelled for laboratory and development applications, having received world wide recognition as the outstanding instrument for measuring Q, inductance, and capacitance at radio frequencies.

Frequency Range: 50 kc. to 75 mc. (8 ranges)  
 Q Measurement Range: 20 to 250 (20 to 625 with multiplier)  
 Range of Main Q Capacitor: 30-450 mmf.  
 Range of Vernier Q Capacitor: +3 mmf., zero, -3 mmf.



**BOONTON RADIO**

BOONTON - N.J. - U.S.A.

Corporation

For further specifications and descriptive details, write for Catalog F

## FM PRODUCTION INCREASE

(Continued from page 43)

storms are most troublesome, it should mean a good plus market for FM.

Without wasting time or energy on friction because some people still buy AM sets and others want television sets faster than the industry can produce them, 1949 is the year to establish FM as the most reliable service in your community. It is only one which can't be jammed by an enemy if another war should come, the one least subject to fading and interference and static, and the service which covers a known area and serves a loyal audience every day and night in the year.

## FM-TV SITUATION

(Continued from page 18)

to him to provide the foundation on which the whole structure is built. We look to him to develop his station as rapidly as possible so the listeners will receive the maximum benefits of FM broadcasting. We look to him to hew to high standards of program service, and to offer programs that utilize the full fidelity of which FM is capable.

We look to the FM broadcaster to do an adequate job of informing his community about the potentialities of FM. He must be the spark plug in organizing a well-rounded campaign of education with the cooperation of distributors, dealers, and servicemen in his listening area.

Every month, steady growth in station construction and set production makes an FM channel a more valuable asset. There are developments now in the making that presage possibilities that we cannot yet estimate. These are possible only because of FM technical superiorities. You are hearing them discussed by experts at this convention. They are forms of broadcasting that could never be possible with AM. They include transistcastings, store-casting, and facsimile.

In time there may well be other unique services over these FM channels that we do not even dream of now. Facsimile today is only at the threshold of its development. It is only over an FM channel that a radio newspaper can be delivered. If the hopes of its enthusiasts are realized, every one of you FM broadcasters has it within your power to become a newspaper publisher. Some of the leading newspapers are carrying on facsimile experiments, and all newspaper interests are watching the progress of this work intently. With facsimile your FM channel will do double duty.

I should like to call your attention to an experiment conducted Wednesday evening of last week by WFIL-FM in Philadelphia where they multiplexed facsimile and preserved the high fidelity of FM broadcasting at the level of 15,000 cycles. The Commission's standards with

(Concluded on page 46)

## FREE! send for our RADIO BUYING GUIDE

a complete and diversified line-up of:

- electronic equipment
- sound systems
- recording equipment
- amateur gear
- television components and kits
- replacement parts
- laboratory and service test equipment

Save time and money—buy direct from distributor! Consult the NEWARK radio buying guide, featuring all standard makes... a value-packed listing of 20,000 essentials for expert servicemen, engineers, soundmen, experimenters, teachers, hobbyists, amateurs!

**24 HOUR SERVICE ON ALL ORDERS**  
Free technical advisory service!

JUST MAIL THIS COUPON TO GET YOUR CATALOGUE  
 Newark Electric Co., Inc., Dept. 10  
 242 West 55th St., New York 19  
 Please send me the FREE Newark Buying Guide of fine radio equipment.

Name \_\_\_\_\_  
 Address \_\_\_\_\_  
 City \_\_\_\_\_ State \_\_\_\_\_

**NEWARK**  
RADIO & TELEVISION

3 GREAT STORES  
 115 W. 45th St. & 212 Fulton St., NEW YORK  
 and 323 West Madison Street in CHICAGO  
 MAIL ORDER DIVISIONS  
 242 West 55th Street, NEW YORK 19, N. Y.  
 323 West Madison Street, CHICAGO 6, ILL.

## COAXIAL TRANSMISSION LINE

760 Ft. 3 3/8" Com. Products line, new and in original cases \$3.50 per foot f.o.b. Kansas City, Missouri. This is a savings of approximately \$0.50 per foot. Also hangers, etc., are available.



**JOHN A.  
COSTELOW CO.**  
INCORPORATED

125 Kansas Avenue  
Topeka, Kansas

# Your Assurance of True Custom-Quality Performance



This custom-built installation at the home of Mr. A. H. Sherin, Glen Ridge, N. J., includes an H. H. Scott model 210-A Laboratory Amplifier and Dynamic Noise Suppressor.

NO. 4 of a series on the reproduction of music from FM and phonograph records



Hermon Hosmer Scott, Inc.  
383 Putnam Avenue, Cambridge 39, Mass.

*Representatives and distributors  
and dealers in all principal cities*

CUSTOM installations give the owner complete choice of operating characteristics for his radio phonograph. By utilizing existing space or cabinets, quality superior to complete commercial units can be obtained at a lower total cost. It is a serious mistake, however, to effect further saving at the expense of quality of technical components.

Sacrifice of technical quality to price results in an inferior installation, less satisfactory than commercial designs. No installation can be better than its weakest component, and may be far worse if units are improperly matched. Nothing is so disappointing as to waste time on a custom installation to which even your best friend will not listen.

The H. H. Scott 210-A Laboratory Amplifier with Dynamic Noise Suppressor forms a nucleus of most installations of true custom quality. As an amplifier it is outstanding. A new phase-inverter and output circuit combine phenomenally low distortion with high efficiency, an original, non-resonant tone control system, a distortion and whistle filter and, of course, the *finest* version of the original \*Dynamic Noise Suppressor with *continuous* suppression control and *automatic* sensitivity control. No other amplifier or noise suppressor has all these features. The unit is built by the manufacturer of the famous Type 910-C \*Dynamic Noise Suppressor for broadcast stations, and was designed by the same engineering staff.

But H. H. Scott, Inc. does not stop with building the finest amplifier. For a successful installation, all units must be of *comparable quality* and *correctly* matched. Hence, with each amplifier there is supplied, at no extra charge, a magnetic pickup of the highest quality, and the amplifier is further provided with an adjustment allowing *correct matching* to many other types of pickups.

We also suggest a number of loud speakers, not merely by make, but by type and model number which, as determined by actual use, will do justice to the superlative reproduction of the amplifier itself. The 210-A output transformer will match practically any speaker from 2 to 500 ohms, correctly and efficiently. Moreover, we have checked tuners, record changers, and other accessories so as to be in a position to advise each customer regarding the best combination to meet his purposes.

This is why installations of the 210-A are of truly custom quality, not "home made". This is why 210-A owners are such boosters, why they demonstrate their amplifiers with such pride of possession. Write for specifications.

\* Licensed under U. S. and foreign patents pending and issued.

# FREQUENCY MODULATED SIGNAL GENERATOR



MODEL 78FM

86-108 MC

Also Available For  
Other Frequency Ranges



**1 to 100,000  
MICROVOLTS**

Variable Output  
With Negligible Carrier Leakage

**MODULATION:** 400 cycle internal audio oscillator. Deviation directly calibrated: 0 to 30 kc. and 0 to 300 kc. Can be modulated from external audio source.

Audio fidelity is flat within 2 db from dc to 15,000 cycles. Distortion less than 1% at 75 kc. deviation.

The Model 78FM when used with Measurements Model M-275 Converter provides output in the IF ranges of 4.5, 10.7 and 21.7 mc. Circular on Request

**MANUFACTURERS OF**  
Standard Signal Generators  
Pulse Generators  
FM Signal Generators  
Square Wave Generators  
Vacuum Tube Voltmeters  
UHF Radio Noise & Field Strength Meters  
Capacity Bridges  
Megohm Meters  
Phase Sequence Indicators  
Television and FM Test Equipment

**MEASUREMENTS CORPORATION**  
BOONTON NEW JERSEY

## FM-TV SITUATION

(Continued from page 44)

respect to multiplex provide that they could multiplex on FM if they could protect fidelity to 10,000 cycles. They did much better than we had expected.

I sincerely believe that this Second Annual Convention of the FM Association can mark the turning point of your difficult and gallant struggle to bring into being our new system of sound broadcasting.

It is always a pleasure for me to be in attendance at an FM meeting. I share your hopes and aspirations. I shall do all that I can, as Chairman of the Federal Communications Commission, and as a member of that Commission (I am a member as well as Chairman) to assist you in an orderly development of an FM broadcasting system.

### CLASSIFIED ADVERTISEMENTS

**Positions Wanted:** No charge. Use either your own name and address or FM and TELEVISION box number.

**Other Advertisements:** 20¢ per word, minimum \$2.00. One-inch advertisements in ruled box, \$10.

Copy received up to the 20th of the month will be published on the 15th of the month following.

Address replies to box numbers: FM and TELEVISION, Savings Bank Building, Great Barrington, Mass.

## ELECTRONIC ENGINEERS WANTED

### TELEVISION

experienced in circuit designs, either video amplifier design or scanning circuit design.

### TRANSMITTER

#### SENIORS . . .

Technical graduates with a minimum of 6 years engineering and supervisory experience, capable of assuming responsibilities for directing engineers and designers on specific projects connected with pulse type transmitters and timer equipment.

#### INTERMEDIATE ENGINEERS . . .

Technical graduates or equivalent with at least a minimum 4 years practical experience in design of transmitter and associated equipment.

#### JUNIOR ENGINEERS . . .

Technical degree, minimum 1 year experience in development for production of electronic equipment.

#### RESEARCH CHEMIST . . .

Technical degree and experience for development work on selenium rectifier.

#### ENGINEERS . . .

Also needed having experience with telephone systems in general, particularly in voice frequency equipment engineering, tall transmission systems and carrier telephone equipment.

**SALARY COMMENSURATE WITH ABILITY**

**APPLY IN PERSON OR WRITE PERSONNEL MANAGER**

**FEDERAL TELEPHONE & RADIO CORP.**

100 KINGSLAND ROAD, CLIFTON, NEW JERSEY

FOR SALE: 16-in. portable recorder, \$250. Gerald Shirley, 474 W. 238 St., N. Y. 63, N. Y.

ENGINEER, single, specialist transmitter installation, operation, and maintenance. 18 months installation and supervision 250 w., 2 years Navy electronics, class A amateur experience. Desire position 5 or 10 kw. AM, TV, or FM station anywhere in U. S. Will also consider mobile installation-maintenance position. Excellent references, available on 2 weeks notice. Box 107, FM AND TELEVISION.

ANNOUNCER, married, 18 months FM broadcast experience. Operate latest control board, write copy, ad lib, handle anything but sports. Will go anywhere if salary is satisfactory. Box 108, FM AND TELEVISION.

RADIOMAN, 2 years FM-AM broadcast experience. 1st class phone, 3 years Signal Corps. Desire opportunity broadcast or mobile field. Box 105, FM AND TELEVISION.

YOUNG WOMAN, attractive, wealth of experience advertising, merchandising, writing, publicity. Short on actual air credits but long on potential as editor-writer-commentator. Want spot at station or agency where know-how is supreme factor. Quite photogenic, can double in production. Free to travel. Box 109, FM AND TELEVISION.

SALESMAN, 15 years with well-known corporation. Acquainted entire eastern U. S. College graduate, dependable, live wire. Seek sales position radio, appliances, electronics. Box 108, FM AND TELEVISION.

WANTED, distributorship television and radio line. Distribution points Memphis and Little Rock. Please contact Leon Lyons, 236 Madison, Memphis, Tenn.

FM AND TELEVISION



## Investigate Alden Facsimile

FM Stations use the Alden Facsimile system as a promotional means to increase their listening audience and call attention to their FM stations.

They choose Alden because:

1. The Alden Recorders produce the most beautiful pictures not only in black and white but in the pleasantly toned Alfax sepia papers.
2. The Alden system assures attention-getting programs by combining sound and the operation of bulletin-size recorders in semi-public places, enlarging the same program that is sent to the home and other points.
3. The Alden system with its low frequency requirements simplifies the operation over ordinary telephone lines and with existing communication sets, making it capable of universal adoption.
4. The Alden system is designed and priced for the mass market; is not restricted as to particular FM sets and thus has the promotional interest of all set dealers in your area.
5. The Alden equipment has basic simplicity, minimizes service through interchangeable spare parts and is thoroughly suitable for use by non-technical people.
6. The Alden system has every factor, including program possibilities, that insure the largest saturation of recorders per area, operation in marginal signal areas, and thus the greatest possible coverage for your station.

Investigate Alden Facsimile  
and Alfax Paper now

**ALDEN PRODUCTS CO.**  
Brockton 64F, Massachusetts

**FREE**

**ALLIED'S  
NEW 1949  
RADIO  
CATALOG**



**Everything in Radio  
and Electronic Supplies**

**Complete, Expert Service  
for Radio Engineers**

You'll find everything you need in radio and electronic equipment for laboratory and development work, in the new 180-page ALLIED Catalog. Rely on one dependable source for the world's largest stocks—thousands of parts, tubes, tools, books, test instruments, sound apparatus—ready for instant expert shipment at lowest market prices. Write today for your FREE copy of ALLIED's newest Buying Guide.

### ALLIED RADIO

ALLIED RADIO CORP., Dept. 20-K-8  
833 W. Jackson Blvd., Chicago 7, Ill.

Send FREE New ALLIED Catalog.

Name.....

Address.....

## Advertisers' Index

Adair, George P. ....	15
Alden Products Company .....	47
Alford, Andrew .....	14
Allied Radio Corp. ....	47
Altee Lansing Corp. ....	42
Amy, Aceves & King, Inc. ....	10
Andrew Corporation .....	6, 14
Barone, S. A., Company .....	15
Bell Telephone Labs. ....	16
Blaw-Knox .....	41
Bliley Electric Co. ....	40
Boonton Radio Corp. ....	44
Brach Mfg. Corp., L. S. ....	43
Brociner Elec. Lab. ....	10
Browning Laboratories, Inc. ....	7
Clare & Co., C. P. .... <i>Inside Front Cover</i>	
Collins Audio Products .....	10
Commercial Radio Equip. Co. ....	15
Communications Research Corp. ....	15
Costelow, John A., Co., Inc. ....	44
Davis, George C. ....	15
Eitel-McCullough, Inc. ....	48
Electronics Research Pub. Co. ....	10
Federal Tel. & Radio Corp. ....	46
General Radio Co. ....	37
Graybar Electric Co. ....	16
Hallicrafters Co. ....	1
Hughey & Phillips Company .....	10
Jansky & Bailey .....	14
Karp Metal Products Co., Inc. ....	35
Kay Electric Co. ....	10
Kear and Kennedy .....	15
Knights, The James, Co. ....	8
Lansing, James B., Sound, Inc. ....	47
Mallory & Co., Inc., P. R. ....	39
Maurer, J. A., Inc. ....	11
May, Russell P. ....	14
McCachren, Winfield Scott .....	15
McIntosh, Frank H. ....	15
McKey, Dixie B. & Assoc. ....	14
McNary and Wrathall .....	15
Measurements Corp. ....	46
National Co. ....	4
Newark Electric Co., Inc. ....	44
Philco Corp. .... <i>Inside Back Cover</i>	
Pollack, Dale .....	14
Radio Consultants, Inc. ....	14
RCA Communications, Inc. ....	10
Radio Engineering Labs, Inc. .... <i>Back Cover</i>	
Radio Music Corp. ....	10
Ray, Garo W. ....	14
Raytheon Mfg. Co. ....	2
Sangamo Electric Co. ....	12, 13
Scott, Inc., H. H. ....	45
Simpson Electric Co. ....	9
Smeby, Lynne C. ....	14
Sprague Electric Co. ....	5
Topflight Tape Co. ....	10
U.H.F. Resonator Co. ....	3
U. S. Recording Co. ....	10
Weldon & Carr .....	15
Western Electric Co. ....	16
Williams, Nathan .....	14
Willette, Raymond M. ....	14
Workshop Associates, The .....	10

*Jim Lansing*  
**SIGNATURE**  
*Speakers*

ARE  
**Designed**  
FOR  
**MAXIMUM  
PERFORMANCE**



**MODEL  
D-130**

These outstanding Loud Speakers are the result of more than a quarter century of development in the Sound reproduction field. They are designed to provide maximum dynamic range and frequency response.

**Compare  
JIM LANSING  
SIGNATURE SPEAKERS  
Before YOU BUY—  
MODEL D-1002**

### Two Way System

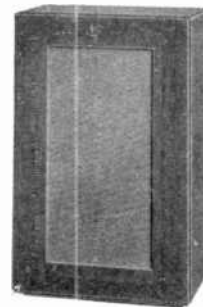

The world's finest, modern styled two-way console Loud Speaker designed especially for FM monitoring and high quality home sound reproduction.

Write for descriptive catalog containing complete specifications.

**AVAILABLE THROUGH YOUR  
JOBBER**

**JAMES B. LANSING  
SOUND INC.**  
4221 SOUTH LINCOLN BLVD  
VENICE, CALIFORNIA

# OUTSTANDING

Follow the Leaders to

**Eimac**  
TUBES  
The Power for R-F

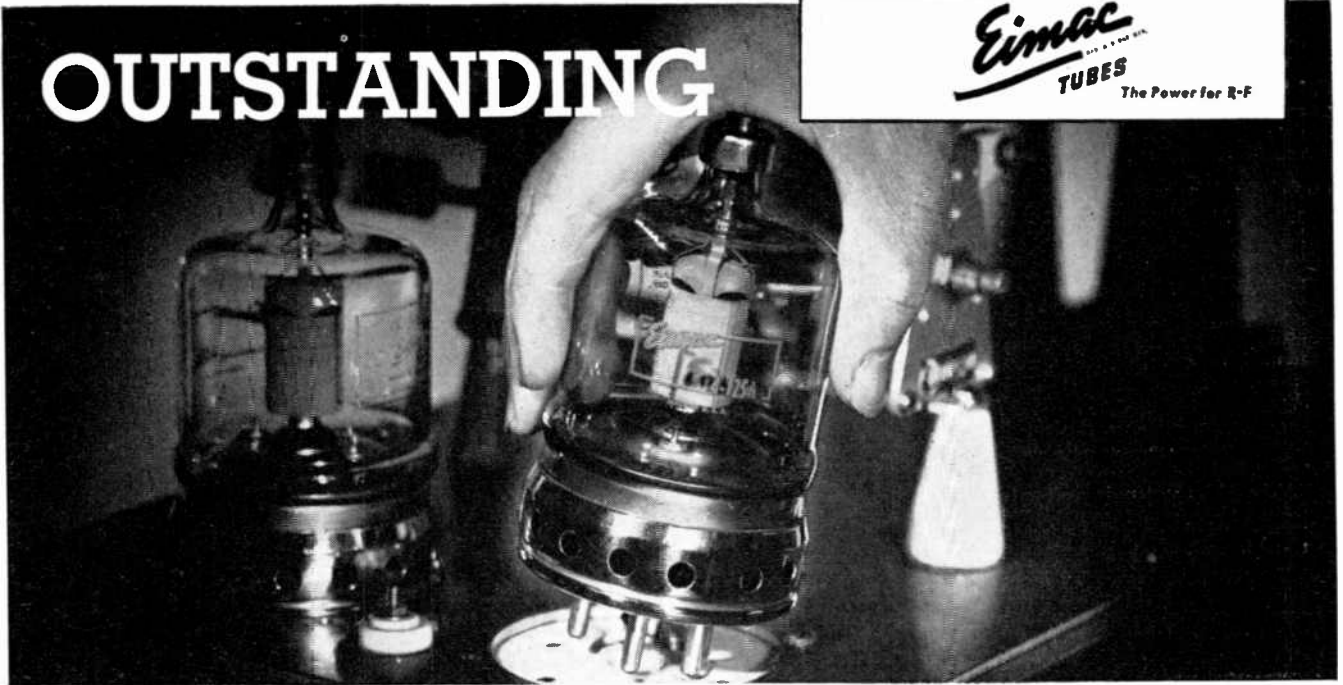

The Eimac 4-125A

Look about you . . . check the equipment shows . . . thumb through the trade magazines . . . talk to design engineers . . . yes, the Eimac 4-125A power tetrode is the standout vacuum tube, accepted in all fields of electronic endeavor for its stability, long-life and dependability.

Each tube is backed by the combined engineering resources of Eitel-McCullough plus over a million hours of proven field-service. It's Pyrovac<sup>®</sup> plate is highly resistant to momentary overloads and contributes to the tube's long life. Processed grids control primary and secondary emission, providing a high degree of operational stability. The tube is ruggedly designed to withstand abnormal physical as well as electrical abuse.

Detailed data and application notes are immediately available and statistics for unusual applications will be supplied on request.

**EITEL-McCULLOUGH, INC.**

204 San Mateo Ave., San Bruno, California

Export Agents: Frozer & Hansen, 310 Clay Street, San Francisco 11, California

\*Reg. Trade Mark

Filament: Thoriated tungsten Voltage 5.0 volts Current 6.5 amperes Grid-Screen Amplification Factor (Average) 6.2					
RADIO FREQUENCY POWER AMPLIFIER AND OSCILLATOR		HIGH-LEVEL MODULATED RADIO FREQUENCY AMPLIFIER		AUDIO FREQUENCY POWER AMPLIFIER AND MODULATOR	
Class-C Telephony or FM Telephony Maximum Ratings (Key-down conditions, 1 tube)		Class-C Telephony (Carrier conditions unless otherwise specified, 1 tube)		Class AB <sup>1</sup> (Sinusoidal wave, two tubes unless otherwise specified)	
D-C PLATE VOLTAGE 3000 MAX. VOLTS D-C SCREEN VOLTAGE 400 MAX. VOLTS D-C GRID VOLTAGE -580 MAX. VOLTS D-C PLATE CURRENT 275 MAX. MA. PLATE DISSIPATION 125 MAX. WATTS SCREEN DISSIPATION 20 MAX. WATTS GRID DISSIPATION 5 MAX. WATTS		2500 MAX. VOLTS 400 MAX. VOLTS -580 MAX. VOLTS 208 MAX. MA. 85 MAX. WATTS 20 MAX. WATTS 5 MAX. WATTS		3000 MAX. VOLTS 400 MAX. VOLTS 225 MAX. MA. 125 MAX. WATTS 20 MAX. WATTS	
Typical Operation (Frequencies below 120 Mc.)				TYPICAL OPERATION	
D-C Plate Voltage 2500 3000 volts D-C Screen Voltage 350 350 volts D-C Grid Voltage -150 -150 volts D-C Plate Current 200 167 ma. D-C Screen Current 40 30 ma. D-C Grid Current 12 9 ma. Screen Dissipation 14 10.5 watts Grid Dissipation 2 1.2 watts Peak R-F Grid Input Voltage (approx) 320 280 volts Driving Power (approx) 3.0 2.5 watts Plate Power Input 580 500 watts Plate Dissipation 125 125 watts Plate Power Output 375 375 watts		2000 2500 volts 350 350 volts -220 -210 volts 150 152 ma. 33 30 ma. 18 9 ma. 11.5 10.5 watts 1.4 1.4 watts 375 360 volts 3.0 3.3 watts 300 380 watts 75 80 watts 225 300 watts		2000 2500 volts 400 400 volts -94 -96 volts 50 50 ma. 240 232 ma. -0.5 -0.3 ma. 6.4 8.5 ma. 13,400 20,300 ohms 13,600 22,200 ohms 94 96 volts 0 0 watts 125 125 watts 230 130 watts 2 2.6 perct. 1 2.2 perct.	

NOW WITH . . . Pyrovac Plates • Processed Grids

# PHILCO

F-M RADIOPHONE 30 to 50 mc. 152 to 162 mc.  
COMMUNICATIONS SYSTEMS



for :

POLICE

FIRE

TAXICABS

UTILITIES

BUSES

TRUCKING

Clear, crisp, two-way voice communications under all conditions with proven reliability, new operating efficiency and economy . . . backed by the facilities of the world's largest radio manufacturer and serviced by a nation wide service organization.

Free Engineering Consultation Service

Write Today For Details

# PHILCO

INDUSTRIAL DIVISION

PHILADELPHIA 34 • PENNSYLVANIA

Industrial Division, Dept. OU 5  
Philco Corporation  
C and Tioga Streets  
Philadelphia 34, Penna.

Gentlemen:

Please send me information about the new  
PHILCO FM Radiophone Communications  
Systems.

NAME \_\_\_\_\_

ADDRESS \_\_\_\_\_

CITY \_\_\_\_\_

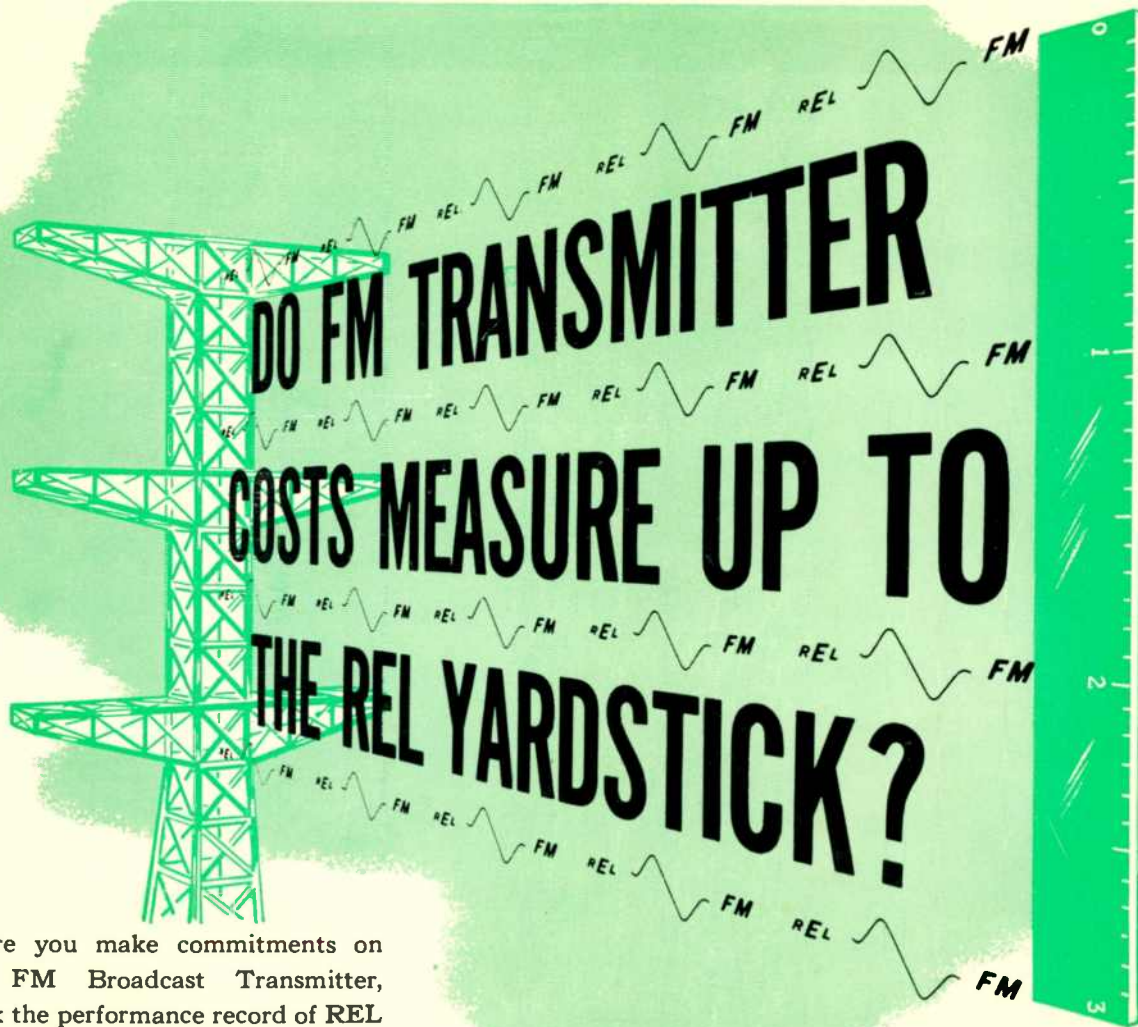

Before you make commitments on any FM Broadcast Transmitter, check the performance record of REL tetrode powered FM Transmitters. These actual case histories of installations in all sections of the country offer convincing evidence of the lower first cost and lower operating cost of REL FM Broadcast Transmitters. They tell, in every instance, an equally important story of maximum operating convenience, negligible maintenance, low tube cost and unmatched dependability.

These records provide a new and valuable yardstick for judging FM transmitter costs. If you are interested in applying the REL yardstick to your FM problem, simply call or write today. Complete information will be supplied and visits to operating installations can be arranged.

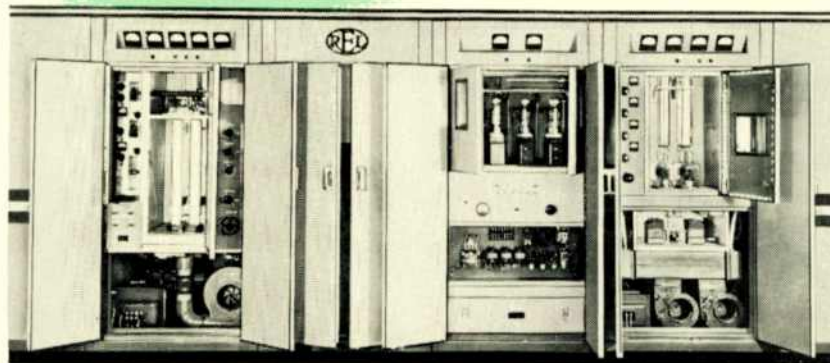

FRONT VIEW OF REL 10,000 WATT FM BROADCAST TRANSMITTER. THE FOUR TUBE FINAL AMPLIFIER EMPLOYS INTERNAL ANODE TETRODE TUBES IN THE QUADRILINE CIRCUIT.

**RADIO ENGINEERING LABS · Inc.**  
LONG ISLAND CITY 1, NEW YORK

