

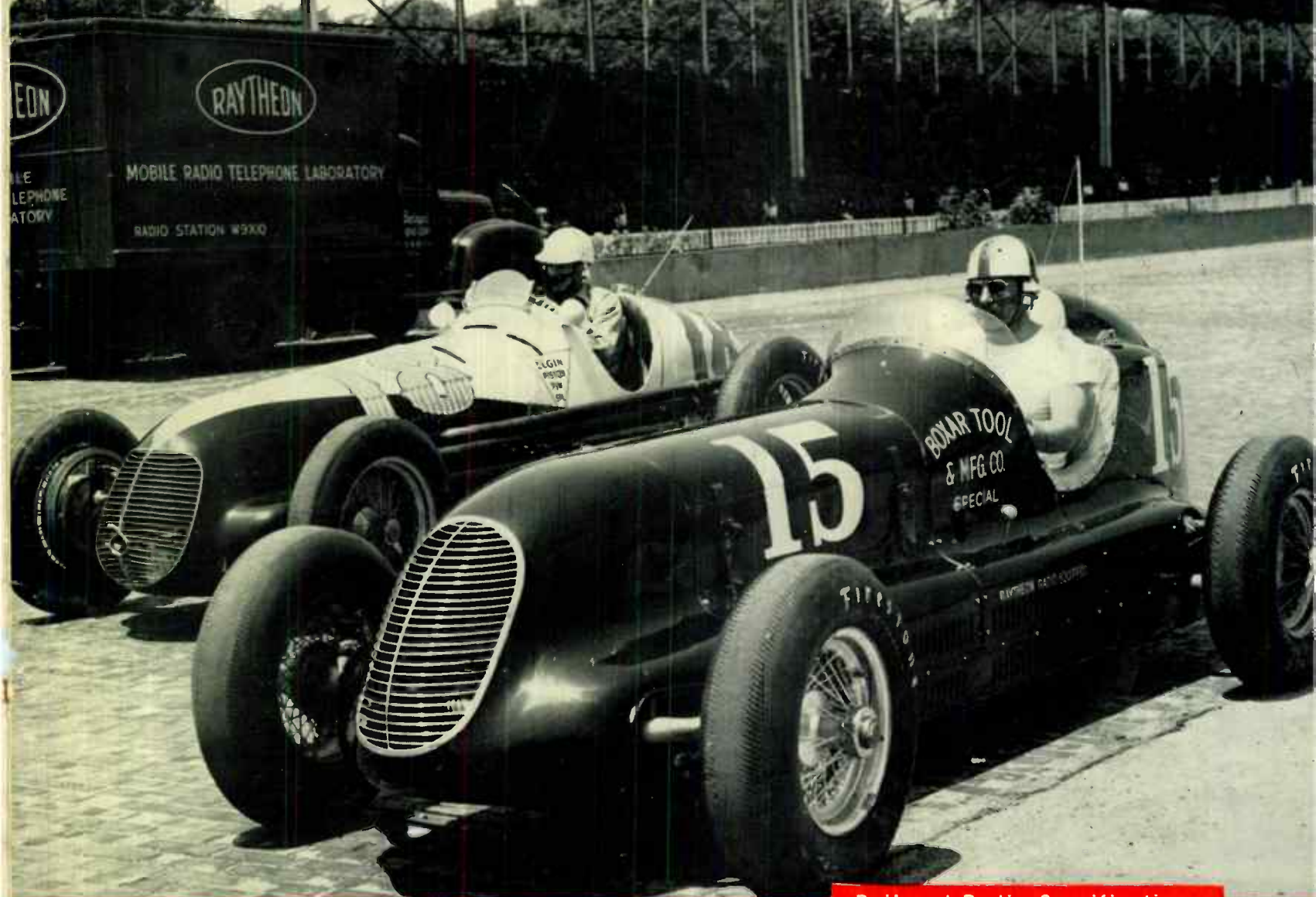

AND TELEVISION

MORE FM COMMUNICATIONS



Railroad Radio Specifications

★ ★ Edited by Milton B. Sleeper ★ ★

Largest **MYCALEX** Part Ever Molded

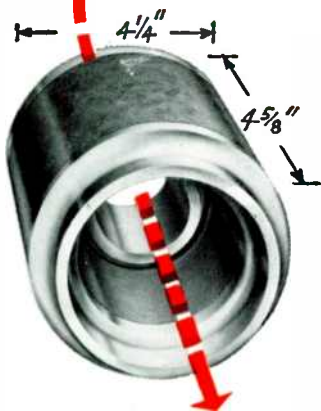

This cross section of a MYCALEX-to-metal molded component part was made for one of the country's leading manufacturers, and is the result of close cooperation between the customer's and our own engineering staffs. It exemplifies a new development in the molding of MYCALEX 410 with metal to form a hermetic seal.

The objective was to take advantage of the low loss factor and other desirable properties of MYCALEX 410 to produce a rugged bushing assembly in a single molding operation.

A difficulty was presented by the extremely long and branched path which the MYCALEX 410 had to follow. Total charge of MYCALEX 410 was 7 pounds, while the metal weighed 6 pounds to make a total weight of 13 pounds.

The MYCALEX and metal were sealed into one closely-bonded integral part, held to extremely close dimensional tolerances.

For more than 27 years MYCALEX has met and surpassed the most exacting needs engineers have been able to devise from year to year. MYCALEX 410, together with our highly perfected methods of molding it, is the greatest advancement in this high frequency low loss insulation to date.

Our technical staff is at your service. What is your problem in low loss insulation?

MYCALEX CORPORATION OF AMERICA

"Owners of 'MYCALEX' Patents"

Plant and General Offices, CLIFTON, N. J.

Executive Offices, 30 ROCKEFELLER PLAZA, NEW YORK 20, N. Y.

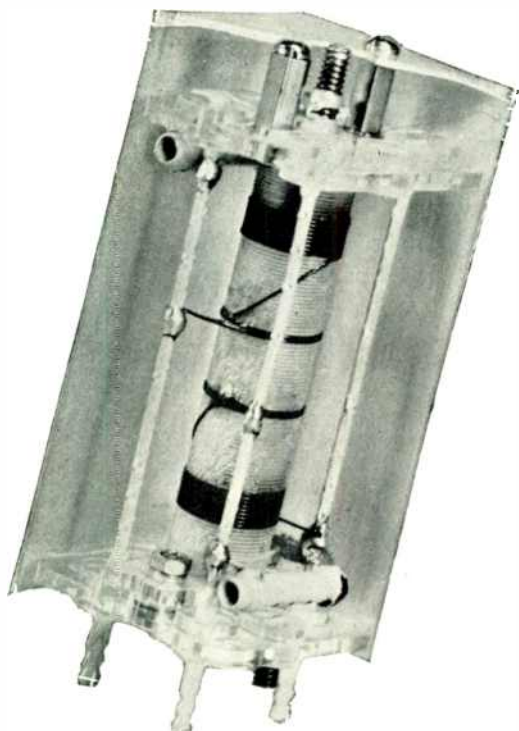

NEW IF TRANSFORMERS

These new IF transformers are designed to meet the highest standards of performance in high frequency FM and AM. All operate at 10.7 Mc., making them ideal for the new FM band. Iron core tuning is employed and the tuning does not affect the bandwidth of 100 Kc. for the IFN or 150 Kc. for the IFM.

The discriminator output is linear over the full 150 Kc. output and remains symmetrical regardless of the position of the tuning cores.

Insulation is polystyrene for low losses. Mechanical construction is simple, compact and rugged. The transformer is $1\frac{7}{8}$ inches square and stands $3\frac{1}{8}$ inches above the chassis.



NATIONAL COMPANY, INC., MALDEN, MASS.

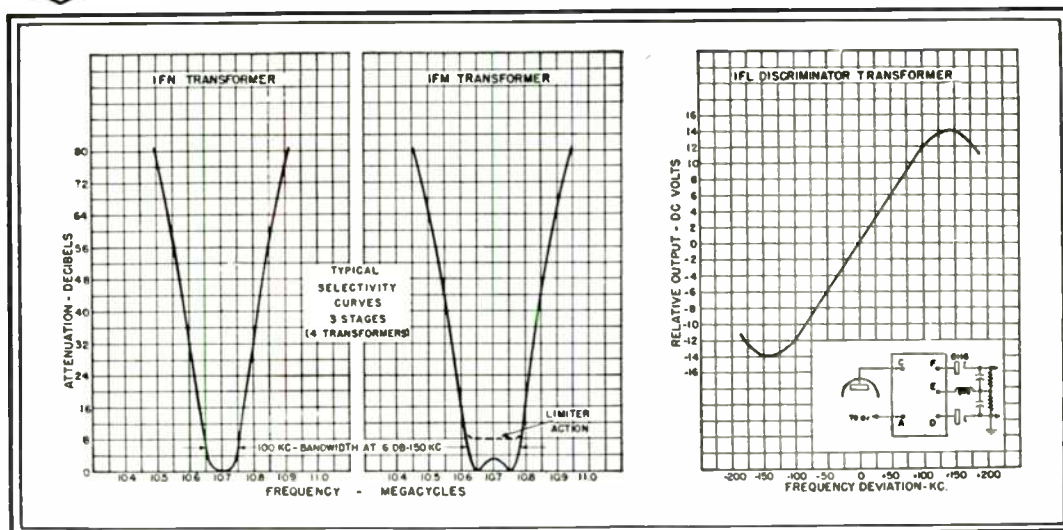

The TRUTH About TELEVISION

WITH the opening of Du Mont's John Wanamaker Studios in New York, Commercial Television has become a full-fledged reality. It is fitting, therefore, that I thank my associates and friends in the television and electronics fields for the help which they have given us during the past fifteen years, from the days of our earliest television pioneering.

Today, black and white television of magnificent quality is a reality—ininitely better than prewar television.

Clever propaganda has spread the notion that there are two television camps: one for and one against color. This is deliberate misrepresentation. No one is opposed to color. For many years the majority of the industry has been deep in television color research.

But, after fifteen years of concentrated effort in this field, to which I have dedicated my life, I must state reluctantly, but unequivocally, that practical commercial color television for the home is, in my opinion, still in the far distant future.

The layman in his eagerness for Utopia may be dazzled by color demonstrations, but the informed, sincere scientist is not convinced by dramatically staged and carefully controlled laboratory demonstrations of any new art. It is a far cry from the successful laboratory experiment to the practical, useful product for the consumer.

Color is desirable but its importance has been overemphasized. For instance, after 30 years of color motion pictures, less than 6 percent of today's motion pictures are in color.



DR. ALLEN B. DU MONT, President
Allen B. Du Mont Laboratories, Inc.

Evidence of Du Mont's unqualified faith in black and white television and the commercial standards established by the Federal Communications Commission is manifested in our investments in research, television stations, and in manufacturing facilities for receiver and transmitting equipment.

We believe that diligent research and exhaustive field experimentation in the years to come will add color television as a further refinement to an already existing public service of unprecedented value. Du Mont believes in the future of color television and we will devote our efforts to develop this refinement just as we have applied ourselves over the years to the creation of superior black and white television.

Practical color television for the public is not yet in sight. *Black and white television is ready to serve the nation now!*

Allen B. Du Mont

NOTE: *If you are interested in studying the numerous technical difficulties that must be overcome before color television is ready for the public, please request a copy of our booklet, "The Truth About Color Television." Address: Dr. Allen B. Du Mont, 2 Main Avenue, Passaic, N. J.*

Copyright 1946, Allen B. Du Mont Laboratories, Inc.



ALLEN B. DU MONT LABORATORIES, INC., GENERAL OFFICES AND PLANT, 2 MAIN AVENUE, PASSAIC, N. J.
TELEVISION STUDIOS AND STATION WABD, 515 MADISON AVENUE, NEW YORK 22, NEW YORK



AND TELEVISION

FORMERLY: FM MAGAZINE and FM RADIO-ELECTRONICS

VOL. 6

JUNE, 1946

NO. 6

COPYRIGHT 1946, Milton B. Sleeper

CONTENTS

WHAT'S NEW THIS MONTH

Chicago Radio Show—FMBI—Sets in the Nude..... 4

RAILROAD RADIO COMMUNICATIONS

Milton B. Sleeper..... 19

FX CAN HELP MAKE FM PROFITABLE

Milton Alden..... 21

PROPOSED FCC CHANGES FOR FM

Official Text of Proposed Changes in Rules & Standards..... 24

COAXIAL TRANSMISSION LINES—Part I

C. Russell Cox..... 28

CHECKING EMERGENCY TRANSMITTERS

A. J. Zink, Jr..... 32

EXAMINING FM TRANSMITTER PERFORMANCE

J. R. Popkin-Clurman..... 35

RAILROAD RADIO SPECIFICATIONS

From Rock Island Lines..... 40

SPECIAL DEPARTMENTS

What's New This Month..... 4

Engineering Sales..... 8

Spot News Notes..... 26

News Pictures..... 27

THE COVER DESIGN AND CONTENTS OF FM AND TELEVISION MAGAZINE ARE FULLY PROTECTED BY U. S. COPYRIGHTS, AND MUST NOT BE REPRODUCED IN ANY MANNER OR IN ANY FORM WITHOUT WRITTEN PERMISSION

★ ★ ★ ★ ★

MILTON B. SLEEPER, *Editor and Publisher*

ARNOLD NYGREN, *Associate Editor*

WILLIAM T. MOHRMAN, *Advertising Manager*

STELLA DUGGAN, *Production Manager*

Published by: FM COMPANY

Publication Office: 264 Main St., Great Barrington, Mass. Tel. Great Barrington 1014

New York: 511 Fifth Avenue, New York 17, Tel. VA 6-2483

Chicago: MARIAN FLEISCHMAN, 360 N. Michigan Ave., Tel. STATE 1822

Pasadena: MILO D. PUGH, 35 S. Raymond Ave., Pasadena 1, Calif. Tel. Madison 6272

FM Magazine is issued on the 20th of each month. Single copies 25c — Yearly subscription in the U. S. A. \$3.00; Canada \$3.50; foreign \$4.00. Subscriptions should be sent to FM Company, Great Barrington, Mass., or 511 Fifth Avenue, New York 17, N. Y.

Contributions will be neither acknowledged nor returned unless accompanied by adequate postage, packing, and directions, nor will FM Magazine be responsible for their safe handling in its office or in transit. Payments are made upon acceptance of final manuscripts.



★ ★ Edited by Milton B. Sleeper ★ ★

THIS MONTH'S COVER

Entirely new uses for 2-way FM radio are adding greatly to the huge volume of business from emergency and mobile urban and highway services. One of the most interesting new kinds of installations were made in three cars which participated in the 500-mile race at Indianapolis last month. Two cars, driven by Emil Andres and Louis Tomei, are shown on this month's cover. Purpose was to enable the pit to warn drivers of bad tires and to provide other safety information. Also, drivers could advise pit of need to stop for repairs. Note helmets with phones and moustache mikes. Raytheon made installations and furnished fixed-point service from laboratory truck.

Entered as second-class matter, August 22, 1945, at the Post Office, Great Barrington, Mass., under the Act of March 3, 1879. Additional entry at the Post Office, Concord, N. H. Printed in the U. S. A.

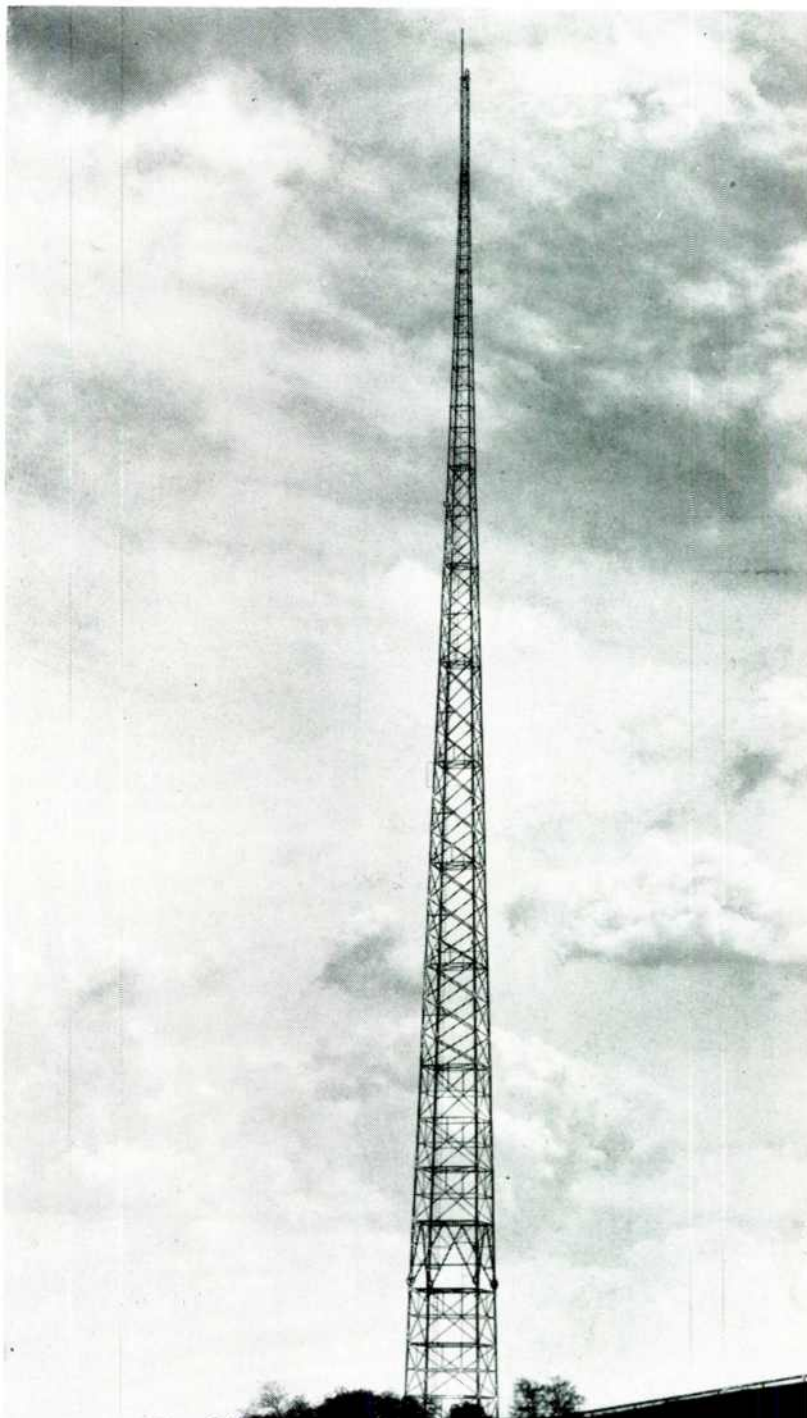
There's no DOUBT about it!
 ...That's the big advantage of any
 antenna designed and built by Blaw-Knox.
BLAW-KNOX DIVISION
 OF BLAW-KNOX COMPANY
 2046 Farmers Bank Building • Pittsburgh, Pa.

BLAW-KNOX VERTICAL RADIATORS
 FM and TELEVISION

*Do you have a
TRANSFORMER
COMPONENT PROBLEM?*

If so...

**Choose The Source
with--
COMPLETE FACILITIES
plus--
MANUFACTURING KNOW-HOW**

At Chicago Transformer, facilities for every step in transformer manufacture—from production of coils, cores and mounting parts thru final assembly—are combined with plant-wide manufacturing know-how, gained during C.T.'s years of experience in the specialty transformer field. Thus, in selecting a source for your transformer components, consider Chicago Transformer, an established manufacturer in the Electronic Industry.

CHICAGO TRANSFORMER
DIVISION OF ESSEX WIRE CORPORATION
3501 ADDISON STREET · CHICAGO, 18



WHAT'S NEW THIS MONTH

1. CHICAGO PARTS SHOW
2. FMBI
3. SETS IN THE NUDE

1. Registrations at the Chicago Parts Show totalled 7,562, an all time high for attendance at any event limited to members of the radio trade. Exhibitors, uniformly limited to small size booths, filled the exhibition hall at Hotel Stevens to capacity, and some companies were unable to obtain space.

As a trade event, it was an outstanding success, and great credit is due the management staff for their skillful handling of all details. Dealers, jobbers, and representatives came from every state in the Union to beg for more goods and new items. And if orders could have been accepted without reservation as to new prices, the dollar-volume would have run up to astronomical figures.

However, the shadow of copper and steel shortages and OPA limitations lay over the scene of activities. Competition in radio components has always been so keen that profit margins were never large, but it is clear that quantity deliveries will not get under way until the manufacturers are allowed to make the relatively small percentage of profit that they earned prewar.

There is a prevailing opinion outside the industry that, because radio manufacturers returned millions of dollars to the Government under renegotiation during the latter part of the war, production costs were reduced. Exactly the opposite was true. Costs rose enormously during the war years, far beyond the added element of expense of doing business with the Army and Navy under emergency conditions. Principal contributing factor was the decline in output per worker in all lines of industry. This amounted to a decline of 34% as compared to prewar output, with average workers spending less than 50% of their energy on their jobs, according to a study made by O. C. Cool, director of the Labor Relations Institute, New York City.

The apparent reduction of costs, evidenced by refunds under renegotiation, were due chiefly to the fact that pilot runs were generally used as a basis for figuring prices on subsequent large-quantity contracts. Thus, manufacturers protected themselves against loss due to changes in specifications, revisions of designs, and delays which sometimes held up huge

(CONCLUDED ON PAGE 44)

FM AND TELEVISION

WMCA WQXR CBS MBS DIC NEWS REELS TELEV. NBC ABC BBC CBC WHN WNEW
 ↓ ↓ ↓ ↓ ↓ ↓ ↓ ↓ ↓ ↓ ↓ ↓



Security Council Chamber, United Nations, Hunter College, New York. Robert Glenn, Inc., Builder, N.Y.C.

As The World Listens...

... to the United Nations Security Council in session, whether by radio, by television, or by newsreel, it is listening through the latest in audio facilities. The entire system in the Security Council Chamber, which feeds all services, is Langevin engineered, designed and manufactured, with the exception of the microphones which are Western Electric.

The Langevin Company

INCORPORATED

SOUND REINFORCEMENT AND REPRODUCTION ENGINEERING

NEW YORK, 37 W. 65 St., 23 • SAN FRANCISCO, 1050 Howard St., 3 • LOS ANGELES, 1000 N. Seward St., 38

ANDREW DRY AIR EQUIPMENT for pressurizing coaxial cable lines

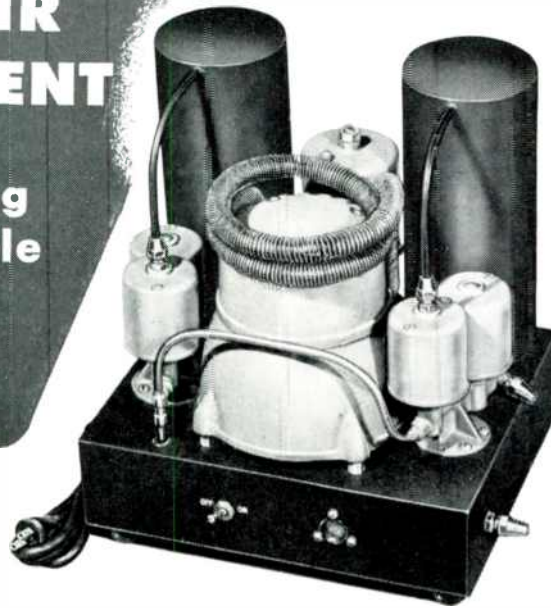

TYPE 1800 AUTOMATIC DEHYDRATOR

A compact, *completely automatic* unit that pressurizes coaxial transmission lines with clean, dry air. Starts and stops itself. Maintains steady pressure of 15 pounds. A motor driven air compressor feeds air through one of two cylinders containing a chemical drying agent where it gives up all moisture and emerges absolutely clean and dry. Weighs 40 pounds; 14 inches wide, 14 inches high, 11 inches deep. Power consumption, 210 watts, 320 watts during reactivation.



TYPE 720 PANEL MOUNTING DRY AIR PUMP

Specially designed for use in equipment requiring a small, built-in source of dry air. Only 2 inches in diameter, 6 inches long. Pressures as high as 30 pounds are easily generated. Piston type compressor drives air through a chemical drier. Pump supplies dry air with only 7 to 10% relative humidity. Additional silica gel refills available at reasonable cost.



TYPE 876-B

Designed over the simple tire pump principle, this all-purpose dry air pump has numerous applications. Output of each stroke is about 26 cubic inches of free air. Transparent lucite barrel holds silica gel. Supplied complete with 7-foot length of hose. Height 25½ inches. Net weight 8½ pounds.

Andrew Dry Air Equipment is used in a multitude of other applications. Write for further information.

ANDREW CO.

363 E. 75th ST., CHICAGO 19, ILLINOIS

Pioneer Specialists in the Manufacture of a Complete Line of Antenna Equipment

ADVERTISERS INDEX

Aerovox Corporation.....	56
Aircraft Radio Corporation.....	47
Alloy Associates Co.....	58
American Phenolic Corporation.....	49
Anderson, H. V., & Associates.....	17
Andrew Company.....	6, 17
Blaw-Knox.....	3
Brach Manufacturing Corp., L. S.....	54
Brook Electronics, Inc.....	58
Browning Laboratories, Inc.....	46
Burstein-Applebee Co.....	54
Capitol Radio Eng. Inst.....	8
Carter Motor Co.....	59
Centralab.....	55
Chicago Transformer Corp.....	4
Collins Radio Company	
<i>Inside Back Cover</i>	
Commercial Radio Equip. Co.....	17
Cornish Wire Company.....	59
Drake Mfg. Corp.....	56
DuMont Labs., Inc., Allen B.....	2
Eitel-McCullough, Inc.....	43
Engineering Research Associates, Inc.....	17
Fairchild Camera & Inst. Corp.....	7
Fed. Tel. & Radio Corp.....	10
Finch Telecommunications, Inc.....	48
FM Company.....	52, 57
Freeland & Olschner Products, Inc..	17
Galvin Mfg. Corporation.....	14
General Electric Company.....	12, 13
Hammarlund Mfg. Co., Inc.....	60
Hytron Radio & Electronics Corp...	50
Jansky & Bailey.....	17
Jensen Radio Mfg. Company.....	45
Kaufman, Robert L.....	17
Keel, John J.....	17
Kluge Electronics Co.....	17
Langevin Company.....	5
Link, F. M.....	<i>Back Cover</i>
McIntosh, Frank H.....	17
May & Bond.....	17
McKey & Shaw.....	17
Measurements, Inc.....	59
Mycalex Corp. of America	
<i>Inside Front Cover</i>	
National Company, Inc.....	1
Presto Recording Corp.....	11
Radio Engineering Labs, Inc.....	18
Radio Wire Television, Inc.....	58
Ray, Garo W.....	17
Raytheon Mfg. Co.....	15
RCA Communications, Inc.....	17
Shure Brothers.....	51
Standard Measuring & Equip. Co...	17
Sylvania Electric Products, Inc.....	9
Triplett Elect. Inst. Co.....	53
U. S. Recording Co.....	17
Western Electric Co.....	16
Wilmotte, Raymond M.....	17
Wilson, Herbert L.....	17

FM AND TELEVISION

SOUND EQUIPMENT—precisionized—mechanically and electronically—for finer performance

*Solidly
Built*



Unit 524
Transcription
Turntable

To keep the original sound alive!

Today, the human ear should not be able to distinguish a recorded program from an original 'live' studio performance.

Why? Because all tell-tale rumble, noise and 'WOWS' have been eliminated from transcription turntable performance.

How? By the advanced design and solid construction of the new Unit 524 Fairchild Transcription Turntable.

We've removed its attractive access panel so that you can study it carefully. Let's start with its construction: The synchronous motor and drive are

spring-mounted and precision-aligned in a single heavy casting at the bottom of the cabinet to reduce rumble. The hollow vertical drive shaft is equipped with mechanical filters and a special rubber coupling to reduce the transmission of vibration. And the turntable, with its sturdy shaft, is mounted in a heavily-webbed aluminum panel at the top of the cabinet to further reduce vertical vibration.

What about 'WOW'? That's reduced to a minimum at either 33.3 or 78 rpm by the famed Fairchild direct-from-the-center, two-speed drive. Evenness

of speed is assured by a carefully calculated loading of the drive mechanism that keeps the motor pulling constantly, by precision control of all alignments that might cause intermittent grab and release.

The Unit 524 Fairchild Transcription Turntable is of broadcast height. It is available with or without the Unit 542 Fairchild Lateral Dynamic Pickup, illustrated below. Arrange to hear it. Listen to it critically. Then let it keep your original sound alive! Address: 88-06 Van Wyck Boulevard, Jamaica 1, New York.

**SOUND
EQUIPMENT**



Fairchild

CAMERA AND INSTRUMENT CORPORATION

**FOR IMPROVED
PERFORMANCE**



UNIT 542
LATERAL DYNAMIC PICKUP

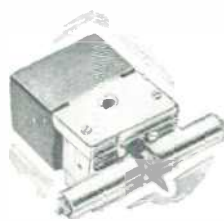

UNIT 541
MAGNETIC CUTTERHEAD

Earlier FAIRCHILD portable models and many other types of recorder-playbacks will give vastly improved performance if equipped with an adapter and an improved Fairchild Pickup and Cutterhead.

Write for complete information.

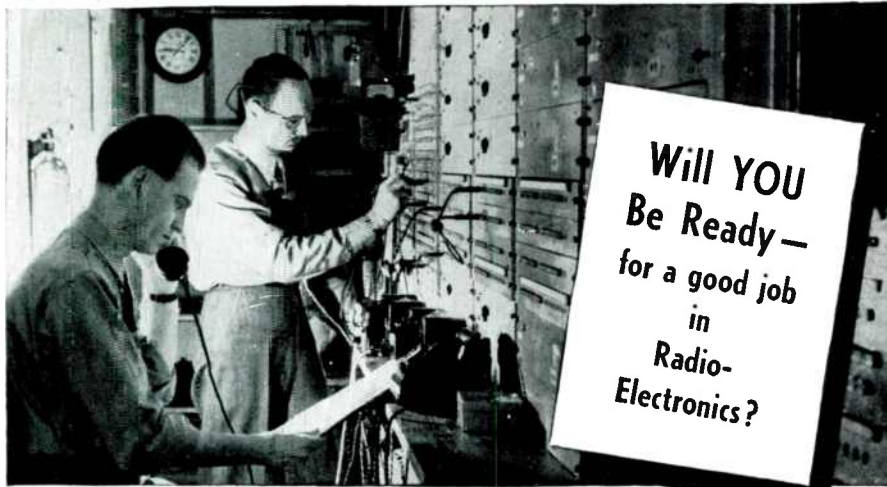

CREI Home Study Training Can Equip You to Step Ahead of Competition and Gain the Confidence Born of Knowledge

CREI technical home study training prepares you for the secure radio jobs that pay good money for ability.

Yes, YOU can be ready to enjoy the security of an important technical position and take advantage of new career opportunities . . . if you prepare yourself now!

Join the thousands of other ambitious radiomen who have enrolled with CREI to assure themselves of secure, good-paying jobs with a planned program of advancement made possible by CREI home study training in practical Radio-Electronics Engineering. You can study at home — in your spare time — develop your technical ability — increase your knowledge to keep pace with important developments now taking place in the industry.

By adding CREI training to your present radio experience you can safeguard your future and keep pace with such new developments as U.H.F. Circuits, Cavity Resonators, Pulse Generators, Wave Guides, Klystrons and Magnetrons. Are you equipped to handle them? CREI is equipped to help you by providing the technical background that is required.

In our proved method of instruction you learn not only *how* but *why*! Easy-to-read-and-understand lessons are provided well in advance, and each student has the benefit of individual guidance and supervision from a trained instructor. This is the basis of the CREI method of training for which many thousands of professional radiomen have enrolled during the past 19 years . . . and which has resulted in large numbers of promotions to more responsible positions.

It costs you nothing to read the interesting facts . . . to learn how CREI can help you enjoy the security you want . . . the better paying job that can be yours. Write for particulars now! (CREI training for veterans is approved under the "G.I." Bill.)

CAPITOL RADIO ENGINEERING INSTITUTE

E. H. Rietzke, President

Dept. F-6, 16th and Park Road, N. W., Washington 10, D. C.

Branch Offices:

New York (7): 170 Broadway
San Diego (1): 316 C Street

Chicago (2): 30 N. LaSalle Street
San Francisco (2): 760 Market Street

Member: NATIONAL HOME STUDY COUNCIL; NATIONAL COUNCIL OF TECHNICAL SCHOOLS

ENGINEERING SALES

G.E.: Delivery of G.E. television receivers has been promised from Bridgeport plant in August or September. First model will have 10-in. direct-view tube. Price will be about \$300. Broadcasters are being promised television transmitters and studio equipment, built at Syracuse, early in 1947.

C. P. Clare: Has appointed John E. Kindall as sales representative for eastern Missouri. His headquarters are at K-S Electrical Sales, 2004 Locust Street, St. Louis 3.

Resistors: New line of fixed and variable resistors is being set up for parts jobbers by Joseph J. Cerny's new company, Resistors, Inc., 2241 Indiana Avenue, Chicago 16.

Libby Glass: L. E. Durholt has been appointed sales engineer to develop sales of bulbs and tubing for radio and television applications. He will make his headquarters Libby Glass Company's Toledo office.

Cleveland: Max G. Bauer has resigned as editor of *Radio and Electronic Jobber News*, and has returned to radio jobbing under the company name Pioneer Radio Supply Corporation at 2115 Prospect Ave., Cleveland.

RCA: Julius Haber has been named advertising and sales promotion manager of RCA Victor tube department. He has been with RCA since 1923 and, prior to this new assignment, handled special advertising and promotion in the public relations department. His headquarters will now be at Harrison, N. J.

Zenith: H. C. Bonfig, has been appointed vice president and director of sales for Zenith Radio Corporation. An old-timer in the industry, he was the Zenith distributor in Kansas City from 1924 to 1927.

DuMont: At a recent public showing of postwar television receivers, DuMont Laboratories displayed models which included FM-AM broadcast reception and automatic phonographs. All types were designed for direct viewing, with 14-in. and 20-in. tubes. Prices started at \$600.

Scott: Sales and shipping departments of Scott Radio Laboratories have been

CONCLUDED ON PAGE 54)

Just Off the Press!



WRITE FOR FREE 36-PAGE BOOKLET

"Your Opportunity in the New World of Electronics"

Tells how CREI Courses can be adapted to your particular needs.

If you have had professional or amateur radio experience and want to make more money, let us prove to you we have something you need to qualify for a better radio job. To help us intelligently answer your inquiry—PLEASE STATE BRIEFLY YOUR BACKGROUND OF EXPERIENCE, EDUCATION AND PRESENT POSITION.

SYLVANIA NEWS

CIRCUIT ENGINEERING EDITION

JUNE

Prepared by SYLVANIA ELECTRIC PRODUCTS INC., Emporium, Pa.

1946



More compact television receivers will be made possible by the T-3.

Much Smaller Sets Possible

Radical reductions in the size and weight of many types of electronic equipment are seen as a distinct possibility arising from Sylvania Electric's development of the extremely small T-3 tube. The T-3 is the commercial version of the peanut-sized electronic tube of proximity fuze fame.

Tiny as it is, the T-3 tube is characterized by exceptional ruggedness. It has a life of hundreds of hours, and is ideally suited for operation at high frequencies.

Savings in Space and Weight

The small size of the T-3 contributed directly to compactness and lightness in the design of radio and television receivers and other types of electronic equipment. Other fea-

RUGGED ELECTRONIC TUBE TINY ENOUGH TO REVOLUTIONIZE DESIGN OF RADIO RECEIVERS AND OTHER EQUIPMENT

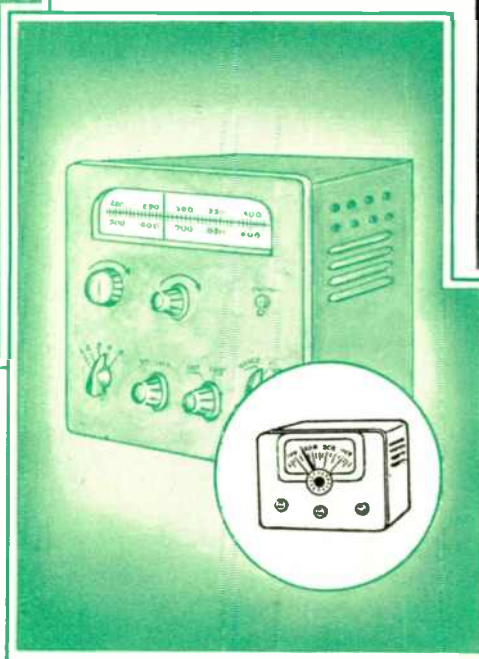

Weight-saving features of the T-3 will be of special value in air-borne equipment.

tures of the tube make possible still further reductions in space and weight.

Range of Applications

The design possibilities opened by the T-3 are naturally of greatest interest in the case of portable and air-borne equipment. However, its potentialities are not limited to these fields. Write Sylvania Electric Products Inc., Emporium, Pa.

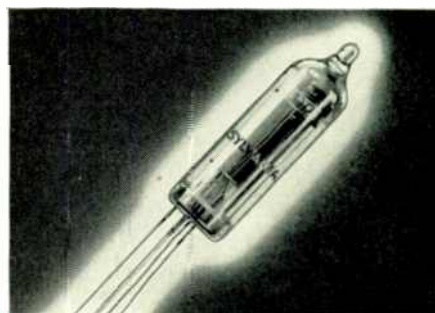

The T-3 tube is shown here in its actual size.

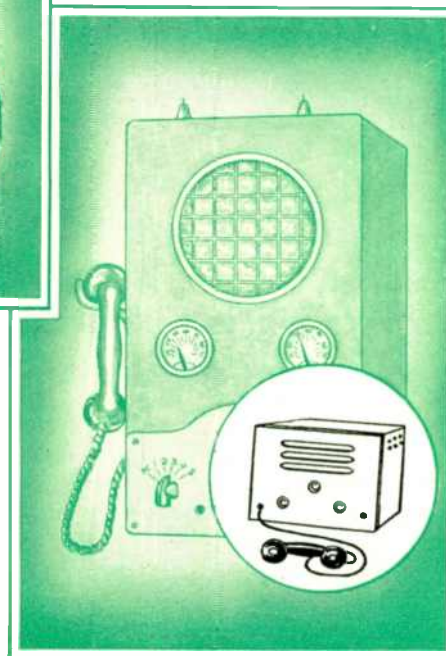

Equipment for motor boats and yachts can be made smaller and lighter.

SYLVANIA ELECTRIC

Emporium, Pa.

MAKERS OF RADIO TUBES; CATHODE RAY TUBES; ELECTRONIC DEVICES; FLUORESCENT LAMPS, FIXTURES, WIRING DEVICES; ELECTRIC LIGHT BULBS

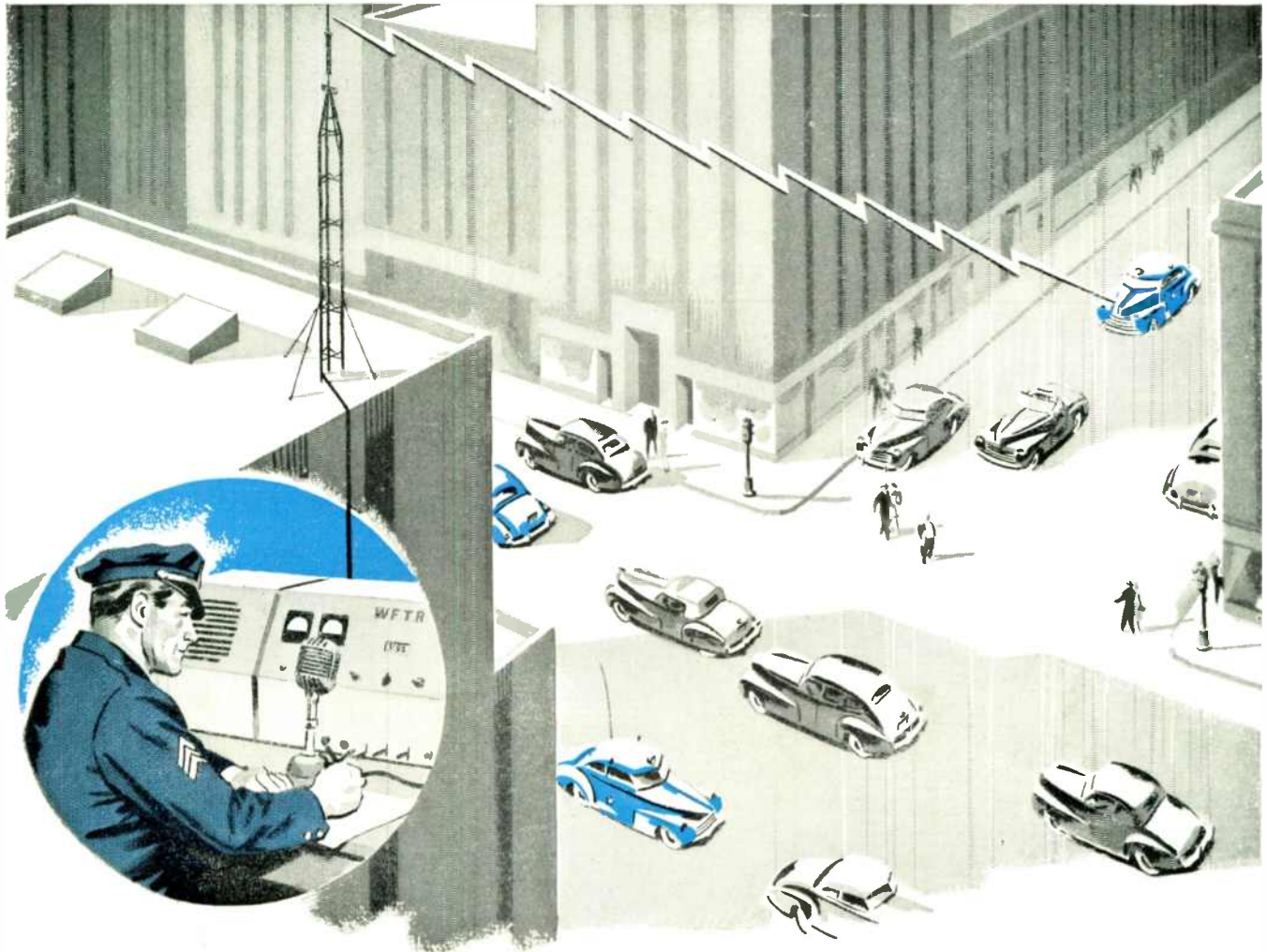

Now...he "Selecto-calls" the **ONE** car he wants
with **FEDERAL's "SELECTO-CALL"**

...the complete FM radio telephone system that works like a private line



Like a private telephone, the receiver unit of Federal's new mobile communication system remains silent until its "number" is called...no matter how many radio transmitters may be operating in the same area...even on the same frequency!

Thus, "Selecto-Call" now makes it possible to talk to any one car...or to all of them...at the flick of a switch...with blanket coverage for emergency service.

Employing a wholly new type of squelch circuit, "Selecto-Call" eliminates responses to unwanted signals and interference from adjacent channels. Batteries and tubes actually "loaf" except when their "number" is called...which means longer life for the equipment and lower operating costs.

Built to serve tomorrow's communication needs, "Selecto-Call" is available now, in one small, compact unit that plugs in as simply as a desk drawer. Write for complete information. Federal Telephone and Radio Corporation, Newark 1, N. J.

Federal Telephone and Radio Corporation

Export Distributor:
International Standard Electric Corporation

Newark 1, New Jersey



ANSWERING THE DEMAND FOR **"Something Better"**



PRESTO
MODEL "L"



A better portable playback—compact, easy to carry, simple to set up. The remarkably clear, wide range of reproduction—far superior to what is ordinarily expected of a portable playback—makes it a favorite with broadcasting stations and advertising agencies who demand top performance in demonstrating recorded programs to prospective clients.

Model L plays 6 to 16" records, 78 or 33 $\frac{1}{3}$ R.P.M., on a 12" rim-driven turntable. Standard equipment includes high quality 16" pickup on a swivel mounting which folds into a case when not in use, four stage amplifier, 8" loudspeaker with 20' extension cable, and a Presto Transcriptone semi-permanent playing needle. For use on 110 volts AC only.

The complete equipment, in an attractive grey carrying case, weighs only 46 lbs.

**PRESTO**

RECORDING CORPORATION
242 West 55th Street, New York 19, N. Y.
WALTER P. DOWNS, LTD., in Canada

WORLD'S LARGEST MANUFACTURER OF INSTANTANEOUS SOUND RECORDING EQUIPMENT

June 1946—formerly FM, and FM RADIO ELECTRONICS

11

New 

250 WATT

THE TRANSMITTER

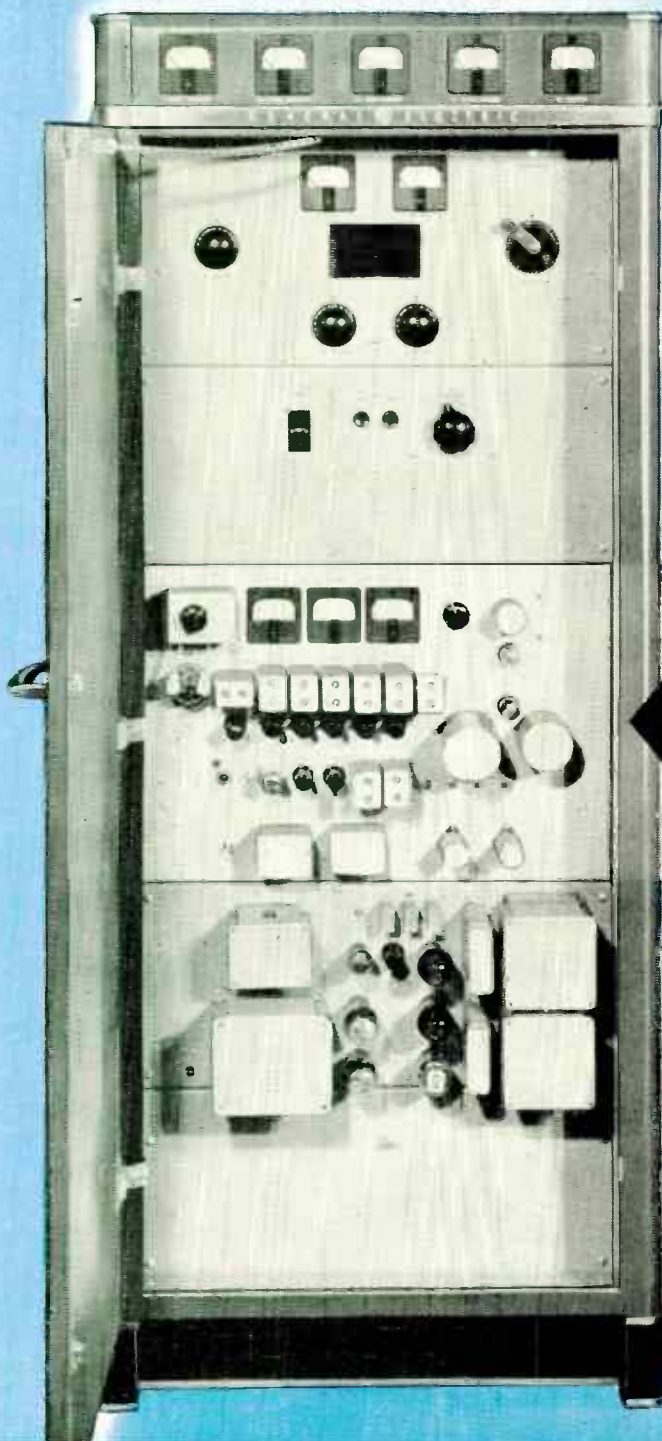

THE NEW G-E PHASITRON MODULATOR

This is the *simple* all-electronic modulation system which uses only 10 receiving-type tubes. The heart of this system is the G-E Phasitron. This tube, with its wide phase shift, allows a frequency multiplication of only 432 to produce a ± 75 -kc swing at the output frequency. Frequency conversions are unnecessary, thereby eliminating spurious responses. Important, too, is direct single-crystal control—*independent of modulation.*

Have you placed

STUDIO AND STATION EQUIPMENT • TRANSMITTERS

GENERAL  **ELECTRIC**

FIRST AND GREATEST NAME IN ELECTRONICS

160-E6-6914

World Radio History

FM TRANSMITTER

WITH THE PHASITRON CIRCUIT

- **Simple Design**

Only 9 r-f circuits and 10 r-f tubes from crystal to output frequency. Direct crystal control with *one* crystal. Minimum number of components and controls.

- **Easy-to-Get-At**

Vertical chassis construction. Full-length front and rear doors. Plenty of room to work in.

- **Basic Unit For Any Power**

Your transmitter today—your exciter tomorrow. Allows increase in power with no equipment obsolescence. Simplified inter-unit connections.

- **Lower Price**

your order yet?

For information on this outstanding transmitter and the complete line of G-E FM broadcast equipment, call your G-E broadcast sales engineer, or write: *Electronics Department, General Electric Company, Syracuse 1, N. Y.*

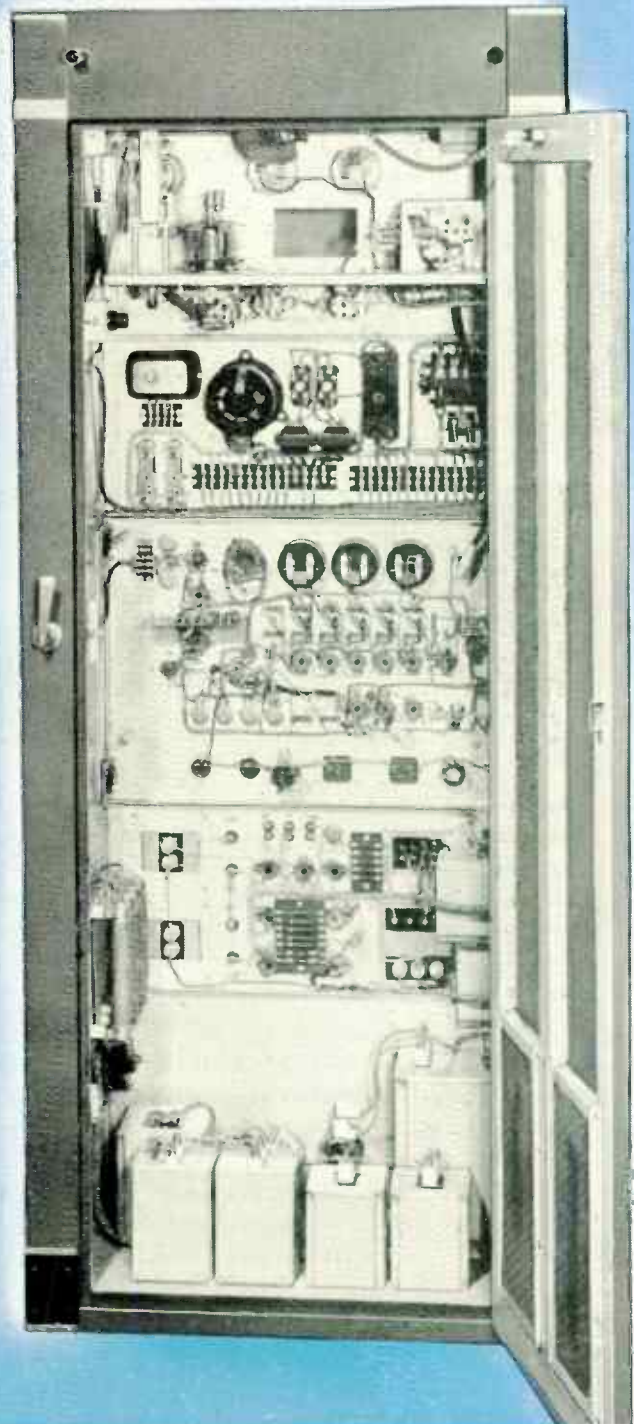

ANTENNAS • ELECTRONIC TUBES • HOME RECEIVERS

FM • TELEVISION • AM

See G.E. for all three!

LINE IS OUT-POLE NO. 521, HIGHWAY 66!

THIS KIND OF TALK
via Motorola
F-M 2- AND 3-WAY RADIOTELEPHONE
SAVES TIME AND MONEY FOR YOU!

Split-second communication between all personnel of your maintenance department means greatly increased efficiency throughout your entire system. No time is lost by repair crews waiting for instructions by telephone, or in reporting back between jobs. Fewer Patrol cars and repair cars are necessary when their efficiency is increased with Motorola Radiotelephone. So the initial cost of the equipment is quickly balanced by the savings in time and maintenance.

WHEN YOU DECIDE ON RADIOTELEPHONE—CHOOSE MOTOROLA!

Motorola dependability has been *proved* time and again! The California Electric Power Co. uses Motorola equipment exclusively for line patrolling. Police of 34 states and over 1,000 communities rely on Motorola for emergency communications. Ask us to submit specific recommendations on the application of Motorola Radiotelephone in *your* system. There's no obligation, of course—**WRITE TODAY!**

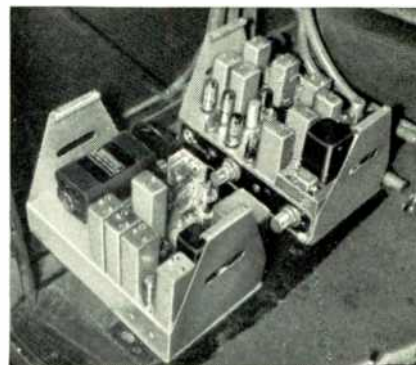

One of the many types of Motorola mobile units for use in patrol cars, repair cars, etc. (Shown with dust covers removed.)

GALVIN MFG. CORPORATION • CHICAGO 51
 COMMUNICATIONS AND ELECTRONICS DIVISION

F-M & A-M HOME RADIO • AUTO RADIO • PHONOGRAPHS • TELEVISION • "HANDIE TALKIES" • POLICE RADIO • RADAR • MILITARY RADIO

fm

-but by Raytheon

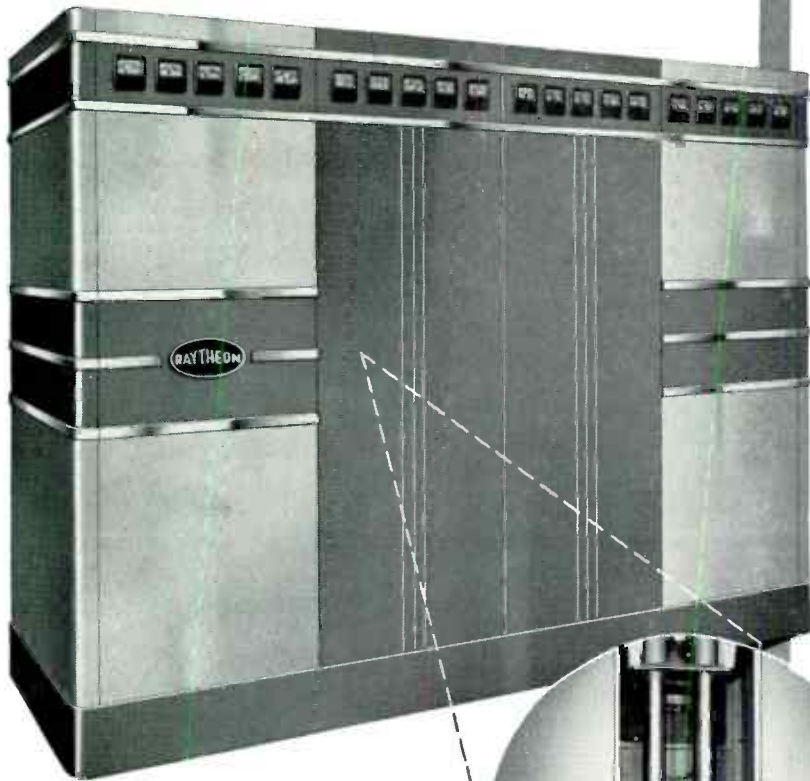

Raytheon's 10 KW FM transmitter. One of a complete line of FM transmitters incorporating *Simplified* Phase Shift Modulation with Direct Crystal control plus many other exclusive Raytheon features.

NEW!—Simplified Phase Shift Modulation and Direct Crystal Control

- **Simplicity**—Recognizing Phase Shift Modulation as the best method of Modulating, Raytheon has engineered greater stability and efficiency into this method by exclusive and greatly simplified circuit design.
- **Rugged Dependability**—Direct crystal control, independent of modulation, gives positive and automatic control of the mean carrier frequency. Simple linear type tank circuits are used for all stages operating in the FM band—cannot get out of tune or adjustment.
- **Efficiency**—Every circuit is completely shielded to eliminate power losses by radiation, interaction and parasitic oscillation.
- **Unit Construction**—Buy now only the power you need and add a unit for increased power later. All units are perfectly matched in size, styling and colors.
- **Easy Installation**—Unit dimensions have been held to convenient cubicle sizes for moving through standard doors, in elevators, etc.
- **Lasting Economy**—Not only is the purchase price of a Raytheon transmitter less but your savings continue through lower operating costs achieved by greater operating efficiency, lower power consumption and long life quality tubes and components.
- **Operating Safety**—Complete power interlock and an automatic shut-off of power when rear doors are opened provide absolute safety for all operating personnel.

RAYTHEON MANUFACTURING COMPANY

Broadcast Equipment Division

7517 No. Clark Street, Chicago 26, Illinois

RAYTHEON

Excellence in Electronics

DEVOTED TO RESEARCH AND MANUFACTURE FOR THE BROADCASTING INDUSTRY

13. Light weight.
14. Easy to assemble—low erection costs.
15. Half wavelength spacing reduces side lobe energy.
16. No critical dimensions required to obtain maximum efficiency.
17. Wide vertical beam width for reliable coverage.
18. Designed for high wind and heavy ice loads.
19. One design for all FM broadcast frequencies.
20. One design matches impedance of any coaxial line.
21. Simple de-icing elements—no rf filters needed.
22. Built-in vertically polarized radiation suppressor.
23. Built-in second harmonic attenuator.
24. Built-in climbing steps.



12 more* reasons why FM stations are choosing the *Western Electric* CLOVER-LEAF ANTENNA



The Western Electric 54A Clover-Leaf Antenna, designed by Bell Telephone Laboratories specifically for FM broadcasting in the 88—108mc band, radiates horizontally polarized waves in a highly concentrated, *circular* azimuth pattern.

Exhaustive tests on accurately scaled models confirm that the distribution of energy in azimuth is circular within ± 0.2 db and that the beam width is realized in practice to $\pm 1^\circ$. Advertised gain figures have been confirmed within 0.2 db.

For complete electrical and structural details, write to Graybar Electric Co., 420 Lexington Avenue, New York 17, N. Y.—or phone your nearest Graybar Broadcast Equipment Representative.

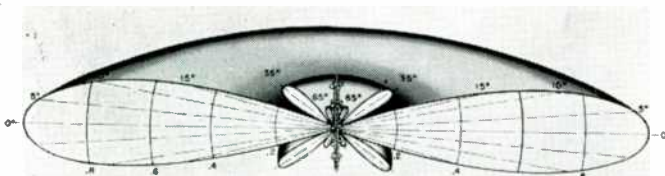

Radiation Pattern for 5 unit array.

*For 12 additional reasons, see previous ad on Clover-Leaf Antenna.



FM AND TELEVISION

Professional Service Directory

Jansky & Bailey

AN ORGANIZATION OF
Qualified Radio Engineers
DEDICATED TO THE
SERVICE OF BROADCASTING
National Press Bldg., Washington, D. C.

RAYMOND M. WILMOTTE
Consulting Radio Engineer

PAUL A. DEMARS
Associate

1469 Church St., N.W., Washington 5, D. C.
Decatur 1234

FRANK H.
McINTOSH

Consulting Radio Engineers
710 14th St. N.W., Wash. 5, D. C.
MEtropolitan 4477



ANDREW CO.

Consulting Radio Engineers
363 EAST 75th STREET, CHICAGO 19
Triangle 4400

MAY & BOND

CONSULTING RADIO ENGINEERS

★ ★ ★

1422 F Street, N. W. Wash. 4, D. C.
Kellogg Building Republic 3984

JOHN J. KEEL

Consulting Radio Engineers

Earle Building
NATIONAL 6313
Washington 4, D. C.

• TELEPHONE BRIDGEPORT 5-2055 •

GARO W. RAY

Consulting Radio Engineers

For Standard and FM Services
991 Broad Street, Suite 9-11
Bridgeport 3, Conn.

LABORATORY: Hilltop Drive
Stratford, Conn.—Phone 7-2465

Herbert L. Wilson
and Associates

CONSULTING RADIO ENGINEERS
AM-FM Television Facsimile

1018 Vermont Avenue, N.W.
Washington 5, D. C.
National 7161

H. V. Anderson

—AND ASSOCIATES—

• Consulting Radio Engineers

715 American Bank Bldg. Tel. RAYmond 0111
New Orleans 12, Louisiana

The

ROBERT L. KAUFMAN
ORGANIZATION

• Construction Supervision (FM-AM),
Technical Maintenance, and Business Ser-
vices for Radio Broadcast Stations.

Munsey Building Washington 4, D. C.
District 2292

DIXIE B. MCKEY
ROBERT C. SHAW

CONSULTING
RADIO ENGINEERS

1730 Connecticut Avenue, N. W.
Washington 9, D. C. Adoms 3711

Frequency Measurements

Highest Accuracy — Anytime

One of the best equipped monitoring stations
in the nation

STANDARD

MEASURING & EQUIPMENT CO.
Phones 877-2652 Enid, Oklahoma
Since 1939

MORE RF KILOWATT HOURS
PER DOLLAR WITH
F & O TRANSMITTING TUBES

Freeland & Olschner Products, Inc.

611 Baronne Street, New Orleans 13, La.
Raymond 4756

High Power Tube Specialists Exclusively

**FREQUENCY MEASURING
SERVICE**

Exact Measurements - of any time



RCA COMMUNICATIONS, INC.
64 Broad Street, New York 4, N. Y.



Radio Engineering Consultants,
Frequency Monitoring

Commercial Radio Equip. Co.

International Building • Washington, D. C.
321 E. Gregory Boulevard • Kansas City, Mo.
Cross Roads of the World • Hollywood, Calif.

ERA

COMPLETE Technical and
Management
Consultant Service

Immediate FM and VHF
Field Measurement Service Available

Engineering Research Associates, Inc.

Washington, D. C. Office: Laboratories:
827-14th Street, N. W. St. Paul 4, Minnesota
Phone: EXecutive 4742 Phone: NEStar 9601



1031 N. ALVARADO - LOS ANGELES 26, CALIF.

Custom-Built

SPEECH INPUT EQUIPMENT

U. S. Recording Co.

1121 Vermont Avenue
Washington 5, D. C.
District 1660

THERE'S A NEW **REL** 1 KW FM TRANSMITTER NOW OPERATING AT ALPINE

The birthplace of FM, W2XMN (WFMN) Alpine, N. J. is owned and operated by Major Armstrong. Just as the first commercial FM equipment was delivered to Alpine by REL in 1938—so, in 1946 REL has again demonstrated its leadership.

Others who are now on the air with new REL FM Transmitting Equipment (88-108 MC.) are:

W3XO —
Washington, D.C. (WINX)

WDRC-FM —
Hartford, Conn.

WTIC-FM —
Hartford, Conn.

WENA —
Detroit, Mich.

WNBF-FM —
Binghamton, N. Y.

WGTR —
Paxton, Mass.

WMIT —
Winston-Salem, N. C.

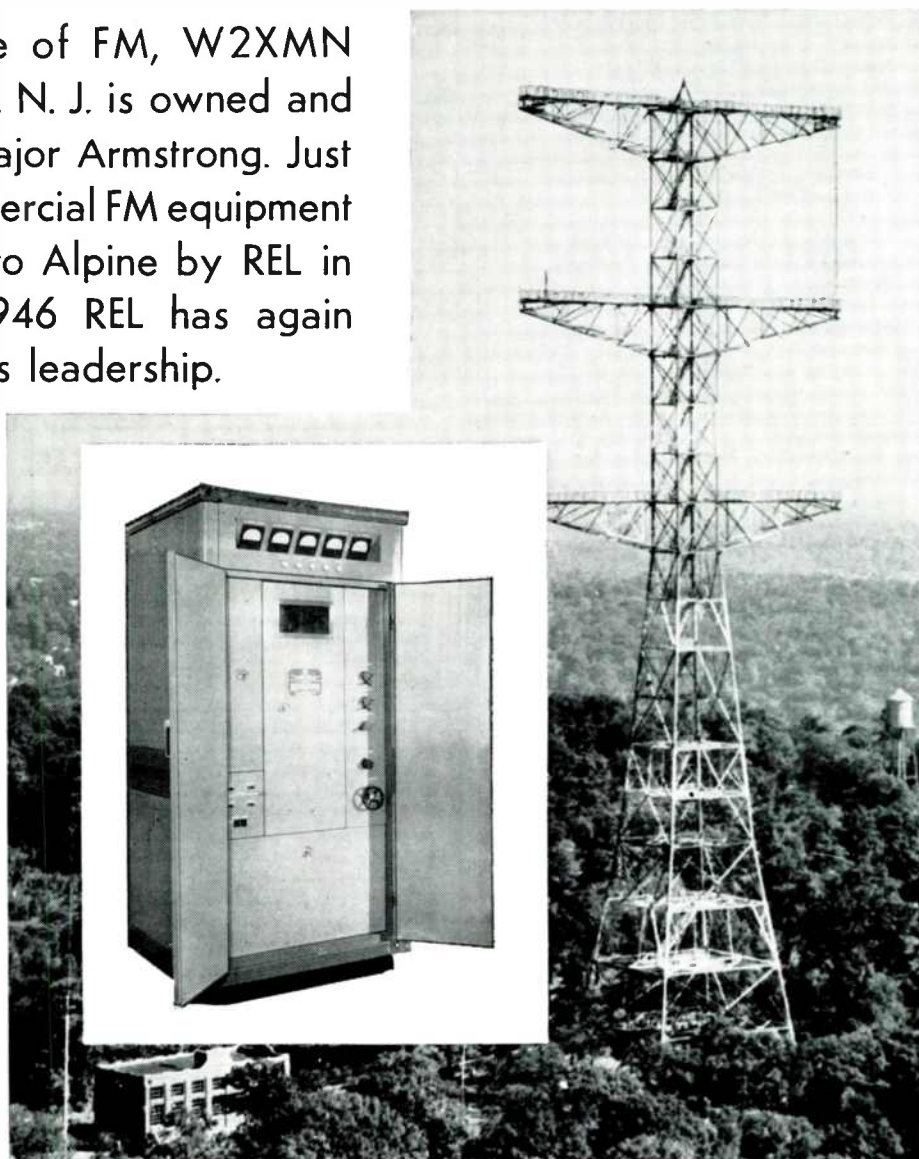

REL is now delivering FM Broadcast Equipment including Transmitters, FM Monitors, Speech Consoles, and a compact turnstile Antenna with Power Gain of 2. Consult us if you have any problems with delivery of your new FM Broadcast Equipment.

PIONEER MANUFACTURERS OF FM TRANSMITTERS EMPLOYING ARMSTRONG PHASE-SHIFT MODULATION

RADIO ENGINEERING LABS., INC.
Long Island City, N.Y.

STATUS OF RAILROAD RADIO

A Progress Report and a Re-evaluation of Radio Services for Railroads

BY MILTON B. SLEEPER



FIG. 1. RADIN DISTANCE INDICATOR IS ABOVE THE ENGINEER'S HAND

LOOKING back over the record of efforts made by U. S. railroads to employ radio for communications purposes,¹ it wouldn't be surprising if they had finally tossed the whole project out the window, and had refused to make any further effort in that direction.

And so they might well have done except for the success scored by FM in the mobile communications field. On the basis of that experience it appeared, at least to those without knowledge of railroad operation, that standard units developed for police cars and headquarters stations could be readily installed in locomotives, cabooses, and signal towers. Then, presto! railroads would have system-wide communications as effective as state police installations.

It Was Too Easy ★ It all seemed so simple that FM nearly got off on the wrong foot with the railroads. To be sure, standard mobile equipment was used very successfully in certain special applications, particularly in arsenal yards, during the war, where switching locomotives moved high explosives.

But there was a catch to this application. Cars containing munitions were handled with the utmost care, and radio on the locomotives did not meet the abuse to which it is subject in ordinary freight traffic. Consider, as just one example, that freight cars do not have any spring take-up on the couplings, and that there is about 5 ins. play between cars. Thus, when a train of 100 cars starts up, the caboose may be jerked forward more than 30 ft. with a jolt that might shear off half the rivets used to assemble some types of mobile equipment!

Thus, in the course of initial tests of FM for railroad service, standard equip-

ment was found altogether inadequate. Moreover, these tests were conducted in the 30- to 40-mc. band, and antennas of efficient design at those frequencies were of dimensions outside the limits imposed by the proximity of bridges and other wayside construction.

Success at 160 Mc. ★ FM might have been stopped at that point, had it not been for the success of tests on 160 mc. This, of course, solved the problem of reducing the mechanical dimensions of mobile antennas. And, in this new band, the transmitting range with 25 watts output has proved adequate² for railroad communications purposes.

The remaining problems of front-to-rear, train-to-train, and train-to-wayside communications now lie chiefly in mechanical design and operational organization. The former presents only minor difficulties now that design specifications³ have been worked out. Methods of operation and servicing of equipment must, of course, be planned to suit the requirements and the facilities of each individual road. In most cases, plans will have to be worked out by divisions or sections, because of varying conditions and needs.

The Value of Radio to Railroads ★ Railroad officials have been reluctant to admit that radio, as a supplement to existing signal and safety devices, will make any real contribution to safe operation. Every time an accident occurs, if the question is raised as to whether or not radio could have prevented it, general policy is to deny that the use of radio would have made any difference. For example, after the wreck of the Burlington's streamliners last April, when 44 passengers were killed,

one official told the writer that the use of train-to-train radio would have prevented this accident. He further stated that the cost of settling suits and the damage to rolling stock would run between 5 and 6 million dollars, or several times the cost of a complete radio communications system.

Another official, however, insisted that, according to the report of the investigators, the engineer knowingly disregarded signals set against him, so that the use of radio would have had no effect.

Railroading is such a highly specialized profession that outsiders are hardly privileged to have opinions in these controversial situations. However, it does appear that, in the case of accidents, railroad officials are reluctant to admit that any safety measure not employed would have been of any value, because such an admission would be used by lawyers representing the injured to prove negligence on the part of the road.

As for the Burlington engineer who ran past the signals set against him, we can only observe that, just as officers who ride the police cars become so dependent on radio that they are reluctant to start out if their equipment is not working properly, so we may find engineers and conductors, in the not distant future, holding up freight and passenger trains until a defective transmitter or receiver is replaced with one in good working order.

Radin ★ What may prove to be the greatest contribution to the safety of railroad passengers, employees, and rolling stock is the development of Radin, a project carried out jointly by Sperry Gyroscope and the Rock Island Railroad.

Radin is not related in its mode of operation to radar, yet it is used to indicate exactly in miles the distance from a locomotive to the rear car of a train ahead on the same track. Indication is obtained

¹ First tests were conducted by Delaware, Lackawanna & Western, 1914-1919. For complete review of efforts by other roads, see "Plans for Railroad Radio Communications," by René Hemmes, *FM AND TELEVISION*, Nov. 1944.

² See report of Detroit tests, "161-Mc. Satellite System for Rail Yards" by Arnold C. Nygren and William G. Clinton, *FM AND TELEVISION*, April, 1946.

³ See "Railroad Radio Specifications," *FM AND TELEVISION*, June, 1946.

from a simple meter, illustrated in Fig. 1, calibrated up to 8 miles, the maximum distance required.

The radio equipment is extremely simple in design and operation. It operates on a principle employed for I.F.F. at airports during the war. That is, an FM transmitter on the locomotive sends a signal forward, which is picked up by a receiver on the last car of the train ahead. Then the received signal is fed into an associated transmitter, and sent back to the locomotive. Finally, and here is the distinctive feature of Radin, the distance between the two installations is measured by determining the phase difference between the out-going and incoming signals.

Operation is not affected by other trains or steel structures. When a curve separates two trains on the same track, the indication is that of a chord, rather than the distance over the roadbed. That is not objectionable, however, since the Radin indicator will show that they are a little nearer together than they are actually.

Cost of Accidents ★ Here are some cold facts about the cost of railroad accidents resulting in injury or death to passengers and damage to rolling stock:

The usual settlement for the death of a passenger is \$10,000. However, in case of injury, the cost to the road may be much greater, since the courts decide each claim on its merits.

A big diesel engine costs \$500,000 to \$600,000; pullman cars \$100,000 to \$120,000; and passenger coaches \$75,000 to \$80,000.

When an accident occurs, there are many other items of expense incurred, to which must be added the loss of use of revenue-producing locomotives and cars. The public only hears of accidents involving loss of life. However, the annual cost of wrecked freight trains, and resulting delays in operating schedules, is probably greater than of all the accidents reported in the newspapers.

Operational Use of Radio ★ Although there is no authoritative data available on railroad radio as a supplementary safety service, a highly informative report on operational use, based on actual tests and experience, has been submitted to the FCC by the Chicago, Rock Island & Pacific Railway Company, over the signature of J. D. Farrington, chief executive officer. The report was prepared by C. O. Ellis, superintendent of communications, and E. A. Dahl, electronics engineer. The following summary of operational uses of radio communications is quoted from that report:

1. TERMINAL AND YARD OPERATION — 2-WAY SERVICE: (a) Yard Master would instruct engine crews of any additional switching required in the area in which they are working.
- (b) Engine crews would be advised of the time and track numbers of incoming trains, and instructed regarding the break-up of the trains.
- (c) Engine crews would report any delay in the execution of their work, and any questions arising in connection therewith.
- (d) Yard Master would instruct engine

crews operating in other yards and on industrial sidings regarding additional work in their territory, or work to be done on their return to the home yard.

(c) The movement of trains in and out of yards and the delivery of cars to other lines could be considerably expedited, and greater usage derived from cars and engine equipment.

2. END-TO-END TRAIN COMMUNICATION — 2-WAY SERVICE: (a) Hot journals or defective equipment could be observed from the caboose, and train could be brought to a stop without the necessity of air application from the rear, which would minimize delay to train and possibility of damage to equipment. Estimated time saved in such instances is 15 to 45 minutes, depending on length of train and weather conditions.

(b) Conductor could contact engineer to instruct regarding clearance of highway crossings and insulated track joints to permit clearance of signals and operation of interlocking plants, eliminating delay to trains, and delay to public on account of blocked crossings.

(c) Engineer and conductor would be able to communicate with respect to the completion of air tests and conductor would instruct engineer to proceed when the flagman had returned to caboose.

(d) When trains would enter or leave a siding, conductor would inform engineer when switch had been lined and crews aboard.

(e) Conductor and engineer could discuss
(CONCLUDED ON PAGE 53)

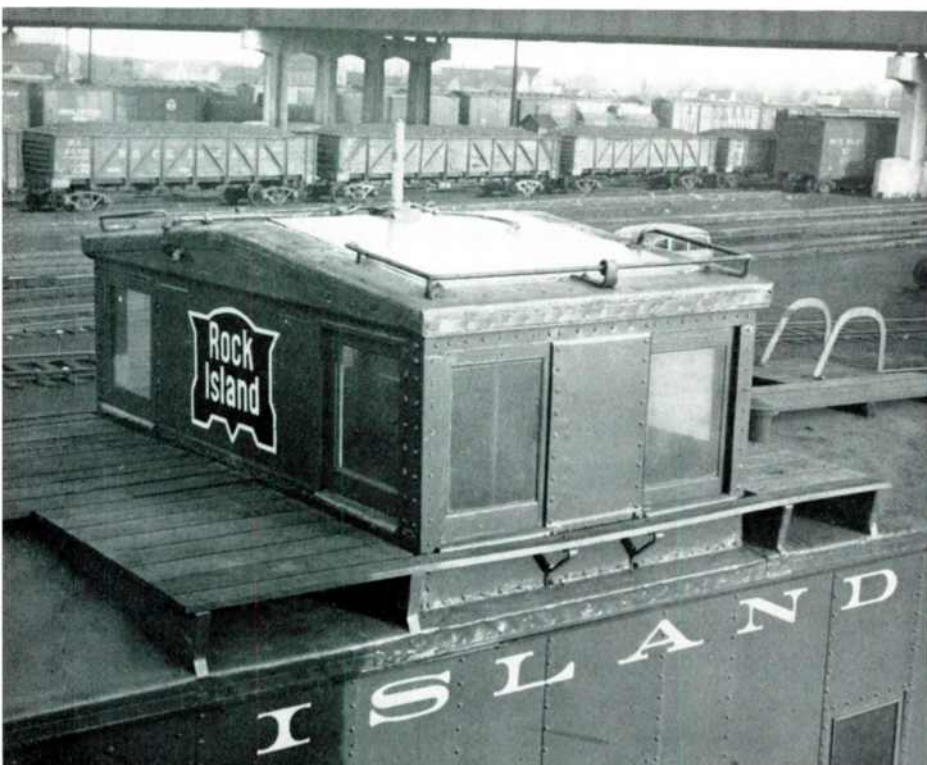

FIG. 2. SHIFTING RAILROAD RADIO TO 160 MC. HAS MADE POSSIBLE THE USE OF SHORT ANTENNAS, SUCH AS THE AMPHENOL TYPE ABOVE

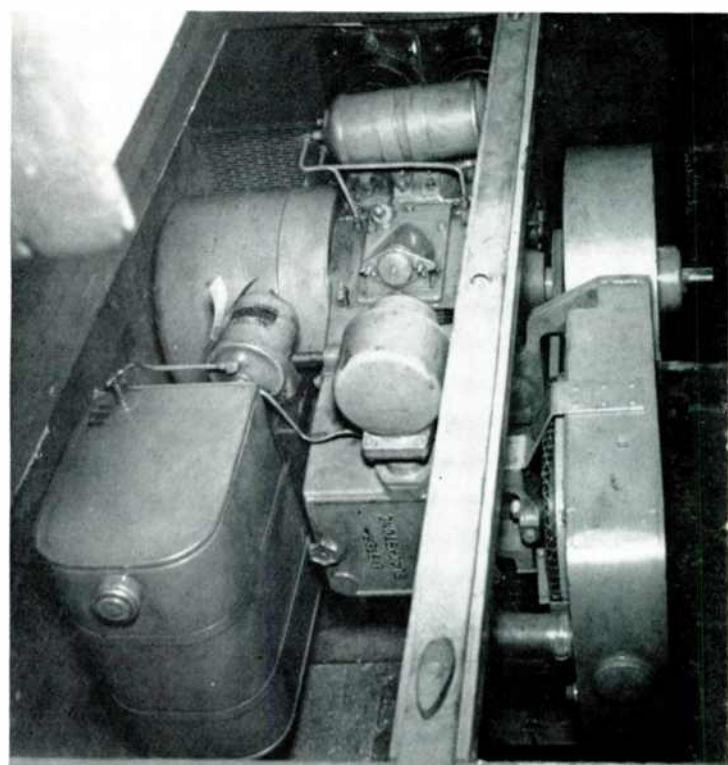

FIG. 3. 5-KW. DIESEL-DRIVEN GENERATOR HAS PROVED HIGHLY SATISFACTORY AS POWER SUPPLY

FX CAN HELP MAKE FM STATIONS PAY

Audio-Plus-Facsimile on FM Can Build Bigger Revenue than AM Station Sales

BY MILTON ALDEN*

THE operation of FM stations can easily develop in a short time into a much larger business than the present broadcasting industry. There is, however, a hurdle to be met.

We are told that advertisers say: "Where are your listeners?" When they are numerically indicated to the advertiser, he reminds the FM station, assuming that it is affiliated with an AM station or the advertiser is buying AM time in the area the station serves, that the FM broadcaster has not created any new listeners, but has only changed the type of radio sets which the listeners are using.

There does appear, however, to be one way in which Frequency Modulation stations can reduce the time required to achieve profitable operation. It is to be able to tell the advertisers that not only are there the assured listeners during the high-priced program hours, but many more besides — that even in the small hours before dawn their advertising messages are being delivered.

This is all a possibility in either 1947 or 1948.

It can be done by the transmission of exceptionally interesting dual aural and facsimile programs. And this does not mean just sending stale news and recipes by facsimile.

Here is the method: The radio listener-readers will have sets equipped with an automatic timer and station selector.

In the early morning hours the FX transmitter would send out a complete listing of all programs with sufficiently detailed descriptions and names of sponsors (not the boiled-down newspaper listing) so that the FX audience will know what will be on for the day. Following shortly after the listing, illustrated previews will be sent, highlighting the special-interest programs of the day.

During the day and early afternoon these programs will be directed to the women, children, and youth interests, since they are the people who spend the family budget or bring the greatest influence to bear on its use.

The FX program will not necessarily tie in with the aural component, and it must not be designed as tag-along program any more than talking pictures could have simply supplied words to the pantomime of silent pictures. It calls for a new art in programming, and will engage the best imaginative brains of the type that produce women's magazines or the feature sections of newspapers.

* President, Alden Products Co., Brockton, Mass.

It is easy to see that intriguing knitting stitches, styles, and actual patterns (already worked out), youth games, and other features provided in these programs can be of such interest that Mrs. Smith cannot let Mrs. Jones get ahead of her with the choice information she received over her FM-FX.

In order to prepare the way for this new public service, and to be ready with feature programs engineered as to scanner settings and employing artists of Walt Disney standards, feature writers, editors, etc., the Alfax Programs, Inc. has been

unobtrusive will be developed to preclude the reader reaction of too much advertising. The advertising will be welcomed because of the specific information it gives.

It is of course self-evident that, with this type of dual audio-facsimile program, a greater percentage of time can be sold for local advertising than with only audio programs. This will make such stations much less dependent on network advertising. It will increase their margin of profit from more around-the-clock operation, and higher rates will be justified by its greater effectiveness.

In the night hours, the listener can also select the more prosy, longer, special-interest programs that would be inappropriate in the daytime. For example, condensed novels, such as appear in each issue of *Readers' Digest*, can be transmitted. Short stories, and the more elaborate, illustrated features of magazines and newspaper supplements are equally suitable. The short programs and previews can tease the reader-listener to set his station selector to receive them whether he or she is at home, or at work, or asleep.

There will be no lack of masculine appeal: — baseball scores, commentators, and on-the-spot photos of special events. This would permit more than one commentator to be received at the same time — one over audio and the other on the facsimile.

1947-1948 — Not far away. What is the first step?

Early this fall we shall start deliveries on prototype scanners and recorders of all sizes. This prototype equipment will be available in sections, comprising amplifiers, synchronizing controls, oscillators, and all the other circuit elements, tailored for individual station requirements.

There are no particular problems of actually operating facsimile. The problems are rather the psychological reactions of the listener and practical convenience of operating.

We are more concerned about the ease and convenience of putting in the paper, and to have type composition and subject matter planned to make the listener want the recording, than we are in trying to put *National Geographic* quality of illustrations into the home.

We are more concerned that engineers learn the operation of scanners — know the material best suited for transmission — and the most favorable settings, so that recordings will be of high standard from the start.

We are also somewhat concerned to



FIG. 1. FACSIMILE RECORDER BUILT INTO CONVENTIONAL CABINET

set up to conduct research along these lines. Thus these programs will be sure-fire and, by being syndicated, will be made reasonable in cost to the individual stations.

Techniques of program production and engineering will be tested out so that stations can use the method for the locally-originating portion of the program that will insure its quality and effectiveness.

The art of producing effective advertising that will be compact, inoffensive, and

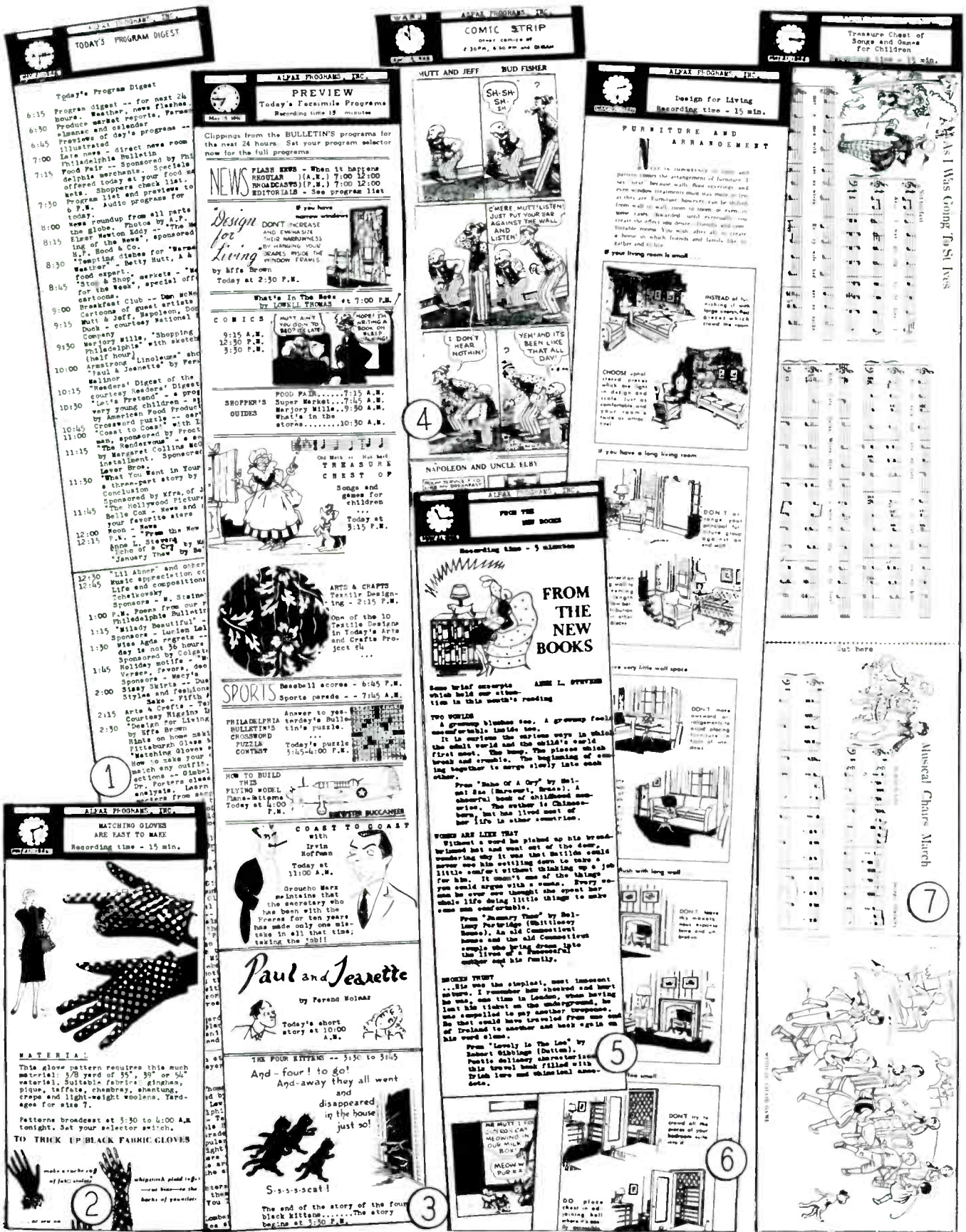

FIG. 2. EXAMPLES OF PROGRAM MATERIAL: 1, COMPLETE PROGRAM DIGEST; 2, HOW-TO-MAKE-IT ARTICLES; 3, PROGRAM PREVIEWS; 4, COMIC STRIPS; 5, BOOK REVIEWS; 6, HINTS FOR HOUSEWIVES; 7, ILLUSTRATED MUSIC FOR CHILDREN

avoid the use of established newspaper practice or standards of format which are only suited to metropolitan locations.

Our research as to reader reactions indicates that one column about the width found in Fortune Magazine, and paper about 4 ins. wide are much more accept-

See acknowledgments at conclusion of this article.

able and practical than four-column newspaper format.

The lower paper cost — less trouble of handling and storing paper — paper disposal — space occupied by recorder — all are factors of importance.

The decision, however, should not be by us, but by actual unbiased reactions of

the typical audience of each particular station. Out of it can come the common denominator, the single-purpose machine that can be quickly designed and produced to "ring the bell."

The winter and spring of 1947 should not only see the stations owned by metropolitan newspapers making use tests,

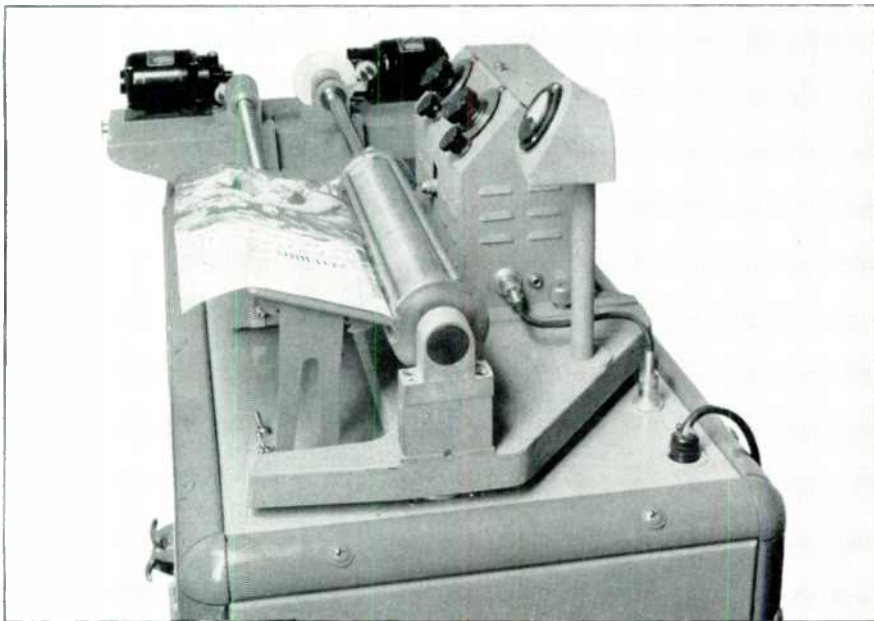

FIG. 3. CLOSE-UP OF SCANNER FOR BROADCAST STATIONS. AFTER COPY IS FED TO REVOLVING DRUM, THE OPERATION IS ENTIRELY AUTOMATIC

but also a reasonable number of progressive, smaller stations, with the FCC following this work closely to implement duplex programs by issuing the necessary authority.

This done, scanners meeting every critical requirement can be produced in 1947-1948, with manufacturers making receiving sets incorporating the recorders or providing for their attachment.

The procedure which, we have found, appeals to FM station owners and prospective owners as a practical procedure is as follows:

They are ordering universal scanners that can broadcast signals for any width recorder and any number of lines per inch.

The universal scanner may or may not be superseded later with single-purpose equipment. The single-purpose equipment may be more convenient, but in that case the initial scanner will become standby equipment, and will be used for testing copy, determining optimum settings for programs prior to putting them on the air.

The scanner is furnished with synchronizing equipment for the convenience of listeners who are not all on a common power line. The amplifiers and other elements of equipment are of unit construction, so that only what is needed need be bought.

Two views of the universal scanner are given in Figs. 3 and 4. This machine takes drums of practically any size for putting out signals to operate recorders of various widths. Usually 4-, 8-, and 18-in. drums are supplied. Change gears allow the use of various speeds to increase or decrease the number of lines per inch. Amplifiers and auxiliary equipment are contained in the cabinet.

A not unusual plan is to order up to 25 or perhaps 50 4-in. recorders, to be preceded by a few to go into the homes of

tion can be observed and program reaction noted.

Not too much thought is given at present to the physical form of sets and cabinets, because these can be styled readily once the other factors are determined.

Regardless of who pays for the paper, the user must not feel that it is being wasted. Human nature impels the turning off of a faucet if it drips or water trickles. Thus, this most dynamic means of entertainment, education, and stimulation of wants for our whole population hinges on the fine details of convenience and the amount of interest that can be packed in small space copy without sacrifice of legibility.

The advertising agency that thinks in terms of billboards and full-page splurges will be superseded by craftsmen who can build thumbnail ads that pull, and that will make Facsimile click.

It will be the stations which will study the details of customer reaction and are satisfied only with the highest standards of performance that will lead and will be amply repaid in financial returns.

NOTE: Copyright material illustrated for facsimile transmission is reproduced by permission of Condé Nast Publications, Inc., from *Vogue Pattern Book* June-July, 1946; Cima Publishing Company, from Effa Brown's "Design for Living"; *Woman's Day Magazine*; Bell Syndicate; Chicago Times; Treasure Chest Publications.

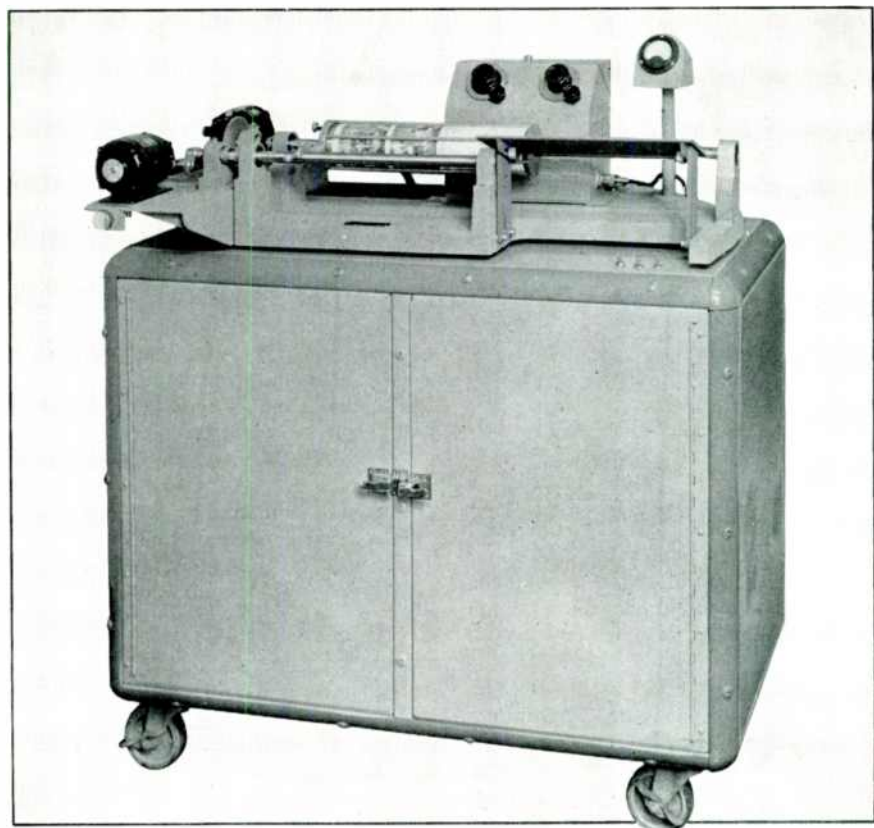

FIG. 4. THE COMPLETE FACSIMILE SCANNER FOR STATION USE, THIS MACHINE TAKES DRUMS FOR OPERATING RECORDERS OF VARIOUS WIDTHS UP TO 18 INS.

FCC PROPOSES FM BROADCAST REVISIONS

Text of Proposed Amendments of Rules and Standards for FM Broadcasting, May 28, 1946

THE Federal Communications Commission announced on May 28th the adoption of an order proposing to amend certain of its Rules and Standards concerning FM Broadcasting. The proposed changes are designed to simplify the allocation and assignment of facilities in this service. In absence of protests on or before June 15, 1946, it is not contemplated that Oral Argument will be held thereon.

The three previous classes of FM Broadcast stations would be reduced to two: Class A (formerly designated as Community) and Class B (including the former Metropolitan and Rural Classes). The 20 Class A channels are designed to render service primarily to a community or to a city or town other than the principal city of an area, and surrounding rural area. The 60 Class B channels are designed to render service primarily to metropolitan districts or principal cities and surrounding rural areas, or to rural areas removed from large centers of population.

Stations in the Community class are now limited to 250 watts of effective radiated power with an antenna height of 250 ft.; the proposed rule for Class A stations provides a coverage equivalent to a minimum of .1 kw. and a maximum of 1 kw. effective radiated power with the same antenna height. The minimum mileage separation specified for Class A stations would be the same as now specified for Community stations.

The present rule states that service areas will be designated by the Commission for Metropolitan stations in Area II and appropriate power and antenna height will be authorized. Under the proposed rule, a range of power and antenna heights are provided for Class B stations within which appropriate values may be requested by applicants.

For the purpose of allocation, the proposed rules divide the United States into two areas as at present (Sec. 3.202). However, the footnote appended to this rule would be modified to reflect present conditions.

It is contemplated that the tentative allocation plan for Metropolitan and Rural FM stations, announced in December 1945, will be followed in the assignment of Class B stations. No allocation plan is being proposed at this time for Class A stations.

Ten channels (from 106.1 to 107.9 mc.) are not now available for Community stations in Area II. The proposed rules provide for 20 Class A channels in both Area I and Area II, and no channels would be specifically reserved for facsimile. However, it is proposed that facsimile transmission would be authorized

on any channel, whether Class A or Class B, in both Area I and Area II.

TEXT OF FCC ORDER

Washington, D. C.

DOCKET NO. 6768

In the Matter of Promulgation of Rules and Regulations and Standards of Good Engineering Practice for FM Broadcasting Other Than Non-Commercial Educational Broadcast Service.

ORDER: At a session of the Federal Communications Commission held in its offices in Washington, D. C. on the 24th day of May 1946:

WHEREAS, It appears that the public interest, convenience, and necessity may be served by the adoption of the attached proposed amendments to the Commission's Rules and Regulations, and Standards of Good Engineering Practice for FM broadcasting other than non-commercial educational broadcast service;

NOW, THEREFORE, IT IS ORDERED, That any persons desiring to submit written statements with respect to these proposed rules and regulations and standards, file such statements with the Commission on or before June 15, 1946; and any persons desiring the opportunity of oral argument file their requests with the Commission on or before June 15, 1946; and

IT IS FURTHER ORDERED, That in absence of protests on or before June 15, 1946, the proposed rules and regulations and standards will be promulgated.

FEDERAL COMMUNICATIONS
COMMISSION

T. J. SLOWIE

Secretary

PROPOSED REVISIONS

3.202 Areas of the United States: For the purpose of allocation the United States is divided into two areas. The first area — Area I — includes southern New Hampshire; all of Massachusetts, Rhode Island, and Connecticut; southeastern New York as far north as Albany-Troy-Schenectady; all of New Jersey, Delaware, and the District of Columbia; Maryland as far west as Hagerstown; and eastern Pennsylvania as far west as Harrisburg.¹ The second area — Area II — comprehends the remainder of the United States not included in Area I.

¹ In some of the territory contiguous to Area I, the demand for frequencies requires that applications be given careful study and consideration to insure an equitable distribution of facilities throughout the region. This region includes the remainder of Maryland, Pennsylvania, and New York (except the northeastern corner) not included in Area I; Virginia, West Virginia, North Carolina, South Carolina, Ohio and Indiana; southern Michigan as far north as Saginaw; eastern Illinois as far west as Rockford-Decatur; and southeastern Wisconsin as far north as Sheboygan. Other regions may be added as required.

3.203 Class A Stations: (a) A Class A station is a station which operates on a Class A channel and is designed to render service primarily to a community or to a city or town other than the principal city of an area, and the surrounding rural area. The transmitter power and antenna height of a class A station shall normally be capable of coverage equivalent² to a minimum of .1 kw. and a maximum of 1 kw. effective radiated power at 250 ft. antenna height, as determined by the methods prescribed in the Standards of Good Engineering Practice Concerning FM Broadcast Stations. Class A stations will not be authorized with more than 1 kw. effective radiated power. Standard power ratings of transmitters used for Class A stations shall be not less than 250 watts nor more than 1,000 watts. A normal minimum separation for Class A stations of 50 miles will be provided on the same channel and 35 miles on adjacent channels.

(b) Twenty channels beginning with 104.1 mc. and ending with 107.9 mc. (Channels 281 through 300) are designated as Class A channels. All of these channels are available for assignment in cities which are not the central city or cities of metropolitan district. Ten of these channels are also available for assignment in central cities of metropolitan districts which have fewer than six Class B stations.³

3.204 Class B Stations: (a) A Class B station is a station which operates on a Class B channel and is designed to render service primarily to a metropolitan district or principal city and the surrounding rural area, or to rural areas removed from large centers of population. The service area of a Class B station will not be protected beyond the 1,000 $\mu\text{v}/\text{m}$ contour; however, Class B assignments will be made in a manner to insure, insofar as possible, a maximum of service to all listeners, whether urban or rural, giving consideration to the minimum signal capable of providing service. Standard power ratings of transmitters used for Class B stations shall normally be 1,000 watts or greater. In the following subsections, antenna height above average terrain and effective radiated power are to be determined by the methods prescribed in the Standards of Good Engineering Practice Concerning FM Broadcast Stations.

(1) In Area I, Class B stations will be

² For the purpose of determining equivalent coverage, the 1,000 $\mu\text{v}/\text{m}$ contour should be used.

³ For the time being, until more FM broadcast stations are authorized, the Commission will not authorize Class A stations in central cities of metropolitan districts having four or more standard broadcast stations.

licensed to operate with a service area equivalent² to a minimum of 10 kw. effective radiated power and antenna height of 300 ft. above average terrain and maximum of 20 kw. effective radiated power and antenna height of 500 ft. above average terrain⁴ in metropolitan districts in Area I with a population greater than 250,000 the minimum service area shall be the equivalent² of 20 kw. effective radiated power and an antenna height of 350 ft. above average terrain. Class B stations in Area I will not be licensed with an effective radiated power greater than 20 kw.

(2) In Area II, Class B stations will be licensed to operate with a service area equivalent² to a minimum of 2 kw. effective radiated power and antenna height of 300 ft. above average terrain, and a normal maximum of 20 kw. effective radiated power and antenna height of 500 ft. above average terrain.⁴ In Area II, where it is shown that the public interest would be served by authorizing greater power or antenna height either to serve greater area or to provide a higher signal intensity within an area, the power, antenna height, and area will be determined on the merits of the case, with particular attention being given to rural areas which would not otherwise receive service.

(b) Sixty channels beginning at 92.1 mc. and ending at 103.9 mc. (channels 221 through 280) are designated as Class B channels.

3.205 Station location: (a) Each FM broadcast station shall be considered located in the state and city where the main studio is located.

(b) The transmitter of each FM broadcast station shall be so located that satisfactory service is delivered to the city where the main studio is located, in accordance with the Standards of Good Engineering Practice Concerning FM Broadcast Stations; provided, however, upon special showing of need, authorization may be granted to locate the transmitter so that adequate service is not rendered to this city, but in no event shall this city be beyond the 50 $\mu\text{v}/\text{m}$ contour.

3.206 Main Studio: The term "main studio" means the studio from which the majority of local programs originate and/or from which a majority of station announcements are made of programs originating at remote points.

The following changes are proposed for the Standards of Good Engineering Practice Concerning FM Broadcast Stations:

2. Engineering Standards of Allocation: A. Sections 3.202 to 3.206 inclusive of the Rules

⁴In the determination of appropriate coverage, consideration should be given to population distribution, terrain, service from other FM stations, trade area and other economic factors. Among the recognized trade area authorities are the following: J. Walter Thompson (Retail Shopping Areas), Hearst Magazines, Inc. (Consumer Trading Areas), Rand McNally Map Co. (Trading Areas) and Hagstrom Map Co. (Four Color Retail Trading Area Map).

and Regulations describe the basis for allocation of FM Broadcast Stations, including the division of the United States into Areas I and II. Where reference is made in the Rules to antenna heights of Class A stations, Section 2 E (1) of these Standards should be consulted; for Class B stations, Section 2 E (2) should be consulted.

B. In determining the predicted and measured field intensity contours of FM broadcast stations the following shall govern:

(1) Class A stations will normally not be required to determine their contours.

(2) Class B stations shall determine the extent of their 1,000 $\mu\text{v}/\text{m}$ and 50 $\mu\text{v}/\text{m}$ contours.

The above contours shall be determined in accordance with the method prescribed in these Standards.

C. Although some service is provided by tropospheric waves, the service area is considered to be only that served by the ground wave. The extent of the service is determined by the point at which the ground wave is no longer of sufficient intensity to provide satisfactory broadcast service. The field intensity considered necessary for service is as follows:

TABLE I

Area	Median Field Intensity
City, business, or factory areas.....	100 $\mu\text{v}/\text{m}$
Rural areas.....	50 $\mu\text{v}/\text{m}$

A median field intensity of 3,000 to 5,000 $\mu\text{v}/\text{m}$ should be placed over the principal city to be served, and a median field intensity of 1,000 $\mu\text{v}/\text{m}$ should be placed over the business district of cities of 10,000 or greater within the metropolitan district served. The location of the main studio of a Class A station is specified in Section 3.203 of the Rules. A field intensity of 5,000 $\mu\text{v}/\text{m}$ should be provided over the main studio of a Class B station except as otherwise provided in Section 3.204 of the Rules.

These figures are based upon the usual noise levels encountered in the several areas and upon the absence of interference from other FM stations.

D. A basis for allocation of satellite stations has not yet been determined. For the present, applications will be considered on their individual merits.

E. The service area is predicted as follows:

(1) Class A stations: A map, topographic where obtainable, shall be submitted for the area within 15 miles of the proposed antenna site. On this map shall be indicated the antenna location and a circle of 10 miles radius with the antenna location as center. Representative points shall be picked on this circle 15 degrees apart and the elevation of these points determined. The average elevation of these points will be considered the average

elevation of the circle. The difference between the elevation of the center of the radiating system and the average elevation of this circle shall be considered the height of the antenna over the terrain 10 miles from the transmitter. In cases where the applicant believes this method to be grossly in error due to peculiarities of the terrain, this method shall be used for determining the antenna height but a showing may be made, if desired, determining the height by other means and describing the method used. Calculations of the service contours of Class A stations are not required.

(2) Class B Stations.

[No changes in present Section 2 E (2)].

INCREASED SUBSCRIPTION RATE

AN INCREASE in the subscription rate *FM* AND TELEVISION will probably be announced next month.

Although it may not be generally realized, the cost of securing a subscription and handling the details of mailing twelve issues of any general or technical magazine, prior to the end of the war, was about as much as the annual subscription rate. In some cases, these costs ran much higher.

Advertising revenue paid for operating and editorial expense, the cost of engravings, paper, and printing and, presumably, a reasonable profit.

Since the war, however, costs have been enormously increased not only by higher wage rates but by a decrease in hours worked per week at the standard rate.

In the case of *FM* AND TELEVISION, the total cost per page is about three times what it was in 1940, when the present subscription price was established. We have absorbed most of this increase. A part was passed on to advertisers. But now, with still higher wage rates going into effect in July, it is necessary for us to increase the subscription price to an extent that it will pay a part of the publication production costs.

The same condition confronts the big national magazines, as well as technical journals of relatively small circulation, and explains why, for example, the Saturday Evening Post, which used to cost five cents, is now priced at a dime, and will probably go to fifteen cents shortly.

When the new rate on *FM* AND TELEVISION is announced, it will, we expect, be \$5 for one year; \$8 for two years; and \$10 for three years. However, before the new rate goes into effect, our subscribers will have an opportunity to extend their subscriptions up to three years at the old rate.

While some economies could be effected by using a cheaper grade of paper, and lowering the quality of printing and engravings, we believe that the end result would be a disservice to our readers, and an ill-advised action on our part.

SPOT NEWS NOTES

Items and comments, personal and otherwise, about manufacturing, broadcasting, communications, and television activities

New Orleans: First FM station to go on the air in New Orleans is WRCM, an independent operated by Supreme Broadcasting System, Inc., with headquarters at the Jung Hotel. A temporary 250-watt transmitter is now operating on 95.3 mc. from 3:00 p.m. to 9:00 p.m. daily. Permanent installation of a 5-kw. REL transmitter is expected in June, operating with a 300 ft., 3-bay REL antenna. An active promotion campaign is already under way, and 37 public demonstrations have been scheduled for various civic clubs and similar organizations. WRCM is adding to the 47 high-band sets in New Orleans by converting low-band models.

Backfire: Republican National Committee is making capital of FCC's campaign to censor radio programs. Maybe it makes sense. Can you imagine what would happen to a political party if it attempted to tamper with such newspaper equivalents of soap-box operas as Orphan Annie, Dick Tracy, or the Gumps?

NAB Convention: Will be held at Chicago on October 21st to 24th, at Hotel Stevens.

21st Birthday: Milton J. Karp celebrated the 21st birthday of Karp Metal Products Company by presenting watches to three employees who have been with him since the company started out with five men on the payroll. Number has now risen to 350.

WENA, Detroit: FM transmitter operated by *Detroit News* is installing Finch facsimile transmission equipment, and will soon have recorders operating at various strategic points in the Detroit area. AM affiliate WWJ had started tests on facsimile just before Pearl Harbor.

Editorial Policy: Believing that an inflated ego, fattened on widespread publicity, accounts in part for the objectionable actions of the president of the American Federation of Musicians, he will not be mentioned by name in *FM AND TELEVISION* until a successor is named to the present incumbent.

Glenn E. Webster: Formerly in charge of speech equipment at Collins Radio, has been appointed chief engineer for The Turner Company, microphone manufacturers, at Cedar Rapids, Ia. After graduation with an E.E. degree at Kansas State College, he became chief engineer of KSAC, and was subsequently associated with stations WOC, WOS, and NBC in Chicago.

Television Course: Will be conducted by RCA Institutes for broadcast station engineers. Five weeks of study will include labora-

tory periods at RCA Princeton laboratories and at the Camden factory.

Television C. P.'s: Have been granted to Worcester Telegram, Worcester, Mass.; Raytheon Manufacturing Company, Waltham, Mass.; Outlet Company, Providence, R. I.; N.B.C., Cleveland, Ohio; KSTP, St. Paul, Minn.; Havens & Martin, Richmond, Va.; Intermountain-Broadcasting Company, Salt Lake City, Utah; Oregonian Publishing Company, Portland, Ore.; A. S. Abell & Company, Baltimore, Md.; Hearst Radio, Baltimore, Md.; Radio-Television of Baltimore, Baltimore, Md.; and Albuquerque Broadcasting Company, Albuquerque, N. M.

Crossroads Assignment: Western Electric's Will Whitmore has departed on an assign-



WILL WHITMORE OFF TO BIKINI

ment that most radio engineers would give their eye tooth to cover. He will take part in Operations Crossroads, at Bikini Atoll as a member of Captain C. L. Engleman's group, which is responsible for all electronic activities connected with the atom bomb tests.

FM Station Score: FCC breakdown of FM station status up to May 22nd shows 48 stations licensed, 5 stations under construction which were authorized prior to war restrictions, 54 new construction permits granted, 441 conditional grants issued, 126 applications in hearing, and more than 260 applications pending on which action has not been initiated. Thus the total is about equal to the

number of AM stations on the air. Recent upward revision of power for community stations will accelerate filing of FM applications now in preparation.

J. J. Nance: Former vice president of Zenith Radio Corporation has joined General Electric as a member of the president's staff.

Metropolitan Antennas: Problem of FM and television towers in city areas will probably be resolved favorably, since CAA has advised the House of Representatives District Committee that it favors erection of high towers in cities rather than in open country.

IRE Winter Meeting: Scheduled for March 4th to 7th in New York City. Because of crowded conditions at Hotel Astor last January, exhibits and technical sessions will be at the Armory, 34th Street and Park Avenue. However, the banquet, social events, and some sessions will be held at Hotel Commodore, on 42nd Street. Plans are being made to accommodate an even greater number than the record-breaking attendance at the last Winter Meeting.

Television Withdrawals: Up to the middle of May, 37 television applications filed with the FCC had been withdrawn. This is more than one-third of the original number.

Col. John A. Proctor: President and director of Oxford Radio, Chicago, has been elected vice president and director of Mycalex Corporation of America.

Highway FM Service: FCC has authorized Southwestern Bell Telephone to operate 2-way mobile service in St. Louis. First subscribers will be parcel delivery and express companies, newspaper publishers, power companies, contractors, bus, truck, and moving van operators, and concerns handling service work on such equipment as oil burners, refrigerators, and elevators. Three classes of service will be offered: 1) general 2-way phone service between mobile units and with other telephone subscribers, 2) 2-way service between an operator's office and his own mobile units only, and 3) 1-way service to mobile units. Local 3-minute calls will cost 30 to 40 cents, or 15 cents for one minute. Radio equipment on cars can be provided by the customer or the Telephone Company. In the latter case, the installation charge will be \$25, and \$15 per month service charge.

WGNC: FM affiliate of WGN, Chicago, received the first G.E. FM transmitter to

(CONTINUED ON PAGE 56)

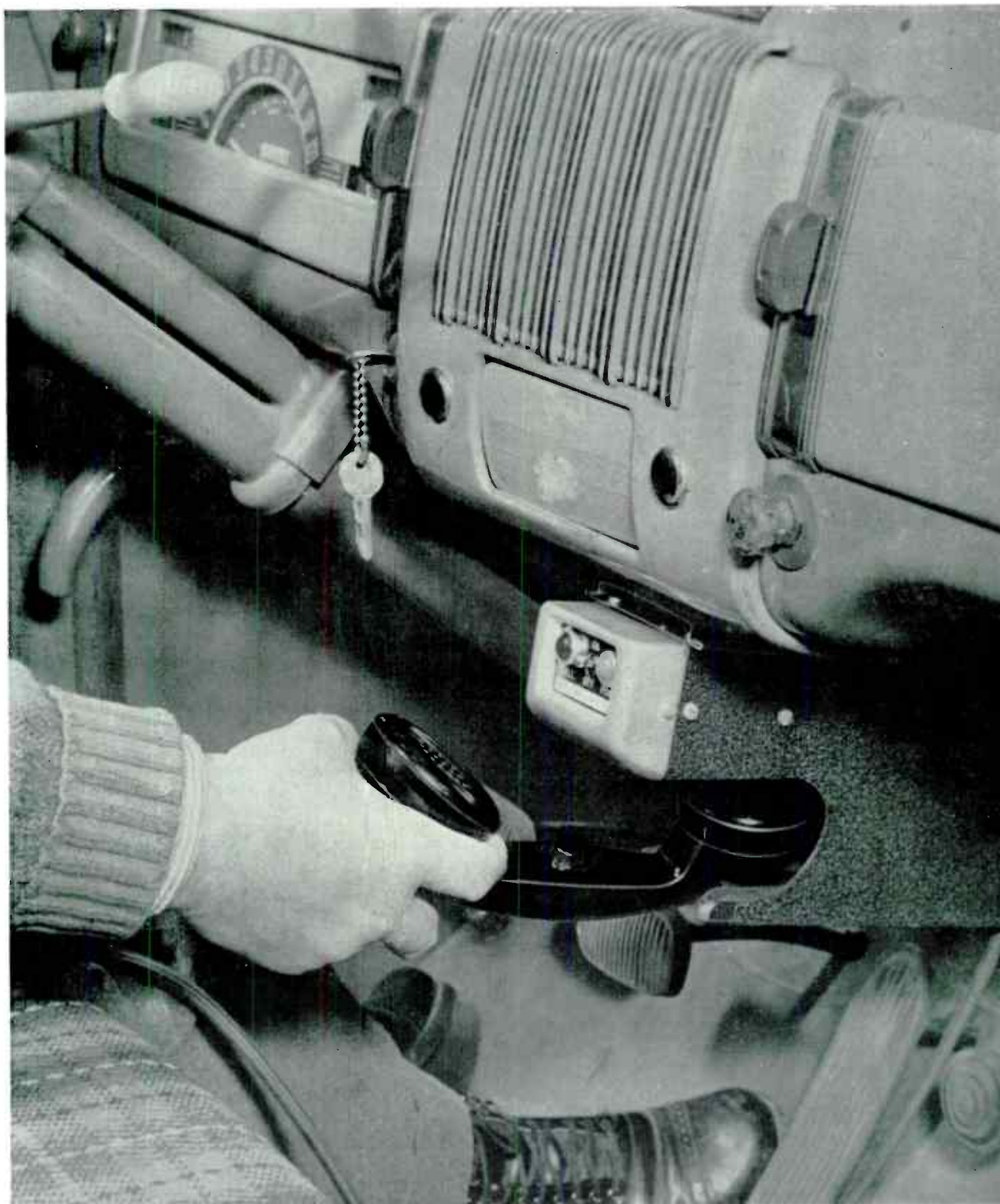

NEWS PICTURE

NO, it isn't just another picture taken in a police car. But it is related to the \$100,000,000 that will be spent in 1946 on radio equipment for mobile services.

This photograph shows one of the radio

units which will be used to connect all kinds of vehicles to the Bell Telephone system. This service, now starting up in Kansas City, will be extended to all metropolitan areas, and to main highways, for use by both commercial and private trucks and automobiles.

Mobile equipment for this purpose will be rented by the Telephone Company, or subscribers can purchase their own units

from independent manufacturers. It has been demonstrated that time saved by trucks, buses, and taxicabs, as a result of speeding their operation with radio telephone instructions, will make the radio equipment a highly profitable investment. Already, over 6,000 applications for such installations have been filed with the FCC, and this is just an inkling of the demand to come.

TRANSMISSION LINES FOR FM STATIONS

Data on the Characteristics of Coaxial Lines, and Methods of Installation—Part 1

BY C. RUSSELL COX*



FIG. 1. INTERNAL CONSTRUCTION OF COAXIAL LINES

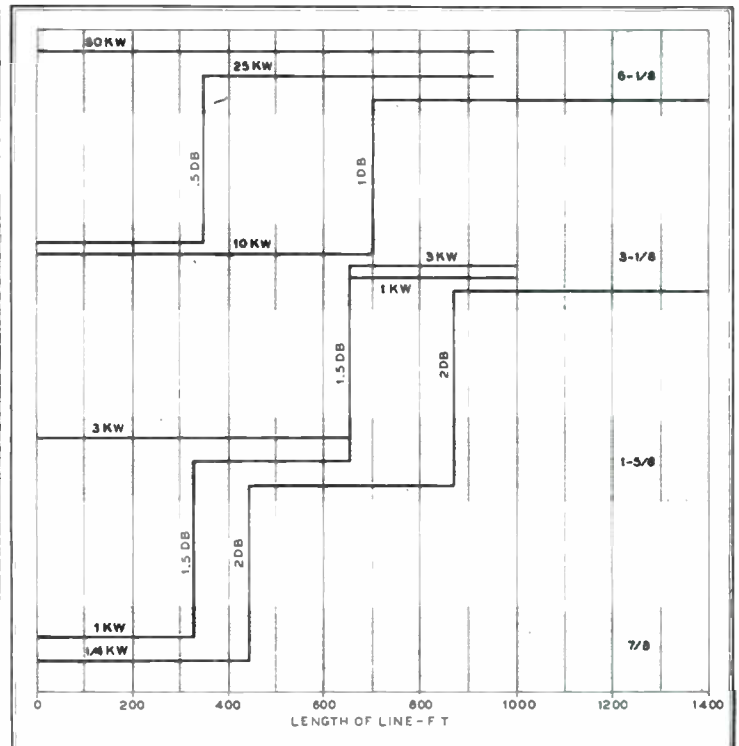

FIG. 2. DIAMETERS OF LINES FOR VARIOUS POWERS & LENGTHS

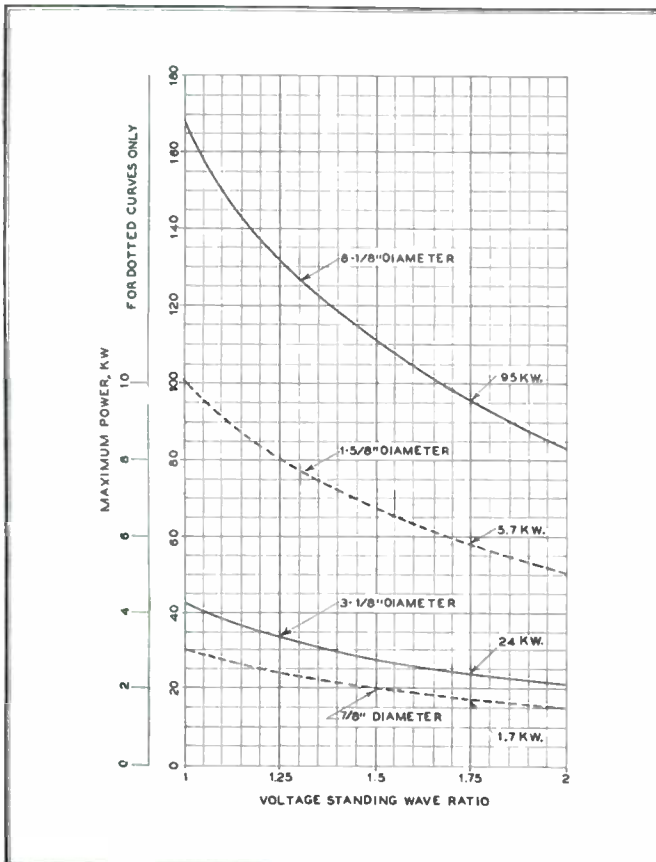

FIG. 3. MAXIMUM POWER RATINGS BASED ON SAFE TEMPERATURE RISE

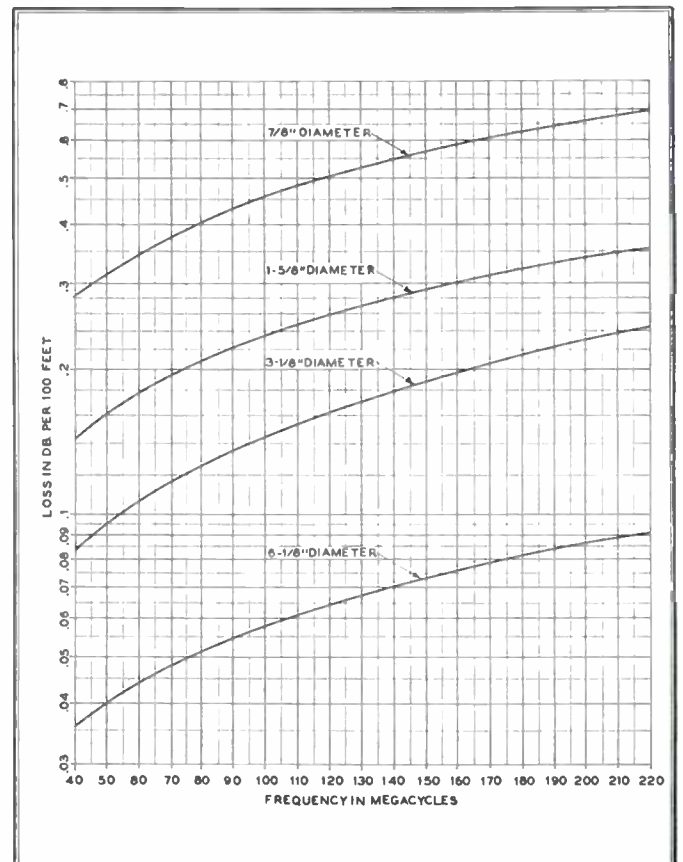

FIG. 4. ATTENUATION PER 100 FT. AT 40 TO 220 MC.

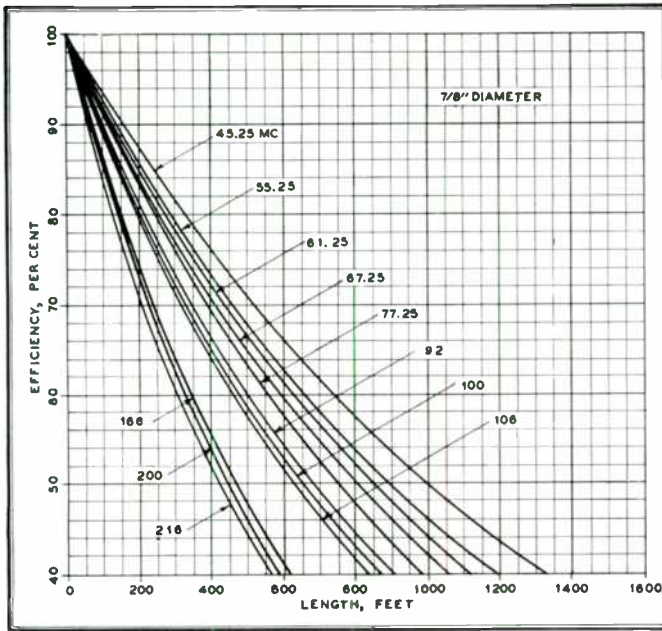

FIG. 5. EFFICIENCY OF 7/8-IN. LINE FOR LENGTHS TO 1600 FT.

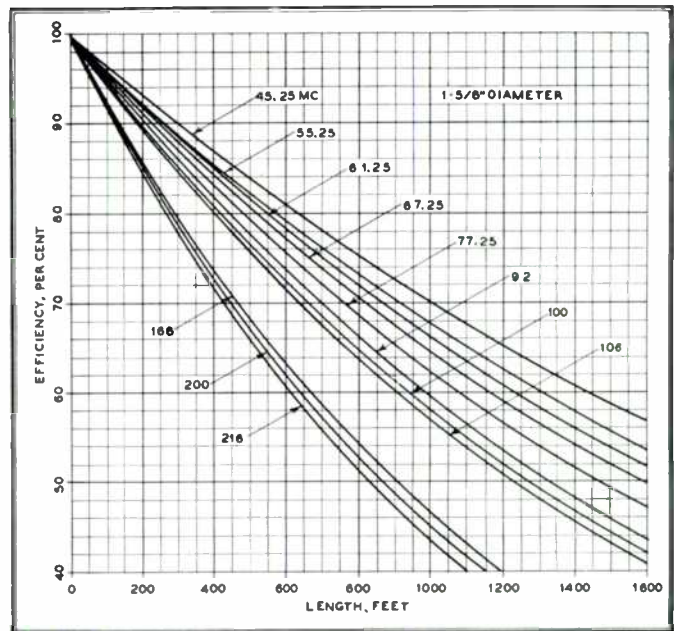

FIG. 6. EFFICIENCY OF 1-5/8-IN. LINE FOR LENGTHS UP TO 1600 FT.

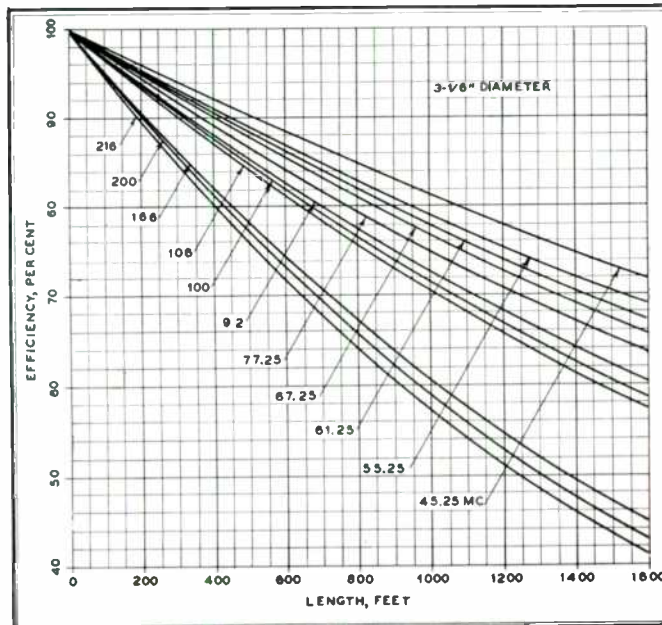

FIG. 7. EFFICIENCY OF 3-1/8-IN. LINE FOR LENGTHS TO 1600 FT.

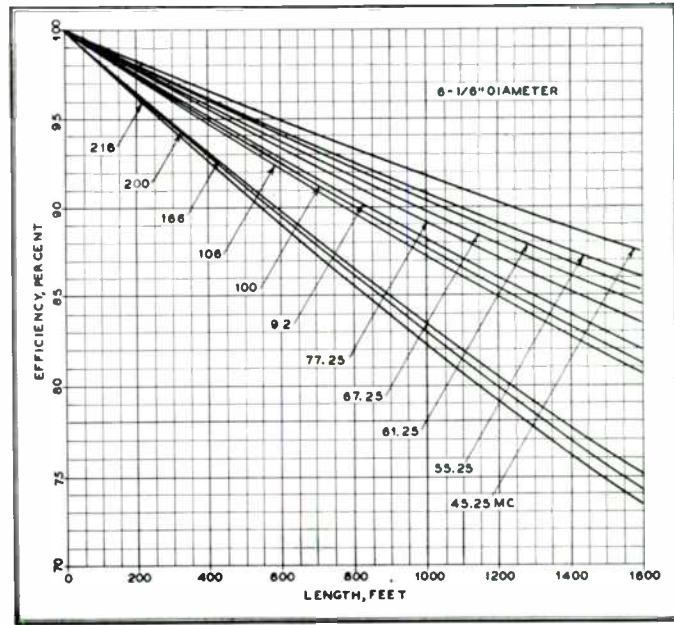

FIG. 8. EFFICIENCY OF 6-1/8-IN. LINE FOR LENGTHS UP TO 1600 FT.

EVERY FM or television broadcast transmitter, whether its power is 250 watts or 50,000 watts, must deliver energy to an antenna through some form of coaxial transmission line. Such coaxial lines must be installed with considerable care, because the mechanical problems of mounting large, heavy cables on towers or tall buildings are severe. No less important is the need for careful attention to electrical details, because freedom from reflections and from excessive attenuation is not easily achieved at 100 mc. Practices common in AM broadcasting would produce reflections and standing waves at 100 mc. far in excess of system tolerances.

Transmission lines which exhibit the required electrical properties at FM and

* Chief Engineer, Andrew Co. 363 East 75th St., Chicago 19, Illinois. NOTE: The text and illustrations of this article are copyright, and must not be reproduced in whole or in part without the permission of the author.

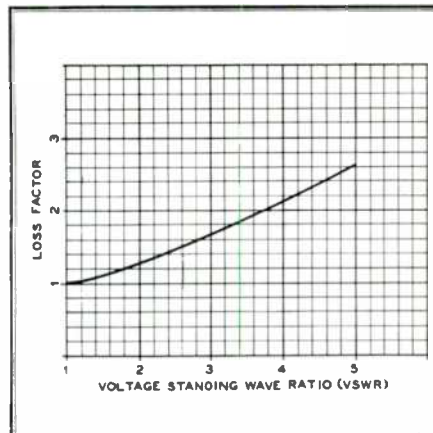

FIG. 9. LOSSES DUE TO STANDING WAVES television frequencies up to 216 mc. have been designed and are available. It is the purpose of this article to explain their use, and to describe the results obtained.

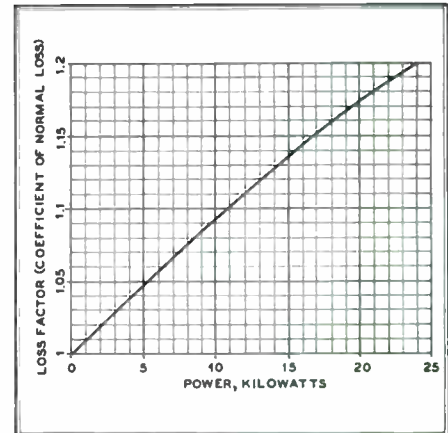

FIG. 10. RESISTANCE & INSULATION LOSS Characteristic Impedance * For various reasons, a characteristic impedance of 51.5 ohms has become generally accepted as a standard transmission line impedance for



FIG. 11. CONSTRUCTION OF JOINTS FOR INNER AND OUTER CONDUCTORS, AND GAS SEAL BETWEEN 20-FT. LENGTHS

FM and television. Most of the major manufacturers of transmitters and transmitting antennas are designing equipment around this value of impedance, and it is expected that the Radio Manufacturers Association will eventually lend its weight toward establishing an impedance of 51.5 ohms as standard. The 70-ohm transmission lines used for many years in AM broadcasting will continue to be available, but are not recommended for FM. Although entirely satisfactory at standard AM broadcast frequencies, such lines do not offer the required degree of electrical performance at 100 mc.

Diameter ★ Transmission line sizes have been chosen so that the diameter of each line is approximately twice that of the next smaller size. Four standard diameters are offered, as follows: $\frac{7}{8}$, $1\frac{5}{8}$, $3\frac{1}{8}$, and $6\frac{1}{8}$ ". RMA standardization is also expected on these values of transmission line diameter; in fact, transmission line standards of very broad scope are being formulated and will help enormously in providing uniformity of electrical ratings

and interchangeability of all components. Unless the line is extremely short, the choice of a suitable diameter depends upon maximum permissible attenuation, or minimum permissible efficiency. The

very short lines, the procedure described above may lead to the selection of a diameter too small to carry the required amount of power, so the maximum power rating should be checked against Fig. 3.

FIG. 13. SOLDERLESS FLANGED COUPLING USED WHEN A 20-FT. SECTION MUST BE CUT OFF IN THE FIELD

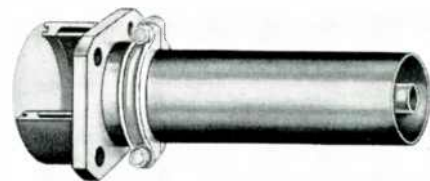

latter factor may be determined by dividing the power required at the input terminals of the antenna by the maximum power output of the transmitter. The proper diameter for any specified length may then be determined by selecting from Figs. 5, 6, 7, or 8 a diameter which produces an efficiency equal to or greater than the quotient of these two powers. For

Fig. 2 shows recommended transmission line diameters for various transmitter output powers and line lengths, based on arbitrarily assigned maximum attenuation values (2 db for 250 watts, 1.5 db for 1 and 3 kw, 1 db for 10 kw, and 0.5 db for 25 and 50 kw). The curves provide a graphical illustration of the importance of short transmission lines, because diameter



© ANDREW CO



FIG. 12. 90° AND 45° ELBOWS, USING FLANGED CONNECTIONS, FOR CONSTRUCTION REQUIRING BENDS

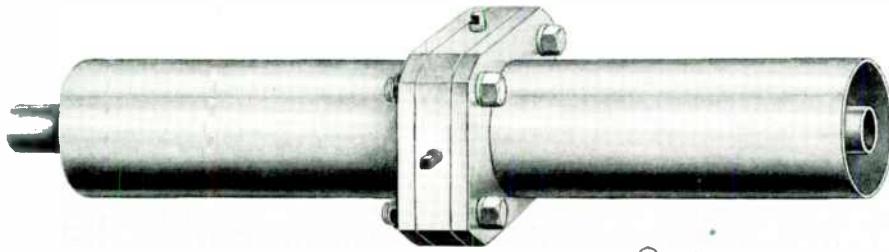

© ANDREW CO

FIG. 14. A GAS INLET FITTING SET BETWEEN FLANGES ON THE ENDS OF 20-FT. SECTIONS OF COAXIAL LINE

and cost increase rapidly with the length. The maximum power ratings shown in Fig. 3 for the four standard diameters are based on safe temperature rise, and should not be exceeded. The standing wave ratio depends on impedance mis-match at the antenna, but since this factor should never exceed 1.75, the corresponding power

the factors contributing to transmission loss. The result is that the attenuation and efficiency values presented in Figs. 4 through 8 appear more pessimistic than previously published data which fail to make full allowance for insulator and conductor losses. Actually, transmission loss in the new 51.5-ohm coaxial cables is less

tion both increase with temperature. Fig. 10 indicates the order of magnitude of this increase due to operation at high power levels.

Mechanical Details ★ Since FM antennas are usually mounted on towers or tall buildings where torch soldering is difficult, it

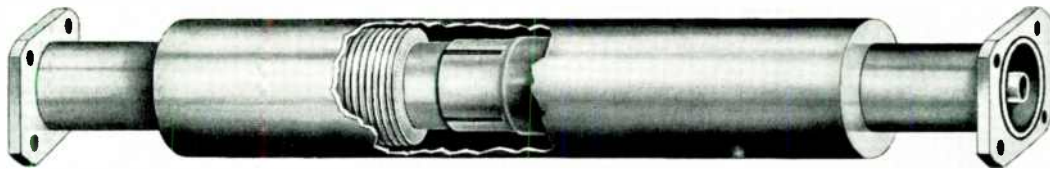

FIG. 15. THIS EXPANSION FITTING IS DESIGNED TO INTRODUCE ONLY NEGLIGIBLE REFLECTIONS IN THE LINE

ratings are suggested as maximum. At FM and television frequencies, only very short transmission lines are operated near the maximum power rating because, for even moderately long lines, the limitation of minimum permissible efficiency demands the choice of a larger diameter.

Efficiency ★ In calculating attenuation in the new FM and television lines, every effort has been made to determine precisely all

than that in any of the previously available commercial types. In making comparisons, it should be verified that both sets of loss curves are calculated on the same basis.

Attenuation increases when standing waves are present, as shown in Fig. 9. Also, operation at maximum power rating or at excessive temperature rise causes an increase in attenuation, because resistivity of copper and loss factor of insula-

was decided that all connectors and other accessories must be designed to permit a completely solderless installation. The connectors used for this purpose are gasketed brass flanges, silver brazed at the factory to both ends of each 20 ft. transmission line section. As shown in Fig. 11, successive sections are joined together by means of bolts passing through the flanges on adjacent ends. The gas seal is made

(CONCLUDED ON PAGE 59)

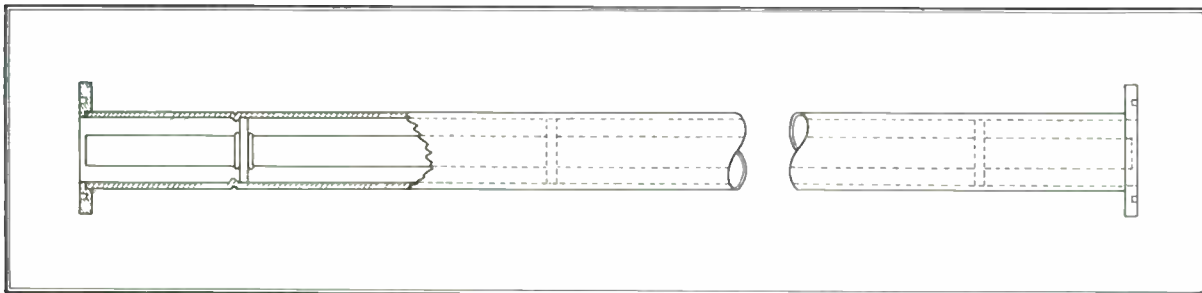

FIG. 16. THE ROLLED-IN GROOVE SUPPORTS THE INNER CONDUCTOR ON VERTICAL RUNS OF LINE

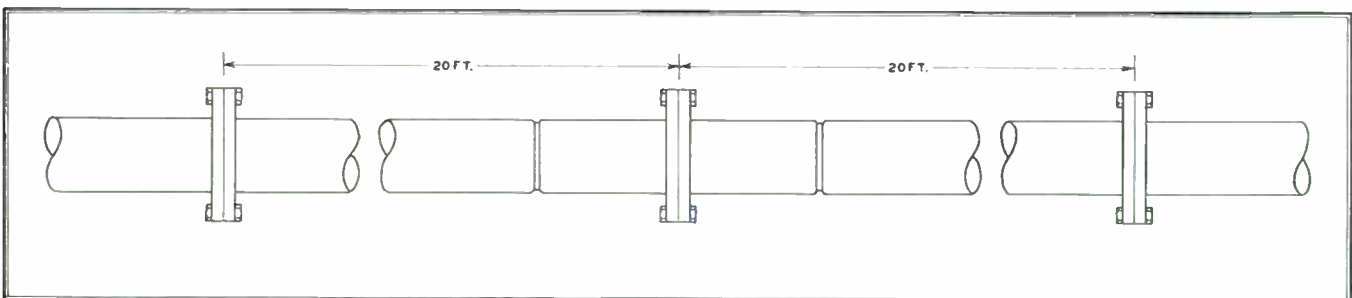

FIG. 17. ON HORIZONTAL RUNS, THE POSITION OF THE GROOVE IS REVERSED IN ALTERNATE 20-FT. LENGTHS OF LINE

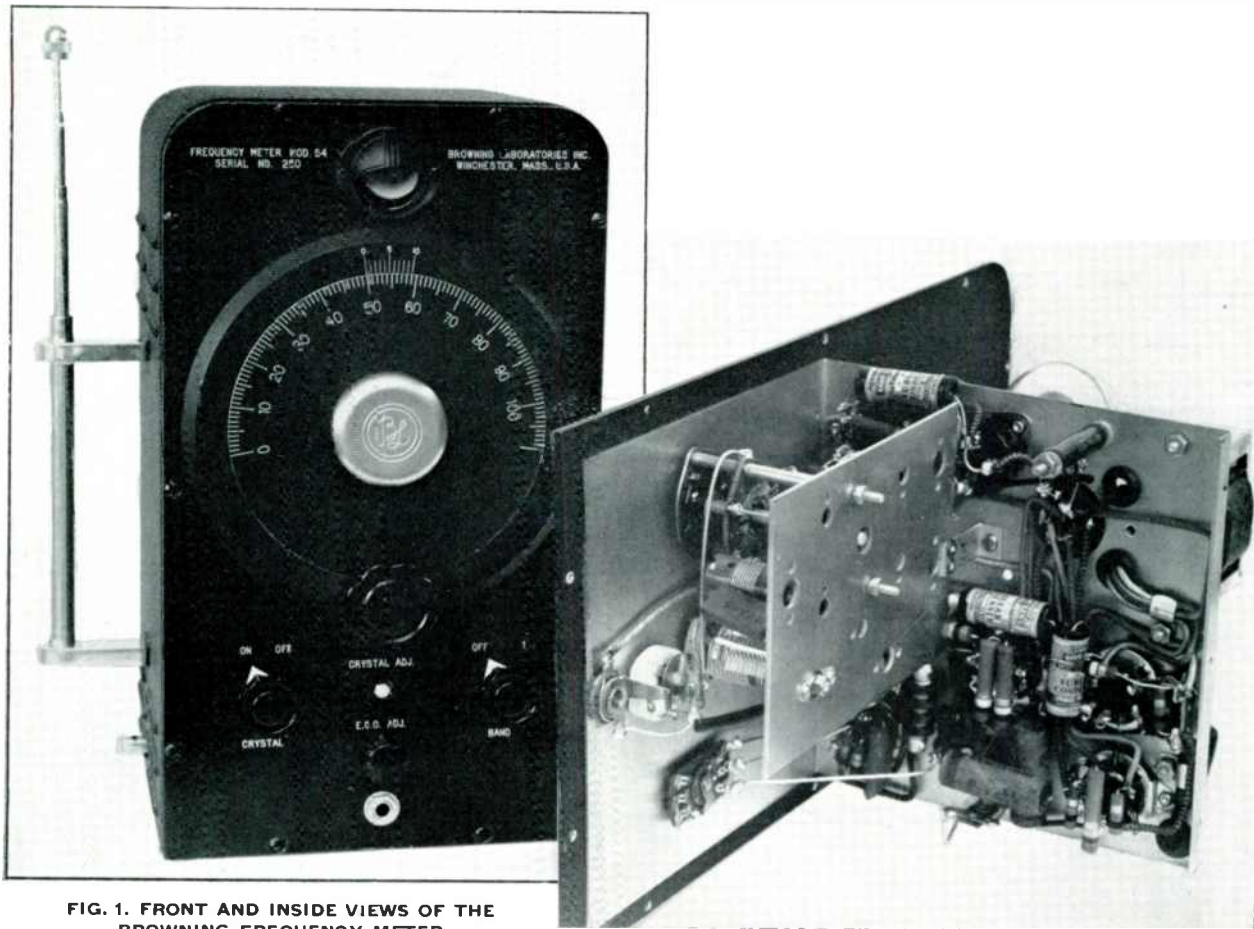

FIG. 1. FRONT AND INSIDE VIEWS OF THE BROWNING FREQUENCY METER

HOW TO CHECK EMERGENCY EQUIPMENT

Information on the Use of the Browning Frequency Meter for Checking Emergency Transmitters

BY A. J. ZINK, JR.*

THE increasing demand for frequency assignments in communications channels requires an increasingly closer adherence to assigned frequency by each licensee. Accurate frequency measurements are essential, therefore, to the most effective use of the all-too-limited spectrum, for if one transmitter is off frequency, its range is reduced greatly, and oftentimes serious interference is set up with adjacent-channel transmitters.

When radio supervisors fail to maintain their transmitters on the assigned frequencies, it is most often due to the fact that they are not familiar with the technique of frequency measurements. As a result, they are reluctant to make frequency checks, even though they have the instruments necessary.

With this situation in mind, the following information has been prepared for the benefit of those to whom the frequency meter and its use are still enshrouded in

mystery and doubt. While the data presented concerns the Browning type S4 meter specifically, a study of this article will shed much light on the use of frequency meters of any make intended for the emergency services.

Electrical Circuits ★ FCC rules for the emergency services require that each transmitter be given a periodic frequency check. For use by police and other emergency stations, it is advisable to use a meter accurate to plus-or-minus .0025%. Then there will be no question about meeting FCC requirements. The Browning meter illustrated in Fig. 1, is calibrated with the required precision at one to five different frequencies within the band from 1.5 to 100 mc.

As shown in the block diagram, Fig. 2, the instrument contains two oscillators. One of these, indicated as TUNABLE OSC. in the block diagram, is adjusted by the tuning knob, and is used for making frequency measurements. Any oscillator cir-

cuit which depends on the mechanical dimensions of the components for frequency is subject to drift. Therefore, a crystal-controlled reference oscillator, indicated as REF OSC., is provided. When a measurement is to be made, the tunable oscillator is checked at two points on the dial against the crystal-controlled reference oscillator, as will be explained later. Any drift in the former can be corrected by an adjustment of the knob marked E.C.O. ADJ.

Headphone connections are provided for a rough check of the beat frequency set up between these two oscillators or between the tunable oscillator and the transmitter that is being checked. For exact adjustment, an electron eye tube is used, the beat frequency being indicated by the deflection of the eye.

A mixer tube and associated AF amplifier are used with the eye tube. The mixer circuit is of conventional design, in which the grid of a 6SA7 oscillator section remains connected to the tunable oscillator,

* Engineering Department, Browning Laboratories, Inc., Winchester, Mass.

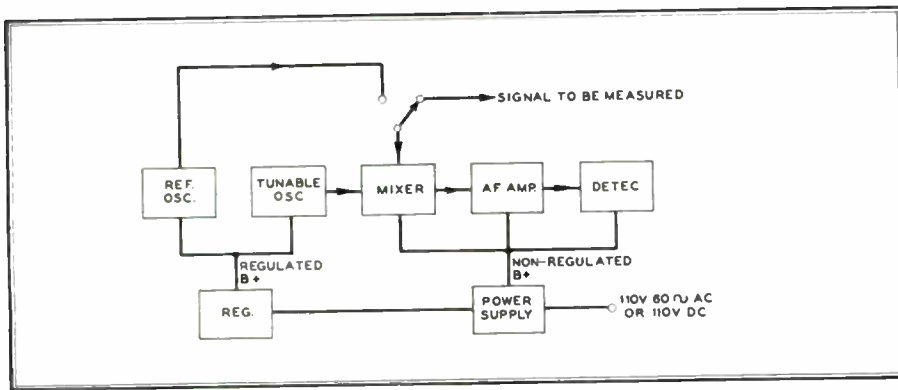

FIG. 2. CIRCUIT ELEMENTS OF THE CRYSTAL-CONTROLLED METER

and the grid of the pentode section is switched to the reference oscillator or to the unknown signal. A single-ended triode audio amplifier stage is coupled to the mixer output for zero-beat amplification. Good low-frequency response is provided in order to drive the triode section of the 6L5 eye tube at beat frequencies below 25 cycles. At exact zero-beat condition, the amplification is sufficient to give a 90° deflection of the eye.

Compact overall design and lightweight are achieved through the use of a transformerless power supply and half-wave rectifier. Heat dissipation within the cabinet is kept at minimum by using a live-cord resistor in series with 6-volt heater-type tubes. Approximately 150 volts are delivered to the mixer and detector stages, and regulated 60 volts to each of the two oscillators.

A telescoping antenna, so mounted that it can be used as a carrying handle, provides a flexible method of coupling to the transmitter under test. A 50-watt fixed transmitter, feeding a coaxial line and located within 20 ft. of the meter, will usually give sufficient coupling through leakage if the antenna on the meter is fully extended. It will give sufficient pickup to measure the frequency of a 25-watt mobile transmitter at a distance of about 50 ft. when the antenna is pulled all the way out, although this may vary considerably under special conditions.

How to Read the Vernier ★ The first requirement for using the frequency meter is an understanding of the vernier scale. The vernier, Fig. 3, simply shows the exact number of tenths of a main-scale division to be added in the complete reading. For example, the reading of the scale in Fig. 3 is 31 divisions plus a fraction to be expressed in tenths.

To determine this fraction, note which line on the vernier is exactly opposite a line on the main scale. In this case, line 3 is opposite a main scale line. Therefore, the fraction three-tenths should be added to the reading 31. Thus, the full reading of the main scale is 31.3. If line 7 on the vernier had been opposite a line on the main scale, the reading would have been 31.7.

If it is desired to set the dial at a speci-

fied value, such as 47.6, the main scale should be set so that 47 is opposite 0 on the vernier. Then it should be turned just a little farther in the direction of 48, until line 6 on the vernier is opposite a line on the main scale. This gives a setting of 47.6.

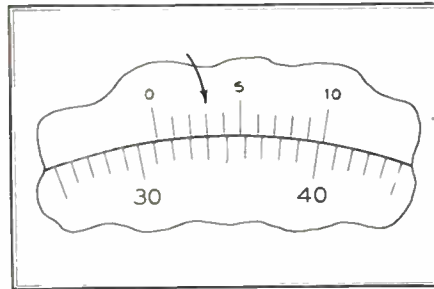

FIG. 3. THE VERNIER TUNING DIAL

Checking the Calibration ★ Always before making a measurement, the tunable oscillator must be checked against the built-in

crystal-controlled reference oscillator. At first thought, the method for checking an oscillator for exact setting at, for example, 39.66 mc. from a 100-ke. crystal may not be clear. Actually, it is very simple, as will be explained:

The oscillations generated by a crystal contain a great number of harmonics which set up beat notes of various frequencies when a separate, coupled oscillator is tuned over a wide frequency band. It is possible, for example, to obtain a response from a 100-ke. crystal at 39.5 mc. and at 39.75 mc. These are not, of course, harmonics of the crystal frequency, but are responses produced by harmonics of the crystal in combination with harmonics of the tunable oscillator. Thus the tunable oscillator in the frequency meter could be checked for calibration at those two points. If it is correct at those check points, it follows that the calibration will be accurate at any intermediate point, such as 39.66 mc.

Of course, if the tuning range of the E.C.O. ADJ. condenser were wide enough, other crystal response frequencies would be reached. Since that would be confusing, the inductance used with the condenser is adjusted, during the original factory calibration, so that only two check points, on each side of the specified frequency, can be covered by the adjustment of the E.C.O. ADJ. condenser.

This can be seen in Figs. 4 and 5. Fig. 4 is an actual calibration chart for a meter designed for the specified frequency of 39.66 mc. Above the calibration line, the percentage of deviation is marked to cor-

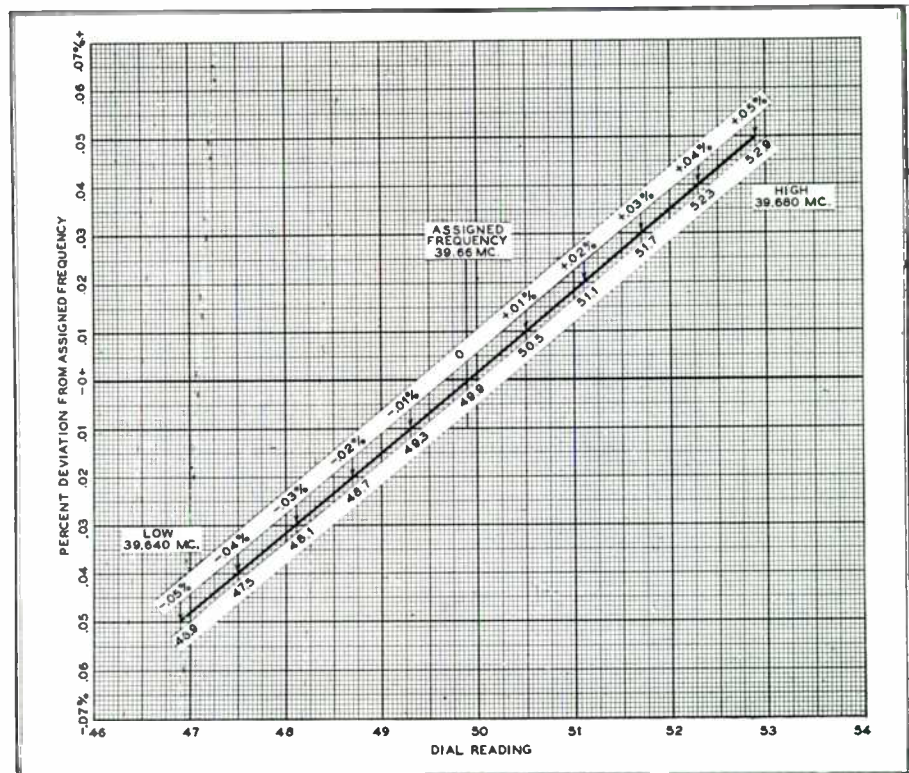

FIG. 4. THIS CALIBRATION CURVE SHOWS THE PERCENTAGE OF ERROR FROM THE SPECIFIED FREQUENCY AT VARIOUS SETTINGS OF THE TUNING DIAL

respond to dial settings which appear below the line. As the chart shows, a deviation of minus .05% is 39.64 mc., while plus .05% is 39.68 mc.

The complete calibration for the dial is given in Fig. 5, where the check points, indicated as C.P., appear at 39.75 and 39.5 me., corresponding to dial settings of 62.9 and 27.4 divisions. Thus, when the E.C.O. ADJ. knob has been set to align the tunable oscillator with the crystal at

Checking a Transmitter ★ An FM or AM transmitter can be checked with this frequency meter in either of two ways: 1) by measuring the frequency at which a transmitter is operating, and reading the percentage deviation from the calibration chart, or 2) by setting the meter at the assigned frequency, and adjusting the transmitter to resonance with the meter. The same procedure is followed in either case. Here are the steps:

ment to warm up for at least 30 minutes.

2. Turn the BAND switch to the proper band for the required frequency.

3. Plug a pair of phones into the jack provided.

4. Referring to the calibration chart for the tuning band to be used, find the dial setting for the check point nearer the assigned frequency of the transmitter, and set the dial to that reading by means of the vernier scale.

5. Adjust the E.C.O. ADJ. knob for zero beat in the phones. At this point, the eye will flutter. A further, exact adjustment will hold the eye open. This means that the tunable oscillator is exactly in resonance with a harmonic of the crystal. (Note: if the setting is in the range from 30 to 40 mc., the two oscillators will agree to an accuracy of at least 1 part in 5,000,000.)

6. Turn the CRYSTAL switch to the OFF position.

7. Extend the telescoping antenna. The meter should be within 50 ft. of the transmitter. Turn the transmitter on by pressing the push-to-talk switch on the microphone, but do not modulate the transmitter.

8. Adjust the transmitter frequency until a zero beat is obtained with the meter, using the phones and the tuning eye.

9. To determine the percentage of error in the transmitter, adjust the meter until zero beat is obtained with the transmitter. Then check the dial setting against the calibration curve. This will show the percentage of error.

Checking the Crystal ★ Any portable meter of whatever make should be checked periodically against the standard frequency signals transmitted by the Bureau of Standards from station WWV in Washington. This is necessary because, unless a crystal is protected by a constant temperature enclosure, it is subject to drift.

For that reason, a slot adjustment below the dial knob, marked CRYSTAL ADJ., is provided. The tuning range of this trimmer is so limited that it cannot be set to zero beat at other than 100 kc., the correct crystal frequency, when compared with WWV signals. The Browning model RH-10 calibrator is specifically designed for checking any frequency meter against the standard frequency signals from WWV.

Illustrations, schematics and parts lists are given for typical equipments used in the various services. Commander Freedman also devotes a chapter to induction radio and guided carrier systems as applied to railroad communications. Design and installation problems relating to antennas and power supplies of both fixed and mobile installations are discussed in detail.

This book is recommended to those who are interested in a general review of the theory and application of 2-way radio.

BROWNING LABORATORIES, Inc.					
BAND NO. 1		Type C-4	Serial No. 99		
Frequency (Megacycles)	Dial Reading	Frequency (Megacycles)	Dial Reading	Frequency (Megacycles)	Dial Reading
39.910	85.3	39.725	59.5	39.540	32.5
39.905	84.5	39.720	59.8	39.535	31.9
39.900	83.6	39.715	59.1	39.530	31.2
39.895	82.9	39.710	57.4	39.525	30.6
39.890	82.1	39.705	56.7	39.520	29.9
39.885	81.4	39.700	55.9	39.515	29.2
39.880	80.6	39.695	55.2	39.510	28.6
39.875	79.9	39.690	54.5	39.505	28.0
39.870	79.2	39.685	53.7	39.500	27.4 C.P.
39.865	78.4	39.680	52.9	39.495	26.7
39.860	77.7	39.675	52.2	39.490	26.1
39.855	77.0	39.670	51.5	39.485	25.4
39.850	76.3	39.665	50.7	39.480	24.7
39.845	75.6	39.660 S.F.	49.9	39.475	24.1
39.840	74.9	39.655	49.2	39.470	23.4
39.835	74.2	39.650	48.4	39.465	22.8
39.830	73.6	39.645	47.7	39.460	22.2
39.825	72.9	39.640	46.9	39.455	21.6
39.820	72.2	39.635	46.2	39.450	20.9
39.815	71.6	39.630	45.4	39.445	20.3
39.810	70.9	39.625	44.6	39.440	19.6
39.805	70.2	39.620	43.9	39.435	19.0
39.800	69.6	39.615	43.1	39.430	18.4
39.795	68.9	39.610	42.4	39.425	17.7
39.790	68.3	39.605	41.7	39.420	17.1
39.785	67.5	39.600	41.0	39.415	16.4
39.780	66.9	39.595	40.2	39.410	15.7
39.775	66.3	39.590	39.5	39.405	15.1
39.770	65.6	39.585	38.8	39.400	14.4
39.765	64.9	39.580	38.1	39.395	13.7
39.760	64.3	39.575	37.4	39.390	13.0
39.755	63.6	39.570	36.6	39.385	12.3
39.750	62.9 C.P.	39.565	35.9	39.380	11.6
39.745	62.3	39.560	35.2	39.375	10.8
39.740	61.6	39.555	34.6	39.370	10.1
39.735	60.9	39.550	33.9	39.365	9.3
39.730	60.2	39.545	33.2	39.360	8.6

C. P. - Crystal check points
S. F. - Specified Frequency

FIG. 5. COMPLETE DIAL CALIBRATION, WITH CHECK POINTS AND THE SPECIFIED FREQUENCY MARKED C.P. AND S.F. RESPECTIVELY

those two dial settings, a frequency of exactly 39.66 mc. will be obtained when the dial is at 49.9 divisions.

BOOK REVIEW

TWO-WAY RADIO, by Samuel Freedman, Commander S (E) T, USNR. 257 pages, well illustrated, cloth binding, 6 by 9 1/4 ins. Published by Ziff-Davis Publishing Company, 350 Fifth Avenue, New York, N. Y., Price \$5.00.

Commander Freedman is well qualified to discuss the subject of two-way radio communications. During the past 26 years he has been a radio operator, engineer, inventor, author, teacher, and consultant

1. Plug the meter power cord into 115 volts, AC or DC. Turn the CRYSTAL switch to the ON position, and allow the instru-

and in the last 12 years has specialized in communications while serving in the United States Naval Reserve. Two-Way Radio covers the planning, installation and maintenance of communications systems for railroads, police, fire, forestry, highway, public utilities, marine and aeronautical applications. The basic differences between AM and FM equipments are discussed and illustrated along with elementary theory. Theory is presented in simple and non-mathematical form.

EXAMINING FM TRANSMITTER PERFORMANCE

Use of the Panalyzer for Analyzing the Characteristics of FM Circuits—Part 1

BY J. R. POPKIN-CLURMAN*

THE growth of FM has made it imperative that better ways of checking and measuring the characteristics of FM signals be used in order to obtain the maximum benefits from properly adjusted FM systems.

The Panalyzer, Fig. 1, is one such instrument, for it provides great assistance in determining the performance characteristics of FM transmitters. It is, in effect, a radio frequency spectrum analyzer, capable of showing simultaneously large bands of signals and signal distributions as deflections on the screen of a cathode ray tube. Being of the heterodyne type, it reproduces signals in any portion of the frequency spectrum. Each discrete quantity of radio frequency energy produces a characteristic deflection which indicates the frequency, relative amplitude, stability, and relationship to other frequencies of the spectrum.

Because of its ability to show many signals at once, it is easy for the Panalyzer to show the spectral distributions of FM signals whose carriers, under modulation, break up predictably in accordance with Bessel function distributions. The voltage frequency distribution for an FM wave is given by the following series:

$$E_0 = E_m \left\{ J_0(\beta) \sin(\Omega + 2u)t + J_1(\beta) \left| \sin(\Omega + u)t - \sin(\Omega - u)t \right| \right. \\ \left. + J_2(\beta) \left[\sin(\Omega + 2u)t + \sin(\Omega - 2u)t \right] \right. \\ \left. + J_3(\beta) \left[\sin(\Omega + 3u)t + \sin(\Omega - 3u)t \right] \right. \\ \left. + \dots + J_n(\beta) \left[\sin(\Omega + nu)t + (-1)^n (\sin \Omega - un)t \right] \right\}$$

where E_i is the amplitudes of voltages for an FM signal

E_m = the maximum voltage of the unmodulated FM carrier

β = the deviation ratio of frequency deviation to modulating frequency (f) where $J_0(\beta)$, $J_1(\beta)$ represent the amplitude order of carrier, 1st sideband pair, 2nd sideband pair, etc. Under modulation these sideband pairs extend symmetrically away from the carrier position.

Appearance of FM Signals ★ As long as there is no modulation present, a simple horizontal line broken by an inverted V-like signal (representing the carrier) at the center of the line, appears on the cathode ray tube screen as shown in Fig. 2. This line represents a frequency axis and maintains its calibration unchanged, irrespective of the portion of the radiation spectrum which is being inspected. In the presence of FM modulation, the hori-

zontal line breaks up, providing a series of inverted V's whose amplitude indicates the relative strength of the side frequencies and the carrier. The significance of each deflection is two-dimensional, since the Panalyzer shows frequency along

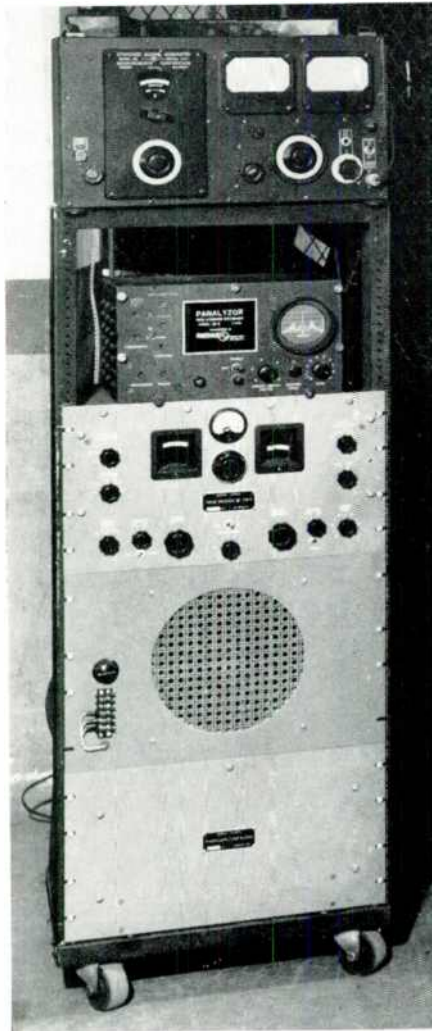

FIG. 1 THE PANALYZOR MOUNTED IN A MOVABLE TESTING ASSEMBLY

the X or horizontal axis and amplitude along the Y or vertical axis.

Resolution ★ By resolution is meant the ability of the Panalyzer to discriminate between signals that are closely adjacent in frequency. In FM, this means between adjacent side frequencies. This factor corresponds to selectivity in receivers. Resolution is a function of a number of factors, among them being the bandwidth analyzed, the rate at which the instrument sweeps through the bandwidth, and the selectivity of the analyzing element. In

observing ± 100 kc. for FM, it becomes necessary to provide for a fairly wide analyzing element: Because of this, modulation frequencies below 5 or 6 kc. tend to mix or beat with each other. This is not detrimental, since the energy distribution envelope of the FM signals, and hence their deviations, can still be observed.

Operation of the Panalyzer ★ The fundamental objective of the Panalyzer is to reproduce on the screen of a cathode ray tube, a series of adjacent signals so that an effective analysis by inspection is possible. Realization of this objective involves the following points:

1. Signals extending over a range of frequencies, determined by the particular type of Panalyzer used, must be reproducible regardless of the mean frequency of the range.

2. Reproduction must be such that the relative amplitudes of the signal deflections are in the same ratio as the original signal strengths.

3. The linear separations of the deflections along the baseline must be proportional to the differences in frequency between the original signals.

4. Any one of the reproduced signals must be capable of isolation and detailed visual analysis.

In order to realize the first objective, the Panalyzer is designed to operate in conjunction with an external signal generator whose output is used to heterodyne the series of test signals. If the frequency of the signal generator is so chosen that the beat frequency between it and the mean frequency of the test range is identical with the input frequency of the Panalyzer being used, then the entire range of signals will become visible. For example: A Panalyzer having a maximum sweep-width (maximum visual band) of 200 kc. is used to reproduce a series of signals from an FM transmitter extending from 100.1 mc. to approximately 100.3 mc., as indicated at Fig. 3, Block A. If the input frequency of the Panalyzer is 500 kc., the frequency of the heterodyne oscillator, Fig. 3, block B should be either 100.7 or 99.7 mc. Both the FM and heterodyne signals are fed to the aperiodic mixer, indicated as 1 in Fig. 3.

Accomplishment of the second point calls for an amplification characteristic that is flat over the maximum visual band of the Panalyzer. In the example given above, the response curve of the input amplifier stages up to the 2nd conversion point must be essentially linear over 200

* Assistant Chief Engineer, Panoramic Radio Corporation, 242 West 55th Street, New York 19, N. Y.

ke.; that is, linear from 400 ke. to 600 ke. The figures given indicate symmetrical linearity over a range of ± 100 ke. from the input frequency. Specially designed bandpass circuits, 2 in Fig. 3, meet this problem without difficulty.

To obtain the results required under the third point, a linear frequency modulation of the Panalyzer's local oscillator is required. This is accomplished by a carefully designed sawtooth oscillator, 7 in Fig. 3, and a reactance modulation circuit, 5 in Fig. 3. More complete details concerning these circuits will be found later in this paper.

With regard to the fourth point, closer inspection of individual signals is made possible by the variable sweep-width feature which is a part of every Panalyzer. The bandwidth examined may be reduced at will, thus enlarging the details of signals.

The Heterodyne Oscillator ★ The useful range of the Panalyzer is determined by the frequency range of the external heterodyne oscillator, Fig. 3B. The frequency of the heterodyne oscillator should preferably be higher in frequency than the test signal by an amount equal to the center input frequency of the Panalyzer as previously explained. This is

$$F_2 = F_1 + F_3$$

where:

F_2 = frequency of the external heterodyne oscillator

deflections when the product of the test signal and the signal produced by the heterodyne oscillator, both measured in microvolts, is 50,000 or more.

Functional Explanation ★ In many respects the Panalyzer resembles a high-efficiency superheterodyne receiver in operation. RF amplification, frequency conversion, IF

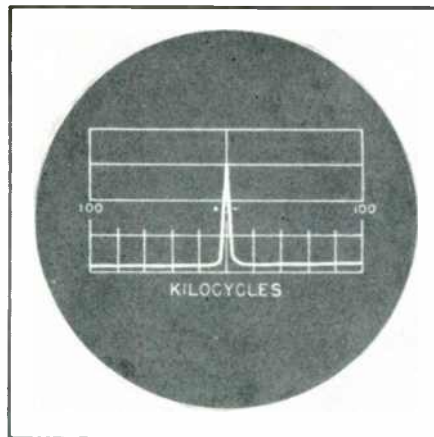

FIG. 2. TRACE ON CATHODE-RAY TUBE WITH NO MODULATION

amplification, detection, and signal amplification, are all present, as shown in the simplified, overall schematic diagram, Fig. 4. The significant points of difference are outlined below:

A. RF BANDPASS ACTION — the radio frequency amplification system aims at flat bandpass action over the range for

varied between limits established by the design of the particular Panalyzer in use. For a Panalyzer whose maximum bandwidth is 200 ke., the oscillator frequency will vary linearly over a range equal to ± 100 ke. around a predetermined mean frequency. In the course of these frequency excursions, the oscillator successively beats with each of the signals present in the converter, producing a series of signals of the proper intermediate frequency to be amplified by the sharply tuned or narrow-band IF amplifier which follows. These successive IF pulses, separated from each other by time, are then fed to a diode detector. They are then fed to the vertical plates of the cathode ray tube through a DC coupled video amplifier.

C. REACTANCE-TUBE CIRCUIT — The frequency modulation of the oscillator is produced by the reactance-tube method. The reactor, acting as an artificial inductance in parallel with the tank inductance of the oscillator, changes the oscillator frequency by an amount which depends upon the potential applied to its grid. The source of voltage for the reactor grid is a sawtooth oscillator of the blocking-tube variety. Thus, as the potential of the reactor grid changes in accordance with the linear variations of the sawtooth output, its effective inductance is altered in the same linear fashion. The result, therefore, is that the frequency of the oscillator is swept linearly and periodically over a continuous portion of the spectrum. One limit of this range is approximately the same as the oscillator would produce if it were acting alone, and the other limit is determined by the amount of shunt inductance that the reactor can supply.

D. THE SAWTOOTH GENERATOR — The sawtooth generator performs two functions simultaneously. First, it varies the voltage applied to the grid of the reactor as explained in section C. Second, through an amplifier it sweeps the electron beam of the CRT horizontally across the face of the tube in coincidence with a horizontal calibrated base-line engraved on the filter over the viewing end of the tube.

The Panalyzer screen is equipped with a filter which enables optimum visual reproduction of the signals on the screen without being greatly affected by ambient light falling on the face of the CRT.

The sawtooth frequency is generally synchronized to one-half the line frequency, i.e., 30 cycles per second. This means that the local oscillator completes 30 excursions during each second and that the beam sweeps horizontally 30 times in each second. The voltage pulses produced by the successively heterodyned signals are detected, amplified, and fed to the vertical CRT deflection plates, producing pips of different amplitudes which are proportional to the corresponding voltages.

As these deflections appear, the horizontal motion of the electron beam causes each one to appear at its own position on

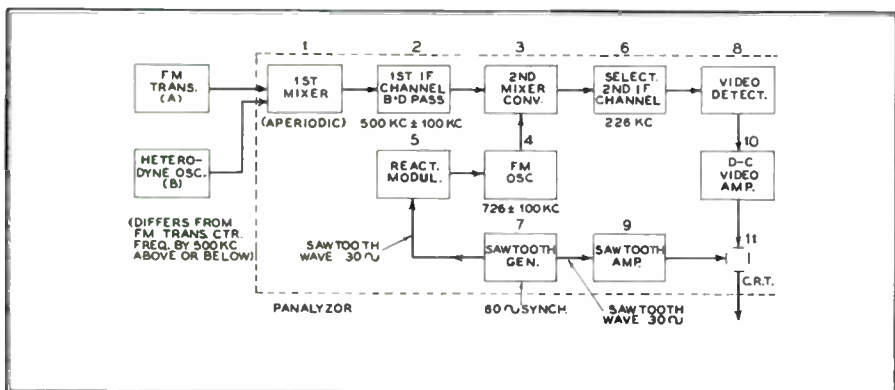

FIG. 3. FM TRANSMITTER, OSCILLATOR, AND PANALYZOR FOR FM TESTS

F_1 = the test signal (FM) at or near the center of the test range

F_3 = input frequency of the Panalyzer

When this relationship is used, the calibration marking of the CRT screen is correct; the higher frequencies appear on the left side of the screen, while the lower frequencies are seen on the right.

A heterodyning signal whose frequency is lower than that of the test signal can be used without difficulty except that in this case the screen scale calibration will be reversed in sign. Then

$$F_2 = F_1 - F_3$$

Sensitivity ★ The sensitivity of the Panalyzer is such as to produce usable de-

which the particular Panalyzer is designed. By means of a properly-loaded coupling transformer between the aperiodic mixer stage and the second converter, an essentially flat response curve is obtained. The test signals are mixed with the heterodyning oscillator signal in the input tube, usually a pentagrid type; the mixed difference frequencies are fed to the converter through the bandpass coupling transformer so that they produce voltages whose amplitudes at the grid of the latter are in the same ratio as the original signal strengths.

B. THE FM OSCILLATOR — A portion of the converter tube functions as the local oscillator whose frequency is periodically

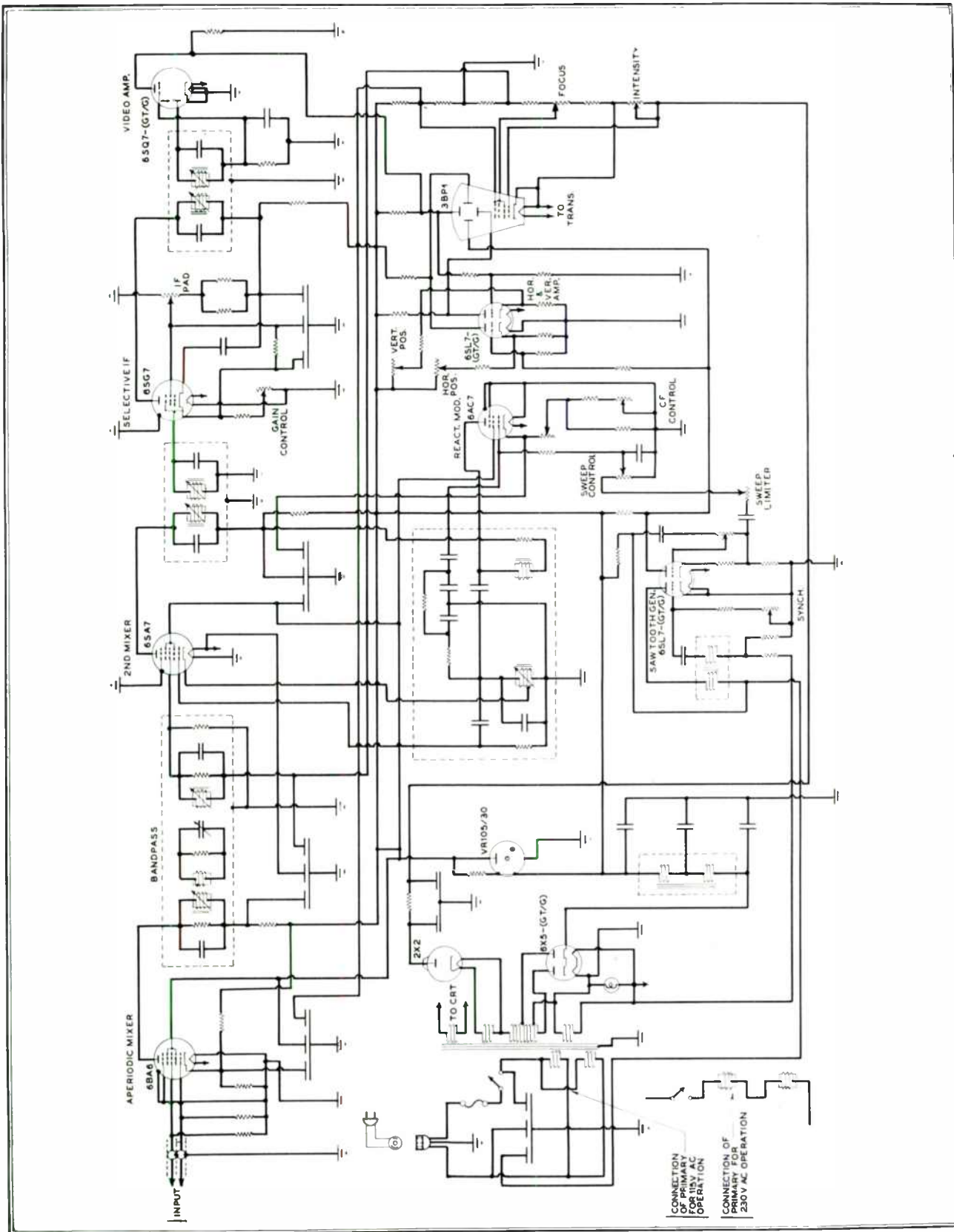

FIG. 4. SCHEMATIC DIAGRAM OF THE COMPLETE PANALYZOR. IT WILL BE SEEN THAT THE CIRCUIT RESEMBLES THAT OF A SUPERHETERODYNE, WITH THE ADDITION OF A CATHODE-RAY TUBE AND ITS ASSOCIATED CONTROLS. RF, IF, AND AF AMPLIFICATION, AN FREQUENCY CONVERSION ARE USED

the screen. The repetitive action of the sawtooth generator, synchronized with the sweeping of the oscillator and the beam of the CRT, permits each deflection to appear in the same place 30 times in each second. Persistence of vision and fluorescence create the illusion of constant, steady indications.

The direct-coupled video amplifier is used in order to examine the carrier for hum, noise, etc. Also it eliminates DC reinsertion problems in reproducing each "pip."

Tests on 250-Watt FM Transmitter ★ To obtain measurements under actual operating con-

ditions, the test setup in Fig. 5 was installed to check a 250-watt transmitter at the Transmitter Equipment Manufacturing Company, New York City. Output was taken from a small, untuned coupling loop near the final tank circuit of the transmitter and fed into one of the Panalyzer inputs. The other input was

fed from a Measurements generator, Model 80, which was set 500 kc. away from the center frequency of the FM transmitter.

The operation of the center frequency stabilizing control was clearly shown by deliberately detuning the direct FM master oscillator of the transmitter. Any overshoot of the control could be immediately seen. Unsymmetrical modulation (obtained by running unbalanced reactance modulators) is also immediately obvious. Under conditions of 120-ke. deviation, it was possible to observe the effects of AM on FM. By shifting the operating point of the modulators away from optimum, it was possible to observe the entire FM spectrum shift from its static center frequency with accompanying distortion.

The 120-cycle hum on the FM carrier was obtained by removing some of the filter from the final amplifier. This hum was observed as amplitude modulation on the carrier.

It is very easy to watch the screen of the Panalyzer and determine program modulation, since the entire FM signal shows at once. If any of the amplifier circuits is not tuned properly, or if there is any distortion, the screen will show this up.

1. Static Characteristics ★ To determine the static characteristics of an FM transmitter, one input of the Panalyzer is connected to the transmitter output in the normal manner, and the heterodyne oscillator is connected to the other input of the Panalyzer. The audio network is disconnected from the FM modulator and DC voltages of known value are fed to the modulator.

The deviation of the carrier can be determined directly by observing the Pan-

alyzer screen. For small carrier deviations it may be desirable to reduce the bandwidth observed by turning down the sweep-width control.

above can be used with sine wave by substituting sine waves for direct current voltages. In this case the Panalyzer will show the limits of the deviation which, for the lower audio frequencies, fall off very

rapidly after reaching the normal deviation. This is illustrated in Fig. 6.

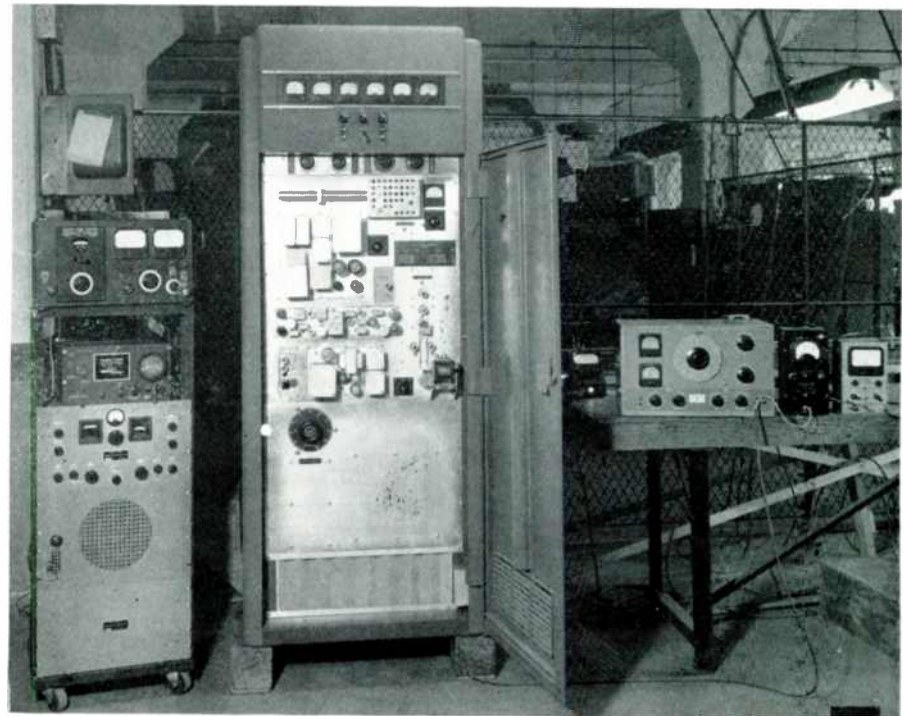

FIG. 5. COMPLETE EQUIPMENT TO ANALYZE FM TRANSMITTER PERFORMANCE

alyzer screen. For small carrier deviations it may be desirable to reduce the bandwidth observed by turning down the sweep-width control.

A. NON-SYMMETRICAL MODULATION — Because of the instantaneous presentation of the FM signal, it is possible to observe, for a sine wave modulation, any shift in frequency of the side current and the car-

rier, such as the condition shown in Fig. 7,

as the modulation index is increased. If balanced modulators or reactance-tube modulators are used, this shift indicates a non-linear or non-symmetrical action of the modulator, and it is possible to correct this non-linearity while watching the Panalyzer. For a pair of series reactors, operating in push-pull, one of the ways to adjust for proper operation would be to

used in the Temco 250-watt transmitter.

Behavior of the carrier frequency can be observed by using a modulation frequency greater than the minimum resolution of the Panalyzer so that the carrier can be observed without interference from the side bands. Usually an audio modulation frequency greater than 6 kc. is desirable.

B. Hum — Hum can be divided into two categories: amplitude-modulated hum and hum appearing on the audio system or at the modulators. To determine which hum is present, the transmitter modulation is reduced to zero and the Panalyzer center-frequency control which changes the Panalyzer frequency is set so that the carrier appears at the center of the screen. The Panalyzer sweep-width is reduced to zero until a straight line appears across the screen if no hum is present. If amplitude-modulated hum of either the 60- or 120-cycle variety is present, as the center-frequency control on the Panalyzer is shifted, the shape of the hum pattern will remain unchanged but merely move up and down on the screen, Fig. 8A. If the sweep frequency is set at 30 cycles, there will be two bumps on the line for 60 cycle hum, and four bumps on the line for 120 cycle hum, Fig. 8B. If frequency-modulated hum from the balanced modulator or reactance tubes is present, or if there is hum pick-up in the audio frequency line, the hum pattern will change phase, as illustrated in Fig. 8C, when the center

(CONTINUED ON PAGE 44)

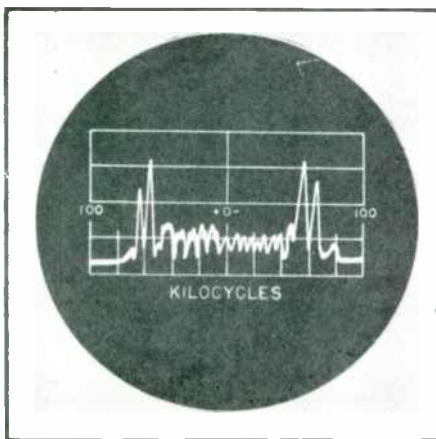

FIG. 6. MODULATION 4 KC., DEVIATION = 60 KC., β IS 15

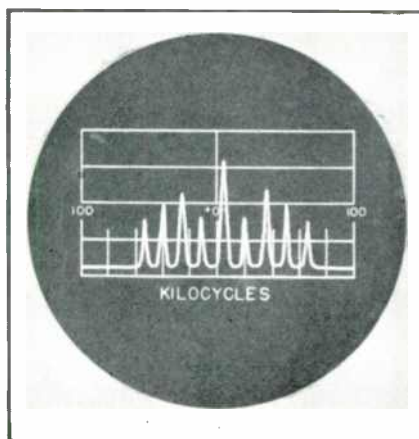

FIG. 7. CARRIER SHIFT 15 KC., DEVIATION = 60 KC., $\beta = 4$

rier, such as the condition shown in Fig. 7, as the modulation index is increased. If balanced modulators or reactance-tube modulators are used, this shift indicates a non-linear or non-symmetrical action of the modulator, and it is possible to correct this non-linearity while watching the Panalyzer. For a pair of series reactors, operating in push-pull, one of the ways to adjust for proper operation would be to

tie the modulator input grids of the reactance tube in parallel and adjust the operating point so that minimum FM is obtained. This was the method used in balancing up the frequency modulators

tie the modulator input grids of the reactance tube in parallel and adjust the operating point so that minimum FM is obtained. This was the method used in balancing up the frequency modulators

RAILROAD RADIO SPECIFICATIONS

Requirements for Radio Telephone Transmitting and Receiving Equipment and Accessories

A — Purpose: The purpose of this specification¹ is to guide the seller-contractor in the manufacture of radio telephone equipment for use on railroad rolling stock and at fixed points.

B — Drawings: None included.

C — Scope: This specification is intended to cover radio transmitting and receiving apparatus, appropriate power supplies, and auxiliary devices associated therewith and generally necessary to provide a complete radio station.

D — General: D1-SERVICE CONDITIONS: Unless otherwise specified, all performance requirements of this specification shall be met for any combination of service conditions specified below:

- Ambient Temperature* — Minus 30° C. to plus 60° C.
- Ambient Humidity* — Zero to 95%
- Duty* — Intermittent
- Power Supply* — Single phase, 60 cycles per second, 105–125 volts r.m.s.
- Power Output* — Any value up to full rated output

D2-NORMAL OPERATING CONDITIONS: Unless otherwise specified, the term *normal operating conditions* as used in this specification shall be understood to have the definition given below:

- Ambient Temperature* — plus 25° C
- Ambient Humidity* — 30%
- Line Voltage* — 117 volts r.m.s., 60 cycles, single phase
- Power Output* — Full rated
- Mode of operation* — Intermittent²

D3-FREQUENCY RANGE: This equipment shall be capable of operation on any specified frequencies between 158 and 162 mc. or between 186 and 216 mc. as ordered, with no adjustments other than changing crystals and retuning.

The tuned circuit constants shall be such that it is impossible to tune any stage to other than the correct harmonic of the preceding stage. The design of tuned circuits and selection of components shall be such that tuning adjustments are not critical.

D4-WEATHERPROOF HOUSING: When so ordered, this equipment shall be furnished with a weatherproof housing suitable for mounting on the exterior of locomotives, water tenders, cabooses or cabin cars.

¹ These specifications are published through the courtesy of the Rock Island Railroad. It is understood that similar specifications will be adopted by the Association of American Railroads.

² Cycle of 5 minutes on and 15 minutes off for a period of 7 hours, and 10 seconds on and 20 seconds off for 1 hour.

D5-MOUNTING: When so ordered, this equipment shall be provided with mountings capable of reducing the effects of vibration and shock encountered on freight train cabooses, sufficient to prevent damage to the equipment.

E — Transmitter Unit: E1-PERFORMANCE REQUIREMENTS OF TRANSMITTER: a. *Audio Gain* — Sufficient audio gain shall be furnished so that when a person is talking into the microphone in a normal tone of voice, an amplitude-modulated transmitter will be modulated 90% or a Frequency-Modulated transmitter deviated ± 13.5 kc.

b. *Audio Response (amplitude-modulated transmitters)* — The audio response shall not vary more than 4 db for any two frequencies between 300 and 3,000 cycles, and shall be a minimum of 6 db below the 1,000-cycle point at 4,000 cycles.

c. *Audio Response (frequency-modulated transmitters)* — The overall transmitter audio response when measured with a demodulating circuit having linear characteristics shall increase 6 db per octave at a rate linear within 4 db from 300 to 3,000 cycles. Response above 3,000 cycles shall be smoothly attenuated with a minimum allowable attenuation at 4,000 cycles of 6 db. This pre-emphasis characteristic is to be applied in such a manner that the frequency range can be expanded if desired.

d. *Modulation* — Either frequency-modulated or amplitude-modulated transmitters shall be capable of 90% modulation at any audio frequency between 300 and 3,000 cycles with harmonic distortion not in excess of 5%. 100% modulation for a frequency-modulated transmitter is defined as ± 15 kilocycles deviation.

Suitable audio limiter circuits shall be provided to prevent modulation in excess of 100%.

e. *Power Output* — The basic transmitter shall be designed to supply full-rated radio frequency output of 10 to 50 watts as ordered into a 52-ohm grounded load.

f. *Amplitude Modulation of FM transmitter* — Amplitude modulation of the transmitter output, at any modulation level from 0 to 100%, shall be less than 2%.

g. *Frequency Stability* — The overall frequency shift of the transmitter shall not exceed plus or minus 0.005%.

h. *Effect of Temperature* — The following requirement shall be met for any ambient temperature in the range of minus 30° to plus 60° Centigrade. AC power line voltage shall be held constant at normal value during tests to demonstrate com-

pliance with these requirements.

1. Power output shall not drop below its full-rated value.

i. *Spurious Radiations* — Spurious radiation shall be at least 75 db below fundamental carrier level at all frequencies.

j. *Instability and Parasitics* — There shall be no parasitics or spurious oscillations in any of the transmitter circuits.

E2-GENERAL REQUIREMENTS FOR TRANSMITTER: a. *Input Impedance* — The transmitter shall have a nominal 200-ohm audio input circuit.

b. *Output Impedance* — The output coupling system shall be suitable for feeding a 52-ohm grounded coaxial line.

c. *Filament Voltages* — When 117 volts are applied to the power terminals, all filaments and heaters shall receive a voltage within 5% of the tube manufacturer's rated value.

d. *Transmitter Crystals* — Transmitter crystals employed in this equipment shall:

1. Not be ground to a fundamental frequency above 7.0 mc.

2. Start readily and operate reliably at any temperature between the limits -30° C and $+60^{\circ}$ C.

3. Be ground to an accuracy which will provide transmitter operation within 500 cycles of the specified output frequencies at 50° C, and means shall be provided to adjust the crystal oscillator to provide output frequencies within this tolerance.

e. *Tubes* — 1. No tube shall be operated with any current, voltage or dissipation in excess of that recommended by the tube manufacturer for continuous duty commercial service.

2. Each RF tube (except crystal tube) shall be biased so that in event of loss of excitation it shall preferably draw no more than 20% of the plate current it draws with the transmitter operating normally, and in any event the maximum plate dissipation for any class of continuous commercial service set by the tube manufacturer shall not be exceeded.

3. All tubes shall be of standard, commercially available types especially suitable for use at the specified normal operating frequencies in lieu of older types not so suited.

f. *Overload protection* — A protective device in the form of a circuit-breaker shall be provided in the input circuit of each power transformer. Circuit-breakers used shall be of a thermal type, similar to Vapor Car Heating Company's¹ type M-8705-FF thermal breaker or of equivalent reliability and speed of action, and

¹ Vapor Car Heating Company, 4905 W. 18 Street, Chicago, Ill.

shall function with a speed such that ample protection against damage to the power supply is provided.

F—Receiver Unit: F1—PERFORMANCE REQUIREMENTS OF RECEIVER: a. *Selectivity* — 1. The selectivity of the receiver to the grid circuit of the limiter (FM receiver) or the first audio amplifier (AM receiver) shall be as follows:

Kc. off resonance (each side)	Decrease in gain in db with gain at resonance as reference
18	Less than 6
60	More than 40
120	More than 75

2. Measurements to determine compliance with the above requirements shall be made by varying the signal input voltage so as to hold the output voltage of the IF amplifier constant.

b. *Spurious Response* — The response of the receiver to all frequencies more than 120 kc. off resonance shall be at least 75 db below the response at resonance.

c. *Frequency Stability* — The receiver frequency stability shall be maintained within $\pm 0.005\%$.

d. *Limiter Action (FM receiver)* — The limiting action for FM Receivers shall be such that limiter grid saturation occurs with a signal input of 1 microvolt or less.

e. *Sensitivity* — Shall be such that 1 microvolt or less input will produce an audio output of 5 watts.

f. *Signal-to-Noise Ratio* — Shall be such that an input of 1 microvolt or less shall provide 20 db quieting.

g. *Squeech* — A squeech circuit shall be provided such that 0.5 microvolt or less signal input shall open the squeech when the squeech control is set at its most sensitive position.

h. *Audio Output* — Shall be at least 5 watts with a maximum overall distortion of 5% measured at frequencies of 40 and 1,000 cycles.

i. *Audio Frequency Response (amplitude modulation)* — Audio frequency response shall not vary more than 2 db for any two frequencies between 300 and 3,000 cycles and shall be down a minimum of 6 db at 4,000 cycles.

j. *Audio Frequency Response (frequency modulation)* — The overall receiver audio response characteristic shall decrease 6 db per octave at a rate linear within 2 db from 300 to 3,000 cycles. Response above 3,000 cycles shall be smoothly attenuated with a minimum allowable attenuation at 4,000 cycles of 6 db. This de-emphasis characteristic shall be obtained in the audio circuits only, and shall be capable of being modified to change or expand the frequency response.

k. *Automatic Volume Control (amplitude modulation)* — The audio output shall not rise more than 4 db when the signal input is increased from 1 microvolt to 1

volt at constant frequency and percentage of modulation. There shall be no tendency for the receiver to overload at 1 volt input.

F2—GENERAL REQUIREMENTS FOR RECEIVER: a. *Input Impedance* — The receiver input circuit shall be designed for operation from a 52-ohm grounded coaxial transmission line.

b. *Output Impedance* — The receiver shall be designed to feed a 500-ohm ungrounded resistive load with taps at 4 and 8 ohms.

c. *Filament Voltages* — When 117 volts are applied to the power terminals, all filaments and heaters shall receive a voltage within 5% of the tube manufacturer's rated value.

d. *Receiver Crystals* — Receiver crystals employed in this equipment shall:

1. Not be ground to a fundamental frequency above 7.0 mc;

2. Start readily and operate reliably at any temperature between the limits of -30°C and $+60^{\circ}\text{C}$.

3. Provide receiver operation within plus or minus 500 cycles of the specified frequency, or means must be furnished whereby the crystal oscillator frequency can be adjusted to provide receiver operation within plus or minus 500 cycles of the specified frequency.

e. *Tubes* — All tubes shall be of standard commercially available types especially suitable for use at frequencies specified in sub-section D3 and shall be operated within the tube manufacturer's published ratings.

f. *Overload Protection* — Protective devices in the form of a circuit breaker shall be provided in the input circuit of each power transformer. Circuit breakers used shall be of a thermal type similar to Vapor Car Heating Company's¹ type M-8705-FF thermal breaker or of equivalent reliability and speed of action, and shall function with a speed such that ample protection against damage to the power supply is provided.

g. *Radio Frequency Amplifiers* — The receiver shall have at least one stage of radio frequency amplification.

G—Requirements for Component Parts of Transmitter and Receiver: G1—GENERAL: The units shall be fabricated from high-quality components, entirely free from aging effects.

G2—CAPACITORS: Such paper-dielectric capacitors as are used in this equipment shall comply with the requirements of ASA specification C75.16 — 1944. No capacitors shall be subjected to voltages in excess of two-thirds their rating under any conditions encountered in starting and operating the equipment. Capacitors in radio frequency circuits shall be of the ceramic, mica or air-dielectric type. Mica-dielectric capacitors shall comply with the requirements of ASA Specification C75.3 — 1942.

G3—RESISTORS: Carbon resistors of the

type commonly used in receivers may be used in the receiver equipment and also in the exciter unit of the transmitter provided no such resistor dissipates more than one-fourth of its rated "free air" dissipation. Where resistors of higher ratings are necessary, wire-wound resistors with elements assembled on a non-hygroscopic ceramic form and protected by a cement coating equivalent to the International Resistance Company's type "C" coating, may be used.

G4—TRANSFORMERS AND REACTORS (LOW FREQUENCY): All low-frequency reactors and transformers, both for audio and power circuits, shall be thoroughly vacuum-impregnated with a high-quality insulating varnish. Each unit shall be potted with a compound having a melting point above 110°C , and enclosed in a metal case of the fully-enclosed type so as to be moisture-proof. The terminals shall be brought out to a terminal board provided with riveted tinned lug terminals of such size and so mounted as to permit the convenient soldering and support of connecting wires. These terminals shall be permanently and legibly marked to permit identification on the schematic wiring diagram. Terminal boards shall be on non-hygroscopic insulation of such nature that under any specified service condition, or in the process of soldering the terminals, said terminals will not become loosened nor the insulation material be injured.

G5—TUBE SOCKETS: Tube sockets for the power supply and receiver units may be of the molded-phenolic wafer type with contacts of cadmium-plated phosphor bronze or equal, recessed in the insulating material to prevent rotation. Also, similar sockets may be used in the transmitter units where performance equivalent to that obtainable with ceramic-insulated sockets can be realized. However, in circuits where improved performance can be obtained by its use, glazed ceramic insulation shall be employed for tube sockets. The proper tube designation shall be marked adjacent to each socket.

All tube sockets shall be rigidly mounted, so that the entire periphery of each socket rests on the chassis. The use of small angle brackets or similar means for supporting sockets only at their mounting holes will not be permitted.

H—Miscellaneous Mechanical Requirements: H1—GENERAL: All component parts shall be arranged and mounted so as to be easily accessible and removable without disturbing other parts of the unit. All components shall be fastened to the chassis by means of machine screws and nuts secured by the use of shakeproof washers of non-corrosive material. Rivets or self-tapping screws shall not be employed.

H2—CHASSIS, FRONT PANELS AND MOUNT-

ING BRACKETS: Chassis, front panels, and mounting brackets may be either aluminum or steel. If steel is used, it is required that all parts except the front panels be cadmium plated after all machining operations have been completed with a plating at least .001 in. thick. If aluminum is used for the panels, it is required that the front surface be etched prior to finishing. If aluminum is used for the chassis, it shall be a minimum of No. 11 B. & S. gauge.

H3-SMALL PART MOUNTINGS: Fixed resistors and similar small items, not provided with mounting holes, may be supported by soldering their leads directly to the points in the circuits to which they are to connect, provided short lead lengths are necessary from the electrical standpoint. For such mountings, the length of leads shall not exceed $\frac{1}{2}$ in. Otherwise, these items shall be mounted on laminated phenolic panels, the leads being soldered to eyelets or terminals in these panels with no slack in the leads that will permit them to move.

If resistors having ferrule-type connections are employed, they shall be mounted in clips equal to those of the positive pressure type made by the Square D Company. Resistors having lug terminals shall be firmly mounted in such a manner as to prevent rotation without relying upon the lugs for support, but shall be easily replaceable in case of failure.

H4-WIRING: All wiring shall be cabled, when practicable, and clamped to the chassis. Wiring shall be color-coded to differentiate between types of circuits such as plate, grid, and power circuits. Where insulated leads pass through holes in the chassis, the holes shall be equipped with smoothly finished grommets. Only rosin or rosin and alcohol shall be used for soldering flux. All wires connected to terminals shall be securely fastened to the terminals by crimping the terminals firmly on the wire, or the wire on the terminals before soldering, and shall not depend on solder for mechanical strength. In no case shall any insulating material be subjected to the pressure required to make good electrical connections. No electrical connections shall be made by clamping wires smaller than No. 18 A.W.G. between metal parts. Wherever a wire is connected to an unthreaded stud, the stud shall be grooved or have a hole drilled through it and wire rounded into the groove or placed through the hole and twisted around the stud before soldering. All wire shall be suitable for continuous operation at 75° C. The minimum size of insulated conductor shall be No. 18 A.W.G. Conductors carrying 10 amps. or more shall be No. 10 A.W.G. or larger, and those carrying from 1 to 10 amps. shall be No. 14 A.W.G. or larger. The voltage rating of all insulated wire shall be at least 50% greater than the peak voltage to ground on the conductor in normal operation, and in no case less than 500 volts.

H5-EXTERNAL CONNECTIONS: All connectors permanently fastened to this equipment which are to be used for connection of coaxial cable shall be Amphenol type 83-1 series or its mechanical and electrical equivalent.

H6-FINISHES: All surfaces of the panel of each unit shall be thoroughly cleaned to remove all dirt and grease, after which it shall be given one coat of zinc-chromate primer. The front and edges of panels shall be finished in one of the following ways: (1) black wrinkle enamel baked on, or (2) light umber gray, RCA finish type 685. The plated chassis require no finish of any kind.

H7-ACCESSIBILITY OF PARTS: All circuit components shall be so mounted in the chassis assemblies as to permit their replacement without appreciable disassembling. All switches and controls shall be mounted in such a manner as to permit their convenient replacement without removal of other units.

H8-HARDWARE: All bolts, studs, screws, nuts, etc., used in this equipment shall be cadmium- or nickel-plated or equivalent, and shall be in accordance with the American National Form as adopted by the National Screw Thread Commission and of the coarse or fine thread series. A minimum of two complete threads in use in all materials is required.

J—Accessories: **J1-ANTENNAS:** Antennas furnished for use with this equipment shall be of such design as to reduce high-angle radiation to a minimum. The antenna shall be so designed that when fed by a 52-ohm grounded coaxial transmission line, the standing-wave ratio will be not greater than 1.2 to 1.

J2-MICROPHONES: Unless otherwise specified, microphones furnished for use with this equipment shall be of the handset type, incorporating a spring-release, push-to-talk switch.

Frequency response shall be substantially flat between 300 and 3,000 cycles. The microphone shall be capable of satisfactory operation in ambient temperatures from -30° C. to +60° C.

J3-REMOTE CONTROL UNIT: When the method of installation so requires, a remote control unit shall be provided for the purpose of controlling the radio station from a remote point over a 600-ohm metallic telephone line. This unit shall incorporate all controls and indicators necessary for effective operation of the radio station and/or required by governmental regulations in effect at the time of installation.

K—Instruction Books: **K1-PURPOSE AND SCOPE:** The instruction books are for the guidance of the personnel who will operate and maintain the equipment. The information included in the instruction books shall be such as to convey a thor-

ough understanding of the operation of the equipment so that improper operation may be readily detected and corrected. In many cases, the men who will use these instruction books are men without advanced technical training and whose knowledge of radio equipment has been incidental to their other duties. It is, therefore, essential that highly technical discussions and explanations be avoided, and that the book be written with a careful choice of words so as to be clear, concise, and free from ambiguities and duplications.

Separate books may be furnished for transmitter units and receiver units, if desired, in which case data on accessories associated with each unit shall be included in the book pertaining thereto.

K2-QUANTITY: One instruction book of the proper type shall be supplied for each equipment ordered. Additional instruction books, as required, may be ordered by the purchaser.

K3-PRELIMINARY INSTRUCTION BOOK: Each equipment shipped before the final instruction book is ready shall have one preliminary instruction book supplied with it. This book shall contain all information required to install, adjust, operate, and maintain the equipment. The above information shall include a parts list and all applicable drawings, but may be without photographs and may be printed by some inexpensive process, such as by stencil. Equipment will not be considered complete unless supplied with a preliminary instruction book or, in lieu thereof, the specified number of instruction books. (*Instruction Book* as used in the preceding sentence and elsewhere in this specification is to be construed to mean the final instruction books, unless preceded by the word *preliminary*.)

K4-CONTENTS: The contents of the book are listed below in their proper order:

- Front Cover*—The front cover shall contain the same general information ordinarily given on the name plates of units.

- Title Page*—Same information as front cover.

- Summary*—A technical summary of the equipment such as frequency range, power, etc.

- Safety Notice*—The safety notice shall be prominently displayed and shall indicate all safety precautions to be taken by personnel employed in the installation or maintenance of the equipment.

- Table of Contents*—The table of contents shall be a complete index to all divisions and subdivisions of the book exclusive of the title page and table of contents, but including the list of photographs and drawings.

- Text*—The text of the individual books shall be divided into definite sections and the necessary sub-sections with appropriate titles, arranged in the order given in subsection K5, which states the

requirements for the various sections of the text.

g. *Parts List and Typical Test Data* — These shall be placed in the instruction book at the end of the text.

h. *Drawings and Photographs* — The list of drawings and photographs shall index by title, number, and page all drawings and photographs consecutively as they appear in the book. Where necessary for clarity of detail, drawings and diagrams shall be on double- or triple-width pages.

K5-DETAILED REQUIREMENTS FOR TEXT: The text of the instruction book shall be divided into four sections as follows:

a. *Description* — This shall contain a general description of the unit followed by a detailed description and discussion of the mechanical construction and electrical theory of operation of the subject unit.

b. *Installation* — This shall cover the installation of the subject unit. It shall contain instructions for unpacking, positioning, and wiring the unit, and the installation and wiring of any separately-erated components. Instructions shall also be included to cover necessary dis-assembling and packing of equipment for shipment.

c. *Operation* — This shall outline and describe in detail all adjustments, checks, and tests required to place the subject unit in satisfactory operation. Instructions and information regarding the limitations of the equipment shall be given, especially in connection with components likely to be damaged by improper adjustments.

d. *Maintenance* — This shall be devoted primarily to maintenance of the equipment and shall give detailed instructions for its inspection and repair. A table shall be included showing routine inspections and tests which are required to assure continuity of service. This section shall contain a list of possible troubles, together with their remedies, and a table of the normal voltages and currents for various items, including vacuum tubes, over their normal range of operation.

K6-DETAILED REQUIREMENTS FOR PARTS LIST:

a. *Reference Marking and Information* — The instruction book shall contain a complete list of all parts for the subject unit, including such minor items as tube sockets, terminal strips, etc. This list shall be made up in tabular form and contain:

1. The item number corresponding to diagrams furnished (such as C-1, R-1, L-1, etc.).

2. A description of the item, rating where applicable, and a statement of its function such as (Condenser, 5.5 mmfd., 400 volts, bypass).

3. Stock number.

b. *Replacement Data* — For standard parts which contractor has purchased, the data given shall be sufficient to permit ordering replacements from the manufacturer, including, as a minimum, the part symbol,

name of part and its function, manufacturer's rating, name and address of manufacturer, and his type designation.

K7-DRAWINGS: The following diagrams are the minimum to be included in instruction books:

a. *Transmitter Circuit* — Schematic diagram of complete transmitter including power supply.

b. *Control Circuit* — Schematic diagram of all control circuits.

c. *Receiver Circuit* — Schematic diagram of complete receiver and power supply.

d. *External Circuits* — External connection diagram for each type of installation.

e. *Designations* — Item designations corresponding to the parts list shall be shown on all drawings.

f. *Calibration Charts* — Calibration charts of all controls and adjustments where such calibrations are necessary to proper maintenance of the equipment.

g. *Special Mechanisms* — Mechanical details of any special mechanisms employed in the equipment.

K8-PHOTOGRAPHS: Sufficient views of individual units to show all controls, external connections, and major components of equipment including full-page photographs of the top of the chassis and the bottom of the chassis of each major unit shall be included in the instruction book. Each visible item on each photograph shall be marked with the same symbol and part number used on the schematic diagrams.

K9-FORMAT OF INSTRUCTION BOOKS: a. *Paper and Printing* — The book exclusive of the cover shall be produced on a good grade of white bond or lithographic paper by printing or other process which will produce a permanent copy and an easily read book.

b. *Pages* — The individual pages shall be 8 ins. wide by 10 ins. high.

c. *Binding* — The individual books shall be bound securely and covered with a paper commercially designated as French gray, double thick, or equivalent.

L — Tests: **L1-GENERAL:** a. *Inspection* — The purchaser shall have the right to make such inspection and tests of equipment furnished under this specification as he may desire. The inspector for the purchaser shall have the right to reject units or parts thereof which are defective in any respect.

b. *Tests by Purchaser* — Tests may be made at the place of production on samples selected at random or at destination as preferred by the purchaser. When tests are made at the place of production, the contractor shall furnish all necessary facilities, including equipment and personnel, to perform tests required to demonstrate that the equipment complies with this specification. Such tests shall be conducted in the presence of and witnessed by the purchaser's inspector.

c. *Tests by Contractor* — In lieu of tests made under observation of the purchaser's inspector, the purchaser may require the contractor to furnish certified test data on tests made to determine that the equipment complies with this specification.

L2-DETAILS OF TESTS: Tests made by the contractor shall include at least the following which shall be made on a sufficient number of units to insure that all equipment supplied under this specification complies therewith in all respects:

a. *Visual Inspection* — Units shall be inspected visually to establish compliance with mechanical requirements, wiring, operation of controls, and workmanship.

b. *Heat and Humidity Test* — The unit shall be placed in an ambient temperature of minus 30° C, and after the temperature of the units has stabilized at the ambient temperature value, the unit shall be turned on and adjusted for full-rated output. After the unit is checked for proper operation at the lower temperature, the ambient temperature shall be raised to plus 60° C, and maintained at this value for 6 hours. During this test, such measurements as are required to demonstrate compliance with requirements of this specification involving effect of temperature variation shall be taken. With the equipment operating and stabilized in the 50° C, ambient temperature, the relative humidity of the test chamber atmosphere shall be increased to 95%. Immediately following the test the unit shall be inspected for mechanical defects and for corrosion. Should there be any indication of inadequate corrosion resistance of surfaces, the contractor shall take proper corrective measures on all units.

c. *Performance Tests* — After the heat and humidity test described above, individual tests shall be performed on the unit to show compliance with each requirement of the specification where the variation in ambient temperature is not involved.

L3-TEST PROCEDURES: The contractor shall determine the test procedures and data to be taken to show compliance with this specification. The purchaser retains the right to require modification of the contractor's test procedures. In general tests shall be based on standard methods recognized by the radio industry. Test equipment and circuits which will insure accurate results shall be used.

M — Packing: Equipments shall be so packed as to permit convenient handling and to protect against loss or damage during shipment.

N — Marking: The name of the article, code number, quantity, gross weight, purchaser's order number and requisition numbers, name of consignee, and such additional information as may be specified on the order shall be plainly marked on a strong linen tag affixed to each package.

(CONCLUDED ON PAGE 59)

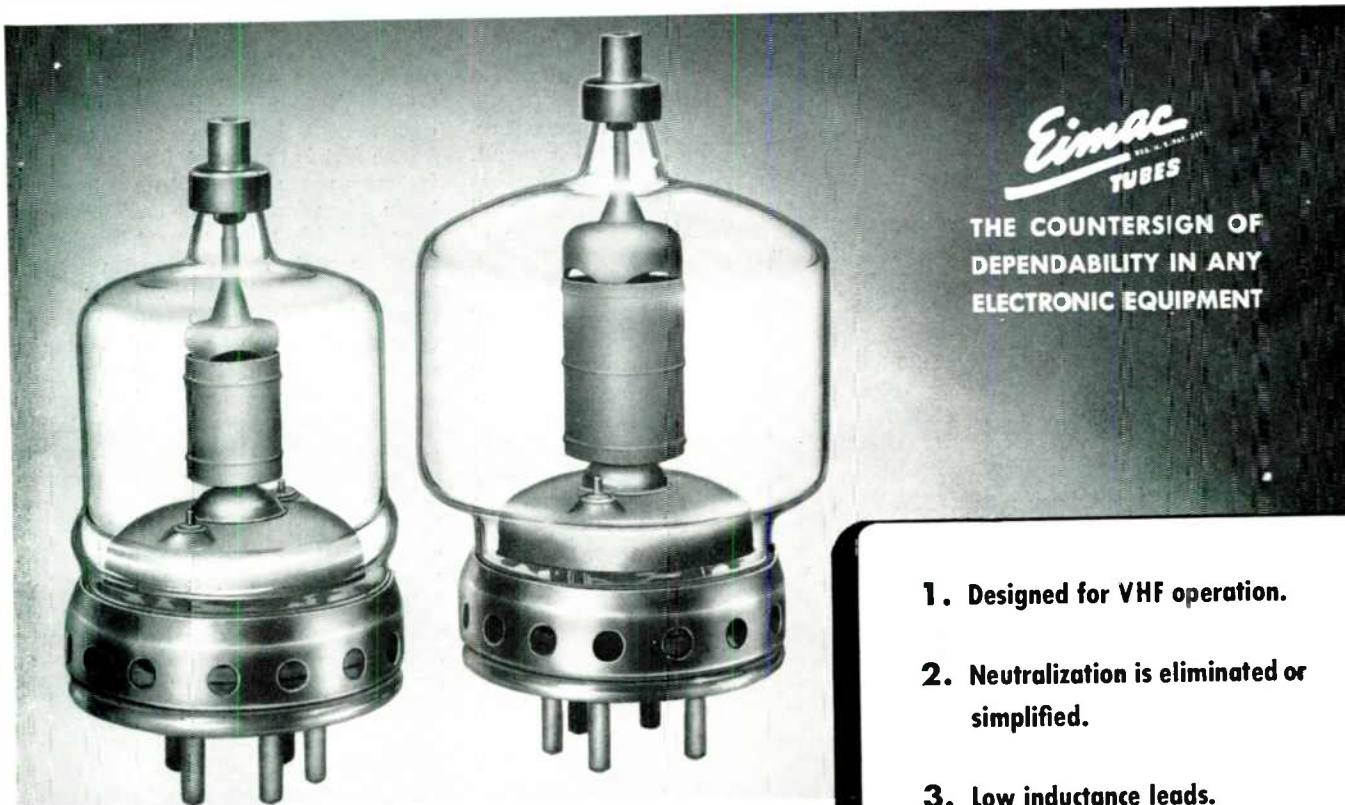

Eimac
TUBES
THE COUNTERSIGN OF
DEPENDABILITY IN ANY
ELECTRONIC EQUIPMENT

THE SOLUTION TO VHF TUBE PROBLEMS

Any way you look at it, these Eimac tetrodes are a natural choice for VHF transmitters. They are designed to permit operation beyond the highest FM broadcast band. Their extremely low grid-plate capacitance eliminates need for neutralization in many cases — simplifies neutralization in others. Non-emitting grids give stability of operation, and their high power-gain reduces drive requirements. For example... at 120 Mc the Eimac 4-125A will deliver 375 watts plate power output with less than 3 watts drive.

Yes! Any way you look at it, Eimac 4-125A and 4-250A tetrodes provide the answer for most VHF transmitter problems. Get further information now.

1. Designed for VHF operation.
2. Neutralization is eliminated or simplified.
3. Low inductance leads.
4. Low drive requirements.
5. Low output capacitance.
6. No internal insulators.
7. Unconditionally guaranteed against failures due to gas released internally.

ELECTRICAL CHARACTERISTICS	EIMAC 4-125A	EIMAC 4-250A
Filament: Thoriated tungsten		
Voltage	5.0 volts	5.0 volts
Current	6.5 amps.	14.5 amps.
Plate Dissipation (Maximum)	125 watts	250 watts
Direct Interelectrode Capacitances (Average)		
Grid-Plate (Without shield- ing, base grounded) . . .	0.05 uufd.	0.06 uufd.
Input	10.8 uufd.	12.7 uufd.
Output	3.1 uufd.	4.5 uufd.

Follow the leaders to
Eimac
REG. U. S. PAT. OFF.
TUBES

EITEL-McCULLOUGH, INC., 1248L San Mateo Ave., San Bruno, California

Plant located at: San Bruno, California

Export Agents: Frazar and Hansen, 301 Clay Street, San Francisco 11, California, U. S. A.

CALL IN AN EIMAC REPRESENTATIVE FOR INFORMATION

ROYAL J. HIGGINS (W9AIO) . . .
600 South Michigan Avenue, Room
818, Chicago 5, Illinois. Phone:
Harrison 5948.

VERNER O. JENSEN, Verner O.
Jensen Company, 2616 Second
Avenue, Seattle 1, Washington.
Phone: Elliott 6871.

RONALD G. BOWEN, 1886 South
Humboldt Street, Denver 10, Colo-
rado. Phone: Spruce 9368.

JAMES MILLAR ASSOCIATES, J. E.
Jayner, Jr. (W4TO) 1000 Peachtree
Street, N. E., Atlanta, Georgia.

M. B. PATTERSON (W5CI) . . . Pat-
terson & Company, 1124 Irwin-
Keaster Building, Dallas 1, Texas.
Phone: Central 5764.

ADOLPH SCHWARTZ (W2CN) . . .
220 Broadway, Room 221D, New
York 7, New York. Phone: Cort-
land 7-0011.

HERB BECKER (W6QD) . . . 1406 So.
Grand Avenue, Los Angeles 15,
California. Phone: Richmond 6191.

TIM COAKLEY (W1KKP) . . . 11 Bea-
con Street, Boston 8, Massachu-
setts. Phone: Capitol 0050.

WHAT'S NEW THIS MONTH

(CONTINUED FROM PAGE 4)

amounts of partly fabricated equipment for weeks or months. If, however, production went forward smoothly, these loss factors were eliminated, and refund adjustments were made accordingly.

From the point of view of factory workers, the present delay is most unfortunate. Unfilled demands for components and sets is at a level that would assure continuous employment for two years or more. And that would mean, at present rates, at least three times the annual wages earned in radio plants before the war! Instead, while dealers, jobbers, and set manufacturers swarmed around the Chicago Show, begging permission to place orders, thousands of factory workers were sitting at home wondering if their war bonds would carry their families until they could get steady employment again.

Maybe that's part of OPA's technique to prevent inflation by using unemployment to siphon off excess funds which might otherwise be spent in the black market.

2 Even before FM broadcasting started, FM Broadcasters, Inc., was organized by a forward-looking group of station operators for the purpose of advancing the progress of this new art. In March, 1940, the members planned and presented testimony before the FCC which resulted in the allocation of a band from 42 to 50 mc. to FM broadcast service. This was a major accomplishment, making possible the establishment of 50 stations prior to the wartime cessation of new construction.

The very effective work of FMBI was brought to a stop after Pearl Harbor. When RTPB was set up, FMBI had a voice in its deliberations, but the fine spirit shown in 1940 was lacking, and its very sound proposal to extend the 40- to 50-mc. band was lost in the shuffle. Such testimony as FMBI members offered at the Allocations Hearing was poorly organized and was given little consideration.

It became increasingly apparent that individual members who operated AM stations, and they were in the majority, had become fearful that any commitments made on behalf of FM might react against their AM interests.

Meanwhile, general interest in the subject of Frequency Modulation had increased to such an extent that in January, 1944, when FMBI announced plans for a modest two-day engineering conference, attendance reached the astonishing total of 700 broadcast engineers and executives. This was the largest meeting of its kind ever held up to that time.

Nevertheless, at the directors meeting in Milwaukee last August, it was decided that FMBI should become a department of National Association of Broadcasters. That signed the death warrant of the organization, by delivering it into the

hands of the AM opposition. From that time on, FMBI has been only a column in the weekly NAB bulletin.

Today, the need of an independent organization of FM broadcasters is urgent. Little can be expected from NAB, for that association management has its hands full of many urgent AM matters, some of which are in direct conflict with FM interests.

This was emphasized by Commissioner Durr when, on May 3rd, he said of FM broadcasting: "Conditions could not be more ideal for launching a new service. But there seems to be a disturbing inclination on the part of radio to cling to its old system of aural broadcasting rather than give free rein to a new system. The new system is admittedly superior, but it means newcomers and, hence, new competition."

These words summarize the need of an FM broadcasters association whose membership is limited to those who do not have AM affiliations. Nearly 300 FM applications have been filed by those who have no AM connections. This is several times the original FMBI membership, and a number sufficient to form an extremely active and effective association for the following purposes:

1. To advise with FCC engineers on technical problems involved in the expansion of FM broadcasting.

2. To represent the membership before the FCC Commissioners in matters affecting rules, regulations, and policies.

3. To consider matters relating to labor unions.

4. To consult, through an engineering committee, with radio equipment manufacturers.

5. To hold an annual conference for the discussion of program, operation, engineering, and policy problems.

6. To consider and explore the possibilities of establishing FM networks by wire or relay circuits, or rebroadcasting.

7. To organize and hold seminars for advertising executives and program directors to discuss and demonstrate the new effects and greater impact obtainable with FM as compared to AM broadcasting.

8. To hold public demonstrations of FM reception, so that listeners, as well as dealers and servicemen, can hear the superior service that they can obtain with new receivers.

Consideration of these points, and the realization that nothing is being done to promote understanding of the common interests and needs of FM broadcasters, sponsors, and listeners are the best arguments in favor of an association of independent FM broadcasters. We shall be glad to publish comments on this subject in *FM AND TELEVISION*.

3 Set manufacturers may be forced to adopt the advertising slogan "Buy Your Radio in the Nude" if something doesn't happen soon to make wood cabi-

nets available. Furniture plants just aren't interested in making radio cabinets, OPA isn't to blame for this condition, either.

The fact is that most furniture manufacturers never did like to sell the radio trade. They don't like the credit risk, and they don't like the treatment they've had in years past. Radio cabinet work was always a pain in the neck. Now they are pleased to turn an indifferent eye on radio cabinet orders and say, "You'd better get someone else to build 'em for you."

This is a very serious condition, for only a few radio companies make cabinets, and then for only a part of their requirements.

As a result, a number of set manufacturers went to Chicago to see the very handsome metal cabinets used for new communications receivers offered by National, Hammerlund, and Hallicrafters. If, they argue, people are paying \$250 and up for those sets in metal cabinets, why can't we use them as a less expensive substitute for wood cabinets to house broadcast receivers?

They can be connected to speakers in plain wood cases, such as the Jensen reflex type. They can even be painted, like radiator covers, to match the woodwork. If there are no furniture pieces to carry broadcast receivers, why not eliminate the furniture and stop trying to camouflage the sets.

Well, why not? The functional appearance of the new communications receivers is far more acceptable than the borax pieces that were used for most consoles and phonograph cabinets before the war! Besides, a broadcast receiver in a beautifully-finished steel cabinet, connected to a separate speaker in a plain, inconspicuous case, will cost less and give much better tone than when the set and speaker are mounted in one of those anomalous monstrosities which come apart and rattle after a year's use. — *Milton B. Sleeper*

TRANSMITTER PERFORMANCE

(CONTINUED FROM PAGE 38)

frequency control of the Panalyzer is rotated. If a combination of AM and FM is present, the phase of the pattern shown may not change 180°.

NOTE: The heterodyne frequency voltage should be free of modulation, either amplitude or frequency. Otherwise, patterns on the screen will appear as if the hum were coming from the FM transmitter.

When the heterodyne voltage contains AM hum, the entire signal amplitude pattern will be distorted by the type of AM hum present. If the heterodyne output voltage is made sufficiently great, any AM hum present tends to be wiped out in the first aperiodic mixer of the Panalyzer.

For low frequency (60 cycles) FM hum, little distortion will be observed if the FM signal from the transmitter has wide deviation.

(To be concluded next month)

ANOTHER NEW

Jensen *Coaxial*

The most significant postwar loud speaker development yet announced is the new Jensen family of Type H Articulated Coaxial Speakers. The latest member is Model HNP-51, an all *ALNICO 5* design — in which low-frequency and high-frequency speakers are employed coaxially in an articulated assembly. The 15-inch l-f cone acts as an extension of the h-f speaker horn. The two loud speakers are electrically and acoustically coordinated into a system achieving brilliant and natural response through the entire useful frequency range (l-f performance depends upon the baffle or enclosure used). Frequency-dividing network has variable control in range above 4,000 cycles.

HNP-51 is recommended for FM receivers, high quality phonograph reproduction, television, review rooms, monitoring and home and public entertainment generally.

Coaxial Models HNP-50 and HNF-50 (for manufacturers) and HNP-51 (for general use), are now nearing quantity production. All Type J Jensen Coaxials (3 models) are now in production. Write for complete information.



JENSEN RADIO MANUFACTURING CO., 6609 S. Laramie Ave., Chicago 38, Ill.
In Canada: Copper Wire Products, Ltd., 137 Oxford Street, Guelph, Ontario

Specialists in Design and Manufacture of Fine Acoustic Equipment

June 1946 — formerly FM, and FM RADIO-ELECTRONICS

TYPE H SPECIFICATIONS

MODEL HNP-51 (15-inch) with *ALNICO 5* in both l-f and h-f units. Power rating, 25 watts maximum in speech and music systems. Input impedance, 500 ohms. List price approximately \$125.

MODEL HNF-50 (15-inch) *ALNICO 5* design h-f unit, field coil in l-f unit; otherwise same as HNP-51. List price approximately \$115.

COMPLETE REPRODUCERS. Model HNP-51 Speaker is offered in 2 cabinet models to form complete reproducers. Model "CR" Reproducer employs beautiful Jensen Imperial Walnut cabinet. Model "RA" Reproducer employs attractively finished general utility cabinet.





CALIBRATOR, Model GA-10
POWER SUPPLY, Model PF-10

A Precision Instrument for Calibrating 60-Cycle Switchboard-Type Direct-Reading and Recording Frequency Meters Used by Public Utility Power Systems.

Browning 60-Cycle Frequency Meter Calibrator

25 Volt-Amperes at 56 to 64 Cycles, Accurate to Plus-or-Minus .05%

THE BROWNING Frequency Meter Calibrator is designed for checking 60-cycle frequency meters, and the frequency of 60-cycle line voltage. It can be used also as an accurate frequency source from 56 to 64 cycles, with an output up to 25 volt-amperes and output voltage adjustable from 100 to 130 volts. Filters which require accurate adjustments can be set by means of this equipment.

The Model GA-10 Calibrator will determine with $\pm .05\%$ accuracy the correctness of switchboard frequency meters in the range of 56 to 64 cycles per second. A stable phase-shift oscillator generates the required sine-wave output. Subsequent amplifiers raise the level to 25 volt-amperes at 100 to 130 volts. The voltage output is indicated directly on an expanded-scale

meter. A control is provided to set the output voltage.

The oscillator calibration curve is checked by combining the oscillator harmonics with the submultiple of a crystal oscillator. The resulting beat is detected and indicated on a sensitive DC meter. The oscillator can then be adjusted to the original calibration curve by means of an auxiliary control. Maintenance of accuracy and minimum warm-up time is thus assured.

Line frequency can be determined to $\pm .03$ cycle per second at 60 cycles per second, using the same procedure as standardizing

the oscillator. In this case, the oscillator output is directly compared with line frequency.

The crystal oscillator stability is extremely high and does not require adjustment.

In many instances, such as the adjusting and checking of sharply peaked filters, it may be desirable to cover a different range of frequencies. The BROWNING Frequency Meter Calibrator can be made on special order to cover any narrow range of audio frequencies with the same accuracy and stability. For further information and prices, address:

Another Precision Instrument from the
BROWNING LABORATORIES, INC.
WINCHESTER • MASSACHUSETTS



your **Signpost** in the sky

For the private pilot who wants the last word in complete air-ground radio, ARC now offers equipment built to exacting Army-Navy standards. Featuring designs tested through millions of hours of wartime operation, the ARC Type 11 Aircraft Communication System provides top quality performance under conditions of vibration, moisture, changes in altitude and temperature, and shocks from rough landings.

The Type 11 System combines a wide band (190 to 550 KC) LF Range Receiver and a VHF Transmitter with provision for 5-channel operation at the turn of a switch. The small separate control unit is located for convenience of operation and the major units remotely mounted. This avoids disturbance of normal weight and balance of the airplane and usually permits a short antenna lead-in. The complete antenna system consists of a single vertical rod 22 inches long and is furnished with the Type 11 System.

This compact ARC equipment is based on more than 18 years of design and development in the field of airborne radio and is a *quality* instrument for the operator who requires the basic essentials in aircraft communication and navigation facilities. Remember, when selecting the radio for your airplane, nothing but the best is good enough—specify ARC. For descriptive information and prices, write Aircraft Radio Corporation, Boonton, New Jersey.



ARC ADVANTAGES

Light Weight — Less than 15 pounds for the entire Type 11 System installed.

Reliable Reception — Unusual sensitivity and selectivity plus rugged construction. Noise-limiting circuitry insures clarity of reception and makes shielding unnecessary in some airplanes.

VHF Transmission—Crystal-controlled on 2 present channels, with provision for 5-channel operation to cover additional frequencies when allocated.

A Complete Installation — The Type 11 System is available complete with antenna, crystals, tubes, cables, microphone and headset — no extras to buy.

**AVAILABLE FOR DELIVERY
JULY 1, 1946**

AIRCRAFT RADIO CORPORATION

BOONTON, NEW JERSEY



TELEFAX—WORLD'S FASTEST, MOST ACCURATE COMMUNICATIONS...

BY RADIO TO HOMES—Finch self-synchronizing Telefax (Facsimile Equipment) enables broadcasters to transmit and homes to receive facsimile copies of anything that can be printed or written on paper... a complete Air Press Service of news, photos, market reports, box scores, printed and illustrated advertising... by radio! The present rate of speed is 2760 square inches of text matter per hour—equal to about 30,000 words. Reservations for equipment are now being made... make yours NOW, to be first in your territory!



BY RADIO OR WIRE TO EVERYWHERE With Telefax (Finch Facsimile) written or printed messages can be exchanged as by some "instant courier" between any two points, mobile or fixed, far or near, which can be connected by electric circuits. The messages as received are exact *facsimiles* of the original—complete in every detail of text or illustrations, and entirely free of errors in transmission. The rate of speed in words per minute far exceeds old-style telegraphic printing, and 100% accuracy is assured.



TELEFAX (FINCH FACSIMILE) gives you a new, faster, more flexible and completely accurate means of communication, with higher speeds, greater economy and total freedom from mistakes in transmission. It opens up rich new fields for broadcasting, will assuredly replace with better service

hitherto accepted methods of transmitting intelligence by wire. Write for folder giving full information, and list of principal Finch patents covering all important phases of Facsimile. Finch Telecommunications, Inc., 10 East 40th Street, New York 16, N. Y.

 self-synchronizing
finch facsimile

More

Quality Components for the Electronic Industries

AMERICAN PHENOLIC CORPORATION

is now completing a sizable addition to its Chicago plant. This means a substantial increase of the already great facilities for production of quality parts for communications and electronics... components that have built the high reputation enjoyed the world over by products bearing the Amphenol name.



By this timely expansion of facilities American Phenolic Corporation is meeting its responsibility of leadership and specialization in mass production of quality components to better serve the rapidly expanding electronics industry.

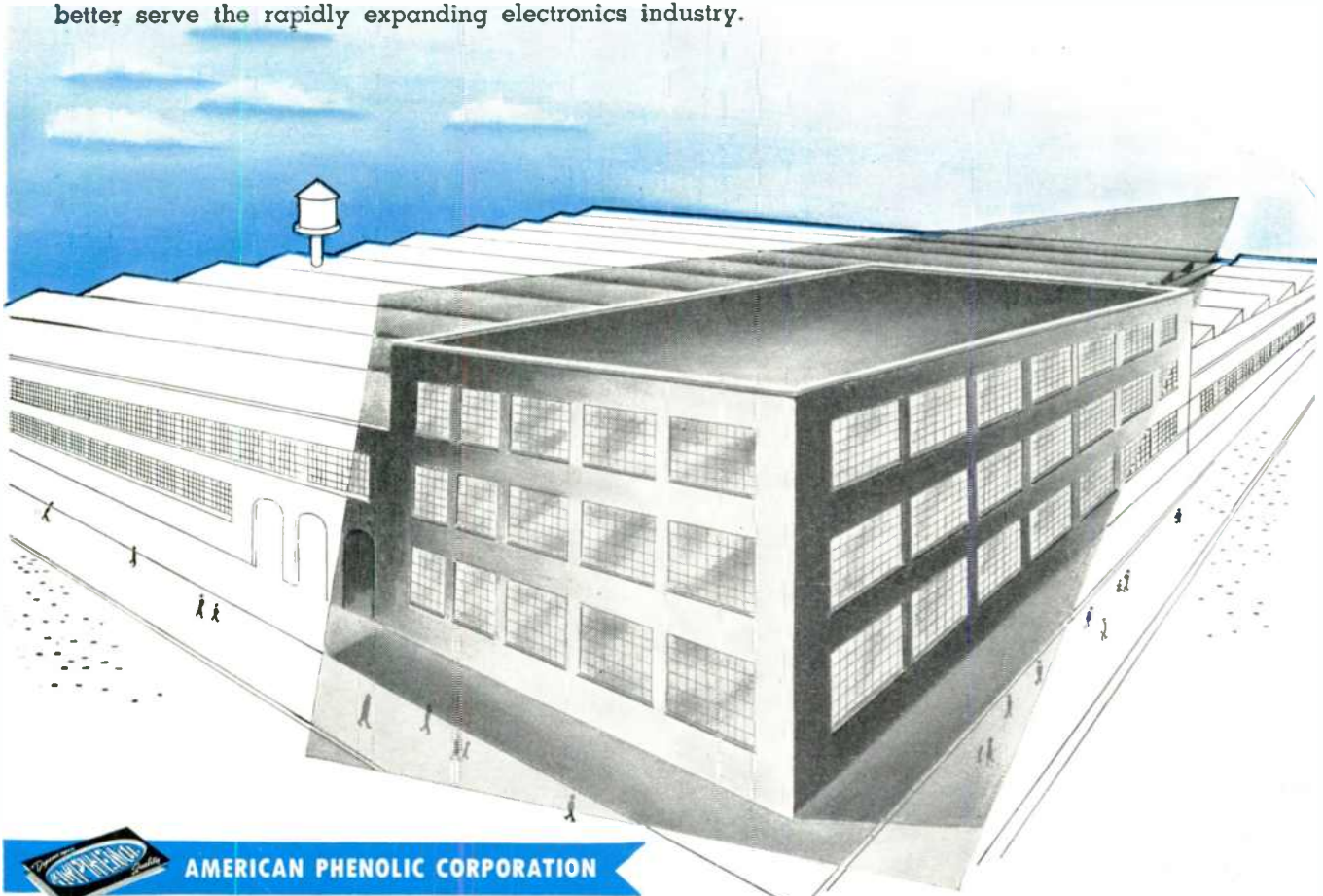

AMERICAN PHENOLIC CORPORATION

CHICAGO 50, ILLINOIS • IN CANADA • AMPHENOL LIMITED • TORONTO

COAXIAL CABLES AND CONNECTORS • INDUSTRIAL CONNECTORS, FITTINGS AND CONDUIT • ANTENNAS • RADIO COMPONENTS • PLASTICS FOR ELECTRONICS

BUILT TO ORDER

Designers of mobile equipment and amateur vhf enthusiasts asked for this driver tube. The 2E30 (outgrowth of the Hytron development type HD59) is a filamentary-type beam tetrode. Standby current is eliminated. Yet the 2E30 is ready to operate a second after electrode potentials are simultaneously applied.

In vhf equipment, the 2E30 is ideal as a class C oscillator, frequency multiplier, or audio frequency amplifier. Important to you—the 2E30 is a transmitting tube—not just a re-hashed receiving type.

Check its versatility and its many features. Quite possibly you will discover that the 2E30 was built to order for you too.



HYTRON TYPE 2E30

Instant-Heating Miniature Beam Tetrode

GENERAL CHARACTERISTICS

Filament.....	Oxide coated
Potential, a-c or d-c.....	6.0 ± 10% volts
Current.....	0.7 ampere
Grid-plate capacitance.....	0.5 mmfd
Input capacitance.....	10.0 mmfd
Output capacitance.....	5.0 mmfd
Max overall length.....	2 5/8 in.
Max diameter.....	3/4 in.
Base.....	T-5 1/2 min button 7-pin

ABSOLUTE MAXIMUM RATINGS

D-c plate potential.....	250 volts max
D-c screen-grid potential.....	250 volts max
D-c plate current.....	60 ma max
D-c screen-grid input power.....	2.5 watts max
Plate dissipation.....	10 watts max

OUTPUT—TYPICAL OPERATION

Output, class A1 power amplifier.....	4 watts
Output, class C oscillator.....	7.5 watts†
Output, class C doubler (80 to 160 mc).....	3 watts†

†Useful power output delivered to load under normal circuit efficiency. Total plate power output (including power actually lost in circuit and by radiation) is at least two watts higher.

FEATURES THE 2E30 OFFERS YOU

- Designed, manufactured, and tested for transmitting
- Special testing controls assure interchangeability*
- Oscillator, frequency multiplier, or a-f amplifier
- Filament power is fully adequate for transmitting
- 1/10 watt driving power for 4 watts output at 80 mc
- 10 watts plate dissipation—surplus reserve for vhf
- Miniature bulb saves space and has low base losses
- Low lead inductance and capacitance—ideal for vhf
- High efficiency at low plate potential—250 volts
- Instant-heating filament—approximately one second

*For example, characteristics are tested at positive grid potentials.

TYPICAL CIRCUIT FOR VERSATILE HYTRON 2E30

Extremely Compact Driver Giving 3 Watts to Load at 160 Mc

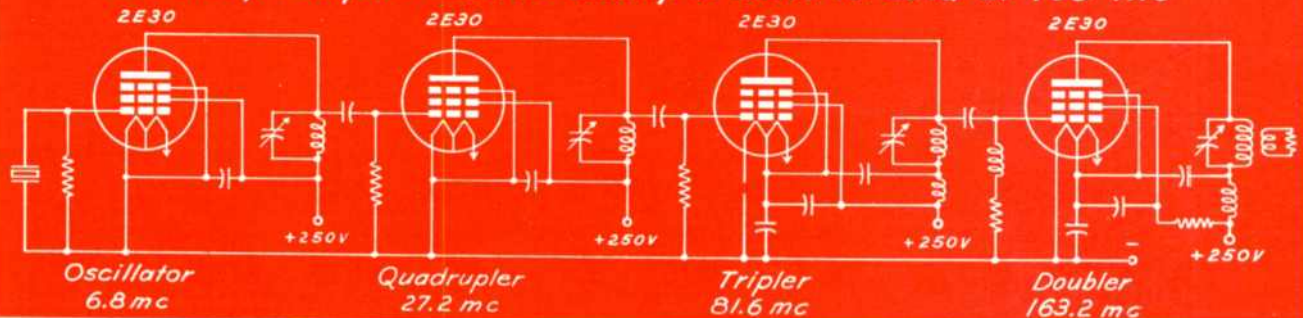

OLDEST MANUFACTURER SPECIALIZING IN RADIO RECEIVING TUBES



HYTRON

RADIO AND ELECTRONICS CORP.



MAIN OFFICE: SALEM, MASSACHUSETTS

Answers to your Questions about the SHURE "556" Super-Cardioid Broadcast Dynamic

Q. *What is meant by Super-Cardioid?*

Answer: Super-Cardioid is an improvement on the cardioid (heart-shaped) pickup pattern, which makes it even more unidirectional. "Super-Cardioid" reduces pickup of random noises by 73% as compared to 67% for the Cardioid, and yet has a wide pickup angle across the front.

Q. *To accomplish this, is it necessary to have two Microphones in a single case?*

Answer: No. The Shure "556" is designed according to the "Uniphase" principle, a patented Shure development which makes it possible to obtain the "Super-Cardioid" pattern in a single compact, rugged unit.

Q. *Over what range does the Shure "556" give quality reproduction?*

Answer: The Shure "556" provides a high degree of directivity, both horizontally and vertically over a wide frequency range from 40 to 10,000 cycles.

Q. *Does the Shure "556" reduce feedback?*

Answer: Yes! Reflected sounds and "spill-over" from loud speakers entering from the rear are cancelled out within the Microphone.

Q. *Can the Shure "556" be used outdoors?*

Answer: Yes. It is insensitive to wind and will withstand heat and humidity. The low impedance models may be used at practically unlimited distances from the amplifier.

Q. *Can the Shure "556" be used for Studio Broadcasting?*

Answer: More than 750 Radio Broadcast Stations in the United States and Canada use the Shure "556" in their studios. Because it can be placed with its back to the wall without picking up reflected sounds or echoes, it facilitates Microphone placement.

*Model 556A for 35-50 Ohm circuits—
LIST PRICE \$82*

*Model 556B for 200-600 Ohm circuits—
LIST PRICE \$82*

SHURE BROTHERS

*Designers and Manufacturers of Microphones
and Acoustic Devices*

225 West Huron Street, Chicago 10, Illinois

CABLE ADDRESS: SHURE MICRO



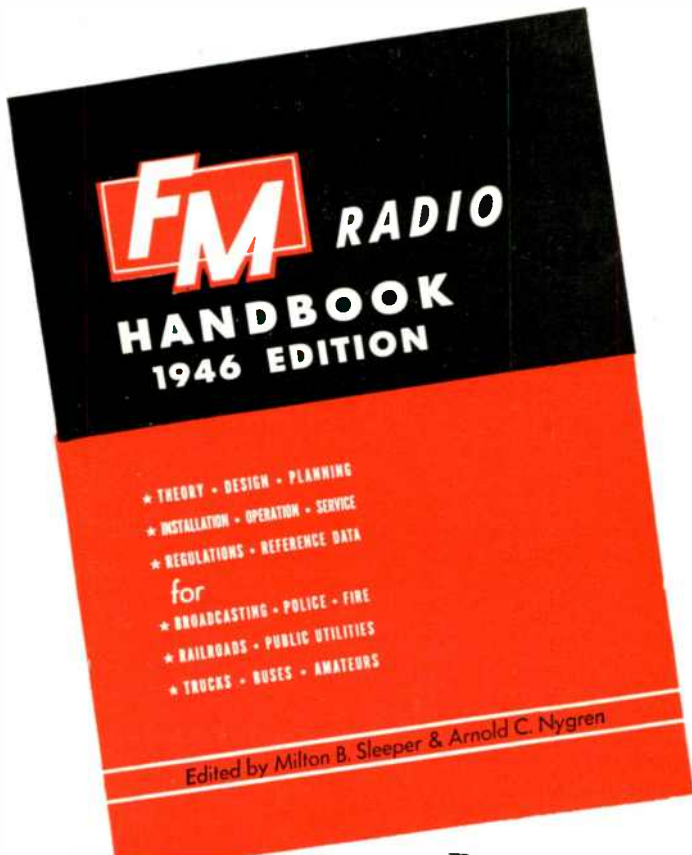

Essential Information for COMMUNICATIONS ENGINEERS in : The Standard Handbook of FM RADIO

Detailing Systems for 30 to 160 Mc. for Police, Fire, Railroads, Public Utilities



FREE

with your subscription to
FM and TELEVISION

For six years, FM and TELEVISION Magazine has been the leading source of information on FM communications equipment and installations. More articles and more detailed working data on these subjects have appeared in FM and TELEVISION than in all other radio publications combined.

These articles, written by specialists in the communications field, cover the design, installation, operation, maintenance, and performance of new equipment and systems incorporating new features of outstanding interest to communications engineers.

A subscription to FM and TELEVISION Magazine will keep you abreast of all developments in the rapidly expanding radio communications field. If you use the coupon on this page, we'll send you, without charge, a copy of the new FM HANDBOOK. Take advantage of this offer NOW, for it will be withdrawn without notice.

FM communications has become the most rapidly expanding field of radio development. With an enormous increase in frequencies made available by the FCC for this service, much new equipment has been brought out since the end of the war. New uses are being found for 2-way FM at such a rate that the FCC is swamped with license applications. In addition, many prewar AM installations are being replaced with FM systems.

All these postwar developments, from theory to application, are covered in the completely new FM RADIO HANDBOOK. This large volume, edited by men of long experience in FM communications, gives detailed, working information on all phases of 2-way installations, including the latest fixed and mobile equipment for operation on all the newly-assigned frequencies, antennas, unattended relays, selective dial calling, and maintenance methods. Also included is a complete Emergency Station Directory, listing details of all municipal, county, state, zone, fire, forestry, public utility, and special communications systems.

Individual chapters were written by men chosen for their outstanding achievements and experience in various branches of communications work. The FM RADIO HANDBOOK is no pocket-size compilation of condensed data, but a volume 8¾ by 11½ inches, profusely illustrated with hundreds of handsomely printed photographs and drawings.

All equipment and installations de-

scribed are of postwar design. Thus the HANDBOOK is a completely up-to-date guide to the very latest advances in communications practice.

In short, it is an essential book for engineers engaged in the manufacture, installation, operation, or service of communications equipment.

You can buy this book separately, or the paper bound edition will be sent FREE if you order a new, renewal, or extension subscription to FM and TELEVISION Magazine. Place your order NOW, for this special offer will be withdrawn without notice.

\$4.00 in lifetime library binding paper bound edition **\$1.50**

Order your FREE COPY NOW

FM and TELEVISION Magazine 511 Fifth Avenue, New York 17, N. Y.	
Enter my	<input type="checkbox"/> new subscription for <input type="checkbox"/> 1 yr. \$3.00 <input type="checkbox"/> renewal <input type="checkbox"/> 3 yrs. \$6.00
Add \$1.00 per year foreign postage; 50c Canada; send me ABSOLUTELY FREE a copy of the new FM RADIO HANDBOOK paper bound edition.	
Name.....	
Street.....	
City & Zone..... State.....	
My official position is:.....	
Company:.....	
NOTE: If you want your FM RADIO HANDBOOK in the lifetime library binding, add \$2.50 to the subscription prices above. 5	

FM AND TELEVISION

STATUS OF RAILROAD RADIO

(CONTINUED FROM PAGE 20)

running time and jointly determine locations at which sidings would be taken for trains of superior rights.

(f) Conductor and engineer would compare orders and messages hooked up to them while train is in motion.

(g) Conductor would advise engineer and head brakeman as to the location of cars to be switched and where to be spotted, and where cars are to be picked up at stations, in advance.

(h) Engineer would advise conductor of reason for unscheduled stops and they could jointly determine action necessary to get train in motion with minimum delay.

3. COMMUNICATION BETWEEN TRAINS ENROUTE AND WAY-STATIONS — 2-WAY SERVICE: (a) Conductors would report to way stations, for relay to dispatcher, any unusual stops or delays, which would enable the dispatcher to issue instructions changing meeting and passing points.

(b) Way stations could advise conductor of work to be done and of cars to be picked up and spotted, prior to the arrival of the train at the station. On many occasions this would involve work that could be performed at sidings in advance of arrival at

the depot, and the time required for returning to these locations would be saved, and this would also permit the conductor to proceed with his work immediately on arrival at the station.

(c) Information could be given to the conductor, and he in turn could pass it to the engineer, regarding conditions concerning the location of trains in trouble, and such trains could be rerouted or detained at certain points to avoid congestion.

(d) Conductor would be able to report details of any trouble experienced, such as accidents, equipment failures, or other emergencies.

4. EMERGENCY EQUIPMENT — PORTABLE: (a) Portable transmitters and receivers with suitable power supply would be provided at several convenient locations on the system for use in emergencies for bridging gaps in communication circuits due to storms, floods, etc., and also for use in restoring transportation service during floods and other emergencies.

The foregoing review of applications of radio communications to railroad operations is particularly significant because it was prepared by railroad men who are thoroughly experienced in the use of radio, rather than by radio men who have gained some knowledge of railroading. This point is stressed to emphasize the fact that

radio is an extremely versatile and adaptable art, while railroad operation is a highly complex business and must, by its very nature, be stabilized by standard practices which cannot be altered readily. Therefore, plans to provide radio service to a railroad system, large or small, will prove ultimately successful to the extent that the installation is designed to meet the limitations of the road's established practices and methods, and with the least dislocation to the habits of the personnel.

Future Progress ★ Railroad officials say that they have been criticized unfairly and without justification for not having made more rapid progress in the use of radio communications. They point to the investigations and tests of FM that were initiated during the war when, under WPB restrictions, they almost had to steal the equipment they used; and to the fact that no frequencies were assigned to this service until a few months ago. Then they ask: "Why talk about what we might have done at a time when it was physically impossible for us to have done it?"

Now, however, it is freely predicted that FM and the higher frequencies at last make possible the application of radio to railroad communications, and that this field will prove to be the industry's greatest new market.

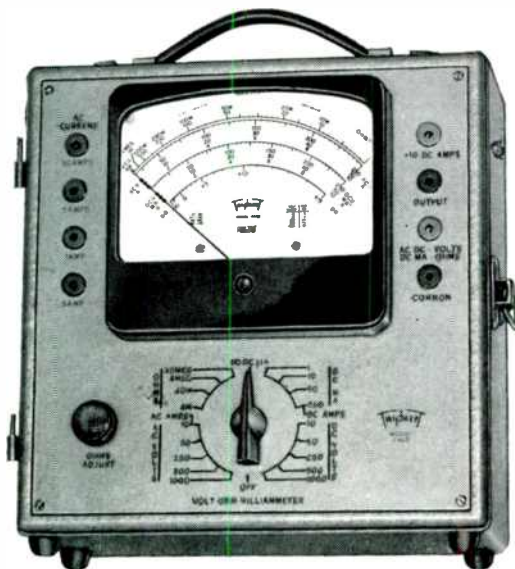

NEW ENGINEERING • NEW DESIGN • NEW RANGES 30 RANGES

- Voltage: 5 D.C. 0-10-50-250-500-1000 at 25000 ohms per volt.
5 A.C. 0-10-50-250-500-1000 at 1000 ohms per volt.
- Current: 4 A.C. 0-.5-1-5-10 amp.
6 D.C. 0-50 microamperes — 0-1-10-50-250 milliamperes—0-10 amperes.
- 4 Resistance 0-4000-40,000 ohms—4-40 megohms.
6 Decibel -10 to +15, +29, +43, +49, +55
Output Condenser in series with A.C. volt ranges.

Model 2100 is similar but has D.C. volts Ranges at 5000 ohms per volt.

Write for complete description

MODEL 2405

Volt•Ohm•Milliammeter

25,000 OHMS PER VOLT D.C.



SPECIFICATIONS

NEW "SQUARE LINE" metal case, attractive tan "hammered" baked-on enamel, brown trim.

■ **PLUG-IN RECTIFIER**—replacement in case of overloading is as simple as changing radio tube.

■ **READABILITY**—the most readable of all Volt-Ohm-Milliammeter scales—5.6 inches long at top arc.

■ **RED•DOT LIFETIME GUARANTEE** on 6" instrument protects against defects in workmanship and material.

Triplet

ELECTRICAL INSTRUMENT CO.

BLUFFTON OHIO.

A Buy-word for Excellence

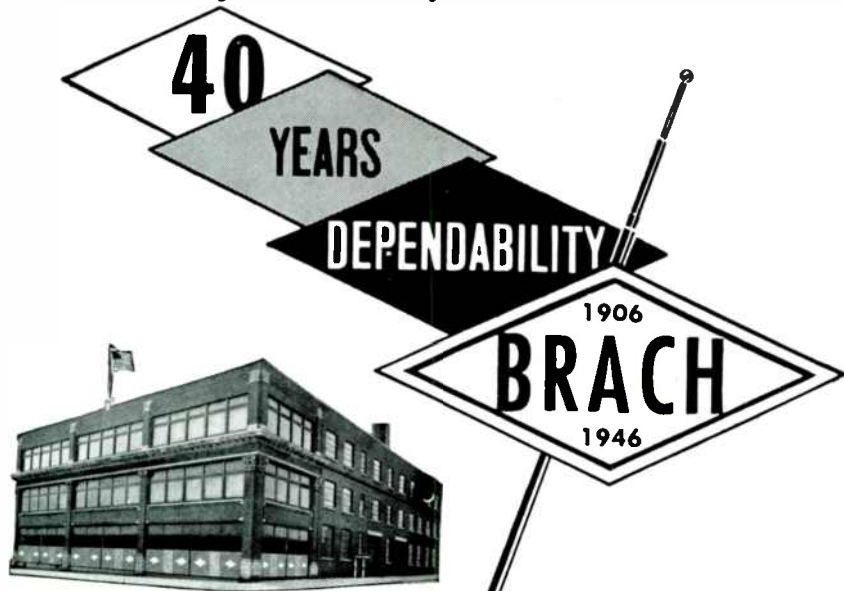

PUR-A-TONE ANTENNAS
Reg. Trade Mark

ALL TYPES FOR
 • AUTOS
 • HOMES
 • MARINE
 A.M. — F.M. — TELEVISION

Make pleased customers and bigger profits . . . ask your distributor for BRACH Puratone ANTENNAS.

Special-purpose transmitting antennas designed for volume production to your own specifications. Collapsible—sectional—direction finding — radar and coaxial type. All sizes, lengths and materials. Consult us on your needs.

L. S. BRACH MFG. CORP.
 200 CENTRAL AVENUE NEWARK, N. J.
 WORLD'S OLDEST AND LARGEST MANUFACTURERS OF RADIO ANTENNAS AND ACCESSORIES.

COMING!
 The Important, New
TELEVISION HANDBOOK
 By Madison Cawein
 to appear monthly in
FM AND TELEVISION MAGAZINE

18 YEARS IN RADIO

Latest developments in radio and electronic parts and devices, newest "Ham" gear, "Gadgets" to delight the experimenter, bargains in war surplus goods, all in new catalog for you.

BURSTEIN-APPLEBEE CO.,
 1012 McGee, Kansas City 6, Mo.
 Send me FREE new B-A Catalog. FM&T

I AM _____
 STATE CONNECTION IN INDUSTRY _____
 NAME _____
 ADDRESS _____
 TOWN _____ STATE _____

BIG CATALOG FREE

ENGINEERING SALES
 (CONTINUED FROM PAGE 8)

moved to the company's building at 4541 Ravenswood Avenue, Chicago. Vice-president E. J. Halter has announced that sales since February exceeded the volume of any 18 months in the company's history.

San Antonio: Mission Radio Distributors has moved to larger quarters at 814 S. Presa Street, San Antonio, Texas.

Sylvania: Has prepared a series of wall charts and explanatory folders for self-instruction radio courses. They cover basic electrical theory and information on vacuum tubes. This material is available on request from Sylvania Electric Products, Inc., Emporium, Pa.

Detrola: Harley R. Wall, who joined International Detrola last year as Michigan State radio sales manager, has been appointed sales manager for all home radio sets.

G.E.: Has initiated a bi-monthly bulletin called *G.E. Ham News*, devoted to information on new rigs and tricks, and data on amateur types of tubes. Editor is George H. Floyd, W6OJK/2. We understand that copies will be sent without charge to parts jobbers and hams who ask to have their names put on the mailing list. Requests should be sent to General Electric Company, Tube Division, Syracuse, N. Y.

Sams: New idea in complete service on home radio receivers has been introduced by Howard W. Sams & Company, Inc., 2924 E. Washington Street, Indianapolis, Ind. Individual data sheets not only show schematic wiring diagram, but list all the alignment procedure, voltage and resistance values, stage gains, and other information required for correct diagnosis of faults and quick repairs. Data published in these sheets is obtained from actual tests made on models submitted by set manufacturers.

Centralab

CRL

The Mark of QUALITY

THE initials "CRL" in the diamond represent the research-laboratory and technical manufacturing facilities of Centralab . . . a name outstanding for quality, precision and new developments in the field of radio and electronics.

Always Specify Centralab.

Send for Catalog No. 25.



Centralab

Division of GLOBE-UNION INC., Milwaukee

PRODUCERS OF



Ceramic Trimmers
Bulletin 695



Variable Resistors
Bulletin 697

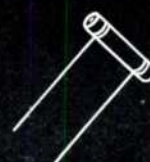

Tubular Ceramic
Capacitors
Bulletins 630 and 586



Selector Switches
Bulletin 722



Ceramic High Voltage Capacitors
Bulletin 814

**CHECK THE PATENTED
FEATURES AND GREATER
ECONOMY OF DRAKE
LIGHT ASSEMBLIES**



You'll lower production costs yet increase quality and efficiency with DRAKE Socket and Jewel Pilot Light Assemblies. Get the benefit of our patented features — of high speed precision methods and machinery developed through 15 years of specialization. Every conceivable type offered in standard and special designs. Refer to the newest DRAKE catalog for complete information. Do you have a copy?



DRAKE MANUFACTURING CO.

1713 W. HUBBARD ST., CHICAGO 22, ILL.

SPOT NEWS NOTES

(CONTINUED FROM PAGE 26)

be delivered. Installation of this 250-watt unit will be followed by the addition of amplifiers to bring the transmitter up to its assigned power of 20 kw. G. William Lang is chief engineer of WGNB and WGN.

Worms Squirm: The American Federation of Musicians has announced, through its president, the determination to stop all network music originating in New York, Los Angeles, and Chicago, if the Supreme Court upholds the Lea Bill.

This ultimate act of defiance against our lawmakers and our courts brings to mind the statement made previously in these columns that the broadcasters may find themselves in a stew they brewed themselves by continued temporizing, over a period of many years, with the AFM. Now, if this so-called labor union has set itself up as a racket to prey upon sponsors who, after all, pay radio's bills, it is because the stations have maintained a we'll-pay-but-don't-take-us-off-the-air policy. And this in spite of the fact that if they went off the air for 24 hours, they could rally greater public support than any other struck industry in this country.

Nevertheless, it is timely to ask what manner of men and women are these AFM members who propose to maintain a rulership over radio stations, and thus over radio listeners, as autocratic as the despotism of governments which the founders of our Country sought to escape when they came to these lands.

Facsimile Advertising: Is getting an initial workout over the Chicago Tribune's FM station WGNB. First advertisements, transmitted on May 25th, were for Marshall Field and the Illinois Bell Telephone Company. Tribune publisher McCormick has a recorder at his farm near Wheaton, Ill. Another, for public demonstration purposes, is operating at the Rosenwald Museum of Science and Industry.

Railroad FM: Westinghouse is now offering fixed and mobile FM communications equipment specifically designed for railroad service. Units are designed for 117 volts AC. This is supplied to mobile equipment by rotary converters running on 32 or 64 volts CC. Operation is in the 152- to 162-mc. band.

Chicago: Resistors, Inc., 2241 Indiana Avenue, Chicago 16 has been formed by Joseph J. Cerny, former president and founder of Lectrohm.

CBS-FM: Another FM station in Washington, D. C. is planned by Columbia, according to a newly-filed application. This is in addition to CBS station WABC-FM in New York and WBBM-FM Chicago, now on the air, and others projected in

(CONCLUDED ON PAGE 58)

BOOST KVA RATING BY FIVE OR MORE



● The new Aerovox Series 1780 water-cooled oil-filled mica capacitors handle exceptional KVA loads for their size. The higher KVA ratings are attained by: (1) Exceptional design — critical arrangement and location of sections; specially-plated parts; large cross-section of conductors, etc., and (2) Use of water-cooling system designed for maximum heat transfer from capacitor section to cooling coils.

All in all, sturdy, hard-working, compact, trouble-free mica capacitors for extra-heavy-duty service. Ratings up to 25,000 v. A.C. Test. Capacitances up to .01 mfd.

Details on Request



**FOR RADIO-ELECTRONIC AND
INDUSTRIAL APPLICATIONS**

AEROVOX CORP., NEW BEDFORD, MASS., U.S.A.
Export: 13 E. 40th St., New York 16, N.Y. • Cable: 'ARLAB'
In Canada: AEROVOX CANADA LTD., Hamilton, Ont.



THE idea of publishing a magazine of information on Frequency Modulation was conceived by Milton Sleeper, whose contributions to the radio industry as an engineer, manufacturer, and publisher date back to 1916.

His FM experience in 1939 and 1940 as sales manager for Pilot Radio Corporation, one of the first Armstrong licensees, proved that there was an urgent need for such a publication. In the fall of 1940, having resigned from Pilot Radio, he brought out the first issue of FM, dated November, 1940.



HARDLY had FM MAGAZINE become established when the United States entered the second World War. Over night, this cut off the applications for FM broadcast stations which were then pouring into the FCC, and stopped the rising production of FM home receivers.



However, Frequency Modulation was gaining a firm hold on the communications field because of its demonstrated success in police and military services. The editorial content of FM MAGAZINE followed this trend, and the explanatory sub-title RADIO-ELECTRONIC ENGINEERING & DESIGN was added to the original name in May, 1942.



FM MAGAZINE prospered with the expanding use of Frequency Modulation in new wartime communications services. Many letters of congratulations were received from civilian and military engineers, commenting on the highly useful job that this journal was doing in spite of wartime restrictions.

There were complaints, however, that the appearance of our front cover had been spoiled by the lengthy sub-title. Therefore, in March, 1943, as a concession to those who had gone all out for the word "electronics," the sub-title was reduced to: RADIO-ELECTRONICS.



THEREUPON, both readers and advertisers demanded: "Are you going to make FM MAGAZINE into another electronics paper?" The answer was "No!" FM MAGAZINE had made its place as "the complete and authoritative source of information on Frequency Modulation," and would not abandon that position.

The only change in editorial policy since 1940 was the addition of articles on television. So, to identify the contents accurately, the sub-title was changed in April, 1944 to AND TELEVISION. That seemed to satisfy everyone.

However, it appears that those changes have not altered the habits of readers and advertisers. In both conversation and correspondence, the name FM has stuck, except among those who choose to be so formal as to identify this publication as "Frequency Modulation Magazine."

DID YOU GET YOUR FREE BARGAIN GUIDE?



**RADIO BARGAINS BY THE HUNDREDS
PACKED INTO THIS LATEST RWT FLYER!!**

Who but the largest name in Radio Values would bring you bargains like these NOW! For twenty-five years we've been scouring the markets for you engineers, servicers, hams and experimenters. Send for this bargain flyer and see the values RWT has for you in nationally known merchandise. Clip convenient coupon NOW!

SPECIAL!!!

Another RWT achievement! Use this versatile xmitter tube as a modulator-oscillator-amplifier! Filament voltage: 5 or 10 volts. Plate: 3,000 volts. Plate current: 900 ma. Plate dissipation: 300 watts. Limited quantity only.

304TH
Xmitter tube now
being sold at
\$50 elsewhere

RWT's price
to you,
only... **\$9.95**

**USE
COUPON
TO
ORDER!
MAIL
TODAY!**

**Radio Wire
Television Inc.**

• NEW YORK 13 • BOSTON 10 • NEWARK 2

Originators and
Marketers of
the Famous

Lafayette Radio

RWT Dept. HF6
100 Avenue of the Americas, New York 13.
Gentlemen: Enter my order for xmitter
tube(s).
 Check enclosed. M. O. Send C.O.D.
 Send me FREE copy of your latest BARGAIN
GUIDE C37 and place my name on list for your
NEW SUPER CATALOG.

NAME.....

ADDRESS.....

CITY..... ZONE..... STATE.....

Paste on Penny Postcard.

SPOT NEWS NOTES

(CONTINUED FROM PAGE 56)

Boston, Los Angeles, St. Louis, and Minneapolis.

Merger: In accordance with arrangements consumated on May 31st, Submarine Signal Company was merged into Raytheon Manufacturing Company. J. P. Morgan & Company was designated as agent for the exchange of 5½ shares of Raytheon common for each share of Submarine capital stock.

St. Louis: Recently established St. Louis Microphone Company will move into its newly-constructed building at 2726 Brentwood Boulevard on August 1st. Officials include R. H. Mayer, vice-president and general manager; R. M. Bennett, chief engineer; L. Summer, sales engineer; and G. W. Tucker, sales manager. New line include microphones for all purposes.

Boston: Don G. Mitchell, former executive vice president of Sylvania, has been elected president, succeeding Walter E. Poor, who was elevated to the board chairmanship. Also at Sylvania, Virgil M. Graham, formerly industrial apparatus plant manager, has been appointed manager of technical relations under E. Finley Carter, vice president in charge of engineering.

RADIO ELECTRONIC PARTS

CHASSIS

CABINETS

DIAL PARTS

BOXES - CASES

Other sheet metal fabricated components manufactured to specifications.



Inquiries
 Invited

ALLOY ASSOCIATES CO.

149 BROADWAY
NEW YORK 6, N. Y.

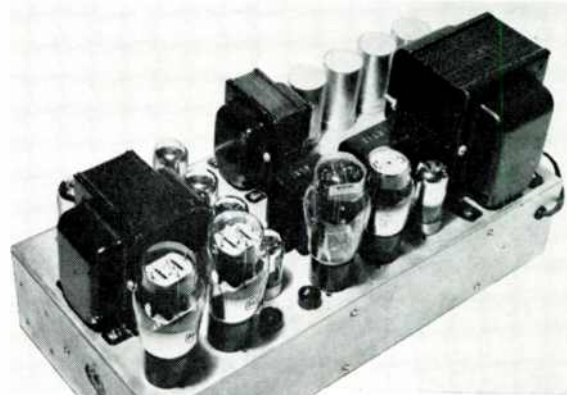

The BROOK High Quality Audio Amplifier Designed by Lincoln Walsh

Built to give the lowest possible distortion
AT 5 WATTS, 2nd harmonic is 0.6%—3rd harmonic is 0.3%.
Higher harmonics not measurable.
Cross modulation less than 0.2%.

AT 35 WATTS, total distortion is 6%.

No transformer saturation at 35 watts at 25 cycles. Frequency Response 20 to 20,000 cycles 0.2 db. Uses all triodes in a patented circuit with automatic bias control. Output 2—2A3's.

BROOK ELECTRONICS, INC.

ELizabeth 2-7600

Elizabeth 2, N. J.

there is
NO SUBSTITUTE

for GOOD communications
and industrial wire. We are
shipping you more and
more of it now . . .



WIRES



cornish
WIRE COMPANY, INC.



15 Park Row, New York 7, N. Y.

"Made by Engineers for Engineers"

Carter

The Finest

ROTARY POWER SUPPLY



The Carter Super Dynamotor illustrated above is the preferred power supply of leading mobile radio manufacturers, and is operating in over 42 State Police radio networks.

Ideally suited for Police, Marine, Aircraft, Railroad, and other mobile communications, the Super provides unequalled efficiency, reliability, and stamina for mobile transmitters. Write for latest bulletin of Carter Products today!

SALES OFFICES IN PRINCIPAL CITIES



1605 Milwaukee Avenue

Cable: Genemotor

RAILROAD RADIO SPECIFICATIONS

(CONTINUED FROM PAGE 42)

P—Warranty: The seller/contractor shall warrant that the equipment furnished under this specification shall be free from defects in design, material and workmanship. The seller/contractor's obligation under this warranty shall not apply to any equipment which has been subject to misuse, negligence or accident after acceptance.

The contractor/seller shall covenant and agree to save harmless and indemnify the purchaser against all claims, suits, actions or proceedings, damages, costs, fees, and expenses by reason of alleged infringement of patents or for royalties involved, in consequence of the purchase or use of the equipments covered hereby.

TRANSMISSION LINES

(CONTINUED FROM PAGE 31)

with an "O" ring, a rubber gasket of circular cross section, and the inner conductor connection is made with a slotted spring-temper connector.

Fig. 12 shows 90° and 45° elbows using flanged connectors, and Fig. 13 illustrates a solderless flanged coupling device used when one of the 20-ft. sections must be cut in the field. Fig. 14 represents a gas inlet fitting which can be inserted between flanges on the ends of 20-ft. sections, while Fig. 15 shows a design for an expansion fitting. All these fittings are carefully designed to introduce only negligible reflections when inserted in a transmission line of 51.5 ohms impedance.

Since, in normal operation, the inner conductor develops some temperature rise, a means is required for absorbing its expansion with respect to the outer conductor. One satisfactory solution utilizes the inner conductor connector as a differential expansion joint. The design of this part, Fig. 11, permits variations in engagement with both inner conductors sufficient to accommodate any normal increase in length.

Inner conductor support on vertical runs is provided by a groove rolled into the outer conductor on one side of the bottom bead, as shown in Fig. 16. Each 20-ft. section of inner conductor then rests on its own bottom bead, and any motion due to differential expansion must be upwards. On horizontal runs, alternate 20-ft. sections are reversed, as shown in Fig. 17. This arrangement causes the motion due to differential expansion in successive 20-ft. sections of inner conductor to be alternated in direction, thereby preventing inner conductor creep.

The construction illustrated in Figs. 16 and 17 provides adequate mechanical support for the inner conductor, eliminating entirely the need for anchor joints.

Part 2 will be published next month.

Laboratory Standards

By
MEASUREMENTS CORPORATION



**FM SIGNAL GENERATOR
MODEL 78-FM**

RANGE: 86 to 108 megacycles
OUTPUT: 1 to 100,000 microvolts
Individually Calibrated Dial



**PULSE GENERATOR
MODEL 79-B**

RANGE: 50 to 100,000 cycles
In three ranges
PULSE WIDTH: 0.5 to 40 microseconds
OUTPUT: 150 volts

- MANUFACTURERS OF**
- Standard Signal Generators
 - Pulse Generators
 - FM Signal Generators
 - Square Wave Generators
 - Vacuum Tube Voltmeters
 - UHF Radio Noise & Field Strength Meters
 - Capacity Bridges
 - Megohm Meters
 - Phase Sequence Indicators
 - Television and FM Test Equipment

Catalog on request

MEASUREMENTS CORPORATION
BOONTON NEW JERSEY



**FOR HAMS—
EXPERIMENTERS—MANUFACTURERS**

NEW PRODUCTS

Small "butterflies" in a convenient variety of capacities for VHF and UHF.

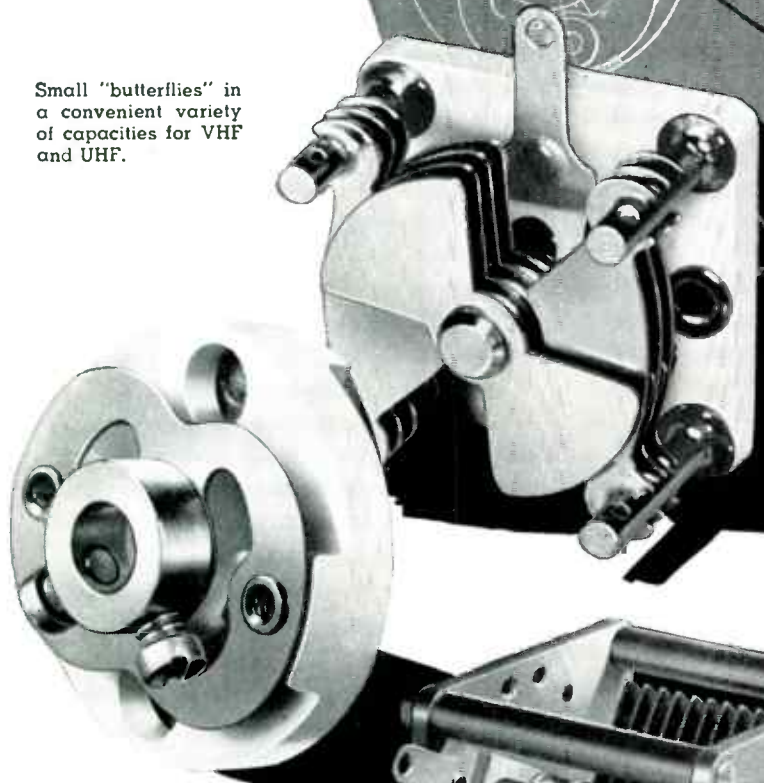

Flexible couplings in two types—insulated and non-insulated.

"RMC," a rugged midget for mobile and other uses requiring great mechanical rigidity.

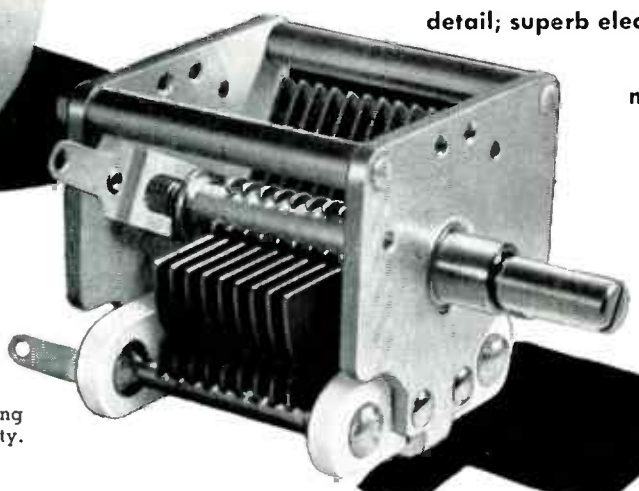

HAMMARLUND

THE HAMMARLUND MFG. CO., INC., 460 W. 34TH ST., NEW YORK 1, N. Y.
MANUFACTURERS OF PRECISION COMMUNICATIONS EQUIPMENT

New and improved mechanical detail; superb electrical design; precision manufacturing—Three basic qualities of every Hammarlund product.

Write for technical bulletins.

FM AND TELEVISION

For Better Remote Broadcasts . . .



Construction is compact and clean



...Complete in One Package!

The light weight, small size, a-c or battery operated Collins 12Z remote amplifier is a modern contribution to the furtherance of high quality remote broadcasts. Its frequency response of 30-12,000 cps \pm 1.0 db and noise level of more than 55 db below program level are in keeping with high fidelity AM and FM standards.

The 12Z features excellent performance, program protection, and convenience. Stabilized feedback maintains program quality over a wide variation of operating conditions. The self-contained batteries are connected automatically should the a-c power source fail. If the program line should fail, a twist of a knob connects a second line. The four microphone input channels have individual attenuator controls, in addition to the master control. The large, illuminated VU meter reads output level or operating voltages.

Complete in one package, the equipment weighs only 40 pounds and can be carried readily by one person. Transportation and set-up problems are reduced to a minimum. Maintenance is greatly simplified through advanced chassis design. Write us for full information.

Collins Radio Company, Cedar Rapids, Iowa

11 W. 42nd St., New York 18, N. Y. • 458 S. Spring St., Los Angeles 13, Cal.

Specifications:

Mixing channels: four
 Gain: approximately 90 db
 Frequency response: 30-12,000 cps \pm 1.0 db
 Noise level: more than 55 db below program level
 Distortion: less than 1% from 50-7500 cps
 Input impedance: 30/50 ohms. 200/250 ohms on special order
 Output impedance: 600 ohms (150 ohms available)
 Power output: 50 milliwatts (+17 dbm)
 Power source: 115 volts a-c, or self-contained batteries
 Batteries: standard types, easily obtained
 Weight: 40 lbs. complete
 Size: 14 1/2" w, 11 1/2" h, 8 1/4" d

FOR BROADCAST QUALITY, IT'S . . .



The **BIG** DIFFERENCE
IN PERFORMANCE

IS THE *Link* TYPE 3XA
HIGH GAIN ANTENNA

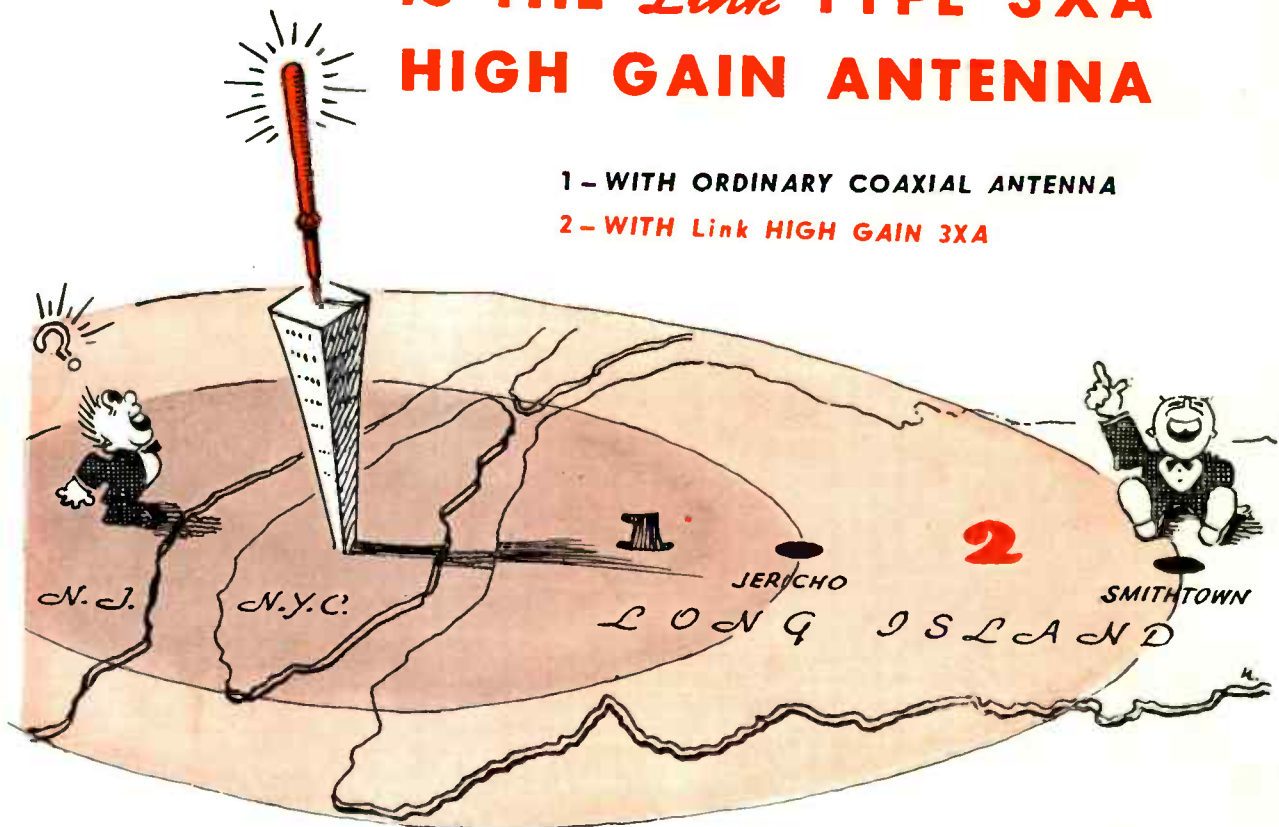

1 - WITH ORDINARY COAXIAL ANTENNA

2 - WITH *Link* HIGH GAIN 3XA

The same preferred features that have made Link FM radio communications equipment the recognized leader in every emergency service field, plus added wartime developments are now incorporated in Link 152-162 mc main stations (Type 1907 and 1908) and mobile units (Type FMTR-7C).

The Link Type 3XA, a specially and recently developed colinear coaxial radiator for use with Link 152-162 mc radio communications systems has a power gain

of approximately 3 in all directions.

The effect of using this Link 3XA antenna in a Link 152-162 mc main station installation is the same as increasing the effective power of ALL transmitters in the system, both mobile and main station by approximately 3 times. Thus without sacrificing coverage there is an economical factor in initial outlay with conservative equipment rating and low battery drain mobile units.

Full information will be mailed on request.

ENGINEER • MANUFACTURER

Fred M. Link

125 WEST 17th STREET • NEW YORK 11, N. Y.

PREFERRED *FM* RADIO
COMMUNICATION EQUIPMENT