



AND TELEVISION

**RADIO PRINTER FOR
WORLD-WIDE SYSTEM**

SEE PAGE 3



Directory of R. R. Signal Engineers

★ ★ *Edited by Milton B. Sleeper* ★ ★

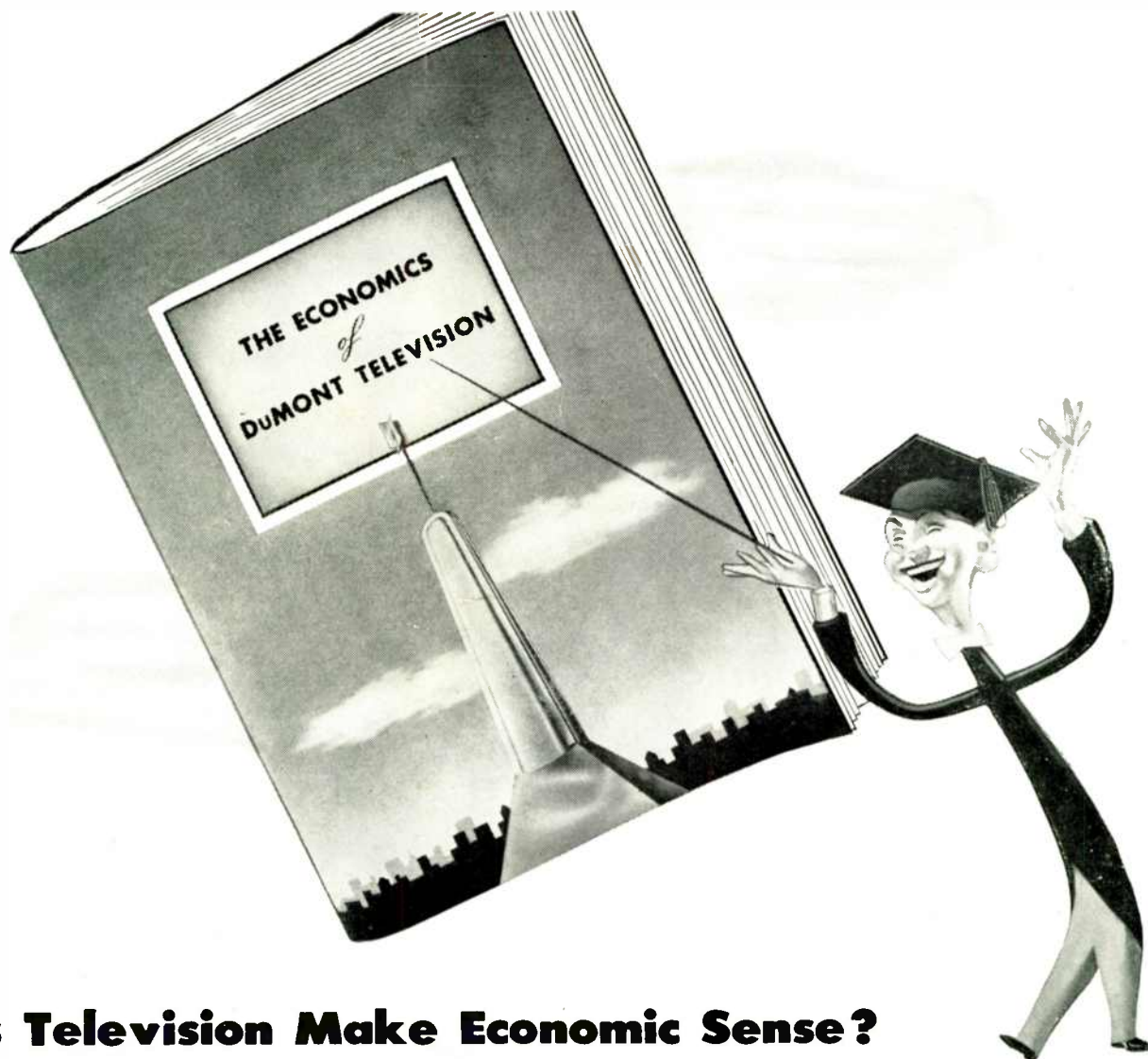

Does Television Make Economic Sense?

What capital investment is required for a full-service television station? What will be its annual operating cost? What is the revenue expectancy from time sales? What is a fair tele-time rate? Shall rehearsal time be charged for? How will a network affiliation affect profits?

These hard-headed questions are boldly and frankly answered with exciting facts and figures in DuMont's new booklet: "The Economics of Television"—just off the press!

DuMont's answers are backed by DuMont's

extensive experience in developing television broadcasting equipment, in building more tele-stations than any other company, in designing and constructing DuMont's new John Wanamaker Studios, in operating its own tele-station since 1941, and by continuous laboratory, market and audience research.

Television experts generally are agreed that DuMont has the "tele-know-how" needed to set a pattern for profitable station management. This new booklet makes such a pattern available. Please request it on your firm letterhead.

Copyright 1945, Allen B. DuMont Laboratories, Inc.



ALLEN B. DUMONT LABORATORIES, INC., GENERAL OFFICES AND PLANT, 2 MAIN AVENUE, PASSAIC, N. J.
TELEVISION STUDIOS AND STATION WABD, 515 MADISON AVENUE, NEW YORK 22, NEW YORK

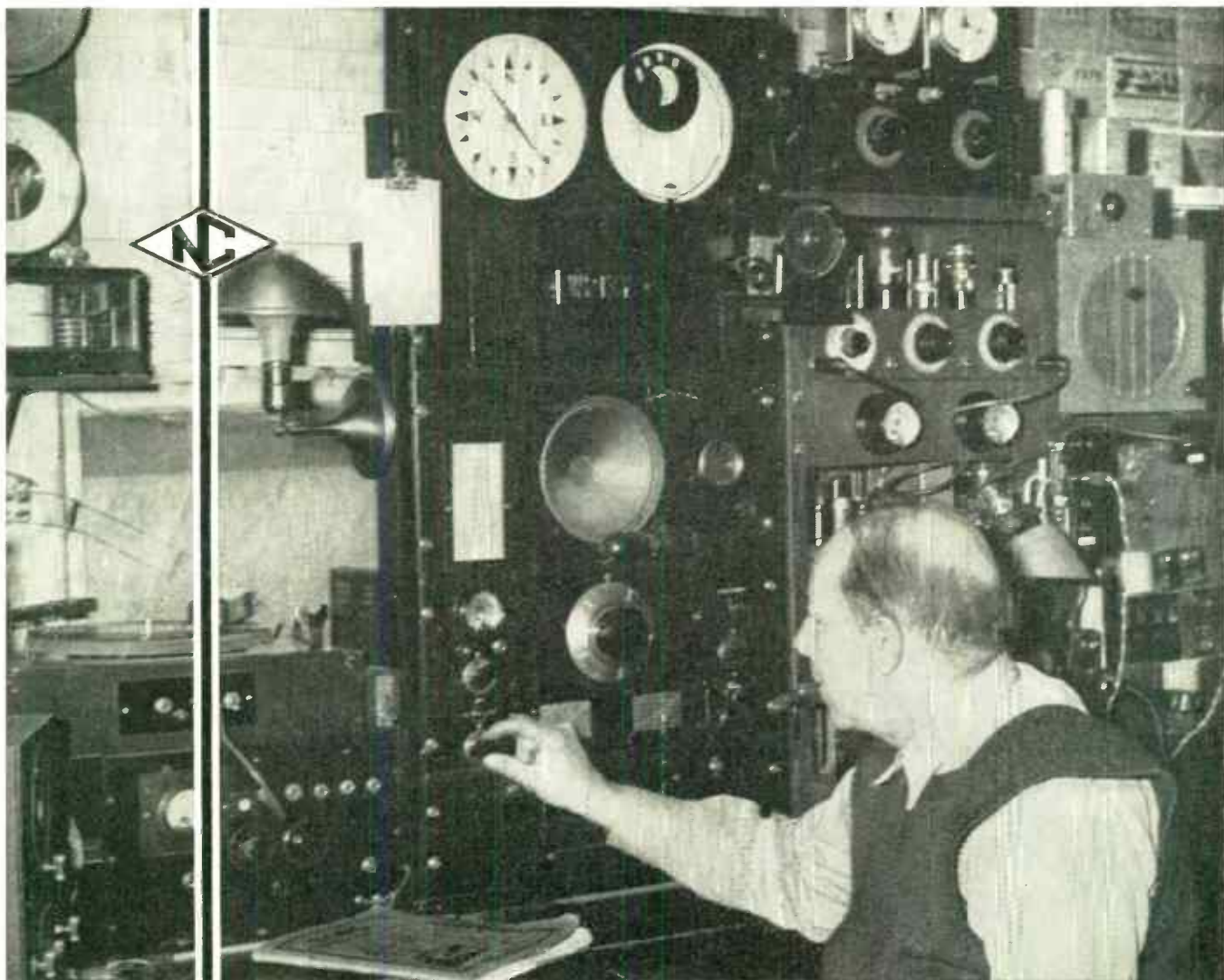

CAPTAIN HORACE L. HALL, U.S. Merchant Marine, retired, at his home in Springfield, L.I., N.Y., made daily recordings of transmissions from Australia, for more than four years, missing but four days. The apparently harmless news broadcasts kept the Australian Government in New York and Washington informed of every phase of the progress of the war, by a pre-arranged code.

The National HRO, used for this remarkable accomplishment is the first ever to have been shipped into the New York area and is over ten years old.

NATIONAL COMPANY INC., MALDEN, MASS.

COMCO

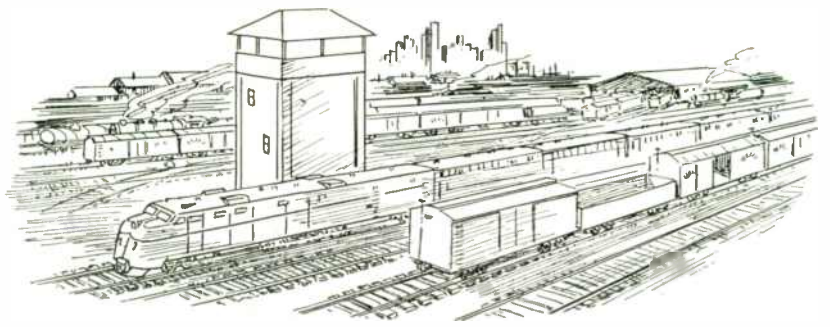

IS NOW DELIVERING

No phone wires or carrier lines to go out in emergencies. FM space Railroad Radio Control, as engineered by COMCO, bores through to the head end from tower or caboose under adverse conditions. For high-line or classification yard work, you can count on COMCO units, engineered by men who have pioneered practical two-way transportation control for 16 years. And they are ready NOW for delivery.

RAILROAD FM RADIO CONTROL

Proven in Long Operational Tests

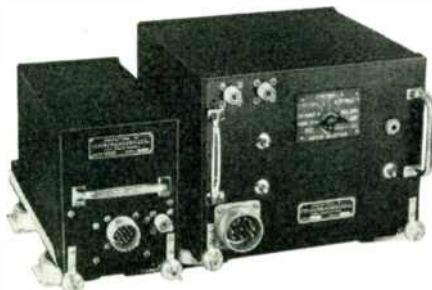

MOBILE 2-WAY UNITS

First in VHF! These two COMCO mobile units, engineered for use together and with the fixed equipments illustrated to the right, supply proven space radio control over remarkable distances. Frequency range: 152-162 Mc. 172-T FM Transmitter 10" x 12" x 9"; 13 pounds; required power supply available: 15 watts.

173-R FM Receiver 6" x 12" x 7½"; 7½ pounds. Matched to other COMCO units shown for dependable space radio operation.

Write for Complete Details

FIXED 2-WAY UNITS

Frequency Range: 152-162 Mc. 170-3C FM Transmitter 48" x 23" x 18". Readily accessible. Designed specifically for fixed-station transportation transmitting work, and demonstrated over very difficult rights of way.

132-3R FM Receiver 14½" x 19" x 5¼". Matched for precise working of mobile units and, like all COMCO equipment, protected from shock, and the effects of temperature and humidity extremes.



MANUFACTURERS OF RADIO & ELECTRONIC EQUIPMENT



COMMUNICATIONS COMPANY, Inc.

CORAL GABLES 34, FLORIDA



AND TELEVISION

FORMERLY: FM, and FM RADIO-ELECTRONICS

VOL. 5

DECEMBER, 1945

NO. 12

COPYRIGHT 1945, Milton B. Sleeper

CONTENTS

WHAT'S NEW THIS MONTH

Railroad Radio—Globe Wireless, Ltd.—Color Television. . . . 4

PROGRESS REPORT ON RAILROAD FM

Arnold Nygren. 23

THE PHASITRON MODULATOR TUBE

Dr. Robert Adler. 30

CATHODE-RAY TUBES

Dr. P. S. Christaldi and I. E. Lempert. 36

TEMCO 250-WATT FM TRANSMITTER

Samuel L. Sack. 46

FM HANDBOOK, Chapter 8, concluded

Burt Zimet. 54

INDEX OF ARTICLES AND AUTHORS

January, 1945 to December, 1945. 62

SPECIAL DEPARTMENTS

What's New This Month. 4

Engineering Sales. 8

Spot News Notes. 32

News Picture. 33

Directory of Railroad Communications Officials. 64

THE COVER DESIGN AND CONTENTS OF FM AND TELEVISION MAGAZINE ARE FULLY PROTECTED BY U. S. COPYRIGHTS, AND MUST NOT BE REPRODUCED IN ANY MANNER OR IN ANY FORM WITHOUT WRITTEN PERMISSION

MILTON B. SLEEPER, *Editor and Publisher*

ARNOLD NYGREN, *Associate Editor*
WILLIAM T. MOHRMAN, *Advertising Manager*
ANDREW GLIER, *Circulation Manager*
STELLA DUGGAN, *Production Manager*
Published by: FM COMPANY

Publication Office: 264 Main St., Great Barrington, Mass. Tel. Great Barrington 1014
Advertising Office: 511 Fifth Avenue, New York 17, Tel. VA 6-2483

Chicago Representative:

MARIAN FLEISCHMAN, 360 N. Michigan Ave., Tel. STAt 4822

West Coast Representative:

MIL0 D. PUGH, 35 S. Raymond Ave., Pasadena 1, Calif. Tel. Madison 6272

FM Magazine is issued on the 20th of each month. Single copies 25¢ — Yearly subscription in the U. S. A. \$3.00; foreign \$4.00. Subscriptions should be sent to FM Company, Great Barrington, Mass., or 511 Fifth Avenue, New York 17, N. Y.

Contributions will be neither acknowledged nor returned unless accompanied by adequate postage, packing, and directions, nor will FM Magazine be responsible for their safe handling in its office or in transit. Payments are made upon acceptance of final manuscripts.



THIS MONTH'S COVER

AS A RESULT of the need for maintaining communications with our Army and Navy in all parts of the world during the war, U. S. companies have acquired a strong position in the manufacture and operation of radio communications equipment and systems. Now, under new international agreements, telephone and telegraph services will be expanded throughout the world, and at home, land lines will be superseded to a large extent by radio relays. Latest entry in this far-flung expansion is ship-operator Dollar's Globe Wireless, Ltd. This month's cover shows Globe vice presidents Gen. Walter P. Boatwright, left, and Walter Lemmon with his Radiotype, the rights to which have been acquired by Globe from IBM.

How High?

Should future developments in electronic communications (either audio or video) require vertical radiators of extreme height look to Blaw-Knox for the kind of structural engineering which will assure the success of such towers.

Thousands of installations, ranging from 66 ft. to 1000 ft., are ample proof that you can rely on Blaw-Knox for complete responsibility in the fabrication, erection and testing of complete antenna systems.

BLAW-KNOX DIVISION
OF BLAW-KNOX COMPANY
2046 FARMERS BANK BLDG.
PITTSBURGH • PENNSYLVANIA

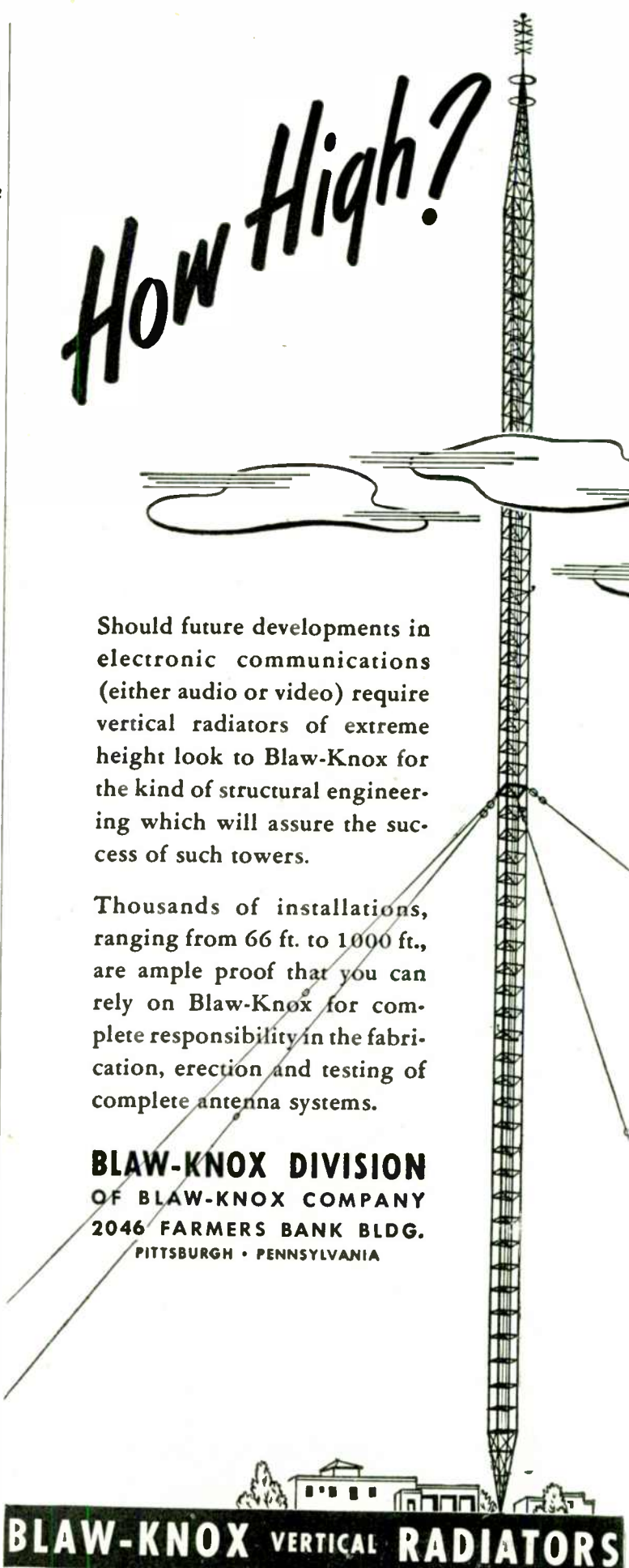

BLAW-KNOX VERTICAL RADIATORS

WHAT'S NEW THIS MONTH

1. RAILROAD RADIO
2. GLOBE WIRELESS, LTD.
3. COLOR TELEVISION

1. *The following comment on railway communications was received from one of our foremost consulting engineers, accompanied by the request that his name be withheld because the observations are too frank to be identified with an office handling clients in the railroad industry:*

☞ To me, the art of communication has always meant long wire lines, telephones, radio, high speed facsimile, and the like. It was quite a surprise, therefore, to come across an industry in which slow hand-keying by not-too-expert Morse operators was the epitome of modernity. It seemed shocking that in one of our greatest industries, individuals too far apart to shout at each other usually walked until the distance between them was adequately reduced, or they waved odd sheets of cloth or paper or smelly oil lamps when the visibility permitted.

That is what the railroads have been using while other industries spent untold amounts on radio and telephone lines. Instead of using facsimile, they exchange written messages, picking them up by a system plagiarizing the great sport of catching rings in the round-a-bout at county fairs. Of course this, like many elementary arts, has become truly an art, though not a science — an art borne of long experience and trudging perseverance, to which the roads adapt their men, for no railroadman, at least none I have met, has worked less than twenty years on the road. After the first ten years or so, it appears that they begin to know something about communications. They learn that if they walk 200 yards at a certain part of the line from the caboose it will be possible to get in sight of the engine if the train is a certain length, but if it is longer it is better to go in another direction in which it will be necessary to walk 220 yards.

Here, as in all real arts, there are to be found these pretty vistas reflecting the true spirit of the early pioneer, where the beautiful and quaint atmosphere of history can be studied. I discovered this in the method of the railroadman who cutely and appropriately brings his right hand to his nose and waves his left in smooth, gentle arcs over his head when he spies a hot box.

My research in railroad communication.
(CONTINUED ON PAGE 80)



New!

A SIMPLIFIED VERTICAL MOUNTING FOR SMALL TRANSFORMERS

Sizes fit Core Stacks with
 $\frac{1}{2}$ " to $\frac{7}{8}$ " center legs

To fully mount the smaller sizes of transformers, Chicago Transformer has developed a new, vertical, shield-type construction possessed of many outstanding characteristics.

- Readily adaptable to various chassis mounting requirements.
- Flexible in application to varying core thicknesses.
- Simple in design: two-unit construction makes for economy.
- Allows grounding of core by direct contact with mounting surface.
- Meets the requirements of the Underwriters' Laboratories.

CHICAGO TRANSFORMER

DIVISION OF ESSEX WIRE CORPORATION

3501 WEST ADDISON STREET

CHICAGO, ILL.



TRADE MARK REG.



SYLVANIA NEWS

ELECTRONIC EQUIPMENT EDITION

DEC.

Published by SYLVANIA ELECTRIC PRODUCTS INC., Emporium, Pa.

1945

NEW, SENSATIONALLY SMALL SYLVANIA TUBE WILL PERMIT RADIOS OF CIGARETTE-PACK SIZE

Fuze-Type Tube Adaptable To All Battery Sets

Sylvania Electric announces a revolutionary new radio tube, the size of a peanut, which is as significant to the development of sets as the famous Sylvania Lock-In Tube.

Originally designed as the T-3 fuze-type tube, this tiny electronic unit is the commercial version of the radio proximity fuze tube developed by Sylvania. These tubes are being made

in low-drain filament types. They have long life and are so rugged that they won't break when dropped. Their low-drain characteristics take advantage of a new miniature battery developed during the war — permitting the design of radios ranging from the size of a package of cigarettes up to a deluxe farm receiver.

The new, tiny, complete electronic

unit will provide electrically and mechanically superior features similar to the Sylvania Lock-In Tube. Since the T-3 type of tube was originally designed to withstand the shock of travelling inside a spinning artillery shell, it will be even more rugged than the Lock-In, which has become known for its superiority for all types of sets.

THE T-3 TUBE LINES UP WITH OTHER FAMOUS SYLVANIA TUBES

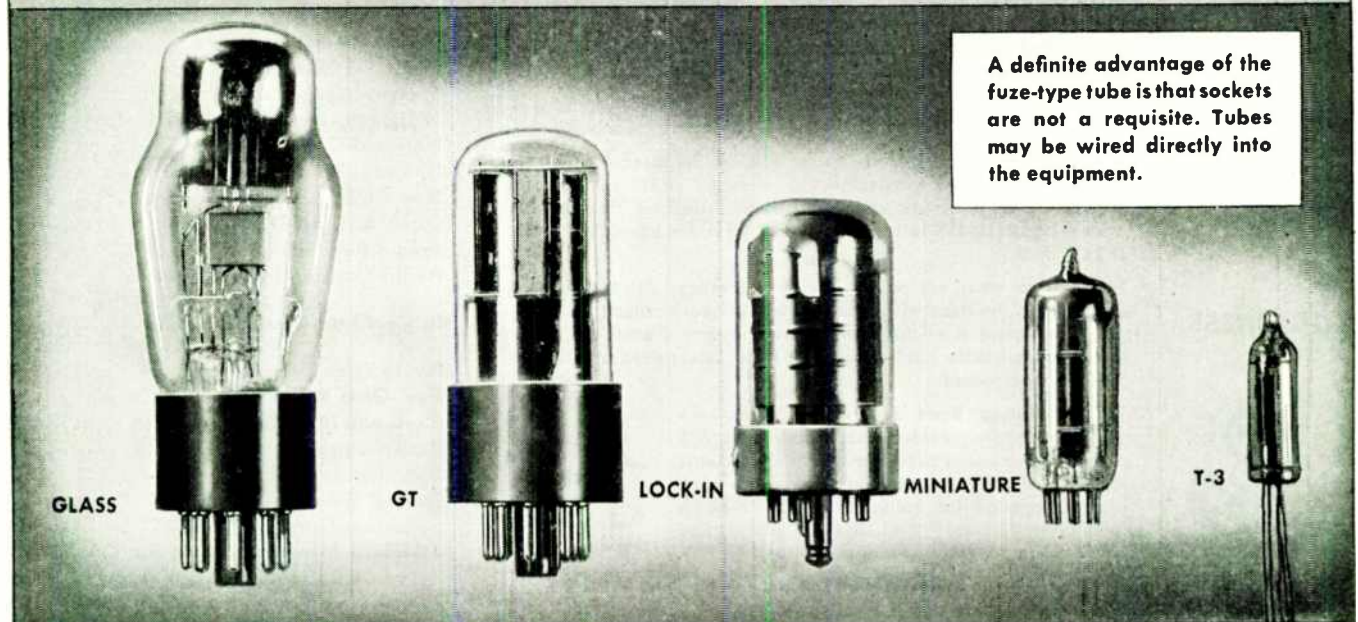

SYLVANIA ELECTRIC

Emporium, Pa.

MAKERS OF RADIO TUBES; CATHODE RAY TUBES; ELECTRONIC DEVICES; FLUORESCENT LAMPS, FIXTURES, WIRING DEVICES; ELECTRIC LIGHT BULBS

December 1945 — formerly FM RADIO-ELECTRONICS

World Radio History

How to Get Your Money's Worth in FREQUENCY METERS

ADVERTISERS INDEX

Aerovox Corp.....	83
Aireon Mfg. Corp.....	69
Altec Lansing Corp.....	74
American Phenolic Corporation....	11
Amperite Company.....	80
Andrew Company.....	21, 77
Bentley, Harris Mfg. Co.....	70
Blaw-Knox.....	3
Boonton Radio Corp.....	80
Browning Laboratories, Inc.....	20
Burstein-Applebee Co.....	67
Capitol Radio Eng. Inst.....	79
Centralab.....	Facing 16
Chicago Transformer Corp.....	4
Cinaudagraph Corp.....	74
Commercial Radio Equip. Co.....	21
Communications Company, Inc.....	2
Communications Parts.....	82
Corning Glass Works.....	76
Doolittle Radio, Inc.....	68
Drake Mfg. Corp.....	78
Dumont Laboratories, Inc., Allen B.	

Inside Front Cover

Eitel-McCullough, Inc.....	61
Electrical Reactance Corp.....	68
Federal Tel. & Radio Corp.....	73
Finch, Telecommunications, Inc.....	17
FM Company.....	67
Freeland & Olshner Products, Inc..	21
Galvin Mfg. Corp.....	15
General Electric Company.....	18, 19, 71
Hallicrafters Co.....	22
Hammarlund Mfg. Co., Inc.....	84
Harvey Radio Labs., Inc.....	10
Jansky & Bailey.....	21
J-B-T Instruments, Inc.....	6
Jensen Radio Mfg. Company.....	63
Kaufman, Robert L.....	21
Keel, John J.....	21
Kluge Electronics Co.....	21
Langevin Company.....	14
Link, F. M.....	Back Cover
May & Bond.....	21
McKey & Shaw.....	21
Measurements, Inc.....	74
Mossman, Donald P., Inc.....	8
National Company, Inc.....	1
National Union Radio Corp.....	75
Newark Electric Co.....	67
Onan & Sons, D. W.....	65
Presto Recording Corp.....	7
Radio Corporation of America	

41, 42, 43, 44

Radio Engineering Labs, Inc. Inside Back Cover

Radio Wire Television, Inc.....	83
Ray, Garo W.....	21
Raytheon Mfg. Co.....	12, 13
RCA Communications, Inc.....	21
Rogan Bros.....	67
Russell Electric Co.....	Facing 17
Selenium Corp. of Amer.....	81
Standard Measuring & Equip. Co...	21
Sylvania Electric Products, Inc.....	5
Transmitter Equipment Mfg. Co....	16
Triplett Elec. Inst. Corp.....	65
United Catalog Publishers, Inc.....	72
United Transformer Co.....	9
U. S. Recording Co.....	21
Wilmotte, Raymond M.....	21
Wilson, Herbert L.....	21
Wincharger Corp.....	81
Zenith Optical Laboratory.....	82

FM AND TELEVISION



Model 33-F, Full-cycle increment, shows indicating frequency of 60 cycles. Black dial for special application.

Here are the facts on J-B-T VIBRATING REED FREQUENCY METERS

ACCURACY

Half-cycle increment, $\pm 0.2\%$; full-cycle increment, $\pm 0.3\%$. This accuracy is not affected by normal temperature change, wave form or external magnetic fields.

COMPACTNESS

Made in several sizes, most popular of which is the standard $3\frac{1}{4}$ " panel mounting model. Also made to meet C39.2-1944 ASA specifications and Jan-I-6 for mounting and stud size of Electrical Indicating Instruments. No external reactor.

WEIGHT

Model 31-F, $3\frac{1}{2}$ inch, 5 reeds, weighs only 0.54 lb; Model 33-F, $3\frac{1}{2}$ inch, 11 reeds, 0.59 lb. Other models are correspondingly light.

VOLTAGE VARIATION

Will operate on voltages as low as 8 volts. Standard 110-115 volt models will operate satisfactorily over range of 100 to 130 volts. Also made for narrower voltage variation if desired. (Incidentally, current consumption is low. For Model 33-F, for example, $\frac{1}{2}$ watt at 115V.)

RUGGEDNESS

No parts to wear out or get out of calibration. All are securely anchored to the base with lock washers at every critical point. The only movement is at the free end of the spring steel reed. J-B-T meters on portable field equipment have established an enviable performance record.

J-B-T Vibrating Reed Frequency Meters are available for frequencies from 12 cycles to 525 cycles with various reed groupings, increments and case sizes. For additional facts on the complete line, send for Bulletins VF-43, VF-43-1A (400 cycle Meters) VF-43-1B ($2\frac{1}{2}$ " sizes), and VF-43-1C (interesting new applications)

(Manufactured under Triplett Patents and/or Patents Pending)



J-B-T INSTRUMENTS, INC.

473 CHAPEL STREET • NEW HAVEN 8, CONNECTICUT

12-JBT-5



"You take it and like it

...from a

PRESTO RECORDING!"

"We have each of our programs transcribed on Presto equipment because it's easy to take criticism from a Presto Recording," says lovely Evelyn Knight, singing star of CBS' "Powder Box Theatre". "When you specialize in tricky rhythms as I do, it's important to be able to play back the show to review your work."

Broadcasting stations and recording studios use Presto equipment because they can depend on Presto to produce high quality work. Schools and business organizations, too, prefer Presto because a Presto Recorder can take hard usage and is simple to operate. Write for complete information.



PRESTO

RECORDING CORPORATION
242 West 55th Street, New York 19, N. Y.
Walter P. Downs, Ltd., in Canada



WORLD'S LARGEST MANUFACTURER OF INSTANTANEOUS SOUND RECORDING EQUIPMENT AND DISCS

December 1945 — formerly FM RADIO-ELECTRONICS

This MOSSMAN "Gear Shift Switch" Adds Choice of Five Positions To Unusual Circuit Flexibility

New Mossman Series 4500 five position "gear shift" switch.

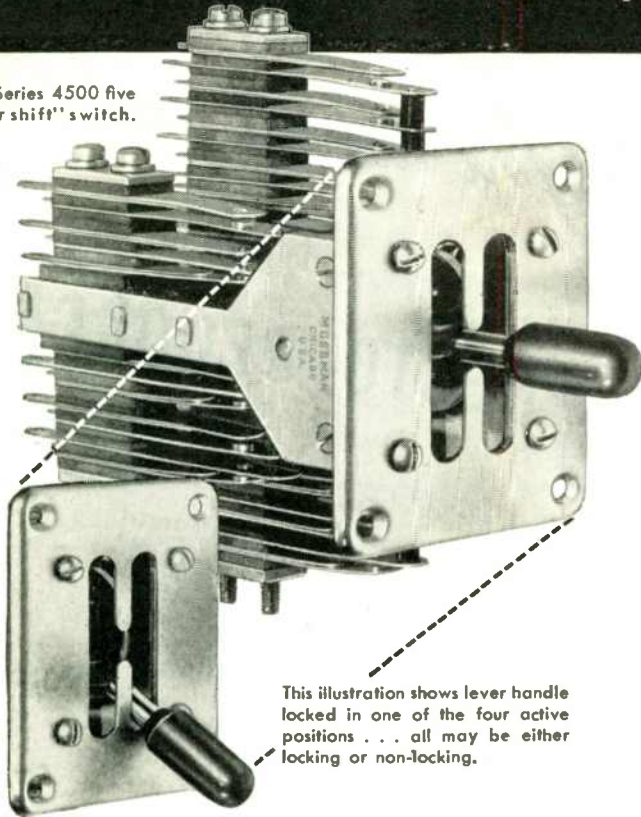

This illustration shows lever handle locked in one of the four active positions . . . all may be either locking or non-locking.

A new Mossman Switch—Series 4500—has been developed to meet new and unusual requirements for precision electrical components adapted to radio and electronic control circuits. This is a five position heavy duty lever switch, built of high grade materials specified by the U. S. Navy.

The rigidly braced, heavy brass frame supports a chromium plated latch plate and spring-actuated piston, in which a roller is mounted clevis fashion. Axles, stop pins and piston are stainless steel. Plated phosphor bronze springs have spun-in heavy duty silver contacts.

Series 4500 Switch has four independent contact spring pile-ups, each of which is actuated either locking or non-locking. Contact assemblies are built up from standard forms.

A special feature of the Series 4500 Switch is that it is not provided with fixed stops. Action of the different positions may be changed by inserting or removing stop plates beneath the escutcheon. Also available are a special safety latching feature, special housings, wiring and other features to meet your requirements.

Many types of Mossman heavy duty, multiple circuit lever switches, turn switches, push switches, plug jacks and other special switching components are shown in the Mossman Catalog. Send for your copy.

DONALD P. MOSSMAN, INC., 612 N. Michigan Ave., Chicago 11, Illinois

MOSSMAN

Electrical Components

ENGINEERING SALES

G. E.: Added district representatives are: W. C. Jaeger, broadcast transmitters, J. T. Harrington, emergency radio and E. F. Reihman, tubes, with headquarters at 140 Federal Street, Boston; I. M. Ellis, emergency radio, 1405 Locust Street, Philadelphia; D. S. Covert, radio receivers, E. S. Clark, tubes, John Middlebrook, Musaphronic receivers, and F. R. Walker, broadcast transmitters, with headquarters at 215 W. 3rd Street, Cincinnati; J. Q. Cunningham, tubes, 840 South Canal Street, Chicago; G. P. Foster, broadcast transmitters, G. W. Davis, tubes, U. W. George, emergency radio and J. L. Fowler, radio receivers, with headquarters at 106 W. 14th Street, Kansas City, Mo.; C. M. Vance, tubes, at 187 Spring Street, N. W., Atlanta; W. F. Trevarrow, tubes, at 1801 N. Lamar Street, Dallas.

Maguire: Robert M. Karet, after 10 years with Utah, has resigned as sales manager of the wholesale and sound divisions to become manager of electronic and industrial sales for Maguire Industries subsidiaries. These comprise Meissner, Thordarson, and Radiart. He will be located at the Maguire offices, 936 North Michigan Avenue, Chicago.

Hallicrafters: Equipment will be distributed exclusively in Canada by Rogers Majestic, Ltd., 622 Fleet Street, West, Toronto, Ontario.

Shure: Has shifted R. Clark from his wartime post as chief purchasing agent to the sales department, where his first undertaking will be to introduce Shure's Glider phono pickup to manufacturers.

Scott: Receiver sales will be handled exclusively by Marshall Field in Chicago.

Motorola: G. Porter Burgess, who launched Motorola's roadside sign campaign, has been appointed regional manager for Texas, Louisiana, Arkansas, and Oklahoma.

Weston: Harold L. Olesen, associated with Weston Electrical Instrument Corporation since 1931, has been named general sales manager. H. L. Gerstenberger, who formerly served in that capacity, continues as vice president in charge of sales.

Brach: Special Products Company, Silver Spring, Md., will handle the national distribution through radio parts jobbers of L. S. Brach antennas for automobiles, FM, and television.

UNUSUAL DESIGNS AT



RESONANT TRANSFORMERS

This high voltage application involved a minimum size requirement. For maximum compactness, the final transformer produced has a turns ratio of 115/5,800, but a voltage ratio due to resonance of 115/10,000 V.



VARIABLE AC SATURATED INDUCTOR

This inductor is part of a voltage sensitive non-linear network. By adjustment of the inductor with a specific capacitor, peak non-linearity can be adjusted over a substantial range in voltage.



CONDENSER - PULSE WELDING TRANSFORMER

This transformer is designed for a small precise spot welding set. For this type of application, design factors include High Q and maximum surge power transfer. The transformer shown is the equivalent of 100 VA in size, but handles 1,000 VA pulses.



SPECIAL CONTROL TRANSFORMER

In this odd application, the requirements were that the primary current go down with increase in load current. In actual practice, when normal load is placed on the secondary, the primary current drops 50%.

The UTC application engineering section is available for your problem.

United Transformer Corp.

150 VARICK STREET

NEW YORK 13, N. Y.

EXPORT DIVISION: 13 EAST 40th STREET, NEW YORK 16, N. Y.

CABLES: "ARLAB"





250 AND 1000 WATT FM BROADCAST TRANSMITTERS ARE *On The Way...*

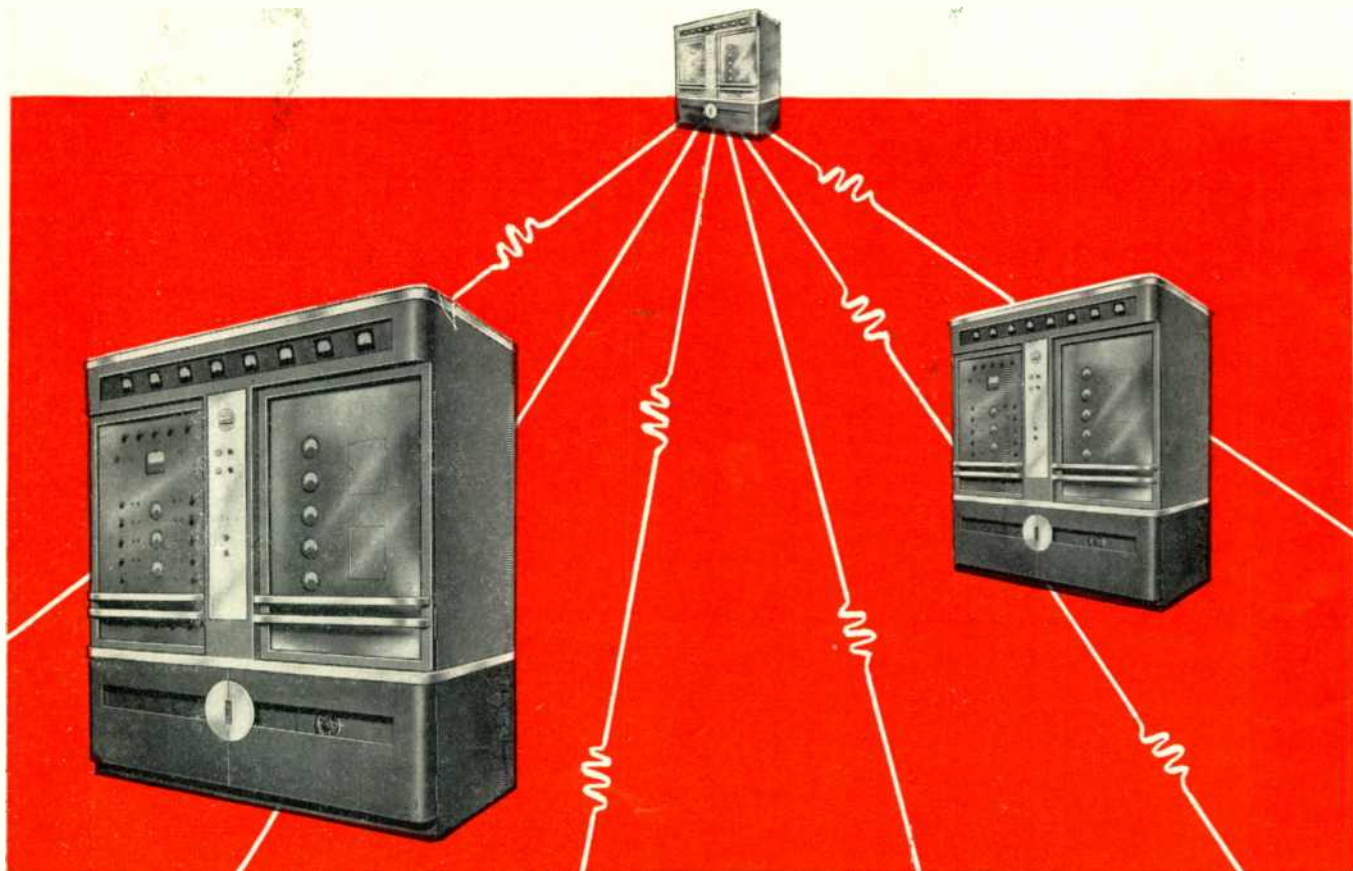

For many years, HARVEY OF CAMBRIDGE has built transmitters considered standards of quality and dependability. Yet, these new HAR-CAM FM Broadcast Transmitters that are about ready for release, will be far and away the finest ever to bear the HAR-CAM name.

Here's why:

As specialists in the manufacture and development of communications equipment, receivers as well as transmitters, for Commercial, Marine and Emergency use, we have gained a thorough knowledge and understanding of *all* phases of the industry. This sound background has been greatly enhanced by the additional skill and "know-how" gained through war work, par-

ticularly in the development and production of vital Loran Radar Transmitters and other important communications units. Add to this improved production facilities and advanced precision methods of manufacture and you can readily understand why HAR-CAM FM Broadcast Transmitters will provide the last word in efficient, dependable and economical transmission.

Now is the time to get the complete story on these new HAR-CAM 250 and 1000 watt FM Broadcast TRANSMITTERS.

HARVEY RADIO LABORATORIES, INC.

443 CONCORD AVENUE · CAMBRIDGE 38, MASSACHUSETTS



Presenting MINIATURE SOCKETS



Available Types

Shielded • Saddle Plate • Chassis Lock
Bottom Mounted • Rubber Mounted
Shielded Rubber Mounted

As war-designed and tested improvements are freed for general use, Amphenol is proud to announce more and more new units to aid manufacturers of postwar electronics equipment.

Amphenol Miniature Sockets are typical of this policy. They're new, represent advanced engineering, possess many exclusive features, plus the famous Amphenol built-in perfection and performance.

Think of them where space is limited or easy portability is an advantage—for use with handy-talkie radios, miniature and portable sets, electronic controls and endless industrial applications in the coming era of electronics.

How will they fit in with your products? Amphenol engineers are ready and glad to give you all technical data NOW . . . and any engineering assistance of help to you.



Write for this free
bulletin . . . It tells
the story of Amphenol
Miniature Sockets



AMERICAN PHENOLIC CORPORATION

Chicago 50, Illinois

In Canada • Amphenol Limited • Toronto



Now

YOU

THIS IS TO CERTIFY THAT

Frank's Radio Service

has met the requirements to qualify as

**RAYTHEON
BONDED
ELECTRONIC TECHNICIANS**

A Surety Bond Has Been Issued by the

WESTERN NATIONAL INDEMNITY COMPANY,

Expiring the _____ day of _____, 19____, Bonding This Firm to:

1. GUARANTEE ITS RADIO REPAIR WORK FOR 90 DAYS FROM DATE PERFORMED and REPLACEMENT PARTS FOR 90 DAYS FROM DATE INSTALLED.
2. Use only parts of recognized quality in its repair work.
3. Not charge more than list price for parts installed.
4. Test customers' tubes as accurately and reliably as possible.
5. Keep charges for labor at a fair and reasonable level.
6. Perform only such work as is authorized.
7. Maintain the high quality service indicated by the experience required of all Bonded Electronic Technicians.
8. Maintain and use test equipment essential to good repair work and reliable tube checking.



10224

Signed and Sealed

By _____
RAYTHEON MANUFACTURING COMPANY
A. E. Anderson
A. E. Anderson, Vice-President in Charge

By _____
WESTERN NATIONAL INDEMNITY COMPANY
A. L. Robertson, Secretary in Charge
Exec. Officers and Directors • 212 West Jackson Boulevard, Chicago 6, Illinois

can become a

BONDED ELECTRONIC TECHNICIAN

If you can qualify for this new, revolutionary Raytheon merchandising program, you can be sure of greater sales and profits than ever before . . . and you can forget your worries about "security" in the peacetime years ahead.

This program is the perfect answer to those who have been suggesting licensing, government regulation and other impractical "remedies" to protect the public from unethical radio service dealers.

The bond certificate illustrated, showing the code of ethics and 90 day guarantee, and backed by one of the nation's largest surety firms, will be issued to *each* service dealer who can meet the necessary qualifications.

It is only one unit in a *complete* plan which includes the largest, most effective selection of displays and helps ever offered to the radio tube industry.

As a Bonded Electronic Technician, you will **STAND OUT** in your community as the **TOP** radio service dealer . . . the one to be trusted with all kinds of radio service, the one in whom the public can have complete confidence.

So for more service business, increased sales of tubes and other parts, apply to your Raytheon distributor to become a Bonded Electronic Technician. Remember, for your protection Raytheon tubes are distributed only by leading parts wholesalers.

Raytheon
Manufacturing Company
RADIO RECEIVING TUBE DIVISION

NEWTON, MASS. • LOS ANGELES • NEW YORK • CHICAGO • ATLANTA

RAYTHEON
Radio Tubes



DEVOTED TO RESEARCH AND THE MANUFACTURE OF TUBES FOR THE NEW ERA OF ELECTRONICS

108 SERIES Amplifiers

WITH MOUNTING ACCESSORIES

TYPE 108-B two-stage Amplifier provides transformer input impedances for either 30 or 250 ohms with nominal output impedance 500 or 8 ohms. Variable gain 65/105 db. with electronic volume control. Frequency response better than ± 1 db. 30/16,000 c.p.s. Power output +43 V.U. (20 watts) with less than 5% RMS harmonic content. Noise level full gain 56 db. below full output.



THE 108 SERIES consist of four different amplifiers available simply by changing one or two small input panels on the master chassis. Except for these input panels all amplifiers have the same transmission characteristics. Input impedance, gain and noise level depending on types listed below.

These units are designed for the highest type audio service having gain-frequency characteristics better than ± 1 db. 30/16,000 c.p.s. Power output +43 V.U. (20 watts) with less than 5% RMS harmonic content.

TYPE 108-A two-stage Amplifier provides transformer input for either 600 ohm or bridging. 600 ohm input fixed gain 61 db. Bridging input variable gain 6/46 db. Noise level 68 db. below full output.

Bridging input variable gain 2/42 db. Channel 2—high gain 30/250 ohm input variable gain 62/102 db. with electronic volume control. Noise level 56 db. below full output.

TYPE 108-B as illustrated and described above.

TYPE 108-C combines the input channels of the 108-A and 108-B Amplifiers. Channel 1—600 ohm input variable gain 20/60 db.

TYPE 108-D two-channel each 30/250 ohm input. Either channel variable gain 62/102 db. with electronic volume control. Noise level 56 db. below full output.

MOUNTING ACCESSORIES

TYPE 202-A Wall Mounting Cabinet permits universal installation of 108 Series Amplifiers to any flat surface. Well ventilated and designed for maximum accessibility, servicing and convenience of installation. Standard aluminum gray finish.

TYPE 9-A Modification Group permits 108 Series Amplifiers to mount on standard 19" telephone relay racks. Occupies 7" rack space. Allows servicing from front of rack. Standard aluminum gray finish.

The Langevin Company

INCORPORATED

SOUND REINFORCEMENT AND REPRODUCTION ENGINEERING

NEW YORK
37 W. 65 St., 23

SAN FRANCISCO
1050 Howard St., 3
World Radio History

LOS ANGELES
1000 N. Seward St., 38



The Old "97" was born 50 years too soon!

THAT FAMOUS OLD WRECK WOULD NEVER HAVE OCCURRED WITH MOTOROLA RIDING IN THE ENGINEER'S CAB...

Not only does Radiotelephone add new safety to modern railroading, it greatly increases the efficiency of almost every phase of operation. Now, engineers, conductors and train dispatchers are in constant contact with each other for split-second action at all times. In everyday routine railroading as well as in emergencies, Motorola F-M 2- and 3-way Radiotelephone pays big dividends in safety, economy and efficiency.

It is significant that the first Federally licensed railroad radio used Motorola equipment exclusively. Motorola is an experienced hand at mobile communications equipment. Highway police of 34 states, railroads, public utilities and many other public service agencies depend on Motorola for 2-way communication. Ask Motorola engineers to show you how F-M Radiotelephone can increase the efficiency of your operation. Write today!

Motorola
F-M 2- and 3-WAY RADIOTELEPHONE

GALVIN

MFG. CORPORATION • CHICAGO 51

COMMUNICATIONS AND ELECTRONICS DIVISION

F-M & A-M HOME RADIO • AUTO RADIO • AUTOMATIC PHONOGRAPHS • TELEVISION • "HANDIE TALKIES" • POLICE RADIO • RADAR

See!

The New TEMCO

High Fidelity

FM BROADCAST TRANSMITTER



Ready for delivery*

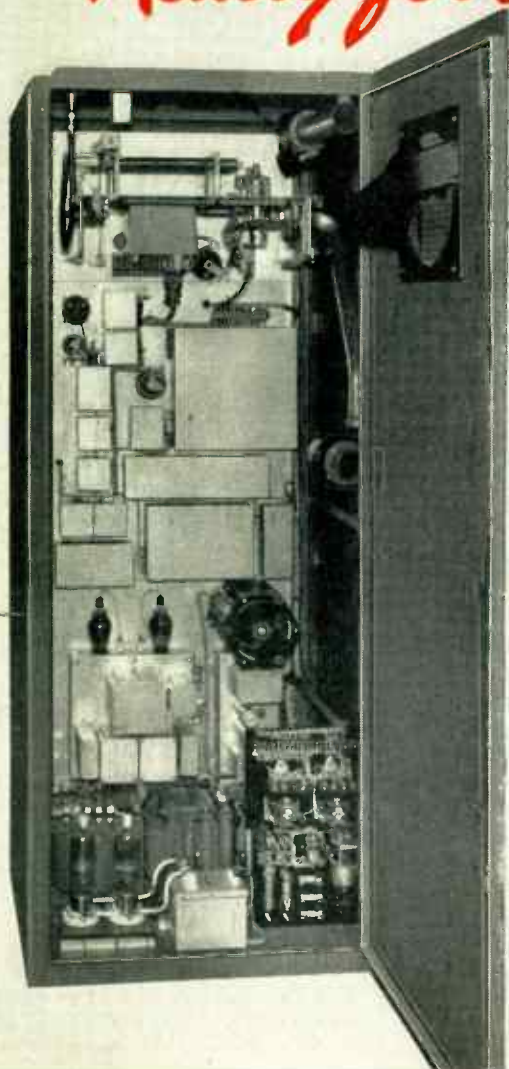

MODEL 250 BCF 88-108 MEGACYCLES

TEMCO proudly presents this outstanding achievement in FM engineering—the result of 10 years of pioneering in custom-built, superlative communication equipment.

HIGHLIGHTS OF THE TEMCO 250 BCF

- Normal rated output power 250 watts. Maximum rated output power 375 watts.
- Continuous monitoring of the carrier frequency by a center frequency deviation meter calibrated directly in cycles.
- An exciter unit—heart of the transmitter—characterized by tuning simplicity accomplished by employing only 4 stages to raise the primary oscillator frequency to the carrier frequency.
- A new circuit of technically ad-

vanced concept which maintains a high degree of center frequency stabilization without introduction of distortion.

- Peak efficiency and great dependability are obtained by the use of new miniature V-H-F tubes in the exciter.

- Improved design in the IPA and PA stages eliminating tank radiation, feedback, radio frequency and high voltage potentials from the tank circuits and transmitter frame.

*A limited quantity of the TEMCO Model 250 BCF will be available for January delivery. Orders will be filled in rotation as received. ACT NOW. Place your order at once.

NOW ON DISPLAY FOR YOUR INSPECTION.

Phone or wire for an appointment.

TEMCO

RADIO COMMUNICATION EQUIPMENT

TRANSMITTER EQUIPMENT MFG. CO., INC.

345 Hudson Street, New York 14, N. Y.



Centralab METALLIZED STEATITE

COIL forms, spacer rods, strain insulators and rotor shafts of steatite can now be bonded in an inseparable union with brass, stainless steel, silver, copper and other metals. These shafts of steatite and metal are indicated wherever high frequency insulating material is specified. Both electrically and mechanically they fulfill the most exacting requirements. . . . Centralab is now

equipped to supply metallized Steatite in practically any form.



Centralab

Division of GLOBE-UNION INC., Milwaukee

PRODUCERS OF: Variable Resistors • Selector Switches
• Ceramic Capacitors, Fixed and Variable • Steatite
Insulators and Button-type Silver Mica Capacitors.

FM does it

with
the



CIRCULAR ANTENNA

4800 SQUARE MILES

More coverage for the same power

● FM can increase your effective radiated power and coverage to give *more* listeners *better* reception. General Electric FM makes this improved service possible with high-gain antennas that multiply your effective radiated power output many times.

● **This is why.**

● Conventional antennas designed for standard broadcast frequencies produce no signal gain; for on standard broadcast frequencies, high-gain antennas are impractical to erect because of physical limitations. With FM, however, high-gain antennas have practical dimensions and are easy to install. Antennas of this type can give one kilowatt the effectiveness of eight; five kilowatts the effectiveness of forty—at *no increase in transmitter, tube, maintenance, or power costs!*

● Outstanding performer among high-gain antennas is the G-E circular antenna which produces higher signal gain per bay and

gives substantially equal coverage in all directions. And for those installations where other than circular radiation patterns are required, G-E circular antennas of special design will be available. Compare these facts:

NO. OF BAYS	POWER GAIN*	COVERAGE**
2	1.70	10,600 sq. mi.
4	3.63	13,250 sq. mi.
6	5.50	14,500 sq. mi.
8	7.24	15,400 sq. mi.

* Compared to a standard half-wave dipole.
** 50 microvolt-per-meter contour.
Transmitter power output, 10 kw.
Average antenna elevation, 400 feet.

● Today, G-E circular antennas are proving themselves in many of the nation's leading FM broadcast stations where they are giving greater coverage per watt and more effective radiated power per station dollar.

For complete information on General Electric FM circular antennas and on FM broadcast equipment, write *Electronics Department, General Electric Company, Schenectady 5, N. Y.*

For earliest possible
delivery of your
broadcast equipment,
place your order now.

STUDIO AND STATION EQUIPMENT • TRANSMITTERS

GENERAL ELECTRIC

160-D7-6814

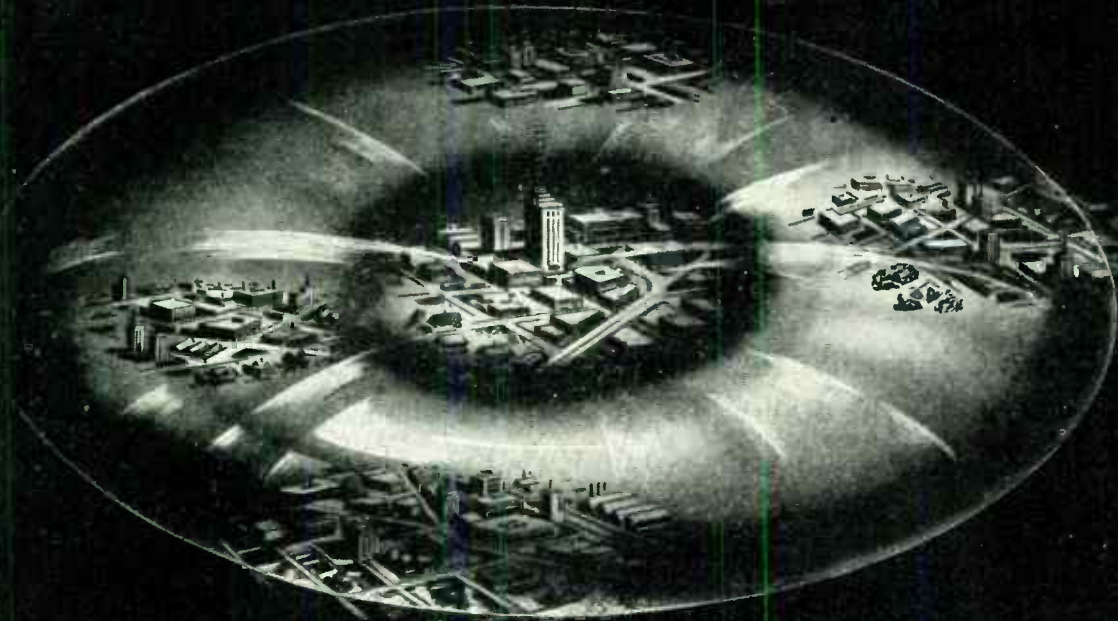

◀ 8-BAY TYPE
 Rated transmitter power
 10 kw.
 Effective radiated power
 72.4 kw.
 Effective coverage
 15,400 sq. mi.

ADDITIONAL COVERAGE WITH NO INCREASE IN TRANSMITTER POWER.



◀ 2-BAY TYPE
 Rated transmitter power
 10 kw.
 Effective radiated power
 17 kw.
 Effective coverage
 10,600 sq. mi.

An exclusive development of General Electric, this horizontally polarized circular antenna—often called the "doughnut"—is capable of providing substantially equal coverage in all directions with power gains of 7 or more. Lower coupling between bays make this antenna non-critical and easy to tune.

G-E FM circular antennas are simple in design, rugged in construction, withstand high wind velocities and provide high efficiency over the entire FM broadcast band. Sleet-melting units are available where required.

53 FM BROADCAST STATIONS ARE ON THE AIR; OVER 400 APPLICATIONS ARE PENDING.

- FM DOES IT—**
- FM increases your effective radiated power with the G-E Circular Antenna.
 - FM triples your tone range and adds a new dimension to your programs.
 - FM gives your audience programs with virtually no static or man-made noise.
 - FM multiplies your effective coverage day and night.

- FM minimizes station interference.
- FM gives your programs vivid naturalness with greater dynamic sound range.
- FM contributes to the economy of your broadcast system.

Use G-E Electronic Tubes in your station for maximum dependability and finer performance.

ANTENNAS • ELECTRONIC TUBES • HOME RECEIVERS

AM • TELEVISION • FM

See G.E. for all three!

FOR RAILROAD RADIO COMMUNICATIONS

The FCC specifies that "the carrier frequency of stations in the Railroad Radio Service shall be maintained within plus-or-minus .005% of the assigned frequency."

It's no problem to meet that requirement if you have a BROWNING Frequency Meter. For years, these instruments have been standard equipment in the police services, where the same high degree of precision is necessary.

Nor is it any trouble to meet the FCC rule that each transmitter must be checked "at least once in six months". The BROWNING crystal-controlled Frequency Meter is so easy to use that it has become regular practice to check police mobile equipment once a month. That's the best way to assure peak efficiency in any communications system.

For detailed information on BROWNING Frequency Meters for Railroad Radio Service, address:

**BROWNING
LABORATORIES
INC. WINCHESTER
MASSACHUSETTS**

Professional Service Directory

Jansky & Bailey

AN ORGANIZATION OF
Qualified Radio Engineers
DEDICATED TO THE
SERVICE OF BROADCASTING

National Press Bldg., Washington, D. C.

RAYMOND M. WILMOTTE
Consulting Radio Engineer

PAUL A. DEMARS
Associate

1469 Church St., N.W., Washington 5, D. C.
Decatur 1234

★ ★

BOUND VOLUMES OF
FM AND TELEVISION
ARE AN ESSENTIAL PART
OF EVERY ENGINEERING
REFERENCE LIBRARY

FOR PRICES, SEE PAGE 67

★ ★



ANDREW CO.

Consulting Radio Engineers
363 EAST 75th STREET, CHICAGO 19
Triangle 4400

MAY & BOND

CONSULTING RADIO ENGINEERS

★ ★ ★

1422 F Street, N. W. Wash. 4, D. C.
Kellogg Building Republic 3984

• TELEPHONE BRIDGEPORT 5-2055 •

GARO W. RAY

Consulting Radio Engineers

For Standard and FM Services
991 Broad Street, Suite 9-11
Bridgeport 3, Conn.

LABORATORY: Hilltop Drive
Strofford, Conn.—Phone 7-2465

Herbert L. Wilson

and Associates

CONSULTING RADIO ENGINEERS
AM-FM Television Facsimile

1018 Vermont Avenue, N.W.
Washington 5, D. C.
National 7161

JOHN J. KEEL

Consulting Radio Engineers

Earle Building
NATIONAL 6513
Washington 4, D. C.

The
ROBERT L. KAUFMAN
ORGANIZATION

• Construction Supervision (FM-AM),
Technical Maintenance, and Business Ser-
vices for Radio Broadcast Stations.

Munsey Building Washington 4, D. C.
District 2292

DIXIE B. MCKEY
ROBERT C. SHAW

CONSULTING
RADIO ENGINEERS

1108 16th Street, N. W. Suite 405
Washington, D. C. METropolitan 3604

MORE RF KILOWATT HOURS
PER DOLLAR WITH
F & O TRANSMITTING TUBES

Freeland & Olschner Products, Inc.
611 Baronne Street, New Orleans 13, La.
Raymond 4756
High Power Tube Specialists Exclusively

Custom-Built
SPEECH INPUT EQUIPMENT
U. S. Recording Co.

1121 Vermont Avenue
Washington 5, D. C.
District 1640

**FREQUENCY MEASURING
SERVICE**

Exact Measurements - at any time



RCA COMMUNICATIONS, INC.
64 Broad Street New York 4, N. Y.

Frequency Measurements

Highest Accuracy — Anytime
One of the best equipped monitoring stations
in the nation

STANDARD
MEASURING & EQUIPMENT CO.
Phones 877-2652 Enid, Oklahoma
Since 1939

RATES FOR
PROFESSIONAL CARDS
IN THIS DIRECTORY

\$10 Per Month for This Standard
Space. Orders Are Accepted
for 12 Insertions Only

KLUGE ELECTRONICS CO.

*Commercial and Industrial
EQUIPMENT*

1031 North Alvarado
Los Angeles 26, California
MYRON E. KLUGE EXposition 1742



*Radio Engineering Consultant,
Frequency Monitoring*
Commercial Radio Equip. Co.
International Building • Washington, D. C.
321 E. Gregory Boulevard • Kansas City, Mo.
Cross Roads of the World • Hollywood, Calif.



CLAIM STAKING

Hallicrafters and Very High Frequency

Based on the facts in the case, Hallicrafters can stake out a very strong claim to leadership in the very high frequency field. The facts include such things as the Model S-37, FM-AM receiver for very high frequency work. The Model S-37 operates from 130 to 210 Mc.—the highest frequency range of any general coverage commercial type receiver.

Hallicrafters further supports its claim to domination in the high frequency field with the Model S-36A, FM-AM-CW receiver. The 36A operates from 27.8 to 143 Mc., covers both old and new FM bands and is the only commercially built receiver covering this range.

Further developments in this direction can soon be revealed—adding further support to Hallicrafters claim to continued supremacy in the high frequency field.

HALLICRAFTERS NEW \$600,000 HOME NOW UNDER CONSTRUCTION.

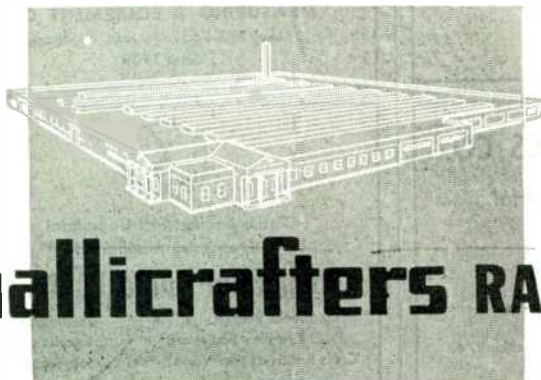

hallicrafters RADIO



THE HALLICRAFTERS CO., MANUFACTURERS OF RADIO AND ELECTRONIC EQUIPMENT • CHICAGO 16, U. S. A.

COPYRIGHT 1945 THE HALLICRAFTERS CO.



FIG. 1. THE AUTHOR, COMCO ENGINEER RANSBURG, AND TRAINMASTER NORWOOD AT THE MIAMI TERMINAL, LISTENING TO SWITCHING CREW



FIG. 2. AT THE 29TH STREET YARDMASTER'S OFFICE RADIO AT THE PUMP HOUSE WAS REMOTE-CONTROLLED

PROGRESS REPORT ON RAILROAD FM

Success of Tests Conducted in 1945 Indicate Wide Application of Radio Next Year

BY ARNOLD C. NYGREN

EVER since 2-way FM equipment was made available to the railroads, more and more lines have been running tests to determine how, and to what extent, they can make use of this means of communication. It's beginning to look as if railroad officials have been criticized unfairly for their apparent lack of enthusiasm about making use of radio. At least the records show that, prior to the war, a number of roads carried on extensive tests with AM equipment, but the equipment simply failed to perform. So, if officials were too busy with war transportation problems to get very excited about new promises of FM performance, it's not surprising, particularly since the new equipment was not available until the last few months.

Railroad Radio Tests ★ Now, as man-power is becoming available, the work of fitting together FM capabilities and railroad requirements is

progressing rapidly, and some installations are already going into regular service. One road after another has inaugurated FM tests between engines and cabooses, and between engines and wayside points. The author has personally visited some of the typical projects in order to present a review of the results obtained. Although these reports do not cover all the work done by the different roads and cooperating radio manufacturers, they do indicate

the general progress of railroad radio work in 1945.

Miami Terminal ★ At the invitation of officials of the Florida East Coast Railway, I arrived at Miami on October 16th to observe the 160-mc. tests of FM equipment manufactured by Communications Company, Inc.,¹ of Coral Gables, for the Miami terminal. I was particularly anxious to attend as I had been unable to observe the tests at Jacksonville in September.

At Miami, equipment had been installed at the main station, Fig. 1; at the 29th street yardmaster's office, Fig. 2; and on one switching locomotive, Fig. 3. All the equipment was identical with that used earlier at Jacksonville.

Mr. Ransburg, of Communications Company, drove me

FIG. 3. RADIO ON LOCOMOTIVE 272 WAS INSTALLED DIRECTLY BELOW ANTENNA

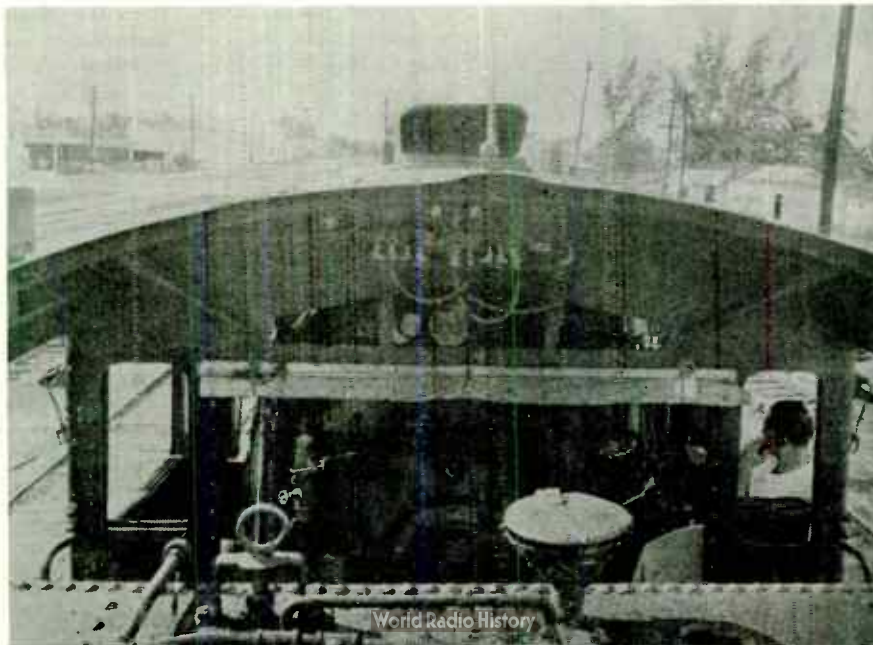

¹ See "152-to-156 mc. Mobile Unit" by G. A. Leap, *FM AND TELEVISION*, May, 1945, for detailed description of this equipment.

to the main station for our first check. There, Mr. Norwood, Miami trainmaster of the F.E.C., showed us a map of the terminal area and outlined their communication problems. He explained: "As you probably know a yard engine conductor is given specific work at the beginning of his shift. During this period, it is only natural that numerous changes must be made to his original orders. Under our present system, it is necessary to have the conductor phone in at regular intervals to receive any changes, or have the yardmaster attempt to contact the conductor by telephone or messenger at some point in the yard. With two-way radio, we find that changes in orders can be made immediately and directly to the conductor without loss of time."

The trainmaster then picked up the radio handset and made a short call to engine 272, Figs. 3 and 5. The engineer on 272 promptly answered and asked for instructions. When he was asked his location, the engineer replied that he was switching in the vicinity of 27th street. Mr. Norwood then called the 29th street yardmaster's office, Fig. 2, asked for a signal check on both transmitters, and received a "loud and clear" reply. The switching engine was then ordered to



FIG. 4. TRAINMASTER NORWOOD SAT AT HIS DESK AND GAVE ORDERS TO LOCOMOTIVE 272 WITHOUT HAVING TO RAISE HIS VOICE OR LEAVE HIS CHAIR

shuttle through the entire terminal area and for the next hour we were kept informed of its movements. Three-way communication remained perfect throughout, even though, at times, we were told that

the engine was alongside buildings, water towers and other trains. Mr. Norwood commented that with such satisfactory radio communication, terminal operations would be greatly simplified and speeded up.

What impressed me greatly was the simplicity of the installation, the lack of any elaborate antennas, and the excellent communication available throughout the terminal area. The transmitter and receiver in the locomotive had been installed above the engineer's head in the cab, as shown in Fig. 3. The fixed installations used similar, non-directional antennas, although the layout of the terminal would justify the use of directional arrays. I asked the radio engineer in charge of the installation what difficulties he had encountered. The answer was: "None! We had everything in operation the same day we began the work, and have made no changes."

The following day, I had occasion to recall this remark. On very short notice, due to a change in engine and crew schedules, he was asked to remove the equipment from No. 272 and install it in No. 714. This required only a few hours.

Communications Company engineers had provided a loudspeaker at each location in addition to the handset receiver. Even with the unusually high ambient noise encountered in a locomotive, there never seemed to be any difficulty understanding a transmission. An additional handset and loudspeaker were installed at the rear of the tender for remote control of the equipment, and to allow operation without the necessity of climbing into the cab. This is shown in Fig. 6.

During all the tests, Communications Company had a receiver and 50-watt transmitter on the air at their Coral Gables plant, approximately 11 miles south of Miami. They answered all test calls from the Miami transmitters promptly, and without asking to have any messages repeated. To convince myself that the coverage was really solid, I took a turn at the microphone of each transmitter. After several hours, I began to feel as though I were operating an inter-office communication system, and not a 4-way radio system.

Officials of the Florida East Coast Railroad who had the opportunity of witnessing tests included C. V. Jelluson, supervisor of telephone and telegraph; W. A. Hoffman, superintendent of signals and telegraphs; J. W. Eddy, general foreman at the Jacksonville terminal; R. T. Jeffries, assistant general passenger agent; F. P. Oldfather, assistant general freight agent; and W. L. Zimpelmann, district superintendent for the Pullman Co.

FIG. 5. THE ENGINEER ON NO. 272 CAN GET HIS ORDERS WITHOUT TAKING HIS EYES OFF THE TRACK AHEAD



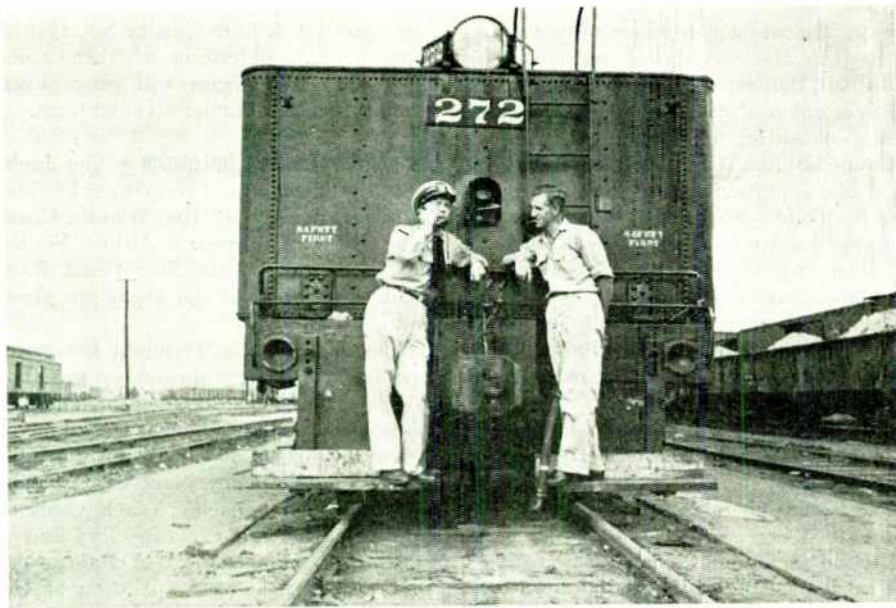

FIG. 6. THE AUTHOR AND RUBE HOLSTROM OF THE F.E.C. TALK TO THE YARDMASTER FROM THE AUXILIARY SPEAKER AND HANDSET AT THE REAR OF NO. 272

Although the test requirements were for terminal coverage only, Communications Company installed an additional 15-watt transmitter and receiver at Homestead, Florida, approximately 32 miles distant, to check the maximum range. I had noticed that the antenna at the main station in Miami was fairly low, having been installed temporarily on the roof of the two-story main building. I was informed that a similar antenna installation had been made on their Homestead station. With the engineer carrying out his normal switching orders between Miami and Homestead, the signals received in Miami and on the locomotive were excellent up to a distance of about 12 miles. Beyond this point it was usually necessary to cut out the squelch circuit to assure communication. Conversation with Homestead from the locomotive was also excellent up to 12 miles, with sufficient signal to operate the squelch up to this distance.

Thus communication was complete between the locomotive and Homestead except for a stretch of about 6 miles. This distance could have been covered, too, by the simple expedient of raising the antennas at the fixed points.

Rock Island Tests ★ The Rock Island Lines are conducting very exhaustive tests on radio communications, under the direction of their electronics engineer, E. A. Dahl. At this time of writing, tests are still under way, so that no conclusions can be presented here.

However, through Mr. Dahl's cooperation, we have a report on the performance of 160-mc. Communications Company equipment for front-to-rear service on long freight trains. The tests were made

on a run between Chicago and Silvis, Illinois, near Rock Island, on the night of July 10, and between Silvis and Council Bluffs, near Omaha, on the night of the 12th. The train between Chicago and Silvis carried 85 cars, and between Silvis and Council Bluffs, 98 cars. The tests were conducted between a caboose behind the engine, and the Rock Island Laboratory test car³ which was adjacent to the caboose at the end of the train.

The transmitter output was approximately 10 watts. The receiver had a sensitivity of less than 1 microvolt at which point the audio output was in the neighborhood of 25DB (1 milliwatt base) and a signal to noise ratio of around 2 or 3. FM equipment was also used to talk from the laboratory car to the caboose up front, but no measurements were taken on transmission in that direction.

Mr. R. A. Clark, Jr., of Communications Equipment and Engineering Company, C. O. Ellis, Superintendent of Communications for the

³ For details of the laboratory test car see "FM on the Rock Island," by Norman Wunderlich, *FM and Television*, June, 1945.

Rock Island Lines, and E. A. Dahl, participated in these tests. The test equipment consisted of a recording milliammeter on the receiver connected to a vacuum tube voltmeter which, in turn, was connected to the DC circuit operating from the automatic volume control. A direct reading decibel meter was connected across the audio output, with a loud speaker placed across the DB meter. The loud speaker impedance was high enough so that there was no effect on the accuracy of the DB meter. Tones were applied to the transmitter at levels well below the overloading point so that the variation in audio signal could be observed, also any noise or flutter. Figs. 7, 8 and 9 show the manner in which the equipment was installed. The 160-mc. type of antenna can be seen in Fig. 10.

The run between Chicago and Omaha provided practically every type of right-of-way condition except mountainous terrain. There are numerous large cities on this route. In some of them, the tracks parallel the main streets. Other special conditions encountered were the Mississippi River Bridge and numerous small bridges and overpasses. In the vicinity of Bureau, Illinois, and between Atlantic and Council Bluffs, there are sharp curves,

FIG. 7. VISUAL AND AUDIO EQUIPMENT USED ON THE ROCK ISLAND TEST CAR FOR MEASURING RADIO RECEPTION

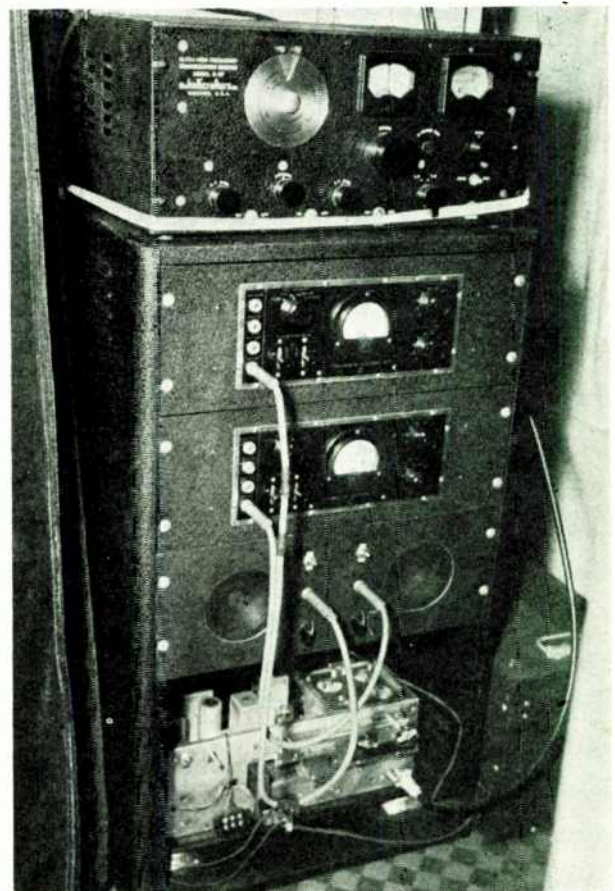

deep cuts, and heavy vegetation. While the train lengths were not the absolute maximum which may be encountered, they represented the average long freight trains. Heavy rain and lightning storms were encountered on the run.

Under conditions of straight right-of-way and clear ground, the signal strength was in the order of 1,000 microvolts. Under the worst conditions, the indicated average field strength dropped down to the order of 15 microvolts. Even under such conditions the signals were clear, with occasional hits or clicks. These were of very short duration, however, and did not affect the quality of the signal. Both antennas consisted of vertical quarter-waves with ground rods, shown in Fig. 10.

The variation in transmission at 160 mc. from the front to the rear of the train appeared to be in the order of 50 to 60 db. High losses occurred when the train rounded steep curves, and when there was heavy vegetation close to the right-of-

way. The worst conditions were encountered in the vicinity of milepost 115, Bureau, Illinois; milepost 185, Davenport, Iowa; milepost 237, Iowa City; milepost 445, Atlantic; and mileposts 476-95, Council Bluffs. While these represent typical bad conditions, there were also many other points where the signal strength dropped down to a 15 microvolt average.

There was no question but what FM on 160 mc. gave very satisfactory results. We did not observe a signal outage at any time, although the noise hits indicated that there was very little margin left under the worst conditions.

There is a possibility that higher frequencies will provide even better results, particularly in the mountainous areas which were not encountered in the tests described here. This would permit a reduction in antenna size so that beamed arrays could be utilized to obtain a considerable power gain. That is not practical on 160 mc. Tests are being made now in

the region of 2660 mc., using Sperry FM equipment, to determine whether or not such high frequencies will prove even more satisfactory under all conditions.

Jacksonville Terminal Installation ★ The Jacksonville Terminal Company, Florida, is owned jointly by the Atlantic Coast Line Railway, Seaboard Airline, Southern, and the Florida East Coast Railroad. Two views of the yards are given in Figs. 13 and 14.

The Jacksonville Terminal Company operates a passenger station comprised of 25 platform tracks designed for handling passengers, mail and baggage; mail facilities of 6 tracks of 30-car capacity; a Railway Express Agency plant of 25 tracks and a 270-car capacity; coach yards of approximately 800-car capacity; and a freight interchange yard of 750-car capacity. The passenger operation of the Jacksonville Terminal is conceded to be one of the fastest switching operations of occupied passenger cars in the country, and it is believed that as many or more occupied passenger cars are switched from one line to another at this station than at any other station in the country.

In other words, it is not a terminal station for the majority of its trains but, on the contrary, the trains are mostly through connections, and must be switched from one railroad to another, or from one division of a railroad to another. The need for minimizing station margins between trains emphasizes the importance of instant communication. For over 15 years, the management of the terminal has been trying to work out a satisfactory method of meeting this need. In addition, it has been recognized that a great safety factor would be provided by a system with which the towermen could communicate directly with engineers.

In the summer of 1945 the terminal made its first test of instant communication with improvised equipment of the AM type. While it was much better than nothing at all, it did not prove satisfactory because of interference from static and other noise sources. Then, early in September, 1945, tests were made with FM equipment manufactured by Communications Company. Completely satisfactory service was obtained from units similar to those shown in Figs. 2 and 3.

The writer is indebted to John L. Wilkes, president and general manager of the Jacksonville Terminal Company, for the following account of the initial tests and subsequent plans for the permanent radio installation:

Because of the nature of the work in the Jacksonville Terminal, it was felt necessary to use one radio frequency for the east end of our terminal, point 5, Fig. 11, and a separate frequency for the west end

FIG. 8. ESTERLINE-ANGUS RECORDERS REGISTER RECEPTION CONTINUOUSLY. FIG. 9. COMMUNICATIONS COMPANY EQUIPMENT INSTALLED ON THE ROCK ISLAND

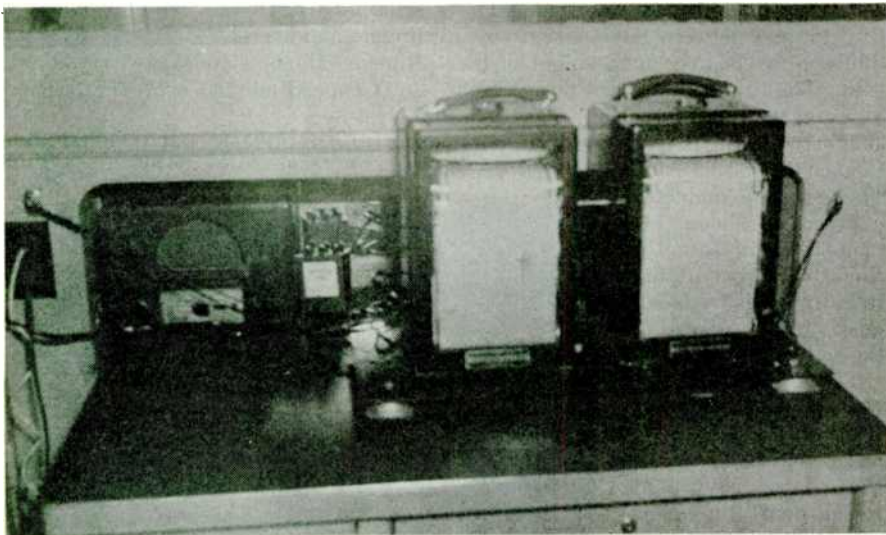

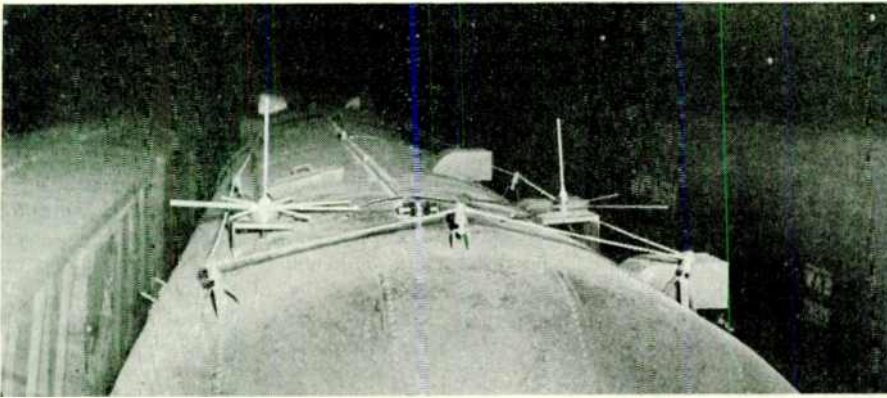

FIG. 10. TWO 160-MC. ANTENNAS MOUNTED ON ROCK ISLAND LABORATORY CAR

of the terminal, point 4, Fig. 12, which controls operations completely separate and distinct from the east end. Operations are such that radio communications at both ends of the terminal are required simultaneously during peak movements and, therefore, provisions had to be made so that these points would not interfere with each other.

In addition, it was felt that the system would not be complete unless radio communications from the Myrtle Avenue station, point 4, was provided by remote control so that Beaver Street Tower, point 1, could communicate with switching locomotives in its vicinity; The yardmaster in the coach yards point 2 could communicate with switch engines operating in what we call the non-interlocking territory in our coach and repair yards; and the yardmaster in our Railway Express plant point 3, could communicate with engines operating in that territory, which is also non-interlocking.

To meet this situation, Communications Company designed a remote-controlled radio system between Beaver Street tower, the coach yard yardmaster, and the Railway Express plant yardmaster, which allows us to contact engines in these territories by remote control of the Myrtle Avenue radio installation without having to ask the train director in the Myrtle Avenue tower to handle the messages.

The management felt that they should go one step further in relieving Myrtle Avenue tower and its radio transmitter of unnecessary traffic. Therefore a land-line intercommunication system between the points 1, 2, and 3 is being provided to handle traffic not requiring communication with switching locomotives. In addition to reducing traffic on the Myrtle Avenue radio transmitter, the land lines will provide faster communications between these three remote points as the regular telephone circuits are frequently busy.

As a result of the highly successful results obtained in the initial tests, we have

committed ourselves to the purchase of 12 mobile radio units for switch engines, two complete dual-frequency radio units for tower equipment at Lee Street and Myrtle Avenue, and four remote-control interphone equipments. It is expected that this equipment will be in operation before the end of 1945, and the management is looking forward to its operation with anticipation of greatly improved terminal communications.

At the present time we are normally handling 110 passenger trains in and out of the terminal daily, approximately 40,000 passenger cars per month, and approximately 45,000 freight cars through its interchange per month. The Railway Express Agency is the largest plant of its kind in the Country, and throughout its peak season, beginning with November 15th, it transfers and loads out approx-

imately 200 to 225 cars of perishable fruits per day, all moving by express trains. During the peak season 30 to 32 switching crews are working on this property, so that instant radio communications will be of the greatest value in maintaining satisfactory terminal operations.

Among the railway officials who observed the initial tests were J. P. Walker, General Superintendent, and E. B. Bush, Superintendent of Transportation of the Atlantic Coast Line Railway; S. B. Little, general foreman, Florida East Coast Railroad; T. W. Parsons, assistant general manager, Seaboard Airline Railway; and S. A. Gloff, superintendent of terminals of the Southern Railway.

Reading Railroad Tests ★ At Wayne Junction, Pa., the Reading Railroad is running tests in the 160-mc. band, using equipment manufactured by Maguire Industries, Inc., of Bridgeport, Conn. The work is under the direction of L. A. Moll, communications engineer for the Reading Railroad, with the assistance of Maguire engineer Nelson Wells.

E. W. Reich, superintendent of telegraphs and signals, explained that the Wayne Junction yard was selected because its maze of catenary structures, steel buildings, and tracks converging at various levels present communications difficulties that make it an ideal test spot.

The 25-watt main station transmitter and receiver has been erected at the Wayne Junction yardmaster's office. This installation can be operated over remote-

FIG. 11. 160-MC. TEST INSTALLATION ON A ROCK ISLAND TELEGRAPH SERVICE TRUCK

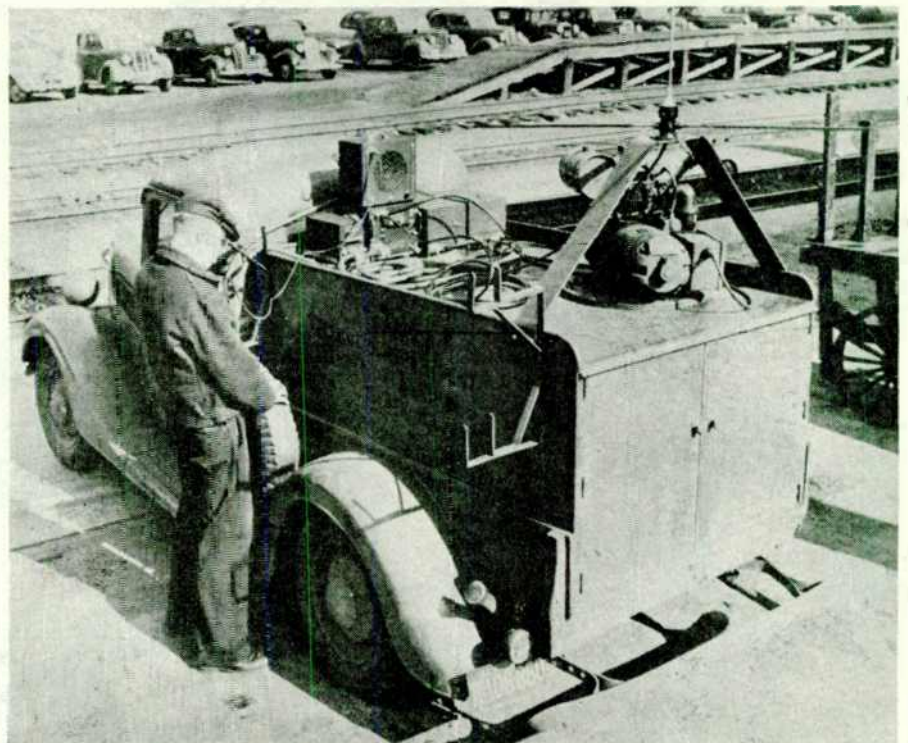

control wire lines across some trackage to the trainmaster's office, and to the yardmaster's office at Nicetown Junction, the next station to the north.

From any of these three points, it has proved possible to hold 2-way conversations with the crews of diesel-electric locomotives equipped with receivers and 15-watt transmitters. Three locomotives have been equipped already, and installations will be made in two more.

An interesting feature of this radio system is the use of automatic film recording to register 2-way conversations. A voice-actuated relay starts and stops the recorder. The voice-on-film will be used to check the performance of the system and its contribution to increasing the efficiency of yard operations.

Conclusions ★ The installations described here, and work being carried on by other roads with various makes of equipment indicate definitely that FM has contributed the interference reduction that was lacking in AM systems, tried by numerous companies over a period of 20-odd years. In addition, the use of 160 mc. and even higher frequencies has reduced the me-

chanical dimensions of antennas to the point where they can be mounted on rolling stock without introducing any hazard to personnel, or interference with structures above the tracks.

There is much work to be done before radio communications can be set up for all railroad services, and integrated with railroad customs and practice. Officials who have taken part in the installation tests concede that radio can contribute much toward greater safety and speed of operations. It requires no great stretch of the imagination to see the present projects expanded, over perhaps five years, to the point where nearly all yards will handle switching operations by radio, and where most of the freight and passenger trains will be equipped for end-to-end communications. In addition, service will be provided between trains and signal towers or, in open country, relays along the right of way.

Market for Railroad Radio ★ The use of radio by the roads will, in no application, replace any present communications or signal systems. On the contrary, it will represent a source of employment for

many ex-servicemen who have become expert in the operation and maintenance of military communications equipment.

As a new market for radio equipment, this is one of the largest created by wartime progress of the art. According to the Association of American Railroads, there were in service during 1943 a total of 45,210 locomotives, 38,485 passenger cars, and 1,780,000 freight cars, operating on 229,174 miles of railroad with 399,627 miles of track. Railroads paid taxes in 1943 totalling \$1,870,880,000.

The total property investment of Class One¹ roads amounted to \$25,838,000,000 or an investment of \$113,000 per mile. This group, in 1943, carried 730,407,500,000 ton-miles of freight, and 891,790,000 revenue passengers representing 87,974,200,000 passenger-miles. They paid 1,376,000 employees \$3,564,330,000 in wages.

In contrast to the situation after the last war, the roads have entered the new peace with strong reserves for replacement and improvement of equipment and facilities.

¹ Class One roads are those with annual operating income of \$1,000,000 or more; Class Two, of \$100,000 or more; Class Three, of less than \$100,000.

FIG. 12. EASTERN PART OF THE TERMINAL AT JACKSONVILLE, FLA. POINT 5— LOWER LEFT CORNER — IS THE LOCATION OF ONE OF THE TWO TRANSMITTER-RECEIVER INSTALLATIONS NOW INSTALLED TO EXPEDITE MOVEMENT OF CARS

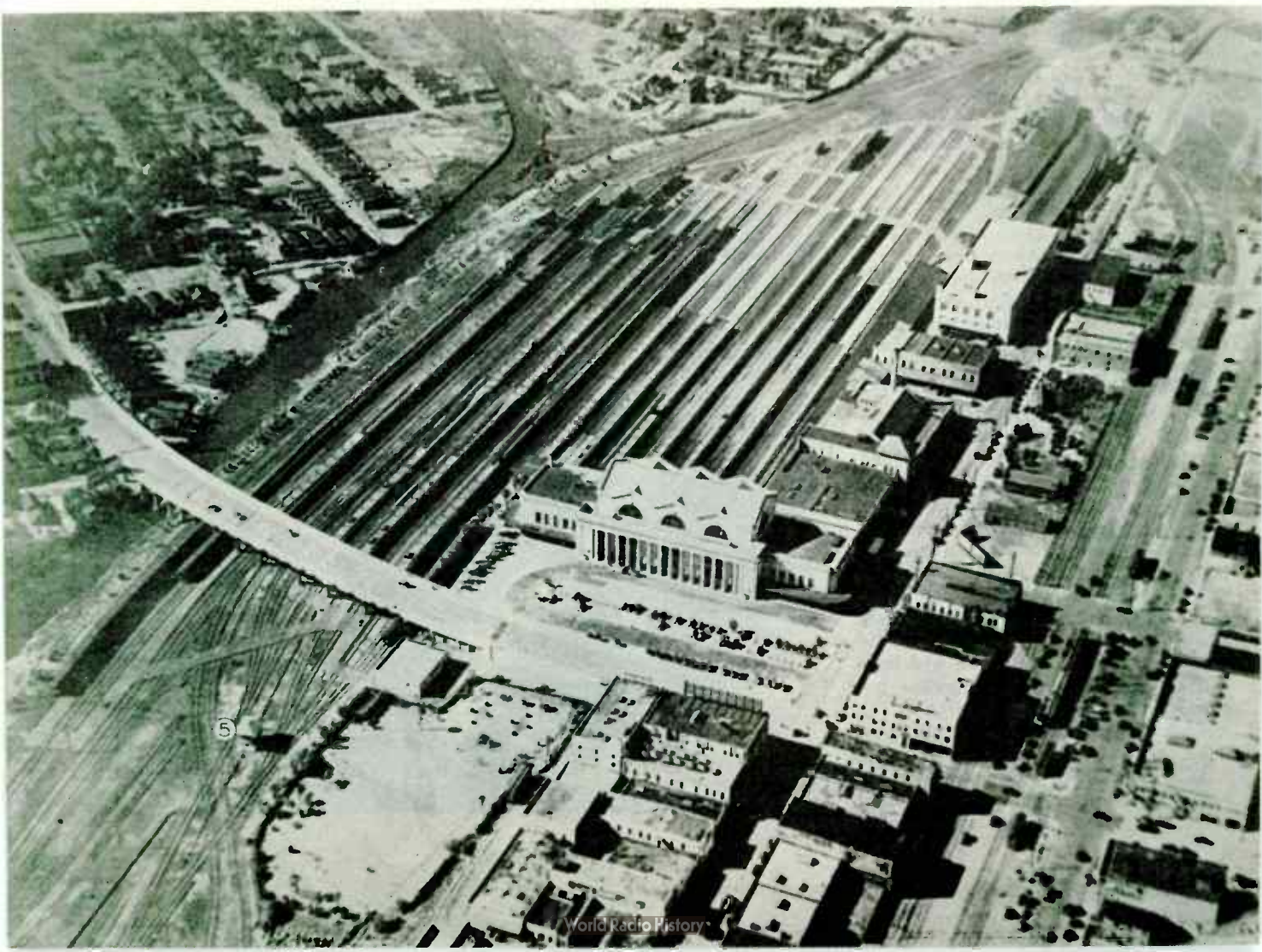

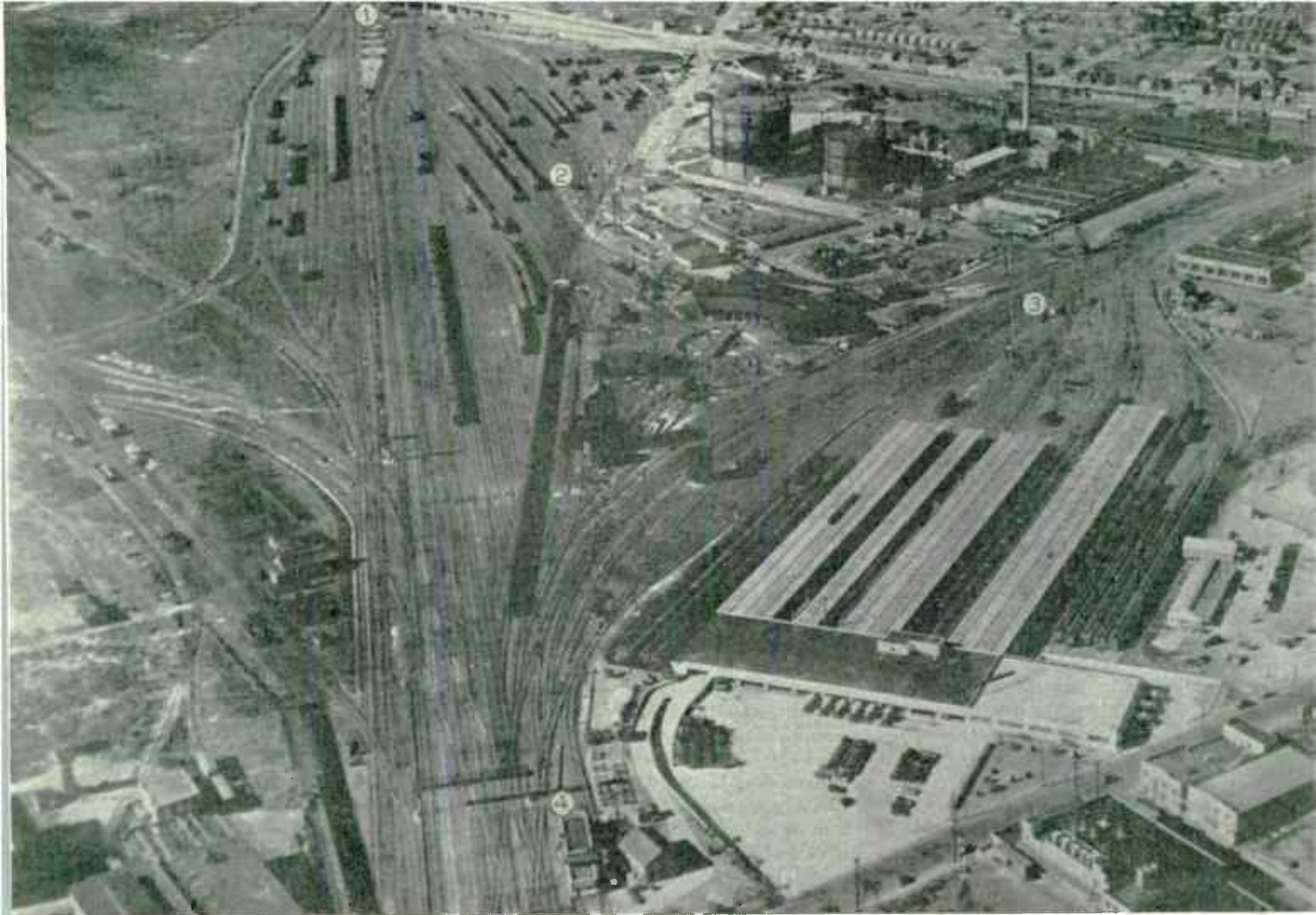

FIG. 13. WESTERN END OF THE TERMINAL. MYRTLE AVENUE TRANSMITTER-RECEIVER, POINT 4, CAN BE OPERATED REMOTELY FROM BEAVER STREET TOWER, POINT 1; FROM YARDMASTER'S OFFICE, POINT 2, IN THE COACH YARD; OR FROM THE YARDMASTER'S OFFICE IN THE RAILWAY EXPRESS PLANT, POINT 3. ALL SWITCHING ENGINES ARE WITHIN RADIO RANGE OF 1 OR 2.

REVIEWS OF NEW BOOKS

NETWORK ANALYSIS AND FEEDBACK AMPLIFIER DESIGN. By Hendrik W. Bode, Ph.D. 551 pages, extensively illustrated, cloth binding, 9 $\frac{1}{4}$ by 6 ins. Published by D. Van Nostrand Company, Inc., 250 Fourth Avenue, New York City. Price \$7.50.

Dr. Bode has contributed a 15th, and a valuable addition to the series of text books written by members of the Bell Telephone Laboratories, and published by D. Van Nostrand. As research mathematician at the Laboratories, he originally prepared this text for one of the Out-of-Horn courses there in the winters of 1939-40, and 1940-41. During the war, copies were furnished to other laboratories engaged in military research. Now, with some changes and additions, it is available in book form.

Although planned originally to encompass only the design of feedback amplifiers, an extensive preliminary development of electrical network theory was found necessary before the feedback problem could be taken up. Thus the book

became a treatise on general network theory, including material on the design of both feedback and non-feedback amplifiers, particularly of the wide-band type, and various problems arising in wide-band systems. Considerable of the material on network theory has not been published previously, but transmission line and filter theory, available in other books, have been omitted.

Illustrative of the thorough and practical treatment is the refinement to which design methods are carried out. The author's comment on this point is that the original notes he prepared were for engineers concerned with repeaters for long-distance telephone systems. Since such systems may include many repeater points, the cumulative effects of even small imperfections in individual amplifiers may be serious. Hence, the amplifier designs require more care than in most ordinary engineering applications.

An important service to readers, so often neglected in books of this sort, is the very complete index of subjects.

HORN TYPE LOUD SPEAKERS, fifth in the

series of Jensen technical monographs, 16 pages, 17 illustrations. Published by Jensen Radio Mfg. Company, 6601 S. Laramie Avenue, Chicago 38. Price 25¢.

Data presented in this monograph is planned to enable the reader to choose the type of driver and horn best suited to specific requirements for sound distribution. Designs of various driver units are discussed, together with horns intended to concentrate or diffuse sound radiation. These range from speakers intended for use in high ambient noise, as in railway locomotives, to bass reflex types combined with high-frequency drivers and diffusing horns, and high-intensity, multiple assemblies of "bull horn" construction. A group of 35 patterns shows the polar response characteristics with different exponential horns at frequencies from 1,000 to 10,000 cycles.

Other monographs in this series are: Loudspeaker Frequency-Response Measurements; Impedance Matching and Power Distribution; Frequency Range and Power Considerations in Music Reproduction; Effective Reproduction of Speech.

PHASITRON MODULATOR

New Approach to the Problem of Producing Frequency Modulation

BY DR. ROBERT ADLER*

FREQUENCY Modulation transmitter circuits designed for the lower broadcast band have proved quite satisfactory in their performance during the war years. However, the reactance-tube method of modulation, with a correction factor of about 150 to 1, had the disadvantage of operating as a result of deviation from the established center frequency, since it did not employ direct crystal control. The phase-shift method of modulation offered the advantage of direct crystal control, but involved the extra expense and the supervision of relatively elaborate and costly circuits.

*Zenith Radio Corporation, 6003 Dickens Avenue, Chicago, Illinois.

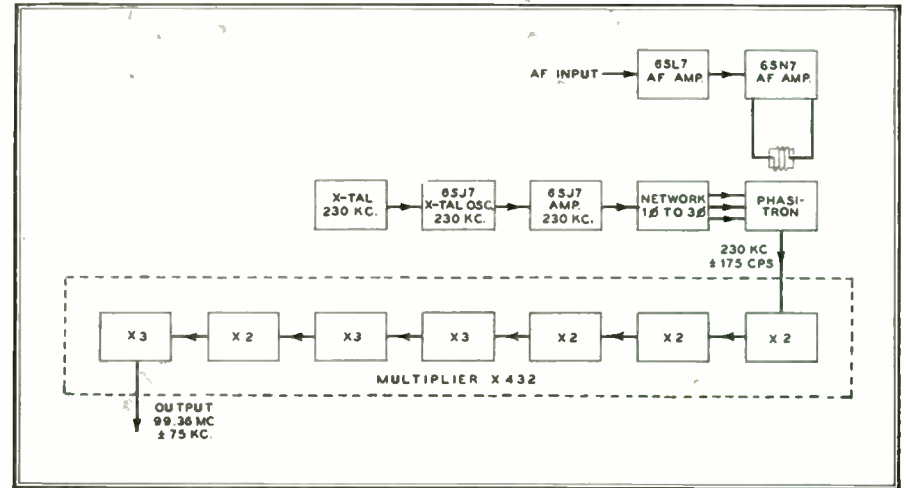

FIG. 1. BLOCK DIAGRAM OF AN FM TRANSMITTER USING PHASITRON MODULATION

Stability at Higher Frequencies ★ With the shift of FM broadcasting to the new band, and the employment of frequencies twice as high as in the old band, FCC requirements cut the frequency stability tolerance to one-half its prewar value. That meant complicating prewar transmitter circuits with new refinements in order to meet the new limits set by the FCC.

Accordingly, the writer undertook to find an approach to frequency modulation that would eliminate the mechanical or electrical lag in frequency correction of the reactance-tube method, and reduce the cost of the phase-shift method.

Phasitron Tube ★ The obvious answer was

to employ a tube for the purpose, if such a tube could be designed, since no standard type was available for the purpose. In this attempt, the writer had the unusual experience of developing a theory which, when applied to an experimental tube, actually worked the first time! That tube, and its immediate successors were made in the laboratory at Zenith Radio Corporation.

Subsequent refinements in the Phasitron tube, as we named it, were contributed by Dr. F. M. Bailey and H. P. Thomas of General Electric's electronic department. In its final form, the Phasitron method of frequency modulation proved to have such advantages that it was adopted by General Electric for their

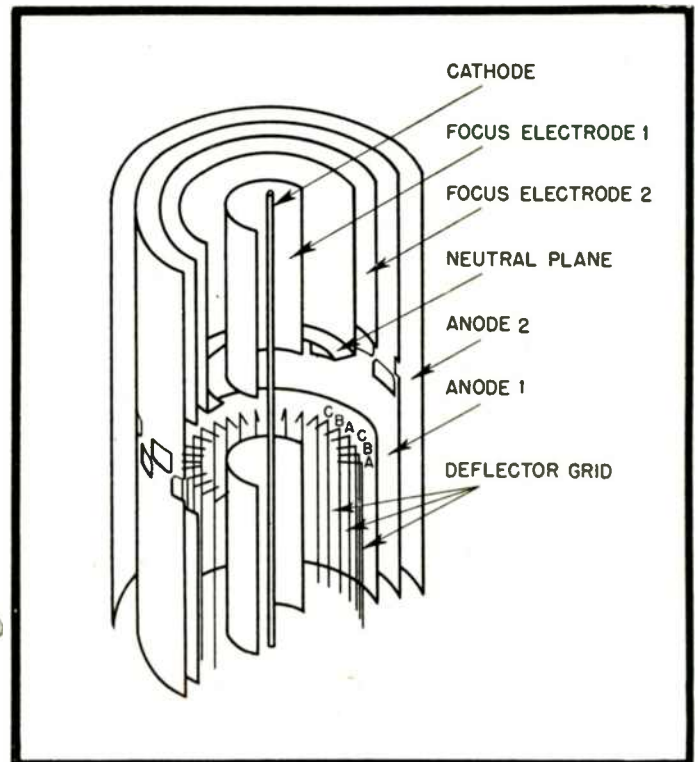
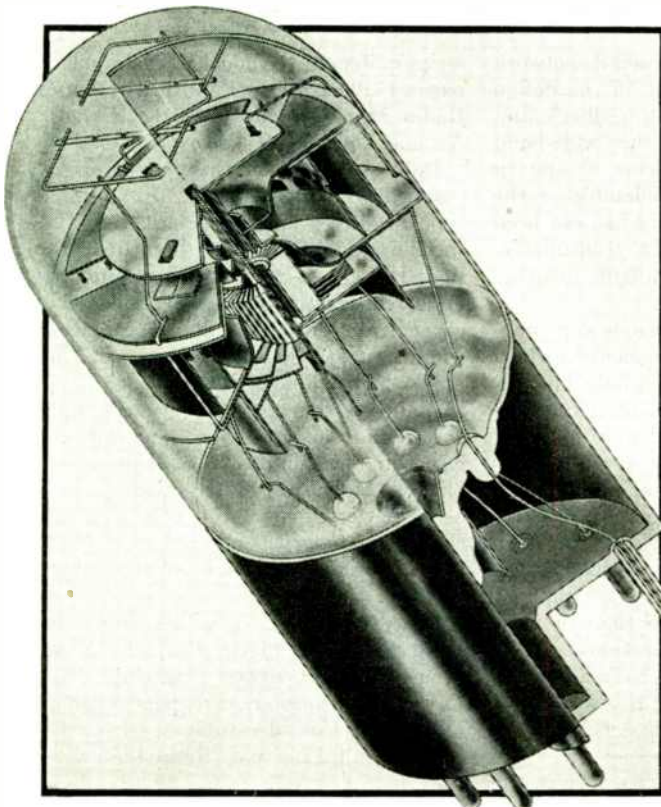

FIGS. 2 AND 3. CONSTRUCTION DETAILS OF THE PHASITRON

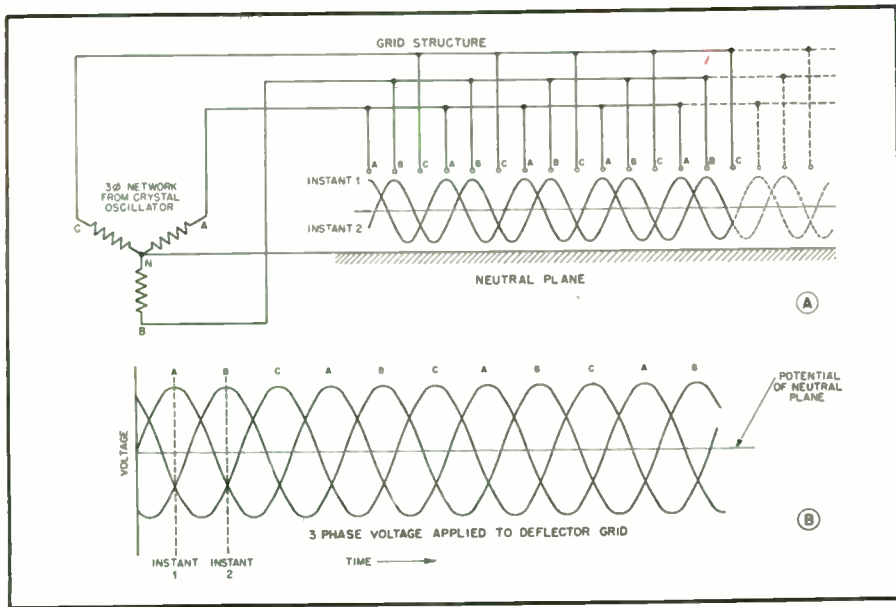

FIG. 4. APPLICATION OF 3-PHASE VOLTAGE TO THE DEFLECTOR GRID STRUCTURE

postwar FM transmitters, and resulted in reducing the prices of their new transmitters by as much as 10% below prewar figures for some models.

The specific advantages attained by designing FM transmitters around the Phasitron modulator tube are:

1. Direct crystal control using a single crystal.
2. Modulation independent of frequency control.
3. Reduction of distortion.
4. Reduction of noise level.
5. Increased frequency stability.
6. Simple, direct reliable design.
7. Lower cost of transmitters.

How the Phasitron Works ★ Fig. 1 gives a block diagram of the General Electric FM transmitter using the Phasitron, while details of the tube are shown in Figs. 2 and 3. The tube works in this manner:

Anodes 1 and 2, Fig. 3, are at positive DC potential, and draw electrons from the cathode. By means of the two focusing electrodes, the movement of the electrons forms a disc, tapered to a thin edge, in the horizontal plane. This "disc," with the cathode for its axis, lies between the neutral plane and the deflector grid structure,

extending out to anodes 1 and 2.

The deflector grid, consisting of 36 separate grid wires, are lettered A, B, and C in Fig. 3. All the A wires are connected to-

gether in one group. The B and C wires are connected in similar groups. The grouping of these grid wires and the arrangement of the neutral plane are illustrated in Fig. 4.

As Fig. 1 shows, the output of the crystal-controlled oscillator is amplified and fed into a phase-splitting network which converts the single-phase radio-frequency voltage to three-phase. This three-phase voltage is applied to the deflector grid, Fig. 4. Phase A connects to the grid wire group marked A, phase B to the B group, and phase C to the C group.

The deflecting action on the disc of elec-

trons passing between the deflector grid and the neutral plane, Fig. 4, operates in this manner: At instant 1, grid wires A are positive with respect to the neutral plane, while grid wires B and C are negative. The electron disc is therefore deflected as shown in Fig. 4. The appearance of the disc is illustrated in Fig. 5. At instant 2, one-third of a cycle later, grid wires B are positive and wires A and C are negative, causing the deflection shown at instant 2 in Fig. 4. The ruffled edge of the disc would appear to have moved the space of one grid wire during the time interval between instant 1 and 2. Thus, when the three-phase voltage is applied to the deflector, the disc, Fig. 5, has the effect of rotation.

There are 24 openings in anode 1, as indicated in the developed view, Fig. 6, with 12 openings above and 12 below the electron disc.

Electrons at the edge of the disc pass through these holes. At an instant when the ruffled edge of the disc is lined up as shown by the solid line in Fig. 6, most of the electrons pass on to anode 2. One-half cycle later, the edge of the disc has moved

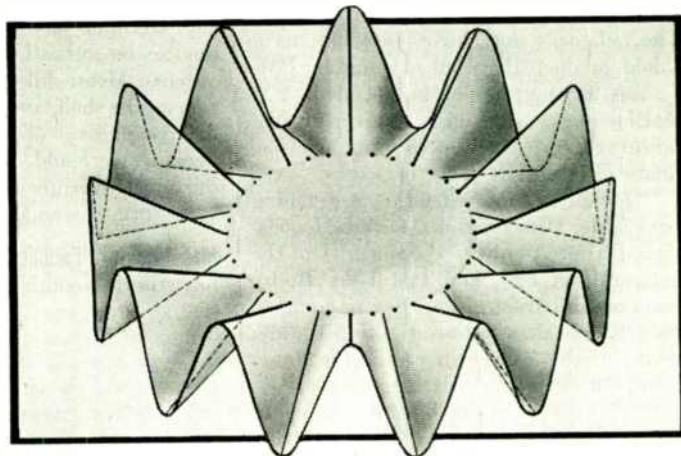

FIG. 5. DEFLECTING ACTION ON THE ELECTRON DISC

to the position shown by the dotted line in Fig. 6. At this instant few, if any, electrons can reach anode 2. Thus, the current flowing to anode 2 varies sinusoidally at the crystal frequency. Also, it can be seen that any variation in the angular velocity of rotation of the electron disc will result in variations of phase and frequency in this output current.

A coil in the output of the audio amplifier is placed around the Phasitron tube, as indicated in Fig. 1. The magnetic field resulting from current flowing in this coil is perpendicular to the plane of the electron disc. The electrons, travelling radially from the cathode toward the anodes through this field, have a force exerted on them in a direction perpendicular to their path and perpendicular to the direction of the magnetic field, causing audio fre-

(CONCLUDED ON PAGE 68)

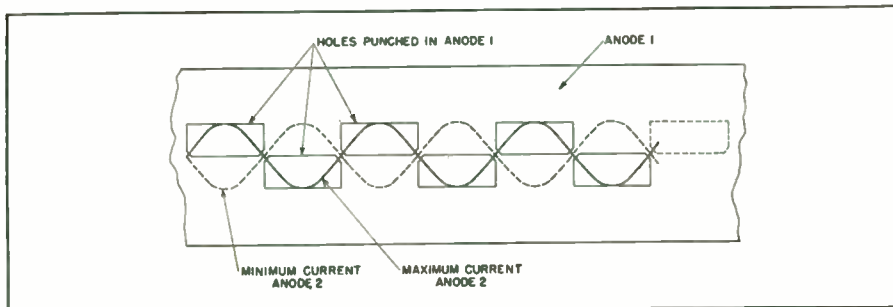

FIG. 6. ELECTRONS PASS THROUGH THE SERIES OF OPENINGS IN ANODE 1

SPOT NEWS NOTES

Items and comments, personal and otherwise, about manufacturing, broadcasting, communications, and television activities

Ira A. Hirschmann: *The New York Times* of December 18th carried an interesting statement from Ira A. Hirschmann, vice president of Metropolitan Television, Inc., and manager of radio activities for Federated Department Stores, Inc.

According to *The Times*, Mr. Hirschmann "accused national networks of trying to 'hold back' the development of FM, and purposely 'abdicating' to James C. Petrillo.

"Mr. Hirschmann noted that the three networks having FM affiliates in New York took them off the air immediately after Mr. Petrillo issued his demand in October that twice as many musicians be employed if a program be duplicated simultaneously over both AM and FM stations.

"I think the networks have played into the hands of Petrillo by demonstrating his power to force them off the air," Mr. Hirschmann continued. "I have no sympathy with Petrillo, but maybe he is not the sinister enemy he has been pictured. The networks may have used him as a shield against the continuation of FM. . . . A large group of independent FM stations have managed to keep going, however, and they have not had the financial resources of the networks.

"I want to know when they are coming back," Mr. Hirschmann asserted. "I questioned before the FCC the sincerity of the networks on FM, and I still do. If, by reaction and frustration, they're going to hold FM back, they are fighting the demand of the American public for something better in broadcasting.

"The networks don't want to give up something they have now; they're sitting on the lid of broadcasting. But a better means of broadcasting can't be stopped, and neither can new competition. . . . It's time there was competition in excellence, and not competition in mediocrity."

Independent FM Broadcasters Association: Feeling among the independent FM broadcasters is that NAB-FMFI will not promote their interests adequately. In order to advance the competition advantages of FM over AM in an aggressive manner, and to present these advantages to sponsors and agencies, it is expected that the independent FM broadcasters will form an association of their own in the near future.

Attention, Newspapers: "It is apparently only a question of time before radio will bring us a daily newspaper, complete with photographs and comic strips. This will be done by facsimile broadcasting. Facsimile is already practical for the trans-

mission of newspapers, documents, and maps from one specific point to another, and it has also been accomplished to a limited extent on a broadcast basis." — from an address by FCC chairman Porter, over WRVA on November 2nd.



Paul S. Ellison: Director of Sylvania's advertising and sales promotion has been elected chairman of the Association of National Advertisers. An ANA member since 1925, he has served on the board of directors for several

years, and is the present chairman of the public relations committee.

Sounds Familiar: C. A. Petry of United Air Lines, back from a Government assignment in Europe: "For almost 10 years, the Germans used instrument landing devices on aircraft with a high degree of success. Meanwhile, we had a better system on the shelf, and had not made practical commercial application of it simply because we could not agree between industry, Government, and military as to what form it should take."

Manufacturing 'Facilities: Of Press Wireless have been organized in a subsidiary as

Press Wireless Manufacturing Corporation. Vice president and general manager is Ray H. de Pasquale. According to A. Warren Norton, president of the parent company and of the subsidiary, wartime production facilities on Long Island will now be used for production of communications equipment.

No Radio: Train-to-train radio might well have warned the engineer of Seaboard Airline's Silver Meteor that he was approaching the Sun Queen, thereby avoiding the wreck on December 16th near Killock, S. C., in which at least 7 persons were killed and upwards of 50 were hospitalized. The accident occurred at a remote spot where, lacking communications, aid was finally brought to the injured by a motorist who chanced to pass the scene.

New TBA Members: Two of the foremost groups affiliated with the motion picture industry have joined the Television Broadcasters Association. They are the Research Council of the Academy of Motion Picture Arts and Sciences, and the Eastman Kodak Company.

Walter Widlar: One of the NDRC engineers who pioneered the New London Underwater Sound Laboratory's Sonobuoy project has been appointed general manager of the Mec-Rad Division of Black Industries, Cleveland. For 10 years prior to joining NDRC, he was facilities engineer for WGAR.

Television Optics: According to FCC Commissioner Jett, because motion picture quality seems poor when you sit close to the screen, it follows that "if you sit far enough back from the 525-line (television) picture, the quality is about as good as the 1,000-line picture." If he's right, we might just as well have 200-line television so that people wouldn't have to sit back so far. Or maybe someone ought to send Commissioner Jett a book on optics.

FM-Facsimile Station: A sky-rocket antenna designed by Dr. Andrew Alford has been erected for Capt. W. G. H. Finch's station WGHH at 10 E. 40th Street, New York City. It is expected that this station, operating on 99.7 mc., will be the first to broadcast facsimile using equipment of postwar design.

I. R. E. Building Fund: Has topped \$623,000, with small sums still coming in. Goal was \$500,000.

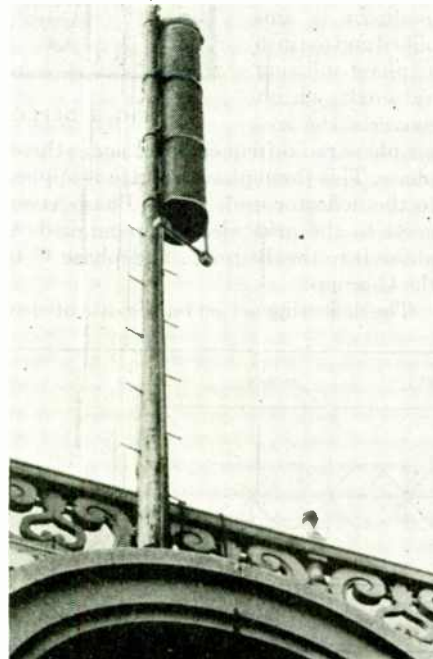

ANTENNA AT FACSIMILE STATION WGHH



NEWS PICTURE

BOTH manufacturers and railroad officials are learning much about the practical applications of radio to railway com-

munications from the numerous tests which have been in progress for nearly a year. Where AM and FM installations have been tested side-by-side, FM has proved definitely superior in practically every case. This picture was taken during a trial run on the Illinois Central Railroad, when Conductor Thomas Sullivan sat in

the caboose of a freight train and verified train orders with the engineer, 85 cars forward. Conversation was by 2-way FM. The instruments shown here are among the first to be designed specifically for railway radio service. Conductor Sullivan is the father of the five brothers who were lost on the U.S.S. *Juneau*.

FCC RULES GOVERNING RAILROAD RADIO

Complete Text of FCC Regulations Issued Nov. 14, 1945, to Become Effective Dec. 31, 1945

DEFINITIONS¹

16.1. Railroad: The term *railroad* as used in this Part includes any railroad common carrier and all facilities of every kind used or necessary in railway transportation.

16.2. Railroad Radio Service: The term *Railroad Radio Service* means a radio communication service used in connection with and concerning railroad operations.

16.3. Train Radio Station: The term *train radio station* means a radio station used primarily for end-to-end, fixed-point-to-train, and train-to-train communications, in connection with the operation of railroad trains over a track or tracks extending through yards and between stations upon which trains are operated by time table or train order, or both, or the use of which is governed by block signals.

16.4. Yard & Terminal Radio Station: The term *yard and terminal radio station* means a radio station used for radio communication within railroad yard or terminal areas.

16.5. Railroad Utility Radio Station: The term *railroad utility radio station* means a station used for communications which are of practical necessity in connection with railroad operation and maintenance.

LICENSES

16.21. Eligibility for License: Authorizations for the various classes of stations in the Railroad Radio Service will be issued only to persons or organizations operating as railroad common carriers. However, experimental authorizations may be issued to communications common carriers for the purpose of providing railroad radio service.

16.22. License Period: Unless otherwise stated in the authorization, licenses for all stations in the Railroad Radio Service will

¹ Reference is made to Section 3 of the Communications Act of 1934, as amended, for definitions of "Radio communication," *Land station, Mobile station, etc.*, and to Article 1, Sections 1, 2 and 3 of the General Radio Regulations (Cairo Revision, 1938) annexed to the International Telecommunication Convention for other definitions. These sections are contained in Appendix A of Part 2 of the Commission's Rules and Regulations.

The Part 2 General Rules and Regulations of the Commission contain those general regulations which are applicable to all types of radio stations, in addition to the specialized regulations prescribed for particular services. The procedural regulations of the Commission governing such matters as the form to be followed in the filing of applications for station authorizations in all services are contained in Part 1 of the Commission's Rules of Practice and Procedure. As soon as practicable, all of the Part 2 General Rules and certain of the Part 1 Procedural Rules, applicable to railroad-radio stations, will be integrated within this Part 16 for convenience of reference.

be issued for a period of two years, or such shorter period as may be necessary to provide for the expiration of all licenses at 3 A.M. Eastern Standard Time on February 1.

16.23. Posting Station Licenses: a) The license of each station operated at a fixed location

FOR the first time in the history of radio communications, the art has advanced to the point where it can meet the mechanical specifications and the degree of dependability required by the railroads.

Transmitters, receivers, and associated equipment can be produced now for telephone communications, facsimile and remote control operations as rapidly as the roads determine their requirements. Practically all railroad needs will be met with standard equipment, thereby effecting great economy over custom-built units.

In our issue of December, 1944, the scope of railroad radio communications was discussed in great detail. Information presented was supplied by the Association of American Railroads and the Railroad Committee of RTPB Panel 13.

Now, the FCC has implemented the immediate expansion of railroad radio plans in this new field by formulating the Rules and Regulations which are set forth here in full.

shall be posted at a convenient place where the transmitter is located.

b) The license covering each portable and mobile station shall be retained in the files of the licensee and remain available for inspection upon request by any authorized representative of the Commission.

c) A license verification card issued by the Commission and certifying to the licensed status of each portable or mobile unit shall be attached to each portable or mobile transmitter.

APPLICATIONS

16.41. Stations Operated Exclusively on Railroad Rolling Stock: A construction permit is not required for stations located and operated exclusively on railroad rolling stock, but a

station license is required for each such station. A single license application may be submitted covering any designated number of identical mobile transmitter units of the same class of station.

16.42. Portable or Mobile Stations Not Operated Exclusively on Railroad Rolling Stock: a) A construction permit and station license is required for all transmitter units of portable or mobile stations not located and operated exclusively on railroad rolling stock. A single construction permit application may be submitted covering any designated number of identical portable or mobile transmitter units of the same class of station.

b) An application for license covering any number of identical portable or mobile transmitter units of the same class of station may be submitted after completion of construction or installation of such transmitter units in accordance with the terms of the construction permit.

16.43. Stations at Fixed Locations: a) An individual construction permit application shall be submitted for each station to be located and operated exclusively at a fixed point.

b) An application for a license for each station at a fixed location may be submitted after completion of construction or installation of the station in accordance with the terms of the construction permit.

16.44. Renewal or Modification of Licenses: An individual application may be submitted for the renewal or modification of any station license in the Railroad Radio Service; or a blanket application may be submitted for renewal of a group of station licenses of the same class or for modification of a group of station licenses of the same class where the modification requested is the same for all stations covered by the application. The radio stations covered by a blanket application shall be clearly identified therein.

TECHNICAL SPECIFICATIONS

16.61. Frequencies: The following frequencies (in megacycles) are allocated to the following classes of stations in the Railroad Radio Service:

a) To train radio stations primarily for stations on board railroad rolling stock and for land stations primarily for use in communicating with stations on board railroad rolling stock:

158.43 159.15 159.87 160.59 161.31
158.49 159.21 159.93 160.65 161.37

158.55 159.27 159.99 160.71 161.43
 158.61 159.33 160.05 160.77 161.49
 158.67 159.39 160.11 160.83 161.55
 158.73 159.45 160.17 160.89 161.61
 158.79 159.51 160.23 160.95 161.67
 158.85 159.57 160.29 161.01 161.73
 158.91 159.63 160.35 161.07 161.79
 158.97 159.69 160.41 161.13 161.85
 159.03 159.75 160.47 161.19 161.91
 159.09 159.81 160.53 161.25 161.97

These frequencies may also be used on a secondary basis for inter-communication between adjacent land stations provided interference is not caused to the train radio station service for which the frequencies are primarily allocated.

b) To yard and terminal and railroad utility stations:

1) All frequencies in paragraph a) of this section except 158.43, 159.09, 159.57, 159.81, 160.53 and 161.01 mc., provided interference is not caused to train radio stations. The application requesting assignment of these frequencies for use by yard, terminal or railroad utility stations shall show why interference will not be caused to train radio stations.

2) Specific frequencies to be designated within the following television channels: 44-50, 54-60, 60-66, 66-72, 82-88, 186-192, 192-198, 198-204, 204-210, 210-216 mc. Frequencies so designated will be assigned on a mutually non-interfering basis subject to such additional limitations and restrictions as may be deemed necessary.

c) The assignment of any of the frequencies enumerated above in paragraphs a) and b) may be restricted in use to one or more specified geographic areas and may be authorized for use by one or more licensees.

d) The frequency or frequencies immediately available for assignment to any particular area or railroad may be ascertained by communicating with the Secretary of the Federal Communications Commission, Washington 25, D. C.

16.62. Emissions: Types A-1, A-2, A-3, A-4 and special emission 1) for frequency modulation for telephony, and 2) for operation of signalling, calling and similar devices, may be authorized for stations in the Railroad Radio Service. Where special emission other than frequency modulation for telephony is requested to be authorized, the application shall describe the type of emission in complete detail.

16.63. Modulation and Band Width: a) In the case of amplitude modulation, the carrier shall be modulated to a sufficiently high degree to provide effective communication, but the modulation shall not exceed 100 per cent on peaks.

b) In the case of frequency modulation, the maximum positive or the maximum

negative frequency deviation arising from modulation plus the deviation of the carrier from the assigned frequency due to frequency instability shall not exceed 30 kc. In all cases, the emissions shall be confined within the assigned channel to the extent permitted by the development of the art.

16.64. Frequency Stability: The carrier frequency of stations in the Railroad Radio Service shall be maintained within 0.005 per cent of the assigned frequency.

16.65. Frequency Measurements: The licensee of each station shall employ a suitable procedure to determine that the carrier frequency of each licensed transmitter is within the prescribed tolerance and shall make such determination at least once each six months. The results of these determinations and the signature of the person making the determination shall be entered in the licensee's records.

16.66. Power: The power which may be used by a station in the Railroad Radio Service shall be no more than the minimum required for satisfactory technical operation commensurate with the size of the area to be served and local conditions which affect radio transmission and reception. The normal power shall not exceed 100 watts input to the final radio frequency stage of the transmitter. Power in excess of this amount may be authorized where data in support of such request are submitted clearly showing the need for higher power.

OPERATING SPECIFICATIONS

16.81. Permissible Transmissions: Stations in the Railroad Radio Service may be used only for transmissions relating to and essential to operation of railroads.

16.82. Points of Communication: In accordance with the provisions of Section 16.81, stations in Railroad Radio Service may be used to communicate with:

a) Other stations in the Railroad Radio Service licensed to the same licensee or receiving stations operated by the same licensee.

b) Stations in the Railroad Radio Service licensed to other licensees or receiving stations operated by other railroads where cooperation or coordination of activities is necessary in connection with railroad operations.

c) Licensed stations in other radio services and U. S. Government stations or receiving stations in case of an emergency or impending emergency jeopardizing life, public safety, or important property.

16.83. Coordinated Service: Any applicant for an instrument of authorization, or existing licensee, proposing to furnish a coordi-

nated railroad radiocommunication service to one or more railroads eligible under the Commission's Rules for railroad radio station authorizations, shall make specific notarized request, in duplicate, for authority to furnish such service. The request or application for such authority shall contain a complete description of the service to be rendered, the terms and conditions upon which such service is to be rendered or exchanged, including the details of any arrangements for the sharing of capital investment or operating expenses and the basis of any charges to be made for the rendition of such service. Copies of all agreements or other arrangements including written statements of any oral agreements or arrangements relating to such services shall be attached to the application.

RECORDS

16.101. Station Record: All stations in the Railroad Radio Service operated at fixed locations shall maintain records showing:

a) Names of railroad employees who use the radio transmitters.

b) Results of maintenance tests made pursuant to Section 16.122.

c) Failure or improper operation of radio transmitting equipment.

d) Where an antenna or antenna supporting structure (s) is required to be illuminated.

1) The time the tower lights are turned on and off if manually controlled;

2) The time the daily visual observation of the tower lights was made;

3) In the event of any observed failure of a tower light,

I) Nature of such failure;

II) Time the failure was observed;

III) Time and nature of the adjustments, repairs or replacements made;

IV) Time notice was given to the Airways Communication Station (C.A.A.) of the failure of any tower light not corrected within thirty minutes;

V) Time notice was given to the Airways Communication Station (C.A.A.) that the required illumination was resumed; and

4) Upon completion of the periodic inspection required at least once each three months,

I) The date of the inspection and the conditions of all tower lights and associated tower lighting control devices; and

II) Any adjustments, replacements or repairs made to insure compliance with the lighting requirements.

16.102 Required Retention Period: Records required by the Railroad Radio Service rules shall be retained by the licensee for a period of at least one year.

(CONTINUED ON PAGE 78)

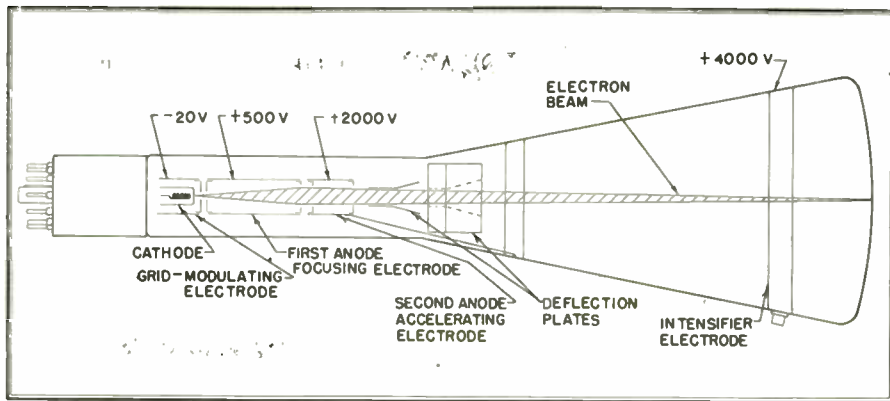

FIG. 1. ARRANGEMENT OF THE ELECTRODES IN A TYPICAL ELECTROSTATIC TYPE OF CATHODE-RAY TUBE

APPLICATION TECHNIQUES FOR CATHODE-RAY TUBES

Basic Requirements for Operation of Cathode-Ray Tubes, and Use of Published Specifications

BY DR. P. S. CHRISTALDI AND I. E. LEMPERT *

1. Introduction

THE tremendous increase in the use of cathode-ray tubes in the war effort has created a need for practical design information to promote efficient utilization of commercial cathode-ray tubes. It is the purpose of this paper to discuss the basic requirements for operating cathode-ray tubes, the provisions needed in equipment to assure proper operation of mass-production cathode-ray tubes, and some of the more important operating circuits. Particular emphasis will be placed upon the use of published specifications in designing equipment.

2. Operational Description of CRT

A TYPICAL cathode-ray tube arrangement is shown in Fig. 1, which also shows representative electrode voltages.

The indirectly-heated oxide cathode provides electron emission, and the structure in the region of the grid forms a diverging electron beam which is focused at the screen by the field between the first and second anodes. The amount of current in the beam may be varied from zero to the maximum current available by varying the grid voltage from the cutoff potential to zero potential.¹

The spot is focused by varying the first-anode voltage. The second-anode voltage

is fixed. The focused spot is deflected to any point of the screen by the application of suitable voltages to the two mutually perpendicular pairs of deflection plates.

Most modern electrostatic cathode-ray tubes employ an intensifier electrode after the deflection plates to increase the voltage of the electron beam, thus giving greater brightness with relatively little effect upon deflection sensitivity.

Fig. 2 shows a cathode-ray tube employing magnetic focusing and deflection. The first part of the gun of the magnetic tube is basically the same as that of the electrostatic tube, but the focusing is accomplished by an axial magnetic field and the deflection by two mutually perpendicular magnetic fields. Magnetic deflection has also been used with electric focusing.

It will be seen from the foregoing that the essential equipment needed to operate a cathode-ray tube are the following:

1. A source of heater voltage
2. A source of grid voltage variable from zero to cutoff
3. A variable source of first-anode voltage
4. A source of second-anode voltage (fixed potential)
5. A source of intensifier voltage (fixed potential)
6. Suitable sources of deflection voltages.

In the case of magnetically-focused tubes, a variable focus current must be available instead of the variable first-anode voltage.

Use of CRT Specifications ★ In the not-too-dis-

tant past, the practice in designing equipment to operate a given type of cathode-ray tube was to obtain a sample of the tube, build up a sample unit to give approximately the right voltages, then adjust the circuit components so that there would be enough negative grid-voltage to cut the beam off, and so that the first-anode voltage-control brought the tube to a focus at some point in its range and defocused it to some extent on both sides of the focus point. As might have been expected, the result of this type of design procedure was that when the equipment got into production tubes other than the original sample often would not work in the units due to production variations in individual tubes and to variations between the characteristics of tubes made by different manufacturers. This condition led to the formulation of specifications for the various tube types by the RMA and the Army and Navy, the use of which, together with regard for certain principles of design which have been formulated over a period of time by those in the cathode-ray field, make it possible to design equipment for a given tube type that will operate properly with any tube of that type made by any manufacturer.

A typical cathode-ray tube specification and outline drawing (for the 5CP1 tube) are shown in Figs. 3A and 3B respectively. It will be observed that the rated heater voltage is 6.3 volts, and that this voltage should not vary from 6.3 volts by more than 10%. Neglect of this specification will result in reduced performance and/or life.

* Respectively Chief Engineer and Head of Tube Engineering Dept., Allen B. DuMont Laboratories, Inc., Passaic, N. J. Paper presented at the Radio Club of America, New York City. Reprinted from the Proceedings of the Radio Club of America.

¹ In referring to potentials, it is understood that they are measured with respect to cathode, unless otherwise specified.

Referring to the grid-cutoff voltage specification F-8j, it will be observed that a minimum, bogie, and a maximum value are specified. "Bogie" is the tube manufacturer's term for a design point, a value which he attempts to hold in production; it is not necessarily an average. The important specification here, to the equipment manufacturer, is the maximum value (67.5 volts in this case). Since the intensity control which provides variable grid voltage nearly always provides a voltage between zero and some negative value, it is only necessary to design so that at least -67.5 volts are always available at one extreme of the control, in order to assure that the equipment will be capable of varying the intensity of any 5CP1 tube from maximum to cutoff; the tube specification tells him that no tubes are to have cutoff voltages higher than 67.5 volts. An exception to the above design procedure is found when positive pulsing of the grid is employed in the circuit, and it is desired to be able to cut off the beam entirely during pulsing. In that case, an additional negative voltage must be available to cut off the grid while it is being pulsed. If a 40-volt grid pulse is applied, for example, then a negative DC voltage of $40 + 67 = 107$ volts should be available to assure being able to cut off the tube. The value of maximum cutoff voltage given on the tube specification sheet applies, of course, only for the operating condition with 1500 volts on the second anode. The maximum cutoff voltage for any other second-anode voltage

is readily found, however, as it is proportional to the second-anode voltage.

Referring to the specification for first-anode voltage, it will be observed that, over the entire operating range of the tube, the first-anode voltage for focus of any tube must remain within the range from 302 to 518 volts. Thus, the focus control

provide the necessary range of voltages for first-anode currents between zero and the maximum value specified under F-8b (1).

The second-anode voltage and intensifier voltage used depend upon the brightness and line-width requirements for the particular application, but in no case

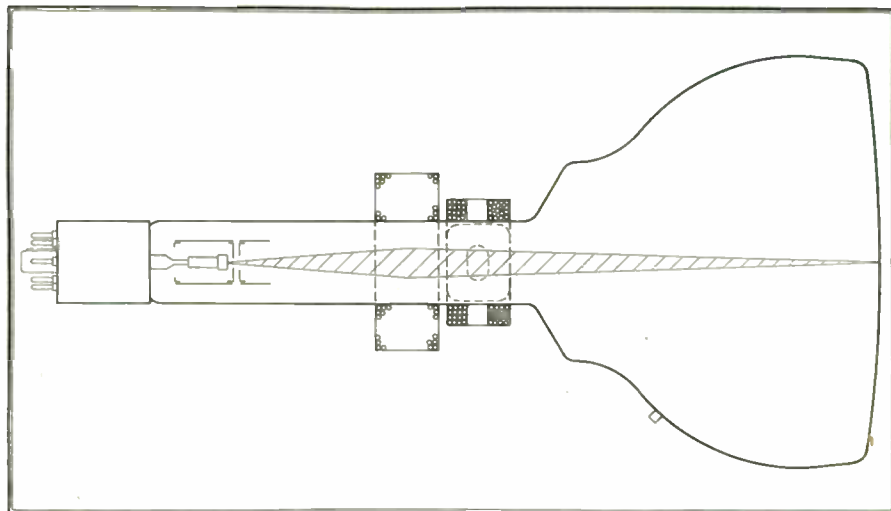

FIG. 2. ARRANGEMENT OF ELECTRODES, FOCUS COIL, AND DEFLECTION COILS IN A TYPICAL MAGNETIC TYPE OF CATHODE-RAY TUBE

must provide for this range of voltages. Again, the limits given apply only for a second-anode voltage of 1500 volts, but are directly proportional to the second-anode voltage. It should also be pointed out that the divider must be such as to

should they exceed the maximum ratings indicated. In addition, the ratio of intensifier voltage to second-anode voltage

$\frac{E_{b3}}{E_{b2}}$ must not exceed the specified maxi-

imum value; otherwise spot distortion and/or reduction of the usable screen area may occur. Line width for a given brightness will decrease as the overall voltage goes up, and the brightness attainable will go up. For the range of voltages from 0 to 4000, the brightness for a given beam current can be considered to increase as the square of the overall voltage.

The deflection-voltage sources must be so designed as to provide suitable deflection in spite of the range of deflection sensitivity over which tubes may vary. For circuits having deflection-amplitude controls which vary the deflection voltages from zero to maximum, it is necessary to be sure that there is sufficient voltage to produce the required deflection for tubes having the maximum allowable deflection factor (least allowable sensitivity). Again, the values of deflection factors given apply only for the specified second-anode and intensifier voltages, but are proportional to the second-anode voltage so

long as the ratio $\frac{E_{b3}}{E_{b2}}$ is constant. For ratios

other than the two given $\left(\frac{E_{b3}}{E_{b2}} = 1, 2\right)$ the deflection factors can be estimated roughly

FIG. 3A. 5CP1 TUBE SPECIFICATIONS

Ratings	Min.	Max.	Ratings	Min.	Max.
E_f		$6.3 \text{ V} \pm 10\%$	E_{b3}	1500 V, DC	4400 V, DC
E_{c1}	-125 V, DC	0	R_g	---	1.5 Meg.
e_d	---	550 V	Z_d	---	1.0 Meg.
E_{b1}	---	1100 V, DC	E_{hk}	---	-125 V, DC
E_{b2}	1500 V, DC	2200 V, DC	E_{b3}/E_{b2}	---	2.3

Ref.	Test	Conditions	Min.	Bogie	Max.
F-6i	Heater current		540	600	660 mA
F-8b (1)	1st anode current	Light 3 ft. L.	-50	0	500 uA, DC
F-8b (1)	Cathode current	Light 3 ft. L.	---	0	1000 uA, DC
F-8d (1)	Terminal alignment	1D2, pin No. 5	---	0	10°
F-8d (2)	Angle between traces		87	90	93°
F-8d (3)	Base & neck alignment		---	0	2°
F-8d (4)	Neck & bulb alignment		---	---	2.25 ins.
F-8d (5)	Side terminal alignment	1D2	---	0	10°
F-8f (4)	Light output		3.0	---	--- ft. L.
F-8h (3)	Leakage spot displacement	10 meg.	---	---	10 mm.
F-8h (2)	Position of spot		---	---	within 25 by 25 mm.
F-8j	Grid cut-off voltage		-22.5	-45	-67.5 vDC
F-8n	Deflection uniformity		---	0	5%
F-8p (1)	Heater cathode leakage	$E_{hk} = -125 \text{ V, DC}$	---	---	30 uA, DC
F-8p (2)	Grid leak	$E_c = E_{c0}$	---	---	5 uA, DC
F-8p (3)	1st anode leakage	$E_c = E_{c0}$	---	---	15 uA, DC

The following symbols are used in cathode-ray tube specifications:

- e_d = voltage peak between 2nd anode and any deflecting plate
- E_{b1} = 1st anode voltage
- E_{b2} = 2nd anode voltage
- E_{b3} = intensifier voltage
- E_{c0} = grid cut-off voltage
- E_{c1} = modulating voltage
- E_f = filament (or heater) voltage

- E_{hk} = heater-cathode voltage (sign indicates polarity of filament with respect to cathode)
- I_{b1} = 1st anode current
- I_f = filament (or heater) current
- I_k = cathode current
- mA, DC = milliamperes, direct current
- R_g = grid circuit resistance
- uA, DC = microamperes, direct current
- Z_d = impedance of deflection plate circuit at power supply frequency

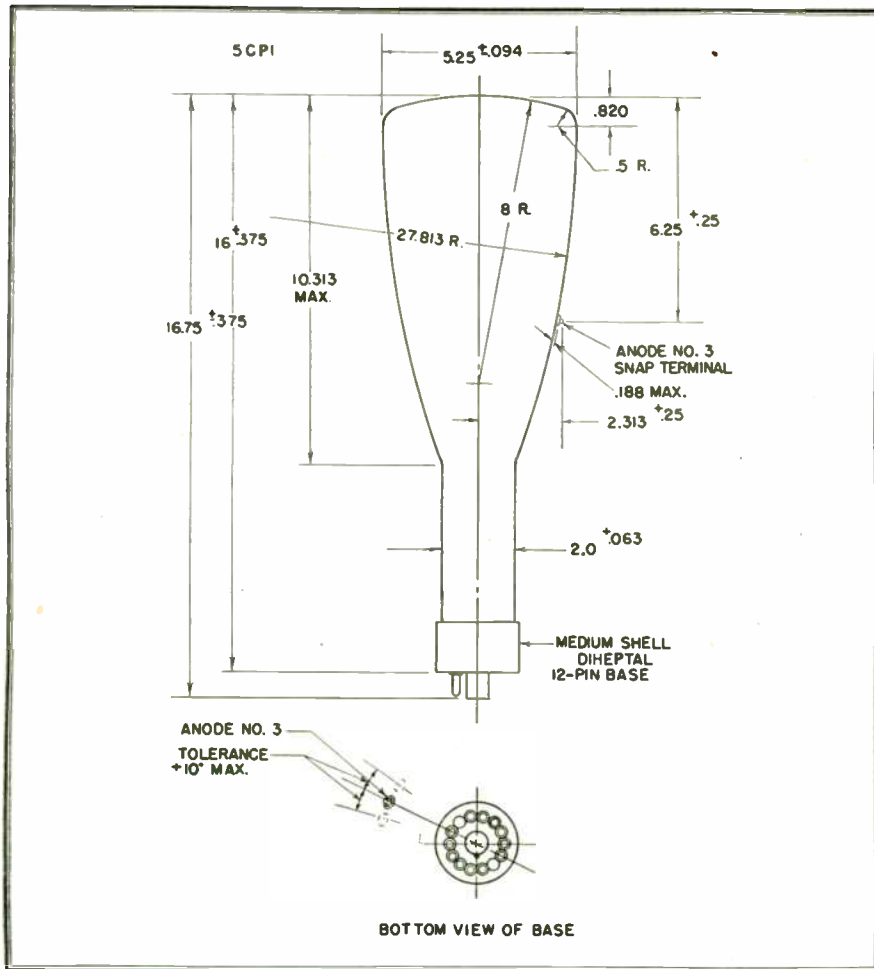

FIG. 3B. TYPICAL ELECTROSTATIC CATHODE-RAY TUBE, SHOWING DIMENSIONS IN INCHES

depends upon the deflection yoke, of course, and is not specified at all. The only tube variation which would affect deflection sensitivity would be variations of the reference line (see Fig. 4), with respect to the face. This assumes that the deflection yoke is located with respect to the reference line, as it usually is, the yoke being pushed forward as far as it will go. It can be assumed, as a good approximation, that the deflection sensitivity will be proportional to the distance from the center of the yoke to the face of the tube, for a given yoke and anode voltage.

The specifications which have been discussed in the foregoing are the ones which past experience has shown to be most important. Other parts of the tube specifications will now be discussed briefly. It goes without saying, of course, that all maximum voltage ratings should be adhered to strictly. The minimum rating specified for E_{c1} is of the nature of a maximum rating, and is given as a minimum merely because it happens to be negative. The minimum values of E_{b2} and E_{b3} are the minimum values recommended for operation of the cathode-ray tube. When operated at voltages below these values, brightness and spot size may not be satisfactory. The maximum value of R_g is the maximum DC grid resistance recommended for use with the cathode-ray tube.

If the resistance of the grid circuit is made too high, it will result in an increase in the apparent cutoff bias due to grid leakage. It might be noted at this time

from the effect of changing from $\frac{E_{b3}}{E_{b2}} = 1$
to $\frac{E_{b3}}{E_{b2}} = 2$.

In the case of magnetic tubes, the focus and deflection requirements are complicated by the fact that components external to the tube itself affect the current requirements. Specifications of focusing current for magnetic tubes are based upon currents obtained in standardized focus coils. The equipment designer, who ordinarily will not intend to use the standard focus coil will, therefore, have no way of knowing what current range he should provide with his coil. The most practical way to proceed in this case will probably be to obtain a calibrated tube from a manufacturer. From the current reading obtained under standard conditions, the equipment designer will know by what percentage the calibrated tube deviates from bogie, and can, therefore, estimate the range of focus current required in this equipment from a reading obtained on his equipment for the calibrated tube.

Deflection sensitivity of magnetic tubes

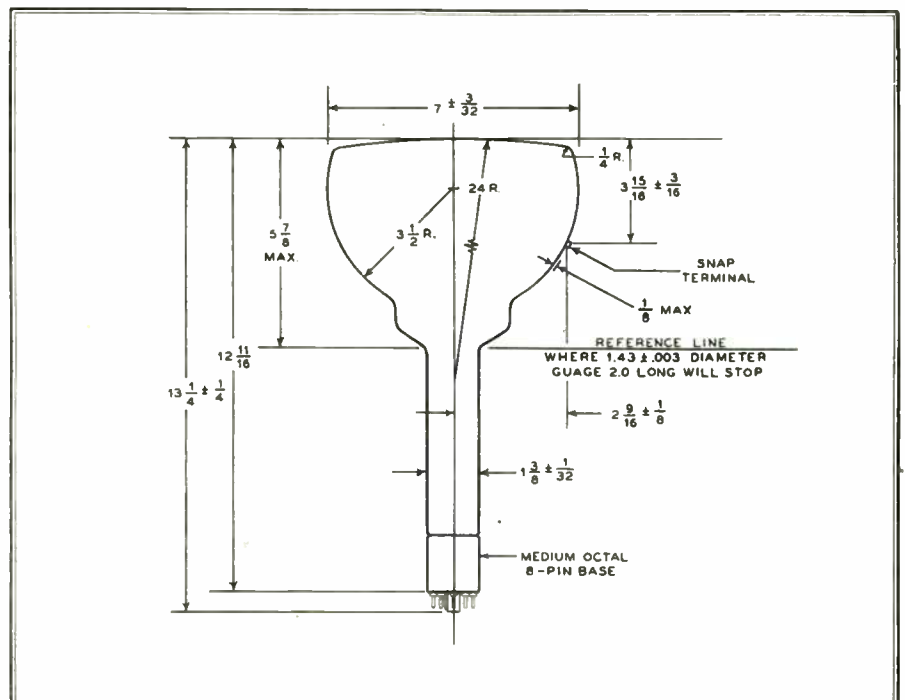

FIG. 4. TYPICAL MAGNETIC TYPE TUBE, SHOWING DIMENSIONS IN INCHES

that, in making plans to provide sufficient voltage for grid cutoff in cases where there is a resistance in series with the grid, provision should be made so that the required voltage will actually be present at the grid when the grid leakage has its maximum specified value (5 μ A in the case of the 5CP1). The maximum value Z_d (1 megohm in the case of the 5CP1) is the maximum impedance at heater-supply frequency which should be used in the deflection-plate circuit. If this value is exceeded, ripple voltages at power-supply frequency may build up at the deflection plates. It is to be noted that this is an AC impedance; a DC return of higher resistance can be used.

In addition to the tests listed here, there are many others that are of no particular interest to the equipment designer.

F-6i gives the heater current which must be supplied to the tube at 6.3 volts. F-8b(1) gives the maximum first-anode current which the bleeder will be called upon to supply in order for the tube to deliver its minimum specified light output. The specification of maximum cathode current gives the maximum current which the power supply will be required to supply at the minimum specified light output. The voltage breakdown test emphasizes the fact that the maximum ratings are absolute maximums beyond which the tubes are not necessarily tested, and are not to be expected to operate satisfactorily. Equipment in which voltages are expected to fluctuate should be so designed that the greatest fluctuation will not cause maximum ratings to be exceeded.

F-8d(1) and F-8d(5) indicate the misalignment of base and side contact with respect to the traces which must be provided for by suitable arrangements in the mechanical design of the equipment. F-8d(2) indicates the deviation from right angles which may be expected between traces, and this specification indicates that equipment should not be designed for use with a standard 5CP1 which will not tolerate a departure of 3° from right angular alignment. F-8d(3) is a specification of straightness of the base with respect to the neck and usually does not have to be given much consideration. F-8d(4) is a specification intended to limit crooked necks. As a practical matter, it has been found that it is of little importance in connection with electrostatic tubes but of great importance in connection with magnetic tubes where the tube must fit into a deflection-yoke and focus-coil structure, as well as into a socket and face-support structure. The reference F-8d(4) in the JAN-1A² specification describes this test very precisely, but as a practical matter

the specification means that, with the base and face supported rigidly, the neck is required to be straight enough so that it will pass through a circle of specified diameter concentric with a line through the center of the base and through the center of the face. This means that either the diameter of the focus coil and deflection yoke must be as great as the maximum dimension given, or else provision must be made for motion of the focus coil and deflection-yoke structure. In the latter case, the inside diameter of the deflection yoke and

is required for individual applications.

F-8h(2) indicates the maximum deviation of the spot from the center with no deflection voltages applied, due to misalignments of the gun structure. In the case of the 5CP1, the specification states that the undeflected spot will fall within a 25- by 25-mm. square centered with respect to the tube face. Sufficient positioning voltage must be supplied by the equipment designer to bring the spot back to the center of the face. It is to be noted that this deviation is for the case where the

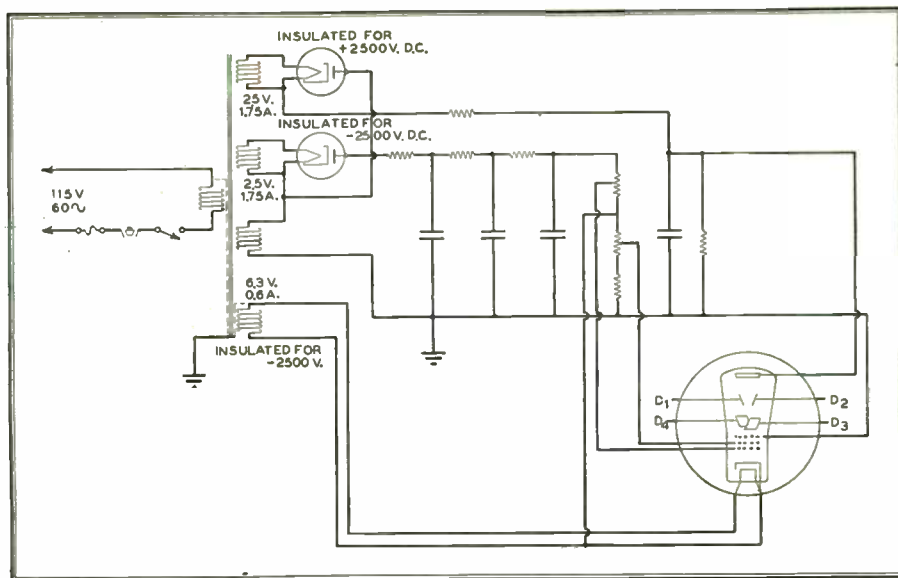

FIG. 5. TYPICAL POWER SUPPLY FOR ELECTROSTATIC TYPE CATHODE-RAY TUBE

focus coil need only be sufficient to pass a tube having the maximum neck diameter indicated on the outline drawing.

F-8f(4) specifies the minimum light output of 5CP1's as measured by the standard RMA method, using a 2- by 2-in. raster and a foot-candle meter in close contact with the face of the tube. Greater light output than the minimum specified value should not be counted upon at the test voltage ($E_{b2} = 1500$ V, $E_{b3} = 3000$ V in this case) when designing equipment. As stated previously, the light output at a given beam current will vary approximately as the square of the over-all voltage (E_{b3}) up to 4000 volts. In addition, the maximum beam current available will increase approximately as the 1.4 power of the second-anode voltage for tubes such as the 5CP1 which do not have a constant voltage electrode next to the grid.

In tubes which have an extra electrode next to the grid, the voltage of which is not dependent upon the second-anode potential (as in most presently available magnetic tubes), the maximum beam current available will vary with the voltage of this electrode. It will be necessary, of course, to determine what light output, as measured by the standard method,

tube is shielded from the earth's magnetic field and that the vertical component of the earth's magnetic field may produce a horizontal deflection of the order of 1/2 in. when the tube is operated horizontally. In the event that the tube is not shielded magnetically, additional positioning voltage should be provided to take care of this deflection.

F-8h(3) is really a deflection-plate leakage test. It indicates the amount of deflection which may be produced by the voltage built up across a 10-megohm resistor in the deflection-plate circuit. In the event that the resistance in the plate circuit is other than 10 megohms, the maximum allowable displacement will be in proportion to the resistance. Sufficient positioning voltage should be available to take care of this displacement in addition to the others.

F-8n is a specification of deflection linearity which is explained in the JAN-1A² reference.

F-8p(1) specifies the maximum heater-cathode leakage which may occur and, when the cathode is not connected to one side of the heater, care should be taken to see that the resistance of the cathode circuit is low enough so that 30 microam-

² Joint Army-Navy Specification JAN-1A for radio electron tubes.

peres will not produce objectionable voltage drops.

The same considerations apply to F-8p(2) grid leakage. F-8p(3) will not generally be of much interest to the designer as he must provide for much heavier currents in the first-anode circuit anyway.

3. Cathode-Ray Tube Circuits

Power Supply ★ In the greatest number of installations, power for operating cath-

tion and, therefore, more space. Finally, it is good practice to use electrostatic shields around both primary and cathode-ray tube heater windings, particularly when the heater is not grounded, to prevent the induction of voltages in those windings from the high-voltage secondary. Induced voltages in the primary may be dangerous, while those in the heater winding may result in objectionable modulation of beam intensity.

The current rating of the high-voltage

The filter is generally of the resistance-capacitance type using one or more sections, depending upon the degree of filtering required. When modulation of beam intensity is to be used, at least two and usually three sections will be found necessary, while otherwise one section, with the addition of a by-pass capacitor between cathode-ray tube grid and cathode, will suffice. Only one section is required for the intensifier supply.

The voltage ratings should be adequate to permit operation at the peak value of the voltage delivered by the transformer, since the load is small, and allowance should be made for variations in line voltage above the design-center value. Peak values of current through the first filter capacitor should be limited by using input resistance, although this will result in a loss of useful voltage across the bleeder. With such a filter there will be, in a typical case, a loss in voltage of approximately two hundred volts. Since there will be a further loss of a hundred volts or so across the rectifier tube, the voltage rating of the transformer must be somewhat higher than the quotient of the desired output

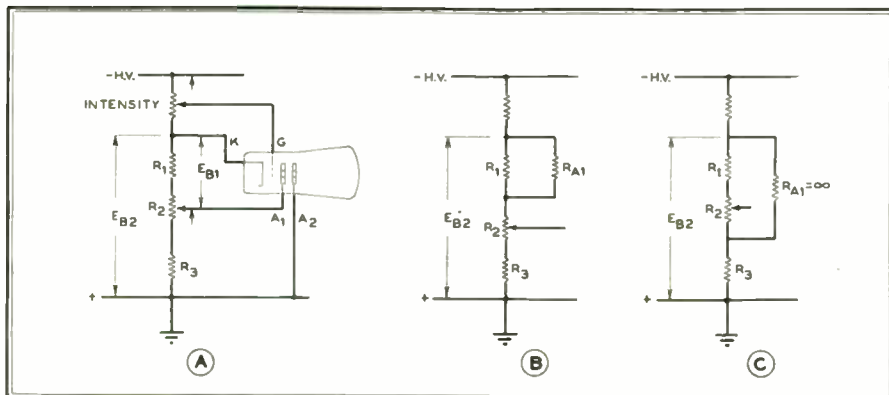

FIG. 6. A: TYPICAL BLEEDER CIRCUIT. B: EQUIVALENT CIRCUIT FOR DETERMINING MAXIMUM 1ST ANODE CURRENT AT MINIMUM REQUIRED BRIGHTNESS. C: EQUIVALENT CIRCUIT FOR CUT-OFF BIAS

ode-ray equipment is obtained from 115-volt, 60-cycle lines, and such a source will be assumed in the following discussion, although it is perfectly feasible to use sources of other frequencies or batteries in conjunction with vibrators or inverters. Whatever the source may be, it is necessary to maintain the voltage within $\pm 10\%$ of its nominal value if the voltage rating of the cathode-ray tube heater is not to be exceeded.

The power transformer used to step up voltage to the 1,500 volts or more used to accelerate the electron beam may be separate from that required to operate associated circuits, or an extension of low-voltage windings may be used. In either case, it is good practice to insulate windings from each other and from the core to withstand twice the rated voltages plus 1000 volts. When voltages above 4000 or 5000 volts are used, precautions should be observed to prevent corona discharge, which often results in erratic deflections or changes in intensity of the electron beam.

The size of transformers supplying cathode-ray tube equipment is usually considerably larger than that of units of similar power used in other applications, for a number of reasons. The core is usually made larger than normally required for the supply frequency used in order to reduce external magnetic fields, which might deflect the beam; extra magnetic shielding of the transformer is often used. The higher voltages require more insula-

FIG. 7. POSITIONING CIRCUITS FOR MAGNETIC DEFLECTION USING, A: TRANSFORMER COUPLING, AND B: DIRECT COUPLING

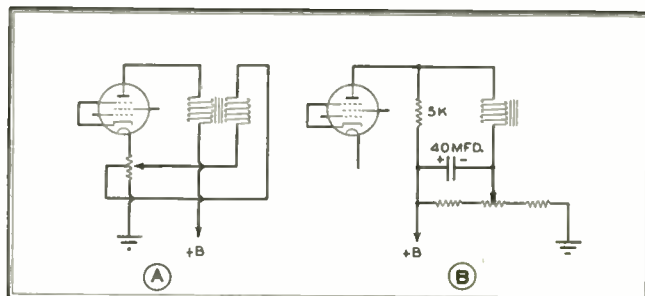

winding is generally governed by the wire size used, since the total current drain is only a few milliamperes for conventional circuits. It is desirable to have relatively good voltage regulation in order to minimize defocusing and change of pattern size with variations of intensity, and this is usually accomplished by using a bleeder current of from 1 to 5 milliamperes, depending on the current variations to be expected in the electron gun. The bleeder is used as a voltage divider to provide other operating potentials for the gun.

A half-wave rectifier circuit is generally used, since the load current is small. In cases where an intensifier electrode is used, it is advantageous to use a voltage-doubling circuit. In the latter case, the rectifier heater windings should be insulated from each other to withstand twice the voltage to ground of either of them. Since in most applications the deflection plates operate at or near ground potential, that part of the high-voltage supply used to operate the gun is operated with its positive side grounded.

voltage by the factor 1.414.

Fig. 5 is representative of the type of power supply used to operate electrostatic-type cathode-ray tubes.

The bleeder is used as a voltage divider to provide variable grid bias and variable focusing electrode potentials. In its design it is necessary to know not only the range of cutoff bias permitted by the specification on the particular type of cathode-ray tube to be used, but also the range of focusing electrode voltages and currents that must be provided.

Having decided upon the bleeder current to be used, the total resistance of the bleeder string can be determined and from it, by simple proportion, the resistance of the grid-bias potentiometer to provide the required range of voltages, based upon the specified maximum cutoff bias, plus peak modulation voltages, when they are to be used. It should be remembered that allowance must be made for the tolerances of resistors and potentiometers, as well as those of electrode potentials.

In determining the value of the focusing

What is
Direct FM



Direct FM is the system in which the oscillator that determines the "mean" or "carrier" frequency is modulated directly by the voice or audio frequency

Such a system is

- ...Simpler*
- ...Requires fewer tubes*
- ...Needs less adjusting*
- ...Introduces less distortion*
- ...Is less susceptible to noise interference*

*- and remember
in RCA FM Transmitters
you get*

GROUND
ERID *for the best* **FM**

***Direct FM** plus a new frequency-
control circuit of unique design
is used in the exciter unit of
the new RCA FM Transmitters*

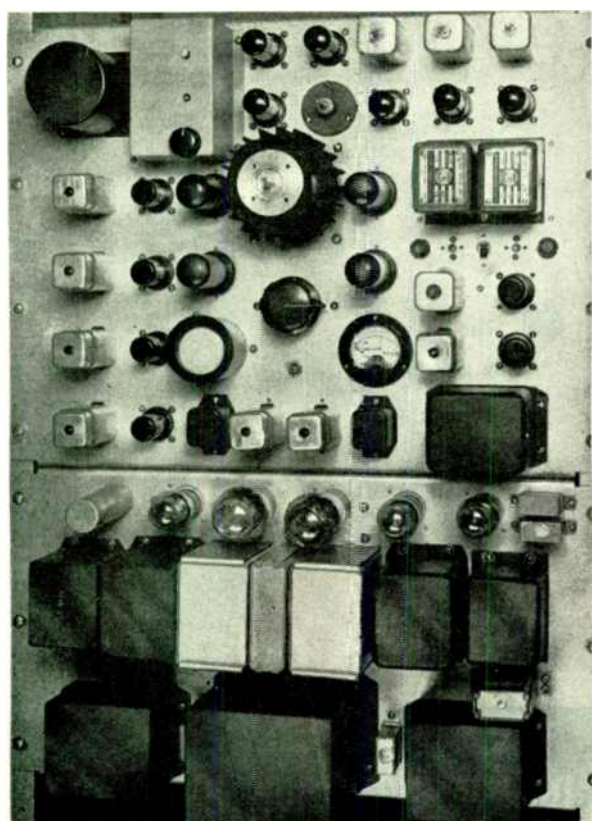

● In the new RCA FM Exciter Unit, the "carrier" frequency is generated by an oscillator operating at medium frequency. A special modulator circuit is used to vary the frequency of this oscillator in accordance with the voice or audio frequency. Thus frequency modulation is accomplished directly—without the necessity of proceeding through numerous multiplier and converter stages, each of which unavoidably adds its contribution to noise and distortion products. This system, developed by RCA Engineers, is simpler, surer, and provides better performance. We call it DIRECT FM!

Carrier-frequency stability in this new exciter is maintained by a unique "watchdog" circuit. This circuit constantly compares the output signal with a standard frequency generated by a precision-ground, temperature-controlled, quartz-crystal oscillator. Any difference between these frequencies causes a two-phase motor to start turning. A frequency-compensating condenser (connected across the oscillator) is mounted directly on the shaft of this motor. The motor turns until the condenser reaches a position where the carrier frequency is exactly synchronized with the standard frequency. Thus the transmitted frequency is maintained with the same precision as that of the crystal.

Fewer circuits and fewer components are used in this new exciter than in any developed to date. The motor-condenser drive is direct; there are no gears. The motor operates in a fraction of a second, holds the carrier frequency in exact synchronization with the crystal. Only the crystal is heat-controlled. Only 16 tubes are used (about half as many as in some exciters). All components are mounted on a single vertical panel and are easily accessible. An oscilloscope for checking circuits is built in.

Because it is simpler and more straightforward in design than any previous type, this new exciter is more dependable, requires less maintenance. The over-all distortion is less than 1% from 30 to 15,000 cycles. The frequency stability is equal to that of the crystal itself.



The new
RCA 250-Watt
FM Transmitter—
Type BTF-250

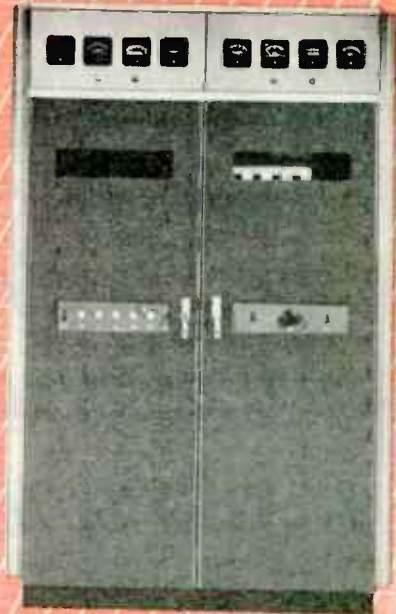

The new
RCA 1-KW
FM Transmitter—
Type BTF-1

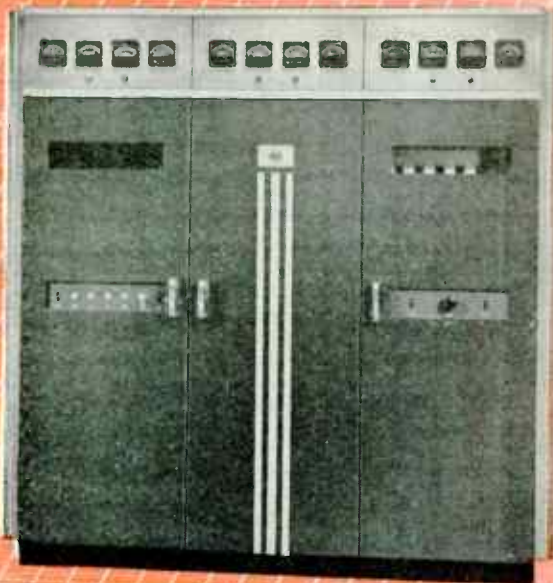

The new RCA
3-KW FM Transmitter—
Type BTF-3



MAIL THIS COUPON for details about this important New
RCA Line of FM Transmitters with the GROUNDED GRID!

Broadcast Equipment Section
RCA, Camden, N. J.

Please send me full information about your new RCA FM Transmitters with the new Grounded Grid.

Name _____

Title _____

Company _____

Street Address _____

City and State _____

97-6156-172

RADIO CORPORATION OF AMERICA

RCA VICTOR DIVISION • CAMDEN, N. J.

In Canada, RCA VICTOR COMPANY LIMITED, Montréal

electrode potentiometer for electrostatic focus tubes, it is convenient to replace the path from focusing electrode to cathode by equivalent resistances, one determined for maximum first-anode current, for which there is specified a value at minimum required brightness, and the other for zero current (cutoff grid bias). For the first case, the minimum specified value of focusing voltage should be used, corresponding to minimum shunt resistance. A comparison of Figs. 6a and 6b will illustrate the method used. Fig. 6c, showing the case for grid bias at the cutoff value, is equivalent to the bleeder alone without additional shunt resistance.

voltages must be produced, and that these currents have to be produced in inductive loads. The wave-forms required to produce sawtooth currents in partially inductive and partially resistive loads have been discussed fully elsewhere, and will not be taken up here.

As a practical matter, to obtain deflection at a uniform rate, e.g., a linear time base, the usual arrangement is to use a source of sawtooth voltage which has been modified to produce a short negative pulse just before the positive rise of the sawtooth. Such a voltage, with the amplitudes of pulse and sawtooth voltages in proper proportion, will result in a saw-

rent supply characteristics than in the case of a triode.

2. Sufficient insulation must be provided so that the high voltage which occurs across the coil when the current is suddenly stopped during a return sweep will not cause breakdown. In this connection, it should be pointed out that, for sweeps of the order of 15 kc. with return time of 10% or thereabouts, voltages of 2,000 to 4,000 volts will build up during the return time. It is important to bear in mind that the polarity of operation of the output tube cannot be chosen indiscriminately because it would be impossible for the power unit to supply the high voltage

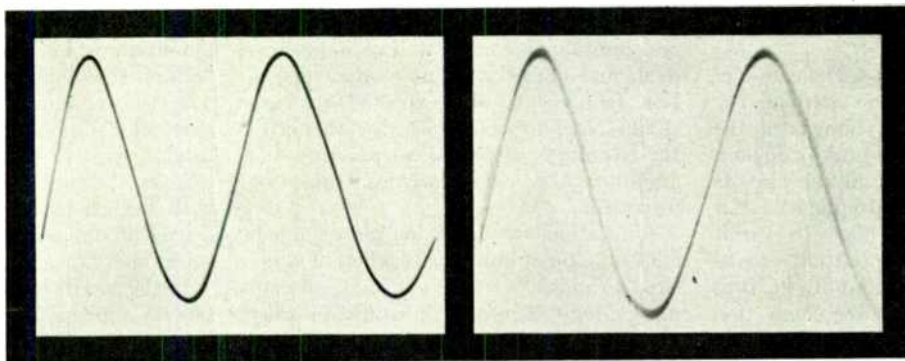

FIG. 8. ILLUSTRATING EFFECT OF UNBALANCED DEFLECTION. LEFT, ALL PLATES RETURNED TO GROUND. RIGHT, -148 VOLTS ON VERTICAL PLATES

Magnetic Focus and Deflection ★ In the case of magnetic-focus tubes, the focusing coil may be connected across a power supply of suitable voltage and current rating or, if the load is sufficiently constant, in series with it. In the first case, the focus coil will have relatively high resistance and, as the coil heats up, changes in its resistance will cause changes in focus current which will require compensation. In the case of series coils, the coil resistance is usually small compared to the load resistance, so that current through it is largely dependent upon the characteristics of the load. As it was pointed out above, specifications are written in terms of a standard focus coil, with a specified range of focusing currents required for a particular tube type and for a definite position of the focusing coil. While the exact values depend upon the design of both coil and gun, a typical value of focusing ampere-turns for a tube operated at 7000 volts is 100 milliamperes.

The same general comments apply to deflection-coil requirements for tubes using magnetic deflection as were made concerning focusing.

The design of magnetic deflection circuits is somewhat more complicated than that of electrostatic circuits because of the requirements that sawtooth currents or other special wave shapes rather than

tooth current through a load made up of resistance and inductance.

The practical problems encountered in magnetic-deflection circuits are quite different for low-frequency circuits, of the order of 60 cycles, and for high-frequency circuits of the order of 5,000 to 15,000 cycles. In the case of high-frequency circuits, transformer coupling is usually used so as to reduce the effect of the capacitance of the leads to the deflection yoke and to transfer insulation problems from the yoke to the transformer.

In discussing high-frequency drive circuits, we will consider the load as being driven by the amplifier without regard to whether or not there is a transformer present. In either case, the impedance presented to the tube plate will be about the same. The problems in the case of high-frequency circuits are to so design the amplifier driving the deflection coil as to accomplish the following:

1. Provide sufficient voltage to take up

the $L \frac{di}{dt}$ drop occurring across the induc-

tance during the forward sweep and still leave a sufficient voltage at the plate of the tube. The use of a pentode amplifier is advantageous in this respect as the plate voltage can drop considerably lower without appreciably affecting the tube's cur-

rent that would be required to return the sweep if this return sweep were produced by an increase of current through the coil. Thus such output amplifiers must always operate with the forward sweep produced by increasing plate current.

3. Suitable damping must be provided to prevent shock oscillations from occurring after the return sweep. The method of damping and values of constants are usually determined experimentally for particular cases.

4. The design of the transformer and coil system must be such as to permit the required speed of return. This requirement, of course, means keeping capacitances down as much as possible, as well as giving attention to certain specialized problems which depend upon the type of circuit used.

In connection with low-frequency circuits, the problem is usually that of obtaining satisfactory linearity. When transformer coupling is used at low frequencies, it will be found that, in order to produce a sawtooth current in the secondary, it is necessary to provide a parabolic waveform in the primary. If the current in the primary is a sawtooth, the secondary current will be a saturating exponential instead of sawtooth.

The reason that this occurs in low-frequency transformers and not in high is

that it is a function of Q , and Q cannot be made high enough to prevent the effect at the lower frequencies. Various circuits have been devised for correcting this condition, but none of them has been found to be entirely satisfactory. The preferred method is to drive low-frequency deflection coils directly from a tube plate, using resistance coupling. The problem then becomes merely that of providing sufficient capacitance in a coupling capacitor. A higher-sensitivity coil, of course, is required than if transformer coupling is used.

Positioning can be accomplished in transformer-coupled circuits as indicated in Fig. 7a, and, in the case of direct-coupled circuits, positioning can be accomplished as shown in Fig. 7b.

Deflection in Electrostatic Tubes ★ Deflection of the beam in electrostatic cathode-ray tubes generally requires voltages of the order of 500 volts peak-to-peak or higher. Often such voltages exist in the circuits being studied, but more frequently it is necessary to provide amplifiers to permit indication with reasonable pattern sizes of signals of a few volts of amplitude. It is often useful to provide for the connection of signals directly to the deflection plates in order to eliminate any effects on waveform that the use of an amplifier might produce. One of these effects is a restriction of frequency range, since an amplifier is equivalent to a band-pass filter; the other is the effect of input impedance, which is generally higher for the deflection plates of a cathode-ray tube than for the input circuit of an amplifier.

The signal voltages applied to the deflection plates should preferably be balanced, whether or not an amplifier is used, and the potential about which they are balanced should be that of the second anode. Adherence to this principle of design will result in a minimum of astigmatism, which is evidenced by a spot of other than round shape, and of trapezoidal distortion, which appears as a non-linearity of deflection sensitivity on one axis dependent upon position along the other axis. Both of these defects have been discussed at some length in textbooks and manuals. Fig. 8 illustrates the effect of balanced deflection potentials. Here, with second anode grounded, the average potential of both pairs of deflection plates was first made zero, resulting in good, uniform focus. Then the average potential of the vertical pair was increased to +148 volts, with considerable defocusing resulting.

From the design standpoint, the characteristics of greatest importance are deflection-plate capacitance, deflection factor, and leakage. Unless wide-band or tuned amplifiers are required, the capacitances can be neglected, since they are

generally less than 10 μf . and, therefore, small by comparison with other circuit capacitances. If they cannot be neglected, then some provision must be made to compensate for variation of capacitance from tube to tube. This often is in the form of variable iron-core inductances in wide-band shunt-compensated amplifiers, or of trimmer capacitances when the circuits are tuned.

The deflection factor determines not only how much gain is required when the input signal level is known, but also how much deflection-signal voltage must be developed. This latter requirement influences the design of the amplifier power supply. The use of balanced, or symmetrical, deflection permits a 2-to-1 reduction in amplifier power-supply voltage, when this is a limiting factor, as well as improving focus and linearity. In any event, deflection factors may be expected to vary $\pm 20\%$, and this tolerance, together with the tolerances of plate-load resistors and amplifier-tube characteristics, must be provided.

Limitations of deflection-plate impedance may be of importance where it is desired to make the time constants of coupling circuits as long as possible, in order to provide good low-frequency response, yet keep the physical size of coupling capacitors small to minimize shunt capacitance. Wherever the maximum rated impedance threatens to impair performance, direct coupling to the deflection plates may be considered.

Other circuits are used in connection with the deflection amplifiers. A typical example is the linear-time-base generator. Such circuits, however, do not depend upon the characteristics and ratings of the cathode-ray tube to as great an extent as do the deflection amplifiers, so they will not be considered here.

Intensity Modulation ★ One type of circuit which is affected by cathode-ray tube characteristics and which, therefore, requires consideration of them is that used for modulation of the intensity of the spot. Variations of this type are produced by applying signals between the grid and cathode of the tube. Thus a knowledge of cutoff bias rating, grid-cathode capacitance, and grid-cathode leakage rating are essential, particularly where circuit design must be carried to the limit to obtain the required performance. The range of cutoff bias fixes the value of grid-drive voltage required, for sufficient voltage should be available to drive from the minimum cutoff value to zero bias. Provision should be made to prevent the grid from going positive under any conditions of operation. It is desirable to have means available for controlling the level of the intensity-modulation signal voltage.

Grid capacitance and grid leakage have comparable effects on grid modulating circuits to those of deflection-plate capacitance and leakage on deflection circuits, and they must be taken into consideration in designing the circuit in much the same way.

The Fluorescent Spot ★ The fluorescent spot of a cathode-ray tube has several important characteristics other than those of motion and relative intensity. Most important of these characteristics are size, color, brightness, and persistence.

The usefulness of a cathode-ray tube depends upon its presenting an indication or a record. Thus the light output, or brightness, is of importance. Since one of the factors influencing it is accelerating potential, which also controls deflection factors, the choice of both tube type and operating conditions will depend on the particular applications involved. The brightness and the spot size are interrelated, the spot size generally increasing with brightness, and this must be considered in determining the suitability of a tube type.

In the specifications, the maximum spot size for a given accelerating potential and for a given required minimum brightness is given, and the test method takes account of astigmatism of the spot as well as of actual dimensions. In designing equipment, the specified values should be anticipated, although in many cases actual performance will be found to be better.

The color of the spot is usually relatively unimportant, although in most cases fluorescent screens providing a blue spot are superior for photographic work to those giving other colors. Generally the color is incidental to the persistence characteristic, which is ordinarily classified as short, medium, or long. Short-persistence screens are generally required only for photography on moving film, while those of medium persistence are best suited to visual observation of phenomena recurring at rates not less than fifteen times a second. Where repetition rates are lower than this, or for the study of transient phenomena, long-persistence screens should be used.

4. Conclusion

In the application of cathode-ray tubes, the first step in the design of equipment is to determine the type of tube which can provide the performance required, as determined from its specifications and ratings. It is then necessary to design the equipment not from a sample of that tube type but rather from the specifications, in order to ensure that in the course of production and maintenance the equipment will operate satisfactorily and interchangeably with all tubes falling within the specified tolerances.

THE TEMCO 250-WATT FM TRANSMITTER

Explanation of Design Considerations for a Transmitter Employing Reactance-Tube Modulation and Motor-Driven Center-Frequency Correction

BY SAMUEL L. SACK*

WHEN the Federal Communications Commission moved the FM broadcast band from 42 to 50 mc. up to 88 to 108 mc., broadcast transmitter manufacturers were faced with completely new problems of equipment design and construction. One of the major difficulties was the problem of obtaining tubes which would operate satisfactorily in the frequency band of 88 to 108 mc., and deliver output powers ranging from 250 watts to 50 kw. At the present moment, tubes capable of developing output powers above 250 watts are still in the experimental stage, but the possibilities for obtaining tubes rated up to 10 kw. are much better than they were a few months ago. This discussion, therefore, will concern itself mainly with the problems encountered in the successful design and construction of 250-watt FM transmitters suitable for low-power stations, or as a driving unit to which amplifiers can be added to deliver higher power as soon as development is completed on the new transmitting tubes.

General Construction Details ★ Fig. 1 illustrates the external appearance of the Temco 250-watt FM transmitter. It can be seen that the only controls exposed to the operating personnel are the filament and plate start-stop buttons, and the intermediate power-amplifier, doubler plate control. The unit was purposely designed in this manner to prevent unauthorized persons from tampering with any of the controls and to prevent accidental misadjustments of any tuned circuit elements in the transmitter.

Fig. 2 is a front view of the transmitter with the door open, showing all the controls necessary for tuning and adjusting the transmitter. It can also be seen that vertical construction is used in the exciter portion of the unit, and that all tubes can be changed, if necessary, at a moment's notice.

The rear view of the unit, Fig. 3, illustrates very clearly the accessibility of all components. Components constituting the major portion of the total weight of the transmitter, namely, the power amplifier high voltage plate supply, are located at the bottom of the cabinet.

*Chief Engineer, Transmitter Equipment Mfg. Co., Inc., 345 Hudson Street, New York 14, N.Y.

The filament and plate contactors, time delay relay, under-bias and overload relays, as well as all fuses protecting the various circuit elements, are on a relay panel at the rear of the cabinet. Immediately above the high-voltage rectifier unit and relay panel are the 800-volt plate supply for the second doubler and intermediate power amplifier, the bias supply for the grids of the final amplifier, and the high-voltage plate variac for controlling the plate voltage to the final amplifier tubes. These units are mounted

on a common panel which can be removed as a complete unit for servicing, without disturbing any of the other assemblies. The exciter unit is immediately above the low-voltage plate and bias supply panel.

Fig. 4 is a closeup of the front of the exciter unit. The balanced reactance tube modulators are at the lower right hand corner of the panel. Immediately above the modulator tubes are the motor and drive mechanism for correcting drift in center-frequency of the primary oscillator. The initial primary oscillator frequency can be adjusted by a screw driver adjustment located between the oscillator tube and the pulley driving the capacitor.

The first doubler tube is directly above the oscillator tube, and screw driver adjustment of its tank circuit is likewise provided. The second doubler tube can be seen in Fig. 3, at the top left of the exciter panel. Its tank circuit can be adjusted from the front of the panel with a screw driver. The third doubler and IPA stage, directly above the second doubler, employs a linear concentric line tank element which can be tuned from the front of the panel. An interesting feature of the IPA tank circuit is the fact that the outer conductor is at ground potential for both DC and RF voltages. Normally, a cover, shown in Fig. 2, is placed over the plate stems of the IPA tube to prevent operating personnel from accidentally coming in contact with any high voltage.

A 50-ohm concentric line, terminated in a loop, couples the IPA tank to the grid tank of the final amplifier, as shown in Fig. 3. This illustration also shows the speech input box, located directly beneath the two balanced modulator boxes. It contains the pre-emphasis network, the balance control for the modulator tubes, and the pad for controlling the audio level into the modulator grids. Fig. 4 shows this control at the lower right. Immediately to the left of this gain control are the DC amplifier and thyatron motor control tubes which provide the control voltage for the two-phase motor. To the left of this unit is the phase detector which supplies a DC potential of the proper sine for center-frequency control of the oscillator. Immediately above those elements are the

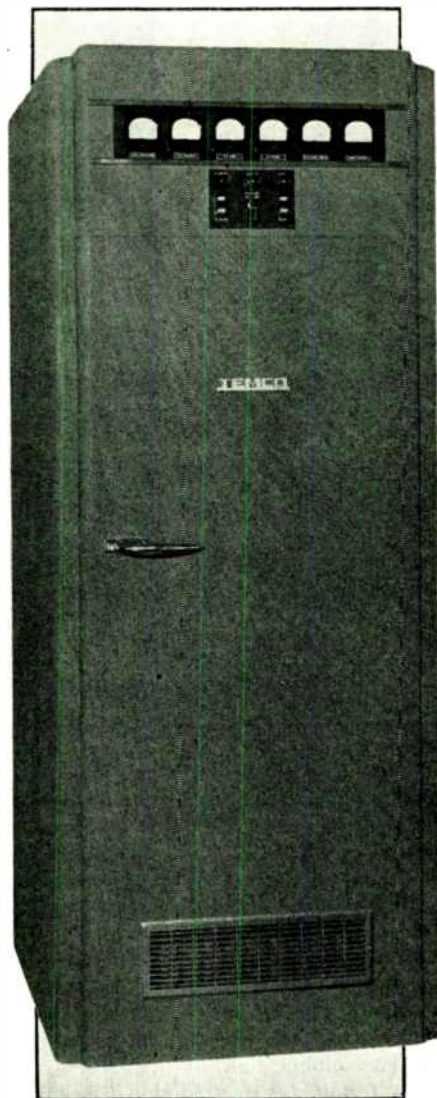

FIG. 1. THE COMPLETE TRANSMITTER

AM and FM mixers and discriminator for supplying voltages to the phase detector. The standard crystal oscillator and diode limiter, against which the drift of the primary oscillator is referred, is next above.

To the left of the standard crystal oscillator is the regulated power supply which furnishes plate voltages for the modulator, crystal oscillator, and primary oscillator tubes. Unregulated voltage is

Fig. 4. Thus, any trouble that might develop in the exciter circuits can be located. The final amplifier plate and grid tuning capacitors, as well as the variac controlling the filament voltage for the amplifier tubes, are on the final amplifier panel, directly above the exciter unit.

A closeup view of the rear of the final amplifier is given in Fig. 5. The tubes and concentric-line plate tank elements are mounted on a shelf fastened to the am-

the top of the cabinet. Blowers for cooling the plate seals and the filament, grid, and screen grid seals are at the right of the cabinet, as shown in Fig. 3.

Circuit Considerations ★ The design of the exciter unit contains some of the most interesting features of this transmitter. Fig. 6 is a schematic diagram of the complete exciter, showing the reactance tube modulators, push-pull oscillator, and

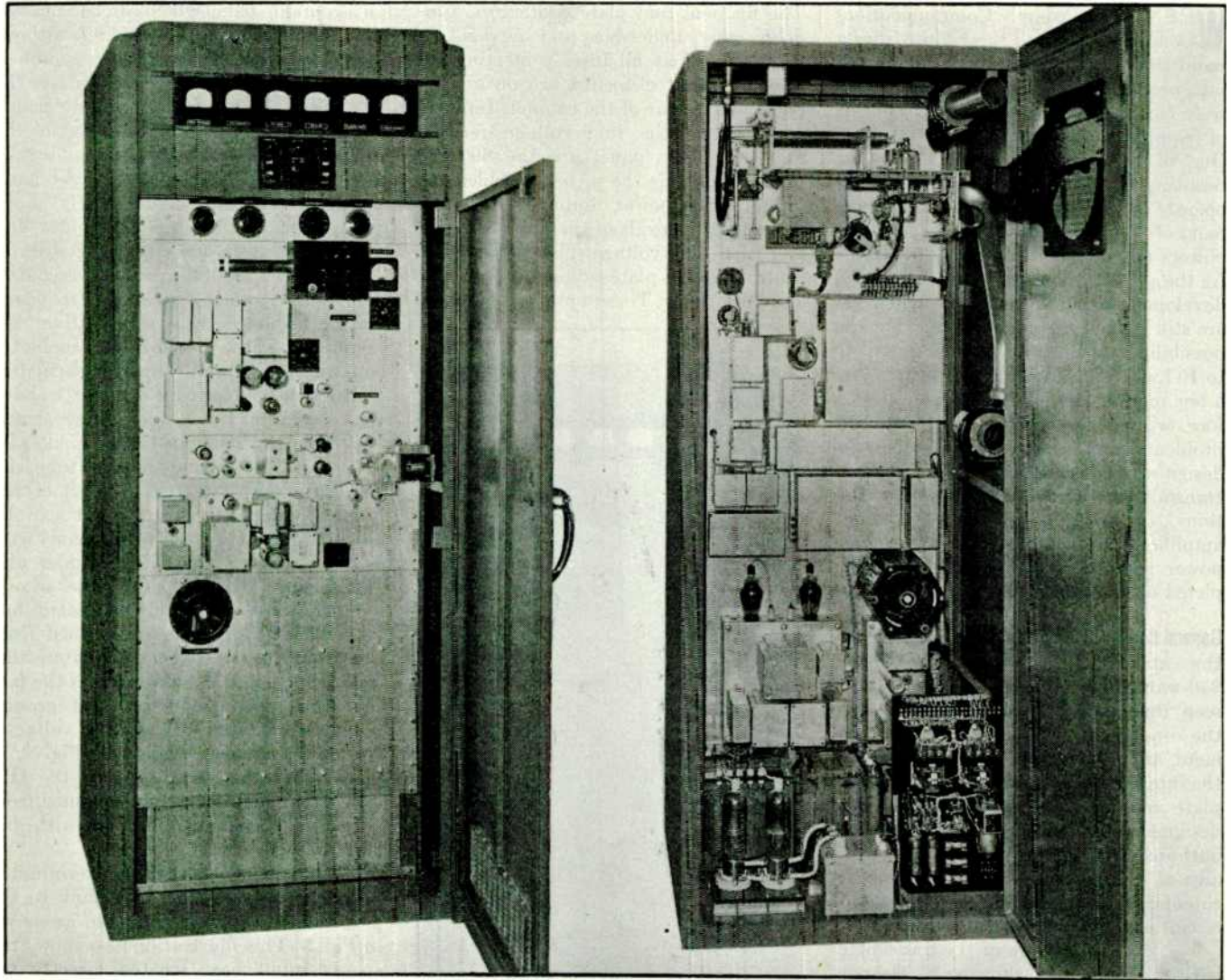

FIG. 1, LEFT. FRONT VIEW WITH DOOR OPENED. FIG. 3, RIGHT. REAR VIEW OF THE 250-WATT FM BROADCAST TRANSMITTER

also obtained from this supply to feed the plate of the first doubler tube as well as all tubes in the AM and FM mixer unit. There are controls, as indicated in Fig. 4, for the excitation to the IPA and final amplifier stages. The meter in the upper right hand corner of the exciter panel provides means for checking the plate current, grid current, and plate and screen voltages of all the stages in the exciter unit. The switch for selecting any particular circuit for metering is located at the bottom of the final amplifier panel,

plifier panel. The outer conductors of these lines are at DC and RF ground potential. The lines can be touched while the transmitter is in operation, with voltage applied to the plates of the PA tubes, without the slightest danger to the operator. This type of construction prevents excessive RF radiation, and reduces the danger of external coupling between the grid and plate circuits. The adjustable output coupling link, at the ends of the lines, terminates in a 50-ohm concentric cable fastened to the output connector at

the first, second, and third doublers. It also shows the regulated supply and the control units for center-frequency stabilization. The primary oscillator operates within the frequency range of 11 to 13.5 mc. A multiplication of eight times is used to raise the oscillator to the desired carrier frequency. Balanced modulators and a push-pull oscillator provide twice the FM swing of the oscillator frequency that would normally be obtained with a single modulator, and permit the use of such a low multiplication factor. It has

the further advantage of eliminating distortion due to second order products.

An examination of Fig. 6 shows that means are provided for balancing the cathode currents of the 6AK5 modulator tubes, as well as controls for adjusting the value of the quadrature voltage fed back to each grid. It is interesting to note that the quadrature voltages fed to the grids of the modulator tubes are in phase and that, if the grids are connected together and a modulating voltage of the same phase is applied, the reactive currents flowing through the push-pull oscillator tank coil, as a result of the modulator plate currents, will be effectively zero. This provides a means of adjusting the cathode currents of the modulator and the values of the quadrature voltages fed to each grid so that no FM modulation of the oscillator frequency takes place with a modulating voltage applied to the grids of the modulators. The balancing of the modulators can then be carried on at various input levels of modulating voltage, and insures that the modulator tubes are both operating on the same portion of their G_m characteristic, resulting in symmetrical shift of the oscillator frequency around its center value.

The 6AK5 miniature pentode tubes were purposely selected as modulators due to their low inter-electrode capacities and comparatively low input and output capacities, and because they have relatively high transconductance. To insure stable modulator operation, and to prevent relaxation types of oscillation that can develop in the modulators, it was necessary to shield the grid and plate circuits of each modulator tube carefully and to place each modulator in a separate can, as shown in Fig. 3.

The slope of the pre-emphasis curve can be adjusted by varying the resistance arm of the network so that it will lie between the limits specified by the FCC. The audio voltage, after pre-emphasis, is fed through a 500-ohm pad to the grids of the modulator tubes. The can containing the pre-emphasis network, the pad, and the cathode balance control for the modulator tubes can be seen in Fig. 3, directly below the modulator cans. The

exciter schematic, Fig. 6, shows that no correcting voltage, developed as a result of drift in the primary oscillator as compared to the standard crystal oscillator, is fed back to the grids of the modulator tubes for the purpose of center-frequency correction.

The plates of the modulator tubes are connected directly to the plates of the 6J6 dual miniature triode, used in a push-pull Hartley oscillator. Careful consideration was given to the selection of the oscillator tube. Essentially, the same

the oscillator frequency constitute a considerable portion of the total tank current. Thus, the constants of the tank circuit have to be so designed as to insure stable oscillator operation and, at the same time, permit ready modulation of the oscillator. It is likewise necessary that the oscillator be capable of developing sufficient output power to drive the first doubler stage properly. The use of the 6J6 tube as an oscillator is thus indicated, since all components can be kept physically small, the complete oscillator can be successfully shielded and, at the same time, develop approximately $3\frac{1}{2}$ watts of useful output power.

The factors involved in the selection of the oscillator tube apply equally to the first doubler tube. Since the grid and cathode of the doubler tube will be effectively across the tank circuit of the oscillator, it is necessary that it, too, have low grid-to-cathode capacity. A 6J6 miniature twin triode is therefore used as the first doubler. An examination of the exciter schematic will show that this tube is being used as a push-push doubler. The grids of the first doubler are capacity-coupled in push-pull to the plates of the oscillator tube and the plates of the doubler are connected in parallel and tuned to double the oscillator frequency. One of the most efficient doublers known is the push-push type of circuit, and its use is further indicated because of the use of a push-pull oscillator. It is possible to develop approximately 3 watts of output from the 6J6 as a push-push doubler.

It is necessary to develop considerable power from the second doubler to insure saturation of the grids of the third doubler. Accordingly, an 807 tube was selected. In spite of the fact that the input capacity of the 807 is relatively high, being approximately 11 mmf., it is still capable of use as a doubler, since the plate-to-cathode capacities of the 6J6 tube connected in parallel are only in the order of .8 mmf. Therefore the use of lumped constants in the first doubler plate circuit is still feasible since it is operating in the region of 22 to 27 mc. In order to obtain considerable amounts of second harmonic voltages from the 807 plate tank circuit,

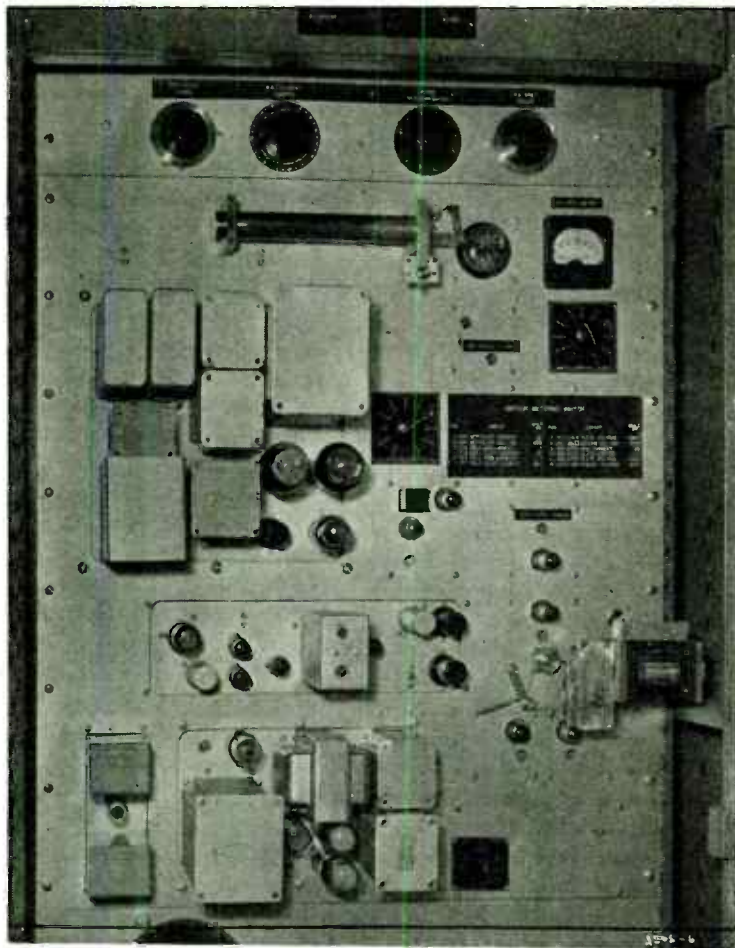

FIG. 4. THE CONTROL CIRCUITS ARE LOCALIZED ON THIS PANEL

considerations which were involved in the selection of the modulator tube applied to the oscillator. It is necessary that the tube have low grid-to-cathode and plate-to-cathode capacities, combined with high transconductance, so that these capacities constitute a negligible portion of the total tank circuit capacity. High transconductance is necessary in order that the tube oscillate readily in the frequency range of 11 to 13.5 mc. The fundamental consideration in the selection of an oscillator tube is that of low plate-to-cathode capacity. It is necessary that the reactive currents developed by the modulator to obtain a minimum deviation of ± 10 kc. of

it is necessary to use a large value of grid resistance in the 807 grid circuit which, in turn, necessitates the development of considerable amounts of driving power from the 6J6 first doubler. To reduce the effects of the output capacities of the 807, a split tank is employed in the plate circuit of this stage so that effectively only half of its output capacity appears across the tank coil, and a push-pull beam power RF amplifier tube is used as the third doubler, so that only half its input capacity is across the 807 tank circuit.

This circuit arrangement still permits the use of lumped constants in the 807 plate tank, in spite of the fact that it operates in the frequency range of 44 to 54 mc. The 807 second doubler is capable of developing considerably more power than is required to drive the grids of the third doubler stage. A potentiometer is connected in the screen circuit of this tube, so that the driving power delivered

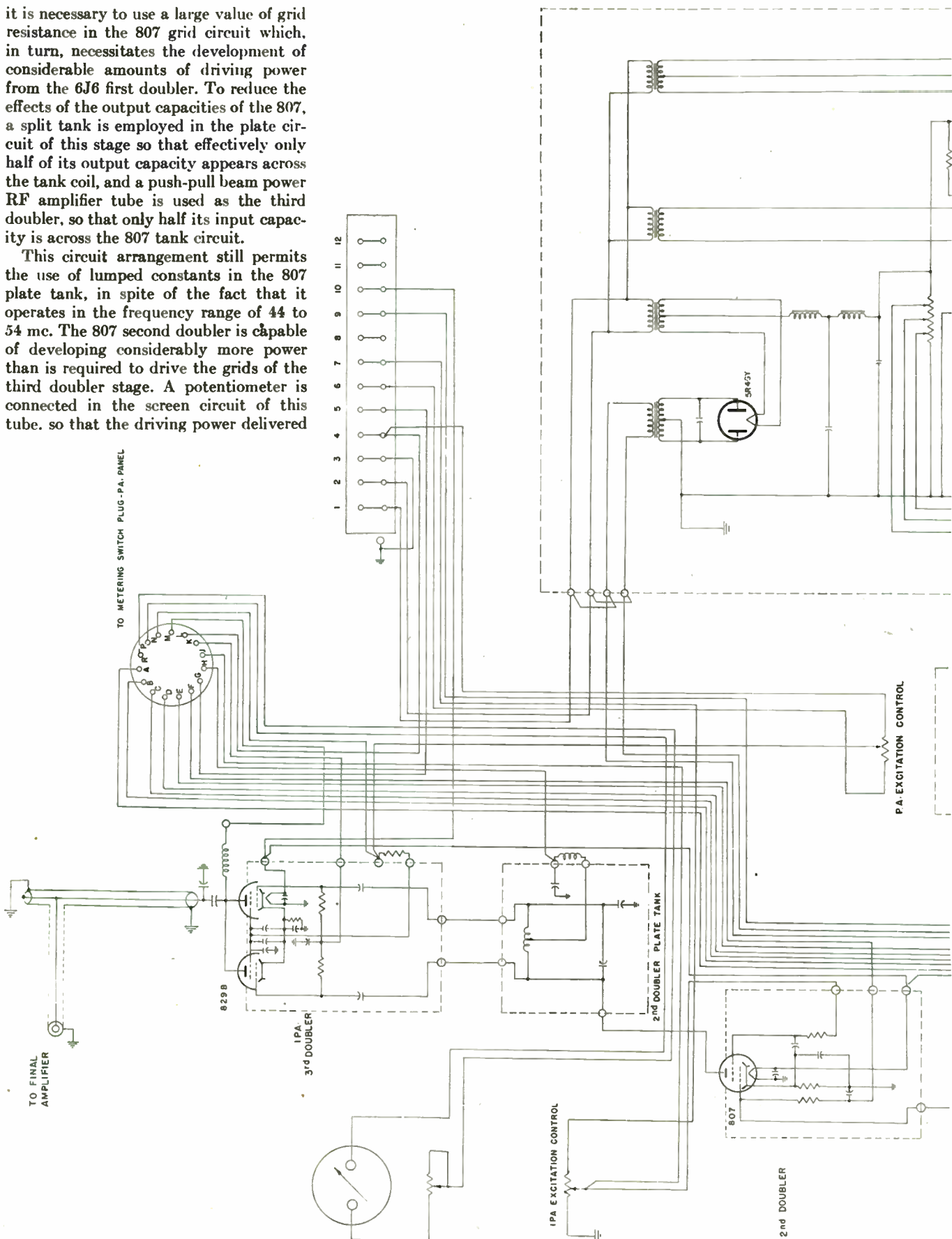
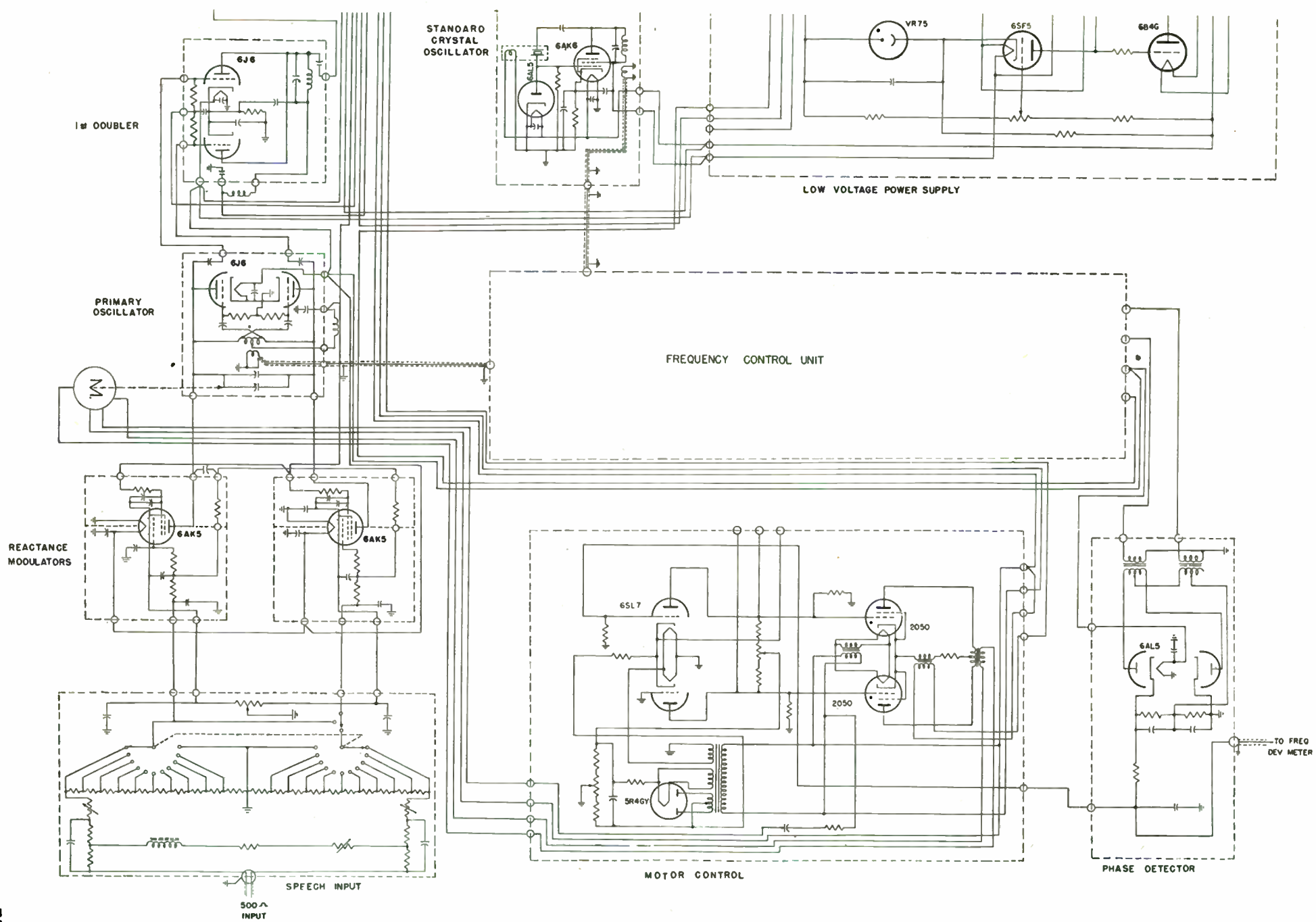

FIG. 6. SCHEMATIC WIRING DIAGRAM OF THE TEMCO 250-WATT FM TRANSMITTER. SEE FIG. 7 FOR FINAL AMPLIFIER



to the grids of the third doubler can be adjusted for optimum conditions. To insure stable operation of the 807 as a doubler in the region of 50 mc., it is necessary to isolate the grid and plate circuits perfectly. This is accomplished by putting each circuit in a separate shield, as shown in Fig. 3. The split tank circuit of the 807 doubler is capacity-coupled to the grids of the third doubler.

At the time this transmitter was designed, the only tubes that were available and capable of supplying 250 watts of output power in the frequency range of 88 to 108 mc. were the Eimac tetrodes, type 4-125A. The data available indicated that the driving power required at the grids of the 4-125A's at 108 mc. was approximately 9 watts. Since it is desirable from an operational standpoint and because of space considerations, it was decided to use the third doubler as the driver for the 4-125A's. In order to assure sufficient power from this stage, capable of supplying any transmission losses between its output tank circuit and the grid circuit of the 4-125A's, an 829B push-pull beam power amplifier was selected as the third doubler and driver for the final amplifier. To further assure fairly large amounts of reserve driving power, this tube is used as a push-push doubler,

which necessitates connecting its plates in parallel. Inasmuch as the total output capacities of the plates connected in parallel are approximately 14 mmf., it is not possible to use lumped constants in the 829B plate tank circuit at 88 to 108 mc.

Therefore, a linear concentric line element was chosen as the tank. Due to the relatively high power gain of this tube, and the fairly high frequencies involved, the problem of designing a stable doubler assumed proportions that do not exist at lower frequencies. To obtain stable operation, it is essential that no external coupling exist between the grid and plate circuits. To prevent this condition, a concentric transmission line is used as the tank element, with the outer conductor at both DC and RF ground potential. This method of construction effectively prevents any radiation from the tank circuit. Since, mechanically, it was necessary to have the 829B tank circuit on the front of the panel, Fig. 4, this construction removes the possibility of accidental shock due to contact with this tank circuit. A 50-ohm concentric line connected to the 50-ohm point on the 829B tank, and terminating in a small loop, couples the grid circuit of the final amplifier to the tank circuit of the driver.

In order to obtain high efficiencies from

the plate circuit of the final amplifier, linear concentric line elements are employed. The reasons that dictated the use of concentric lines with the outer conductor grounded in the driver stage apply to the final amplifier as well. In spite of all precautions to prevent external coupling between plate and grid circuits, and in spite of the fact that special sockets were constructed to serve as the bypass capacitors for the screens and filaments of these tubes, it was found necessary to neutralize the grid-to-plate capacitance. Because of the original socket construction, it was not feasible to attempt to tune out the screen grid lead inductance. Likewise, it was not possible to cross-neutralize in the conventional manner, since the neutralizing leads themselves offered considerable inductance at these frequencies. It was necessary, therefore, to use a neutralizing coil and plates placed in fairly close proximity to the plates of the 4-125A's in order to obtain satisfactory neutralization. This method is clearly shown in Fig. 5. Tuning of the lines is accomplished by placing a small capacitor at a point of low impedance across the lines. It is possible to use a capacitor with fairly close spacing, as no DC potential exists across it, and the capacitor is placed at a point of low RF potential.

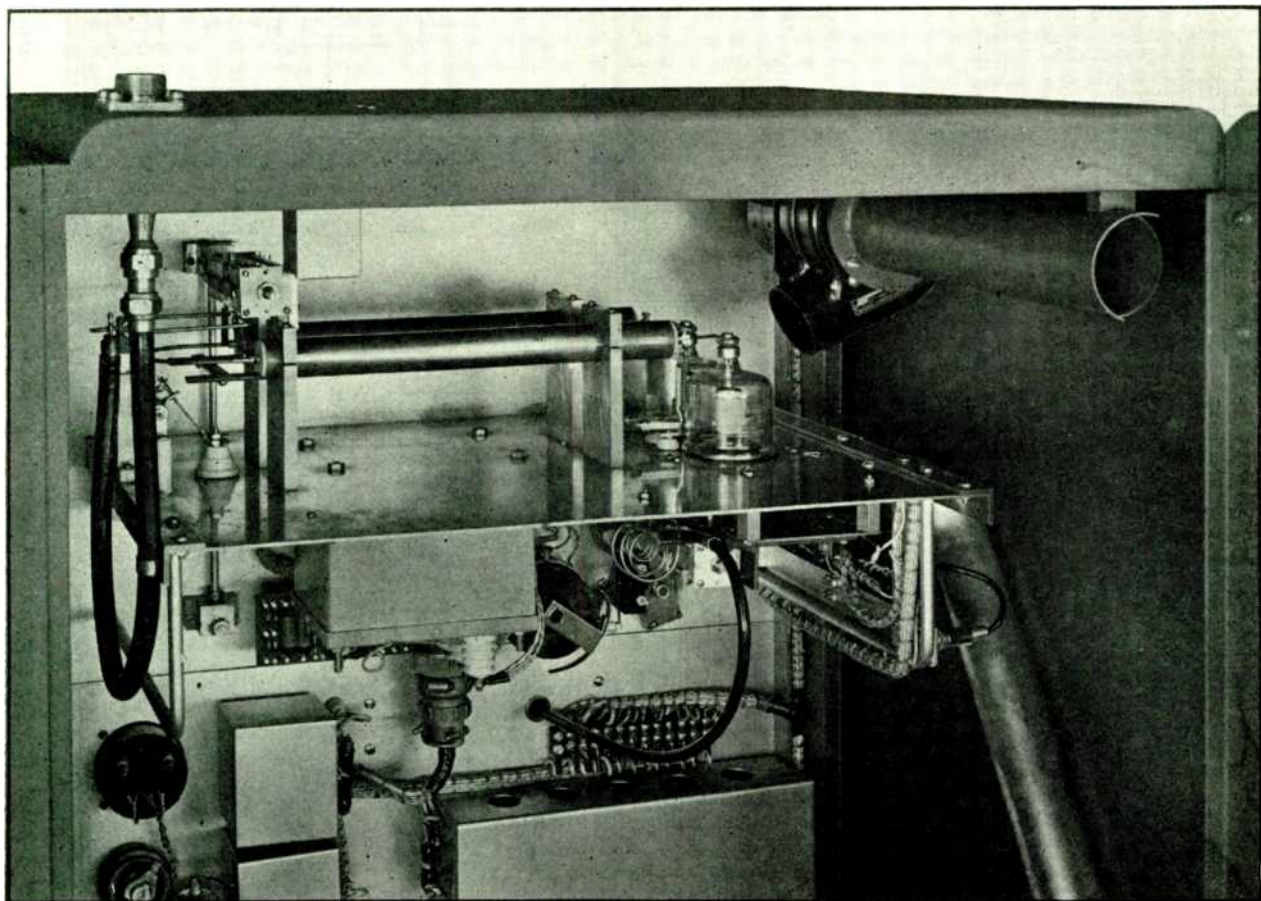

FIG. 5. CLOSEUP VIEW OF THE REAR OF THE FINAL AMPLIFIER, SHOWING THE CONCENTRIC-LINE PLATE TANK ELEMENTS

The output power from the final amplifier tank circuit is taken off by means of an adjustable coupling link terminating in a 50-ohm line, connected to the output terminal at the top of the cabinet. A relative measure of the output power of the final amplifier tank circuit is obtained by the use of a diode rectifier, connected at the junction of the 50-ohm concentric line and the output connector. The output indicator box with its diode can be seen in Fig. 5, and is shown schematically in Fig. 7. The 6AL5 diode is used as a rectifier to supply DC to the output indicator. If the line is properly terminated, it is possible to use the indicator as a direct measure of output power, since it was designed to have an expanded scale over a narrow range.

The output of the primary oscillator and the standard crystal oscillator are fed to two mixer stages. The AM audio component is obtained from one mixer stage, while the other mixer stage is fed through limiters and to a discriminator from which the FM audio is recovered. The AM and FM audio are then fed to a phase detector. The phase of the FM audio in relation to the AM audio is dependent upon the sine of the beat difference between the standard crystal oscillator carrier used as a reference and the primary oscillator carrier. The level of the DC output voltage from the phase detector is a direct function of the beat difference between the two carriers, and the sine of that voltage is a function of the sine of the beat between the carriers. The output voltage from the phase detector is then passed through a DC amplifier which, in turn, controls the grids of a pair of thyratron tubes. The output of the thyratrons provides the AC voltage of the proper phase to operate a two-phase motor, mechanically coupled to the primary oscillator tuning capacitor. The

DC output voltage from the phase detector is used as a measure of the beat difference between the two carriers. Thus, placing a zero-center DC voltmeter of high internal resistance across the output of the phase detector provides a direct indication of the primary oscillator frequency in cycles with respect to the standard crystal oscillator frequency, and indicates the sine of that difference as well. Fig. 6 shows the operation of this circuit.

The power supply for the crystal oscillator, primary oscillator, and modulator is shown in Fig. 6. The control tube is a 6B4 triode of high transconductance, a feature necessary for proper operation as a control tube. The amplifier tube is a high- μ triode, type 6SF5, the cathode of which is kept at a constant reference level by the use of a VR-75 voltage regulator tube. This type of regulator circuit has proved highly satisfactory.

A pair of 866A mercury vapor rectifier tubes, followed by a choke input low-pass filter, constitutes the essential elements of the rectifier system for the 807 second doubler and 829B third doubler. The main consideration in the design of this supply is good regulation and low hum output. The supply was designed to have capabilities far in excess of the requirements of the second and third doubler, thus insuring trouble-free operation.

The bias supply for the final amplifier grids uses a full-wave 5R4GY rectifier, the output of which is connected to a condenser input filter. The supply was designed to have low internal impedance and the filter components were selected to obtain low percentages of hum voltage. The main function of the bias supply is to act as a protective device for the 4-125A final amplifier tubes, in the event that no excitation is supplied to the grids. An under-bias relay is placed in series with the bleeder resistor of that supply.

The contacts are in series with the coil circuit of the plate contactor, so that in the event of bias failure the plate voltage will be removed from the final amplifier.

A major consideration in the design of any broadcast transmitter is the incorporation of sufficient protective devices to safeguard the components and to protect all operating personnel against accidental shock. Briefly, the operation of the system in this transmitter is as follows: The filament start-stop switch, located on the control panel, energizes the coil circuit of the filament contactor. Once the START button has been depressed, the holding contact on the contactor keeps the coil circuit energized. Line voltage is then applied to the primaries of all filament transformers and the bias supply transformer, as well as to the primary of the low-voltage regulated supply and the coil circuit of the time delay relay. One leg of the plate contactor coil is likewise supplied from a contact on the filament contactor. The other leg of the plate contactor coil is in series with contacts on the time delay relay, under-bias relay, the normally-closed plate overload relay, and the plate ON button contacts, as well as a micro-switch mechanically operated by the variac controlling the final amplifier filament voltage.

When the time delay relay has completed its cycle and the variac controlling the voltage of the final amplifier filaments has been raised to the proper value, then the plate ON button can be depressed. Plate voltage will be applied to the primaries of the transformer supplying the final amplifier and second and third doublers. In the event that an overload takes place in the final amplifier tank circuit, the overload relay contacts open and it is necessary to depress the plate ON button in order to re-apply plate voltage to all tubes.

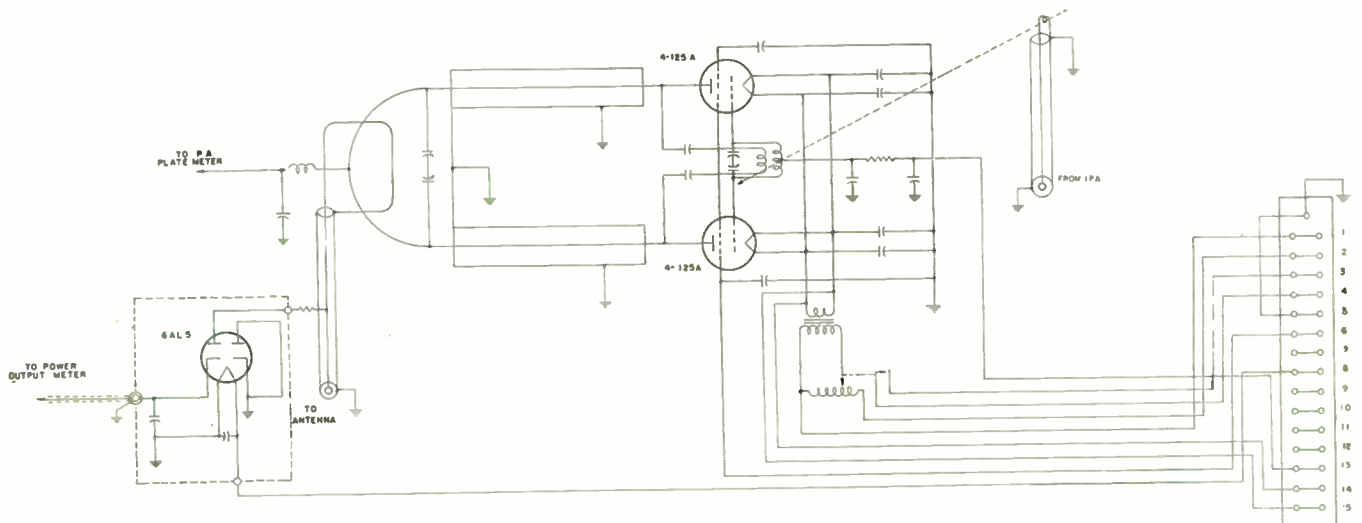

FIG. 7. SCHEMATIC OF THE FINAL AMPLIFIER, EMPLOYING TWO EIMAC 4-125A'S. OUTPUT INDICATOR IS AT LEFT

FM BROADCASTING & COMMUNICATIONS HANDBOOK

Chapter 8—Conclusion: Principles of Automatic Frequency Control, and Applications to FM Receivers

BY BURT ZIMET*

Circuit Design Considerations ★ For proper results an AFC system should not be considered as an accessory to be added to an existing receiver design. Rather, the receiver with the AFC system should be regarded as a unit to be designed for the desired end result.

An FM receiver in which an AFC system is to be used must have good stability of alignment in the various tuned circuits, as the proper operation of the control system depends upon the maintenance of alignment, especially in the discriminator network. It is desirable to include two IF amplifier stages, as well as two limiter stages, to obtain as much over-all sensitivity as possible. The IF stages must be designed in accordance with the best practice as to amplification, and band-pass characteristics.

* 2017 E. 24th Street, Brooklyn 29, N. Y.

Generally, it is desirable to supply the local heterodyne oscillator and the reactance tube with regulated plate voltage, to aid in controlling the oscillator. Tuning drift, due to thermal causes, should be made as small as possible by using temperature compensated components. The use of short leads is especially important in AFC systems, and the reactance tube and its associated components should be so installed that the coupling leads to the local oscillator will be as short as possible.

It may sometimes be desirable to use the second harmonic of the local oscillator for reasons of stability. Under this condition the reactance tube circuit would still be connected across the oscillator tuned circuit, but its holding action range would be doubled, since the plate circuit of the oscillator is tuned to the second harmonic. If insufficient reactive plate current is

developed, it can be increased in the usual manner by means of an additional linear amplifier, as shown in Fig. 75.

Discriminator Sensitivity ★ In a discriminator of the Foster-Seeley type—that is, one using a center-tapped secondary with both primary and secondary tuned to the same frequency—the sensitivity of the device to changes in frequency of the applied signal is equivalent to the slope of the discriminator characteristic curve at resonance. The sensitivity of the discriminator is an important factor in the design of an AFC system, since it determines the control voltage developed for a given frequency shift. Foster and Seeley³ give the following formula for calculating sensitivity:

$$S = 8\pi L Q^2 G_m \frac{(AK)^{1/2}}{(1 + K^2) \left(1 + \frac{AK^2}{4}\right)^{1/2}}$$

- where L = primary inductance
 Q = quality factor of primary
 G_m = transconductance of tube preceding discriminator transformer
 A = ratio of total secondary inductance to primary inductance
 K = ratio of actual to critical coupling between primary and secondary. $2\pi f M = K \sqrt{r_1 r_2}$. (r_1 = apparent primary series resistance, which includes the effect of the plate impedance of the tube, the natural primary series resistance, and any other resistive load other than the secondary, and r_2 = apparent secondary series resistance.)

In deriving this formula the apparent Q values of primary and secondary (when in circuit) were assumed to be equal. It is apparent that the sensitivity is independent of frequency, proportional to L , Q^2 and G_m , and a function of the ratio of inductances and the percent of critical coupling. It can be shown that, for any ratio of secondary to primary inductance, the optimum coupling will be less than the critical value.

The separation of the two peaks of the

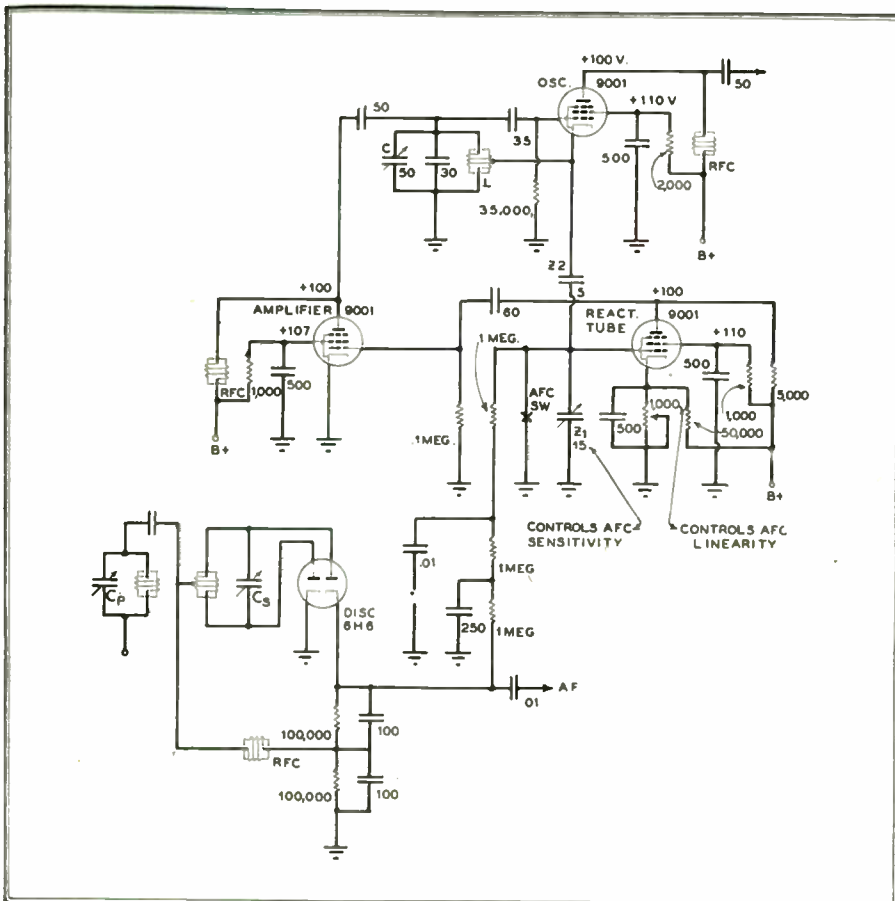

FIG. 75. WHEN THE SECOND HARMONIC OF THE LOCAL OSCILLATOR IS USED FOR STABILITY, A LINEAR AMPLIFIER MAY BE NEEDED TO INCREASE THE REACTIVE PLATE CURRENT

³ See "Automatic Tuning Simplified Circuits, and Design Practice" by D. E. Foster and S. W. Seeley, *Proceedings of the Institute of Radio Engineers*.

discriminator characteristic may be increased to increase the band width, either by raising the value of coupling above optimum, or by reducing the Q of the circuits. In either case the sensitivity will be reduced; however, changing the coupling will affect the sensitivity the least for a given change in the peak separation. If the coupling between the primary and secondary of the discriminator transformer is not greater than 75% of the critical value, the peak separation of the discriminator characteristic will be approximately equal to f_o/Q_o , where f_o is the carrier frequency and Q_o is the effective Q of the secondary with diode loading considered.

Time Delays ★ Attention must be given to the relative time delays of the discriminator output filter system and the power supply filter. The discriminator filter should have a smaller time constant than that of the power supply, in order that the AFC system may prevent changes in the oscillator frequency due to line voltage variations.

Discriminator Filter ★ It is necessary to insert a low-pass filter in the discriminator output line to the reactance tube, in order that the reactance tube will not be affected by low frequency audio voltages.

Polarity ★ The polarity of the voltage developed at the ungrounded output terminal of the discriminator network, with respect to ground, is determined solely by the sign of the coupling between the two tuned circuits. It is desirable to so phase the inductive coupling as to compensate for capacitive unbalances existing in the circuit. Then the polarity of the output voltage may be changed, when necessary, by interchanging the grounded and ungrounded terminals.

In the discriminator circuit shown in Fig. 75, the diode rectifiers produce a loading effect on the discriminator transformer. In the case of the primary, the load is equivalent to a shunt resistance equal to the diode load divided by four times the efficiency of rectification, $R_1/4\eta$. For the full secondary, the load is equivalent to a shunt resistance equal to the diode load divided by the rectification efficiency, R_1/η . Providing the effect of this loading on the Q 's of the circuit is taken into account, ordinary coupled-circuit theory can be used in calculating the primary, secondary and output voltages.

Reactance Tube ★ The maximum amount of control or holding action is proportional to the product of the transconductance G_m of the reactance tube, and the grid bias E_c . Since it is desired in practice that the range of holding action

be as large as possible for a given change in bias, a sharp cutoff tube should be selected. The transconductance of the tube should change linearly with variations in grid bias. These requirements are satisfied by pentodes that produce substantial power amplification. Such tubes,

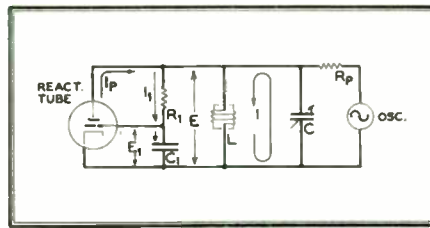

FIG. 76. RC PHASE-SHIFT NETWORK

besides having high transconductance, also isolate the plate current from the plate voltage, if the screen grid is operated at a lower voltage than the plate. In addition, since the plate current depends to a great extent upon the screen voltage, the discriminator output voltage can be impressed on the screen rather than on the control grid, thus reducing back actions.

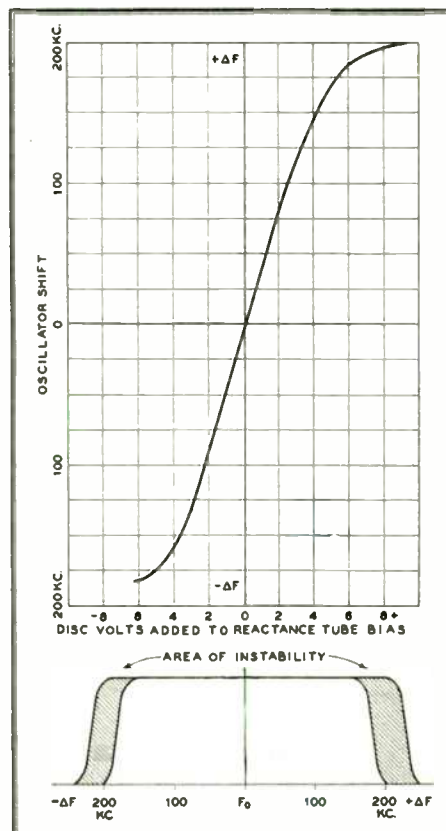

FIG. 77. HOLDING ACTION OF A TYPICAL AFC REACTANCE TUBE CIRCUIT

By proper choice of the values of capacitor C_1 and resistor R_1 in the phase shift network, the amount of holding action obtained can be varied to meet requirements. The oscillator tuned circuit voltage

is affected by the resistive branch of the phase shift network; therefore, this resistance value should be selected first to give the proper tuned circuit voltage over the desired frequency range. The capacitive branch has little effect on the tuned circuit voltage; it does, however, govern the amount of holding action of the reactance tube, since it determines the alternating voltage applied between grid and cathode of the reactance tube. When the peak value of this alternating grid voltage exceeds the negative grid bias, the holding action ceases.

Therefore, the oscillator tuned circuit voltage appearing across the phase shift network limits the value of the resistive and capacitive branches which can be used without exceeding the negative grid bias. Reducing the tuned circuit voltage across the phase shift network increases the range of control, but the voltage must be sufficient to result in adequate translation. Since the impedance of the capacitive branch varies inversely with frequency, the tuned circuit voltage should vary reciprocally and directly with frequency, in order that a uniform holding range will be realized. The tuned circuit voltage should also remain as nearly constant in magnitude as possible over the entire frequency spectrum for best results.

The holding action limit is governed by reactance tube plate current cutoff with negative discriminator output voltage, and by reactance tube grid current with positive discriminator output voltage. The oscillator tuned circuit voltage affects the grid current cutoff point, but does not determine the plate current cutoff point. Hence, when the tuned circuit voltage does not vary inversely with the impedance across the reactance tube, the holding action range will not be symmetrical about the zero discriminator voltage axis.

A simple method of determining the relative merits of tubes, with regard to holding action, is shown in the tables following. The tables illustrate variations in control possibility, using four common pentodes that can be used to develop a reactive plate current. The tubes selected for the examples are the 9001, 6AK5, 1852, and 12SH7. Plate and screen voltages are based upon the manufacturer's recommended values; however, these values can be varied to satisfy particular requirements.

An RC type of phase shift network is used in the example, as shown in Fig. 76. The value of the resistive branch R_1 is selected first so that the proper tuned circuit voltage E is realized over the desired range. The capacitive branch C_1 , which has little effect on the tuned circuit voltage E , governs the amount of control. For purposes of illustration, an arbitrary peak

value of 25 volts is assigned to the voltage E , which also appears across the phase shift network R_1C_1 . The resistor R_1 has a value of 50,000 ohms.

Cutoff in the positive direction can be determined by using trial impedance values of 1,000 ohms and 5,000 ohms for capacitor C_1 . When the capacitive reactance is 1,000 ohms, cutoff in the positive direction will be 0.5 volt; a capacitive reactance of 5,000 ohms will give a cutoff value of 2.5 volts.

The transconductance of a 9001 tube is approximately 2,000 at 0.5-volt bias, and 1,600 with a bias of 2.5 volts. Thus, for a change in the reactance of capacitor C_1 from 1,000 ohms to 5,000 ohms, a change in transconductance from 2,000 micromhos

VARIATION OF CONTROL POSSIBILITY WITH BIAS CHANGES

9001			6AK5		
E_c	G_m micromhos	$G_m E_c$	E_c	G_m micromhos	$G_m E_c$
-6.5	cutoff	0	-6.0	cutoff	0
5.0	300	1500	5.0	900	4500
4.0	800	3200	4.0	1500	6000
3.0	1400	4200	3.0	3000	9000
2.0	1800	3600	2.0	5000	10000
1.0	2000	2000	1.0	—	—
E_p 250 volts, E_{ac} 100 volts			E_p 180 volts, E_{ac} 120 volts		

12SH7			1852-6AC7		
E_c	G_m micromhos	$G_m E_c$	E_c	G_m micromhos	$G_m E_c$
-4.0	cutoff	0	-4.0	cutoff	0
3.0	900	2700	3.0	1000	3000
2.0	2700	5400	2.0	4000	8000
1.0	4000	4000	1.0	8000	8000
E_p 250 volts, E_{ac} 100 volts			E_p 300 volts, E_{ac} 100 volts		

Holding Action ★ Fig. 77 shows the holding action of a typical reactance tube

system will not take control again to restore the signal unless this is done. This effect occurs both above and below the mid-frequency. The FM receiver should be tuned so that it is not operating at the outer edge of the control range, i.e., within the shaded areas shown. Whenever the receiver is tuned within this area it is in an unstable condition and, in addition to possibly introducing unnecessary distortion, the signal may disappear abruptly.

Design Equations ★ The maximum plate current developed by the reactance tube occurs when the discriminator output voltage reaches a positive maximum.

$$I_p \text{ max} = \omega CE + G_m E_m + G_m E_1, \quad (\omega t = 90^\circ).$$

Minimum plate current occurs when the discriminator output voltage reaches a negative maximum,

$$I_p \text{ min} = \omega CE - G_m E_m + G_m E_1, \quad (\omega t = 270^\circ).$$

These values are shown in Fig. 76, where the peak amplitude of the oscillator frequency voltage E_1 applied to the grid of the reactance tube is fixed, since this value,

$$E_1 \text{ peak} = \omega CE + G_m E_1,$$

exists with zero discriminator voltage E_m . In the circuit of Fig. 76, the grid exciting voltage E_1 lags the small exciting current I_1 by an angle of 90 degrees, and the resultant plate current I_p , flowing through the oscillator tuned circuit $L-C$, also lags the tuned circuit voltage E by the same angle. The total peak current I through the capacitive branch C of the frequency-determining elements $L-C$ is, therefore, no longer ωCE , but for zero discriminator voltage E_m becomes

$$I_o = \omega CE - G_m E_1.$$

or approximately

$$I_o = \omega CE - G_m \frac{E}{\omega C_1 R_1},$$

since, for a 90-degree lagging current I_p , the phase shift network in the circuit shown consists of a capacitive branch

$$Z_1 = \frac{1}{\omega C_1}$$

and a resistive branch

$$Z_2 = R_1,$$

where, in practice the value of R_1 is selected equal to or greater than five times the value offered by the capacitive branch Z_1 , or

$$R_1 > \frac{5}{\omega C_1}.$$

The current I_1 flowing through the phase

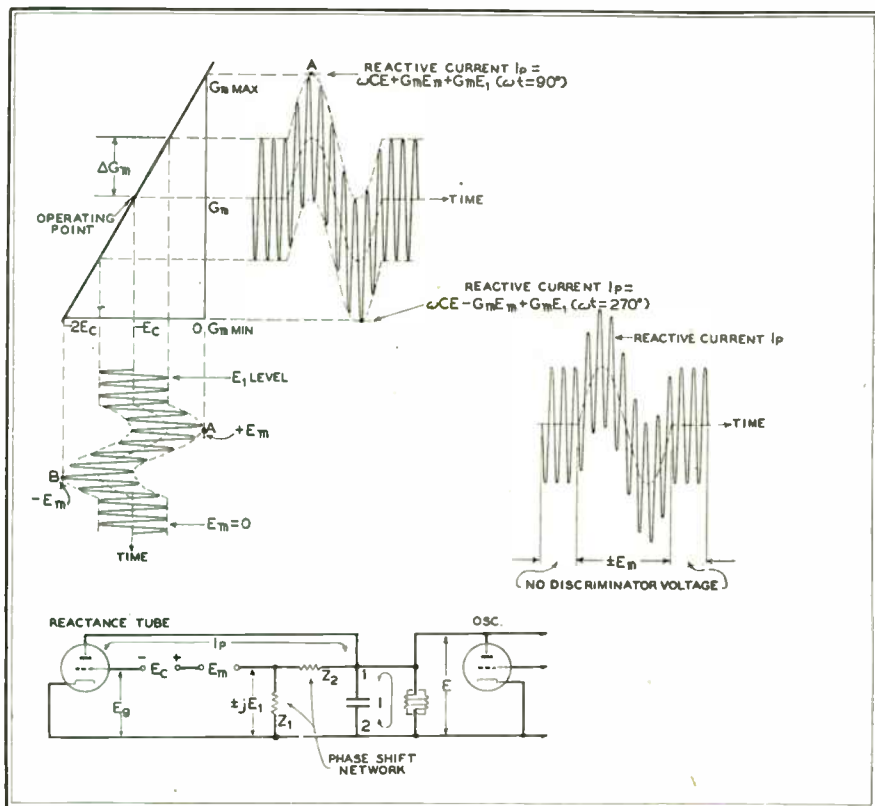

FIG. 78. GRAPHIC REPRESENTATION OF THE EFFECT OF VARIATIONS IN DISCRIMINATOR OUTPUT ON REACTANCE-TUBE PLATE CURRENT

hos to 1,600 micromhos occurs. This five-to-one change in bias, from 0.5 volt to 2.5 volts, results in a 25% change in the transconductance of the tube.

Using the 6AK5 tube, since its control possibility is highest, circuit values which result in a peak bias of 2.0 volts on the reactance tube will give maximum control. The normal operating bias applied to the reactance tube should be midway between the 2.0-volt I_{X_0} drop and the negative bias necessary for plate current cutoff. Since the cutoff bias is approximately -6.0 volts, the operating bias on the 6AK5, with zero discriminator voltage applied, should be about -4.0 volts.

circuit, where the shaded portion represents the area of instability. When the signal intensity decreases, due to fading, the control action is lost and is not regained unless the receiver is retuned. A sudden drop in line voltage could also reduce the holding action sufficiently that the desired signal would be completely lost. As shown in Fig. 77, the AFC circuit takes control at mid-frequency and holds the output substantially flat until the signal is detuned 200 kilocycles, at which point the AFC loses control and the output drops rapidly to zero. To regain the signal, the receiver must be retuned to nearly the mid-frequency, since the AFC

shift network $Z_1 - Z_2$ is practically equal to

$$I_1 = \frac{E}{R_1}$$

The grid exciting voltage E_1 applied to the reactance tube is

$$E_1 = \frac{I_1}{\omega C_1} = \frac{E}{\omega C_1 R_1}$$

and the resultant reactive plate current is

$$I_p = E_1 G_m = \frac{E G_m}{\omega C_1 R_1}$$

The effective impedance applied to the oscillator tuned circuit L, C is then

$$Z_e = \frac{E}{I_p} = \frac{\omega C_1 R_1}{G_m} = \frac{E}{G_m E_1}$$

Because this impedance varies directly with frequency, it appears as an inductance L_q . This apparent inductance can be computed from the equation

$$L_q = \frac{C_1 R_1}{G_m} \text{ henrys,}$$

where the units are farads, ohms, and mhos. Consider, for example, the following values:

$$G_m = 5 \times 10^{-3} \text{ mho}$$

$$R_1 = 50,000 \text{ ohms or } 5 \times 10^4 \text{ ohms}$$

$$C_1 = 2 \times 10^{-12} \text{ farad.}$$

$$L_q = \frac{2 \times 10^{-12} \times 5 \times 10^4}{5 \times 10^{-3}} = 2 \times 10^{-5} \text{ henrys,}$$

or 20 microhenrys. The apparent inductance L_q developed by the circuit of Fig. 76 is shunted across the tuned circuit inductance L . Hence, the total effective inductance in the oscillator circuit becomes less as L_q is decreased, resulting in an increase of the oscillator frequency from its nominal value. The effective inductance in the oscillator circuit is

$$L_o = \frac{C_1 R_1 L}{C_1 R_1 + G_m L}$$

and the operating frequency f will be

$$f = \frac{1}{2\pi\sqrt{CL_o}}$$

The oscillator frequency, if no inductance were introduced by the reactance tube circuit, would be

$$f = \frac{1}{2\pi\sqrt{CL}}$$

These equations apply only to static conditions, which exist when zero discriminator voltage E_m is developed, i.e., intermediate frequency carrier at mid-frequency f_o . With changes in intermediate frequency, the discriminator develops direct voltages of $\pm E_m$, which cause variations of the inductive reactance

about the quiescent value, as shown in Fig. 78. Since the phase shift network shown in Fig. 76 draws a current I_p which leads E by 90 degrees, the alternating voltage applied to the grid of the reactance tube is jE_1 , i.e., the $\cos \omega t$ function when the oscillator voltage E is a $\sin \omega t$ function. Because of the linear transconductance curve, the variations in the plate current I_p caused by the discriminator voltage E_m no longer equal $G_m E_1$, but rather

$$I_p = G_m E_1 \pm G_m E_m$$

with maximum values of discriminator voltage E_m are developed. Therefore, a peak voltage E_a of

$$E_a = E_1 \pm E_m$$

appears on the grid of the reactance tube, which causes the variation of the grid

$$f = \frac{1}{2\pi\sqrt{\left(C + \frac{G_m L_1}{R_1}\right)L}}$$

All values are in cycles per second, ohms, henrys and mhos. The effective oscillator frequency is governed not only by the L, C branches, but also by the capacitance C_Q supplied by the reactance tube circuit and L_1 in the phase shift network. The static value of C_Q is

$$C_Q = \frac{G_m L_1}{R_1}$$

When the oscillator frequency f shifts by an amount Δf , a voltage $\pm E_m$ developed by the discriminator, causes the reactance tube to inject a reactance L_Q or C_Q into the oscillator tuned circuit L, C , which returns the oscillator to the original frequency f . The pull-back action

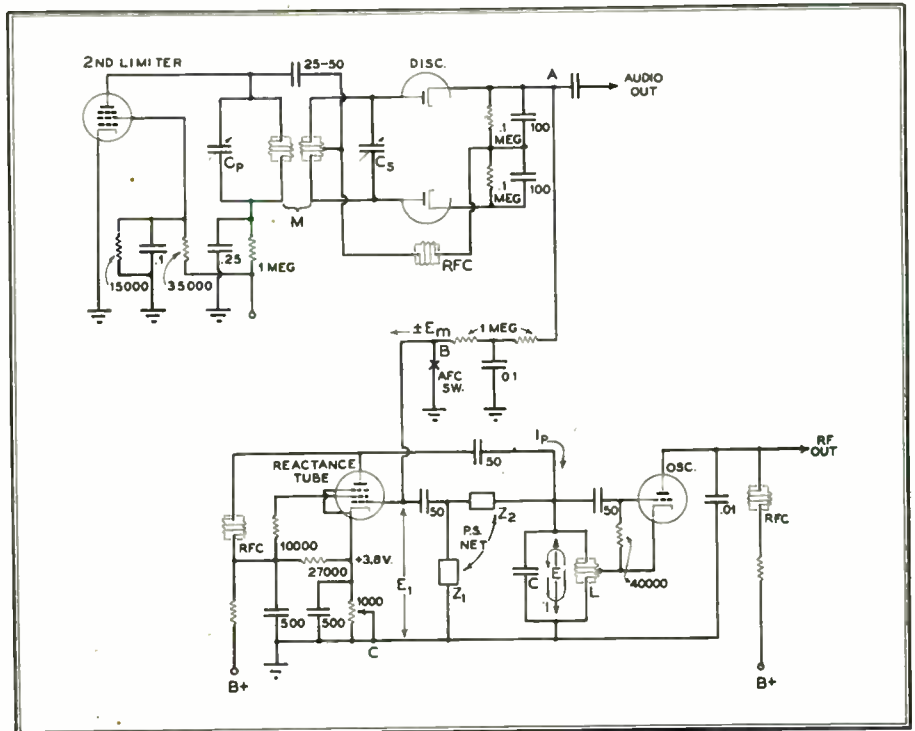

FIG. 79. COMPLETE AUTOMATIC FREQUENCY CONTROL SYSTEM FOR AN FM RECEIVER

voltage time axis shown in Fig. 78.

Optimum conditions are realized when the alternating grid voltage E_1 and the discriminator voltage E_m are each adjusted to one-half the grid bias E_o . This results in an effective total grid voltage E of $1.5E_1$, instead of E_1 , when zero discriminator voltage E_m is developed. The total grid voltage E_a draws a plate current

$$\text{Peak } I_p = G_m E_1.$$

When an inductance is substituted for the capacitance in the phase shift network the following equation can be used to calculate the oscillator frequency when the discriminator voltage is zero:

created by the injected reactance is then

$$f_p = f \pm \Delta f.$$

This change in frequency, or pull-back action, is caused by the voltage $1.5E_1 - E_1$, or $0.5E_1$, applied to the grid of the reactance tube. The current $0.5G_m E_1$, with respect to the normal circulating tuned circuit current

$$I = \omega CE,$$

represents the change of current for the shift of the frequency from the nominal value to its maximum deviation. The bandwidth equals twice the frequency deviation, or

$$W = 2\Delta f.$$

Since

$$\Delta f = 39.83 \frac{G_m E_1}{CF} \text{ kc./sec.},$$

$$W = 79.7 \frac{G_m E_1}{CE} \text{ kc./sec.}$$

G_m is given in micromhos, and C in microfarads. E_1/E , being a numerical ratio, requires no units.

Complete Circuit ★ The complete system shown in Fig. 79 is an application of

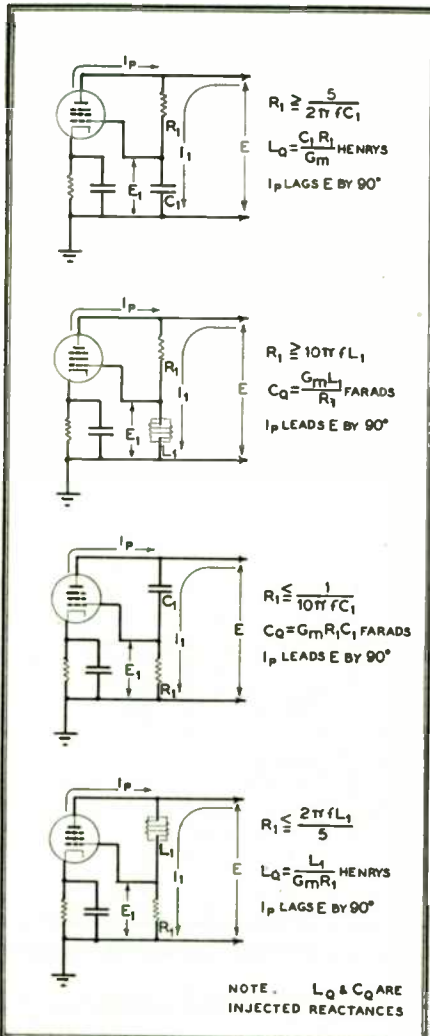

FIG. 80. REACTANCE TUBE ARRANGEMENTS

the principles already discussed. The discriminator is of the conventional type, and the Hartley oscillator requires no special comment. The reactance tube, using a combination fixed- and self-bias circuit, merits mention. The self-bias is developed across the cathode resistor, while the fixed bias is obtained across the screen-cathode resistor. The self-bias improves stability, and the fixed bias increases the sensitivity of the reactance tube action, because degeneration due to the voltage

drop across the cathode resistor is reduced. Such a combined bias arrangement results in stable reactance tube action without sacrificing sensitivity.

The excitation voltage applied to the grid of the reactance tube is obtained from a phase shift network consisting of impedances Z_1 and Z_2 , where Z_1 is 5 mmf., and Z_2 is 50,000 ohms. Four different reactance tube arrangements and their design equations are shown in Fig. 80.

A variable cathode resistor is used in the reactance tube circuit to permit adjustment of the cathode voltage. The resistor is adjusted for an initial bias in the center of the reactance tube characteristic, so that a symmetrical oscillator frequency control is realized for equal positive and negative changes in discriminator control voltage. The effect of this adjustment is shown in Fig. 81A. When the discriminator develops a positive voltage, a limiting point is reached in which the reactance tube biases itself by grid current through the filter resistor system. The bias attained is nearly equal to the peak value of impressed oscillator frequency voltage. Since the tube may operate under this condition for long periods, the screen voltage must be reduced to avoid excessive plate current and consequent shortened of tube life. When the discriminator develops a negative voltage, control action is limited by plate current cutoff. With sufficient signal input to the discriminator rectifiers, the total range of control is thus independent of the maximum value of voltage generated by the discriminator.

Equipment for Aligning ★ The process of aligning the discriminator and AFC networks in an FM receiver requires several pieces of equipment. A good signal generator which covers the frequency range with fundamental frequencies is necessary. In addition, a vacuum tube voltmeter with a center-zero scale, or some suitable substitute, such as a vacuum tube voltmeter with a left-zero scale combined with a polarity-reversing switch or a center-zero DC microammeter, must be at hand. If a DC microammeter is to be used, it should have an external series resistor of about 100,000 ohms to reduce the circuit loading. Visual alignment equipment, with a modulated signal generator, will facilitate the alignment process, but quite satisfactory results can be obtained with the equipment enumerated.

Aligning Discriminator ★ For aligning the discriminator circuit, the unmodulated output from the signal generator, adjusted to intermediate frequency, is applied to the grid of the limiter. The vacuum tube voltmeter, or microammeter, is connected to A and B, Fig. 82, and the

signal generator is adjusted for maximum output. Adjust the secondary trimmer C_S of the discriminator transformer to exactly zero deflection. When making this adjustment, three positions of the trimmer will indicate zero deflection. One of these indications occurs when the trimmer capacity is at minimum; the second occurs at maximum capacity, while the third occurs at a position approximately midway between the first two. The minimum and maximum capacity adjustments of the trimmer are incorrect, and should be avoided. The correct adjustment can always be recognized easily because of the fact that the indicator deflection changes

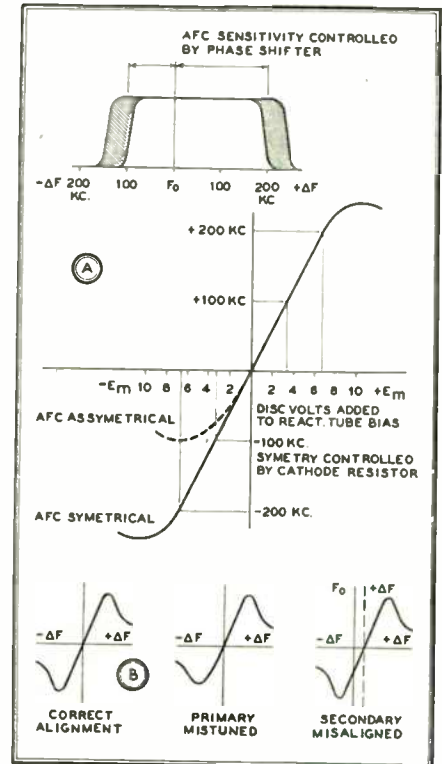

FIG. 81. EFFECTS OF CONTROL VOLTAGE

rapidly from plus to minus, or vice versa, for a slight change in the trimmer setting.

When the secondary trimmer is adjusted properly, the primary trimmer C_P must be adjusted for maximum deflection of the meter. This is accomplished in the following manner: Increase the frequency of the signal generator to 75 kc. above the intermediate frequency. As this shift is being made, the meter will indicate an increasing positive voltage until the frequency shift is completed. At the +75-kilocycle deviation, adjust the primary trimmer for maximum meter deflection. Should the meter pointer tend to move off-scale as this is done, it will be necessary to reduce the output from the signal generator. The adjustment of C_P is completed when the greatest deflection is obtained. The secondary trimmer C_S must

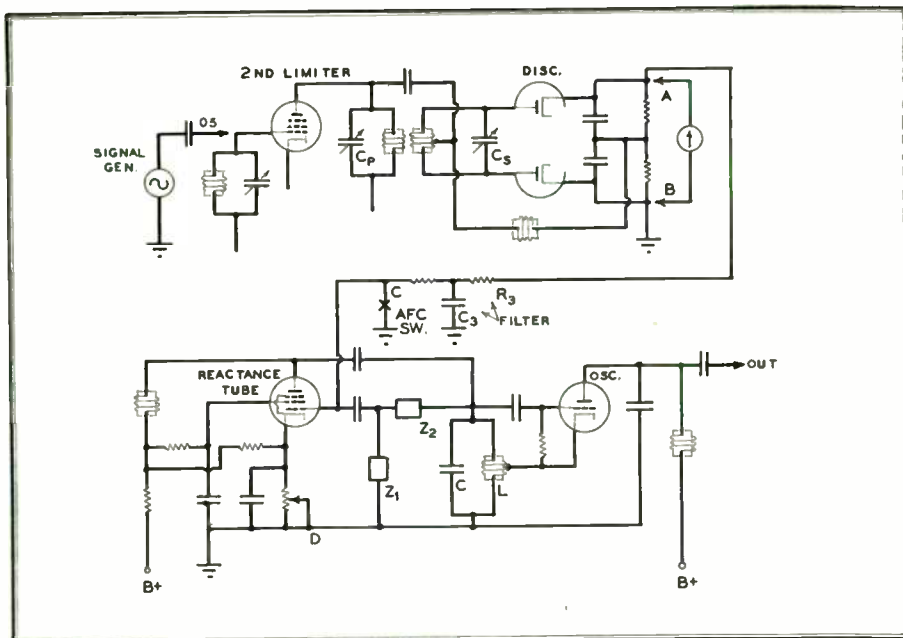

FIG. 82. SETUP FOR ALIGNING THE DISCRIMINATOR CIRCUIT FOR AFC

not again be adjusted after the zero deflection is obtained.

The adjustment of the discriminator should now be tested for linearity. With the signal generator returned to the exact intermediate frequency, the indicating meter should again read zero if the secondary trimmer was not readjusted. Then tune the signal generator to 75 kc. below the intermediate frequency. As the signal frequency decreases, the meter will indicate an increasing negative voltage until the frequency shift is completed. At 75 kc. below the intermediate frequency, the indicated voltage should be exactly the same value as that at 75 kc. above the intermediate frequency, but of opposite polarity. If these voltages are unequal, it is necessary to retune the primary trimmer until the voltages are distributed equally on both sides of zero deflection. When this equality is achieved, the discriminator is properly aligned. Discriminator alignment curves are shown in Fig. 81B.

The alignment of the secondary branch of the discriminator network is very important, since the correct operation of the entire system depends upon it. The alignment determines the polarity and magnitude of the control voltage developed by the discriminator circuit. While the alignment of the primary branch is not critical and does not affect the phase relationship of the induced and coupled voltages across the secondary branch, it does determine the magnitude of these voltages. Hence it should be adjusted carefully. The tuning capacitor across the secondary winding controls the frequency at which zero control voltage occurs, and the primary tuning capacitor determines the amplitude

and symmetry of the two peaks of the discriminator characteristic curve.

Holding Action ★ The holding action of the reactance tube can be ascertained in the following manner: Apply the signal generator output to the antenna terminals of the receiver, and adjust both the generator and receiver to the same frequency in the desired spectrum. Short point C in Fig. 82 to ground so that no discriminator voltage will be applied to the grid of the

point C, so that the discriminator voltage will control the reactance tube. If the circuits are properly aligned the meter deflection will remain zero.

Increase the signal generator frequency by small increments, while noting the meter deflection. The meter will indicate an increasing positive voltage, until a point is reached where the indicator will abruptly return to a value slightly above zero. This near-zero deflection indicates that the reactance tube no longer controls the oscillator. The signal generator frequency should then be decreased slightly to the point of maximum meter deflection, i.e., just before control is lost, and the deviation in frequency from the center value should be noted. This frequency deviation represents the limit of the holding range in the positive direction.

Next, readjust the signal generator frequency to the original center value, decreasing it by small increments to the value which gives maximum meter deflection, as before. The frequency deviation at the point of maximum deflection, just before control is again lost, should be noted. This deviation represents the limit of holding range in the negative direction.

The positive and negative AFC holding limits should be symmetrical; however, any asymmetry can be corrected by varying the cathode resistor in the reactance tube circuit. The holding range will become broader as the signal input level is increased, as illustrated in the following table, data for which was taken on an experimental receiver using a 12SH7 reactance tube:

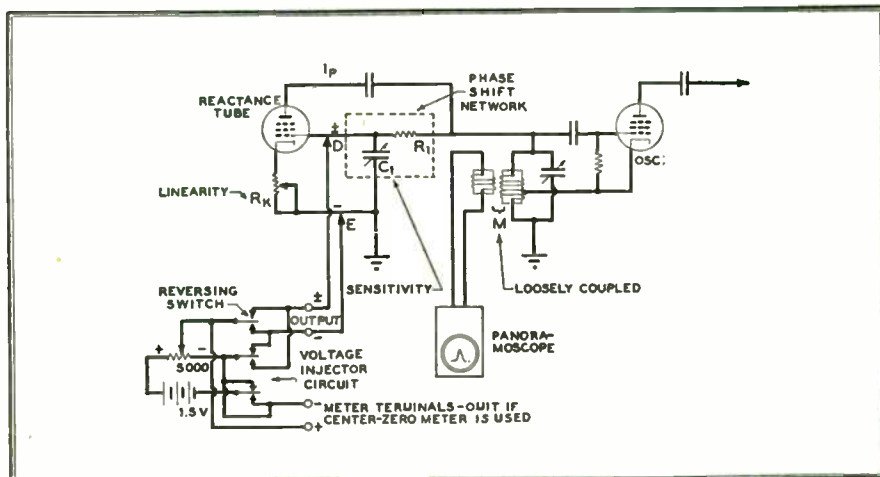

FIG. 83. CIRCUIT USED WITH PANAMOSCOPE FOR BALANCING THE AFC SYSTEM

reactance tube during this tuning adjustment. Leave the indicating meter connected to A and B, as for alignment of the discriminator.

Zero deflection of the meter should result when the signal generator and receiver are tuned to the same frequency. Then remove the shorting conductor from

SIGNAL INPUT	AFC LIMIT
15 microvolts . . .	± 150 kc.
50 microvolts . . .	± 250 kc.
100 microvolts . . .	± 300 kc.

Balancing ★ To balance the AFC system, when necessary, a simple circuit (CONTINUED ON PAGE 77)

INDEX OF ARTICLES AND AUTHORS

From January 1945 to December 1945

INDEX OF ARTICLES

	1946	Page
	Issue	
AFM		
Attitude of servicemen	Mar.	4
Restrictions on FM-AM programs, M. B. Sleeper	Nov.	27
AIRBORNE EQUIPMENT, FM		
FM carrier equipment, F. T. Buddman	Jan.	30
ALLOCATIONS		
Allocations released by FCC Jan. 16, 1945	Jan.	4
Discussion of Jan. 16th allocations, M. B. Sleeper	Jan.	23
FCC comments on Jan. 16th allocations	Jan.	35
Discussion of FM allocations	Feb.	19
Report on the FM oral argument, M. B. Sleeper	Mar.	23
Proposed FM frequencies, E. H. Armstrong	Mar.	26
Discussion of FM allocations	Apr.	4
Opposing views on lower television band, DuMont and C.B.S. briefs	Apr.	23
FM channels, 1937 to 1945	Front cover	May
Allocations released by FCC May 17, 1945	May	23
Final allocations, 42 to 108 mc., June 27, 1945	July	27
Plan of national FM allocations	Sept.	39
How many FM broadcast bands?	Oct.	4
FCC standards of allocation, Sept. 20, 1945	Oct.	28
FM channel chart	Oct.	40
Discussion of FCC-CBS single-market plan	Nov.	4
Secret hearing on FM, March 12, 13, 1945, Paul de Mars	Nov.	47
ANTENNAS		
Plywood one-man mast	Jan.	37
Antennas for FM links, Lieut. R. W. Ehrlich	Apr.	31
Corner antenna for television, J. D. McLean	Apr.	40
Circular antennas for FM broadcasting, M. W. Scheldorf	May	30
Circular antennas for FM broadcasting, M. W. Scheldorf	June	40
Rhombic antenna for N. Y. to Schenectady relay, J. D. McLean	July	33
FM and television antenna on Empire State Bldg.	Aug.	41
FCC FM standards, Sept. 20, 1945	Oct.	33
Platform tower erected by two men, Zeb Bouck	Nov.	58
BROADCAST STATION OPERATION, FM		
Income and expense of AM stations, 1942, Keith Kelsey	Jan.	42
Allocations in 42 to 108 mc., June 27, 1945	July	27
FM prepares for expansion, M. B. Sleeper	July	27
Notes on FM broadcasting, D. W. Gallurp	Sept.	27
FCC rules for FM broadcasting	Sept.	39
Observations of an AM listener, M. B. Sleeper	Nov.	27
BROADCAST STATION PLANNING, FM		
Do you plan to build a station? Keith Kelsey	Jan.	39
Facts about 10-kw. FM transmitters, M. B. Sleeper	Sept.	33
FCC rules for FM broadcasting	Sept.	39
FM engineering standards, Sept. 20, 1945	Oct.	28
Discussion of FCC-CBS single-market plan	Nov.	4
BROADCAST STATIONS, FM		
Directory of FM stations	Sept.	58
Conditional FCC grants to Nov. 2, 1945	Nov.	46
CARRIER EQUIPMENT, FM		
FM carrier equipment, F. T. Buddman	Jan.	30
How FM links Army wire systems, Lieut. R. W. Ehrlich	Apr.	26
CATHODE-RAY TUBES		
Application techniques, Dr. P. S. Christaldi and I. E. Lempert	Dec.	36
CIO-PAC		
CIO-PAC petition	Nov.	4
DYNAMIC RANGE		
Explanation of dynamic range, R. T. Hemmes	Mar.	46
Do FM listeners want high-fidelity? M. B. Sleeper	Oct.	23
EMERGENCY FM SERVICES		
N. H. State Police system, Lieut. Basil Cutting	Jan.	24
Number of stations licensed in June, 1944	Jan.	36
Railroad wreck at Poplar Grove, P. C. Bennett	Mar.	82
Miami police 118-mc. system, Lieut. Ben Demby	May	24
100- to 165-mc. mobile units, G. A. Leap	May	38
FCC policy on police radio	July	4
Police allocations, 42 to 108 mc., July 27, 1945	July	27
Unattended, automatic relays, W. M. Lee	July	28
New FM emergency equipment, H. F. Mickel	July	38
ESPRL standards report	Sept.	4
Selective calling equipment, G. G. Brown	Oct.	41
FM communications, 72 to 76 mc., F. T. Buddman	Nov.	38
FACSIMILE		
Facsimile newspapers, Lieut. R. D. Levitt	Jan.	38
Facsimile dispatch & report system, Milton Alden	Aug.	32
Facsimile dispatch & report system, Milton Alden	Sept.	36
FCC		
Chairman Porter	Feb.	4
Norton's curves, FCC exhibit 380	Mar.	27
Effects of allocations delay, M. B. Sleeper	June	4
FCC delay is threat to radio industry, E. L. Hall, E. F. McDonald, Jr., Arthur Freed, Dr. Ray Manson, A. C. Analey, P. V. Galvin, W. S. Halligan	June	26
FCC policy on police radio, M. B. Sleeper	July	4
Final allocations for 42 to 108 mc., June 27, 1945	July	27
FCC hearing on FM frequencies — a poem	July	37
What's behind the AM vs. FM battle? M. B. Sleeper	Aug.	27
Proposed rules for FM broadcasting	Sept.	39
Standards of engineering practice, Sept. 20, 1945	Oct.	28
FM channel chart	Oct.	40
Discussion of FCC-CBS single-market plan	Nov.	4
Secret FM hearing, Mar. 12, 13, 1945	Nov.	47
Rules for railroad radio	Dec.	34
FIRE DEPARTMENT COMMUNICATIONS		
Expected expansion of fire department FM	Jan.	36
FM for Boston fire department	Feb.	21
FM EQUIPMENT		
Western Electric police transmitter	Jan.	24
Motorola mobile and relay equipment	Jan.	24
Link FM relays	Jan.	30
Link telemetering equipment	Jan.	30
Motorola walkie-talkie	Feb.	23
Link FM relays	Feb.	31
Motorola railroad radio	Apr.	33
Motorola 118-mc. police system	May	24
Comco 100- to 165-mc. mobile units	May	38
Crosby-RCA reactance modulator	May	44
Western Electric-Morrison frequency stabilizer	May	48
Link unattended relays	July	28
Wincharger wind-driven battery charger	July	28
RCA emergency equipment	July	38
REL power frequency converter	Aug.	53
Federal selective calling equipment	Oct.	41
RCA broadcast transmitters	Nov.	28
Link emergency equipment for 72 to 76 mc.	Nov.	38
Communications Company railroad radio equipment	Dec.	23
G.E. Phasitron tube	Dec.	30
Transmitter Equipment 250-watt FM transmitter	Dec.	47
FM HANDBOOK		
1, AM and FM waves, R. T. Hemmes	Feb.	31
2, Advantages of FM circuits, R. T. Hemmes	Mar.	36
3, Propagation at FM frequencies, R. T. Hemmes	Apr.	34
4, FM transmitter circuits, R. T. Hemmes	May	44
5, FM transmitter circuits, R. T. Hemmes	June	30
6, FM signed amplifiers & limiters, R. T. Hemmes	July	40
7, FM detectors, special circuits, R. T. Hemmes	Aug.	42
8, Principles of AFC circuits, Burt Zimet	Nov.	43
8, Principles of AFC circuits, Burt Zimet	Dec.	54
INDEX OF ARTICLES AND AUTHORS		
November, 1940 to December, 1944	Apr.	46
INTERFERENCE, NOISE		
Distribution of random noise, R. T. Hemmes	Mar.	39
LENSES		
Optical systems, television reception, J. P. Taylor	June	43
Lenses for projection television, J. P. Taylor	Oct.	25
LICENSES, ARMSTRONG FM		
Resolution of June 6, 1945, on allocations	June	28
Meeting on July 6, 1945, on receivers	July	36
METERS, FREQUENCY		
Vibrating-reed frequency meters, D. E. Anderson	Aug.	29
FCC standards, Sept. 20, 1945	Oct.	37
MILITARY EQUIPMENT, FM		
FM carrier communications equipment, F. T. Buddman	Jan.	30
How FM links Army wire systems, Lieut. R. W. Ehrlich	Apr.	26
FM relay experience in North Africa, R. A. Berg	Aug.	37
MODULATORS, FM		
Reactance-tube modulators, R. T. Hemmes	May	44
Armstrong modulator circuits, R. T. Hemmes	June	30
Frequency and phase modulation, R. S. Hawkins	Sept.	50
RCA modulation system, C. M. Lewis	Nov.	30
NETWORK FACILITIES		
15,000 cycles for networks (AT&T lines)	Feb.	24
OSCILLATORS, LOCKED-IN		
Patent issued to E. H. Armstrong	Jan.	36
PERSONALITIES		
Brown, Gilbert	Front cover	Oct.
DuMont, Allen	Front cover	Feb.
Denny, Charles R., Jr.	Front cover	May
Fly, James Lawrence	Aug.	40
Hammurud, Oscar	Sept.	34
Poppele, Jack	Front cover	Feb.
Porter, Paul A.	Front cover	Mar.
de Mars, Lt. Condr. Paul A.	Feb.	22
Nygren, Comdr. Arnold C.	Nov.	37
Walker, Frank W.	Aug.	40
White, Thomas A.	Feb.	22
Wendell, E. N.	Front cover	Oct.
Whitmore, Will	Front cover	May
Wills, William H.	Aug.	40
Wunderlich, Norman	Front cover	Oct.
POLICE RADIO		
N. H. State Police system, Lieut. Basil Cutting	Jan.	24
Number of police stations licensed in June 1944	Jan.	36
Railroad wreck at Polar Grove, P. C. Bennett	Mar.	82
Miami has first 118-mc. system, Lieut. Ben Demby	May	24
100- to 165-mc. mobile units, G. A. Leap	May	38
FCC policy on police radio, M. B. Sleeper	July	4
Police allocations in 42 to 108 mc. band, July 27, '45	July	27
Unattended, automatic relays, W. M. Lee	July	28
New emergency equipment, H. F. Mickel	July	38
ESPRL standards report	Sept.	4
Selective calling equipment, G. G. Brown	Oct.	41
FM communications on 72 to 76 mc. F. T. Buddman	Nov.	38
PRE-EMPHASIS, DE-EMPHASIS		
Effects of pre-emphasis & de-emphasis, R. T. Hemmes	Mar.	44
FCC standards for pre-emphasis, Sept. 20, 1945	Oct.	34
PRINTERS, RADIO-OPERATED		
Radio type demonstration	May	37
PROPAGATION		
Proposed FM frequencies, E. H. Armstrong	Mar.	26
AM and FM propagation, R. T. Hemmes	Apr.	34
Sun, earth, and S.W. Propagation, H. E. Hallborg	June	48
Zenith FM tests, G. E. Gustafson	Oct.	4
Observations of an FM listener, M. B. Sleeper	Oct.	27
Secret FM hearing, Mar. 12, 13, 1945, P. A. de Mars	Nov.	47
RADAR		
Basic principles of radar operation	Mar.	24
RADIO MANUFACTURERS ASSOCIATION		
Letter from president Cosgrove to Leonard Asch	Oct.	38
RMA information on FM	Nov.	60
RAILROAD RADIO COMMUNICATION		
Tests on Denver & Rio Grande Western	Apr.	33
100- to 165-mc. equipment	May	38
Rock Island R.R. test car, Norman Wunderlich	June	23
Comments on railroad communications	Dec.	4
Progress report on railroad FM, Arnold C. Nygren	Dec.	23
FCC Rules for railroad radio	Dec.	34
RECEIVERS, HOME BROADCAST		
Better ways to meet listeners' needs, Part 1, M. B. Sleeper	Feb.	25
Better ways to meet listeners' needs, Part 2, M. B. Sleeper	May	40
FM receiver design, R. T. Hemmes	July	40
FM receiver design, R. T. Hemmes	Aug.	42
RECEIVERS, TELEVISION		
RCA projection receiver	Mar.	35

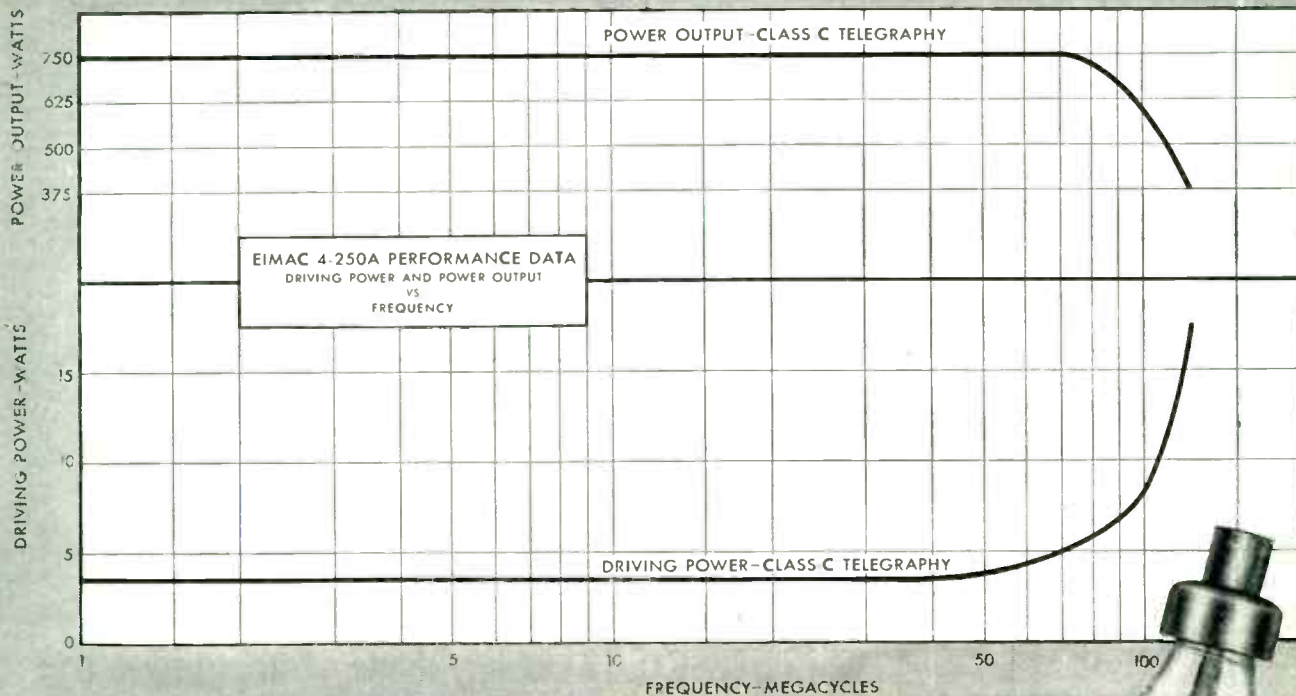

NEW EIMAC 4-250A TETRODE

Heading a parade of sensational new tubes now in production, the Eimac 4-250A Tetrode—introduced several months ago—is already in great demand. It may pay to check these performance characteristics against your own requirements.

As can be seen by the chart above, the new Eimac 4-250A Tetrode will deliver 750 watts output at frequencies up to 70 Mc. with a driving power of only 5 watts. At frequencies up to 40 Mc. an output of 750 watts may be obtained with a driving power of 3.5 watts.

The grid-plate capacitance of 0.12 $\mu\text{mfd.}$ is extremely low, allowing operation at high frequencies without neutralization. Use of Eimac "X" process control grid reduces both primary and secondary emission which provides utmost stability.

You are invited to supplement the information given here with a technical bulletin on Eimac 4-250A Power Tetrode. It contains an elaboration of the tube's characteristics and constant current curves. Send your name and address and a copy will go to you by return mail.

The Lid's Coming Off...

Watch your favorite trade journals for announcements of other new Eimac tubes to be released this year.

CAUTION! Check serial numbers on Eimac tubes before you buy. Be sure you're getting newest types. Look for latest serial numbers.

FOLLOW THE LEADERS TO



EITEL-McCULLOUGH, INC., 1086 San Mateo Avenue, San Bruno, Calif.

Plants located at: San Bruno, California and Salt Lake City, Utah

Export Agents: Frezar & Hansen, 301 Clay St., San Francisco 11, Calif., U. S. A.



TYPE 4-250A—POWER TETRODE
ELECTRICAL CHARACTERISTICS

Filament: Thoriated Tungsten	
Voltage	5.0 volts
Current	14.5 amperes
Plate Dissipation (Maximum)	250 watts
Direct Interelectrode Capacitances (Average)	
Grid-Plate	0.12 $\mu\text{mfd.}$
Input	12.7 $\mu\text{mfd.}$
Output	4.5 $\mu\text{mfd.}$
Transconductance ($i_b = 80 \text{ ma.}$, $E_b = 3000 \text{ v.}, E_{c2} = 50\theta \text{ v.}$)	
	4000 μmhos

RAILROAD COMMUNICATION OFFICIALS

In Charge of Telegraph, Telephone and Radio on Roads in U. S., Canada and Mexico

- AERON, CANTON & YOUNGSTOWN RAILROAD**
H. G. Watkins, Vice President, Operations, 12 East Exchange Street, Akron 8, Ohio.
- ALGOMA, CENTRAL & HUDSON BAY RAILWAY**
E. B. Barber, President, Sault Ste. Marie, Ont.
- ALTON & SOUTHERN RAILROAD**
R. Durley, Vice President, P. O. Box 270, East St. Louis, Ill.
- ALTON RAILROAD**
H. C. Sampson, Superintendent, Signals and Telegraph, Union Station, Bloomington, Ill.
- ANN ARBOR RAILROAD**
R. J. BelSmith, Superintendent, Telegraph, Decatur 7, Ill.
F. K. McKesson, Supervisor, Radio, Frankfort, Mich.
- ATCHISON, TOPKAW & SANTA FE RAILWAY**
J. A. Parkinson, Superintendent, Communications, Chicago 4, Ill.
L. R. Thomas, Electronics Engineer, Chicago 4, Ill.
- GULF, COLORADO & SANTA FE RAILWAY**
J. A. Parkinson, Superintendent, Communications, Chicago 4, Ill.
- ATLANTA, BIRMINGHAM & COAST RAILROAD**
W. A. Spell, Chief Engineer, 26 Cain Street, N. W., Atlanta, Ga.
- ATLANTIC & YADKIN RAILWAY**
E. L. Faulconer, Vice President and General Manager, Greensboro, N. C.
- ATLANTIC COAST LINE RAILROAD**
Lowell White, General Superintendent, Telegraph and Mail Traffic, Wilmington, N. C.
N. A. Peebles, Electronic Engineer, Atlantic Coast Line, Wilmington, N. C.
- BALTIMORE & OHIO CHICAGO TERMINAL RAILROAD**
A. S. Hunt, Chief Engineer, Communications and Signals, Baltimore 1, Md.
L. J. Prendergast, Superintendent, Communications, Baltimore 1, Md.
J. H. Walls, Communications Engineer, Baltimore 1, Md.
- BALTIMORE & OHIO RAILROAD**
A. S. Hunt, Chief Engineer, Communications and Signals, Baltimore 1, Md.
L. J. Prendergast, Superintendent, Communications, Baltimore 1, Md.
J. H. Walls, Communications Engineer, Baltimore 1, Md.
- HANGOR & ARDOSTOOK RAILROAD**
R. H. MacCreedy, Vice President, P. O. Box 938, Bangor, Me.
- BERSEMER & LAKE ERIE RAILROAD**
F. R. Laying, Chief Engineer, Greenville, Pa.
- BOSTON & MAINE RAILROAD**
J. P. Muller, Engineer, Signals and Telegraph, North Station, Boston 14, Mass.
- BUFFALO CREEK RAILROAD**
W. M. Spoford, Superintendent, 824 Ohio Street, Buffalo 3, N. Y.
- BURLINGTON-ROCK ISLAND RAILROAD**
R. B. Smith, Superintendent, Houston 2, Texas.
- CAMBRIA & INDIANA RAILROAD**
G. H. Burnett, President, Room 1333, Broad Street Station Building, 1617 Pennsylvania Boulevard, Philadelphia 3, Pa.
- CANADIAN NATIONAL RAILWAYS**
W. M. Armstrong, General Manager, Telegraph Department, 347 Bay Street, Toronto 2, Ont.
R. B. Steele, Chief Engineer, Telegraph Department, 347 Bay Street, Toronto 2, Ont.
- CENTRAL VERMONT RAILWAY**
F. E. McArthur, Superintendent, Telegraph, St. Albans, Vt.
- CANADIAN PACIFIC RAILWAY**
W. D. Nell, General Manager, Communications, 204 Hospital Street, Montreal, Que.
L. A. W. East, Chief Engineer, 204 Hospital St., Montreal, Que.
- CENTRAL OF GEORGIA RAILWAY**
R. R. Cummins, General Manager, Savannah, Ga.
- CENTRAL RAILROAD COMPANY OF NEW JERSEY**
F. W. Bender, Signal Engineer, Jersey City, N. J.
- CHARLESTON & WESTERN CAROLINA RAILWAY**
Lowell White, General Superintendent, Telegraph and Mail Traffic, Wilmington, N. C.
- CHESAPEAKE & OHIO RAILWAY**
W. N. Hartman, Superintendent, Telegraph and Signals, Richmond 10, Va.
P. A. Finnerer, Communication Engineer, Richmond 10, Va.
- CHICAGO & EASTERN ILLINOIS RAILWAY**
G. P. Neal, Superintendent, Signals and Telegraph, Danville, Ill.
- CHICAGO & ILLINOIS MIDLAND RAILWAY**
F. L. Seider, Vice President, 821 Illinois Building, Springfield, Ill.
- CHICAGO & NORTH WESTERN RAILWAY**
S. E. Noble, Superintendent, Telegraph and Signals, 400 West Madison Street, Chicago 6, Ill.
- CHICAGO, ST. PAUL, MINNEAPOLIS & OMAHA RAILWAY**
S. E. Noble, Superintendent, Telegraph and Signals, 400 West Madison Street, Chicago 6, Ill.
- CHICAGO & WESTERN INDIANA RAILROAD**
C. T. Peters, Chief Electrician, Dearborn Station, Chicago 5, Ill.
- CHICAGO, ATTICA & SOUTHERN RAILROAD**
F. E. Chesk, General Superintendent, Attica, Ind.
- CHICAGO, BURLINGTON & QUINCY RAILROAD**
H. H. Hasselbacher, Superintendent, Telegraph, 547 West Jackson Boulevard, Chicago 6, Ill.
T. W. Wigton, Supervisor, Electronics, 547 West Jackson Blvd., Chicago 6, Ill.
- CHICAGO GREAT WESTERN RAILWAY**
T. H. Kearton, Superintendent, Telegraph and Signals, 309 West Jackson Boulevard, Chicago 6, Ill.
- CHICAGO, INDIANAPOLIS & LOUISVILLE RAILWAY**
E. G. Stradling, Superintendent, Telegraph and Signals, Lafayette, Ind.
- CHICAGO, MILWAUKEE, ST. PAUL & PACIFIC RAILROAD**
L. B. Porter, Superintendent, Telegraph and Signals, Union Depot, Milwaukee 3, Wis.
- CHICAGO, ROCK ISLAND & PACIFIC RAILWAY**
C. J. Ellis, Superintendent, Communications, LaSalle Street Station, Chicago 5, Ill.
E. A. Dahl, Electronic Engineer, LaSalle Street Station, Chicago 5, Ill.
- CINCINNATI RAILROAD**
C. D. Meek, General Superintendent, Erwin, Tenn.
- COLORADO & SOUTHERN RAILWAY**
Robert Rice, Vice President, Denver, Colo.
H. H. Hasselbacher, General Superintendent, Telegraph, 547 West Jackson Boulevard, Chicago 6, Ill.
- COLUMBUS & GREENVILLE RAILWAY**
R. C. Stovall, President, Columbus, Miss.
- DELAWARE & HUDSON RAILROAD**
A. H. Rice, Signal Engineer and Superintendent, Telegraph, Albany 1, N. Y.
- DELAWARE, ACKAWANNA & WESTERN RAILROAD**
P. M. Shoemaker, General Superintendent, 140 Cedar Street, New York 6, N. Y.
- DENVER & RIO GRANDE WESTERN RAILROAD**
W. W. Puhman, Superintendent, Communications, 206 Rio Grande Building, Denver, Colo.
E. H. Musgrove, Radio Engineer, 206 Rio Grande Building, Denver, Colo.
- DENVER & SALT LAKE RAILWAY**
A. L. Johnson, General Superintendent, Denver National Bldg., Denver 2, Colo.
- DETROIT & MACINAC RAILWAY**
C. A. Pinkerton, President and General Manager, Tawas City, Mich.
- DETROIT & TOLEDO SHORE LINE RAILROAD**
E. L. Ray, General Manager, 441 East Jefferson Avenue, Detroit 26, Mich.
- DETROIT, TOLEDO & IRONTON RAILROAD**
P. L. Forbes, Superintendent, Telegraphs and Signals, Dearborn, Mich.
- DIRECCION GENERAL DE CONSTRUCCION DE FERROCARRILES**
Ing. Antonio Doval Jamie, Director General, Direccion General de Construcion de Ferrocarriles, Plaza de la Reforma 2, Mexico, D. F. Mexico.
- DULUTH, MISSABE & IRON RANGE RAILWAY**
M. H. Brickley, Superintendent, Telegraphs and Telegraph, Two Harbors, Minn.
- DULUTH, SOUTH SHORE & ATLANTIC RAILWAY**
E. A. Whitman, Co-Trustee and Vice President, First National-Soo Line Building, Minneapolis, Minn.
- ELGIN, JOLIET & EASTERN RAILWAY**
T. M. Millard, General Superintendent, Joliet Building, Joliet, Ill.
- ERIE RAILROAD**
F. H. Menagh, Superintendent, Communications, Telegraph and Telephone, Midland Building, Cleveland 15, Ohio.
G. D. Poole, Communications Engineer, Midland Bldg., Cleveland 15, Ohio.
- FLORIDA EAST COAST RAILWAY**
W. A. Hoffman, Superintendent, Telegraph and Signals, St. Augustine, Fla.
- FT. DODGE, DES MOINES & SOUTHERN RAILROAD**
C. M. Kelly, Superintendent, Boone, Ia.
- FT. WORTH & DENVER CITY RAILWAY**
H. H. Hasselbacher, General Superintendent, Telegraph, 547 West Jackson Boulevard, Chicago 6, Ill.
- GALVESTON, HOUSTON & HENDERSON RAILROAD**
G. G. Moore, President and General Manager, Galveston, Texas.
- GEORGIA RAILROAD**
G. K. Williams, Superintendent Transportation, 4 Hunter Street, S. E., Atlanta 3, Ga.
- GEORGIA & FLORIDA RAILROAD**
H. W. Purvis, Receiver and General Manager, Augusta, Ga.
- GREAT NORTHERN RAILWAY**
C. O. Jenks, Vice President, St. Paul 1, Minn.
R. C. Thayer, Superintendent, Telegraph, St. Paul 1, Minn.
- GREEN BAY & WESTERN RAILROAD**
H. E. McGee, President, Green Bay, Wis.
- GULF, MOBILE & OHIO RAILROAD**
G. P. Brook, Vice President and General Manager, Mobile, Ala.
K. P. Goodwin, Superintendent, Telephone, Telegraph and Signals, Mobile, Ala.
- HUNTINGTON & BROAD TOP MOUNTAIN RAILROAD AND COAL COMPANY**
S. E. Realey, General Manager, Huntington, Pa.
- ILLINOIS CENTRAL SYSTEM**
J. M. Trissal, Superintendent, Communications and Electrical Engineering, 135 East 11th Place, Chicago 5, Ill.
P. B. Burley, Electronics Engineer, 135 East 11th Place, Chicago 5, Ill.
- ILLINOIS TERMINAL RAILROAD**
A. P. Titus, President and General Manager, 10 North 12th Boulevard, St. Louis 1, Mo.
J. Leisenring, Electrical Superintendent, Springfield, Ill.
- INDIANAPOLIS UNION RAILWAY**
W. H. McKittrick, Superintendent, Indianapolis, Ind.
- KANSAS CITY, MEXICO & ORIENT RAILWAY OF MEXICO**
P. Fontes, General Manager, Apartado Postal Num. 31, Chihuahua, Chih., Mexico.
- KANSAS CITY SOUTHERN RAILWAY**
F. H. Hooper, General Manager, Kansas City, Mo.
A. H. Ryden, Superintendent, Telegraph, Kansas City, Mo.
- KENTUCKY & INDIANA TERMINAL RAILROAD**
R. C. Frey, Chief Train Dispatcher, Louisville, Ky.
- LAKE SUPERIOR & IPEWEMING RAILROAD**
A. Syverson, Vice President and General Manager, Marquette, Mich.
- LEHIGH & HUDSON RIVER RAILWAY**
H. B. Bennett, Signal Supervisor, Warwick, N. Y.
- LEHIGH & NEW ENGLAND RAILROAD**
J. E. Hackman, Supervisor, Telegraphs and Signals, 624 Main Street, Bethlehem, Pa.
- LEHIGH VALLEY RAILROAD**
J. F. Yerger, Superintendent, Telegraph and Signals, Bethlehem, Pa.
- LOUISIANA & ARKANSAS RAILWAY**
F. H. Hooper, General Manager, Kansas City, Mo.
A. H. Ryden, Superintendent, Telegraph, Kansas City, Mo.
- LOUISVILLE & NASHVILLE RAILROAD**
J. G. Metcalf, Superintendent, Transportation, Louisville 1, Ky.
- MCCLOUD RIVER RAILROAD**
P. N. Myers, Vice President and General Manager, McCLOUD, Calif.
- MAINE CENTRAL RAILROAD**
J. P. Muller, Signal Engineer, North Station, Boston 14, Mass.
- MEXICAN RAILWAY COMPANY, LTD.**
J. D. Holmes, General Manager, Apartado 08 Bis., Mexico City, Mexico.
- MEXICO NORTH-WESTERN RAILWAY**
F. J. Clark, Vice President, Edificio Sauer, Ciudad Juarez, Chih., Mexico.
- MIDLAND VALLEY RAILROAD**
J. M. Kahley, Chief Engineer, Muskogee, Okla.
- MINNEAPOLIS & ST. LOUIS RAILWAY**
J. W. Devins, Vice President and General Manager, Minneapolis 2, Minn.
E. L. Crimmon, General Superintendent, Minneapolis 2, Minn.
- MINNEAPOLIS, ST. PAUL & SAULT STE. MARIE RAILROAD**
R. L. Simpson, General Manager, First National-Soo Line Building, Minneapolis 2, Minn.
- MISSISSIPPI CENTRAL RAILROAD**
J. E. Burns, Superintendent, Hattiesburg, Miss.
- MISSOURI-KANSAS-TEXAS RAILROAD**
J. A. Johnson, Superintendent, Telegraph and Signals, Denison, Texas.
- BEAVER, MEADE & ENGLEWOOD RAILROAD**
- F. W. Grace, Vice President and General Manager, Dallas 2, Texas.
- MISSOURI-KANSAS-TEXAS RAILROAD COMPANY OF TEXAS**
J. A. Johnson, Superintendent, Telegraph and Signals, Denison, Texas.
- MISSOURI PACIFIC RAILROAD**
W. Rogers, Superintendent, Telegraph, Missouri Pacific Building, St. Louis 3, Mo.
W. Chunn, Assistant Superintendent, Telegraph, Missouri Pacific Building, St. Louis 3, Mo.
W. Rogers, Superintendent, Telegraph, Missouri Pacific Building, St. Louis 3, Mo.
- INTERNATIONAL-GREAT NORTHERN RAILROAD**
W. Rogers, Superintendent, Telegraph, Missouri Pacific Building, St. Louis 3, Mo.
- MONTOUR RAILROAD**
W. H. Hamilton, General Superintendent, Corapolis, Pa.
- NASHVILLE, CHATTANOOGA & ST. LOUIS RAILWAY**
E. W. Anderson, Signal and Telephone Engineer, 924 Broadway, Nashville 3, Tenn.
- NATIONAL RAILWAYS OF MEXICO**
B. E. Arlas, Superintendent, Telegraph and Electrical Department, Apartado Postal 322, Estacion de Buenavista Mexico, D. F., Mexico.
- NEVADA NORTHERN RAILWAY**
Hurford A. Miller, Chief Electrician, East Ely, Nev.
- NEW YORK CENTRAL RAILROAD**
W. A. Jackson, General Superintendent, Telegraph and Telephone, 466 Lexington Avenue, New York 17, N. Y.
J. L. Niese, Assistant General Superintendent, Telegraph and Telephone, 466 Lexington Avenue, New York 17, N. Y.
- INDIANA HARBOR BELT RAILROAD**
W. A. Jackson, General Superintendent, Telegraph and Telephone, 466 Lexington Avenue, New York 17, N. Y.
- PITTSBURGH & LAKE ERIE RAILROAD**
W. A. Jackson, General Superintendent, Telegraph and Telephone, 466 Lexington Avenue, New York 17, N. Y.
- NEW YORK, CHICAGO & ST. LOUIS RAILROAD**
R. C. Winkler, Superintendent, Communications, Terminal Building, Cleveland, Ohio.
- NEW YORK, NEW HAVEN & HARTFORD RAILROAD**
W. A. Moore, General Superintendent, Electric Transmission and Communication, New Haven 6, Conn.
G. N. Loomis, Communication Engineer, New Haven 6, Conn.
- NEW YORK, SUQUEHANNA & WESTERN RAILROAD**
J. P. Kretzer, Acting Superintendent, Telegraph and Telephone, 818 Republic Building, Cleveland 15, Ohio.
- NORFOLK & WESTERN RAILWAY**
J. A. Beoddy, Superintendent, Telegraph and Signals, Roanoke 17, Va.
- NORFOLK SOUTHERN RAILROAD**
F. L. Nicholson, Chief Engineer, Norfolk, Va.
- NORTHERN PACIFIC RAILWAY**
F. L. Steinbright, Superintendent, Telegraph, St. Paul 1, Minn.
- NORTHWEST PACIFIC RAILROAD**
A. W. Flanagan, Superintendent, Telegraph, 65 Market Street, San Francisco 5, Calif.
- PENNSYLVANIA RAILROAD**
W. R. Triem, General Superintendent, Telegraph, Broad Street Station Building, Philadelphia 4, Pa.
- LONG ISLAND RAILROAD**
J. S. Gensheimer, Superintendent, Telegraph and Signals, Pennsylvania Station, New York 1, N. Y.
- PENNSYLVANIA-READING SEASHORE LINES**
Harry Babcock, General Manager and Traffic Manager, 22 Federal Street, Camden, N. J.
- PEORIA & PEKIN UNION RAILWAY**
J. T. O'Dea, President, Union Station Peoria, Ill.
- PERE MARQUETTE RAILWAY**
H. C. Lorenzen, Signal Engineer and Superintendent, Telegraph, General Motors Building, Detroit 2, Mich.
- MANHATTAN & NORTHEASTERN RAILWAY**
J. Gordon Johnson, General Manager and Traffic Manager, Manhattan, Mich.
- PIEDMONT & NORTHERN RAILWAY**
F. H. Cothran, President, Charlotte, N. C.
- PITTSBURGH & SHAWMUT RAILROAD**
W. W. Morris, Vice President and General Manager, Kittanning, Pa.
- PITTSBURGH, SHAWMUT & NORTHERN RAILROAD**
J. N. Thompson, Chief Engineer, Main-tenance of Way, Gettysburg, N. Y.
- PITTSBURGH & WEST VIRGINIA RAILWAY**
W. E. Roblnholt, Superintendent, Transportation, Wabash Building, Pittsburgh, Pa.

MODEL 2405

Volt•Ohm•Milliammeter

25,000 OHMS PER VOLT D.C.



SPECIFICATIONS

NEW "SQUARE LINE" metal case, attractive tan "hammered" baked-on enamel, brown trim.

- **PLUG-IN RECTIFIER**—replacement in case of overloading is as simple as changing radio tube.
- **READABILITY**—the most readable of all Volt-Ohm-Milliammeter scales—5.6 inches long at top arc.
- **RED•DOT LIFETIME GUARANTEE** on 6" instrument protects against defects in workmanship and material.



NEW ENGINEERING • NEW DESIGN • NEW RANGES 50 RANGES

- Voltage: 5 D.C. 0-10-50-250-500-1000 at 25000 ohms per volt.
5 A.C. 0-10-50-250-500-1000 at 1000 ohms per volt.
- Current: 4 A.C. 0-.5-1-5-10 amp.
6 D.C. 0-50 microamperes—0-1-10-50-250 milliamperes—0-10 amperes.
- 4 Resistance 0-4000-40,000 ohms—4-40 megohms.
6 Decibel -10 to +15, +29, +43, +49, +55
Output Condenser in series with A.C. volt ranges.

Model 2400 is similar but has D.C. volts Ranges at 5000 ohms per volt.

Write for complete description

Triplet

ELECTRICAL INSTRUMENT CO.

BLUFFTON, OHIO.

Power for TRAIN-RADIO Systems

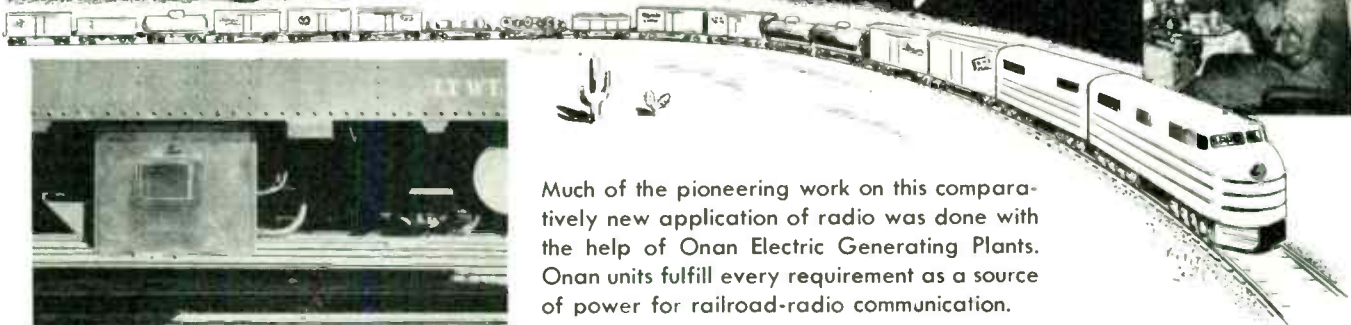

Much of the pioneering work on this comparatively new application of radio was done with the help of Onan Electric Generating Plants. Onan units fulfill every requirement as a source of power for railroad-radio communication.

CHECK THESE ONAN FEATURES

- Compact Construction.**
- Spring Steel Mounting.** Absorbs vibration and shock.
- Air-Cooled.**
- Remote Control Starting and Stopping.**
- Fuel Pump.** Draws gasoline from separately mounted tank if desired.
- Produces Standard A.C. Current**—115-volt, 60-cycle, single-phase.
- Radio Suppression.** Plant is fully shielded.
- Battery Charging Circuit.** A separate D.C. circuit charges the starting batteries.
- Ample Power.** For radio and lighting caboose, etc.
- Easily Serviced.**

If you are planning for train-radio communication, write our engineering sales department. We will be pleased to have our nearest representative call on you.

D. W. ONAN & SONS

3491 Royalston Avenue, Minneapolis 5, Minnesota

Steel cabinet housing Onan unit suspended under caboose

Sizes range from 350 to 35,000 Watts.

65 basic models ranging in capacity from 350 to 35,000 Watts.

Standard A.C. Models, 115-volt, 60-cycle, single-phase.

Standard D.C. Models, 32 to 115 Volts.

Special voltages to 660 A.C., and 4000 Volts D.C.

5 KW to 35 KW units available in 3-phase.

High frequency to 800 cycles.

Combination A.C.-D.C. types available.

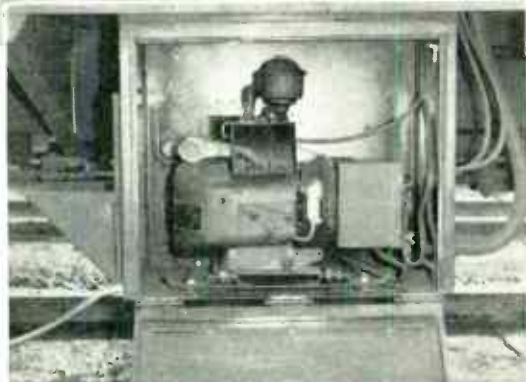

This is the Onan 1500 watt, 115 volt, 60 cycle unit that furnishes the power

PRESCOTT & NORTHWESTERN RAILROAD
J. R. Bemis, President, Prescott, Ark.
RHIFAN RIVER RAILROAD
H. Fliskov, Manager, South Amboy,
N. J.
READING COMPANY
E. W. Hecl, Superintendent, Telegraph
and Signals, Spring Garden Station,
Philadelphia 23, Pa.
RICHMOND, FREDERICKSBURG & POTOMAC
RAILROAD
F. C. Omohundro, Chief Operator, Broad
Street Station, Richmond, Va.
RUTLAND RAILROAD
H. J. Nichols, Superintendent, Tele-
graph, Rutland, Vt.
ST. LOUIS-SAN FRANCISCO RAILWAY
G. F. Linster, Superintendent, Tele-
graph, Springfield, Mo.
ST. LOUIS-SOUTHWESTERN RAILWAY LINES
R. M. Stone, Superintendent, Tele-
graph, Tyler, Texas.
SAN DIEGO & ARIZONA EASTERN RAILWAY
D. J. Russell, President, 65 Market
Street, San Francisco 5, Calif.
SAVANNAH & ATLANTA RAILWAY
C. E. Gay, Jr., President, Savannah, Ga.
SEABOARD AIR LINE RAILWAY
J. R. DePriest, Superintendent, Tele-
graph and Signals, Norfolk 10, Va.
SOUTHERN PACIFIC COMPANY
A. W. Flanagan, Superintendent, Tele-
graph, 65 Market Street, San Fran-
cisco 5, Calif.
TEXAS & NEW ORLEANS RAILROAD
M. O. Scobee, Superintendent, Tele-
graph, Houston 1, Texas.
SOUTHERN PACIFIC RAILROAD COMPANY OF
MEXICO
J. A. Small, President, Guadalajara,
Jalisco, Mexico
SOUTHERN RAILWAY SYSTEM
J. R. Smith, Assistant to Vice President,
Communications, McPherson Square,
Washington 13, D. C.
SPOKANE INTERNATIONAL RAILWAY
D. R. Walte, Superintendent, Spokane,
Wash.
SPOKANE, PORTLAND & SEATTLE RAILWAY
E. H. Showalter, Superintendent, Port-
land 7, Ore.
TEMBELAMING & NORTHERN ONTARIO
RAILWAY
S. B. Clement, Chief Engineer, North
Bay, Ont.
TENNESSEE, ALABAMA & GEORGIA RAIL-
WAY
H. F. Bohr, Vice President, Chatta-
nooga 2, Tenn.
TENNESSEE CENTRAL RAILWAY
H. R. Manby, Chief Engineer, Nashville
3, Tenn.
TERMINAL RAILROAD ASSOCIATION OF ST.
LOUIS
E. B. McCormick, Manager, Telegraph
and Telephone Department, Room
402, Union Station, St. Louis 3, Mo.
TEXAS & PACIFIC RAILWAY
W. A. Roberts, Superintendent, Tele-
graph, Dallas, Texas.
J. M. Compton, Communications Engi-
neer, Telegraph Department, Dallas,
Texas.
TEXAS MEXICAN RAILWAY
D. L. Kelsor, Vice President, Laredo,
Texas.
TORONTO, HAMILTON & BUFFALO RAIL-
WAY
H. T. Malcolmson, President and Gen-
eral Manager, Hamilton, Ont.
TREMONT & GULF RAILWAY
A. L. Smith, Executive Vice President
and General Manager, Winnfield, La.
UNION PACIFIC RAILROAD
G. R. Van Eaton, Superintendent, Tele-
graph, 1416 Dodge Street, Omaha 2,
Nebr.
UNION RAILWAY
W. E. Lamb, President, P. O. Box 2697,
DeSoto Station, Memphis 2, Tenn.
UNION RAILROAD
R. C. McIntyre, General Manager, East
Pittsburgh, Pa.
VIRGINIAN RAILWAY
A. R. Kyle, Superintendent, Telegraph
and Signals, Princeton, W. Va.
WARREN RAILROAD
R. J. Bellsmith, Superintendent, Tele-
graph, Decatur 7, Ill.
WESTERN MARYLAND RAILWAY
K. L. Muse, Signal and Telephone Engi-
neer, Hagerstown, Md.
WESTERN PACIFIC RAILROAD
J. P. Quikley, Superintendent, Trans-
portation and Telegraph, 526 Mission
Street, San Francisco 5, Calif.
WESTERN RAILWAY OF ALABAMA
G. K. Williams, Superintendent, Trans-
portation, Atlanta 3, Ga.
WHEELING & LAKE ERIE RAILWAY
George Durham, President and General
Manager, 803 Huron-Sixth Building,
Cleveland 15, Ohio.
W. J. Jenkins, Superintendent, Tele-
graph and Telephone, Brewster, Ohio.
WICHITA VALLEY RAILWAY
H. H. Hasselbacher, General Superin-
tendent, Telegraph, 547 West Jackson
Boulevard, Chicago 6, Ill.
WINSTON-SALEM SOUTHBOUND RAILWAY
C. W. Russell, General Superintendent,
Winston-Salem 1, N. C.
YOUNGSTOWN & SOUTHERN RAILWAY
Lloyd Lyon, Vice President, P. O. Box
688, Youngstown 1, Ohio.

Arias, B. E.
National Railways of Mexico
Armstrong, W. M.
Canadian National Railways
Babcock, Harry
Pennsylvania-Reading Seashore Lines
Barber, E. B.
Algonia, Central & Hudson Bay Railway
Bellsmith, R. J.
Wabash Railroad
Ann Arbor Railroad
Bemis, J. R.
Prescott & Northwestern Railroad
Bender, F. W.
Central Railroad Company of New Jersey
Hennett, C. H.
Lehigh & Hudson River Railway
Beoddy, J. A.
Nortfolk and Western Railway
Bohr, H. F.
Tennessee, Alabama & Georgia Railway
Briekley, M. H.
Duluth, Missabe & Iron Range Railway
Brook, G. P.
Gulf, Mobile & Ohio Railroad
Burley, P. B.
Illinois Central System
Burnette, C. H.
Cambria & Indiana Railroad

Forbes, P. L.
Detroit, Toledo & Ironton Railroad
Frey, R. C.
Kentucky & Indiana Permal Railroad
Gay, C. E., Jr.
Savannah & Atlanta Railway
Genshelmer, J. S.
Long Island Railroad
Goodwin, K. F.
Gulf, Mobile & Ohio Railroad
Grace, F. W.
Beaver, Meade & Englewood Railroad
Hackman, J. E.
Lehigh & New England Railroad
Hamilton, W. H.
Montour Railroad
Hartmen, W. N.
Chesapeake & Ohio Railway
Hasselbacher, H. H.
Chicago, Burlington & Quincy Railroad
Colorado & Southern Railway
E. Worth & Denver City Railway
Wichita Valley Railway
Hoffman, W. A.
Florida East Coast Railway
Holmes, J. D.
Mexican Railway Company, Ltd.
Hooper, F. H.
Kansas City Southern Railway

Loomis, G. N.
New York, New Haven & Hartford Rail-
road
Lorenzen, H. C.
Pere Marquette Railway
Lyon, Lloyd
Youngstown & Southern Railway
MacCreedy, R. H.
Bangor & Aroostook Railroad
Malcolmson, H. T.
Toronto, Hamilton & Buffalo Railway
Manby, H. R.
Tennessee Central Railway
McArthur, F. E.
Central Vermont Railway
McCormick, E. B.
Terminal Railroad Association of St.
Louis
McGee, H. E.
Green Bay & Western Railroad
McIntyre, R. C.
Union Railroad
McKesson, F. K.
Ann Arbor Railroad
McKittrick, W. H.
Indianapolis Union Railway
Menagh, F. H.
Erie Railroad
Metcalf, J. G.
Louisville & Ashville Railroad
Miller, Burton A.
Nevada Northern Railway
Milligan, T. M.
Elgin, Joliet & Eastern Railway
Moore, G. G.
Galveston, Houston & Henderson Rail-
road
Moore, W. A.
New York, New Haven & Hartford
Railroad
Morrison, W. W.
Pittsburgh & Shawmut Railroad
Moss, C. D.
Cincinnati Railroad
Muller, J. P.
Boston & Maine Railroad
Maine Central Railroad
Muse, K. L.
Western Maryland Railway
Musgrove, E. H.
Denver & Rio Grande Western Railroad
Myers, P. N.
McCloud River Railroad
Neal, G. P.
Chicago & Eastern Illinois Railway
Nell, W. D.
Canadian Pacific Railway
Nichols, H. J.
Rutland Railroad
Nicholson, F. L.
Norfolk Southern Railway
Noble, S. E.
Chicago & North Western Railway
Chicago, St. Paul, Minneapolis & Omaha
Railway
O'Dea, J. T.
Peoria & Pekin Union Railway
Omohundro, P. C.
Richmond, Fredericksburg & Potomac
Railroad
Ort, J.
Minneapolis, St. Paul & Sault Ste. Marie
Railroad
Parkinson, J. A.
Atchison, Topeka & Santa Fe Railway
Gulf, Colorado & Santa Fe Railway
Peebles, N. A.
Atlantic Coast Line
Peters, C. T.
Chicago & Western Indiana Railroad
Pinkerton, C. A.
Detroit & Mackinac Railway
Poole, C. D.
Erie Railroad
Porter, L. B.
Chicago, Milwaukee, St. Paul & Pacific
Railroad
Prendergast, L. J.
Baltimore & Ohio Chicago Terminal
Railroad
Baltimore & Ohio Railroad
Pulham, W. W.
Denver & Rio Grande Western Railroad
Purvis, H. W.
Georgia & Florida Railroad
Quikley, J. J.
Western Pacific Railroad
Ray, E. L.
Detroit & Toledo Shore Line Railroad
Reich, E. W.
Reading Company
Resley, S. E.
Huntington & Broad Top Mountain
Railroad & Coal Co.
Rice, A. H.
Delaware & Hudson Railroad
Rice, Robert
Colorado & Southern Railway
Roberts, W. A.
Texas & Pacific Railway
Robbinhoft, W. E.
Pittsburgh & West Virginia Railroad
Rogers, W.
Missouri Pacific Railroad
International-Great Northern Railroad
Russell, C. W.
Winston-Salem Southbound Railway
Russell, D. J.
San Diego & Arizona Eastern Railway
Ryden, A. H.
Kansas City Southern Railway
Louisiana & Arkansas Railway
Sampson, H. C.
Alton Railroad
Schrader, F. L.
Chicago & Illinois Midland Railway
Scobee, M. O.
Texas & New Orleans Railroad
Shoemaker, P. M.
Delaware, Lackawanna & Western Rail-
road
Sowalter, E. H.
Spokane, Portland & Seattle Railway

SCHEDULE OF DIRECTORIES FOR 1946

JANUARY • Emergency Stations

Call letters and names of radio supervisors of all municipal, county, and state police systems, and forestry, fire, public utility, railroad, trade, and bus radio systems.

FEBRUARY • FM and Television Stations

Both stations on the air and for which applications have been filed, together with their frequencies and call letters, and the names of the general managers and chief engineers.

APRIL • Products Directory

This is the most comprehensive Products Directory appearing in any radio publication. Items are indexed according to the requirements of purchasing agents and engineers, for quick reference, under more than 300 individual headings.

MAY • Parts Jobbers and Factory Representatives

Another exclusive directory, listing all accredited parts jobbers, and showing the lines handled by each factory representative.

JULY • Emergency Stations

Call letters and names of radio supervisors of all municipal, county, and state police systems, and forestry, fire, public utility, railroad, trade, and bus radio systems.

AUGUST • FM and Television Stations

Both stations on the air and for which applications have been filed, together with their frequencies and call letters, and the names of the general managers and chief engineers.

OCTOBER • Products Directory

This is the most comprehensive Products Directory appearing in any radio publication. Items are indexed according to the requirements of purchasing agents and engineers, for quick reference, under more than 300 individual headings.

NOVEMBER • Manufacturers Directory

Names and addresses of all companies manufacturing radio and associated equipment, tubes, materials, components, supplies, and insulating parts. Also will include names of sales managers purchasing agents, and chief engineers.

Burns, J. E.
Mississippi Central Railroad
Dahl, E. A.
Chicago, Rock Island & Pacific Railway
DePriest, J. R.
Seaboard Air Line Railway
Devins, J. W.
Minneapolis & St. Louis Railway
Durham, George
Wheeling & Lake Erie Railway
Durlay, R.
Alton & Southern Railroad
Choak, F. E.
Chicago, Attica & Southern Railroad
Chunn, W.
Missouri Pacific Railroad
Clark, F. J.
Mexico North-Western Railway
Clement, S. B.
Temiskaming & Northern Ontario Rail-
way
Compton, J. M.
Texas & Pacific Railway
Cotman, P. H.
Piedmont & Northern Railway
Crimmen, E. L.
Minneapolis & St. Louis Railway
Cummins, R. R.
Central of Georgia Railway
East, L. A. W.
Canadian Pacific Railway
Ellis, C. O.
Chicago, Rock Island & Pacific Railway
Faulconer, E. L.
Atlantic & Yadkin Railway
Fiskov, H.
Raritan River Railroad
Flanagan, A. W.
Northwestern Pacific Railroad
Southern Pacific Company
Flanagan, P. A.
Chesapeake & Ohio Railway
Fontenot, S.
Kansas City, Mexico & Orient Railway
of Mexico

Louisiana & Arkansas Railway
Hunt, A. S.
Baltimore & Ohio Railroad
Baltimore & Ohio Chicago Terminal
Railroad
Jackson, W. A.
New York Central Railroad
Indiana Harbor Belt Railroad
Pittsburgh & Lake Erie Railroad
Jamble, Ing. Antonio Dovall
Direccion General De Construccion De
Ferrocarriles
Jenkins, W. J.
Wheeling & Lake Erie Railway
Jenks, C. O.
Great Northern Railway
Johnson, A. L.
Denver & Salt Lake Railway
Johnson, J. A.
Missouri-Kansas-Texas Railroad
Missouri-Kansas-Texas Railroad of Texas
Johnson, J. Gordon
Manistee & Northeastern Railway
Kahley, J. M.
Midland Valley Railroad
Kearton, T. H.
Chicago Great Western Railway
Kelsor, D. L.
Texas Mexican Railway
Kelly, C. M.
F. Dodge, Des Moines & Southern
Railroad
Kretler, J. P.
New York, Susquehanna & Western
Railroad
Kyle, A. R.
Virginian Railway
Lamb, W. E.
Union Railway
Layng, F. R.
Bessemer & Lake Erie Railroad
Lelsenring, J.
Illinois Terminal Railroad
Linter, G. E. F.
St. Louis-San Francisco Railway

LISTING OF OFFICIALS

Anderson, E. W.
Nashville, Chattanooga & St. Louis Rail-
road

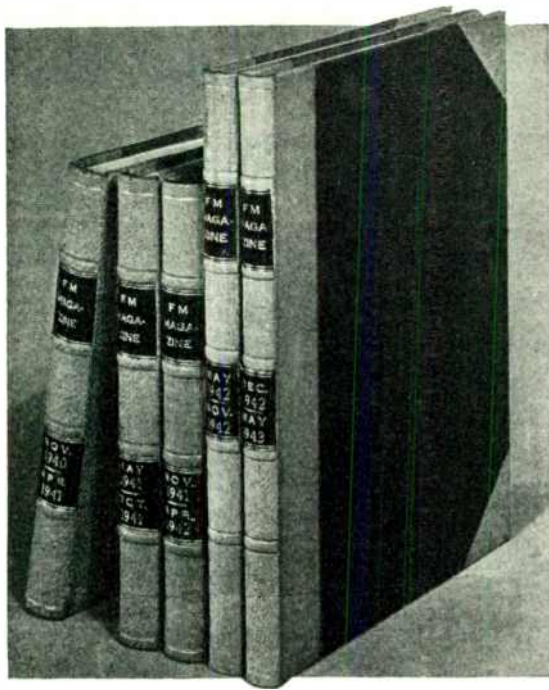

Essential to Every TECHNICAL LIBRARY

Here is an invaluable source of information on the most important radio development—a complete record of FM progress in all its phases. In addition, these bound volumes of *FM AND TELEVISION* contain a wealth of technical information and design data which should be available in every engineering and patent library.

May 1941 to October 1941
 November 1941 to April 1942
 May 1942 to November 1942
 December 1942 to May 1943
 June 1943 to December 1943
 January 1944 to June 1944
 July 1944 to December 1944
 January 1945 to July 1945

NOTE: November 1940 to April 1941 is out of print

Each volume is bound in beautiful three-quarter pigskin and blue cloth by the famous Eggeling Bindery.

PRICE \$5.50 PER VOLUME (plus 25¢ for shipping)
 Foreign Postage 50c

FM AND TELEVISION MAGAZINE
 511 Fifth Avenue New York 17, N. Y.

December 1945 — formerly *FM RADIO-ELECTRONICS*

Compression Molded PLASTIC PRODUCTS

★ Here at Rogan, you are invited to avail yourselves of our complete knowledge and long experience in all phases of plastic molding. Our staff of trained experts will be glad to assist you with your plastic problems, no matter how involved or comprehensive.

In addition to compression molding, we also offer an exclusive "deep relief" branding process that goes a long way toward reducing the cost of plastics that must bear markings, lettering or other descriptive matter.

Write for facts on this lower cost, combination service today.

ROGAN BROS.

Compression Molders and Branders of Plastics
 2000 S. MICHIGAN AVENUE • CHICAGO 16, ILLINOIS

FILTER CONDENSER BARGAINS!

Thousands of rugged, oil-filled, oil-impregnated condensers at ridiculously low prices. Write for list! New Time Payment Plan if desired.

BIG NEW CATALOG! By mailing us your name and address, you will be among the first to get a copy of our own big new catalog, plus latest announcements of new and bargain components and equipment. Write today! Address Dept. F of nearest Newark branch.



FREE TO YOU COLOR CODE AND OHMS LAW CALCULATOR

A great convenience. Easy to work. Solves many problems. Attach coupon to your letterhead. Free to radio men, engineers, etc.

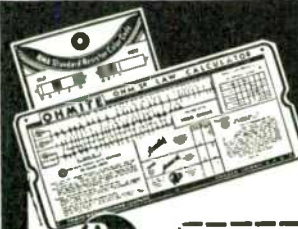

BURSTEIN-APPLEBEE COMPANY
 1012 McGee St.
 Kansas City 6, Mo.

Mail Coupon Now

BURSTEIN-APPLEBEE COMPANY
 1012 McGee, Kansas City 6, Mo.

Send me FREE Color Code and Ohms Law Calculator along with latest catalog.

I am _____ STATE CONNECTION IN INDUSTRY
 NAME _____
 ADDRESS _____
 TOWN _____ STATE _____

Engineered and built by

Doolittle



**FM and AM
FREQUENCY
MONITORS**

Direct reading. No charts or complicated calculations necessary. Models available for 110 volt A.C. or battery operated portable use. Meet FCC requirements.



**DISTORTION
METER**

Direct reading device which indicates as a percentage of the fundamental frequency, the square root of the sum of the squares of the harmonic components. It is used for audio frequency measurements in any audio device in the usual range of voice or musical notes from 150 to 15,000 cycles.

• Utilize the many advantages of these units now. They are sturdily built, self-contained, moderately priced. Remember . . . equipment pioneered by DOOLITTLE years ago, still serves efficiently today!

SEND FOR FULL DETAILS

Doolittle

RADIO, INC.

7421 SOUTH LOOMIS BOULEVARD
CHICAGO 36, ILLINOIS

**BUILDERS OF PRECISION
RADIO EQUIPMENT**

Simpson, R. L.
Minneapolis, St. Paul & Sault Ste. Marie
Railroad
Small, J. A.
Southern Pacific Railroad Co. of Mexico
Smith, A. L.
Tremont & Gulf Railway
Smith, J. R.
Southern Railway System
Smith, R. B.
Burlington-Rock Island Railroad
Spell, W. A.
Atlanta, Birmingham, & Coast Railroad
Sproleder, W. M.
Buffalo Creed Railroad
Stradling, E. G.
Chicago, Indianapolis & Louisville Rail-
way
Steele, R. B.
Canadian National Railways
Steinbright, F. L.
Northern Pacific Railway
Stone, R. M.
St. Louis Southwestern Railway Lines
Stovall, R. C.
Columbus & Greenville Railway
Syverson, A.
Lake Superior & Ishpeming Railroad
Thayer, R. C.
Great Northern Railway
Thomas, L. R.
Atchison, Topeka & Santa Fe Railway
Thompson, J. N.
Pittsburgh, Shawmut & Northern Rail-
road
Titus, A. P.
Illinois Terminal Railroad
Triem, W. R.
Pennsylvania Railroad
Trisala, J. M.
Illinois Central System
Van Eaton, G. R.
Union Pacific Railroad
Walte, D. R.
Spokane, International Railway
Walls, J. H.
Baltimore & Ohio Railroad
Baltimore & Ohio Chicago Terminal
Railroad
Watkins, H. G.
Akron, Canton & Youngstown Railroad
Wickizer, R. C.
New York, Chicago & St. Louis Railroad
Williams, G. K.
Western Railway of Alabama
Georgia Railroad
White, Lowell
Charleston & Western Carolina Railway
Atlantic Coast Line Railroad
Whitman, E. A.
Duluth, South Shore & Atlantic Railway
Wigton, T. W.
Chicago, Burlington & Quincy Railroad
Yerger, J. F.
Lehigh Valley Railroad

(CONTINUED FROM PAGE 31)

quency phase shift in the output current from anode 2, as explained above.

This current, flowing through a load impedance, develops a phase-modulated radio-frequency voltage whose average frequency is that of the crystal.

The angular phase displacement of the rotating electron disc induced by the audio modulation can be compared with a similar action characteristic of a rotating synchronous machine. At no load, the synchronous rotor is aligned with the three-phase rotating magnetic field of the stationary armature winding. However, the external application of load results in a displacement of this alignment, the direction and amount of which are determined by the load. Nevertheless for any normal load the steady-state rotor speed remain constant.

The amplitude of the audio voltage across the coil around the Phasitron tube is constant, with varying audio frequency. Thus the current flowing through the coil decreases as the audio frequency increases, because the coil is almost a pure inductance over the audio range. The magnetic field strength, and thus the phase swing of the output current decreases, therefore (6db per octave) with increasing modulation frequency, effectively producing frequency modulation.

This, in brief, is the method of obtaining frequency modulation with direct crystal control through the use of an entirely new type of vacuum tube, the Phasitron.

**DEPENDABLE
PERFORMANCE**



IT'S ENGINEERED
WITH **HI-Q**
COMPONENTS

Dependable performance in any electronic equipment is the sum of little things. And when those "little things" are Hi-Q components you can rest assured that performance will be thoroughly dependable. Hi-Q components are available in any desired quantities to your specifications. Send for samples and complete data.



CERAMIC CAPACITORS

CI Type: axial leads

CN Type: parallel leads

Made of titanium dioxide (for temperature compensating types). Tested for physical dimensions, temperature coefficients, power factor and dielectric strength.



WIRE WOUND RESISTORS

Fixed Type

Immediately available in standard ratings or precision built to any tolerance or value.



CHOKE COILS

Sturdy construction. Insulated or uninsulated. Quantity production available at once.

**ELECTRICAL REACTANCE
CORPORATION**
FRANKLINVILLE, N. Y.

Aireon

meets every
railroad need
for radio communication

NOW



FIRST radio communication equipment on any main-line railroad, AIREON sets have logged hundreds of thousands of miles in daily service. They are doing the job of speeding, making more positive and efficient railroad traffic control. Here's how:

1 With Aireon's inductive communication system, you can:

- A. Talk with any train, at any time.
- B. Talk between engines and cabooses.*
- C. Talk between adjacent trains.*
- D. Talk between wayside stations.**

2 With Aireon's space radio system, you can:

- A. Talk between engines and cabooses.
- B. Talk between adjacent trains.
- C. Talk between trains, or switch engines and yard offices.
- D. Talk between trains and wayside stations.***

INQUIRY INVITED. Please address S. W. Fordyce, III.

3 With Aireon's portable radio system, you can:

- A. Talk between brakemen and either end of trains.
- B. Talk between car inspectors or yard checkers and yard offices.
- C. Talk between foremen and work gangs.

4 With Aireon's space radio system for emergencies, you can:

Restore communication when wire lines are down from storms and floods.

5 With Aireon's carrier system, you can:

Talk from station to station when added facilities are needed during peak movements.

6 With Aireon's space radio system for motor vehicles, you can:

Talk with any truck or bus from fixed stations or control points.***

*Where one or more wayside wires are within reasonable proximity to trains.

**For distances up to 100 miles, de-

pending on condition of wayside wires.

***For distances up to 15 miles, depending on local terrain.

Aireon MANUFACTURING CORPORATION

Fairfax and Funston Roads, Kansas City 15, Kansas

**BUT THEY SAY CORNING SUPPLIES
4 ENGINEERS WITH EVERY ORDER!**



**HOW 4 SPECIAL CORNING SERVICES
CAN SAVE YOU LOTS OF GRIEF!**

IT'S quite a job getting a new electronic product into production. Materials, methods and prices buzz around your head like a bunch of bees. But you don't have to solve your problems all alone. For Corning has four special engineering services to help you:

1. Sales Engineers—To keep you in touch with latest developments and explain your problems to Corning's technical experts for prompt solution.
2. Product Engineers—Technical men who translate Corning Research in Glass into practical applications which may solve your particular headaches.
3. Plant Engineers—These men are anxious to see you get the best possible price on your order. They often point out changes in design which reduce costs.

4. Technical Service Engineers — These men get you started right. They help your people lick the production bugs.

Of course, Corning Electronic Glassware also means thousands of glass formulae so you can get the right one for your job. It means Corning's unique metallizing process forming a permanent bond between glass and metal. Tubes, bushings, headers, etc., can be soldered in place to form permanent hermetic seals. It means an entire plant at Bradford, Pa., devoted exclusively to the manufacture of electronic specialties quickly, in large quantities. To get the fastest service in solving your pet problem, write, wire or phone Electronic Sales Department, F-12, Technical Products Division, Corning Glass Works, Corning, New York.

Note — The metallized Tubes and Bushings, Headers and Coil Forms below are all made by the famous Corning Metallizing Process. Can be soldered into place to form true and permanent hermetic seals. Impervious to dust, moisture and corrosion.



Metallized Tubes for resistors, capacitors, etc. 20 standard sizes $\frac{1}{2}$ " x 2" to 1 $\frac{1}{4}$ " x 10". Mass-produced for immediate shipment.



Metallized Bushings. Tubes in 10 standard sizes, $\frac{3}{16}$ " x $\frac{1}{32}$ " to 1" x $\frac{1}{16}$ " in mass production for immediate shipment.



Headers—The best way to get a large number of leads in a small space for assembly in one operation.

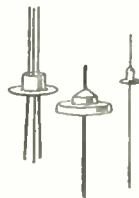

Eyelet Terminals—Single or multiple eyelets permit design flexibility. Standard items readily available in quantity.

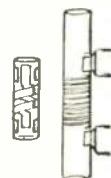

Coil Forms—Grooved for ordinary frequencies—metallized for high frequencies. In various designs and mountings.



VYCOR Brand cylinders—very low loss characteristics. Stands thermal shock up to 900°C. Can be metallized.

CORNING
— means —
Research in Glass

Electronic Glassware



"PYREX", "VYCOR" and "CORNING" are registered trade-marks and indicate manufacture by Corning Glass Works, Corning, N. Y.

sisting of a battery and a double-pole, double-throw switch is very helpful. The circuit is shown in Fig. 83. The output terminals D and E are connected to the reactance tube grid and ground. When balancing is necessary, the receiver and signal generator are adjusted to the same frequency f_0 , after shorting point C, Fig. 82, to ground. The meter across the discriminator output will indicate balance, or zero deflection. The artificial discriminator voltage supplied by the battery is applied between the reactance tube grid and ground. This battery voltage is adjusted by means of the potentiometer to deflect the meter to some positive value, for example, 100 kc. The switch is then snapped over, reversing the polarity of the voltage applied to the grid of the reactance tube. The meter will now be deflected in the opposite direction. If the positive and negative deflections are not symmetrical, the cathode resistor R_K in the reactance tube circuit is adjusted while alternately applying positive and negative voltages to the grid, until a point is reached where symmetrical deflection takes place. The battery circuit is then disconnected and the AFC holding action is determined as outlined in the preceding paragraphs. Should the AFC action be such that the reactance tube pulls away from the desired mean frequency f_0 , it will be necessary to reverse the discriminator cathode leads.

Linearity and Sensitivity ★ The adjustment of AFC linearity and sensitivity will be facilitated if a panoramoscope is available. The output of the signal generator is reduced to zero and a voltage injector circuit, similar to the one shown in Fig. 83, is connected to the reactance tube. A 20,000-ohms-per-volt voltmeter, or a microammeter, is connected across the voltage injector as shown. The receiver is tuned to a desired frequency f_0 , and the panoramoscope is loosely coupled to the receiver oscillator tuned circuit and adjusted to the frequency f_0 of the receiver. This adjustment is made so that the resultant "pip" is centered on the screen of the panoramoscope, indicating that both equipments are tuned to the same frequency. The voltage injector is adjusted to 1 volt output, and the reversing switch is moved to the positive position. The pip on the panoramoscope screen will shift to the right of the center reference line, representing an actual shift in the oscillator frequency due to the action of the reactance tube. The injector switch is then reversed to apply 1 volt negative to the grid of the reactance tube. The pip on the screen of the panoramoscope will shift to the left of the center reference line, indicating a frequency deviation in the negative direction.

(CONTINUED ON PAGE 78)



New FOLDED UNIPOLE ANTENNA

Another Example of ANDREW Ingenuity in Engineering

Concentrating on electrical performance, Andrew engineers have designed a unique Folded Unipole Antenna which—according to comparative tests—easily outperforms other antennas at several times the price.

Used for transmitting and receiving at frequencies from 30 to 40 MC and for powers up to 5,000 watts, this antenna has proved so successful that similar models for higher frequencies are now being designed.

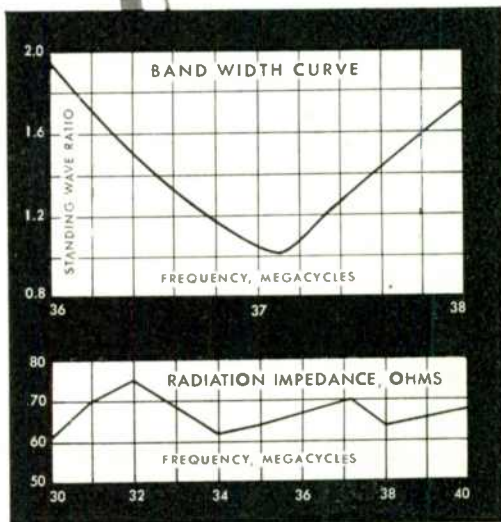

FEATURES:

- Light weight — only 15 pounds — simplifies installation.
- Lightning hazard minimized by grounded vertical element.
- "Slide trombone" calibration permits exact adjustment for any frequency between 30 and 40 MC, using only a wrench. Optimum performance for that frequency is guaranteed without "cut and try" methods.
- Proper termination of coaxial transmission line. Unlike other "70-ohm" antennas, the Folded Unipole actually provides a non-reactive impedance with a resistive component varying between 62 and 75 ohms (see lower curve).
- Excellent band width, ideal for FM (see upper curve).

Andrew Co. specializes in the solution of antenna problems. For designing, engineering and building of antenna equipment, consult Andrew Co.

ANDREW CO.

363 EAST 75th ST., CHICAGO 19, ILL.



WRITE FOR FULL
INFORMATION

Specify DRAKE for Better Dial Light Assemblies

THE Dial Light Assembly of the number 500 U Series illustrated here, is one of the outstanding units of the widely known DRAKE No. 500 Series. The legs of the bracket are made in various lengths, from 27/32" to 1 7/16" from base to shoulder. This unit will fasten on any panel from 0 to .062 thick. When specifying Dial Light Assemblies, remember millions of DRAKE 500's have been used since 1940! These units are TIME-TESTED . . . offer you all the superior advantages developed through years of highly specialized experience in designing and manufacturing Dial and Jewel Light Assemblies *exclusively*. Extensive facilities for high speed production bring you better quality at low cost. Is the newest catalog listing the complete DRAKE line at your finger tips, NOW?

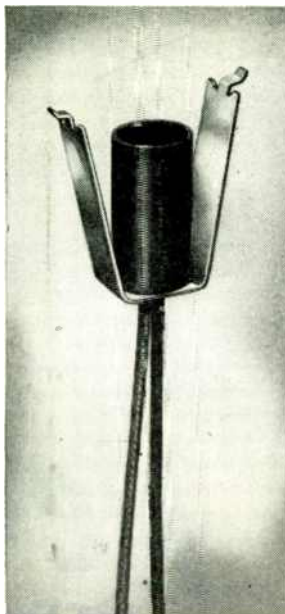

NO. 512 U-43 . . .

the unit shown above, has 1 3/16" legs built for .043 panel. Prompt shipments assured in large quantities for your production line requirements.



SOCKET AND JEWEL LIGHT ASSEMBLIES

DRAKE MANUFACTURING CO.

1713 WEST HUBBARD ST., CHICAGO 22, U.S.A.

FM and Television Magazine
cordially invites you to inspect a display
of FM equipment at Booth 79, during
the Institute of Radio Engineers Winter
Meeting, Hotel Astor, New York City,
from January 23rd to 26th, 1946



FM HANDBOOK

(CONTINUED FROM PAGE 77)

If an applied injector voltage of one volt is insufficient to deviate the receiver local oscillator ± 75 kilocycles, the sensitivity capacitor C_1 , Fig. 83, must be adjusted with a non-metallic alignment screwdriver to add sufficient sensitivity to the AFC circuit to produce the required control range. The receiver tuning control is adjusted to give zero deviation, as indicated on the panoramoscope, each time the capacitor C_1 is changed. The linearity of the AFC circuit can be determined by varying the injector voltage in steps of 0.25 volt from 0 to 1 volt. For a given voltage, the difference should not exceed 1 kc. between the positive and negative frequency deviations shown on the panoramoscope. If the AFC is non-linear, the cathode resistor R_K must be adjusted until equal positive and negative frequency deviations are obtained with a given injected voltage. The alignment of the receiver oscillator should be re-checked, since the adjustment of the AFC sensitivity capacitor C_1 will vary the oscillator frequency.

(CONTINUED FROM PAGE 35)

TESTS

16.121. Equipment Tests: Upon completion of construction of a radio station in exact accordance with the terms of the construction permit, the technical provisions of the application therefor and the rules and regulations governing the station and prior to filing of application for license, the permittee is authorized to test the equipment for a period not to exceed ten days, provided, however, that the inspector in charge of the district in which the station is located is notified 2 days in advance of the beginning of tests and the permittee is not notified by the Commission to cancel, suspend or change the date for the period of such tests.

16.122. Service Tests: When construction and equipment tests are completed in exact compliance with the terms of the construction permit, the technical provisions of the application therefor, and the rules and regulations governing the station and after an application for station license has been filed with the Commission showing the transmitter to be in satisfactory operating condition, the permittee is authorized to conduct service tests in exact accordance with the terms of the construction permit for a period not to exceed 30 days, provided, however, that the inspector in charge of the district in which the station is located is notified 2 days in advance of the beginning of such tests and the permittee is not notified by the Commission to cancel, suspend or change the date for the period of such tests. Service tests are not authorized after expiration date of the construction permit.

(CONCLUDED ON PAGE 79)

16.123. Maintenance Tests: All licensed stations in the Railroad Radio Service shall be tested as may be required for proper maintenance of the stations and the railroad radio communication systems. All necessary precautions shall be taken, however, to avoid interference with other stations and test time shall be kept to the minimum commensurate with insurance of reliable communication.

MISCELLANEOUS

16.141. Station Identification: Each station in the Railroad Radio Service shall be identified during each communication or exchange of a series of communications. During an exchange of communications exceeding fifteen minutes in length, each station shall be identified at the end of each fifteen minute period. In lieu of assigned call letters, identification may be made by the name of the railroad and the train number, caboose number, engine number or name of fixed wayside station; or, if that is not practicable, by such other number or name as may be specified by the railroad concerned for the use of employees of the railroad to identify the fixed point or mobile unit where the radio station is located. Where identification is made other than by train number, caboose number or engine number, a list of such identifications shall be maintained by the railroad. An abbreviated name or initial letters of the railroad may be used where such name or initial letters are in general usage. In those cases where it is shown that no difficulty would be encountered in identifying the transmissions of a particular station, as for example where stations of one licensee are located in a yard isolated from other radio installations, approval may be given to a request of the licensee for permission to omit station identification.

16.142. Who May Operate Stations: Stations in the Railroad Radio Service may be operated only by persons holding commercial radio operators licenses issued by the Commission and in accordance with the rules governing commercial radio operators or by employees of the station licensee meeting the qualifications prescribed by the Commission and in accordance with the limitations prescribed by the Commission in its Order No. 126 for operation by such employees.

16.143. Inspection of Stations: All classes of stations in the Railroad Radio Service shall be made available for inspection upon request of a representative of the Commission except where serious interference with a railroad operation in progress or immediately impending would result, in which event the station shall be made available immediately upon termination of the operation or at such other time as may be satisfactory to the Commission's representative.



Here's How CREI Prepares You Now for A Better Job and a Secure Career in RADIO-ELECTRONICS

Add CREI technical training to your present experience—then get that better radio job you want—make more money—enjoy security

CREI practical home-study training in Radio-Electronics Engineering equips you with the ability to go after — and get — a better-paying, secure radio job.

Now, that the war is over, each good radio-electronics job will go to the man best qualified. Employers are once again "choosey" in selecting the best-trained, best-equipped men for the best jobs. So, face the facts! You **must** keep pace with the industry and start anew to add to your store of radio-electronics knowledge.

In the CREI proved course of home-study training, you learn not only **how** . . . but **why!** Easy-to-read-and-understand lessons are provided you well in advance, and each student has his personal instructor who corrects, criticizes and offers suggestions on each lesson examination. This is the successful CREI training for which more than 10,000 professional radiomen have enrolled since 1927.

Your ability to solve tough problems on paper and then follow-up with the necessary mechanical operation, is a true indication that you have the **confidence** born of **knowledge** . . . confidence in your ability to get and hold an important job with a secure, promising future. These jobs are available for radiomen with the necessary modern technical training. Investigate CREI home-study training . . . and prepare now for security and happiness in the years to come!



WRITE FOR
FREE 36-PAGE
BOOKLET

"Your Opportunity
in the New World
of Electronics"

If you have had professional or amateur radio experience and want to make more money, let us prove to you we have something you need to qualify for a better radio job. To help us intelligently answer your inquiry — PLEASE STATE BRIEFLY YOUR BACKGROUND OF EXPERIENCE, EDUCATION AND PRESENT POSITION.

CAPITOL RADIO ENGINEERING INSTITUTE

HOME STUDY COURSES IN PRACTICAL RADIO-ELECTRONICS
ENGINEERING FOR PROFESSIONAL SELF-IMPROVEMENT

Dept. F-12, 3224-16th Street, N. W., Washington 10, D. C.

Contractors to U. S. Navy — U. S. Coast Guard — Canadian Broadcasting Corp.
Producers of Well-trained Technical Radiomen for Industry

Member: NATIONAL COUNCIL OF TECHNICAL SCHOOLS

(CONTINUED FROM PAGE 4)

tions was interesting and stimulating as few of my investigations in special communications fields have been. It seemed like a study of prehistoric times but, strangely enough, it was nothing of the kind, for the methods of railway communication proved generally adequate, and one can see why the industry has not been too interested in investing large sums to improve a system that has been working pretty well.

But, working pretty well or even very well is not the whole story. How much does it cost? That is a question more to the point. To that, I am convinced, there is but one answer in almost every case. I could find little or no factual information on how much time could be saved by improving the communication systems, but the amount must run into millions of dollars a year, enough to pay for all the equipment in a very short period, even taking into account that any railroad equipment has to be ten times as robust as similar equipment for use in another industry. (Why that is so in some cases is pretty clear, but in others it is not so obvious.)

There are innumerable cases where modern communication methods can speed train schedules, making up of freight trains, warning engineers of hot boxes, and transferring instructions and accident reports from the dispatchers to moving trains.

With proper engineering and careful planning to meet the communication requirements, using radio where necessary and operating wire lines to their full capacity, it is possible to install modern systems which, in most cases, will save enough in man-hours and increased use of rolling stock to pay 25% or more on the investment annually. The radio art has now developed to the point where railroads should consider its use not only from the point of view of safety, in which the Government seems primarily interested, but also from the point of view of increased return on invested capital.

And here's a last thought: During the war, hundreds of thousands of radio transmitters were built into proximity fuses, and fired at enemy troops and planes. Radio instruments that can be shot from guns are certainly tough enough to stand up in railroad service.

2. Presaging its expansion into a world-wide communications system, Globe Wireless, Ltd. has acquired from International Business Machines Corporation their interest in the Radiotype printer developed by Walter Lemmon.

Globe Wireless, Ltd., of which R. Stanley Dollar is now president, was founded in 1928 by Robert Dollar, head of the vast shipping and other interests which bear

(CONTINUED ON PAGE 81)



THERMOSTATIC METAL TYPE DELAY RELAYS

PROVIDE DELAYS RANGING
FROM 1 TO 120 SECONDS

Other important features include:—

1. Compensated for ambient temperature changes from -40° to 110° F.
2. Contact ratings up to 115V-10a AC.
3. Hermetically sealed — not affected by altitude, moisture or other climate changes . . . Explosion-proof.
4. Octal radio base for easy replacement.
5. Compact, light, rugged, inexpensive.
6. Circuits available: SPST Normally Open; SPST Normally Closed.

WHAT'S YOUR PROBLEM? Send for "Special Problem Sheet" and Descriptive Bulletin.

AMPERITE CO. 561 BROADWAY
NEW YORK 12, N. Y.

In Canada: Atlas Radio Corp., Ltd.
560 King St. W., Toronto

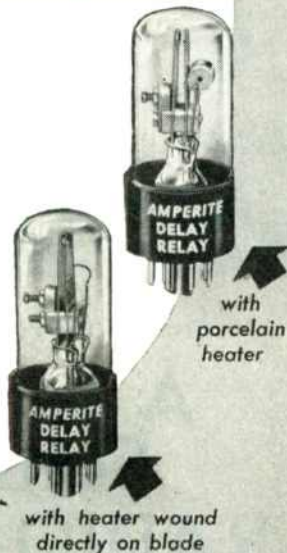

QX CHECKER

TYPE 110-A

A dependable

TEST AND MEASURING INSTRUMENT

The factory counterpart of the Q-Meter. Compares fundamental characteristics of inductance or capacitance and Q under production line conditions with a high degree of accuracy, yet quickly and simply. Insures uniform parts held within close tolerances. Frequency range 100 kc. to 25 mc.



BOONTON RADIO
Corporation
BOONTON, N. J.

DESIGNERS AND MANUFACTURERS OF THE "Q" METER . . . QX-CHECKER . . . FREQUENCY MODULATED SIGNAL GENERATOR . . . BEAT FREQUENCY GENERATOR . . . AND OTHER DIRECT READING TEST INSTRUMENTS

WHAT'S NEW THIS MONTH

(CONTINUED FROM PAGE 80)

his name. It was incorporated in Nevada in 1930 and in Manila in 1935. It operates engineering and construction shops at San Francisco, where an expansion program recently began to take form. Globe has held patents in its own rights covering inventions in the field of transmitters and receivers. It is licensed to use the patents of Heintz and Kaufman, Ltd., of San Francisco, which constructed its original equipment, and those of RCA, Westinghouse, and Farnsworth. In 1937, the FCC reported that Globe Wireless carried 55 per cent of all the paid wordage between Continental United States and Hawaii and the Philippines during the previous year.

Before World War II Globe Wireless, Ltd. operated overseas radio circuits to important points throughout the Pacific area and to Latin America. Stations then in existence were operated at San Francisco, Seattle, Portland, Los Angeles, New York, Havana, Cuba, and Bogotá, Colombia, in the Western Hemisphere and at Manila, Honolulu, Guam, and Shanghai, China, in the Orient. All of these facilities were turned over to the United States Army after Pearl Harbor, and formed an important network for military communications. Just before the Army left Corregidor, the Manila station was blown up, to prevent its falling into the hands of the Japanese. All of the remaining stations now have been returned to the company, and the rehabilitation of such of the properties as suffered damage is going forward rapidly.

Brig. Gen. Walter P. Boatwright, who recently retired from the United States Army, will serve Globe as a vice-president. On December 7, he was awarded the Distinguished Service Medal for his work as Chief of the Tank Automotive Center, in Detroit. General Boatwright will have his office in the Chrysler Building, New York, the eastern headquarters of Globe. The home office is in San Francisco, where additions will be made to present engineering and manufacturing facilities to provide for the company's growth here and abroad.

Walter Lemmon, also elected a vice president, will continue in charge of Radiotype and associated developments, a position which he held previously at IBM.

The agreement between Globe and IBM transfers to the communications company both United States and foreign patent rights, and sets up within Globe the techniques and manufacturing direction not only of Radiotype, but of various other items of equipment in communications by which Globe will be enabled to enlarge its scope of operations on a thoroughly modernized, postwar basis.

Radiotype machines, capable of han-

(CONTINUED ON PAGE 82)



DC means SC . . . Selenium Control and Selenium Conversion for the practical, profitable performance planned by top flight design engineers. Selenium provides maximum efficiency . . . unlimited life . . . negative temperature coefficient . . . and other characteristics necessary to solve the electronic problems of tomorrow . . . That's why DC means SC.

SEND FOR BULLETIN

SELENIUM CORPORATION of AMERICA



1719 WEST PICO BOULEVARD
LOS ANGELES 15, CALIFORNIA

EXPORT DIVISION: FRAZAR & HANSEN
301 CLAY STREET, SAN FRANCISCO, CALIFORNIA

IN CANADA: BURLUC LTD., TORONTO 13, ONTARIO, CANADA

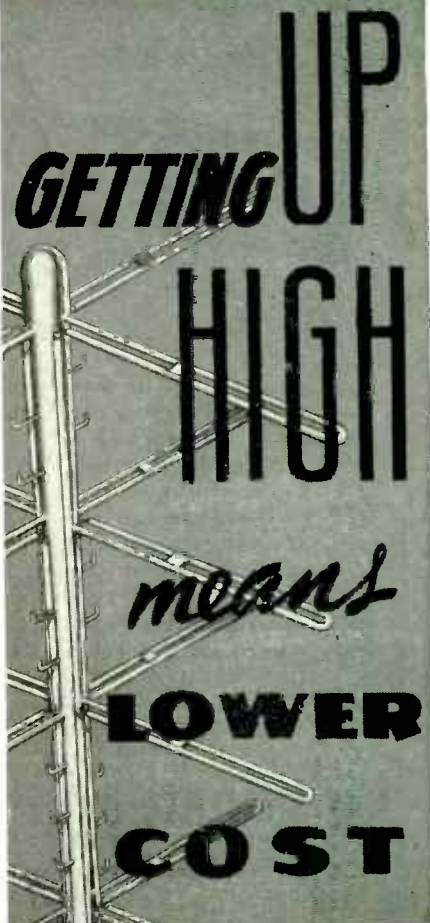

Getting that F-M Antenna up high not only means more efficient area coverage—but it also means lower costs. Doubling the height of the antenna above ground is equivalent to squaring the transmitter power. Thus, a 250 watt transmitter with a 200 foot tower would equal a 1000 watt transmitter with a 100 foot tower. That is real economy—both in initial transmitter cost and in power.

2 Wincharger Products will help you get better F-M Broadcasting at lower costs: (1) A sturdy, economical Wincharger Tower to get your antenna high. (2) An efficient, low cost Wincharger F-M Antenna. For full information write or wire us.

WINCHARGER F.M. ANTENNAS-ANTENNA TOWERS-VERTICAL RADIATORS

WINCHARGER CORP. SIOUX CITY, IOWA

Of Importance to You :

COMMUNICATION PARTS

Is prepared to serve you with a widely diversified list of components, especially those in the fields of radio coils, and special transformers.

Communication Parts has broad experience in design, engineering, and production "know-how"... will aid you in adapting these components you require to better production methods.

If you contemplate a high daily production of these types of radio or electronic components you will be interested in the strides made by Communication Parts in engineering to meet quantity production requirements.

A phone call or letter will receive prompt attention without any obligation whatever.

COMMUNICATION PARTS

NOT INC.

1101 NORTH PAULINA STREET • CHICAGO 22, ILL.



WHAT'S NEW THIS MONTH

(CONTINUED FROM PAGE 81)

dling up to 6,000 words an hour of average message traffic for local or long distance communications by radio or wire, will be released to business organizations on a leased basis. This is an interesting development, because it will bring the Radiotype into the category of general office equipment with radio as an adjunct of business routine.

During the war, these machines have operated over circuits up to 5,400 miles between Washington and Honolulu. Now, as a part of Globe Wireless, their great speed and extreme simplicity of operation will be turned to the purposes for which they were originally intended — the service of public and private commerce.

The keyboard of the Radiotype machine is the same as any standard typewriter, with full upper and lower case characters, and can be operated by any office typist. Pressing of the typewriter keys, when the machine is linked to a radio or wire circuit, sends out groups of radio impulses which actuate the receiving typewriter. Any number of Radiotype receivers, at varying distances of hundreds or thousands of miles, can receive the signals. The messages emerge from the receiving machines fully typewritten with the desired number of carbon copies. The signals can be translated only by Radiotype machines adjusted to their own code of pulse character groups.

These machines have been operated under the most severe conditions. An interesting early test of this nature was made when a research model was loaned to Admiral Byrd for trials from the Antarctic to New York, a span of 11,000 miles. Radiotype impulses were received successfully from the Byrd Expedition just before the party started homeward. In 1939, during the New York World's Fair, a radio circuit operated from the IBM Building in New York regularly supplied news bulletins to the fair grounds visitors.

3. Anticipating by a month the CBS plans to give the press a demonstration of color television, RCA staged such a demonstration at their Princeton laboratories on December 13th.

Hoping to get an answer to the current upper-band-with-color vs. lower-band-black-and-white argument, we attended.

The color transmission was on 10,000 mc. (CBS uses 480 mc.) over the 2½-mile distance from the RCA laboratory to the Princeton Inn. A mechanical filter system, similar to that employed by CBS, was used to introduce the color. The power was less than 1 watt at the transmitter. For the first time, a sound-on-sight system was employed, using the picture scanning fly-back time for the sound. The band width was approximately

(CONCLUDED ON PAGE 83)

TELEVISION MIRRORS and REFLECTORS

FOR TELEVISION, ELECTRONIC
AND SCIENTIFIC APPARATUS

WE specialize in the production of front or rear surface mirrors, made to your specifications. Closest optical and dimensional tolerances observed.

Because of their proven superiority, ZENITH mirrors are preferred by many leading manufacturers of precision equipment.

- EXCEPTIONAL REFLECTIVITY
- ALUMINUM, SILVER, GOLD, etc.
- OPAQUE OR SEMI-TRANSPARENT
- PERMANENT CHARACTERISTICS
- PROMPT SERVICE

We invite your inquiry. Samples and quotations will be submitted promptly.

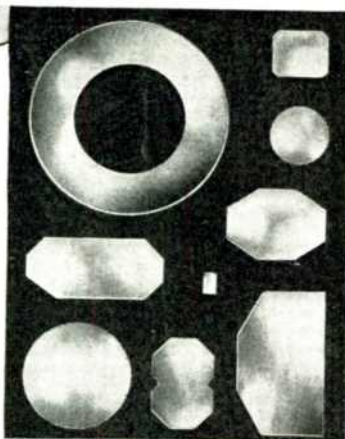

ZENITH OPTICAL LABORATORY

SPECIALISTS IN
VACUUM DEPOSITION



123 WEST 64th STREET
NEW YORK 23, N. Y.

WHAT'S NEW THIS MONTH

(CONTINUED FROM PAGE 82)

10 mc., so that each color component was televised three times.

RCA president Sarnoff told us that, in his opinion, the color system simply isn't ready yet for commercial use. Perhaps CBS will show that he is mistaken, but unless they have something much better to offer than we saw at Princeton, we can get along with black and white.

And, while there's no denying that color television and RCA's trick 3-dimension effect with Polaroid glasses have significant possibilities, it's also true that they only indicate what can be done if and when further research has bridged the wide gap that lies between a scientific curiosity and practical commercial reality.

It seems accurate to say that color television, limited by the RCA or CBS mechanical filter system, is about as near acceptable perfection as was black-and-white television produced by pinholes in a whirling disc. That, too, was hailed as revolutionary, back in the roaring 20's.

Dr. Jolliffe, speaking at the Princeton demonstration, said that even if the performance of the mechanical color system were now perfected to the point of attaining public acceptance, which it is not, it would still be necessary to:

1. Develop and design transmitters with adequate power to deliver home broadcast service.
2. Develop and design receivers to field-test such a system.
3. Determine, analyze, and solve the problems relating to transmission, reception, and studio operation.
4. Arrive at industry agreements on technical standard.
5. And, finally, to obtain FCC approval of the overall system.

In addition, Dr. Jolliffe pointed out that the coaxial cables now in use, and which are being extended at the present time, cannot carry 10-mc. programs. This is an important consideration, since the economy of network operation is an essential factor to the commercialization of television.

Meanwhile, although steady progress is being made in black-and-white reception, the full possibilities of 525-line scanning have not been realized. The honest rating of present definition is about 325-line quality. While it will never be possible to obtain 525-line definition from a 525-line system, equipment now in use is subject to considerable improvement before there will be justification for raising the standards.

Let's have the best quality of black-and-white television, set up on a commercial basis, before we worry about color. The motion picture industry grew up that way, and did very well for itself.

We may change our thinking after we see what CBS has to offer next month. At least, we mean to be open-minded.



That's the story. Aerovox Series "14" oil-filled capacitors are only 1 3/4" in diameter by 2 1/4" or 2 3/4" high. 3000 v. .01, .05 and .1 mfd. Unit here shown actual size. And that's compactness for your ultra-compact "rigs". Ask your Aerovox jobber for these compact capacitors. Ask for latest catalog—or write us direct. Meanwhile, be sure to look for that yellow label!

AEROVOX
Capacitors
INDIVIDUALLY TESTED

AEROVOX CORP., NEW BEDFORD, MASS., U. S. A.
In Canada: AEROVOX CANADA LTD., HAMILTON, ONT.
Export: 13 E. 40 ST., NEW YORK 16, N. Y. Cable: "ARLAB"

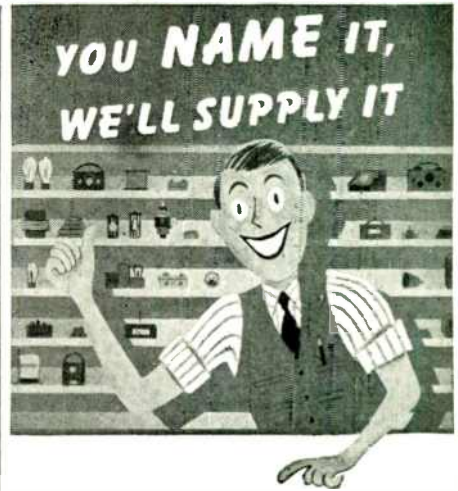

EVERYTHING IN RADIO AND ELECTRONICS

R. W. T., world's oldest and largest Radio Supply House is ready again with tremendous stocks of sets, parts and equipment. You can depend on our quarter-century reputation for quality, sound values and super-speed service. Orders shipped out same day received. All standard lines already here or on the way, including: National, Hammarlund, R. C. A., Hallicrafters, Bud, Cardwell, Biley and all the others you know so well.

Originators and Marketers of the Famous *Lafayette Radio*

Radio Wire Television Inc.

SEND TODAY! 100 Avenue of the Americas (Formerly 6th Ave) New York 13 Boston, Mass. • Newark, N. J.

R. W. T. DEPT. HL 5, 100 AVENUE OF THE AMERICAS, NEW YORK 13, N. Y.

I want your big new post-war Catalogue.

NAME _____
ADDRESS _____
HAMB (CALL LETTERS) _____
ENGINEER? SERVICE MAN? STUDENT?

Try
it!
Compare
it!

\$129*
AMATEUR NET
LESS SPEAKER

HQ-129-X



Prices subject to change without notice.

Frequency
31—.54
Megacycles

Try — then compare, and you'll agree that this professional receiver is an outstanding value. It is built by craftsmen who specialize in communication equipment. The HQ-129-X has endless improvements which are fully described in an eight-page booklet . . . Write today for complete technical information.



HAMMARLUND

THE HAMMARLUND MFG. CO., INC., 460 W. 34TH ST., NEW YORK 1, N.Y.
MANUFACTURERS OF PRECISION COMMUNICATIONS EQUIPMENT

THIS IS IT!

The New 1000 Watt **F**requency-**M**odulation Broadcast Transmitter*



Using the Armstrong Dual Channel
Direct Crystal Controlled Modulator

Simple

Stable

Efficient Performance

Other REL FM Broadcast Equipment Available for ordering

	Cat. No.
250 Watt FM Broadcast Transmitter.....	549 A-DL
3000 Watt FM Broadcast Transmitter.....	519 A-DL
10,000 Watt FM Broadcast Transmitter.....	520 A-DL

Speech Equipment

Cat.

603—Studio Speech Console, table type, 6 position.

604—Station Speech Console, table type, combined with Cat. 600 Monitor and transmitter desk control.

Monitoring Equipment

Cat.

600—FM Station Frequency and Modulation Monitor.

**PLACE YOUR ORDER NOW FOR
EARLY DELIVERY!**

* We invite your inspection of this equipment in production at our plant. Arrange to visit us during the I.R.E. Winter Technical Meeting at the Hotel Astor—Jan. 23—Jan. 26.

Sales Representatives

MICHIGAN	MIDWEST	PACIFIC COAST
M. N. Duffy & Co., Inc. 2040 Grand River Ave., W. Detroit, Mich.	REL Equipment Sales, Inc. 612 N. Michigan Blvd. Chicago, Ill.	Norman B. Neely Enterprises 7422 Melrose Avenue Hollywood 46, Calif.

PIONEER MANUFACTURERS OF FM TRANSMITTERS EMPLOYING
ARMSTRONG PHASE-SHIFT MODULATION

RADIO ENGINEERING LABS., INC.
Long Island City, N.Y.

Link EMERGENCY RADIO Leads

in BOSTON, MASS. METROPOLITAN AREA too—

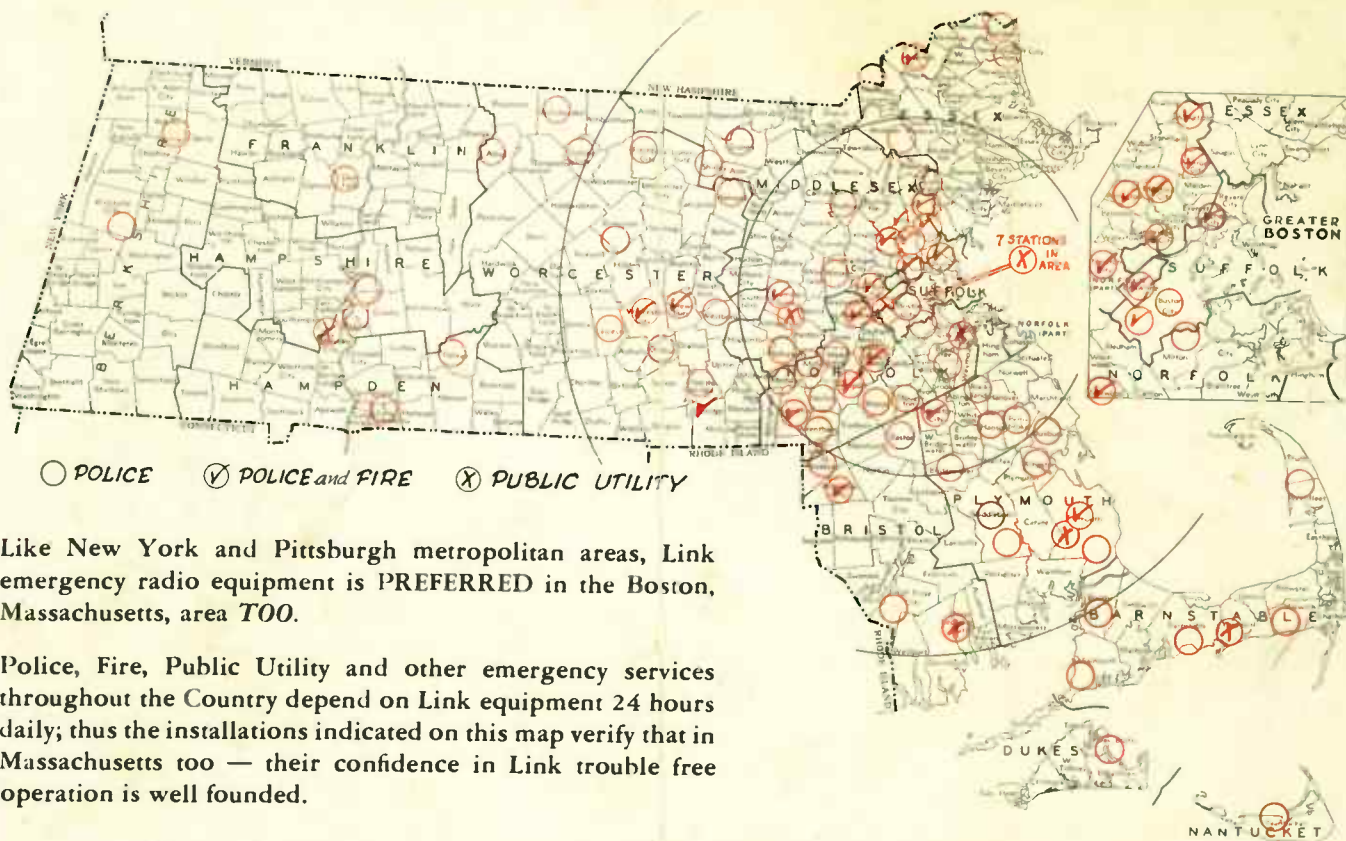

Like New York and Pittsburgh metropolitan areas, Link emergency radio equipment is **PREFERRED** in the Boston, Massachusetts, area **TOO**.

Police, Fire, Public Utility and other emergency services throughout the Country depend on Link equipment 24 hours daily; thus the installations indicated on this map verify that in Massachusetts too — their confidence in Link trouble free operation is well founded.

PARTIAL LIST of LINK RADIO USERS IN THIS AREA

Police Departments

Massachusetts State Police
Metropolitan District
Commission
Arlington
Athol
Attleboro
Bedford
Boston
Bridgewater
Brockton
Brookline
Cambridge
Chelsea
Deerfield
Duxbury
East Longmeadow
Framingham
Franklin
Fitchburg

Gardner
Gloucester
Groton
Hanson
Haverhill
Harvard
Holliston
Kingston
Lynnfield
Medfield
Medway
Melrose
Methuen
Middleborough
Millbury
Mills
Needham
Newburyport
Newton
North Attleboro
Northbridge
North Easton
Norwood
Norfolk
Pembroke

Plymouth
Rockland
Salisbury
Shrewsbury
Shirley
Stoughton
South Hadley
Wakefield
Walpole
Winchendon
Worcester
Wrentham
Westboro
Weston

Framingham
Franklin
Haverhill
Medford
Melrose
Needham
Newton
Norwood
Palmer
Plymouth
Shrewsbury
Wakefield
Walpole
Worcester
Uxbridge

Fire Departments

Mass. Dept. of Conservation
Arlington
Attleboro
Brockton
Brookline
Cambridge
Chelsea

Public Utilities

Boston Edison Co.
Cape & Vineyard Electric Co.
Holyoke Water Power Co.
New Bedford Gas & Edison
Light Co.
Plymouth County Electric Co.



ENGINEER • MANUFACTURER

Fred M. Link

125 WEST 17th STREET • NEW YORK 11, N. Y.

PREFERRED FM RADIO COMMUNICATION EQUIPMENT

MANUFACTURED UNDER LICENSE OF THE
ARMSTRONG PHASE SHIFT MODULATION PATENTS