

PRICE TWENTY-FIVE CENTS



JULY-AUG 1942

RADIO-ELECTRONIC ENGINEERING & DESIGN



MOTOR-TUNED MOBILE ANTENNA

Radio-Electronic Products Directory

**THE JOURNAL OF WARTIME RADIO-ELECTRONIC DEVELOPMENT,
ENGINEERING & MANUFACTURING** ★ Edited by M. B. Sleeper ★

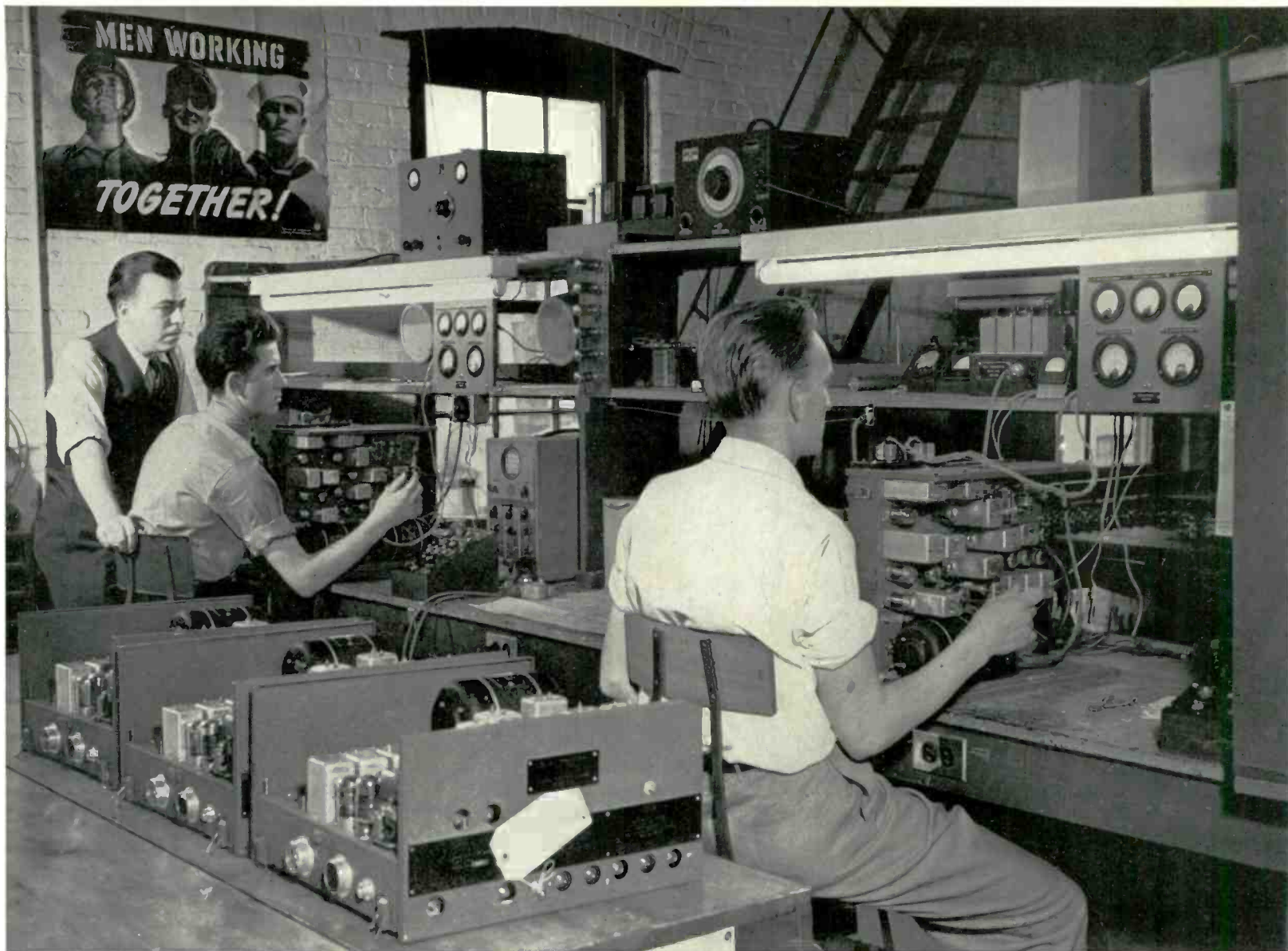

A Knack for Getting Results Fast

IN peacetime, the ability to deliver required results quickly saves money. In wartime, this ability saves lives!

REL has the engineering know-how, backed by laboratory equipment and manufacturing facilities that translate experience into action.

Back in 1934, for example, when other manufacturers were declaring that 2-way police communication was impractical, REL was producing and install-

ing 2-way mobile equipment.

In 1940, while others were wondering if it could be done, REL built and installed the first of a series of 50-kw. FM transmitters. Up to the present time, no other company has delivered a single FM transmitter of more than 10 kw. output.

Repeatedly, under War conditions, REL has been called upon by the U. S. and allied governments to perform unusual services because "REL has a knack

for getting results fast."

Every man in this organization is doing his utmost to maintain this reputation in the service of our Armed Forces.



RADIO ENGINEERING LABS., Inc.
Long Island City New York

Sales Offices:

5334 Hollywood Blvd., Hollywood, California
2040 Grand River Ave. W., Detroit, Michigan
310 Fifteenth St., Denver, Colorado

A MESSAGE ~

And an explanation to the readers of this publication:

LAST SPRING, THE EXIGENCIES of War activities delayed the publication date of this Magazine. I regret any inconvenience or confusion that this has caused.

The delay resulted from taking on additional responsibilities concerned with the War effort, and from the need of readjustments such as almost every engineer has had to make who is engaged in the development and production of military radio equipment.

It would have been easier to delegate the work of editing this publication to someone else for the duration of the War. However, I felt that a radio-electronic paper, published in the service of engineers and executives engaged in wartime radio activities, required an editor who possessed an

understanding of what is going on in the industry from actually participating in it himself.

Much of the most interesting material cannot be published now, because of military limitations, but someone in the position of an outsider, forbidden to pass the doors marked Visitors Not Allowed, would be at a loss to secure permitted material of interest to the readers of this Journal.

In order to reestablish the regular publication date, this issue, mailed on August 20th, has been indicated as the July-August number. The September issue will be mailed on September 20th, and this date of issue will be maintained in the future. Every subscription will be extended one additional month.

M. B. SLEEPER

RADIO-ELECTRONIC ENGINEERING & DESIGN



Ready For Anything

WHETHER you are interested in Industrial Rectifiers from 1 volt to 250,000 volts and from 1 Ma. to 2,500 Amps

OR if you are interested in small transformers in our Ultra-Compact, Ouncer or Sub-Ouncer types (our smallest units weigh only one-third ounce)

OR if you require high power transformer equipment for a 500 Kw. transmitter

OR an industrial application or a special Varitran or Voltage Regulator to suit a specific requirement.



MAY WE ASSIST YOU IN YOUR PROBLEM?
A note to our Engineering Division will bring a quick response with details on units to your requirements.

*Is the Choice of
Leaders of Industry*

UNITED TRANSFORMER CO.
150 VARICK STREET ★ NEW YORK, N. Y.
EXPORT DIVISION: 100 VARICK STREET NEW YORK, N. Y. CABLES: "ARLAB"



Now! FOR THE First Time
YOU CAN ENLIST IN THE
U. S. ARMY SIGNAL CORPS!

... restrictions have been cut to a minimum. If you are eighteen to nineteen and physically fit, you can enlist directly into the U. S. Army Signal Corps ... if you are nineteen to forty-five and can pass the physical examinations, you can enlist providing you have some experience in the Communications Industry and have not received your notice for induction.

the hallicrafters co.
CHICAGO, U. S. A.
Keep Communications Open

LOUIS



AT SCHOOL DEDICATION, LEFT TO RIGHT — LT.-COMDR. LUDLAM, ROGER W. CLIPP, COMDR. S. W. TOWNSEND, COMMUNICATIONS OFFICER, SAMUEL R. ROSENBAUM, WFIL PRESIDENT, AND LT. K. B. EMMONS, IN CHARGE OF NAVY RECRUITING IN PHILADELPHIA

WFIL HELPS NAVY APPLICANTS

Station's Code School Training Gives Men Head Start on Navy Radio Careers

BY LIEUT. ARNOLD NYGREN, U.S.N.R.*

THE idea behind the WFIL radio code school is to serve the dual purpose of helping the U. S. Navy in its urgent need for more radio operators, and to help young men who are interested in this branch of the service, particularly those classified as 1A, to get a head start in their training before enlisting in the Navy.

The plan of the school, conceived by Roger W. Clipp, general manager and vice-president of WFIL and W53PH, and Lieut. K. B. Emmons, in charge of recruiting in the Philadelphia District, is presented here with the hope that it will encourage other broadcasting stations to organize similar training classes, with their engineers serving as the faculty.

Purpose of the School ★ Speaking over WFIL during the dedication ceremonies, Commander S. W. Townsend, district communications officer, summarized the purpose of the school in these words: "WFIL has given us a ready and extremely practical answer to the acute need for radio operators by creating here in its studios a school for training men for the highly

necessary radio operating duties of our Navy. The WFIL radio school for Naval applicants is highly valuable for two important reasons.

"First, it trains men in the very atmosphere of radio, going on twenty hours every day along the most modern lines here in WFIL's commercial broadcasting studios.

"Second, these men, in a few brief weeks, will be taught to copy Continental code up to twenty-five words a minute, and to copy on a typewriter. When they reach this standard, a large part of their primary training as Naval radio operators is accomplished.

"The graduates of this radio school will go to the Navy Recruiting Service and start on the road to becoming petty officers in the Naval Communications Service.

"The shortage of trained radiomen of the Navy is in the thousands, and the management of WFIL is to be commended for taking the initiative in establishing this fine school."

Benefits to Students ★ In addition to obtaining men of technical aptitudes for radio

training who might otherwise be called up in the draft as privates, this school affords a very practical service to the students. Those who complete the course are ordinarily accepted for the V-3 (radio) rating by the Navy, and receive \$78 a month as radiomen, third class, instead of the regular apprentice seaman's pay of \$50. Many of the men starting this course look upon it as a preparation for better jobs when they return to civilian life.

Class Instruction ★ The instructors at the WFIL school are members of the staff who have volunteered their services. Lou Littlejohn, director of the school and now acting chief engineer of the Station, had an amateur license at the age of 13, and later went to sea as an operator on tankers, freighters, and passenger ships. Fred Moore was radioman on a sub-chaser in War I, and put in 12 years in the U. S. Navy. Charles Coleman has many records to the credit of his amateur station. Bill Neill, William Lovainy, and Tony Wheeler have had both commercial and amateur operating experience.

These men, typical of the engineers available at the larger broadcast stations,

* Formerly chief engineer, Station WFIL, Philadelphia, Pa.

put in a full week's time on their regular jobs, and then run the school after hours. They enjoy it, too. Fred Moore remarked, after his first night of teaching: "I haven't had such a thoroughly enjoyable three hours in a long time!"

The radio school is located in a large room adjacent to the FM studio. As the accompanying illustrations show, the room is equipped with code transmitting and receiving apparatus and typewriters for 24 students.

No difficulty was encountered in obtaining the equipment necessary. It comprises:

1. Automatic Tape Transmitter — purchased by WFIL from McElroy, of Boston.
2. Keys and Incidentals — purchased by WFIL locally.
3. Control Board, to enable instructor to keep in touch with individual students — designed and built by WFIL engineers.
4. Marine Receiver — donated by one of the engineers.
5. Tables for the students — donated by Lit Brothers, local department store.
6. Typewriters with blank keys for teaching touch typing — donated by Strayers Business School.

Code reception is taught by hand and tape transmission starting, of course, at greatly reduced speed. The tape transmitter, employing a photo-electric cell, permits the instructor to increase the words per minute very gradually. The control board enables the instructor to connect with any pair of headphones.

Coincident with code practice is instruction in touch typing, which is of equal importance to Navy operators. Locations of the letters on the keyboard are shown

only by the wall charts. Typing instruction is given by Mrs. Alice Faust, secretary to Mr. Clipp.

Advanced code practice includes practical problems in transmission and reception of message traffic, and tactical opera-

average in intelligence, and share a sincere enthusiasm. In short, the applicants are fine material for training.

The age limit imposed by the Navy is 18 to 28. Those with this age group who write or stop in at the Station are told to



FROM THE START, STUDENTS MUST TRANSCRIBE CODE BY TOUCH TYPING

tions, during which each man at his desk is a "ship" in a squadron. An incidental but important part of the course is the study of geography.

Selection of Students ★ Applicants for the WFIL school hear about this course from announcements on the air, from newspaper items, or from their friends. They apply by letter or in person. They come from all walks of life, and range in age from 16 to 60. They are generally above

report to the WFIL Educational Director. He interviews them, and checks on their qualifications. Lads under 21 must have their parents' consent. Married men must have the consent of their wives.

If passed by the Director, the applicant then goes to the Navy Recruiting Office at the Philadelphia Customs House. There he is put through the regulation physical examination. About one man in three fails to meet the Navy requirements, and his name is dropped at the school. Those who pass are told to go back to the school where they then learn how soon they can start the course. Usually, this is the following Monday.

Since classes are held at night, those who are employed can continue to work right up to the time they have finished their training and are taken into the Service. On the other hand, if a student finds he is not fitted to serve as a radio operator, his regular work has not been interrupted.

After a student starts, he must attend every one of his classes, five nights a week, for the first three weeks. This length of time is usually sufficient to eliminate those who started with nothing to back up their initial enthusiasm.

Students may enlist in the Navy at any time up to, and including, the date they graduate from the course. However, they are not accepted for active duty until they meet the required sending and receiving speed of 25 words per minute. At this time of writing, nine men in the school are already enlisted in the Navy.



VERNA STAIR AND LOUIS LITTLEJOHN AT THE CODE TRANSMITTER DESK

(CONTINUED ON PAGE 24)

HIGH-FREQUENCY IRON CORES

Part 1. Better Characteristics and Greater Uniformity Result from Thoroughly Americanized Materials and Production Methods Forced by War

BY AUSTIN C. LESCARBOURA *

REGARDING high-frequency iron cores, as with many other items deemed vital to the successful prosecution of the war, this nation has declared its complete independence. We no longer need European or other outside aid. We now produce our own powdered-iron cores. Such cores are made from domestic materials. We have evolved a production technique that provides provably superior iron cores. Our output today is on a fantastic scale as regards volume, coupled with great precision of production control, which is to say that it has become a full-fledged American wartime industry.

Old Idea in New Dress ★ The purpose of the powdered-iron core is to reduce high-frequency losses by minimizing the path or length of travel of magnetic currents. The finer the iron particles the lower the losses at still higher frequencies, other factors being equal. The iron particles are held together by a suitable binder and molded into solid shapes. An earlier technique of coating paper with powdered iron, has long since been abandoned in favor of molded cores.

The powdered-iron core art goes back to 1892 and probably as early as 1878, when iron filings imbedded in shellac or resin were used for high-frequency applications. Some of the early superheterodyne receiver kits featured powdered-iron core IF transformers in which iron filings were held in shellac or plaster of paris. More recently the art has been given a fresh start, first in Germany and other European countries, particularly Czechoslovakia, and later in the United States, notably in the development of new forms of powdered iron and alloys, better binders, and more critical control of the required electrical characteristics.

For years, the better grade cores were imported from Germany. Later, German powders were imported for American-made cores. With the outbreak of the present war, however, overseas supplies were soon cut off. Then Crowley engi-

neers, already pioneering in ceramic or steatite parts, which had much in common with iron-core production, gave the powdered-iron technique an entirely new direction.

General Considerations ★ To appreciate what has been accomplished, it is necessary to understand the general conditions involved. To begin with, the Q of a coil is controlled not only by the loss in its core but also by the permeability of the core material. As the particle size is decreased beyond a certain point, the gain (lower losses) from reduction in particle size tends to become proportionately less and less, while at the same time the net effective permeability tends to drop at an increasing rate. This results in the crossing of these two lines at some point, after which further reduction in size becomes negative in its effect upon coil quality or Q factor.

At this point special production methods must be resorted to, and even these of course only change the point at which the two lines cross. Hence reduction of particle size is limited and, for given ma-

terials, there is an optimum size depending upon a ratio between effective permeability and loss. Loss consists of hysteresis loss and eddy current loss. With particle size reasonably small and operating at high frequencies, hysteresis is the more important. By increasing specific resistivity, we are able further to reduce eddy current loss.

Crowley engineers therefore aimed their efforts in a new direction, namely, to decrease hysteresis and, if possible and at the same time, to increase permeability. In considering the possibilities, it seemed reasonable to expect lower hysteresis in materials whose atomic or molecular structure was least dense and, conversely, to expect permanent magnetic effect and high hysteresis in the denser structures.

Without going into these specific metallurgical specifications, it can be said that the objectives have been attained. Crowley Magicore alloys show higher effective permeability at higher frequencies, together with lower losses, than do materials which are better at lower frequencies. Also, the method of insulating the particles was carefully considered and an entirely new technique finally chosen. The difficulties and shortcomings of resinous binders at high frequencies are too well known to require discussion here. Suffice it to state that the dimensions of the insulating coatings are quite minute, and in this regard again the background of ceramic experience has been of great help.

Mechanical Considerations ★ Of as great importance as electrical characteristics are mechanical considerations. Here the stress is definitely placed on the use of standard or established shapes and dimensions as far as possible, for which dies are available. Sample specification forms are available, showing what information is necessary as to dimensions, screw inserts, slots, tolerances and other details.

Mechanically, powdered-iron cores are made of powdered ferrous particles held together in a hard metallic mass by a suitable binder. Various molding techniques are employed for shaping the cores. Cylindri-



FIG. 1. CHECKING CORES ON PRODUCTION TYPE Q METER

*In collaboration with the Engineering Department, Henry L. Crowley & Co., Inc., West Orange, N. J.

cal cores, tubes, cups and similar shapes are formed in automatic presses which deliver a high production rate and remarkable uniformity of pieces and characteristics at low cost.

In addition to basic molding operations, iron cores can be further shaped or fabricated by various machining operations. Drilling, threading or tapping, milling, grinding, slotting and other operations are permissible, some materials lending themselves to such machining better than others, although all Crowley iron-core materials can be ground or cut to shape.

Typical Core Shapes ★ Small cylindrical cores or "slugs" constitute the major portion of core production today, and a wide array of standard sizes have already been set up through usage. For IF transformers, cores from .255 in. in diameter by $\frac{5}{16}$ in. long, to .370 in. in diameter by $\frac{3}{4}$ in. long are generally used, depending again upon material used and range-circuit requirements. For push-button receivers, cores from .255 in. in diameter by $\frac{1}{2}$ in. to $1\frac{1}{2}$ in. long to .310 in. in diameter by $\frac{1}{2}$ in. to $1\frac{1}{2}$ in. long are mostly used, depending upon the material and the range-circuit requirements.

Cup-shaped cores are also widely employed, from .500 in. inside diameter by .187 in. inside depth (for each half) and .937 in. outside diameter by .310 in. outside depth (for each half). A center core or slug slips through the two cups, forming a closed-core transformer in combination with the coil that fits inside the cups.

Powdered-iron tubes or sleeves are used for shielding coils in high-grade receivers, and can be supplied in any of the core materials. Also, large cores, 1 in. in diameter by 2 ins. long, are employed for transmitter inductances. They improve



FIG. 2. PLUNGER CORES, WITH THREADED INSERTS, FOR PERMEABILITY TUNING

the Q of the circuit and decrease the physical dimensions of the inductances required for any given range. By means of a tapped inductance and such a core, no variable condenser is required, thus reducing size and weight still further.

Powdered-iron cores are also made in I-shapes similar to transformer laminations, for carrier-current coupling functions and for high-fidelity transformers.

Again, large toroidal cores are made for carrier-current work and other similar low-frequency audio equipment. Recently, there has been a growing demand for large core shapes, especially in cylindrical shapes with a length to diameter ratio of $1\frac{1}{2}$ or 2 to 1. In high-frequency circuits, Q 's of 300 are by no means uncommon, with an effective permeability of approximately 2. These large cores can be pro-

duced with special binders which prevent over-heating with large power output, thereby permitting their use in tank circuits of transmitters having high-power output. Other applications include large-size cores in the design of filter chokes intended to carry DC and at the same time to filter out high-frequency currents.

Desirable Characteristics of Cores ★ The characteristics desired for core materials are high permeability and the control of losses and Q , so as to predetermine the Q . There is a very definite demand for increased permeability, and this constitutes a tricky problem because of the high frequencies and the very low applied voltages. This requires that the UHF curve start relatively high and be quite flat. In other words the permeability must be high, and relatively unaffected by the degree of loading. It is interesting to note that under these conditions and frequencies, some powdered core materials are superior to such excellent materials as permalloy.

In some applications, it is desirable that the Q of coils remain practically constant with or without the core. This permits the designing of a circuit providing for any change introduced by station selection at one or the other end of the band; in other words, with the core all the way in or out.

In other applications it may be desirable to have a distinctly different condition, so that the selectivity is increased at one end of the band or the other. In fact, both these conditions are sometimes met in different circuits. Materials have been developed for these opposite purposes. The expanding of the band with higher frequencies is another requirement in some circuits.

Incidentally, at high frequencies where high Q is desirable, this objective can be obtained by proper proportioning of the space between the core and the coil. It is a fairly good rule that the higher the

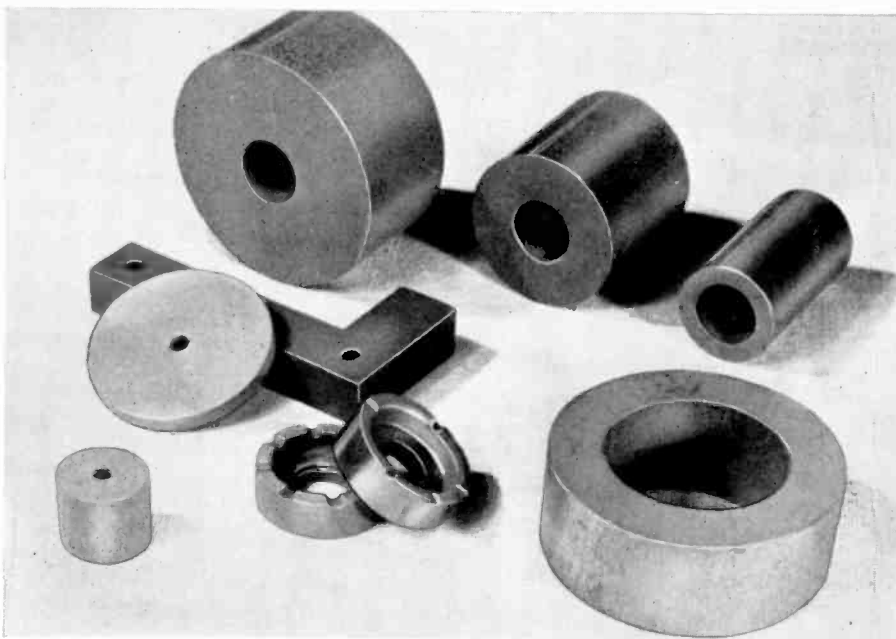

8 FIG. 3. SOME SPECIAL-PURPOSE CORES. LARGER PIECES ARE FOR EQUIPMENT DEVELOPED FOR CARRIER-CURRENT COMMUNICATION SYSTEMS

frequency with ordinary coils, the greater the space between core and coil walls, and the less the weight of core material that should be used.

Iron Cores in Receivers ★ The use of powdered-iron cores in broadcast receivers was given an impetus by the introduction of push-button tuning. Iron cores have been used for oscillators, wave traps, antenna couplers and other components. They were used not only for increasing Q and sharpening tuning, but also for stability and for broad band passing. Couplings intended to pass all frequencies without critical points or great variations in the degree of coupling are made possible by means of special core materials now available and in general use. The use of completely closed cores or cups of the proper material is especially favorable for such functions.

In the short-wave field it is frequently

tion at will or change from one station to another on a given push button, without requiring skill or instruments, thereby eliminating the usual service calls which most other means require, especially with trimmer condensers.

The first and simplest method of using cores in two-stage tuning is with two separate cores, each with a screw molded therein, moving in coils adjacent and parallel to each other, one for the oscillator and the other for the antenna, connected by means of a metal yoke to which is attached a screw that comes forward through the panel and underneath the proper push button. The usual push-button switch is used, so that when the button is pressed in, the two coils are cut across their corresponding portion of the circuit.

In the normal routine of adjusting a set at any frequency within the band, the

respondingly shorter. The core $\frac{5}{16}$ in. in diameter by $\frac{5}{8}$ in. long represents a most effective size.

Permeability Tuning ★ This method of tuning is similar to push-button tuning in that a set of cores is used to replace the variable tuning condensers. Generally this is accomplished by a quite heavy or high permeability core, from $1\frac{1}{2}$ in. to $1\frac{7}{8}$ in. long, placed in the axis of a long solenoid, and moved back and forth by mechanical means. Frequently a powdered-iron core sleeve is placed around the coil to increase the tuning range and to improve shielding, and dispensing with aluminum shielding. It is also feasible to place coils above and below the chassis, with respect to each other, as a further shielding means.

Each coil represents a stage of tuning, so that for three-stage tuning there would be three separate coils and three separate cores, with some mechanical means for the group movement of the cores. Such a tuning unit replaces the usual variable tuning condensers. Its obvious advantages are lower cost, more accurate tuning, better tracking and high average output.

Part 2 will present Q -frequency curves for various core materials.

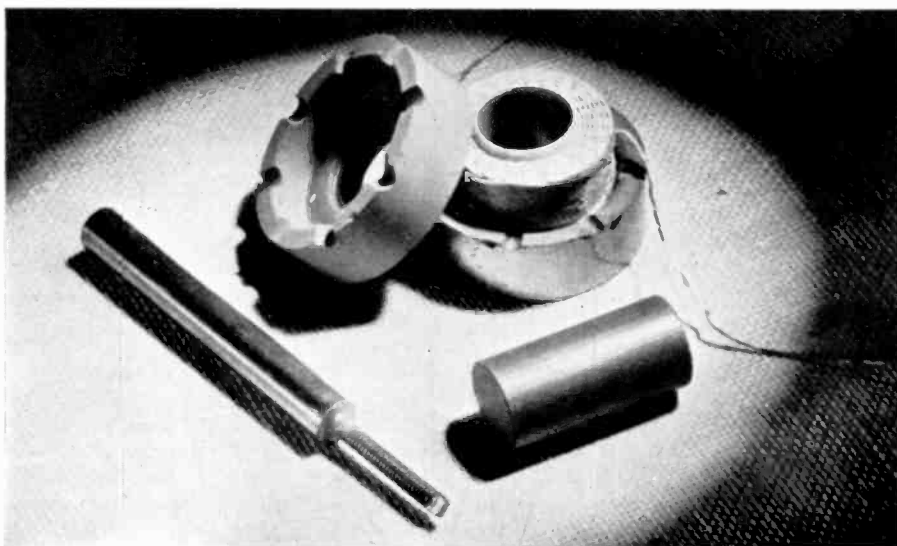

FIG. 4. CUP CORE AND SLUG ARE USED FOR INTERMEDIATE FREQUENCY TRANSFORMERS. LONG PLUNGER IS FOR PERMEABILITY TUNING

desirable to have a core that will not reduce the Q of a coil materially when introduced therein. This type of core is particularly important in permeability tuning of the vernier adjustment. For this purpose, special materials such as HF-7 and O-9 were developed. For very high frequencies (50 to 300 megacycles) cores made with conventional binders sometimes burn up. For such applications Crowley engineers have worked out new binders that will withstand the heat produced by losses at those frequencies.

Push-Button Tuning ★ Pre-set station selection at broadcast frequencies is relatively simple by means of coils with adjustable iron cores. There are several major advantages gained by this method. One is maximum stability over a long period of time, regardless of temperature and other climatic conditions, as well as severe mechanical jolting. There is also the advantage that the operator can select his sta-

push buttons are depressed successively and the two corresponding cores moved separately until they track. This brings the antenna and oscillator coils into alignment. Then the user can adjust the two together by means of a screw fastened to the yoke. Other mechanical methods can, of course, be employed to achieve the same end.

In order to track the oscillator with the antenna coil by the same movement, the oscillator coil can be either wound differently in shape or size from the antenna coil, or the iron core can be made shorter. A more expensive way is to shape the iron core. In some instances, two cores are made of different permeability, but having the same physical dimensions, so as to arrive at the same results.

The recommended cores are less than the usual standard size. In other words, instead of using $\frac{3}{8}$ in. by 1 in., or $\frac{3}{8}$ in. by $\frac{1}{2}$ in., the cores recommended are $\frac{5}{16}$ in. or even $\frac{1}{4}$ in. in diameter and cor-

FM SERVICE AT BINGHAMTON

PRELIMINARY tests on the recently installed W49BN transmitter have been completed, and the station is now in regular operation.

The equipment comprises an REL model 519DL transmitter of 3-kw. output, operated with a vertical coaxial antenna mounted above a 107-ft. mast. Total height above sea level is approximately 1,800 ft.

For the present, the transmitter is running at about 1,970 watts input, which is the calculated value to overcome the losses in the power amplifier and transmission line, and to assure 1 kw. of antenna radiation.

This power and the antenna at W49BN assure the field strength calculated for their service area. The actual field strength in many of the towns located in a 50-mile circle was surprisingly good. This is another one of the areas where the broadcasters receive very poor signals on standard AM frequencies.

Some of the dealers were attempting to demonstrate poorly designed receivers, which did not provide proper limiting circuits. Reception from these sets, I must admit, was not up to FM standards of quiet, high-fidelity performance.

However, correctly designed sets, using a stage of tuned RF and adequate limiters, proved that W49BN is putting out the kind of signals that listeners want. Beyond that, it is up to the dealers to see that their customers buy the right receivers, and have them installed properly.

Frank A. Gunther

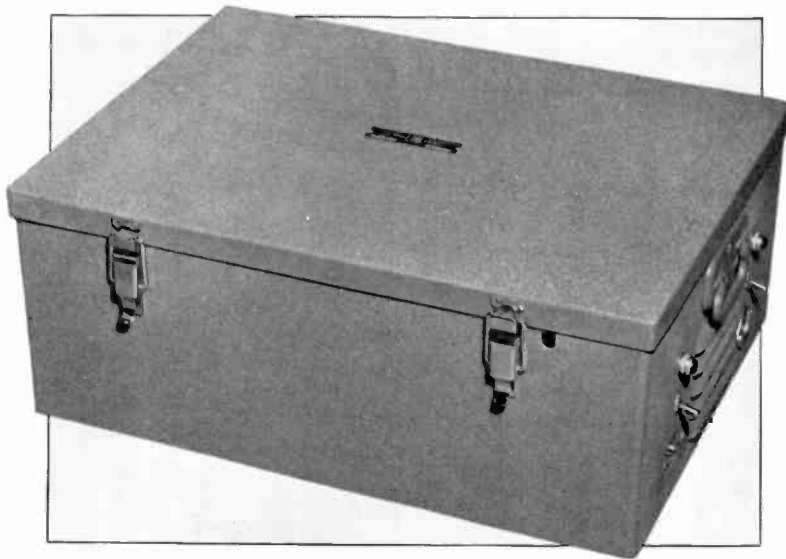

FIG. 2. MODEL 5FRX-W IS COMPLETELY CONTAINED IN A STEEL CASE

SHORT-RANGE FM EQUIPMENT

AC-DC Circuits Afford Economies and Conveniences Where Higher Power Is Not Necessary

BY FREDERICK T. BUDELMAN*

FOR many of the new applications of FM transmission, it is not necessary to use as much power as is delivered by the standard 25- to 50-watt mobile units. In many cases, too, there is need for extremely simple apparatus that can be set up anywhere, under any conditions, at a moment's notice.

Design Features ★ To meet these new requirements, F. M. Link has developed and is now producing a design which combines, in a single unit, an FM transmitter, receiver, 6-volt DC power supply, and a 115-volt AC power supply.

The unique feature of the built-in dual power supply provides a design that is suitable for either fixed or mobile use. The compact arrangement makes the unit easy to handle and quick to install for, whereas the four elements of the equipment are usually mounted separately, in this design they are combined into a single piece of apparatus.

Two models are available. One is the type 5FRX, which comprises the transmitter and receiver unit, as shown in Fig. 1, with a separate control box, loudspeaker, push-to-talk handset and hang-up bracket, antenna and mounting, control-box cable, and mounting hardware. This type is intended primarily for mobile

use, although it can be used for fixed installations. The case shown in Fig. 1 is only 13½ ins. long by 11 ins. wide.

Type 5FRX-W, Fig. 2, combines all the equipment listed above in a weather-proof metal cabinet which carries the antenna mounting on the end, and has louvres behind which the speaker is secured. A cradle inside the cabinet holds the handset during transportation.

The weather-proof cabinet, of heavy-gauge steel, measures 21 ins. long, 15 ins. wide, and 8¾ ins. high. The cover, fastened with quick-opening trunk catches, has a key and lock, so that the equipment is kept tamper-proof.

The loudspeaker has a neoprene diaphragm, so that moisture cannot enter the cabinet through the louvres. A slot in the case allows the handset cable to be permanently connected inside the cabinet, and yet the handset can be used externally with the cover closed. On-off switches and pilot lights are mounted on either side of the speaker. No other controls are on the outside.

At the opposite end from the speaker and control switches are mounted an insulated antenna base and a coaxial line fitting. In many past applications of this 5FRX-W equipment, a quarter-wave whip antenna, mounted directly on the case by means of the antenna base, proved to be a satisfactory radiating system. Then only a 115-volt AC or 6-volt DC

power source was necessary to complete the communications system.

In both types, the receiver portion is identical to the standard Link 11UF Ed. 3 super-sensitive receiver which utilizes 11 tubes in a time-proven circuit of high signal-to-noise ratio and dependability.

With a total receiver and transmitter tube complement of only 16 receiving type tubes, including one rectifier, the 5FRX is hardly larger than other FM receivers, and actually has less drain. In either the receiving or transmitting position, the unit draws approximately 11 amps. at 6 volts DC, or 90 watts at 115 volts AC.

Tube Complement ★ The tubes and their uses are as follows:

7F7	Crystal oscillator, phase modulator
7W7	Quadrupler
7C5	Quadrupler
7C5	Doubler, power amplifier
6AC7	RF amplifier
6K8	1st detector
6V6GT	Crystal oscillator, multiplier
6SH7	IF amplifier
6K8	2nd detector, crystal oscillator
6SJ7	1st limiter
6AC7	2nd limiter
6H6	Discriminator
6H6	AVC, squelch filter
6SL7GT	1st audio, squelch
6K6GT	Audio output
6X5GT	Power supply rectifier

Transmitter and Power Supply ★ The transmitter has an entirely new circuit of only four tubes, utilizing the phase-shift principle of producing frequency modulation with direct crystal control. This new circuit contributes to the compactness and simplicity of the transmitter. Frequency multiplication of 32 times is used to produce the standard maximum swing of ±15 kc.

The built-in power supply operates in a conventional manner on 115 volts, 50-60 cycles. When operation from a 6-volt battery supply is desired, a built-in vibrator is switched into the circuit, utilizing the same power transformer, rectifier, and filter components.

Transfer from one source of power to the other is accomplished instantaneously by means of switches located on the outside of the chassis.

This latter feature makes the set ideal for normal operation on AC, with a storage battery as an emergency power source. At the same time, it is equally effective as a high-performance, low-power mobile set.

Control of all facilities is accomplished from a control box which is either mounted remotely when used with the type 5FRX or inside the cabinet of the 5FRX-W.

The 5FRX runs on 6 volts DC or 115

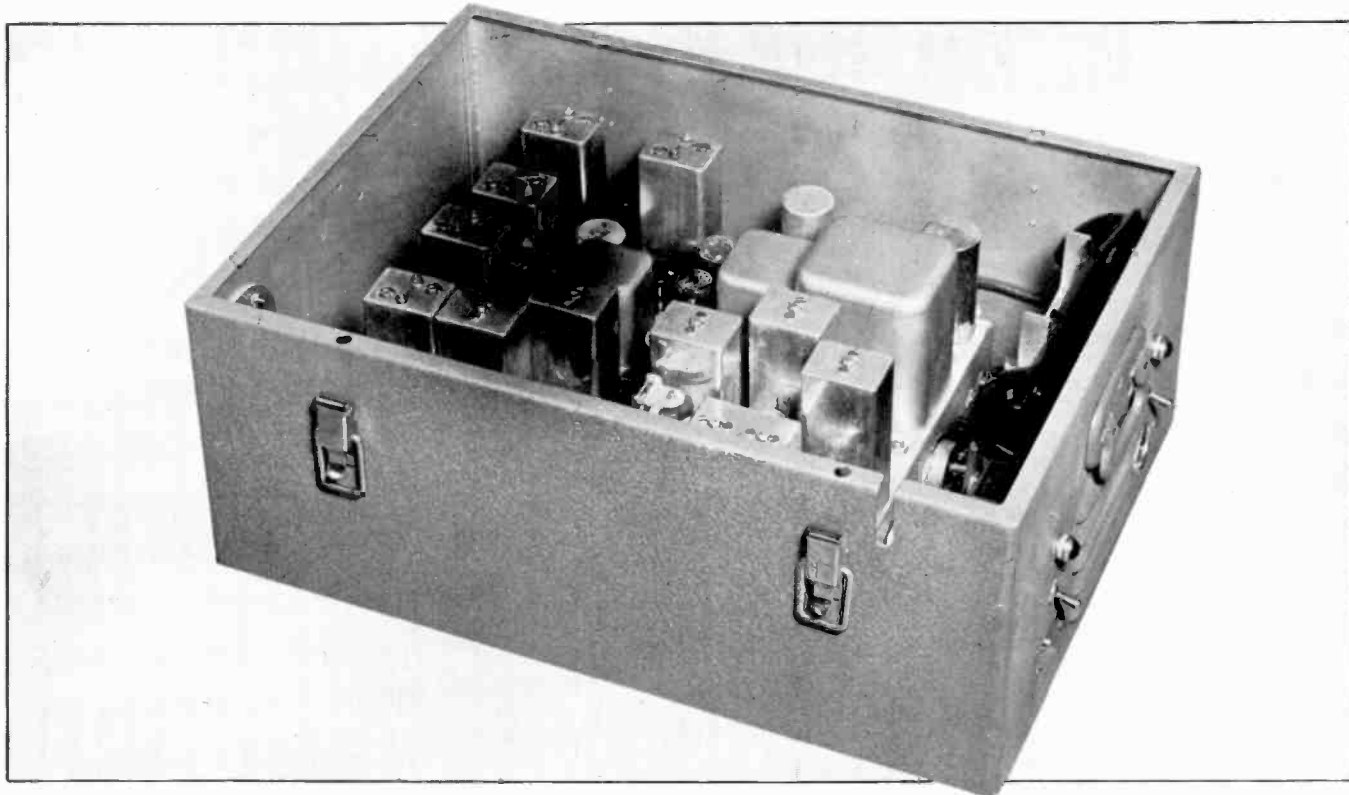

FIG. 1. THE 5FRX FM TRANSMITTER, RECEIVER, AND THE 6-VOLT AND AC POWER SUPPLIES ARE COMBINED IN THIS SINGLE UNIT

volts AC, depending upon the position of the two power toggle switches at the rear of the right hand side of the chassis, behind the power plugs. When these switches are up, the set operates on AC. When they are down, it operates on DC. The set will work without regard to the polarity of the DC source.

Characteristics ★ The principal characteristics of the transmitter and receiver are as follows:

Transmitter Power Output — 3 watts, nominal

Frequency Range — Any crystal-controlled frequency between 30 and 40 mc.

Type of Emission — Frequency modulated

Frequency Deviation — ± 15 kc.

Audio Range — 300 to 3,000 cycles with high-frequency pre-emphasis and sharp cut-off filter at 3,000 cycles

Power Source — Dual 6-volt DC or 115-volt AC supply

Power Input — 11 amps. at 6 volts DC or 90 watts at 115 volts AC.

Transmitter Output Impedance — Any usually fed into concentric line

Control — Remote, by self-contained relay

Receiver Output Impedance — 500 ohms

Receiver Power Output — 1 watt

While the frequency range of the standard unit is 30 to 40 mc., it is readily possible to provide either a higher or lower operating frequency for special applications. Police and guard systems, emergency services, and most other appli-

cations of this equipment are in the 30- to 40-mc. band.

Applications ★ The 5FRX-W is well suited to any kind of a temporary mobile installation in an open car, jeep, or station wagon. The 5FRX is more satisfactory for a permanent mobile installation, as the remote control unit and handset can be mounted on the dash and the speaker placed for best audibility.

For guard house, patrol booths and similar installations, either the 5FRX-W or the 5FRX can be used. If a 5FRX is used, the transmitter-receiver can be placed convenient to the antenna, while the speaker and control can be mounted wherever convenient to the operator.

Both types are ideally suited to marine installations, and are applicable to boats of all kinds. Where the equipment is mounted in the pilot house, the whip antenna can be mounted readily overhead, with a coaxial transmission line lead to the transmitter. Where the quarter wave rod or whip is mounted on guard house or deck house, a large metal plate or screen should first be put on the roof to act as a ground, with the antenna at the center. For longer ranges, the antenna can be mounted on a mast or yard arm.

The 5FRX-W, in addition to having the universal mount on the side of the case, has a coaxial line fitting so that a coaxial transmission line can be connected to feed either a quarter-wave whip or a half-wave coaxial antenna. A new design of "hang-up" coaxial antenna is available which can be fed by a new type

of flexible coaxial transmission line. These accessories further widen the applications of the versatile 5FRX and 5FRX-W.

The low power of the transmitter is no criterion of its capabilities. The consistent range is 3 to 10 miles, but it gives very acceptable service over distances greatly in excess of these figures. In many ways it closely approaches the performance of higher powered mobile equipment, at very much less battery drain and with the additional advantage of being operable on AC.

A complete system of fixed station and mobile equipments can be engineered using this unit only, making for economy in first cost and minimum cost in maintenance spare parts.

The unit has so many advantages and is capable of so many applications that it already shows promise of out-stripping heavier and more elaborate equipment.

Many interesting applications have already been made but these cannot be discussed at the present time for obvious reasons. It is easy to understand, however, just how this unit can be applied in literally hundreds of different ways after consideration of the characteristics and the make-up of the equipment.

In Preparation: A comprehensive analysis of automatic frequency control circuits applied to FM receivers is scheduled for the September issue. The material is being prepared by Murray Weinstein, who has achieved notable success with AFC for FM reception.

SPOT NEWS NOTES

Items and comments, personal and otherwise, about manufacturing, broadcasting, communications, and television activities

Savings: Stoppage of civilian radio set production is estimated by WPB to have effected an annual saving of 70,000 tons of steel, 10,500 tons of copper, 2,100 tons of aluminum, 280 tons of nickel.

S.W. Interference: FCC has approved temporary frequency shifts of short-wave broadcast stations on occasions when other stations interfere with reception at foreign points. In most cases, change will be only a few kilocycles.

A-N Production Award: Conferred on Philco for "high achievement in production of war equipment." Philco is delivering communications equipment for planes and tanks, and also shells, fuses, and heavy-duty storage batteries.

John Shepard, 3rd: Honored by a citation for public service by the Commonwealth of Massachusetts on the 20th anniversary of station WNAC. Presentation was by Lieut.-Governor Horace T. Cahill. Other speakers included Boston's Mayor Tobin and FCC Chairman Fly, who sent a transcribed message from Washington, D. C.

No Tires: Radio distributors, dealers, and servicemen and those providing transportation for the repair of any portable household effects have been dropped from the list of eligibles for new or recapped tires.

WFIL: Although located on the top floor of the office building which carries Philadelphia's tallest structure (their FM antenna) the WFIL studios were flooded during a deluge of rain which fell on July 27th.

Draft Deferment: Recommended by War Manpower Commission for those engaged in production of communication equipment, and in communication services. Radio equipment assemblers and electrical and radio testers are listed among occupations essential to War production.

Cooperation: In response to requests of U. S. troops across the Pacific, GE's San Francisco station

KGEI is short-waving CBS shows which feature popular orchestras. Coverage includes Alaska, Hawaii, Midway, China, Burma, Australia, New Zealand.

Lifeboat Radios: No use spending time designing clever lifeboat radios to call help when ships are torpedoed. Reason is that if submarine sees anything that looks like an antenna, they machine-gun the boat and crew because radio call would disclose location of submarine.

W85A: Replaces W2XOY as call of GE station at Schenectady. Schedule is from 3:00 to 10:00 P.M. daily.

Radio Set Sales: All-time record excise taxes of \$13,052,325 were collected in first six months of 1942. At 10%, this indicates net sales of \$130,523,250, or retail sales of about \$260,000,000. In corresponding 1941 period, taxes at 5½% were \$3,082,540, indicating net sales of \$56,046,200, or retail sales of about \$112,000,000.

TO CONSERVE MATERIALS AT KFI, H. L. BLATTERMAN NOW EVEN WINDS HIS OWN RF CHOKES IN STATION'S WORKSHOP

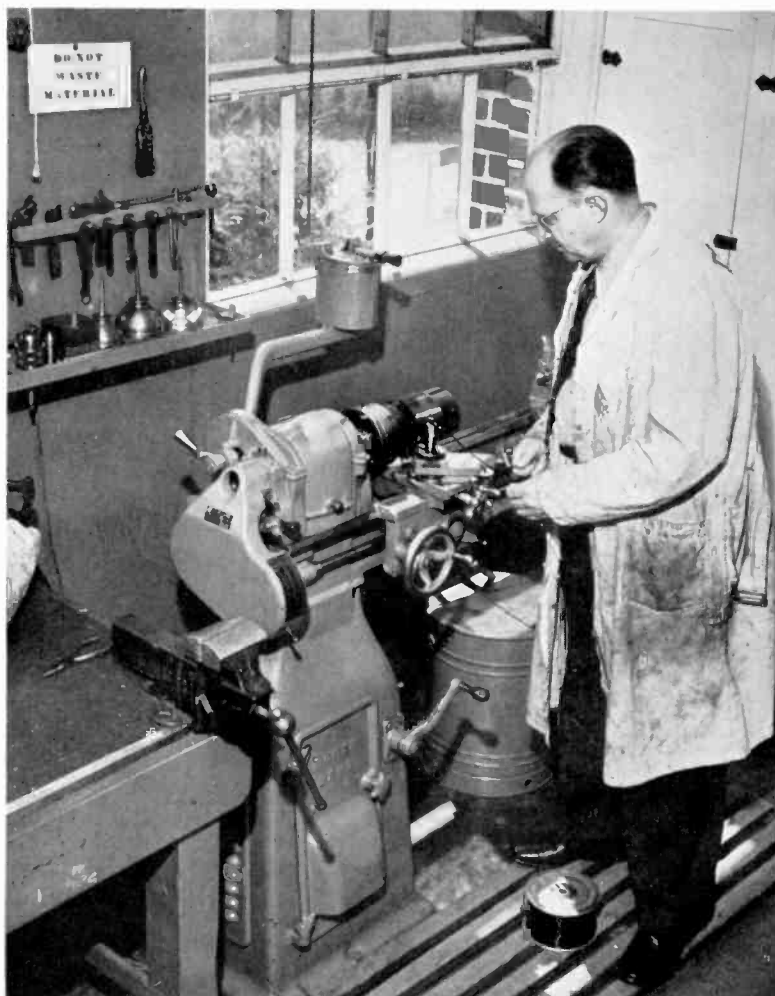

Editor's Note: How much more enjoyment is provided from original music by FM instead of AM reception was brought home to your Editor when one of the tubes let go in the FM end of his set, and he had to listen to the last half of the NBC Symphony Orchestra, conducted by Arturo Toscanini, on AM. Frankly, the part heard on AM sounded, by comparison with FM, decidedly dull and flat, and of not much more importance than any recorded program of average quality.

New RMA Members: Latest additions are Westinghouse, with radio plants in Pittsburgh, Baltimore, and Bloomfield, N. J.; Remington-Rand, Inc., Electronics Division of New York City and Middletown, Conn.; Radio Engineering Laboratories, Inc., Long Island City; Technical Radio, Inc., San Francisco.

New Plant: Of 40,000 sq. ft. has been opened by National Union Radio Corporation of Lansdale, N. J. Formal inspection was made by Major Kenneth D. Johnson, of Washington. Training classes for skilled and unskilled workers are now in progress.

Mexico: Major Jose Clark Flores, Chief Signal Section, Mexican Army, announces from Mexico City that his Government is purchasing large quantities of U. S. radio, telephone, and telegraph equipment.

Resistors: New catalog shows Lectrohm line of fixed, adjustable, "Ribbon-edge" and ferrule type resistors, and associated hardware. Also listed are power line and RF chokes, and small solder pots of 1¾- and 2-lb. capacity for production service. Lectrohm, Inc., Cicero, Ill.

Domestic Mica: Of good electrical grades is available in the USA, contrary to prevailing opinion. Lacking penny-a-day labor market of India, it was not practical to operate domestic mines, since only 8 to 10% of tonnage splits into sheets for condensers. Now,
(CONTINUED ON PAGE 24)



NEWS PICTURE

This Coast Guard Cutter, wheeling to attack a suspected submarine while guarding a transatlantic convoy, is given greatly increased effectiveness by newly devel-

oped radio communications and signaling equipment. Action is so fast, that when submarine is located, coordination and speed of men and machines determines success or failure in the protection of convoyed vessels.

The fact that we have not lost a single transport from our Atlantic convoys is greatly to the credit of the manufacturers

who are building radio equipment for the U. S. Navy.

If Navy radio specifications and inspection sometimes seem severe, they are well-grounded on experience, and are amply justified by the fact that when equipment fails, it constitutes a liability to the men who depend upon it to carry out their duties.

LONG-DISTANCE FM RECEPTION

Reception from Eastern FM Transmitters, as Recorded at Station KVOO, Tulsa

BY L. W. STINSON*

AS a matter of curiosity, if nothing more, the appended charts may be of some interest to the readers of RADIO-ELECTRONIC ENGINEERING.

The same recordings and the charts shown in the accompanying illustrations, summarizing the field intensities recorded at station KVOO, Tulsa, Oklahoma, were

* Engineer, Station KVOO, Tulsa, Oklahoma.

made during the past year, in an attempt to get a limited amount of factual, quantitative information on high frequency sporadic transmissions. From these observations, certain deductions are fairly evident.

For instance, it seems certain that a reasonable amount of sporadic interference can be anticipated well within the

fifty microvolt-per-meter contours of same-channel FM stations when the use of such stations on high power becomes general throughout the country. This interference is to be expected, unfortunately, during the months of June, July and August, months during which static-free reception by FM is a strong argument in its favor over AM broadcasting.

RECEPTION FROM DETROIT, NASHVILLE, NEW YORK, BOSTON, AND ROCHESTER AS RECORDED AT SUMMERTIME INTERVALS

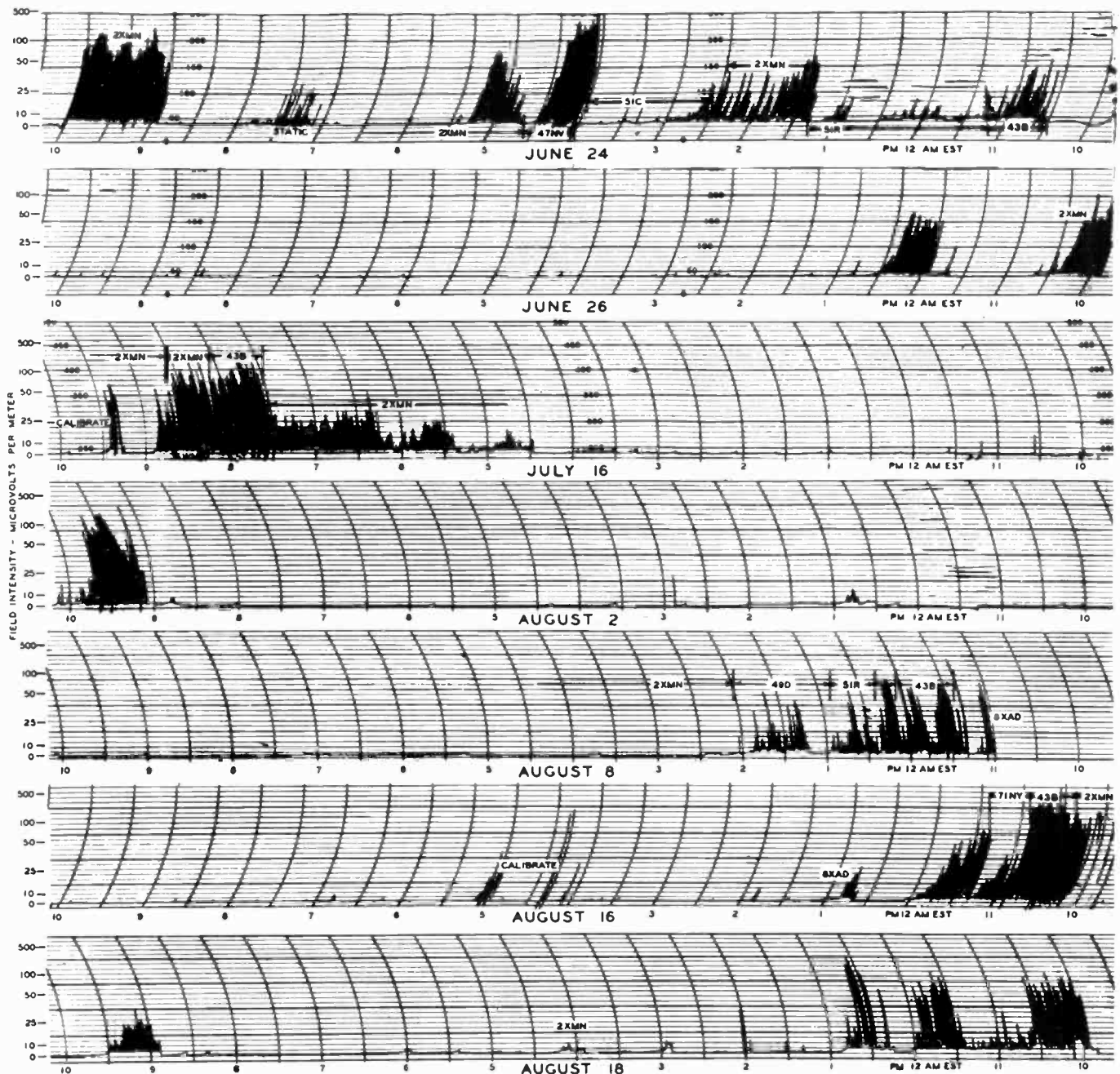

GRAPHIC CHARTS OF SKY-WAVE RECEPTION OF FREQUENCY MODULATED STATIONS AS RECORDED AT TULSA, OKLAHOMA
KVOO ENG. DEPT. -- SEPTEMBER 1941
RECORDER TUNED TO W2XMN EXCEPT AS NOTED

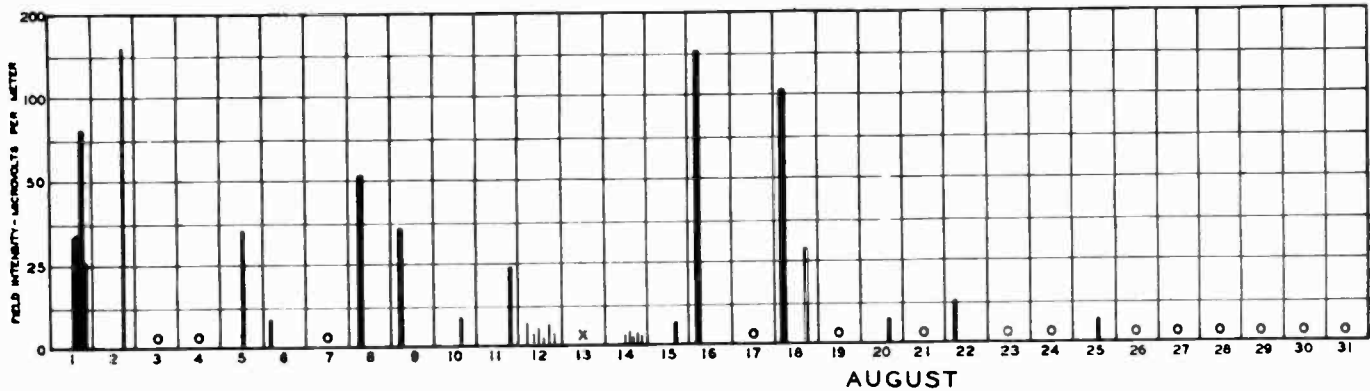
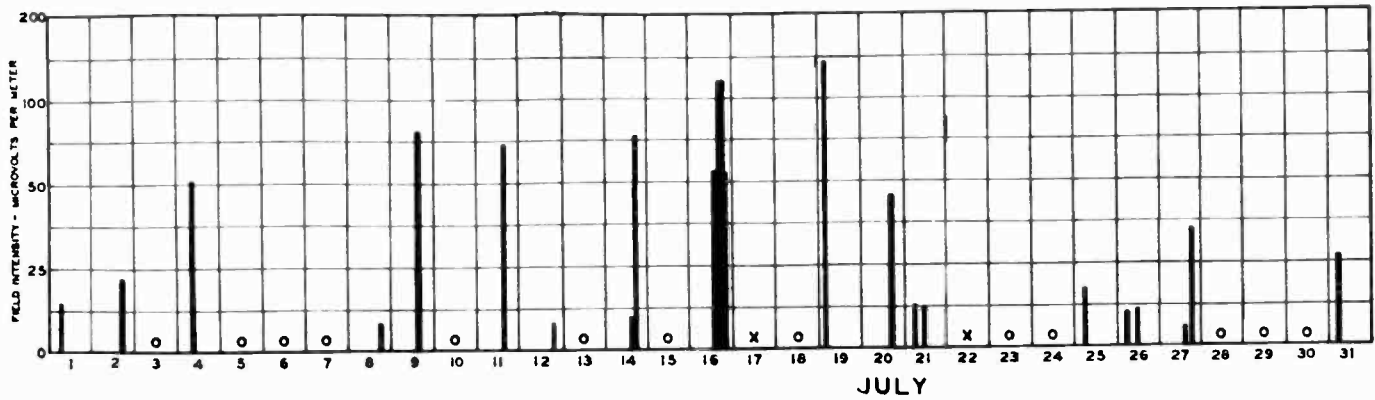

DAILY PERIOD ON CHART REPRESENTS TIME 7 AM TO 12 PM E.S.T. WITH DURATION AND HOURS OF RECEPTION APPROXIMATELY SHOWN

O - NO SIGNALS INDICATED ON RECORDER CHART THIS DATE
 X - RECORDER INOPERATIVE THIS DATE

INTENSITY AND OCCURRENCE OF SPORADIC-E SKY-WAVE SIGNALS FROM W2XMN ALPINE N.J., AS RECORDED AT TULSA OKLAHOMA

KVOO ENG. DEPT.-- SEPT. 1941...

CAREFUL STUDY OF THIS DATA IS REQUIRED TO DETERMINE THE TRUE SIGNIFICANCE OF THE DEGREE OF INTERFERENCE SHOWN

The periods of reception of these signals have been checked against the reports of vertical incidence measurements of the Bureau of Standards, and have been found to agree quite well. This indicates that an analysis of their measurements over the past few years should be useful in predicting the average annual interference to be expected over various distances.

The recording program will probably be continued this year again, as reception during the first days of June has indicated that a great many of the distant signals are coming through with high intensities.

Editor's Note: The records made by Mr. Stinson and presented here prompt the suggestion that the War period offers an opportunity to collect complete data on potential FM interference which will serve as a guide to the allocation of frequencies and specifications of power output at the time when new broadcast station construction is permitted again.

If there is going to be an interference problem on FM channels, this preparation would eliminate changes and alterations such as the AM stations have had to make. On the other hand, if it is known from year-round observations that there will be no serious interference problem, the FCC can be more liberal in allocating

the same frequencies to several stations.

In either case, such data will provide a sound basis for planning the expansion of FM broadcasting.

Mr. Stinson's data is reassuring insofar as it shows potential interference, during what he has observed as the worst months, to be decidedly sporadic. Compared to conditions on AM broadcast channels, where eastern stations, for example, and those in Texas and on the west coast squeal with one another, the FM picture seems highly reassuring.

Listeners in the rural sections, particularly, would be grateful for the absence of the AM squeals which come in at so many points during the evening. If, on FM, powerful signals from a remote station should take over temporarily a channel also occupied by a local station, reception would be clear, at least, and fit to hear. Reception might change at intervals from one station to another, as the remote signals swing in and out, but not to the accompaniment of shrieks and howls which characterize AM interference.

Some engineers feel that, with the expansion of FM service, a serious interference situation may develop. Others take the position that it is reasonable to expect trouble.

Radio receiver manufacturers will want to know about this matter when they start their preparations to resume civilian production. So will the companies building transmitters, and the men who will be called upon to finance the erection of FM stations.

Gathering FM transmission data at this opportune time will not involve the use of a burdensome number of engineering man-hours. Most of the data required can be taken by unattended recording devices, such as used at station KVOO. Perhaps arrangements for gathering information can be organized by the engineers of the FCC. Coördinated efforts are needed to assure the collection of data that can be integrated readily.

U.S. SIGNAL CORPS APPOINTMENT

New chief radio engineer of the Signal Corps is Robert M. Morris, one of the original staff of WEAJ when it was established by AT&T in 1924.

He moved over to NBC, as chief development engineer, when that Company was organized in 1927, and continued in that capacity until he was made business manager of the NBC Radio-Recording Division, in 1941.

CW & PHONE TRANSMITTER

500-Watt Self-Contained Transmitter Features Versatile Tuning Circuits and Instantaneous Frequency Selection

BY FRANK A. GUNTHER*

REQUIREMENTS for many of the new types of special-purpose radio apparatus are giving radio engineers wider scope for the use of new ideas than has been possible within the limitations of the more conventional prewar specifications.

The 500-watt AM transmitter illustrated here falls within the category of such new types.

Electrical specifications called for the instantaneous selection of any one frequency from a number up to five between 300 kc. and 23 mc., for either phone or CW telegraph. Mechanical requirements were for extremely rigid single-unit construction, using a dust-proof steel cabinet, with only the microphone, telegraph key, and desk-type amplifier and operating control to be mounted separately. Full protection against extremes of temperature and humidity were also specified.

General Description ★ Figs. 1 and 2 show how the design was worked out in the finished transmitter. It is designated as the REL type 421A, and is now being produced as a standard model.

The equipment is divided into five sections, as shown at the right, in Fig. 2. These carry, from bottom to top: (1) power supply circuits and blower for air-cooling the tubes, (2) speech amplifier, (3) crystal oscillator and buffer stages, (4) power amplifier, and (5) antenna line coupling condensers.

Circuit elements in these sections which require adjustment can be set and locked while the safety door is closed, as shown in Fig. 2, right.

While the particular transmitter illustrated is equipped for only three operating frequencies, provisions are made to add circuit elements for two more frequencies if and when they are required.

All vertical wiring for interconnecting the sections is cabled and run in channels formed by the corner uprights of the welded steel frame. Welded construction is used throughout to eliminate nuts and bolts except where parts must be removable. The result is an absolutely rigid frame that cannot become loose in transit or under any adverse operating conditions.

Power Supply ★ All the heavy components of the power supply circuits and the rectifier tubes are located in the bottom section. Here, also, are the blower motor and, against the rear of the cabinet, the spun-glass filter for the air intake. The air blast is directed upward to an outlet at the top of the cabinet.

Altogether there are five supplies in this transmitter. They are:

1. C bias supply, furnishing 150 volts from a type 80 tube.
2. The 300-volt oscillator supply, also using a type 80 tube.
3. Next is the 500-volt doubler supply, which uses a 5Z3 tube.
4. Two 872-A tubes furnish 2,000 volts for the modulator and amplifier.
5. Finally, a 5Z3 supplies power for the AF stage.

Starting time-delay and plate overload and underload relays and other AC control equipment can be seen in the bottom section.

An auto transformer is provided so that the transmitter can be operated from any 50- to 60-cycle single-phase line capable of delivering 3 kw. at 190 to 270 volts. The auto transformer has 20 steps for voltage adjustment. All circuits after the transformer are designed for 210-volt operation. Accurate regulation of the filament voltage is obtained from a manually operated regulator.

Audio Section ★ The speech amplifier and audio section are located above the power supply. The audio tube complement comprises a pair of 76's in push-pull, driving four 6A3's in push-pull parallel, which feed a pair of Eimac 100TH tubes in push-pull class B, serving as modulators.

These latter are mounted at the center of the section, where they are cooled by the air stream from the blower below.

On this section, too, are mounted the main circuit breaker and controls for the plate voltage and primary voltage. The knobs are accessible when the safety door is closed.

Oscillator and Buffer ★ On the center section there are two separate chassis, one at the left for the crystal oscillator circuits, and one at the right for the doublers.

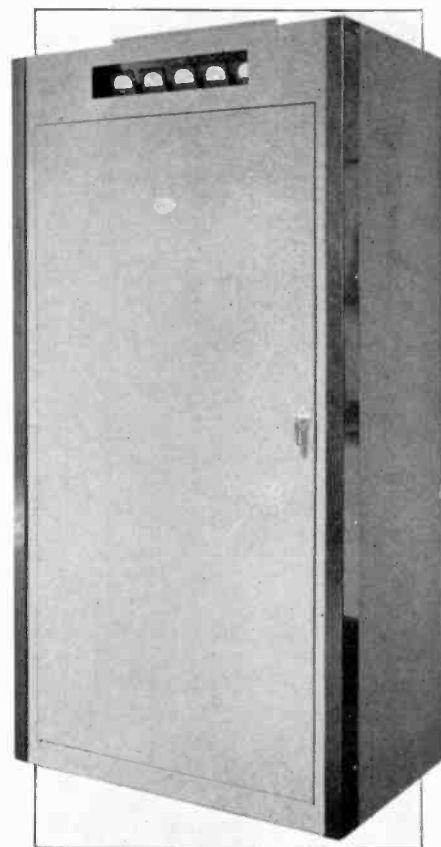

FIG. 1. REL MODEL 421A 500-WATT UNIT, WITH QUICK-CHANGE FREQUENCY CONTROL

The views in Fig. 2 show the locked dials for the three separate crystal oscillator units, and the oscillator plate current meter. Each unit has its own crystal control. Three Leach relays, just visible above the panel, select the required oscillator circuit and connect it to the 802 tube.

Three corresponding buffer circuits are located at the right, each with its plate tuning condenser and relay to cut in the unit required for the working frequency. The tube is another 802.

The meter on the left shows the buffer grid current, and the one on the right, the buffer plate current.

Controls for the modulator bias voltage and buffer screen voltage are located behind the Bakelite plate at the center.

On both the crystal oscillator and doubler panels there are holes at the left and right for the shafts of additional condensers, in case more than three tuning units are required for additional operating frequencies.

Power Amplifier ★ Two HK257 power amplifiers and the corresponding tuning circuits are mounted on the next section. The plate circuit coils have separate shields. Dials for the plate tuning condensers can be seen at the front. Here, again, provisions are made for extra tuning units.

Antenna Tuning ★ The antenna line coupling condensers are located in the top section.

Across the front are jacks into which either an RF meter panel or a blank panel can be plugged. For reasons of economy, only one meter panel is furnished. When it is desired to read the antenna current for any frequency, the meter panel is plugged in at the corresponding position. This puts a meter in each side of the balanced line.

Sections at the left and right are provided with removable blank panels if additional tuning circuits are used.

The antenna is fed by an open transmission line of 400 to 600 ohms. A separate antenna is required for each operating frequency.

Meters ★ The five meters at the top of the cabinet show, from left to right, the power amplifier filament voltage, power amplifier grid current, power amplifier plate current, modulator plate current, and the power amplifier plate voltage.

Control Unit ★ A sloping-front control unit, connected to the transmitter by a 20-ft. cable in Greenfield covering, contains the microphone pae-amplifier with its own power supply.

Both the microphone and telegraph key plug into the control unit. Either a crystal or dynamic microphone, controlled by a grip-to-talk switch, can be used. Gain controls are provided for the microphone and for a separate 500-ohm input line.

The unit also carries the controls neces-

sary for starting and stopping the transmitter, and selecting the transmitter frequency.

When the CW telegraph key is pressed or the microphone switch gripped, the transmitter circuits are operated automatically. Breaking either circuit kills all the power in the transmitter, permitting the receiver to function without interference. Also, suitable relays in the transmitter shunt out the plate and screen windings of the class B modulation transformer when the telegraph key is operated, and light the filaments of the audio and modulator tubes when telephone transmission is employed.

The audio system is essentially distortionless, and has a flat response, ± 3 db, from 150 to 6,000 cycles. This measurement is from the microphone input terminals to the antenna terminals, with 100 per cent modulation of the RF carrier.

Dimensions ★ The transmitter cabinet measures 76 ins. high, 39 ins. wide, and $25\frac{1}{2}$ ins. deep, and weighs 1,260 lbs. complete. The control unit is 18 ins. long, 9 ins. high, and $10\frac{1}{2}$ ins. deep. It weighs 20 lbs.

Application ★ The type 421A transmitter is intended primarily for communications services, and as such it is an extremely versatile design. The quick-change frequency control makes it admirably adapted for a central station, handling traffic with a number of distant points. It can be

used for speech transmission under normal conditions, and switched to CW telegraph in case of atmospheric interference. All components are intended to stand up against salt water dampness, making it as well suited to use at sea as on land.

CANDY FACTORY TO MAKE CONDENSERS

One of the oldest candy manufacturers in the east is preparing to convert part of its plant into paper condenser production. This will take up slack resulting from reduced supply of cocoa. The concern is the New England Confectionery Company, of Cambridge, Mass.

This may seem far fetched at first thought, but it is actually a practical use for an air-conditioned factory employing women workers of great manual dexterity. Production of paper condensers, particularly of the oil-filled and oil-impregnated types, continues to lag further behind requirements, despite the enormously increased facilities of the established condenser manufacturers.

The idea of bringing in a non-competitive company is a practical way to meet the emergency for, when the War is over, the candy manufacturer will simply junk what will probably be worn-out machinery, and go back to making chocolate bars.

It is understood that the WPB, sponsors of this plan, has obtained the cooperation of Tobe Deutschman Corp., Canton, Mass., to expedite the conversion. Production is scheduled to start September first.

FIG. 2, LEFT: APPEARANCE WITH SAFETY DOOR OPEN. RIGHT: INTERCHANGEABLE TUNING UNITS AND METER PANEL CAN BE SEEN HERE

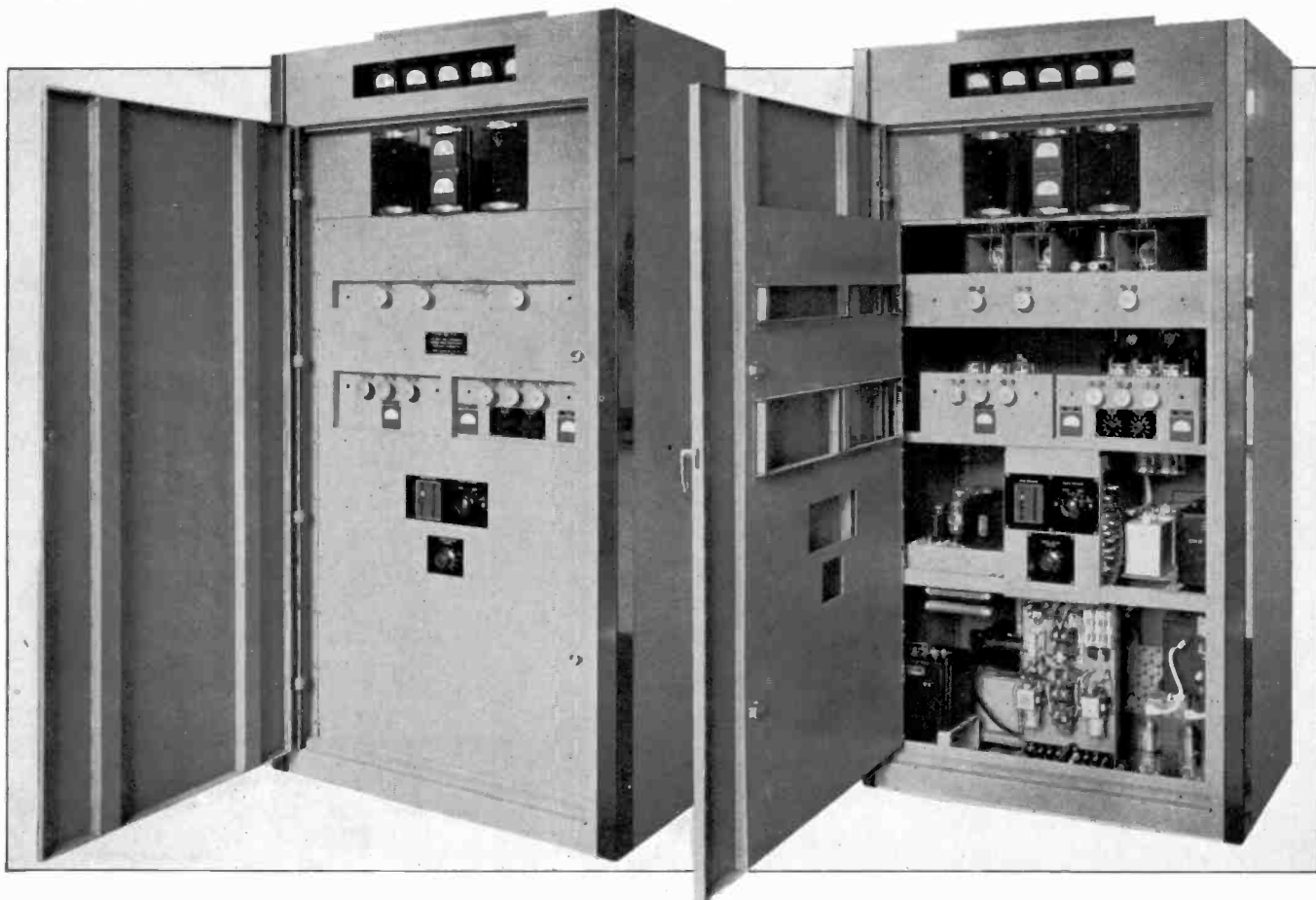

USE OF THE LIMIT BRIDGE

For the Rapid Determination of Percent Variation from Resistance Standard

BY M. LIEBLICH *

EXACT specifications of allowable percentage of variation for so many of the resistors used in military equipment have brought about the widespread use of the direct-reading resistance limit bridge. This instrument is the most practical means for checking resistors accurately and rapidly in large quantities.

It has the added advantage of classifying resistors as to resistance variation so that they can be sorted finally by a single test. That is, if the allowable tolerance for a given value for a specific purpose is $\pm 4\%$, resistors of larger variations can be sorted during the initial inspection, and set aside to be used in other applications for which they would be acceptable. This eliminates the need for subsequent rechecking and reclassification.

Fig. 1 shows the Radio City Products model 670 limit bridge, and the circuit diagram is given in Fig. 2.

No skill is required to operate the instrument beyond accurate observation of

the scale reading. The zero-center scale indicates the percentage of variation of the resistance under test from a standard resistance, up to 10%, with an accuracy of $\pm .1\%$. The $4\frac{1}{2}$ -in. meter, having a sensitivity of 25–0–25 microamperes, is fitted with a scale calibrated .5% per division, permitting very accurate reading.

Either an internal or external standard resistor can be used. A specified standard is furnished with each instrument. Any other standard value can be connected to the binding posts at the right hand edge of the front panel. Then the switch, just above the binding posts, must be thrown to the EXTERNAL position.

Four dry batteries, carried within the case, furnish the filament current and the operating voltages. In addition to the ON-OFF switch at the right, there is a safety switch, above the meter, that opens the filament circuit when the cover is closed. A pilot light on the left of the panel shows when the filaments are on.

Binding posts and a switch are provided

at the left for connecting an external battery in case a resistance standard value is used which requires a higher voltage than the $7\frac{1}{2}$ -volt battery in the case, to give full-scale deflection at 10% variation when the zero adjustment, below the meter, has been turned to its limit.

Operation ★ To test resistors against the internal standard, the following procedure should be carried out:

1. Put the control switch at the ON position, and BATTERY and STANDARD switches in the INTERNAL positions. Allow 30 seconds for the tubes to reach a stable condition.
2. If necessary, reset the ZERO ADJUST knob so that the pointer is at zero on the meter scale.
3. Connect the unknown resistor to the R_x posts at the bottom of the panel.
4. Press the PRESS TO READ button at the left of the binding posts.
5. Read the plus or minus deviation from the standard directly on the scale of the meter.

When an external resistance standard of a different value is used, it is necessary to readjust the potentiometer mounted behind the front panel. This is R_6 in Fig. 2.

The procedure is as follows:

1. Remove the instrument from the case.
2. Put the control switch in the ON position, and STANDARD switch in the EXTERNAL position. Allow 30 seconds for the tubes to reach a stable condition.
3. Connect the new standard resistor to EXTERNAL STANDARD.
4. If necessary, reset the ZERO ADJUST so that the pointer is at zero on the meter scale.
5. Connect a resistor of exactly 10% more or less resistance than the standard to posts R_x .
6. Adjust the potentiometer mounted behind the panel, using a screwdriver, until the meter reads exactly 10%. This will be the correct reading, since the test resistor varies exactly 10% from the external standard.
7. If the 10% reading cannot be obtained by adjusting the potentiometer, it will be

(CONTINUED ON PAGE 25)

* Chief Engineer, Radio City Products Company, Inc., 127 West 26th Street, New York City.

FIG. 1. THIS RESISTANCE LIMIT BRIDGE IS OPERATED BY SELF-CONTAINED BATTERIES



VACUUM TUBE REVIEW

829-A

Push-Pull Beam Power Amplifier

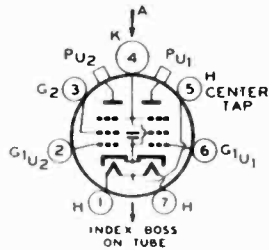

PLANE OF ELECTRODES OF EACH UNIT IS PARALLEL TO PLANE THROUGH AXIS OF TUBE AND AA'

BOTTOM OF TUBE

829-A is a push-pull beam power transmitting tube of the heater-cathode type. It contains two beam power units in one envelope. Total maximum plate dissipation is 40 watts. The exceptional efficiency and high power sensitivity permit full power output with very low driving power. For example, a single tube operated in

push-pull class C telegraph service is capable of handling a power input of 120 watts with less than 1 watt of driving power at frequencies as high as 200 mc. The 829-A can be operated at reduced ratings at frequencies as high as 250 mc. Plate-to-plate circuit resonance of the tube is 750 mc.

The exceptional efficiency of this tube at the ultra-high frequencies is made possible by the balanced and compact structure of the beam power units, excellent internal shielding, and close electrode spacing. The internal leads are short and heavy in order to minimize internal lead inductance. The terminal arrangement provides excellent insulation and is designed to facilitate symmetry of circuit layout. Neutralization of the tube is unnecessary in adequately shielded circuits.

The heaters are arranged to allow operation from either a 12.6 or a 6.3-volt supply.

CHARACTERISTICS AND RATINGS

Unless otherwise specified, the following values are for both units:

Heater:
Voltage, AC or DC, per unit . . . 6.3 volts
Current, per unit 1.125 amps.
Transconductance for plate current of 60 milliamps., approx. 8,500 μ mhos
Grid-screen mu factor 7

Direct interelectrode capacitances, each unit:

Grid-plate, with external shielding, maximum 1 μ f.
Input 14.5 μ f.
Output 7.0 μ f.

Screen-cathode capacitance, including internal screen bypass condenser, approx. 65 μ f.

Bulb T-16
Terminal mounting . . . See INSTALLATION
Type of cooling See INSTALLATION

MAXIMUM CONTINUOUS COMMERCIAL SERVICE RATINGS AND TYPICAL OPERATING CONDITIONS

Following maximum ratings are absolute values:

AS GRID-MODULATED PUSH-PULL RF POWER AMPLIFIER, CLASS C TELEPHONY
Carrier conditions per tube for use with a maximum modulation factor of 1.0:

DC plate, max. 750 volts
DC screen, grid 2, max. 225 volts
DC grid, grid 1, max. -175 volts
DC plate, max. 120 ma.
Plate input, max. 60 watts
Screen input, max. 6 watts
Plate dissipation, max. 40 watts

Typical operation with modulation factor of 0.7:

A reference index of tubes listed in previous issues of Radio-Electronic Engineering will be found on page 24. A revised index is published each month

DC plate 500 750 volts
DC screen 200 200 volts
DC grid -38 -55 volts
Peak RF grid-to-grid . . . 82 104 volts
Peak AF grid 17 15 volts
DC plate current 120 80 ma.
DC screen 10 5 ma.
DC grid, approx. 2 0 ma.
Driving power, approx. 0.5 0.7 watt
Power output, approx. . . 23 24 watts

AS PLATE-MODULATED PUSH-PULL RF POWER AMPLIFIER, CLASS C TELEPHONY

Carrier conditions per tube for use with a maximum modulation factor of 1.0:

DC plate, max. 600 volts
DC screen, grid 2, max. 225 volts
DC grid, grid 1, max. -175 volts
DC plate, max. 212 ma.
DC grid, max. 15 ma.
Plate input, max. 90 watts
Screen input, max. 7 watts
Plate dissipation, max. 28 watts

Typical operation:

DC plate 425 600 volts
DC screen voltage of 200 200 volts
from series resistor of ² 6,400 13,300 ohms
DC grid voltage of . . -60 -70 volts
from grid resistor of ³ 5,500 5,800 ohms
Peak RF grid-to-grid. 154 172 volts
DC plate 212 150 ma.
DC screen 35 30 ma.
DC grid, approx. 11 12 ma.
Driving power, approx. 0.8 0.9 watt
Power output, approx. 63 70 watts

AS PUSH-PULL RF POWER AMPLIFIER AND OSCILLATOR, CLASS C TELEPHONY

Key-down conditions per tube, without modulation ⁴:

DC plate, max. 750 volts
DC screen, grid 2, max. 225 volts
DC grid, grid 1, max. -175 volts
DC plate, max. 240 ma.
DC grid, max. 15 ma.
Plate input, max. 120 watts
Screen input, max. 7 watts
Plate dissipation, max. 40 watts

Typical operation:

DC plate 500 750 volts
DC screen voltage:
from fixed supply of 200 200 volts
from series resistor of 9,300 18,300 ohms
DC grid voltage:
from fixed supply of -45 -55 volts
from cathode resist. of 160 270 ohms
From grid resistor of ³ 3,750 4,600 ohms
Peak RF grid-to-grid. 124 140 volts
DC plate 240 160 ma.
DC screen 32 30 ma.

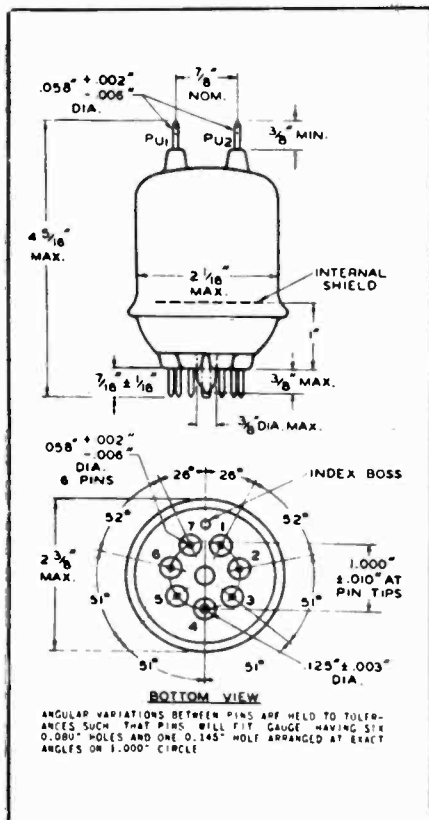

ANGULAR VARIATIONS BETWEEN PINS ARE HELD TO TOLERANCES SUCH THAT PINS WILL FIT GAUGE HAVING SIX 0.001" HOLES AND ONE 0.145" HOLE ARRANGED AT EXACT ANGLES ON 1.000" CIRCLE

DC grid, approx.	12 ma.
Driving power, approx.	0.7 0.8 watt
Power output, approx.	83 87 watts

¹ At crest of AF cycle, with modulation factor of 0.7.

² Connected to modulated plate-voltage supply.

³ The grid circuit resistance should never exceed 15,000 ohms total per tube, or 30,000 ohms per unit. If additional bias is necessary, use a cathode resistor or a fixed supply.

⁴ Modulation essentially negative can be used if the positive peak of the AF envelope does not exceed 115% of the carrier conditions.

INSTALLATION

The 829-A may be mounted by means of a special socket having floating contacts, such as the RCA Nos. 9934 or 9935.

tinuous operation of the tube so that forced air cooling is recommended. Forced air cooling is not required for the 829-A in intermittent service where the "on" period of plate power application is ordinarily not more than five minutes, and where the "off" period is not less than the "on" period.

The heaters of the 829-A are connected in series within the tube. The center connection is brought out of the bulb to a separate pin terminal to permit either series operation from a 12.6-volt supply or parallel operation from a 6.3-volt supply. Either an AC or a DC supply may be used. Under any condition of operation,

passed by means of a 65 μf . condenser connected inside the tube between the screens and cathodes. Screen voltage may be obtained from a separate source, from the plate supply through a series resistor, or by means of a voltage divider. The choice of method depends on the service in which the tube is used (see APPLICATION). When the screen voltage is obtained from a separate source, or from a voltage divider, plate voltage should be applied before or with the screen voltage. Otherwise, with voltage on the screens only, the screen current may rise high enough to cause excessive screen dissipation. When screen-voltage regulation is not an important factor, the series resistance method for obtaining screen voltage is desirable because of its simplicity and because it limits the DC power input to the screen. A DC milliammeter should be used in the screen circuit so that the screen current can be measured and the DC power input to the screen determined. The screens should not be allowed to attain a temperature corresponding to more than a barely perceptible red color. This temperature corresponds to the screen-input values shown under CHARACTERISTICS.

The screen current is a very sensitive indication of plate-circuit loading and the screen current rises excessively (often to the point of damaging the tube) when the amplifier is operated without a load. Therefore, care should be taken when tuning an 829-A under no-load conditions in order to prevent exceeding the screen-input rating of the tube.

A protective device, such as a high-voltage fuse, should be used to protect both the screens and plates against overloads. When a bleeder resistor of poor regulation or a series resistor is used for obtaining the screen voltage, this device should be placed in the common positive high-voltage supply lead. It should remove the high-voltage supply when the DC plate current reaches a value 50% greater than normal. When the screen voltage is obtained from a separate source or from a voltage divider of good regulation, a protective device should also be placed in the screen-supply lead. It should remove the screen voltage when the DC screen current reaches a value of 50% greater than normal.

Shielding of the RF amplifier stage employing the 829-A is required for stable operation. A convenient method of shielding is to insert the plate end of the tube through a hole in a metal plate so that the edge of the opening is in close proximity to the internal shield of the tube. An alternative shielding and mounting arrangement is to insert the grid end of the tube through a hole in the shield and then clamp a ring or cup to the chassis so as to complete the shielding and lock the tube in the mounting.

RF by-passing of the 829-A at its terminals is necessary in order to realize the

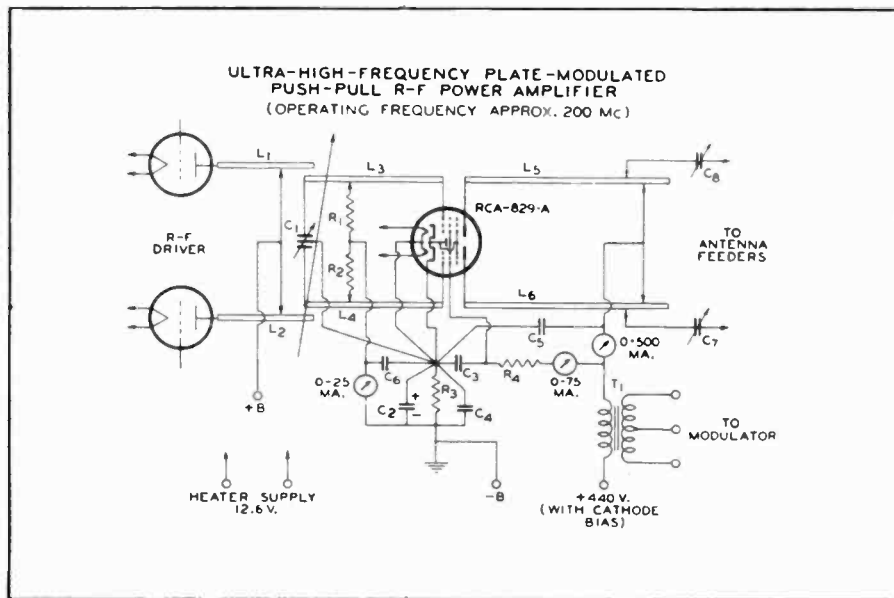

NOTE 1: Adjust coupling of L_1 , L_2 , and L_3 , L_4 for optimum grid excitation.

NOTE 2: Grid resistors should be adjusted on L_3 , L_4 at voltage node.

- C_1 1.2 to 10 μf . per section.
- C_2 25 mfd., 200 volts.
- C_3 500 μf . mica.
- C_4 500 μf . mica.
- C_5 500 μf . mica.
- C_6 500 μf . mica.
- C_7 3 to 35 μf .
- C_8 3 to 35 μf .

- R_1 7,500 to 15,000 ohms, 1 watt.
- R_2 7,500 to 15,000 ohms, 1 watt.
- R_3 60 ohms, 10 watts.
- R_4 6,400 ohms, 15 watts.
- T_1 Modulation transformer.
- L_1 Dimensions dependent on type of driver tube. Approximately same as L_5 , L_6 .
- L_2 Same as above.
- L_3 $\frac{1}{4}$ " diameter copper tube, approx. 10" long, spaced $\frac{3}{8}$ " between centers.
- L_4 Same as above.
- L_5 $\frac{3}{8}$ " diameter copper tube, approx. 7" long, spaced $\frac{3}{8}$ " between centers.
- L_6 Same as above.

No. 9934 (UT-106) is made for use at frequencies below 60 mc. No. 9935 (UT-107) has built-in by-pass condensers for the heater and the screen and is designed for use at frequencies above 60 mc. The plate terminals take clips with flexible leads.

Flexible leads are necessary so that normal expansion will not place a strain on the glass at the seals. Each lead should be connected to its clip before the clip is placed on the plate terminal. Connections should never be soldered directly to the tube terminals because the heat of the soldering operation may crack the lead seals. The 829-A may be mounted in a vertical position with the plate terminals either up or down. It may also be mounted in a horizontal position provided the plane of each plate is vertical (on edge).

The bulb becomes very hot during con-

the heater-voltage should not deviate more than $\pm 10\%$ from the rated value.

The cathodes of the 829-A are connected together within the tube. The cathode circuit should be connected to the electrical mid-point of the heater circuit when the heaters are operated from an AC supply, or to the negative heater-supply lead when the heaters are operated from a DC source. In circuits where the cathode is not directly connected to the heater, the potential difference between them should not exceed 100 volts. If the use of a large resistor is necessary between heater and cathode in some circuits, it should be bypassed to avoid the possibility of hum.

The plates of the 829-A show no color when the tube is operated at its maximum plate-dissipation rating.

The screens of the 829-A are connected together within the tube, and they are by-

DEATH *before* DISHONOR!

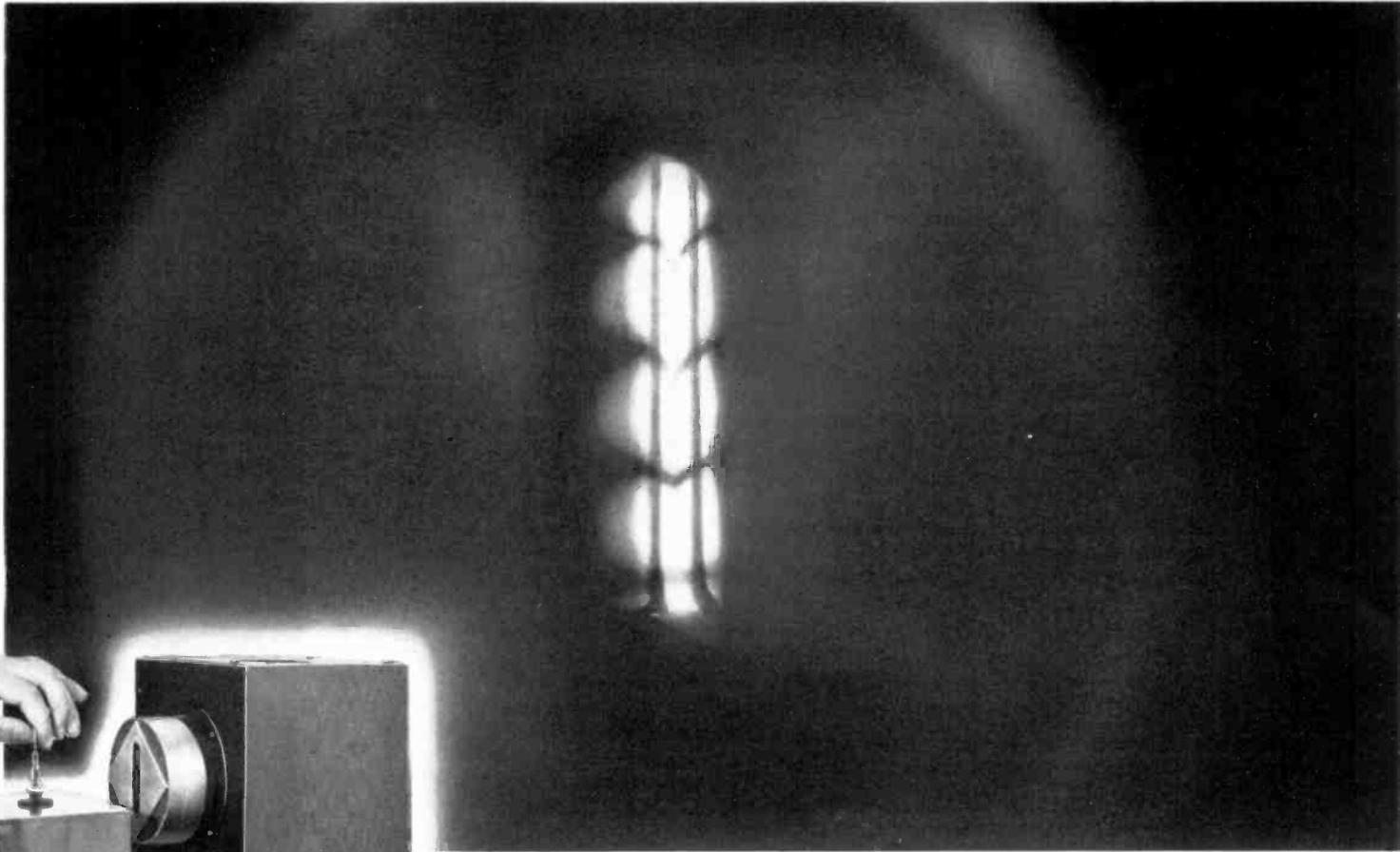

Casual observation of a vacuum tube does not reveal its flaws. That's why Eimac engineers have developed many devices for the purpose of exposing even slight weaknesses in construction. The above is not a dungeon window, but a close-up photo of a faulty bead on a filament stem as viewed through a special bead testing device. Needless to say, this stem will never reach final assembly... better "death before dishonor" to the Eimac tradition of dependability.

Such care in production plus constant research into the phenomenon of the electron tube assures you of the utmost in performance from every Eimac tube... provides the answer to why Eimac tubes are first choice by most of the leading engineers throughout the world.

Export Agents:
(FRAZAR & CO., LTD., 301 Clay St.)
 San Francisco, California, U. S. A.

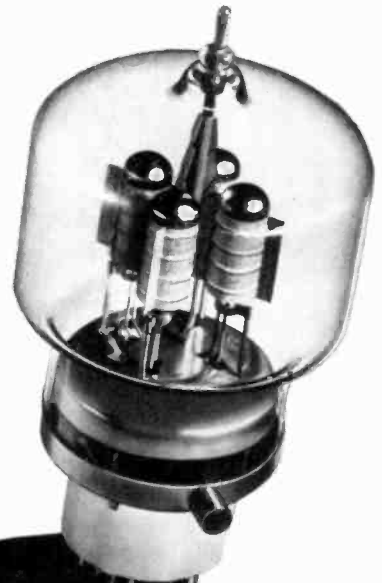

Follow the leaders to

Eimac
TUBES



Observation of the stress points on glass seal seals around vacuum tube leads is made with this device. Close-up photo above shows the actual view of a faulty lead. Note the change in polarized light creating distorted shadows which show up stress and strain in beads. Such strain sometimes occurs where metal and glass are sealed together.

Inspecting the entire glass bulb with the help of a polarized light. This device shows up stress and strain on the glass which might be created during the shaping operations.

Mfg. by Eitel-McCullough, Inc., San Bruno, California, U. S. A.

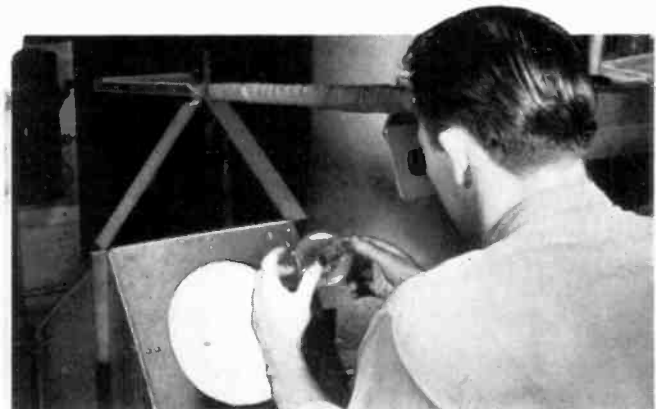
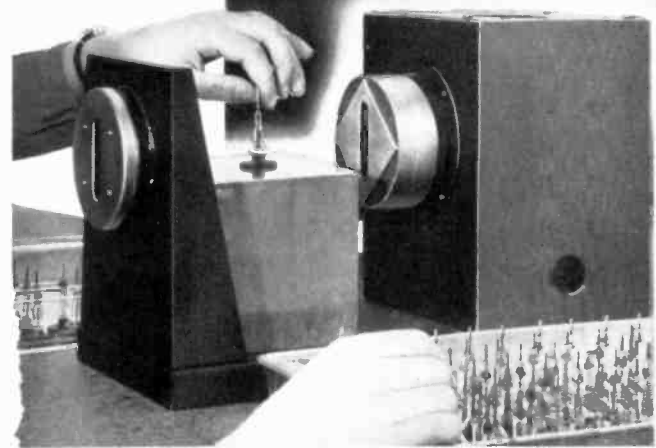

full capabilities of the tube at the ultra-high frequencies. Conventional by-passing methods and grounding are not adequate. One convenient method of by-passing is to use ribbon heater and screen leads to the tube terminals and to insulate the leads from the external shield plate by means of mica spacers to former by-pass condensers right at the tube terminals. It is important that the grid, plate, and screen circuit returns are made to the common cathode connection in order to avoid RF interaction through common return circuits.

It may also be advisable in some applications to supplement the action of the by-pass condensers by RF chokes placed close to the condensers in the voltage supply leads.

In order that the maximum ratings given under CHARACTERISTICS are not exceeded, changes in electrode voltages due to battery- or line-voltage fluctuation, load variation, and manufacturing variation of the associated apparatus must be determined. An average value of voltage for each electrode should then be chosen so that under the usual voltage variations the maximum rated voltages will not be exceeded.

When a new circuit is tried or when adjustments are made, it is advisable to reduce the plate and screen voltage. This may be done conveniently by means of a protective resistance of about 2,000 ohms (total) in series with the screen lead and a protective resistance of about 2,000 ohms in series with the high-voltage supply lead.

APPLICATION

In grid modulated class C telephone service, the 829-A is supplied with unmodulated RF grid excitation voltage and with a DC grid bias which is modulated at audio frequencies. Grid bias should preferably be obtained from a fixed supply. The plates are supplied with unmodulated DC voltage. The audio power required in this service is very small and need be sufficient only to meet the peak power requirement of the grids of the class C amplifier on the positive crest of the input signal. The actual peak value is generally never more than 0.15 watt. The screen voltage should be obtained from a separate source or from a voltage divider connected across the plate supply.

In plate-modulated class C RF amplifier service, the 829-A can be modulated 100%. The screen voltage may be obtained from a separate source; a voltage-dropping resistor in series with the modulated plate supply may be used also. In any case, the screen voltage must be modulated simultaneously with the plate voltage so that the ratio of screen voltage to plate voltage remains constant. Modulation of a fixed screen-voltage supply can be accomplished either by connecting the screen lead to a separate winding on the modulation transformer or by connecting it through a blocking condenser to a tap on the modulation transformer or choke. With the latter method, an AF choke of suitable impedance for low audio frequencies should be connected in series with the screen-supply lead. Control grid bias should be obtained from a grid resistor or from a combination of either grid resistor and fixed supply, or grid resistor and cathode bias resistor. The combination method of grid resistor and fixed supply has the advantage of not only protecting the tube from damage through loss of excitation, but also of minimizing distortion effects by bias-supply compensation.

In class C RF telegraph service, the 829-A may be supplied with screen voltage by any of the methods shown under INSTALLATION. When a series screen resistor is used, the regulation of the plate supply should be good enough so that the screen voltage will not exceed 600 volts under key-up conditions. Grid bias may be obtained by any convenient method.

The 829-A may be operated at maximum ratings in all classes of service at frequencies as high as 200 mc. The tube may be operated at higher frequencies provided the maximum values of plate voltage and power input are reduced as the frequency is raised (other maximum ratings are the same as shown under CHARACTERISTICS). The tabulation below shows the highest percentage of maximum plate voltage and power input that can be used up to 250 mc. for any class of service. Special attention should be given to shielding, cooling and RF by-passing at these frequencies.

Max. permissible percentage of max. rated plate voltage and plate input:

Class C	200 mc.	250 mc.
grid modulation	100%	94%
plate modulation	100%	89%
telegraphy	100%	89%

NEW BOOKS ON RADIO ENGINEERING SUBJECTS

BASIC RADIO — *The Essentials of Electron Tubes and Their Circuits*, by J. Barton Hoag, Ph.D. 379 pages, profusely illustrated, 8 $\frac{3}{4}$ by 6 ins. Published by D. Van Nostrand Company, Inc., 250 Fourth Avenue, New York City. Price, \$3.25.

In the preparation of this text and the excellent illustrations, Dr. Hoag has done a highly useful job for the great number of new radio-electronic students who, with only a limited knowledge of physics and mathematics, must gain a working knowledge of vacuum tubes, their circuits, and their functions.

The book is up-to-the-minute in the subjects covered, making it of special value to students of military radio-electronic equipment. With practically no mathematics, the functioning of modern tubes is made clear, and then related, in subsequent chapters, to feedback amplifiers, receivers and transmitters, signal generators, television equipment, oscilloscope testing, alignment of superheterodyne circuits, frequency modulation, direction finders, UHF circuits, and microwave apparatus, including the Klystron.

Twenty-two pages of problems and questions, comprising a practical review,

were prepared by E. B. Redington, Instructor in Charge, Radio Engineering and Maintenance School, U.S.C.G. The author holds the rank of Lieutenant Commander as head of the Department of Science, U. S. Coast Guard Academy, at New London.

This book is recommended highly to all students preparing for civilian or military radio work.

DEFINITIONS OF ELECTRICAL TERMS, compiled by the A.I.E.E. Standards Committee. Over 300 pages, 8 by 11 ins. Published by the American Institute of Electrical Engineers, 33 West 39th Street, New York City. Price, \$1.00.

Standards Committees of 31 engineering societies and organizations, including the Bureau of Engineering, U. S. Navy Department, have collaborated in establishing the American Standard Definitions of Electrical Terms, under the procedure of the American Standards Association.

Definitions are arranged in groups which cover fundamental and derived terms for: Rotating machinery; Transformers, regulators, reactors, and rectifiers; Switching equipment; Control equipment; Instruments, meters, and meter

testing; Generation, transmission, and distribution; Transportation; Transportation-air; Transportation-land; Electro-mechanical applications; Electric welding and cutting; Illuminating engineering; Electrochemistry and Electrometallurgy; Electrocommunication; Electronics; Radiology; Electrobiography including electrotherapeutics; Miscellaneous.

In the group of Electrocommunication definitions are those related to instruments for conversion to and from electric waves, circuit elements, networks, lines, antennas, radio transmitters and receivers, direction finders, television, telephone systems, stations and sets, lines and trunks, switching systems and apparatus, and telegraph systems.

Electronic definitions cover vacuum tubes and electrodes, electrode voltage, current, and power, electrode impedances and admittances, amplifiers, gas tubes, phototubes, cathode-ray tubes, and X-ray tubes.

At a time when great emphasis is being placed on simplification and time conservation through technical standardization, every engineer will benefit by a careful study of the data concerning his particular activities which is presented in this volume.

SPEED

PRODUCTION TESTS

... save engineering time in labs ...

with **R. C. P. ELECTRICAL** and
ELECTRONIC TEST INSTRUMENTS



MODEL 670

ELECTRONIC LIMIT BRIDGE FOR PRECISION RESISTANCE TESTING

For rapid, precision resistance measurements. Direct reading, accurate to 0.1 of 1%, in $\pm\%$ deviations from predetermined standards. Internal standards to specifications. Instrument also provides for external standards. External and internal standards can be used in combination. Battery operated, self-contained with $4\frac{1}{2}$ " galvanometer. **150.**

RADIO CITY PRODUCTS New line of up-to-the-minute electrical and electronic test instruments are specifically designed to meet today's war-time needs for speed, accuracy and flexibility.

Special-purpose type: meet the most exacting demands of laboratory and production line alike, while other models are designed "without frills" for wider-latitude applications. Several typical instruments in the Radio City Products' line are illustrated.



MODEL 423

VOLT—OHM—MILLIAMMETER

Meter sensitivity 2,500 ohms per volt. $\pm 2\%$ accurate. 5 DC ranges 0-1,000 volts. 4 AC ranges 0-1,000 volts. 4 DC ma. ranges 0-1,000. 4 Ohmmeter ranges 0-10 meg. db range from -10 to +55. Complete **23.50**
In portable case with leads, as illustrated \$25.95.

**ELECTRONIC AC-DC VOLTMETER
—OHMMETER—CAPACITIMETER**

Vacuum tube voltmeter with 6 AC ranges and 7 DC ranges, 0-6000 V.—input resistance 16 and 160 meg-ohms. Seven range direct reading vacuum tube ohmmeter to 1,000 megs. Seven range vacuum tube capacity meter to 2,000 mfd. In rugged welded crystalline finish case. **47.50**



MODEL 662

VACUUM TUBE VOLTMETER

A peak voltmeter designed for measurements covering the entire audio range. Meter $4\frac{1}{2}$ " 0-200 microammeter. Operates on 60 cycle 105-130 volt power supply. Provisions for battery operation. Complete. **35.50**



MODEL 666

RCP Instruments are available through local distributors. Don't accept substitutes. If unable to obtain from regular sources of supply order direct.

RCP's engineering and production staffs are active in the design and manufacture of instruments to specifications. Your inquiries are cordially invited.

Write today for Bulletin No. 126 describing the complete RCP line of dependable precision instruments. Use convenient coupon below.

RADIO CITY PRODUCTS COMPANY, INC.
127 WEST 26TH STREET, NEW YORK CITY

Gentlemen: Please send me immediately a copy of your Bulletin No. 126.

NAME.....

ADDRESS.....

CITY.....STATE.....

RADIO CITY PRODUCTS COMPANY
INCORPORATED

127 WEST 26th STREET - NEW YORK CITY

F742



CHECK HERE!

... if you want a **BETTER** radio job!

Technical ability is the only thing that stands between you and a better job.

CREI can prepare you NOW with just the training you need!

Yes, YOUR opportunity is here, NOW! Our home study courses are "made to order" for this opportunity. CREI trained men are in demand throughout the radio industry... and the demand will increase as the months go by. If the lack of technical training is your stumbling block... you can do something about it now—if you will. Your radio experience backed by CREI modern training will equip you to share in the better, good-paying jobs that await trained men. 5000 radiomen can't be wrong! They're the men who have already turned to CREI for the advanced training they realize is necessary for success. Can't we help you?

Write for Details

about CREI Home Study Courses

If you are a professional radioman and want to make more money—let us prove to you we have something you need to qualify for the **BETTER** career-job opportunities that can be yours. To help us intelligently answer your inquiry—please state briefly your education, radio experience and present position.



Free Booklet Sent

CAPITOL RADIO ENGINEERING INSTITUTE

Dept. F-8, 3224-16TH ST., N. W., WASHINGTON, D. C.

CASES and TRUNKS

FOR ALL TYPES OF

MILITARY RADIO EQUIPMENT, FIELD INSTRUMENTS & SPARE PARTS, CONSTRUCTED FOR AIR, LAND, or SEA SERVICE

For quotations and samples built to Army-Navy specifications, call

NEW YORK CASE CO.

Contractors to the U. S. Government

670 Broadway, New York City

Telephone: ALgonquin 4-6246

WFIL HELPS NAVY APPLICANTS

(CONTINUED FROM PAGE 6)

After completing this course, the men are sent to the Navy Radio School at Newport, R. I., for advanced instruction and training in radio theory and practice, in preparation for going to sea.

Additional Information ★ The Navy hopes that other broadcast stations will establish similar courses, so as to make instruction available in all parts of the Country to men who are potential operators. Commenting on this plan, Roger Clipp said: "If the radio stations of America will carry on the work started here, we can meet the Navy's need for technical men in this field. I shall gladly place at the disposal of any interested station all the information as to the organization and maintenance of a Navy code school."

SPOT NEWS

(CONTINUED FROM PAGE 12)

however, production of Mycalex, using ground mica scrap, has risen to a point where sale of waste makes US mica mining profitable.

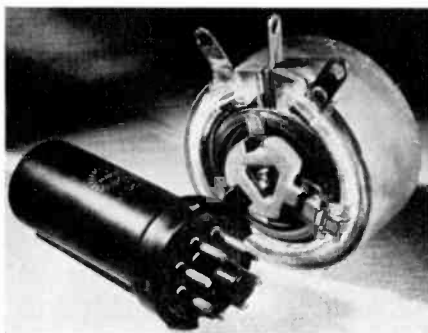

50-Watt Rheostats: Are now being produced by Clarostat Mfg. Company, of Brooklyn, N. Y. Resistances up to 10,000 ohms are available. Design is similar to Clarostat's 25-watt line, with element embedded in ceramic housing. Shaft is completely insulated from rotating contactor.

Lock Washers, Terminals: Shakeproof, Inc., of Chicago, is now standardizing on reduced number of lock-washers and locking terminals, according to sales manager E. W. Fuller. Discontinued types will be supplied until exhausted. Stock types, listed in new catalog sheets, cover 90% of radio and electrical applications.

Chicago: Surface lines are using a Motorola FM installation to reach the service trucks around the City, so as to speed them from one job to another.

Condensers: Oil-filled and oil-impregnated paper condensers, encased in metal tubes, are listed in all values and voltages in a new catalog released by Solar Mfg. Cor-

poration, of Bayonne, N. J. Demand for such types of paper condensers has increased enormously because they are so widely specified for Army and Navy equipment.

UHF Bibliography: A 52-page reference book on this subject, compiled by E. Kelsey, has just been published by Zenith Radio Corporation, Chicago. Books and papers listed include those published abroad, as well as in the USA.

Franklin M. Doolittle: General manager of WDRC and W65H has been appointed technical FM adviser to Board of War Communications, at Washington. He will represent FM Broadcasters, Inc. in this capacity.

Use of Silver: Is saving huge quantities of tin at General Electric, according to vice president Harry A. Winne. G.E. used about 500 tons of tin in 1940. This year, with output doubled, tin consumption will not increase, due to substitution of silver for tin in soft solder. In the past, soft solder has ranged from almost pure tin to 40% tin and 60% lead. Now, compositions run from 20% tin, 1% silver, and 79% lead to 97.5% lead and 2.5% silver. Brazing instead of soft-soldering joints and connections is saving copper, too. Widely used brazing alloy was mainly copper, with small silver and phosphorus content. Now, typical brazing alloy has 16% copper, 50% silver, 16% zinc, and 18% cadmium.

Indianapolis: W73IN will be on the air shortly, using transmitting equipment ordered and built before the freeze order was put into effect. So says R. M. Crandall, president of Associated Broadcasters, by whom the FM station will be operated.

Correction: Last month, on the Spot News page, W49BN was referred to as a Rochester station. As the call letters indicate, this station is located at Binghamton, N. Y. It is affiliated with WNBK.

Reference Index: Vacuum Tube Reviews

Complete design data on the following tubes has been presented in Radio-Electronic Engineering to date:

1635	Class B twin amplifier	June, 1942
1642	Twin triode amplifier	June, 1942
9004	UHF diode	May, 1942
9005	UHF diode	May, 1942
1A3	HF diode	May, 1942
3A4	Power amplifier pentode	May, 1942
3A5	HF twin triode	May, 1942
829A	P-P RF beam power amp.	July, 1942
6C4	HF power pentode	May, 1942
9JP1/1809P1	9-in. cathode ray	June, 1942
1L4	RF amplifier pentode	May, 1942

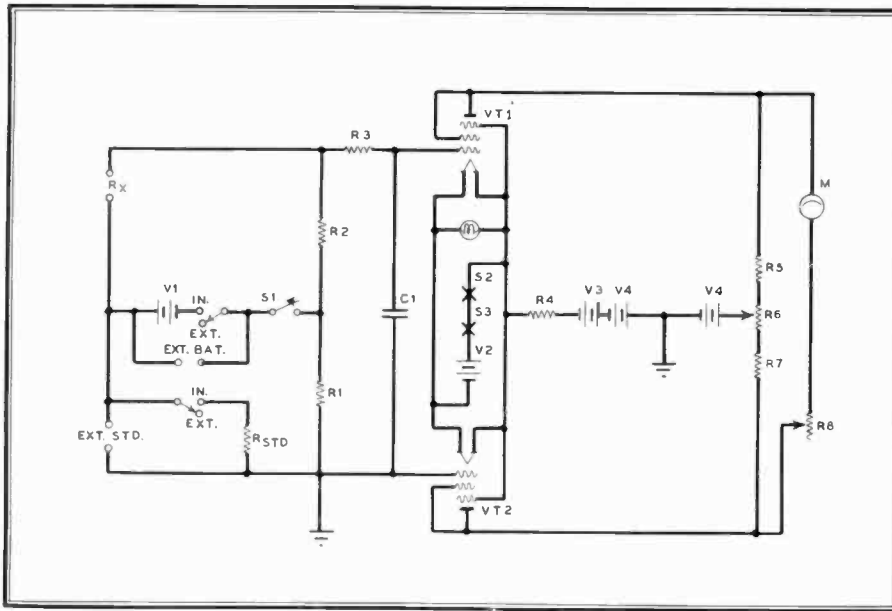

FIG. 2. COMPLETE CIRCUIT OF THE DIRECT-READING RESISTANCE LIMIT BRIDGE

USE OF THE LIMIT BRIDGE

(CONTINUED FROM PAGE 18)

necessary to use an external battery of more than the $7\frac{1}{2}$ -volt battery V1. In that case, put the battery switch at EXTERNAL, and connect a voltage greater than $7\frac{1}{2}$ to the EXTERNAL BATTERY posts on the panel. The exact value must be determined experimentally by readjusting the potentiometer until, with a test resistor varying 10% from the standard, the meter reads 10%.

Calibration Check ★ From time to time, after the batteries have been in use for several months, the ZERO RESET should be adjusted and the meter reading checked against a resistor varying 10% from a standard value. If the meter does not read exactly 10%, the potentiometer behind the panel should be adjusted. If this is not adequate to correct the reading, the batteries should be replaced, and the readjustment process repeated.

Circuit Data ★ The four batteries shown in Fig. 2 are:

- V₁ — 7.5 volts. Burgess F5BP.
- V₂ — 1.5 volts. Burgess 4FA.
- V₃ — 9 volts. Burgess X466.
- V₄, V₄ — 45 volts. Burgess 5308, grounded at the center tap.

Other values of components in the wiring diagram are:

- R-STD — Internal standard resistance.
- R₁ — 1,000 ohms.
- R₂ — 1,000 ohms.
- R₃ — 2 meg.
- R₄ — 50,000 ohms.
- R₅ — 20,000 ohms.
- R₆ — 2,000-ohm potentiometer.
- R₈ — 15,000-ohm zero reset.
- C₁ — .01 mfd.
- S₁ — Press-to-Read switch.
- S₂ — Safety switch.

- S₂ — ON-OFF switch.
- M — 25-0-25 microamperes.
- VT₁ — 1C5GT tube.

The size of the case, with the cover closed, is $14\frac{3}{4}$ ins. high, $10\frac{1}{4}$ ins. wide, and $8\frac{1}{2}$ ins. deep. Weight, including batteries, is $10\frac{1}{4}$ lbs.

BOOK REVIEW

ULTRA-HIGH-FREQUENCY TECHNIQUES, by J. G. Brainerd, editor, Glenn Koehler, Herbert J. Reich, and L. F. Woodruff, professors at University of Pennsylvania, Wisconsin, and Illinois and at Massachusetts Institute of Technology, respectively. 535 pages, 316 illustrations, $6\frac{1}{2}$ by $9\frac{1}{2}$ ins. Published by D. Van Nostrand Company, Inc., 250 Fourth Avenue, New York City. Price \$4.50.

Here is another book based on wartime needs for technical literature. The four authors who collaborated in the preparation of this text were members of the conference held at M.I.T. in November, 1941, to consider the need, engendered by the War, for engineers trained in the ultra-high-frequency field.

Discussion at this conference brought out emphatically that lessons learned from our allies and our enemies indicated that a serious shortage is developing in specialists trained in electrodynamics and ultra-frequency techniques. This demand has been brought about by the introduction of radically new weapons, battle tactics, and military and naval devices, all related to the vital role of radio communication.

Men who have had this extra training are needed for (1) various branches of the Army, Navy, and Marine Corps, (2) Electronics Training Group Replacement, for service in England, (3) Government re-

(CONTINUED ON PAGE 27)



PRONG-BASE

ELECTROLYTICS

● This already popular type is made still more popular because of certain Aerovox refinements. Indeed, it will pay you to check these refinements for yourself when considering prong-base electrolytics.

featuring . . .

- Square can shoulder instead of sloped. Cap or plug rests solidly in place. No sharp edges. No danger of shearing cathode tabs.
- Lugs rigidly riveted to bakelite disc which fits in cup-shaped soft-rubber plug.
- Slotted protrusions or sleeves in rubber plug surround and seal in the tabs and lugs. No electrolyte leakage. No terminal corrosion.
- No danger of bakelite corrosive effects since rubber sleeves protect raw bakelite slots and metal parts.
- Positive pin-hole vent instantly responds to excess gas pressure, yet normally self-closing.

● Check these features for yourself. Sample cheerfully submitted. Let us quote on your requirements. Literature on request.

AEROVOX
CORPORATION
NEW BEDFORD, MASS., U. S. A.
In Canada: AEROVOX CANADA LTD., Hamilton, Ont.
EXPORT: 100 Varick St., N. Y., CaMe 'ARLAB'

RADIO-ELECTRONIC PRODUCTS DIRECTORY

The Radio Engineers' & Purchasing Agents' Guide to Essential Materials, Components, and Equipment

* Indicates that addresses and phone numbers of representatives in War Production centers are listed at the end of the Radio-Electronic Products Directory

ANTENNAS, Transmitting

Blaw-Knox Co., Pittsburgh, Pa.
Lehigh Structural Steel Co., 17 Battery Pl., N. Y. C.
Lingo & Son, John E., Camden, N. J.
Truscon Steel Co., Youngstown, O.
Wincharger Corp., Sioux City, Iowa

BEADS, Insulating

American Lava Corp., Chattanooga, Tenn.
Dunn, Inc., Struthers, 1321 Cherry, Phila., Pa.
Star Porcelain Co., Trenton, N. J.
Steward Mfg. Co., Chattanooga, Tenn.

BOLTS, NUTS & SCREWS, Machine

American Screw Co., Providence, R. I.
Hirstol Co., The Waterbury, Conn.
Central Screw Co., 3519 Shields Av., Chicago
Chandler Prods. Corp., Cleveland, O.
Continental Screw Co., New Bedford, Mass.
Corbin Screw Corp., New Britain, Conn.
Harper Co., H. M., 2609 Fletcher, Chicago
International Screw Co., Detroit
Lamson & Sessions Co., Cleveland, O.
National Screw & Mfg. Co., Cleveland
New England Screw Co., Keene, N. H.
Ohio Nut & Bolt Co., Berea, Ohio
Parker Co., Charles, Meriden, Conn.
Parker-Kalon Corp., 198 Varick, N. Y. C.
Pawtucket Screw Co., Pawtucket, R. I.
Progressive Mfg. Co., Torrington, Conn.
Republic Steel Corp., Cleveland, O.
Russell, Burdull & Ward Bolt & Nut Co., Port Chester, N. Y.
Seovill Mfg. Co., Waterbury, Conn.
Shakeproof, Inc., 2501 N. Keeler, Chicago
Southington Hardware Mfg. Co., The Southington, Conn.
Whitney Screw Corp., Nashua, N. H.

CABLE, Coaxial

American Phenolex Corp., 1830 S. 54 Av., Chicago
Anaconda Wire & Cable Co., 25 B'way, N. Y. C.
Andrew Co., Victor J., 363 E. 75 St., Chicago
Belden Mfg. Co., 4673 W. Van Buren, Chicago
Boston Insulated Wire & Cable Co., Boston
Communications Prods. Co., Jersey City, N. J.
Cornish Wire Co., 15 Park Row, N. Y. C.
General Cable Corp., 420 Lexington, N. Y. C.
Doolittle Radio, Inc., 7521 S. Loomis Blvd., Chicago
General Insulated Wire Corp., 53 Park Pl., N. Y. C.
Simplex Wire & Cable Corp., Cambridge, Mass.

CABLE, Microphone, Speaker & Battery

Alden Prods. Co., Brockton, Mass.
Anaconda Wire & Cable Co., 25 Broadway, N. Y. C.
Belden Mfg. Co., 4633 W. Van Buren, Chicago
Boston Insulated Wire & Cable Co., Dorchester, Mass.
Givett Mfg. Co., Brookfield, Mass.
Holyoke Wire & Cable Corp., Holyoke, Mass.

CASTINGS, Die

Aluminum Co. of America, Pittsburgh, Pa.
American Brass Co., Waterbury, Conn.
Dow Chemical Co., Dowmetal Div., Midland, Mich.

CERAMICS, Bushings, Washers, Special Shapes

Akron Porcelain Co., Akron, O.
Electronic Mechanics, Inc., Paterson, N. J.
Isolanite, Inc., Belleville, N. J.
Lapp Insulator Co., Leroy, N. Y.
Louthan Mfg. Co., E. Liverpool, O.
Star Porcelain Co., Trenton, N. J.
Steward Mfg. Co., Chattanooga, Tenn.
Victor Insulator Co., Victor, N. Y.

CHOKES, RF

Magdin Radio Industries, 501 W. 35th, Chicago
Alden Prods. Co., Brockton, Mass.
American Communications Corp., 306 B'way, N. Y. C.
Barker & Williamson, Upper Darby, Pa.
Coto-Coll Co., Providence, R. I.
D-X Radio Prods. Co., 1575 Milwaukee, Chicago
General Winding Co., 254 W. 31 St., N. Y. C.
Guthman & Co., Edwin, 400 S. Peoria, Chicago
Hammarlund Mfg. Co., 424 W. 33 St., N. Y. C.
Johnson Co., E. F., Waseca, Minn.
Lectrohm, Inc., Cicero, Ill.
Melssner Mfg. Co., Mt. Carmel, Ill.
Miller Co., J. W., Los Angeles, Cal.
Muter Co., 1255 S. Michigan, Chicago

National Co., Malden, Mass.
Ohmite Mfg. Co., 4835 W. Flournoy St., Chicago
Radex Corp., 1328 Elston Av., Chicago
Siekles Co., F. W., Chicopee, Mass.
Teleradio Eng. Corp., 484 Broome St., N. Y. C.
Triumph Mfg. Co., 4017 W. Lake St., Chicago

CLIPS, Connector

Mueller Electric Co., Cleveland, O.

CLIPS & MOUNTINGS, Fuse

Alden Prods. Co., Brockton, Mass.
Dante Elec. Mfg. Co., Bantam, Conn.
Ilico Copper Tube & Prods., Inc., Station M, Cincinnati
Jefferson Elec. Co., Bellwood, Ill.
Jones, Howard B., 2300 Wabansla, Chicago
Littlefuse, Inc., 4753 Ravenswood, Chicago
Patton MacGuyre Co., Providence, R. I.
Sherman Mfg. Co., H. B., Battle Creek, Mich.

CLOTH, Insulating

Aerac Wire Co., New Haven, Conn.
Brand & Co., Wm., 276-4th Av., N. Y. C.
Endurette Corp. of Amer., Cliffwood, N. J.
Insulation Mfgs. Corp., 565 W. Wash. Blvd., Chicago
Irvington Varulsh & Insulating Co., Irvington, N. J.
Mica Insulator Co., 196 Varick, N. Y. C.

CONDENSERS, Fixed

* Aerovox Corp., New Bedford, Mass.
American Condenser Corp., 2508 S. Michigan, Chicago
Art Radio Corp., 115 Liberty, N. Y. C.
Atlas Condenser Prods. Co., 548 Westchester Av., N. Y. C.
Automatic Winding Co., East Newark, N. J.
Bud Radio, Inc., Cleveland, O.
Cardwell Mfg. Corp., Allen D., Brooklyn, N. Y.
Centralab, Milwaukee, Wis.
Condenser Corp. of America, South Plainfield, N. J.
Condenser Prods. Co., 1375 N. Branch, Chicago
Cornell-Duplier Elec. Corp., S. Plainfield, N. J.
Cosmic Radio Co., 699 E. 135th St., N. Y. C.
Crowley & Co., Henry L., W. Orange, N. J.
Deutschmann Corp., Tobe, Canton, Mass.
Dumont Elec. Co., 34 Hubert St., N. Y. C.
Electro-Motive Mfg. Co., Willmantle, Conn.
Erie Resistor Corp., Erie, Pa.
Faas & Co., John E., 3123 N. Crawford, Chicago
General Radio Co., Cambridge, Mass.
Girard-Hopkins, Oakland, Calif.
H. R. S. Prods., 5707 W. Lake St., Chicago
Hillnole Cond. Co., 3252 W. North Av., Chicago
Industrial Cond. Corp., 1725 W. North Av., Chicago
Insuline Corp. of America, Long Island City, N. Y.
Johnson Co., E. F., Waseca, Minn.
Kelllogg Switchboard & Supply Co., 6650 Cicero, Chicago
Mallory & Co., P. R., Indianapolis, Ind.
Mearns Radio Corp., Brooklyn, N. Y.
Muter Co., 1255 S. Michigan, Chicago
Potter Co., 1950 Sheridan Rd., N. Chicago
RCA Mfg. Co., Camden, N. J.
Saugamo Elec. Co., Springfield, Ill.
Solar Mfg. Corp., Bayonne, N. J.
Sprague Specialties Co., N. Adams, Mass.
Teleradio Engineering Corp., 484 Broome St., N. Y. C.

CONDENSERS, Variable Receiver Tuning

Alden Prods. Co., Brockton, Mass.
American Steel Package Co., Defiance, Ohio
Barker & Williamson, Ardmore, Pa.
Bud Radio, Inc., Cleveland, O.
Cardwell Mfg. Corp., Allen D., Brooklyn, N. Y.
General Instrument Corp., Elizabeth, N. J.
Hammarlund Mfg. Co., 424 W. 33rd St., N. Y. C.
Insuline Corp. of Amer., L. I. City, N. Y.
Melssner Mfg. Co., Mt. Carmel, Ill.
Miller Mfg. Co., Malden, Mass.
National Co., Malden, Mass.
Radio Condenser Co., Camden, N. J.
Relliance Die & St'g Co., 1260 Clybourn Av., Chicago

CONDENSERS, Variable Transmitter Tuning

Barker & Williamson, Upper Darby, Pa.
Bud Radio, Cleveland, O.
Cardwell Mfg. Corp., Allen D., Brooklyn, N. Y.
Hammarlund Mfg. Co., 424 W. 33 St., N. Y. C.
Insuline Corp. of Amer., L. I. City, N. Y.
Johnson, E. F., Waseca, Minn.
Miller Mfg. Co., James, Malden, Mass.
National Co., Malden, Mass.

CONDENSERS, Variable Trimmer

* Aerovox Corp., New Bedford, Mass.
Alden Prods. Co., Brockton, Mass.
American Steel Package Co., Defiance, O.
Bud Radio, Inc., Cleveland, O.
Cardwell Mfg. Corp., Allen, Brooklyn, N. Y.
Centralab, Milwaukee, Wis.
General Radio Co., Cambridge, Mass.
Guthman, Inc., E. L., 400 S. Peoria, Chicago
Hammarlund Mfg. Co., 424 W. 33 St., N. Y. C.
Insuline Corp. of America, Long Island City, N. Y.
Johnson Co., E. F., Waseca, Minn.
Melssner Mfg. Co., Mt. Carmel, Ill.
Miller Mfg. Co., James, Malden, Mass.
Miller Co., J. W., Los Angeles, Cal.
Muter Co., 1255 S. Michigan Av., Chicago
National Co., Malden, Mass.
Potter Co., 1950 Sheridan Rd., N. Chicago
Siekles Co., F. W., Chicopee, Mass.
Solar Mfg. Corp., Bayonne, N. J.
Teleradio Eng. Corp., 484 Broome, N. Y. C.

CONNECTORS, Cable

Aero Electric Corp., Los Angeles, Calif.
Alden Prods. Co., Brockton, Mass.
Amer. Microphone Co., 1915 S. Western Av., Los Angeles
Amer. Phenolex Corp., 1830 S. 54th St., Chicago
American Radio Hardware Co., 476 B'way, N. Y. C.
Andrew, Victor J., 6429 S. Laverne Av., Chicago
Atlas Sound Corp., 1442 39th St., Brooklyn, N. Y.
Birnbach Radio, 145 Hudson St., N. Y. C.
Breeze Mfg. Corp., Newark, N. J.
Brush Development Co., Cleveland, O.
Bud Radio, Cleveland, Ohio
Cannon Elec. Development, 3209 Humboldt, Los Angeles
Ely, Inc., Hugh H., Philadelphia
Electro Voice Mfg. Co., South Bend, Indiana
General Radio Co., Cambridge, Mass.
Insuline Corp. of Amer., L. I. City, N. Y.
Jones, Howard B., 2300 Wabansla, Chicago
Mallory & Co., P. R., Indianapolis, Ind.
Radio City Products Co., 127 W. 26 St., N. Y. C.

CRYSTALS, Quartz

Bausch & Lomb Optical Co., Rochester, N. Y.
Bellefonte Eng. Labs., Bellefonte, Penna.
Billie Elec. Co., Erie, Penna.
Burnett, Wm. W. I., San Diego, Cal.
Collins Radio Co., Cedar Rapids, Iowa
General Electric Co., Schenectady, N. Y.
General Radio Co., Cambridge, Mass.
Harvey-Wells Communications, Southbridge, Mass.
Hilpower Crystal Co., 2035 W. Charles, Chicago
Hollister Crystal Co., Merriam, Kan.
Hunt & Sons, G. C., Carlisle, Pa.
Kaar Engineering Co., Palo Alto, Cal.
Miller, August G., North Bergen, N. J.
Peterson Radio, Council Bluffs, Iowa
Precision Crystal Labs., Springfield, Mass.
Precision Plezo Service, Baton Rouge, La.
Premier Crystal Labs., 63 Park Row, N. Y. C.
RCA Mfg. Co., Camden, N. J.
Scientific Radio Service, Hyattsville, Md.
Standard Plezo Co., Carlisle, Pa.
Valpey Crystals, Holliston, Mass.
Zeiss, Inc., Carl, 485 Fifth Av., N. Y. C.

FELT

American Felt Co., Inc., Glenville, Conn.
Western Felt Works, 4031 Ogden Av., Chicago

FIBRE, Vulcanized

Brandywine Fibre Prods. Co., Wilmington, Del.
Continental-Diamond Fibre Co., Newark, Del.
Insulation Mfgs. Corp., 565 W. Wash. Blvd., Chicago
Mica Insulator Co., 196 Varick, N. Y. C.
Nat'l Vulcanized Fibre Co., Wilmington, Del.
Taylor Fibre Co., Norristown, Pa.
Wilmington Fibre Specialty Co., Wilmington, Del.

FILTERS, Electrical Noise

Tobe Deutschmann Corp., Canton, Mass.

FINISHES, Metal

Alross Chemical Co., Providence, R. I.
Aluminum Co. of America, Pittsburgh, Pa.
Ault & Wilborg Corp., 75 Varick, N. Y. C.
Hilo Varulsh Corp., Brooklyn, N. Y.
Maas & Waldstein Co., Newark, N. J.
New Wrinkle, Inc., Dayton, O.

FUSES, Enclosed

Dante Elec. Mfg. Co., Bantam, Conn.
Jefferson Elec. Co., Bellwood, Ill.
Littlefuse, Inc., 4753 Ravenswood Av., Chicago

GEARS & PINIONS, Metal

Gear Specialties, Inc., 2650 W. Medill, Chicago
Perkins Machine & Gear Co., Springfield, Mass.
Thompson Clock Co., H. C., Bristol, Conn.
Continental-Diamond Fibre Co., Newark, Del.

GEARS & PINIONS, Non-Metallic

Brandywine Fibre Prods. Co., Wilmington, Del.
Formica Insulation Co., Cincinnati, O.
Gear Specialties, Inc., 2650 W. Medill, Chicago
* General Electric Co., Pittsfield, Mass.
Mica Insulator Co., 196 Varick Et., N. Y. C.
National Vulcanized Fibre Co., Wilmington, Del.
Perkins Machine & Gear Co., Springfield, Mass.
Richardson Co., Melrose Park, Chicago
Synthane Corp., Oaks, Pa.
Taylor Fibre Co., Norristown, Pa.
Wilmington Fibre Specialty Co., Wilmington, Del.

GENERATORS, Gas Engine Driven

Kato Engineering Co., Mankato, Minn.

HEADPHONES

Brush Development Co., Cleveland, O.
Conn. Tel. & Electric Co., Meriden, Conn.
Carrier Microphone Co., Inglewood, Cal.
Cannon Co., C. E., Springfield, N. Y.
Carron Mfg. Co., 415 S. Aberdeen, Chicago
Chicago Tel. Supply Co., Elkhart, Ind.
Connecticut Tel. & Elec. Co., Meriden, Conn.
Elec. Industries Mfg. Co., Red Bank, N. J.
* General Electric Co., Pittsfield, Mass.
Kelllogg Switchboard & Supply Co., 6650 S. Cicero Av., Chicago
Murdock Mfg. Co., Chelsea, Mass.
Trimm Radio Mfg. Co., 1770 W. Bertram, Chicago
Universal Microphone Co., Inglewood, Cal.

From month to month, new companies are entering the Radio-Electronic field. Older concerns are adding new products. Accordingly, this Directory will be revised each month, so as to assure engineers and purchasing agents of up-to-date information. We shall be pleased to receive suggestions as to company names which should be added, and hard-to-find items which should be listed in this Directory.

W450
Stands Out in Detroit

Michigan's pioneer Frequency Modulation Station,
owned and operated by The Detroit News. Associate
A. M. Station WWJ.

Rate Card on Request

**4500 Penobscot Bldg.
DETROIT, MICHIGAN**

**WHAT ISSUES OF FM
MAGAZINE ARE MISS-
ING FROM YOUR FILES?
COMPLETE YOUR BACK
NUMBERS. SEE SPECIAL
OFFER ON PAGE 29**

Symbol of Tomorrow

LOOK TO LINGO

For Proven FM Efficiency

The Lingo FM Turnstile Antenna is our important contribution to the industry's FM accomplishments. The years that have been devoted to developments, have already borne fruit in the form of an outstanding record of efficiency from an imposing list of actual installations. Even now, while our plant is engaged in all-out Victory production, we continue our development efforts to assure even greater efficiency in design and performance to meet the requirements of a greater FM industry tomorrow.

JOHN E. LINGO & SON, INC.

LICENSED MANUFACTURERS OF PATENTED TURNSTILE ANTENNAS
CAMDEN, NEW JERSEY

BOOK REVIEW

(CONTINUED FROM PAGE 25)

search and development in the Radiation Laboratory and Civil Service, (4) industries engaged in War production, and (5) teaching, to enlarge further the reserve of trained specialists.

To aid the rapid progress of the training program, a new textbook was required for the use of institutions giving the necessary course of instruction. Thus it came about that four specialists in this field collaborated in preparing and editing the text of **ULTRA-HIGH-FREQUENCY TECHNIQUES**.

In order to speed the publication of this book, the text was typed, and the pages printed by offset. Therefore the contents is as up-to-the-minute as the fastest book-production methods could make it.

The fifteen chapters cover: Linear circuit analysis; Fundamentals of tubes, power supplies; Amplification; Trigger circuits, pulse-sharpening circuits, and oscillators; Cathode-ray tubes and circuits; Modulation; Demodulation; Radio receivers; Transmitters; Ultra-high-frequency generators; Transmission lines; Radiation; Propagation; Hollow wave guides; Laboratory manual.

such construction has proceeded to the point where it is possible to provide a limited but satisfactory FM service. The Commission will also consider applications where construction has been completed and the permittee has been unable to secure equipment and technical personnel to make measurements, required as a prerequisite to issuance of a license. Such licenses will be granted on the definite understanding that immediately the required materials and personnel are available, steps will be taken to comply fully with the original construction permit."

In order for a station to qualify under the FCC policy: it will be necessary for each applicant to show:

1. diligence in proceeding with construction and the reasons for failure to complete construction;
2. the actual status of construction which the applicant believes sufficient to provide an acceptable FM service;
3. the materials and technical personnel needed to complete construction and make proof of performance; and
4. the applicant's determination to proceed with the final completion in accordance with the Rules, Regulations, and Standards of the Commission when ma-

(CONTINUED ON PAGE 30)

FCC RELAXES FM REGULATIONS

THE FCC has announced a new wartime policy for FM broadcast stations which will have the effect of encouraging those already on the air to continue for the duration, and will enable several new stations, not yet in operation, to go ahead with their plans.

The announcement from the FCC states: "The Commission observes that the Communications Act does not contemplate extensions of time within which

to complete construction unless it appears that construction can be completed within a reasonable length of time. Nor is it desirable to continue the issuance of special temporary authorizations upon a short term basis. However, it is desirable to encourage such service as is now possible to listeners having FM receivers. Accordingly, the Commission will give consideration to applications for licenses to cover partial construction of FM stations where

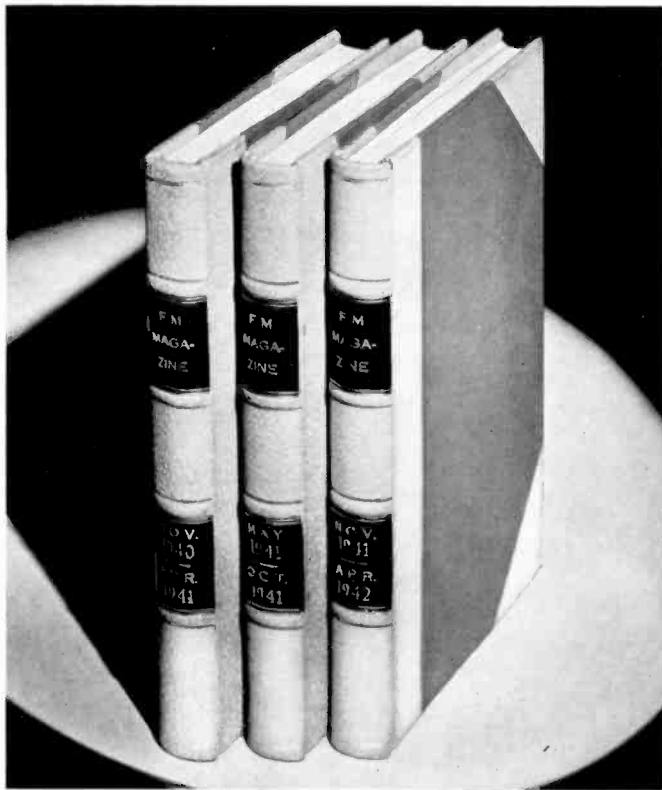

LIMITED EDITION

3 Essential Radio Reference Volumes for Engineering, Patent & Private Libraries

Each volume is a 300-page record of progress in research and development during the most significant period in the history of radio progress. The information and data contained in these volumes are available from no other source.

Each volume has been bound in lifetime pigskin, by the famous Eggeling Bindery.

A limited number of these volumes is available. Of the first, only 9 copies remain. All are offered subject to prior sale at \$5.00 each, postpaid.

F M COMPANY

28

112 EAST 36th STREET, NEW YORK CITY

HORNS, Outdoor
University Laboratories, 195 Chrystle St., N. Y. C.

IRONS, Soldering
Hexacon Electric Co., Roselle Park, N. J.

KNOBS, Radio & Instrument
Alden Prods. Co., Brockton, Mass.
American Insulator Corp., New Freedom, Pa.
Chicago Molded Prods. Corp., 1025 N. Kolmar, Chicago
General Radio Co., Cambridge, Mass.
Imperial Molded Prods. Corp., 2921 W. Harrison, Chicago
Kurtz Kaseh, Inc., Dayton, O.
Millen Mfg. Co., James, Malden, Mass.
Nat'l Co., Inc., Malden, Mass.
Radio City Products Co., 127 W. 26 St., N. Y. C.
Rogan Bros., 2001 S. Michigan, Chicago

LABORATORIES, Electronic Research
★ Browning Labs., Inc., Winchester, Mass.

LIGHTS, Pilot or Indicator
Alden Prods. Co., Brockton, Mass.
Dial Light Co. of America, 90 West, N. Y. C.
Drake Mfg. Co., 1713 W. Hubbard, Chicago
General Control Co., Cambridge, Mass.
★ General Elec. Co., Lamp Dept., Nela Specialty Div., Hoboken, N. J.
Herzog Miniature Lamp Works, 12-19 Jackson Av., Long Island City, N. Y.
Kirkland Co., H. R., Morristown, N. J.
Mallory & Co., P. R., Indianapolis, Ind.

LUGS, Copper
Buridy Engineering Co., 459 E. 133rd St., N. Y. C.
Dante Elec. Mfg. Co., Bantam, Conn.
Ideal Commutator Dresser Co., Sycamore, Ill.
Iseco Copper Tube & Prods., Inc., Station M., Cincinnati
Krueger & Hudepohl, Third & Vine, Cincinnati, O.
Patton-MacGuyver Co., 17 Virginia Av., Providence, R. I.
Sherman Mfg. Co., Battle Creek, Mich.

MACHINES, Impregnating
Stokes Machine Co., E. J., Phila., Pa.

MACHINES, Numbering
Altair Machinery Corp., 55 VanDam, N. Y. C.
Numberal Stamp & Tool Co., Huguenot Park, Staten Island, N. Y.

MACHINES, Riveting
Chicago Rivet & Machine Co., Bellwood, Illinois

MACHINES, Screwdriving
Detroit Power Screwdriver Co., Detroit, Mich.
Stanley Tool Div. of the Stanley Works, New Britain, Conn.

MAGNETS, Permanent
General Elec. Co., Schenectady, N. Y.
Mallory & Co., P. R., Indianapolis, Ind.

METAL, Thermostatic
Baker & Co., 113 Astor, Newark, N. J.
C. S. Brainin Co., 20 VanDam, N. Y. C.
Callite Timken Co., Union City, N. J.
Chace Co., W. M., Detroit, Mich.
Metals & Controls Corp., Attleboro, Mass.
Wilson Co., H. A., 105 Chestnut, Newark, N. J.

METALS, Pressed Powder
Gibson Elec. Co., Pittsburg, Pa.
Mallory & Co., P. R., Indianapolis, Ind.

METERS, Ammeters, Voltmeters, Small Panel
Cambridge Inst. Co., Grand Central Terminal, N. Y. C.
De Juir-Anasco Corp., Shelton, Conn.
★ General Electric Co., Bridgeport, Conn.
Hekok Elec. Inst. Co., Cleveland, O.
Hoyt Elec. Inst. Works, Boston, Mass.
Readrite Meter Works, Bluffton, O.
Roller-Smith Co., Bethlehem, Pa.
Slingson Elec. Co., 5218 W. Kinzie, Chicago
Triplett Elec. Inst. Co., Bluffton, O.
Westinghouse Elec. & Mfg. Co., E. Pittsburg, Pa.
Weston Elec. Inst. Corp., Newark, N. J.

MICA
Brand & Co., Wm., 276 Fourth Av., N. Y. C.
Insulation Mfgs. Corp., 565 W. Wash. Blvd., Chicago
Macallen Co., Boston, Mass.
Mica Insulator Corp., 196 Varick, N. Y. C.
New England Mica Co., Waltham, Mass.
Richardson Co., Melrose Park, Chicago

MICROPHONES
Amer. Microphone Co., 1015 Western Av., Los Angeles
Amperite Co., 561 B'way, N. Y. C.
Astrak Corp., Youngstown, O.
Brush Development Co., Cleveland, O.
Carrier Microphone Co., Inglewood, Cal.
Elect. Industries Mfg. Co., Red Bank, N. J.
Electro Voice Mfg. Co., South Bend, Ind.

Kellogg Switchboard & Supply Co., 6650 S. Cicero, Chicago
Radio Speakers, Inc., 221 E. Cullerton, Chicago
Philmore Mfg. Co., 113 University Pl., N. Y. C.
Permotlux Corp., 4916 W. Grand Av., Chicago
Rowe Industries, Inc., Toledo, O.
★ Shure Bros., 225 W. Huron St., Chicago
Turner Co., Cedar Rapids, Ia.
Universal Microphone Co., Inglewood, Cal.

MONITORS, Frequency
★ Browning Labs., Inc., Winchester, Mass.
★ Link, F. M., 127 W. 17 St., N. Y. C.

MOTOR-GENERATORS, Dynamo-tors, Rotary Converters
Alliance Mfg. Co., Alliance, O.
Air-Way Mfg. Co., Toledo, O.
Bendix, Red Bank, N. J.
Black & Decker Mfg. Co., Towson, Md.
Boilne Elec. Co., 2262 W. Ohio, Chicago
Carter Motor Co., 1608 Milwaukee, Chicago
Clements Mfg. Co., Chicago, Ill.
Continental Electric Co., Newark, N. J.
Delco Appliance, Rochester, N. Y.
Diehl Mfg. Co., Elizabethport, N. J.
Dormeyer Co., Chicago, Ill.
Eclipse Aviation, Bendix, N. J.
Elector, Inc., 1060 W. Adams, Chicago
Electric Motors Corp., Racine, Wis.
Electric Specialty Co., Stamford, Conn.
Electrolux Corp., Old Greenwich, Conn.
Emerson Electric Co., St. Louis, Mo.
Eureka Vacuum Cleaner, Detroit, Mich.
★ General Electric Co., Schenectady, N. Y.
Jannette Mfg. Co., 558 W. Monroe, Chicago
Knapp-Monarch, St. Louis, Mo.
Leland Electric Co., Dayton, O.
Ohio Electric Co., 74 Trinity Pl., N. Y. C.
Pioneer Gen-E-Motor, 5841 W. Dickens Av., Chicago
Redmond Co., A. G., Owosso, Mich.
Russell Co., Chicago, Ill.
Webster Co., Chicago, Ill.
Westinghouse Elect. Mfg. Co., Lima, O.
Winelarger Corp., Sioux City, Iowa

MOUNTINGS, Shock Absorbing
Lord Mfg. Co., Erie, Pa.
U. S. Rubber Co., 1230-6th Ave., N. Y. C.

MYCALEX
★ General Electric Co., Schenectady, N. Y.
Mycalex Corp. of Amer., 7 E. 42 St., N. Y. C.

NUTS, Self-Locking
Elastic Stop Nut Corp., Union, N. J.
Palnut Co., Inc., Irvington, N. J.
Standard Pressed Steel Co., Jenkintown, Pa.

OVENS, Industrial & Laboratory
★ General Elec. Co., Schenectady, N. Y.
Trent Co., Harold E., Philadelphia

PHOSPHOR BRONZE
American Brass Co., Waterbury, Conn.
Bunting Brass & Bronze Co., Toledo, O.
Driver-Harris Co., Harrison, N. J.
Phosphor Bronze Smelting Co., Philadelphia
Revere Copper & Brass, 230 Park Av., N. Y. C.
Seymour Mfg. Co., Seymour, Conn.

PLASTICS, Extruded
Blum & Co., Inc., Julius, 532 W. 22 St., N. Y. C.
Brand & Co., Wm., 276 Fourth Av., N. Y. C.
Extruded Plastics, Inc., Norwalk, Conn.
Irvington Varnish & Insulator Co., Irvington, N. J.

PLASTICS, Laminated or Molded
Acadia Synthetic Prods., 4031 Ogden Av., Chicago
Alden Prods. Co., Brockton, Mass.
American Cyanamid Co., 30 Rockefeller Plaza, N. Y. C.
American Insulator Corp., New Freedom, Pa.
American Molded Prods. Co., 1753 N. Honore, Chicago
Auburn Button Works, Auburn, N. Y.
Barber-Colman Co., Rockford, Ill.
Brandywine Fibre Prods. Co., Wilmington, Del.
Catalin Corp., 1 Park Av., N. Y. C.
Cetane Cellulose Corp., 180 Madison Av., N. Y. C.
Chicago Molded Prods. Corp., 1024 N. Kolmar, Chicago
Continental-Diamond Fibre Co., Newark, Del.
Dow Chemical Co., Midland, Mich.
Durez Plastics & Chemicals, Inc., N. Tonawanda, N. Y.
Extruded Plastics, Inc., Norwalk, Conn.
Formica Insulation Co., Cincinnati, O.
★ General Electric Co., Plastics Dept., Pittsfield, Mass.
General Industries Co., Elyria, O.
Imperial Molded Prods. Co., 2921 W. Harrison, Chicago
Industrial Molded Prods. Co., 2035 Charleston, Chicago
Kurtz-Kaseh, Inc., Dayton, O.
Macallen Co., Boston, Mass.
Mica Insulator Co., 196 Varick, N. Y. C.
Monsanto Chemical Co., Springfield, Mass.
National Vulcanized Fibre Co., Wilmington, Del.
Northern Industrial Chemical Co., Boston, Mass.
Radio City Products Co., 127 W. 26 St., N. Y. C.
Richardson Co., Melrose Park, Chicago

Rogan Bros., 180 N. Wacker Dr., Chicago
 Rohm & Haas Co., Philadelphia
 Stokes Rubber Co., Joseph, Trenton, N. J.
 Surprenant Elec. Ins. Co., Boston
 Synthane Corp., Oaks, Pa.
 Taylor Fibre Co., Norristown, Pa.
 Westinghouse Elec. & Mfg. Co., E. Pittsburgh, Pa.
 Wilmington Fibre Specialty Co., Wilmington, Del.

PLUGS & JACKS, Spring Type
 Eby, Inc., Hugh H., Philadelphia, Pa.
 Ohmite Mfg. Co., Newtonville, Mass.

PLUGS & JACKS, Telephone Type
 Alden Prods. Co., Brockton, Mass.
 American Molded Prods. Co., 1753 N. Honore, Chicago
 Chicago Tel. Supply Co., Elkhart, Ind.
 Guardian Elec. Mfg. Co., 1627 W. Walnut, Chicago
 Jones, Howard B., 2300 Wabansia Av., Chicago

PRESSES, Plastic Molding
 Kux Machine Co., 3930 W. Harrison, Chicago

PRESSES
 Stokes Machine Co., F. J., Philadelphia
 Watson-Stillman Corp., The, Roselle Park, N. J.

RECTIFIERS, Current
 * Benwood Linze Co., St. Louis, Mo.
 Continental Elec. Co., 903 Merchandise Mart, Chicago
 Electronics Labs., Indianapolis, Ind.
 Faustel Metallurgical Corp., N. Chicago, Ill.
 * General Electric Co., Bridgeport, Conn.
 International Tel. & Radio Mfg. Corp., Newark, N. J.
 Mallory & Co., P. R., Indianapolis, Ind.
 Nothelmer Winding Labs., Trenton, N. J.
 United Clinephone Corp., Torrington, Conn.
 Westinghouse Elec. & Mfg. Co., E. Pittsburgh, Pa.

REGULATORS, Temperature
 Allen-Bradley Co., Milwaukee, Wis.
 Dunn, Inc., Struthers, 1321 Cherry, Philadelphia
 Fenwal Inc., Ashland, Mass.
 * General Electric Co., Schenectady, N. Y.
 Meroid Corp., 4217 Belmont, Chicago
 Minneapolis-Honeywell Regulator, Minneapolis, Minn.
 Spencer Thermostat Co., Attleboro, Mass.

REGULATORS, Voltage
 Acme Elec. & Mfg. Co., Cuba, N. Y.
 Ferranti Elec. Inc., 30 Rockefeller Plaza, N. Y. C.
 * General Elec. Co., Schenectady, N. Y.
 H-B Elec. Co., Philadelphia
 Sola Electric Co., 2525 Clybourn Av., Chicago
 United Transformer Corp., 150 Varlek St., N. Y. C.

RESISTORS, Fixed
 Acme Elec. Heating Co., Boston, Mass.
 * Aerovox Corp., New Bedford, Mass.
 Allen-Bradley Co., Milwaukee, Wis.
 Atlas Resistor Co., 423 Broome St., N. Y. C.
 Centralab, Milwaukee, Wisconsin
 Clarostat Mfg. Co., Brooklyn, N. Y.
 Cont'l Carbon, Inc., Cleveland, O.
 Daven Co., 138 Summit St., Newark, N. J.
 Dixon Crucible Co., Jersey City, N. J.
 Erie Resistor Corp., Erie, Pa.
 Globar Div. Carborundum Co., Niagara Falls, N. Y.
 Hardwick, Hindle, Inc., Newark, N. J.
 Instrument Resistors Co., Little Falls, N. J.
 Intern'l Resistance Co., Philadelphia
 Lectrohm, Inc., Cleora, Ill.
 Ohmite Mfg. Co., 4835 W. Flournoy, Chicago
 Precision Resistor Co., Newark, N. J.
 Sensitive Research Inst. Corp., 4545 Bronx Blvd., N. Y. C.
 Shalleross Mfg. Co., Collingdale, Pa.
 Sprague Specialties Co., N. Adams, Mass.
 Stackpole Carbon Co., St. Marys, Pa.
 Ward Leonard Elec. Co., Mt. Vernon, N. Y.
 White Dental Mfg. Co., 10 E. 40th St., N. Y. C.
 Wirt Co., Germantown, Pa.

RESISTORS, Fixed Precision
 Instrument Resistors, Inc., Little Falls, N. J.
 Intern'l Resistance Co., Philadelphia
 Ohmite Mfg. Co., 4835 Flournoy St., Chicago

RESISTORS, Variable
 * Aerovox Corp., New Bedford, Mass.
 Allen-Bradley Co., Milwaukee, Wis.
 Amer. Instrument Co., Silver Spring, Md.
 Atlas Resistor Co., N. Y. C.
 Centralab, Milwaukee, Wis.
 Chicago Tel. Supply Co., Elkhart, Ind.
 Cinema Eng. Co., Burbank, Cal.
 Clarostat Mfg. Co., Brooklyn, N. Y.
 Cutler-Hammer, Inc., Milwaukee, Wis.
 DeJur Amseco Corp., Shelton, Conn.
 Electro Motive Mfg. Co., Willimantic, Conn.
 General Radio Co., Cambridge, Mass.
 G-M Labs., Inc., Chicago, Ill.
 Hardwick, Hindle, Inc., Newark, N. J.
 Instrument Resistors, Inc., Little Falls, N. J.

Intern'l Resistance Co., Philadelphia
 Mallory & Co., P. R., Indianapolis, Ind.
 Ohio Carbon Co., Cleveland, Ohio
 Ohmite Mfg. Co., 4835 W. Flournoy St., Chicago
 Precision Resistor Co., Newark, N. J.
 Shalleross Mfg. Co., Collingdale, Pa.
 Stackpole Carbon Co., St. Marys, Pa.
 Utah Radio Prods. Co., 820 Orleans St., Chicago
 Ward Leonard Elec. Co., Mt. Vernon, N. Y.
 Wirt Co., Germantown, Pa.

RESISTORS, Variable, Ceramic Base
 Ohmite Mfg. Co., 4835 Flournoy St., Chicago

RIVETS, Plain
 Central Screw Co., 3519 Shields Av., Chicago
 Progressive Mfg. Co., Torrington, Conn.
 Republic Steel Corp., Cleveland, O.

SCREW MACHINE PARTS, Non-Metallic
 Continental-Diamond Fibre Co., Newark, Del.

SCREWS, Recessed Head
 American Screw Co., Providence, R. I.
 Bristol Co., The, Waterbury, Conn.
 Chandler Prods. Co., Cleveland, O.
 Continental Screw Co., New Bedford, Mass.
 Corbin Screw Corp., New Britain, Conn.
 International Screw Co., Detroit, Mich.
 Lamson & Sessions, Cleveland, O.
 National Screw & Mfg. Co., Cleveland, O.
 New England Screw Co., Keene, N. H.
 Parker Co., Charles, The, Meriden, Conn.
 Parker-Kalon Corp., 198 Varlek, N. Y. C.
 Pawtucket Screw Co., Pawtucket, R. I.
 Pheol Mfg. Co., Chicago
 Russell, Burdall & Ward Bolt & Nut Co., Port Chester, N. Y.
 Scovell Mfg. Co., Waterbury, Conn.
 Shakeproof, Inc., 2501 N. Keeler Av., Chicago
 Southington Hardw. Mfg. Co., Southington, Conn.
 Standard Pressed Steel Co., Jenkintown, Pa.
 Whitney Screw Corp., Nashua, N. H.

SCREWS, Self-Tapping
 American Screw Co., Providence, R. I.
 Central Screw Co., 3519 Shields Av., Chicago
 Continental Screw Co., New Bedford, Mass.
 Parker-Kalon Corp., 198 Varlek, N. Y. C.
 Shakeproof, Inc., 2501 N. Keeler, Chicago

SCREWS, Set and Cap
 Allen Mfg. Co., Hartford, Conn.
 Parker-Kalon Corp., 198 Varlek, N. Y. C.
 Republic Steel Corp., Cleveland, O.
 Shakeproof, Inc., 2501 N. Keeler Av., Chicago

SCREWS, Hollow & Socket Head
 Allen Mfg. Co., Hartford, Conn.
 Central Screw Co., 3519 Shields, Chicago
 Parker-Kalon, 198 Varlek, N. Y. C.
 Standard Pressed Steel Co., Jenkintown, Pa.

SELENIUM
 * Benwood Linze Co., St. Louis, Mo.

SHEETS, Electrical
 American Rolling Mill Co., Middletown, O.
 Carnegie-Illinois Steel Corp., Pittsburgh, Pa.
 Follansbee Steel Corp., Pittsburgh, Pa.
 Granite City Steel Co., Granite City, Ill.
 Newport Rolling Mill Co., Newport, Ky.
 Republic Steel Corp., Cleveland, O.
 Ryerson & Son, Inc., Jos. T., Chicago

SOCKETS, Tube
 Aladdin Radio Industries, 501 W. 35th St., Chicago
 Alden Prods. Co., Brockton, Mass.
 Amer. Phenolic Corp., 1830 S. 54th Av., Chicago
 Amer. Radio Hardware Co., 476 B'way, N. Y. C.
 Birnbach Radio Co., 145 Hudson, N. Y. C.
 Bud Radio, Inc., Cleveland, O.
 Cineh Mfg. Co., 2335 W. Van Buren St., Chicago
 Cont'l-Diamond Fibre Co., Newark, Del.
 Eagle Elec. Mfg. Co., Brooklyn, N. Y.
 Eby, Inc., H. H., Philadelphia
 Federal Screw Prods. Co., 26 S. Jefferson, Chicago
 Franklin Mfg. Corp., 175 Varlek, N. Y. C.
 Hammantund Mfg. Co., 424 W. 33 St., N. Y. C.
 Johnson Co., E. F., Waseca, Minn.
 Jones, Howard B., 2300 Wabansia, Chicago
 Micarta Fabricators, Inc., 4619 Ravenswood, Chicago
 Millen Mfg. Co., James, Malden, Mass.
 Miller Co., J. W., Los Angeles, Cal.
 Nat'l Co., Malden, Mass.
 Remler Co., San Francisco, Cal.
 Smith Co., Maxwell, Hollywood, Cal.

SOLDER, Self-fluxing
 Garden City Laboratory, 2744 W. 37th Pl., Chicago
 * General Elec. Co., Bridgeport, Conn.
 Kester Solder Co., 4209 Wrightwood Av., Chicago
 Ituby Chemical Co., Columbus, O.

ARE YOU MISSING ANY BACK ISSUES OF FM?

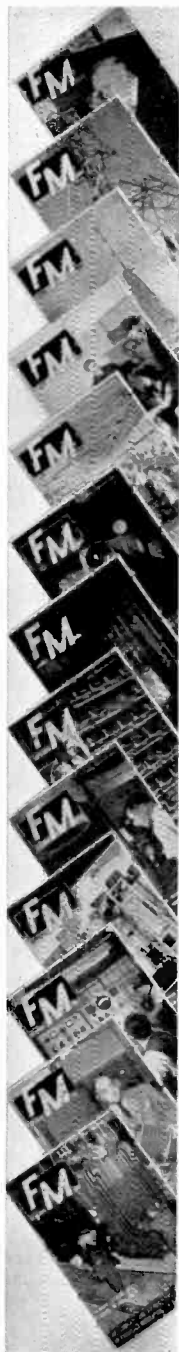

Every issue of FM contains data on the mechanical and electrical design of radio equipment that every engineer should have right on his desk. Check this list to see which issues are missing from your file:

- November, 1940
- July
- Out of Print
- August
- December
- September
- January, 1941
- October
- February
- November
- Out of Print
- December
- March
- January, 1942
- April
- February
- May
- March
- June
- April

Then send in your order at once. The price is 25 cents each, or six copies for \$1.00, postpaid.

If you haven't the December 1940 and January 1941 issues, order them now, as only a few copies remain.

This is your opportunity to get a wealth of technical data written by leading engineers, available from no other source.

SIX COPIES \$1.00 POST PAID

FM Company, Publishers

112 East 36th Street • New York City

SOLDER POTS

Lectrolum, Inc., Cicero, Ill.

SPEAKERS, Outdoor Type

University Labs., 195 Chrystle St., N. Y. C.

SPRINGS

Accurate Spring Mfg. Co., 3817 W. Lake, Chicago

American Spring & Mfg. Corp., Holly, Mich.

American Steel & Wire Co., Rockefeller Bldg., Cleveland, O.

Barnes Co., Wallace, Bristol, Conn.

Cuyahoga Spring Co., Cleveland, O.

Gibson Co., Wm. D., 1800 Clybourn Ave., Chicago

Hubbard Spring Co., M. D., Pontiac, Mich.

Hunter Pressed Steel Co., Lansdale, Pa.

Instrument Specialties Co., Little Falls, N. Y.

Muehlhausen Spring Corp., Logansport, Ind.

Peek Spring Co., Plainville, Conn.

Raymond Mfg. Co., Corry, Pa.

SUPPRESSORS, Parasitic

Ohmite Mfg. Co., 4835 Flournoy St., Chicago

SWITCHES, Key

Chicago Tel. Supply Co., Elkhart, Ind.

SWITCHES, Rotary Tap, Ceramic Base

Ohmite Mfg. Co., 4835 Flournoy St., Chicago

TRANSFORMERS, IF

Aladdin Radio Industries, 501 W. 35th St., Chicago

Amer. Transformer Co., Newark, N. J.

Automatic Windings Co., E. Passaic, N. J.

Caron Mfg. Co., 415 S. Aberdeen, Chicago

D-X Radio Prods. Co., 1575 Milwaukee, Chicago

General Winding Co., 254 W. 31 St., N. Y. C.

Guthman & Co., 400 S. Peoria St., Chicago

Hannmarlund Mfg. Co., 424 W. 33 St., N. Y. C.

Melssner Mfg. Co., Mt. Carmel, Ill.

Millen Mfg. Co., James, Malden, Mass.

Miller Co., J. W., Los Angeles, Cal.

Natl'l Co., Malden, Mass.

Sickles Co., F. W., Springfield, Mass.

Telradco Eng. Corp., 484 Broome St., N. Y. C.

Triumph Mfg. Co., 4017 W. Lake, Chicago

TRANSFORMERS, Receiver Audio & Power

Aemie Elec. & Mfg. Co., Cuba, N. Y.

Amer. Transformer Co., Newark, N. J.

Amplifier Co. of Amer., 17 W. 20th St., N. Y. C.

Audio Devel. Co., N. Minneapolis, Minn.

Cineadigraph Speakers, Inc., 3929 S. Michigan, Chicago

Electronic Trans. Co., 515 W. 29 St., N. Y. C.

Ferranti Elec., Inc., 30 Rockefeller Plaza, N. Y. C.

Freed Trans. Co., 72 Spring St., N. Y. C.

Gen'l Radio Co., Cambridge, Mass.

General Trans. Corp., 1250 W. Van Buren, Chicago

Haldorson Co., 4500 Ravenswood, Chicago

Jefferson Elec. Co., Bellwood, Ill.

Kenyon Transformer Co., 840 Barry St., N. Y. C.

Magnetic Windings Co., Easton, Pa.

New York Transformer Co., 51 W. 3rd, N. Y. C.

Norwalk Transformer Corp., 8. Norwalk, Conn.

Raytheon Mfg. Co., Waltham, Mass.

Skaugs Transformer Co., Los Angeles, Cal.

Standard Transformer Corp., 1500 N. Halsted, Chicago

Superior Elec. Co., Bristol, Conn.

Thorlanson Elec. Mfg. Co., 500 W. Huron, Chicago

Utah Radio Prods. Co., 820 Orleans St., Chicago

TUBE MANUFACTURING MACHINES

Hilton Eng. Labs., Redwood City, Calif.

TUBES, Cathode Ray

Dumont Labs., Allen B., Passaic, N. J.

Farnsworth Tele. & Radio Corp., Ft. Wayne, Ind.

General Elec. Co., Schenectady, N. Y.

Hygrade-Sylvania Corp., Salem, Mass.

Natl'l Union Radio Corp., Newark, N. J.

RCA Mfg. Co., Camden, N. J.

TUBES, Current Regulating

Ampertec Co., 561 Broadway, N. Y. C.

Champion Radio Works, Danvers, Mass.

Hytron Corp. & Hytronic Labs., Salem, Mass.

RCA Mfg. Co., Camden, N. J.

TUBES, Photo-Electric

Bradley Labs., New Haven, Conn.

Cont'l Elec. Co., Geneva, Ill.

De Jur-Amsco Corp., Shelton, Conn.

De Vry, Herman A., 1111 W. Center, Chicago

Electronic Laboratory, Los Angeles, Cal.

Emby Prods. Co., Los Angeles, Cal.

General Elec. Co., Schenectady, N. Y.

General Scientific Corp., 4829 S. Kedzie Av., Chicago

G-M Labs., 4313 N. Knox Av., Chicago

Leeds & Northrup Co., Philadelphia

Natl'l Union Radio Corp., Newark, N. J.

Photobell Corp., 123 Liberty St., N. Y. C.

RCA Mfg. Co., Camden, N. J.

Reitron Corp., 2159 Magnolia Av., Chicago

Rhamstine, J., Detroit, Mich.

Westinghouse Lamp Div., Bloomfield, N. J.

Weston Elec. Inst. Corp., Newark, N. J.

TUBES, Receiving

General Electric Co., Schenectady, N. Y.

Hygrade-Sylvania Corp., Salem, Mass.

Hytron Corp., Salem, Mass.

Ken-Rad Tube & Lamp Corp., Owensboro, Ky.

Natl'l Union Radio Corp., Newark, N. J.

Raytheon Prod. Corp., 420 Lexington Av., N. Y. C.

RCA MFG Co., Camden, N. J.

Tung-Sol Lamp Works, Newark, N. J.

TUBES, Transmitting

Ampertec Electronic Prods., Brooklyn, N. Y.

Elbel-McCullough, Inc., San Bruno, Cal.

Federal Telegraph Co., Newark, N. J.

General Elec. Co., Schenectady, N. Y.

Helntz & Kaufman, S. San Francisco, Cal.

Hytron Corp., Salem, Mass.

Natl'l Union Radio Corp., Newark, N. J.

Raytheon Prod. Corp., 420 Lexington Av., N. Y. C.

RCA Mfg. Co., Camden, N. J.

Taylor Tubes, Inc., 2341 Wabasha, Chicago

United Electronics Co., Newark, N. J.

Westinghouse Lamp Div., Bloomfield, N. J.

TUBES, Voltage-Regulating

Ampertec Co., 561 Broadway, N. Y. C.

Hygrade-Sylvania Corp., Salem, Mass.

Hytron Corp., Salem, Mass.

RCA Mfg. Co., Camden, N. J.

TUBING, Laminated Phenolic

Brandywine Fibre Prods. Co., Wilmington, Del.

Formica Insulation Co., Chelmsford, O.

General Electric Co., Pittsfield, Mass.

Insulation Mfgs. Corp., 565 W. Washington Blvd., Chicago

Mesa Insulator Co., 196 Varlek, N. Y. C.

Natl'l Vulcanized Fibre Co., Wilmington, Del.

Richardson Co., Melrose Park, Chicago

Synthane Corp., Oaks, Pa.

Westinghouse Elec. & Mfg. Co., E. Pittsburgh, Pa.

BENWOOD LINZE CO.

Chicago: 549 W. Randolph St.

Hollywood: 6406 Sunset Blvd.

New York: 17 E. 42 St.

Pittsburgh: 337 Ave. F. Forrest Hills

BROWNING LABORATORIES, INC.

Address all correspondence to Winchester, Mass.: 755 Main St., Win. 2121

GENERAL ELECTRIC CO.

Boston: 140 Federal St., Hubbard 1800

Chicago: 840 S. Canal St., Wabash 5611

Cleveland: 4966 Woodland Ave., Euclid 4464

New York: 570 Lexington Ave., Wlekergham 2-1311

Philadelphia: 1405 Locust Ave., Pennypacker 9000

San Francisco: 235 Montgomery St., Douglas 3740

LINGO & SON, INC., JOHN E.

Address all correspondence to Camden, N. J.: 28 & Van Buren Ave., Camden 487

Wilmington Fibre Specialty Co., Wilmington, Del.

TUBING & SLEEVING, Varnished

Cambric, Glass-Fibre, Spaghetti

Bentley-Harris Mfg. Co., Conshohocken, Pa.

Brand & Co., Wm., 276 Fourth Av., N. Y. C.

Endurette Corp. of America, Cliffwood, N. J.

General Elec. Co., Bridgeport, Conn.

Insulation Mfgs. Corp., 565 W. Washington Blvd., Chicago

Mesa Insulator Co., 196 Varlek St., N. Y. C.

VARNISHES, Insulating, Air-Drying

John C. Dolph Co., Newark, N. J.

VARNISHES, Insulating, Baking

John C. Dolph Co., Newark, N. J.

VIBRATORS, Power Supply

Turner Co., Cedar Rapids, Ia.

WIRE, Bare

American Steel & Wire Co., Cleveland, O.

Anaconda Wire & Cable Co., 25 Broadway, N. Y. C.

Ansonia Elec. Co., Ansonia, Conn.

Belden Mfg. Co., 4633 W. Van Buren, Chicago

General Elec. Co., Bridgeport, Conn.

Phosphor Bronze Smelting Co., Philadelphia

Rea Magnet Wire Co., Fort Wayne, Ind.

Roebling's Sons Co., John, Trenton, N. J.

WIRE, Hookup

Garett Mfg. Co., Brookfield, Mass.

WIRE, Magnet

Aeme Wire Co., New Haven, Conn.

American Steel & Wire Co., Cleveland, O.

Anaconda Wire & Cable Co., 25 Broadway, N. Y. C.

Ansonia Elec. Co., Ansonia, Conn.

Belden Mfg. Co., 4633 W. Van Buren, Chicago

Electric Auto-Lite Co., The, Port Huron, Mich.

General Elec. Co., Bridgeport, Conn.

General Elec. Co., Schenectady, N. Y.

Holyoke Wire & Cable Corp., Holyoke, Mass.

Rea Magnet Wire Co., Fort Wayne, Indiana

Rockbestos Prods. Corp., New Haven, Conn.

Roebling's Sons Co., John, Trenton, N. J.

DIRECTORY OF MANUFACTURERS'

REPRESENTATIVES & SALES OFFICES

IN RADIO WAR PRODUCTION AREAS

* These manufacturers' names are starred in the Radio-Electronics Products Directory

AEROVOX CORP.

Boston: 94 Portland St., Lafayette 3484
Chicago: 4753 B'way, Long Beach 0109
Cleveland: 219 Film Ex. Bldg., Prospect 0719

Los Angeles: 1341 S. Hope St., Itchen-
mond 9121

New York: 347 Fifth Ave., Murray Hill
5-7090

Pittsburgh: 918 Hill St., Churchhill 0838

FCC RELAXES FM REGULATIONS

(CONTINUED FROM PAGE 27)

terial for further construction and needed technical personnel become available.

The following stations, totalling fifty-one, come within the scope of the FCC announcement. In this list, CP indicates that the station already holds a construction permit. PT indicates that the station is now engaged in program tests. SA shows that the station has a special temporary authorization, permitting it to be on the air.

K31LA CP Columbia Broadcasting System, Hollywood, Calif.

K37LA CP Earle C. Anthony, Inc., Los Angeles, Calif.

K45LA SA Don Lee Broadcasting System, Los Angeles, Calif.

K6LA CP Metro-Goldwyn-Mayer Studios, Los Angeles, Calif.

W53H PT Travelers Broadcasting Service, Hartford, Conn.

W65H SA WDRC, Inc., Hartford, Conn.

W47C CP WJJD, Inc., Chicago, Ill.

W50C SA WGN, Inc., Chicago, Ill.

W67C SA Columbia Broadcasting System, Chicago, Ill.

W75C SA Moody Bible Institute, Chicago, Ill.

W79C CP Oak Park Realty & Amusement Co., Chicago, Ill.

W83C CP WHFC, Inc., Chicago, Ill.

W71RCP Rockford Broadcasters, Inc., Rockford, Ill.

W71SB CP South Bend Tribune, South Bend, Ind.

W49FW SA Westinghouse Radio Stations, Fort Wayne, Ind.

W73I CP Associated Broadcasters, Inc., Indianapolis, Ind.

W45BR PT Baton Rouge Broadcasting Co., Baton Rouge, La.

W43B SA Yankee Network, Boston, Mass.

W67B SA Westinghouse Radio Stations, Boston, Mass.

W77XI CP WJIM, Inc., Lansing, Mich.

W46D PT The Evening News Association, Detroit

W49D SA John Lord Booth, Detroit, Mich.

K51L CP St. Louis University, St. Louis, Mo.

K59L CP Columbia Broadcasting System, St. Louis

K49KC SA Commercial Radio Equipment Co., Kansas City, Mo.

W39BPT Yankee Network, Mount Washington, N. H.

W01NJ CP New Jersey Broadcasting Corp., Jersey City, N. J.

W95NJ CP Bremer Broadcasting Corp., Jersey City

W31NY CP Edwin H. Armstrong, Alpine, N. J.

W39NY CP Municipal Broadcasting System, N. Y. C.

W47NYS SA Muzak Radio Broadcasting Station, N. Y. C.

W55NY CP William G. H. Finch, New York City

W59NY CP Interstate Broadcasting Co., N. Y. C.

W63NY SA Marcus Loew Booking Agency, N. Y. C.

W67NY SA Columbia Broadcasting System, N. Y. C.

W71NY SA Barnberger Broadcasting Service, N. Y. C.

W75NY CP Metropolitan Television, Inc., N. Y. C.

W47ASA Capital Broadcasting Co., Schenectady, N. Y.

W85A PT General Electric Company, Schenectady, N. Y.

W49BN CP Wylie B. Jones Adv. Agency, Binghamton, N. Y.

W41MM SA Gordon Gray, Clingman's Peak, N. C.

W45CM SA WBNS, Inc., Columbus, Ohio

W49PH SA Pennsylvania Broadcasting Co., Philadelphia, Pa.

W53PH PT WFIL Broadcasting Corp., Philadelphia

W57PH SA Westinghouse Radio Stations, Philadelphia, Pa.

W69PH SA WCAU Broadcasting Co., Philadelphia

W73PH SA William Penn Broadcasting Corp., Philadelphia, Pa.

W65PH CP Seaboard Radio Broadcasting Corp., Philadelphia, Pa.

W75P SA Westinghouse Radio Stations, Pittsburgh

K51AM CP Amarillo Broadcasting Corp., Amarillo, Texas

K47SL CP Radio Service Corporation of Utah, Salt Lake City, Utah

W55M PT The Journal Company, Milwaukee, Wis.

W51C Zenith Radio Corporation, Chicago, Ill.

W45V Evansville On the Air, Inc., Evansville, Ind.

W51R Stromberg-Carlson Telephone Mfg. Co., Rochester, N. Y.

W47P Walker-Downing Radio Corp., Pittsburgh, Pa.

W47NV National Life & Accident Insurance Co., Nashville, Tenn.



GROUP SUBSCRIPTIONS

FM MAGAZINE, 112 E. 36 St., New York City

Please enter the following subscriptions, for which remittance is enclosed:

- One 1-year subscription \$3.00
- Two 1-year subscriptions \$5.00
- Three 1-year subscriptions \$6.00
- Four 1-year subscriptions \$7.00
- Five 1-year subscriptions \$8.00

NOTE: Groups of 6 subscriptions or more will be accepted at the rate of \$1.60 each for one year.

NAME

STREET

CITY, STATE

Position

Company

NAME

STREET

CITY, STATE

Position

Company

NAME

STREET

CITY, STATE

Position

Company

NAME

STREET

CITY, STATE

Position

Company

NAME

STREET

CITY, STATE

Position

Company

FREE: A copy of the second or third bound volume, as illustrated on page 28, will be sent you absolutely free if you will make up a group of five subscriptions among your associates. Take advantage of this unusual offer without delay!

The Right Answers to Unusual Radio-Electronic Problems

FOR EXAMPLE: what is probably the most sensitive, effective, and certain method of protecting electric substation equipment, radio transmitters, pumping stations, and similar installations is the Browning Boundary Protection System.

Born of the wartime need of protection against saboteurs, this system was developed and perfected by the Browning Laboratories, in collaboration with public utilities. It is capable of innumerable applications where it is desired to signal, in any of several ways, the approach of a trespasser to the boundary of property requiring protection.

This is only one of many products of research which has given the Browning Laboratories such a prominent position in the radio-electronic field.

In personnel, equipment, and experience, this organization, under the direction of Glenn H. Browning, affords exceptional facilities leading to sound and practical applications of radio-electronic equipment for both military and commercial use.

★ BROWNING ★ Frequency Monitor

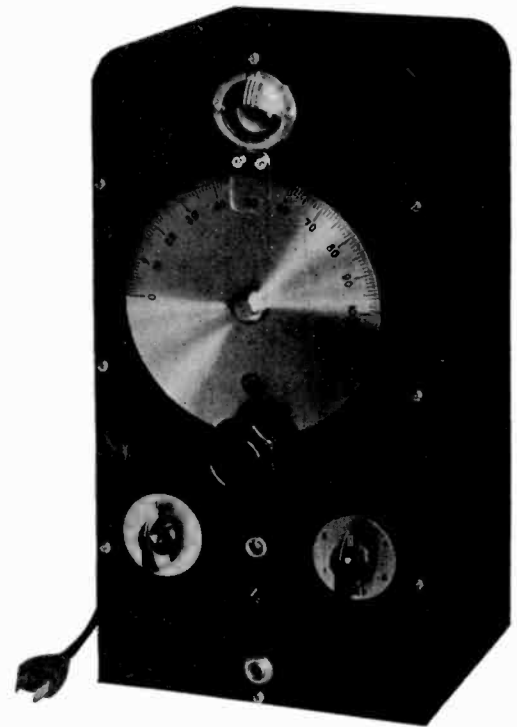

Available with One to Four Bands
Priced \$125 to \$185

The Browning Frequency Monitor, illustrated above, is used as standard equipment for police and public utility emergency radio systems throughout the USA. It provides the greater precision now required by the FCC for all emergency transmitters. Suitable for both FM and AM, the Browning Monitor is built with one to four bands, for any frequencies between 1.5 and 60 mc. Prices:

1 Band.....\$125	3 Bands.....\$165
2 Bands..... 145	4 Bands..... 185

BROWNING LABORATORIES, Inc.

32 755 MAIN STREET

WINCHESTER, MASS.

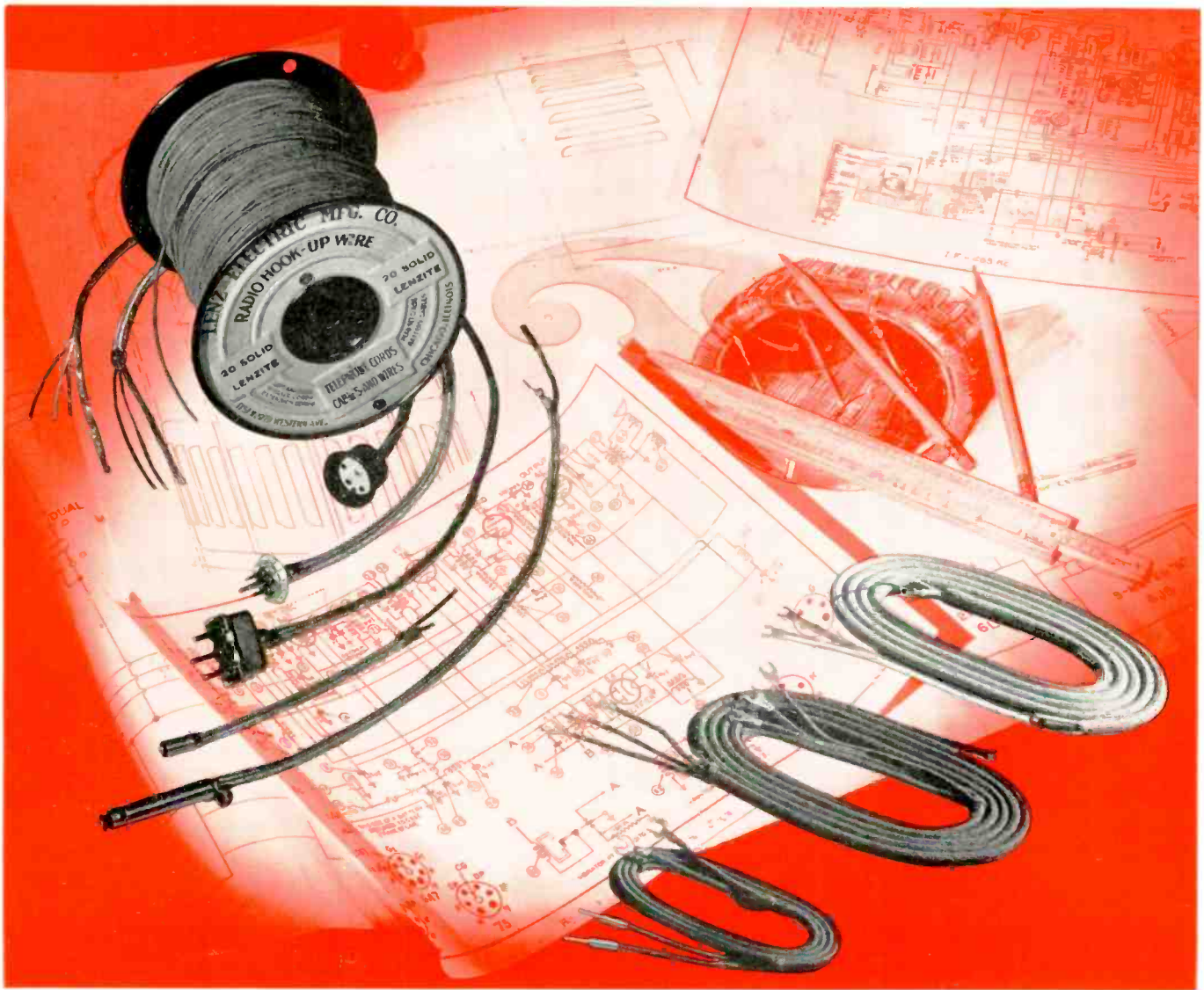

to the designers of **ELECTRONIC EQUIPMENT**



LENZ is an organization of specialists in design of wires and cables for electronic equipment. You'll find thousands upon thousands of feet of LENZ standard and specially designed Wires, Cables and Cords in military radio and wire communications the world over—in Radar and

other types of electronic equipment.

This specialized experience and the facilities of the LENZ organization are at your disposal for the solution of your wire problems. Call in a LENZ Wire and Cable Technician—with no obligation. Mail the coupon for a LENZ Catalog.

ELECTRICAL CORDS, WIRES & CABLES



LENZ ELECTRIC MFG. CO.

1751 NO. WESTERN AVENUE CHICAGO, ILLINOIS

IN BUSINESS SINCE 1904

**MAIL THIS COUPON FOR LENZ CATALOG
AND TECHNICAL INFORMATION**

Lenz Electric Mfg. Co., 1751 No. Western Ave., Chicago ■ Please send me Lenz Catalog

Name.....

Address.....

City..... State.....



LINK MODEL 205
INTERMEDIATE FREQ. AM RECEIVER

LINK CONTROL BOX, HANDSET,
AND SPRING BASE ANTENNA

LINK MODEL 35UFM
MOBILE FM TRANSMITTER

North Carolina goes 2-way with **LINK FM EQUIPMENT**

Another state-wide two-way radio communication system is being completed by the North Carolina Department of Motor Vehicles, Highway Patrol Division, under the direction of Major J. T. Armstrong.

Link equipment, as illustrated, has been purchased for this project. North Carolina was already equipped for one-way communication to Patrol cars, but this proved inadequate to meet the new responsibilities put upon the Highway Patrol by War conditions.

Confronted with the need of conserving critical communication equipment while augmenting the existing system to meet minimum defense requirements, the following plan was adopted:

The present AM main station transmitter and car receivers are continued in service, and Link Model 35UFM talk-back transmitters are being installed in cars. FM pickup receivers are being set up at strategic points as necessary.

Thus with a minimum use of additional critical equipment, the system efficiency is brought up to wartime requirements with two-way communication, resulting in greatly increased effectiveness of the Highway Patrol.

The experience and knowledge of Link Engineers are at the service of State, County, and Municipal Police officials who are required to revise and enlarge existing or projected systems in accordance with wartime needs.

THESE LINK-EQUIPPED FM STATE-WIDE POLICE SYSTEMS NOW SERVE THE ATLANTIC SEABOARD

CONNECTICUT
DELAWARE
MARYLAND

MASSACHUSETTS
NEW JERSEY

NEW YORK
NORTH CAROLINA
VIRGINIA

THE BEST-EQUIPPED MUNICIPAL POLICE SYSTEMS ALSO USE LINK EQUIPMENT EXCLUSIVELY

*"The Difficult we do Immediately -
The Impossible takes a little longer"*



Fred M. Link 125 WEST 17th ST., NEW YORK, N.Y.
Engineer • Manufacturer Telephone: CHELSEA 2-3838