

FMM

FEBRUARY 1942



100-KW. STATION WGEO
MOVES TO WEST COAST

**RADIO BROADCAST, COMMUNICATIONS & TELEVISION ENGINEERING
AND DESIGN PRACTICE** ★ ★ *Edited by M. B. SLEEPER*

REG. U. S. PAT. OFF.

FM

W51C JUMPS TO 50,000 WATTS

with GL-880's

ZENITH RADIO CORPORATION

ZENITH
RADIO
6001 DICHENS AVENUE
CHICAGO, U.S.A.

CABLE ADDRESS
ZENITHRAD
ALLCOPRA

FOUNDED
DECEMBER 15, 1900

October 27, 1941

Mr. Earl Abbott
General Electric Company
840 South Canal Street
Chicago, Illinois

Dear Mr. Abbott:

We have been operating W51C Zenith's Frequency-Modulated Radio Station in Chicago and its predecessor W9XZR for almost two years. Early in October we raised the power of this station to fifty thousand watts in accordance with the terms of our Construction Permit.

The original installation was planned more than a year ago on the basis of ultimately using two GL-880's in the final stage. These plans were based on the fact that the 880's appeared to us to be the most efficient transmitting tubes for high power operation on the high frequency class. It seemed very evident and should, therefore, be most practical to permit the best circuit design and should, therefore, be most practical in a high-power frequency-modulation transmitter. Even though these tubes had not been seen any commercial field service at the time of our original planning, we believed their use was logical and would represent a forward step.

We are glad to say that we have been very happy with their performance, and feel that we have without doubt made the correct choice. We have found them easy to drive, easy to neutralize, and have found no cooling problems. We believe we are going to receive excellent service from them.

Yours very truly,

ZENITH RADIO CORPORATION
G. E. Gustafson
J. E. Brown
ENGINEERING DEPARTMENT

JES:BO

THE WORLD'S LARGEST RADIO FACTORY ON ONE FLOOR



"the most efficient tubes ... for high frequencies"

The GL-880's ingenious "folded" anode reduces internal lead lengths by 10 inches without sacrificing cooling surface.

"easy to drive"

Two GL-880's with only 1500 watts driving power will deliver an easy 50 kw of FM at 50 mc.

"easy to neutralize"

Dual grid leads for separation of excitation and neutralization minimize neutralizing problems.

"no cooling problems"

The GL-880 is just one tube in General Electric's complete line of top performers. Specify "G-E" on your next tube order, and measure the difference yourself. *General Electric Co., Schenectady, New York.*

(Left) G. E. Gustafson,
Asst. Vice President in
Charge of Engineering;
(right) J. E. Brown, Exec-
utive Engineer

This tube, although developed for FM and television, has unusual efficiency at international and standard broadcast frequencies. A pair will give a 50-kw plate-modulated carrier at 25 mc!



FOR



ALL YOUR



FM



NEEDS



FM Broadcast Transmitters
250 to 50,000 Watts

S-T Transmitters

Measuring and Testing
Equipment

Receivers for Home
and S-T Service

FM Police and Emergency
Transmitters and Receivers

Tubes

GENERAL ELECTRIC

161-91B-8850

FACTS AND FIGURES*



9. How does the cost of advertising in *FM Magazine* compare with other radio engineering papers? An examination of the following figures discloses some interesting facts, in the light of present conditions:

Priorities control has made great changes in the relative effectiveness of radio publications. In the radio field, useful circulation is practically limited to engineers and executives of companies manufacturing radio and associated equipment, of broadcast, communications, and airport stations, large public utilities, state and municipal police, and government departments.

Magazine "A", with a total circulation* of more than 16,000, groups its circulation in the above fields as follows:

Manufacturers	2,579
Management, operation, maintenance	2,929
Consultants and laboratories	584
	6,092

At the 12-time rate, the cost per page per thousand of effective radio coverage is \$40.

This publication has, in addition, circulation among servicemen, students, non-radio manufacturers, schools and libraries, government occupations other than communications, miscellaneous and unclassified to the extent of 9,985.

FM Magazine, with a total circulation* of 5,290, is concentrated in effectiveness as shown below:

Radio manufacturers	1,322
Radio stations	1,497
Government, police, utilities	1,089
Airports	408
Sold as bound volumes	100
	4,416

At the 12-time rate, the cost per page per thousand of effective radio coverage in *FM Magazine* is \$27.

There are about 700 manufacturers of radio apparatus, materials, components, and associated equipment, 850 radio stations, 650 police systems in cities above 17,000 population, 150 public utilities with 20,000 electric meters or more, and 420 airports handling radio traffic. These total 2,570. They represent the sources capable of placing orders with sufficiently high priority ratings to warrant acceptance.

These figures show clearly the extent to which events of the last few months have changed the relative effectiveness of radio engineering publications as advertising media.

*As given in Standard Rate & Data

M. B. SLEEPER, *Editor and Publisher*

NEW SHURE BROADCAST DYNAMIC SUPER-CARDIOID

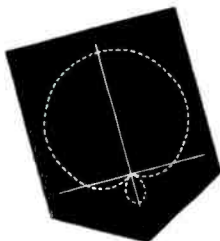

Model 556A for 35-50 ohms, Model 556B for 200-250 ohms, and Model 556C high impedance . . . at only \$75.00 list.

A New Concept
of Directional
Performance for
Broadcast Service



NEW — Wide Angle Pick-up—yet Twice as Unidirectional as the Cardioid

NEW — Single Moving-Coil Highly Immune to Mechanical Vibration and Wind Noises

NEW — Improved "Ultra" Wide-Range Response from 40 to 10,000 cycles

*Patented by Shure Brothers

Now Available for Immediate Delivery

The newest, most advanced microphone available today for Broadcast service. The "Super-Cardioid" pattern first developed by Shure Engineers, together with the patented Shure Uni-phase* single-unit construction makes the big difference. It has the most unidirectional pattern in the limaçon family. It is twice as unidirectional as the Cardi-

oid, from the standpoint of receiving front sounds and rejecting rear sounds, yet has wide-angle front pick-up. Decreases pick-up of reverberation energy and random noise 73%. Improved frequency response assures full reproduction of music, crisp reproduction of speech. The axial polar pattern is symmetrical at all frequencies. It's

the ideal answer for studio and remote microphone problems.

Broadcast Engineers: You can have the "Super-Cardioid" for 30-day free test in your station without obligation. Write us today.

SHURE BROTHERS, 221 W. Huron Street, Chicago, U. S. A.

Designers and Manufacturers of Microphones & Acoustic Devices

SHURE



WGEO MOVES

OF GREAT significance is the dismantling of General Electric's 100-kw. short-wave transmitter at Schenectady, after its purchase by the U. S. Government and its removal to San Francisco.

This transmitter, under the new call KWID, will beam unbiased news of the world to the Far East to combat Axis-originated propaganda and at the same time keep the men in our own armed forces in touch with their home land. Details of the original WGEO were given in *FM Magazine* for November, 1941.

This month's cover photograph shows some of the transformers, the largest weighing 10 tons, as they were being loaded on flat cars at Schenectady in preparation for the trip.

Studios for the new WKID are being set up at Hotel Mark Hopkins in San Francisco, where experts in foreign languages will handle the west-bound programs. The new station will augment the service from 50-kw. KGEL, which has been on the air for more than three years with programs for Latin America, Asia, the Antipodes, and Africa, in eight languages and two foreign dialects.

O. F. Walker, from Schenectady, is now in San Francisco, supervising the erection of KWID.

What a contrast between the state of the radio in 1917 and 1942! At that time there was a general conviction long-distant transmission required the use of long waves, around 10,000 meters.



THE RADIO ENGINEERING NEWS JOURNAL OF BROADCASTING, COMMUNICATIONS & TELEVISION

VOL. 2

FEBRUARY, 1942

NO. 4

COPYRIGHT 1942 M. B. SLEEPER

CONTENTS

DON LEE FM TRANSMITTER	4
RADIO PREPARES FOR U. S. OFFENSIVE	5
<i>by M. B. Sleeper</i>	
NEW APPLICATIONS OF FM	6
<i>by Karl Rath</i>	
FM PACKAGED FOR EMERGENCIES	10
<i>by Paul A. Wandelt</i>	
THE MANUFACTURERS SAY:	12
<i>A Statement by Octave Blake</i>	
FIELD STRENGTH SURVEY METHODS	14
<i>by Charles Singer</i>	
MAKING A START IN TELEVISION, Part 3	21
<i>by Austin Lescaboura</i>	
DYNAMIC SYMMETRY IN RADIO DESIGN, Part 2	24
<i>by Arthur F. Van Dyck</i>	
SPOT NEWS	32
NEWS PICTURE	33
<i>Broadcast from I.R.E. Convention</i>	
FM STATION LISTING	35
FCC DEFINES FREEZING POLICIES	39

THE COVER DESIGN AND CONTENTS OF FM MAGAZINE ARE FULLY PROTECTED BY U. S. COPYRIGHTS, AND MUST NOT BE REPRODUCED IN ANY MANNER OR IN ANY FORM WITHOUT WRITTEN PERMISSION

★ ★ ★ ★ ★

M. B. SLEEPER, *Editor and Publisher*

S. R. COWAN, *Advertising Manager*

Published by: FM COMPANY

Editorial and Advertising Office:

112 East 36th Street, New York City, Tel. LE 2-3070

FM Magazine is issued on the 20th of each month. Single copies 25¢ — Yearly subscription in the U.S.A. \$3.00; foreign \$4.00. Subscriptions should be sent to FM Company, 112 East 36th St., New York City.

A charge of 25¢ each will be made for duplicating copies returned because of subscriber's failure to give change of address.

The publishers will be pleased to receive articles, particularly those well illustrated with photos and drawings, concerning all phases of FM developments. Manuscripts should be sent to the publication office, at New York City. Contributions will be neither acknowledged nor returned unless accompanied by adequate postage, packing, and directions, nor will FM Magazine be responsible for their safe handling in its office or in transit.

Advertising correspondence, copy, and cuts should be addressed to the advertising office at New York City.



K45LA, LOS ANGELES

DON LEE STATION ON 1,700-FT. MT. LEE GETS ITS PROGRAMS OVER A 4-MILE, 15,000-CYCLE LINE FROM THE HOLLYWOOD STUDIOS. WESTERN ELECTRIC TRANSMITTER PUTS 1 KW. INTO THE LINGO ANTENNA SHOWN HERE. POWER WILL BE INCREASED LATER. MEANWHILE, LISTENERS FROM SAN DIEGO TO VENTURA ARE BECOMING FM PROGRAM ENTHUSIASTS. STATION IS PROGRAMED INDEPENDENTLY, TAKING ONLY HIGH SPOTS FROM MUTUAL AND DON LEE NETS

†

RADIO PREPARES FOR U. S. OFFENSIVE

Industry Is Better Set Up Than in 1917 to Serve in Fast-Moving Military Action

BY M. B. SLEEPER

CLEAR-THINKING minds have long known that the English could, at best, do little more than hold the British Isles while losing ground slowly elsewhere until such time as the United States assumed the major rôle of carrying defeat to the Axis.

This condition was known to Chamberlain and voiced by him, though the ears of the American people could not hear because they were turned toward the more pleasant words of those who, we know now, served the enemy so well by urging that we keep out of the war by helping England to win it, yet without helping enough to be drawn in ourselves.

Now, added to what has happened at Pearl Harbor, Singapore and the Philippines, we have Churchill's speech of February 15th to make it clear that this is Uncle Sam's war, in which we are joined with allies whose aid to us depends to a large extent upon the production of our own industries.

We have at last come face to face with the responsibility of assuming the offensive, while enabling our allies to hold their own. In this effort, radio has a tremendous load to carry.

Conditions in 1917 ★ At the time of the last war, the few companies which produced radio equipment had to manufacture practically every part they needed in their own plants. Radio shop workers were nearly all instrument makers. While the circuits were relatively simple, the mechanical design was more complicated, the construction more bulky, and the man-hours per set much greater than today.

Of the vacuum tube transmitter and receiver designs put into production, many went into warehouses in French ports and stayed there. Aircraft receivers were made, but hardly used. The most effective aircraft transmitters employed spark coils, operated by artillery observers who pounded massive keys with gloved fists. Communication between planes was limited to wing-dipping or hand-waving. Code practice was something that cadet pilots endured in training and forgot at the front.

On the ground, radio communication served more effectively, but while it was valuable when it worked, it failed often enough to be

suspect at all times. The best equipment was still experimental when the war ended.

Developments Since 1918 ★ During the ensuing years, the Army and Navy went their own ways in developing new equipment. Some of the improved designs were worked out by the Signal Corps or the Bureau of Engineering. Others were developed by or with the cooperation of a few small companies that led a precarious existence by specializing on government work, or by the very large concerns making diversified lines of electrical products. The latter wanted to keep in contact with this kind of business, even though, under competitive bidding, contracts went to whatever bidder was currently willing to take a loss for the privilege of continuing to serve the government.

The possibility of showing a profit on this work was generally precluded by innocent-looking typewritten sheets known as Test Specifications. In some cases, the testing equipment, including huge chambers for running tests at high and low temperatures and under conditions of extreme humidity, cost more than the radio apparatus.

A further, and a very great, hazard was the fact that bidders were required to meet specifications that were set forth by men who had no knowledge of their own as to how they could be met. Bidders sometimes spent thousands of dollars on samples, only to have their designs rejected.

These brief notes high-spot the peacetime picture of that totally separate and distinct field of radio activity known as government contract work.

New, Strange and Confusing ★ The obvious plan was to place most of the radio contracts with the few manufacturers who were already handling similar orders. The heavier equipment and that requiring complicated parts of high mechanical precision could not be handled by set manufacturers.

The design of Navy apparatus is entirely different from that used by the Army. The former runs to weight and ruggedness, for it

(CONTINUED ON PAGE 42)

NEW APPLICATIONS OF FM

Part 1. The Zakarias Space Charge Discriminator, and Its Use in Condenser Microphone Circuits

BY KARL RATH*

A NEW frequency discriminator, developed by I. Zakarias,¹ characterized by simple design and high efficiency, appears to be destined to open up numerous possibilities in the radio, audio, measuring, electronic control and various other allied fields. Among the applications to be described in this article are the following: (1) a simple "high frequency" condenser microphone amplifier; (2) an electronic ultra-micrometer; (3) a simplified

phone, has the disadvantage that the aluminum ribbon, with a thickness of only a few thousandths of a millimeter, is extremely sensitive to mechanical shocks and air drafts which greatly impair its performance and operating safety. For this reason, the dynamic and crystal microphone have found a wide use in practice.

Condenser Microphones ★ It is a well known fact,

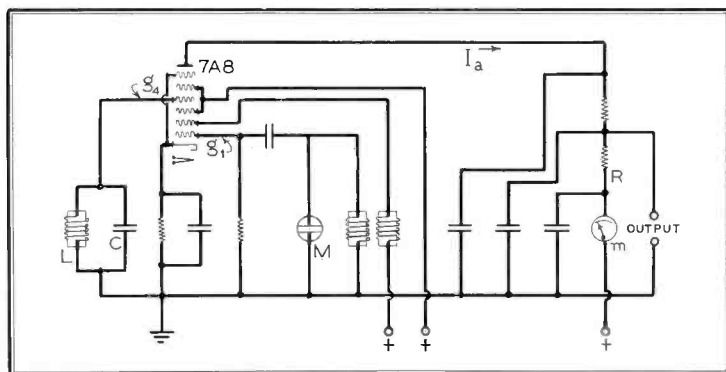

FIG. 1. FM CIRCUIT USED WITH A CONDENSER MICROPHONE IS SAID TO HAVE PERFECT CHARACTERISTICS. THIS DEVELOPMENT IS PARTICULARLY IMPORTANT NOW, BECAUSE NO PERMANENT MAGNET IS USED

method of investigating loud speaker diaphragms; (4) a low frequency generator; (5) a device for checking or measuring inductance, capacitance, and loss angle; (6) a pressure indicator or recording device; and (7) a simple and efficient demodulator for FM radio signals.

A survey of the different types of microphones at present known shows that the use of the original carbon microphone has been more and more limited due mainly to its excessive noise level, its high threshold value, and unfavorable frequency characteristics. The velocity microphone operating on the electrodynamic principle has come more and more into use. This type of microphone, while having more favorable frequency characteristics and lower noise level than the carbon micro-

however, that the most uniform frequency characteristic and the lowest noise level are obtainable with the condenser microphone operated by high frequency current. In this respect, highly favorable results were obtained many years ago. However, due to the lack of a suitable and efficient discriminator to convert the frequency variations produced by the diaphragm movements into proportionate current intensity changes, the high frequency operation of the condenser microphone was abandoned in favor of the low frequency-current polarizing voltage. With the latter, however, many other disadvantages had to be taken into account, such as the use of polarizing voltages up to 400 volts to increase the response sensitivity. This resulted in serious operating difficulties especially in humid air, due to electric discharges between the diaphragm and the fixed electrode spaced by a distance of only a

*Engineer, Radio Patents Corporation, 10 E. 40th Street, New York City.

¹ U. S. Patent 2,208,091.

few hundredths of a millimeter. This caused objectionable speaker noise and defeated the initial advantages of the condenser microphone.

The development of the space charge type discriminator, following the introduction of the modern multi-grid electron tube, has enabled the successful resumption of the high frequency operation of the condenser microphone as well as numerous other devices involving the conversion of small capacity, in-

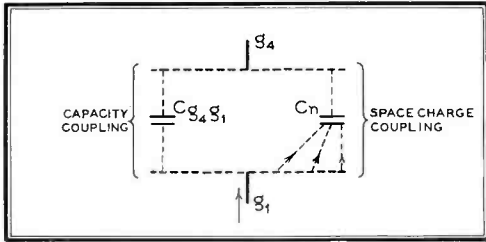

FIG. 2. ILLUSTRATING THE SPACE CHARGE COUPLING EFFECT OBTAINED IN THE CIRCUIT OF FIG. 1

ductance or frequency changes into proportionate and relatively large current variations.

At first the theoretical basis of the new discriminator circuit shown in Fig. 1 will be described briefly.

The tube shown is an octode of the 7A8 mixer type, but any other tube having a pair of control grids g_1 and g_4 separated by a screen grid can be used successfully. Grid g_1 is excited by the frequency modulated oscillations generated by the local oscillator circuit associated with the first and second grids of the tube and including a condenser pick-up or microphone M , while grid g_4 is connected to ground or cathode through a resonant impedance in the form of a parallel resonant circuit LC completely shielded from the rest of the circuit. The plate circuit is of special design basically distinguishing it from the common frequency converter in accordance with the novel function of the tube to demodulate the frequency modulated oscillations impressed upon grid g_1 by the local oscillator or any other input source.

Since the plate current in the usual case of modulation by speech or music includes audio frequency components from about 16 to 15,000 cycles, the plate load resistance R is made of the order of .1 megohm, to develop an effective voltage within this frequency range. The high frequency components in the plate circuit are eliminated by means of by-pass or filtering condensers in the usual manner. The natural or resonating frequency of the LC circuit connected to grid g_4 is equal to or does not deviate by more than 2% from the unmodulated os-

illator or other input frequency applied to grid g_1 .

The demodulation of the frequency modulated oscillations is effected through the action of the electron space charge produced adjacent to the grid g_4 . As is well known, the space charge coupling between the local oscillator and signal input grids in an electronic mixer tube constitutes a serious drawback and special remedial means have been proposed to reduce or eliminate it in superheterodyne receivers. The present circuit, on the other hand, utilizes the space charge coupling effect for the demodulation of frequency modulated oscillations.

The electron current emitted from the cathode is initially subjected to the influence of the local oscillator or any other input signal impressed upon grid g_1 . The electron current varying in the rhythm of the oscillating frequency is accelerated by the positively biased third grid and subsequently decelerated by the grid g_4 operated at cathode potential or a potential negative with respect to the cathode, whereby an intense concentrated space charge or virtual cathode will be produced adjacent to grid g_4 , having a charge density varying in the rhythm of and in phase with the oscillating or other input frequency. This oscillating space charge due to its close proximity to grid

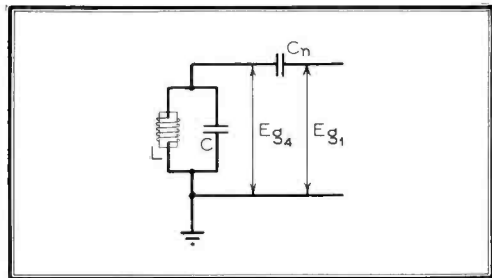

FIG. 3. A SUBSTITUTE CIRCUIT SHOWN TO ILLUSTRATE THE THEORY OF OPERATION

g_4 will exert an influencing effect upon this grid in such a manner that, in case of the natural frequency of the outer LC circuit being equal to the oscillating frequency, a substantial potential at this frequency which may amount to several volts will be developed upon grid g_4 by the induced displacement current.

To state it briefly, the space charge coupling between grid g_1 and g_4 may be regarded as a capacitive coupling as shown in Fig. 2, with this difference, however, that its phase differs by 180° from the phase of a normal capacitive coupling such as the inter-electrode capacity between the grids. Thus, assuming a positive voltage impulse to be impressed upon grid g_1 while the cathode heating current is shut off,

the inter-electrode capacity between the grids will cause a negative charge to be produced upon the grid g_1 . If the heating current is switched on, however, a positive voltage upon grid g_1 will result in an increased density of the space charge adjacent to grid g_4 and an induced positive charge upon the latter. Moreover, the space charge coupling is of a unilateral character, in the direction from grid g_1 towards grid g_4 . The inter-electrode capacity between the grids is of the order of .1 $\mu\mu\text{f.}$, while the space charge coupling in the normal operation of the tube is equivalent to a negative capacitative coupling of the order of 1 to 2 $\mu\mu\text{f.}$, substantially exceeding the inter-electrode capacity. Still higher space charge coupling effects up to 10 $\mu\mu\text{f.}$ and more, are obtainable by proper design of the operating constants of the tube.

Fig. 3 shows a substitute circuit wherein the space charge coupling is replaced by an equivalent negative or unilateral capacity C_n . This circuit may serve as a basis for a simplified theoretical treatment. For brevity's sake, only the results will be presented in the following.

The maximum voltage E_{g4} developed upon grid g_4 , assuming that the LC circuit is tuned to the oscillator frequency, is found as follows:

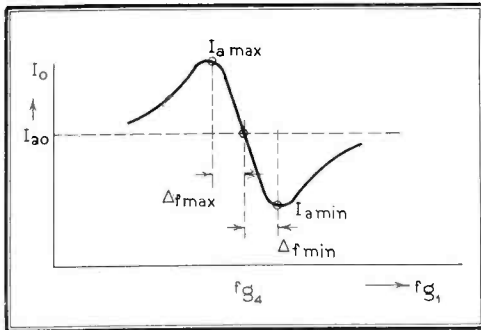

FIG. 4. CHARACTERISTIC CURVE SHOWING PLATE CURRENT AS A FUNCTION OF INPUT FREQUENCY

$$E_{g4 \text{ max}} = E_{g1} Q \frac{C_n}{C}$$

wherein E_{g1} represents the voltage applied to grid g_1 , $Q = \frac{\omega L}{r}$ is the figure of merit of the resonant circuit, and C the capacity of the resonant circuit. From the theory of multiplicative mixing, it follows that the combination of two oscillations of like frequency will result in an "intermediate frequency" equal to zero, that is a direct current change in the plate circuit. This direct plate current change is found to be expressed as follows:

$$\Delta I_a = K S_1 S_4 E_{g1} E_{g4} \cos \gamma \tag{2}$$

wherein K is a constant, S_1 and S_4 are the static mutual conductances for the grids g_1 and g_4 and γ is the phase angle between E_{g1} and E_{g4} . If the LC circuit is resonant to the oscillator frequency f_{g1} , the potential developed upon the grid g_4 will lag behind the oscillator

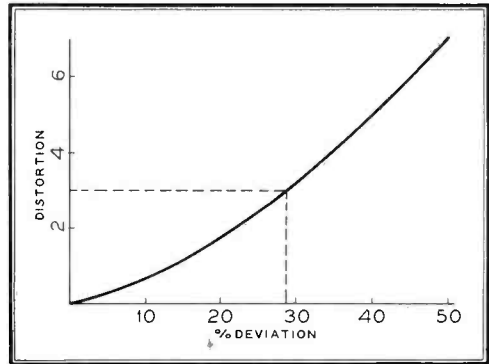

FIG. 5. SHOWING THE RELATION OF DISTORTION TO THE PERCENTAGE OF FREQUENCY DEVIATION

potential by exactly 90° whereby its effect upon the direct plate current I_{a0} , i.e. ΔI_a , will be zero. This is due to the fact that the induced current produced by the variable space charge lagging by 90° the space charge fluctuations will cause an in-phase voltage drop through the LC circuit representing a pure ohmic resistance. If the resonant frequency f_{g4} of the LC circuit is below the input frequency f_{g1} , the phase angle between the control voltages E_{g1} and E_{g4} will become greater than 90° , that is, the potential E_{g4} will include a component in phase opposition to potential E_{g1} thus resulting in a decrease of the plate direct current I_{a0} . On the other hand, if the resonant frequency of the LC circuit is above the oscillator frequency, E_{g4} will include a component in phase with E_{g1} resulting in an increase of the plate direct current.

Fig. 4 shows the operating characteristic representing the direct plate current as a function of the input frequency or in general of the relative frequency departure of the impressed oscillations upon grid g_1 from the resonant frequency of the LC circuit connected to grid g_4 . This curve resembles the characteristic of other well known frequency discriminators. In Fig. 4 the abscissae represent the oscillating frequency f_{g1} assuming that the resonant frequency f_{g4} of the LC circuit is maintained constant. The direct plate current varies substantially linearly between a maximum value $I_{a \text{ max}}$ and a minimum value $I_{a \text{ min}}$. Between these values there is a steep rectilinear portion which may be utilized for the demodulation of

the frequency modulated oscillations. A slight change of the input frequency will result in a substantial change of the direct plate current.

Further detailed analysis made under the assumption that the static characteristics of the tube are substantially straight lines and excluding any excessive control action has yielded the following results:

Maximum anode current change:

$$I_{a \text{ max}} - I_{a \text{ min}} = \pm \frac{K}{4} S_1 S_4 E_{g1}^2 Q \frac{C_n}{C} \quad (3)$$

Maximum slope of the operating characteristic:

detuning. In the interest of stable operation, Q should be chosen not higher than about 20 to obtain a straight-line operating range as wide as possible.

Further investigation has shown that the distortion within the full frequency deviation range varies as shown in Fig. 5. Up to 30% deviation the non-linear distortion remains below 3% and the distortion rises to 7% only after the deviation is increased beyond 50%. For 1,000 kc. and a $Q=20$, therefore, the maximum frequency swing should not exceed 15 kc. if distortion is to remain within 3%, or beyond 25 kc. if a 7% distortion is permissible. When

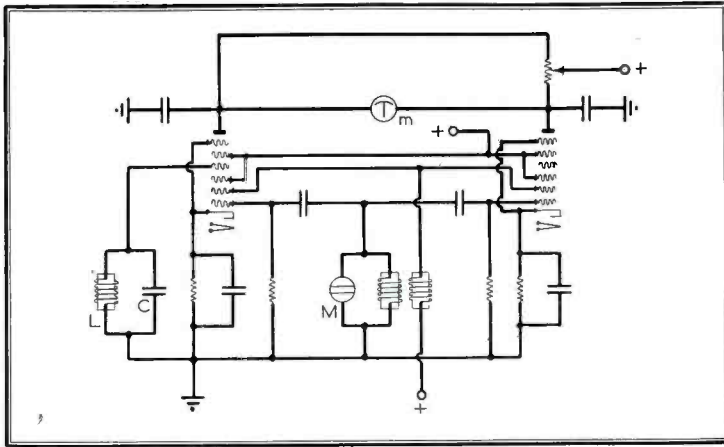

FIG. 6. A SIMPLER METHOD OF OBTAINING COMPENSATION IS TO USE A SECOND OCTODE, AS SHOWN HERE

$$\frac{dI_a}{df_{\text{max}}} = -K S_1 S_4 E_{g1}^2 Q^2 \frac{C_n}{C} \frac{1}{f_{g4}} \quad (4)$$

Frequency range covered by the straight line portion of the characteristic:

$$f_{g \text{ min}} - f_{g \text{ max}} = \frac{f_{g4}}{Q} \quad (5)$$

wherein K is a constant which under the assumption made is equal to unity but in general is less, from about .5 to .9. Within the frequency range primarily of interest in practice, from about 300 kc. to 60 mc., both C_n as well as Q may be regarded as independent of frequency. Depending upon the operating conditions, C_n may be assumed from 1 to 10 $\mu\mu\text{f}$. and Q from 10 to 80, and C will have values between value from 50 to 1000 $\mu\mu\text{f}$.

Since the remaining magnitudes are also independent of frequency, it follows that the characteristic is substantially independent of frequency. For average purposes, the slope of the characteristic as a function of the relative percentage detuning between the input frequency and the frequency of the LC circuit may be assumed to be about 1 ma. per 1% of

using the circuit for the demodulation of FM signals in radio receivers with an intermediate frequency of about 5 mc., a 30% frequency deviation about the operating point will allow of a maximum 75 kc. swing as used in present FM practice, with the distortion not exceeding 3%.

In the case of the condenser microphone, the frequency deviation, when using the circuit for the demodulation of the oscillations which are frequency modulated by the condenser microphone, is found to be extremely small. Assuming an average sound intensity, the audio frequency voltage developed by a plate load resistance of .1 megohm may be assumed to be about .1 volt audio frequency. With a slope of 1 ma. per 1% detuning, the frequency variation corresponding to a current variation of 1 microampere ($10^{-6}a$) will be about .001%. From this the average excursion of the microphone diaphragm may be calculated. Assuming a distance of the diaphragm from the fixed electrode equal to .05 mm., the amplitude excursion of the diaphragm will be equal to 10^{-6}

(CONTINUED ON PAGE 46)

FM PACKAGED FOR EMERGENCIES

Complete 2-Way FM Communications Systems for Protection of Great Industrial Plants Now Can Be Installed Over Night

BY PAUL A. WANDELT *

A YEAR from now, what will we wish we had done today?" This slogan, on the wall of Donald Nelson's office, expresses the thought behind the growing number of wireless communications systems that are going into service for the protection of factories, power plants, sub stations, and other installations which must be guarded against acts of sabotage. Such systems not only furnish communications from the central office to outlying guard posts but include patrol cars which cover all approaches.

Intercommunication by Radio ★ To meet this need, Link Radio Corporation has literally "packaged" standard 2-way FM units in desk-size cabinets so that they can be installed by merely making an antenna connection, plugging the cord into a 115-volt, 50 or 60-cycle outlet, and adjusting the antenna output circuit.

* Engineer, Link Radio Corporation, 125 W. 17th Street, New York City.

¹ See illustration of antenna used by Indiana Michigan Electric Company, *FM Magazine*, page 6, May, 1941.

FIG. 1. THIS COMPLETE 2-WAY DESK TYPE UNIT IS ONLY 21 INS. WIDE, 10 INS. DEEP, 27 INS. HIGH

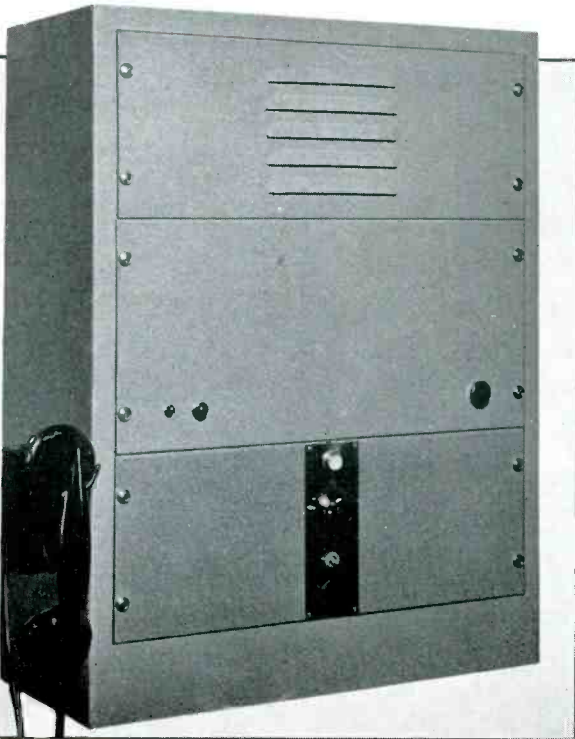

This equipment is suited for communication with similar fixed installations, and with mobile units in patrol cars. To this flexibility of use is added the saving of time and the cost of running wires for watchmen's systems, and the extra safety of eliminating wires which might be cut by saboteurs.

Many of these installations have emergency power supplies for the fixed stations so that, in the event of a power failure, when emergency communications would be needed most, there will be no interruption of the service. A small gasoline engine or a motor run from a storage battery is used to drive an AC generator.

Transmitting Range ★ Various types of transmitters are available, the choice at any specific installation depending upon the area to be covered and the height of the antenna. In most places there is some structure of sufficient height already available to support the very simple coaxial antenna recommended.

Good engineering practice, and the rules of the FCC require the use of the lowest power that will assure dependable communication. At most installations, the 25/30-watt Link model 25UFS equipment, Fig. 1, provides complete coverage of the area to be patrolled, even under conditions of severe interference. Higher power is supplied by the 50-watt unit, model 50 UFS, shown in Fig. 2.

Each has a complete transmitter and receiver, requiring only connections to the antenna and 115-volt, 50 or 60-cycle line, and is small enough to put on a desk or table.

Use and Operation ★ No more skill or experience is required to use a 2-way FM system than for an ordinary telephone. The receiver is kept on at all times, and the filaments of the transmitting tubes. Thus a call coming in is heard in the loudspeaker mounted behind the louvers at the top of the cabinet.

To reply, the handset, shown at the left of the cabinet in Fig. 1, is lifted from the hook. When the handset is picked up, the output of the receiver is automatically switched from the loudspeaker to the handset. There is a button on the handset which must be pressed while talking. Pushing this button transfers the antenna from the receiver to the transmitter, disables the receiver, and puts the plate

voltage on the transmitting tubes. No other attention to the equipment is required of the operator.

There is nothing to tune, because the frequency of the receiver and transmitter is fixed, and is maintained by crystal control.

In some cases, it is necessary to mount the equipment at one point, with the speaker and microphone at another. This can be done without making any special provisions if they are not separated more than 30 ft. At greater distances, a remote control unit may be required. There are three different types of 2-wire remote control units available to suit various requirements.

The filaments of the transmitter tubes are kept lighted at all times to avoid any lag when the push-to-talk button is pressed for transmission. Since the plate voltage is only applied to the plates during actual transmission, the tube life is practically as long as if the filament current, too, were turned off normally.

Receiver ★ The same receiver, type 12UF, is used with either transmitter. It is crystal-controlled to the assigned operating frequency. Two quartz crystals are employed, assuring stable operation under all variations of temperature and humidity. A double IF system gives excellent band pass characteristics, with a very favorable image ratio.

Audio response is 3 db from 300 to 3,000 cycles. An audio filter gives a sharp cutoff at 3,000 cycles to accentuate the higher frequencies.

The tube complement comprises:

- 6AC7 or 6SH7 RF amplifier
- 6K8 1st detector
- 6V6 Crystal oscillator-multiplier
- 6SH7 or 6SG7 IF amplifier
- 6K8 2nd detector, crystal oscillator
- 6SJ7 or 6AC7 1st limiter
- 6AC7 2nd limiter
- 6H6 Discriminator
- 6H6 Squelch filter
- 6SL7GT 1st audio, squelch
- 6K6GT AF Output
- 80 Rectifier

Power input to the receiver is 65 watts from 115 volts. The output into 500 ohms is approximately 1 watt.

There are 3 tuning-meter jacks on the receiver chassis. The first is for measuring the grid current of the first limiter, which indicates resonance in all the preceding stages. The second is to measure the grid current of the last limiter. The third is for balancing the discriminator circuit. The first two require a 0-1 milliampere meter, and the third, a 50- or 100-microampere meter, preferably of the 0-center type.

Before shipment, the receiver is equipped

with tubes and crystals and is tuned to the operating frequency, so that it is only necessary to make a quick check of the adjustments with the tuning meters after the equipment has been set up. The approximate settings of the tuning controls are marked in red.

The squelch control must be set in accordance with local noise conditions. The most sensitive position is completely clockwise. With the squelch in this position and the squelch switch at ON, the volume control is advanced, with no signal coming in, until background noise can be heard. Then the squelch is turned counter-clockwise until the speaker is silent. This adjustment will hold for most noise conditions, no matter how severe. In its most sensitive position, the squelch sensitivity is better than .1 microvolt, and this adjustment can be used if the normal noise level is low. The noise in the speaker when the squelch switch is at OFF is entirely normal, and ceases when the squelch is cut in.

25- to 30-Watt Transmitter ★ Fig. 1 shows the complete unit with the receiver below, the 25/30- (CONTINUED ON PAGE 45)

FIG. 2. THE 50-WATT EQUIPMENT. 2-WAY FM SYSTEMS ARE AS EASY TO USE AS AN ORDINARY PHONE





OCTAVE BLAKE

ON THE FIGHTING FRONT IN THE LAST WAR AS U. S. NAVY FLIGHT LIEUTENANT, NOW ON THE INDUSTRIAL FRONT OF WORLD WAR NO. 2, BATTLING FOR MORE CONDENSER PRODUCTION. OCTAVE BLAKE ORGANIZED CORNELL ELECTRIC MANUFACTURING COMPANY IN 1924, BECAME PRESIDENT OF CORNELL-DUBILIER IN 1933

WHAT MANUFACTURERS SAY:

A Statement by Octave Blake, President, Cornell-Dubilier Electric Corporation

TODAY those engaged in the radio industry find radio capacitors available in endless variety to meet the requirements of every possible application. Such was not always the case for, during World War No. 1, of which we are today constantly reminded, wireless communication was greatly retarded by the lack of capacitors of compact and practical proportions for transmitters.

At that time, transmitting equipment ashore and afloat was dependent on fragile, bulky Leyden jars for capacitors. Strangely enough, Germany had a monopoly on the supply of Leyden glass jars.

As early as 1904, William Dubilier's interest in Marconi's experiments led him to explore ways and means of substituting other units for the inefficient and easily damaged Leyden jars. The need for a substitute had become acute by 1910 when his first mica capacitor was submitted to the Navy Department and the Signal Corps.

The firing of heavy guns aboard naval ships quickly reduced Leyden jars to fragments. The bulk, weight and fragility of Leyden jars was holding up development of portable radio transmitting equipment. Although Dubilier manufactured a considerable number of his new mica type capacitors both here and in England, without causing much excitement, the outbreak of World War No. 1 focused attention on the German Leyden jar monopoly. At the invitation of several Allied governments and the U. S. Navy, Dubilier began rapidly to expand his production. Long before America's entry into this conflict, our services were well supplied with capacitors utilizing Indian mica in place of glass, and stacked construction which reduced capacitor size to a fractional part of earlier proportions.

As these new type capacitors were immediately adopted by all the Allied nations, Dubilier became their exclusive supplier for the duration of the war, furnishing hundreds of thousands annually.

Soon after the signing of the Armistice, radio broadcasting was born. The tiny Micadon of postage stamp size became his company's principal product. That was the real beginning of condenser production for receiving sets on a large scale, followed later by a new demand for paper condensers of higher capacities in battery eliminator circuits and then in AC-operated sets.

Broadcasting grew rapidly to giant stature and the demand for condensers increased at a faster rate because more and more condensers

were used in improved receivers. In 1933, Dubilier merged with the Cornell Electric Manufacturing Co., which had become an important rival since its founding in 1924. Cornell brought to the consolidation a new and highly compact type of high capacity filter unit. Despite depression years, Cornell-Dubilier payrolls jumped from 400 to 700, to 1200, and then to 1500 workers.

New types of capacitors were developed for electric refrigerators, fluorescent lighting, power-factor correction on transmission lines, for high-voltage impulse-generators and X-Ray equipment, for improvement of welding, and numerous other electronic and electrical applications. By 1934, the company had overspread all available neighborhood space at its Bronx Boulevard plant in upper New York City. The business was then moved to South Plainfield, N. J., where 200,000 square feet of manufacturing space practically tripled former facilities. Here, large artesian wells, needed for making electrolytic capacitors, were also available. By 1940, however, our plant facilities were over-taxed.

Expansion in South Plainfield was deemed impractical for the reason that the entire labor supply available in that community had been absorbed. The rapid development of fluorescent lighting had resulted in demand for a new type of capacitor in tremendous quantities. The rising tide of defense orders made huge, new demands upon the power companies which turned to us for power-factor capacitors.

Something had to be done and done quickly. The decision was strongly influenced by the modern war's new strategy which sends the bomber to destroy manufacturing facilities on the home fronts. Decentralization of production provides greater assurance of continuing sources of supply.

The choice, therefore, was a textile mill at New Bedford, Mass., remotely located from our South Plainfield plant. By this purchase, approximately 400,000 square feet of additional space was gained to take care of expanding requirements. About 1400 new employees were taken on, and this figure has since been considerably increased. Today, the New Bedford output is about 40% of our total production.

The company uses a large number of critical materials, but so far has experienced little difficulty in obtaining them, due to the high priority ratings of the national defense and war orders which it has received for capacitors.

(CONTINUED ON PAGE 44)



FIELD STRENGTH SURVEY METHODS

Part 1. Description of Equipment Used in Measuring Field Strength of W71NY

BY CHARLES SINGER*

1. Introduction ★ When the construction of an FM station has been completed and it is ready for full-power commercial operation, the engineers are confronted with the problem of making a field strength survey, not only to meet FCC requirements, but for the information of the sales department. This is an undertaking of considerable magnitude and involves new problems, as we learned from the initial survey made on our original 1-kw. transmitter W2XOR and, more recently, on our 10-kw. installation W71NY.

This detailed account of the equipment used and the methods employed, together with a summary of the results obtained from W71NY, are presented here so that engineers at other FM stations may have the benefit of our experiences and check their results with ours.

W71NY is owned and operated by Station WOR of the Bamberger Broadcasting Service, Inc., Carteret, New Jersey. The launching of the FM station on 10-kw. power climaxed two years of planning and experiments made by WOR engineers, headed by J. R. Poppele. In August, 1939, WOR's first 1-kw. FM unit, known as W2XWI, was launched at Carteret. In June of 1940, a new Western Electric transmitter of the same power, under the call W2XOR, was opened at the present FM location, 444 Madison Avenue, New York City,

and in November of 1941 the new 10-kw. station¹ was formally dedicated.

In our report of October, 1940, data was presented showing the pattern of W2XOR using a power of 1 kw. This is shown in Fig. 1, which gives the 1,000-microvolt and 10-microvolt contours. With the power increased to 10 kw., this station is making FM history under the new call W71NY, using the first 10-kw. Western Electric FM type transmitter. In the months of October and November, 1941, a field survey was made of the new transmitter with unity antenna gain. The second part of this report will show how the coverage has been increased.

This data has particular engineering significance because, in both sets of measurements, a vertical coaxial antenna with a power gain of 1 was used for transmission.

The survey was made by the WOR Technical Facilities Division. Taking part in this work were Joseph Waldschmitt who made the new field tests, George Klingaman, Richard H. Davis, Reinhardt Rast, C. W. Harrison, and several of the engineers from the Carteret transmitter. R. F. Guy of the NBC Engineering Department very kindly assisted us in preparing the recording devices.

2. Transmitter ★ The transmitter embodies the latest FM advances at the Bell Telephone Laboratories. The output of the transmitter is

* Technical Supervisor, WOR-W71NY, Carteret, N. J.
¹ Described in *FM Magazine*, December, 1941.

LEFT: VIEWS ALONG EIGHT RADIALS FROM THE W71NY ANTENNA ATOP 444 MADISON AVENUE, NEW YORK CITY. VERY LITTLE SHADOW EFFECT IS EXPERIENCED ON FM RECEPTION, DESPITE THESE TALL BUILDINGS

FIG. 1, RIGHT: THIS CONTOUR MAP OF EXPERIMENTAL STATION W2XOR WAS REDUCED SO AS TO BE IN THE SAME PROPORTION AS THE MAP OF W71NY, WHICH WILL BE SHOWN IN PART 2

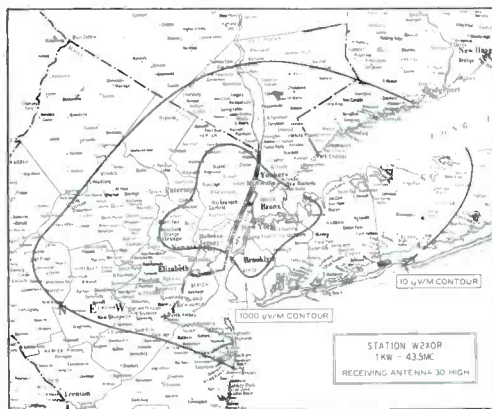

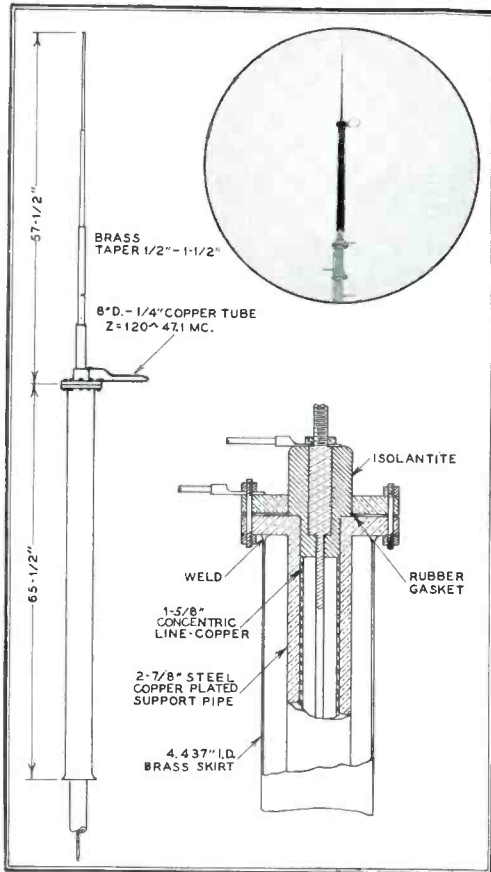

FIG. 2. DETAILED DRAWINGS AND PHOTOGRAPH OF W71NY ANTENNA. FIG. 3, BELOW: THE FIELD STRENGTH RECORDING EQUIPMENT

fed to the antenna by means of a $1\frac{5}{8}$ -in. concentric transmission line. The radiator, of special design, was manufactured for W71NY by the Communication Products Company of Jersey City, N. J. Details of its construction are given in Fig. 2. This is the first coaxial antenna to handle power of 10 kw. at this frequency at a height of 635 ft. above sea level.

Much curiosity has been aroused over the loop mounted at the insulated base of the upper element. It is a single-turn inductance, so made as to neutralize the capacitive reactance of the large insulator at the center of the antenna. This reactance is in the order of 120 ohms at 47.1 mc.

A Boonton Radio Q meter was used to adjust the loop to the exact value required. The coil was then mounted at right angles to the plane of the antenna, at the point of minimum field which is the center of the antenna.

The top element was adjusted in length for maximum field strength at a point distant from the antenna. The bottom element, or skirt, was adjusted for minimum standing waves on the transmission line feeding the antenna.

Also employed at W71NY is the first antenna concentric-line protective device in this frequency range. It offers effective protection to the antenna transmission line in the event of a flash-over from causes beyond control of the operating technician.

The location of W71NY's transmitter with respect to the surrounding terrain can be observed from the accompanying photographs. These were taken from atop the 444 Madison Avenue Building, where the transmitter is installed. They show clearly that, with a few exceptions, the signal is quite free of any serious obstacles. The greatest attenuation of

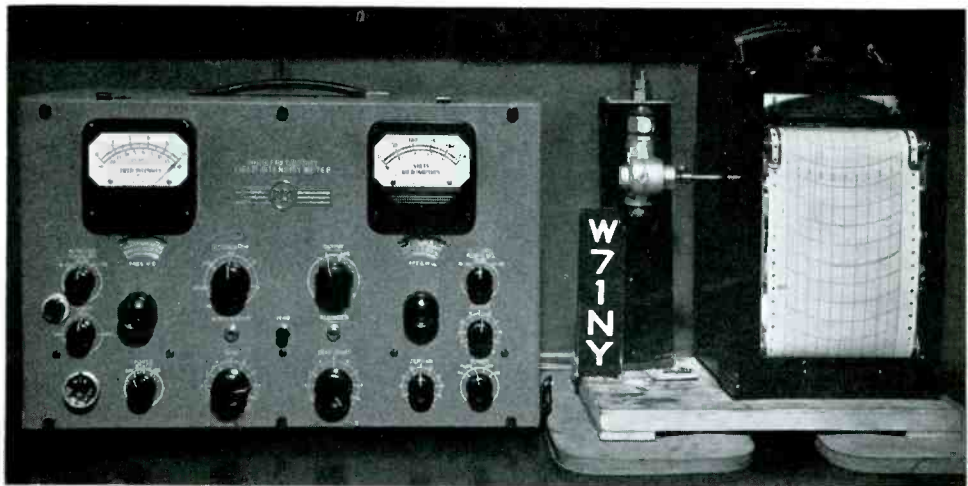

the signal is found in a southerly direction, toward Staten Island. The reason for this is partially due to the tall buildings in that direction. Photographs taken in the west and northwest directions show a mountainous area in the distance.

Radio City, at 49th Street and Sixth Avenue appearing in the west photograph, caused a sharp but not objectionable shadow for a short distance. The general contour of the remaining territory is quite level, the horizon having a radius of about 35 miles.

3. Measuring Equipment ★ The measuring equipment is illustrated by means of a block diagram, Fig. 4. A photograph of the equipment is shown in Fig. 4. It consists of an RCA High frequency field-intensity meter, type 301-A, with a type 93-A vibrator power unit. Primary power is a 6-volt storage battery. The carrier level is recorded by means of a type AW Esterline-Angus 0-5 recording milliammeter. The recorder is driven directly from the car's transmission. The high-frequency field-intensity unit is intended primarily for amplitude-modulated signals and does not contain a discriminator. The transmitter frequency swing was held below 50 ke. The audio output was fed into the audio amplifier of a portable battery-operated Radiola receiver and used for monitoring purposes.

The antenna was a half-wave dipole, having an overall length of 124 ins. This was supported 10 ft. above the ground on a maple wood pole. The regular shielded two-conductor cable, furnished with the field set, was used with the antenna and was found to very effectively eliminate standing-wave difficulties.

The recorder drive arrangement was built from parts used in taximeters. The car speedom-

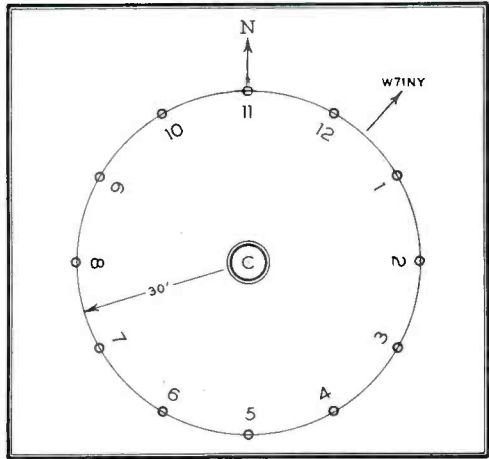

FIG. 5. COMPASS ROSE LAID OUT ON THE GROUND TO CALIBRATE THE MEASURING EQUIPMENT

eter cable was removed at the transmission, and a reduction gear inserted. This reduction gear had two outlets: one was a direct drive to the speedometer, and the other reduced the speed from 1,009 revolutions per mile to 48 revolutions per mile, a ratio of 21:1. From this point, a flexible cable, 8 ft. long, drove a second reduction gear, attached to the recorder driveshaft. This reduced the speed to 4 revolutions per mile, a ratio of 252.2:1. The recorder was then geared to record at a rate of 6½ inches of paper per mile. This was found to give a most convenient chart of field strength versus distance.

The coupling between the driving mechanism and the recorder was arranged to permit the drive to run free, or to be engaged by sim-

FIG. 4. FIELD SURVEY EQUIPMENT COMPRISING:

- A — RCA FIELD INTENSITY METER, TYPE 301-A
- B — ESTERLINE ANGUS MILLIAMPERE RECORDING METER, DRIVEN FROM THE TRANSMISSION
- C — FM RECEIVER AND AMPLIFIER
- D — 93-A POWER SUPPLY UNIT FOR FIELD INTENSITY METER

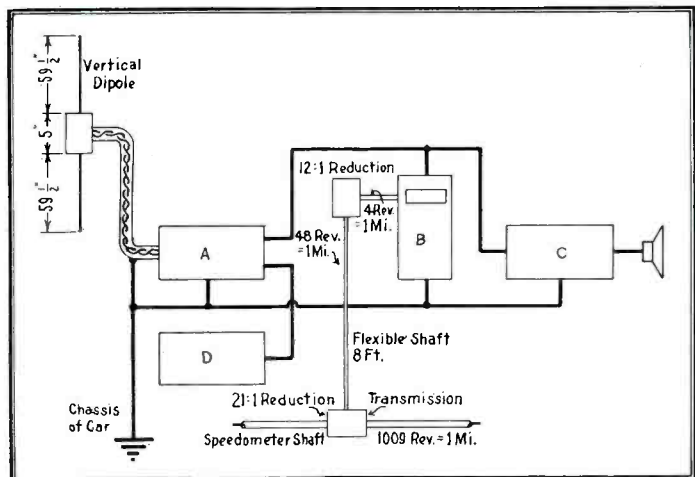

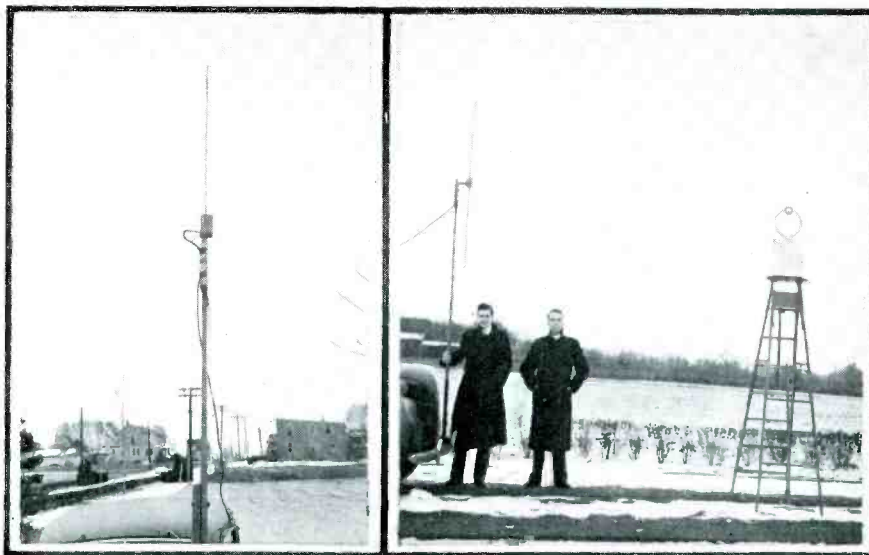

FIG. 6, LEFT: FIELD STRENGTH MEASURING ANTENNA MOUNTED ON THE LEFT FRONT BUMPER OF THE TEST CAR. FIG. 7, RIGHT: FIELD GENERATOR SET UP FOR CALIBRATING PURPOSES

ple set-screw method. The recorder had its own self-contained clockwork and control which enabled us to make stationary or time runs.

4. Antenna Calibration ★ Two methods were used in determining the antenna constant to be used with the car antenna. The antenna furnished with the RCA Field Intensity Meter had a recommended length of $52\frac{1}{2}$ ins. per element and a constant of 10, at 47.1 mc., for a height of 11 ft. above ground. The field strength was then the meter or recorder reading multiplied by the attenuator setting and the antenna constant (10). However, the new antenna elements had a length of 62 ins. and were supported 10 ft. above ground, very close to the large metal surface of the car body.

A compass rose was laid out, as shown in Fig. 5, by driving stakes in a 60-ft. circle in a large open field at the WOR Transmitter, Carteret, N. J., a distance of 18 miles from Columbus Circle in New York City. The nearest obstacles were at least 250 ft. away.

The antenna, furnished with the Field Intensity Meter, was first set up at the center of the circle, with the measuring equipment on the ground as far away as possible (30 ft.). The center of the antenna was 11 ft. above ground. The following data was then obtained, using W71NY as a signal source:

Observations	
Scale setting.....	20
Reading.....	3.3
Antenna constant.....	10

Field Intensity.....	660 μ v/m
Transmitter Power.....	9.2 kw.
Frequency.....	47.1 mc.
Date.....	October 27, 1941

The signal was observed to be constant during the test. The measuring equipment was mounted in the automobile as shown in Figs. 6 and 7 which was driven to the center of the circle. The antenna was always supported directly at 10 ft. above the ground. The car was then moved around and readings taken with the car facing each of 12 directions. Thus the following data was obtained:

Position	Attenuator		Antenna Constant (K)
	Scale	Reading	
1	20	6	5.5
2	20	5.6	5.9
3	20	5.7	5.8
4	80	6.2	5.3
5	20	5.8	5.7
6	20	5.2	6.4
7	20	5.1	6.5
8	20	5.6	5.9
9	20	6.1	5.4
10	20	6.2	5.3
11	20	6.2	5.3
12	20	6.0	5.5

The antenna constant above was found at the ratio

$$K = \frac{660}{\text{Attenuator Scale} \times \text{Meter Reading}}$$

The constant *K* has been plotted in Fig. 11 and shows the effect of the car body on the

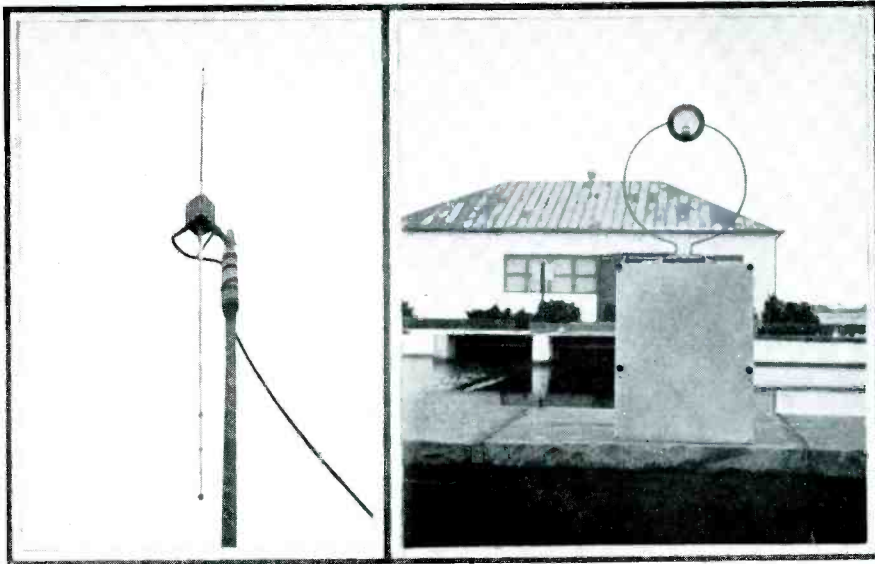

FIG. 8, LEFT: ANOTHER VIEW OF THE ANTENNA ON THE CAR. FIG. 9, RIGHT: CLOSE-UP OF THE FIELD GENERATOR, SHOWING THE SHIELDED CASE, LOOP, AND THERMOMILLIAMMETER. SEE FIG. 10 FOR CIRCUIT

received field as the front of the car faced various directions.

These measurements indicated, as expected, that the gain of the antenna was at minimum when the direction of the transmitter is toward the rear of the car. The gain was somewhat better when the car faced the transmitter, for the antenna was mounted on front right bumper. The signal was maximum when the car was at right angles to the transmitter. This put the receiving antenna in the open. The latter case proved there was little effect from the car itself, whereas the former shows serious shielding effects from the car body.

To take account of this pattern, it is interesting to note, when recording a radial approaching the transmitter, positions 10, 11, 12, 1, 2, 3 and 4 were averaged. When the radial was recorded going away from the station, positions 4, 5, 6, 7, 8, 9 and 10 were averaged. Since practically all records were made in the latter direction, a constant of 6 was chosen. This constant was checked three weeks later at the conclusion of the survey, in direction 4. A value of 5.5 was obtained, as compared to the previous value of 5.3.

To check the preceding method of calibration, a local field generator was used. It consisted of a low-power self-contained oscillator, rigidly shielded with the exception of a small loop extending above the shield, as shown in Figs. 7 and 9.

The oscillator was mounted on an insulated panel away from the sides of the shield and effectively avoided capacitive coupling to the

loop through stray currents. No openings were left in the shield except those necessary to bring the leads to the loop through the box. The shield was made of $\frac{1}{8}$ -in. aluminum. A thermomilliammeter was connected in series with the loop, at a point of low potential with respect to the shield. The circuit is given in Fig. 10.

Added details concerning the field generator may interest some readers, and are presented herewith:

The coupling coil was mounted at the "cold" end of the tank to minimize capacitive coupling. An electrostatic shield was placed between the coils as an added precaution. The coupling coil was tuned to resonance by the 50-mmfd. condenser.

The two sides of the loop were balanced with respect to the shield by means of the 1-2-mmfd. condenser. Usually it was necessary to slightly change the spacing of the leads feeding the loop, with respect to the shield, in order to obtain perfect balance. The circumference of the loop was but a small fraction of a wave-length, in order to maintain a uniform distribution of current. Its size is not critical, a loop of 10.9-in. diameter being used. Resonance was obtained in each case by means of the 50 mmfd. The 20-meg. variable resistor was used to adjust the loop current.

The field from a radiating loop in free space is given by:

$$E = \frac{120 \pi^2 N A I}{\lambda^2 D} \left(I - J \frac{\lambda}{2\pi D} \right)$$

where:

Estimating the Costs of

MAKING A START IN TELEVISION . . .

Part 3. Figures on Which Estimates Can Be Based for Determining the Investment Required for a Television Transmitter and Accessory Equipment

BY AUSTIN C. LESCARBOURA *

Television Transmitter ★ One of the major cost items is the television transmitter, and this more than any other determines the total investment required, because of the wide spread in power ratings. But here again a start can be made on a modest basis. The initial transmitter may be a 400-watt (peak) video with 200-watt audio, with a 20-kw. (peak) video and 10-kw. audio transmitter as the ultimate commercial goal. The transmitter should be designed for use on the four television channels assigned in the United States, namely, 50-56 megacycles, 60-66 megacycles, 66-72 megacycles and 78-84 megacycles, and should function with equal efficiency on any one of these channels. The design of Du Mont television transmitters incorporates several exclusive refinements. Such transmitters are designed for single side-band operation. One of the unique refinements which greatly simplifies operation is the application of the principle of filtering off the sideband before amplification. This reduces considerably the complexity of the sideband filtering system, and also cuts down the mechanical size of the transmitter.

The recommended transmitter for covering both the experimental period and early commercial operation, is the 4-kw. (peak) video and 2-kw. frequency modulated audio combination. Under normal topographical conditions and with a sufficiently elevated antenna system, this transmitter should provide complete coverage within a radius of 50 miles. A start can be made with even a 400-watt (peak) video and 200-watt audio transmitter, with an operating range of 10 to 15 miles under favorable conditions.

Transmitting Antenna ★ The coverage of the television transmitter depends not only on available power but also the elevation of the transmitting antenna and its relation to the surroundings. Because of the many variables here involved, no definite recommendations or costs can be set for the transmitting antenna. As a matter of rough estimating, the cost of a good antenna installation should not exceed \$10,000.00. This amount is based on the actual cost of installing the 130-foot derrick-type steel tower surmounted by the mast and antenna proper for the Du Mont Station W2XWV in New York City. The antenna system in this case is fed by coaxial cable. It incorporates a design having broad band characteristics, and has been designed to function most efficiently with the 1-kw. transmitter.

A good antenna system should be installed. Otherwise much of the power of the transmitter may be wasted. The antenna should be placed atop the tallest building or hill available, to dominate the surrounding territory, bearing in mind the quasi-optical characteristics of the ultra-short-wave television signals.

The previously described television station equipment only provides for transmission of studio programs, including live talent and films. While it is feasible to operate a station with programs originating in the central studio, much of the spot news value, which television must provide, is lost. The thrill and interest of seeing events at points remote from where the event occurs, and at the very time it occurs, is one of the outstanding attractions of television. In order to achieve this result it is necessary to have an additional transmitter of relatively low power, usually 150 watts. This transmitter must be made portable. A convenient arrangement is to install this portable relay transmitter in a truck provided with a source of power from a gasoline-driven generator. Provision should be made in this truck for housing the camera control equipment mounted on a small hand truck, together with other necessary equipment including portable lights, microphones, sound equipment, and cables. Such equipment constitutes a complete field unit. Its make-up may vary over wide limits, depending on requirements and funds available. No attempt is made here to set it down in detail or in dollars and cents.

* In charge of television information service for Allen B. Du Mont Labs., Inc., Passaic, N. J. Author, "This Thing Called Broadcasting," "Radio for Everybody," "The Cinema Handbook," "Behind the Motion Picture Screen," etc.

APPROXIMATE COST OF TELEVISION STATION EQUIPMENT

DUAL ICONOSCOPE CAMERA CHAIN*

Dual Iconoscope Camera Chain, consisting of the following:

- (1) Two—Type 455-A Iconoscope Camera mounted on Akeley Gyro-head Tripod, including one Type 471-A Iconoscope Camera Power Supply
- (2) Two—Type 414 Electronic View Finder, including one Type 474 Electronic View Finder Supply Unit
- (3) Two—Type 452 Iconoscope Camera Control unit, including one Type 472 Iconoscope Camera Control Power Supply
- (4) Two—Type 453-A Shading Generator and Monitor Cathode-Ray Oscillograph
- (5) Two—Type 414-A Camera Monitor, including one Type 474-A Camera Monitor Supply Unit
- (6) One—Type 454-B Line Amplifier, switching unit and Monitor Cathode-Ray Oscillograph, including one Type 472 Line Amplifier Power Supply
- (7) One—Type 414-A Line Monitor, including one Type 474-B Line Monitor supply unit
- (8) One—Type 491 Synchronizing Generator
- (9) Cables, Termination boxes and miscellaneous equipment.

Note:

Approximate Total Cost \$23,755.00
 Single Iconoscope Camera Chain \$13,155.00
 Cost of Orthicon Camera Chain, approximately the same as for Iconoscope Camera Chain.

ICONOSCOPE FILM PICKUP CAMERA CHAIN*

Dual Motion Picture Iconoscope Camera Chain for continuous transmission of film programs consisting of the following:

- (1) Two—Type 421 Iconoscope Film Pickup Cameras mounted in separate racks.

Accessory equipment contained in Type 421 rack:

- (a) Iconoscope, video pre-amplifier and protective relay circuits
- (b) Iconoscope blanking
- (c) Cable termination unit
- (d) Iconoscope power supply
- (e) Super-regulated power supply
- (f) DC voltage for bias and rim lights.

- (2) One—Type 491-A Synchronizing Generator Rack mounted.

Accessory equipment contained in Type 491-A rack:

- (a) Frequency divider
- (b) Blanking, sweeps and power supply
- (c) Signal distribution amplifier.

- (3) One—Type 475 Power Supply Rack.

Accessory equipment contained in Type 475 rack:

- (a) Power for No. 1 camera scanning and intermediate amp.
- (b) Power for No. 2 camera scanning and intermediate amp.
- (c) Shading Oscillograph supply unit
- (d) AC Power switch panel
- (e) Video oscillograph supply unit
- (f) 12-in. Monitor power supply
- (g) Synch. gen. cable termination unit

- (4) One—Type 433 Shading Rack

Accessory equipment contained in Type 422 Rack:

- (a) Camera No. 1 scanning unit
- (b) Camera No. 2 scanning unit
- (c) Twelve inch station monitor
- (d) Two five-inch oscillographs for shading
- (e) Shading Monitor control panel
- (f) Shading Generator No. 1
- (g) Shading Generator No. 2
- (h) Regulated power supply for shading generators
- (i) Shading controls (console mounted)

- (5) One—Type 423 Video Control Rack

Accessory equipment contained in Type 423 Rack:

- (a) Intermediate amplifier No. 1
- (b) Intermediate amplifier No. 2
- (c) Twelve inch station monitor
- (d) Two five-inch oscillographs, for video
- (e) Video monitoring control panel
- (f) Video control termination unit
- (g) 12 inch Monitor power supply
- (h) Iconoscope control cable termination unit
- (i) Video and switching controls (console mounted)

- (6) One—Type 425 Video Line and patching rack:

Accessory equipment contained in Type 425 Rack:

- (a) Line amplifier No. 1
- (b) Line amplifier No. 2
- (c) Auxiliary synch. amplifier
- (d) Three inch oscillograph
- (e) Video patching panel
- (f) Switching relay unit
- (g) Line amplifier control termination unit
- (h) Regulated power supply for line amplifier No. 1
- (i) Regulated power supply for line amplifier No. 2

Cables, power cords, plugs, monitor console, etc.

Total Approximate Cost \$21,000.00

Approximate Cost of Two

Special Film Projectors \$12,000.00

TRANSMITTING EQUIPMENT

150-watt Relay Transmitter (120-200 mc.)	\$8,000.00
4-KW (peak) Video Transmitter and 2-KW	
FM Aural Transmitter	31,000.00
Relay Receiver	2,000.00
12-in. Station Monitor	750.00

* Approximate prices as of November 15, 1941.



ABOVE: VIDEO AND AUDIO TRANSMITTERS INSTALLED AT TELEVISION STATION W2XWV



LEFT: TWO OF THE STANDARD CAMERAS SET UP AND READY FOR ACTION IN THE STUDIO. TRIPODS ARE STANDARD TYPE USED FOR MOTION PICTURE CAMERAS

Relay Receiver ★ In order to translate the signal transmitted by the relay transmitter into television program terms, a relay receiver is required at the main transmitter location. This receiver may be fed into the studio control equipment which is part of the film pickup equipment. In this or equivalent circuits it is monitored and then fed to the main transmitter and out over the air.

In the adjacent tables, typical equipment setups are presented, with approximate costs figured as of November 15, 1941, and subject to change. From these typical figures you can line up your required equipment, and gain an approximate idea of the investment involved.

Typical Setups ★ Du Mont engineers figure television installations in four major class groups, as follows:

CLASS I. Iconoscope Camera and Chain; 400-watt (peak) video and 200-watt aural transmitter. Purely experimental basis. Approximately \$12,700 for the transmitting facilities, plus \$13,155 for pickup equipment, or approximately \$26,000 total.

CLASS II. Dual Iconoscope Chain; 1 kw. video and 2-kw. aural transmitter. Recommended equipment for experimental start leading to early commercial operation, providing live studio programs. Approximate total cost \$55,000.

CLASS III. Complete studio equipment including dual iconoscope camera chain plus dual film camera chain, with two special film projectors and 12-in. station monitor; 4-kw. (peak) video and 2-kw. aural transmitter. Approximate total cost of \$88,000.

CLASS IV. Complete studio equipment same as for Class III. but with more elaborate transmitting antenna, with total cost of \$100,000 and over, particularly if relay transmitter and relay receiver are included for remote pickups. With a well-equipped truck and pickup equipment permanently used for this work, in addition to studio equipment (not taking advantage of dual function feature) total cost may reach \$150,000.

Personnel ★ In personnel, as in equipment, it is largely a question of working capital and flexibility desired. The minimum personnel requirements, based on actual experience in the Du Mont New York station, operating on an experimental license (CONTINUED ON PAGE 38)

DYNAMIC SYMMETRY IN RADIO DESIGN

Part 2. Methods for Applying Principles of Dynamic Symmetry to Radio Apparatus, and Examples of Applications to Specific Problems

BY ARTHUR VAN DYCK*

Examples of Constructions ★ Given a square, draw a whirling-square rectangle inside it. Then diagonals of the square and the rectangle define a small square concentric with the large square, as in Fig. 13.

If the sides of the small square of Fig. 13 are extended, as in Fig. 14, a nest of squares and whirling-square rectangles is formed.

The intersections of the diagonals of the whirling-square rectangle inscribed in a square with their perpendiculars, form the "eyes" of the rectangle, and also are vital spots of the square. See Fig. 15.

A very interesting and frequently useful relation is that formed by the diagonals of dynamic rectangles and their perpendiculars, as in Figs. 16 and 17. Note that they divide:

- a root-two rectangle into two or three parts,
- a root-three rectangle into three or four parts,
- a root-four rectangle into four or five parts,
- etc.

depending upon whether the dividing lines are drawn through the points where the perpendiculars strike the sides or through the intersections of the diagonals.

Dynamic rectangles may similarly be divided into smaller rectangles *proportional to the whole*, as shown in these illustrations.

* Manager, RCA License Laboratory, 711 Fifth Avenue, New York City.

It may be noted that the lines which subdivide the n root rectangles into n parts in each direction, are the extensions of the spiral lines around the eyes of the rectangle, as shown more clearly in Fig. 18. Also the division process can be carried to infinity.

Some subdivisions of the root-two rectangle are shown in Fig. 19:

(a) is constructed by making $AB = AE$, the rest being obvious. The points O are the focuses of the escribed ellipse and P is a focus of the inscribed semi-ellipse touching E, F, D .

(b) is constructed by making $AB = BC$, and $CD = DE$, the rest being obvious. The known ancient use of this familiar symbol is evidence that this rectangle was used long ago.

(c) shows relation of this rectangle to the square and octagon.

(d) $AB = 1.0$
 $BC = \sqrt{2} = 1.414$
 $AD = 1.5$

(e) shows the indefinite extension possibilities of a dynamic plan for design purposes. Hidden shapes and relations continually appear, to prove the basic correctness and inherent harmony of a true fundamental plan.

The root-two plan is a favorite one for books and writing paper design, because the

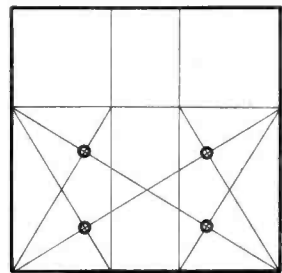
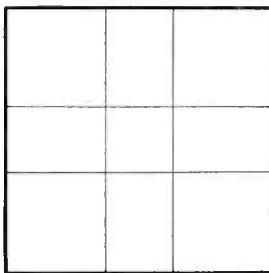
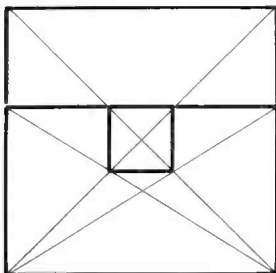

FIGS. 13, 14, AND 15 SHOW CONSTRUCTIONS BASED UPON A WHIRLING-SQUARE RECTANGLE CONSTRUCTED IN A SQUARE. THESE DEVELOP POWERFUL AREAS AND RELATIONSHIPS

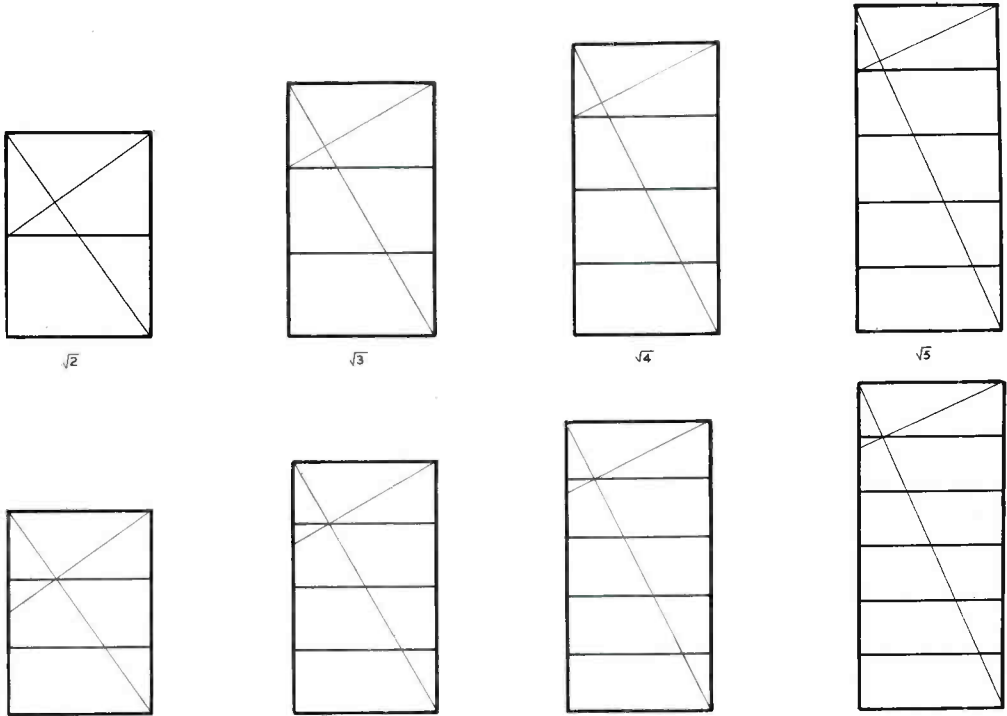
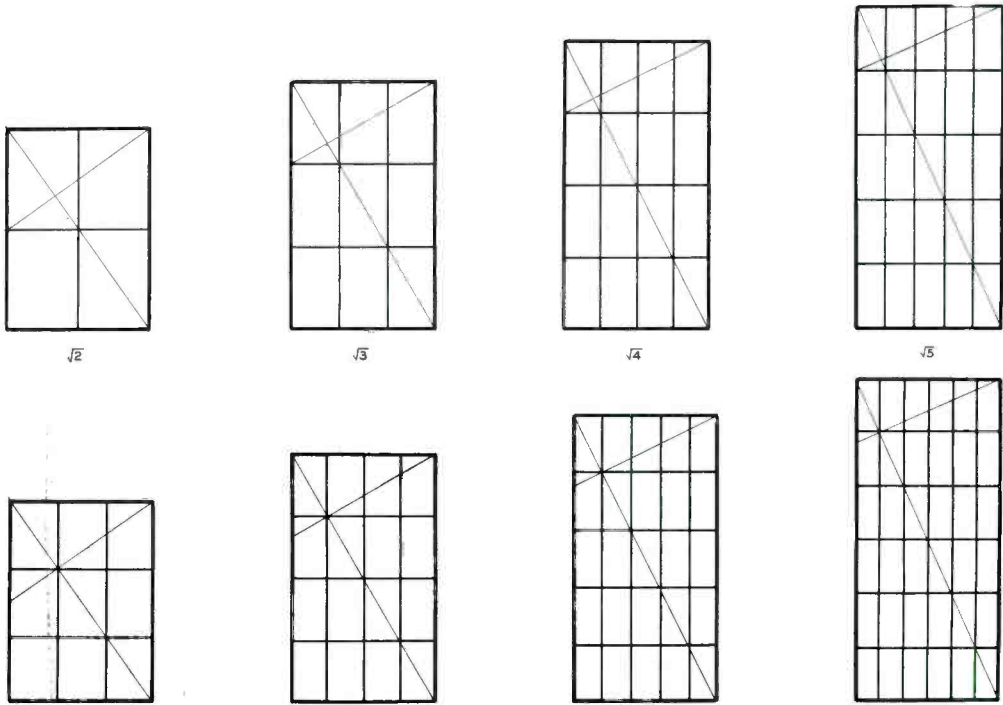

FIG. 16, ABOVE: ROOT 2 TO ROOT 5 RECTANGLES, SHOWING HOW THEY CAN BE DIVIDED BY A LINE AT RIGHT ANGLES TO A DIAGONAL. FIG. 17, BELOW: A VARIATION OF THE SAME METHOD OF DIVISION



open and closed conditions have similar shapes and therefore more pleasing appearance.

The mathematical relations between the several root rectangles is shown in the two constructions of Figs. 20 and 21.

Dynamic Symmetry in Nature ★ Designs of nature are based upon dynamic symmetry principles, which is "natural" since nature's handiwork is infinite growth upon an orderly basis. Con-

thousands of years, particularly in building work, but had not refined or extended it. The Greeks, with their greater philosophical and mathematical abilities, did extend and refine its practice, and soon far outstripped the Egyptians in its use. Among the Greek discoveries and applications was the one that the human body was in accord with dynamic growth principles, and this resulted in the

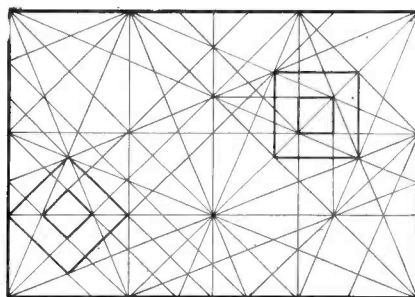
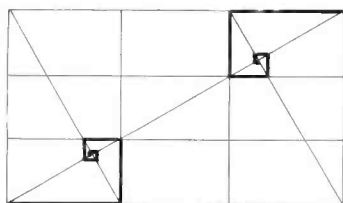
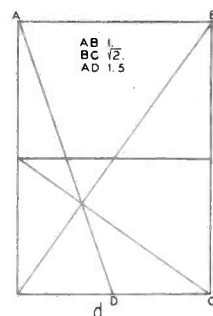
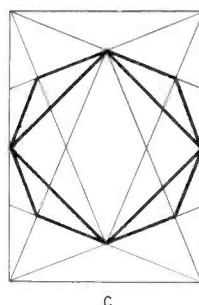
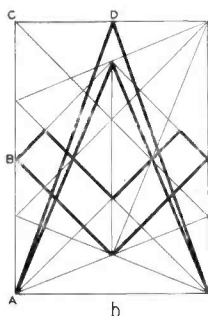
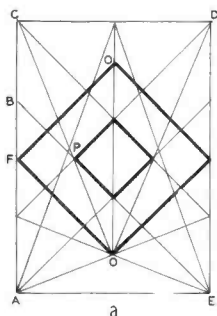

FIG. 18. FURTHER EXTENSION OF DIVISIONS SHOWN IN FIGS. 16 AND 17. FIG. 19, RIGHT: INTERESTING SUBDIVISIONS OF A ROOT-2 RECTANGLE AND, BELOW, SOME OF THE HIDDEN SHAPES AND RELATIONS THAT CAN BE BROUGHT OUT BY DRAWING DIAGONALS AND LINES JOINING SIGNIFICANT POINTS. OTHER CONSTRUCTIONS IN ROOT-2 RECTANGLES APPEAR BELOW



sideration of this phase of the subject is beyond the scope of these notes. Adequate treatment may be found in the publications of Hambidge and others, with proof of the discovery that the designs of nature are not accidental, but are in harmony with definite, exact basic plans. They warrant and should induce a faith in the validity and utility of these laws in all design work. The published works of Hambidge show various illustrations of these relations. For purposes of this paper, we need note only that dynamic ratios exist not only in plants but throughout the human body, with an astonishing degree of fidelity in any normal specimen. This was apparently discovered first by the Greeks, probably in the sixth or seventh century B.C., shortly after they acquired knowledge of the subject from the Egyptians, who first practiced it in the first or second dynasty (4000-5000 B.C.). The Egyptians, therefore, had practiced it for

extraordinary advance in Greek art, which we today call the "classic Greek," and which has not since then been surpassed or equalled. In fact, Hambidge considers that the human skeleton is the best source of the most vital principles of design.

Incidentally, it is interesting to note that the Romans did not learn the secret from the Greeks correctly. Mathematics was so undeveloped that they made the easy mistake of thinking that similarity of *line* was involved, rather than *area*, and therefore Roman art did not rise above the possibilities of static symmetry, which is better than no theoretical basis at all, but is much less vital and effective than is "dynamic symmetry." Greek and Egyptian art is much superior to the Hindu, Chinese, Japanese, Byzantine, etc., the former being "dynamic" and all the latter "static."

Radio Design Methods ★ The principles described

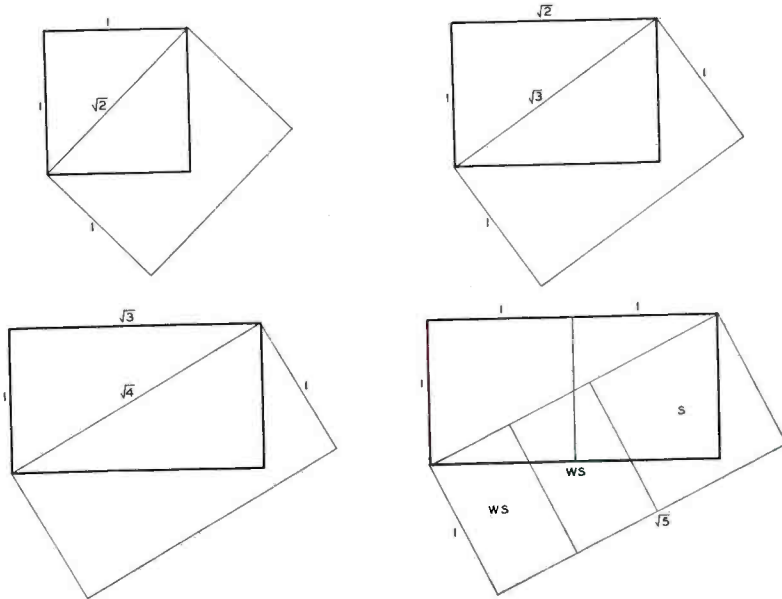

FIG. 20. RELATIONS BETWEEN ROOT-2, 3, 4, AND 5 RECTANGLES SHOW THESE SUCCESSIVE CONSTRUCTIONS

previously are very simple. Nevertheless, their application to actual design is not easy when we first try to use them, because we have been trained so long to design without fundamental plan. Considerable study and practice is necessary before useful results are obtained readily. Effort is well worth while, however,

because not only is beauty of design assured, but such beauty can be obtained with certainty, ease, and efficiency, as reward of the effort.

The most useful and most frequently needed application of dynamic symmetry to radio design is, at present, to the cabinets and

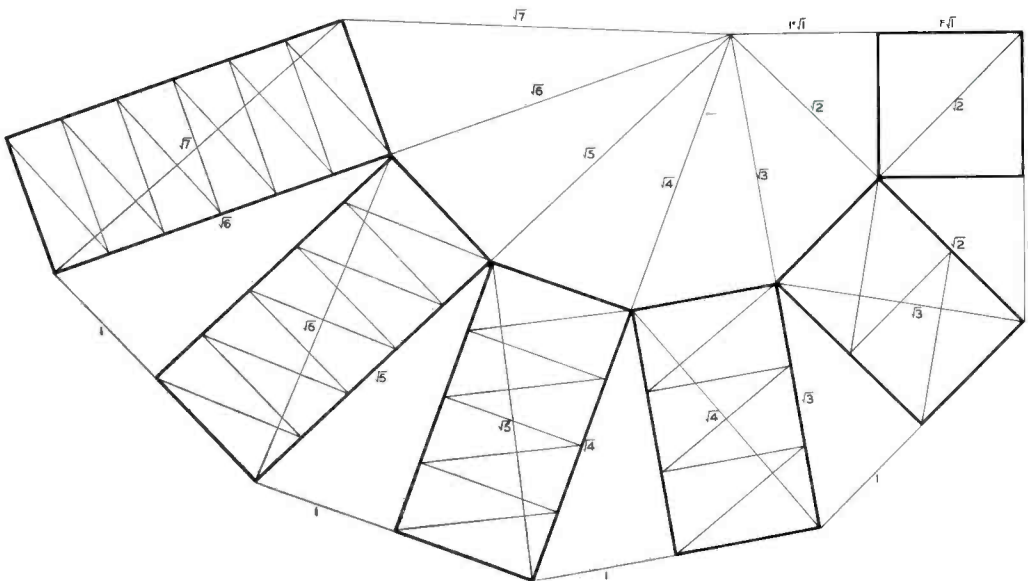

FIG. 21. ANOTHER INTERESTING SERIES OF RELATIONSHIPS APPEAR IN THESE VITAL RECTANGLES

panels of transmitters and receivers. In these instruments, a high standard of artistic excellence is desired, and it would be of much advantage to radio design if the radio engineer could execute properly the fundamental features of his cabinets, even if the decorative detail were left to the trained designer artist.

bizarre application of simple geometrical figures of nondynamic proportions, and largely resulting in displeasing, often ugly designs. Dynamic designs are not limited to simple forms, straight lines, etc., but are those which employ proper proportions in whole, in parts, and in relations of all parts to the whole. Some

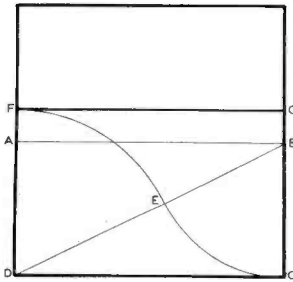

FIG. 22. CONSTRUCTION OF A WHIRLING SQUARE, 1.618 RATIO, WITHIN A SQUARE

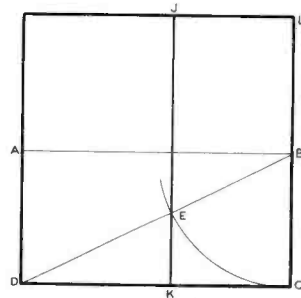

FIG. 23. JLCK IS A ROOT-5 RECTANGLE CONSTRUCTED IN A SQUARE IN THE MANNER SHOWN

This advantage would result from the fact that the preliminary layout work of the radio engineer could be guided properly by himself, and proper choice made from the various possible arrangements which are usually present. The need for *extensive* later work by an artist, with possible requirements of changes and delays, is thereby lessened, and the form,

modern design is dynamic, pleasing, and such work is likely to have lasting value and influence. It appears likely that use of dynamic principles will extend rapidly after more commercial demonstrations have been made.

Before proceeding with illustrations of application of the principles to specific radio design problems, let us review some of the con-

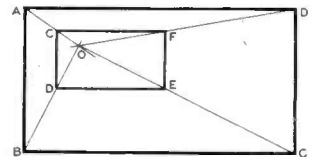
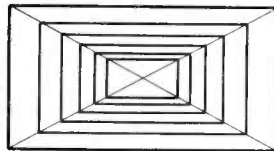
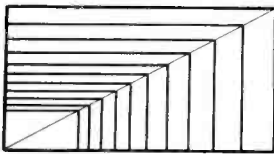

FIG. 24, LEFT: SIMILAR RECTANGLES WITH TWO SIDES COINCIDENT. FIG. 25, CENTER: SIMILAR RECTANGLES OF CONCENTRIC LOCATION. FIG. 26, RIGHT: SIMILAR RECTANGLE WITHIN ANOTHER

dimensions and specifications given by the engineer to the artist for decorative treatment will be fundamentally correct, and will not require change to result in an excellent completed design.

Dynamic symmetry has been used by Tiffany, famous jewelers and precious metal workers, for several years, and it is generally believed that their designs have improved enormously as a result and now have a fine classic beauty which was not often obtained by them before, even in work such as that which created the Tiffany reputation. Also, a considerable number of independent artists of high reputation are using it increasingly with excellent results. It should be understood that most of the so-called "Modern Art" has no relation whatever to dynamic symmetry. Much of modern art has been merely excessive and

structions which are most useful in that work.

To place a whirling-square rectangle (1.618 ratio) within a square, proceed as in Fig. 22.

Given the square.

Bisect it at *AB*.

Draw *BD*.

Swing arc to *E* with radius *BC*.

With radius *DE*, swing arc to *F*.

Draw *FG*.

FGCD is the whirling-square rectangle.

To place a root-five rectangle within a square, proceed as in Fig. 23.

Given the square.

Bisect it at *AB*.

Draw *BD*.

Swing arc to *E* with radius *BC*.

Draw *JK*.

JLCK is the root-five rectangle.

Given any rectangle, to produce similar ones of different size but with two sides coincident, proceed as in Fig. 24. For concentric location, proceed as in Fig. 25.

Given any rectangle, to produce a similar one at any points in the rectangle, proceed as in Fig. 26.

- ABCD* is the rectangle.
- C* and *D* are the points.
- Draw *AC* and *BD* through *O*.
- Draw *OC* and *OD*.
- Draw *DE* and *CF* parallel to *AD*.
- CDEF* is proportional to *ABCD*.

These three constructions apply to rectangles of any ratio, dynamic or not. But unless dynamic ratios are used, the results will be limited, flat, and dead. Every choice of rec-

of growth or division which meets the practical specifications of the job. Usually certain dimensions are adjustable, within certain limits at least, and others cannot be changed. Where the latter are too numerous, it will probably be difficult to find a completely satisfactory solution, although some assistance and benefit can be had even under such disadvantageous circumstances.

When designing cabinets, it must be understood that these principles are applicable to *three dimensional use*, and must be applied to *all views* of such objects, if the objects are to have dynamic appearance in perspective view from any side. Different ratios may be used for different sides, of course, but they must be related ratios.

There are two general methods of procedure,

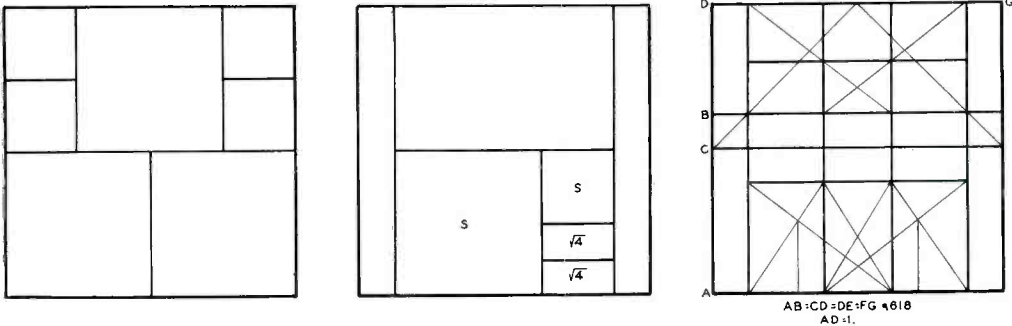

FIG. 27. AN UNLIMITED CHOICE OF RECTANGLES, ALL OF DYNAMIC RELATIONSHIPS, IS AVAILABLE TO THE DESIGNER. HERE SOME OF THE POSSIBLE SUBDIVISIONS OF A SQUARE ARE INDICATED

tangle, line, and point should be made with reference to and by aid of dynamic relations. This will ordinarily not conflict with practical requirements to serious degree, because the vital relations are many, and one usually can be found close enough to that required by practical considerations to satisfy them.

For example, consider some of the various dynamic rectangles which can be put inside a given dynamic rectangle, at about a certain position and of about a certain size. All of the rectangles are dynamic and any one nearest to practical requirements may be used.

Fig. 27 gives a few of the possible subdivisions of a square. Resulting lines, points, and areas may be used for location and sizes of parts.

Fig. 28 gives a few divisions of certain dynamic rectangles.

Specific Radio Problems ★ The geometric illustrations which have been given in the foregoing are obviously but a few of the countless manners of division which are possible in dynamic shapes. In attacking a definite design problem one will need to search for that plan

which we may call respectively the convergent and the divergent. In the convergent method we would start with a plan for the outline of the whole object and work inward searching for proper sizes and locations of interior parts. In the divergent method, we would start with some central small part of the object and work outward toward other parts and the whole outline.

The convergent method may be more convenient where the outline dimensions are already approximately fixed, as for example in radio equipment desired to be of approximately a certain height, width, and depth.

To use this method, first select that dynamic shape which is nearest in ratio to that of the approximate outline dimensions desired. Lay out that ratio rectangle, and next draw in a few of the most important division lines and areas thereof, including especially the ones thought most likely to fit known details of the desired design. Then roughly block in the major elements of the object, with some regard for vital locations and some for practical requirements. Then check the layout carefully for practical requirements, and make changes

where necessary, always seeking new locations or sizes which will conform to other vital parts of the basic rectangle. These can be discovered as needed. The operation is therefore convergent in another sense also, with attention alternating between practical and dynamic requirements until both are satisfied.

The divergent method is perhaps a more natural one, and usually more simple, to use. It utilizes the outward growth or unfolding from a nucleus, thus imitating the method of growth in Nature. Under this method, we would start with some important component part of the desired design and build the other parts around it. Both methods are exemplified in the following illustrations.

As a first example, consider the commercial loud speaker shown in Fig. 29 (Radiola Loud Speaker Model 100-A).

This figure shows the outline of the speaker to accurate scale and the dynamic plan in light lines. The design is based upon the root-two rectangle, which forms the over-all outline, and is a pleasing one, although it has two slight departures from complete correctness. The *AB* dimension is determined by division with diagonals. (See the method of Fig. 16.) The points of beginning of the side curves (*G* and *H*) are determined by the intersection of diagonals with the horizontal center line. The base moulding is determined by further division with diagonals and its general direction by diagonal *EF*.

The center of the circles (*O*) is not placed vitally in the design, and would be better slightly lower with the circles slightly smaller. The points *C* and *D* are not placed vitally and should be slightly lower or higher.

The next example utilizes the divergent method. In this suppose it is desired to design a new vacuum tube envelope of approximately certain shape and size, but with considerable freedom as to detail dimensions. One rigorous specification is given, namely the base diameter. The internal parts require clearances

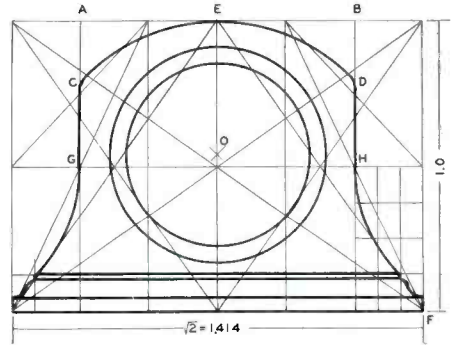

FIG. 29. AN EXAMPLE OF CONVERGENT DESIGN

about as shown in Fig 30, and a metal terminal is to be located on top.

We decide to start from the base, since that is an important part of the tube and since its diameter is specified. From general knowledge of bases we decide that the ratio of its diameter to height could be 1.309 and adopt that as a plan. We therefore lay out the base *ABCD* (Fig. 31a) with that ratio. Since we know that the envelope is to be wider than the base by about one-third, we will add on some 1.309 rectangles with the longer side horizontal, and the shorter side equal to the longer side of the

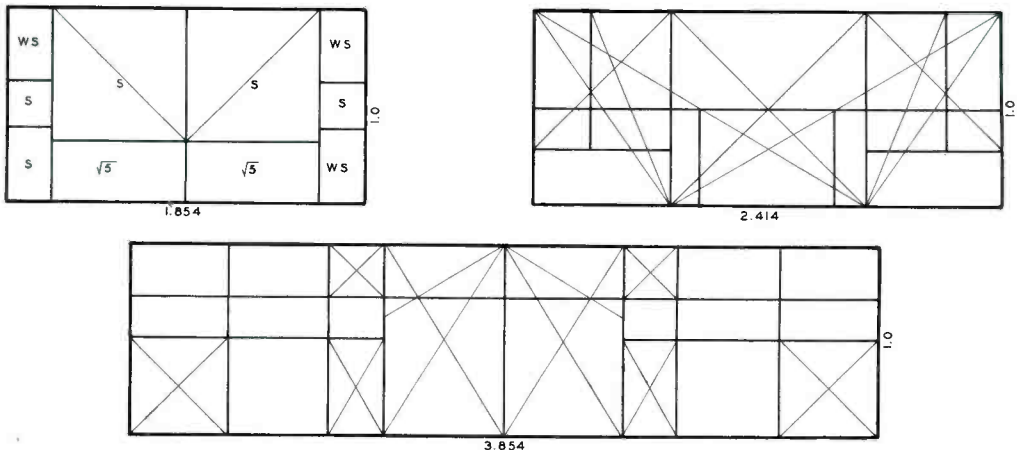

FIG. 28. FURTHER EXAMPLES OF DYNAMIC AREAS CONSTRUCTED WITHIN RECTANGLES OF THE RATIOS DISCUSSED IN PART 1 OF THIS ARTICLE. "WS" INDICATES WHIRLING SQUARE

base rectangle. Three such rectangles take us to the necessary height. To obtain a few more divisions, let us cut squares from top and bottom, bisect the top rectangle horizontally and extend the base sides up through the figure (Fig. 31b). If the calculations are made it will appear that the top rectangle *EFGH* has the ratio of 2.618 or a whirling-square rectangle

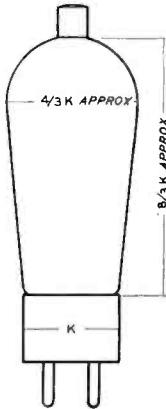

FIG. 30. ORIGINAL DESIGN OF GLASS ENVELOPE

plus a square. Therefore, since squares have powerful relation in this rectangle let us cut a square off each end of it (Fig. 31c).

For the tube prongs we need an area below the tube base somewhat less than the base in height. A 1.309 rectangle may provide this if constructed vertically downward with *DC* as its short side, as *DCMN*.

We now have enough plan possibilities to rough out a tube outline and, possibly after

a few trials, we decide upon the one shown in Fig. 32a. Then with suitable rounding and shaping we have the final outline design of Fig. 32b. The original specification of Fig. 30 has been fully met with a minimum of glass and evacuated space, some practical advantages such as better handhold, and an appearance which is likely to be more pleasing than would have been obtained by drafting without plan. Also if we later desire larger or smaller sizes in the same style, we have a basis for rapid reproduction of proportional ones which will have harmonious relation.

A simple and frequently advantageous application of planned design is found in such problems as packing carton dimensions. If fundamentally correct dimensions for single cartons are used, for vacuum tubes as example, it will be found that various quantities of single cartons can be grouped into efficient packages and that various sizes of single cartons can be grouped into one package with convenient and efficient results.

The study of motion picture screen area shapes is an interesting application. A paper by Loyd A. Jones¹ concerns this subject and gives data on the proportions used by master artists. While established practice is a controlling factor in this field, future changes, if any, may be guided advantageously by dynamic principles.

Switchboard design permits useful application of these principles, in over-all proportions, and in location of individual instruments. Rack panels, so widely used in radio and tele-

¹ Loyd A. Jones, "Rectangle proportions in composition," *Jour. S.M.P.E.* January, 1930.

(CONTINUED ON PAGE 43)

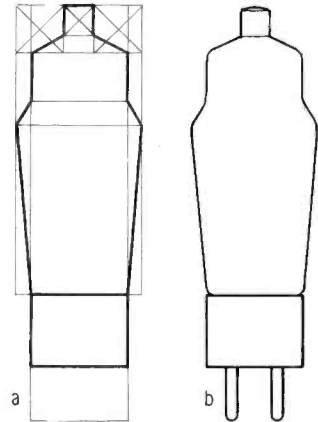
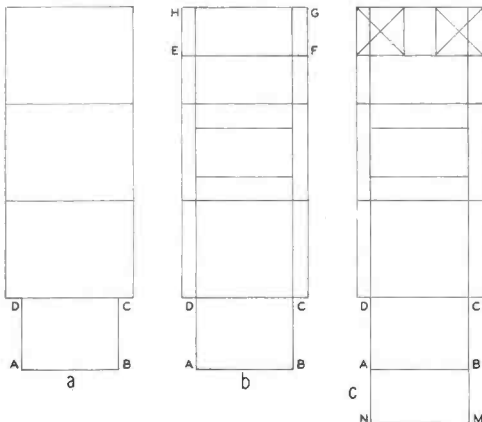

FIG 31, LEFT: PRELIMINARY STEPS IN DESIGNING A GLASS TUBE ENVELOPE BY THE DIVERGENT METHOD OF APPLYING PRINCIPLES OF DYNAMIC SYMMETRY. FIG. 32, RIGHT: FINAL STAGES OF THE DESIGN

SPOT NEWS

Notes and Comments, personal and otherwise, about broadcast, communications, and television activities

FM Stations: Orders stopping the construction of new stations and new construction at existing ones are specific in their reference to "standard broadcast stations." There is nothing to indicate that the freezing orders so far issued apply to FM transmitters.

Radio Receivers: One dealer, asked what he will sell when his stock of radio sets is cleaned out, replied: "I'll build 'em myself." Is it possible that others, particularly those who do a substantial service business, are like-minded? If so, war conditions may bring about the renaissance of set building. And why not?

On the Air: There are now 29 FM broadcast stations on the air with daily schedules. They are distributed as follows:

1 — Baton Rouge	1 — Rochester, N. Y.
1 — Boston	2 — Detroit
1 — Columbus, O.	2 — Hartford
1 — Evansville	2 — Philadelphia
1 — Los Angeles	2 — Pittsburgh
1 — Milwaukee	2 — Schenectady
1 — Mt. Washington	4 — Chicago
1 — Nashville	6 — New York City

G. E. Electronics: Pushing wartime developments in electronics and eyeing later peacetime applications, General Electric is setting a new laboratory as a division of the Company's radio and television department. William C. White, formerly in charge of vacuum tube division, has been appointed director of the new laboratory.



Clifford G. Fick: His appointment as assistant design engineer of G.E.'s transmitter division has been announced by J. M. Howell, manager of the Schenectady works. Fick has been with the Company since 1927, working on aircraft equipment and transmitters.

Michigan: State Highway Department has received CP's for two 50-watt FM transmitters, located at St. Ignace and Mackinac City, to operate on 31.26 mc. These will communicate with State-operated ferry boats operating in the Straits of Mackinac and adjacent waters.

New York City: Metropolitan Television, Inc., affiliated with Bloomingdale's department store, has been granted an extension until June 30, 1942, to complete construction of W75NY.

Congratulations: The Milwaukee *Journal's* W55M will go to full power on February 22nd, using their newly installed 50-kw. transmitter. Service area is 8,500 square miles, with 1,500,000 population. Chairman Fly of the FCC, in a lead story published by the *Journal*, voiced the sentiments of the radio industry in congratulating "55" and its parent station WTMS for outstanding service to listeners in the Milwaukee area.

Amarillo, Tex.: An FM CP has just been issued to Amarillo Broadcasting Corporation for 45.1 mc. This application has been pending for many months.

Philco: If Government orders are forthcoming in sufficient quantities, James T. Buckley, Philco president, estimates that his company can produce war equipment at the rate of \$160,000,000 a year on an all-out basis.

New York City: FM application of American Network has been designated for a consolidated hearing which will include seven applicants in the New York area.

Philadelphia: W53PH, operated by WFIL, put its full-power transmitter on the air February 10th. This is a 10-kw. R.E.L. installation. FM studios are in the Widener Building.

ST Links: Leonard Asch, president of Capitol Broadcasting Company, Inc., has straightened us out on the ST link situation. Yankee Network's link transmitter, operating on 133.03 mc., was the first FM type to be installed. However, Capitol's transmitter was the first to be put into commercial service in the new 331 mc. band. It operates over an airline distance of 12 miles.

Normandie: Interesting example of importance of movie camera was the shooting of the Normandie disaster by Ed Anhalt, whose 16 mm. picture record was then televised over WCBW. This puts television in direct competition with news-reel theatres, with a keep-your-slippers-on advantage.

Taco: FM, television, and war orders have stepped up antenna business to the point that Technical Appliance Corporation has moved to larger quarters at 516 West 34th Street, New York City, where they now have 20,000 sq. ft. of factory space.

Listeners' Preferences: As reported by Robert Kelley, public relations director of W45D, Detroit, were recorded in replies to question-



NEWS PICTURE

Discussing FM on a WOR-W71NY broadcast from the I.R.F. Convention were, l. to r.: M. B. Sleeper, Fred M. Link of Link

Radio; I. S. Coggeshall, chairman of the Convention committee; Harry Carlson, announcer; Arthur F. Van Dyck, I.R.F. president; Dr. Lynde P. Wheeler, chief of the technical sec-

tion, FCC; John V. L. Hogan, president, Interstate Broadcasting Co., WQXR-W2XQR; J. R. Poppele, chief engineer, WOR-W71NY; Dick Dorrance, Manager, FMBI.

naires. Listeners were asked which of six types of programs they liked and to indicate the order of their preferences. Results were:

1. Classical and concert music82%
2. News broadcasts71%
3. Semi-classical vocalists62%
4. Popular music45%
5. Popular vocalists28%
6. Sports24%

No one asked for soap-box operas or jingles, although 63 per cent added enthusiastic notes concerning FM broadcasting. Favorite listening hours were shown to be:

- 6:00 to 8:00 P.M.74% of listeners
 8:00 to 10:00 P.M.80% of listeners
 10:00 to 12:00 P.M.33% of listeners

Winston-Salem: Gordon Gray will use a 25-watt FM link to carry studio programs to the FM transmitter on Clingman's Peak. CP has been granted for operation on 337 mc. In addition, a



C. R. RUNYON, CLOSE ASSOCIATE OF MAJOR ARMSTRONG AND OWNER OF THE YONKERS' EXPERIMENTAL STATION WHICH HAS TAKEN PART IN MANY OF THE PIONEER FM TESTS

CP has been granted for the use of a 50-watt FM transmitter, to operate on 156.75, 158.5, 159.3 and 161.1 mc. as a spare in case of failure or unsatisfactory operation of the ST link.

Television: Philco's television station WPTZ is transmitting some of WFIL's programs. The first to be handled in this cooperative effort is WFIL's "Our Future Admirals," a series of broadcasts portraying the training of Naval

officers. This program is not produced specifically for television, but is offered as a behind-the-scenes-in-radio idea. Camera shots show the director, sound man, musicians and actors at the WFIL studio. Future programs, however, will be produced for simultaneous transmission on television and on sound only.

RCA: So effective has been RCA Manufacturing Company's "Beat the Promise" campaign in winning the cooperation of their workers that they are being asked by other war production plants to furnish details of this plan. Currently, RCA workers are pushing production to "Give the Squeeze to the Japanese".

Boston: Yankee Network is giving Bennington College students a chance to get practical experience in studio technique. First apprentice is Miss Dorothea Douglas who is working under the guidance of Miss Aerialia Rice, member of Yankee's staff. John Shepard, 3rd, has inaugurated this plan for the particular purpose of developing script writers and artists who have a thorough understanding of the facilities and practical limitations of broadcasting.

Shakeproof: Every engineer and draftsman working on radio apparatus design will find the 140-page Shakeproof data book of great value in his daily work. It covers lock washers, thread-cutting screws, fasteners, terminals and baking screws. In addition to the most complete information on types, sizes and dimensions of these items, there is a special section on government specifications and approvals which will save many a headache. Those writing for the book are asked to use company stationery. Address: Shakeproof, Inc., 2501-F North Keeler Avenue, Chicago, Ill.

Long Distance: Zenith Radio Corporation, operating W51C, has received a letter from a listener in Monterey, Mexico, telling of daily reception of this station between 3:00 P.M. and 6:00 P.M. This is the greatest distance, 1,100 airline miles, from which consistent reception of the 50 kw. transmitter has been reported.

Sargents Purchase, N. H.: Many radio men have searched their maps to find this spot in New Hampshire. It is the formal name for the spot where the Mt. Washington FM transmitter is located.

Sponsors: W71NY has appointed William Stedman its first sales representative. The splendid programming of this FM station will certainly give him something to sell. Stedman comes from R. H. Macy's advertising department. W71NY is maintaining an 8:00 A.M. to 12:00 M. schedule.

FM STATIONS

List of Stations for Which C.P. Applications Have Been Filed, and Those Granted up to Feb. 17th

EDITOR'S NOTE: *This FM Station Listing, revised from month to month, is a regular feature of FM Magazine. We ask the cooperation of the Station Managers in correcting any errors or omissions which may appear, due to changes in the status of the stations, modifications, or confusion in the source of information.*

★ Indicates that station is maintaining full program schedule. E Indicates experimental operation. X Indicates that the FCC is withholding action, pending the outcome of the Newspaper-Radio investigation. C Indicates that construction is under way, and station will be on the air shortly.

CALIFORNIA		Los Angeles		IOWA	Cedar Rapids	
K31LA	Columbia B'e'st'g System			47 X	The Gazette Co.	
K37LA	Earle C. Anthony, Inc.					
K45LA ★	Don Lee B'e'st'g System	2,600,000		KENTUCKY	Ashland	
K53LA	Standard Broadcasting Co.			61 X	Ashland Broadcasting Co.	
K61LA	Metro-Goldwyn-Mayer Studios, Inc.				Lexington	
				W51SL	American B'e'st'g Corp. of Ky.	
65 X	Oakland				Louisville	
	Tribune Building Co.			57 X	L'v'le Courier-Journal & Times	
41 X	San Bernardino			LOUISIANA	Alexandria	
	The Sun Co. of San Bernardino			47 X	Alexandria Broadcasting Co.	
35	San Francisco				Baton Rouge	
	Don Lee Broadcasting System			W45BR ★	Baton Rouge B'e'st'g Co.	361,400
				MAINE	Falmouth	
COLORADO	Denver			71 X	Portland Broadcasting System	
65	Eugene P. O'Fallon, Inc.			MARYLAND	Baltimore	
				59	Baltimore Radio Show, Inc.	
CONNECTICUT	Hartford			63 X	The A. S. Abell Co.	
W53H E	The Travelers Broadcasting Serv., Inc.			MASSACHUSETTS	Boston	
W65H ★	WDRG, Inc.	1,119,000		35	Columbia Broadcasting System	
				W43B ★	The Yankee Network	6,635,751
DISTRICT OF COLUMBIA				47	Boston Edison Co.	
71	M.A. Leese Radio Corp.			W67B E	Westinghouse Radio Stations, Inc.	
					New Bedford	
GEORGIA	Atlanta			57 X	E. Anthony & Sons, Inc.	
53	Constitution Publishing Co.				Springfield	
				W81SP E	Westinghouse Radio Stations, Inc.	
ILLINOIS	Chicago				Worcester	
W47C	WJJD, Inc.			61 X	Worcester Telegram Publishing Co.	
W51C ★	Zenith Radio Corp.	4,500,000		MICHIGAN	Battle Creek	
W59C ★	WGN, Inc.	4,500,000		81 X	Federated Publications, Inc.	
W63C C	National B'e'st'g Co.				Detroit	
W67C ★	Columbia B'e'st'g System	4,500,000		W45D ★	The Evening News Ass'n	2,498,000
W75C ★	Moody Bible Institute	4,500,000		W49D ★	John Lord Booth	2,900,000
W79C	Oak Park Realty & Amus. Co.			W53D	WJR, The Goodwill Station	
79	Chicago Federation of Labor			65	James F. Hopkins, Inc.	
				W73D	King Trendle Broadcasting Co.	
					Grand Rapids	
83	Cicero			55	King Trendle Broadcasting Corp.	
	WHFC, Inc.			61 X	Federated Publications, Inc.	
					Lansing	
	Rockford			71 X	Federated Publications, Inc.	
W71RF X	Rockford Broadcasters, Inc.			W77XL	WJIM, Inc.	
INDIANA	Evansville					
W45V ★	Evansville on the Air	465,000				
	Fort Wayne					
W49FW	Westinghouse Radio Stations, Inc.					
	Indianapolis					
53 X	Indianapolis B'e'st'g Co., Inc.					
73	Associated Broadcasters, Inc.					
	South Bend					
W71SB X	South Bend Tribune					

MISSOURI	Kansas City				Syracuse
K49KC	Commercial Radio Equipment Co.			W63SY	Central N. Y. Broadcasting Co.
	St. Louis			NORTH CAROLINA	Winston-Salem
47 X	Star-Times Publishing Co.			W41MM C	Gordon Gray
47 X	Globe-Democrat Publishing Co.			67 X	Piedmont Publishing Co.
K51L	St. Louis University			OHIO	Cleveland
55	The Pulitzer Publishing Co.			85 X	United Broadcasting Co.
K59L	Columbia Broadcasting System				Columbus
NEW HAMPSHIRE	Mount Washington			W45CM ★	WBNS, Inc. 1,100,000
W39B ★	The Yankee Network	2,000,000			Youngstown
	Manchester			35	William F. Maag, Jr.
35	The Radio Voice of New Hampshire			PENNSYLVANIA	Philadelphia
NEW JERSEY	Ewing Township			W49PH C	Pennsylvania Broadcasting Co.
47 X	Mercer Broadcasting Co.			W53PH ★	WFIL Broadcasting Corp. 3,850,000
	Jersey City			W57PH	Westinghouse Radio Stations, Inc.
91	N. J. Broadcasting Corp.			61 X	Gibraltar Service Corp.
95	Bremer Broadcasting Corp.			W65PH	Seaboard Radio Broadcasting Corp.
NEW YORK	Albany			W69PH ★	WCAU Broadcasting Co. 3,850,000
51 X	WOKO, Inc.			73	Wm. Penn B'c'st'g Co.
	Binghamton				Pittsburgh
W49BN	Wylie B. Jones Advt. Agency			W47P ★	Walker-Downing Corp. 2,100,000
	New York City			65	Pittsburgh Radio Supply House
W31NY E	Mj. Edwin H. Armstrong	12,200,000		W75P	Westinghouse Radio Stations, Inc.
W35NY	Municipal B'c'st'g System				Reading
W47NY ★	Muzak Corporation			65	Hawley B'c'st'g Co.
W51NY E	National Broadcasting Co.			RHODE ISLAND	Providence
W55NY	William G. H. Finch			75	Cherry & Webb Broadcasting Co.
W59NY ★	Interstate Broadcasting Co.			85	The Outlet Company
59	Frequency B'c'st'g Corp.			TENNESSEE	Nashville
W63NY C	Marcus Loew Booking Agency			W47NV ★	National Life & Acc. Ins. Co. 819,000
W67NY ★	Columbia B'c'st'g System	12,000,000		TEXAS	Amarillo
67	Wodaam Corporation			51 X	Amarillo Broadcasting Corp.
W71NY ★	Bamberger B'c'st'g Service	12,000,000			Houston
W75NY	Metropolitan Television, Inc.			65	Houston Printing Corp.
79 X	News Syndicate Co., Inc.			UTAH	Salt Lake City
79	The American Network, Inc.			K47SL X	Radio Service Corp. of Utah
83	FM Radio Broadcasting Co., Inc.			WISCONSIN	La Crosse
83	Knickerbocker Broadcasting Co.			65 X	La Crosse Tribune Co.
83	WBNX Broadcasting Co.				Milwaukee
87	The Debs Memorial Radio Fund, Inc.			W55M ★	The Journal Co. 1,522,000
87	Greater N. Y. B'c'st'g Corp.				Superior
	Rochester			45 X	Head of the Lakes Broadcasting Co.
47 X	WHEC, Inc.				
W51R ★	Stromberg-Carlson Tel. Mfg. Co.	585,000			
	Schenectady				
W47A ★	Capitol Broadcasting Co.	967,000			
W57A E	General Electric Co.				

EXPERIMENTAL FM STATIONS CURRENTLY OPERATING

W1XK	Westinghouse Radio Stations, Inc., Hull, Mass.	42.6 mc. 100 w.
W1XSN	Westinghouse Radio Stations, Inc., West Springfield, Mass.	44.6 mc. 1 kw.
W1XSO	The Travelers Broadcasting Service, Hartford, Conn.	43.7 mc. 1 kw.
W1XTG	Worcester Telegram Pub. Co., Inc., Worcester, Mass.	43.4 mc. 1 kw.
W2XMN	Edwin H. Armstrong, Alpine, N. J.	42.8 mc. 40 kw.
W2XOY	General Electric Co., Schenectady, N. Y.	43.2 mc. 2½ kw.
W2XQR	John V. L. Hogan, New York City	43.2 mc. 1 kw.
W2XWG	National Broadcasting Co., New York City	45.1 mc. 1 kw.
W3XMC	McNary & Chambers, Washington, D. C.	42.6 mc. 100 kw.
W3XO	Jansky & Bailey, Washington, D. C.	43.2 mc. 1 kw.
W8XAD	W H E C, Inc., Rochester, N. Y.	42.6 mc. 1 kw.
W9XYH	Head of the Lakes Broadcasting Co., Superior, Wisconsin	43.0 mc. 1 kw.
W9XER	Midland Broadcasting Co., Kansas City	46.5 mc. 1½ kw.
W8XFM	Crosley Corporation, Chicago	43.2 mc. 1 kw.

Always NEW!

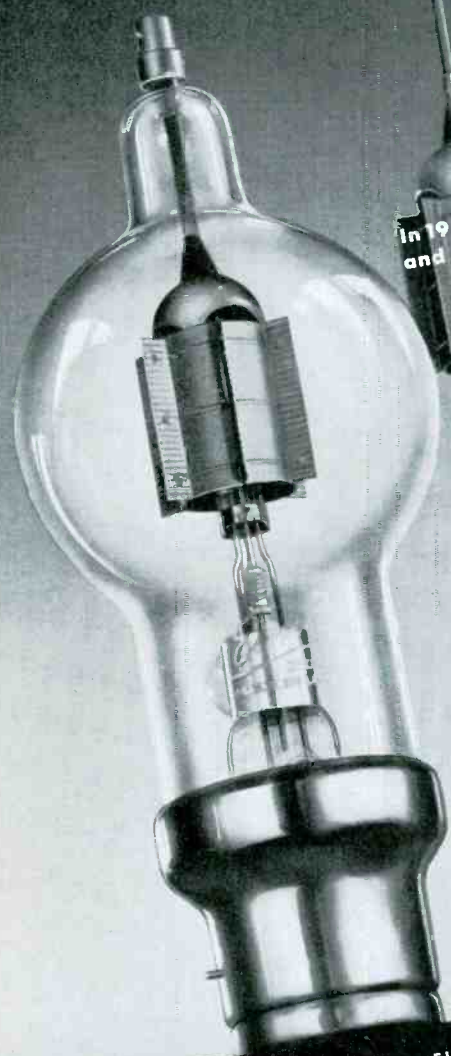

In 1941 further improvements and still greater efficiency.

A radical plate design in 1936 greatly improved power capabilities and efficiency of 250T.

VETERANS of many outstanding achievements in radio, yet there's no such thing as an OLD tube type at Eimac. Past achievements led to leadership in the field. Leadership made possible by "heads-up" developments in tube construction and performance capabilities. The tubes in Eimac tubes today are not the same, by a long way as those originally used. And yet basically they are the same. Note the improvement, Eimac tubes are kept "always NEW" ... always a step ahead of the needs of the industry. Each tube has behind it the successful design... ability to perform without strain where many others failed. Such is the Eimac 250T. Originally the Eimac 150T, it surprised the industry by performing so easily, the task of much larger tubes that, with slight modifications, its rated capabilities were boosted by more than 60%. The record today shows these comparatively small triodes being used in newer transmitters for jobs once thought impossible. Eimac tubes are like that, one and all. They are the only tubes on the market which carry unconditional guarantee against tube failures resulting from gas released internally.

Follow the leaders to

Eimac TUBES

Eitel-McCullough, Inc.
San Bruno, Calif.

EIMAC 250T

Plate Dissipation (normal)	250 Watts
Filament Voltage	5 to 5.1 Volts
Maximum Plate Voltage	3000
Power Output at 3000 volts on plate	750 Watts

EIMAC REPRESENTATIVES

California, Nevada
HERB BECKER, 1530 W.
104th St., Los Angeles, Cal.
N. Y., N. J., Penn., Md., Del.,
Dist. of Col., Maine, N. H.,
R. I., Conn., Mass.
ADOLPH SCHWARTZ, 262
Grayson Place, Teaneck, New
Jersey

Wash., Ore., Idaho, Mont.
GENERAL SALES CO.,
Verner O. Jensen, 2605-07
Second Ave., Seattle, Wash.
Colo., Wyo., New Mexico,
Arizona, Utah
RICHARD A. HYDE, 4253
Quitman St., Denver, Colo.

Chicago, Illinois, Wisconsin
G. G. RYAN, 349 W.
Washington Blvd., Chicago,
Ill.
N. Caro., S. Caro., Georgia,
Tenn., Flor., Ala., Miss.
JAMES MILLAR, 316 Ninth
St. N. E., Atlanta, Georgia.

Texas, La., Okla., Ark.
J. EARL SMITH, 2821 Live
Oak St., Dallas, Texas.
Ohio, Mich., Ky., Ind., Minn.,
Mo., Kan., Neb., Iowa
PEEL SALES ENGINEER-
ING CO., E. R. Peel, 154
E. Erie St., Chicago, Ill.

Export Agents: Frozor & Co., Ltd., 301 Cloy Street, San Francisco

(CONTINUED FROM PAGE 23) but actually putting out entertainment programs from time to time, are:

One man at the transmitter. One man for each camera in operation. One man for each set of controls handling two cameras. (Insurance laws require that more than one man work at a time in the presence of high voltages, so that the personnel may have to be assigned with that requirement in mind.)

Note that these men can double in various functions. When films are being transmitted, for instance, the same men can be at the film pickup equipment.

For field operations, the personnel requirements again are:

One man for each camera. One man for the controls handling two cameras if necessary. One man for the relay transmitter.

Other personnel may be necessary if the programs are of a more elaborate nature. Thus there may be a program director handling the action of performers. There may be a lighting technician. There may be personnel required for handling studio scenery. Local union regulations may also have a bearing on the staff required. Here again we have variables which prevent any hard and fast estimates.

Studio and Station Quarters ★ The greatest variable of all is that of quarters to accommodate studios and station proper. Each case stands by itself. Where telecasting is to be a supplementary service of an existing broadcasting station, there will be little or no added expense to include television, particularly using Du Mont units and chains that can be run in when and as needed.

Because of the complexity and cost of coaxial lines or relay transmitters and receivers, the transmitter usually will be located close to the studios. Due to the enormous publicity value of early television, in many communities the necessary quarters may be rented at exceptionally low rates, while the roof can be used to support the lofty antenna.

Because of the technical limitations of television pickup in these early stages, the television studios can be limited in size. A 20 by 40-ft. minimum space may be satisfactory for the more ambitious studio programs, and half or even one-quarter that space will serve for the closeups which, with films and outside pickups, must constitute the bulk of the television programs. Also, if pageants or stage plays are to be handled, they had best be considered as remote pickups and handled in theatres or outdoors where adequate space and illumination are already available. In the case of the Du Mont New York Station, ambitious programs are to be handled in local movie studios by relay link.

As we said in the beginning, we say again: Television is no piker's game. It calls for real money, much grit, and a gambling spirit, in keeping with the big stakes promised in the future. The Du Mont unit and chain technique, however, does permit of enormous flexibility in making a start and then growing up with the developing art.

Since each television undertaking is peculiar unto itself, the foregoing facts and figures must be largely in the nature of rough ideas on the subject, but they serve as a basis for working out definite plans of facilities and financing.

BOOK REVIEW

THE RADIO HANDBOOK, 1942 edition, published by Editors and Engineers, Ltd., Santa Barbara, Calif. 640 pages, 6½ by 9½ ins., 577 illustrations, 41 tables, cloth bound, \$1.75.

The Radio Handbook is a general compilation of practical radio data covering the basic theory of radio circuits from the practical point of view, constructional information on transmitters, receivers, and test equipment, and tables, reference charts and graphs, and formulas of special usefulness.

There are 27 chapters, covering: Introduction to amateur radio, Fundamental electrical and radio theory, Vacuum tube theory, Radio receiver theory, Radio receiving tube characteristics, Radio receiver construction, Trans-

mitter theory, Radio telephony theory, Frequency modulation, Transmitting tubes, Transmitter design, Exciters and low power transmitters, Medium and high power RF amplifiers, Speech and modulation equipment, Power supplies, Transmitter construction, UHF communication, UHF receivers and transceivers, UHF transmitters, Antenna theory and operation, Directive antenna arrays, UHF antennas, Transmitter adjustment, Test and measuring equipment, Workshop practice, Broadcast interference, and radio mathematics and calculations.

Several of the chapters have been completely revised from the 1941 edition, and 32 pages of text have been added to bring this year's edition up to date.

FCC DEFINES POLICIES CONCERNING STANDARD BROADCAST APPLICATIONS

SINCE the first announcement of the plan to freeze broadcast station facilities, there has been much speculation as to whether this would result in a curtailment of radio service to the public.

Such announcements as have been issued referred specifically to "standard broadcast stations," and made no reference to FM or television stations already in operation or in course of construction. Noticeable, however, was the fact that two CP's for FM stations in New Jersey and one in Amarillo, Texas, were issued after the plan to freeze standard broadcast facilities was formulated.

From this, it appears that, at least in some cases, FM station construction will be permitted to proceed. This may be because FM transmitters lend themselves to special purposes for which AM stations are not suited.

The situation is partly clarified by the Memorandum Opinion issued on February 24th by the Federal Communications Commission. In the last paragraph, the Memorandum refers to special policies which are being developed with respect to FM, television, facsimile, and auxiliary broadcast services. Whether broad policies will be applied, or if each case will be considered on its merits is not known at this time. The full text of the memorandum follows:

Because of the present war emergency, the Commission is called upon to formulate a policy and procedures for the future handling of standard broadcast station applications. The effective conduct of the war is, of course, a paramount consideration for all of us. The requirements of the armed services have created a shortage of the critical materials and skilled personnel required for the construction, operation and maintenance of radio broadcast stations. This must inevitably affect plans for the increase or improvement of broadcast facilities.

However, it is not clear at this time that the expansion of broadcasting should be entirely eliminated for the duration of the war. For the best war effort, it is important that there be adequate broadcast facilities throughout the nation. The three governmental agencies concerned with this problem — the Defense Communications Board, the War Production Board, and the Federal Communications Commission — are in agreement that, so far as possible, every part of the country should receive a good radio service. We have not yet reached that goal.

It follows that the scarce materials and limited personnel available to the broadcast services should be carefully conserved to meet this basic need. The public interest clearly requires



Hyvol line of oil-filled Xmitting capacitors includes several types, including the rectangular-can '09 series for higher working voltages.

- Here are two recent additions to the Hyvol Transmitting Capacitor Line to meet higher voltage requirements such as cathode-ray power supplies, by-pass circuits of transmitters, high-power rectifiers, P-A systems, etc. Type '12 (left) provides high-voltage pillar terminals in minimum height, due to separator ribs. 2000 to 7500 v. D.C.W. Type '14 (right) has single pillar-insulator terminal and grounded can. 3000 v. D.C.W. Both are immersion proof. Both with adjustable mounting ring for upright or inverted installation.

● Ask Our Jobber . . .

Ask about Aerovox Hyvol Capacitors — a wide choice to meet all needs. And if you are engaged in professional radio work requiring transmitting capacitors, ask our jobber or write us on business stationery, for Transmitting Capacitor Catalog.

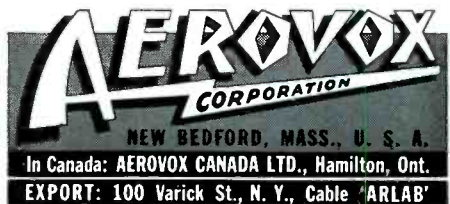

FCC DEFINES POLICIES CONCERNING STANDARD BROADCAST APPLICATIONS

(CONTINUED FROM PAGE 39)

such conservation and the Commission must apply the test of public interest in exercising its licensing functions. The problem as to materials is of course primarily the concern of the War Production Board. On January 30, 1942, the Commission announced in a press release that at the request of the Defense Communications Board, pending the adoption of a specific policy by that Board and the War Production Board, the Commission would make no further grants for the construction of stations or authorize changes in existing standard broadcast transmitting facilities where all or a substantial part of the proposed new primary service area already receives primary service from one or more other stations. The Defense Communications Board, on February 12, made its further specific recommendations to the Commission and to the War Production Board. Cooperating with both those Boards, the Commission has now worked out a policy and procedures for the handling of new and pending standard broadcast applications.

Under the policy adopted the Commission will grant no standard broadcast station application unless a showing is made that:

- (1) Construction (if any) pursuant to the grant will not involve the use of materials of a type determined by the War Production Board to be critical; or
- (2) Where the application is for a new standard broadcast station, the station will provide primary coverage of an area no substantial part of which already receives primary service¹ from one or more standard broadcast stations; or
- (3) Where the application is for a change in the facilities of an existing standard broadcast station, the change will result in a substantial new primary service area, no substantial part of which is already provided with primary service¹ from one or more standard broadcast stations.

The Federal Communications Commission Standards of Good Engineering Practice will be used as a guide in the determination of primary service. For the time being, requests involving essential requirements for repair or maintenance will be treated as heretofore.

Applications not heretofore acted upon which do not fall within one of the three described categories will be designated for hearing upon appropriate issues. In cases heretofore designated for hearing, where notice of issues has already been announced, specific

issues appropriate to the new policy will be added. Cases which have already been heard will, when necessary to apply the new policy, be redesignated for hearing upon issues under this policy. Cases in which proposed findings have already been issued will be determined as heretofore.

Applicants who consider that their applications satisfy the new requirements may wish to support their applications by filing a proper petition supported by affidavit setting forth detailed data on this point.

In cases where an application has heretofore been granted subject to approval of a further application to be filed by the applicant, such further application will not be granted unless the proposal meets the requirements set forth above, or the applicant has, pursuant to the grant, actually commenced construction or made substantial expenditures for materials or equipment prior to the date hereof.

The Communications Act contemplates that construction permits should not be issued or allowed to remain outstanding where there is no reasonable prospect of completion of the proposed construction within a reasonable period of time. Hence, requests for extensions of completion dates under standard broadcast authorizations will not be granted by the Commission unless the applicant can by proper petition show that the proposed construction meets the requirements set forth above, or that the applicant has actually commenced construction prior to the date hereof and has available all the critical materials and equipment necessary to the completion thereof. However, requests for extension of completion dates under authorizations issued in cases where proposed findings are now outstanding will be granted if the requirements set forth above are met, or if the applicant has available all critical materials and equipment necessary for completion.

The foregoing requirements may be waived where changes in facilities are required to be made by an agency of the Federal Government.

Special policies are now being developed with respect to experimental operation, frequency modulation and television stations, facsimile and auxiliary broadcast services, taking into account the technical experimental benefits to be gained especially insofar as they may assist the war effort. Applications involving international broadcast stations will be considered and acted upon in accordance with policies worked out in cooperation with other Governmental agencies concerned with this field.

¹ As here used, "primary service" includes service to be rendered pursuant to an outstanding broadcast construction authorization.

DEAN POUND TESTIFIES BEFORE FCC

ONE of the important points at issue in the lengthy FCC investigation of the press-radio situation is the question as to whether a blanket ruling can be applied to this group, or if each case should be considered individually on its merits.

While it is considered by many that the authority under which the FCC functions quite clearly calls upon the Commission to follow the latter course, this view is not shared by all the Commissioners.

Among those testifying at the hearing was Roscoe Pound, dean emeritus of the Harvard School of Law. He appeared on behalf of the Newspaper-Radio Committee which has been representing the newspapers who now operate radio broadcast stations, or have applied for FM construction permits.

Commenting upon the conditions in cities where the only daily newspaper owns the only broadcast station, Dean Pound said that, from the theoretical standpoint, the situation looked pretty bad, but that he did not think "it is an actuality."

Dean Pound was very definite in expressing to the Commission his belief that all factors in each application should be considered, on the basis that a general rule cannot take care of all exceptions and conditions. Questioned as to who should and who should not be permitted to own and operate a broadcasting station, Dean Pound said that it all depended upon the people who would operate the station. More diversity of ownership would not assure anything, he said, adding: "The questions involved are distinctly a move toward the suppression of free speech."

Chairman Fly, acting as chairman of the investigation on this occasion, asked Dean Pound what his attitude would be in the case of two rival applications, one from a newspaper and one from a non-newspaper interest.

In his reply, the Dean stated that he thought it proper for the Commission to take account of the newspaper ownership by one applicant, but that he did not feel that this should be the controlling factor in granting a license to operate a broadcasting station.

Any proposal, he said, which had as its object the promulgation of rules which would discriminate against newspapers as a group would be an infringement upon the Bill of Rights. Under these circumstances, according to the Dean, the government would begin to develop a tendency to extend control beyond the original intention at the time the FCC was created.

Further, he said: "The time to resist such a tendency is at the beginning."

Donald Harris, FCC counsel, asked the Dean if, in his opinion, affirmative government action was necessary to safeguard the freedom of the press and of speech. In reply, Dean



The product of CATHODE-RAY HEADQUARTERS

- ★ Replete with features that make your work easier and more pleasant, DuMont Type 208 Cathode-Ray Oscilloscope will extend your investigations into studies not previously feasible without much labor and expense. That is why it has already won the highest endorsements of users.

This oscilloscope is but one of a large line of instruments, cathode-ray tubes and associated equipment developed, produced and marketed by the DuMont organization in a decade of intensive specialization.



- ★ Write for descriptive literature on this and other DuMont products. Submit your cathode-ray problem for engineering aid, recommendations, specifications, quotations.

DUMONT

**ALLEN B. DU MONT
LABORATORIES, Inc.**

Passaic ★ New Jersey

Cable Address: Wesplexin, New York

Pound said: "That is errant nonsense. The tendency of those who have power is to reach for more power. Any government control of the press is the beginning of autocracy."

Many complaints have been voiced over the continuation of the press-radio hearings, because this investigation, started long before our declaration of war, is putting a great burden of time and expense on broadcast station executives just when so many wartime problems demand solution. However, Chairman Fly has declined to drop the investigation.

The feeling is shared by many that the

broadcasters are entitled to the same cooperation from the government that they are being asked to give, and are giving so generously just when station revenues are falling off. This is due, of course, to the fact that some of the largest buyers of time are concerns whose plants are being given over to war production, thereby restricting the manufacture of their peacetime products, and calling for sharp curtailment of advertising expenditures. Evidence of this is the reduction of Chrysler's Amateur Hour to thirty minutes, and the dropping of the Ford Hour on Sundays.

RADIO PREPARES FOR U.S. OFFENSIVE

(CONTINUED FROM PAGE 5)

must withstand shocks, vibration and corrosion. Army equipment is generally used under more favorable conditions and must be light for mobility. Many sacrifices are made to cut down the weight of aircraft apparatus.

Set manufacturers can handle many of the Army contracts and most of those for aircraft radio. They can do very little for the Navy.

However, the whole set-up of handling government orders is a mystery to them. Much of it does not make sense to their way of thinking, and is so far from their conventional business that they have shied away from it in years past.

Now, suddenly, set manufacturers are told that they must stop manufacturing home radios and fill their plants with war contracts, or have their men and equipment shifted "to other parts of the economy where they could be mobilized for war production." The former they can do, but all the good will in the world does not make the latter an easy accomplishment.

It is easy for the WPB to issue edicts but what is the use to give orders before the way has been provided for carrying them out. Right now, set manufacturers are bedeviled from the rear by one government department and blocked off by another. Doing business as a prime contractor is a new, strange and bewildering undertaking for these concerns.

Getting a sub-contract is a different problem, but one of no less magnitude. It is mostly catch-as-catch-can, for there is no central office for clearing sub-contract orders. Many of the radio companies, including some of the very large ones, are chiefly assembly plants with relatively little production machinery. They cannot immediately install tool-room and machine-shop equipment to undertake work which would call for extensive tooling up. That would mean virtual reorganization and months of delay. In the meantime, their em-

ployees would drift away to other work, and it would be impossible to get them back.

Organized Radio Production ★ With certain exceptions, radio equipment needed in the greatest quantities is comparable in general design to home radio receivers. Some may be a little more complex, while some is much simpler. All is made up largely of components produced by specialists, such as resistors, condensers, sockets, switches and tubes.

If more production machinery is required, it should be added in plants where most of this work is being done already, and the components, molded pieces, stampings and screw machine parts supplied to the home radio manufacturers who as sub-contractors, can then put their assembling and testing facilities and their man-power to work at tasks with which they are familiar and can perform to best advantage.

This general policy will give the greatest production in the shortest time and will have resulted in the least disruption of the radio industry when peace comes again.

The methods of buying radio equipment established by the Army and Navy during peace time may not be altogether understood by the WPB. The Signal Corps and the Bureau of Engineering have had no previous contact with the organizations of home radio manufacturers. Urgency now calls for adjustment on both sides. Meanwhile, the threat of the WPB hangs heavy over those who cannot connect with prime or sub-contracts to take the place of dwindling production of their regular merchandise.

From the point of view of equipping our armed forces for aggressive action against our enemies, our position, insofar as radio equipment is concerned, is far more favorable than in 1917. However, one gets the impression that most of the driving force is still at the top, and has not yet permeated the enormous spread of new government departments. This may be due to the fact that lack of time

and rapid expansion, requiring many changes of personnel and promotions, has so far prevented the establishment of smooth-running routine.

On the other hand, there is the feeling at times that workers who are on government payrolls presume upon the protection of government employment and that their wartime responsibilities to our armed forces sit lightly on their shoulders.

A very effective way of correcting this condition is employed by the British. They plant a sprinkling of returned soldiers among the civilian workers because, when the need arises, they are sure to whip out that grim reminder: "Man, don't yer know there's a bloody war on?"

DYNAMIC SYMMETRY IN RADIO DESIGN

(CONTINUED FROM PAGE 31)

phone practice for amplifying equipment, etc., are particular examples.

Conclusion ★ It should be understood clearly that the use of dynamic symmetry principles does not result in mere geometrical designs having none of the beauty of form and detail which is associated with the work of the artistic genius. The true artist with genuine creative ability has freedom for the revelation of his art, even when he employs dynamic principles to the utmost. They merely guide and assist him. They give greater aid to those designers not endowed with that artistic sense which instinctively selects those forms which are pleasing. While the work of such designers will not be as effective as that of true artists, even though it is aided by dynamic principles, it is likely to be much more acceptable than if it had been carried out with no vital basic plan.

After the decline of Greece politically, the use of dynamic symmetry decreased, probably coincidentally with the lessening of appreciation of art and the increase of materialism. It seems to have disappeared completely during the first century B.C. Now, after two thousand years, it has been rediscovered, and it is the author's belief that it will again become a dominant force in all design work. If so, we can hope confidently that the world — with its present knowledge of arithmetic, geometry, and science, and its wide industrial opportunities, all denied to the ancients — will see a classic art period far surpassing those already recorded in history.

The author wishes to emphasize that although one may find difficulty in the first attempts at applying these principles, it is well worth while to study and apply them, not only for assistance in design work, but for the enjoyment and appreciation one obtains from a clearer understanding of the universal power and applicability of nature's laws of life and growth.

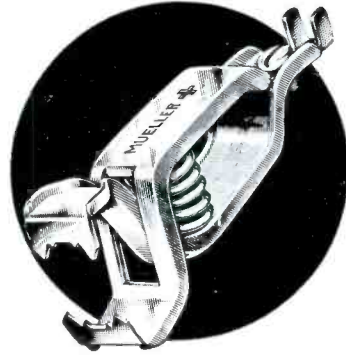

CLIPS for every purpose

Dependable and efficient temporary and semi-permanent electrical connections can be quickly made by using the right type Mueller Clip or Clamp. Our line of "Alligator" and "Crocodile" clips is complete — from the Wee-Pee-Wee, 1 1/4" long, made of phosphor bronze to the biggest clip in the world — the Big Brute, a channel copper model that carries 300 amps. *Insist on Mueller Clips.*



Our NEW CATALOG No. 713 will be sent FREE to engineers and executives. Dozens of different type clips are illustrated, complete technical data and recommendations for their use is given. Write today.

Mueller Electric Co.

1601 EAST 31st STREET CLEVELAND, OHIO

LOOK TO LINGO

for proven

FM

Antenna Efficiency

The Lingo Turnstile Antenna has a definite, important place in your FM plans. This company pioneered in the development of FM broadcasting and since then Lingo Turnstile Radiators have achieved a proven record of efficiency from an imposing list of actual installations. Although today our plant is engaged wholly in national defense production, we will continue our efforts to provide even greater efficiency in design and performance to meet the requirements of a greater FM industry tomorrow!

JOHN E. LINGO & SON INC.
 Licensed Manufacturers of Patented Turnstile Antennas
 CAMDEN, NEW JERSEY

Your Opportunity
to Own Two Important

REFERENCE VOLUMES

If You Act Promptly!

**1ST BOUND VOLUME
OF FM MAGAZINE**
NOVEMBER 1940 TO APRIL 1941

**2ND BOUND VOLUME
OF FM MAGAZINE**
MAY 1941 TO OCTOBER 1941

These two bound volumes of **FM Magazine** comprise a 600-page record of the most important developments in modern radio progress, invaluable as a reference source to engineers, patent attorneys and radio executives.

When the remaining volumes have been sold, there will be no way to get complete files of **FM Magazine**.

The binding, of three-quarter pigskin, was done by Eggeling, and is of the finest workmanship, designed to last a lifetime.

The cost is less than you would pay to have a single set of copies bound.—
Send your order at once!

\$5.00

EACH, POSTPAID, IN THE U. S. A.

FM COMPANY
112 EAST 36th STREET
NEW YORK CITY

FIELD STRENGTH SURVEY METHODS

(CONTINUED FROM PAGE 20)

Meter reading = 7.9
Attenuator scale = 500
Car position = Broadside to field generator
(right side)
From which:

$$K = \frac{25,600}{7.9 \times 500} = 6.5$$

The calibration of a receiver with a known field from a loop antenna is not without the possibility of error, the most probable error being due to the finite length of the receiving antenna. Other sources are current unbalances in the loop, leakage fields from the oscillator, and the presence of nearby metallic or other objects which distort the field. However, with proper precautions, the total error is probably not more than one or two decibels.

The close check between the two calibration methods was gratifying, since the latter method was the basis of the original survey of the W71NY one-kilowatt transmitter. The calibrating field generator did not require constant checking. Its stability was amazingly constant and required no additional tuning when once set to the proper frequency.

EDITOR'S NOTE. — Part 2 will appear in the March issue. This will include complete data taken on the radials from W71NY's 10-kw. transmitter, and reproductions of the charts made by the recording milliammeter operated from the equipment in the test car.

THE MANUFACTURERS SAY:

(CONTINUED FROM PAGE 13)

Approximately 80% of our present productive capacity is being used to fill orders carrying high priority ratings.

Great quantities of ruby Indian mica were formerly imported from India. Today, satisfactory sources of supply have been tapped in South America. Because war orders take precedence, there are serious delays in filling non-defense orders but, for the most part, distributors and manufacturers recognize the unavailability of the situation and make their plans accordingly.

It is pertinent to inject one thought here concerning the availability of capacitors at the present time and during the months to come. The use of a limited number of standard types of capacitors for replacement purposes serve more than 95% of all requirements. If our non-defense facilities can be concentrated on certain standardized types, our output logically can be much larger and there will be less delay in filling orders. It is also true that manufacturers' orders for standard rather than special types will, in most cases, eliminate serious delays under prevailing emergency conditions.

FM PACKAGED FOR EMERGENCIES

(CONTINUED FROM PAGE 11)

watt transmitter at the center, and the speaker panel at the top.

The phase-shift system of modulation is employed, so designed as to give a frequency shift of at least 15,000 cycles — entirely adequate for speech — at a modulating frequency of 500 cycles and a signal input of 6 milliamperes at zero level into the 500-ohm input circuit.

High-frequency pre-emphasis is inherent in the design, so that with a signal input of constant amplitude the frequency deviation shows a linear increase of 15 db from 500 cycles. Filter networks attenuate modulating frequencies above 3,000 cycles, in order to prevent excessive sidebands.

Direct crystal control is made possible by the use of phase-shift modulation. Thus it is practical to guarantee a tolerance within .01% under ambient temperatures of -18° F. to $+110^{\circ}$ F. The crystal supplied has a coefficient of not more than 2 cycles per megacycle per degree of temperature. Transmitters can be matched to within 50 cycles at the operating frequency.

Of the 8 tubes, 7 are of the low-drain receiving types. All are mounted on the transmitter chassis:

- 7C7 Crystal oscillator
- 7A8 Balanced modulator
- 7A8 Balanced modulator
- 7C7 1st frequency quadrupler
- 7C7 2nd frequency quadrupler
- 7C5 Frequency doubler
- 807 Final amplifier
- 5Z3 Rectifier

The input is 100 watts in the normal standby position, or 200 watts during transmission. Standard equipment operates on 110 to 130 volts, 60 cycles, single phase, but other voltages can be specified.

Complete protection to the operator is provided by a locked door at the rear which has an interlocking switch to disconnect all circuits when the door is opened. The front panel is "dead" at all times, so that it is impossible for the operator to get an accidental shock.

Monitoring jacks on the chassis permit checking the grid circuit of each stage. Tuning adjustments are not critical, and slight errors in setting them will not affect the output frequency, quality, or modulation level.

Dimensions of the cabinet are: 21 ins. wide, 10 ins. deep, and 27 ins. high.

The antenna recommended for this unit is a half-wave vertical radiator, matched to a concentric transmission line by a quarter-wave, 2-wire matching transformer, or a concentric antenna with a concentric transmission line.



Radio Engineer's BOOK SHELF . . .

*Selected Volumes Obtainable
from FM's Book Department*

RADIO ENGINEERING, by F. E. Terman

A comprehensive treatment covering all phases of radio communications. Written for both students and engineers. 813 pages, 475 illustrations. 2nd edition. \$5.50

ELEMENTS OF RADIO COMMUNICATIONS, by Prof. J. H. Morecroft

By the author of the well-known "Principles," this book treats the subject of communications in a more elementary fashion. Mathematics are limited to simple algebra. 286 pages, 170 illustrations. 2nd edition. \$3.00

COMMUNICATION ENGINEERING, by W. L. Everitt

A general text book for both first year and advanced courses. Presents complete treatment of network theory, including mathematical analysis of radio circuits and vacuum tubes. 727 pages, 411 illustrations. \$5.00

ENGINEERING ELECTRONICS, by Donald G. Fink

Covers the field of electronic tubes and their applications, including not only radio but other fields where vacuum, gas-filled, and photo-sensitive tubes are being used. Includes theory, but mathematical treatment is relatively simple. 358 pages, 217 illustrations. \$3.50

EXPERIMENTAL RADIO ENGINEERING, by Prof. J. H. Morecroft

An excellent laboratory text, directed particularly to the principles involved in the operation of radio apparatus. It is intended as a supplementary volume to "Elements of Radio Communications." Of particular interest is Prof. Morecroft's list of 51 experiments. 345 pages, 250 illustrations. \$3.50

Prices include postage in the U. S. A.

FM COMPANY

112 East 36th Street

New York City

Complete

YOUR FILE OF

Back Numbers

Check your file of back copies against the list below, and order those you are missing while we can still supply them. There are only a few copies of some issues.

- | | |
|---|------------------------------------|
| <input type="checkbox"/> November, 1940 | <input type="checkbox"/> May |
| Out of Print | <input type="checkbox"/> June |
| <input type="checkbox"/> December, 1940 | <input type="checkbox"/> July |
| <input type="checkbox"/> January, 1941 | <input type="checkbox"/> August |
| <input type="checkbox"/> February | <input type="checkbox"/> September |
| Out of Print | <input type="checkbox"/> October |
| <input type="checkbox"/> March | <input type="checkbox"/> November |
| <input type="checkbox"/> April, 1941 | <input type="checkbox"/> December |
| <input type="checkbox"/> January, 1942 | |

Back issues of "FM" are a source of important reference material and engineering data, available from no other source. As time goes on, these issues are proving to be of increasing value. Complete your file of back numbers while you have the chance.

\$1.00 for SIX ISSUES

Any six issues, from March to December, 1941, will be sent postpaid for \$1.00, provided the copies you want are still available when your order is received.

FM COMPANY

112 EAST 36th STREET
NEW YORK CITY

At the radio unit, the conductors are connected by means of a coaxial plug.

When the antenna and power line connections have been made, it is a matter of only a few minutes to check the tuning adjustments in accordance with the simple instructions furnished. Then the equipment is ready for use.

50-Watt Transmitter ★ Fig. 2 shows the 50-watt assembly. The receiver is the same as that already described. An extra panel is required for the power supply of the two 807 final amplifiers. This makes the cabinet 21 ins. wide, 10 ins. deep, and 34 ins. high.

There are 8 tubes on the transmitter chassis and 2 rectifier tubes on the power supply section:

- 7C7 Crystal oscillator
- 7A8 Balanced modulator
- 7A8 Balanced modulator
- 7C7 1st frequency quadrupler
- 7C5 2nd frequency quadrupler
- 6L6 Frequency doubler
- 807 Final amplifier
- 807 Final amplifier

- 816 Rectifier
- 816 Rectifier

The details of the 25/30-watt transmitter and the method of installation are essentially the same as for the 50-watt unit. The choice between the two lies entirely in the particular conditions under which the system is to be operated. Other standard Link units are available for systems which must cover larger areas, but the two described here have sufficient output for most protective installations at industrial plants.

FOUND! A FEW COPIES OF DECEMBER, 1940

For several months, we have been advising those who have wanted to order copies of December, 1940 that that issue is out of print. Just recently, we came across 25 copies, and they are now offered at the regular price of 25¢, subject to prior sale.

NEW APPLICATIONS OF FM

(CONTINUED FROM PAGE 9)

mm.: i.e. of the order of the wavelength of X-rays. When utilizing the maximum sensitivity obtainable it is self-evident to employ highly stabilized operating voltage sources and compensation of the quiescent anode current. With less stringent requirements, compensation by means of a second octode will be sufficient as shown in Fig. 6.

Note: Part 2 of this article will appear in March.



Meeting Their Needs at This Time

TIME IS SHORT . . . Leisure is gone! . . . Reading habits have changed completely in recent months. TODAY, the value of any paper to advertisers is measured by its USEFULNESS to its readers.

FM MAGAZINE is the radio publication most read and most often referred to by radio engineers and executives because its editorial contents are so exactly geared to their needs at this time.



THE MAGAZINE OF GREATEST USEFULNESS TO RADIO ENGINEERS & EXECUTIVES

**Partial List of Police
Departments, Public
Utilities, and other
purchasers of
Browning Monitors**

Police Departments

- Arlington, Mass.
- Atchison, Kansas
- Big Spring, Texas
- Bloomington, Indiana
- Bremerton, Washington
- Centralia, Washington
- Coffeyville, Kansas
- Columbia, Missouri
- Crawfordsville, Indiana
- Emporia, Kansas
- Fitchburg, Mass.
- Fond du Lac County, Wisconsin
- Great Bend, Kansas
- Klamath Falls, Oregon
- Leominster, Mass.
- Marathon County, Wisconsin
- Milton, Pa.
- Nampa, Idaho
- Sharon, Mass.
- Shelby County, Indiana
- Sidney, Ohio
- St. Charles, Missouri
- Twin Falls, Idaho
- General Electric Company
- Graybar Electric Company
- Burdick Corp., Milton, Wis.
- Cleveland Railway Company
Cleveland, Ohio
- Water Supply Commission
Belchertown, Mass.
- Hygrade Sylvania Corp.
Salem, Mass.
- San Antonio Public Service
San Antonio, Texas
- San Diego Gas & Electric
San Diego, California
- Southern California Edison
Los Angeles, California
- Toledo Edison Company
Toledo, Ohio
- Transmitter Mfg. Company, Inc.
New York City
- United Electric Light Company
Springfield, Mass.
- United Illuminating Company
New Haven, Connecticut
- University of Maryland
College Park, Md.

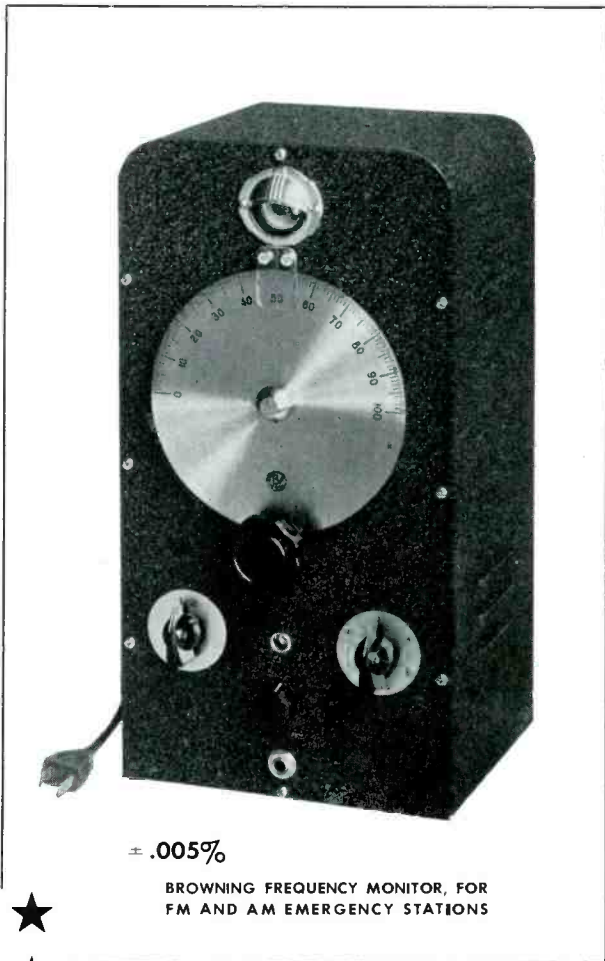

± .005%

BROWNING FREQUENCY MONITOR, FOR
FM AND AM EMERGENCY STATIONS



Increased Accuracy to Meet New

FCC REQUIREMENTS

For All Emergency Transmitters

The new Type S-2 Browning Frequency Monitor provides the greater precision now required by the FCC for all emergency transmitters. Suitable for both FM and AM, the Browning Monitor is built with one to four bands, for any frequencies between 1.5 and 60 mc. Prices:

1 Band \$125.00 3 Bands \$165.00
2 Bands 145.00 4 Bands 185.00

BROWNING LABORATORIES, Inc.

755 MAIN STREET

WINCHESTER, MASSACHUSETTS



Cat. No. 565-A

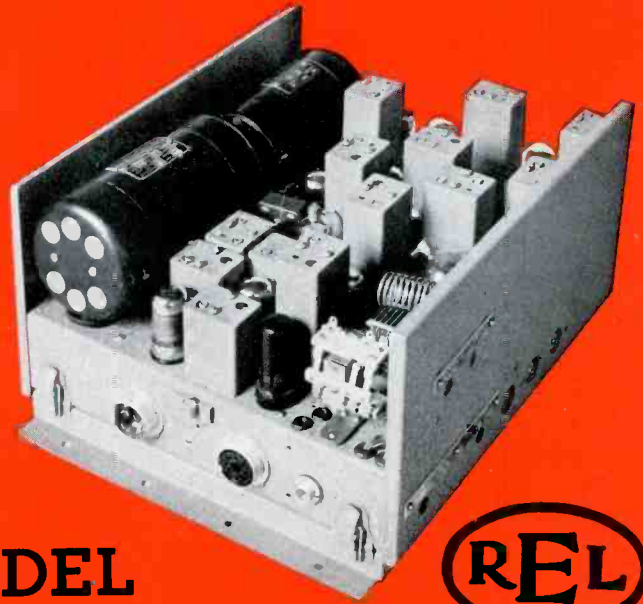

VICTORY MODEL

FM 2-Way Radio for All Emergency Services

The Greatest Advance in

FM 2-WAY MOBILE EQUIPMENT

THIS newly perfected REL model is the first FM emergency equipment with the receiver and transmitter combined on a single chassis—an arrangement which affords many mechanical and electrical improvements which increase efficiency and simplify installation and service. These improvements cannot be found in the older multi-chassis construction.

Greater range, higher quality, and better signal-to-noise ratio and squelch action result from increased efficiency obtained by simplified circuits of compact design. The 807 tube, source of troublesome parasitics, has been replaced by the new 815 power tube, designed specifically for ultra-frequencies.

Simplified construction, based on 10 years of field experience with mobile equipment, makes the REL Victory Model the last word in ruggedness and dependability. Loose connections in inter-chassis cables are eliminated. Test jacks are protected from dust by the snap-on cover.

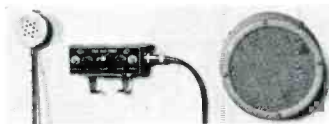

Hours are saved in installation and servicing.

Low-voltage receiver dynamotor supplies power to all transmitting tubes except power amplifier, thus avoiding plate voltage dropping-resistor loss and its resulting storage battery drain.

Finally, the improvements in the REL Victory Model are geared to new production methods which assure fast deliveries for all emergency service needs.

565-A SPECIFICATIONS

Frequency: Any frequency in the 30-40 mc. band. **Drain:** 14 amps. receiving, 34 amps. transmitting from 6v. battery. **Size:** 17¼" long, 14¾" deep, 9" high. **Weight:** 50 lbs. **Accessories:** Supplied complete with all cables, antenna and support, control unit, speaker, choice of hand-grip microphone or French type hand set. **Receiver:** 11 tubes, double IF super-

heterodyne, single-crystal control, limiter acts on signals of less than 1 microvolt, with squelch action on less than .5 microvolt.*

Transmitter: 6 tubes, output in excess of 25 watts, crystal-control phase shift, new single-tube modulator in newest FM circuit development.

Cat. No. 565A: Supplied with loudspeaker and press-to-talk hand grip microphone as illustrated.

Cat. No. 565AWE: Supplied with loudspeaker and french type press-to-talk hand set microphone and earphone.

* Measurements made on production receiver with General Radio 804-B signal generator. Still greater sensitivity is indicated by other types of measuring instruments.



RADIO ENGINEERING LABS., Inc.
Long Island City New York

Sales Offices:

5334 Hollywood Blvd., Hollywood, Calif.
420 Market Street, San Francisco, Calif.
2040 Grand River Ave. W., Detroit, Mich.
310 Fifteenth St., Denver, Colo.