

Communication Engineering

'53-3

May-June 1953

MILTON B. SLEEPER, Publisher

Price 65 Cents



Established as
FM
1940

ANNOUNCING

The Newest, Most Advanced 2-Way Communication System Ever Designed!

PLATT MOBILE RADIO EQUIPMENT

MODEL 30-TRM-31

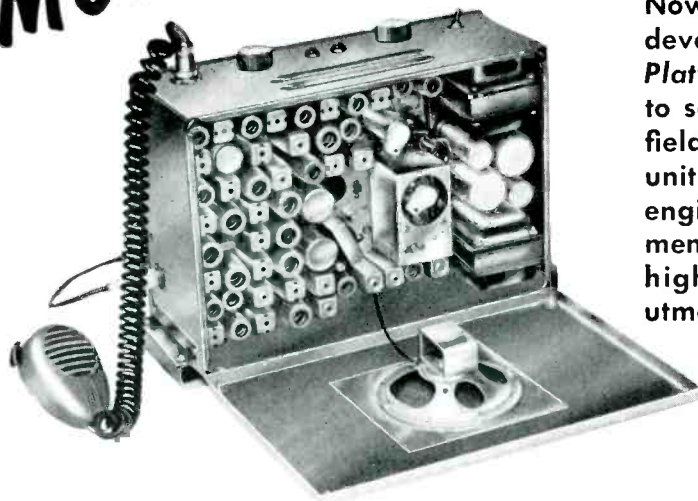

Now, after years of intensive research and development by America's foremost engineers, *Platt Mobile Radio Equipment* is out of the lab to set a new standard in the communications field! It incorporates in one rugged packaged unit all the desirable features that operators, engineers, maintenance men and installation men have demanded for ease of operation, high performance, simple installation and utmost economy.

PLATT MOBILE RADIO EQUIPMENT MODEL 30-TRM-31 (shown). Freq: 152-174 MC. 24 tubes. Dimensions: 14 $\frac{1}{4}$ " x 9 $\frac{3}{4}$ " x 5 $\frac{3}{4}$ ".

ALSO AVAILABLE:

Mobile Equip. Model 30-TRM-11. Freq: 25-50 MC.
Base Station Model 30-TRS-31. Freq: 152-174 MC.
Base Station Model 30-TRS-11. Freq: 25-50 MC.

OPERATES IN 152-174 MC BAND

Platt Mobile Radio Equipment Model 30-TRM-31 incorporates a transmitter and receiver mounted on a single chassis which is installed under one cover with a vibrator power supply affording 30 watts of R-F output in the 152-174 megacycle band.

Simplest, Easiest Installation!

Brackets are supplied for installation for front mounting under the dashboard or glove compartment, or in certain installations, under the driver's seat. The controls and loudspeaker are incorporated as an integral part of the cabinet. *Only one short lightweight cable and antenna assembly are required for complete installation in any vehicle having a 6 volt DC battery system. (12 volts available.)*

Finest Components!

The components utilized, without exception, are the very best heat-resistant parts, manufactured for operation at 85° C. without any change in performance.

Competitively Priced!

Platt Mobile Radio Equipment is comparatively low priced, making it an ideal choice for taxi fleets, police, fire departments, forestry, railroads, trucks, civil defense, etc.

**Get All the Facts on this Advanced Equipment.
WRITE TODAY FOR YOUR LITERATURE!**



PLATT Manufacturing Corp.

489 BROOME STREET • NEW YORK 13 • NEW YORK • WORTH 4-0827

RCA MICROWAVE

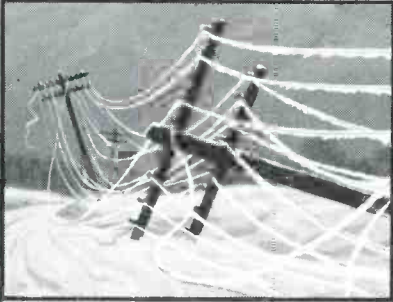
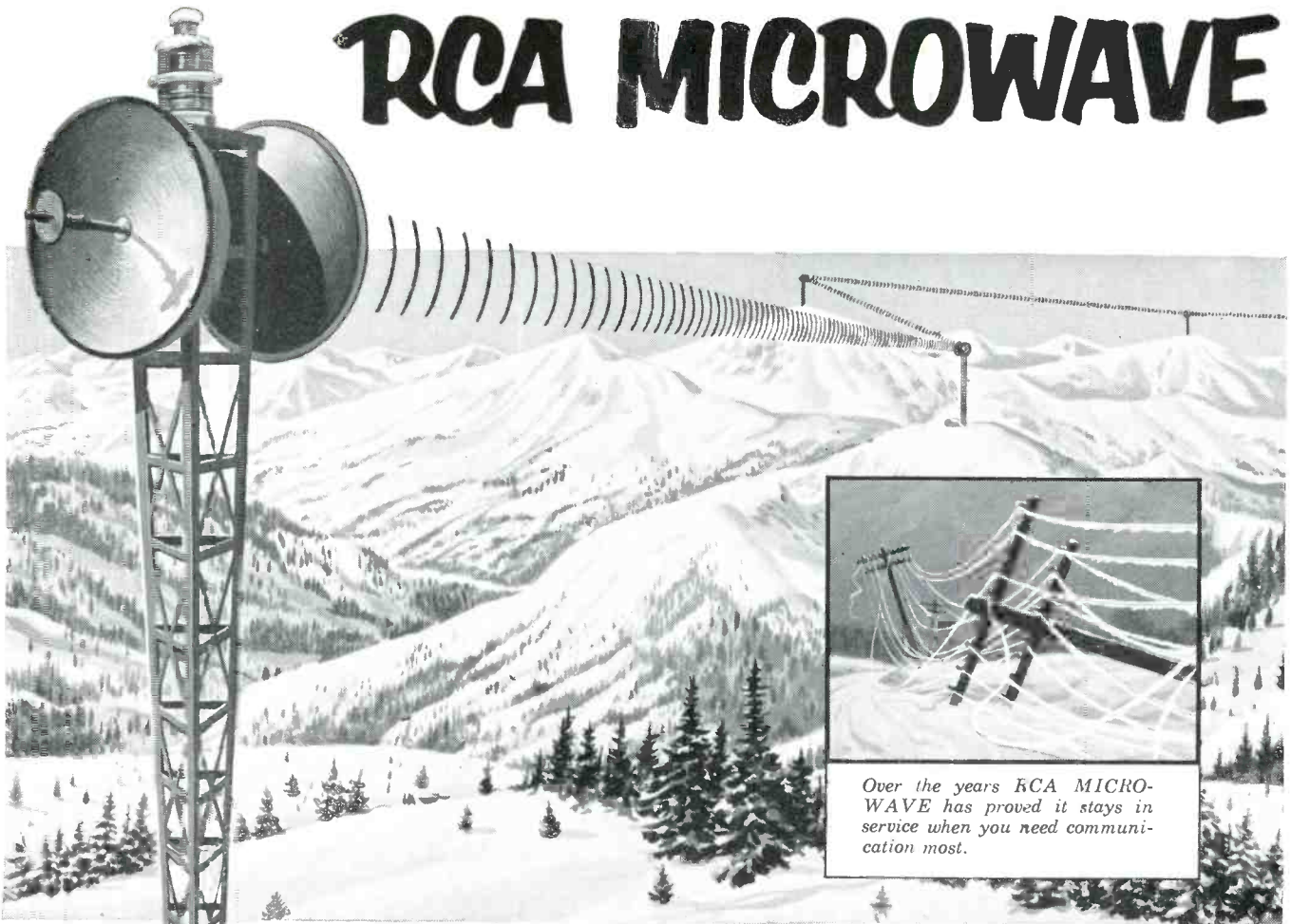

Over the years RCA MICROWAVE has proved it stays in service when you need communication most.

Most practical system, most complete service

To get the most from your microwave investment, check the record for downright dependability—and you'll specify RCA MICROWAVE.

For example, check the operating records of RCA MICROWAVE systems over the years. Check RCA's long history of successful operation through every kind of weather. Or check the numerous RCA installations that are now providing continuity of service in many applications. RCA can offer you a long working record of dependability.

For complete Service, check

RCA's survey, construction, and installation facilities. They're complete single-source, single-responsibility service.

For more speed, for improved operation, check RCA Communication Equipment for your business. Contact your local RCA Regional Office for information, or *mail coupon now*.

Check RCA 2-way radio for downright dependability in mobile communications.

And remember, only RCA can provide the nationwide service facilities of the RCA Service Company.



RADIO CORPORATION of AMERICA
COMMUNICATIONS DIVISION CAMDEN, N. J.

Radio Corporation of America
Communications Division
Dept. 132Q, Building 15-1
Camden, N. J.

Please send me your new, free booklet on:

- RCA Microwave
- RCA 2-Way Radio

Name _____
Title _____ Company _____
Address _____
City _____ Zone _____ State _____



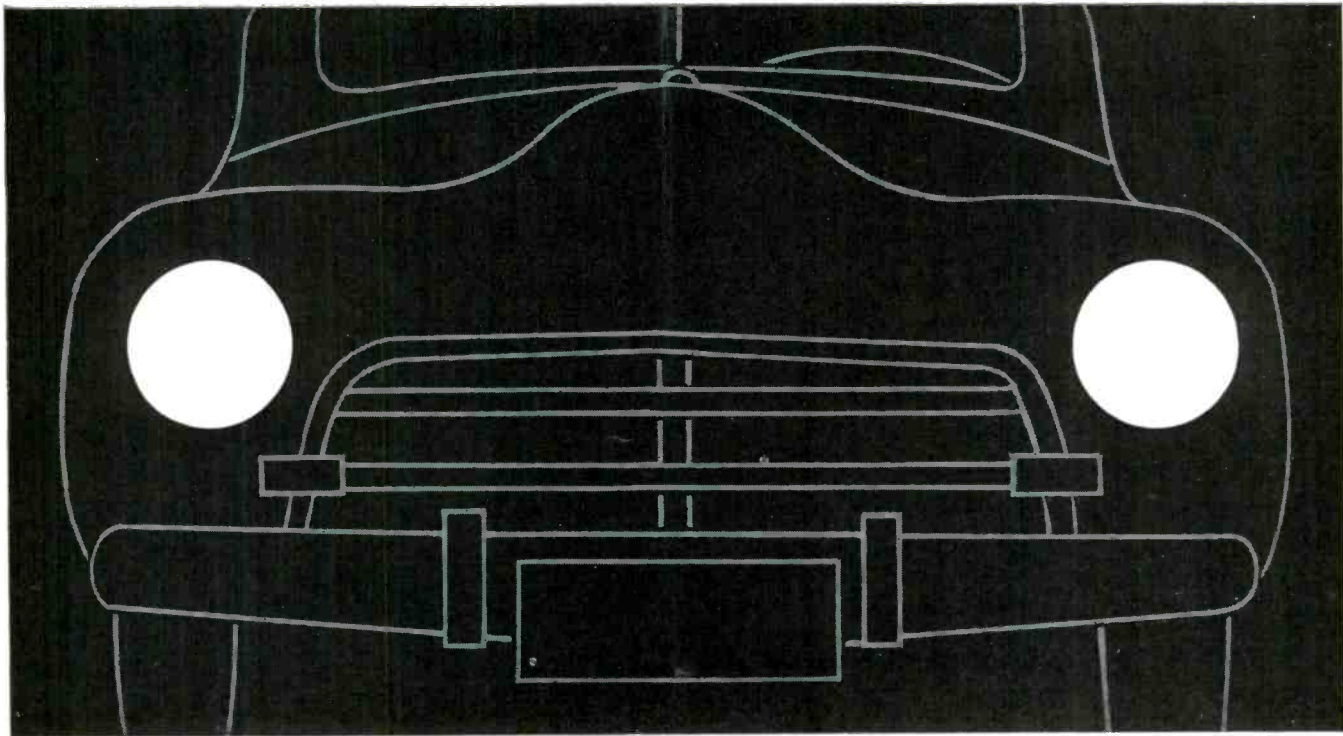

Revolutionary 2-Way Mobile Radio Pulls No More Amps Than A Headlight!

... 15 great features, including a new electronic squelch that gives you *all of the signal, none of the noise.*

This new Bendix 2-way radio is called the Traffic-master. It's a clean and rugged, compact unit. Let's look at some of the advantages it has over ordinary mobile units.

A new electronic squelch

It's a Bendix developed squelch that eliminates chopped up messages in fringe areas. It has a delaying action that screens out all the noise. It gives you only the voice message. True and sharp like in a home radio from 20 miles and farther out.

From Hand Sets to Land Stations

In addition to the latest type of mobile equipment ... Bendix offers a complete line of fixed stations from 2½ to 250 watts. As well as accessories from hand sets to speakers, antenna to shock mounts ... plus all technical help in obtaining license and complete system engineering.

*Reg. U. S. Pat. Off

BUY ON INSTALLMENT PLAN

Bendix has developed with local banks, what has been called one of the finest financial plans anywhere. You pay for your new Bendix 2-way radio ... as you use it and as it makes money for you. Write for details.

Write today ... because you too can now afford the best in 2-way radio. Bendix costs you no more than ordinary equipment. Get all the information.

Longer life

Your new Bendix Traffic-master has been field tested under the most difficult conditions. Longer life of tubes and components is assured. Another big feature is that Bendix uses Selenium stacks ... instead of rectifier tubes. They almost never wear out!

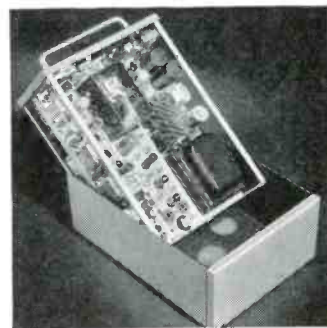

BENDIX* RADIO
BALTIMORE 4, MD.

DIVISION OF



EXPORT SALES: Bendix International Division, 72 Fifth Avenue, New York 11, N. Y.

Bendix
THE MOST TRUSTED NAME IN
Radio

Communication Engineering

Formerly FM-TV and RADIO COMMUNICATION

VOL. 13 MAY - JUNE, 1953 NO. 3

COPYRIGHT 1953, by RADIOCOM, INC.

DEPARTMENTS

| | |
|--|----|
| Systems Data | |
| Breakdown of new application information | 3 |
| Product Information | |
| New components, equipment, and literature | 6 |
| Companies and People | |
| Expansions, activities, appointments, awards | 12 |
| Meetings and Events | |
| Schedule of important shows and conferences | 12 |
| Communication Review | |
| General news of the industry | 17 |

ARTICLES

| | |
|---|----|
| Microwave Developments Overseas | |
| Victor J. Nexon | 19 |
| Multiplex Channel Response Speed | |
| J. S. Smith | 22 |
| Microwave System Test Equipment | |
| A. S. May | 24 |
| New York's Fire Radio System, Part 4 | |
| Lieut. Samuel Harmatuk | 26 |
| The Future of Microwaves | |
| Edwin L. White | 29 |
| Mobile Radio Equipment Design | |
| James B. Ferguson | 30 |
| Rigid Waveguide Specifications | |
| Complete information on standard waveguides | 32 |
| Prediction of Circuit Failures | |
| How incipient failures can be detected | 34 |
| Measuring Standing-Wave Ratio | |
| Gerald W. Lee | 36 |

THE COVER DESIGN AND CONTENTS OF COMMUNICATION ENGINEERING MAGAZINE ARE FULLY PROTECTED BY U. S. COPYRIGHTS, AND MUST NOT BE REPRODUCED IN ANY MANNER OR IN ANY FORM WITHOUT WRITTEN PERMISSION

ROY F. ALLISON, *Editor*

MILTON B. SLEEPER, *Publisher*

| | | |
|--|--|---|
| FRED C. MICHALOVE <i>Eastern Manager</i> | CHARLES KLINE <i>Western Manager</i> | EDWARD BRAND <i>West Coast Manager</i> |
| MIRIAM D. MANNING <i>Production Manager</i> | LILLIAN BENDROSS <i>Accounting</i> | |
| WARREN SYER <i>Promotion Manager</i> | ELEANOR GILCHRIST <i>Art Director</i> | |

Publication Office: The Publishing House, Great Barrington, Mass. Tel. Great Barrington 1300.

Chicago Office: 426 North Pine Avenue, Tel. Columbus 1-1779.

New York Office: 6 East 39th Street, Room 1209, Tel. Murray Hill 5-6332.

West Coast Office: 1052 West 6th Street, Los Angeles, Tel. Michigan 1732.

COMMUNICATION ENGINEERING MAGAZINE is mailed on the 20th of January, March, May, July, September, and November.

Subscriptions: Should be sent to Publishing House, Great Barrington, Mass. Single copies 65c—Subscription rates: \$6.00 for 3 years, \$3.00 for 1 year. Contributions will be neither acknowledged nor returned unless accompanied by adequate postage, packing, and directions, nor will COMMUNICATION ENGINEERING Magazine be responsible for their safe handling in its office or in transit.

Entered as second-class matter August 22, 1946, at the Post Office, Great Barrington, Mass., under the Act of March 3, 1879. Additional entry at Post Office, Boston, Mass. Printed in the U. S. A.

SPECIFICALLY DESIGNED FOR RUGGED SERVICE

MORE FOR YOUR MONEY

RADIART VIBRATORS
The Complete Replacement Line

Radiart solves all the problems on the vibrator side of the radio communications picture with the complete RUGGED SERVICE line that has been the leader for years. Exclusive design plus quality controlled manufacture deliver vibrators that are completely dependable! No short-lived performances... they work perfectly even under the most adverse conditions BECAUSE THEY ARE BUILT TO "TAKE IT"! Make a comparison and you, too, will agree RADIART VIBRATORS ARE THE STANDARD OF COMPARISON!

At all good radio parts jobbers. Ask for the new Form F781 listing the latest replacement recommendations.

IT'S RIGHT WHEN IT'S RADIART

THE RADIART CORPORATION
CLEVELAND 13, OHIO

• ROTORS • VIBRATORS • AUTO AERIALS
• TV ANTENNAS • POWER SUPPLIES



CIRCULATION AUDITED BY
HENRY R. SYKES
CERTIFIED PUBLIC ACCOUNTANT
SYKES, GIDDINGS & JOHNSON
PITTSFIELD, MASSACHUSETTS

From Alden's Line of Ready-made Components
for Unitized Plug-in Unit Construction:

Miniature Sensing and Indicating Components by

ALDEN

PATENTS PENDING

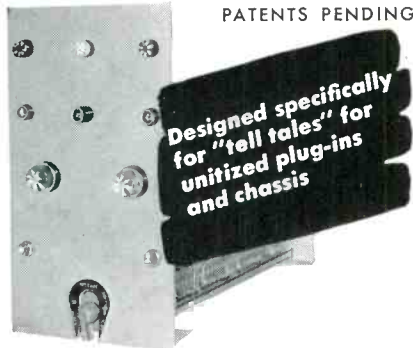

TOPS IN QUALITY & APPEARANCE
SAVE INSTALLATION COST & SPACE

ALDEN "PAN-i-LITE"

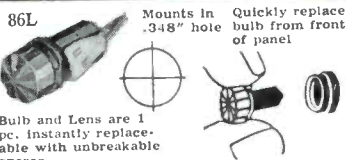

You can use this new tiny Alden Pan-i-Lite indicator where never before possible. Easily serviced one-piece lens-bulb replaceable from front of panel. Mounts simply by pushing into .348" hole. Gives beautiful indication; glows like a red hot poker. Tiny spares can always be kept ready in kit or taped in recess of equipment. Available in 6V, 12V and 28V, various colors.

ALDEN "FUSELITE"

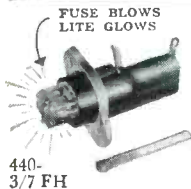

Spot trouble instantly. Neon indicator light in lens glows when fuse blows. One-piece molded lens-and-indicator-lite unscrews from front of panel. Ideal for monitoring power

ALDEN TEST POINT JACK

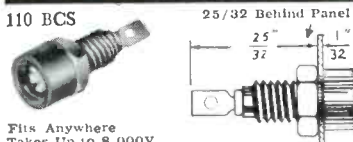

Provides a quick front panel check point for any circuit voltages in your equipment. This tiny Jack fits .257" hole and takes only 25/32" behind panel. Beryllium copper contact withstands hundreds of insertions. Phenolic or nylon insulation, many colors.

SEND FOR FREE SAMPLES

— also request free "Alden Handbook" 226 pages of techniques and components for Unitized Plug-in Unit Construction.



ALDEN PRODUCTS CO.

145 N. Main St., Brockton 64, Mass.

SYSTEMS DATA

THE accompanying table shows the number of fixed and mobile transmitters for which applications were filed with the FCC during the months of March and April, for the various services indicated. This data was compiled from our Weekly Reports which show the details of each application filed from day to day. A separate listing below summarizes applications for 450-mc. fixed and mobile units, and for relay and control stations operating on various frequencies.

Since the figures are for applications, the data presented is the most accurate, up-to-date indication of current activity in each service. It is entirely independent of change in the rate of processing at the Commission, as would be the case if the figures were based on grants of construction permits or licenses issued.

It is significant to note that the number of mobile and fixed transmitters for which licenses were applied during March and April exceeds the figures for the entire first quarter of 1952 by 60 to 75%, and exceeds the total of January-February 1953 units by 40%. The largest increase was in the number of mobile transmitters operating on 152 to 174 mc. This was from 4,393 to 7,183.

Surprisingly, the police service accounted for the largest number of units, up from 1,410 in January-February to 3,182 in March-April. Other substantial increases occurred in the power utility,

pipeline petroleum, special industrial, and taxi services. Low-power units were up from 811 to 1,066.

There were no particularly large systems represented to account for these gains. On the contrary, they seem to represent an increased demand for radio communication that has the industry and the FCC asking: "How high is up?"

New systems to be operated on 450 mc. accounted for 325 mobile and 10 fixed transmitters. This, too, represents a gain, but there seems to be a reluctance to move quickly into this field, despite the highly satisfactory performance of 450-mc. equipment.

Following is the list of transmitters *not included* in the accompanying table because they will be operated on frequencies outside the 30 to 50 and 152 to 174-mc. bands:

POLICE: 70 speedmeters on 2,445 mc.; 25 mobile and 1 fixed transmitter on 453 mc.; 5 interzone CW transmitters; 4 relays on 73 mc., 7 on 155 mc., 3 on 455 mc., 1 on 6,745 mc.; 8 control stations on 74 mc., 2 on 455 mc., 1 on 960 mc., 3 on 6,625 mc.

FIRE: 1 relay on 956 mc.; 1 control on 953 mc.

SPECIAL EMERGENCY: 1 relay on 72 mc.; 2 on 162 mc., and 1 on 455 mc.; 1 control on 72 mc., and 1 on 454 mc.

FOREST CONSERVATION: 3 relays on 155 mc., 1 on 455 mc.; 2 control stations on

Concluded on page 41

TABLE OF APPLICATIONS FILED MARCH 1 TO APRIL 30, 1953

| | TOTAL | | —30 to 50 mc.— | | | —152 to 174 mc.— | | | |
|--------------------------|--------|-------|----------------|--------|------|------------------|--------|------|-----|
| | MOBILE | BASE | TOTAL | MOBILE | BASE | TOTAL | MOBILE | BASE | |
| Police | 3,182 | 222 | 151 | 1,848 | 105 | 48 | 1,334 | 117 | 103 |
| Fire | 873 | 63 | 115 | 250 | 30 | 14 | 623 | 33 | 101 |
| Special Emergency | 214 | 75 | — | 158 | 69 | — | 56 | 6 | — |
| Highway Maintenance... | 414 | 26 | — | 314 | 12 | — | 100 | 14 | — |
| Forestry Conservation... | 49 | 95 | — | 49 | 34 | — | — | 61 | — |
| Power Utility | 1,550 | 106 | 30 | 972 | 73 | 16 | 578 | 33 | 14 |
| Pipeline Petroleum | 755 | 97 | 44 | 585 | 80 | 40 | 170 | 17 | 4 |
| Special Industrial | 2,852 | 367 | 47 | 2,001 | 255 | 19 | 851 | 112 | 28 |
| Low-Power Industrial .. | — | — | 534 | — | — | 154 | — | — | 380 |
| Relay Press | 5 | — | — | — | — | — | 5 | — | — |
| Motion Picture | 60 | 3 | — | — | — | — | 60 | 3 | — |
| Forest Products | 269 | 28 | 12 | 250 | 27 | 12 | 19 | 1 | — |
| Taxicabs | 2,146 | 156 | — | — | — | — | 2,146 | 156 | — |
| Railroads | 366 | 59 | 133 | — | — | — | 366 | 59 | 133 |
| Highway Trucks | 466 | 50 | — | 466 | 50 | — | — | — | — |
| Intercity Busses | 18 | 2 | — | 18 | 2 | — | — | — | — |
| Transit Utilities | 35 | 1 | — | 35 | 1 | — | — | — | — |
| Auto Emergency | 131 | 17 | — | 131 | 17 | — | — | — | — |
| Radio Paging | — | 8 | — | — | 8 | — | — | — | — |
| Common Carrier | 425 | 4 | — | 175 | 2 | — | 250 | 2 | — |
| Miscellaneous Com. Car. | 625 | 19 | — | — | — | — | 625 | 19 | — |
| | 14,435 | 1,398 | 1,066 | 7,252 | 765 | 303 | 7,183 | 633 | 763 |

FOR EXTREME STABILITY.. *Bliley* CRYSTALS PLUS *Bliley* TEMPERATURE STABILIZERS

Crystal frequency stability is a finite factor determined by ambient temperature variation. Bliley Temperature Stabilizers, used with Bliley Crystals, are thermostatically controlled ovens engineered to deliver extreme stability regardless of ambient temperature changes.

TCO SERIES

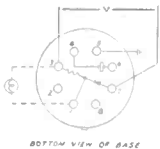
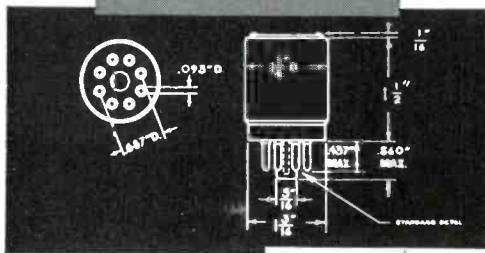

Designed specifically for use with Bliley types BH6A and SR11 crystal units. Standard models are supplied as indicated:

| Model | Heater Voltage | Watts | Crystal Sockets | Control Temperature |
|--------|----------------|-------|-----------------|---------------------|
| TCO-1A | 6.3 | 5.5 | 1 | 75°C or 85°C |
| TCO-1C | 24 or 26.5 | 7.75 | 1 | 75°C or 85°C |
| TCO-2 | 6.3 | 5.5 | 2 | 75°C |
| TCO-2 | 6.3 | 7.9 | 2 | 85°C |
| TCO-2D | 24 or 26.5 | 7.75 | 2 | 75°C or 85°C |

TYPES TC911-TC92-TC93

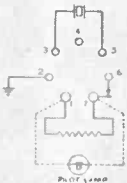
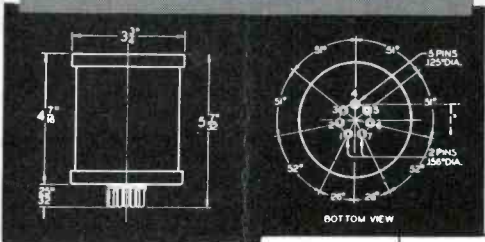

Designed specifically for use with Bliley Crystal units. Standard models are supplied, for crystal types, as indicated:

| Model | Heater Voltage | Watts | Crystal Group | Control Temperature |
|-------|----------------|-------|---------------|---------------------|
| TC911 | 115 | 10 | B | 70°C |
| TC92 | 6.3 | 10 | A | 60°C |
| TC93 | 18 | 10 | A | 60°C |

Crystal Group A Types FM6, BH81A, MC7, AR4, AR5

Crystal Group B Types BH8, MC75, MS46A

TYPE TC97

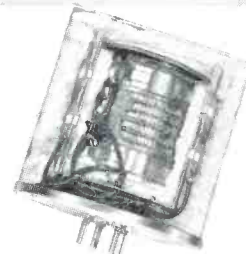
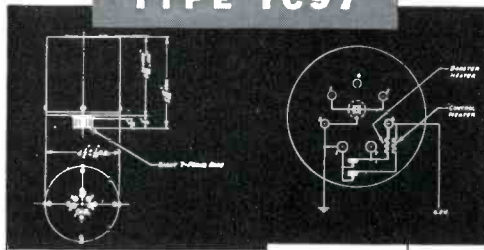

Exceptional temperature stability is provided by two separate heaters, individually regulated by separate thermostats. Ambient temperature variations are first minimized by outer stage (booster) heater with final regulation by inner stage (control) heater.

| Model | Heater Voltage | Watts | Crystal Group | Control Temperature |
|-------|----------------|-------|---------------|---------------------|
| TC97 | 6.3 | 11 | A | 75°C |

Crystal Group A Types FM6, BH81A, MC7, AR4, AR5

BLILEY ELECTRIC COMPANY
UNION STATION BUILDING, ERIE, PENNSYLVANIA

REL

RADIO ENGINEERING LABS., Inc.

PIONEERS IN THE CORRECT USE OF
ARMSTRONG FREQUENCY MODULATION

HERE ARE FACTS about REL Multiplex Installations

The number of REL multiplex radio relay and point-to-point installations now in use, and the length of time they have been in service, provide ample evidence of their reliability and economy. Heart of REL installations is the Serrasoid Modulator, distinguished for low noise, low distortion, and long-time stability.

Among the companies using REL equipment in order to achieve that quality of performance are:

Canadian National Telegraphs
Canadian Pacific Railways
Chesapeake & Potomac Tel. Co.
Empresa Nacional de Tele-
comunicaciones, Columbia
Israel Ministry of Communications
Mutual Tel. Co. of Hawaii
New England Tel. & Tel. Co.
Pacific Tel. & Tel. Co.
Panair do Brazil
Quebec Telephone Co.
Salt Lake Pipe Line Co.

REL manufacturers standard units for 70 to 2,000 mc., and modulation to 300 kc. for as many as 50 voice circuits. This equipment is suited to operation under topographical or climatic conditions encountered in any part of the world. Special types can be designed and built to suit unusual requirements. REL multiplex equipment is now in use by telephone companies, railroads, broadcasters, government services, and other operators of communication systems. Consultation service is available to those planning new installations or the modification of present facilities. Address:

Engineers and Manufacturers of
Broadcast, Communication, and
Associated Equipment since 1922

RADIO ENGINEERING LABORATORIES, Inc.

TEL: STILLWELL 6-2100 TELETYPE: N. Y. 2816
36-40 37th Street, Long Island City 1, N. Y.

PRODUCT INFORMATION

Hermetically-Sealed Crystals: Precision gold or silver-plated crystals are now available in hermetically-sealed 6V6GT octal tube envelopes. James Knights Company, Sandwich, Ill.

One-Way Signaling Units: Separate tone transmitter and receiver chassis for signaling,

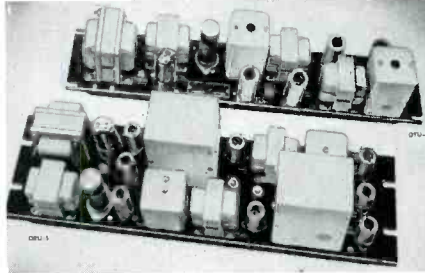

dialing, slow-speed telemetering, and supervisory control applications are now available. Each panel section contains two tone transmitters (DTU-1) or two receivers (DRU-1), which can be used with standard DSU-2 units. Specifications are the same. Hammarlund Mfg. Company, Inc., 460 W. 34th Street, New York 1, N. Y.

Mobile Equipment Catalog: Operating specifications on all mobile radiotelephone equipment and accessories available from the manufacturer are included in a new catalog, which can be obtained on request from Kaar Engineering Corp., Palo Alto, Calif.

Custom Converters: A line of DC to AC converters, called Custom models, provide 300, 400, or 500 watts AC output, operate from batteries or line voltages of 12, 24, 28, 32, 64, 115, or 230 volts DC. All are available with manual frequency control. Specifications and dimensions are available in an illustrated booklet from Carter Motor Company, Dept. 18, 2640 N. Maplewood Avenue, Chicago 47, Ill.

DC Power Amplifier: Model B power amplifier will deliver $6\frac{1}{4}$ watts to 100 ohms with a 10-volt input; has essentially flat response from 0 to 20,000 cycles. Developed to

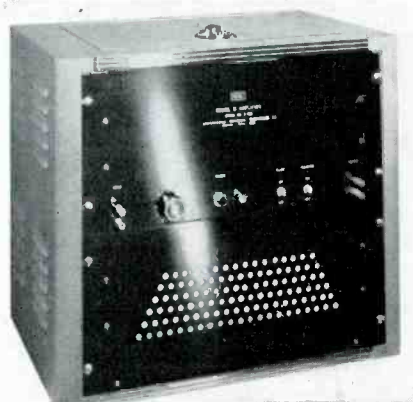

drive precision industrial devices and to amplify output of test transducers. Southwestern Industrial Electronics Company, 2831 Post Oak Road, Houston 19, Texas.

X-Band Test Set: Contained in a case 17 by 10½ by 13 ins. overall, a multi-purpose test set contains integrated signal generator, power monitor, wavemeter, and spectrum analyzer sections. Capable of operation with CW or square-wave, FM, or pulse modulation over the range from 8,500 to 10,500 mc. Century Electronics, 14806 Oxnard Street, Van Nuys, Calif.

Mycalex Handbook: Containing detailed specifications and suggested applications for all injection-molded and compression-molded grades of glass-bonded mica insulation, as well as fabrication and machine-working data and a catalog of special parts and tube sockets, a new lithographed engineer's handbook is available on request from Mycalex Corporation of America, Clifton Boulevard, Clifton, N. J.

New Radio Equipment: Claimed to provide more power per pound than any previous portable, model MRT-9 transmitter-receiver operates at 152 to 174 mc., can be furnished with wet or dry-cell battery, vi-

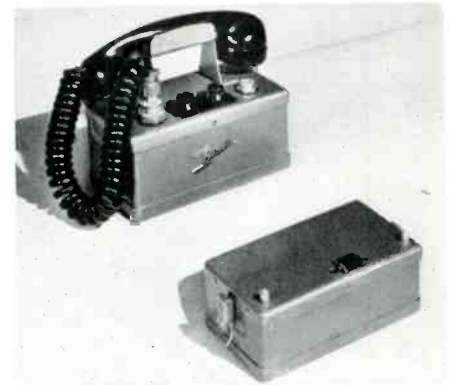

brator, or AC power supply. Output is 1 watt RF on one or two frequencies.

The RA-18B aircraft receiver provides reception of 360 crystal-controlled frequencies in the 118 to 135.9-mc. band, weighs 18 lbs. Power supply operates from 27.5 volts DC or 115 volts AC. Bendix Radio Division, Bendix Aviation Corp, Baltimore 4, Md.

Telemetering Booklet: Bulletin M1710 contains suggested applications and engineering data on telemetering instruments for remote recording, indicating, and totalization of electric variables by means of multiplexed radio, wire-line, carrier-current, and microwave carriers. The Bristol Company, Waterbury 20, Conn.

New Vibrator Designs: Series 4500 vibrators are claimed to represent almost complete departures from standard vibrator design techniques. Replacements for types 1501, 1502, 246, 248, and 249 are available. P. R. Mallory & Company, Inc., 3029 East Washington Street, Indianapolis 6, Ind.

Sensitive Inverter: When used in conjunction with any device capable of measuring 60-cycle AC voltages, Model 700 inverter permits accurate DC measurements as low as

Continued on page 7

NEW PRODUCTS

(Continued from page 6)

10 microvolts, detection of DC potentials down to 1 microvolt. Loading not less than 10 megohms; DC to RMS AC inversion ratios of 1 to 100 and 10 to 1. Ballantine Laboratories, Inc., Boonton, N. J.

Duratrak Variacs: New line of Variac auto-transformers features silver-alloy coated brush track for longer life, higher surge current and overload ratings, reduced maintenance. Bulletin available from General Radio Company, Cambridge 39, Mass.

Vacuum-Impregnated Diodes: Bulletin GD-1 describes and gives specifications for a new line of vacuum-impregnated germanium diodes. These units exceed JAN specifications. International Rectifier Corp., 1521 East Grand Ave., El Segundo, Calif.

Tantalex Capacitors: Type 100D Tantalex capacitors, a line of tantalum electrolytics, has been announced by Sprague. Hermetically sealed, the ultra-compact units are intended primarily for military and industrial applications where low leakage is important. Bulletin 350 available from Sprague Electric Company, 243 Marshall Street, North Adams, Mass.

Multi-Master 2-Way Radio: Incorporating transmitter, receiver, power supply, controls, microphone, and antenna in one 50-lb. assembly, this 2-way FM unit can be used as fixed-station or mobile equipment in the 152

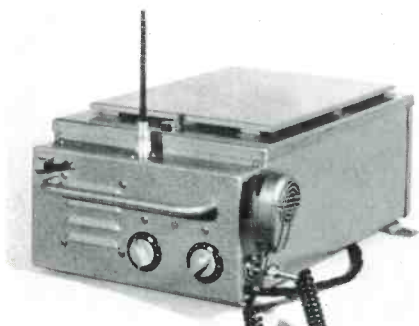

to 174-mc. band. Models for 6, 12, or 64-v. DC or 117-v. AC operation are available with 2, 10, 25, or 35 watts output. The AC model can be obtained also with 60 watts output. Bendix Radio Division, Bendix Aviation Corp., Baltimore 4, Md.

Carrier Terms Dictionary: Definitions of 150 terms commonly used in telephone and telegraph carrier equipment literature, with a general discussion of carrier equipment theory, can be found in bulletin EB-101. *A Dictionary of Carrier Terms.* Lenkurt Electric Company, 1191 County Road, San Carlos, Calif.

Station Antennas: Complete specifications and installation information on high-gain omni-directional station antennas for 150 and 450-mc. bands are given in bulletin 65-B, available from Andrew Corporation, 333 East 75th Street, Chicago 19, Ill.

Pattern Selector Switch: Remote control of directional antenna pattern can be obtained with a new motor-operated 2-circuit DPDT switch, which can interchange connections of four open-wire 30-kv. high-frequency antenna lines. Trylon Tower Division, Wind Turbine Company, West Chester, Pa.

Continued on page 8

ANDREW

offers a complete line
of antennas for the 450-470 MC band!

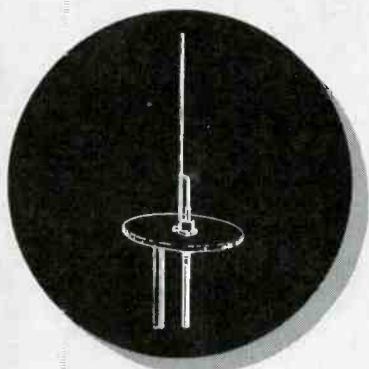

The Isopole antenna, omnidirectional, rugged, inexpensive Type N input.

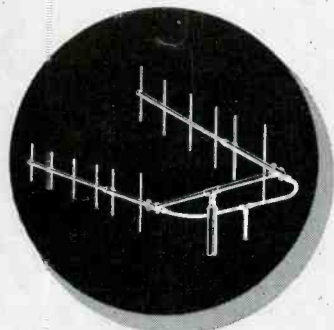

The Yagi antenna, two models with gains of 9.5 db and 12 db horizontal or vertical polarization.

The High Gain antenna, omnidirectional, gain 6 DECIBELS PLUS.



The Corner Reflector antenna, 8db forward gain, broadband, horizontal or vertical polarization.

Andrew

CORPORATION

ANTENNA SPECIALISTS

333 EAST 75TH STREET, CHICAGO 19

TRANSMISSION LINES FOR AM-FM-TV-MICROWAVE • ANTENNAS • DIRECTIONAL ANTENNA EQUIPMENT • ANTENNA TUNING UNITS • TOWER LIGHTING EQUIPMENT

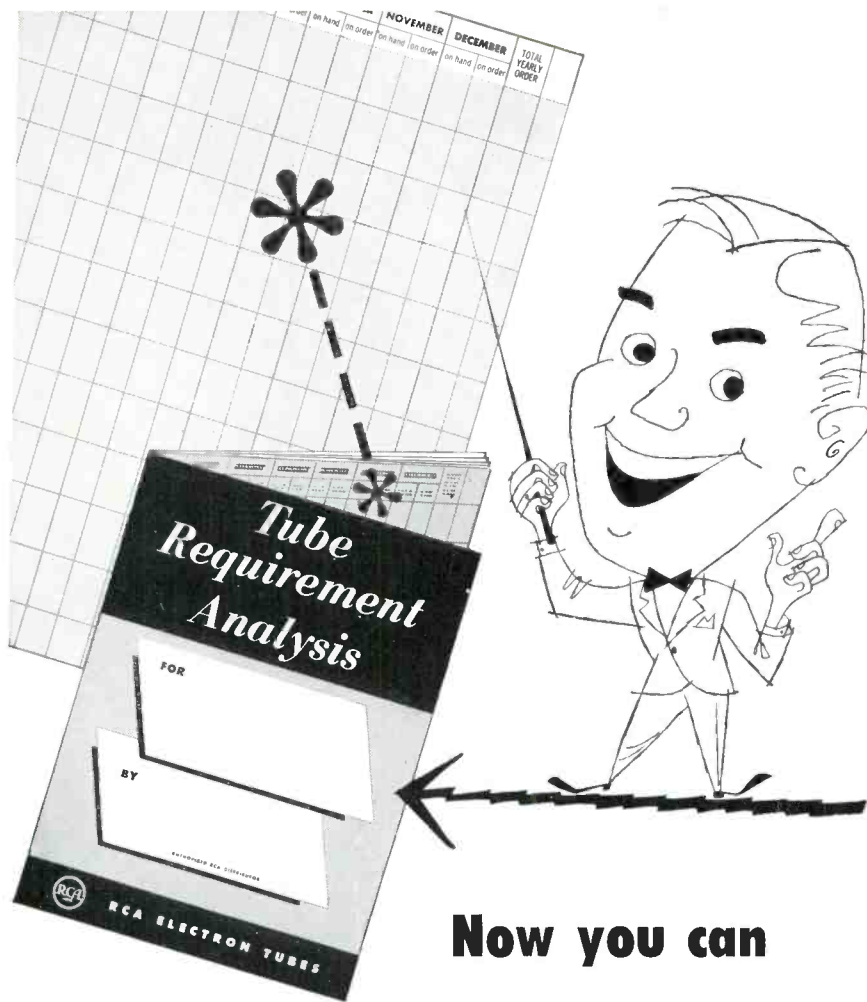

Now you can
Avoid Costly Downtime
of your communications equipment



Now you can avoid possible shutdowns of mobile communications equipment due to unexpected shortages of key tube types. Without extra cost or effort, you can be sure you have the *right* tubes on hand when you need them.

HERE'S ALL YOU HAVE TO DO . . .

Get in touch with your RCA Tube Distributor. Tell him you would like to take advantage of the free RCA Tube Requirement Analysis Program.

Your RCA Tube Distributor will survey your mobile communications equipment, analyze your tube requirements, and prepare a suggested inventory control system for your spare tube stock . . . tailored specifically to your equipment and your operation. There is no charge or obligation for this service.

RESULT: No shortages. No "overstocks." No costly downtime of your mobile communications equipment.

RCA's new Tube Requirement Analysis is available exclusively through your local RCA Tube Distributor. Call or write him today. No charge or obligation.



RADIO CORPORATION of AMERICA
 ELECTRON TUBES HARRISON, N. J.

NEW PRODUCTS

(Continued from page 7)

Series-Drive Vibrators: A new line of vibrators, incorporating series-drive construction, has been designed specifically for long, dependable service in communication equipment. Data sheet giving full information is available from James Vibrapower Company, 4036 N. Rockwell Street, Chicago 18, Ill.

Railroad Radio Information: How type FE heavy-duty railroad radio units can be used for end-to-end, train-to-train, wayside-to-train, dispatcher-to-wayside or train, or wire-line bridging communication applications is described in booklet B-5787-A. Complete equipment specs are given also. Westinghouse Electric Corp., Box 2099, Pittsburgh 30, Pa.

Subminiature Connectors: A series of sub-miniature hermetically-sealed round-shell connectors is available in 3 or 6-contact sizes. Rated for 5 amps., 1700 volts DC; engagement by bayonet and type J slot. Series U connectors are described fully in bulletin U-3, from Cannon Electric Company, 3203 Humboldt Street, Los Angeles 31, Calif.

Tower Data: Three types of self-supporting steel towers, fold-over tower kits, and telescoping masts are described completely with full specifications in a brochure available from Rohn Manufacturing Company, 116 Limestone Street, Bellevue, Peoria, Ill.

Mobile Power Booster: Now in production is this 60-watt power booster for mobile 2-way FM equipments operating in the 152 to 174-mc. band. Inserted between present low-power transmitter and antenna, the booster

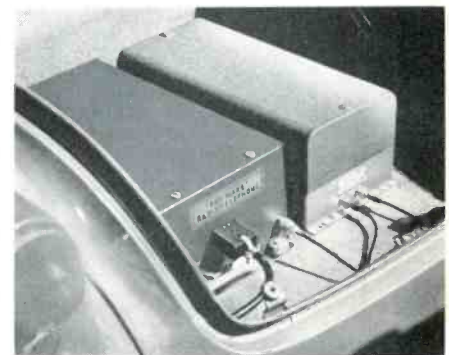

can be cut in or out by a dashboard-mounted switch. No extra power is drawn from the battery until mike-heating button is pushed, since tubes are instant-heating types. A low-band model is also in development. Kaar Engineering Corp., Palo Alto, Calif.

Laminate Bond Resin: Silicone-glass laminates bonded with 2105 resin are said to have 100 times the dielectric life of previous silicone-glass laminates, and to be easier to produce. Pressures from 300 to 1,000 psi. and temperatures from 175 to 250°C. are suitable. Complete data sheets available from Dow Corning Corp., Midland, Mich.

High-Temperature Solder: Consol alloy, with melting temperature of 296°C., is now available in standard 3-core solder form. Especially useful for soldering joints subjected to high ambient heat levels, at which tin-lead solders creep or melt. Samples and literature available from Multicore Sales Corp., Dept. M, 164 Duane Street, New York 13.

Side-Band Filters: Designed to replace more expensive crystal types, a new series of filters has been developed for commercial single side-band receivers. A 25-kc. low-frequency system is employed. Literature is available from Burnell & Company, Dept. SB, 45 Warburton Ave., Yonkers, N. Y.

Circuit Tracer: The Circuitracer is a compact instrument convertible quickly to a continuity tester or a low or high-voltage tester. Locates grounds, opens, or shorts

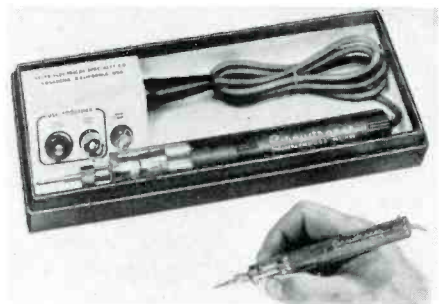

in dead circuits or live circuits from 2 to 600 volts. Delta Electrical Specialty Company, 1456 East Walnut Street, Pasadena, Calif.

UHF Test Equipment: Describing a wide range of instruments and equipment making up an integrated line for UHF test and measurement work, a bulletin from General Radio Company gives complete specifications and prices. Free on request to the company at 275 Massachusetts Ave., Cambridge 39, Mass.

Acetate Coil Bobbins: Acetate or acetate-and-paper coil bobbins for RF and IF coils, relays, push-pull solenoids, switching, timing, and reversing circuits, and other uses requiring exceptionally good insulation, are now available in any size, shape, and quantity. Precision Paper Tube Company, Dept. T7, 2051 W. Charleston Street, Chicago 47, Ill.

Encapsulation Service: Encapsulation of electronic components and circuits in thermo-setting plastic is now being done on an

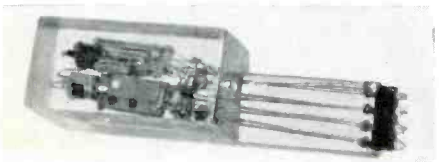

economical mass-production basis. Folder available on request from Calresin Corp., Arcadia, Calif.

Tubes and Transistors: Literature and data is available on the following components: RCA Victor Tube Department, Harrison, N. J. — RCA-5690 full-wave rectifier, 4th in Special Red line, 10,000-hour warranty. Maximum ratings: peak inverse plate voltage, 1120; peak plate current, 375 ma. per plate; DC output current, 150 ma. per plate. Four transistors: RCA-2N32, point-contact, for pulse or switching applications; RCA-2N33, point-contact, for oscillator applications up to 50 mc.; RCA-2N34, *p-n-p* junction, and RCA-2N35, *n-p-n* junction, for low-power, low-frequency applications.

Radio Receptor Company, Inc., Sales Dept., 251 W. 19th Street, New York 11, N. Y. — Three *p-n-p* junction transistors, sealed in plastic, useful from DC to low RF. Types RR20, RR21, and RR14 have various current gains and noise figures.

Continued on page 10

SINGLE-INSTRUMENT FM MODULATION CHECKING



— from
25 to 174 megacycles with the **NEW** Browning MD-33

The MD-33 Frequency Modulation Monitor is a completely new instrument, for precision performance in critical work. No plug-in units of any kind are required.

The unique peak-flasher circuit permits the operator to select either of two pre-set values for flasher indication of transient overmodulation, adjustable to 20 kc.

Remember: the best costs less—in the long run.

Coverage . . . 25 to 174 megacycles, continuous, in two bands.

Sensitivity . . . better than 1 mv to 140 kc, and better than 2 mv to 174 kc.

Panel meter . . . 20 kc maximum, on linear scale.

Flasher . . . indicates peaks in excess of either of two pre-set values, from 1 to 20 kc.

Audio output . . . adjustable, 5 volts RMS maximum, flat from 100 cps to 15 kc.

Phone jack . . . on front panel.

Drift . . . obviated by AFC applied to local oscillator.

For detailed information, write for data sheet

ENGINEERED
FOR
ENGINEERS



BROWNING
Laboratories, Inc.
Winchester, Mass.

LOST POWER INSTANTLY with the KAAR



For greater range and clearer signals, vehicle-to-station or vehicle-to-vehicle, the new Kaar Power Booster will increase the power output of any 10 watt mobile transmitter six times without increasing the standby battery current.

Here's how it works:

1. Insert Power Booster between low power transmitter and antenna.
2. Select power needed by switch on dashboard.
3. Push microphone button to go on the air *instantly* with added power.

Using an Eimac 4-65A tetrode, the Power Booster is "Instant Heating" — does *not* draw power from battery until microphone button is pushed. Selector switch on dashboard simply puts Power

Booster in readiness. (Note: The added power is used *only* when needed — thus conforming to the FCC good engineering requirements.)

Use the Kaar Power Booster with any mobile transmitter operating in the 152-174 mc band and enjoy mobile communication excellence never before attained. (Another Kaar Power Booster will soon be available for use in the 25-50 mc band.)

WRITE TODAY FOR COMPLETE INFORMATION!



KAAR ENGINEERING CORP.
Middlefield Road, Palo Alto, Calif.

DEALERS' NOTE:

Kaar is the only major manufacturer of mobile radiotelephone equipment distributing through authorized dealers. There are a few territories open for dealerships. If interested, write for complete details. State qualifications.

NEW PRODUCTS

(Continued from page 9)

Regulated DC Supply: Model PT-110 regulated DC power unit provides 400 to 450 v. at 225 to 325 ma., with regulation better than .2% and ripple less than 8 mv. RMS. Centering current return for TV applications. Bias supply of — 150 v. at 10 ma. is included. Controls and fuses available from front of rack-mounted chassis. Polarad Electronics Corp., 100 Metropolitan Ave., Brooklyn 11, N. Y.

Plug-in-Units: Line of components for plug-in unit construction consists of unique series of sub-assemblies which plug together so that any part can be replaced quickly and with-

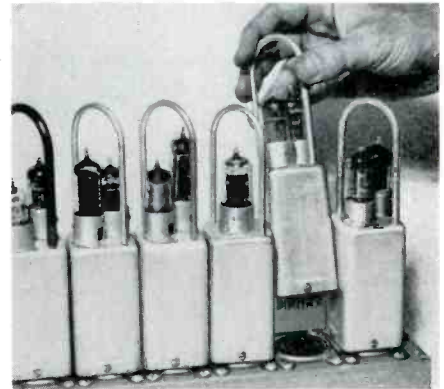

out error. Color coding, keyed connectors, and fault indicators increase speed of maintenance and reduce chance of error. Alden Products Company, Brockton, Mass.

PC Rotary Switch: Types PCF-1 and PCF-2 are printed-circuit rotary switches with 60 shorting positions and 30 non-shorting positions respectively. Switch segments are silver alloy, bonded to phenolic contact panel. Individual soldering eyelets are connected to each segment. Dimensions are 3 by 2 1/16 ins. The Daven Company, Dept. PCS, 191 Central Avenue, Newark, N. J.

Capacitors and Filters: The Hivomike series of high-voltage midget mica capacitors has been expanded to include ratings up to 2,500 volts with no increase in size. Ratings exceed Jan C-5 specs. Complete information in bulletin 422-3.

More than 135 different types of feed-thru, pi, and universal RF filters in the Quietone line are described with detailed specifications and sample circuits in bulletin NB-148, available from Cornell-Dubilier Electric Corp., South Plainfield, N. J.

Interchangeability Chart: Bulletin 253 gives brief type descriptions, list-price information, and tabulations of tube types with which Los Gatos power tubes are interchangeable. Lewis and Kaufman, Ltd., 62 El Rancho Avenue, Los Gatos, Calif.

Mechanical Filter: Now offered on a component basis are mechanical filters for transmitter sideband suppression and receiver IF applications. Unit consists of input transducer, a series of mechanically-resonant disks, and output transducer in hermetically-sealed case smaller than IF transformer; operating frequencies from 100 kc. to 1 mc. Collins Radio Company, Burbank, Calif.

Control Relay Booklet: Application and design information for the type N control

relay, used for remote-control operation, is available in Bulletin B-5817. Westinghouse Electric Corp., Box 2099, Pittsburgh 30, Pa.

Transistor Enclosures: Bases and hermetically-sealed enclosures for junction and point-contact transistors are being mass-produced by Hermaseal Company, Inc., 1101 Lafayette Street, Elkhart 10, Indiana.

Standby Power Units: Emergency gasoline and diesel engine-driven AC generators, with capacities from 1,000 to 35,000 watts, are described in form A-307, from D. W. Onan & Sons, Inc., Minneapolis, Minn.

Blue-Point Capacitors: A new line of dry-assembled, oil-impregnated paper capacitors, housed in non-flammable molded plastic cases, incorporates a solid glass-like thermo-setting bond material that becomes integral with the cases. It is claimed that this forms a permanent moisture seal, locks in the leads, and makes the units invulnerable to flame or soldering-iron heat. Bulletin AB-20A, Astron Corp., 225 Grant Avenue, East Newark, N. J.

New Megohmmeter: Available for immediate delivery is the type 1020-B megohmmeter, a self-contained AC-operated instrument for laboratory use or production testing. Regulated 500-volt supply is removed from terminals in inoperative position. Six ranges cover 1 to 2,000,000 megohms. Freed Transformer Company, 1718 Weirfield Street, Brooklyn 27, N. Y.

Polyester Film: A new technical bulletin contains up-to-date information on the physical, electrical, and chemical properties of Mylar polyester film, with suggested applications. Properties are compared with those of cellophane, polyethylene, and acetate, comparison shows that the new film may find wide application as a dielectric, insulator, and base. Bulletin 1-2-53 can be obtained from Technical Service Section, DuPont Film Dept., Wilmington 98, Del.

Dual Crystal Detector: Miniaturized dual crystal detector designed to function with direct and reverse crystal assembly 1N23BRM fits waveguide contact flanges being standardized by RTMA. Furnished with type N fittings or wired-on connectors. Data can be obtained from Airtron, Inc., 20 East Elizabeth Avenue, Linden, N. J.

Sealed Resistors: A new line of encapsulated and bonded precision resistors are claimed to meet requirements of MIL-R-93A and JAN-R-93. Windings are reversed and balanced pi; operating range is -65°C . to $+125^{\circ}\text{C}$. Rigid terminals are hot-solder coatel brass. Mepco. Co., Inc., Morristown, N. J.

Automatic Welders: Tweezer-Weld automatic welding equipment welds extremely small parts at 1,200 per hour, studs at 6,000 per hour, glass beadings at 200 per hour. Federal Tool Engineering Company, 1386 Pompton Avenue, Cedar Grove, N. J.

Copper-Clad Aluminum: Designed to replace copper and brass for many applications at lower cost. Alcuplate copper-clad aluminum can be supplied soft or in the usual range of cold-worked tempers. Sheet or strip is available up to 1/16 in. thick and up to 12 1/2 ins. wide. Bulletin available from General Plate Division, Metals & Controls Corp., Attleboro, Mass.

Continued on page 40

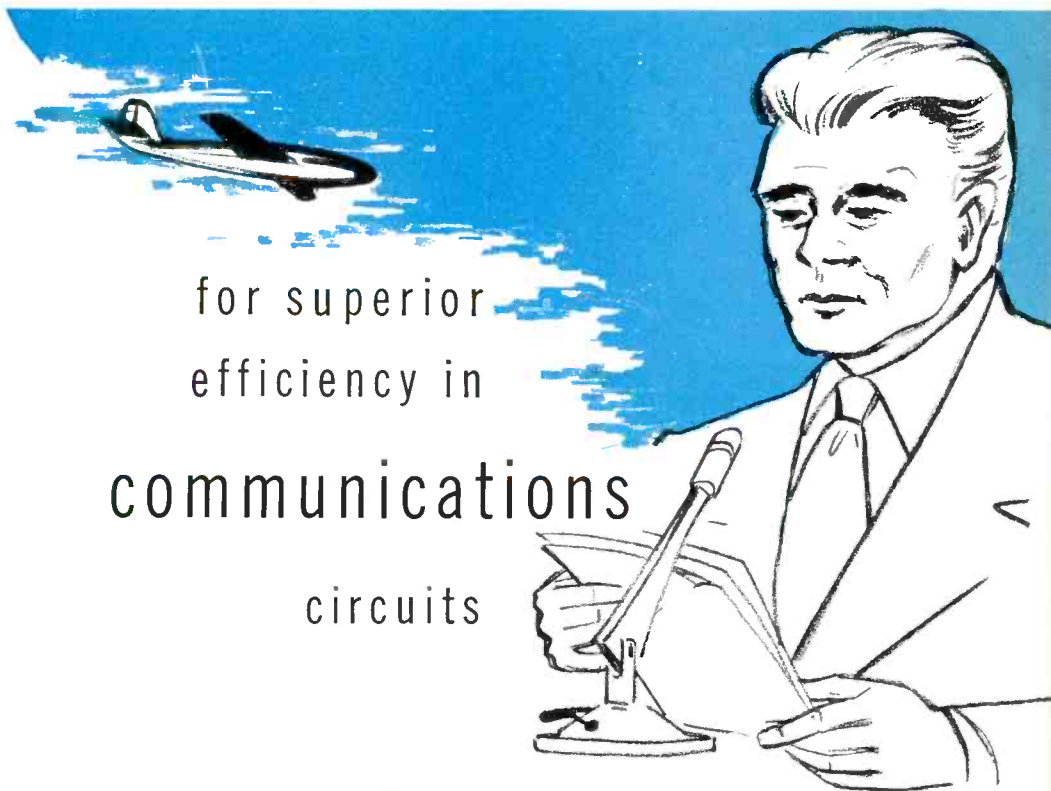

for superior
efficiency in
communications
circuits

rely on AMPHENOL components



COAXIAL CABLES

AMPHENOL Cables are designed and manufactured to meet the most exacting of military requirements. This insures a constant high standard of production for civil communication circuits, too. These cables have strict end-to-end uniformity, low RF loss and all-around superior mechanical efficiency. Polyethylene is the dielectric most used in AMPHENOL Cables due to its flexibility and low water absorption. For extreme heat conditions, Teflon* dielectric is used.

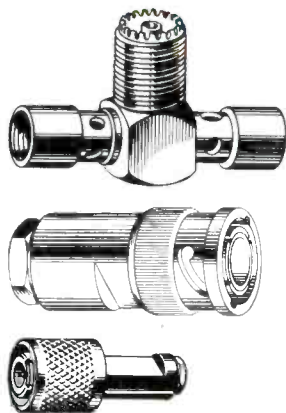

RF CONNECTORS

Important to communication continuity, cable connectors have to be of top quality. AMPHENOL RF Connectors are designed and built to preserve the desired transmission characteristics with a minimum of loss and interference—for years! Like AMPHENOL Cables, they conform to rigid military specifications. AMPHENOL RF Connectors are available in many types and designs; some with Teflon* inserts for covered equipment or other high temperature applications.

*E. I. DuPont Reg. trade mark

see your



distributor

AMERICAN PHENOLIC CORPORATION
chicago 50, illinois

The NEW



Delivers MORE Power for PROFESSIONAL Use

These latest-of-all Carter DC to AC Converters are specially engineered for professional and commercial applications requiring a high capacity source of 60 cycles AC from a DC power supply. Operates from storage batteries or from DC line voltage. Three "Custom" models, delivering 300, 400, or 500 watts 115 or 220 V. AC. Wide range of input voltage, 12, 24, 32, 64, 110 or 230 V. DC. Unequaled capacity for operating professional recording, sound movie equipment and large screen TV receivers. Available with or without manual frequency control feature.



HOW LEADING NETWORKS USE CARTER CONVERTERS

Photo shows Tommy Bartlett, star of NBC "Welcome Travellers" program, aboard N.Y.C. R.R. "Twilight Limited." His Carter "Custom" Converter makes recording possible on board the train, from regular train current converted to 110 V. AC. Radio networks, stations, program producers use Carter Converters for all sorts of on-the-spot recording.

MAIL COUPON FOR CATALOG

Carter MOTOR CO.
2641 N. Maplewood Ave.
Chicago 47

Carter Motor Co.
2641 N. Maplewood Ave., Chicago 47

Please send new catalogs containing complete information on Carter "Custom" Converters and other Rotary Power Supplies.

Name _____
Address _____
City _____ State _____

THE COVER PICTURE

Microwave communication equipment is receiving a lot of attention these days. Probably too much, from the point of view of the maintenance man who must keep it operating. One way to make his task easier, and save on maintenance expense in the long run, is to provide him with proper test equipment. This important item is discussed in detail beginning on page 24 by A. S. May of Bell, whose TD-2 repeater station on Buckhorn Mountain, Colorado, is shown on the cover.

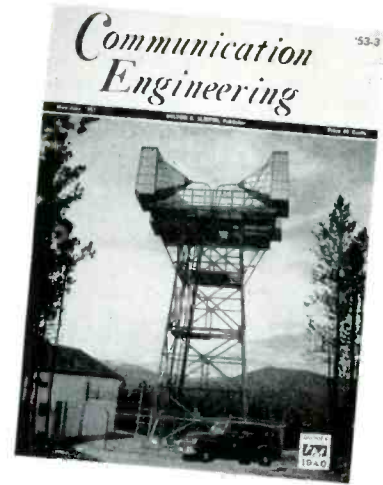

COMPANIES & PEOPLE

FCC Chairman Rosel H. Hyde: All segments of the industry have registered enthusiastic approval of President Eisenhower's elevation of FCC Commissioner Rosel H. Hyde to the chairmanship of this agency. Mr. Hyde's term expires June 30, 1959. However, his appointment as chairman is for one year, running to May 4, 1954. Paul A. Walker, who has served as chairman since the resignation of Wayne Coy on February 21, 1952, will continue as a Commissioner until the end of his term on June 30 of this year. Politically, Rosel Hyde, George Sterling, and John Doerfer line up on the Republican side; Paul Walker, Robert Bartley, and Frieda Hemcock are Democrats, while E. M. Webster is an independent. Expectation is that Mr. Walker will be succeeded by a Republican. Mr. Hyde, born at Downey, Idaho in 1900, is a career man in the FCC. He joined the Federal Radio Commission in 1928, rose to the post of general counsel in 1945, and was appointed a Commissioner in April 1946. A graduate of George Washington University Law School, he was admitted to the District of Columbia bar in 1929.

FCC Commissioner John C. Doerfer: First Commissioner to be appointed by a Republican President is John C. Doerfer, formerly chairman of the Wisconsin Public Service Commission. He replaces Eugene H. Merrill, appointed last year without Senate confirmation to fill Robert Jones' unexpired term. Commissioner Doerfer will serve until June 30, 1954.

Clevite Acquires Boston Concern: Clevite Corp. of Cleveland, Ohio, has acquired a majority stock interest in Transistor Products, Inc. Dr. Roland B. Holt, formerly director of the Nuclear Research Laboratory of Harvard University, is president.

T. H. Mitchell: Elected president of RCA Communications, Inc., to succeed H. C. Ingles, retiring at 65. Mr. Mitchell has been with the firm since 1927, shortly after his graduation from Annapolis.

Herbert M. Hucke: Appointed staff assistant to the general manager, Bendix Radio Division of Bendix Aviation Corp. He was previously in charge of facilities planning for RCA's Engineering Products Dept., and has 27 years logged in radio.

Ampere Medal: Awarded to Henri G. Andre "in recognition of his outstanding contributions to electrical science and, in particular, for his work in the field of electrical energy storage." This pertains to his development of a small rechargeable silver-zinc accumulator.

Alan B. Chapman: Appointed development engineer in charge of Communica-

Continued on page 18.

MEETINGS and EVENTS

JUNE 11 - 12,
IRE COMMUNICATIONS GRP. SYMPOSIUM
Long Lines Bldg., AT&T, N. Y. C.

JUNE 15 - 19,
AIEE SUMMER GENERAL MEETING
Chalfont-Haddon Hall, Atlantic City, N. J.

JUNE 24,
COM. ON PETROLEUM RADIO FACILITIES
Hotel Mayflower, Washington, D. C.

JUNE 25,
PETROLEUM RADIO FREQ. CO-ORD. COM.
Hotel Mayflower, Washington, D. C.

JULY 13 - 16,
MUSIC INDUSTRY TRADE SHOW
Palmer House, Chicago

AUGUST 19 - 21,
WESTERN ELECTRONIC SHOW
San Francisco Auditorium, San Francisco

SEPTEMBER 1 - 3,
INT'L SIGHT AND SOUND EXPOSITION
Palmer House, Chicago

SEPTEMBER 28 - 30,
9TH NATIONAL ELECTRONICS CONFERENCE
Hotel Sherman, Chicago

OCTOBER 14 - 17,
AES CONVENTION, AUDIO FAIR
Hotel New Yorker, N. Y. C.

OCTOBER 26 - 28,
RTMA-IRE RADIO FALL MEETING
Toronto, Ontario, Canada

COMPANIES & PEOPLE

(Continued from page 12)

tion Engineering Company's recently-expanded Development Section at Dallas, Texas. During the recent war, he served as an advisor to the Navy on radar, after which he was active in television service operations for RCA.

H. & B. Buys Karp: H. & B. American Machine Company has purchased Karp Metal Products Company, Inc., of Brooklyn, N. Y., one of the larger manufacturers of sheet metal products. Activities of the company will be expanded under Milton J. Karp, who will remain as president.

Robert B. Beetham: Now works manager of the Hicksville plant of Amperex Electronic Corp. He was with Collins Radio Company for 14 years, and at Airborne Instrument Laboratory for the past 5 years as executive assistant to the vice-president in charge of research and engineering.

REP Awards: At the annual spring meeting of the Los Angeles chapter of The Representatives of Electronics Parts Manufacturers, Inc., president John T. Hill presented miniature ebony gavels to past presidents Jerry T. Hill, Harry A. Lasure, William C. Hitt, Norman B. Neely, David N. Marshbank, Carl A. Stone, Gerald B. Miller, Harold A. Kittleson, Ernest V. Roberts, and John B. Tubergen.

Henry F. Argento: Appointed vice-president and general manager of Raytheon Television and Radio Corporation, Chicago, a subsidiary of Raytheon Manufacturing Company, Waltham, Mass. Mr. Argento has been with Raytheon since 1932, and has most recently served as assistant vice-president and assistant manager of Raytheon's Power Tube Division.

Statistics on FCC Applications: From time to time, when the FCC releases figures on the number of safety and special services applications received and processed, we receive letters asking why there is such disparity between those figures and the number listed in our Weekly Reports. The principal reason is that, in the past, the Commission has counted an application for a CP and for a license as two applications. The Weekly Reports list applications for CP's only. Now, however, FCC will consider the request for a CP and license as one application.

Thomas Paxton: Named general manager of Hallicrafters-Chicago, Inc., re-

Continued on page 14

formerly *FM-TV* RADIO COMMUNICATION

FOR CIVILIAN DEFENCE

AND EMERGENCY REQUIREMENTS

THE NEW **Link** - AVF - EQUIPMENT

COMBINING

117 V. AC and 6 V. DC OPERATION



The new **Link** — AVF — series of equipment combines 117 volt AC operation with 6 volt DC standby facilities. Both sources of power may be simultaneously applied with manual or automatic changeover.

Available for the 25-50 Mc. or 144-174 Mc. band.

SPECIFICATIONS

RECEIVER

.5 microvolt sensitivity
Adjacent / split - channel
selectivity
1 watt audio output
Single or dual-frequency
operation

TRANSMITTER

10 watts RF output
Peak modulation control
.0005% frequency
stability
Single or dual-frequency
operation

For Additional Information Write to

LINK RADIO CORPORATION

125 W. 17th St.

New York 11, N. Y.

*Had we
but world enough
and time*

no one would need monitors but
speed in communication is economy
and often a life and death matter.



MODEL PR9 FOR 152-174 MC BAND

If you have a police, fire, forestry,
pipeline, civil defense, taxi or any
other vital 2-way radio system, here is
how monitors pay off.

Says Chief McMurtry—of the Sheri-
dan, Indiana, Volunteer Fire Depart-
ment:

"In the past, the largest obstacles
for our Volunteer Fire Department to
overcome has been the method of deter-
mining the exact location of the fire
and beating the traffic there. Speed
of course is essential for the efficient
operation of any Fire Department.
Now, with the Town Police Radio
Base Station located in the Depart-
ment and with the use of 18 PR9
Receivers in the homes of our mem-
bers we not only learn of the fire
before the Town Siren is blown, but
we in many cases arrive at the fire
before the equipment....*We do not
hesitate to recommend this Receiver
to any Department!*"

Franchises available, write for infor-
mation.

RADIO APPARATUS CORPORATION
FACTORY—55 NORTH NEW JERSEY STREET
INDIANAPOLIS 4, IND., PHONE: ATLANTIC 1524
SALES OFFICE: 1604 WEST 92ND STREET
CHICAGO 20, ILL., PHONE: BEVERLY 8-7770

MONITORADIO



Chief McMurtry and members of Sheridan, Indiana, Volunteer Fire Department with John Oakley Vice-President of Midwest Fire and Safety Equipment Co. who supervised monitorradio installation.



Professional Directory

McINTOSH & INGLIS

1216 WYATT BLDG.
WASHINGTON, D. C.

Metropolitan 8-4477

Member AFCCE*

JOHN D. TRILSCH CO.

TOWERS for
RADIO • TELEVISION
COMMUNICATION

1310 McKinney Ave., Houston, Texas
Phone: ATwood 9351

General Electric TWO WAY RADIO

- Systems Engineering
- Installation
- Contract Maintenance

Communications Engineering Co.

900 Dragon St.
Dallas, Tex.
PR 7508

6422 Long Dr.
Houston, Tex.
OL 8501

COMPANIES & PEOPLE

(Continued from page 13)

placing Ernest Riehl. Mr. Paxton has
been district sales manager since 1952,
when he came to the company from
Zenith.

Charles W. Finnegan: Appointed chief
electronics engineer of the Stromberg-
Carlson Company, to replace Garrard
Mountjoy who resigned to join American
Radio-Television, Inc. of Little Rock.
Mr. Finnegan has been with Stromberg-
Carlson previously, from 1941 to 1949.

Aerovox-Cinema Engineering: Aero-
vox Corporation has acquired Cinema
Engineering Company of Burbank, Calif.,
which will become a division. A. C.
Davis and James Fouch will remain as
director and general manager, respec-
tively.

H. A. Triplett: Appointed research di-
rector for Littlefuse, Inc. He was for-
merly chief engineer of Scheitzer and
Conrad and then of Pacific Oerlikon.

Dr. John Ruze: Named director in
charge of The Gabriel Laboratories at
Needham Heights, Mass. Before joining
Continued on page 15

Professional Directory

Jansky & Bailey

Consulting Radio Engineers

EXECUTIVE OFFICES:

970 National Press Bldg.
Washington, 4, D. C. ME 5411

OFFICES AND LABORATORIES:

1339 Wisconsin Ave., N.W.
Washington, 7, D. C. AD 2414

Member AFCCE

WELDON & CARR

Consulting
Radio & Television
Engineers

Washington, D. C. Dallas, Texas
1605 Connecticut Ave. 4212 So. Buckner Blvd.

MICROWAVE SERVICES, INC.

"Architects of Modern Communications"

Independent Consultants,
Engineers, Constructors

Wire, Carrier, Radio — Transmission, Distribution
— Inside and Outside Plant Facilities —
Appraisals, Surveys, Specifications, Design,
Construction

Circle 7-4953 45 Rockefeller Plaza, New York 20



SINCE
1931

Professional 16mm Sound-On-Film Motion
Picture Cameras for Television Newsreels,
Commercials and other Television Filming.

Write for free illustrated catalog.

BERNDT-BACH, Inc.

7349 Beverly Blvd., Los Angeles 36, Calif.

RUSSELL P. MAY

CONSULTING RADIO ENGINEERS

★ ★ ★

1422 F Street, N.W., Wash. 4, D. C.
Kellogg Building Republic 3984

Member AFCCE

WORKSHOP ASSOCIATES DIVISION

THE GABRIEL COMPANY



Specialists in
High-Frequency
Antennas

Endicott Street Norwood, Massachusetts
Norwood 7-3800

COMPANIES & PEOPLE

(Continued from page 14)

Gabriel, Dr. Ruze was head of the Antenna Design section of SCEL during the war, and later became assistant chief of the Antenna Laboratory at the Air Force Cambridge Research Laboratory.

Robert T. Cavanagh: Appointed assistant director of research at the Du Mont Research Laboratories. Mr. Cavanagh joined Du Mont as a research engineer in November, 1947, having previously been engaged in joint research activities with Du Mont from his former home in Toronto, Ontario, Canada.

Sylvania Officers: New officers of Sylvania Electric Products, Inc. include Don G. Mitchell, board chairman, and H. Ward Zimmer, president. Mr. Mitchell, president since 1946, succeeds Max F. Balcolm, retiring. Mr. Zimmer was formerly vice-president of operations and then executive vice-president.

W. M. Allison: Appointed technical advisor to Sprague Electric Company. He has been a senior executive in the Sprague Research and Engineering Dept. for 20 years, and has been active in engineering committee work for RTMA and NEMA.

Approved Communication Equipment: FCC type approval has been issued to Platt Manufacturing Company for their communication equipment models 30-TRM-11, 30-TRM-31, 30-TRS-11, and 30-TRS-31. These units are, therefore, acceptable for specification on form 400 applications.

Leo G. Sands: Resigned as president of Bogue Railway Equipment Division to take the post of sales manager at Langevin Manufacturing Corp. He was formerly with Bendix and Philco.

Plant Expansions: JFD Manufacturing Company has added 140,000 sq. ft. in a new building at 6215 15th Avenue, Brooklyn, two blocks from the main office.

Two new plants have been added to facilities of Westinghouse's Electronic Tube Division. Both are in upstate New York. The Elmira plant will turn out large TV picture tubes and power tubes; small receiving tubes will be made at the Bath plant.

Production is under way at the International Resistance Company's plant situated on a 66-acre site in Asheville, N. C. H. J. McCauly will manage the Asheville plant, which will employ eventually about 500 persons.

Ebert Electronics Company has moved
Concluded on page 41

Professional Directory

KEAR & KENNEDY

Consulting Radio Engineers

1302 18th St., N. W. HUDSON 3-9000
Washington, D. C.

GEORGE P. ADAIR

Consulting Engineers

Radio, Communications, Electronics

1610 Eye St., N.W. EXECUTIVE 3-1230
Washington 6, D. C.

Paul W. Klipsch
Professional Engineer
Acoustic development
and consulting

Klipsch and Associates
building the authentic
KLIPSCHORN
world's finest sound reproducer

Hope, Arkansas

Tel. Hope 995



16-MM Professional Motion Picture
Production Equipment

J. A. MAURER, Inc.

37-07 31st Street, Long Island City 1, N. Y.
Tel. Stillwell 4-4601

MEASUREMENTS CORPORATION



Research &
Manufacturing
Engineers

Harry W. Houck Jerry B. Minter
John M. van Beuren
Specialists in the Design and
Development of Electronic Test Instruments
BOONTON, N. J.

RATES FOR

PROFESSIONAL CARDS

IN THIS DIRECTORY

\$12 Per Issue for This Standard
Space. Orders Are Accepted
for 6 Insertions Only

Motorola uses

Eimac 2C39A's

In the First 460 Mc
Type-Approved Equipment
For Operation in the
Class-A, "Citizen's Band"

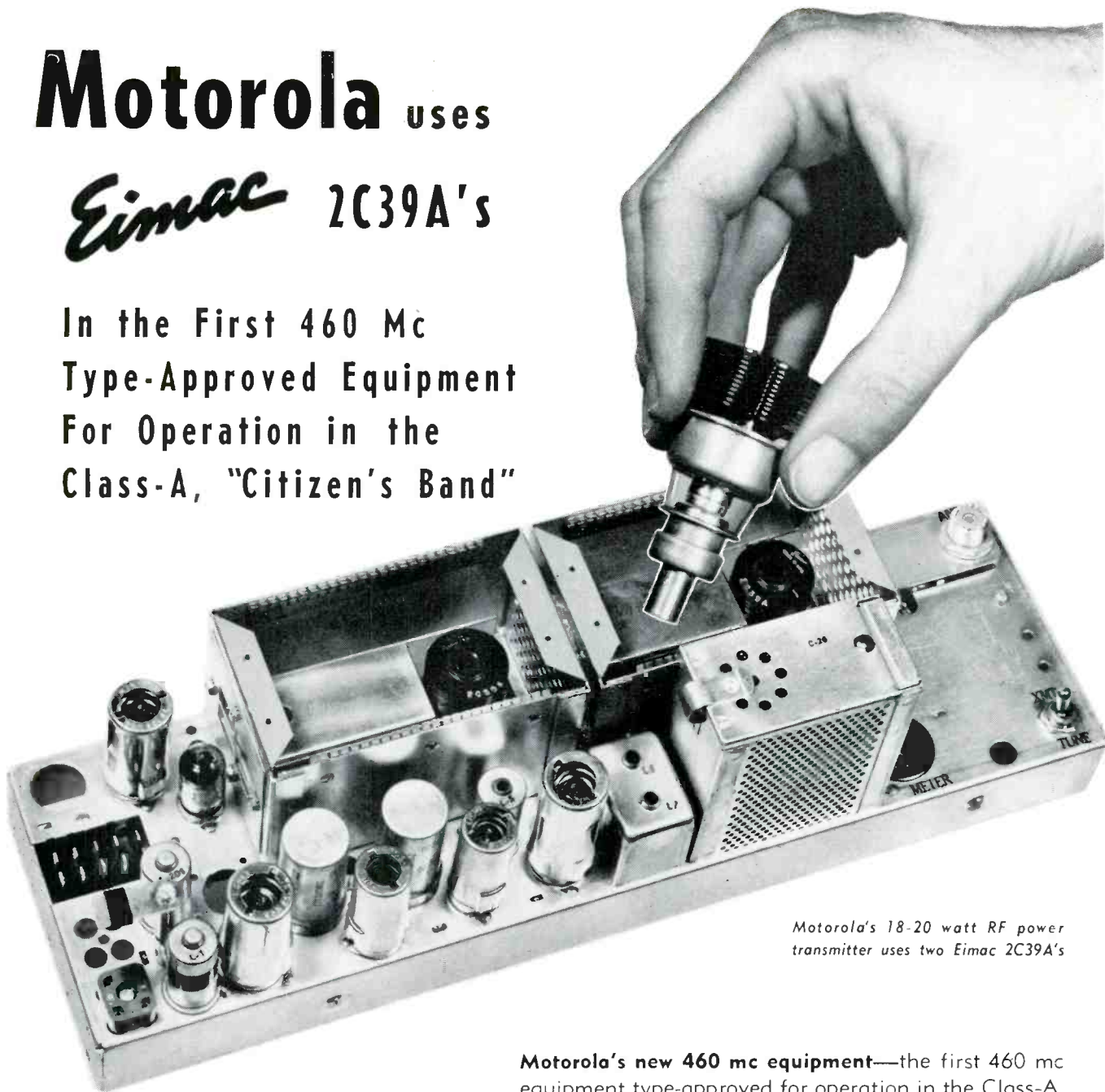

Motorola's 18-20 watt RF power transmitter uses two Eimac 2C39A's

FOR INFORMATION ABOUT THE
2C39A WRITE EIMAC'S APPLICATION
ENGINEERING DEPARTMENT

Motorola's new 460 mc equipment—the first 460 mc equipment type-approved for operation in the Class-A, "Citizen's Band" employs Eimac 2C39A's as tripler-drivers and power amplifiers in its mobile and base station transmitters. In the Eimac 2C39A, Motorola utilizes a highly efficient, domestically available tube that has been JAN accepted and proved in rugged and exacting military service. Motorola, through the use of Eimac 2C39A's and other late electronic developments, makes available a UHF two-way radio system designed to meet the demands of individuals, industry and emergency services.

FOLLOW THE LEADERS TO

Eimac
REG. U. S. PAT. OFF.
TUBES

EITEL - McCULLOUGH, INC.
SAN BRUNO, CALIFORNIA

Export Agents: Frazar & Hansen, 301 Clay St., San Francisco, California

COMMUNICATION REVIEW

NO report will be made on what could have been the most interesting session at the Houston convention of the Petroleum Industry Electrical Association. That was the occasion when engineers responsible for microwave radio relay systems were to take their hair down and disclose some, if not all, of the facts about operation experience and maintenance costs, and the comparative costs of privately-owned communication facilities and equivalent service rendered by the Telephone Company.

When the idea of putting cost-data cards on the table was first taken up at management level, the answers were explosive "No's." Subsequently, approval was given with the understanding that no transcript would be made, and that anyone presuming to quote the speakers would be branded as a liar.

That attitude on the part of the relay system operators is understandable. Some systems have proved highly successful. Some still have operational or maintenance problems not yet ironed out. Probably no other industry would have gambled the millions that petroleum and pipeline companies have poured into pioneering microwave systems. Thus they have made an important contribution to the radio communication art, to the industry, and to present and future users of microwave equipment.

At this stage, performance records are strictly the concern of companies that put up the money. As for operating data now available, efforts to draw general conclusions would hardly be informative, and might be misleading.

MORE and more legal catches and loopholes are being developed at the FCC all the time. For example, when a license is granted in the Safety & Special Radio Services without a hearing, as most licenses are, the grant is subject to protest for a period of 30 days. During that period, any "party in interest" may file a protest and request a hearing on the application granted. However, there is some question as to the qualifications of a party in interest. According to the decision in the case of FCC vs. Sanders Bros. Radio Station, if anyone can show that he will suffer economic injury from a grant, he may protest the grant as a party in interest.

Of course, it's not that simple. When the Yellow Cab Company of Chicago filed a protest against a grant to Service Livery, Inc., claiming that it would suffer substantial and direct loss since Service Livery is a competitor, the Commission dismissed the protest. Reason: the Yellow Cab Company did not make the required showing of economic injury because its use of radio is only incidental to its primary business, and because frequencies are allocated on a shared basis by all

users. Said dissenter Hennock: "That radio is not the primary business of these parties, and that the license hereunder challenged is an adjunct rather than the essence of the competition between them is a distinction without a substantial difference."

Our comment: With the introduction of such an indeterminate variable as distinction-without-a-substantial-difference, radio communication can now consider itself qualified as a thoroughly complicated business.

EXPERIENCE with FCC Form 400 indicates that in perhaps 7 out of 10 cases, applicants for communication facilities to be used in the public safety, industrial, or land transportation service can save both time and money by engaging qualified consultants to prepare their applications.

On the face of it, Form 400 appears to be so simple that any high school boy should be able to fill it out correctly. It looks so easy that most applicants do not consider it necessary to read the 8 pages of instructions that the Commission has issued as a guide in making out this form.

This innocuous appearance, however, is strictly a snare and a delusion. The complications are there, only you don't realize it unless or until you start to read the instructions. And when you tackle the instructions, it becomes obvious on the first page that they were not written for lay readers. Who, other than an expert in FCC matters, would find guidance in these instructions for filling out the second part of the first item in Form 400:

"First read the appropriate Rules governing assignment of frequencies in the Radio Service for which application is being made." (That one will stop you dead, if you don't have the FCC's Rules & Regulations. And if you have the book, you'll give up hunting for the appropriate Rules before you'll ever find them, or if you find them, you'll run the risk of being led astray because it may not contain latest revisions.) "Enter in Item 1(b) the specific frequency or frequencies selected from those listed in the appropriate subpart of the Rules for the specific service in which operation is proposed." (Even if you can locate the appropriate subpart

of the Rules, which is doubtful, and if you select a frequency that the FCC will not let you use, which is unlikely, it will be a matter of pure luck if it is the frequency you should have asked for in the first place, because of local interference conditions.) "For each entry made in Item 1(b), a corresponding entry must be made in Items 1(c), (d), and (e), as explained below." (Below what? If you can find out, you'll be entitled to an extra bowl of Wheaties for breakfast, but if you



SESSION AT SYMPOSIUM ON REL 900-MC. MULTIPLEX POINT-TO-POINT EQUIPMENT FOR TELEPHONE COMPANIES. FROM LEFT TO RIGHT AROUND TABLE ARE C. N. ANDERSON, H. B. PATTERSON, J. M. WILLIAMS, R. E. JOHNSON, R. G. DUDLEY, B. BLAKELY, JR., L. W. MAPLES, E. J. BOWEN, E. T. MATTHEWS, H. C. FRANKE, AND J. TENNIS

can't, the FCC may find it has to return your application.)

"Supplementary data, if required by the appropriate Rules to support each frequency selection, shall be attached to the completed application form when submitting it to the Commission." (See what we mean by saying that the apparent simplicity of Form 400 is a snare and a delusion? Or are you prepared to locate the appropriate Rule, determine if supplementary data will be needed, and then prepare written arguments in support of your frequency selections that will convince the particular FCC examiner into whose hands your application will fall?)

Just for the sake of argument, suppose you fill out Items 1 through 5 correctly, what are you going to do with Item 6? This has to do with the location of each transmitter control point. The fourth paragraph of the instructions offers this elucidation:

"When one or more transmitters are to be controlled by a transmitter at another location, the correct entry for the control point is the call sign of the station associated with the control point of the system. If such call sign has not yet been assigned, give the location of the station associated with the control point of the system in the 'Remarks and additional Data' section on the reverse side of the form, and leave Item 6 blank for completion by the Commission." Is that clear? If so, you may be able to struggle along until you arrive at Item 12.

The instructions say that: "The Communications Act of 1934, as amended, requires a licensee to maintain control of his station. . . . If it is considered that the necessary control is doubtful or cannot be maintained, explain details of the proposed arrangement on a separate sheet and include reasons why the arrangement is considered to be necessary. An applicant proposing to enter into cooperative arrangements under provisions of the various Rules should explain the manner in which proper legal control will be maintained." In other words, having stated that you can't do something, can you explain how you will do it anyway? The simplest way would be to use mirrors, but you can't get by with that.

The one certainty about FCC procedure is that somewhere in the Communications Act of 1934, as amended, there are amendments which provide that the simple way of doing anything is in conflict with some appropriate Rule or other.

An opportunity for artistic self-expression, if you're interested, is offered in the instructions for Item 13, relating to the preparation of a functional system diagram. But even here there are limitations. You must confine yourself to the use of a sheet not exceeding 18 by 24 ins., and "information must be presented in a standardized manner," but you are permitted to have a lot of fun with solid circles, open circles, and leaders. Just be careful not to give the FCC examiners any wrong ideas by winding up with a diagram that looks like that long-lost map for locating Captain Kidd's treasure.

Don't forget the three final Items, 18 to 20, on the reverse side of Form 400. It looks as if you only have to put check marks in the yes-or-no squares. Don't be so easily misled. You may want to swear, but not before a Notary (whose seal must appear on your application) when you read these instructions:

"These items which appear on the reverse side of the application form are designed to show whether or not the applicant, if a non-government corporation or association is eligible for a station license in accordance with the citizenship provisions of Section 310 of the Communications Act of 1934 as amended."

Finally, if you do struggle through the ordeal of filling out a Form 400 application, just before you ask the notary to acknowledge your oath, be sure to read that line of fine type: "The applicant certifies that he has a current copy of the

Commission's Rules governing the radio service named in Item 4(2) above." Don't take a chance of having to admit, someday, that you subscribed under oath to a false statement.

The foregoing is a rather light treatment of a serious matter. But you probably wouldn't read a discussion written in the serious vein that the subject deserves. Nor were the comments intended to discredit the members of the FCC staff who prepared Form 400 and the instructions. FCC Rules, Regulations, and procedures have been built up, layer upon layer, to close loopholes discovered by people who seek to serve private ends by legal circumvention of the Commission's purposes and intentions.

Yet many people seem to expect that applying for radio-facilities should be just as simple as getting a dog license for a bull bitch. That's apparent from the high percentage of errors in Form 400 applications being filed with the FCC, and applications which lack correct or sufficient information as called for in the Form 400 instructions. Of course, if you do not fill out your application correctly, you'll get it back — eventually. The nature of your mistake will be indicated, but this probably won't be much help in correcting your error. After all, the Commission is not a correspondence school. It isn't their job to correct your papers!

Unless you are one of the minority group of experts, long-experienced in handling FCC matters, or have the assistance of such an expert readily at hand, here are some simple suggestions for speeding your FCC grant:

1. Don't try to fill out a Form 400 application yourself.
2. Don't ask your local legal counsel to do it for you. He won't know much more about FCC practices than you do.
3. Engage the services of an engineering consultant or attorney who specializes in FCC matters. The fee for filing a Form 400 application is a small price to pay for getting your grant quickly.
4. FCC processing lines are set up in such a way that grants are issued very quickly on applications that are correct in each detail. Those that are not correct are set aside by the examiners, and there's no telling how long they may be held up. Sometimes, mistakes are made which result in the denial of an application. When that happens professional assistance really gets to be expensive!

LOW power industrial service Rules were clarified by amendments set forth in an FCC Report and Order released on April 23. In brief, frequencies of 33.14, 35.02, and 42.98 mc. are available for assignment to transmitters other than those aboard aircraft, in this service only, and 154.57 mc. on a shared basis in the other services. The frequency of 27.51 is available to transmitters including those on aircraft, in this service only, and 27.225 on a shared basis with other services. Plate power input to the final RF stage is limited to 3 watts, and antenna radiation in any direction must not exceed that of a simple half-wave dipole.

The following is quoted exactly, because it is not entirely self-explanatory: "Emission shall be confined to voice radiotelephony only, which is construed as including tone signals or signaling devices whose sole function is to establish or maintain communications between associated stations and receivers: Provided, however, that other types of emission may be authorized on the frequency 27.225 mc. upon compliance with the provisions of Section 11.103 of this Part."

Except on aircraft, the maximum distance from the transmitter to the center of the radiating portion of the antenna must not exceed 25 ft., although no limitation is put on the distance from the dispatch point to the transmitter.

This seems to be a severe limitation on those who must sell low-power units: "A transmitter licensed in this Service

Concluded on page 41

Microwave Developments Overseas

A COUNTRY-BY-COUNTRY ANALYSIS OF MICROWAVE RELAYING TECHNIQUES IN PRESENT AND PROJECTED RADIO LINK SYSTEMS — By VICTOR J. NEXON*

RADIO relaying practices in other countries have assumed great importance to us lately, primarily because of the political activity accompanying interconnection of the free countries with television and communications networks. This has been especially true in regard to connection of the NATO countries for defense purposes. Considerable activity has been in progress on plans for transatlantic radio relay systems for television, communications, and navigation.

There are good economic reasons also for interest in the radio relay situation abroad. Export business of microwave equipment made in this country is affected by the interest and economy of countries abroad, and by their own radio relay developments. On the other hand, the more we know about the experience obtained with similar equipment in other countries, the more knowledge we can apply in our own equipment development and systems engineering. There has been considerable experimentation with new and different systems in Europe, and this has been reflected in some of our more recent developments. Special attention should be paid to the commercial as well as the technical aspects of foreign equipment developments, for they both differ considerably from those in the United States. The commercial situation in Europe is influenced by the factor of Government control and ownership of communication facilities. A virtual monopoly exists, and it is on the basis of this monopoly of Government operation that the various manufacturers must do business.

We would have the same situation in this country if one group was authorized to purchase and operate wire, carrier, and radio facilities for all communication, television, and navigation services. This would mean that our manufacturers would have essentially only one customer. Because of this method of doing business in Europe, equipment tends to be gold-plated, so to speak, and quite expensive. Therefore, from the technical view-point, there is little tendency to design equipment on a competitive cost basis such as is usually done here. However, World War II in Europe has had a deterring effect on technical developments, and some differences have been caused by delays resulting from the economic conditions.

General Trends: The extraordinary advances in microwave techniques made during the war, through the design of radar systems, have been utilized more in England than on the Continent. This has led European companies to favor the lower portion of the spectrum for radio relaying. Frequency allocation charts in Europe are, on the whole, similar to the one used in the United States, but restrictions on the use of VHF for fixed long-distance communication do not exist in Europe as they do here. The mobile radio field is not nearly so developed as in the U. S. Neither do the European countries foresee the need for UHF television channels. This frees a sizable portion of the VHF and lower UHF spectrum for fixed communication purposes.

Technical specifications for relay links are much more rigid in Europe than in the United States because they are under the supervision of the CCIF. This is an international body which was set up after World War I for the purpose of coordinating and standardizing telephone practices between vari-

ous European countries. It has been extended further since then. The CCIF is now the telephone section of the CIT or ICT, the International Committee on Telecommunications, with headquarters in Geneva, Switzerland.

The ICT consists of the Telephone Committee (CCIF), the Radio Committee (CCIR), and the Telegraph Committee (CCIT). Radio links have been under the jurisdiction of the CCIR. For long-distance links, with repeaters and line-of-sight frequencies, however, the CCIF has now claimed jurisdiction. At the last plenary session of the CCIF this problem was discussed in detail; no final solution has been reached yet. The CCIF is a much stronger organization than the CCIR because it has a permanent secretary who can act between international sessions. CCIF specifications are generally similar to the specifications of the Bell System, but rather more strict.

Governments and operating companies only are represented in the ICT. The decisions of ICT, or of the various sections, are formalized in reports which often result in treaties between the countries concerned.

Relay Systems in Europe: The accompanying map depicts the status of radio relay operations in Europe, North Africa, and the Near East. It can be seen that there is extensive development in some areas, partly because such relays are being installed to replace facilities destroyed during the war. Solid lines on the map represent systems installed or in process of installation, while dashed lines indicate radio link systems under consideration.

Belgium: There are essentially four systems in Belgium, as the map shows. These systems were supplied and installed for the Belgium Telephone Administration and the Air Forces by two companies; SBR, a home-owned firm, and BTM, a subsidiary of IT&T. These links are essentially two-terminal systems operating in the UHF band at 2,000 mc. They employ time-division multiplexing with 6, 12, or 24 channels. The equipment is similar to time-division equipment manufactured in this country by Federal and G. E.

It is obvious that the distances covered by the systems are small. Nevertheless, microwave has been found to be the most economical system, and also better for defense purposes. Of possible interest is the fact that most tower heights are kept below 150 ft., because of the feeling that a direct hit by bombing is less probable with a lower tower height.

The Belgium systems are used primarily in the radar defense network to convey information to the various screening centers.

Czechoslovakia: The latest information available on Czechoslovakia indicates only that an order for several 400 to 500-mc. systems was filled by Standard Telephones & Cables, Ltd., of England. The equipment provided 24 channels by time-division multiplexing.

Denmark: In Denmark, there are installed or contemplated 6 systems, primarily VHF in the 60 to 90-mc. range. The equipment utilizes broadband FM modulation, and furnishes 6 to 12 channels. It is a modification of U. S. Signal Corps type AN/TRC equipment.

In the northern part of Denmark is a small system operating between Hammel and Aarhus. This is an experimental 24-channel, 1,500-mc. time-division system made by the Great Northern Company. As in Belgium, radio relays in Denmark

*Vice President and Staff Consultant, Microwave Services Inc., 45 Rockefeller Plaza, New York 20, N. Y.



are used primarily for defense purposes. There are also other systems in the planning stages which are not shown.

France: Considerable activity is apparent in the use of radio relays for television and communication systems. There are approximately nine such systems installed or on order. The major suppliers of relay systems in France are SFR, CFTH, and LMT. As a parallel to U. S. manufacturers, SFR may be compared to RCA, CFTH to General Electric, and LMT to Western Electric. However, they are much smaller companies — the size ratio is easily 20 or 30 to 1.

The map shows two systems from Paris to Lille. One is a 900-mc. FM system used for a TV link; the other is a 3,500 to 4,000-mc. FM link capable of carrying 480 telephone channels and one TV channel. The first system, supplied by CFTH, employs an AM subcarrier. The 4,000-mc. system was installed by SFR, and is very similar to the TV links used by the Bell System in this country.

Shown also is the Strasbourg to Dijon system, a 60-channel broadband FM system operating at 300 mc. The Deauville link is a 12-channel time-division system working on 1,300 mc. The Avignon-Mt. Ventoux system is similar except that only 6 channels are available. On the other hand, 12 channels are furnished by the VHF-FM link between Grasse and La Punta. The system between Chasseraie and Dijon provides 60 multiplexed channels on a 300-mc. broadband FM carrier.

The trend in France is toward the use of time-division systems for telephone communication, and broad-band FM for TV links.

Radio link installations are handled in France by PTT, which is the Telephone Administration. This Agency prepares the specifications that are used by the various other administrations. For instance, PTT specifies the technical characteristics of television links. Once installed under its

supervision, they are used by the Broadcasting Administration, which handles television programs.

SFR has supplied experimental microwave systems for North Africa, most of which have used passive repeaters. Also, the French Telephone Administration is actively engaged in the development of traveling-wave tubes to promote the use of microwave systems at higher frequencies.

England: The most important manufacturers in England are Standard Telephones and Cables, or STC, and General Electric Company. This firm is not connected with G. E. of the United States. Because of the close relationship between England and the U. S. during the war, British developments and practices parallel closely those of America. The British have extensive knowledge of UHF tubes and, therefore, utilize the higher frequencies to a greater extent than the rest of Europe.

A TV link has been installed and is in operation between London and Birmingham. This system, operating at 900 mc., was developed by G. E. C. and uses an AM subcarrier and FM RF carrier modulation. The second link of the TV network in operation was that between Manchester and Edinburgh, and was supplied by STC. This is a direct-FM system at 4,000-mc., using a traveling-wave tube amplifier in the output stage. Such links are parts of a TV network covering the United Kingdom. The network is composed partially of coaxial cable, and extends across the channel to Paris and Europe.

For telephony, the British Post Office has used for some time 6-channel VHF links, but has not yet decided on the use of microwaves. The Post Office seems to be rather reluctant to use microwaves for telephone communication systems, preferring to reserve this new medium for television links.

There have been about 12 over-water systems in use since 1932. They are mostly 60-mc. AM 6-channel systems, manufactured and installed by the British Post Office. These systems laid the foundation for VHF war-time developments in radar, communication, and navigation.

Germany: The important suppliers in Germany are Siemens, Telefunken, and Lorenz. Siemens used to be the largest electric company in Germany before the war. Now, since most of their factories are in the Russian zone, their position is not known precisely. Telefunken and Lorenz have been doing most of the business of late.

The map shows an extensive relay network, with Frankfurt as the hub of 5 systems. These were operated originally at 600 mc. and furnished 8 to 20 channels; however, they have now been developed into more modern form for use at 2,000 mc. on a broadband FM basis. The original equipment was developed during the war for military purposes to interconnect the various military establishments.

Siemens has developed recently a new time-division system with improved design of the multiplexing apparatus. It uses very few tubes and many germanium diodes, and is reputed to be simpler than any of the time-division systems in use commercially in the United States. This is a good example of the capabilities of German science and engineering in spite of the occupation.

Not shown on the map are a number of VHF systems patterned after the Signal Corps AN/TRC equipment. Unusual also is the high-power 41 to 68-mc. FM system between Berlin and West Germany. This is remarkable because it operates definitely beyond the line of sight. Utilizing frequency-division FM, it provides 12 channels of good quality and is dependable in spite of a fading margin less than 15 db. There are also some TV links, such as the one between Feldberg and Darmstadt which operates at 2,000 mc.

Switzerland: There is considerable interest on the part of the Swiss Government in radio links, both VHF and UHF. Approximately 8 systems are operating in Switzerland, which

were supplied for the most part by Brown-Boveri. The Zurich to Geneva links are a 6-channel 170-mc. FM system and a double 24-channel 2,000-mc. time division system. The Berne to Geneva and the Berne to Lugano links are 180-channel 4,000-mc. FM systems.

Extensive propagation tests have been made and reported on in various Swiss scientific journals. They are especially interesting because they reveal the most thorough attempts to cover long distances with single links at VHF and UHF. The results obtained in Switzerland indicate the practicability of operating with greater distances between repeaters than is customary in the U. S. When the operation is in mountainous regions, distances on the order of 60 miles have been covered successfully for one year or more with no more than 20-db fading margins. In spite of this success, however, additional tests are necessary before it can be determined finally that it is safe to operate over such large distances between repeater points even in mountainous terrain.

Italy: Because of favorable topography, and the great need to re-establish communication facilities destroyed by the war, considerable emphasis has been directed toward radio link construction in Italy. The new systems operate primarily in the VHF range, from 50 to 300 mc. There are many competitive manufacturers such as Compagnia Elettronica, Marconi, Brown-Boveri, Bacchini Company, and Telettra. In Northern Italy, the Milan system accommodates 12 to 24 time-division channels at 400 mc. The Milan to Rome link, one of the longest, is an 8-channel VHF system using time-division multiplexing. Another long VHF high-power system is that from Rome to Cagliari, with a capacity of 24 to 60 channels. This is over 270 miles long — quite an over-water hop for a multi-channel system. Apparently, there is a lot of telephone traffic between Rome and Sardinia. Here again, there is emphasis on VHF because of the AN/TRC equipments left by the U. S. Army after the invasion of North Africa and Italy.

Greece: A unique situation has come about in Greece. For the first time, a program is underway to combine all the various major cities and islands by microwave, in order to achieve a completely-integrated public telephone system. The equipment being used is basically French variations of IT&T time-division components developed in the United States. The links installed or to be installed are all 2,000-mc. 24-channel time-division systems.

Turkey: The link between Istanbul and Ankara, Turkey, is a 24-channel 2,000-mc. time-division system. The same is true for the system connecting Smyrna, Cyprus, and Beirut.

Israel: Equipment used in Israel is exported from this country, for the most part. VHF frequency-division systems, with carrier telephone type multiplexing, provide 12 channels between the various main cities.

In this area conventional HF systems have been employed also, because of the difficulty of supplying power to isolated repeaters. This activity has been primarily in the petroleum pipeline field.

Holland: The Netherlands has been consistently in the fore-front of radio link development and applications. There, the first time-division system in the world was put into service on a commercial basis. This system was supplied by STC in London directly after the war. It is a 500-mc. 9-channel system, operating over a distance of 11 miles.

Phillips, the most important manufacturer, has been doing considerable work in the 1,000-mc. region on TV links with bandwidths of 6 to 8 mc. There has been one such system installed in Holland since 1950. Because of the flat terrain, underground cables are preferred to radio links. However, in places where water is troublesome, radio is gaining popularity.

Norway: Radio link construction in Norway has been primarily of a military nature. Most of the systems are sim-

Continued on page 45

How Response Speed is Affected by the

Bandwidth of Multiplex Channels

A DETAILED DISCUSSION OF THE FACTORS WHICH INTERRELATE RESPONSE SPEED AND MULTIPLEX SUBCARRIER CHANNEL BANDWIDTH — By J. S. SMITH*

THE constantly-increasing use of carrier-current and microwave channels for control purposes has created a need for closer spacing of channels. The attempt to increase the number of available control functions in a given frequency band results in an inevitable increase in response time as each control function is allotted less bandwidth. The purpose of this paper is to explain, in a strictly non-rigorous manner by means of a power-system analogy, how channel response time is affected by decreasing bandwidth, and to show how definite limitations are thus imposed on the number of control functions which can be multiplexed on one channel.

Transmission-Line Analogy: Although its existence is well recognized, power industry engineers are not concerned with propagation time in sixty-cycle transmission lines except on very long lines. The propagation of a wave on any transmission line does, however, require some finite though small time. A theoretical line, considered to be free of loss, can be represented by the familiar configuration shown in Fig. 1A. Lumped parameters represent the uniformly-distributed series inductance and shunt capacitance. For a transmission line, it is possible to calculate from well-known transmission-line formulae the propagation constant $\delta = \alpha \pm j\beta$, in which the imaginary part represents phase shift per unit length, and the real part, attenuation.

For a theoretical line without losses, it is possible to calculate the time of propagation as follows^{1, 2}:

$$\frac{\beta L}{\omega} = T, \text{ where}$$

β = radians per unit length
 L = length
 ω = radians per second
 T = time in seconds

For the lumped circuit shown, there are also finite amplitude and phase responses. Fig. 1B shows curves of attenuation and phase shift typical for one section of this configuration. The region to the left of f_c is the region of transmission. Since a no-loss system is being considered, no attenuation exists in this region. Phase shift does occur, however, and has a reasonably constant slope across the region of transmission. Neglecting for the moment the fact that the region of transmission is limited, the time of propagation through this network would be:

$$\frac{\Delta\beta}{\Delta\omega} = t$$

Practically, the network differs from the line in that some of the impressed wave appears at the output terminals almost immediately; but because of the length of an actual transmission line, there is a small time delay before any output

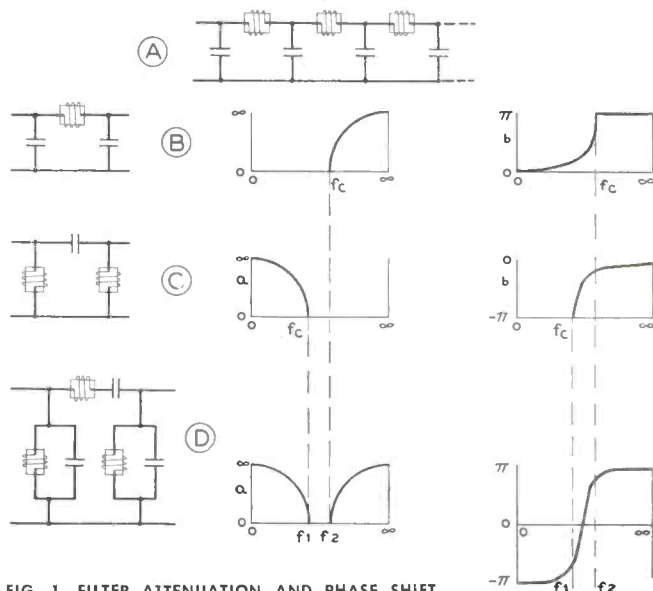

FIG. 1. FILTER ATTENUATION AND PHASE SHIFT

occurs. Except for this, the distributed line and the lumped-parameter line behave in much the same manner.³ In the distributed line, phase and attenuation characteristics have to be reckoned with on a per-unit-length basis. The lumped line can be broken into T or π sections for calculations.

The lumped network which has been compared to a transmission line is really a constant -K low-pass π -section filter. Another configuration of parameters is shown in Fig. 1C. Instead of the series inductance of the transmission line there is series capacitance and, instead of shunt capacitance, shunt inductance. This is one section of a constant -K high-pass filter. The amplitude and phase characteristics are as shown. Again, considering only the phase characteristic, the time of transmission depends on $d\beta/d\omega$. Fig. 1D represents a configuration in which the series elements of the low and high-pass filters have been connected in series, and the parallel elements in parallel. To obtain the phase and amplitude characteristics shown, the magnitudes of the parameters of this filter are not the same as those of the low and high-pass sections. Filters with these characteristics are called band-pass filters; Fig. 1D is one section of a constant -K band-pass filter. The slope of the phase characteristic again defines the time of transmission through the filter. The same general phase and amplitude characteristics can be obtained by other types of circuit configurations besides the constant -K but, in general, variations in this respect will not alter materially the results. As an example, a configuration known as a three-element shunt filter has one-half the phase shift per section of the constant -K, but it has only half the selectivity; consequently, two sections of 3-element shunt filter can be considered the same as one section of a constant -K. This is true because the amplitude or selectivity characteristic and the phase characteristic cannot be specified independently.⁴

*Carrier Current Engineering Section, Commercial Equipment Dept., General Electric Company, Syracuse, N. Y. This paper was given at the AIEE Fall General Meeting in New Orleans, October, 1952.

¹"Phase Distortion in Telephone Apparatus," C. E. Lane, *Bell System Technical Journal*, July 1930, pages 493 to 521.

²"The Measurement of Delay Distortion in Microwave Repeaters," D. H. Ring, *Bell System Technical Journal*, April 1948, pages 247 to 264.

³*Communication Networks*, Vol. II, E. A. Guillemin, John Wiley and Sons, Inc., New York, N. Y., 1949.

⁴*Transmission Networks and Wave Filters*, T. E. Shea, D. Van Nostrand Company, Inc., New York, N. Y., 1929.

Effects on Response Time: Whenever multiplexing is achieved by frequency division, some configuration of circuits is used to achieve the amplitude characteristic shown in Fig. 1D. The phase characteristic must be considered as a consequence of this. Together, they control the response time.

The transmission of control function intelligence in frequency division multiplex channels is normally achieved by turning on or off (amplitude modulation) or shifting in frequency (frequency modulation) a carrier, which may lie in the audible range or in what is considered to be the RF range in carrier-current systems. Either method of modulation has about the same limitations so far as response time for a filter of a given bandwidth is concerned. Therefore, the more easily-presented case of an audio tone which is keyed on and off will be discussed.

For a control signal which does not exist before time $t = 0$, and which has the shape of a sine wave of a given amplitude for any time after $t = 0$, a transient analysis can be made by the Fourier method. This shows that the resulting wave can be represented by a carrier at the center frequency of the signal, and a number of sidebands distributed on either side of the carrier. The relative amplitudes of the various sidebands depend on the time the control signal consumes in rising from zero to full amplitude; as faster response is obtained, it becomes necessary to pass sidebands further from the center frequency of the carrier.⁵ In order to reproduce such a wave exactly at the output of a filter, the amplitude characteristic of the filter must be flat on either side of the center frequency out far enough to pass all the significant sidebands with the relative amplitudes unchanged. Further, the phase characteristic must be a straight line over this band so that sidebands of different frequencies are subjected to phase shifts such that their relative phase angles are unchanged at the filter output. If these requirements are met, then the delay time before significant output is determined by the slope of the phase characteristic, $d\beta/d\omega$.⁶

In any practical frequency-division system, it is necessary that the bandwidth for each channel be some limited part of the total available bandwidth. This means a definite restriction on passing those sideband frequencies far removed from the center frequency which are needed if rapid response is to be expected even after the time of initial delay. Clearly, a response faster than the period of the last significant sideband the filter will transmit without appreciable attenuation is impossible. In Fig. 1B, for example, if f_c were 1,000 cycles, then regardless of $d\beta/d\omega$ a response time of .0002 second could not be expected, since this would require passage of 5000-cycle variations. These would be highly attenuated, of course, because of our definition of f_c . In Fig. 1D the sidebands would be distributed around a center frequency between f_1 and f_2 . For a situation equivalent to that of Fig. 1B, f_1 to f_2 would be 2,000 cycles.

Fig. 2 represents an idealized envelope of a carrier at the output of a filter. T_e , the time delay caused by the phase

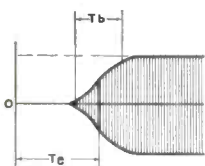

FIG. 2. RESPONSE OF ON-OFF KEYED CARRIER

characteristic, and T_b , the time delay produced by the restricted amplitude characteristic, are shown. Much experimentation on transient-response time has established that T_e is determined by the slope of the phase characteristic and T_b is inversely proportional to the width of the transmission

band. Since the slope of the phase characteristic for a given number of filter sections depends upon the width of the transmission band, as illustrated in Fig. 1D, it can be seen that envelope delay is also a function of bandwidth.

Table I lists a number of control functions and shows bandwidths which have been used commercially. Under CARRIER CHANNELS, telephone communication operate time is shown as a frequency band since, in this case, T_b is the limiting factor for intelligence. The bandwidth shown for pilot relaying includes that needed for the emergency telephone function. Frequency-shift (FS) telemeter operate time is shown as an upper frequency limit, since the envelope delay time is not normally significant if T_b is small enough to pass the highest telemeter frequency without too much distortion. Under AUDIO FREQUENCY CHANNELS, the Teletype and Telegraph categories shown are for the low to medium-speed equipment. The functions of Telemetry, Dialing, Load Control, and Ringing/Calling have no time indicated since, as with FS Telemetry, a small envelope delay is not a limiting factor if the bandwidth is large enough to make the function operable.

Limitations: With control functions for which the build-up and decay times must meet certain requirements to assure correct operation of the associated control apparatus, it is clear that the selective circuits must be limited by these requirements. If a great many channels are to be multiplexed in a given bandwidth, it will be necessary to provide selectivity between each adjacent multiplex channel and to assign a certain portion of the band for the operation of each multiplex channel. The required selectivity demands a certain number of filter sections with unavoidable phase shift, whose slope over the operating bandwidth determines T_e . For the given operating bandwidth T_b is also determined. As the number of multiplex channels is increased, the operating bandwidth must be reduced. This reduction increases T_b and, at the

TABLE I

| CONTROL FUNCTION | APPROXIMATE OPERATE TIME | COMMERCIAL BANDWIDTHS |
|---|--|---------------------------|
| CARRIER CHANNELS | | |
| Telephone Communication | (300-3000 cycles) ¹ | 3 kc. ¹ |
| Pilot Relay with Emergency Telephone | 3.0 millisees. (300-2000 cycles) ¹ | 2.0 kc. ¹ |
| FS Telemeter | (35 cycles) ¹ | .03 to .045% ¹ |
| FS Transfer Trip | 30 millisees. | " |
| FS Supervisory Control | 10 millisees. | " |
| AUDIO FREQUENCY CHANNELS | | |
| Telephone Communication | (300-3000 cycles) ¹ | 3 kc. ¹ |
| Pilot Relaying | 3.0 millisees. | 200 cycles |
| Supervisory Control | 10.0 millisees. | 200 cycles |
| Transfer Trip | 30 millisees. | 60 cycles |
| Teletype and Telegraph | Note 1 | 60 cycles |
| Telemetry | Note 1 | 20-60 cycles |
| Dialing | Note 1 | 20-60 cycles |
| Load Control | Note 1 | 20-60 cycles |
| Ringing/Calling | Note 1 | 20-60 cycles |

Note 1: See discussion in text.

same time, if the adjacent channel selectivity is maintained, then the increased phase slope causes an increase in T_e .

The limit as to the actual number of multiplex channels possible for a given operate time in a given band depends on a number of factors, as follows:

1) If the channel is to be used for a high-reliability service, then the selectivity against the adjacent channel must be very high to guard against spurious operation and to provide reserve signal against channel deterioration. For a given re-

Concluded on page 43

⁵"Transient Oscillations in Electric Wave Filters," J. R. Carson and O. J. Zobel, *Bell System Technical Journal*, July 1923, pages 1 to 52.

⁶*Radio Engineering*, F. E. Terman, McGraw-Hill, New York, N. Y., 1946.

Microwave System Test Equipment

SPECIALIZED TEST EQUIPMENT IS REQUIRED FOR EFFICIENT PREVENTIVE MAINTENANCE AND REPAIR WORK ON MICROWAVE SYSTEMS — By A. S. MAY*

MAINTENANCE is one of the major items that must be taken into consideration in designing, manufacturing, and operating a communication system. Test equipment must be designed and built to handle routine maintenance and to expedite repairs on defective units. Practically all the equipment of the TD-2 microwave radio relay system has been designed for a specific operation and is highly specialized; test equipment capable of giving adequate information about the radio relay system must, of necessity, be equally specialized.

Equipment Requirements: There are two principal types of TD-2 microwave stations—repeater stations and terminal stations. Repeater stations contain a receiver to convert microwave signals to an intermediate frequency for amplification, and a transmitter to convert the amplified signals back to microwaves for transmission. Terminal stations contain these same elements, but they are not connected directly together to form a through circuit. Instead, the receiver is connected to receiving terminal equipment and the transmitter to transmitting terminal equipment. Terminal receivers convert frequency-modulated IF signals to amplitude-modulation signals for connection to television circuits or to telephone carrier terminal circuits, while a terminal transmitter performs the reverse function.

Since there are many more repeater stations than terminal stations, the test equipment is divided into two sets: a transmitter-receiver test set, used at all stations, and a terminal test set used at terminal stations only. The fundamental elements of the transmitter-receiver test set needed to test the repeater equipment are IF and RF sweep oscillators to insert test signals, a meter to measure signal power, and an oscilloscope for observing the test signal as it enters and leaves each component. The terminal test set contains an oscilloscope, FM test equipment, and a linearity tester.

Test Equipment Used: The first transmitter-receiver test set that was developed for field use is housed in an 8-ft. high rolling cabinet, and the terminal test set is in a sloping-front console. These sets are principally an assembly of those laboratory test components and TD-2 system elements that were available when field test equipment was first needed.

As field operations of the system progressed, it was found desirable to make improvements and simplifications in the test equipment. The large size of the transmitter-receiver test set made it unhandy to wheel about in congested stations, and the oscilloscope in the sloping front of the terminal test set was difficult to see while adjusting a control in the lower part of an equipment frame. These and other important objections were overcome by redesigning the equipment. Synchronous motors used to drive sweep oscillator capacitors were replaced by diaphragm motors to eliminate bearing maintenance problems. A 402A tube requiring a 1,500-volt power supply was replaced by a low-voltage tube. This substitution eliminated both a high-voltage maintenance hazard and the factory servicing required to replace defective 402A tubes and to readjust their magnets. The striking features of the new sets are improved appearance, greater utility, superior mobility, and simplified arrangement. Also, the cost is less.

The cabinet developed to house the new test sets is only 5 ft. high. For convenience in making power connections two 115-volt AC power inlets are provided at the back, one at the top and one at the bottom. A switch near the nameplate at the top of the cabinet connects the equipment to the power inlet being used and disconnects the other, so as to avoid danger from exposed terminals. A ventilating fan in the rear of the cabinet circulates filtered air to cool the equipment. Power wiring in the cabinet is enclosed in conduit, and a plug-in strip provides safe and easily-accessible receptacles. In some instances, more than one station will be maintained by one set of equipment. Because of this, all the units are available in portable cases, and all operate on commercial AC power.

The top unit of the new transmitter-receiver test set is a specially-designed oscilloscope. In order beneath the oscilloscope are an IF sweep oscillator, an RF sweep oscillator, a waveguide panel, and two drawers for detachable parts, cables, and connectors.

Incoming microwave signals at relay stations are converted to a 70-mc. intermediate frequency for amplification and gain control. Outgoing signals are converted to microwaves for final amplification, and then transmitted to the next station. The condition of the IF and RF components is determined by the use of the two sweep oscillators and the oscilloscope for visual checking.

For the oscilloscope, a 3-in. cathode ray tube with a flat viewing face is used. This flat face gives good definition to the very edge, and is equivalent to the usable portion of the surface of a conventional 5-in. curved face tube. Several features not found in ordinary oscilloscopes are included for use in special tests. A preamplifier is used to build up very low-level signals to amplitudes large enough to give satisfactory deflections.

A 30-cycle reed-operated switch makes it possible to view the detected input and output signals of an amplifier simultaneously for comparison. As the vibrating reed moves from side to side, the input to the oscilloscope is alternately connected to the two signals being investigated and the two pictures appear on the screen in rapid succession. Persistence of the sensitized coating of the screen holds both pictures for a short time after the signals are removed, and they appear together.

The IF sweep oscillator is designed to test the performance of the 70-mc. amplifiers. It is swept over a range of ± 20 mc. with a center frequency of 70 mc. by a diaphragm-driven capacitor. This unconventional device is a small unit similar to a loud-speaker without a cone. A movable coil is suspended from a small diaphragm in the field of a permanent magnet. The sweep voltage applied to this coil causes it to move into and out of the field, thus driving the diaphragm. Projecting from this diaphragm is a set of concentric vanes, interleaved with but not touching a similar fixed set of vanes to form a small capacitor. Movement of the diaphragm under the influence of the sweep signal changes the area common to the two sets of vanes, and changes the capacitance. This capacitance in the oscillator circuit sweeps it over the range mentioned. Two outputs are available from the sweep oscillator for test and reference circuits.

A third output, proportional to the oscillator frequency, provides horizontal deflection for the oscilloscope and gives

*Transmission Systems Development I, Bell Telephone Laboratories, Inc., 463 West Street, New York 14, N. Y. This material appeared originally in the *Bell Laboratories Record* for May, 1953.

a linear frequency display. Three rows of push-buttons on the panel are used to adjust calibrated attenuators that are inserted in the test circuit. Two IF frequency meters, calibrated from 60 to 80 mc., are included for measuring purposes. These can be inserted in a test circuit, to produce markers on the oscilloscope trace for frequency identification.

For microwave tests, an RF sweep oscillator is used. It is swept over ± 25 mc. by a phase-shift capacitor driven by a diaphragm unit similar to the one described, but modified for microwave use. Instead of concentric vanes forming a capacitor, a T-shaped rod moves two small metal plates into and out of the feedback path of the oscillator. This oscillator is a 416A tube in a special mounting. The mounting is divided into input and output cavities coupled by the tube, and a waveguide feedback path. As the two small metal plates move into and out of this feedback path, the phase of the feedback voltage is changed, and the frequency of the oscillator varies.

The center frequency of the oscillator is adjustable over the range from 3,700 to 4,200 mc., and the output amplitude is maintained constant at +23 dbm by automatic gain control. While the RF oscillator in the original test set used a 1,500-volt power supply, the voltages in the new unit are comparable to those encountered in ordinary test equipment. Included as part of this unit is a power meter using calibrated crystal detectors for measurement of IF and RF power. Although accurate enough for normal test routines, it must be calibrated occasionally with a portable precision power meter kept at maintenance centers. Five push-buttons control an attenuator for the simplified IF power meter.

The large amount of waveguide plumbing used in the earlier equipment for attenuation has been replaced, in the new unit, by a compact waveguide panel just below the RF oscillator. This was made possible by the use of calibrated directional couplers, which are short pieces of waveguide soldered to the main waveguide at right angles, with holes in the common surfaces of the waveguides where they cross. A portion of the signal, the amount determined by the size and spacing of the holes, is passed from the main waveguide

into the cross-piece. Signal is fed into the unit from the RF sweep oscillator above it through transducers and a short length of coaxial cable, and can be picked off at any one of the three connections near the top of the panel. These three outputs give fixed attenuations of 22, 35, and 55 db for certain measurements, while the fourth connection in the lower left-hand corner of the panel provides calibrated attenuation variable from 0 to 20 db. The cover plates for the connectors can be stored in a small rack at the lower right when not in use. Special fast-acting clamps are used to hold the plates or detachable waveguide parts in place.

Microwave connections to the bay under test were formerly made using flexible waveguide sections that were bulky and difficult to handle. These have been replaced by broad-band transducers and coaxial cables. The transducers are small shorted sections of waveguide, each with a coaxial cable projecting into the waveguide as a probe, and so positioned that the cable and waveguide impedances are matched to give good transfer characteristics. The transducers, spare parts, cables, and fittings are stored in two drawers in the lower part of the cabinet. Also stored here is an RF frequency meter of the absorption type. It is a resonant line with its length determined by a micrometer adjustment. The micrometer has been redesigned with white figures on a black background for better readability, and the calibration chart is mounted on the handle for convenience.

Terminal Test Sets: A terminal transmitter changes a video signal to a 70-mc. frequency-modulated signal in two steps. The video signal frequency-modulates a microwave oscillator, and the resulting signal is translated to IF by beating with a second microwave oscillator. A terminal receiver at the other end of the circuit changes the 70-mc. FM signal back to video. The receiver is similar in function to a commercial broadcast FM receiver, and contains amplifiers, limiters, and a discriminator. The FM terminal test set is used to check and adjust the transmitter and receiver signal conversions existing.

Continued on page 44

FIG. 1. EQUIPMENT & BENCH SETUP AT A MAINTENANCE CENTER, WHERE MAJOR TEST AND REPAIR WORK IS DONE

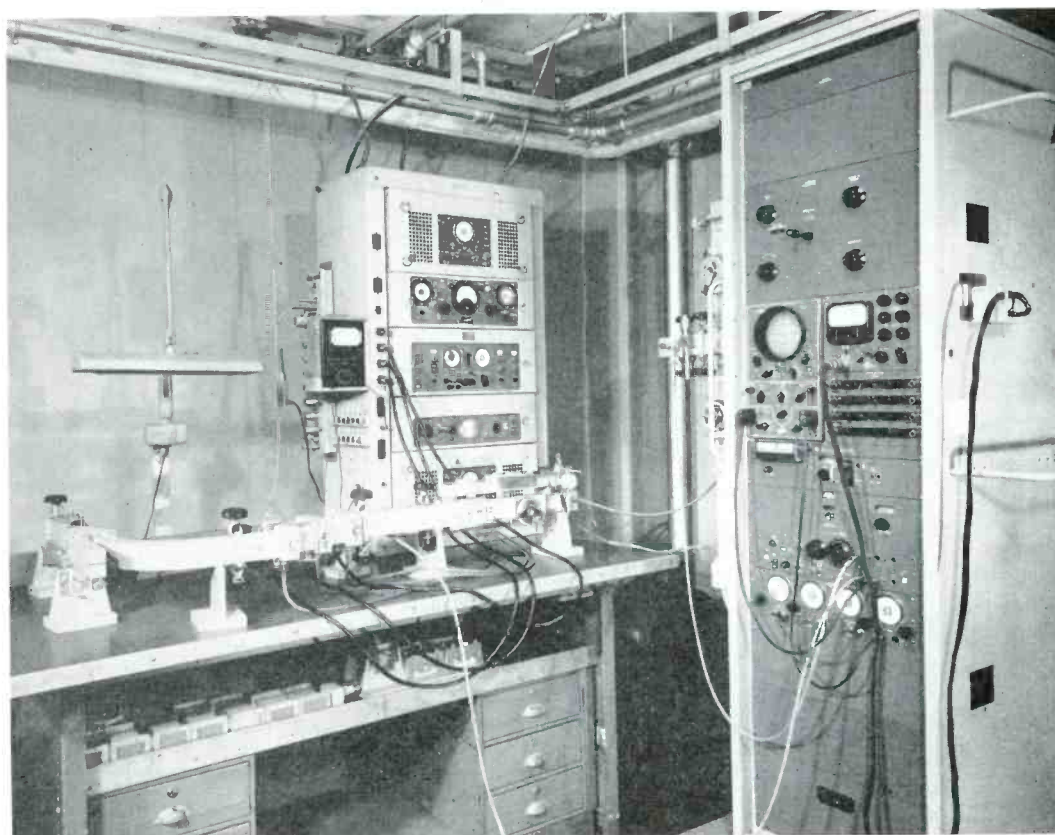
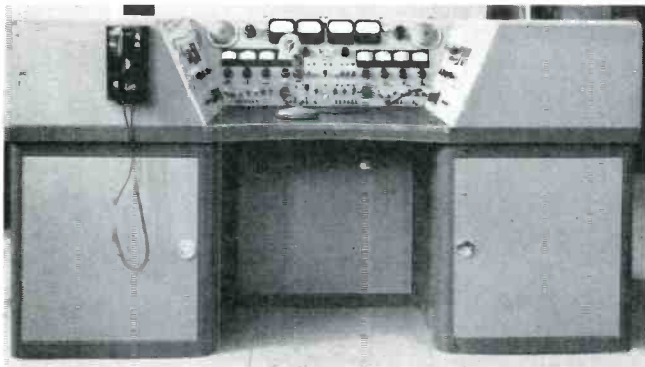



FIG. 1. CONTROL CONSOLE IN THE QUEENS FIRE ALARM CENTRAL OFFICE. BOTH BROOKLYN AND QUEENS TRANSMITTERS CAN BE CONTROLLED FROM HERE

New York's Fire Radio System

PART 4, CONCLUSION: DESIGN AND OPERATING FEATURES OF THE NETWORK CONTROL CONSOLES AND TAPE RECORDERS—By LIEUT. SAMUEL HARMATUK*



FIGS. 2, ABOVE, AND 3, BELOW: HOW THE DOOR PANELS CAN BE REMOVED

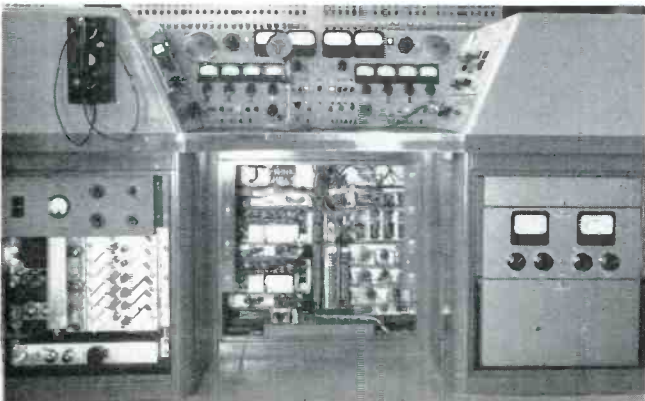

TO review briefly the plan of operation for the New York City Fire Department's radio system: Each of the 5 boroughs normally dispatches its own fire-fighting units from its Fire Alarm Central Office. Thus, each borough has a control console intended primarily for use with local fires. Only 3 pairs of frequencies are used for this purpose, since the boroughs of Brooklyn and Queens utilize the same pair, as do Bronx and Manhattan. Richmond has its own pair.

These networks are tied together by the city-wide system which operates on another pair of frequencies, making 4 in all. This is used primarily for the marine division and department officials. In other words, the system serves mobile units and fireboats that may be called on to operate in any part of the City. The control console for the city-wide network is located in the Manhattan Central Office, so that there are in all 6 consoles — one for each borough and one for the city-wide network.

One 350-watt transmitter is located in Brooklyn and one in Queens. Both operate on either the Brooklyn-Queens frequency or the city-wide frequency, and each can be controlled by either console. Another transmitter, operating at either the Bronx-Manhattan or the city-wide frequency, serves and

*Radio Supervisor, Bureau of Fire Alarm Telegraph, New York Fire Department, Municipal Building, New York City. Parts 1, 2, and 3 of this article appeared in RADIO COMMUNICATION Magazine for April, May, and June, 1952 respectively.

can be controlled by the Manhattan, Bronx, or city-wide console. Two transmitters (one standby) are operated by the city-wide console on the city-wide or the Manhattan-Bronx frequency. Richmond has two transmitters (one standby) which operate at either the Richmond or the city-wide frequency. Each network, then, can be served by at least one alternative transmitter, should the usual transmitter fail; and each network, with the exception of Richmond, can be controlled by at least two consoles. Two antennas are provided also at each transmitting point.

Six fixed pickup receivers are located in each borough, feeding the associated control console by wire lines. Three each are tuned to the borough mobile-unit frequency and the city-wide mobile-unit frequency. Outputs from the city-wide receiver lines are fed through each console to land lines connected with the city-wide console.

This system, including all equipment with the exception of the control consoles, was described in detail in the first 3 parts of this series. Unavoidable delays prevented delivery of some subcontract components of the consoles, and therefore of the concluding part of the article.

The Control Consoles: Because the control consoles are alike to the point of being interchangeable, only one is described here. The pictures on these pages are of the console at the Queens Fire Alarm Central Office. The alarm telegraph termination panels, arranged in polygonal fashion around the dispatching room, are visible in Fig. 1. Duty dispatcher Charles Cappello is at the radio console in the foreground. Supervising dispatcher Ed Hanley is at the file desk. Using the telephone, in the far background, is Fred Croissant.

Front views of the console with and without the removable door panels are given in Figs. 2 and 3. The left-hand section contains Motorola Vibrasender components, which generate the audio tones used for remote-control functions. A line amplifier can be seen at the bottom. The bottom panel on the right is a G. E. limiting amplifier. This can be cut in or bypassed by means of a switch on the control board. Just above is a test panel.

The control panel, Fig. 4, is divided roughly into left and right sections for the city-wide network and the borough net-

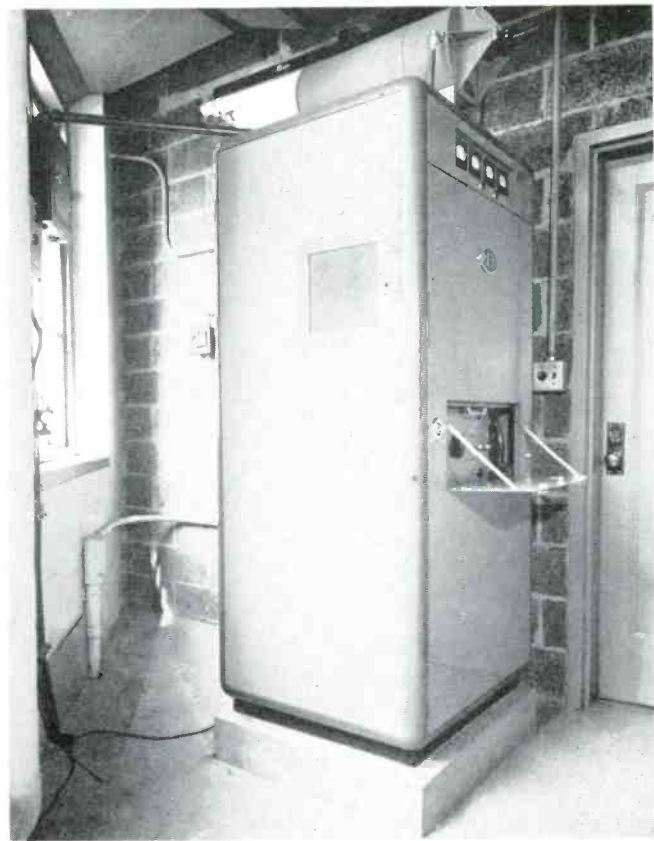

FIG. 5. REL 350-WATT TRANSMITTER AT THE QUEENS CENTRAL STATION

work respectively. In the top row at the extreme left and right are Jensen monitor speakers with associated gain controls. Inputs to these speakers are controlled by the two outside banks of push-buttons at the bottom of the board, so that any of the various inputs to the console or the output can be monitored. The left-hand VU meter in the top row can be switched to any of these audio lines by means of the group of push-buttons second from the left at the bottom of the board. Other meters in this row, from left to right, are the city-wide and borough VU meters and the carrier level meter. Master gain controls are under the two center VU meters, and under the city-wide master gain control are switches and tally lights for the tone generators which con-

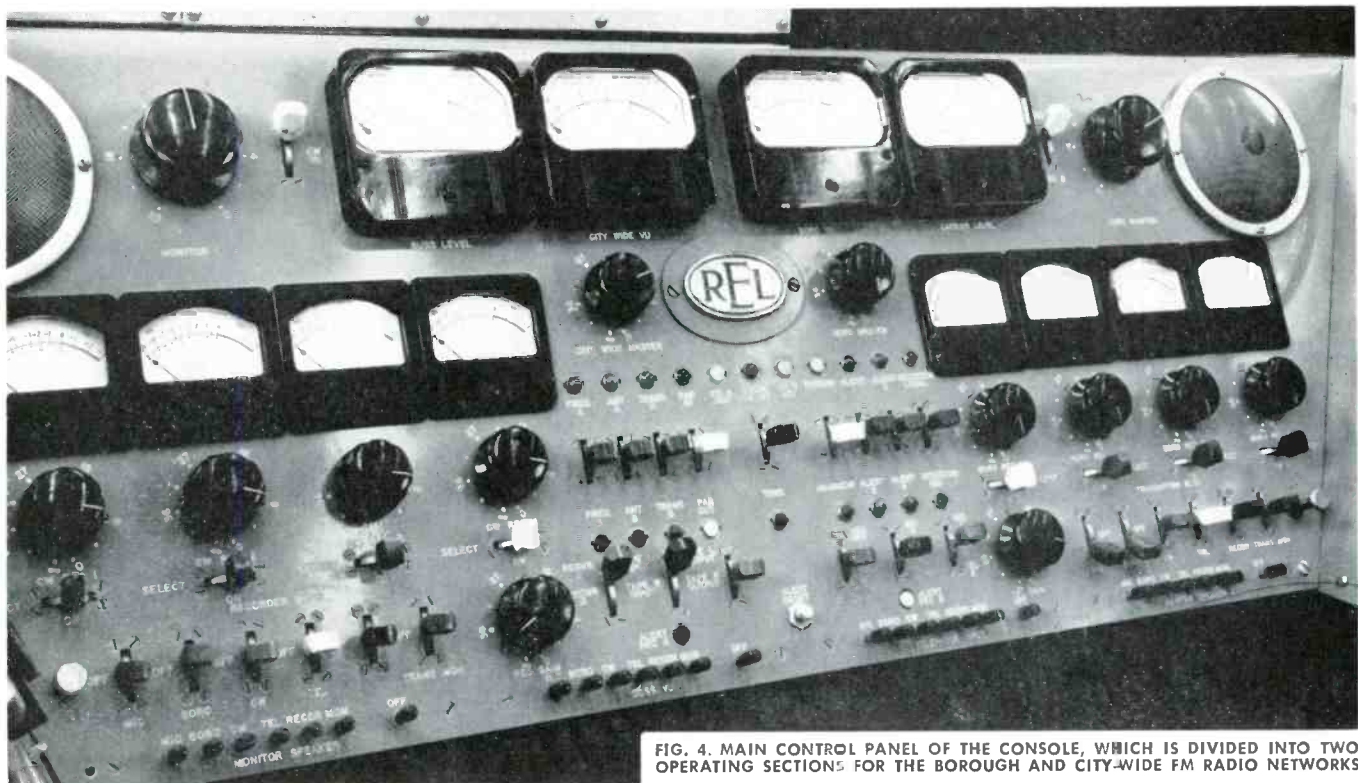
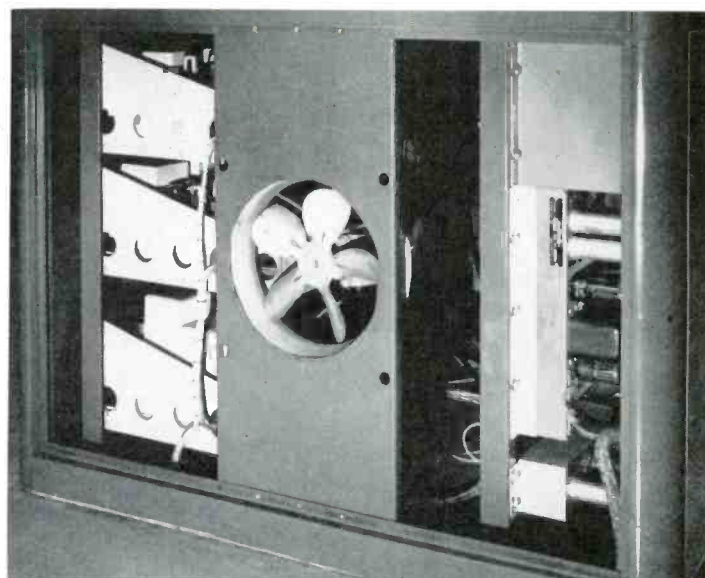
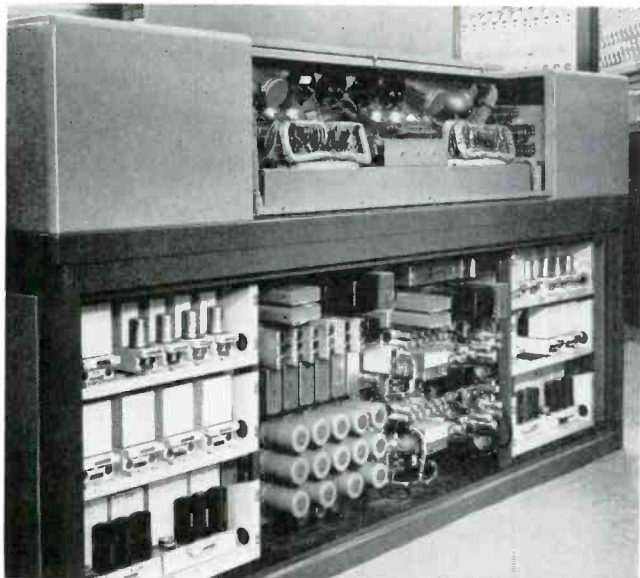

FIG. 4. MAIN CONTROL PANEL OF THE CONSOLE, WHICH IS DIVIDED INTO TWO OPERATING SECTIONS: FOR THE BOROUGH AND CITY-WIDE FM RADIO NETWORKS



FIGS. 6 AND 7. VIEWS OF THE BACK AND SIDE OF THE CONSOLE WITH THE PANELS REMOVED. MAINTENANCE AND SERVICE WORK SHOULD BE VERY EASY

control operating frequency and switch antennas and transmitters. To the right, in the center of the board, is a carrier on-off switch. Further to the right are an override switch, to take control of the local transmitter when it is being operated by another console, other tone switches to initiate alert signals, and an intercom control switch.

Under these two groups of four switches are two groups of three switches each. The one on the left controls tape recorder circuits; that on the right is for switching the limiter in or out and switching between two microphones and two telephone lines. Directly below this is a group of push-buttons controlling the telephone-line input.

The second row of VU meters has a gain-control and a switch under each meter. These control the pickup receiver inputs; the city-wide controls are at the left, and the borough controls at the right. The six outside meters and gain controls are for the individual receivers, which can be switched on or off the network busses independently. The two inside switches can put all the receivers on the busses simultaneously.

Below the city-wide receiver controls are a group of switches controlling the inputs to the tape recorder bus. In the corresponding position on the right side of the control board is a group of switches which control the inputs to the transmitter bus.

Fig. 5 shows the 350-watt REL transmitter at the Queens Central Office. The door in the front opens for access to the

frequency and antenna switching controls. A handset and on-off controls are provided also, so that the transmitter can be operated at this location in an emergency. A receiver cavity filter can be seen on top of the cabinet. This is tunable to permit trapping out any strong local interference from the receiver's antenna feed line.

Back and side views of the control console, with the cover plates removed, are given in Figs. 6 and 7. At the extreme left, Fig. 6, are audio amplifiers for receiver, microphone, and telephone circuits. Just to the right are the Vibrasponder tone receivers and associated relays and amplifiers. Farther to the right are Quik-call feeder units, the local monitor receiver chassis, and power supplies. Preamps, line amplifiers, and associated power supplies can be seen at the extreme right. One fan such as that shown in Fig. 7 is used in each side of the console.

Tape Recorders: Two tape recorders are installed in each console, one on each side, as Figs. 8 and 9 show. Another recorder in portable cases is used for standby and training purposes.

These recorders were supplied by Magnecord with modifications to meet the specifications of the Fire Department. Operating at 17 $\frac{1}{8}$ i.p.s., they provide 4 hours of recording on a standard NAB reel; with 2 units, 8 hours of solid recordings

Concluded on page 43

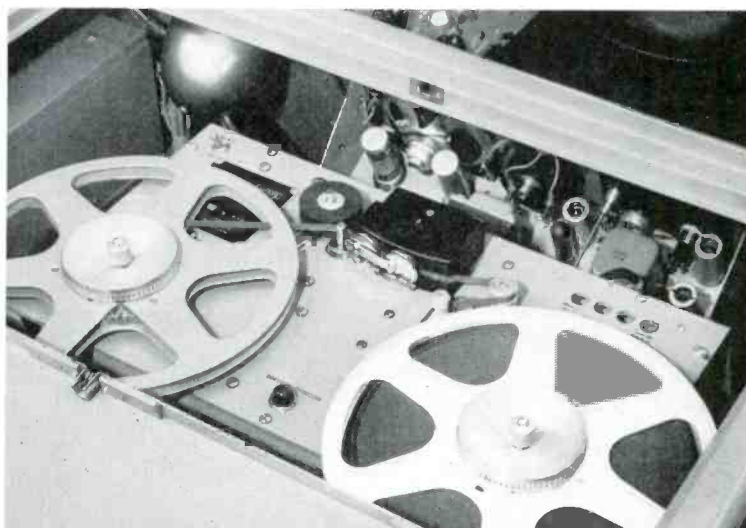

FIG. 8. CONTROL PANEL FOR ONE TAPE RECORDER. NOTE COUNTER AT LEFT OF METER. FIG. 9. TOP PANEL OPENS FOR LOADING NAB-SIZE TAPE REELS

The Future of Microwaves

AN OUTLINE OF PROBLEMS INVOLVED IN UTILIZATION OF THE MICROWAVE SPECTRUM TO MAXIMUM ADVANTAGE IN THE FUTURE — *By* EDWIN L. WHITE*

DURING the course of my remarks at your meeting last year I mentioned, among other things, the problems facing the Commission and the industry in using the microwave region of the radio spectrum. On this occasion, I would like to refer to this subject again, and establish a basis for discussion in the hope that thinking will be generated which will help the Commission in reaching a sound decision.

As I stated last year, the fundamental difficulty facing the Commission is the fact that there are not sufficient frequencies in the radio spectrum to permit everyone to use radio for the purpose he desires and in the manner he sees fit. The frequencies must be shared. The basis of sharing varies. In some cases as, for example, 500 kc., [which is] the international marine distress frequency, an assignment is made to serve a very restricted purpose. All, without distinction, are permitted to use that frequency for that particular purpose. In other cases, such as in broadcasting, the frequency is assigned exclusively to one licensee in a geographical area, and the use of that frequency is not permitted by another at a location where he will cause interference in the primary service area of the first licensee. In still other fields, such as the amateur group, the frequencies are made available to all persons of a class, and all using the frequencies must cooperate in their use. Our Rules provide no protection against intra-service interference.

Microwave Assignments: In the microwave area, the circumstances require a slightly different method of frequency assignment. I think we can all agree that, from the point of view of the operator of a multi-channel point-to-point microwave system, there must be assurance of interference-free operation of that system. Protection from objectionable interference could be achieved by assigning frequencies in the same manner as assignments are made to broadcast stations. That is, exclusive licensing of frequencies to individual applicants, and permitting no other assignments on the same frequencies in the same geographical area. However, it may be that it is unnecessary to restrict the use of the spectrum in this uneconomical manner. In fact, with the growth in the number of microwave systems, this course could soon exhaust the number of frequencies available for this purpose.

One outstanding characteristic of microwave systems is the ease with which the radiations of the transmitters and the angle of acceptance of receivers can be restricted. To protect a microwave point-to-point system, it is quite practical to restrict the geographical area required to a very narrow path. If the directivity of the transmitting and receiving antenna is of a high order, the same frequency can be and is being used in the same geographical area by two independent point-to-point systems without noticeable interference. If this engineering can be carried to the ultimate, it might well be that as a matter of policy, the Commission could assign identical frequencies to a number of systems in the same area without harmful mutual interference resulting. Such an arrangement could be successful only if each licensee of a system applied the best engineering techniques to his system and cooperated with other potential users so that, by applying the same level of engineering skill, they could physically engineer the second system into the same area. This would be an as-

ignment plan based on geometry rather than on frequency or service.

Let us explore some of the benefits and some of the drawbacks of such a procedure. In the first place, if such a procedure is practicable, the number of potential channels in any one area could become so large that some of the means of frequency economy to be applied to individual systems might become unnecessary. For example, it might not make too great a difference if passive reflectors were used, and frequency requirements for any point-to-point system doubled thereby. Further, the bandwidth required for the type of multiplexing might not be of great importance. Possibly, the Commission could permit each system to be as the applicant might desire, both as to choice of apparatus and ultimate capacity, and would not have to inquire into the plans of the applicants for future growth. In other words, it might be possible for the Commission to assign a channel 8 or 10 mc. wide to each microwave system, leaving it to the licensee to make his choice of modulation system and to use as much of the channel as his needs dictate, provided only that the techniques used do not result in occupancy of frequencies outside the channel or produce radiation outside the geographic area specified for the system.

On the other hand, while the cost of the system might be materially greater under such a plan, it would probably be better in the long run for the operator to apply initially the highest engineering standards to a point-to-point system, even though at the moment there might be no other application in view. This statement is made in the belief that it is much cheaper to install an adequate system in the first place than to go back later to modify and re-engineer the system. There is no adequate method of predicting the extent to which, and in what direction, communications will grow.

Considering the Commission's records and procedures, if such a policy were adopted it would probably be necessary to inquire much more completely with respect to the actual location and orientation of both transmitter and receiver of the point-to-point system [than is done now]. Probably, the Commission would issue a system license incorporating all the details in a single document, so that a potential system operator might be able to perform his initial engineering and gain sufficient information to make an intelligent decision as to whether or not he wished to continue.

Frequency Uses: There are one or two other collateral items that I might mention. All engineering studies which have come to our attention indicate that for multiple-user applications, such as mobile and broadcast systems, the frequencies above 800 or 900 mc. become less attractive. Information also indicates that, above approximately 8,000 or 10,000 mc., atmospheric absorption becomes a serious problem. At some future time we may find that because of requirements for mobile uses we cannot afford to use the frequencies below 800 mc. for point-to-point communication. If this should happen, point-to-point systems designed to operate in the lower portion of the spectrum would be forced to vacate and move up to those frequencies suitable for point-to-point but unsuitable for mobile applications.

If the increases in number of point-to-point systems continue, the problems of operating in congested areas may soon

Continued on page 46

*Chief, Safety & Special Radio Services Bureau, Federal Communications Commission, Washington, D. C. A speech made before the Petroleum Industry Electrical Association, in Houston, Texas, April 9, 1953.

How Costs can be Reduced in

Mobile Radio Equipment Design

REDUCTIONS IN FIRST COST AND MAINTENANCE CAN BE ACHIEVED WITH NEW DESIGN AND MANUFACTURING TECHNIQUES — By JAMES B. FERGUSON*

AT this stage in the development of 2-way radio, it can be said that what differences there are in the performances of various competitive equipments are slight, and of real importance only in a very few special cases. The major differences involve such factors as availability, ease of installation, and costs of maintenance. First costs are, for the most part, uniform throughout the industry.

However, through proper design and manufacturing techniques, the first cost can be lowered significantly without sacrificing performance. At the same time, improvements can be made which reduce installation and maintenance expenses.

Component Costs: It is a generally-accepted fact that the use of sub-standard materials actually increases the ultimate cost of most manufactured articles, and this is particularly true of complex electronics equipment. Therefore, it is extremely important that each component used in mobile radio equipment be of the highest quality, in both electrical and mechanical characteristics, and that its normal operating rating be well in excess of any extremes of voltage, current, or temperature to which it might be subjected in the equipment. In the same way, reduction of component costs by the elimination of amplifier or multiplier stages usually results in marginal performance that not only increases the manufacturer's labor cost but means a continuing maintenance burden for the purchaser.

It follows that, in order to effect substantial and safe economies, a careful analysis must be made to determine if any stages or components are actually unnecessary, or if their elimination would make manufacturing processes too costly or inefficient. This reasoning was applied to the design of the Platt "Thirty" series of FM 2-way radio equipment with most satisfactory results.

In the transmitter section we added one tube to the number generally considered adequate, and increased the power-handling capabilities of the last two multipliers, Fig. 1, by using a 6AQ5 and a 2E26. This combination drives the 6146 final amplifier at about 25% above the design center value at

the low impedance required by that tube. While this increased the tube cost, our labor cost was reduced by a greater amount because of the complete elimination of rejects for substandard power output.

The tube change increased both the plate and heater current requirements of the system. To compensate for this, we added a pentode buffer after the modulator which so overdrives the first two multipliers that they operate with about 40% of the normally-required plate current. Also, because we wanted to use a 6AQ5 in the audio output stage of the receiver, it was logical to use one 6AQ5 tube in the dual capacity of third transmitter multiplier and receiver audio output. This doubling of functions, accomplish without switching, resulted in the reduction in heater current to within 1/4 ampere of its value before the tubes were added. Incidentally, another unusual and desirable feature was obtained at the same time. The loudspeaker is energized during transmission and, with proper modulation, is completely quiet. But if the automatic modulation limiter is adjusted improperly or fails, the speaker emits a loud rasping sound, warning the operator that service is required.

The same philosophy was followed in the design of the receiver. Tubes were added to the IF amplifier, oscillator multiplier, and squelch systems. As in the transmitter, these added tubes gave the necessary margin of safety, reducing receiver rejects to the vanishing point. The added power drain of the receiver was compensated for by using a doubler-type power supply. The 250-volt output of this supply feeds the audio stages only, while the balance of the receiver is fed by the half-voltage point of the doubler. This combination provides a 3 1/2-watt audio system, yet keeps total power drain at a normal level.

Reducing Costs: So far, performance improvements which entail no increase in cost have been described. There are, however, three general categories in which substantial savings can be realized:

1) *Elimination of unnecessary materials and labor.* It has been general practice to design equipment primarily for rear-deck installation. In some cases, it has been made convert-

*Chief Engineer, Platt Manufacturing Corp., 489 Broome Street, New York 13, N. Y.

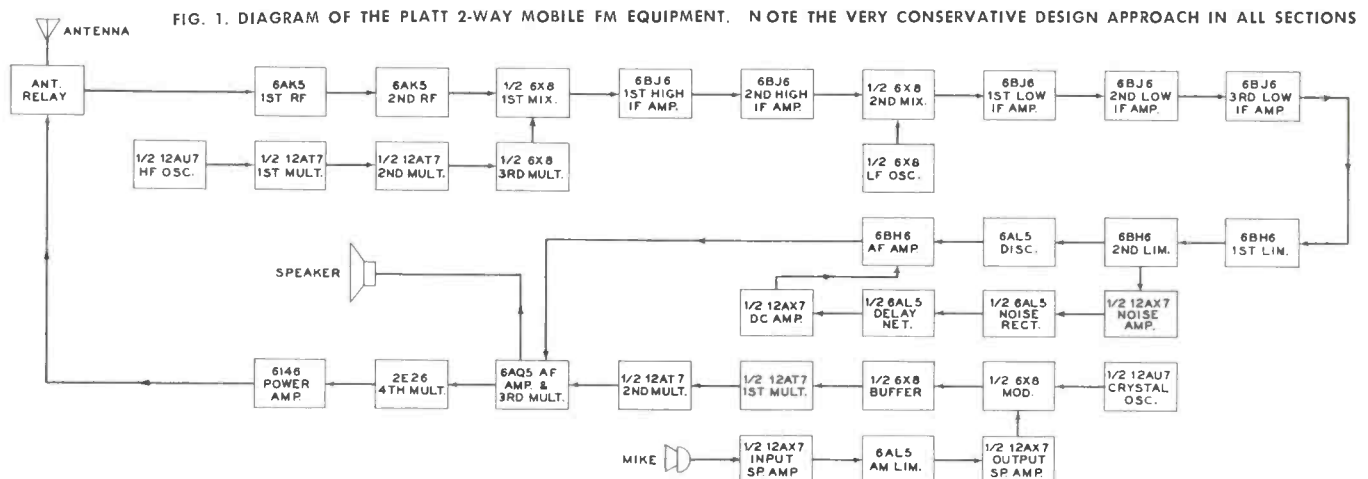



FIG. 2. CASE CONTAINS CONTROLS, TRANSCIEVER, POWER SUPPLY, SPEAKER

ible to front-compartment mounting. This penalizes the purchaser who can use front-mounted units, and results in no saving to the rear-deck user.

A careful survey showed that a majority of commercial operators either demanded or preferred front-mounted equipment, and a lesser but still surprisingly large number had no preference but would welcome the savings effected by elimination of the additional material and installation costs involved in rear-deck installations.

Our design effort, therefore, was concentrated on a front-mounting case, Fig. 2. Then, having obtained a single self-contained unit of a size that permits easy front-compartment installation, we found that the addition of an inexpensive four-pin microphone-type connector and a small single-pole relay made the equipment suitable for rear-deck usage. This conversion can be made after production, or even in the field.

2) *Concentration of production.* The mobile radio market, while substantial in size, cannot be supplied by mass-produced equipment. Therefore, it is essential that production be concentrated on as few major items as is possible without restricting potential sales too severely.

In order to achieve the utmost efficiency, we decided to produce only one basic transmitter-receiver and two power supplies. The transmitter-receivers for both the 25 to 50 and 152 to 174-mc. ranges are identical, except for the inductances

of some of the coils. These chassis are designed to deliver thirty watts in either band, and are interchangeable without modification for either 6-v. DC or 117-v. AC operation.

Only two power supplies are manufactured on a production basis. One, a 6-v. dual vibrator type, is convertible for 12-v. operation; the other is for 117-v. 50 to 60-cycle use. Figs. 3 and 4 show the transmitter-receiver chassis and cabinet with the vibrator supply for mobile installations, and the AC supply for base-station use, respectively.

Such concentration of production results in appreciable savings in direct labor, production planning, and procurement costs, and reduces inventory investment substantially.

Other items such as power amplifiers and remote control units are manufactured on a semi-custom-built basis to meet individual customers' requirements.

3) *Production Techniques.* Because of the relatively small number of units that may be produced, careful consideration must be given to the problem of minimizing the amount of special tools and dies required. Means must be found to produce efficiently, in moderate quantities, those items that would normally be tooled for mass production.

The outer housing or cabinet, for instance, must usually be made to close dimensional tolerances in order that the equipment chassis will fit properly. This requires drawing and forming dies, the cost of which must be charged to the expected production of that particular cabinet. To eliminate this unnecessary cost, we designed a method of mounting our equipment that allows for cabinet variations of as much as $\frac{1}{8}$ in. without any misalignment, so that it can be produced economically by the average sheet-metal shop.

Our transmitter-receiver chassis has somewhat more than 250 holes of many sizes and shapes. A piercing die for this would have cost well over \$10,000, and would have been usable for only as long as we produced that particular model. If the chassis were to be produced by an outside contractor, using the sequential group punching method, they would cost from three to five dollars each. Therefore, we decided to set up our own plant with equipment designed specifically for the production of chassis of the types that we might require for the next five years. This plant is currently handling our chassis requirements at a cost averaging 70% less than the prices quoted by outside suppliers, and helps also in our custom-building department because we can make a few pieces of special chassis quickly and economically.

RF and IF coils presented a somewhat similar problem because, of the 40 tuned circuits in each set, only 16 windings

Concluded on page 48

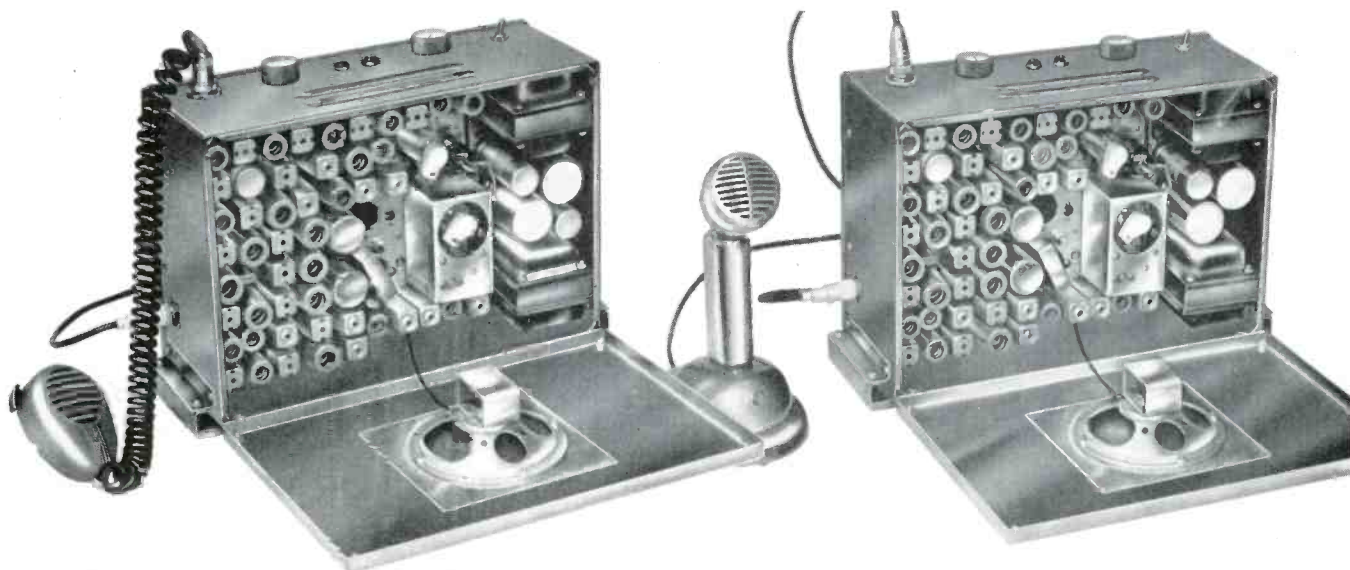

FIGS. 3 AND 4. MINIMUM CHANGES ARE NECESSARY TO ADAPT THE BASIC MOBILE EQUIPMENT, LEFT, FOR AC OPERATION AS A BASE-STATION UNIT

Rigid Waveguide Specifications

THE table and charts on this page show in convenient forms the frequency range, attenuation, dimensions, and maximum power-handling capacity for standard sizes of rigid waveguide. These characteristics are given for various materials in the ranges where they are most often used.

It should be pointed out that the figures shown for attenuation and power-handling capacity are taken from theoretical calculations; practical waveguides, because of wall roughness and discontinuities at joints, exhibit markedly greater attenuation and can carry less power safely.

| JAN TYPE | MATERIAL | INTERNAL DIMNSNS, INCHES | BAND | RECOMMENDED OPERATING RANGE | | CUTOFF | | CALC. ATTEN., DB/100 FT. | | CALC. MAX. CW POWER, MGWTTs. | |
|----------------------|----------|--------------------------|------|-----------------------------|-------------|-------------|-------------|--------------------------|------------|------------------------------|------------|
| | | | | FREQ., KMC. | WVLGTH, CM. | FREQ., KMC. | WVLGTH, CM. | LOW FREQ. | HIGH FREQ. | LOW FREQ. | HIGH FREQ. |
| RG-69/U | Brass | 6.500 x 3.250 | L | 1.12-1.70 | 26.79-17.65 | .908 | 33.04 | .424 | .284 | 11.9 | 17.2 |
| RG-103/U | Aluminum | " " " | " | " " " | " " " | " " " | " " " | .269 | .178 | " | " |
| RG-104/U | Brass | 4.300 x 2.150 | — | 1.70-2.60 | 17.65-11.54 | 1.375 | 21.82 | .788 | .516 | 5.2 | 7.5 |
| RG-105/U | Aluminum | " " " | " | " " " | " " " | " " " | " " " | .501 | .330 | " | " |
| RG-48/U | Brass | 2.840 x 1.340 | S | 2.60-3.95 | 11.54-7.60 | 2.080 | 14.42 | 1.478 | 1.008 | 2.2 | 3.2 |
| RG-75/U | Aluminum | " " " | " | " " " | " " " | " " " | " " " | .940 | .641 | " | " |
| RG-49/U | Brass | 1.872 x .872 | C | 3.95-5.85 | 7.60-5.13 | 3.155 | 9.51 | 2.79 | 1.93 | 1.4 | 2.0 |
| RG-95/U | Aluminum | " " " | " | " " " | " " " | " " " | " " " | 1.77 | 1.22 | " | " |
| RG-50/U | Brass | 1.372 x .622 | Xb | 5.85-8.20 | 5.13-3.66 | 4.285 | 7.00 | 3.85 | 3.08 | .56 | .71 |
| RG-106/U | Aluminum | " " " | " | " " " | " " " | " " " | " " " | 2.45 | 1.94 | " | " |
| RG-51/U | Brass | 1.122 x .497 | XI | 7.05-10.0 | 4.25-3.00 | 5.260 | 5.70 | 5.51 | 4.31 | .35 | .46 |
| RG-68/U | Aluminum | " " " | " | " " " | " " " | " " " | " " " | 3.50 | 2.74 | " | " |
| RG-52/U | Brass | .900 x .400 | Xs | 8.20-12.4 | 3.66-2.42 | 6.560 | 4.57 | 8.64 | 6.02 | .20 | .29 |
| RG-67/U | Aluminum | " " " | " | " " " | " " " | " " " | " " " | 5.49 | 3.83 | " | " |
| RG-91/U | Brass | .622 x .311 | Ku | 12.40-18.00 | 2.42-1.67 | 9.490 | 3.16 | 12.76 | 11.15 | .12 | .16 |
| RG-107/U | Silver | " " " | " | " " " | " " " | " " " | " " " | 6.14 | 5.36 | " | " |
| RG-53/U | Brass | .420 x .170 | K | 18.00-26.50 | 1.67-1.13 | 14.08 | 2.13 | 27.7 | 19.8 | .043 | .058 |
| RG-66/U | Silver | " " " | " | " " " | " " " | " " " | " " " | 13.3 | 9.50 | " | " |
| RG-96/U | Silver | .280 x .140 | V | 26.50-40.00 | 1.13-.750 | 21.10 | 1.423 | 21.9 | 15.0 | .022 | .031 |
| RG-97/U | Silver | .224 x .112 | — | 33.00-50.00 | .909-.600 | 26.35 | 1.138 | 31.0 | 20.9 | .014 | .020 |
| RG-98/U | Silver | .148 x .074 | WR15 | 50.00-75.00 | .600-.400 | 39.90 | .752 | 52.9 | 39.1 | .0063 | .009 |
| RG-99/U ^s | Silver | .122 x .061 | WR12 | 60.00-90.00 | .500-.330 | 48.40 | .620 | 93.3 | 52.2 | .0042 | .006 |

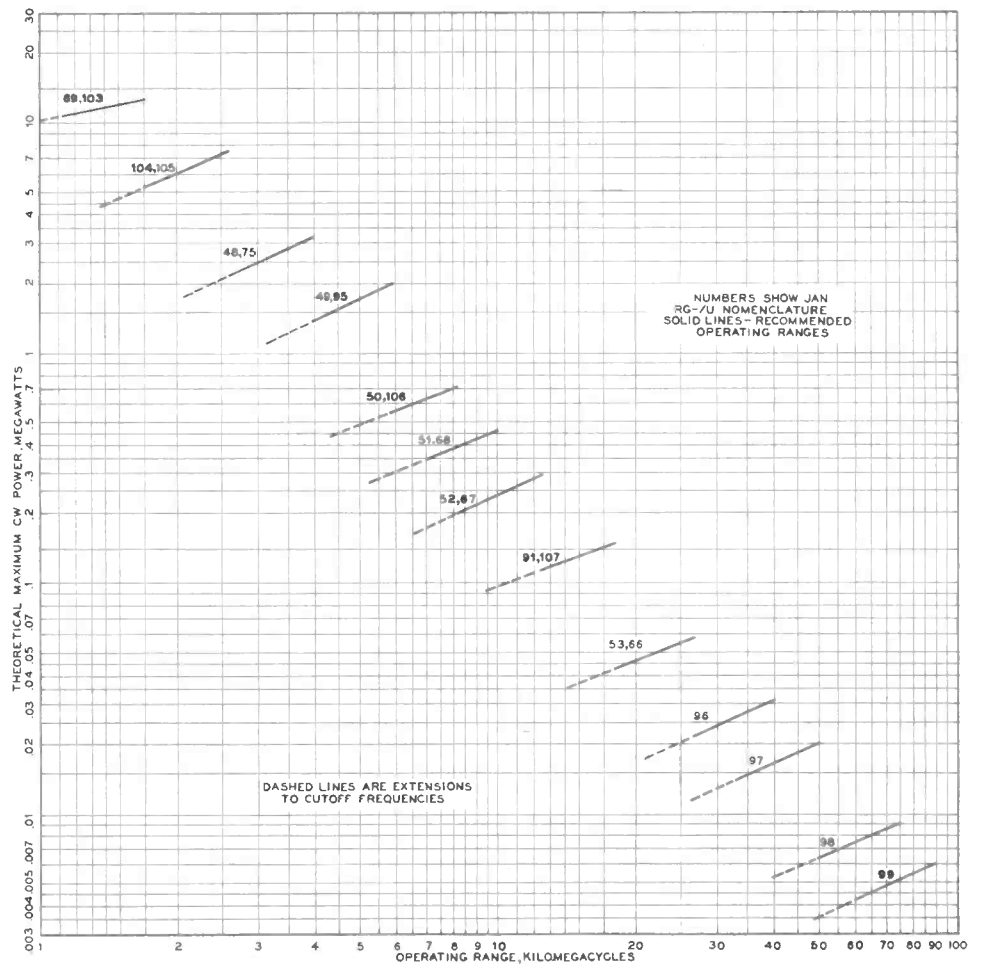
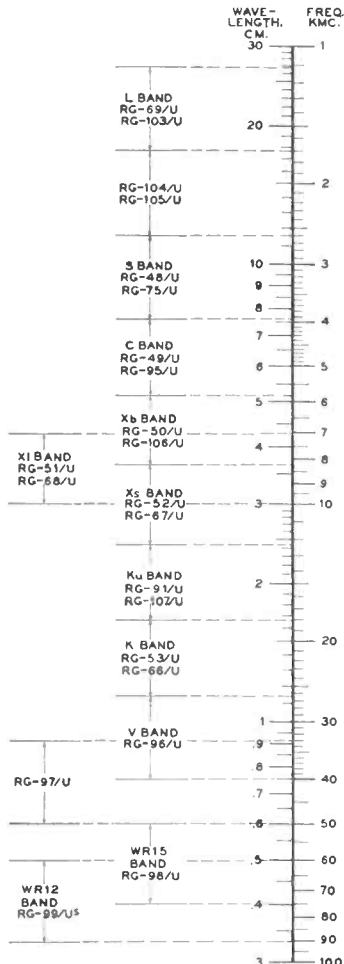

LEFT: FREQUENCY BANDS COVERED BY VARIOUS WAVEGUIDES. RIGHT: POWER-HANDLING CAPACITY VS. FREQUENCY FOR STANDARD WAVEGUIDES

Here's performance you can count on

RCA 2-WAY RADIO



Straight-Forward Circuits to bring your message in without interference—even when you're operating close to an adjacent-channel transmitter.

Automatic Modulation Control to lower loud voices, raise weak voices, to correct level, without distortion.

Long Tube Life for dependable, low-maintenance service. Half the tubes operate at 1/5 maximum ratings.

Full Frequency Range: Fleetfone 30-50 mc, Carfone 152-174 mc.

Fits Anywhere: Transmitter-receiver unit takes no more space than a spare tire, mounts in any position, operates at low drain on 6- or 12-volt battery.

Stable Performance for minimum distortion. Ovenless crystals stay on frequency without warm-up, without wasting stand-by power.

Single-Case Construction for easy tuning and servicing. Offers plenty of protection—makes chassis and all components instantly accessible.

For Extra Dependability, installation and service facilities of the RCA Service Company are available.

* * *

For Complete Details on RCA 2-Way Radio contact the Communications Specialist at your nearest RCA Office or MAIL COUPON NOW.



RADIO CORPORATION of AMERICA
COMMUNICATIONS DIVISION
CAMDEN, N. J.



Radio Corporation of America
Communications Division
Dept. 132Q, Building 15-1
Camden, N. J.

Please send me information on RCA 2-way Radio

- Carfone Fleetfone
 Have RCA Representative call

Name _____
Address _____
Company _____
City _____ State _____ Zone _____



Speeding Electronic Progress through

crystal 
research

The new JK G-9 is a medium priced, high precision, 100 kc frequency standard crystal available for use with or without oven, depending on tolerances desired. Supplied for operation at series resonance or into specified load capacities. Hermetically sealed, evacuated glass holder provides thermal insulation, protection against contamination. Consult us on specific applications.



JK STABILIZED G-9 CRYSTAL

Did you know?

So accurately processed are JK Crystals that dimensions must be checked electrically and even the touch of a hand will change their characteristics. Yet, in a protective, "stabilized" JK mounting they maintain precise frequency with unflinching accuracy. Creative research combined with precision production methods brings you JK "Crystals for the Critical."

THE JAMES KNIGHTS COMPANY
SANDWICH, ILLINOIS



PREDICTION OF CIRCUIT FAILURES

A relatively unexplored approach to the problem of insuring higher reliability in electronic equipment is being investigated at the National Bureau of Standards. With promising results, the Bureau is studying the feasibility of detecting incipient failures of equipment long before they affect over-all performance perceptibly. Quick and easy failure-prediction checking by unskilled personnel is the goal of the work, which is being conducted under the sponsorship of the Office of Naval Research by J. H. Muncy of the NBS engineering electronics laboratory. A technique has been evolved experimentally by which a maintenance man simply plugs a portable failure-prediction unit into the slightly-modified equipment to be checked and turns a multi-point selector switch; a red light flashes on to identify stages or components that have deteriorated below safe levels and have become prospective causes of equipment failure. In accelerated-aging experiments on a military radio receiver, most failures have been predicted many hours before they occur.

As applications of radio and electronic equipment continue to increase in extent and importance, problems of maintenance and reliability become increasingly serious. This is particularly true of military electronic equipment. In addition to its importance for military communication, such equipment is relied on more and more by the Armed Forces for radar detection of aircraft and vessels, for the automatic aiming, firing, and detonating

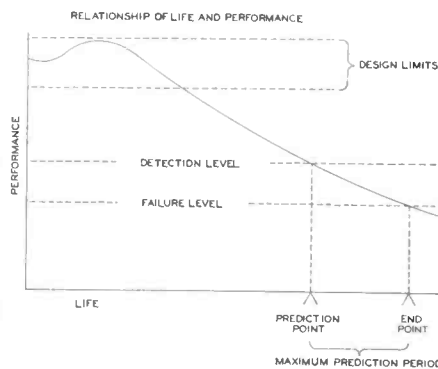

FIG. 1. USUAL COMPONENT FAILURE PATTERN

of weapons and missiles, and for many instrumentation and control applications. The inevitable complexity of much of this equipment increases the danger that component failures will cause essential equipment to malfunction at critical times. Although much progress has been made toward better dependability, particularly through components of improved quality, the dependability of present-day equipment still leaves much to be desired. In some large and highly-specialized installations, such as the

Whirlwind computer, valuable means for detecting marginal stages automatically have been built into the equipment. Until now, however, very little study seems to have been made of the practical possibility of detecting incipient failures by means of simple routine checks with portable test equipment.

The magnitude of the problem of attaining satisfactory reliability in military electronic equipment is suggested by the fact that some large bombers, for example, now use about 2,000 vacuum

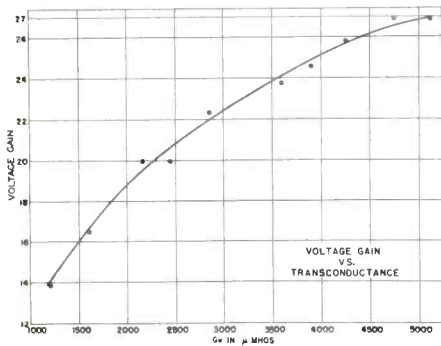

FIG. 2. MEASURED GAIN OF AMPLIFIER STAGE

tubes. It has been estimated that the average home television receiver, with about 20 tubes, has an average of one tube failure for every 1,200 hours of operation; if a plane with 2,000 tubes had the same rate of failure, there would be one failure every 12 hours. Yet failure probabilities are increased in the plane because environmental conditions are much more severe.

Operating Principle: Failure of such equipment to function properly may be caused either by sudden or by gradual deterioration of a tube or other component. Although quality improvement seems to be the only way to reduce sudden component failures, surveys have indicated that at least half of all equipment failures are produced by components which go bad gradually. The NBS work has been concerned with practical means of spotting these gradual failures before the equipment becomes inoperative.

Fig. 1 shows a curve representative of the change of performance level with service life of an electrical component. A curve of this type is applicable to many types of components, including tubes, resistors, capacitors, and complete sub-assemblies. After some performance fluctuations that may be either upward or downward, the component deteriorates gradually until it reaches the failure level.

In multi-stage equipments it is usually impossible to detect such incipient failures by input-output performance measurements. This is because the tolerances of an over-all measurement usually mask the performance decrease of one stage

Continued on page 36

CANNON PLUGS

get good reception

O SERIES

X SERIES

P SERIES

XK SERIES

GB SERIES

UA SERIES

XL SERIES

D SERIES

XKW-B1 SERIES

U SERIES

TELEPHONE RECORDER

K SERIES

WRITE FOR PRICE FOLDER CPL-6

K SERIES

TELEVISION

The high quality audio connectors shown above are available from all Cannon Franchised Distributors. In their great variety of sizes, shapes and contact arrangements there is no problem or technical requirement in the radio, sound, TV or related fields that cannot be met. Cannon plugs are standard on leading makes of audio equipment and microphones.

CANNON ELECTRIC

Since 1915



Factories in Los Angeles, Toronto, New Haven, Benton Harbor. Representatives in principal cities. Address inquiries to Cannon Electric Company, Dept. E-146, P. O. Box 75, Lincoln Heights Station, Los Angeles 31, California.

CIRCUIT FAILURES

(Continued from page 35)

that may precede failure in that stage. Daily variations in measured gain of a typical piece of equipment are greater than the change caused by the gradual deterioration of one tube in one stage; as the tube continues to deteriorate, the time at which impairment of over-all performance becomes detectable may practically coincide with the time at which over-all failure occurs. Successful failure prediction requires, therefore, that the condition of each important stage or small group of stages be established individually. In Fig. 2 is a curve showing an actual measurement of gradually decreasing voltage, corresponding to gradually decreasing gain, for one amplifier stage in a receiver. Over-all performance was not measurably affected by the decreasing performance of this stage until the test voltage had fallen to little more than half its original value; by this time, the deteriorating stage was almost ready to cause complete receiver failure.

The designer of electronic equipment must allow certain design tolerances for the performance of any type of component. Component performance may vary in a positive as well as a negative manner with time, and the designer must allow for these drifts as well as for initial spread. In equipment designed for reasonably long life, a component can deteriorate gradually a great deal before

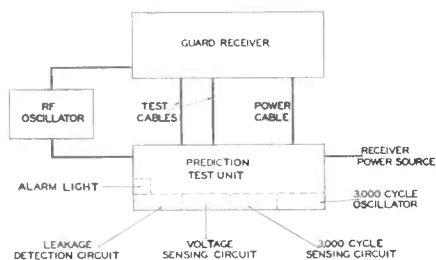

FIG. 3. UNITS MAKING UP FAILURE PREDICTOR

it reaches the level of minimum acceptable performance, or the failure level. It is the gradual nature of this deterioration that gives rise to the possibility of predicting failures long in advance.

Practical Test Unit: Tube failure is by far the most common cause of electronic equipment failure, and the experimental failure-prediction system depends primarily on sensing decreases in tube transconductance at critical stages. This is done by operating the tube as a resistance-coupled amplifier, applying a 2,000-cycle signal, and sensing whether the voltage gain has fallen below a predetermined limit. This test also detects changes in components other than the tube if the changes are such as to affect the gain of the stage. In addition, provision is made for checking capacitors for

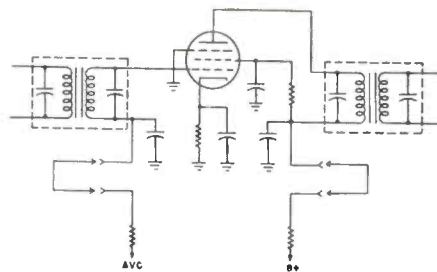

FIG. 4. CHANGES NEEDED FOR USING PREDICTOR leakage, and for voltage and current measurements, although in the equipment studied practically all the failures have been tube failures detectable by the voltage-gain check. A block diagram of the setup used for predicting failures of components in a military radio receiver

is shown in Fig. 3. The RF oscillator shown at the left was not an integral part of the failure-prediction equipment.

The military receiver selected for experimentation, an 18-stage guard-channel receiver, required only slight modifications to adapt it to the failure-prediction system. The circuits were first examined for sensitivity to weak and gassy tubes. Sensitive stages were the RF amplifier, first mixer, high IF amplifier, second mixer, two low IF stages, two crystal oscillators, and two frequency multipliers. Insensitive stages were signal and AVC detectors, audio and AVC amplifiers, series and shunt noise limiters, and the AVC gate. Wiring was modified

Continued on page 39

Open-Line SWR Checks

HOW TO MEASURE STANDING WAVE RATIO ON OPEN WIRE TRANSMISSION LINES — By GERALD W. LEE*

STANDING waves on open-wire transmission lines between the transmitter and antenna radiating elements can be major sources of power loss for radio broadcasting and communication transmitting stations. They are produced whenever the antenna, transmission line, and transmitter output circuits are not perfectly matched in impedance. When this condition occurs, wave trains are reflected along the line to some extent rather than being radiated by the antenna. Because the reflected wave varies in phase relationship with the incident or forward-traveling wave, voltage minima and maxima occur; the ratio of maximum to minimum value is called the standing-wave ratio, or SWR. Since this is proportional to the degree of impedance mismatch, and varies inversely with power transfer, it is a measure of the line efficiency. For good operation, the SWR should be less than 1.25.

However, the SWR is difficult to determine from power loss estimates, input and output current readings, or even the measured amount of impedance mismatch between various elements in the system. It has been the author's ex-

perience that such theoretical methods are not entirely satisfactory. Finally, the method shown on this page was worked out to obtain a direct measurement. This is quite easy to follow through, is accurate and fast, and provides a positive check on the results of field adjustments. The apparatus and procedure used is given below:

- 1) A loop of stiff No. 10 insulated wire is stapled or taped to a pole or stick, whose length is determined by the height of the line above ground, as in Fig. 1A.
- 2) Leads are connected to the loop, clamped to the pole down to a convenient height, and connected to a 0 to 500-mv. millivoltmeter.
- 3) The loop is placed over a hot conductor of the line, and adjusted in size to produce roughly a center-scale reading on the meter.
- 4) Meter readings are taken every few feet along the line. The ratio of the highest and lowest readings gives a good indication of the standing wave ratio.

A DC milliammeter can be used rather than a millivoltmeter. However, a germanium diode to rectify the induced RF current, two small chokes, and a suitable filter capacitor shunting the meter are then required, as shown in Fig. 1B.

*Professional Engineer, 80 St. George Street, Toronto, Ontario, Canada.

FIG. 1. MAKING DIRECT MEASUREMENTS TO FIND VOLTAGE STANDING-WAVE RATIO ON AN OPEN-WIRE TRANSMISSION LINE

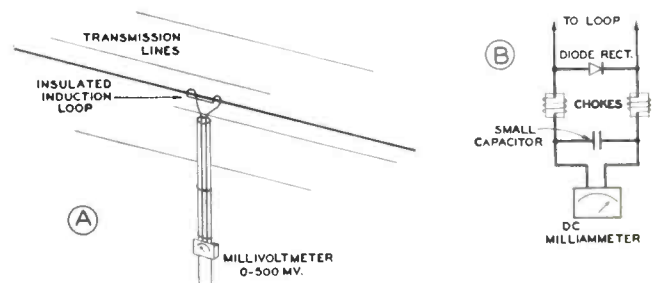

IMPORTANT BOOKS

for your

REFERENCE LIBRARY

To help you in your selection of basic reference works, we have checked hundreds of engineering and technical books. One or more of these will provide the answer to your questions and problems in radio, television, UHF, mobile radio, microwaves, and sound reproduction. For prompt delivery, use the coupon below.

TELEVISION

- TV Standards and Practice**—by *Donald Fink*. No. 40...\$6.50
405 pages, 5½ by 8¼ ins., cloth. Official standards set by NTSC for use by engineers in the TV industry.
- Practical TV Engineering**—by *Scott Helt*. No. 41...\$7.50
708 pages, 6 by 9 ins., cloth. Fundamentals and methods of efficient TV practice for engineers, students, and technicians.
- Television**—by *Zworykin and Morton*. No. 42...\$7.50
646 pages, illus., 6 by 9¼ ins., cloth. An authoritative treatment of fundamentals and practice for TV engineers and service men.

FREQUENCY MODULATION

- Frequency Modulation**—by *August Hund*. No. 43...\$6.75
375 pages, 6 by 9 ins., cloth. An engineering text covering basic principles as well as design of commercial apparatus.
- FM Simplified**—by *Milton S. Kiver*. No. 44...\$6.50
347 pages, 5½ by 8 ins., cloth. An excellent book for the layman who wants to learn about FM transmission and reception.
- Frequency Modulation**—by *Nathan Marchand*. No. 45...\$5.00
409 pages, illus., 6 by 9, cloth. The fundamentals, circuits, and equipment used in FM explained using a minimum of mathematics.

UHF

- UHF Techniques**—*Edited by J. C. Brainerd*. No. 47...\$6.50
534 pages, 6½ by 9½ ins. cloth. A text designed primarily to train engineers and physicists in ultra-high-frequency research work.
- UHF Transmission**—by *Nathan Marchand*. No. 48...\$4.50
322 pages, 6 by 9¼ ins., cloth. For practicing engineers using UHF, the principles given are applicable to particular problems.
- Communication at UHF**—by *John Thomson*. No. 49...\$4.50
203 pages, 5½ by 8½ ins., cloth. Covers radio communications at these frequencies with emphasis on development possibilities.

MICROWAVES

- Introduction to Microwaves**—by *Simon Ramo*. No. 50...\$4.00
138 pages, 5½ by 8½ ins., cloth. An excellent non-mathematical treatment of the concept of microwaves for the novice.
- Understanding Microwaves**—by *V. J. Young*. No. 51...\$6.00
385 pages, 5½ by 8¼ ins., cloth. The underlying principles thoroughly explained for engineers, researchers, and students.
- Microwave Electronics**—by *John C. Slater*. No. 52...\$6.50
406 pages, 6 by 9 ins., cloth. A highly technical treatment of war-time and post-war development in microwaves.

RADIO COMMUNICATION

- Mobile Radio Handbook**—by *M. B. Sleeper*. No. 54...\$2.00
185 pages, 8¼ by 11½ ins., paper. Invaluable references for all concerned with mobile radio and point-to-point communications.

AUDIO REPRODUCTION

- Pianos, Pianists, and Sonics**—by *G. A. Briggs*. No. 55...\$2.50
192 pages, 5½ by 8¾ ins., cloth. The evolution and construction, touch, tuning, and toning of pianos. Of interest to music lovers.
- Sat. Rev. Book of Recorded Music & Sound Reproduction**—by *E. T. Canby, C. G. Burke, & I. Kolodin*. No. 98...\$4.50
320 pages, 6¼ by 9¼ ins., cloth. Complete analyses on all phases of the high-fidelity field. Includes equipment reports.

formerly *FM-TV RADIO COMMUNICATION*

- Sound Recording**—by *Frayne and Wolfe*. No. 53...\$9.50
686 pages, illus., 6 by 9¼, ins., cloth. For designer, engineer, and technician, covers basic problems in recording and reproducing.
- Loudspeakers**—by *G. A. Briggs*. No. 56...\$1.60
88 pages, 5 by 8 ins., paper. A thorough yet concise account of the "why" and "how" of good reproduction in simple language.
- Musical Engineering**—by *Harry F. Olson*. No. 95...\$7.00
369 pages, 6 by 9 ins., illustrated. Interrelated engineering treatment of sound, speech, music, musical instruments, acoustics and sound reproduction.

INSTRUMENTS

- Modern Oscilloscope**—by *J. A. Ruiter, Jr.* No. 58...\$6.00
326 pages, 5¾ by 9 ins., cloth. A description of equipment and operational methods for engineers, servicemen, and teachers.
- Vacuum-Tube Voltmeters**—by *John F. Rider*. No. 59...\$4.50
432 pages, 5½ by 8¼ ins., cloth. Only source book devoted exclusively to this subject. For engineers, technicians, and teachers.
- Encyclopedia on Oscilloscope**—by *J. F. Rider*. No. 60...\$9.00
992 pages, 8½ by 11 ins., cloth. Truly encyclopedic in coverage. This book shows, in detail, efficient use of the scope.

ACOUSTICS

- Acoustic Measurements**—by *Leo L. Beranek*. No. 61...\$7.00
914 pages, 5½ by 8½ ins., cloth. Discusses techniques, apparatus, and theory of acoustic measurements for technicians.
- Acoustic Design in Architecture**—by *Knudsen & Harris*. No. 62...\$7.50
457 pages, 5½ by 8¼ ins., cloth. For engineers and students, a discussion of principles, procedures, and specific applications.
- Acoustic Design Charts**—by *Frank Massa*. No. 63...\$4.00
228 pages, 6 by 9 ins., cloth. Quick, handy reference for those interested in design or construction of electro-acoustic apparatus.

REFERENCE BOOKS

- The Radio Handbook**—*Edited by R. L. Dawley*. No. 64...\$6.00
726 pages, 6½ by 9½ ins., cloth. Detailed constructional information on a wealth of radio communication equipment; all new.
- Broadcast Operators Handbook**—by *H. E. Ennes*. No. 65...\$5.40
265 pages, 5¾ by 8½ ins. cloth. A complete guide to operating and maintenance practice for broadcasters and technicians.
- Data for Radio Engineers**—*Federal T. & R.* No. 66...\$3.75
675 pages, 5½ by 8½ ins., cloth. Revised edition of this comprehensive reference giving data on all phases of radio engineering.
- Radio Eng. Handbook**—by *Keith Henney*. No. 67...\$10.00
1,197 pages, 6 by 9 ins., cloth. The 4th edition contains the latest revisions on all material pertaining to electronics and radio.
- Electrical Eng. Handbook, Vol. 2**—*Pender*. No. 68...\$8.50
1,564 pages, 5½ by 8½ ins., cloth. Covers field of communications, including facsimile, FM, TV, and latest pulse techniques.
- Radio Engineers Handbook**—*Terman*. No. 69...\$9.00
1,019 pages, 6 by 9 ins., cloth. A wealth of technical information, specially selected for application toward practical radio problems.
- Microphones**—by *Engineering Staff, BBC*. No. 73...\$3.25
114 pages, 5½ by 8½ ins., cloth. Covers the theory, design, and characteristics of all standard microphone types.

MISCELLANEOUS

- Radio and TV Almanac**—by *O. E. Dunlap*. No. 71...\$4.00
211 pages, 5¾ by 8 ins., cloth. A chronological record of facts, dates, and people important in the history of radio and television.
- Short-Wave Radiation Phenomena**—*Hund*. No. 72...\$20.00
1,382 pages, 6 by 9¼ ins., cloth, two volumes, not sold separately. A comprehensive treatment of propagation theory and applications.

Book List Department, RADIO COMMUNICATION, Great Barrington, Mass.

I enclose \$..... for which please send me the books indicated by circled numbers below. (No. C.O.D.'s, please.)

| | | | | | | | | | | |
|----|----|----|----|----|----|----|----|----|----|----|
| 40 | 41 | 42 | 43 | 44 | 45 | 47 | 48 | 49 | 50 | 51 |
| 52 | 53 | 54 | 55 | 56 | 58 | 59 | 60 | 61 | 62 | 63 |
| 64 | 65 | 66 | 67 | 68 | 69 | 71 | 72 | 73 | 95 | 98 |

Name

Address

For Every Microphone Need in Two-Way Radio

SHURE

Has a "Field-Proved" Model

Here is the world's most popular fixed-station all-purpose microphone. Outstanding because of its high speech intelligibility, extended frequency range, high output and reduction of feedback. Prevents the transmission of distracting station noises.



Model 55s
"Small Unidyne"
Ultra-Cardioid
Dynamic
Microphone

This is the original "old faithful" mobile hand microphone. Used for rugged field and car duty more than all other makes combined! Features high speech intelligibility and ruggedness. Stands up under heavy use and abuse.



The
"100 Series"
Carbon
Hand-Held
Mobile
Microphone

This Controlled Reluctance Microphone Cartridge is an ideal service replacement for the Model 520SL Dispatcher and for use in special hidden microphone applications. Practically unaffected by heat and humidity.



Model R5
"Controlled
Reluctance"
Microphone
Cartridge

This dispatching unit handles the most severe field requirements of paging and dispatching systems. Supplied with 2-conductor shielded cable, and wired to operate both microphone and relay circuits. Features "Grip-to-Talk, Slide-to-Lock" long-life switch.



Model 520SL
"Dispatcher"
Complete
Dispatching
Unit

Designed for use with small portable and mobile transmitters. Only 2" in diameter and 1 1/4" thick. Has 3-conductor coiled cord, metal-spring strain relief, and Push-to-Talk switch. Has same operating characteristics as "100 Series" Carbon Microphones.



Model 115
Carbon
"Pack"
Microphone

A Controlled Reluctance Microphone and desk stand assembly—ideal for mobile and fixed-station use in all types of communications work. Has a built-in switch for controlling both the microphone circuit and an external relay or control circuit.



Model 510MD
"Controlled
Reluctance"
Microphone
Assembly

SHURE BROTHERS, INC.

Manufacturers of Microphones
and Acoustic Devices

225 W. Huron St. • Chicago 10, Ill.
Cable Address: SHUREMICRO



WEEKLY REPORTS

of FCC Applications Filed for New Communication Systems

Since January 1, the Reports of New FCC Applications for communication systems have been available in the form of Weekly Reports, sent by first class mail or by air mail. This service has been set up because, since COMMUNICATION ENGINEERING is now a bimonthly, too much space would be required to publish the list of applications filed during two months, and there would be too great a delay in making the information available.

Therefore, the Weekly Reports service has been set up at the lowest possible cost, so that communications engineers, frequency coordinating committees, and manufacturers will have complete data promptly on each new application filed in all the safety and special services and aircraft, coastal, and common carrier services.

Each listing gives the full details of the application, including the mail address of the applicant, and the location and purpose of each transmitter.

This data, made available through the cooperation of the Federal Communications Commission, is obtained daily at Washington and rushed to Great Barrington, where the Weekly Reports are prepared and mailed to subscribers.

The annual subscription rate is \$50, or \$15 per quarter. Reduced rates are available to companies ordering extra subscriptions for their executives or field offices, as follows:

| | | |
|------------------|----------|------------|
| 1 Subscription, | per year | \$50.00 |
| 2 Subscriptions, | " | 40.00 each |
| 3 Subscriptions, | " | 35.00 each |
| 4 Subscriptions, | " | 30.00 each |
| 6 Subscriptions, | " | 25.00 each |
| 10 or more, | " | 20.00 each |

Extra for air mail, \$1.50 annually per subscription.

A sample copy of the Weekly Report will be sent upon request, without charge.

New Registry of Industrial Systems

The annual revision of the Registry of Industrial Systems has been completed, and copies are now ready for mailing. Each listing has been checked with the file copy of the original license at the FCC offices in Washington, to assure accuracy.

Complete details are given for each system, including frequencies, call letters, number of mobile units, location of each transmitter, and mailing address of the licensee. Services included are: power utilities, petroleum, pipe lines, special industrial, low-power industrial, motion picture, relay press, and forest products.

Price per copy, prepaid, \$2.00.

RADIOCOM, INC.

The Publishing House, Great Barrington, Mass.

CIRCUIT FAILURES

(Continued from page 36)

sufficiently to permit checks on the 10 sensitive stages. These changes consisted chiefly of provisions for breaking grid and plate return leads to permit insertion of an audio signal and for measurement of gain. A typical IF amplifier stage is shown in Fig. 4, with grid and plate leads broken in order to make failure-prediction measurements. Necessary connections were made to a multi-point connector, into which the plug from the failure-prediction unit could be inserted. Circuit changes entailed the use of only about 7.5% additional components, mostly capacitors and RF chokes; wiring and parts were all fitted without difficulty into the space available in the receiver.

The experimental prediction test unit includes a 3,000-cycle oscillator, voltage-sensing circuits, a leakage detection circuit, and an alarm light. As the main selector switch is rotated to check the gains of the various stages of the receiver, different predetermined levels of audio signal are applied to the grid of each stage. Each input signal is ad-



FIG. 5. THE EXPERIMENTAL FAILURE-PREDICTOR

justed so that if the gain of the stage has changed by more than a safe amount, the voltage-sensing circuits actuate the alarm light. After the test unit has been plugged into the receiver, it takes only a few seconds to rotate the selector switch and discover any weak stages. This switching could be speeded up and made automatic by means of stepping-type switches. A separate 3-position switch on the test unit permits capacitor-leakage sensing and voltage-and-current sensing, in addition to gain sensing. Fig. 5 shows the unit in operation. For field use, it could be made quite compact and portable.

Results: In the laboratory evaluation of this failure-prediction system, 1,000-hour accelerated-aging tests were run on six of the modified receivers. To accelerate failures, temperatures of components were cycled between 10°C. and 120°C. with a 15-minute total period. Voltages

Concluded on page 40

for communications recording
the world around...

magnecord
Voyager

PROFESSIONAL TAPE RECORDER

A single channel recorder specially designed to lighten your remote work — a professional portable recorder and amplifier all in one case. Sturdy, rugged, reliable. Frequency response flat from 50 to 15,000 cps ± 2 db. Other units available with 10 watts of audio.

BINAURAL MAGNECORDER

For two simultaneous recordings on one tape. Can also be used for "third dimensional" sound... unbelievable realism.

NEW! The first automatic continuous recorder... up to 4 channels on a standard $\frac{1}{4}$ inch tape. For commercial and industrial monitoring of communications. Magnecorders are also available for one and 2-channel monitoring.

For demonstration, see your Classified Telephone Directory under "Recorders," or write

Magnecord INC.

Dept. CE-5, 225 W. Ohio Street • Chicago 10, Illinois

6 YEARS PROOF ON 2-WAY RADIO!

Leece-Neville

ALTERNATORS END BATTERY TROUBLES

BATTERY USED FOR STARTING ONLY

Since 1946, L-N Alternators have been eliminating battery troubles on 2-way radio vehicles... or wherever needs for current are high. Replace conventional generators with the L-N Alternator System and get

25 TO 35 AMPERES IDLING!

**ENTIRE ELECTRIC LOAD
CARRIED BY THE ALTERNATOR**

BATTERY KEPT FULLY CHARGED

Let us arrange a demonstration of the L-N Alternator for your fleet. Or



write for all the facts. The Leece-Neville Company, Cleveland 14, Ohio. Distributors in principal cities... Service Stations everywhere.

**HEAVY-DUTY ELECTRIC EQUIPMENT
FOR OVER 43 YEARS**



Be Sure to Specify Leece-Neville

ALTERNATOR SYSTEMS • GENERATORS
STARTING MOTORS • REGULATORS • SWITCHES
FRACTIONAL HP MOTORS



CIRCUIT FAILURES

(Continued from page 39)

were maintained at 15% above design values, and switching transients were simulated by raising plate voltages periodically to 150% of normal for one second. Since the emphasis was upon producing gradual failures, vibration and shock were not included. Prediction checks were made at 5-hour intervals.

A total of 79 tube failures occurred in the six 11-tube receivers during the 1,000-hour test period. Sixty-five of these, or about 80%, were of a gradual and predictable nature—either low trans-

conductance or gassiness—while the other 14 were caused by unpredictable open heaters (7) or shorts (7). The fact that other tube-failure analysis studies have shown only about 50% of failures to be gradual is probably attributable largely to the presence of vibration and shock. Six of the 14 opens and shorts occurred during one 60-hour period during which heaters and plates were cycled one minute on and one minute off; the other 8 were spread over 940 hours.

Fifty-eight of the 65 predictable tube failures were predicted accurately many hours before the receiver failed. Of the seven predictable failures not successfully

predicted, two were in stages not being checked, four were in a single stage where parasitic oscillations interfered with measurement, and one was masked by the change in value of an overloaded resistor. Failures of components other than tubes were negligible and do not warrant any conclusions as to predictability.

The principles of measurement on which the NBS failure-prediction work has been based are not new, and many better failure-prediction systems can undoubtedly be devised. Yet, until now, very little has been done toward developing practical techniques for semi-automatic checks to detect incipient failures. The success of the experimental work at NBS suggests that provision for simple failure-prediction routines for the maintenance of important electronic equipment deserves the serious attention of design engineers.

NEW PRODUCTS

(Continued from page 11)

Relays & Motors: A comprehensive line of relays, contractors, and shaded-pole motors for virtually any electrical application is described in Catalog 122. Hermetic-seal enclosures and octal, solder-terminal, and miniature plug-in connectors are listed also. Potter & Brumfield, Princeton, Ind.

Microwave Materials Data: Describing uses of Polyiron, a high-attenuation permeable dielectric for microwave applications, a new bulletin deals with various kinds of terminations, stock blank sizes, machining and fabrication procedures. *Microwave Components* is available from Henry L. Crowley & Company, Inc., 1 Central Avenue, West Orange, N. J.

Replaceable-Coil Solenoid: Now being produced in quantity are solenoids with coils replaceable upon removal of two spring clamps. Model 230 delivers 6½ in.-lbs. per stroke; model 231, 915 in.-lbs. per stroke. Both are available for any 50 or 60-cycle voltage rating, with dimensions of 2 1/16 by 2 by 3/4 in., exclusive of flanges. Dormeyer Industries, Department L, 3418 N. Milwaukee Avenue, Chicago 41, Ill.

Wire & Cable: Containing reference tables, diagrams, and charts in quantity, catalog PM-3 lists and illustrates a wide variety of wires and cables. Construction, chemical and physical properties, and applications are given for each class. United States Wire & Cable Corp., Progress and Monroe Sts., Union, N. J.

Coaxial Cross-Index: A 22 by 14-in. wall chart contains a cross-index of

coaxial fittings; lists all designations from government part numbers to equivalent manufacturers' part numbers. Sent free by Coaxial Connector Company, 35 North 2nd Street, Mt. Vernon N. Y.

High-Voltage Relay: Series 2800 light-weight relays are available in ST normally-open double-make, SPST normally-closed, and SPDT models. Operate from 1.5 to 250 volts DC; 27.5 volts nominal value. Withstand 1,000 volts RMS between coil and ground, 3,250 volts RMS between contacts and ground. Contacts rated for .25 amperes at 8,000 volts DC. Dimensions, 2 1/8 by 1 7/8 by 1 5/8 ins. Advance Electric and Relay Company, 2435 North Naomi Street, Burbank, Calif.

Telemetry Cable: A new type of shielded cable, BIW626, has been developed for applications requiring minimum microphonic noise characteristics; is claimed to have less than one hundredth that of ordinary microphone cable. Suitable particularly for telemetry and measurements wherein shock and vibration of cable is encountered. Operable from -60° to +400° F.; 600 volts AC rating. Bulletin CE from Boston Insulated Wire & Cable Company, 63 Bay Street, Boston 25, Mass.

SYSTEMS DATA

(Continued from page 4)

155 mc., 1 on 455 mc.

POWER UTILITY: 50 mobile and 3 fixed transmitters on 456 mc.; 5 relays on 37 mc., 2 on 72 mc., 5 on 456 mc., 1 on 959 mc.; 1 control station on 48 mc., 8 on 73 mc., 2 on 456 mc., 10 on 956 mc., and 2 on 6,625 mc.

PIPELINE PETROLEUM: 10 mobile transmitters on 456 mc., 19 on 3 mc., 14 on 1.6 mc.; 7 relays on 72 mc., 2 on 456 mc.; 4 control stations on 72 mc., 8 on 2.92 mc., 4 on 456 mc., and 4 on 6,600 mc.

SPECIAL INDUSTRIAL: 1 control station on 49 mc., 1 on 72 mc., 1 on 152 mc., 3 on 456 mc., 1 on 956.; 3 relays on 72 mc., 1 on 456 mc., 1 on 956 mc.

MOTION PICTURE: 1 control and 1 relay station on 456 mc.

FOREST PRODUCTS: 1 control station on 72 mc., 1 on 456 mc.; 1 relay on 456 mc.

TAXIS: 200 mobile units and 3 base stations on 452 mc.

AUTO EMERGENCY: 40 mobile units and 3 base stations on 453 mc.

COMPANIES & PEOPLE

(Continued from page 15)

to a new location at 212-26 Jamaica Avenue, Queens Village 28, New York City, which will more than triple present production facilities.

Sun Radio and Electronics Company

formerly FM-TV RADIO COMMUNICATION



First in the field for 43 successive years, C-D transmitter capacitors have to be good to get where they are today.

Write for complete technical data.
Cornell-Dubilier Electric Corporation
Dept. TV-53, South Plainfield, N. J.



CONSISTENTLY DEPENDABLE
CORNELL-DUBILIER
CAPACITORS

Plants in South Plainfield, N. J.; New Bedford, Worcester, and Cambridge, Mass.; Providence, R. I.; Indianapolis, Ind.; Fuquay Springs, N. C.; and subsidiary, The Radiant Corp., Cleveland, Ohio

has over 20,000 sq. ft. of floor space on one floor at its new headquarters, 650 Avenue of the Americas, New York City.

Plans of the Erie Resistor Corp. Erie, Pa., include construction of a one-story building of 60,000 sq. ft. at Holly Spring, Miss. The plant will furnish employment for 200 persons within 2 years.

General Instrument Corp. has acquired a fourth plant, to be operated by the F. W. Sickles Division in Danielson, Connecticut. About 65,000 sq. ft. in area, the new plant will be devoted chiefly to assembly work.

The Du Mont Instrument Division has occupied a new building at 750 Bloom-

field Avenue, Clifton, N. J., which contains completely modernized facilities for production of CRT instruments of all types, provides 118,000 sq. ft. of working area on one floor. The main offices of Allen B. Du Mont Laboratories, Inc., will be located there.

REVIEW

(Continued from page 18)

shall not be used as an experimental or demonstrative device." It's doubtful if that provision will be observed strictly because, in many cases, the only way to find out if low-power equipment will perform satisfactorily is to try it! M. B. S.



24 HOUR
DELIVERY
FROM STOCK!

RELAYS

Our stock of more than a million relays — in over a thousand different types — is the world's largest. Don't delay your production for want of large or small quantities of relays of any type.

Telephone, wire or write for quotations.

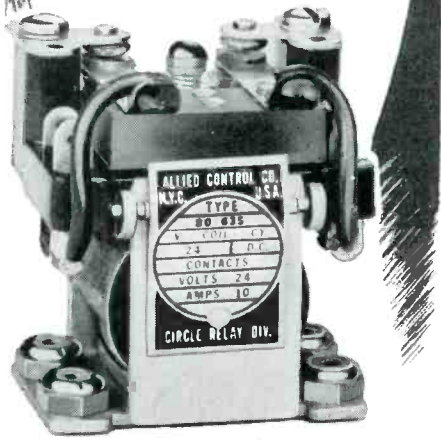

NEW AND MORE
COMPREHENSIVE
1953
RELAY SALES
CATALOG
NOW READY
Be sure to send
for your copy

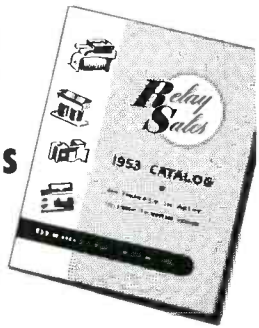

Telephone
SEeley 8-4146
Relay Sales
833 W. CHICAGO AVE.
DEPT. 12, CHICAGO 22, ILL.

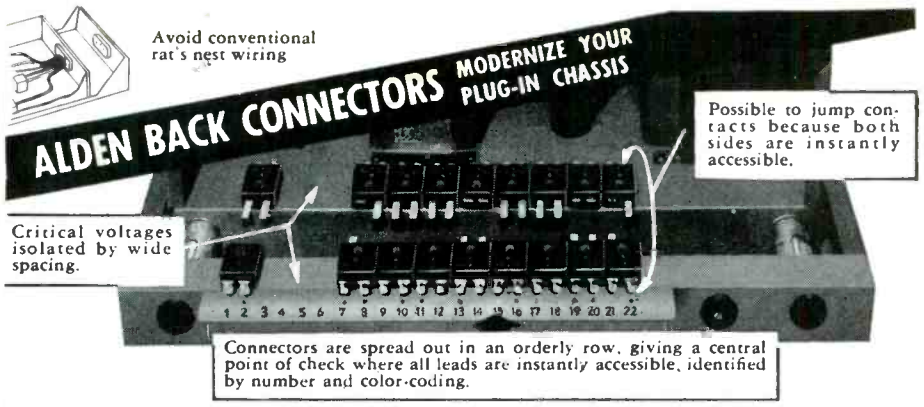

It's as easy as this
Modern design no longer tolerates "blind" connectors and congested rat-nest wiring. Use Alden Back Connectors to convert any chassis to plug-in, with 100% circuit accessibility. It's all done with STANDARD components—no design headaches, no waits, no procurement problems.

ALDEN BACK CONNECTORS

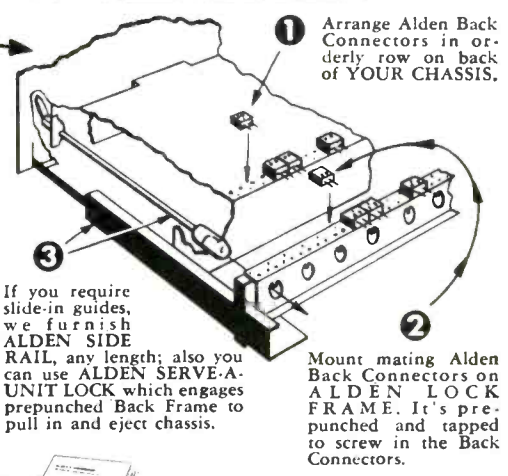
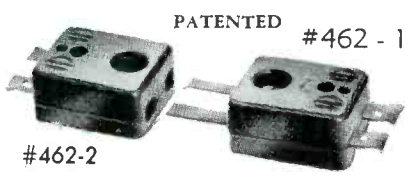

143 N. Main St., Brockton 64, Mass.



SEND FOR FREE SAMPLES — also request free "Alden Handbook" 226 pages of techniques and components for Unitized Plug-in Unit Construction.

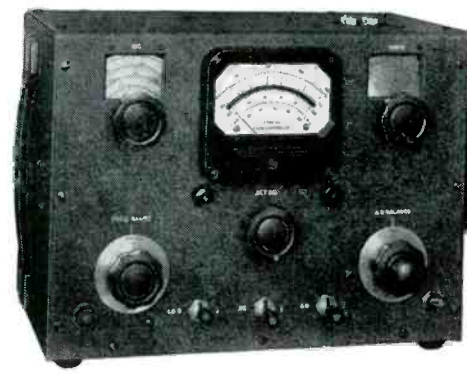

NEW DEVELOPMENT in

VHF measurements

Q-METER TYPE 190-A

17 YEARS OF RESEARCH PRODUCED THESE IMPORTANT FEATURES

- Single, easy-to-read meter, with parallax correction, for all functions.
- Q indicating voltmeter: 50 to 400.
- Multiply Q scale: 0.5 to 3.0.
- A differential Q scale for accurately indicating the difference in Q between two test circuits.
- Additional accurate expanded scale for measuring low values of Q.
- A counter type resonating capacitor dial for improving setting and reading accuracy.
- Careful design to minimize instrument loading of circuit under test.
- Low internal inductance, capacitance and resistance.
- Regulated power supply for increased stability and accuracy.
- Tunable oscillator in four ranges calibrated to high accuracy.
- Compact, simple, rugged construction.

This new 190-A Q Meter measures an essential figure of merit of fundamental components to better overall accuracy than has been previously possible. The VTVM, which measures the Q voltage at resonance, has a higher impedance. Loading of the test component by the Q Meter and the minimum capacitance and inductance have been kept very low.

SPECIFICATIONS—TYPE 190-A

FREQUENCY RANGE: 20 mc. to 260 mc.

RANGE OF Q MEASUREMENT:

| | |
|--------------------------|------------|
| Q indicating voltmeter | 50 to 400 |
| Low Q scale | 10 to 100 |
| Multiply Q scale | 0.5 to 3.0 |
| Differential Q scale | 0 to 100 |
| Total Q indicating range | 5 to 1200 |

PERFORMANCE CHARACTERISTICS OF INTERNAL RESONATING CAPACITANCE: Range — 7 mmfd. to 100 mmfd. (direct reading).

POWER SUPPLY: 90-130 volts — 60 cps (internally regulated).

Write for further information



MULTIPLEX CHANNELS

(Continued from page 23)

quired operating bandwidth which determines T_b , T_e would be increased as additional services are added because of the required adjacent-channel attenuation. As the service reliability requirements become less stringent, an increasing number of channels can be applied in the same space by reducing the margin of safety against inter-channel interference.

2) The class of service determines the required operating bandwidth, as shown in Table I. If telemetering or load-control channels are desired, a great many more can be applied, with the same selectivity against adjacent channels, in the same space that a few relaying channels would occupy.

3) When multiplexing is achieved by audio tones on a carrier telephone or microwave channel, the signal-to-noise ratio and intermodulation of the channel determines the number of services of any class which can be applied. Each additional service degrades the available signal-to-noise ratio and increases the relative magnitude of the intermodulation products with respect to the desired signals.

In general, any practical application will involve a number of different types of services. Therefore, it is necessary to consider each application on its own merits to determine whether requirements can be met in the bandwidth available over a given type of channel equipment. On the other hand, it is quite possible that services could be added in many present multiplex systems by limiting each present channel to the actual bandwidth required for the function involved.

FIRE RADIO SYSTEM

(Continued from page 28)

can be made without changing reels. Voice reproduction is very good, since the frequency response even at such slow speed exceeds that of the standard communication voice band.

The recorders can be run continuously and fed by any or all of the audio busses in the console. Alternatively, they can be voice-operated or started by the carrier-on switch. If not run continuously, it would be quite difficult to locate a specific transmission on a tape. This difficulty has been solved by installing footage counters on each recorder, as can be seen at the top left in Fig. 8. These readings can be correlated with the approximate time of transmission.

Push-buttons are used for manual control of the recorders. They provide for rewind, stop, standard forward speed, and fast forward operation.

**LOOK
at any
part
UP
CLOSE!**

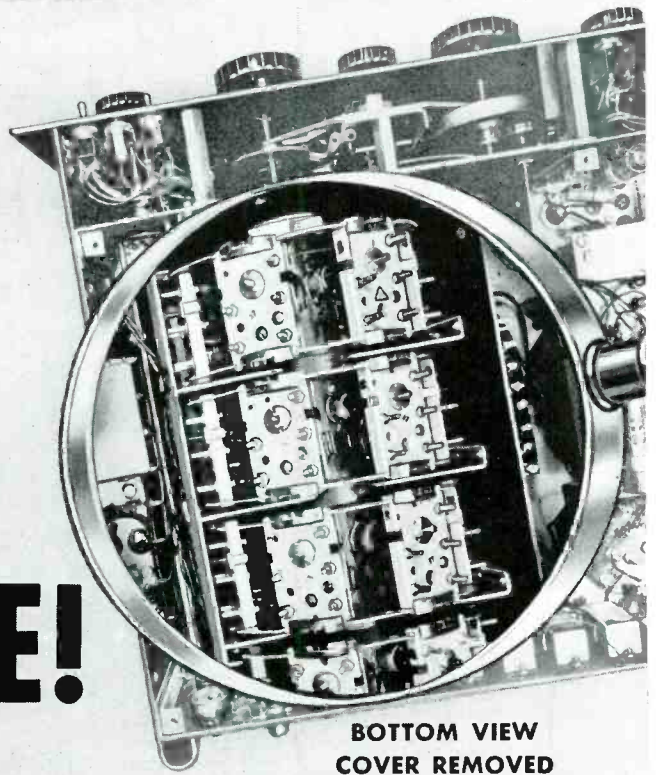

**BOTTOM VIEW
COVER REMOVED**

THE SP-600-JX Communications Receiver USES ROTARY TURRET FOR MAXIMUM SENSITIVITY!

A rotary turret, uniquely incorporated into the "Super-Pro 600-JX," makes possible the placement of the coil assemblies of the two RF Amplifier stages, Mixer stage and First Heterodyne Oscillator stage directly adjacent to their respective sections of the four-gang tuning capacitor and the individual tubes.

Coil assemblies are mounted on the turret. Turning the band selector switch to any one of the six frequency bands places the required coils immediately in their correct positions. This arrangement increases receiver stability, provides uniform maximum performance from band to band, and simplifies servicing.

Every part of the "SP-600-JX" is designed to the highest standards of receiver design. The rotary turret is one example of the fine engineering in this magnificent 20-tube receiver.

The "SP-600-JX", the only professional communications receiver available that provides up to six crystal controlled frequencies, has a range of 540 kc. to 54 mc. It is now being used by the U. S. Army, Navy, and Air Force, other governmental agencies, airlines, the press, maritime, and commercial services, for both single channel and diversity reception. Write today for further details.



HAMMARLUND

42 YEARS EXPERIENCE COUNTS!

HAMMARLUND MANUFACTURING CO., INC.

460 WEST 34th STREET • NEW YORK 1, N. Y.

Simplifying HF Power Measurement
Model 67 TERMALINE
DIRECT-READING R-F WATTMETER

30 mc to 500 mc
(to 1000 mc if specified)
 50 ohms
 Triple Range 0-25 watts
 0-100 "
 0-500 "
 Type N Input Connector
(Adaptor for PL-259 supplied)



● Model 67 is a larger type Wattmeter than the well-known AN-ME-11/U (our Model 611) R-F Wattmeter. Specifically designed for fixed station transmitters to 500 watts output, it may be used nicely on low range for mobile gear. Provided with an aluminum cased, shock-mounted meter, Model 67 is as simple to use as a DC voltmeter. Now in general use throughout the industry, TERMALINE Wattmeters may be depended upon for fast, accurate and repeatable power readings.

NON-RADIATING
 ... Accuracy — 5%
RUGGED CONSTRUCTION
 ... Size — 17" x 9" x 6"
 Wght. — 30 pounds



BIRD
ELECTRONIC CORP.
 1800 EAST 38TH ST., CLEVELAND 14, OHIO
TERMALINE Coaxial Line Instruments

NEELY ENTERPRISES
 Hollywood • San Francisco
 Albuquerque
EARL LIPSCOMB ASSOCIATES
 Dallas • Houston

ROHN
"Superior Design"
COMMUNICATION TOWERS

Proved in Construction, Design, and Operation.
 Truly the finest tower of its kind. Made of heavy-duty tubular steel, electric welded throughout. In 10-ft. sections for easy erection, 14-in. triangular design. Can be used non-guyed to 60-ft.—guyed up to 150-ft.

Get the full facts today!
 Call your Rohn representative or write, phone or wire:
 "Pioneer designers and manufacturers of all type towers."

ROHN MANUFACTURING CO.
 DEPT. CE • 116 LIMESTONE, BELLEVUE
 PEORIA, ILLINOIS • PH. 4-9156

Design Data on the Internationally Famous

WILLIAMSON AMPLIFIER

A new book by D. T. N. Williamson, designer of this renowned audio amplifier, has been published by the "Wireless World" of London. The author, formerly of M. O. Valve Company, and now with Ferranti Research, Ltd., has added a considerable amount of information on high-fidelity reproduction, filters, and an automatic fader to reduce gain while records are being changed.

This book contains 36 pages with 31 photos and diagrams.

PRICE \$1.00 Postpaid in the U.S.A.

NOW AVAILABLE FROM

RADIOCOM, Inc.
 Great Barrington, Mass.

TEST EQUIPMENT

(Continued from page 25)

The earlier FM terminal test set consisted of five elements: an oscilloscope, a linearity tester, a signal generator, an electronic switch, and a TD-2 terminal receiver. In the newer test set these have been integrated into three simpler units: a new oscilloscope, a modified linearity tester, and FM test equipment that includes the functions of the other three elements.

The oscilloscope has a maximum sensitivity of one-quarter volt peak-to-peak per inch of deflection, and the wide frequency response required for wave-form monitoring of TV circuits. Two sweep ranges are provided with center frequencies at one-half field frequency (30 cycles) and one-half line frequency (7,875-cycles). Provision is made for calibrating the oscilloscope to measure input signals that are being monitored.

The FM test unit permits measurement of the 70-mc. FM transmitter and receiver linearity, and monitoring of transmitter deviation. Limiters are included to eliminate amplitude modulation from the input signal. An FM demodulator recovers the video signal component, and a wide-range amplifier boosts the video output to a level that can be varied from 0 to +6 dbm. For viewing two different signals simultaneously, an electronic switch is included. This does the same job as the reed-operated switch mentioned before, but does it electronically to permit a higher switching rate.

In addition to the FM test equipment, and used in conjunction with it, a linearity tester is included for testing and adjusting linearity of FM terminal equipment. Measurements can be made and displayed on the oscilloscope of the repeller voltage of the frequency modulated oscillator versus the output frequency of the FM transmitter, of the discriminator linearity, and of the over-all system linearity.

When units or components of the TD-2 system require repair or major adjustments not possible in the field, they are taken to a maintenance center. These centers are conveniently located to handle a group of stations, and may be part of a normally-attended station or set up specifically for TD-2 maintenance purposes. Test equipment here includes a transmitter-receiver test set and a specially-designed test bench incorporating TD-2 components. Fig. 1 shows this bench set up for a test and repair job on a defective unit. Use of TD-2 control units in the bench-supported cabinet and the power plug-in connecting strip in the left front edge of the cabinet permits the repairman to work on the defective unit while the system is connected for normal operation.

Two auxiliary units are available for occasional use also. These are a frequency calibrator for adjusting transmitter frequency, and an accurate power meter for precise measurements at maintenance centers. Both these units are required for occasional calibration checks at radio stations, and are portable to permit their use at more than one station.

OVERSEAS RADIO

(Continued from page 21)

ilar to the old German Military types, operating at 500 or 4,000 mc., with relatively few channels. They have not been very successful from the standpoint of quality and service, and there is some thought of importing equipment from the United States or England to satisfy the Norwegian Telegraphic Administration's requirements.

Spain: There has not been much new construction in Spain because of political conditions there. The links in operation consists of one 9-channel 2,000 mc. time-division system, supplied by STC of England, which operates across the Strait of Gibraltar; and one from Barcelona to Majorca, an over-water hop, which provides 12 channels on a VHF-FM carrier.

In view of the topographic nature of the country, coupled with the scarcity of copper for new wire-line construction, new interest in radio relays is being shown by the railroads and the Government communication administrations. A network project is planned to connect Madrid with Barcelona and Valencia. It is expected that VHF frequencies will be used.

North Africa: Five systems are operating in North Africa. The most important of these connects Casa Blanca and Afoure, separated by about 280 miles. This distance is covered by 9 repeaters operating at 3,300 mc. Time-division multiplexing is being used.

Another system connecting Tangiers, Rabat, and Fez with 24 channels employs 6 repeaters. Frequencies used are 300 and 2,000 mc.; FM and time-division multiplexing are employed. Between Tunis and Sicily is a 12 to 40-channel VHF-FM system.

Sweden: Although it is not shown on the map, a very large Swedish network is in the planning stage. It is to consist of about 300 repeater stations, which will carry from 1 to 6 telephone channels. Another system of 100 repeaters, capable of carrying 12 to 24 channels, will be installed at strategic operating sites. There are several experimental time-division links now installed which operate at various carrier frequencies, the object being to gain experience before installation of the larger projects.

Concluded on page 46

formerly FM-TV RADIO COMMUNICATION

to the

ELECTRICAL ENGINEER

or

PHYSICIST

with experience in

RADAR

or

ELECTRONICS

Hughes Research and Development Laboratories, one of the nation's leading electronics organizations, are now creating a number of new openings in an important phase of their operations.

Here is what one of these positions offers you:

THE COMPANY

Hughes Research and Development Laboratories, located in Southern California, are presently engaged in the development and production of advanced radar systems, electronic computers and guided missiles.

THE NEW OPENINGS

The positions are for men who will serve as technical advisors to government agencies and companies purchasing Hughes equipment—also as technical consultants with engineers of other companies working on associated equipment. Your specific job would be essentially to help insure successful operation of Hughes equipment in the field.

THE TRAINING

On joining our organization, you will work in the Laboratories for several months to become thoroughly familiar with the equipment which you will later help users to understand and properly employ. If you have already had radar or electronics experience, you will find this knowledge helpful in your new work.

WHERE YOU WORK

After your period of training—at full pay—you may (1) remain with the Laboratories in Southern California in an instructive or administrative capacity, (2) become the Hughes representative at a company where our equipment is being installed, or (3) be the

Hughes representative at a military base in this country or overseas (single men only). Compensation is made for traveling and moving household effects, and married men keep their families with them at all times.

YOUR FUTURE

In one of these positions you will gain all-around experience that will increase your value to our organization as it further expands in the field of electronics. The next few years are certain to see large-scale commercial employment of electronic systems. Your training in and familiarity with the most advanced electronic techniques now will qualify you for even more important future positions.

How to apply:

HUGHES

RESEARCH AND
DEVELOPMENT LABORATORIES

Scientific and Engineering Staff
Culver City,
Los Angeles County, California

If you are under thirty-five years of age, and if you have an E.E. or Physics degree, write to the Laboratories, giving resumé of your experience.

Assurance is required that relocation of the applicant will not cause disruption of an urgent military project.

Communication Registries

WHATEVER information you need about any U. S. communication system in any service group, you will find it in one of the Registries of Communication Systems listed below. These Registries, revised annually from data contained in the original license files at Washington by permission of the FCC.

Each system listing shows the name and address of the licensee, location and type of each transmitter, number of mobile units, call letters, frequencies, type of modulation, and make of equipment used.

Systems are grouped by services in accordance with FCC practice, and are listed alphabetically by states. Currently, facilities added since the previous Registry are so identified.

REGISTRY OF TRANSPORTATION SYSTEMS

Listing all mobile, base, relay, mobile relay, and point-to-point transmitters licensed in the following services:

| | | |
|-----------|-----------------|-------------------|
| TAXICABS | HIGHWAY TRUCKS | TRANSIT UTILITIES |
| RAILROADS | INTERCITY BUSES | AUTO EMERGENCY |

Most active services in this group are the taxicab, railroad, and auto emergency systems.

REGISTRY OF TRANSPORTATION SYSTEMS, postpaid.....\$1.00

REGISTRY OF INDUSTRIAL SYSTEMS

Listing all mobile, base, relay, mobile relay, control, and point-to-point transmitters licensed in the following services:

| | | |
|-----------------|-----------------------|-----------------|
| POWER UTILITIES | PIPELINES & PETROLEUM | FOREST PRODUCTS |
| RELAY PRESS | LOW-POWER INDUSTRIAL | MOTION PICTURE |
| | SPECIAL INDUSTRIAL | |

This Registry has the largest number of new listings, because it includes the relay and point-to-point stations installed by the public utilities and pipe lines. Many listings have been added for the special industrial, forest products, and low-power industrial services, also.

REGISTRY OF INDUSTRIAL SYSTEMS, postpaid\$2.00

REGISTRY OF PUBLIC SAFETY SYSTEMS

Listing all mobile, base, relay, mobile relay, portable, control, and point-to-point transmitters licensed in the following services:

| | | |
|---------------------------|-------------------|-----------------------|
| MUNICIPAL & COUNTY POLICE | STATE POLICE | FORESTRY CONSERVATION |
| ZONE & INTERZONE POLICE | FIRE DEPARTMENTS | HIGHWAY MAINTENANCE |
| | SPECIAL EMERGENCY | |

A large number of new police, fire, and special emergency systems are listed in this Registry. State police systems have been expanded greatly. Interzone police networks now cover practically all the U. S. This is the only CW telegraph service listed in any of the Registries.

REGISTRY OF PUBLIC SAFETY SYSTEMS, postpaid\$1.00

AIR-GROUND AND COMMON CARRIER SYSTEMS

Listing all mobile, base, relay, mobile relay, portable, control, and point-to-point transmitters licensed in the following services:

| | | |
|-------------------|-------------------|----------------------|
| CARRIER AIRCRAFT | AIRDROME ADVISORY | MOBILE UTILITY |
| AIR OPERATIONAL | FLYING SCHOOL | COMMON CARRIER |
| OPERATIONAL FIXED | FLIGHT TEST | COMMON CARRIER RELAY |
| AIRDROME CONTROL | | MISC. COMMON CARRIER |

This Registry lists all transmitters operated in commercial aircraft, and all those used for air-ground communication. Also included are the AT&T relay stations which carry television network programs.

AIR-GROUND & COMMON CARRIER SYSTEMS, postpaid\$1.00

RADIOCOM, Inc.
Great Barrington, Mass.

Please send me the following Registries of Communication Systems, for which I enclose —

\$1.00 Registry of Transportation Systems \$1.00 Registry of Public Safety Systems
 \$2.00 Registry of Industrial Systems \$1.00 Registry of Air-Ground, Com. Car. Systems

Name

Address

OVERSEAS RADIO

(Continued from page 45)

Australia: A 24-channel 4,000-mc. FM system with 3 repeaters is now operating between Sydney and Goulburn. The radio equipment was manufactured by RCA in Canada, and STC in Sydney supplied the frequency-division channelizing equipment. Other systems being installed are manufactured by either STC or AWA, both in Sydney. The former makes 2,000-mc. 24-channel time-division equipment, while AWA supplies 24-channel frequency-division equipment operating at 4,000 mc. There is a complex project underway which will provide many telephone circuits and a two-way television channel between the cities of Sydney and Melbourne.

Conclusion: There has been presented a general outline of commercial radio relay development and application in Europe, Africa, the Near East, and Australia. These areas were chosen because most of the foreign activity has been centered there. In other areas, such as Latin America, the trend has followed very closely that of the United States, with a great deal of emphasis on the utilization of the UHF band.

It can be concluded that most of the activity has been in the VHF range, but that there is a gradual trend toward the use of higher frequencies. This has been so because there does not, in most cases, exist the congestion in the lower frequency ranges suffered in the United States.

MICROWAVES

(Continued from page 29)

be such that intercity point-to-point systems will have to terminate outside the congested areas, and the traffic transferred to down-town offices by other means. Although atmospheric interference is serious above 10,000 mc., experience with radar systems having extremely high peak powers indicates that, if given enough power, you can force signals through five or ten miles of bad weather. Under these circumstances, the fixed frequencies between 800 and 10,000 mc. might be reserved for intercity point-to-point systems, and the fixed frequencies about 10,000 mc. for intracity networks and to connect the suburban terminals of intercity networks with central urban terminals.

The number of microwaves systems is growing. There are approximately 60 fixed microwave communication systems which are over 50 miles in length, in addition to possibly 75 or 80 other systems which consist of one or two hops only. Of

Concluded on page 48

**INDEX
OF
ADVERTISERS**



FOR YOUR CONVENIENCE, TELEPHONE NUMBER OF EACH COMPANY IS SHOWN HERE

| | |
|--|--------------------|
| Adair, George P. | 15 |
| Washington, D. C.: Executive 3-1230 | |
| Alden Products Company | 4-42 |
| Brockton, Mass.: Brockton 160 | |
| American Phenolic Corp. | 11 |
| Chicago: Bishop 2-1000 | |
| Andrew Corp. | 7 |
| Chicago: Triangle 4-4400 | |
| Antenna Specialists | 14 |
| Cleveland, Ohio: Randolph 1-9575 | |
| Bendix Aviation Corp. (Radio Div.) | 2 |
| Baltimore, Md.: Hopkins 3411 | |
| Berndt-Bach, Inc. | 15 |
| Los Angeles, Calif. | |
| Bird Electronic Corp. | 44 |
| Cleveland, Ohio: Express 1-3535 | |
| Bliley Electric Company | 5 |
| Erie, Pa.: Erie 2-2287 | |
| Boonton Radio Corp. | 42 |
| Boonton, N. J.: Boonton 8-3200 | |
| Browning Laboratories, Inc. | 9 |
| Winchester, Mass.: Winchester 6-3700 | |
| Cannon Electric Company | 35 |
| Los Angeles, Calif.: Capitol 5-1251 | |
| Capitol Inst. of Radio Engrng. | 48 |
| Cleveland, Ohio: Executive 1-8888 | |
| Carter Motor Company | 12 |
| Chicago: Humboldt 6-1289 | |
| Communications Company, Inc. | 48 |
| Coral Gables, Fla.: Coral Gables 4-0846 | |
| Communications Engineering Co. | 14 |
| Dallas, Texas: PR 7508 | |
| Cornell-Dubilier Electric Corp. | 41 |
| South Plainfield, N. J.: Plainfield 6-9000 | |
| Eitel-McCullough, Inc. | 16 |
| San Bruno, Cal.: Juno 8-1212 | |
| General Apparatus Corp. | 47 |
| So. Egremont, Mass. | |
| Gerisch Products Inc. | 48 |
| Los Angeles, Calif.: Bradshaw 2-1795 | |
| Hammarlund Mfg. Co., Inc. | 43 |
| New York, N. Y.: Longacre 5-1300 | |
| Hickok Elect. Inst. Company | Inside Back Cover |
| Cleveland, Ohio: Liberty 1-8060 | |
| Hughes Research & Dev. Labs. | 45 |
| Los Angeles, Calif.: Texas 0-7111 | |
| James Knights Co. | 34 |
| Sandwich, Ill.: Sandwich 2141 | |
| Jansky & Bailey | 15 |
| Washington, D. C.: Me 5411 | |
| Jones, Howard B., Division | 48 |
| Chicago: Nevada 2-2000 | |
| Kaar Engineering Co. | 10 |
| Palo Alto, Calif.: Davenport 3-9001 | |
| Kear & Kennedy | 15 |
| Washington, D. C.: Hudson 3-9000 | |
| Klipsch & Associates | 15 |
| Hope, Ark.: Hope 995 | |
| Leece-Neville Company | 40 |
| Cleveland, Ohio: Henderson 1-0740 | |
| Link Radio Corp. | 13 |
| New York, N. Y.: Chelsea 2-1100 | |
| Magnecord, Inc. | 39 |
| Chicago: Whitehall 4-1889 | |
| Maurer, Inc., J. A. | 15 |
| Long Island City, N. Y.: Stillwell 4-4601 | |
| May, Russell P. | 15 |
| Washington, D. C.: Republic 3984 | |
| Measurements Corp. | 15 |
| Boonton, N. J.: Boonton 8-2131 | |
| Microwave Services, Inc. | 15 |
| New York City: Circle 7-4953 | |
| Motorola, Inc. | Back Cover |
| Chicago: Spaulding 2-6500 | |
| Platt Manufacturing Corp. | Inside Front Cover |
| New York City: Worth 4-0827 | |
| Radiart Corp. | 3 |
| Cleveland, Ohio: Melrose 1-6660 | |
| Radio Apparatus Corp. | 14 |
| Indianapolis, Ind.: Franklin 1052 | |
| Radiocom, Inc. | 37, 38, 44, 46 |
| Gt. Barrington, Mass.: Gt. Barrington 1300 | |
| Radio Corp. of America (Eng. Products) | 1, 33 |
| Camden, N. J.: Woodlawn 3-8000 | |
| Radio Corp. of America (Tubes) | 8 |
| Harrison, N. J.: Harrison 6-8000 | |
| Radio Engineering Labs. | 6 |
| Long Island City, N. Y.: Stillwell 6-2101 | |
| Relay Sales Company | 42 |
| Chicago: Seeley 8-4143 | |
| Rohn Manufacturing Co. | 44 |
| Peoria, Ill.: Peoria 4-9156 | |
| Shure Bros. | 38 |
| Chicago: Delaware 7-4450 | |
| John D. Trilisch Company | 14 |
| Houston, Texas: Atwood 9351 | |
| Weldon & Carr | 15 |
| Washington, D. C.: Michigan 4151 | |
| Workshop Associates, Div. of Gabriel Co. | 15 |
| Norwood, Mass.: Norwood 7-3300 | |

FAS Air-Coupler for Bass Reinforcement

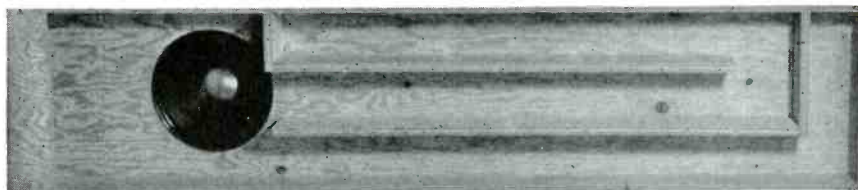

WHEREVER IT IS DEMONSTRATED, the most critical audio experts and designers of custom installations choose the Dual Air-Coupler as the most effective type of enclosure for bass response because 1) It delivers musical bass reproduction down to the lowest organ pedal notes, and 2) the bass does not drop out at low volume.

THE G.A. DUAL AIR-COUPLER, illustrated here with the front plate removed, is an exact duplicate of the original FAS design. It can be mounted under the floor, laid on edge to form part of a seat or low table, or spaced out 6 to 8 ins. from the wall. Dimensions are 72 by 16 by 6 ins.

DUAL AIR-COUPLER, KNOCKED DOWN, all parts precision-cut from high-quality 3/4-in. plywood. Can be assembled with only simple tools. Opening cut for a 12-in. speaker now only \$34.50

DUAL AIR-COUPLER, COMPLETELY ASSEMBLED as illustrated, with front plate mounted, but without speaker. Can be stained or painted, as preferred. Opening cut for a 12-in. speaker now only \$47.50

NEW, COMPACT AIR-COUPLER, supplied completely assembled. A revised design for limited space, measures 42 by 18 by 7 ins. thick. Power-handling capacity is slightly less than standard design, but more than adequate for home use. Without speaker, but cut for mounting a 12-in. speaker \$49.90

ASSOCIATED ITEMS: Altec 600-B speaker for Air-Coupler and intermediate speaker, \$46.50 University 4408 tweeter, \$16.50 Peerless C-455A power choke, \$6.90 Peerless R-560A power transformer, \$10.98 Peerless S-230Q output transformer, \$16.98 English KT-66 output tube, \$4.95. For immediate delivery.

Networks for Two or More Loudspeakers

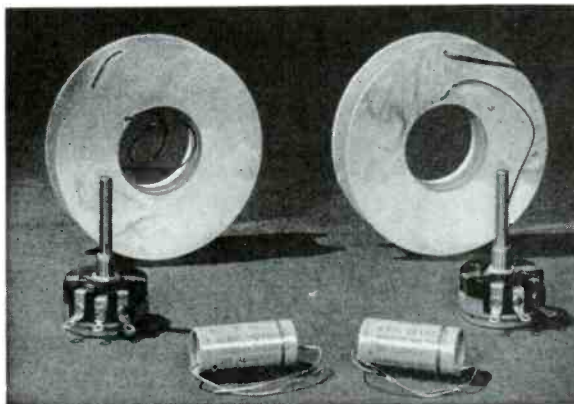

By a judicious selection of associated components the three coil sizes on which G.A. has standardized enable our customers to secure low-cost crossover networks which will operate at 14 different crossover frequencies! For the experimenter, that means a wide range of choice without having to break the bank to buy dozens of coils. For the man who wants to install his system once and for all, it means money saved, because G.A. saves money by making only three coil sizes (10.2, 5.1, and 1.6 Mh) — and it passes on those savings direct to its customers.

If you want to use three speakers with crossover points at 350 and 1,100 cycles, for example, just order two of the networks listed above (for a system employing an 8-ohm woofer, it would be No. 6 and No. 8).

As most everyone has found out by now, G.A. is headquarters for crossover networks. As far as we know, we're the only organization stocking networks specifically designed for use with Air-Couplers.

If you are in doubt about the selection of a network for your particular speakers, send 10c for the G.A. Network Data Sheet, from which you can determine your requirements exactly.

RAPID ATTENUATION NETWORKS

12 db droop per octave. These networks use two inductance coils.

| Impedance of low frequency speaker | Crossover Frequency | Order by Number | Price 2 Coils Only | Price Complete* |
|------------------------------------|---------------------|-----------------|--------------------|-----------------|
| 16 ohms | 2,200 | No. 1 | \$7.00 | \$11.50 |
| | 1,100 | 2 | 7.00 | 12.00 |
| | 700 | 3 | 12.00 | 16.00 |
| | 350 | 4 | 12.00 | 17.50 |
| 8 ohms | 175 | 5 | 20.00 | 24.00 |
| | 1,100 | 6 | 7.00 | 12.00 |
| | 550 | 7 | 7.00 | 13.00 |
| | 350 | 8 | 12.00 | 17.50 |
| 4 ohms | 175 | 9 | 20.00 | 24.00 |
| | 85 | 10 | 20.00 | 26.50 |
| | 550 | 11 | 7.00 | 13.00 |
| | 275 | 12 | 7.00 | 15.00 |
| | 175 | 13 | 12.00 | 19.00 |
| | 85 | 14 | 20.00 | 26.50 |

* Complete networks include necessary capacitors and level controls. Be sure to indicate whether you want just the coils or the complete network.

Air-Couplers are shipped via Railway Express, FOB Great Barrington, Mass.

Other items shipped FOB unless 75c is included to cover parcel post and insurance charges.

General Apparatus Co.

State Road, Great Barrington, Massachusetts

COMCO

Communications Systems
with *Customized* quality

Proven thru the daily operation of thousands of COMCO transmitters and receivers giving reliable service under all operating conditions.



VHF-FM MOBILE PACKAGE

A COMPLETE LINE OF
TWO-WAY RADIO EQUIPMENT

- VHF-FM mobile and base stations
- Remote control equipment & relay stations
- VHF-FM two-way aircraft equipment
- Aeronautical ground station equipment
- VHF-AM mobile unit for airport vehicles
- VHF antennas and other accessories

For details contact your nearest COMCO dealer



Manufacturers of Radio and Electronic Equipment
COMMUNICATIONS COMPANY, INC.
CORAL GABLES 34, FLORIDA

HOW TO GET AN FCC Licensed Radio Operator

you can count on
— in a hurry!

It tells how easily a man of your choice can be selected and trained at home in his spare time to get his FCC license under our "Exclusive Employers' Plan." It offers a detailed, workable program for:

1. Finding such a man.
2. Financing his training.
3. Making sure he gets his license and stays with you.

OUR GUARANTEE

If the student fails his FCC License Examinations, we will continue his training without additional cost until he **DOES** get his License.



Cleveland Institute of Radio Electronics
Special Attention: Desk C
4900 Euclid Avenue
Cleveland 3, Ohio

Rush me information on your "Employers' Plan" for obtaining a Licensed FCC Radio Technician in a hurry.

Name
Firm Position
Address
City Zone State

MICROWAVES

(Continued from page 46)

the large systems, of course, the longest is that of the AT&T, linking both coasts for television and other common-carrier purposes. Over 25 of the remainder are pipeline systems, and over 15 are electric power systems. Eight of the pipeline systems approximate or exceed 1,000 miles in length. The system under construction by the Bonneville Power Administration will extend nearly 1,000 miles, and is the largest of the electric power systems.

I have suggested a method of providing for this expansion. It is predicated on the proposition that by skillful engineering it will be possible for independent users to use the same frequencies at substantially the same locations. There may be other means of achieving this end. However, whatever the method, it must have that result. If we cannot meet this concept we must accept many limitations, and many may have to forego the privilege of using radio.

It is imperative that planning be initiated now for the future use of these frequencies. It is obvious that these plans must have a sound engineering basis, that they take advantage of all known telecommunication techniques, and that they are realistic in meeting the needs of industry. The Commission, because of its small staff and its many problems, is not and may never be in a position to conduct all the studies essential to the formulation of such a long-range plan. Industry has a major stake in this planning. Huge sums are being invested in microwave systems, and every unnecessary risk should be avoided. The help of industry is solicited so that, together, we can insure the most efficient use of this new radio tool in the general public interest.

EQUIPMENT DESIGN

(Continued from page 31)

were duplicated, and these were divided among four different types. Here, too, the cost of outside procurement was prohibitive, and dictated the establishment of our own coil plant.

Conclusion: By careful and intelligent design, it is possible to produce a 2-way radio set of the highest performance and quality at a price considerably less than that of others on the current market. The author wishes to express thanks to Murray Platt, for his contribution to the financial and sales aspects of our program; to Louis Acard, for his invaluable assistance in matters pertaining to production economies and techniques; and to the entire Engineering Staff.

ANY FREQUENCY

20—640 M.C. $\pm 0.001\%$ Accuracy

- Measured
- Generated



Universal application with the Gertsch Model FM-3 direct-reading Frequency Meter. Exceeds FCC requirements. May be standardized against WWV. $\pm 0.001\%$ stability; $\pm 0.0005\%$ resetability. Portable, compact.

Write for free literature to

GERTSCH PRODUCTS, INC.

11846 Mississippi Avenue
P. O. Box 13856 - Los Angeles 25
In Canada, Atlas Radio Corp., Ltd., Toronto

FOR PUBLIC ADDRESS, RADIO, and kindred fields, JONES 400 SERIES PLUGS & SOCKETS

of proven quality!



p.406-CCT

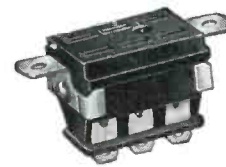

S-406-AB

Socket contacts phosphor bronze cadmium plated. Plug contacts hard brass cadmium plated. Insulation molded bakelite. Plugs and sockets polarized. 2, 4, 6, 8, 10, 12 contacts. Steel caps with baked black crackle enamel.

Catalog No. 18 gives full information on complete line of Jones Electrical Connecting Devices — Plugs, Sockets and Terminal Strips. Write



HOWARD B. JONES DIVISION
CINCH MANUFACTURING CORPORATION
CHICAGO 24, ILLINOIS
SUBSIDIARY OF UNITED-CARR FASTENER CORP.

The Standard of Quality

HICKOK



**Model 292X
SIGNAL GENERATOR**

Frequency Coverage:
125 KC to 220 MC

Calibrated Output:
Less than 1 microvolt,
up to 100,000
microvolts.

Professional engineers and technicians everywhere constantly rely on the accuracy of calibration and long dependability of HICKOK instruments.

In electronic instruments, HICKOK pioneering leadership has been acknowledged for over 42 years.

THE HICKOK ELECTRICAL INSTRUMENT COMPANY
10514 Dupont Avenue • Cleveland 8, Ohio

Motorola Proves-Up Microwave

... for Practical Job Worthiness

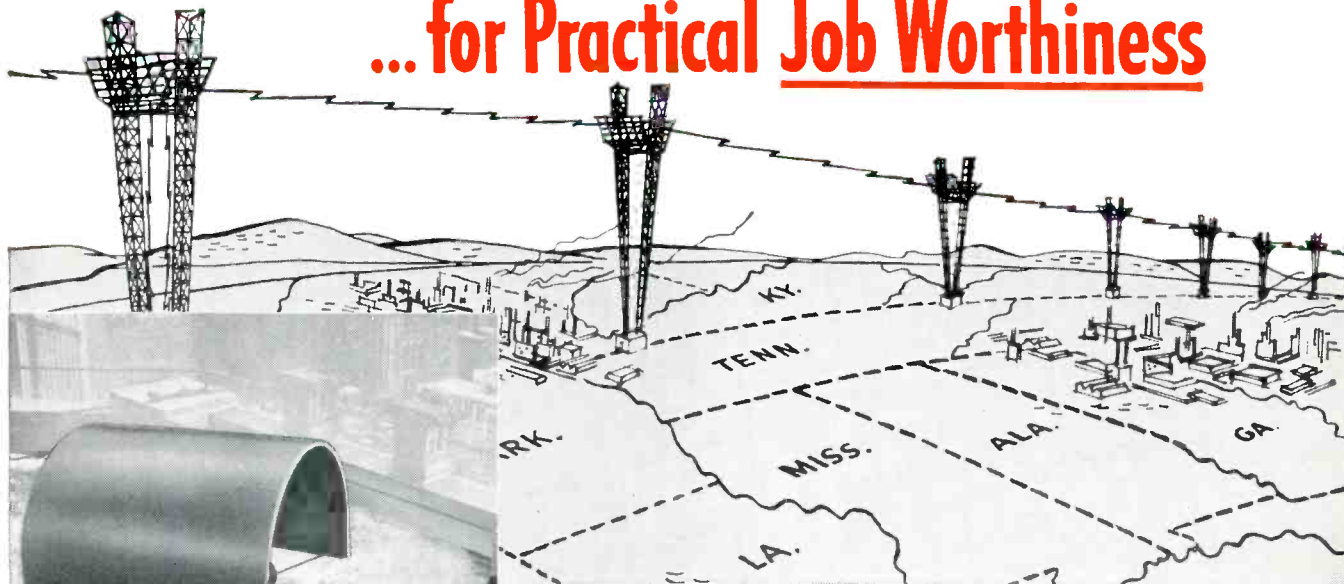

Operating on a round-the-clock basis for Texas-Illinois Natural Gas Pipeline Co., this Chicago roof-top installation terminates a thousand-mile Motorola Microwave system that provides the ultimate in industrial communications.



Simultaneous transmission of numerous telemetering and voice signals over one radio-frequency carrier allows positive, instantaneous control over widely separated, remote system facilities.

Successful Motorola Engineering has produced the kind of thoroughly dependable Microwave that Industry and Safety Services are adopting with justified confidence.

Motorola systems are in and working! Thousands of miles of multi-channel Motorola Microwave systems, with hundreds of operating stations, have been designed, installed and are in daily operation for many pipeline companies, civil agencies and airlines. Eight Motorola systems have been operating 24 hours daily, non-stop, for over four years! With additional major systems under construction, Motorola continues to add to the extensive background of field and engineering experience that has brought outstanding industry acceptance. Below is a partial list of systems installed and operating, and those under construction (*) or under contract (**):

Motorola Systems Are In and Working for These Companies:

Pacific Power and Light Co.,
Portland, Ore.
Brazos River Electric Transmission
Cooperative, Waco, Tex.
Illinois Power Co., Decatur, Ill.
Central Illinois Public Service
Co., Springfield, Ill.
Pan American Pipeline Co.,
Houston, Tex.
Shell Pipeline Co., Houston, Tex.
Panhandle Eastern Pipeline Co.,
Kansas City, Kans.
Mid-Valley Pipeline Co.,
Longview, Tex.
Southern Counties Gas Co.,
Los Angeles, Calif.
*La Fourche Telephone Co.,
Golden Meadow, La.

*Greenwood Telephone Co.,
Greenwood, So. Car.
*Santa Fe Telephone Co., Melrose, Fla.
*Middle South Utilities, Pine Bluff, Ark.
*Bonneville Power Administration,
Chehalis, Wash.
*Sinclair Pipeline Co.,
Independence, Kans.
*Freeport Sulfur Co., New Orleans, La.
*Texas Electric Co., Ft. Worth, Tex.
**West Coast Telephone Co.,
Everett, Wash.
U. S. Atomic Energy Commission
**Dayton Power & Light Co., Dayton, O.
**Southern California Edison Co.,
Los Angeles, Calif.

Job-Proven Microwave . . . by the Leaders of the 2-Way Radio Industry

For full details — write Dept. 22860CE

Motorola Microwave

Motorola Communications & Electronics, Inc.

A SUBSIDIARY OF MOTOROLA, INC.

900 N. Kilbourn Ave., Chicago 51, Illinois
Rogers Majestic Electronics Ltd., Toronto, Canada

— with 20 additional systems under construction