

Communication Engineering

Mar.-Apr. 1953

MILTON B. SLEEPER, *Publisher*

Price 65 Cents

Established as
FM
1940



ANNOUNCING

The Newest, Most Advanced 2-Way Communication System Ever Designed!

PLATT MOBILE RADIO EQUIPMENT

MODEL 30-TRM-31

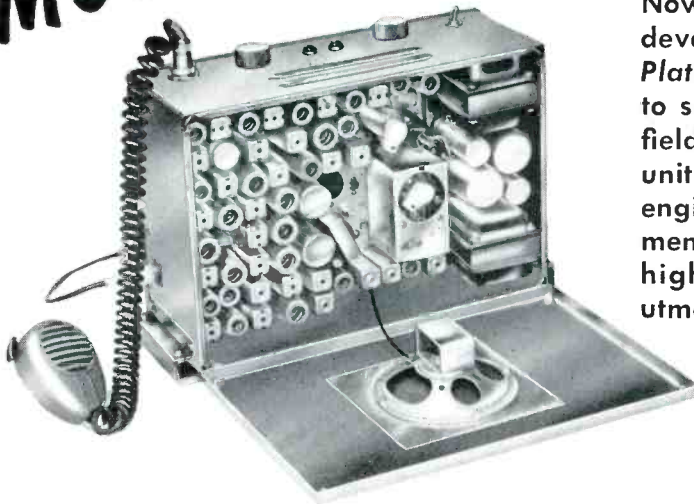

Now, after years of intensive research and development by America's foremost engineers, *Platt Mobile Radio Equipment* is out of the lab to set a new standard in the communications field! It incorporates in one rugged packaged unit all the desirable features that operators, engineers, maintenance men and installation men have demanded for ease of operation, high performance, simple installation and utmost economy.

OPERATES IN 152-174 MC BAND

Platt Mobile Radio Equipment Model 30-TRM-31 incorporates a transmitter and receiver mounted on a single chassis which is installed under one cover with a vibrator power supply affording 30 watts of R-F output in the 152-174 megacycle band.

PLATT MOBILE RADIO EQUIPMENT MODEL 30-TRM-31 (shown). Freq: 152-174 MC. 24 tubes. Dimensions: 14¼" x 9¾" x 5¾".

ALSO AVAILABLE:

Mobile Equip. Model 30-TRM-11. Freq: 25-50 MC.
Base Station Model 30-TRS-31. Freq: 152-174 MC.
Base Station Model 30-TRS-11. Freq: 25-50 MC.

Simplest, Easiest Installation!

Brackets are supplied for installation for front mounting under the dashboard or glove compartment, or in certain installations, under the driver's seat. The controls and loudspeaker are incorporated as an integral part of the cabinet. *Only one short lightweight cable and antenna assembly* are required for complete installation in any vehicle having a 6 volt DC battery system. (12 volts available.)

Finest Components!

The components utilized, without exception, are the very best heat-resistant parts, manufactured for operation at 85° C. without any change in performance.

Competitively Priced!

Platt Mobile Radio Equipment is comparatively low priced, making it an ideal choice for taxi fleets, police, fire departments, forestry, railroads, trucks, civil defense, etc.

Get All the Facts on this Advanced Equipment.

WRITE TODAY FOR YOUR LITERATURE!



PLATT Manufacturing Corp.

489 BROOME STREET • NEW YORK 13 • NEW YORK • WORTH 4-0827

Specify *Bliley*... For 22 Years The Foremost Name In Crystals



Military types CR15, CR16, CR18, CR19, CR23, CR24, CR27, CR32, CR36, CR47 are representative of current production by Bliley. Complete range of types and cross reference index is given in Bulletin 43.

MILITARY



SHIP-TO-SHORE



Types MC7, SR5 and SR8 are suggested for shipboard dependability. Price and details given in Bulletin 44.

BROADCAST



Types BC46T, MO3B, TC92 are first choice for automatic temperature control in AM, FM and TV transmitters. Consult Bulletin 43 for basic details.

SPECIAL PURPOSE



Types SR10 and MC9 provide wide range frequency choice for TV service, diathermy and citizens band. Request Bulletin 44 for price and description.

COMMUNICATIONS



Type BH6A is the predominant choice for land mobile and airborne applications. Consult Bulletin 43 for basic information.

STANDARD



Types KV3, MC9, SMC100 and MS433 cover reference frequencies from 100 kc through 10.7 mc. Price and "stock tolerances" given in Bulletin 44.

AMATEUR



Types AX2 and AX3 together with Bliley packaged oscillator Model CCO-2A were designed to bring precision and price together in the Ham Bands. Price and details are given in Bulletin 44.

ULTRASONIC DELAY LINES



Custom built fused quartz delay lines provide high stability and precision time intervals for manipulation of pulsed or pulse modulated signals. Consult Bulletin 45 for technical information.

FREQUENCY STANDARDS



Model BCS-1A is a high stability instrument for precision reference at 100 kc. Ideal choice for research and development laboratories. Descriptive information given in Bulletin 43.



BLILEY ELECTRIC COMPANY
UNION STATION BUILDING • ERIE, PENNSYLVANIA

Three Specialized Magazines

Each One Is The Leading Publication in Its Own Field:

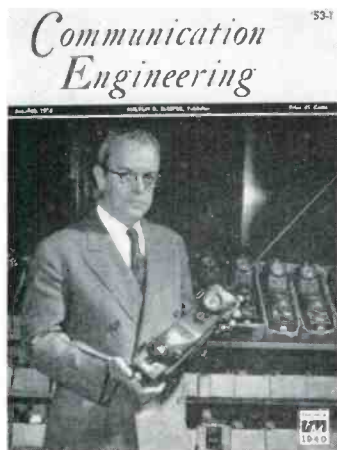

COMMUNICATION ENGINEERING is the only magazine concerned exclusively with the development and design of components and equipment for civilian and military communications, and the planning, installation, operation, and maintenance of fixed, mobile, and microwave relay systems. Edited by Roy F. Allison, it is the principal source of information on new techniques, equipment, and system engineering for the public safety, public utility, petroleum and pipeline, special industrial, transportation, air-ground, and common carrier services. COMMUNICATION ENGINEERING also carries the basic system statistics, and reports on FCC actions concerning the entire field of safety and special services communication systems. It is published on the 20th of January, March, May, July, September, and November. \$3.00 per year, or \$6.00 for 3 years.

TV & RADIO ENGINEERING is the only magazine concerned exclusively with the development and design of TV, AM, and FM receivers, and broadcast studio and transmitting equipment. Edited by Roy F. Allison, this magazine, from issue to issue, is a complete what's-new record of video and audio progress from receiver components to transmitting antennas. You will find this magazine of special value as a source of ideas that can be adapted to solving your particular problems, whether they concern apparatus design or manufacturing techniques, the installation of studios and transmitters, or improved performance of present facilities. In short, if it concerns TV, AM, or FM, you find what you want to know in TV & RADIO ENGINEERING. It is published on the 20th of February, April, June, August, October, and December. \$3.00 per year, or \$6.00 for 3 years.

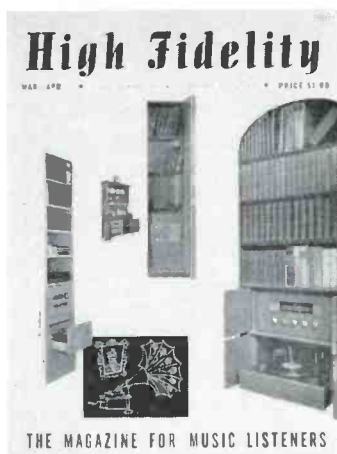

HIGH FIDELITY is the only magazine edited for people who enjoy music from FM, records, and tape. It is planned both for those whose primary interest is in music itself, and for those to whom high-fidelity reproduction is of paramount importance. With Charles Fowler as editor, and John Conly as associate editor, HIGH FIDELITY has really become the bible of these fast-growing groups. LP record reviews, contained in a special 32-page section, are written by nationally-known critics. These are supplemented by feature articles and news of artists and studio activities. For hi-fi enthusiasts, this magazine is the principal source of information on new equipment and its proper use, methods of improving reproduction from FM, records, and tape, and ideas for simple as well as elaborate custom installations. All articles are written in non-technical language, handsomely illustrated, and printed on fine paper. HIGH FIDELITY is also of great value to music teachers, educators, architects, and decorators. Published on the 1st of January, March, May, July, September, and November. \$5.00 per year, or \$10.00 for 3 years.

RADIOCOM, INC., The Publishing House, Great Barrington, Mass.
Please find enclosed my remittance for:

| | |
|--|---|
| COMMUNICATION ENGINEERING | REDUCED RATE FOR BOTH MAGAZINES |
| <input type="checkbox"/> 3 years \$6.00 <input type="checkbox"/> 1 year \$3.00 | <input type="checkbox"/> 3 years \$10.00 <input type="checkbox"/> 1 year \$5.00 |
| TV & RADIO ENGINEERING | Name |
| <input type="checkbox"/> 3 years \$6.00 <input type="checkbox"/> 1 year \$3.00 | Address |

AUDIOCOM, INC.
The Publishing House, Great Barrington, Mass.
Please find enclosed my remittance for:

HIGH FIDELITY MAGAZINE

| | |
|--|--|
| <input type="checkbox"/> 3 years \$10.00 | <input type="checkbox"/> 1 year \$5.00 |
| Add \$1.00 per year for foreign postage. | |
| Name | |
| Address | |

Communication Engineering

Formerly FM-TV and RADIO COMMUNICATION

VOL. 13 MARCH - APRIL, 1953 NO. 2

COPYRIGHT 1953, by RADIOCOM, INC.

DEPARTMENTS

| | |
|--|----|
| Systems Data | |
| Breakdown of new application information | 6 |
| Product Information | |
| New components, equipment, and literature | 7 |
| Companies and People | |
| Expansions, activities, appointments, awards | 10 |
| Meetings and Events | |
| Schedule of important shows and conferences | 10 |
| Communication Review | |
| General news of the industry | 15 |

ARTICLES

| | |
|---|----|
| Channel Spacings at 152 to 174 Mc. | |
| H. E. Strauss | 17 |
| Noise-Free Instrument Cable | |
| New shielded-cable fabrication technique | 22 |
| Profile Charts for Microwave Links | |
| How to determine line-of-sight clearances | 23 |
| Emergency Power Switching Systems | |
| Vincent Callahan | 25 |
| Forming High Frequency Conductors | |
| Gerald W. Lee | 27 |
| Hand-Carried Portable Equipments | |
| Specifications and descriptions | 28 |
| A New Microwave Multiplex System | |
| N. B. Tharp | 31 |

SPECIAL DEPARTMENTS

| | |
|-------------------------------|----|
| Professional Directory | 13 |
| Meetings and Events | 13 |

THE COVER DESIGN AND CONTENTS OF COMMUNICATION ENGINEERING MAGAZINE ARE FULLY PROTECTED BY U. S. COPYRIGHTS, AND MUST NOT BE REPRODUCED IN ANY MANNER OR IN ANY FORM WITHOUT WRITTEN PERMISSION

ROY F. ALLISON, *Editor*

MILTON B. SLEEPER, *Publisher*

FRED C. MICHALOVE *Eastern Manager* CHARLES KLINE *Western Manager* EDWARD BRAND *West Coast Manager*

MIRIAM D. MANNING *Production Manager* LILLIAN BENDROSS *Accounting*

WARREN SYER *Director of Circulation* ELEANOR GILCHRIST *Art Director*

Publication Office: The Publishing House, Great Barrington, Mass. Tel. Great Barrington 1300.

Chicago Office: 426 North Pine Avenue, Tel. Columbus 1-1779.

New York Office: 6 East 39th Street, Room 1209, Tel. Murray Hill 5-6332.

West Coast Office: 1052 West 6th Street, Los Angeles, Tel. Michigan 1732.

COMMUNICATION ENGINEERING Magazine is mailed on the 15th of each month.

Subscriptions: Should be sent to Publishing House, Great Barrington, Mass. Single copies 65c—Subscription rates: \$6.00 for 3 years, \$3.00 for 1 year.

Contributions will be neither acknowledged nor returned unless accompanied by adequate postage, packing, and directions, nor will COMMUNICATION ENGINEERING Magazine be responsible for their safe handling in its office or in transit.

Entered as second-class matter August 22, 1946, at the Post Office, Great Barrington, Mass., under the Act of March 3, 1879. Additional entry at Post Office, Boston, Mass. Printed in the U. S. A.

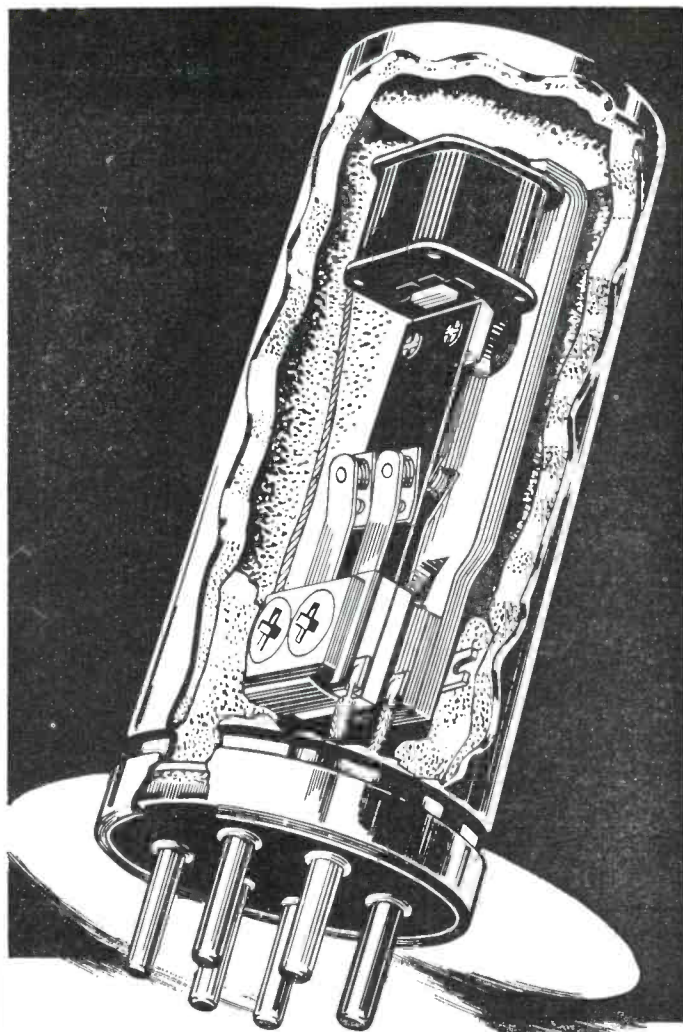

Specifically Designed For
Rugged Mobile Communications Service

DEPENDABLE
and Trouble-Free
VIBRATORS



Select your replacement vibrators wisely... and you, too, will choose Radiart! Laboratory tests and customer reports prove that Radiart Vibrators give LONGER LIFE and trouble-free performance BECAUSE THEY ARE BUILT TO WITHSTAND RUGGED SERVICE! These extra hours of dependable performance is one of the factors that has made Radiart the leader. Superior engineering and design have made them THE STANDARD OF COMPARISON.

At all good radio parts jobbers. Ask for the new Form F781 listing the latest replacement recommendations.



IT'S RIGHT WHEN IT'S RADIART

THE RADIART CORPORATION
CLEVELAND 13, OHIO



• VIBRATORS • AUTO AERIALS
• ROTORS • TV ANTENNAS • POWER SUPPLIES



CIRCULATION AUDITED BY
HENRY R. SYKES
CERTIFIED PUBLIC ACCOUNTANT
SYKES, GIDDINGS & JOHNSON
PITTSFIELD, MASSACHUSETTS

...no matter there's a BENDIX RADIO



W. H. Switzer
3918 E. Hartson Ave.
Spokane 31, Wash.



Raymond H. Gries
588 Bryson Avenue
Palo Alto, California



Stephen J. Holland
8524 Glencoe Circle
Wauwatosa 13, Wisc.



Thomas A. Curtis
2007 W. Court St.
Flint, Michigan



Wayland H. Hoyt
6453 W. 82nd St.
Los Angeles 45, California



D. L. Kesselhuth
10500 Magnolia Blvd.
North Hollywood, California



William N. Harman
2605 Milwaukee
Denver, Colorado



Marvin P. Hoffarth
7424 General Sherman Lane
St. Louis 23, Missouri



R. L. Daniel
West Coast Sales Manager



C. Cressman
1408 Argentia Drive
Apt. B
Dallas 8, Texas



Newton O. Rogers
218 W. Montana
Dallas, Texas

You're looking at capable, experienced engineers in two-way radio. All set to serve you no matter where you operate . . . or what your problem is.

Complete railroad communication systems . . . taxi fleet installations . . . fire and police departments . . . construction projects . . . 2-way industrial applications, etc. You name it.

Each one of these field men is backed by the 4500 other Bendix engineers, who have made Bendix the "Name Millions Trust."

In addition to offering the latest type of Mobile equipment . . . these engineers give all technical help in obtaining your license and complete system engineering. Call or write today.

BENDIX* RADIO

Dept. 85 BALTIMORE 4, MARYLAND

A Division of BENDIX AVIATION CORPORATION

Export Sales: Bendix International Division, 72 Fifth Ave., New York 11, N. Y

*Reg. U. S. Pat. Off

where you look

COMMUNICATIONS ENGINEER near you!



Pierce Bingaman
188 West Randolph Street
Chicago 1, Ill.

W. L. Cunningham
Railroad Sales Manager



A. E. Jones
1454 Madison Pl.
Pompton Lakes,
New Jersey



Robert R. Baldrige
5414 Youngridge Dr.—Apt. A
Pittsburgh 27, Pa.



Charles O. McAtee
39-A Parkway
Haddonfield, N. J.



L. J. Straw, Manager
General Mobile Sales



Herman M. Gillmon
6172 Parkway Drive
Baltimore 12, Md.



T. S. Eader, III
Bendix Radio
Baltimore 4, Maryland



John R. Murphy
22 Lawn Avenue
Middletown, Conn.



Jack R. Stott
Glencoe, Maryland



Wesley F. Wachtel
1847 Yorktown Rd.—Apt. 1
Cincinnati 37, Ohio



Gerald Klugerman
531 S. W. 7th St.
Miami, Florida



Jack J. Baxter
P. O. Box 839
5828 Hallandale Blvd.
Hollywood, Florida

W. W. Price, Manager
Mobile Sales



Bendix THE MOST TRUSTED NAME IN **Radio**



RADIO ENGINEERING LABS., Inc.

PIONEERS IN THE CORRECT USE OF
ARMSTRONG FREQUENCY MODULATION

HERE ARE FACTS about REL Multiplex Installations

The number of REL multiplex radio relay and point-to-point installations now in use, and the length of time they have been in service, provide ample evidence of their reliability and economy. Heart of REL installations is the Serrasoid Modulator, distinguished for low noise, low distortion, and long-time stability.

Among the companies using REL equipment in order to achieve that quality of performance are:

Canadian National Telegraphs
Canadian Pacific Railways
Chesapeake & Potomac Tel. Co.
Empresa Nacional de Tele-
comunicaciones, Columbia
Israel Ministry of Communications
Mutual Tel. Co. of Hawaii
New England Tel. & Tel. Co.
Pacific Tel. & Tel. Co.
Panair do Brazil
Quebec Telephone Co.
Salt Lake Pipe Line Co.

REL manufacturers standard units for 70 to 2,000 mc., and modulation to 300 kc. for as many as 50 voice circuits. This equipment is suited to operation under topographical or climatic conditions encountered in any part of the world. Special types can be designed and built to suit unusual requirements. REL multiplex equipment is now in use by telephone companies, railroads, broadcasters, government services, and other operators of communication systems. Consultation service is available to those planning new installations or the modification of present facilities. Address:

Engineers and Manufacturers of
Broadcast, Communication, and
Associated Equipment since 1922

RADIO ENGINEERING LABORATORIES, Inc.

TEL.: STILLWELL 6-2100 TELETYPE: N. Y. 2816
36-40 37th Street, Long Island City 1, N. Y.

SYSTEMS DATA

EFFECTIVE with this issue, statistics on communication systems will be presented on a 2-month basis, rather than quarterly, because of the bi-monthly publication schedule of COMMUNICATION ENGINEERING. The data in the accompanying table was compiled from our Weekly Reports of new applications filed with the FCC for communication facilities.

The first three columns show the total mobile, base, and portable transmitters to be used in the 30 to 50-mc. and 152 to 174-mc. bands, while the succeeding columns divide the transmitters according to frequency bands.

Special industrial installations still lead in activity, with police and taxi use not far behind. Fire radio transmitters are gaining steadily. As time goes on, this use may equal or even exceed the police service. The conviction is growing among fire chiefs that all cars and apparatus should be radio-equipped. In most cities and towns, the fire department owns more vehicles than the police department. It will be noted that the majority of the new fire radio transmitters are to operate on the lower band. It would seem that outside the larger cities, at least, the upper band should be preferred because of skip reception.

This is the first period when substantial signs of activity on 450 mc. were evident to any great degree. Applications for mobile equipment in that band

were filed by 1 police department, 2 power utilities, 6 taxicab companies, and 1 automobile emergency garage. These 10 systems represented a total of 1,088 mobile units.

Following is the breakdown of applications filed in January and February for transmitters which are not listed in the accompanying table:

POLICE: 22 speedmeters; 4 mobile and 1 base transmitter on 450 mc.; 3 relay or control stations on 150 mc.; 6 relay or control stations on 74 mc.

HIGHWAY MAINTENANCE: 6 speedmeters; 5 relay or control stations on 74 mc.

FOREST PRODUCTS: 14 control stations on 46 mc.; 4 relay or control stations on 152 to 174 mc.

POWER UTILITIES: 6 relay or control stations on 74 mc.; 2 relays on 158 mc.; 60 mobile and 2 base transmitters on 450 mc.; 8 relay or control stations on 460 mc.; 2 fixed stations on 1,900 mc.; and 1 control station on 6,585 mc.

PIPELINE PETROLEUM: 12 relay or control stations on 74 mc.; 10 mobile, 4 control, and 2 mobile relay transmitters on 456 mc.; 1 fixed station on 955 mc.; and 22 relay stations on 1,900 mc.

SPECIAL INDUSTRIAL: 3 relay or control stations on 74 mc.; 7 relay or control stations on 152 mc.; 4 relay stations on 456 mc.

TAXICABS: 999 mobile and 6 base transmitters on 450 mc.

TABLE OF APPLICATIONS FILED JAN. 1 TO FEB. 28, 1953

| | TOTAL | | TOTAL — 30 to 50 mc. — | | | — 152 to 174 mc. — | | | |
|----------------------------------|--------|-------|------------------------|--------|------|--------------------|--------|------|-------|
| | MOBILE | BASE | PORT. | MOBILE | BASE | PORT. | MOBILE | BASE | PORT. |
| Police | 1,410 | 114 | 159 | 837 | 61 | 103 | 573 | 53 | 56 |
| Fire | 800 | 86 | 101 | 488 | 25 | 83 | 312 | 61 | 18 |
| Special Emergency | 243 | 81 | 3 | 211 | 73 | 3 | 32 | 8 | — |
| Highway Maintenance | 371 | 19 | — | 271 | 16 | — | 100 | 3 | — |
| Forestry Conservation | 416 | 72 | 15 | 377 | 44 | 1 | 39 | 28 | 14 |
| Power Utility | 795 | 84 | 24 | 519 | 56 | 13 | 276 | 28 | 11 |
| Pipeline Petroleum | 527 | 119 | 12 | 397 | 96 | 12 | 130 | 23 | — |
| Special Industrial | 2,095 | 196 | 108 | 1,644 | 142 | 50 | 451 | 54 | 58 |
| Low-power Industrial | — | — | 305 | — | — | 64 | — | — | 241 |
| Relay Press | — | — | — | — | — | — | — | — | — |
| Motion Picture | 18 | 1 | — | — | — | — | 18 | 1 | — |
| Forest Products | 230 | 24 | 17 | 210 | 20 | 17 | 20 | 4 | — |
| Taxicabs | 1,215 | 114 | — | — | — | — | 1,215 | 114 | — |
| Railroads | 492 | 29 | 61 | — | — | — | 492 | 29 | 61 |
| Highway Trucks | 472 | 35 | — | 472 | 35 | — | — | — | — |
| Intercity Buses | — | 6 | — | — | 6 | — | — | — | — |
| Transit Utilities | 192 | 2 | 6 | 192 | 2 | 6 | — | — | — |
| Auto Emergency | 146 | 15 | — | 146 | 15 | — | — | — | — |
| Radio Paging | — | 23 | — | — | 23 | — | — | — | — |
| Common Carrier | 250 | 3 | — | — | — | — | 250 | 3 | — |
| Miscellaneous Com. Carrier | 485 | 14 | — | — | — | — | 485 | 14 | — |
| | 10,167 | 1,037 | 811 | 5,764 | 614 | 352 | 4,393 | 423 | 459 |

PRODUCT INFORMATION

Silvered-Mica Capacitors: High-stability SRC silvered-mica capacitors, in ranges from 2 mmf. to .1 mfd. and in tolerances from 1 to 20%, meet or surpass characteristic E of JAN C.5. DC working voltage is 500 up to 10,000 mmf.; 250 above. Particularly in-



tended for precision filter and instrument applications. British Radio Electronics Ltd., No. 1 Thomas Circle, Washington 5, D. C.

Transistor Transformers: Ultra-miniature transformers designed primarily for transistor audio applications weigh less than .1 oz., measure about 1/4 by 3/8 by 3/8 in. Rated at 1 milliwatt. Bulletin available from Standard Transformer Corp., 3580 Elsten Ave., Chicago 18, Ill.

Carrier Telegraph Units: Type 24C AM carrier telegraph equipment can divide physical or carrier-derived voice channels for teleprinter, telemetering, remote control, and other telegraph carrier services. Each 4-wire voice channel provides up to 18 telegraph channels; each 2-wire voice channel, up to 9 subchannels. Equipment for each channel

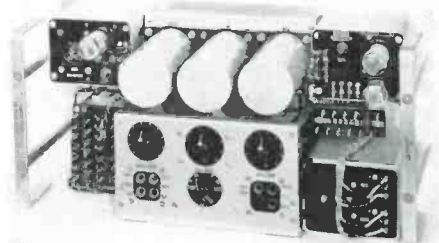

occupies 8 3/4 ins. of 19-in. rack space. Many standard terminal assemblies are available. Lenkurt Electric Company, County Road, San Carlos, Calif.

Helical Beam Antennas: Providing 12 to 14-db gains, unidirectional helical-beam antennas for 450 to 470-mc. applications are polarized circularly with right or left-hand helices. Conductor is sealed in radome housing which can withstand 100-mph. winds with 1/2-in. ice coating. Mark Products Company, 3547-49 Montrose Ave., Chicago 18, Ill.

Connector Manual: New 40-page manual gives detailed analyses of proper techniques for cutting, stripping, soldering, and assembly of wires and cables to AN, RF, and special electrical connectors. Copies available free of charge from American Phenolic Corp., Dept. 13R, 1830 South 54th Ave., Chicago 50, Ill.

Parabolic Reflectors: Complete mechanical dimensions and specifications for over 100 types of stock parabolic reflectors are given in a catalog just prepared and available on request from Workshop Associates Division, The Gabriel Company, Endicott Street, Norwood, Mass.

formerly *FM-TV* RADIO COMMUNICATION

Encapsulated Resistors: Exceeding MIL-R-93 and JAN-R-93 type A Specifications, a new line of encapsulated resistors has low thermal expansion coefficient, is available in 45 variations from 1/2 to 2 watts. Cinema Engineering Company, Burbank, Calif.

FM Police Radio: Model FM-3 communication receiver for monitoring purposes has coverage of 30 to 50 and 150 to 160-mc. bands. Sensitivity of 10 microvolts is claimed. Rex Electric Company, 4009 E. Michigan Street, Indianapolis 1, Indiana.

Line Equalizer: A new program line equalizer, designed to improve frequency response of communications circuits, has 4 points of equalization frequency depending on terminal selection. Consists of parallel network

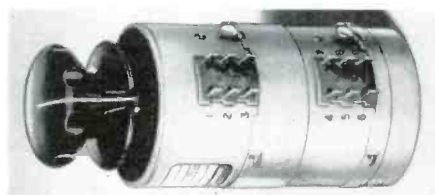

and calibrated step-type series control. Type 286 equalizer can be supplied as multiple assembly on 5 1/4 in. rack panel. The Daven Company, Dept. P, 191 Central Avenue, Newark 4, N. J.

Tantalum Foil Electrolytics: Polarized and non-polarized electrolytic capacitors of wound tantalum foil construction are described in a new bulletin, No. 523. Compactness, ruggedness, non-corrosive electrolyte, extremely low leakage current, long shelf life, low power factor, high operating temperature, and good frequency characteristics are claimed for these units. Cornell Dublier Electric Corp., Industrial Division, South Plainfield, N. J.

New Tube Tester: Professional-type dynamic mutual conductance tube tester 533A accommodates standard, miniature, and sub-miniature types, measures 0 to 15,000 micro-



hos, tests for gas and noise, and gives indication of probable life expectancy. Available in 3 case styles. Hickok Electric

Continued on page 8

From Alden's Line of Ready-made Components
for Unitized Plug-in Unit Construction:

No more blind connectors

#462 - 1



#462-2

ALDEN PATENTED

BACK CONNECTORS

Get accessible central
check point for incoming
and outgoing leads

Color coding

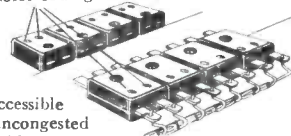

Accessible
uncongested
solder terminals

EASY SERVICING AND RAPID CIRCUIT CHECKS

Solder terminals easily accessible and uncongested for multiple contact wiring. Color-coding on back connector, corresponding to lead color, identifies each lead for instantaneous check to main circuit or trunk line.

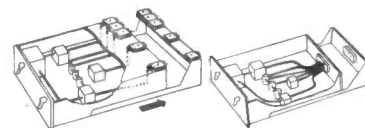

Permit direct
efficient wiring

Avoid conventional
rats nest wiring

EFFICIENT CIRCUIT WIRING

Connectors can be mounted where desired — to allow for isolation of critical voltages or frequencies — to provide most direct wiring from component to connector — to eliminate rat-nest wiring of conventional methods.

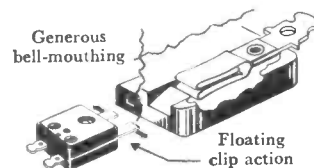

Generous
bell-mouthing

Floating
clip action

EASY INSERTION AND REMOVAL

Made possible by large bell-mouth entries and ample float of rugged live-action beryllium copper contacts. Wide mating tolerances eliminate critical unit alignment problems.

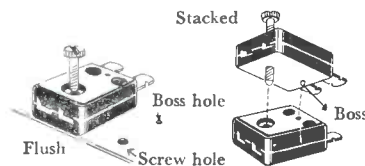

Flush

Stacked

Boss hole

Boss

Screw hole

EASY MOUNTING

Single screw for mounting flush or stacked. Molded locating boss positions and locks connector in place on unit when flush mounted — boss accurately lines up and positions connectors together in stack mounting.

SEND FOR FREE SAMPLES

— also request free "Alden Handbook" 226 pages of techniques and components for Unitized Plug-in Unit Construction.



ALDEN PRODUCTS Co.

143 N. Main St., Brockton 64, Mass.



Before you buy anybody's MICROWAVE SYSTEM

Consider these 5 facts!

1. Who is the manufacturer?

When you specify RCA, the answer is easy. Because RCA is the world's greatest name in radio, television, and related activities. RCA has pioneered in high-frequency radio communications and really knows microwave from start to finish.

2. What has he actually done in the microwave field?

Again, RCA has rolled up an impressive record. Installed and operating are more than 19,000 channel miles of RCA microwave systems, for pipelines, power utilities, turnpikes, and government agencies. One system is over 1000 miles long, extends from New York to Washington and Pittsburgh. And after three years' continuous experience, expansion is being planned . . . proof enough of *outstanding RCA performance.*

3. Is he equipped to install microwave?

Again, with RCA, the answer is "yes." RCA will handle your installation for you . . . will even furnish you with a detailed aerial survey of the microwave route.

4. Is he equipped to maintain microwave?

Again, RCA is out in front, with a nationwide service organization geared to handle your microwave maintenance on a 24-hour basis. It's the *RCA Service Company*—already well known for its service to industry on other types of electronic equipment. It's available to you when *you* specify RCA.

5. Is the equipment designed with an eye to the future?

Yes . . . if it's RCA equipment.

For instance—consider the matter of adding additional voice and signal channels. Thanks to RCA's "eye to the future" design, you can add or drop channels at any station with a minimum of cost . . . a minimum of equipment.

Why settle for less than RCA MICROWAVE?

When you start talking about microwave, you're talking about *money*. So isn't it just good sense to be sure you invest in the best? With RCA, you're dealing with the leading name in radio . . . with men who *know* microwave. *So specify RCA—and be sure.*

You get these 7 plus features with RCA Microwave

1. Uses conventional tubes throughout.
2. Easy to tune. Has built-in metering.
3. Handles large number of single side-band frequency division channels without excessive cross-talk.
4. Flexible. Any or all voice or control channels can be picked up or dropped at any station, repeater or terminal.
5. Service channel with signaling available at each repeater and terminal station.
6. Vertical space, provides ready access both front and rear.
7. Designed, built, and backed up, by RCA . . . world leader in electronics.



RADIO CORPORATION of AMERICA

MORE INFORMATION? MAIL COUPON TODAY

RCA Communications, Dept. 132K, Camden, N. J.

Without obligation, please send me more information on RCA Microwave for the specific application indicated: _____

Name _____

Position _____

Company _____

Address _____

City _____ State _____

Please have an RCA Microwave Engineer call on me.

NEW PRODUCTS

(Continued from page 7)

cal Instrument Company, 10530 Dupont Ave., Cleveland 8, Ohio.

Frequency & Modulation Meters: Type 105-B micrometer frequency meter covers 100 kc. to 175 mc. with accuracy of .0025%, contains internal crystal standard and facilities for zero-beating, as well as internal signal-generator circuits. Model 205 FM



modulation meter has continuous coverage from 25 to 200 mc., direct-reading from 0 to 25 kc. deviation on 3-in. meter. Lampkin Laboratories, Inc., Bradenton, Florida.

Communication Towers: Standard triangular tower sections of heavy-duty tubular steel are available for communication towers which will withstand 80-mph. winds. Sections of 12-in. cross-section are self-supporting up to 50 ft., can be used up to 100 ft. with guys. Sections of 14-in. size can be used up to 150 ft. Rohn Mfg., Company, 2108 Main Street, Peoria, Ill.

Miniature Relays: Hermetically-sealed DPDT relays, weighing 3½ ozs., meet shock requirements of Mil-E-5400, operate under acceleration of 50 G. Coil power re-

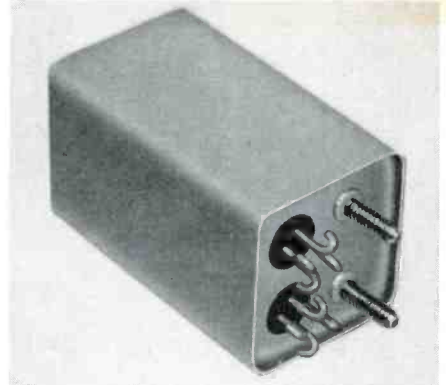

quirements can be as low as 20 milliwatts, coil resistance as high as 15,000 ohms. Life tests to date show over 1.75 million operations without malfunctioning. Phaostron Company, South Pasadena, Calif.

Soldering Machine: A 250-watt soldering machine for use on AN connectors, terminal boards, and high-temperature soldering operations utilizes two needle-point elec-

trodes which can reach in to very cramped spaces with ease. Power switch is foot-actuated. Electrodes are replaceable at low cost, last at least a year. Joyal Products, Inc., 56 Belmont Avenue, Newark 3, N. J.

High-Frequency Relay: Described as completely free from contact bounce and capable of operation at 2,500 times per second, type T relays are now available generally. Pull-in time is 120 microseconds; drop-out time, 100 microseconds. Life expectancy is said to be 5×10^6 operations. C. P. Clare & Company, 4719 West Sunnyside Avenue, Chicago 30.

Molded Paper Capacitors: Type 85-P molded paper capacitors, said to be the smallest available, are rated for continuous operation at 125°C. They are now available for general use in two mould sizes, .175 by 5/8 in. and .200 by 5/8 in., and in 20, 10, and 5% tolerances. Bulletin 205E sent on letterhead request to Sprague Electric Company, 243 Marshall Street, North Adams, Mass.

VHF Trimmer Capacitor: Measuring only 3/4 by 5/8 in. and with a range of 1.4 to 19.6 mmf., type MAC variable capacitor is intended for miniaturized VHF equipments.

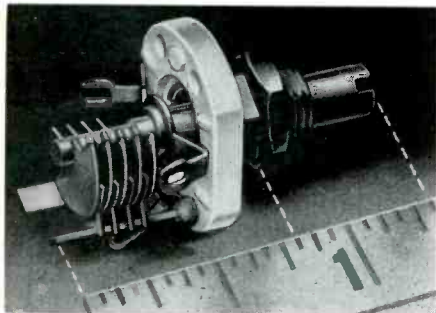

Rotor and stator are of silver-plated brass. The wiper rotor contact is of silver-plated beryllium-copper. Hammarlund Manufacturing Company, Inc., 460 West 34th Street, New York 1, N. Y.

Tubes and Sockets: Literature and technical data is available on the following tubes, germanium diodes, transistors, and sockets:

Eitel-McCullough, Inc., San Bruno, Calif.—Data available on 152 TH medium-mu triode, 600 watts up to 40 mc. as modulator, oscillator, or amplifier; 4E27A/5-125B radial-beam power pentode, 300 to 400 watts up to 75 mc. as modulator, oscillator, or amplifier; 4PR60A radial-beam pulse tetrode, replacing 715C and 5D21, about 270 kw. pulse power as modulator or amplifier; 4X150A and 4X150D radial-beam power tetrodes, 140 watts up to 500 mc. as amplifier, oscillator, or multiplier; 4-250A radial-beam power tetrode, up to 1,000 watts as amplifier, modulator, or oscillator, useful to well above 75 mc.

International Rectifier Corp., 1521 East Grand Avenue, El Segundo, Calif. — Novel germanium diode assemblies, in double housings of phenolic material and glass. Excellent shock and vibration resistance claimed.

Lewis and Kaufman, Ltd., 62 El Rancho Avenue, Los Gatos, Calif. — Technical data sheet available on 4D21 power tetrode as Class AB1 or AB2 AF amplifier and modulator, Class C RF oscillator and unmodulated or high-level modulated amplifier.

Texas Instruments, Inc., 6000 Lemmon Avenue, Dallas 9, Texas — Point-contact transistor types 100 and 101. Former is for switching-circuit applications. Type 101 is high-efficiency amplifier for use below 1 mc. capable of handling large signals.

NEW NEW NEW NEW NEW

MONITORADIO MODEL DR200

Model DR200 Two Band Communications Receiver newly developed—low cost—only one of its kind. Fixed and Tunable Combination AC Receiver for 30-50 MC and 152-174 MC—a long-awaited-for development in less expensive units for monitoring existing 2-way radio communication systems.

Operating in two pertinent fixed frequency ranges, the tunable feature can be used alternately with the flip of a switch. Under routine operating conditions the DR200 performs as any standard crystal controlled monitor receiver. But when conditions require, a flip-of-the-switch makes the unit tunable across the full frequency range.

Such flexibility of performance makes the Monitoradio DR200 ideal for expanding communications systems of municipal police, civil defense, fire, forestry, state police, pipelines, taxis. Use and application of this unique receiver is limited only by the imagination.

Built-in sensitive squelch with level control. Dual conversion, 10.7 MC and 455 KC. Fully tuned RF stage. Fourteen tubes plus rectifier. Sensitivity for 20 DB quieting, one microvolt low band, two microvolts high band. Selectivity 3 DB at plus or minus 20 KC, 80 DB at plus or minus 30 KC. Crystal selector control with provision for two crystals fixed frequency operation (one for each band).

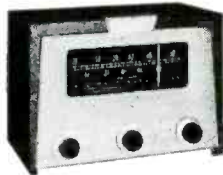

MONITORADIO MODEL MR32 AC RECEIVER FOR 30-50 MC

Built-in squelch for level control. Sensitivity 6 microvolts. 7 tubes plus rectifier. Power transformer. Fully tuned RF stage.

Limited dealer franchises available—write for details.

RADIO APPARATUS CORPORATION
1604 WEST 92ND STREET - CHICAGO 20, ILL.
PHONE: BEVERLY 8-7770

MONITORADIO

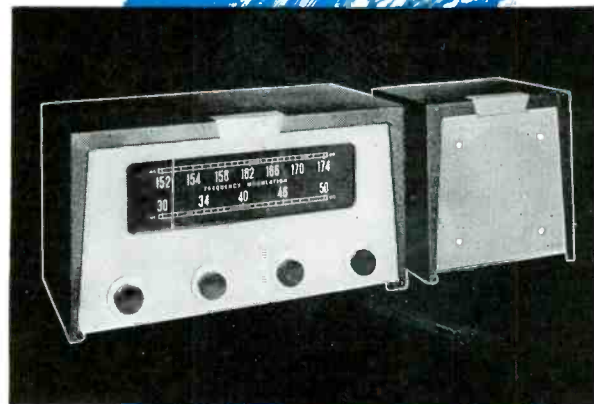

NEW ELECTRO

*filtered DC
power supply*

1%

LESS THAN

RIPPLE at
TOP LOAD

Continuously
Variable,
0 - 28 Volts
Up to
15 Amperes



**Test, Service DC
Equipment from AC Lines
Faster... at Less Cost!**

NEW MODEL "NF" meets most requirements in a DC power supply... extremely low AC ripple or hum, at this output range... low price... dependability. One control gives you adjustable output voltage over its rated range. Exclusive "Electro" application of selenium rectifiers increases rectifier power rating and lowers cost per ampere output. Top quality components and special design withstand high overloads. Net **\$195**

For Autos, Aircraft, Tank, Marine
Electric Equipment.
Laboratory Instruments, Research,
Relays, Solenoids, Phone Circuits.

New 12 Volt DC Power Supply
Model C-12

Model "B" 6 Volts, 1-20 Amps.
Send for **FREE BULLETINS!**



ELECTRO PRODUCTS LABORATORIES
4501-CF North Ravenswood Ave.
Chicago 40, Ill.

Canada: Atlas Radio Corp., Ltd., Toronto

THE COVER PICTURE

The young man on this month's cover is talking over a service channel provided by the newly-installed microwave radio and multiplexing equipment mounted in the terminal-station rack at his side. Such events are becoming more and more common, since microwave equipment sales are booming like everything else in the communication field. The installation shown consists of Westinghouse FR and FJ equipment, which is described in some detail beginning on Page 31.

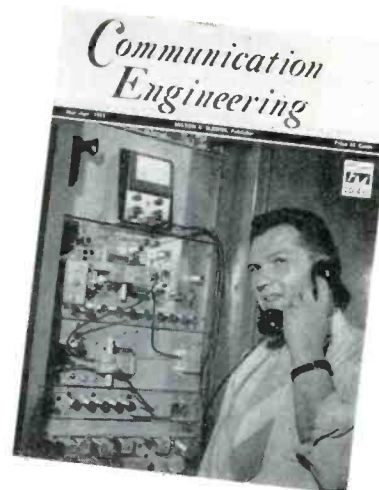

COMPANIES & PEOPLE

RTMA Considers Expansion:

Directors are considering recommendations intended to expand the Association by 1) changing the name to the Electronics Manufacturers Association or some similar name. 2) establishing a division for manufacturers of advanced electronics products, and 3) developing standards and contract specifications for such products in the military and commercial markets.

Instrument Plant:

DuMont Laboratories has opened new plant of 118,000 square feet at 760 Bloomfield Avenue, Clifton, N. J., to provide space for the development and production of cathode-ray instruments for commercial and military use. This location adjoins the company's tube plant and general offices.

L. W. Teegarden:

Elected executive vice president of RCA. Previously, he was vice president in charge of technical products. In that capacity, he had the supervision of the engineering products and tube departments. Mr. Teegarden joined RCA as a district sales manager in 1930.

Life along a Pipe Line:

If you are interested in the facts of life at a pipeline booster-station, you'll find "The Moon Is Our Lantern" an interesting tale told by Edward Tatum Wallace. This book is published by Doubleday & Company, New York City, at \$3.00. Incidentally, the same Mr. Wallace wrote "Hi-Ho Fidelity" which appeared in the January-February issue of HIGH-FIDELITY Magazine.

Leon Podolsky:

Former manager of field engineering at Sprague Electric has been appointed to the newly-created post of technical assistant to the president. In this capacity he will act as a consultant on field engineering problems, supervise the Sprague carrier current development program, and represent the company in standards committee work.

Continued on page 11

MEETINGS and EVENTS

- MARCH 23 - 26,
IRE NATIONAL CONVENTION & SHOW
Grand Central Palace, New York City
- APRIL 11,
NEW ENGLAND RADIO ENGINEERING MEETING
Univ. of Connecticut, Storrs, Conn.
- APRIL 16 - 17,
JOINT RTMA CONFERENCE, U. S. & CANADA
Ambassador Hotel, Los Angeles
- APRIL 18,
CINCINNATI SECTION IRE CONFERENCE
Cincinnati, Ohio
- APRIL 26 - 30,
73RD CONVENTION SMPTE
Hotel Statler, Los Angeles
- APRIL 28 - MAY 1,
NARTB BCST. ENGINEERING CONFERENCE
Philharmonic Auditorium, Los Angeles
- APRIL 29 - 30, MAY 1,
ELECTRONIC COMPONENTS SYMPOSIUM
Shakespeare Club, Pasadena, Calif.
- MAY 11 - 13,
IRE AIRBORNE ELECTRONICS CONFERENCE
Dayton, Ohio
- MAY 18 - 21,
1953 ELECTRONICS PARTS SHOW
Conrad Hilton Hotel, Chicago
- MAY 24 - 28,
45TH ANNUAL NAED CONVENTION
Conrad Hilton Hotel, Chicago
- JULY 13 - 16,
MUSIC INDUSTRY TRADE SHOW
Palmer House, Chicago
- AUGUST 19 - 21,
WESTERN ELECTRONIC SHOW
San Francisco Auditorium, San Francisco
- SEPTEMBER 1 - 3,
INT'L SIGHT AND SOUND EXPOSITION
Palmer House, Chicago
- SEPTEMBER 28 - 30,
9TH NATIONAL ELECTRONICS CONFERENCE
Hotel Sherman, Chicago
- OCTOBER 26 - 28,
RTMA-IRE RADIO FALL MEETING
Toronto, Ontario, Canada

COMPANIES & PEOPLE

(Continued from page 10)

Microwave Relay System:

Will be installed by A & T from Atlanta to Jacksonville. Eleven relay stations will be erected along this 298-mile route, over which a coaxial cable is now in use. Operation will start late this year.

Marion E. Bond, 1904-1953:

The chief engineer of the communication and electronics division at Motorola passed away on January 19. Marion Bond was one of the pioneers in the development of mobile radio communication.

AAR Communications Section:

Officers of the Communication Section of the Association of American Railroads elected for two-year terms are: chairman C. O. Ellis, general superintendent of the Chicago, Rock Island & Pacific Railway, La Salle Street Station, Chicago 5, and vice chairman R. A. Hendrie, general superintendent of communications, Missouri Pacific Railroad, Missouri Pacific Building, St. Louis 3.

Milton R. Freidberg:

Former chief engineer and director of the communications department at Ward Products has organized Antenna Specialists, of which he is president. This company is manufacturing all types of antennas for rear-mounted and roof-top mobile use, and for base-station installations. The new plant is located at 12415 Euclid Avenue, Cleveland 6, Ohio. Telephone number is Randolph 1-9575.

Radio Paging:

Plans for operating radio paging systems, mostly suspended while prospective operators looked into the possibility of shifting to the use of 450 mc., are going ahead now, and on the lower frequencies.

Company Name Changed:

Effective March 5, the Freed Radio Corporation was changed to Freed Electronics & Controls Corporation. Purpose is to describe more accurately the present activities of the company, and the direction of current expansion.

George P. Aldridge:

Awarded the Marconi Gold Medal of Achievement by the Veteran Wireless Operators Association on February 21. The award was made "in recognition of his rise from early wireless operator to a position of leadership." Mr. Aldridge is vice president in charge of sales and Government contracts for Radiomarine Corporation of America, 75 Varick Street, New York 13.

Continued on page 12

Here's 4 reasons why—

RCA is your best buy in 2-way radio

1.

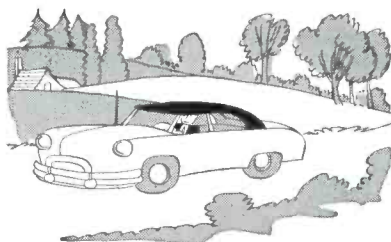

Top performance in tough territory . . . razor-sharp reception in areas crowded with adjacent stations . . . where spurious signals may cause interference.

2.

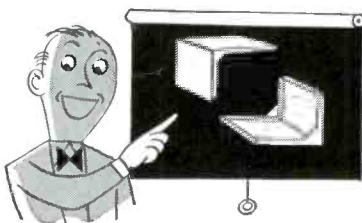

Single-unit design for easy installation . . . case mounts on floor or wall of vehicle; right or left hand. Takes less space, provides easy access for servicing.

3.

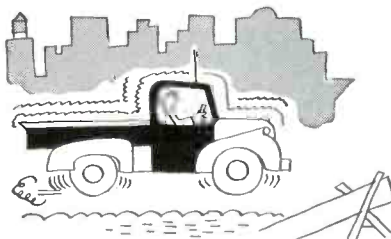

Rugged construction for rough duty . . . vibration tested, shock tested. Treated to resist humidity, to operate in arctic or tropic weather.

4.



RCA-built, RCA-serviced for complete satisfaction . . . backed up by the world's greatest name in radio. Performance exceeds FCC requirements. Uses standard easy-to-get tubes. Continuing service provided by RCA Service Company if desired.

Get full story . . . mail coupon TODAY

Dept. 1320, RCA Engineering Products, Camden, New Jersey

Please send me my FREE copy of illustrated booklet on how RCA 2-way radio can help me in my business checked below:

- General industry (Utilities, Construction, Petroleum, Lumber, Mining, etc.)
- Transportation (Truck, Bus, Taxi, etc.)
- Public safety (Police, Fire, Ranger, etc.)

Name _____ Title _____

Organization _____

Address _____ City _____ State _____



RADIO CORPORATION of AMERICA
MOBILE COMMUNICATIONS
CAMDEN, N. J.

THERE'S A **magnecorder**

FOR EVERY *Communications Monitoring*

NEED

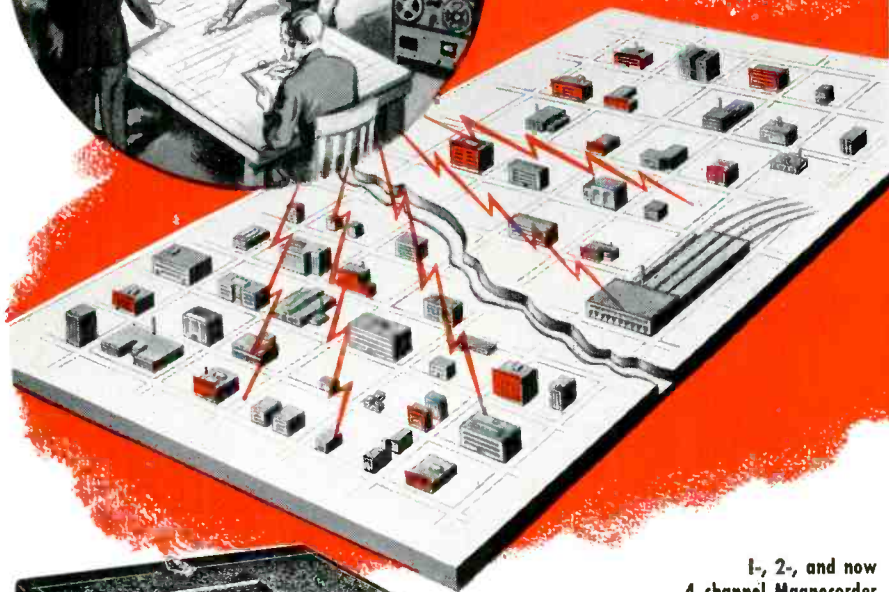
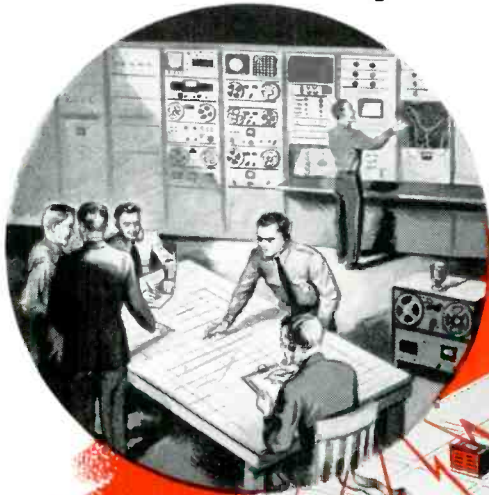

1-, 2-, and now 4-channel Magnecorder

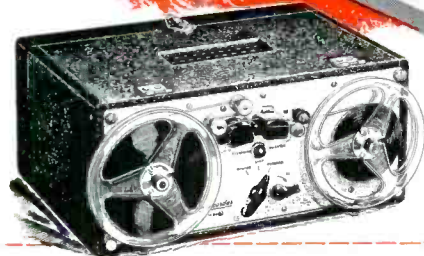

ONE-CHANNEL PORTABLE—the new VOYAGER, a one-case truly portable recorder of professional quality. A standard PT6-AH Magnecorder is mounted back-to-back with line level amplifier which swings forward for instant use. Unsurpassed for remotes or field tests. Lightweight, rugged, reliable.

ONE-CHANNEL MAGNECORDER—long accepted as the standard professional tape recorder in the communications and broadcast fields. Conversion kits quickly adapt your equipment for all special purposes.

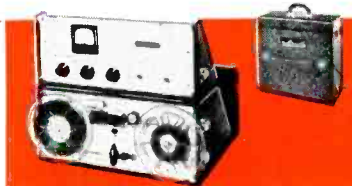

TWO CHANNELS—The acclaimed new Binaural Magnecorder provides either two-channel monitoring or brilliantly realistic 3-dimensional sound on one tape. Two simultaneous tracks accurately reproduce separate sounds or can provide stereo depth and direction, permitting one sound to be identified among many. The versatile dual channels can also be used for separate two-channel communications monitoring.



FOUR CHANNELS—The first automatic continuous recorder that monitors up to four channels at once on a standard 1/4" tape. Originally engineered and JANized for the CAA, it is adaptable for utilities and carriers, fire and police calls, airports and civil defense.

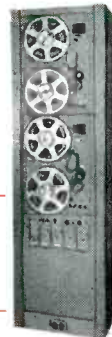

Magnecord INC.

225 West Ohio Street, Dept. CE-3 • Chicago 10, Illinois

Professional Directory

antenna specialists

MANUFACTURERS OF RADIO COMMUNICATIONS ANTENNAS

12415 EUCLID AVENUE
CLEVELAND 6, OHIO
RAndolph 1-9575

JOHN D. TRILSCH CO.

**TOWERS for
RADIO • TELEVISION
COMMUNICATION**

1310 McKinney Ave., Houston, Texas
Phone: ATwood 9351

COMPANIES & PEOPLE

(Continued from page 11)

Old Lines, New Angle:

According to *The REPresentor*, published by "The Representatives" of our industry, the principal difference between salesmen, engineers, and purchasing agents is just a matter of the way they start their career: "A *salesman* is a man who knows very little about a great deal, and keeps on knowing less and less about more and more until he knows practically nothing about everything. An *engineer*, on the other hand, is a man who knows a great deal about a very little, and goes along knowing more and more about less and less until he finally knows practically everything about nothing. A *purchasing agent* starts out knowing practically everything about everything, but ends up knowing nothing about anything due to his association with salesmen and engineers.

Trademark Matter:

William J. Weisz of Motorola, Inc. has given us a correction on the title of his article in the January-February issue of this Magazine. It is proper, he said to refer to the equipment as he described as the Handie-Micro-Talkie transmitter, but for reasons of trade mark protection the trade name should not be used generally as a noun.

Leslie Norde:

Has joined Hammarlund as chief receiver engineer. He has been senior project engineer at Northern Radio Corporation, and from 1944 to 1947 was with Press Wireless as a development engineer.

Concluded on page 13

Professional Directory

Jansky & Bailey

Consulting Radio Engineers

EXECUTIVE OFFICES:

970 National Press Bldg.
Washington, 4, D. C. ME 5411

OFFICES AND LABORATORIES:

1339 Wisconsin Ave., N.W.
Washington, 7, D. C. AD 2414

Member AFCCE

WELDON & CARR

Consulting
Radio & Television
Engineers

Washington, D. C. Dallas, Texas
1605 Connecticut Ave. 4212 So. Buckner Blvd.

MICROWAVE SERVICES, INC.

"Architects of Modern Communications"

Independent Consultants,
Engineers, Constructors

Wire, Carrier, Radio — Transmission, Distribution
— Inside and Outside Plant Facilities —
Appraisals, Surveys, Specifications, Design,
Construction

Circle 7-4953 45 Rockefeller Plaza, New York 20



SINCE
1931

Professional 16mm Sound-On-Film Motion
Picture Cameras for Television Newsreels,
Commercials and other Television Filming.

Write for free illustrated catalog.

BERNDT-BACH, Inc.

7349 Beverly Blvd., Los Angeles 36, Calif.

RUSSELL P. MAY

CONSULTING RADIO ENGINEERS

★ ★ ★

1422 F Street, N.W., Wash. 4, D. C.
Kellogg Building Republic 3984

Member AFCCE

WORKSHOP ASSOCIATES DIVISION

THE GABRIEL COMPANY

Specialists in
High-Frequency
Antennas



Endicott Street Norwood, Massachusetts
Norwood 7-3300

COMPANIES & PEOPLE

(Continued from page 12)

John Silver:

Former general manager of Motorola's communication and electronics division has been elected vice president in charge of the division operations. Prior to joining Motorola in 1944, he was with Crosley and Collins Radio.

9th Old Timers' Nite:

Annual stag event staged by the Delaware Valley Radio Association will be held at Hotel Stay-Trent, Trenton, N. J., on April 25. Tickets for the turkey dinner cost \$5.00. They can be ordered from Chairman Ed G. Raser, 315 Beechwood Avenue, Trenton 8. The W2ZI collection of old-time gear will be on display.

Mobile Radio Expansion:

Bendix Radio now has communication field engineers in 20 regions throughout the Country, working under the direction of L. J. Straw, manager of general mobile sales. Eastern headquarters have been moved to 2120 N. Charles Street, Baltimore 18. The west coast office is at 10500 Magnolia Boulevard, North Hollywood, Calif., where R. L. Daniel is in charge.

H. E. Beane:

Sales manager for The Bristol Company, Bristol, Conn., has been elected vice president in charge of sales. His responsibilities will cover the complete line of products, including control, recording, telemetering, and aircraft instruments, and socket screws. Mr. Beane joined the company in 1920.

1953 Components Symposium:

A very important series of papers will be presented during this conference, to be held April 29 to May 1 at the Shakespear Club, Pasadena. Authors of the papers are from Hughes Aircraft, Vitro Corporation, G. E., Stanford Research Institute, Cornell Aeronautical Laboratory, California Institute of Technology, Sylvania, Aeronautical Radio, Raytheon, Bendix, Bell Telephone Laboratories, Consolidated Vultee, M. I. T., RTMA, Naval Ordnance Laboratory, the Signal Corps, and the Air Force. Details can be obtained from general chairman Dr. A. M. Zarem, 621 S. Hope Street, Los Angeles 17.

Tube Engineering Laboratory:

A building of 120,000 square feet will be erected by Sylvania on 3rd Street, Williamsport, Pa., about 3 miles from the business center, to house a group of divisional laboratories. About 400 people will be engaged there.

Professional Directory

KEAR & KENNEDY

Consulting Radio Engineers

1302 18th St., N. W. HUDSON 3-9000
Washington, D. C.

GEORGE P. ADAIR

Consulting Engineers

Radio, Communications, Electronics
1610 Eye St., N.W. EXECUTIVE 1230
Washington 1, D. C.

Paul W. Klipsch
Professional Engineer
Acoustic development
and consulting

Klipsch and Associates
building the authentic
KLIPSCHORN
world's finest sound reproducer

Hope, Arkansas

Tel. Hope 995



16-MM Professional Motion Picture
Production Equipment

J. A. MAURER, Inc.

37-07 31st Street, Long Island City 1, N. Y.
Tel. Stillwell 4-4601

MEASUREMENTS CORPORATION



Research &
Manufacturing
Engineers

Harry W. Houck Jerry B. Minter
John M. van Beuren
Specialists in the Design and
Development of Electronic Test Instruments
BOONTON, N. J.

RATES FOR PROFESSIONAL CARDS

IN THIS DIRECTORY

\$12 Per Issue for This Standard
Space. Orders Are Accepted
for 6 Insertions Only

follow the leaders to

EIMAC TUBES!

TRIODES



- | | |
|-----------|-------------|
| 2C39A | 100TL |
| 3W5000A3 | 152TH |
| 3W10000A3 | 152TL |
| 3X2500A3 | 250TH |
| 3X2500F3 | 250TL |
| 3X3000A1 | 304TH |
| 3X3000F1 | 304TL |
| 6C21 | 450TH |
| 25T | 450TL |
| 35T | 592/3-200A3 |
| 35TG | 750TL |
| 75TH | 1000T |
| 75TL | 1500T |
| 100TH | 2000T |

TETRODES



- | | |
|---------|----------|
| 4-65A | 4W20000A |
| 4-125A | 4X150A |
| 4-250A | 4X150D |
| 4-400A | 4X150G |
| 4-1000A | 4X500A |
| 4PR60A | 4X500F |

PENTODE

- 4E27A/5-125B



RECTIFIERS

- | | |
|---------|-------------|
| 2-01C | RX21A |
| 2-25A | 250R |
| 2-50A | 253 |
| 2-150D | 866A |
| 2-240A | 872A |
| 2-2000A | 8020 (100R) |
| KY21A | |

AIR SYSTEM SOCKETS

- 4-400A/4000
4-400A/4006*
4-1000A/4000
4-1000A/4006*
4X150A/4000
4X150A/4006*

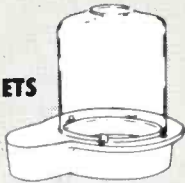

*Replacement Chimneys

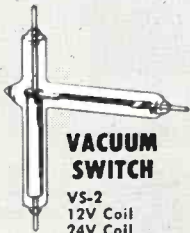

VACUUM SWITCH

- VS-2
12V Coil
24V Coil



ACCESSORIES

- HR Heat dissipating connectors
Performed Contact Finger Stock

VACUUM PUMP

- HV-1
OIL
DIFFUSION
PUMP

- Type A
Pump Oil
HV-1
Pump Parts

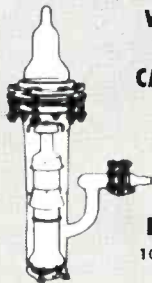

VARIABLE VACUUM CAPACITORS

- VVC60-20
VVC2-60-20
VVC4-60-20

ION GAUGE

- 100 IG ion gauge

VACUUM CAPACITORS

- | | |
|---------|---------|
| VC6-20 | VC25-20 |
| VC6-32 | VC25-32 |
| VC12-20 | VC50-20 |
| VC12-32 | VC50-32 |

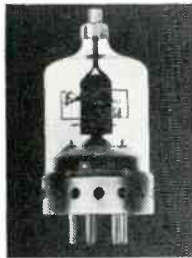

4-125A

The radial-beam power tetrode that made transmitting screen-grid tubes popular. This tube will take a plate input of 500 watts for CW or 380 watts for fone. Driving power is less than two watts. A pair of these tetrodes make an ideal high power fone or CW final for the amateur.



4X150A

This small external anode radial-beam power tetrode operates efficiently at all frequencies into the UHF range with a driving power of only a few watts. Its small size and ruggedness make it ideal for compact equipment such as mobile.

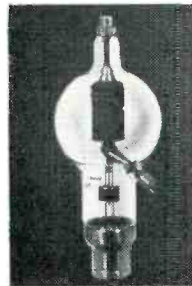

450T

Often referred to as the workhorse of modern communication systems, this dependable triode has a plate dissipation rating of 450 watts. It is widely used as an amplifier, oscillator or modulator.

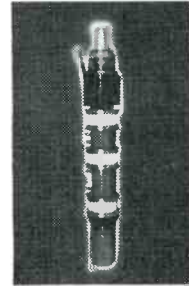

3K20000L (A-F-K)

These Klystrons, the latest development in UHF television transmitting, have a power output of 5000 watts. The three versions of the Klystron will cover the entire UHF range — 470-890 mc. These water and air cooled Klystrons have a power gain of 20 db.



VVC60-20

This is but one type in the Eimac line of variable and fixed vacuum capacitors for plate tank circuits. It is variable over a range of 10 mmfd to 60 mmfd. Maximum rf voltage is 20 kv. at 40 amperes.



2C39A

This small, rugged triode is designed for use as a power amplifier, oscillator or frequency multiplier to frequencies above 2500 mc. It is particularly suitable for compact fixed or mobile equipment.



● Complete technical data available on request.

EITEL-McCULLOUGH, INC.
SAN BRUNO, CALIFORNIA

EXPORT AGENTS: FRAZAR & HANSEN • 301 CLAY STREET • SAN FRANCISCO 11, CALIFORNIA

COMMUNICATION REVIEW

WIDELY divergent views concerning the FCC Form 400 are being expressed at various levels within the Commission, and by outsiders who are affected by the introduction of the new application form for the safety and special radio communication services. Also, remarks from any one quarter vary according to the person addressed, or the manner in which the form in question is made the subject of discussion.

For example, it is not wise to say: "FCC records of the safety and special services are in bad shape. But it's not possible for the staff to keep up with the increased workload when Congress reduces the Commission's appropriation from year to year." That simply sets off a heated defense of the staff and its accomplishments.

The result is totally different if you ask: "How can Congress expect the Commission to perform the functions required of it when its workload is being increased by the expansion of television and the communication services, yet it must operate on reduced appropriations?" Then you will probably be told that, while the staff is doing its utmost, it's impossible to meet the added demands being made upon it.

Actually, the status of Form 400 depends in part, at least, upon one's point of view. Perhaps it is providing as much information as the Commission wants to handle with the limited personnel now available to process it.

On the other hand, it is seriously lacking in information of great value to operators of communication systems, to engineering consultants, frequency coordinating committees, and manufacturers.

It should be noted — and this is a very important point — that Government agencies are responsible for collecting not just the statistics required by the agencies, but those needed by the industries they are intended to serve. If the FCC cannot furnish data needed by the radio industry because it lacks funds to employ the staff necessary, then complaints should be directed not to the Commission, but to Congressional Committees responsible for the annual appropriation within which the Commission must operate. These are:

House Appropriation Committee
House Interstate and Commerce Committee
Senate Interstate and Commerce Committee

Letters should be addressed to the Chairman in each case, at Washington 25, D. C.

If you think that more funds are required for the FCC to carry out its proper functions on behalf of the communication services, by all means make your opinion known to the chairmen of the three committees listed above.

ONE important item of information about new communication systems for which Form 400 makes no provision is the name of the manufacturer whose equipment is to be used. However, at least two companies have instructed their field engineers to stamp the company names on the forms when, as is the usual practice, they fill them out for their customers.

Then, as the information is taken from the applications as they are filed from day to day for COMMUNICATION ENGINEERING's Weekly Reports of New Applications, the manufacturer's names can be listed.

In the matter of transmitter power, Form 400 is responsible for seriously misleading information. Applicants are in-

structed to fill in the maximum power permitted, regardless of the actual power to be employed. Thus, the majority of the applications specify 500 or 600 watts, despite the fact that most of transmitters are 25 or 50-watt types. The result is that frequency-coordinating committees no longer have accurate data on transmitters in a given service. The manufacturers, however, can eliminate this confusion by instructing their field engineers to show actual transmitter power when they fill in new Form 400 applications for their customers.

There is a serious question as to the legality of the practice of applying for maximum power permitted. FCC Rules state specifically that power and antenna height shall be no more than the minimum required for satisfactory technical operation commensurate with the area to be served, and local conditions which affect transmission and reception.

THE discussion of interconnecting privately-owned microwave systems with Telephone Company facilities at terminal offices, written by Jeremiah Courtney in our January-February issue, brought many comments from manufacturers and operators of communication systems. Consensus of opinion was that 1) there is more to the situation than was brought out by Mr. Courtney, 2) it should be discussed openly, but 3) no one wants to start it, or to be quoted.

Several communication engineers not connected with the Telephone Company shared the feeling that, while they recognized the need on the part of operators of private microwave systems for connections with telephone switchboard facilities, the performance of most microwave circuits is so far below the Telephone Company's standards that refusal to provide inter-connections does not seem unreasonable.

Those remarks led to comments on the unfortunate practice of awarding contracts for radio installations to the lowest bidders, because it has tended to encourage the development of equipment designed to minimum electrical and mechanical tolerances and, thus, marginal performance.

As to the cost of installing separate telephone equipment for terminal use in conjunction with microwave systems, referred to by Mr. Courtney, the following letter was received from Automatic Electric Sales Corporation, 1033 W. Van Buren Street, Chicago:

Dear Mr. Allison:

The article on privately-owned microwave circuits and telephone company facilities by Jeremiah Courtney in the January-February issue of COMMUNICATION ENGINEERING is very interesting and factually correct. However, the implication that the economically practical use of microwave by industrial users will depend on the decision of the telephone companies as to interconnection is not always correct. As the largest manufacturer of dial telephone industrial communication equipment, we have for many years sold P-A-X business telephone systems to public utilities and industrial users. Many of these systems have been interconnected over the users' own facilities, either wire, power-line carrier, or telephone carrier. In many cases the use of privately owned telephone switching equipment has resulted in large savings to the user over the cost of renting comparable equipment from the telephone company if they would connect, and under present conditions, these savings are even larger.

The enclosed business telephone reports describe two such industrial telephone systems [Union Oil Company, Los Angeles, and Louisville & Nashville Railroad Company, Louisville, Ky.] which are typical of these installations. While microwave facilities are not now used by either of these companies, at least one of them expects to purchase microwave in the near future and, to a telephone system, a microwave channel looks no different than a conventional wire line.

We make the above comments not in criticism of Mr. Courtney's article, but to point out the broad aspects of industrial communications and the fact that for years the type of companies now interested in microwave have found the use of privately owned dial telephone systems advantageous and economical.

Yours very truly,

K. A. REGEL,

Manager Industrial Sales

One further note on this subject: Aeronautical Radio, Inc., requested permission to reprint Mr. Courtney's article, for distribution to all their member companies, namely, the airlines of the United States.

THERE'S no question but what every one in the radio industry is working harder than he was during the last war. Presumably, leisure hours have been increased because overtime work has been reduced. But somehow, even though engineers have more time to themselves, they have less leisure.

The situation has created a new and very real problem for both editors and advertisers. It is one thing to prepare articles and advertising of must-reading importance. But it is something else entirely to get them read. Evidence now is developing which indicates that greatest attention is attracted to articles in technical magazines if they are on subjects which have no place in such publications.

Witness, for example, an account by Wayne W. Parrish, writing in *American Aviation*, of his introduction to *le bidet* while he was in France, after completing a flight from London to Singapore in a Haviland Comet, as a guest of the company that built the plane. Reader interest in his remarks about this piece of earth-bound plumbing, published in a magazine devoted to flying, extended to international proportions. Further discussion by Mr. Parrish and letters from readers were continued in the magazine over a period of months. Not only were the intended uses of the bidet considered in detail and at great length, but one reader thoughtfully contributed this additional intelligence: "The bidet has many other uses. It is a baby and dog bath; it can be used for washing one's feet, for washing socks, for draining umbrellas, for cooling bottles of beer; you can also put goldfish in it when cleaning out their bowl; another use is for wetting the rears of hens to prevent them from going broody; for aerodynamicists it provides an excellent means for observing the flow of liquids."

Said Mr. Parrish: "The comments on that bidet article have come from all parts of the world. I am sure the readership of that one page exceeded by a wide margin that of anything ever published in any aviation magazine."

ON March 2, New York City's Fire Department radio system was officially dedicated. Speaking at the dedication ceremony, Col. Edwin White, Chief of the FCC Safety and Special Radio Services Bureau, said: "I think the City should be particularly congratulated on having Commissioner Grumet and my good friend Chief Thomas O'Brien on its staff. And Tom should be congratulated on having such an engineer as Lieut. Sam Harmatuk to assist him. These men have done much more than design and install a communication system

for New York's Fire Department. They have made themselves recognized leaders in the field of communications as applied to fire department problems, and have not only assisted other cities, but have been of material aid to the Commission in development of its rules and regulations.

"Those of you in the communication business have heard the old cry: 'Not enough frequencies!' It is only by expert planning that the few frequencies we have can be made to serve the needs of our economy. It is this expert planning that has made it possible not only for the City of New York to have an adequate fire radio system, but also for the cities in the surrounding areas to operate their radio facilities without interference from New York City's transmissions. In spite of the fact that a good showing could be made that New York needed more frequencies than are available to other fire departments in the nation, Chief O'Brien and his staff had the breadth of vision to approach the problem from the point of view of finding out how few frequencies they could get along with, rather than how many they could use."

Details of the preliminary survey, tests of equipment performance, and the final system engineering employed in this adjacent-channel installation were described by Lieut. Harmatuk in our issues of April, May, and June, 1952. Two more articles by Lieut. Harmatuk, now in preparation, will deal with the transmitters, control consoles, and tape recorders, and the cost of operating and maintaining this system.

Specifications for this project were probably the most complete and exacting ever drawn up for a mobile communications system. The contract was awarded to Motorola for \$586,000. Under the terms, Motorola was required to supply the equipment, and to handle all the construction and maintenance as well. More than 500 Motorola mobile units are used in this system. REL, as a subcontractor, supplied the 7 fixed transmitters, 6 consoles, and the Staten Island microwave relay. These items were specially designed and built to the Fire Department's specifications.

A MEETING was held at Hotel Statler, St. Louis, on February 18 and 19 for the purpose of organizing a Special Industrial Radio Service Association. The total attendance of 40 included some 10 representatives of the equipment manufacturers. At the opening session, Joseph Keller, of the Washington law offices of Dow, Lohnes & Albertson, outlined the objectives of the Association as 1) coordinating frequencies of new applications, 2) effecting concerted action on matters related to the special industrial service, and 3) reporting legislative and technical developments, FCC actions, and projects designed to assure the most efficient use of assigned frequencies. Officers elected were: chairman R. J. Morrison, Dickerson, Inc., Monroe, N. C.; vice chairman R. M. Hansen, Halliburton Oil Well Supply Company, Duncan, Okla.; secretary-treasurer R. L. Millican, R. L. Millican Electric Company, Jacksonville, Fla.

The problems of organizing such an association are complicated by the divergent and unrelated interests of licenses in the special industrial group. The service represents a sort of catch-all ranging from contractors and farmers to manufacturers and miners, and from well-drilling services to ranchers. Already the National Ready Mixed Concrete Association and the National Sand and Gravel Association have petitioned the FCC to establish a new construction radio service to meet the particular radio requirements of the "construction companies, ready-mixed concrete and sand and gravel companies, and other sub-contractors serving construction projects." Further information concerning the projected Special Industrial Radio Service Association can be obtained from Chairman R. J. Morrison, whose address is given above.

Channel Spacings at 152 to 174 Mc.

REPORT ON COMPARATIVE PERFORMANCES OF 2-WAY RADIO EQUIPMENTS FOR CHANNELS OF 60, 30, AND 20 KC. IN THE 160-MC. BAND — By H. E. STRAUSS*

ABSTRACT

In order to investigate the feasibility of increasing the number of channels presently available in the 152 to 174-mc. band, a group of tests was conducted to compare the operation of equipments designed for 30-kc. and 20-kc. channels with the present standard 60-kc. equipment. On the basis of a chosen set of system parameters, the performance was degraded continuously by decreasing the channel spacing. This investigation considered the effects of impulse noise, system stability, adjacent-channel interference, and intermodulation.

THE rapidly-increasing use of mobile communications is resulting in over-crowding of the present frequency allocations in the 152 to 174-mc. band. With even greater expansion of the mobile services anticipated in the future, it is mandatory that more efficient use be made of these frequencies. Although greater frequency utility can be accomplished in several ways, it appears that narrow channel spacings would be most satisfactory. The purpose of this paper is to report the results of field tests and other investigations of channel splitting conducted by engineers of RCA's Mobile Communications group at Camden, N. J.

System Considerations: If closer channel spacing is to be used, it is apparent immediately that more selective receivers must be employed. Greater receiver selectivity requires that the transmitter sidebands be held to a narrower range, resulting in a smaller deviation ratio. It should be noted that many different combinations of receiver bandwidth and transmitter deviation ratio can be chosen for any given channel spacing, and it is necessary to select the standard which yields the maximum communication facility. This task is complicated further when the effects of system frequency stability are considered.

The frequency stability of the system is, in itself, nearly independent of channel spacing or system bandwidth, but the total frequency tolerance becomes a greater percentage of the

*Mobile Communications Engineer, Engineering Products Department, RCA Victor, Camden, New Jersey. This paper was presented at the 3rd annual meeting of the IRE Professional Group on Vehicular Communications, Hotel Statler, Washington, D. C.

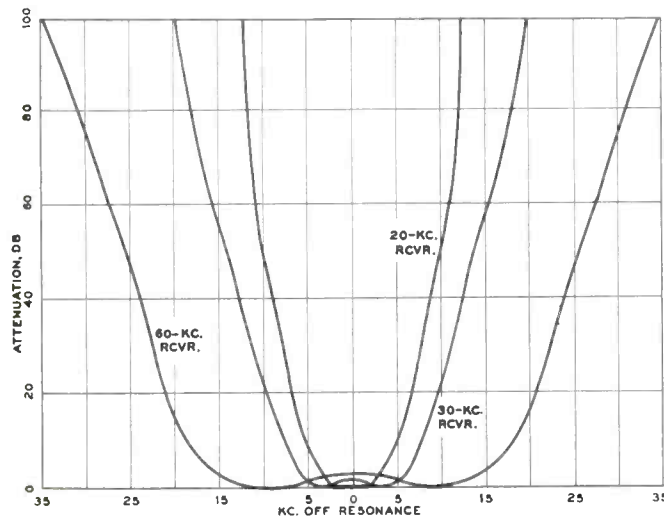

FIG. 1. SELECTIVITY CURVES FOR RECEIVERS WITH 60, 30, AND 20-KC. BANDWIDTHS.

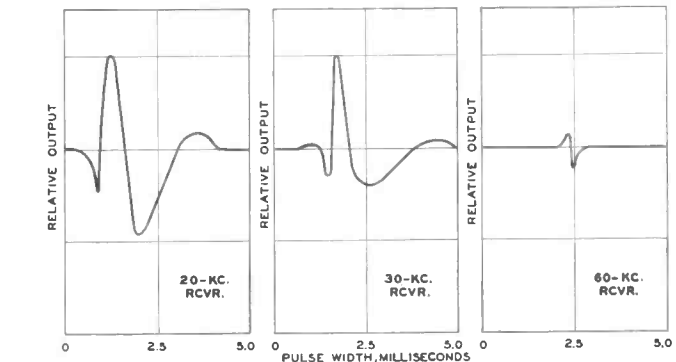

FIG. 3. IMPULSE-NOISE CHARACTERISTICS FOR THE 3 TEST RECEIVERS

system bandwidth as narrower channel spacing is used. If it is desired to contain the significant modulation sidebands in the receiver passband, when the system is detuned by its maximum tolerance, then the receiver bandwidth must be increased by an amount equal to the maximum system tolerance. When this is done it is evident that the signal-to-noise ratio is decreased for on-frequency system operation. But less degradation of the signal-to-noise ratio, less adjacent channel interference, and less distortion result as the system is tuned off-frequency. In order to determine the advisability of allotting a portion of the channel for frequency tolerance, some tests were made with modulation indices which just equaled the receiver passband, while others were made with somewhat reduced indices.

It can be concluded theoretically that a wide-channel FM system will provide a better signal-to-noise ratio than a narrow system in all but the low-intensity signal areas.¹ This improvement is true for either fluctuation or impulse-type noises. In areas of low signal intensity, it can be expected that systems of narrow bandwidth will provide better signal-to-noise ratios than wide-band systems for fluctuation-type noises. For impulse noise, the narrow-band systems could still be superior in weak-signal areas so long as the upper modulation frequency limit remains large; however, as the upper modulating fre-

¹Murray G. Crosby, "Frequency Modulation Noise Characteristics", *Proc. I.R.E.* Vol. 25, pp. 472 to 514, April 1937.

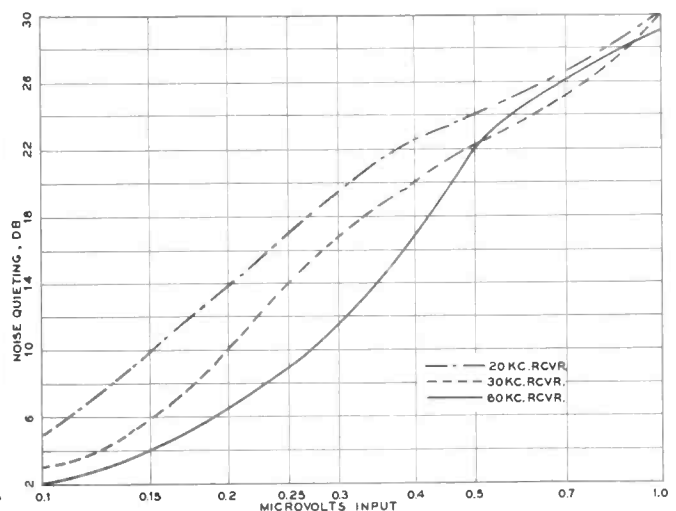

FIG. 2. QUIETING SENSITIVITY FOR CORRESPONDING RECEIVERS

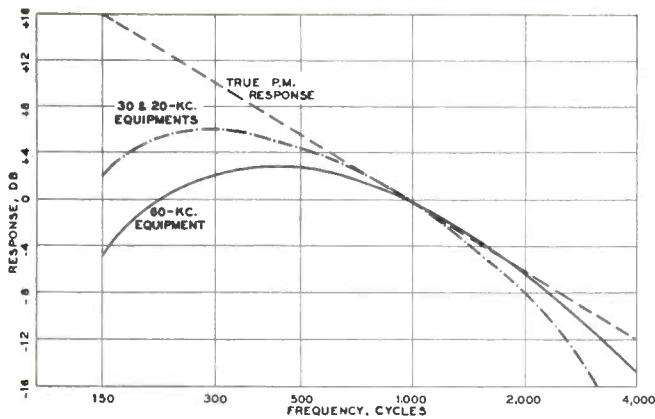

FIG. 4. AUDIO FREQUENCY RESPONSE CURVES FOR THE TEST RECEIVERS
 quency limit is reduced, the narrow-band systems can become more noticeably affected by impulse-type interference. Just how serious this impulse degradation can become is not easy to predict. Therefore, impulse-type interference is a cardinal problem that can be evaluated best by actual measurements and field tests.

Test Parameters: The actual channel spacings used for these tests were 60, 30 and 20 kc. These choices make allowance for the present 60-kc. channels to be split up into integral parts. Channel spacings closer than 20 kc. were not considered practical at the present time, and were not tested.

The best system tolerance feasible with present techniques is ± 2.6 kc. This figure is based upon an operating frequency of 160 mc., and was accumulated from the following major sources of system instability:

| | |
|--------------------------|----------------|
| Transmitter Oscillator | $\pm 0.0005\%$ |
| Receiver Oscillator | ± 0.0005 |
| Receiver Filter Circuits | ± 0.0003 |
| Frequency Setting | ± 0.0003 |
| Total system tolerance, | _____ |
| -30°C. to +60°C. | $\pm 0.0016\%$ |

This stability is considerably better than that of many present 60-kc. installations; consequently, a general improvement over present practice is assumed. This is particularly true of setting a transmitter and receiver on the proper operating frequency. The $\pm 0.0003\%$ noted previously can be achieved only through the use of improved test equipment and

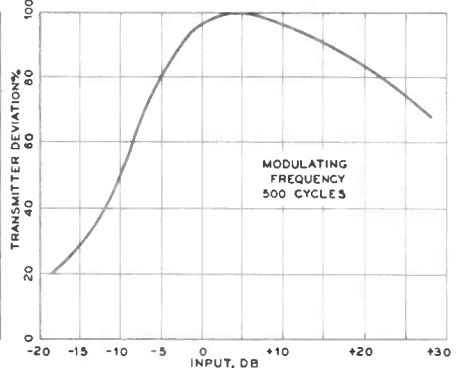
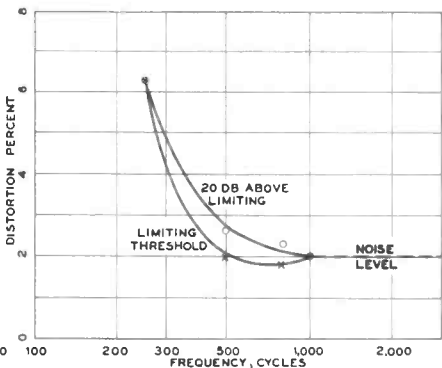
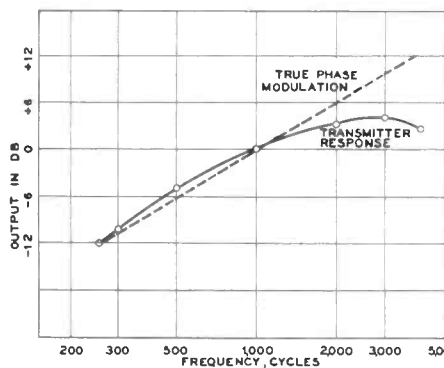

FIGS. 5, 6, AND 7. AUDIO-FREQUENCY RESPONSE, DISTORTION, AND LIMITER PERFORMANCE OF ADJACENT-CHANNEL TRANSMITTER USED IN THE TESTS
 maintenance techniques. The $\pm 0.0005\%$ oscillator stability was achieved by using $\pm 0.001\%$ crystals in temperature-controlled ovens, while the tolerance of the receiver filter circuits previously noted represents the best figure achieved in present 60-kc. equipments.

Receivers: A separate receiver was used for each of the three equipments compared in these tests. The three receivers were identical in circuitry except for the bandwidth of the low-frequency IF amplifiers and the amount of IF skirt attenua-

tion. The receiver used for 60 kc. standard-channel operation was a current production model RCA CMV-4E Carfone with the minimum amount of IF skirt selectivity.

Used for 30-kc. channel operation was the receiver section of a CMV-4E unit with the IF transformer coupling and loading modified to produce the desired bandwidth and skirt-selectivity characteristics. Similarly, the 20-kc. channel receiver was a CMV-4E receiver section with appropriate modifications to give the desired bandwidth and skirt selectivity.

Fig. 1 shows the selectivity characteristics of the three receivers as measured by the 20-db noise quieting method from the 20-db to the 100-db attenuation points. The selectivity characteristics of the passbands of the three receivers were measured by the limiter grid-current method.

Noise-quieting curves for the three receivers are shown in Fig. 2. They indicate that the narrow-channel receivers have somewhat better sensitivity than the 60-kc. receiver for smaller input signals. This agrees with the previous reference to the improvement of narrow-band systems for very low intensity input signals in the presence of fluctuation-type noise only.

Fig. 3 shows the impulse response of the three receivers with an unmodulated desired signal of 2 microvolts. First, the 60-kc. receiver was modulated by ± 15 kc. at 1,000 cycles, and the 30-kc. and 20-kc. receivers were modulated ± 7.5 and ± 5 kc. respectively at 1,000 cycles. The output levels of the three receivers were set for equal oscilloscope deflections, and the modulation was then removed. An interfering signal of 50,000 microvolts modulated 100 cycles by a 1.5-microsecond pulse was applied to the receivers. The oscilloscope tracings of the noise pulses shown in Fig. 3 reveal an increase in impulse susceptibility as the channel spacing is decreased.

The audio responses of the three receivers are shown in Fig. 4. The 60 kc. receiver has standard 6-db-per-octave deemphasis from 1,000 cycles out to 3,000 cycles, with steeper attenuation beyond 3,000 cycles. The low-frequency response of this receiver is down about 3 db at 500 cycles, with a very rapid attenuation below 300 cycles. Audio responses of the 30 and 20-kc. receivers are identical, with 2 db higher response at 500 cycles than the 60-kc. receiver. In addition, the high-frequency roll-off begins at 2,000 cycles at the rate of about 12 db per octave.

Transmitters: The important transmitter features to be considered in the channel-spacing problem are the modulator and

the audio limiting characteristics. Both the desired-signal transmitter and the adjacent-channel transmitter used in these tests had the same audio circuitry and modulator.

Even if it were possible to use receivers with infinite skirt attenuation, interference would still be possible from adjacent-channel transmitters. However, this interference can be minimized by the use of more linear modulation limiters. This led to the use of an automatic volume control type of limiter in the test transmitters. The AVC limiter was followed by a clipper tube to remove any surges caused by AVC time

constants. It should be noted that the normal peak deviation of this limiter is about 2.5 db below maximum peaks, but these maximum peaks occur for only a few milliseconds after speech pauses. Therefore, it is practically correct to say that the peak modulation is only 75% of the values dealt with throughout this paper. The output of this limiter was fed to the modulator tube through a three-position switch and

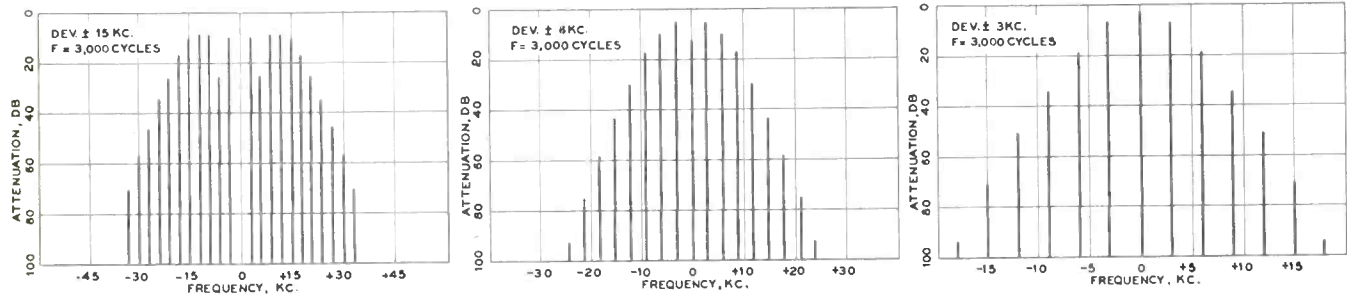

FIGS. 8, 9, AND 10. SIGNIFICANT FM SIDEBANDS PRODUCED BY 3,000-CYCLE MODULATION FOR PEAK CARRIER DEVIATIONS OF ± 15 , ± 6 , AND ± 3 KC.

three separate dividers, thus permitting use of the same transmitter for all three systems.

For minimum interference, a low-distortion modulator is necessary in addition to linear limiting circuits. The modulators used in these tests were capable of producing $\pm 90^\circ$ phase shifts without excessive distortion. By using a frequency multiplication of 36 times, it was possible to produce ± 15 kc. deviation at a modulation frequency of 500 cycles with only 2% distortion.

Audio-frequency response of the adjacent-channel transmitter used in these tests is shown in Fig. 5. Normal audio response is indicated at the low-frequency end of the range, while frequencies above 3,000 cycles are attenuated at a rate of about 12 db per octave.

Fig. 6 shows the distortion characteristics of the adjacent-channel transmitter, with 15 kc. deviation, for two input levels. The x curve is for inputs just equal to the limiting threshold, and reveals distortion on the order of 2% between 500 to 1,000 cycles; the o curve is for inputs equal to 20 db above threshold. It will be noted that the distortion is increased only slightly. The dotted portion of this curve indicates low distortion not measurable because of noise.

Limiter action of the adjacent-channel transmitter for a 500-cycle sine wave input, Fig. 7, reveals good compression for inputs of 26 db above threshold.

As mentioned previously, a set of starting parameters was needed, based upon good adjacent-channel operation with some portion of the receiver passband used to allow for system instability. This led to the choice of ± 15 , ± 6 , and ± 3 kc. as the transmitter deviations to be used for the 60, 30, and 20-kc. systems respectively. These deviations were determined as set forth in the following paragraph:

It was felt that the deviation spectrum obtained by voice-modulating a transmitter could be approximated closely by a 3,000-cycle sine-wave modulating voltage. Deviation spectrums were obtained for such a modulating frequency with the various deviations being developed by the use of Bessel functions. The calculated sidebands were then plotted and considered as an envelope which could be placed on an adjacent-channel receiver selectivity curve so that the two curves just touched. Then, by space-attenuating the transmitter sidebands, it was possible to obtain a relative indication of adjacent-channel interference between the various systems being considered. By manipulating the various degrees of receiver selectivity and different modulation indices as outlined, the previously-noted starting parameters were obtained.

Figs. 8, 9, and 10 show the calculated sideband distributions for ± 15 , ± 6 , and ± 3 -kc. deviations respectively for a 3,000-cycle modulating frequency. The receiver selectivity curves shown in Fig. 1 were used with their respective ad-

acent-channel transmitter sideband envelopes, and the resulting adjacent-channel interference curves for 60, 30, and 20-kc. equipments are shown in Fig. 11. The solid line shows in each case the distances that interference will occur when the transmitter is exactly on the adjacent channel, while the dotted curve indicates distances necessary when the systems are brought closer by an amount equal to the total system

tolerance of 2.6 kc. The following chart shows the anticipated distances obtained by this method:

| SYSTEM | DISTANCES | |
|-------------------------------|------------|------------|
| | ON-FREQ. | OFF-FREQ. |
| 60 Kc. with ± 15 Kc. Mod. | 0.04 miles | 0.15 miles |
| 30 Kc. with ± 6 Kc. Mod. | 0.19 " | 1.1 " |
| 20 Kc. with ± 3 Kc. Mod. | 0.6 " | 4.0 " |

The chart above indicates that good adjacent-channel performance could be expected on all three systems when the equipments are exactly on frequency; however, noticeable deterioration of the 30 and 20-kc. systems would result with off-frequency operation.

The choice of ± 15 , ± 6 , and ± 3 -kc. deviations permitted the use of approximately ± 2.5 kc. of the receiver selectivity curve for frequency stability tolerance in both the 30 and 20-kc. equipments, noted previously as a requirement for the first set of test parameters. The second set of modulation deviations used were ± 15 , ± 10 , and ± 6 -kc. respectively for the 60, 30, and 20-kc. channel equipments. These deviations produced significant transmitter sidebands out to the receiver bandwidths at the 6-db points.

Test Procedure: Field tests were arranged to compare performances of the 60,30, and 20-kc. equipments as follows:

- 1) Range tests with all systems on-frequency.
- 2) Range tests with all systems off-frequency.
- 3) Adjacent-channel tests with all systems on-frequency.
- 4) Intermodulation tests with all systems on-frequency.

All three receivers were mounted in the trunk of the test car, and results were observed from this mobile unit. Each receiver was equipped with a temperature-controlled crystal in the oscillator section, so that drift at the carrier frequency was held to better than ± 150 cycles. A whip antenna mounted on the car roof was fed through coaxial switching relays to the desired receiver while the audio outputs of the

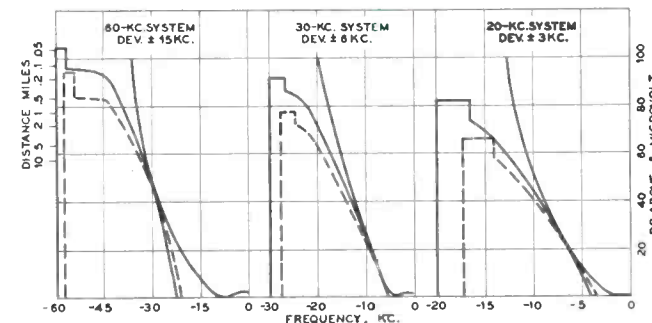

FIG. 11. ADJACENT-CHANNEL INTERFERENCE FOR SYSTEM CONDITIONS SHOWN

receivers were appropriately switched to a single loudspeaker mounted under the car dashboard. This arrangement permitted instant switching between the systems for direct comparisons. The test car was a police-type Ford with a Mercury engine, with Packard resistance cable for ignition suppression. This car was equipped also with a 30-watt transmitter for talk-back purposes, so that all test directions could be made by the test observers. Fig. 12 shows the three receivers mounted in the test car trunk; and Fig. 13, the test controls mounted under the dashboard.

The desired-signal transmitter, as noted previously, was equipped with a 3-position switch for rapid selection of the proper system deviation by the operator. The power of the desired signal was 9 watts at the transmitting terminals. Frequency of this transmitter was maintained to better than ± 125 cycles at the carrier frequency by a crystal oscillator, monitored constantly by a secondary frequency standard. A receiver tuned to the talkback frequency was located also at the desired-transmitter site. Fig. 14 is a picture of the desired transmitter and the measuring equipment.

The adjacent-channel transmitter was equipped with four separate oscillators, including one for the adjacent channel of each of the three systems being compared, and one oscillator for the talkback frequency. A 4-position switch was used for oscillator switching and, at the same time, selection of the proper modulation deviation. The carrier frequencies were maintained to better than ± 360 cycles by crystals in temperature-controlled ovens. Power at the antenna terminals was 60 watts from the adjacent-channel transmitter. A receiver on the talkback frequency was provided at this site, also.

The alternate-channel transmitter was identical to the adjacent-channel unit except that unmodulated carrier only was transmitted. Power delivered to the antenna terminals was 60 watts. Physical arrangement of the stations used in these tests is illustrated in Fig. 15. The antenna heights shown are relative to sea level. The on-frequency range tests were conducted in the following manner: The test car began its course from the desired transmitter site and proceeded in a southeasterly direction until complete degradation of all systems resulted. During these runs the three systems were compared continuously for general readability, and the amount and nature of noise interference. The road traveled during the range tests was the White Horse Pike, on which was found a moderate amount of traffic and ignition noise as would be experienced normally with mobile radio equipment. All observations were made with the test car moving at moderate speeds except at extreme ranges, where some system evaluations were made with the car parked.

Off-frequency range tests were made in the same way as on-frequency tests, except that the desired transmitter was detuned alternately by 1.3 and 2.6 kc. while performances of the 60, 30, and 20-kc. channel equipments were noted.

Adjacent-channel tests were conducted in the following manner: The test car was positioned just far enough from the adjacent-channel transmitter so that no interference occurred on any of the three systems with the received signal input from the desired transmitter equal to about 1 microvolt. The car was then moved closer to the interfering station, in one-block steps, while observations of the performances of the three systems were made at each point. Actual tests were conducted with the car parked, so that no variations in signal intensity would occur. These adjacent-channel tests were made with all equipment on-frequency. It would have been desirable to make tests with the adjacent-channel transmitter detuned. However, the additional manpower and equipment needed prohibited such tests.

The intermodulation tests were made with a modulated adjacent-channel transmitter and an unmodulated alternate-channel transmitter. Starting at the site of the alternate-channel transmitter, the test car proceeded toward the adjacent-channel transmitter site in steps of .2 mile. The amount of intermodulation interference was noted for the three systems while the car was parked at the various points. Received signal from the desired transmitter, during these tests, was about 1 microvolt. The intermodulation tests were made with all equipment on frequency.

Test Results: The following tests were made in accordance with the procedure just outlined, and all tests were recorded on magnetic tape. Recordings of the test were then studied, and the following results were noted:

GROUP A: On-frequency range test using deviations of ± 15 , ± 6 , and ± 3 kc. respectively for the 60, 30, and 20-kc. equipments.

This test showed the maximum useful range of both the 60 and 30-kc. equipments to be about 20 miles, while that of the 20-kc. equipment was 18 miles. For distances between 3 and 17 miles, the 60-kc. equipment had about 6 db less noise than the 30-kc. equipment; for distances beyond approximately 17 miles, the two systems became nearly equal. The 20-kc. equipment exhibited about 10 to 12 db more noise than the 60-kc. equipment from all points beyond approximately 3 miles. The 30 and 20-kc. equipments were prone to respond to ignition-type interference, whereas ignition noise was rarely noted on the 60-kc. unit.

Off-frequency range test with modulation of ± 15 , ± 6 , and ± 3 kc. respectively for the 60, 30, and 20-kc. equipments.

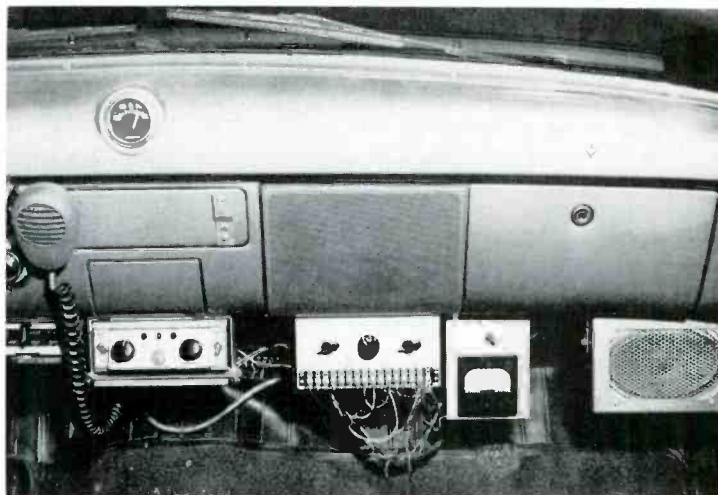

FIGS. 12 AND 13. THE 60, 30, AND 20-KC. RECEIVERS MOUNTED IN TEST CAR LUGGAGE COMPARTMENT, AND THE INSTANTANEOUS SWITCHING CONTROLS

This test revealed that the ratio of the on-frequency distance to 2.6-kc. off-frequency distances was 20/20 miles for the 60-kc. equipment, 20/15 miles for the 30-kc. equipment, and 18/13 miles for the 20-kc. equipment. Detuning by 1.3 kc. showed noticeable degradation of both the 30 and 20-kc. units, but of a lesser magnitude than did the full system tolerance of 2.6 kc. The 60-kc. system showed about 6 db less noise than the 30-kc. equipment from distances beyond approximately 3 miles, while a figure of about 10 to 12 db was noted relative to the 20-kc. system. The 30 and 20-kc. systems were, again, affected noticeably by impulse-type noise.

On-frequency, adjacent-channel interference test with ± 15 , ± 6 , and ± 3 -kc. deviations respectively for the 60, 30, and 20-kc. equipments.

In this test, a 1 microvolt desired signal was readable at about $\frac{1}{2}$ block from the interfering transmitter with the 60-kc. system, while the distances for the 30 and 20-kc. units were 1 block and 2 blocks respectively.

On-frequency intermodulation test using deviations of ± 15 , ± 6 , and ± 3 -kc. respectively for the 60, 30, and 20-kc. equipment.

This test showed about the same amount of intermodulation interference on all three systems. Interference increased as the test car came closer to the adjacent-channel trans-

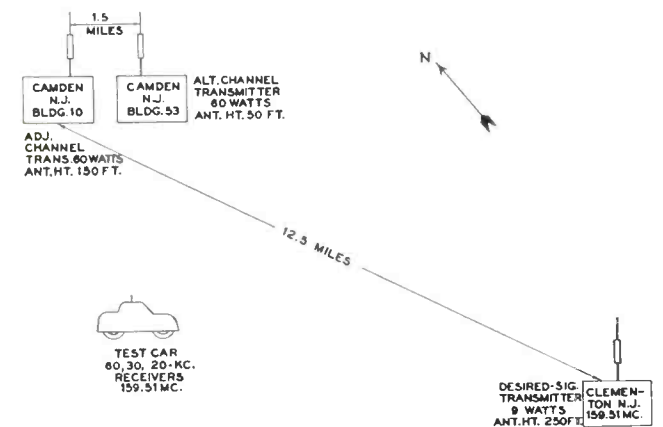

FIG. 15. RELATIVE LOCATIONS OF TRANSMITTING STATIONS FOR THE TESTS

mitter site, with heavy interference starting about 6 blocks away.

GROUP B: *On frequency range test* using ± 15 , ± 10 , and ± 6 -kc. deviations respectively for the 60, 30, and 20-kc. equipments.

Results of this test indicated that the useful range of all three systems was about 21 miles. From approximately 3 to 17 miles, the 60-kc. system was better than the 30-kc. unit by about 4 db, and the 20-kc. unit by about 8 db. For distances greater than 17 miles, the 30-kc. equipment showed about 3 db improvement over the 60-kc. unit, whereas the 20-kc. system became about equal in performance to the 60-kc. equipment. Ignition noise was noticeable on the 30 and 20-kc. units, but the 60-kc. equipment was not affected by normal ignition levels.

Range test off-frequency, using deviations of ± 15 , ± 10 , and ± 6 kc. respectively for the 60, 30, and 20-kc. equipments.

There was no reduction in the range of the 60 and 30-kc. units when detuned by 2.6 kc. However, the 20-kc. range was reduced from approximately 20 to 17 miles. The 60-kc. equipment was about 6 db better than the 30-kc. equipment out to the 16-mile point. At the 19-mile point, these equipments yielded about equal performance. The 60-kc. equipment showed about 8 db improvement over the 20-kc. equipment for distances greater than 3 miles when 2.6-kc. detuning was applied. With 1.3-kc. off-frequency operation, performance degradation was noted from the 30 and 20-kc. equipments, but of a lesser magnitude than with the 2.6-kc. de-

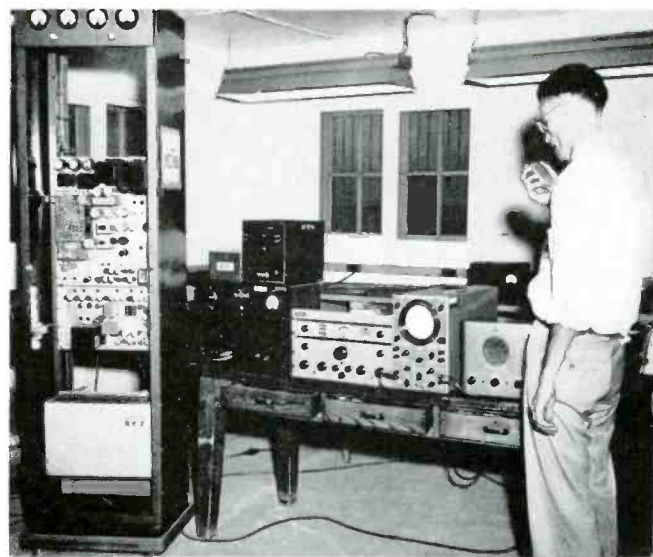

FIG. 14. THE DESIRED-SIGNAL TRANSMITTER AND MEASUREMENT EQUIPMENTS

tuning.

Adjacent-channel interference tests, using ± 15 , ± 10 , and ± 6 kc. deviations respectively for the 60, 30, and 20-kc. equipments.

This test showed that for a desired signal of about $\frac{3}{4}$ microvolt, the 60-kc. equipment was readable to one block, while the 30 and 20-kc. distances were 3 and 4 blocks respectively.

No intermodulation test was conducted for group B conditions because of the time involved as well as the similarity to results obtained under group A test conditions.

A third group of tests were made using ± 6 -kc. deviation on both the 30 and 20-kc. equipments. These tests showed that they gave about identical performance for both on-frequency and off-frequency range tests, while the 30-kc. equipment showed somewhat greater improvement over the 20-kc. equipment for adjacent-channel interference than was noted previously for group B test conditions. Detailed results of these tests are omitted because they are essentially the same as the results of the 20-kc. equipment already described under the group B tests.

The tests described above were made using AVC-type limiters in both the desired and interfering transmitters. In order to evaluate the effects of various types of modulation limiters used in transmitter equipment, a group of tests were made using a clipper-type limiter. The output of the clipper was connected through a 3-section low-pass filter with a cutoff frequency of 2,500 cycles, providing better than 35-db attenuation for all frequencies above 3,000 cycles. Except for the use of a clipper-type limiter in the desired and interfering transmitters, all other equipments and techniques were the same as previously outlined. The clipper-type limiter systems were tested using peak deviations of ± 15 , ± 7.5 , and ± 5 kc. respectively for the 60, 30, and 20-kc. channel equipments. These deviations compare with the ± 15 , ± 10 , and ± 6 kc. used in the group B tests when it is recalled that the average peak deviation using the AVC limiter was 2.5 db below the maximum instantaneous peak. Detailed test results of the clipper-limiter tests are not included here. However, on-frequency and off-frequency range tests as well as adjacent-channel interference tests agree very closely with the results noted for the group B tests made with the AVC-type limiters. Again, the 30 and 20-kc. equipments were affected noticeably by ignition interference.

Conclusions: As has been pointed out, the main concern of these tests lay in finding the particular channel-spacing

Continued on page 27

Noise-Free Instrument Cable

NEW METHOD OF SHIELDED-CABLE FABRICATION DEVELOPED AT NATIONAL BUREAU OF STANDARDS HAS VERY LOW INTERNAL NOISE UNDER FLEXURE

AN instrument cable free from spurious electrical signals caused by mechanical shock and vibration has been developed by Dr. T. A. Perls of the National Bureau of Standards Office of Basic Instrumentation. The noise-free cable is the result of a recent study of spurious cable signals, which was carried out as part of a program of basic instrumentation sponsored by NBS by the Department of Defense and the Atomic Energy Commission. In the course of the investigation, a detailed theoretical explanation was formulated for the generation of the spurious signals.

These signals, or noise voltages, present a problem in many types of instrumentation work where cables are subjected to mechanical forces. They interfere with measurements of pressure in underwater explosion and air-blast research, and with determination of acceleration in shock and vibration studies. They also affect adversely the performance of crystal-type microphones, hearing-aids, phonograph pickups, and many other high-impedance devices in the fields of communication, measurement, and control. Until now, the mechanism of the noise generation has not been well understood. It has been assumed to be related somehow to piezoelectric or converse electrostrictive effects, changes in the electrical constants of the cables, or separation of electrical charges by friction.

Preliminary Studies: In connection with the application of a piezoelectric accelerometer developed recently, it was necessary to reduce as much as possible the spurious signals caused by motion of the cable. Experiments were set up to compare the performances under dynamic stress of various experimental and commercial coaxial cables, each consisting of an inner conductor, an insulating dielectric, and a conducting shield. Each cable was connected between a small piezoelectric accelerometer and a cathode follower, and the output of the cathode follower was recorded through a DC amplifier on a direct-inking oscillograph. The standard test for cable noise consisted in grasping a short section of the cable and subjecting it to severe strains by twisting and bending, while preventing strain or motion transmission to the accelerometer itself. Another test consisted in alternately compressing and releasing a short section of the cable with pliers.

It was found that standard microphone or phonograph pickup cable gave noise signals under these conditions as high as 500 millivolts peak-to-peak. However, the noise was lowered to about 60 millivolts peak-to-peak by tightening the braided shield over the dielectric, thus improving the contact between the dielectric and the shield.

A colloidal suspension of graphite in benzene was then applied, first to the outside of the dielectric only and then to the inside of the dielectric only. While no further reduction in noise was obtained by coating the outside only, the cable signal generated by mechanical flexing was reduced markedly by coating the inside of the dielectric, provided the shield remained tight over the dielectric. Under these conditions, the residual noise was reduced to less than 3 millivolts peak-to-peak. With coatings of the graphite suspension both inside and outside the dielectric, the noise was eliminated almost completely.

In another series of tests, an experimental cable was made from an outer braided shield, the same rubber-like dielectric as before, and an insulated central conductor. This cable

was found to be quite noisy and was not improved materially by applying the graphite suspension to either the inside or outside of the dielectric.

Fig. 1 shows noise signals generated by severe whipping of three types of coaxial cable. The top trace represents microphone cable, .070 in. OD. In the center is the trace made by RG 62/U cable, 0.24 in. OD. The trace at the bottom represents the NBS experimental noise-free cable.

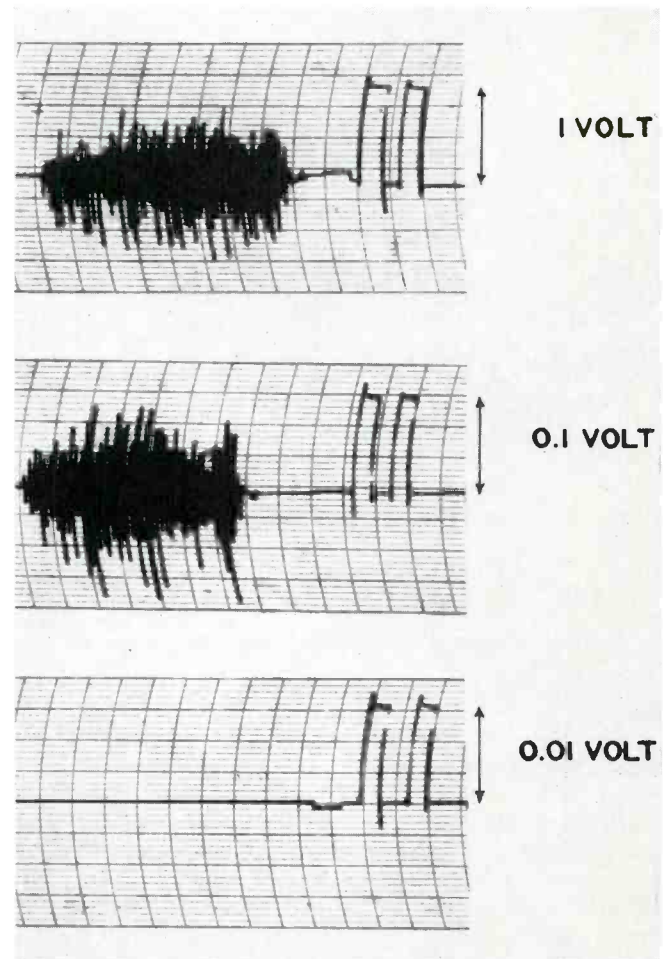

FIG. 1. NOISE OUTPUTS OF VARIOUS CABLES AS DESCRIBED IN THE TEXT .08 in. OD. The two square waves at the right of each trace are for calibration purposes; their corresponding voltage values are indicated.

Noise Theory: Analysis of these results, in combination with other reported data on cable noise, led to the formulation of a theory which describes completely the mechanism of noise generation in instrument cables. According to this theory, the noise signals are caused by currents set up in the cable when static charges are separated at the surfaces of the dielectric. To free the cable of these unwanted signals, it is only necessary that the inside and outside surfaces of the dielectric be covered by a well-bonded conductive coating.

Whenever a metal makes intermittent contact with a solid dielectric, a separation of electrical charges takes place.

Continued on page 37

Profile Charts for Microwave Links

PREPARATION AND USES OF TERRAIN PROFILE CHARTS FOR DETERMINING CLEARANCE AND REFLECTIONS ALONG PROPOSED MICROWAVE LINK ROUTES*

PERFORMANCE of a microwave radio link over a proposed path can often be predicted closely enough, with an accurate terrain profile chart, so that actual propagation tests are unnecessary. This article discusses some aspects of preparing and using such profile charts.

General Problem: Radio waves in the higher frequency ranges used for point-to-point radio links, commonly called microwaves, exhibit many of the properties of light. They travel in relatively straight lines, and they are bent or refracted by the atmosphere, reflected by solid objects or surfaces, and diffracted by physical objects in or near the transmission path. In order to predict the effects of these properties on the efficiency of energy propagation between two antennas, the nature of the terrain between the antennas must be considered.

The first step in estimating the propagation characteristics between two antenna sites is to assemble elevation data concerning the intervening terrain. Using this data, a profile chart is prepared to show the elevation of all hills, ridges, tall buildings, or other obstacles that might interfere with line-of-sight transmission. A satisfactory transmission path can then be selected intelligently by analyzing the information on the profile chart with other pertinent data.

Sources of Data: Several sources can be tapped to provide the data for a profile chart. In many cases, it can be obtained from topographic maps with contour lines showing elevations of land at convenient intervals. Information on maps of this type, prepared by the United States Department of the Interior, is available from the Director, United States Geological Survey, Washington, D. C. A section of a typical map of this type, and a sketch of the area which this map represents, are shown in Figs. 1A and 1B.

In locations for which these topographic maps are unavailable, local county surveyors can often provide the required data.

If no previously prepared maps can be obtained, a special survey may be required although, in many cases, sufficient data can be obtained through one or more common-sense

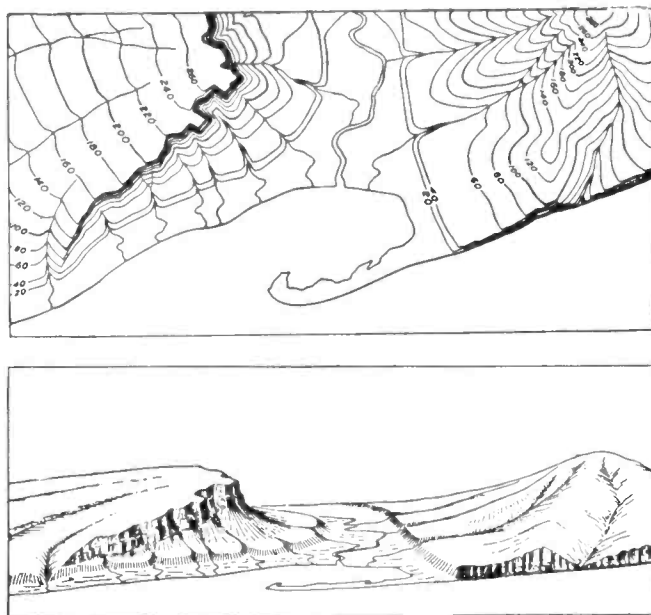

FIGS. 1A AND 1B. TOPOGRAPHIC MAP AND SKETCH OF CORRESPONDING AREA

procedures. In one such method, an altimeter is used to determine the relative heights of land along a proposed transmission path. In some cases a spot-light or sun-reflecting mirror can be used to determine if a line-of-sight path exists and, if conditions permit, the light source can be moved vertically to determine path clearance.

If data obtained from topographic maps show that only marginal clearance exists, the elevations of high points should be checked by survey or altimeter to insure their accuracy.

Consulting engineering services are available to make either ground or aerial surveys of proposed radio link routes.

Preparing the Profile Chart: After tentative antenna sites have been selected, and the relative elevations of land between these sites have been determined, a profile chart can be prepared. In some cases a complete profile, such as those shown in the examples, will be necessary; in other cases, only certain hills or ridges need be indicated to ascertain that adequate path clearance exists.

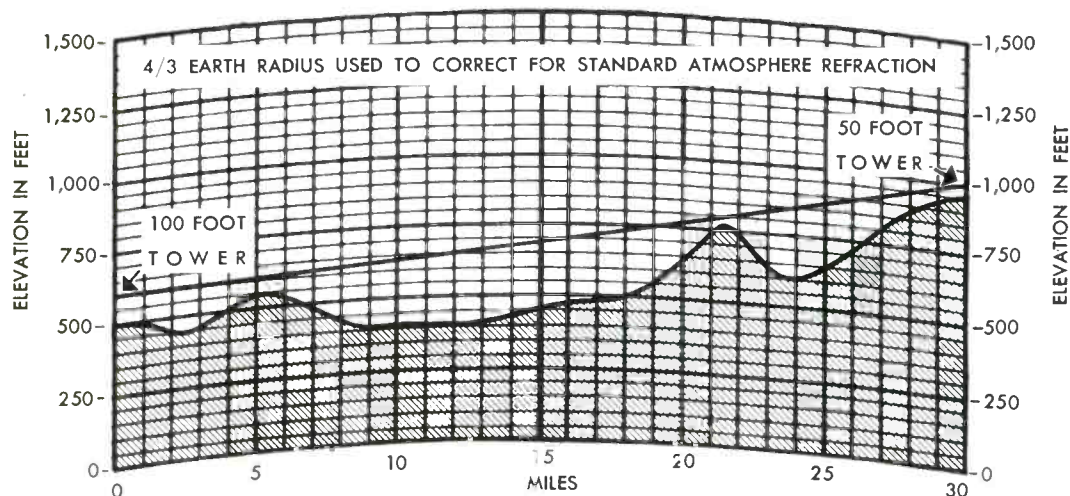

FIG. 2A. PROFILE CHART OF GIVEN TRANSMISSION PATH, PREPARED ON GRAPH PAPER CALIBRATED ACCORDING TO A 4/3 EARTH RADIUS BASIS

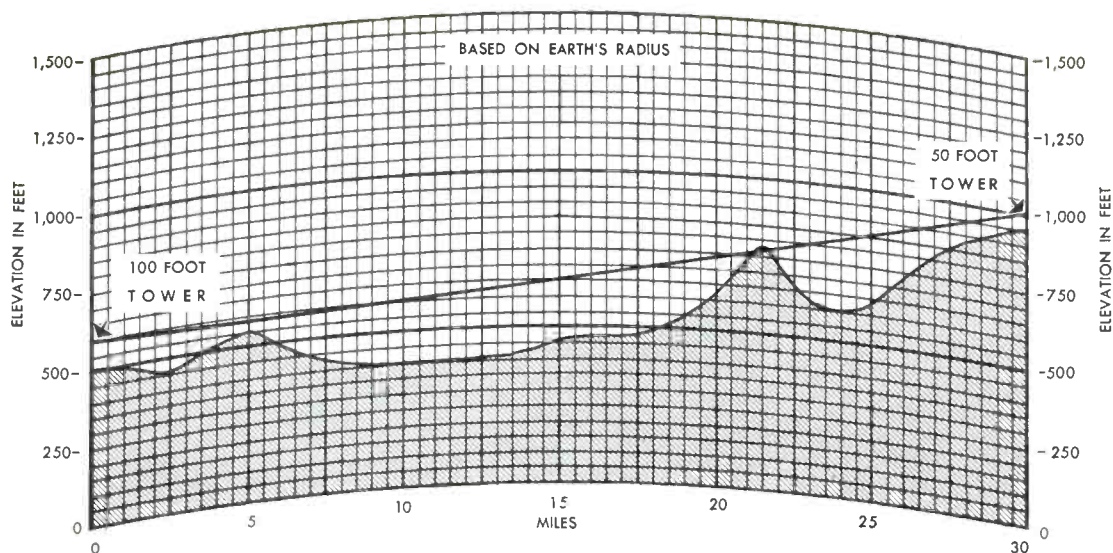

FIG. 2B. CLEAR TERRAIN PATH OF FIG. 2A SHOWS A SERIOUS OBSTRUCTION WHEN PLOTTED ON BASIS OF TRUE EARTH RADIUS

A factor that has a bearing on the shape of a profile chart is refraction. Although the surface of the earth is curved, microwaves tend to travel in straight lines. However, they are refracted a small amount by the atmosphere. The exact amount of refraction varies with atmospheric conditions. The effect of refraction is such that if a profile chart is prepared on the basis of $4/3$ of the true earth radius, a straight line between antenna sites will indicate approximate clearances between the actual transmission path and the earth. However, the factor of $4/3$, which would increase the permissible distance between antennas, is not always accurate. Under some conditions the refraction caused by the atmosphere diminishes, and the actual transmission path approaches true line-of-sight conditions.

Because reliability and continuity of service are usually very important for a multichannel radio link, many radio engineers prefer to be conservative, and base propagation predictions on the basis of path clearance shown on a profile chart prepared with true-earth radius.

The effect of using $4/3$ and true-earth radius for the same path is shown in the two sketches, Fig. 2. Fig. 2A shows that when the amount of atmospheric bending is normal, a clear path is indicated on the profile chart drawn with $4/3$ true-earth radius. Under abnormal conditions, however, the transmission path between antennas is interfered with by the ridge shown on the chart in Fig. 2B, drawn with true-earth radius.

Since the choice of earth radius varies with topography and

climate and is influenced by the amount of fading allowable, the advice of a competent radio engineer familiar with such problems should be obtained when a radio link is being installed over a path where some question about clearance or other factors exists.

Printed forms are available for plotting profile charts. A form used by Lenkurt's engineers has been employed for the examples in this article. This form, which uses true-earth radius, is based on the relationship between the height of an observer and the distance to the horizon where, if h is in feet and d is in miles, $h=2/3d^2$. If $4/3$ earth radius is used, this relationship becomes $h=1/2d^2$. The scale of either chart can be changed if desired by doubling the horizontal interval and quadrupling the vertical interval, or by dividing the horizontal interval by 2 and the vertical interval by 4.

Using the Chart: An accurately-drawn profile chart will show whether or not adequate path clearance exists for the transmission path between antennas. The chart can also be used to determine the reflection point, as shown in the diagram, Fig. 3.

A ray reflected from the earth has an effect depending to a great extent on the character of the surface at the reflection point. A strong reflection can be caused by a smooth body of water or by smooth earth, while a weaker reflection may come from wooded terrain. In general, a strong reflected wave is undesirable because it can cause fading and distortion.

Concluded on page 48

FIG. 3. HOW REFLECTION POINT IS DETERMINED FROM A PROFILE CHART. CONNECTING LINES MUST RISE AT EQUAL RATES

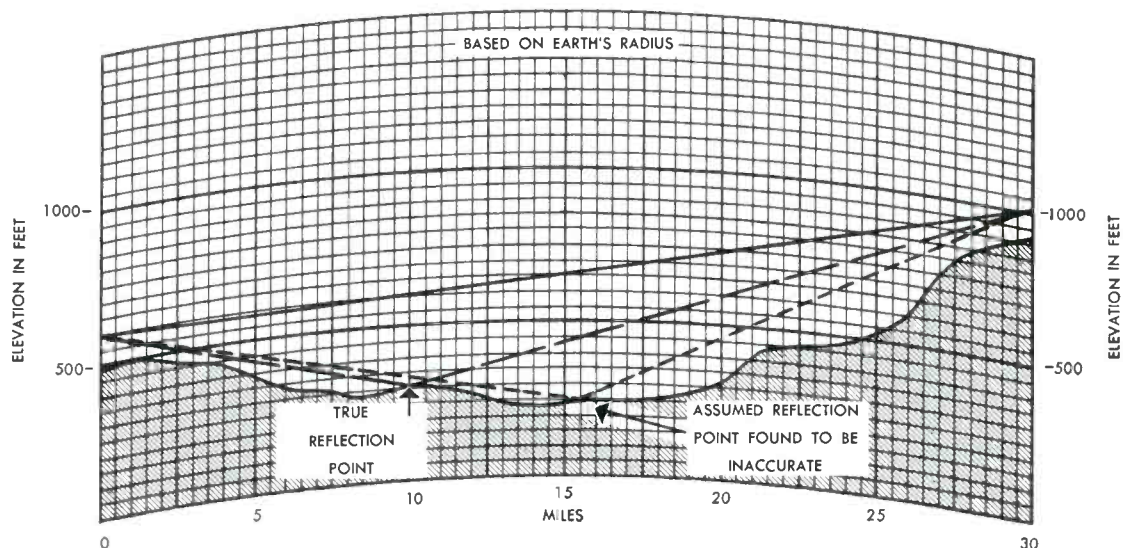

Emergency Power Switching Systems

PROBLEMS ARISING IN THE DESIGN OF EMERGENCY ENGINE-DRIVEN GENERATOR SYSTEMS, AND SOME POSSIBLE SOLUTIONS — By V. T. CALLAHAN*

FEW people in the eastern United States realize that, as they watched television programs from the West Coast early last year, one of the radio relay stations had been operating on its emergency power generator for about two weeks. At Mount Rose, Nevada, high in the Sierra Nevada mountains, 1,600 ft. of power lines were down, along with the alarm and order circuits, completely isolating the station. With 17 to 20 ft. of snow already on the ground, with more falling and high winds blowing, maintenance men could not get through for four days. Finally, using snow shoes, and snow cats, the men reached the station, where they found that the engine-driven alternator, which had automatically assumed the load when the power supply was interrupted, was still working satisfactorily. With a change of lubricating oil, the engine continued to carry the load without attention until the power lines were restored, after being down 14 days.

On earlier carrier routes, such as the Type-J and Type-K systems, reserve power is usually furnished by the repeater

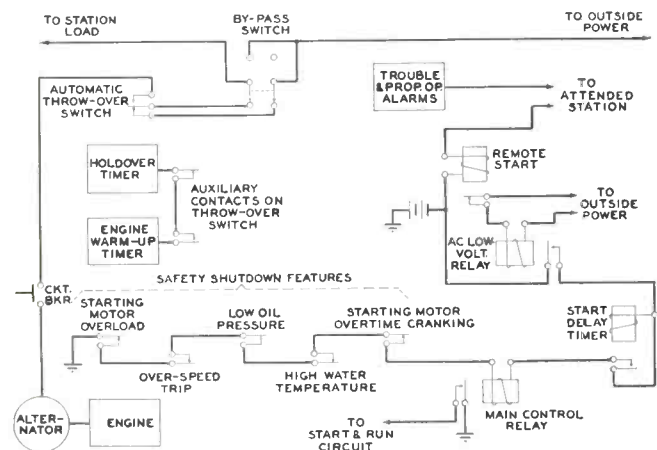

FIG. 1. POWER SWITCHING SYSTEM USED FOR TYPE L UNATTENDED RELAYS

station storage batteries. During unusually long outages of commercial power, portable engine sets are brought up by trailers. This practice, of course, requires battery reserves sufficient for periods as long as 100 hours. A few stations that require more operating power than can economically be furnished with such long battery reserves are supplied with permanent, automatically-controlled engine alternators for emergency use.

Increased power demands of the broad-band systems, such as Type-L carrier and radio relay, plus isolated locations of many of the radio relay stations, have made it economically feasible, in some cases, to install automatic engine-driven alternators for the primary reserve. Storage batteries are included, but limited to 6 or 8-hour capacities sufficient for the period necessary for ordinary engine repairs.

Early radio relay station installations on the transcontinental microwave radio relay system were supplied with automatic gasoline engine sets, but the later stations west of Denver have diesel engines. Development of the automatically-controlled diesel engines had not been completed in time for use throughout the transcontinental system. Both gasoline and diesel automatic sets have capacities of 20 to 60 kw.

Repeater stations are normally unattended, and many are in isolated locations. It has therefore been necessary to provide more elaborate controls than usually needed for commercial standby power supplies. For example, to keep the engine from starting on a temporary voltage dip, which can be taken care of by the battery reserve, a starting delay circuit is included, which requires the low-voltage condition to persist for a predetermined length of time. After this delay, the engine is given its final signal to start, but does not ordinarily assume the station load until after a warm-up period to improve engine operation. During this interval, the station load is carried by storage batteries. At the end of this time the load transfer is made by a very fast-operating contactor. Designed to require electrical power only when transferring the load, this contactor remains mechanically locked in one position until energized, thereby avoiding interruptions of power supply due to temporary voltage variations.

When normal service power is again available after a failure, the engine continues to carry the station load for a predetermined time to insure that the normal voltage condition is not temporary. Unless the engine has been running for some time, it continues to operate long enough to raise its temperature, and thus prevent undue condensation dilution of crankcase oil. At the end of this period, the fast-acting contactor again operates to connect the commercial power supply to the load, the engine then stops, and the circuit is in readiness for the occurrence of the next power failure.

Engine room ventilation in unattended stations requires careful design to maintain desirable operating temperatures. Three automatically-operated shutters are provided in the air system. The air intake louvers open when the engine starts and close when it stops. The air exhaust shutters do not begin to open, however, until the radiator cooling solution reaches about 135° F. The position of these shutters is determined by a mechanism controlled by the cooling solution temperature, the exact position being changed as required to maintain the desired temperature. The third set of louvers is controlled by an engine-room thermostat; these louvers are arranged to recirculate some of the warm radiator air if needed to maintain

FIG. 2. HERCULES DIESEL-ENGINE UNIT

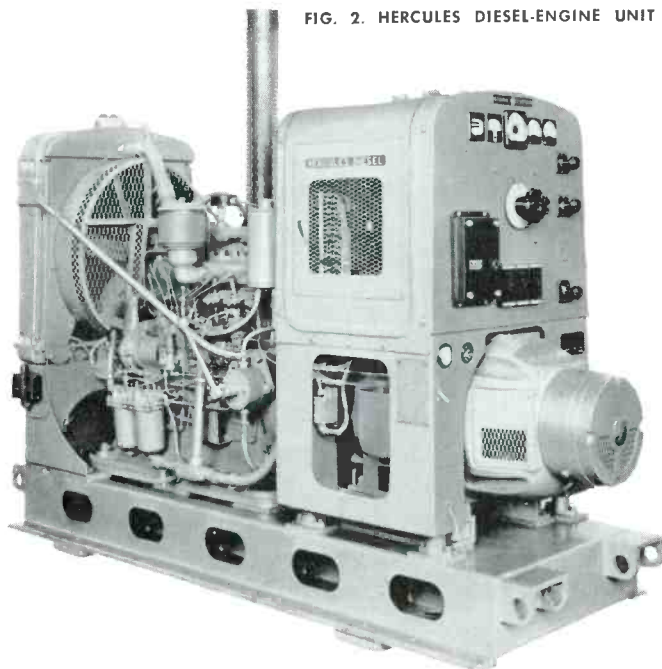

*Power Development Engineering Group, Bell Telephone Laboratories, Inc., 463 West Street, New York 14. This text was originally published in the *Bell Laboratories Record*, January, 1953.

the desired room temperature during engine operation, since engine rooms generally are not heated.

A simplified block diagram of the essential features of the control system is shown in Fig. 1. Since there is usually no attendant within a number of miles of the station, it is important, in case of trouble, to stop the engine before damage is done. If the speed becomes too high, oil pressure too low, or cooling solution too hot, controls are arranged to stop the set and transmit alarm signals to maintenance people at a control center. If the engine should fail to start during the cranking period, cranking is stopped after a predetermined period to avoid complete discharge of the starting battery. This is a separate storage battery with a rectifier to keep it in a fully charged condition. Similarly, if the heavy initial inrush of starting motor current persists—as it would, for example, if the bearings seized—the attempt to crank the engine is discontinued so as to avoid damage to the starting motor. Signals are also given to indicate power failure, to show when the engine set is carrying the station load, and to warn that the fuel supply may be running low.

To be sure that the engine sets are in condition for reliable starting, arrangements are provided for exercising them each week. This can be done locally at the station, or remotely from the maintenance center.

Since they are installed in unheated rooms the engine sets may be exposed to temperatures as low as -20° F. Tests at that temperature have shown that positive and reliable automatic starting requires a 2500-watt thermostatically-controlled heater for the cooling liquid solution. The thermostatic switch used with this heater is set to cut off the heater when the cooling liquid is 80 to 100° F., and to turn on the heater at 60° F. or lower. Due to radiation in air temperatures at -20 degrees F., the heater maintains an engine cylinder combustion air temperature of 45 to 50° F. The types of diesel engines used in these stations require a cylinder combustion air temperature of not less than 35° F. at the start of the compression

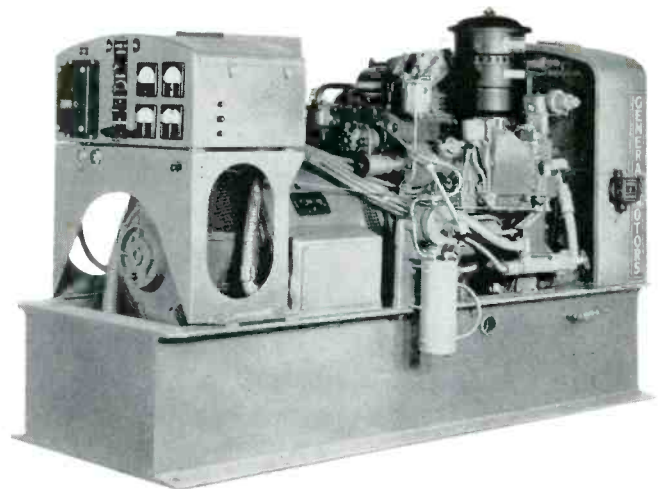

FIG. 3. EMERGENCY ENGINE-DRIVEN GENERATOR MADE BY GENERAL MOTORS stroke, so as to ignite the fuel properly by the heat of compression at the end of the stroke.

Emergency arrangements are made to stop the engine by a switch at the engine or from the control panel. Switching provisions are also included to transmit normal service power directly to the load circuits, and to remove the service power from the control circuits during repair or maintenance.

Three stations on the transcontinental radio relay are in locations where no commercial power supply is available and where the provision of such a supply was economically prohibitive. For these stations, the single-engine control circuit was modified so that two engines could be operated on a continuous basis, one engine operating for twelve hours, then the other for twelve hours, continuing this way for a month, without attendance. Two-engine installations have all the features that the single engines have except that no cooling solution heaters are provided since the rooms are heated.

At the completion of a twelve-hour service period, the idle engine starts, running for five minutes under no-load. The load is then transferred to the other engine, and the first engine shuts down. The control circuits are interlocked to prevent false or improper operation of either engine generator set. If the second set should fail to start or to assume the load, the first set will continue to run, and the failure will be reported over the alarm circuit to the control center.

It is not practicable to provide an engine crankcase of sufficient size to hold enough lubricating oil for a month's continuous operation of the two-engine generator sets without attention. Therefore, to enable monthly maintenance, a wall-mounted tank for the lubricating oil is provided. It has pipes connecting to both engine crankcases and it also has float level valves. To avoid the possibility of flooding the engine crankcases if the float level valves should fail, a high level overflow line is connected to each crankcase. This line runs to a floor tank containing a float-operated switch used to start a small electric motor-driven pump. The pump returns the oil from the floor tank to the wall-mounted reserve tank.

Development of the reserve power plants is an example of cooperation between Bell Laboratories engineers and those of outside suppliers. Through the combined efforts of these engineers, engine alternator sets equipped with the necessary accessories for full automatic operation are now giving excellent emergency service in radio relay stations. Some of the engine-alternator sets were supplied by the Hercules Motor Corporation of Canton, Ohio. Fig. 2 is a photograph of one of these. Another supplier, the Detroit Diesel Division of the General Motors Corporation, also furnished a number of the machines. Fig. 3. The automatic control equipment, built by Western, is contained in twin cabinets. Fig. 4. This equipment is arranged to operate with engine-alternator sets made by either manufacturer.



FIG. 4. A WESTERN CONTROL PANEL FOR TWO ENGINE-DRIVEN GENERATORS

Forming High-Frequency Conductors

HOW SOFT-DRAWN COPPER TUBING CAN BE FORMED WITHOUT BUCKLING OR CRACKING TO MAKE HIGH-FREQUENCY RF CONDUCTORS—By GERALD W. LEE*

IT is common practice, in transmitting equipment installations, to utilize soft-drawn copper tubing for electrical conductor paths wherever an appreciable amount of high-frequency energy is to be transferred. On such installations, the engineer must often bend and shape conductors of various lengths and diameters as new installation ideas evolve, the building housing the equipment is changed, or unit modifications are undertaken in the field. A great deal of conductor-making must be done on the job, since factory-made conductors are often unavailable at the time in correct sizes.

However, bending tubing larger than $\frac{1}{4}$ in. in diameter properly is impossible unless special means are employed to avoid buckling and cracking it. Applying heat is not a satisfactory solution, since the tubing must be kept at such high temperatures for smooth bends that handling becomes impractical. On one job for which we needed a large number of such conductors, we tried various ways of tube shaping until a successful one was developed. This method consisted of filling the tube with fine, dry sand, capping it, and then bending it to require-

ments, as shown in the drawings. A brief set of instructions follows:

1) Take measurements of the distance between the terminals the conductor is to connect together. Cut from a roll of tubing a piece slightly longer than this distance to provide for small errors in measurement.

2) Fill the tubing with fine sand. The sand must be quite dry and fine-textured, preferably screened, so it will flow easily and pack well.

3) Cap the ends of the tubing with plugs of wood or other compressible material. Terminal lugs can be used if they are crimped on tightly.

4) Bend the tubing to the required shape.

5) Empty out the sand, which can be used again, and fit the conductor into place, trimming the ends with a pipe cutter. Terminal lugs can be soldered on the ends if desired.

6) Polish and install the conductor in its proper place.

This method can be applied to tubing of $\frac{1}{4}$ to $\frac{3}{4}$ -in. diameter with uniformly good results. With larger sizes, buckling is likely to occur. Since most high-frequency conductors fall within the specified limits, however, the method is generally applicable to all radio equipment installations.

* Professional Engineer, 46 Roxborough Street, Toronto, Ontario, Canada.

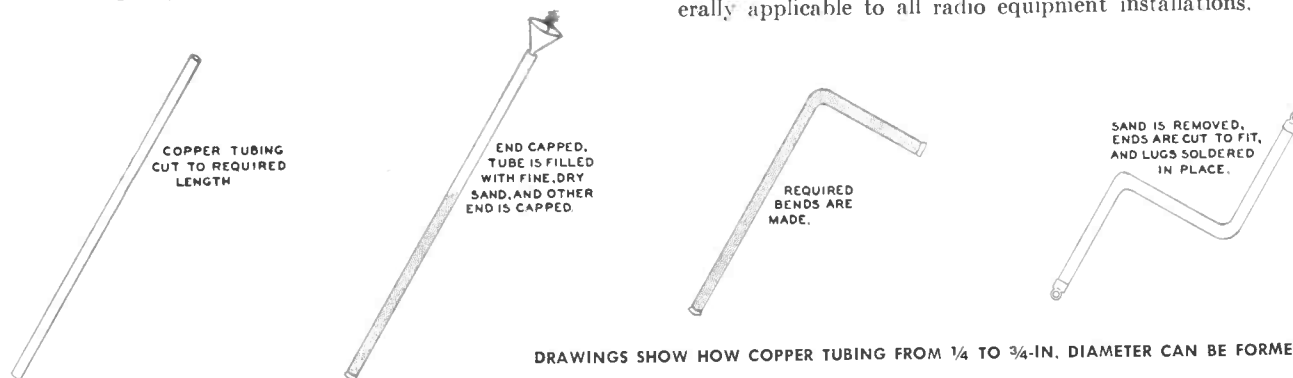

CHANNEL SPACINGS AT 160 MC.

(Continued from page 21)

standard which produces maximum effectiveness. It is evident that the investigations were limited in scope as compared with the vast number of permutations possible by manipulation of the several available parameters. Therefore, it must be remembered that the summations noted herein are based upon the results of only the conditions used in these tests.

Comparisons of the group A and B tests indicate that notable improvement of the 30 and 20-kc. equipments can be gained by using a modulation index whose significant sidebands are about equal to the receiver pass band. The greater deviation does increase the adjacent-channel interference somewhat, as well as slightly increasing the distortion of received signals at extreme range. However, these disadvantages seem more than counterbalanced by the improved on and off-frequency range performances obtained in the group B tests.

If the same modulation deviation is used for both the 30 and 20-kc. equipments, it appears that about identical performance will be obtained. This, of course, results in degrading of the 30-kc. unit, because of its wider receiver bandwidth. Thereby, the advisability of using the greatest possible modulation deviation is violated.

When the same total system tolerance is used for the various channel spacings, the system performance is degraded as the channel spacing is decreased. This is true whether or not any portion of the channel is provided for system stability. One of the major shortcomings of narrow-band systems is their greater sensitivity to impulse-type interference. This was indicated theoretically, and demonstrated adequately by laboratory measurements as well as by field tests. Because of the presence of impulse interference, the 60-kc. system was always superior to 20-kc. equipment, regardless of the signal-to-noise levels involved or whether the systems were both on or off frequency. Likewise, a comparison of 60-kc. and 30-kc. equipments reveals fluctuation-noise superiority of the 60-kc. unit except at extreme range, where the 30-kc. equipment nearly equals the 60-kc. unit for off-frequency operation, and exceeds it by about 3 db for on-frequency use.

Adjacent-channel interference became somewhat greater as the channel spacing was reduced. However, no interference was noted even on the 20-kc. equipment at distances greater than about 5 blocks from the interfering transmitter for on-frequency operation. No off-frequency interference tests were made but it was predicted theoretically that with 2.6-kc. detuning, the 30 and 20-kc. systems would be degraded further by additional space-attenuation of about 1 and 18 db.

Continued on page 46

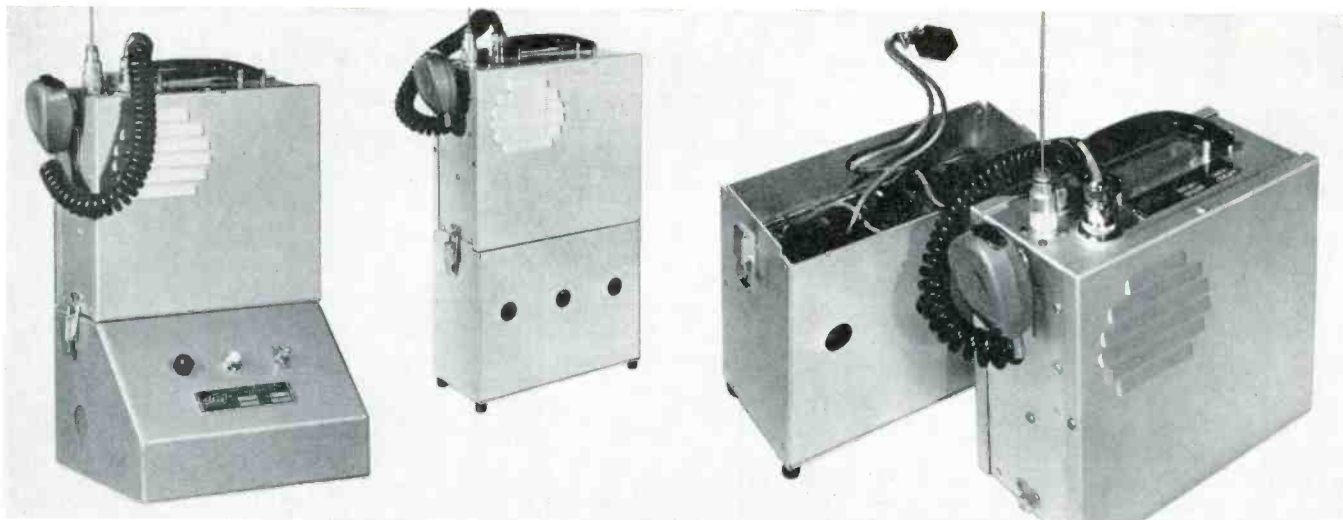

FIG. 1. LEFT, CEECO CENTRAL-STATION EQUIPMENT WITH AC POWER SUPPLY. CENTER AND RIGHT, PORTABLE UNIT WITH HEAVY-DUTY BATTERY SUPPLY

Hand-Carried 2-Way FM Equipment

PERFORMANCE DATA AND MECHANICAL SPECIFICATIONS FOR PORTABLE LOW-POWER TRANSMITTER-RECEIVER UNITS FROM ALL MAJOR MANUFACTURERS

ALTHOUGH hand-carried portable 2-way FM equipments are designed to meet specifications set up by the FCC for low-power industrial applications, they find wide use in other services also. Police and fire departments, forestry conservation, special industrial, highway maintenance, and railroad radio services, among others, use portable units in large quantities. These services account for nearly as many portable equipment authorizations as the low-power industrial service.

Primary reason for this is, of course, the amazing versatility of these miniaturized units. Communication range is greater than might be expected even under adverse conditions, and extends for many miles in more favorable circumstances. Thus, complete communication systems, including base stations, can be and often are built around them.

Public safety services find them of value in extending the ranges of conventional systems, since they provide 2-way communication from anywhere a man can walk. They are particularly useful to industrial concerns for integration of intraplant activities.

Because recognition of the true value and importance of this type of 2-way radio equipment has created considerable interest in its availability, the equipments of all major manufacturers are shown and described on these pages.

Communication Equipment & Engineering Company, 5646 West Race Street, Chicago 44, Ill. The CEECO line includes portable, mobile, and AC-powered units for fixed-station operation, in the 25 to 50 and 152 to 174-mc. bands.

Basic chassis for each frequency band are $9\frac{1}{4}$ by $8\frac{1}{4}$ by $4\frac{1}{8}$ ins. In the lightweight versions of each, having battery lives of 8 to 20 hours, this chassis holds all the batteries required. AF output of 10 milliwatts limits these models to use with handset or hand microphone and earpiece. The heavier versions have extra batteries contained in a chassis 7 ins. high which snaps on the bottom of the basic chassis. These models have battery lives of 25 to 50 hours and provide 1 watt of audio, so that loudspeakers and hand mikes are furnished.

RF output of all models is one watt. Either dry batteries or rechargeable storage batteries can be furnished for any model; vibrator supplies are used with the storage batteries, and these units can be furnished with power cords for attachment to 6-volt vehicle batteries. Alternatively, equipments can be supplied with AC power supplies for station use. Fig. 1 shows some of the various models, and Fig. 2 is a block diagram of the transmitter and receiver circuits.

Weight is 9 to 10 lbs. for the lighter models, and 17 to 23 lbs. for heavy-duty models.

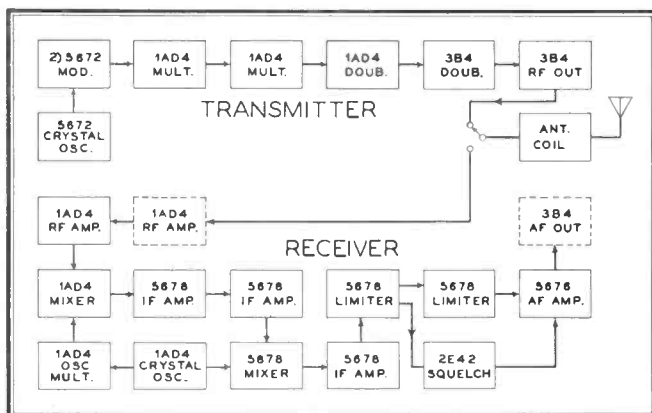

FIG. 2. CEECO 150-MC. MODELS HAVE 2 RF STAGES. HEAVIER MODELS HAVE 1 WATT AF.

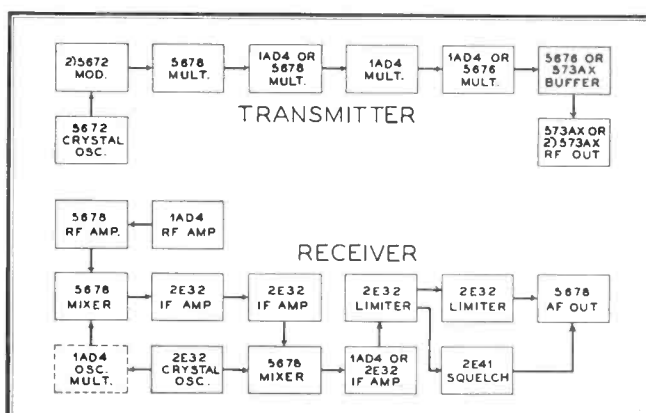
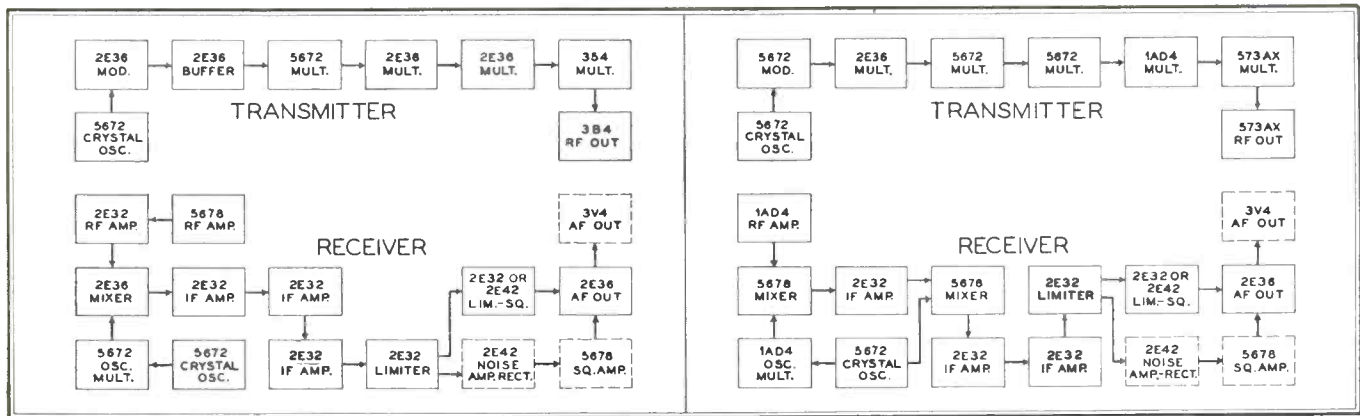

FIG. 3. LITTLE FONES PROVIDE HIGH OR LOW-POWER RF STAGES



FIGS. 8A AND 8B. TUBE LINEUPS FOR MOTOROLA 25 TO 50 AND 152 TO 174-MC. PORTABLES. PACK UNITS HAVE EXTRA STAGES SHOWN IN DOTTED LINES

The Hallicrafters Company, 5th and Kostner Avenues, Chicago 24, Ill. Models of the Littlefone are available for the 25 to 50 and 152 to 174-mc. bands in portable, mobile, or central-station styles, as shown in Figs. 3 and 4. All portables have 5 milliwatts of audio output and are equipped with push-to-talk handsets. However, they can be obtained on special order with hand microphones and shoulder loudspeakers. Low-power models for dry-battery or rechargeable wet-cell and vibrator operation have .75 and .5-watt RF outputs on 25 to 50 mc. and 152 to 174 mc., and weigh 9.5 and 10 lbs. respectively. Heavy-duty models, weighing 14 lbs., provide 2 watts and 1 watt in the low and high bands respectively, and utilize wet cells only. Battery lives are 10 hours for dry batteries, 8 hours for wet cells.

Central-station models for AC operation, and mobile models for 6 or 12-volt DC applications, have AF outputs of 1 watt for loudspeaker drive. RF outputs are 2 watts and 1 watt in the low and high bands.

Industrial Radio Corporation, 428 N. Parkside Avenue, Chicago 44, Ill. This company makes two basic Pakfone models for the 25 to 50 and 152 to 174-mc. bands. They are similar in design and tube-lineup, as Figs. 5, 6, and 7 show. One or 2-frequency transmitters are available in either band. The low-band model has an RF output of 1 watt and an AF output of .5 watt; for the high-band model, the figures are .75 and .5 watt. Hand mikes and loudspeakers are used for both bands.

Various types of power supply are available, however. The standard portable supply consists of dry batteries, with which the unit weighs 20 lbs. and measures 4½ by 10 by 13½ ins.

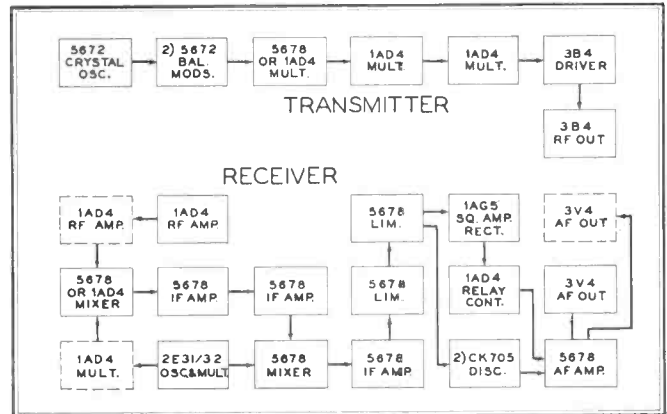

FIG. 5, ABOVE. PAKFONE 152 TO 174-MC. MODEL HAS THE EXTRA RF STAGE FIG. 6, BELOW. AN UNDER-CHASSIS VIEW OF INDUSTRIAL RADIO PAKFONE

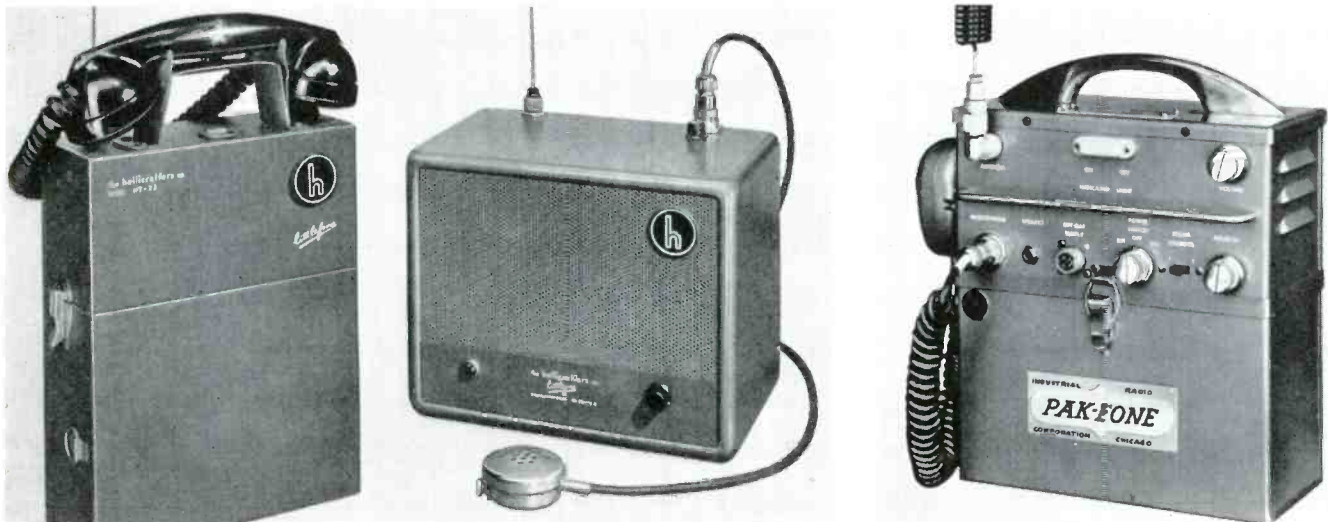
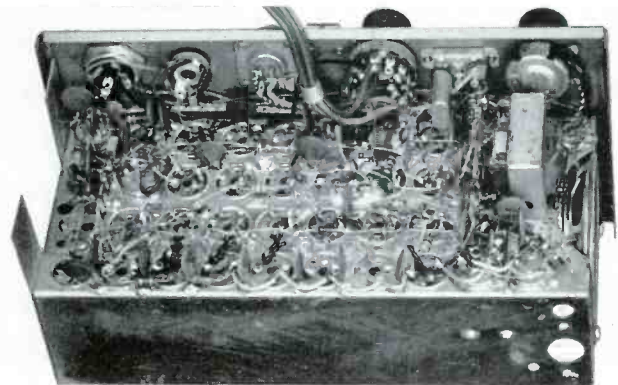
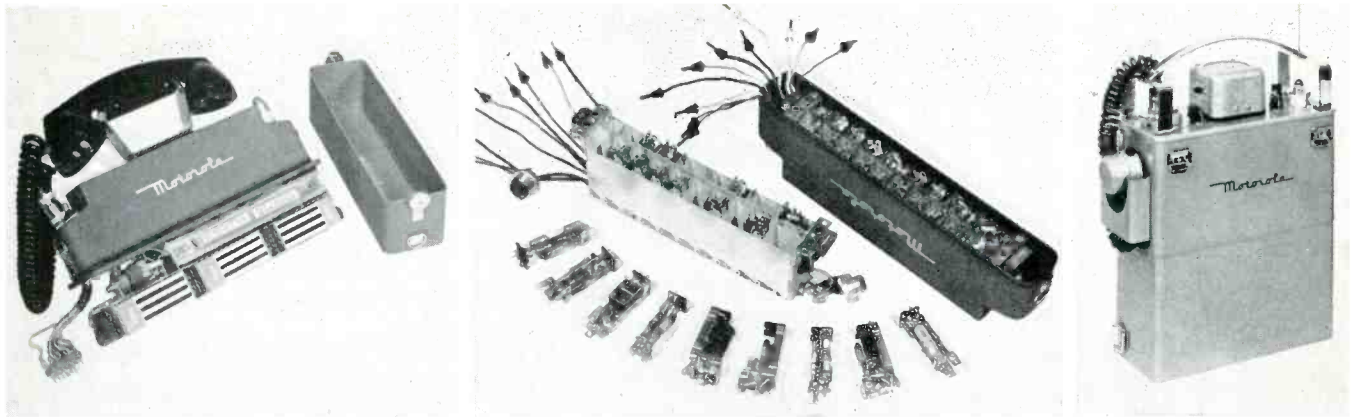

FIG. 4. HALLICRAFTERS PORTABLE AND CENTRAL-STATION LITTLEFONE MODELS. FIG. 7. HEIMARK PAKFONE, MADE BY INDUSTRIAL RADIO CORPORATION



FIGS. 10 AND 11. DISASSEMBLED VIEWS OF THE MOTOROLA HANDIE-TALKIE EQUIPMENT. FIG. 12. MOTOROLA PACK MODEL FOR HEAVY-DUTY APPLICATIONS

overall. A wet cell and vibrator supply can be furnished if specified. An external combination 6-volt DC and 115-volt AC supply is available for operation of the equipment as a mobile or central-station unit.

Motorola, Inc., Communications and Electronics Division, 4545 Augusta Blvd., Chicago 51, Ill. Two lines of portable units are available: a radiophone pack model with hand mike and loudspeaker, and the Handie-Talkie model with push-to-talk handset. Each line consists of models for the 25 to 50 and 152 to 174-mc. bands, Figs. 8A and 8B. Examples of each

line are shown in Figs. 9, 10, 11, and 12. All models can be obtained with two transmitters or 2-frequency transmitters, with dry batteries or wet-cell and vibrator supplies, and with headset and lip-mike facilities if desired.

Handie-Talkie models are 10 or 12½ by 12½ by 3⅞ ins. overall, depending on power-supply type. Weight is 9.8 to 16.2 lbs., depending on use of one or two transmitters and wet-cell supplies. RF output for low-band models is .5 watt; for high-band models, .25 watt.

The larger pack units are 15½ by 10 7/16 by 4 9/16 ins. overall, regardless of power supply. Weight is 21 to 23 lbs. RF output is .75 and .25 watt for low and high-band models respectively. Auxiliary power supplies are available for operation on 6 volts DC or 115 volts AC, so that the equipment can be used in mobile or fixed-station applications.



FIG. 9. VIEW OF A HANDIE-TALKIE AND A 3-UNIT CHASSIS FITTING IN THE UPPER COMPARTMENT

Radio Specialty Manufacturing Company, 2023 SE 6th Avenue, Portland 14, Oregon. The Packmaster line of portable equipment, Figs. 13 and 14, is available for 25 to 50-mc. operation only. One or two-transmitter and one or two-receiver combinations are available.

RF output depends on power-supply used. One watt from 40 to 50 mc. or 1.5 watt up to 40 mc. is obtained with dry battery tray. However, with built-in power supply to operate from an external 6-volt DC or 115-volt AC supply, these figures are increased to 6 and 7.5 watts. AF output to loudspeaker or headphone is 100 milliwatts.

Dimensions are 6 9/16 by 13½ by 11½ ins., including battery tray. Weight is 19½ to 20½ lbs. with light-duty batteries lasting 15 hours minimum, or 25¾ to 26¾ lbs. with medium-duty batteries good for 68 hours minimum.

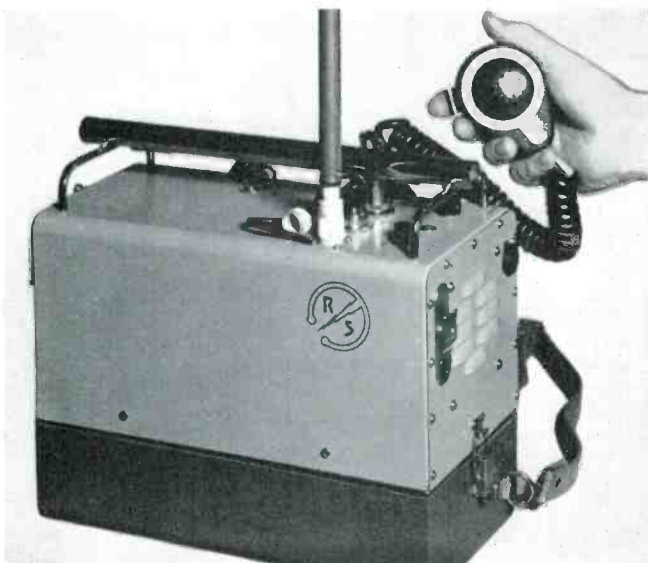
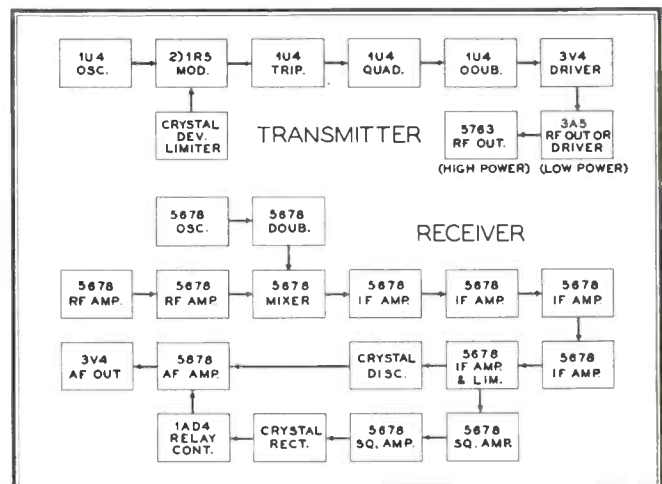

FIG. 13, LEFT. THE RADIO SPECIALTY PACKMASTER FOR 25 TO 50-MC. USE FIG. 14, BELOW. PACKMASTER IS MADE IN LOW AND HIGH-POWER VERSIONS



A New Multiplex Microwave System

DETAILS OF THE FR AND FJ MICROWAVE EQUIPMENTS—By N. B. THARP*

THE last five years have witnessed an amazing growth in microwave communications. FCC licenses have been issued for well over 600 stations, providing for approximately 12,000 system miles in various sections of the Country.

Because microwave radio can be used so advantageously for certain point-to-point services, it is performing many functions that previously have required regular wire-line facilities; in many instances, it is replacing telephone and carrier wire lines for private communications. Microwave links control and provide communications for many new pipeline and power-line systems which, only a few years ago, would have been dependent on conventional telephone lines or power-line carrier. This article discusses some of the factors which make microwave radio equipment advantageous for such applications, and describes the new Westinghouse equipment developed to meet this demand.

Characteristics of Microwaves: Frequencies above 950 mc. are generally considered to lie in the microwave region. The frequency bands now available in the United States for microwave communication services are 952 to 960 mc., 1,850 to 1,900 mc., and 6,575 to 6,875 mc. They are commonly referred to as the 960, 2,000, and 6,700-mc. bands. Because microwaves travel in relatively straight lines, they are particularly suited to private communications. Moreover, by concentrating most of the radiated energy into a single beam, parabolic reflector antennas can provide substantial gain in effective transmitted power. This gain is better than 300 for a 6-ft. reflector at 2,000 mc. This means that relatively small transmitter powers can be used.

Ionosphere reflection is not significant at microwave frequencies. Normal atmospheric refraction tends to make the

*Section manager, Microwave Engineering, Electronics Division, Westinghouse Electric Corp., Baltimore, Maryland.

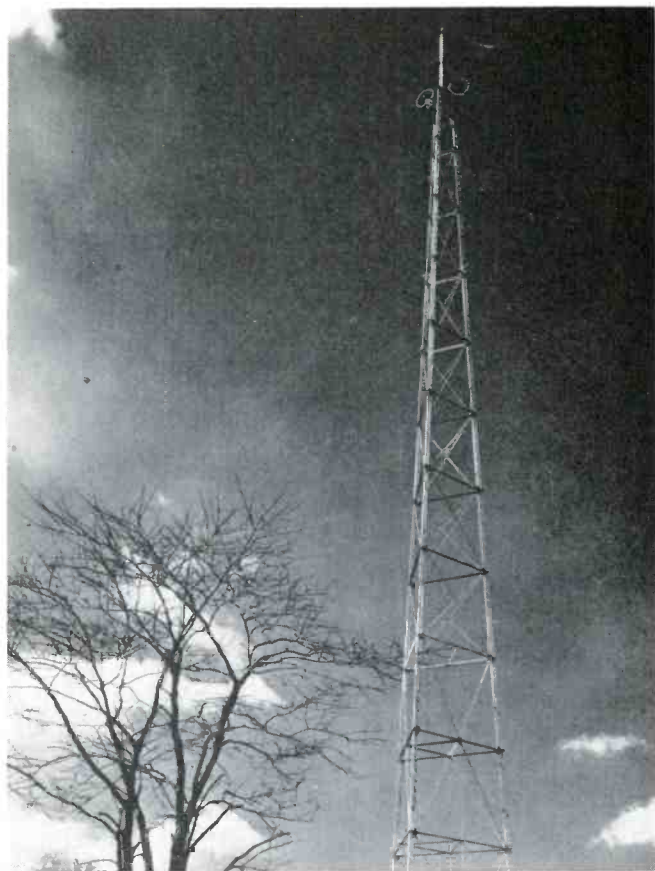
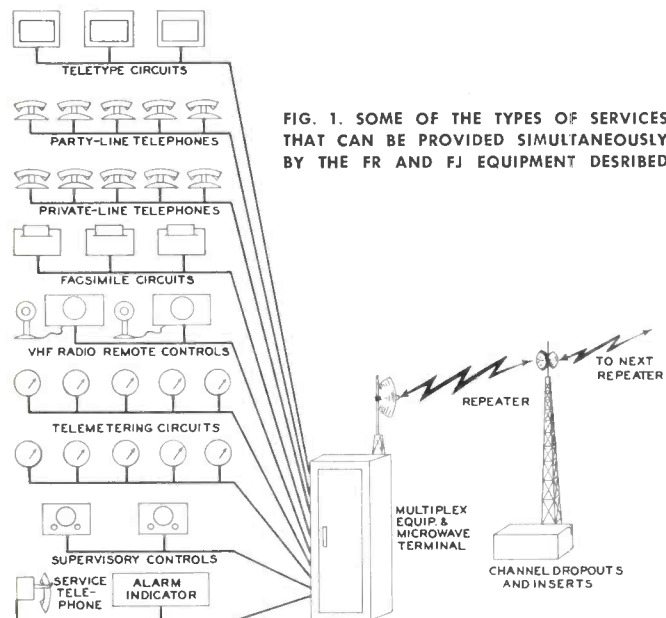

ONE OF THE MICROWAVE TOWERS FOR AN FR SYSTEM AT BALTIMORE, MD.

lower microwave frequencies follow the earth's curvature to some degree, but the range of dependable transmission is limited substantially to a line-of-sight distance between the radiating and receiving antennas. The maximum line-of-sight distance is, of course, a function of the surrounding terrain and the antenna tower height. For flat terrain, the line-of-sight distance is usually determined by the practical and economic limit on antenna tower heights. Average distance per hop is about 30 miles.

An inherent characteristic of microwave radio is that it can carry a great deal of information on a single RF carrier. Practical bandwidths for microwave transmitters operating at 2,000 mc. range between 2,000 and 10,000 kc. This wide-band transmission capability can be exploited by multiplexing techniques. Thus, the signals representing many voice conversations and other types of intelligence can be combined on the microwave carrier for transmission as a single signal, and can be separated with little distortion at the receiver points. By such means, a modern microwave system can carry up to 30 separate voice channels of 250 to 3,000 cycles. Alternatively, a microwave link can carry up to 500 telegraph channels, each 200 cycles wide.

This tremendous information-carrying capacity makes microwave installation, operation, and maintenance cost per channel-mile quite low. For applications in which more than a few channels are required, and considerable distances are involved, microwave systems compare favorably in cost with telephone wire lines, and, in many cases, to power-line carrier service.

As the number of channels required and the mileage increase, an economic crossover point is reached at which a microwave system becomes less expensive than rented lines or new installations of wire lines. Where communications circuits giving satisfactory service already exist, the situation becomes complicated, and careful cost studies should be made when additional channels are needed. In some instances, the more conventional systems best suit the purpose.

Another important factor in the economic comparison between microwave systems and wire lines is the matter of reliability. If communication circuits are intended primarily

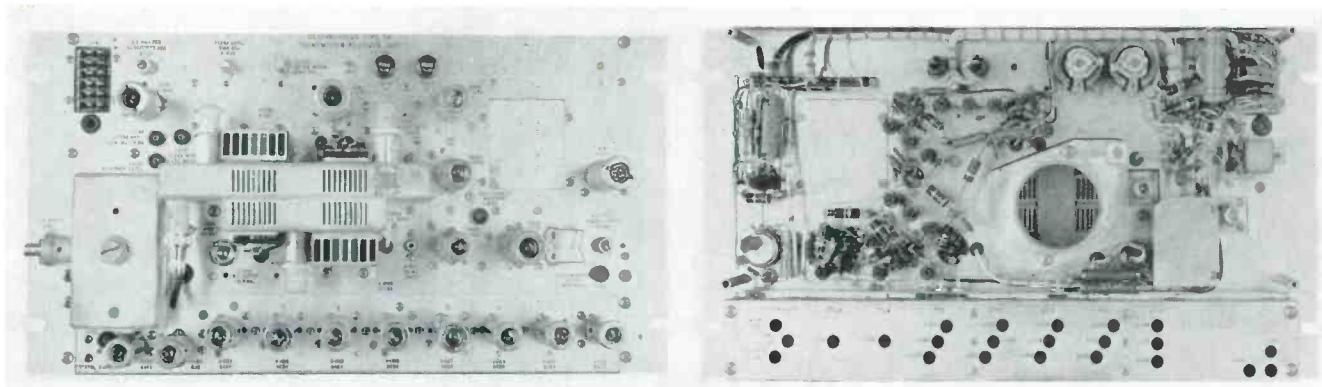

FIG. 2. FRONT AND REAR VIEWS OF THE FR MICROWAVE TRANSMITTER-RECEIVER PANEL. NOTE PIN-JACK TEST POINTS AND TWO CONNECTORS

for operating and maintaining facilities that can be affected by adverse weather conditions, it is obviously advantageous for the communication system to be independent of the weather. A microwave system requiring only physically-impermeable steel towers can be made practically invulnerable to the ravages of wind and ice, which are the worst enemies of wire lines. Since there is no static interference at microwave frequencies, electrical storms do not hamper communication. Obviously, therefore, a microwave system is of more value in servicing a power-transmission line under conditions of ice and wind than a wire-telephone or power-line carrier system.

The multiple-channel capacity of microwave systems makes the equipment valuable in an extensive range of applications. These include signaling, facsimile, teletypewriter, telemetering, relaying, supervisory control, load control, and remote control of VHF radio systems. In fact, a well designed microwave system can provide any service that direct wires can. As such, the field of applications is barely scratched. The next few years will see a tremendous expansion of this type of communication both in this Country and abroad.

New Westinghouse Equipment: A modern microwave system must meet the following requirements: First, of course, the equipment must perform its intended functions satisfactorily. Second, dependability is so important that no system is even worth consideration unless it is highly reliable. Third, versatility is important to the manufacturer and the customer, as well. This includes versatility for initial applications and for rearrangement and expansion to accommodate subsequent needs. Finally, the equipment should be low in first cost and in installation, operation, and maintenance expenses.



FIG. 4. FAULT-ALARM INDICATOR UNIT, WHICH CAN BE LOCATED UP TO 100 FT. FROM ALARM PANEL.

These were the criteria which guided the development of the new Westinghouse equipments, identified as types FR microwave radio equipment and FJ multiplexing apparatus. They are able to handle 30 two-way voice-frequency channels which can be used for voice, telegraph, telemetering, or similar services, in any combination. Fig. 1 shows how a typical system might be set up. A terminal-station rack can be seen in the photograph reproduced on the front cover.

FR Microwave Units: Type FR radio equipment consists of a co-ordinated group of individual panels. Basic units are the transmitter-receiver, Fig. 2, and the local oscillator-modulator, automatic frequency control, and power supply panels. A terminal station uses one each of these panels, while a repeater station requires two transmitter-receiver panels (one for each direction of transmission), a local oscillator-modulator panel, and a power supply, but no AFC panel. This is not required because system frequency control is normally maintained from the terminals.

A service channel panel, Fig. 3, for maintenance communication is included as part of the basic equipment at each terminal or repeater station. A handset connection is provided at each station for full party-line operation over this channel. Signaling provisions are included. To this panel can be added an alarm unit which provides indications of equipment failure, power failure, or other off-normal conditions at outlying stations. Such indications are transmitted automatically by code over the service channel signaling frequency to required stations, where they are displayed on an alarm indicator panel, shown in Fig. 4.

Standby radio equipment is available, which is switched automatically into the circuit in case of failure. Where no standby equipment is included and a station goes entirely out of operation, provision has been made for the repeater on each side of the disabled station to switch automatically to terminal-station operation. In this way, a repeater fault in a long system cannot knock out the entire system. If, however, the repeater station stops transmitting in one direction only, the station normally receiving this transmission

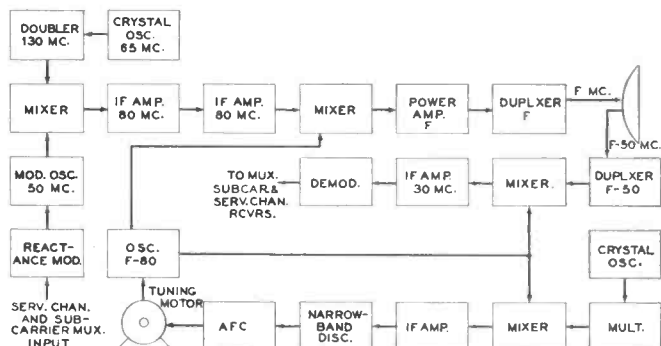

FIG. 5. RADIO CIRCUITS REQUIRED AT A TERMINAL

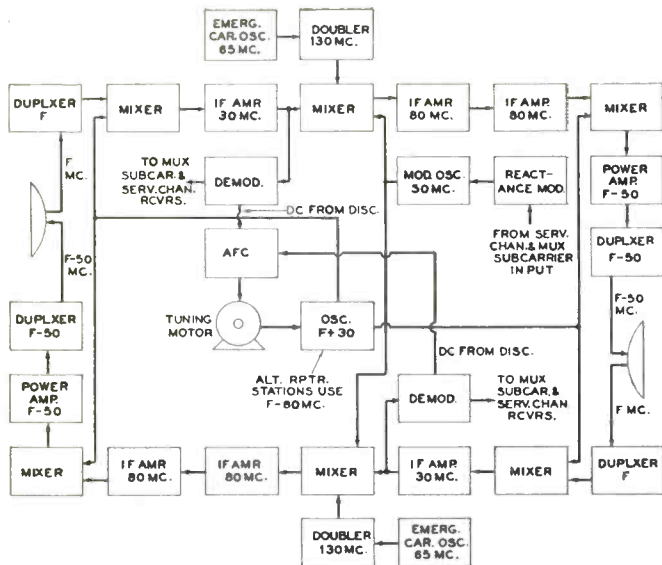

FIG. 6. BLOCK DIAGRAM OF CIRCUITS AT A TYPICAL REPEATER STATION switches to terminal-station operation for the one direction of transmission. For the other direction of transmission, operation of the relay system is unaffected. When the faulty station is brought back into service, the adjacent station or stations automatically return to repeater service, restoring normal operation.

Emphasis has been placed on ease of servicing. Tip-jack electrical test points are provided on the panel fronts, as can be seen in the photographs. All circuit-checking for normal maintenance can be made with a single test meter. A test meter panel is included as part of the FR assembly. The meter can be installed in this panel facing in either direction for servicing the front or rear of the equipment. All tubes except the modulator-oscillator tubes, which are in a temperature-controlled box, are accessible from the front. External electrical connections to all panels are made through plug connectors so that the units can be quickly replaced.

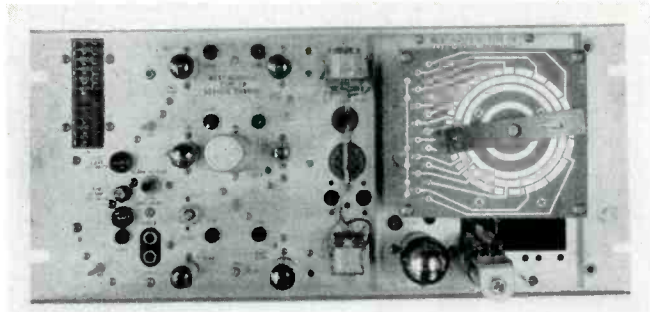

FIG. 3. THE SERVICE CHANNEL PANEL, USED FOR MAINTENANCE CIRCUITS

All components are suitable for high-humidity conditions and are operated conservatively below their ratings. Panels are of steel, cadmium-plated and irridite-finished for resistance to corrosion.

The FR equipment normally receives modulation signals from FJ multiplexing equipment, operating in the 300 to 600-kc. frequency band. This band accommodates thirty separate voice channels, or their equivalents. The service channel utilizes the band between 300 and 4,000 cycles.

Fig. 5 depicts the principal components of an FR terminal-station installation. A composite signal from the multiplex and service channels is passed through a pre-emphasis network, which equalizes the signal-to-noise ratios over the range from 300 to 600 kc. This signal is then applied to the modulator, which produces a ± 2 -mc. peak deviation of the 50-mc. oscillator. This deviation was selected as the best compromise of good signal-to-noise ratio with minimum RF bandwidth. The modulated 50-mc. signal is amplified before injection into the 80-mc. mixer.

The 65-mc. crystal oscillator frequency is doubled. The resultant 130-mc. frequency, when mixed with the modulated 50-mc. frequency, produces an 80-mc. output. This is amplified in three stages and then by a power amplifier, which applies a high-level signal to the RF mixer. In the system illustrated, the local oscillator generates a frequency of 1,870

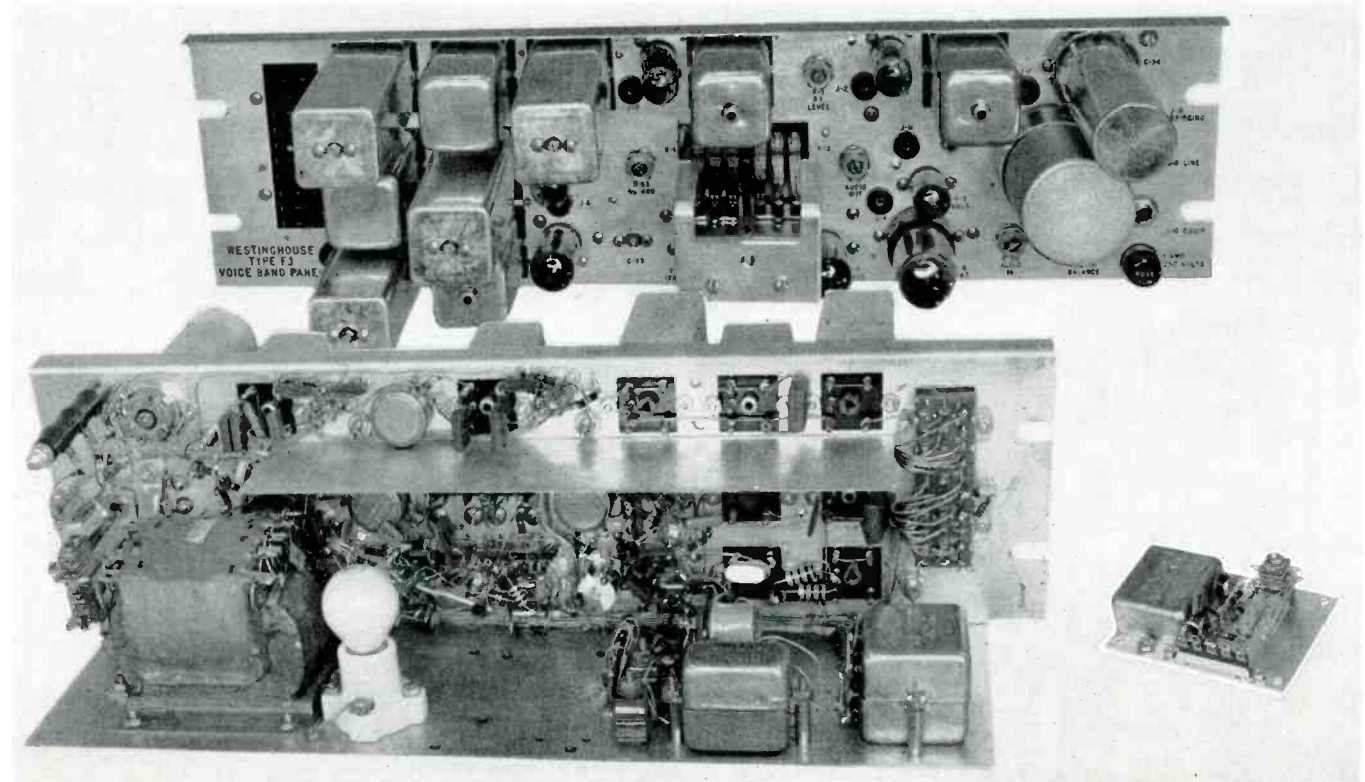

FIG. 7. TWO VIEWS OF THE FJ VOICE-BAND MULTIPLEX TRANSMITTER-RECEIVER CHASSIS. PARTY-LINE SUB-PANEL UNIT IS SHOWN AT LOWER RIGHT

mc., which is 80 mc. below the frequency to be transmitted. This signal is combined in the RF mixer with the 80-mc. signal, to produce a transmitting frequency of 1,950 mc.

After going through an RF amplifier, the signal is fed through the duplexer to the antenna. The RF amplifier isolates the oscillator and thus reduces the need for critical adjustment of transmission-line VSWR. Tuned to the transmitting frequency, the duplexer provides attenuation to spurious output frequencies and a high impedance to the incoming signal displaced by 50 mc. from the transmitted signal. The local oscillator, RF mixer, and power amplifier each use a planar triode 2C39A in a cavity. These circuits permit the use of the inexpensive and easily-replaceable 2C39A without bulky coaxial elements.

A signal being received is first passed through the receiver duplexer which is sufficiently selective to prevent transmitted energy from entering the receiver. From the duplexer, the received energy is combined with the output of the local oscillator in a crystal mixer to obtain an intermediate frequency of 30 mc. The IF strip has a cascode input circuit. After amplification, the 30-mc. signal is limited and demodulated. The demodulated signal is amplified further in the multiplex amplifier, and supplied to the multiplex equipment and service channel panels.

A portion of the local-oscillator output is supplied to the AFC mixer, along with a reference frequency obtained from the AFC crystal oscillator and multiplier. The difference frequency of 21 mc. is amplified and applied to a discriminator to obtain a DC output, which is amplified and used to operate the tuning motor control relays. The tuning motor positions a tuning loop located in the plate cavity of the local oscillator. This frequency-control loop maintains the transmitter frequency output at the value assigned to the system. Two indicator lamps are located beside the local oscillator cavity.

When a frequency correction is taking place, one or the other of the lamps is lighted, depending on the direction of the frequency drift, to give a visual indication that the oscillator is being controlled and thus maintained on frequency.

Fig. 6 is a block diagram of a repeater station which transmits and receives in both directions. The local oscillator-modulator unit is common to both transmitter-receiver units.

In operation, the signal received from the antenna is routed through the receiver duplexer, the crystal mixer, and the 30-mc. IF amplifier and limiter. The oscillator frequency for the crystal mixer is supplied by the local oscillator and has, for the repeater station shown, a frequency 30 mc. above the received frequency. The output of the 30-mc. limiter is fed to the 80-mc. mixer in combination with a 50-mc. signal from the modulator unit. The resulting sum frequency is amplified, mixed with the output of the local oscillator, amplified further in the power amplifier, and passed out through the duplexer to the antenna which transmits it to the next station.

In the example shown, the signal is received at 1,950 mc. (F) and transmitted at 1,900 mc. (F-50). For transmission in the reverse direction, the signal is also received at 1,950 mc. and transmitted at 1,900 mc. However, it is required at the adjacent repeater that signals be received on 1,900 mc. and transmitted on 1,950 mc. This is accomplished by suitable changes in the frequency of the local oscillator, the transmitter and receiver duplexers, and the power amplifier. At the next repeater, the local oscillator operates at 1,870 mc. In either case, the combination of frequencies in the heterodyning processes of the crystal mixer, the 80-mc. mixer, and the RF mixer are such that the received signal is shifted upward or downward only by the frequency of the 50-mc. oscillator in the modulator, and is not affected by

Continued on page 39

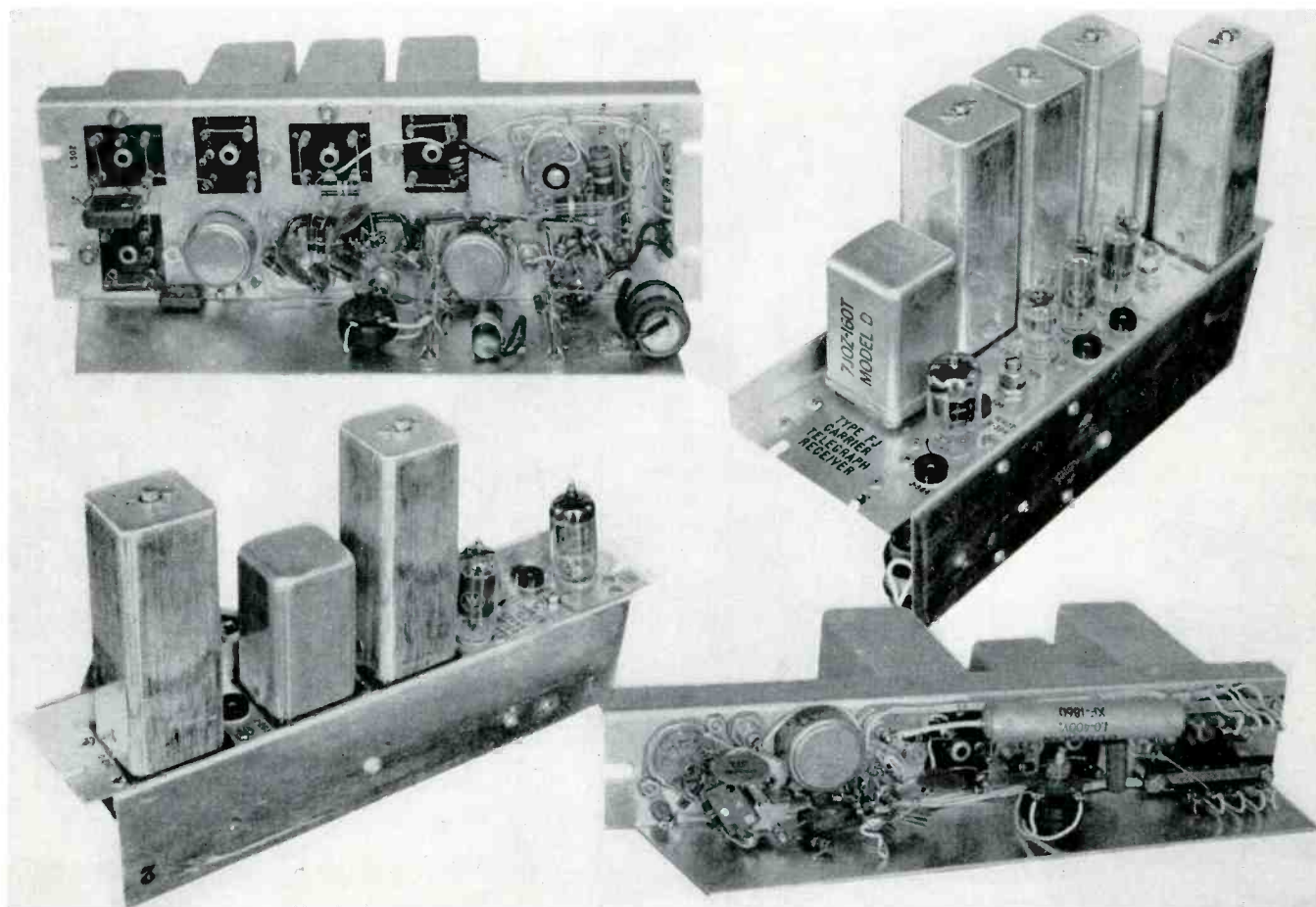

FIG. 8. FJ MULTIPLEX TELEGRAPH RECEIVER, ABOVE, AND TRANSMITTER, BELOW. THESE UNITS CAN BE FURTHER SUB-MULTIPLEXED WITH AUDIO TONES

INCREASED ACCURACY WWV AND WWVH

THE National Bureau of Standards' primary standard of frequency is the foundation upon which are based all time and frequency transmissions from the Bureau's radio broadcasting stations WWV in Beltsville, Maryland and WWVH, Maui, Territory of Hawaii. From these stations, standard radio frequencies of 2.5, 5, 10, 15, 20, and 25 mc. are transmitted continuously, night and day, with accuracies of 2 parts in 100 million.

Operation of the Standard: The primary standard consists of 9 crystal-controlled oscillators and 8 quartz crystal resonators. Three of the oscillators are located at Beltsville, one acting as the main oscillator for all the transmitters, the second as the standby, and the third as a spare. The remaining 6 oscillators and the 8 quartz crystal resonators are maintained in the Bureau's Washington laboratories. All the crystal-controlled oscillators are kept in continuous operation. The best ones, those having the least amount of deviation from exactly 100 kc. for the preceding period of 6 months or longer, are those which determine the standard frequency.

Specially-made GT-cut quartz crystals, with resonant frequencies of 100 kc., control the oscillators. In examining the crystals, it has been generally observed that their performance curves have flat regions within which the crystal frequencies are relatively constant. When the driving current reaches a value of about 150 microamperes, the frequency decreases sharply. In view of this fact, the driving currents applied to the crystal units of the newer oscillators are less than 100 microamperes. A decided improvement in performance occurs, which is especially evident when compared to the older oscillators with driving currents of over 500 microamperes. Increased short-time stability and overall reliability has also been achieved.

The 8 resonator crystals have been part of the frequency standards for about 1½ years. Each resonator's frequency is used in the analysis of the accuracy and constancy of the 9 oscillators. All 8 crystals, each also with a resonant frequency of 100 kc., are installed in a single temperature-controlled oven. They do not incorporate additional components such as tubes, resistors or capacitors. They are not driven continuously but are used only once a day as part of a balanced-bridge network for comparison with one of the standard oscillators. Current driving the crystals are only 10 microamperes.

Continued on page 36

formerly FM-TV RADIO COMMUNICATION

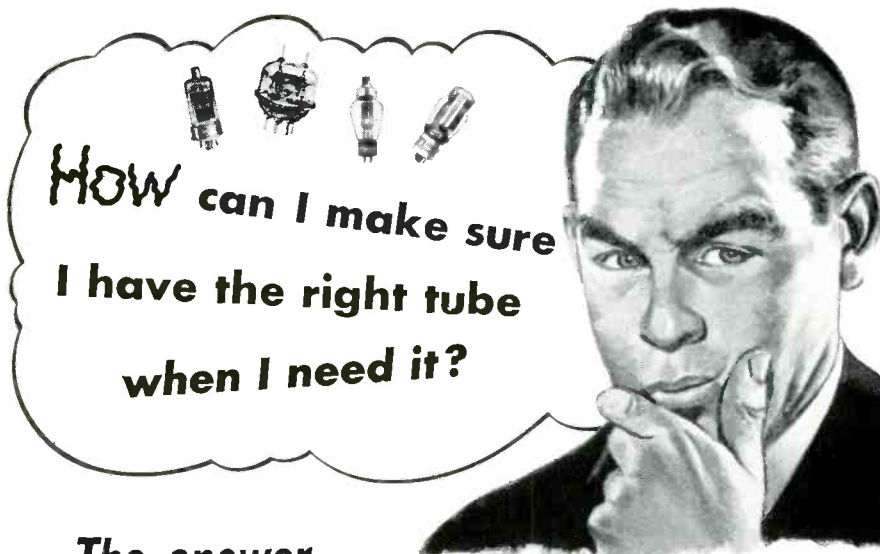

The answer:

RCA's new Tube Requirement Analysis!

Now you can stop worrying about the possibility of communications equipment shut-down—in the event you have neglected to reorder a key tube type. Now you can also save money by avoiding "overstocks." RCA's new Tube Requirement Analysis gives you smooth control over your communications equipment tube requirements.

Get in touch with your RCA Tube Distributor

Give him all the information you can about your electronic equipment, the tube types involved, and your special requirements. In this way, you bring him up to date on the services in which your tubes are operated.

He analyzes your needs

Then your RCA Tube Distributor can prepare a record of movement on each tube type required for your communications equipment—can study *your* specific tube requirements.



He recommends a plan for YOU

Now, your RCA Tube Distributor presents a tube inventory plan—simplified and "tailored" specifically to your operations. He keeps up to date on your inventory . . . and backs it up with inventory service on his end, too! No overstocking. No shortages. Yet you can be sure you have the right tube—when you need it!



RCA's new Tube Requirement Analysis is available exclusively through your local RCA Tube Distributor. Call or write him, today. There is no charge or obligation for this service.



RADIO CORPORATION of AMERICA
ELECTRON TUBES

HARRISON, N. J.

SINGLE-INSTRUMENT FM MODULATION CHECKING



— from
25 to 174 megacycles
with the
NEW
Browning MD-33

The MD-33 Frequency Modulation Monitor is a completely new instrument, for precision performance in critical work. No plug-in units of any kind are required.

The unique peak-flasher circuit permits the operator to select either of two pre-set values for flasher indication of transient overmodulation, adjustable to 20 kc.

Remember: the best costs less—in the long run.

Coverage . . . 25 to 174 megacycles, continuous, in two bands.

Sensitivity . . . better than 1 mv to 140 mc., and better than 2 mv to 174 mc.

Panel meter . . . 20 kc. maximum, on linear scale.

Flasher . . . indicates peaks in excess of either of two pre-set values, from 1 to 20 kc.

Audio output . . . adjustable, 5 volts RMS maximum, flat from 100 cps to 15 kc.

Phone jack . . . on front panel.

Drift . . . obviated by AFC applied to local oscillator.

For detailed information, write for data sheet

ENGINEERED
FOR
ENGINEERS



BROWNING
Laboratories, Inc.
Winchester, Mass.

(Continued from page 35)

Once a day, the relative frequencies of each resonator crystal and each standard oscillator are determined. First, a precision variable oscillator is adjusted to the frequency of one of the resonators. The variable oscillator is then compared to one of the standard oscillators, and the beat or difference frequency is counted on an electronic frequency counter. The variable oscillator is then readjusted to the second resonator crystal, and again compared to the same standard oscillator. The difference frequency between these two oscillators is again recorded. This procedure is continued until data are available indicating the amount of frequency deviation between the standard oscillator and each of the resonator crystals. One of the remaining 8 oscillators is used as a reference against which all the other oscillators are compared.

The reference oscillator is instrumental also in obtaining a continuous record of the frequencies of the 3 standard oscillators at the WWV installation. Automatically, the main, standby, and spare oscillators are switched successively at pre-set intervals to a low-power VHF transmitter. The signals are beamed to the NBS laboratory in Washington, and the received signals are compared to signals derived from the reference oscillator.

Temperature Controls: A more precise and reliable temperature-control system for the ovens enclosing the oscillators has been developed recently. The oven is essentially 4 concentric cubical chambers; the center chamber holds the oscillator unit, and the areas contained by the next and outer chambers are filled with felt insulation. An air-chamber containing mat heaters separates the insulated chambers. The outer heater, designed for coarse temperature control, is operated by a simple mercury thermostat. Control of the inner heater, designed to respond to very small changes in temperature, is achieved by using a network in which the heater element is part of the sensing circuit. In effect, one pair of arms of a resistance bridge is made up of wire with a high temperature coefficient, and the other pair is made of wire with a negligible temperature coefficient. Current through both pairs of wires supplies the necessary heat. An oscillatory circuit, composed of the bridge connected between the input and output of a high-gain amplifier, essentially a feedback loop, controls the temperature. When the temperature is near the desired value, or the bridge is slightly unbalanced, the amplifier is in a stable condition. As the outer temperature of the oven decreases, the bridge

Continued on page 37

becomes further unbalanced and the amplitude of the output oscillations increases so as to supply more current to the bridge wires and, consequently, more heat to the oven. This condition continues until the temperature returns to assigned operating value. Under normal room conditions, the temperature is controlled to better than 0.001 degree C.

Corrections: In order to monitor accurately the time signals generated by the frequency standard, one of the standard oscillators is used to drive a synchronous clock. The 100-kc. output of each oscillator is divided to a frequency suitable for driving a spark chronograph and chronoscope. These instruments are designed so that the driving oscillator can be compared to the time signals of the other 5 oscillators in the Washington laboratory, and those at the WWV installation, to an accuracy of 20 millionths of a second. Time differences or variations in each clock are reported each day to the U. S. Naval Observatory, where they are used in evaluating the mean solar time. The Observatory issues weekly reports giving corrections to the WWV signals with reference to mean solar time. Quarterly corrections for the slight deviations in absolute time and frequency as broadcast by WWV are available from NBS.

NOISE-FREE CABLE

(Continued from page 22)

just as when two different dielectrics are rubbed together. Friction is not necessary for this effect, but it increases the amount of separated charge, probably by insuring better mechanical contact before separation. Thus, as a small area of the cable shield separates from the dielectric, a surface charge is left on the dielectric, and an opposite bound charge is left on the shield. As the air gap increases, the charge on the shield becomes increasingly free, and a portion of this charge is redistributed by flow through the terminal impedance of the cable, so that it appears ultimately on the central conductor at a point opposite the separated charge on the dielectric. It is this flow of current through the terminal impedance of the cable that develops the noise voltage. It is apparent that the process can also take place when the inner conductor, or both conductors, are free to separate from the dielectric.

This theory of cable noise production seems to be confirmed by the experimental results obtained at NBS. For example, signals generated in the manner described are in theory limited by the maximum density of surface charge pos-

(Continued on page 38)

formerly *FM-TV* RADIO COMMUNICATION

CANNON PLUGS

get good reception

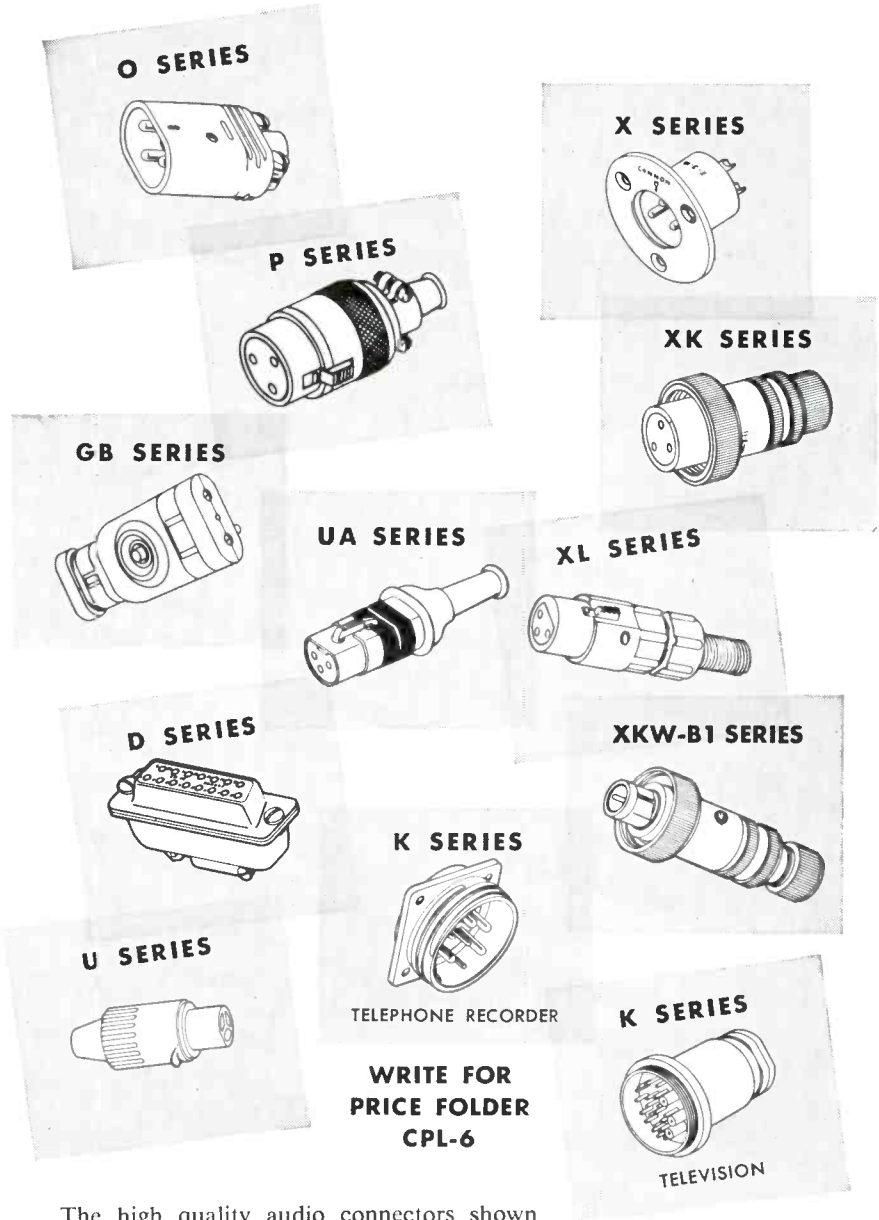

**WRITE FOR
PRICE FOLDER
CPL-6**

The high quality audio connectors shown above are available from all Cannon Franchised Distributors. In their great variety of sizes, shapes and contact arrangements there is no problem or technical requirement in the radio, sound, TV or related fields that cannot be met. Cannon plugs are standard on leading makes of audio equipment and microphones.

See
Cannon Electric
Booth #2-512
Radio Engineering Show
March 23 to 26
Grand Central Palace
New York

CANNON ELECTRIC

Since 1915



Factories in Los Angeles, Toronto, New Haven, Benton Harbor, Representatives in principal cities. Address inquiries to Cannon Electric Company, Dept. C-146, P. O. Box 75, Lincoln Heights Station, Los Angeles 31, California.

6 YEARS PROOF ON 2-WAY RADIO!

Leece-Neville

ALTERNATORS END BATTERY TROUBLES

BATTERY USED FOR STARTING ONLY

Since 1946, L-N Alternators have been eliminating battery troubles on 2-way radio vehicles... or wherever needs for current are high. Replace conventional generators with the L-N Alternator System and get

25 TO 35 AMPERES IDLING!

**ENTIRE ELECTRIC LOAD
CARRIED BY THE ALTERNATOR**

BATTERY KEPT FULLY CHARGED

Let us arrange a demonstration of the L-N Alternator for your fleet. Or



write for all the facts. The Leece-Neville Company, Cleveland 14, Ohio. Distributors in principal cities... Service Stations everywhere.

**HEAVY-DUTY ELECTRIC EQUIPMENT
FOR OVER 43 YEARS**



Be Sure to Specify Leece-Neville

ALTERNATOR SYSTEMS • GENERATORS
STARTING MOTORS • REGULATORS • SWITCHES
FRACTIONAL HP MOTORS



NOISE-FREE CABLE

(Continued from page 37)

sible without breakdown of the gas, usually air, between the cable dielectric and the separated conductor. When the noise voltage generated by this maximum theoretical surface charge is calculated from the electrical constants of the systems, it is found to be not greatly in excess of some of the experimental values. Several other theoretical predictions have been verified by simple experiments. Thus, as predicted by the theory, the voltage generated by a sudden separation of one of the cable conductors

from the dielectric rises suddenly to a peak, followed by an exponential decay. Moreover, both theory and experimental observations indicate that the initial amplitude of the recorded peak is proportional to the area of cable affected, inversely proportional to the total cable capacitance, including any parallel capacitances, and is reduced for a given surface charge if the relative motion permitted between the movable conductor and the dielectric is reduced. It is also found, both theoretically and in practice, that the initial amplitude of the peak is independent of the terminal resistance of the cable, provided this re-

sistance is high enough to produce noise pulses of sufficient duration with respect to the high-frequency response of the electrical system and the time required for separation.

Experiments have shown that the resistance of the conductive coating need not be especially low. In fact, it has been found that a conductive coating having a resistance on the order of 1 to 50 megohms per linear inch of cable reduces the unwanted cable signals by a factor of 500 or more.

Making Noise-Free Cable: Various types of conductive paints, suspensions of graphite, and conductive rubbers that can be used for the conductive coating are available commercially. Several patents have been issued on methods for bonding such coatings to cable insulation.

One method for making noise-free cable, which appears to have commercial possibilities, consists in extruding concentric layers of conductive rubber, non-conductive dielectric, and more conductive rubber over a metallic conductor, preferably stranded for flexibility. All conductors of a multiconductor cable could be treated in this manner. Neither the inside conductor nor the outside shield need fit tightly; in a flexible cable they should preferably be somewhat loose. If desired, a protective insulating outside jacket can be added, and this jacket would not require a conductive coating. There appear to be no limitations on how small such a noise-free cable can be made.

Until such cable becomes available commercially, pieces up to 6 ft. in length can be made by laboratory workers for their own use by combining parts of three different kinds of easily-obtained cable. Lamp cord composed of stranded copper conductors between .006 and .007 in. in diameter can be used to make the central conductor. The shield can be obtained from microphone or phonograph pick-up cable of about .07 in. in outer diameter, and having a readily-removable shield. For the dielectric, push-back hook-up wire with an AWG No. 20 conductor can be used. This wire should have a thin, rubber-like or impermeable plastic insulation, and a solid conductor.

The hook-up wire is first stretched slightly to straighten it. Then the outer surface of the insulation of the wire, except for about 1 in. on each end, is coated with a conductive paint and allowed to dry. Meanwhile, the shield is stripped from the microphone pick-up cable in such a way as to increase the inside diameter of the shield. This can be accomplished by pushing the shield toward the center of the cable and slipping it off after it has been compressed in length and expanded. After the paint

is dry on the outside of the hook-up wire, this shield can be slipped over it, but should be left loose. At this time the stranded copper can be pulled out from the lamp cord. Five or six strands should be pulled out and twisted tightly by holding one end in a vise and the other in a drill chuck.

To make use of the insulation from the hook-up wire, the central conductor must first be removed. This can be done with a vice and pliers. After about 1/2 in. of dielectric has been stripped from each end of the painted length of hook-up wire, the bare wire is held with the vise and pliers, stretched about 10% of its length without stretching the insulation, and then pulled out of the insulation.

The next step is to apply the conductive paint to the inner surface of the insulation. First, a piece of transparent plastic tubing is taped to the outside of the dielectric tube about 1/4 in. from one end. The plastic tubing is connected to a vacuum line, or mouth suction can be used. The other end of the insulation is dipped in the conductive paint. When the paint appears in the plastic tube, the hollow dielectric is blown out enough to leave an opening for the inside conductor. It may be necessary to apply the conductive paint twice in some cases. After the painted conductor has dried, the stranded lamp-cord wire is pushed through the painted insulation, and the shielding is stretched over the entire length of the cable.

For the conductive paint, conductive suspensions in a vehicle designed to bond firmly to the cable dielectric have been found most suitable. Such special paints are available from most manufacturers of conductive paints and suspensions, but they are generally not sufficiently flexible. At NBS, a mixture of 3 parts by weight of finely divided (18 to 25 microns) carbon black, 10 parts of a flexible adhesive, and the 60 parts of methyl ethyl ketone solvent has been used with good results. The mixture must be kept covered tightly, and requires considerable mixing to insure uniform distribution of the conductive materials. This can be achieved by adding porcelain or glass balls to the mixture and rotating the closed container for at least 24 hours after the initial mixing and 15 minutes before use.

MICROWAVE UNITS

(Continued from page 34)

the frequency of the local oscillator. This is because the local oscillator enters twice into the heterodyne process, and any drift in the oscillator frequency is cancelled out. However, it is necessary to control the frequency of the local oscillator closely in order that the IF frequency

C-D and



C-D transmitting capacitors and Faradon* capacitors manufactured exclusively by Cornell-Dubilier, available through all Authorized C-D Distributors. Write for Catalog to: Dept. TV 33, Cornell-Dubilier Electric Corp., South Plainfield, N. J.



ONSISTENTLY DEPENDABLE
CORNELL-DUBILIER
CAPACITORS

Plants in South Plainfield, N. J.; New Bedford, Worcester, and Cambridge, Mass.; Providence, R. I.; Indianapolis, Ind.; Fuquay Springs, N. C.; and subsidiary, The Radiant Corp., Cleveland, Ohio

derived from the crystal mixer is maintained in the center of the pass-band of the 30-mc. IF strip. This is accomplished by the 30-mc. discriminator, which provides a DC output to operate the control relays. These control the tuning motor, thus maintaining the correct local-oscillator frequency.

The transmitter of a repeater station does not radiate a signal unless one is received by its associated receiver and this receiver is operating properly. Thus, it is necessary that provision be made for effectively replacing the received signal in the event that it or the receiver should fail. This permits continuous operation of the system on either side of a faulty

station. Should the 30-mc. signal fail, the loss results in a drop in the bias of the last IF amplifier stage. This activates the 65-mc. oscillator by means of a keyer tube. After being doubled, this signal is fed into the 80-mc. mixer. This frequency, with the 50-mc. output of the modulator, again produces the necessary output for the 80-mc. IF section.

Also, in the event of incoming carrier failure, the receiver output must be squelched to prevent the excessive noise generated in the receiver from interfering with the operation of the remaining system or from causing false operation of terminal equipment. The keyer circuit

Concluded on page 40

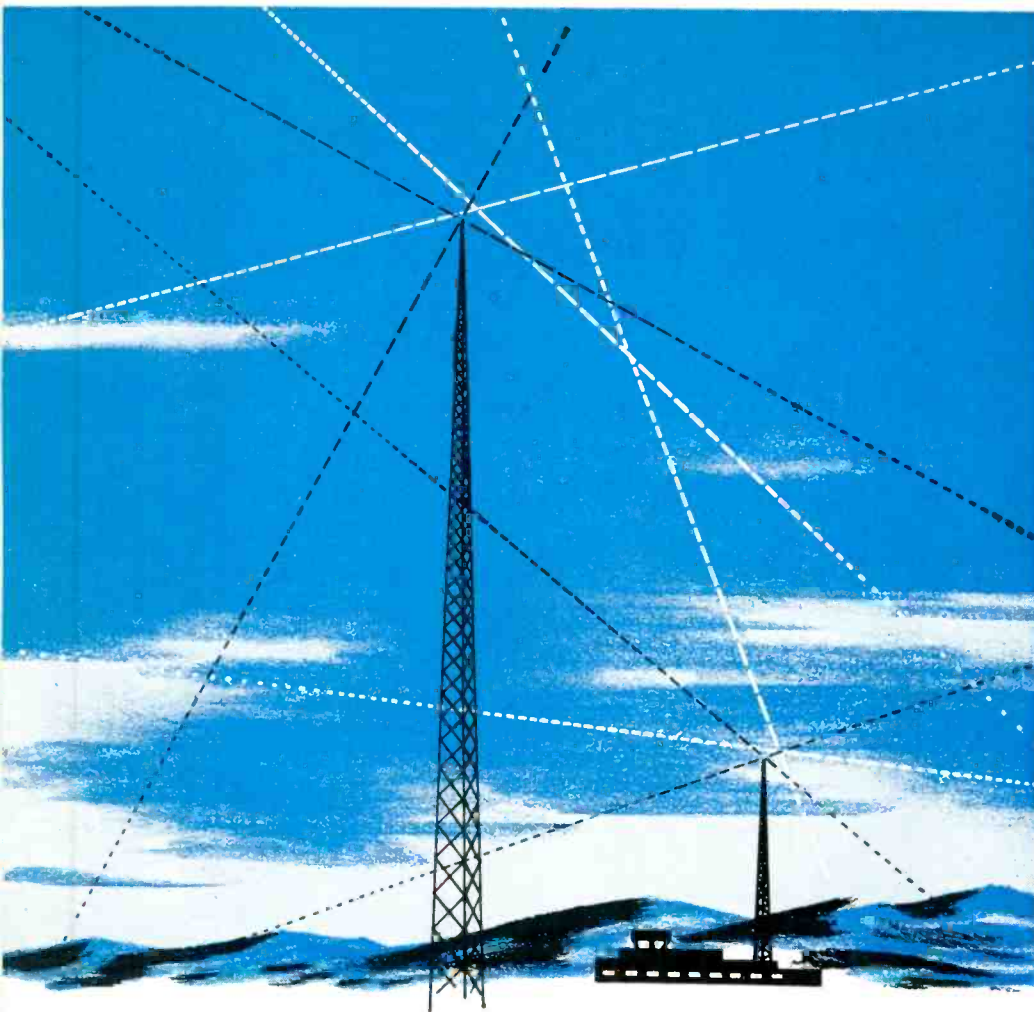

for RELIABLE Communications Circuits depend on AMPHENOL



COAXIAL cables

These quality cables are manufactured of the finest materials and fully meet the rigid requirements of the military specifications. They are noted for their strict end-to-end uniformity, low RF loss and their superior mechanical efficiency. They are available with standard black vinyl jackets, non-contaminating grey jackets or the new Amphenol low temperature non-contaminating black jacket.

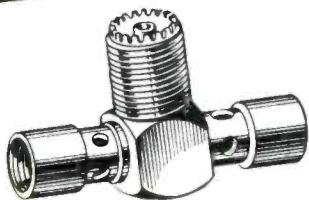

RF connectors

The continuity of any communications circuits depends almost entirely on the quality of the cables and the cable connectors. Amphenol's RF Connectors are the best in the world. Design, materials and finish are carefully pre-selected to perform the intended task to perfection. They too, fully satisfy the stringent military requirements. They are available in a variety of types and designs, some of them with Teflon inserts for covered equipment or other high temperature applications.

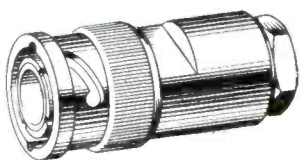

consult your nearest AMPHENOL distributor
for complete information . . .

MICROWAVE UNITS

(Continued from page 39)

provides this squelch action, as well as keying for the 65-mc. oscillator. Transfer to standby radio equipment is also accomplished by this keyer circuit. When a signal is received again, the keyer tube automatically blocks off the 65-mc. oscillator, restoring normal operation.

Service Channels: In a microwave relay system operating over long distances with unattended repeater stations, it is imperative that voice communication and automatic off-normal alarm facilities be furnished for all stations. The service channel panel equipped with an alarm sub-panel provides this service, as well as telephone instrument connections for voice communication over the service channel. A signaling switch for party-line code calling is furnished on the panel also. The signal bell for use with the panel can be located at a convenient point removed from the microwave cabinet. The service channel is intended only for installation and maintenance communication.

The basic service channel unit can be supplied without the off-normal alarm sub-panel for single hop or short systems. However, for larger systems which require the alarm function, alarm transmitter sub-panels at the required stations for sending the fault signals, and alarm receiver sub-panels at the required stations for receiving the fault signals, can be attached to the service panels in the space provided.

With installation of the alarm sub-panels, failure of the radio equipment or emergency power equipment, tower light failure, low emergency generator fuel, or other off-normal conditions can be selected to cause transmission of coded tone pulses from required stations to an attended station, where they light lamps on an indicator unit. The alarm system can report up to 6 indications from up to 31 stations. It can also report up to 5 indications from up to 41 stations. These indications are received and displayed on a unit separate from the microwave and multiplexing equipment, which can be located at any suitable place not more than 100 ft. from the alarm panel. This indicator unit, Fig. 4, is equipped with a group of neon indicator lamps for identification of the off-normal conditions, and a second group of such lights for identification of the station reporting. Any display of off-normal conditions is accompanied by operation of a bell or lamp to provide an audible or visual signal which can be cut off at will.

Each code transmission is started with a clearing pulse which clears any display the board may have carried at the time.

When an off-normal condition has been corrected, the fault alarm unit transmits only the station identification pulses but not the off-normal pulses. This gives a positive indication that the trouble has been cleared. With very little modification, a service channel phone and alarm indicator can be provided at a remote point for the convenience of a dispatcher.

To provide greater equipment dependability, standby microwave units are available to supplement the operating FR assembly. The standby equipment, which is almost identical to the operating assembly, can be switched automatically by an automatic transfer panel in case of failure. Either immediate or delayed transfers can be provided.

FJ Multiplex Equipment: Type FJ multiplexing equipment consists of the voice band panel and the telegraph equipment, shown in Figs. 7 and 8 respectively. These units operate on assigned channel frequencies from 305 kc. to 595 kc. with 10-kc. spacings. Crystal-control is utilized for each unit. Operation at these frequencies permits the use of filters which are essentially alike for all channels. One filter design tunes any channel in the full range of 300 to 600 kc.

Using 10-kc. channels in the 300 to 600-kc. range results in other design advantages, as follows:

- 1) Minimum interaction among channels is obtained by wider channel spacings.
- 2) Double-sideband amplitude modulation of the sub-carriers can be used, providing simple circuitry as well as ease of maintenance and personnel training.
- 3) Telegraph units can be sub-multiplexed by audio tones to greatly increase system capacity.
- 4) In single-function operation, the telegraph channels inject essentially no time delay on impulses, because of the high operating frequency and wide bandwidth.

The FJ voice band panel, shown in Fig. 7, consists of transmitter, receiver, signaling, telephone-line terminating, and power-supply circuits on a common panel. Telephone jacks are provided for audio input, output, and line monitoring purposes. All external electrical connections are made through a single plug connector.

Channels provided by these units can be arranged for private or party-line service to suit the communication requirements of the system. If communication is required between two points, one unit must be installed at each terminal for each channel required. If party-line operation is required, one unit must also be installed at intermediate stations for each channel so arranged, in

Continued on page 43

formerly *FM-TV* RADIO COMMUNICATION



Hammarlund Separate Transmitters and Receivers Offer Maximum Design Flexibility!

Two independent operations for signaling, dialing, slow speed telemetering, or supervisory control may be transmitted in one direction by one Dual Transmitter Unit (DTU-1) and one Dual Receiver Unit (DRU-1) now available.

These units were engineered for operation over wire lines, telephone or power line carrier and radio or microwave communications circuits, and incorporate the same proven basic features as the Hammarlund Duplex Signaling Unit, except that operations may be carried on in one direction only. Each unit includes its own power supply.

The DTU-1 incorporates a pair of transmitters consisting of a stable tone generator and an amplifier designed to bridge across a 600-ohm circuit, all mounted on a 3½ inch standard relay rack panel. Harmonic distortion is negligible, frequency stability is excellent and a total of 36 frequency channels are available between 2000 and 6475 cycles.

The DRU-1 incorporates a pair of receivers consisting of two stages of amplification, a signal rectifier, relay tube and relay, and a sharply selective band pass filter unit, all mounted on a 5¼ inch standard relay rack panel.

Either a continuous or a keyed tone may be used. The units may be installed in multiple and with Hammarlund 2-way signaling units (DSU-2's) as individual installations require.

Write for Bulletin 112 for detailed information.

 **HAMMARLUND**

HAMMARLUND MANUFACTURING CO., INC.
460 WEST 34th ST. • NEW YORK 1, N. Y.

24 HOUR DELIVERY FROM STOCK!

RELAYS

Our stock of more than a million relays — in over a thousand different types — is the world's largest. Don't delay your production for want of large or small quantities of relays of any type.

Telephone, wire or write for quotations.

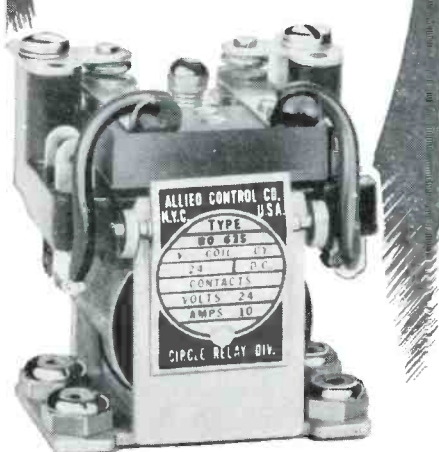

NEW AND MORE COMPREHENSIVE

1953 RELAY SALES CATALOG

NOW READY



Be sure to send for your copy

Telephone SEeley 8-4146

Relay Sales

833 W. CHICAGO AVE.
DEPT. 12, CHICAGO 22, ILL.

When designing any plug-in unit REACH FOR THIS BASE

ALDEN Molded boss to hold mounting cards. Holes to take brackets or bail, kept well away from corners.

20-PIN

Also 11-pin & MIN. 7 & 9-pin



All prongs numbered. Tapped side holes.

DESIGNED SPECIFICALLY FOR PLUG-IN UNIT CONSTRUCTION

TREMENDOUS FLEXIBILITY

Bases are complemented by standard Alden components: handles, brackets, housings, terminal cards to lick almost any problem.

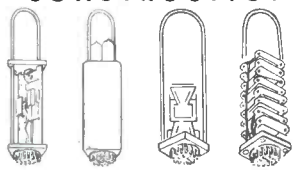

NON-INTERCHANGEABLE COLOR CODED

Choice of variable pin patterns guarantees against mismatching. Color coding directs plug-in to its correct socket.

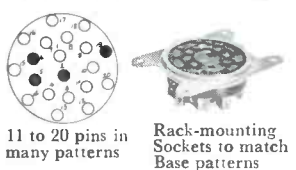

11 to 20 pins in many patterns. Rack-mounting Sockets to match Base patterns

Also 20-pin, 11-pin, 9-pin, 7-pin MATING SOCKETS

Request free samples and free 226-page "Alden Handbook" of Plug-in Unit Construction.

137 N. Main St., Brockton 64, Mass.



ALDEN PRODUCTS CO.



AVOID THESE TROUBLES OF USING TUBE BASES FOR PLUG-IN PACKAGES



LONG PINS BEND EASILY

RIGID BRITTLE BOSS BREAKS



LEVERAGE OF LONG PINS CRACKS BASE

Are you tired at throwing away perfectly good units because of broken bases?

START RIGHT WITH ALDEN BASES Bases specifically designed for Plug-in Unit Construction

Ruggedly designed for specific purpose

Mounting holes well away from edges

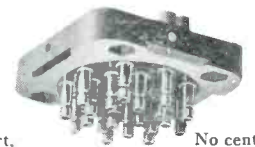

Short, stubby prongs will not bend or break out

No center boss to break or crack base

Standardize on Alden Base Sockets, and your Design Problems vanish.

FM SIGNAL GENERATOR



For testing Mobile Radio receiving equipment

TYPE 202-C

RF range 54-216 mc.

The 202-C FM Signal Generator has been designed for use with mobile communications receivers or other narrow band high sensitivity equipment. Its features include:

- Very low leakage and spurious signal components.
- Switched electronic tuning for rapid selectivity measurements.
- Narrow band continuous electronic tuning.
- Internal calibration of switched electronic tuning.
- FM or AM from either internal or external audio frequencies.
- RF range 54 to 216 mc accurate to 0.5%.

SPECIFICATIONS

RF SPECIFICATIONS:
 Frequency Range: 54 to 216 mc in two ranges. Accuracy $\pm 0.5\%$.
 Fine tuning range: ± 20 kc in 108-216 mc range; ± 10 kc in 54-108 mc range.
 Switched Tuning Range: $\pm 5, \pm 10, \pm 15, \pm 20, \pm 25, \pm 30, \pm 50, \pm 60$ kc in upper RF range; one-half these values in lower range.
 Output Voltage: 0.1 to 200,000 microvolts with standard cable connected.
 Output Impedance: 26.5 ohms looking back into standard cable.

MODULATION:

Frequency Modulation Deviation: 0-24 kc, 0-80 kc, 0-240 kc continuously adjustable.
 Amplitude Modulation: Meter calibrations at 30% and 50%.
 Distortion: FM—Less than 2% at 75 kc, 10% at 240 kc. AM—Less than 3% at 30% and 6.5% at 50%.
 Internal Modulating Voltages: 50, 100 and 400 cps, 1, 5, 7.5, 10, and 60 kc.
 Simultaneous FM and AM available using external and internal audio frequency.
 Spurious Output: All spurious RF output at least 30 db below desired fundamental.
 Signal to Noise ratio: 60 db below 10 kc deviation.
 PRICE: \$1090.00 FOB Baanlan.



BOONTON RADIO Corporation

BOONTON-N.J.-U.S.A.

MICROWAVE UNITS

(Continued from page 41)

addition to the terminals. The signaling provision built into each panel can be used for AC or DC ringdown, for dialing, or for certain control purposes. The unit can be terminated in either two or four-wire telephone circuits. It is designed to be connected easily into any standard telephone system, and to operate as a part of it. Changes in the voice band panel terminations are made in the plug connected to the unit. Thus, regardless of the variety of telephone terminations in a system, a single panel is suitable for replacement purposes.

Double-sideband amplitude modulation is used without carrier-frequency suppression. In private-line operation, the voice band panel carrier is transmitted continuously whether or not an audio input is present. When party-line operation is required, however, a sub-assembly is added to each unit on the party-line channel, and a few circuit changes made at a tie-point terminal strip, which converts the unit to voice-controlled-carrier modulation. In this case, the modulated carrier is transmitted at a level controlled by and proportional to the level of the audio signal. When no audio signal is present, the carrier is not transmitted. The danger of noise due to interference of continuously-transmitting carriers is thus overcome, and the simple reliability of double-sideband modulation is retained. The party-line sub-panel can be seen at the lower right in Fig. 7.

Type FJ telegraph equipment consists of a transmitter unit, a receiver unit, and a telegraph power supply. Front and rear views of the transmitter and receiver units are given in Fig. 8. The power-supply panel contains a space for mounting either 4 telegraph receivers or 8 telegraph transmitters, or suitable combinations of the two. These units are adaptable for use with telemetering, supervisory control, and other standard telegraphic functions, as well as for audio tone sub-multiplexing, facsimile, or low-distortion wide-band program transmission.

The telegraph power supply is protected against overloads by a fuse, in series with the primary of the transformer, which is available from the front of the panel and which can be used as a switch to remove power for servicing. All filter capacitors are hermetically-sealed, plug-in type electrolytics, and the positive leads are fused by a defective capacitor section from the circuit in the event of its failure. Selenium rectifiers are used.

In the telegraph transmitter, the

Continued on page 45

high gain

LOW COST



Andrew Omnidirectional Antenna for VHF Communications

No, this new High Gain Communications Antenna isn't cheap, but it does offer the most economical solution to your coverage problem. Whether you want maximum coverage for a specific transmitter power, minimum power or shortest tower for a specific coverage, or freedom from dead spots, the ANDREW Type 3000 Antenna is the least expensive solution. Why? Because talk-back is the limiting factor in mobile communications. Gain in the central station antenna costs less than increased power in every mobile unit.

ANDREW Type 3000 High Gain Communications Antenna offers better than 6 db gain in the 148-174 MCS band. This means that the power delivered to the receiver on both talk-out and talk-back is increased four times. The horizontal radiation pattern is circular.

Write for the ANDREW High Gain Antenna bulletin today!

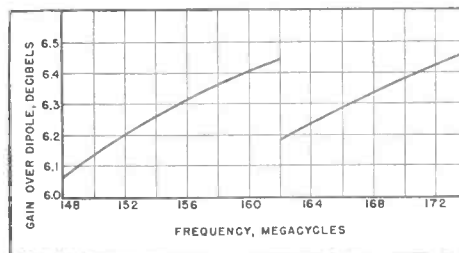

Andrew

CORPORATION

363 EAST 75TH STREET, CHICAGO 19

ANTENNA SPECIALISTS

TRANSMISSION LINES FOR AM-FM-TV-MICROWAVE • ANTENNAS • DIRECTIONAL ANTENNA EQUIPMENT • ANTENNA TUNING UNITS • TOWER LIGHTING EQUIPMENT



**COMPACT
DEPENDABLE
EFFICIENT** *Rotary Power*
by **Carter**



THE NEW

Custom

DC-AC CONVERTER

These latest of all Carter DC to AC Converters are specially engineered for professional and commercial applications requiring a high capacity source of 60 cycle AC from a DC power supply. Operates from storage batteries, or from DC line voltage. Three "Custom" models, delivering 300, 400, or 500 watts 115 or 220 V. AC. Wide range of input voltage, 12, 24, 32, 64, 110 or 230 V. DC. Unequaled capacity for operating professional recording, sound movie equipment and large screen TV receivers. Available with or without manual frequency control feature.

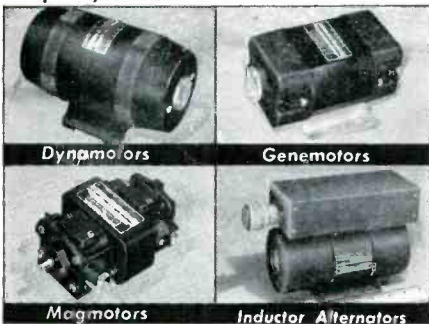

Dynamos

Genemotors

Magmotors

Inductor Alternators

MAIL COUPON FOR CATALOG

Carter Rotary Power Supplies are made in a wide variety of types and capacities for communications, laboratory and industrial applications. Used in aircraft, marine, and mobile radio, geophysical instruments, ignition, timing, etc. MAIL COUPON NOW for complete Dynamotor and Converter Catalogs, with specifications and performance charts on the complete line.

Carter MOTOR CO.
2641 N. Maplewood Ave.
Chicago 47

Carter Motor Co.
2641 N. Maplewood Ave., Chicago 47
Please send new catalogs containing complete information on Carter "Custom" Converters and other Rotary Power Supplies.

Name _____
Address _____
City _____ State _____

IT'S **ALLIED** FOR **RCA**

AUTHORIZED



DISTRIBUTOR

ELECTRON TUBES FOR INDUSTRY

Quick, Expert Service on RCA Tubes

ALLIED maintains in stock for quick shipment, the world's largest distributor inventory of RCA special-purpose tubes. We specialize in supplying the needs of industrial, broadcast, governmental and other users. To save time, effort and money—phone, wire or write to ALLIED. Fill all your electronic needs from one complete reliable supply source.

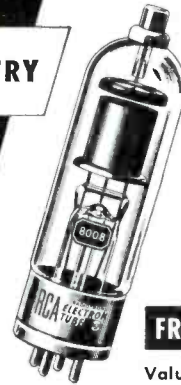

ALL TYPES IN STOCK

- Vacuum Power
- Thyratrons
- Vacuum & Gas Rect.
- Ignitrons
- Cold-Cathode
- Phototubes
- Oscillograph Tubes
- Camera Tubes
- Monoscopes
- Special Types

FREE Interchangeability Directory

Valuable guide to selection of proper RCA tube type replacements. Lists 1600 tube types. Write today for this FREE RCA Guide No. 37-046.

1953 ALLIED CATALOG

Refer to your ALLIED Catalog for all electronic supplies—parts, tubes, test instruments, audio amplifiers, accessories—available from the world's largest stocks. Write today for FREE 1953 ALLIED Catalog.



Everything in Electronics
FROM ONE RELIABLE SOURCE

ALLIED RADIO

833 W. Jackson Blvd., Dept. 20-C-3
Chicago 7, Ill.

FREE CATALOG!—Send for it now!



TERMALINE
DIRECT READING
R. F. WATTMETERS

(DUAL RANGE)

MODEL 611—0-15 and 0-60 Watts

MODEL 612—0-20 and 0-80 Watts

IMPEDANCE—51½ Ohms

Models 611 and 612 are popular instruments in research and design laboratories, vacuum tube plants, transmitter manufacturing plants, and in fixed and mobile communication services.

They are ruggedly built for portable use, and are as simple to use as a D.C. voltmeter. The power absorbing load resistor is non-radiating, thus preventing transmission of unwanted signals which interfere with message traffic in communication services.

Frequency range: 30 to 500 MC (30 to 1,000 MC by special calibration)

Impedance: 51.5 OHMS—VSWR less than 1.1

Accuracy: Within 5% of full scale

Input connector: Female "N" which mates with UG-21 or UG-21B. Adapter UG-146/U is supplied to mate with VHF plug, PL259.

Special Scale Model "61s" are available as low as ½ watt full scale, and other models as high as 5 KW full scale.

Catalog Furnished on Request



BIRD
ELECTRONIC CORP.
1800 EAST 38TH ST., CLEVELAND 14, OHIO
TERMALINE Coaxial Line Instruments

NEELY ENTERPRISES
Hollywood • San Francisco
Albuquerque
EARL LIPSCOMB ASSOCIATES
Dallas • Houston

MICROWAVE UNITS

(Continued from page 43)

audio-frequency input signal is applied to the cathode of the modulator-amplifier tube to produce amplitude modulation of the carrier. The output of this tube is passed through a tunable band-pass filter to the transmit bus. This filter, together with the modulator amplifier, serves to isolate the oscillator from other channels on the bus and to suppress any spurious frequencies generated in the transmitter. The modulator-amplifier tube plate and cathode connections are brought out to the terminal board for use in applications in which an ungrounded or station battery must be used.

As mentioned previously, this equipment has been designed to accommodate many other types of signaling, control, and information services. The telegraph transmitter can be adapted to any of these uses by simple modification of the modulator-amplifier tube screen grid, plate, and cathode connections. For all these services, except program applications or station battery use, the modifications require only a change in strapping on the transmitter terminal board. Program and station-battery uses each require the installation of a capacitor at a different point in the circuitry for each use.

Plate and output circuits of the telegraph receiver unit are wired through an octal socket. With a slight modification of this output circuit and insertion of the proper unit into the octal socket, any of the various types of operation for which this equipment was designed can be handled. Modifications required for major applications are as follows:

1) For teletype operation, a two-winding polar relay is used in the socket with a relay winding in each plate circuit of the output tube.

2) For off-on control applications, a single-winding relay is used in the socket. In some cases a two-winding non-polar relay may be used.

3) For use with variable-frequency telemetering equipment, a low-pass 150-cycle filter is plugged into the socket. This filter suppresses the high-frequency output. The output tube is wired as an amplifier, and restores the variable-frequency signal that was originally impressed on the transmitter. Output impedance and level are suitable for direct connection to telemeter receiver units.

4) For sub-multiplexing applications, the triodes in the output stage are connected as cathode followers in parallel to give single-ended output.

5) For operation with HZ and HZM relaying equipment, a current-metering plug for test purposes is plugged into the socket.

Concluded on page 46

Communication Registries

WHATEVER information you need about any U. S. communication system in any service group, you will find it in one of the Registries of Communication Systems listed below. These Registries, revised annually from data contained in the original license files at Washington by permission of the FCC.

Each system listing shows the name and address of the licensee, location and type of each transmitter, number of mobile units, call letters, frequencies, type of modulation, and make of equipment used.

Systems are grouped by services in accordance with FCC practice, and are listed alphabetically by states. Currently, facilities added since the previous Registry are so identified.

These Registries are invaluable for reference use by system supervisors, maintenance organizations, allocation committees, engineering consultants, and manufacturers' field engineers.

REGISTRY OF TRANSPORTATION SYSTEMS

Listing all mobile, base, relay, mobile relay, and point-to-point transmitters licensed in the following services:

| | | |
|-----------|-----------------|-------------------|
| TAXICABS | HIGHWAY TRUCKS | TRANSIT UTILITIES |
| RAILROADS | INTERCITY BUSES | AUTO EMERGENCY |

Most active services in this group are the taxicab, railroad, and auto emergency systems.

REGISTRY OF TRANSPORTATION SYSTEMS, postpaid.....\$1.00

REGISTRY OF INDUSTRIAL SYSTEMS

Listing all mobile, base, relay, mobile relay, control, and point-to-point transmitters licensed in the following services:

| | | |
|-----------------|-----------------------|-----------------|
| POWER UTILITIES | PIPELINES & PETROLEUM | FOREST PRODUCTS |
| RELAY PRESS | LOW-POWER INDUSTRIAL | MOTION PICTURE |
| | SPECIAL INDUSTRIAL | |

This Registry has the largest number of new listings, because it includes the relay and point-to-point stations installed by the public utilities and pipe lines. Many listings have been added for the special industrial, forest products, and low-power industrial services, also.

REGISTRY OF INDUSTRIAL SYSTEMS, postpaid\$2.00

REGISTRY OF PUBLIC SAFETY SYSTEMS

Listing all mobile, base, relay, mobile relay, portable, control, and point-to-point transmitters licensed in the following services:

| | | |
|---------------------------|-------------------|-----------------------|
| MUNICIPAL & COUNTY POLICE | STATE POLICE | FORESTRY CONSERVATION |
| ZONE & INTERZONE POLICE | FIRE DEPARTMENTS | HIGHWAY MAINTENANCE |
| | SPECIAL EMERGENCY | |

A large number of new police, fire, and special emergency systems are listed in this Registry. State police systems have been expanded greatly. Interzone police networks now cover practically all the U. S. This is the only CW telegraph service listed in any of the Registries.

REGISTRY OF PUBLIC SAFETY SYSTEMS, postpaid\$1.00

AIR-GROUND AND COMMON CARRIER SYSTEMS

Listing all mobile, base, relay, mobile relay, portable, control, and point-to-point transmitters licensed in the following services:

| | | |
|-------------------|-------------------|----------------------|
| CARRIER AIRCRAFT | AIRDROME ADVISORY | MOBILE UTILITY |
| AIR OPERATIONAL | FLYING SCHOOL | COMMON CARRIER |
| OPERATIONAL FIXED | FLIGHT TEST | COMMON CARRIER RELAY |
| AIRDROME CONTROL | | MISC. COMMON CARRIER |

This Registry lists all transmitters operated in commercial aircraft, and all those used for air-ground communication. Also included are the AT&T relay stations which carry television network programs.

AIR-GROUND & COMMON CARRIER SYSTEMS, postpaid\$1.00

RADIOCOM, Inc.
Great Barrington, Mass.

Please send me the following Registries of Communication Systems, for which I enclose —

\$1.00 Registry of Transportation Systems \$1.00 Registry of Public Safety Systems
 \$2.00 Registry of Industrial Systems \$1.00 Registry of Air-Ground, Com. Car. Systems

Name

Address

to the

**ELECTRICAL
ENGINEER**

or

PHYSICIST

with experience in

RADAR

or

ELECTRONICS

Hughes Research and Development Laboratories, one of the nation's leading electronics organizations, are now creating a number of new openings in an important phase of their operations.

Here is what one of these positions offers you:

THE COMPANY

Hughes Research and Development Laboratories, located in Southern California, are presently engaged in the development and production of advanced radar systems, electronic computers and guided missiles.

THE NEW OPENINGS

The positions are for men who will serve as technical advisors to government agencies and companies purchasing Hughes equipment—also as technical consultants with engineers of other companies working on associated equipment. Your specific job would be essentially to help insure successful operation of Hughes equipment in the field.

THE TRAINING

On joining our organization, you will work in the Laboratories for several months to become thoroughly familiar with the equipment which you will later help users to understand and properly employ. If you have already had radar or electronics experience, you will find this knowledge helpful in your new work.

WHERE YOU WORK

After your period of training—at full pay—you may (1) remain with the Laboratories in Southern California in an instructive or administrative capacity, (2) become the Hughes representative at a company where our equipment is being installed, or (3) be the

Hughes representative at a military base in this country or overseas (single men only). Compensation is made for traveling and moving household effects, and married men keep their families with them at all times.

YOUR FUTURE

In one of these positions you will gain all-around experience that will increase your value to our organization as it further expands in the field of electronics. The next few years are certain to see large-scale commercial employment of electronic systems. Your training in and familiarity with the most advanced electronic techniques now will qualify you for even more important future positions.

How to apply:

HUGHES

RESEARCH AND
DEVELOPMENT LABORATORIES

Scientific and Engineering Staff
Culver City,
Los Angeles County, California

If you are under thirty-five years of age, and if you have an E.E. or Physics degree, write to the Laboratories, giving resumé of your experience.

Assurance is required that relocation of the applicant will not cause disruption of an urgent military project.

MICROWAVE UNITS

(Continued from page 45)

6) For use with HKB relaying units, the diode detectors are by-passed and the modulated carrier is then impressed directly on the cathode-follower output tube.

7) For program reception with a 50 to 5,000-cycle bandpass, the RF filter is tuned for a wider passband and the output tube is connected as a single-ended cathode follower. Two multiplexing channel frequency assignments are required to accommodate a 50 to 5,000-cycle program signal.

For each of the cases in which use of the output tube as a cathode follower is involved, no plug-in unit is required at the socket. Where a transformer may be required for line isolation and/or balance, an auxiliary panel is supplied.

Conclusion: In any given microwave system, successful operation depends on the proper selection of antennas, coaxial cable, and antenna locations. The antennas must have sufficient gain and the coaxial cable suitable loss characteristics, such that satisfactory margins of safety for fading and tube aging are provided, thus insuring the best possible system transmission reliability. In general, parabolic antennas of 4, 6, or 10-ft. diameters are required. Coaxial cable used for interconnection of the radio equipment and antennas should ordinarily be $\frac{7}{8}$ or $1\frac{3}{8}$ -in air-dielectric, although solid-dielectric types such as RG-17/U can be used in some cases.

CHANNEL SPACINGS

(Continued from page 27)

Our results indicated that if no interference degradation can be tolerated, the channel spacing must be maintained at 60 kc. If, however, a system which is about 4 or 5 db more sensitive to noise is deemed to be still usable, than a 30-kc. channel spacing and about ± 7.5 -kc. modulation deviation would double the number of presently available channels. If a system which is about 8 db more sensitive to noise, and with a possible reduction of about 15% in range is considered acceptable, then 20 kc. channel spacing with ± 5 -kc. transmitter deviation can be used. The number of additional channels created with a 20-kc. channel spacing is not easily predictable because of the problem of same-area adjacent-channel operation, although it appears that the increase must be between 2 and somewhat less than 3 times those presently available.

Whichever system these data seem to

Concluded on page 48

INDEX

OF

ADVERTISERS

FOR YOUR CONVENIENCE, TELEPHONE NUMBER OF EACH COMPANY IS SHOWN HERE



| | |
|--|--------------------|
| Adair, George P. | 13 |
| Washington, D. C.: Executive 1230 | |
| Alden Products Company | 7, 42 |
| Brockton, Mass.: Brockton 160 | |
| Allied Radio Corp. | 44 |
| Chicago: Haymarket 1-6800 | |
| American Phenolic Corp. | 40 |
| Chicago: Bishop 2-1000 | |
| Andrew Corp. | 43 |
| Chicago: Triangle 4-4400 | |
| Antenna Specialists | 12 |
| Cleveland, Ohio: Randolph 1-9575 | |
| Bendix Aviation Corp. (Radio Div.) | 4, 5 |
| Baltimore, Md.: Hopkins 3411 | |
| Berndt-Bach, Inc. | 13 |
| Los Angeles, Calif. | |
| Bird Electronic Corp. | 44 |
| Cleveland, Ohio: Express 1-3535 | |
| Bliley Electric Company | 1 |
| Erie, Pa.: Erie 2-2287 | |
| Boonton Radio Corp. | 42 |
| Boonton, N. J.: Boonton 8-3200 | |
| Browning Laboratories, Inc. | 36 |
| Winchester, Mass.: Winchester 6-3700 | |
| Cannon Electric Company | 37 |
| Los Angeles, Calif.: Capitol 5-1251 | |
| Carrier Motor Company | 44 |
| Chicago: Humboldt 6-1289 | |
| Cleveland Inst. of Radio-Electronics | 48 |
| Cleveland, Ohio: Executive 1-8888 | |
| Communications Company, Inc. | 48 |
| Coral Gables, Fla.: Coral Gables 4-0846 | |
| Cornell-Dubilier Electric Corp. | 39 |
| South Plainfield, N. J.: Plainfield 6-9000 | |
| Eitel-McCullough, Inc. | 14 |
| San Bruno, Cal.: Juno 8-1212 | |
| Electro Products Labs, Inc. | 10 |
| Chicago: Uptown 8-1141 | |
| General Apparatus Corp. | 47 |
| So. Egremont, Mass. | |
| Hammarlund Mfg. Co., Inc. | 41 |
| New York, N. Y.: Longacres 5-1300 | |
| Hickok Elect. Inst. Company | Inside Back Cover |
| Cleveland, Ohio: Liberty 1-8060 | |
| Hughes Research & Dev. Labs. | 46 |
| Los Angeles, Calif.: Texas 0-7111 | |
| Jansky & Bailey | 13 |
| Washington, D. C.: Me 5411 | |
| Jones, Howard B., Division | 48 |
| Chicago: Nevada 2-2000 | |
| Kaar Engineering Co. | 48 |
| Palo Alto, Calif.: Davenport 3-9001 | |
| Kear & Kennedy | 13 |
| Washington, D. C.: Hudson 3-9000 | |
| Klipsch & Associates | 13 |
| Hope, Ark.: Hope 995 | |
| Lecce-Neville Company | 38 |
| Cleveland, Ohio: Henderson 1-0740 | |
| Magnecord, Inc. | 12 |
| Chicago: Whitehall 4-1889 | |
| Maurer, Inc., J. A. | 13 |
| Long Island City, N. Y.: Stillwell 4-4601 | |
| May, Russell P. | 13 |
| Washington, D. C.: Republic 3984 | |
| Measurements Corp. | 13 |
| Boonton, N. J.: Boonton 8-2131 | |
| Microwave Services, Inc. | 13 |
| New York City: Circle 7-4953 | |
| Motorola, Inc. | Back Cover |
| Chicago: Spaulding 2-6500 | |
| Platt Manufacturing Corp. | Inside Front Cover |
| New York City: Worth 4-0827 | |
| Radiart Corp. | 3 |
| Cleveland, Ohio: Melrose 1-6660 | |
| Radio Apparatus Corp. | 9 |
| Indianapolis, Ind.: Franklin 1052 | |
| Radiocom, Inc. | 2, 45 |
| Gt. Barrington, Mass.: Gt. Barrington 1300 | |
| Radio Corp. of America (Eng. Products) | 8, 11 |
| Camden, N. J.: Woodlawn 3-8000 | |
| Radio Corp. of America (Tubes) | 35 |
| Harrison, N. J.: Harrison 6-8000 | |
| Radio Engineering Labs. | 6 |
| Long Island City, N. Y.: Stillwell 6-2101 | |
| Relay Sales Company | 42 |
| Chicago: Seeley 8-4143 | |
| John D. Triltsch Company | 12 |
| Houston, Texas: Atwood 9351 | |
| Weldon & Carr | 13 |
| Washington, D. C.: Michigan 4151 | |
| Workshop Associates, Div. of Gabriel Co. | 13 |
| Norwood, Mass.: Norwood 7-3300 | |



FAS Air-Coupler for Bass Reinforcement

Good News . . . The Dual Air-Coupler for bass reinforcement is in stock, ready for delivery. This is the improved model described in *Radio Communication* last October, and in the Winter Edition of *High Fidelity*.

As more and more of the most critical audio experts install Air-Couplers in extended-range systems, reports of remarkable performance continue to pour in. One of the most enthusiastic owners is Paul deMars, former chief engineer of the Yankee Network, and a pioneer in high-quality reproduction. He said: "I have never heard such magnificent tone from records and live-tapester FM as I am getting from my Air-Coupler in combination with a dual speaker for intermediate and treble frequencies."

For your convenience . . . the Air-Coupler is available in both knock-down form, so that you can assemble it with a screwdriver, or completely assembled, ready to mount the speaker. Made entirely of first-quality 3/4-in. plywood, with each piece cut to precision fit.

DUAL AIR-COUPLER, COMPLETELY ASSEMBLED . . . now only **47.50**
The Air-Coupler is supplied completely assembled and finished in a truly professional manner, with front panel in place, ready for the speaker. Illustration shows assembled Air-Coupler, before front panel is mounted. Opening is cut for any 12-in. speaker, the recommended size.

DUAL AIR-COUPLER, IN KNOCK-DOWN FORM . . . now only **\$34.50**

MISCELLANY: we carry in stock . . . Altec 600-B 12-in. speaker for the Air-Coupler, \$46.50; Peerless S-230Q output transformer, \$26.00; Peerless R-560A power transformer, \$16.00; Peerless C-455A power choke, \$10.00; English KT-66 output tube, \$4.95; Racon CHU2 tweeter, \$23.10.

Crossover Networks for Any System of Two or More Loudspeakers

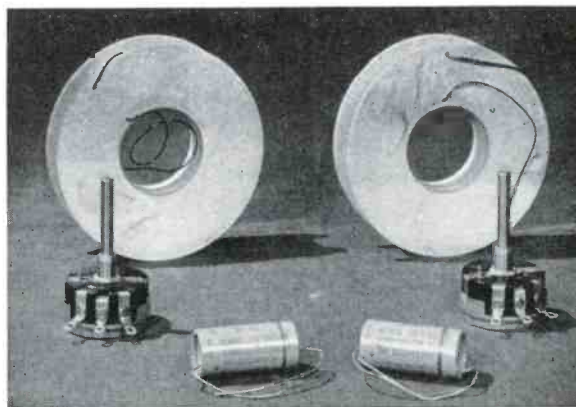

By a judicious selection of associated components, the three coil sizes on which G.A. has standardized enable our customers to secure low-cost crossover networks which will operate at 14 different crossover frequencies! For the experimenter, that means a wide range of choice without having to break the bank to buy dozens of coils. For the man who wants to install his system once and for all, it means money saved, because G.A. saves money by making only three coil sizes (10.2, 5.1, and 1.6 Mh) — and it passes on those savings direct to its customers.

If you want to use three speakers with crossover points at 350 and 1,100 cycles, for example, just order two of the networks listed above (for an 8-ohm system, with rapid crossover attenuation, it would be No. 6 and No. 8).

As most everyone has found out by now, G.A. is headquarters for crossover networks. As far as we know, we're the only organization stocking networks specifically designed for use with Air-Couplers.

If you are in doubt about the selection of a network for your particular speakers, send 10c for the G.A. Network Data Sheet, from which you can determine your requirements exactly.

RAPID ATTENUATION NETWORKS

12 db droop per octave. These networks use two inductance coils.

| Impedance of low frequency speaker | Crossover Frequency | Order by Number | Price 2 Coils Only | Price Complete* |
|------------------------------------|---------------------|-----------------|--------------------|-----------------|
| 16 ohms | 2,200 | No. 1 | \$7.00 | \$11.50 |
| | 1,100 | 2 | 7.00 | 12.00 |
| | 700 | 3 | 12.00 | 16.00 |
| | 350 | 4 | 12.00 | 17.50 |
| | 175 | 5 | 20.00 | 24.00 |
| 8 ohms | 1,100 | 6 | 7.00 | 12.00 |
| | 550 | 7 | 7.00 | 13.00 |
| | 350 | 8 | 12.00 | 17.50 |
| | 175 | 9 | 20.00 | 24.00 |
| 4 ohms | 85 | 10 | 20.00 | 26.50 |
| | 550 | 11 | 7.00 | 13.00 |
| | 275 | 12 | 7.00 | 15.00 |
| | 175 | 13 | 12.00 | 19.00 |
| | 85 | 14 | 20.00 | 26.50 |

* Complete networks include necessary capacitors and level controls. Be sure to indicate whether you want just the coils or the complete network.

Air-Couplers are shipped via Railway Express, FOB South Egremont, Mass.

Other items shipped FOB unless 75c is included to cover parcel post and insurance charges.

General Apparatus Co.

South Egremont, Massachusetts

Pioneer Manufacturers of
VHF-FM Radio Equipment
COMCO WAS FIRST --

- Commercial equipment for 152-162 MC band.
- Complete 152-162 MC police system.
- To manufacture Power Supply Transmitter & Receiver on separate strips.
- Complete Railroad VHF-FM system.
- To use selenium rectifiers in mobile equipment.
- Unit that could be connected to battery regardless of polarity.
- Complete mobile unit for under-dash mount.
- VHF-AM mobile unit with FM type construction.

COMCO manufactures radio communications equipment **EXCLUSIVELY.**

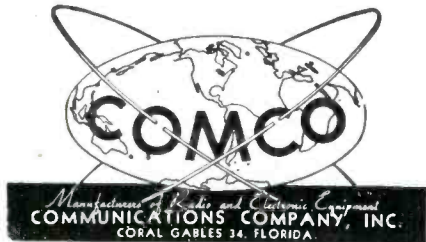

HOW TO GET AN FCC Licensed Radio Operator
you can count on
— in a hurry!

It tells how easily a man of your choice can be selected and trained at home in his spare time to get his FCC license under our "Exclusive Employers' Plan." It offers a detailed, workable program for:

1. Finding such a man.
2. Financing his training.
3. Making sure he gets his license and stays with you.

OUR GUARANTEE
If the student fails his FCC License Examinations, we will continue his training without additional cost until he **DOES** get his License.



Cleveland Institute of Radio Electronics
Special Attention: Desk B
4900 Euclid Avenue
Cleveland 3, Ohio

Rush me information on your "Employers' Plan" for obtaining a Licensed FCC Radio Technician in a hurry.

Name
Firm Position.....
Address
City Zone..... State.....

CHANNEL SPACINGS

(Continued from page 46)

indicate as the better channel-splitting choice, it must be borne in mind that this investigation was, of necessity, limited because of the time involved. However, it is hoped that these results can be integrated with further investigations and the work of others, and thus be of value in the ultimate solution of the channel-splitting problem.

The author wishes to express appreciation to the members of the Mobile Communications group of RCA for their assistance and patience in helping to evaluate the numerous recordings of the channel-splitting tests, and to Messrs. C. A. Rammer and R. A. Beers under whose guidance these investigations were conducted, as well as Messrs. R. M. Huntley and F. V. Henuset for their untiring efforts in the actual execution of these tests.

PROFILE CHARTS

(Continued from page 24)

The reflection point can be found from a profile chart by using a cut-and-try method, illustrated in Fig. 3. By inspection, an assumed reflection point is selected, and straight lines are drawn between this point and the two antennas. The assumed reflection point is the true one if the two lines rise the same number of feet in an equal distance to the right and left of the point. In Fig. 3, the dotted line indicates an incorrect reflection point because the lines do not rise equal amounts in equal distances to the right and left of the assumed point. The dashed lines, however, indicate the true reflection point.

The minimum desirable path clearance varies with frequency and with distance from the transmitting antenna. Lenkurt's engineers usually consider that about 75 ft. minimum clearance is acceptable for a system operating at 900 mc.

Conclusions: With information on path clearances and the reflection point, obtained from a profile chart, the experienced engineer can often predict the performance of given microwave link equipment at proposed antenna sites. In many cases he can estimate whether or not unfavorable topographic conditions can be overcome by using antennas of higher gain, transmitters of greater power, or cables of lower loss than normal, or if different antenna sites are required. An accurate profile chart is invariably helpful to the radio link planner although, under marginal conditions, field tests may be indicated before reaching final conclusions.

For HEAVY DUTY WORK! Severest Electrical Services!

JONES PLUGS & SOCKETS
500 SERIES
Proven Quality

For 5,000 Volts, 25 Amperes per Contact Alterable by circuit Characteristics.

P-506-CE Plug with Cap

S-506-DB Socket with deep Bracket

Socket contacts phosphor bronze, knife-switch type, cadmium plated. Plug contacts hard brass, cadmium plated. 2, 4, 6, 8, 10, and 12 contacts. Plugs and sockets polarized. Long leakage path from terminal, and terminal to ground. Caps and brackets, steel parkerized (rust-proofed). Plug and socket blocks interchangeable in caps and brackets. Terminal connections most accessible. Cap insulated with canvas bakelite.

Write for Jones BULLETIN 19 for full details on line.

Jones **HOWARD B. JONES DIVISION**
CINCH MANUFACTURING CORPORATION
CHICAGO 24, ILLINOIS
SUBSIDIARY OF UNITED-CARR FASTENER CORP.

KAAR RADIOPAK

THE Mobile Radiotelephone

MANUFACTURED BY
KAAR ENGINEERING CO.
PALO ALTO, CALIFORNIA

Write for catalog today!

The Standard of Quality

HICKOK



**Model 292X
SIGNAL GENERATOR**

Frequency Coverage:
125 KC to 220 MC

Calibrated Output:
Less than 1 microvolt,
up to 100,000
microvolts.

Professional engineers and technicians everywhere constantly rely on the accuracy of calibration and long dependability of HICKOK instruments.

In electronic instruments, HICKOK pioneering leadership has been acknowledged for over 42 years.

THE HICKOK ELECTRICAL INSTRUMENT COMPANY
10514 Dupont Avenue • Cleveland 8, Ohio

FIRST AND ONLY 460 MC.

type-approved for operation
in the Class-A, "Citizen's Band"

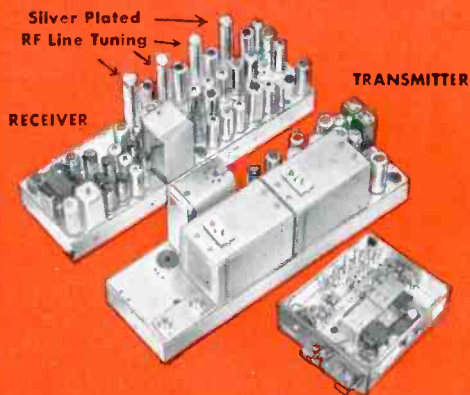

18 to 20 Full Watts. Motorola makes it an outstanding success.



Pole
mounting
cabinet

*Mobile type
CR-406



Motorola has received notice* from F.C.C. that its "Research" Line 460 M. C. equipment has passed the exacting tests for licensing in the Class-A "Citizen's Band". It is the first and only 460 MC. equipment to be so approved.

Automatic Frequency Control

This new Motorola A.F.C. technique is fortified with extraordinary system stability. Fixed barriers prevent channel jumping. The A.F.C. crystal controlled oscillator provides a full 10 to 1 correction ratio and keeps the receiver tuned on the nose to the distant transmitted carrier.

The new U.H.F. tuned circuits and research design cavities for grounded grid amplifier operation provide phenomenal circuit stability, spurious rejection and extraordinary efficiency.

Transmitter

The Motorola 460 MC. system with 9 tuned circuits provides 18 to 20 Watts with efficiencies of more than 65%!

Silver Plated Sealed Tuned Cavities

By use of silver plated line sections, high standards of selectivity protect the receiver from high power U.H.F., TV intermodulation.

*By the leaders in quality-engineered
FM 2-way Radio Communications*

Motorola®
Communications & Electronics, Inc.

A SUBSIDIARY OF MOTOROLA, INC.

900 N. Kilbourn Ave., Chicago 51, Illinois
Rogers Majestic Electronics Ltd., Toronto, Canada