

# Everyday Mechanics

Vol. 1 No. 1

5¢

Dec. 1915



How to make  
your own "Movies"

WALTER  
DARKER

"It Fits Your Pocket"

# Get this Fine MOVIE CAMERA **FREE**

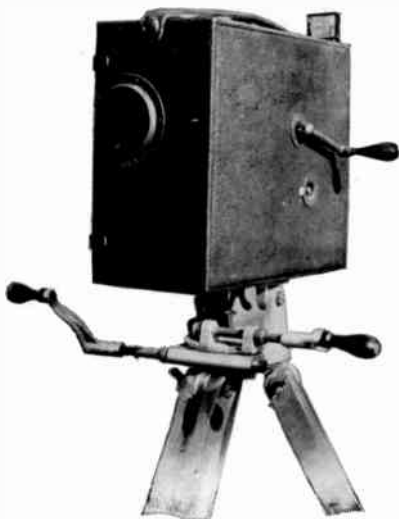

This Amateur Motion Picture Camera, fitted with Zeiss-Tessar anastigmat lens, and complete outfit consisting of tripod, negative and positive film, etc., will be given absolutely free to the one sending us the greatest number of subscriptions between now and March 1st, 1916. In the event of two or more contestants tying, a camera and outfit will be given to each.

The name of the lucky one will be announced in the April issue, out March 15th.

The contest is open to all with the exception of subscription agencies who receive the regular commission and with whom the individual of course could not compete. Fill out the coupon today and get busy! You stand just as good a chance as the next fellow.

-----  
**Coupon**  
-----

**Everyday Mechanics Co., Inc.**  
**Acollan Hall, New York City.**

Gentlemen:—

You may count me in on the Movie Camera Contest. I enclose 10 cents (coin or one-cent stamps) for a Contest Outfit consisting of a sample copy of Everyday Mechanics, subscription blanks, etc. I agree to send in subscriptions as fast as I obtain them and it is understood that you will acknowledge these with your Contest Credit Slips. It is further understood that the contest will close with the last mail on March 1, 1916, and that I am to be credited with all subscriptions sent in envelopes bearing the postmark of my city up to and including that date.

NAME .....

ADDRESS .....

# High Frequency Apparatus

Its Construction and Practical Application

By THOMAS STANLEY CURTIS

This New Book Tells You How to Take a Current at A MILLION VOLTS Through the Body.



The Secrets of  
**ELECTRICITY**  
in Stagecraft  
Exposed!

Price \$2<sup>00</sup> postpaid

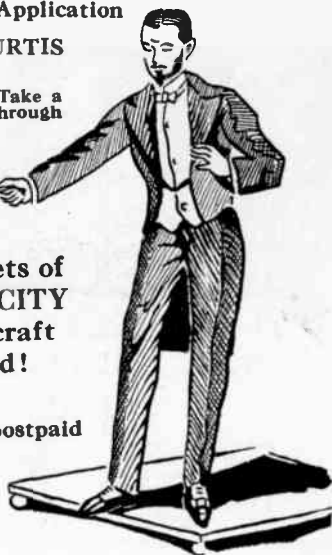

## A FEW OF THE SUBJECTS

Electricity in stagecraft—Electricity in horticulture—Electro-Medical apparatus—How to build the apparatus—How to perform hundreds of experiments—How to use the X-Ray—Proportions for coils of various sizes—Where to get materials and what they cost—How to test and use the apparatus.

*Send stamp for Circular*

**Blueprints** —for the convenience of the worker in the shop, complete sets of dimensioned blueprints showing details of apparatus have been prepared. The price is \$2.00 per set and the subjects offered are as follows:  
**A Million-Volt Tesla Transformer (60-inch spark).**  
**Portable Apparatus for the Lecturer (18-in. spark).**  
**X-Ray and High Frequency Outfit (8-inch spark).**

Send for your copy today

**TECHNICAL PRESS ASSOCIATION**

33 West 42nd Street, New York City

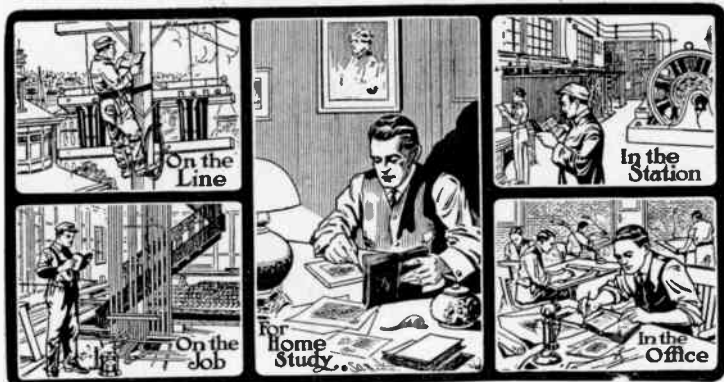

## The American Electricians' Handbook

A practical book—a tool—for all practical electrical men. The author, Terrell Croft, was a wireman, a trouble shooter, a lineman and a dynamo tender. Then after attending college he became an electrical engineer. The book, therefore, embodies the essence of 15 years' experience of a man who started at the bottom and worked up. It contains what a man needs to know in his every-day work and is so written that he can understand it. Its sale to date has been unprecedented.

Over 900 illustrations, 711 pages, leather, full gilt 4 x 6 $\frac{1}{2}$ . It required three years to write the book. The investment was over \$5,000 before a line was printed. The paper is light but very tough. Every illustration was especially drawn. No expense was spared to make it a perfect book.

### BRIEF OUTLINE OF CONTENTS

**Section I. Fundamentals.** Conversion Factors, Electricity Magnetism, Units, Measuring, Testing and Instruments, Properties and Splicing of Conductors, Resistors, Circuits, Electrical Distribution, Batteries, Circuit Calculations. 156 pages. 159 illustrations.

**Section II. Generators and Motors.** Principles, Characteristics, Management and Troubles of Direct-Current Motors and Generators. Principles, Characteristics, Management and Troubles of Alternating-Current Motors and Generators. Starting and Controlling Devices. Application of Motors. Installation of Motors and Generators. 172 pages. 136 illustrations.

**Section III. Outside Distribution.** Poles, Lines, Underground Conduit. Design of Distribution Installations. 72 pages. 118 illustrations.

**Section IV. Interior Wir-**

**ing.** Fittings and Materials. Miscellaneous Wiring Methods. Exposed Knob and Cleat Moulding. Knob and Tube and Conduit Wiring. Electric Light Wiring. Crane Wiring. Bell Annunciator. Burglar Alarm. Telephone and Electric Gas Wiring. Design of Wiring Installations. Wiring Costs. Electric Sign Wiring. Heating Device Installations. Wiring Old Buildings. 190 pages. 274 illustrations.

**Section V. Transformers.** General. Single-phase. Two-phase. Three-phase and Special Transformer Connections. Parallel Operation. Three-phase Transformers. Auto Transformers. Special Transformers. Installation of Transformers. 50 pages. 58 illustrations.

**Section VI. Illumination.** Principles, Units, Reflectors, Arc, Incandescent and Vapor Lamps. Illumination Design. Interior Illumination. Exterior Illumination. 50 pages. 40 illustrations.

The Price is \$3.00 subject to our usual money-back guarantee. Send your order today to

**TECHNICAL PRESS ASSOCIATION**  
33 West 42nd Street, New York City

# Everyday Mechanics

EDITED BY  
THOMAS STANLEY CURTIS

---

---

Published Monthly by

EVERYDAY MECHANICS CO., INC., at 33 West 42nd St., New York, N. Y.

Single copies, 5 cents. Subscription Price, 50 cents a year in the United States, and also to Mexico, Cuba, Porto Rico, Canal Zone, Philippines, Hawaii, Tutuila, Guam, and Shanghai. Canadian postage, 25 cents per year extra. Foreign postage, 50 cents per year extra.

Application for entry as second-class matter at the post office at New York, N. Y., pending.

---

---

VOL. I

DECEMBER, 1915

No. 1

---

---

## CONTENTS

PAGE

HOW TO MAKE YOUR OWN MOVIES..... 1

Wherein the Amateur Photographer is Shown How to Select and Use an Inexpensive Motion Picture Camera.

ELECTRICAL HINTS FOR THE EVERYDAY MAN..... 10

How to Connect Up a Simple Extension Light.

GIANT HIGH FREQUENCY APPARATUS..... 13

How to Build Large Tesla Transformers and Resonators for Use on the Stage

HOW TO BUILD A RADIO TELEPHONE..... 21

Wherein the Construction of a Small Transmitter with Double Arc Generator is Described.

*(Continued on following page.)*

---

---

The Editor will be glad to receive original contributions which tell how to make or how to do some useful thing. The material may be either in the form of a complete article or else merely an idea written in the form of a letter. Available material will be paid for liberally and promptly and all manuscript will have immediate consideration. Return postage should invariably be included to insure safe return of unavailable material.

## CONTENTS—Continued

<b>PRACTICAL MECHANICS FOR EVERYDAY MEN.....</b>	<b>28</b>
How to Take a Flashlight Picture of Yourself. How to Put on a Life-Ring. How to Cut Heavy Plate Glass. Sifting Ashes Without Dust. Attachment for Die for Use in Tight Places. To Make Lamps Flash. Putting a Black Finish on Brass. Motorcycle Lights from Telephone Magneto. To Grind Drills True. How to Remove the Odor of Stale Tobacco Smoke. Double Glass Keeps Out Sound. How to Build an Electric Vibrator. To Glue Up a Table Top Without Clamps. How to Convert a Hand Drill into a Drill Press. Kinks for the Handy-man.	
<b>A LETTER TO THE READER.....</b>	<b>38</b>
An Exposition of the Policy of Everyday Mechanics.	
<b>ODDS AND ENDS FOR THE RADIO AMATEUR.....</b>	<b>41</b>
Simple Detector Designs. Cylindrical Fixed Condenser. Quenched Gap for Spark Coils. Side Acting Key. An Interrupter Suggestion. Simple Tuning Coil Slider.	
<b>THE CARE OF WIRELESS DETECTORS.....</b>	<b>44</b>
Why They Deteriorate and How to Prevent This Deterioration.	
<b>A MODEL ELECTRIC LAUNCH WITH PAPER HULL....</b>	<b>47</b>
An Ingenious Method for Building Model Boats for Electric or Other Propulsion.	
<b>HOW TO MAKE A SLED WITH DOUBLE RUNNER.....</b>	<b>50</b>
This Sled May be Steered.	
<b>HOW TO MAKE A FOLDING KITCHEN TABLE.....</b>	<b>54</b>
A Handy Accessory in the House Where Space is Limited.	
<b>HOW TO BUILD A MODEL BIPLANE.....</b>	<b>56</b>
Wherein the Construction of a Small Machine of Bamboo is Described.	
<b>LETTERS FROM OUR READERS.....</b>	<b>60</b>
What a Few of Our Readers Think of the New Magazine.	
<b>THE TECHNICAL ADVISER.....</b>	<b>62</b>
He Answers Your Questions and Solves Your Problems.	

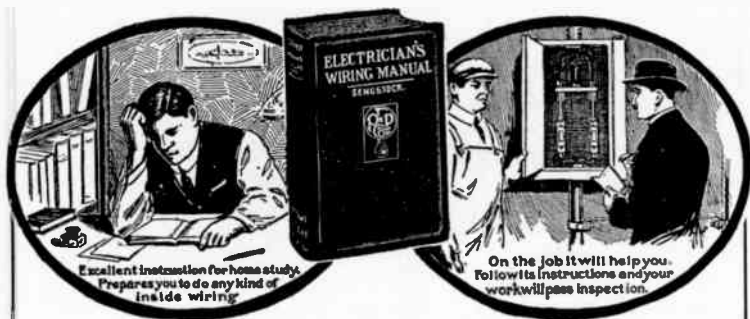

## YOUR HELPER

When you're up against a stiff job, here's the book you want to tell you exactly what to do, and how to do it in strict accordance with the National Electrical Code. In a simple, compact form, it fully covers light and power installations.

# Electrician's Wiring Manual

By F. F. SENGSTOCK, Electrical Inspector Chicago Board of Underwriters

The book that thousands of Wiremen, Contractors and Electricians have been waiting for. Not merely a discussion on Code rules, but straight talk by a man who knows the game from A to Z and gives you the benefit of his many years' experience. Shows you just how to proceed so that your work will pass the most exacting inspector. Every step explained in detail, made clear by 415 careful drawings. A chapter of practical kinks—tricks of the trade unknown to most wiremen—representing the experience of hundreds of practical workers, is alone worth the price of the book.

**Twenty-Seven Chapters, 410 Pages, 415 Illustrations of Sound Practical Information, Flexible Leather Binding, Pocket Size**

1.—Tools and Symbols. 2.—Preliminary Suggestions on Building Wiring. 3.—Moulding. 4.—Flexible Conduit. 5.—Rigid Conduit. 6.—Fixtures and their Installation. 7.—Switches. 8.—General Suggestions on House Wiring. 9.—Installing Household Electric Utensils. 10.—Wires and Cords. 11.—Motors. 12.—Transformers. 13.—Switchboards and Panels. 14.—Motion Picture Theatre. 15.—Bell Circuits, Annunciator Circuits, Gas Lighters, Burglar Alarms, Bell Transformers, Door Lock. 16.—Elevators. 17.—Wiring in Damp

Places. 18.—Outside Wiring. 19.—Grounding and Ground Detectors. 20.—Inspector's Report on a Defective Electrical Equipment. 21.—Estimating and Specifications. 22.—Tables and Formulas. 23.—Electrical Circuits, Calculation of Wiring, Line Losses and National Electrical Code Discussed for the Beginner. 24.—Alternating Currents Simply Explained. 25.—Some Things the Electrician Should Know about Storage Batteries. 26.—Underwriters' Requirements in the Installation of Wireless Telegraph Equipment. 27.—Practical Kinks.

**Price \$1.50 Postpaid**

*Send Your Order Now to*

**TECHNICAL PRESS ASSOCIATION**

33 West 42nd Street, New York City

# AMATEUR'S WIRELESS HANDYBOOK

Price, 25 Cents

The handiest and most useful book for the wireless operator, amateur or professional, ever published.

## WHAT IT WILL DO FOR YOU

Contains a complete list of wireless call letters, 1500 in all, enabling you to locate the origin of any certain call immediately; also the owner of the station or ship and power rating. The Morse and Continental Codes are shown on two large, full page charts so that they can be read from a distance, also, a Beginner's Speed Chart so arranged to assist in learning the Codes quickly.

All the abbreviations used by operators to save time and labor. And last but not least, over 100 Hook-ups and Diagrams. No matter what instruments you have you will find a perfect hook-up that works in this book. Blank pages are provided for keeping a record of your own hook-ups.



# LESSONS IN WIRELESS TELEGRAPHY

Price, 25 Cents

Contains just the information that every amateur should have. Covers the fundamental principles of electricity and wireless telegraphy, with a concise description of each part of the apparatus, showing their purpose and action in connection with the complete outfit.

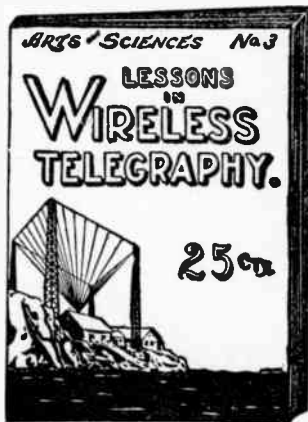

## TECHNICAL PRESS ASSOCIATION

33 West 42nd Street, New York City



# Classified Advertising

Advertisements in these columns 5 cents per word each insertion, payable in advance. To insert ads under proper classifications in January issue copy should reach us not later than December 1st.

## FOR EXPERIMENTERS

WE manufacture metal articles of all kinds to order, also special machinery, tools, dies, punchings, lathe and screw machine work, metal spinnings, plating, wood and metal patterns. Expert advice free. Frank Hess & Co., 410 E. Pratt St., Baltimore, Md.

ENGINE castings with drawings. Cheap. Also special work done at reasonable prices. Eagle Mfg. Co., Dept. EM, Cincinnati, O.

WE cooperate with experimenters to develop and perfect ideas and inventions of every description. We build demonstrative miniature or regular full size machines for inventors, promoters, patentees, patent office and manufacturers, electrical and mechanical experts, scientific and experimental work a specialty. Write for particulars. Wm. C. Houghton, 20 Main St., Saugus, Mass.

GENERAL machine work; designing and perfecting; developing automatic devices and machinery. In a position to do all kinds of light tool and machine work. Prices reasonable; estimates furnished. Regal Model & Tool Co., Dept. EM, So. Clark St., Chicago, Ill.

## MODELS AND DRAWINGS

FOUR ideas and inventions designed, developed and perfected for practical and commercial use. Advice given free by mechanical engineer. M. Pasternak, 616 West 161st St., New York.

MODELS—We develop and perfect your ideas, make models, dies, tools, metal stampings and special work. Gerding Bros., Cincinnati, O.

DRAWINGS for inventors; designing and perfecting into commercially practical form. Expert mechanical work. William Meny, 219 W. 121st St., New York.

INVENTORS—I should like to become acquainted with you and advise you in a practical way about your patent rights. F. V. Winters, Patent Lawyer, 125 East 23d St., New York City.

## PATENTS

IDEAS wanted—Manufacturers are writing for patents procured through me. Book with list of inventions wanted free. I get patent or no fee. R. B. Owen, 21 Owen Bldg., Washington, D. C.

PROTECTIVE patents procured promptly; patent information given; trade marks registered. Robb & Robb, Southern Bldg., Washington, D. C.

SEND for free booklet; all about patents and their cost. Shepherd & Campbell, Patent Lawyers, Dept. EM, Victor Bldg., Washington, D. C.

PATENTS without advance attorney's fees; not due until patent allowed; send sketch for free report; books free. Frank Fuller, Washington, D. C.

## TOOLS AND MACHINERY

WE make tools, dies, punch-press work and special machinery; send us drawing or rough model for estimate. All kinds of model supplies. Pierce Model Works, Dept. EM, Chicago, Ill.

LATHES, engines and other machinery for sale. Write for our prices. J. Lucas & Son, Bridgeport, Conn.

DYNAMOS—50-Light, \$60; 100-Light, \$80. Small payments monthly. Hobart Bros., Troy, Ohio.

SMALL A.C. or D.C. motors at special prices; also dynamos and motor generator sets. Johnston, West End, Pittsburgh, Pa.

SEND for special list on new and used dynamos, lamps and electric equipment for automobiles and boats. The Esterline Co., Dept. EM., Indianapolis, Ind.

COMPLETE stock of alternating and direct current motors at bargain prices. Satisfaction guaranteed or money refunded. Motors bought, exchanged, repaired. Send for our list of supplies. Hyre Electric Co., Dept. EM, S. Dearborn St., Chicago, Ill.

Let this book show you  
**How To Make Things Electrical**

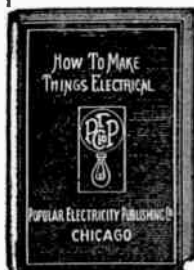

**Complete Directions For Building Over 100 Pieces of Electrical Apparatus Together With a Series of Electrical Experiments**

A Workshop Manual for the student or experimenter showing the construction of everything electrical, from a simple battery cell to an electric starter for a balky horse, including such useful household appliances as Motors, Electric Toasters, Stoves, Clocks, Bell Transformers, Immersion Water Heater, Soldering Iron, etc., in addition to a wide range of new and novel devices that every experimenter would like to know how to make.

Clear, concise directions and over 180 careful drawings are features of this book that should not be overlooked.

No other work contains in such compact form as many up-to-date designs of apparatus that can be made by the experimenter of ordinary ability. Only ordinary tools are required to do the work.

**Read This Partial List of Articles Covered**

Photographing Birds. Firing Flashlights Electrically. Homemade Device for Printing Pictures. Ruby Lamp. Construction of a Dry Cell. Gravity Battery. Bichromate Cell. Storage Batteries. Water Rheostat. Simple Electric Motor. Miniature Motor. How to Build a  $\frac{1}{4}$  Horsepower Motor Without Castings. Controller for Toy Motors. Direct Current Dynamo. To Make a Small Magneto. To Make a Selenium Cell. Watch Demagnetizer. A Simple Static Machine. Reversing Switch. A Simple Circuit Breaker. Telegraph Sounder From an Old Bell. Telegraph Key. Polarized Relay. Simple One-way Telephone. Electric Bell. High Water Alarm. Homemade Cash Drawer Alarm. Electric Bedroom Alarm.

Burglar Alarm Circuit. Office Bell. Tell-tale for the Ice Box Drip Pan. Mail Box Alarm. Bell as Shocking Device. Shocking Outfit from Electric Engine. Shocking Coil. Induction Coil. Shocking Push Button. A Step Down Transformer. Two Hundred Watt Closed Core Transformer. Bell Ringing Transformer. Construction of Ring and Core Type Transformers. High-frequency Apparatus. How Electrical Clock Operates. Electric Furnace. Portable Electric Heater. Electric Stove and Toaster. Immersion Water Heater. Making an Arc Lamp. How to Make a Speaking Arc. Electric Gas Lighter. Simple Microphone. Simple Galvanometer. A Hot Wire Meter. Unique Ammeter, and many others.

**200 Pages, Price \$1.50 Postpaid, 184 Illustrations**

Send for this book today. Our offer of "Money refunded if not satisfactory" protects you if it is not what you want.

**TECHNICAL PRESS ASSOCIATION**

33 West 42nd St., New York City

This Book Will Show You How to  
**Build Your Own Wireless Outfit**

Wireless Telegraph Construction for Amateurs

By  
 Alfred P. Morgan

Revised  
 and  
 Enlarged  
 Edition

225 Pages  
 167 Illustrations

Price, \$1.50  
 Postpaid

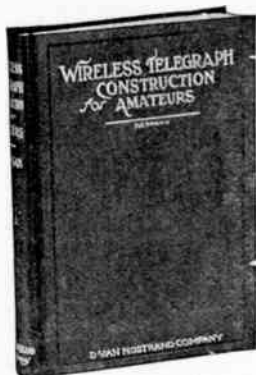

Shows you how to construct various outfits capable of receiving from 100 to 1500 miles and transmitting from 3 to 100 miles, giving in minute detail complete directions for the construction of each part. Also clearly explains the purpose and action of each instrument with directions for operating and testing, etc.

History and all obsolete forms of apparatus have been omitted so the information contained is thoroughly up-to-date. Its thoroughness is a feature not often shown in such books. This together with its splendid treatise of wireless along constructive lines make it the ideal book for an amateur. Endorsed by Wireless Clubs throughout the country as being the most practical book published on wireless for the amateur.

**What the New Edition Contains**

This new and enlarged edition has been carefully revised and brought strictly up-to-date so that it embodies all improvements and changes which have taken place since the first edition was published.

A new chapter discussing the Wireless Law and its relation to the amateur will be found especially interesting and valuable to the experimenter, for it not only tells how to comply with the new regulations, but also how to secure a license.

Several of the old illustrations have been replaced by new ones of direct interest to any one interested in Wireless Telegraphy. Photographs and working drawings of a great many new instruments accompanied by full descriptive matter explaining the construction of new types of Audion, Silicon, and Crystal Detectors, Oscillation Helixes, Rotary Gaps, Quenched Gaps, a Variometer, etc. A full copy of the Wireless Law is included.

**Contents of Chapters**

Introductory, The Apparatus, Aerial and Earth Connections, Induction Coils, Interrupters, Transformers, Oscillation Condensers and Leyden Jars, Spark Gaps or Oscillators, Transmitting Helixes, Keys, Aerial Switches and Anchor Gaps, Hot Wire Ammeter, Oscillation Detectors, Tuning Coils and Transformers, Receiving Condensers, Telephone Receivers and Headbands, Operation, The Amateur and Wireless Law, What it is, How to Comply, How to Secure a License, Appendix, Index.

*Every wireless amateur or experimenter should have a copy of this splendid book. Send for a copy today. Money refunded if not satisfactory.*

**TECHNICAL PRESS ASSOCIATION**

33 West 42nd Street, New York City

# Complete Electrical Tuition \$2

## CONTENTS:

Magnetism; Magnetisation; Magnetic Fields; Theory of Magnetism; Magnetic Induction; Magnetic Circuits; Earth's Magnetism; Voltaic Electricity; Batteries; Electrolysis; Measurement of Current Strength; Resistance; Ohm's Law and Battery Connections; Circuits and Their Resistance; Electromagnetism; Galvanometers; Electromagnets; Ammeters; Electrical Work and Power; Measurement of Pressure; Measurement of Resistance; Electrical Development of Heat; Electrodynamics; Electromagnetic Induction; The Induction Coil; Dynamo-Electric Machines; Armatures; Direct Current Dynamos; Direct Current Motors; Electric Lighting; Alternating Currents; Tables; Formulas.

### No risk to you

We will send you this book on receipt of \$2.00. Keep it ten days and look it over carefully; if it doesn't match up with your notion of what such a book should be, send it back and we'll return the two.

This work has been prepared for those who have not had the time or means to take an Electrical Course in a Technical School or College. It is intended for self-instruction and to this end it has been kept free from high technical treatment. It is the most understandable book on Electricity ever put in type. It is a book that will be of a real service in the acquirement of trustworthy knowledge of Electricity in all its phases.

## Lessons in Practical Electricity

Principles, Experiments and  
Arithmetical Problems

By C. Walton Swoope

*Asso. Mem. A. I. E. E.  
Late Instructor of Applied Electricity  
at the Spring Garden Institute, Philadelphia.*

The work consists of over 500 pp.; where an illustration can serve a useful purpose it is used. There are 404 illustrations; 438 review questions; 154 worked out problems; 119 problems, with answers, for the student to work out and 102 experiments. Indexes make the finding of specific information quick and easy.

### The Plan of Instruction

The book is the most comprehensive ever published. It is the closest approach to "in person" tuition possible; it anticipates everything the student needs in rules and data and reasons why; the student is never left in a doubtful position; he is made to prove his work as he goes along. Every proposition is proven by worked out problems, showing just how results are obtained, and other similar problems, with answers, are given for the student to work out, so that he may fully understand. There are also 438 review questions.

### The Sale of 32,000 Copies

Is somewhat of evidence as to the value of this book. 32,000 men have been helped to better positions and salaries by reading and studying it. "Go thou and do likewise."

## TECHNICAL PRESS ASSOCIATION

33 West 42nd Street, New York City

# Everyday Mechanics

"It Tells You How to Make and How to Do Things"

Vol. 1

DECEMBER, 1915

No. 1

## HOW TO MAKE YOUR OWN MOVIES

WHEREIN THE AMATEUR PHOTOGRAPHER IS SHOWN HOW TO SELECT AND USE AN INEXPENSIVE MOTION PICTURE CAMERA

**T**HE enthusiastic user of the camera has now a new and broader field for his endeavors. The amateur motion picture camera is an accomplished fact. Differing from the familiar still camera or kodak only in point of mechanical construction, the simplified form of cinematographic camera is an instrument well within the capabilities of the amateur photographer who knows the basic principles of the art.

In point of cost, the movie camera is no more expensive than a good kodak. A number of excellent little machines are now on the market at prices varying from \$50.00 to \$150.00, and those at the smaller price are quite capable of good work, although they are obviously inferior in workmanship and equipment to the more expensive models. The camera used as the subject of this article

may be classed among the low-priced instruments but, notwithstanding this fact, it has



Fig. 1. The amateur movie camera costs no more than a good kodak

produced some excellent specimens in the hands of an amateur user.

While it is futile to offer any advice on the selection of a camera that will meet the requirements of every reader, the

\*This is the first of a series of practical articles, each complete in itself, on amateur motion photography. Later articles will tell how to take trick pictures, develop films, etc. The commercial side will also receive attention in order to show the amateur how he may make money with his camera.



Fig. 2. The business end of the camera with lens uncovered

aim will be to point out the pitfalls and the things to look out for when considering the various models. In this way it is hoped that the individual may be enabled to make a selection best adapted to his particular requirements.

Photographically, the movie camera is quite the same as the still camera. The motion pictures are made on a band of celluloid film in a series of miniature photographs, each measuring  $\frac{3}{4}$  in. high by 1 in. wide, and each successive photograph representing a slightly advanced stage in the motion of the object pictured. For instance, if a man walks past the camera, each little photograph records a certain position of his body and limbs. When the

film has been developed and printed and the "positive" or print is run through the projecting machine, the successive views are presented before the eye in such rapid sequence that the change cannot be observed and an impression of continuous motion is received. The movie camera differs from its contemporary only in the mechanism which carries the film past the lens. This mechanism in the motion picture camera is so designed that it moves the film in a succession of steps, holding it steady for each exposure, and then bringing a fresh section into position. This movement of the film is rapid; in order that life motion be recorded, it is necessary for sixteen separate exposures to be made in a space of 1 sec. The film therefore travels past the lens at the rate of 1 ft. per second, making sixteen stops during that time.

A glance inside the camera shows us that the mechanism comprises an upper sprocket; a gate through which the film passes; a pair of claws or teeth which execute a reciprocating movement engaging the perforations along the sides of the film and pulling it down one picture after each exposure; and finally a second sprocket from which the film passes into the receiving magazine where

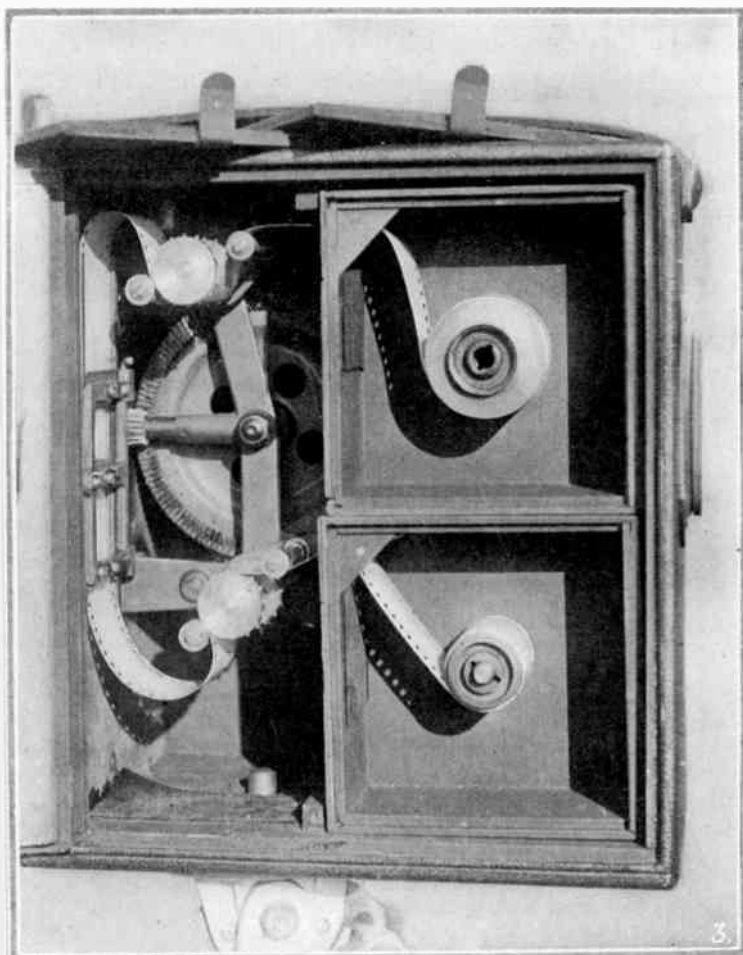

Fig. 3. Showing course of the film in its passage through the mechanism

it is wound upon a bobbin. All of this mechanism is connected by gearing with a crank on the outside of the camera case.

The raw film stock is supplied in rolls of from 50 to 200 ft. in length and the rolls are packed in tin cans which are

carefully sealed to exclude moisture. The film is exceedingly sensitive to even the slightest trace of white light and it must be handled under a dim ruby light in a photographic darkroom. In the handling of the raw stock, the greatest care must be taken to

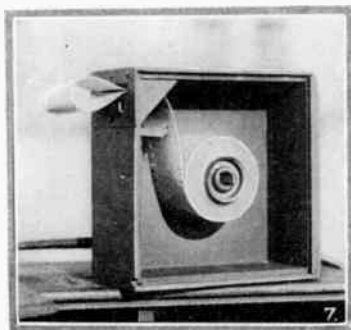

Fig. 4. Interior of magazine with end of film doubled back

avoid touching the sensitized or dull side of the film; the grease from the finger tips will show on the developed film as a distinct finger print wherever contact has been made.

The illustrations show just how the raw film stock in a roll is loaded into a magazine, and how the magazines are fitted into the camera case. The film is usually supplied with the emulsion or dull side toward the inside of the roll and, unless a rewinding device is at hand,

the roll must be placed in the magazine as shown in the illustrations. This produces a sharp bend where the film leaves the magazine and if possible this is to be avoided. It is far better to rewind the stock on the wooden bobbin with the emulsion side *out* in order that the roll may be reversed and the film take an easy curve in coming from the roll. At any rate, the emulsion side of the film must positively be *up* as it leaves the magazine. This is essential in order that the sensitized surface may face the lens.

The film, in passing from the magazine, goes beneath the upper sprocket, passing under the two rollers which hold the perforations on the teeth of the sprocket; then in a loop to the film track and aperture plate through which the exposure is made; and finally in a second loop to the lower sprocket and into the lower magazine. The spindle in this magazine is connected by spring belt with the operating mechanism in order that the film may be automatically wound upon the bobbin as it comes through the mechanism. The loading up is done in daylight and this of course ruins the first foot or two of film in the roll. If a piece of old film is cemented to the end of the fresh roll this waste will



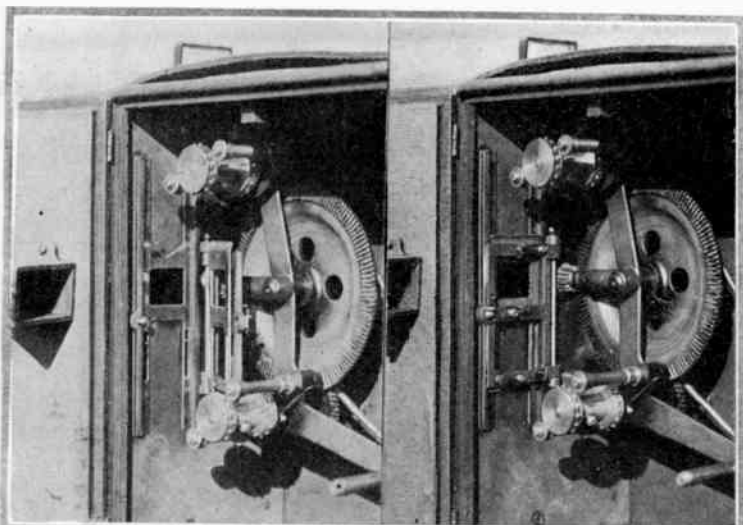

Film gate open

Film gate closed

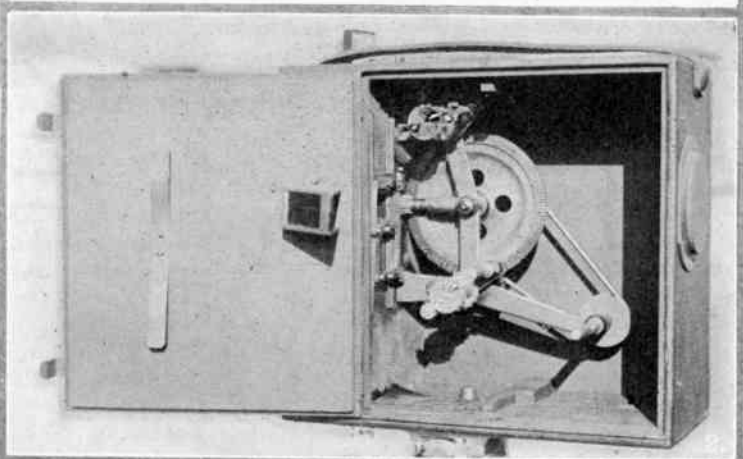

Fig. 5. Interior of camera, showing mechanism with film magazines removed. The direct focusing device is to be seen attached to the door near the film gate

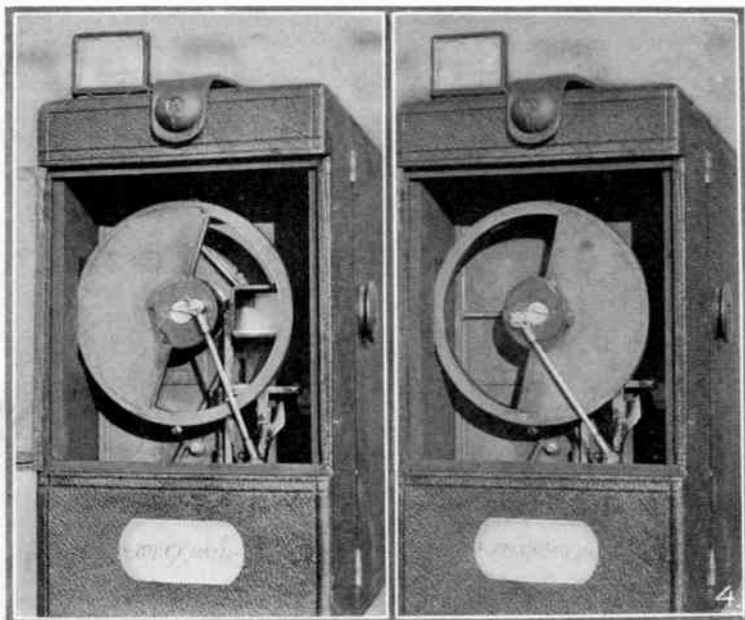

Fig. 6. Front of camera with lens door opened. View to the left shows shutter open and film aperture uncovered; that to the right shows shutter closed

be obviated. To cement the film, the emulsion on the end is moistened for a quarter of an inch and scraped off; this clean celluloid surface is then coated with regular film cement (obtainable from the dealer) as is also the end of the piece to be joined; the two are then immediately placed in contact, care being taken to see that the sprocket holes exactly coincide. The cement dries almost instantly and the joint, if carefully made, is as strong as the

stock itself as the cement literally dissolves the surface.

When loading the magazines in the darkroom, the projecting end of the film should always be doubled into a loop and pushed back into the magazine as shown in Fig. 4. This will prevent the possibility of the stock working back into the magazine after the cover has been closed and the camera taken on a tour. Obviously, if such a thing happens, there is no way to get at the end of the

film without opening the magazine in the daylight which would ruin the entire roll.

Let us now turn to the optical system of the camera. The illustration, Fig. 6, shows the front of the camera opened, disclosing the revolving shutter which covers the film when it is being drawn down and permits the light to pass when the film is at rest. In the illustration the shutter is shown both opened and closed. On the rim of this shutter is cast a heavy ring of metal which serves as a balance wheel to steady the motion of the camera. This is a point of prime importance, and in the selection of a camera the prospective purchaser should make sure that the model shown him has some form of balancing element to compensate for the inevitable jerks as the film is drawn past the lens.

The shutter opens and closes eight times for each revolution of the crank and the proper speed for the crank is obviously two turns per second in order that sixteen exposures may be made in a second. As the opening in the shutter covers just one-half its total area, and the opening passes the lens sixteen times per second, it is clear that each individual exposure is made in  $1/32$  part of a second. This exposure has been found sufficiently rapid for all ordi-

nary work with the exception of rapidly moving objects such as horses running, automobiles racing, etc. For these objects, the camera must be speeded up somewhat to avoid a blur in the picture. Right here may be seen the advantage of a higher priced camera. While the amateur instrument has a fixed aperture in its shutter—quite sufficient so far as it goes—the

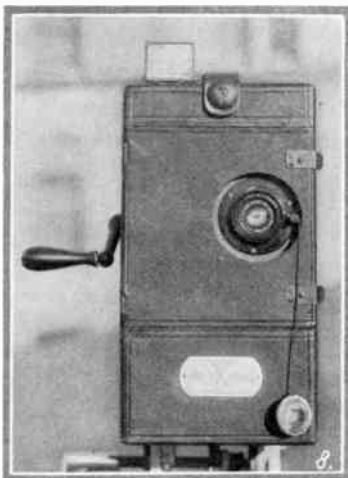

Fig. 7. Front of camera, showing device on lens flange for adjusting focus

professional or higher-priced amateur camera has an adjustable shutter which permits the exposure to be varied within wide limits.

In the front of the camera is a door opening on hinges, and in this door the lens is

placed. The focus is adjusted by means of a lever which actuates a device that moves the lens in or out. A scale of feet marked on the lens flange permits the operator to adjust the focus by estimating the distance between camera and subject. If the operator so desires, he may focus directly on the film by placing his eye to the opening in the side of the camera. This opening is normally closed with a cap to exclude the light after focus has been obtained. In Fig. 5 may be seen a small attachment on the side door of the camera. This is a box enclosing a mirror which reflects the view of the film into the peephole when the door is closed.

In Fig. 6 the reader will notice a small rectangular frame on the top of the camera case to the left. This is the finder which pictures a miniature view exactly similar to that which falls upon the film in the camera. This finder enables the operator to follow his subject and to determine at all times whether or not the subject is properly within the range of the lens.

In Fig. 8 is shown the correct position to assume when operating the instrument. The eye is placed on a level with the finder and about a foot to the rear of it; the left hand grasps

the crank which swings the camera on the tripod while the right hand operates the crank actuating the mechanism.

The most difficult portion of the operation to acquire is the knack of turning the crank with a uniform speed throughout the entire revolution of the crank. The tendency is to give a jerk on the downward throw and to slow up on the upward movement. The only way to master this bit of technique is to practice turning the crank with film in the camera. This does not necessarily mean that a whole lot of good, new stock must be wasted while learning. The operations of loading, threading up the mechanism, turning the crank, and in general, handling the film may be done as well with a few hundred feet of old positive stock that almost any film exchange will sell for a half-cent a foot or perhaps donate outright.

The rules which govern the exposure of an ordinary still photograph apply equally as well to the motion picture. The lens supplied on the movie camera is a good one as a rule. The one used in the preparation of these articles is fitted with a Zeiss Tessar  $f/3.5$ . A lens working at this speed enables the user to take pictures in places where the light is poor and to obtain good exposures

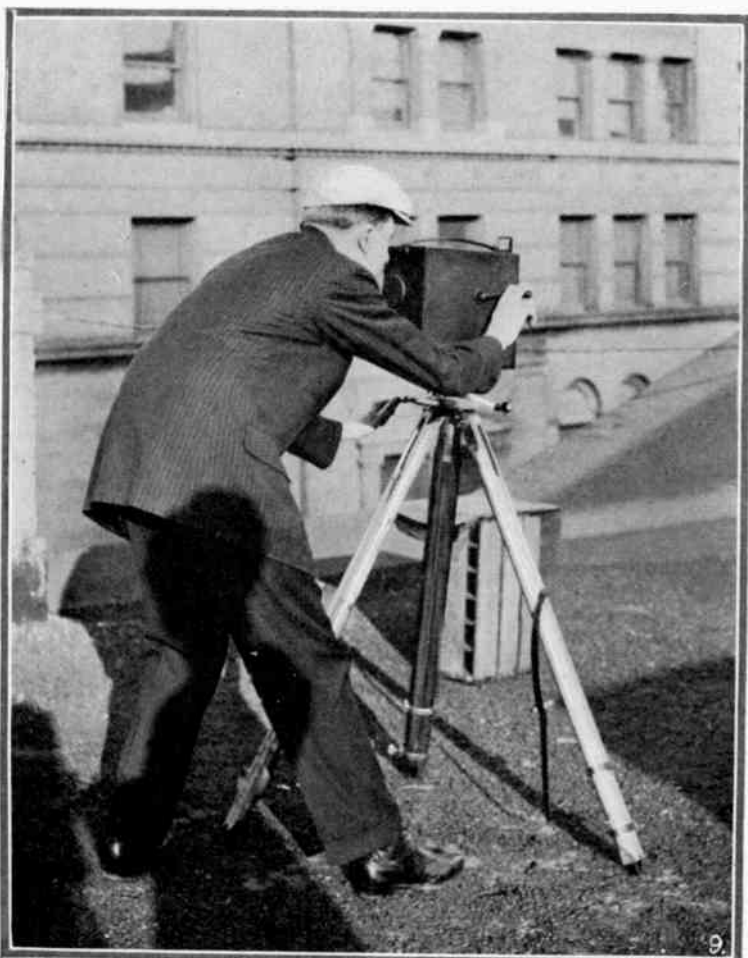

Fig. 8. The camera in use. Note relative positions of direct view finder and eye of the operator. The left hand controls the crank which turns the camera on the tripod

under such conditions. For most ordinary work in bright sunlight, however, the diaphragm of the lens is set at  $f/11$  or even at  $f/16$  if a landscape is being photographed. If

the principal objects are near the camera the stop  $f/8$  gives better results and if a close up portrait is made in bright light, the next larger or  $f/6.3$  is about right. The smaller numbers on down to  $f/3.5$  are used where

the light is poor. The principle is merely that the smaller the number, the larger the opening and consequently the greater the amount of light admitted to the film. This rule invariably obtains.

## ELECTRICAL HINTS FOR THE EVERYDAY MAN

### HOW TO CONNECT UP A SIMPLE EXTENSION LIGHT

**G**IVE the average man a gas mantle, a burner and a length of tubing, and he will proceed to rig up a table lamp or so-called drop light without hesitation. Give the same man an electric lamp socket, a length of flexible cord and an attachment plug, and he will scratch his head in perplexity—unless he is not an average man. There is nothing mysterious about any household electrical fitting and there is no reason why the ordinary individual, man or woman, boy or girl, should hesitate to undertake the connection of a simple electrical device; that is, there is no more difficulty or danger present in the case of the electrical device than there is with the gas attachment. In the latter, if the connection is not properly made the light will be poor and the gas will leak. There is an appreciable amount of danger here to be sure but the odor gives the warning. With the electrical connection if the work is not properly done

there will be a leak of current that may cause a short circuit and blow a fuse. The danger is not as great as in the former case for the trouble is made known at once or as soon as the current is turned on.

The suggestion for this article came to the writer as he was walking through one of those remarkable stores wherein one may buy everything from hardware to clothes at 5 and 10c. On a prominent counter, side by side with the gas fixtures, was an imposing array of incandescent lamps, sockets, plugs, flexible lamp cord, etc. Contrary to expectations, the quality of the merchandise was good; the fittings were in almost every case of standard and approved make. Certainly when such graphic evidence of popularity is shown, it is high time to offer the uninitiated reader a few simple instructions covering the connection and use of drop lights and other extensions.

If the layman will but con-

sider the electric circuit as he would a pipe line through which water or gas is made to flow, much of the mystery will be

done away with. Let him consider that the current comes out of the circuit through one wire, passes through the lamp or

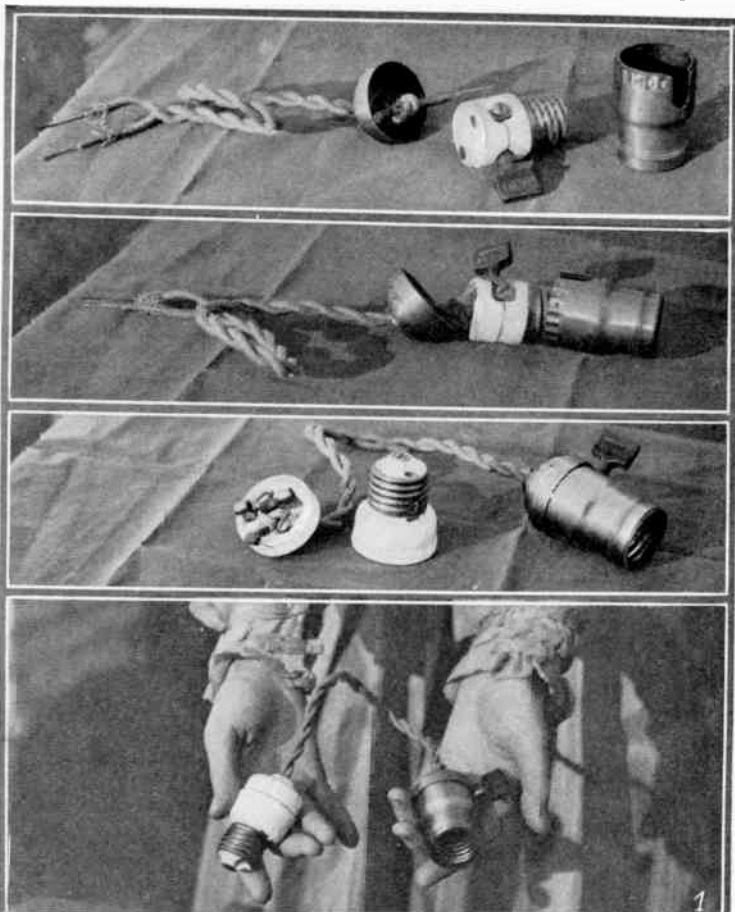

The various stages in the connection of a simple extension light. The top view shows socket taken apart; next, the socket connected and ready for assembly; third, plug attached; fourth, extension complete

other device, and returns to the source of supply through the second wire. Bearing this in mind, he will see that to provide a perfect path for the current, he has only to make sure that the ends of the copper wires, from which the insulation has been removed, are firmly gripped under the heads of the proper terminal screws. The only need for caution is to make certain that no stray bits of wire are left loose to make possible contact with each other or the shell of the socket. The two ends of the twisted lamp cord must always be kept separated for if they should touch each other when the current is turned on, a short circuit would be formed and the fuse or protective device near the meter would blow out.

The illustration shows the successive stages through which an attachment plug, a lamp socket, and a length of flexible lamp cord must go in the process of connecting up a drop light. On the shell of the socket near the key the word "press" is stamped. Pressure on this spot will permit the cap to be removed from the shell, thus exposing the interior of the socket. The interior mechanism shows two brass screw heads and under these heads the bare copper wires are to be clamped. The entire shell and cap is lined

with a black insulating material which should be kept intact.

In connecting the flexible cord to the socket, the worker passes the ends of the double cord through the bushing in the cap, ties a single knot in the cord as shown in the top picture, and removes the insulation from the end of each wire for a space of  $\frac{3}{4}$  inch. A piece of electrician's tape is then split in two to make a narrow tape and two or three wraps are taken around each cord just in back of the bare copper. This will prevent the insulation from fraying. The bare wire is then gripped under the screw heads. Thus, the current may enter one wire, pass through the socket mechanism, and return by way of the second wire. This stage is shown in the second picture.

In the third picture may be seen the removable top of an attachment plug. The other extremity of the cord is passed through the hole in this top, knotted, the insulation removed, and the ends taped as before. The bare tips of the wire are then secured under the screw heads in the plug top just as the others were in the socket. Pressing the top into the base of the plug completes the connection and the extension is ready to use. It is superfluous to say that the lamp cord may be several feet in length.



## GIANT HIGH FREQUENCY APPARATUS

HOW TO BUILD LARGE TESLA TRANSFORMERS AND RESONATORS FOR  
USE ON THE STAGE

OF all the experimental apparatus within the reach of the amateur builder, none can compare with the high potential, high frequency transformer when it comes to a question of demonstration or entertainment. A simple cardboard cylinder, wound with a few hundred turns of magnet wire in one layer, set on the top of the helix of his wireless set will give the experimenter a spark several inches long. This spark he can play with to his heart's content for it is perfectly harmless. Taken through a piece of metal held in the hand, the current produces no shock whatever even though the voltage may be expressed in the thousands. This is explained by the fact that the current changes its direction of flow so rapidly that the nerves cannot transmit the sensation of pain and the muscles cannot respond to the pulsations.

The smaller sizes of high frequency coils have been described in the magazines so many times that the average reader is assumed to be familiar with their construction and the principles upon which they operate. The subject will therefore be con-

sidered from the standpoint of the professional or amateur exhibitor who wishes to produce a very startling and spectacular effect for use in theatrical demonstrations. At the same time it may be well to add that the proportions given in our diagrams are excellent for small apparatus and, as the drawings are all to scale, larger or smaller models may be designed at will, using the diagrams as a basis from which to work.

In the present article, the specifications for two of the most popular transformers are given. These coils are complete in themselves so far as the oscillation transformer end is concerned, but they of course require the addition of the usual high potential transformer, condenser and spark gap before they become operative in the production of high frequency currents. As many readers are no doubt already in possession of this extraneous apparatus, it has been deemed advisable to confine the article to a description of the oscillation transformer. Later articles, each one complete in itself, will deal with the construction of the exciting apparatus for the benefit

of those who have not purchased or built it in connection with their radio sets.

The Tesla transformer illustrated in Fig. 1 is capable of throwing a 50 inch spark between terminals if made in the size shown in the detailed drawings, Fig. 2. This spark can be produced through the use of a two kilowatt transformer in the exciting circuit if the apparatus is tuned properly. The resonator shown in Fig. 3 is designed for the production of a comparatively short, but very heavy spark and it is capable of remarkable performances in the hands of an ingenious manipulator. The various experiments such as lighting lamps with current taken through the body and igniting cotton or paper with sparks taken from the fingertip are well within its scope and this on a big scale. The coil is also excellent for the generation of a very high frequency current at high voltage for the production of a bluish halo or glow which seems to come from the extremities of the body when the performer operates in the dark.

Rather than attempt a minute description of each operation in the construction of these coils, the author will endeavor to cover the constructional features in each case, believing that the reader is sufficiently well-versed

in mechanics to be able to read the drawings without difficulty. The construction is practically identical in the two designs and a description of one will suffice for the other.

The most difficult part of the work is the building of the secondary drum indicated by 1 in the drawings. This is a wooden cylinder with wooden heads. The difficulty is found in the fact that builder must not use metallic nails in the assembly. This is not insurmountable, however, for the shoemaker uses a substitute that fills the bill very nicely. His sharp wooden pegs may be driven like nails if the precaution is taken to start the hole with an awl or drill. If the builder has no lathe, he may order the wooden discs, which constitute the heads and intermediate forms for the cylinder, turned to size, from the mill. The wall of the cylinder is composed of wooden slats placed closely and glued and pegged to the discs. The construction will be materially assisted if holes are bored in the discs prior to assembly and a long curtain pole passed through to line them up. The pole is removed before the last few slats are placed in order that the brass bushings shown in the cylinder heads may be inserted and secured. After this, the final slats are placed in

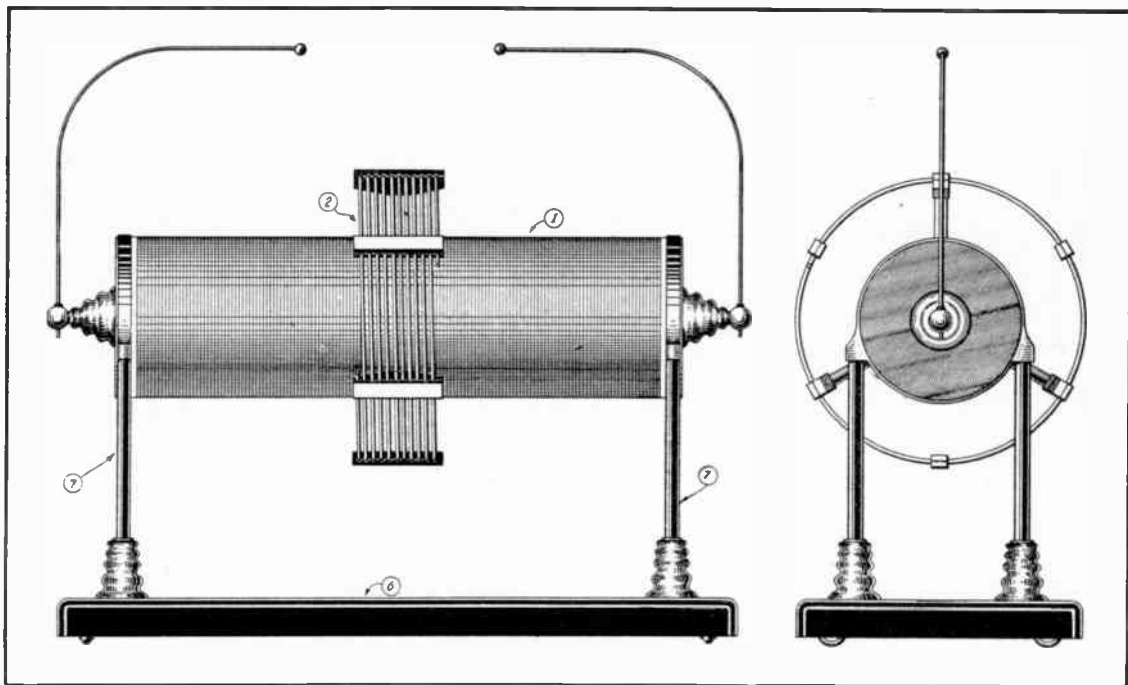

Fig. 1. Tesla Transformer capable of giving a 50-inch spark. The various parts are separable to permit of economy in packing for transportation

position, glued and pegged.

The cylinder may next be mounted upon a pair of horses and arranged to revolve through the agency of a short length of iron rod screwed into each bushing. The rod should be flanged in back of the threaded portion to prevent the strain on the bushing that would otherwise be present. With the cylinder between horses and a staple driven over each spindle, the builder may proceed to finish off the surface. A plane run along the slats will take off the projecting corners and a final rubbing with coarse sandpaper will bring the surface to a fairly smooth condition.

The winding surface is prepared by covering the cylinder with several layers of heavy wrapping paper, each layer being thoroughly soaked with shellac before the next is applied. The easiest and best way to do this is to purchase a roll of paper and place it in hangers beside the cylinder. The Tesla secondary may be wound in two sections with a space between at the centre of the coil. This space will provide for the legs that support the primary helix as shown in the drawings. The wrapping paper need therefore be only half the length of the cylinder in width in order to fully serve the purpose.

When the cylinder is covered

and the paper and shellac have dried quite hard, the winding may be done. The exact size of the wire on the Tesla secondary is of small importance. The only requisite is that the number of turns be kept between 600 and 800. There should be an appreciable space between each turn and its neighbor, however, and this may govern the gauge of the wire employed. It is difficult to secure any wire larger than No. 22 in a length sufficient to wind the cylinder in one piece and a splice is not to be desired. If, therefore, No. 22 B. & S. gauge, double cotton covered magnet wire is available, it may be wound 12 turns to the inch, making in the neighborhood of 300 turns in each half of the winding. The two halves of the winding must be in the same direction; that is to say, the one half is a continuation of the other. This is easily assured by starting at the left end of the cylinder, for instance, and winding until within  $1\frac{1}{2}$  inches of the centre. Here the wire is secured with a wooden peg and a jump taken over  $1\frac{1}{2}$  inches to the other side of the centre of the cylinder. Another peg secures the starting turn and the second half of the winding is completed, turning the cylinder in the same direction. In order to maintain the space between turns a loop

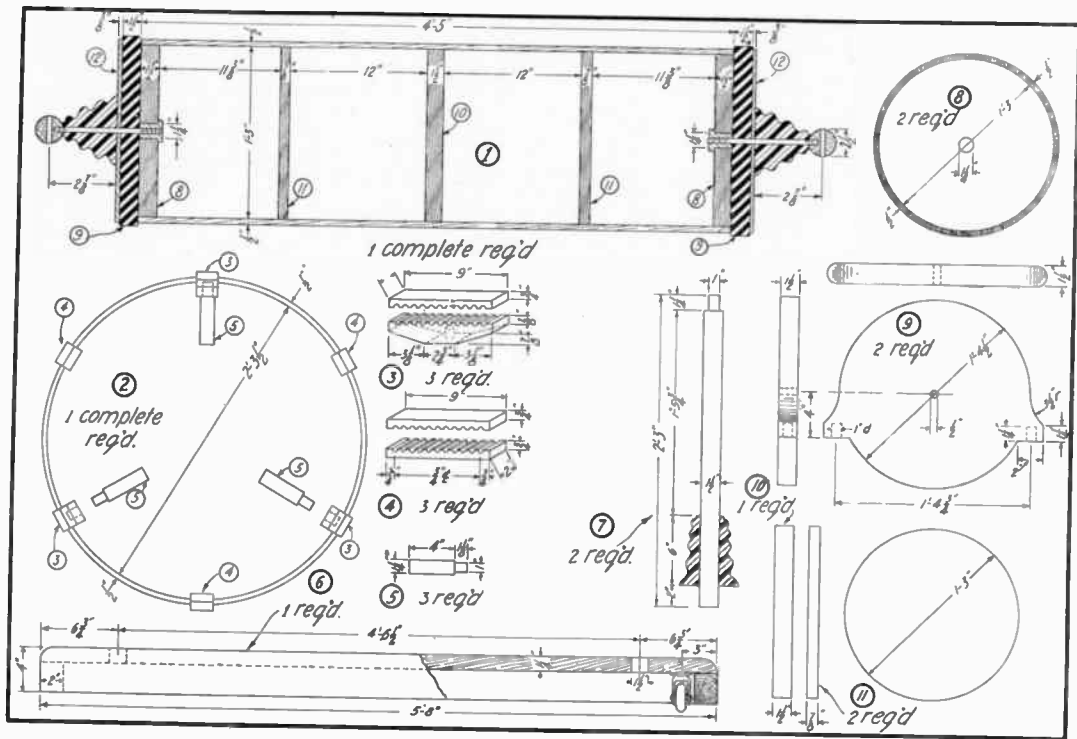

Fig. 2. Details of the Tesla Transformer

of cord is passed over the cylinder and a weight hung from its lower point. The turn of cord, which should be heavy and approximately 1/16 inch thick, will guide each succeeding turn, spacing them with fair accuracy. A correspondent who has built a set of apparatus recently from the author's directions, advises that he was able to straighten up the entire winding by running a metal comb along the wire as an assistant turned the cylinder. The winding, when finished, is given half a dozen coats of shellac, each coat being dried thoroughly before the next is applied.

The construction of the helix forming the primary will readily be understood from the drawings. The conductor is a length of 1/2-inch copper tubing, rubbed bright, and coiled into a helix 27 1/2 inches in diameter for the Tesla coil and 26 inches in diameter for the resonator. A material superior to the tubing is the edgewise-wound copper strip that is now used in nearly all high grade wireless transmitters. This strip can be purchased in a spiral from any large wire manufacturer but to bend it edgewise without buckling is a mechanical problem worthy of an engineer. It can be done by rigging up a drum of metal arranged with clamps to hold the strip flat as it comes

from the reel, but the task is scarcely one within the province of the amateur.

The Tesla coil is mounted upon a base equipped with casters in order that it may be moved quickly and easily. The secondary is supported by four rods of wood which are mounted in wooden bases in imitation of high tension insulators. The secondary is removable from the supporting rods merely by lifting it off, the rods terminating in plugs which fit sockets in the heads of the cylinder. The rods themselves are removable from the base by lifting them from sockets therein. The primary helix is supported on the secondary cylinder by the three legs as shown in the drawings. The helix is so springy that there is no difficulty in springing the third leg into position after the helix has been placed over the cylinder.

The object of having all of the parts removable is of course to permit packing to be done effectively and without the enormous cases that would be necessary if the coil were in one piece. The resonator is made separable in the same manner.

The ends of the Tesla winding are connected to the discharge rods through the rods and balls shown in the sectional drawing. The primary is entirely independent and its only



connection with the secondary is an inductive one. With the resonator, however, the case is different. The lowest turn is connected to the bottom turn in the primary helix and this in turn to a common ground terminal. The discharge rod 4 is also connected with this ground wire beneath the base.

Regarding the resonator, little further need be said save for a few words about the winding. This is in one continuous layer of about 350 turns. As the voltage is lower, this winding may be of No. 18 annunciator wire wound close and most carefully coated with shellac in six applications. The practice of winding the turns close is to be avoided if possible for there is extreme likelihood of the current leaping across through the insulation. A separation of a

single turn of thin cord will help materially.

In closing it may be well to state that the suggestions given in this article are intended for the amateur worker who is not equipped with a lathe sufficiently large to take the cylinders. If the individual is so fortunate as to have access to such a large lathe, he may disregard most of the instructions and proceed in the regular manner. In such a case the work is all plain sailing. Finally, if the instructions have not proved sufficiently clear or the individual worker meets with difficulty, let him take advantage of the department under the heading The Technical Adviser in this magazine. His problems will be solved for him promptly if a solution is within the experience of the Engineering Staff.

---

## TURNING AND THREADING COPPER

Copper is one of the most useful of all the metals to the electrical worker; at the same time, it is the despair of the average amateur mechanic, for it is tough and difficult to work. If the worker will rub a piece of beeswax over the stock as the cutting, threading or sawing

proceeds, he will find that many of his troubles disappear as if by magic. The wax is an admirable lubricant, keeping the metal well under control and preventing to a great extent the annoying bites that try the patience of the average amateur machinist.



## HOW TO BUILD A RADIO TELEPHONE

WHEREIN THE CONSTRUCTION OF A SMALL TRANSMITTER WITH DOUBLE ARC GENERATOR IS DESCRIBED

THE wireless telephone in the hands of the radio amateur is little better than an interesting toy. This is due to the fact that the average amateur is limited both in means and facilities. This fact notwithstanding, however, the construction of an experimental telephone, for use over comparatively short distances of a few

miles at the outside, is quite within the reach of the worker who has already built a radio telegraph.

In the design presented herewith, the arc type of generator has been chosen on account of its simplicity of construction, low cost, and general adaptability. There is nothing new or original in the type presented;

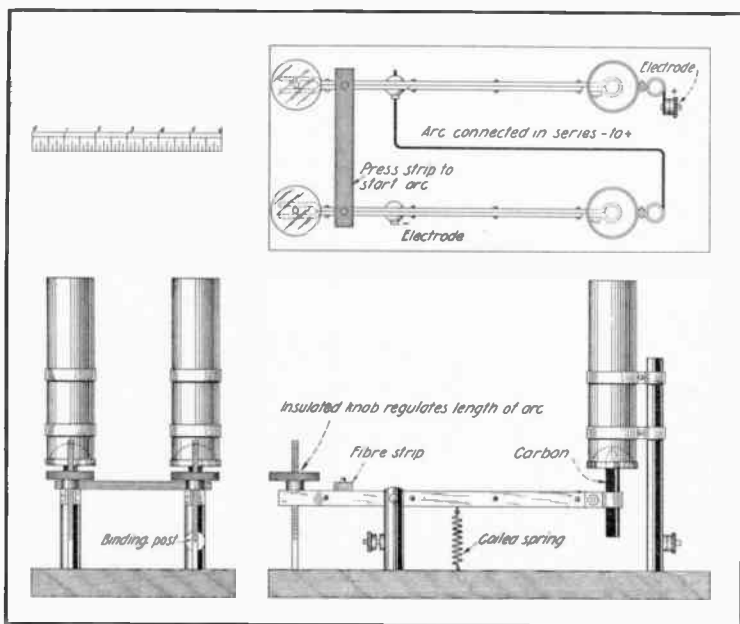

Fig. 1. The arc generator complete

in fact, the design has been adapted directly from a commercial instrument of known efficiency. The changes necessary to bring the construction within the capabilities of the amateur are the only ones worthy of mention.

Before taking up the construction in detail, it may be

available, he will do well to use but one arc instead of two.

With reference to Fig. 1, the generator may be described as having a pair of water cooled copper electrodes consisting of tubes of this metal supported on suitable posts which are held upright on a common base; a pair of carbon electrodes held in

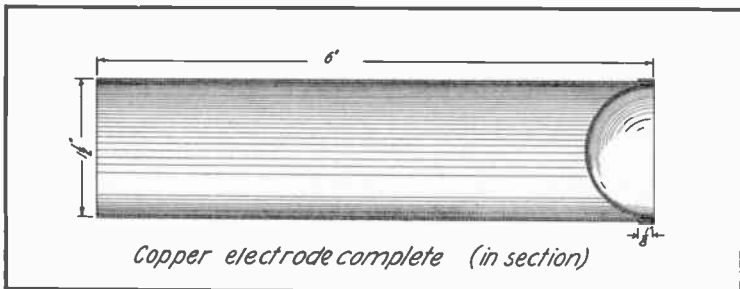

Fig. 2. Section through copper electrode

well to point out that the present article covers the arc generator only. It is believed that the average worker will already have been supplied with a variable condenser, oscillation transformer and aerial, and rather than attempt to cover these accessories in an article of this length, it has been deemed advisable to confine the remarks to the generator alone.

The double arc type of generator, in which the two arcs are placed in series, is adapted for use on 220 to 500 volt D. C. circuits. If the amateur has only the 110 volt direct current

pivoted arms which permit the arc to be struck and adjusted for length; and the whole of this apparatus grouped together on a base of insulating material. No dimensions are given on the drawing but a scale is appended and the worker may use this scale as a rule in taking measurements to determine proportions. The exact dimensions are of small importance and the individual may find scraps of material that will serve the purpose even though they may be of a slightly different size.

Let us first examine the copper electrode. This consists of

a copper tube approximately  $1\frac{1}{2}$  in. in diameter and 6 in. long. There are two of these electrodes, but as the construction is identical a description of one only will be given. In the bottom of the copper tube is secured a concave bottom, also of copper. The construction of this feature requires some little explanation.

Fig. 2 shows the copper electrode in section. The reader will note that the concave bottom consists of half a hollow ball of copper sheeting with a flange or rim turned up and set tightly against the wall of the tube. There are several ways in which this bottom piece may be constructed but the simplest one

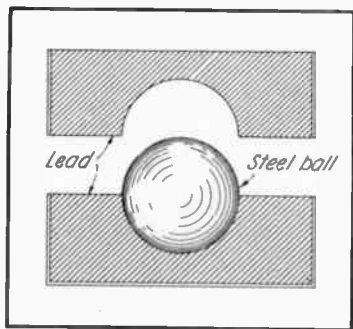

Fig. 3. Section through die

and perhaps the best from the amateur mechanic's view is that illustrated in the series of drawings, Figs. 3, 4 and 5. In Fig. 3 is shown a section of the die

used to press the half-sphere out of the sheet of soft copper. This die is merely the top of a baking powder can filled with lead

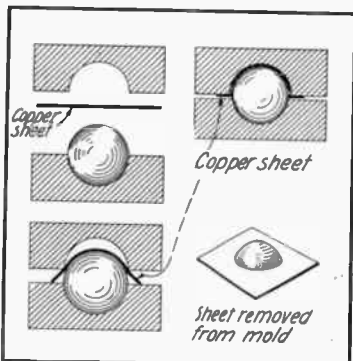

Fig. 4. Forming the concave bottom

and having a steel ball  $1\frac{1}{8}$  in. in diameter cast in the center. A piece of heavy cardboard is then tied around the can, a layer of talc dusted over the surface of the lead, and the second half of the die cast over the first, the cardboard holding the lead until it hardens. The paper removed and the die separated, the sheet of soft copper may be placed between as shown in the first drawing in Fig. 4. The copper may be softened by heating to a dull red and then plunging it into water. The die with the copper sheet between may then be placed in a vise and the jaws set up gradually. The tendency at first will be to buckle the flange of the sheet, but a little

care will permit the worker to at last bring the halves of the die together forming the result shown in Fig. 4.

The sheet is then inscribed as

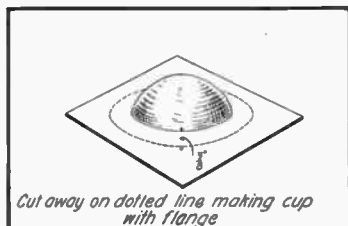

Fig. 5. The concave bottom ready to attach

indicated in Fig. 5 and the metal cut away leaving a flange  $\frac{3}{8}$  in. wide all around the cup. The latter may now be replaced on the ball of the die and the copper tube forced down over the convexity. The flange bent up all around and hammered tight against the tube, the seam may be thoroughly sweat-soldered, and the electrode is finished. In soldering it will be necessary to thoroughly heat the lower end of the tube in order that the solder may run between the flange and wall. As the electrode is to be filled with water, it is obvious that there must be no leak here.

The copper electrodes finished, our attention may next be given to the carbon holders and the mechanism which controls the length of the arc. The carbon is held in the end of a simple arm,

the construction of which is very clearly shown in Fig. 8. This arm is made of two slender bars of brass riveted together, one end forming the carbon clamp while the other is in the shape of a fork. The arm is supported, pivotally, in a post of the design shown in Fig. 9. The relation of these members is shown clearly in Fig. 1. In back of the supporting post a long, threaded brass rod is affixed to the base. This rod passes between the forks of the carbon holder arm, and an insulated knob regulates the separation between the tip of the carbon and the under side of the copper electrode. In order to start the arc, the fiber strip bridging the two arms is pressed; this brings both carbons into contact with the electrodes at the same

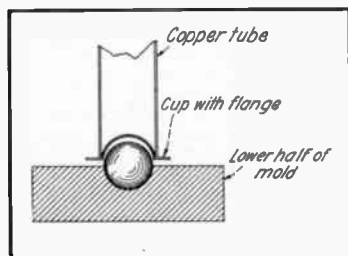

Fig. 6. Attaching copper tube to bottom

time and when they are released, the arc is started. It is quite apparent that the individual regulation of each arc is

not interfered with by the cross bar as the holes in the latter fit loosely over the pins in the carbon holder arms.

The method of supporting the copper electrodes is so obvious from the drawings that no further description should prove necessary. The upright posts are secured to the base with screws passing through the latter. The plan view of the arc generator in Fig. 1 shows how the two arcs are connected in series, the line wire coming to the copper electrode of one, the current flowing through this arc to the post supporting the carbon holder arm, thence through a wire to the second copper electrode and finally through the second arc, arm, and post back to line. The copper electrode is always to be connected with the positive pole of the circuit.

In Fig. 10 is given the wiring diagram for the complete transmitter. Tracing the circuit from the positive terminal of the line, we find the current first traverses a choke coil, made of 200 turns of No. 12 D. C. C. copper wire on a core of iron wires making a bundle 1 in. in diameter and 8 in. long, then to the copper electrode of the first arc, from this to the second arc and thence to a second choke coil and back to the line. A resistance consisting of iron wire, a lamp bank, or other convenient ma-

terial, is connected in series with the circuit to limit the flow of current to 4 or 5 amp. The oscillation circuit consists of the primary of an oscillation trans-

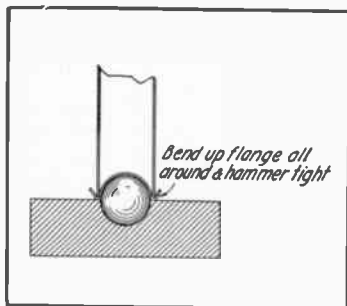

Fig. 7. Attaching tube

former and a variable condenser in series, and the two shunted across the arc. The secondary of the oscillation transformer is connected with aerial and ground, and in the latter circuit an ordinary telephone transmitter is included. Right here is where the amateur will experience his most annoying difficulty. The conventional transmitter will not carry the heavy current without overheating, and despite all that one can do, this difficulty will be present. The use of several transmitters in multiple is unsatisfactory as the tendency is for one or two of the group to take most of the current as the resistance of the transmitters will vary. The reader need not be deterred from building the apparatus on

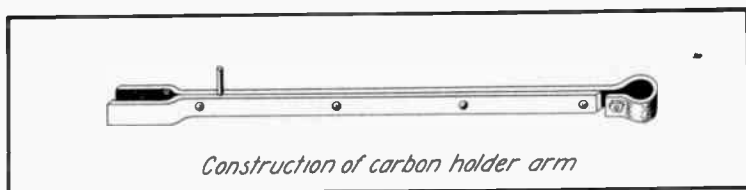

Fig. 8. Carbon holder arm

this account however for, although the transmitting distance is reduced materially thereby, the set can be made to work with fair success on a single transmitter if the output is held down.

The oscillation transformer may be of the conventional sort to be found in almost every station. The variable condenser should preferably be of the revolving plate, oil-immersed type, but if this is not available, good

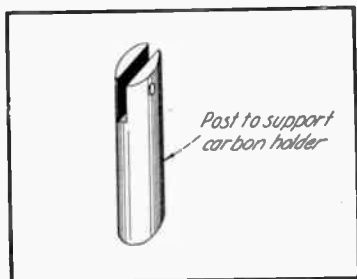

Fig. 9. Post to support carbon holder

results may be secured with the simple variable having sliding glass plates with tinfoil coating.

In using the telephone the

copper electrodes are filled with water and the arcs started by pressing down the fiber bridge. The length of each arc is then adjusted by turning the insulating knobs until it has quieted down and all hissing has stopped. For testing purposes there is nothing better than a phonograph placed at the telephone transmitter. With a receiving station a short distance away, and a line connection between the two, the tuning may be done quickly and effectively if an assistant listens in and keeps the operator advised while he varies the inductance and capacity. The length of arc, amount of current flowing, and the usual adjustments of condenser and oscillation transformer all have an important bearing upon the results obtained. If success does not attend the first efforts, the experimenter should persevere in his tuning. While talking through the radio telephone, it is necessary to use a much louder tone of voice than would be the case with an ordinary wire telephone.

There is also a material advantage in bringing the voice up to a higher pitch or key than normal as the higher notes are more clearly read through the hissing and buzzing that is nearly always present in the receiver.

In conclusion let us remind the amateur that the telephone offers a field far more fascinating in many respects than that

remunerative. The experimenter of to-day is the inventor of tomorrow, and almost every big invention we have was once a crude toy on the workbench of a pure experimenter.

Finally let us say that the department The Technical Adviser in this magazine is intended to supplement the articles. It is impossible to cover

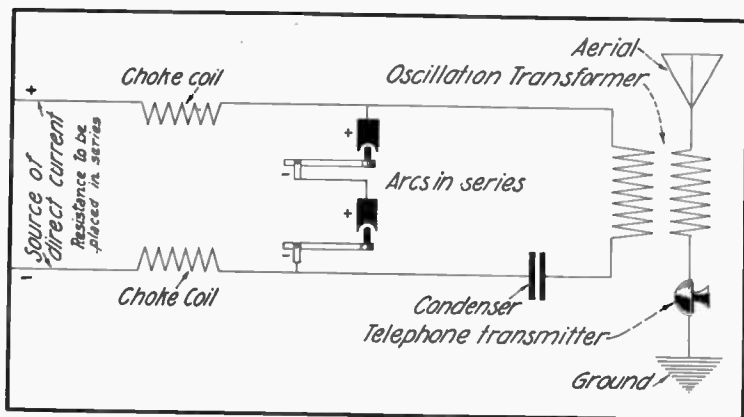

Fig. 10. Complete wiring diagram

of the radio telegraph. The recent achievement of the large interests in maintaining transmission from Arlington to Honolulu is but a forerunner of what may shortly be expected. True, it is too much to assume that the radio telephone will ever displace its contemporary of the wires, but the same may be said of the telegraph. The field is large, interesting, and possibly

the individual requirements of the many readers in a single article, and this department has been inaugurated in the hope that it may serve as an exchange of ideas and experiences. If any reader meets with difficulty in the construction of apparatus described in this magazine, or fails to obtain materials, let him write The Technical Adviser for assistance.

# PRACTICAL MECHANICS FOR EVERYDAY MEN

## HOW TO TAKE A FLASHLIGHT PICTURE OF YOURSELF

This electric igniter for photographic flashlights is simple, cheap and effective. Through its aid the photographer may include himself in a group to be pictured. While the suggestion is particularly well adapted to use with the popular flash sheets sold by all photo dealers, it will prove

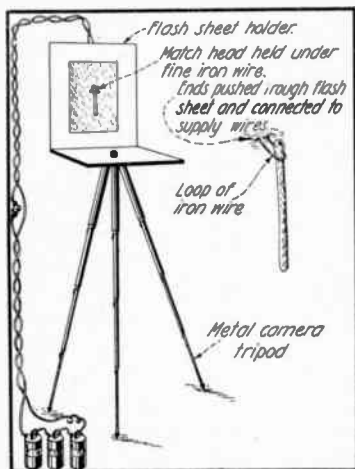

Electric ignition for flashlights

equally as efficacious in the case of flash powder should the individual have preference in

this direction. The device consists of a battery of two or three dry cells, a suitable length of insulated wire, a push button and a piece of fine iron wire. The latter is looped and the ends pushed through a flash sheet; the iron wire is then made to connect the ends of the double copper wire leading from the battery; finally, before connecting up the battery the push button is included in the circuit. An ordinary sulphur match is placed under the iron wire loop in such a manner that the head of the match touches the wire. When the button is pressed, the iron wire loop immediately becomes red hot. This ignites the match which in turn sets off the flash sheet.

If difficulty is experienced in obtaining iron wire fine enough to become red hot when the current is applied, the builder may take a single strand from a length of picture cord, hammer it out flat, and then trim away the greater part of the metal, leaving a thin and narrow strip of iron which will become white hot instantly if the current from a battery of two cells is passed through it.



### HOW TO PUT ON A LIFE-RING

Throw a life-ring to nine people out of ten among the uninitiated "landlubbers" and one and all will attempt to lift the ring above the head. This is impossible in the water as the



To put on a life-ring

heavy preserver merely forces the struggling person down until his head is beneath the surface; the result is panic and a greater quantity of water in the lungs.

Said an old sailor: "The proper way to approach a life-preserver in the water is to take hold of the side nearest you and press upon it with all your weight. That causes the other side to fly up in the air and down over your head, ringing you as neatly as a man rings a cane at a country fair."

### HOW TO CUT HEAVY PLATE GLASS

The amateur worker at times may have occasion to cut a piece of thick plate glass and one brief trial is usually sufficient to dampen his ardor to the point where the professional glazier is

called upon. The operation is not necessarily difficult if one but knows the combination, so to speak. The piece to be cut is laid upon a solid table or bench and a firm, clear cut taken across the surface with an ordinary wheel glass cutter that may be bought for a quarter from any dealer in hardware. Raising the plate of glass from the bench, the under side is tapped rapidly and lightly with a small machinist's hammer or the rounded end of any similar tool. Starting at the edge, the tapping is continued carefully until a crack starts. As the point of tapping advances, the crack will follow the line made by the cutter until the other side is reached. At this stage the

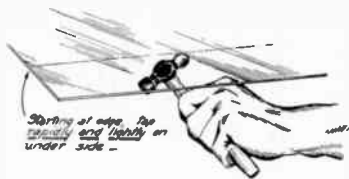

To cut heavy plate glass

plate may be held by the edge with both hands and with pressure applied gently near the crack, the glass will separate as nicely as one would desire. In using the wheel cutter, the cut will be cleaner and deeper if the wheel is slightly moistened with the tongue before it is applied

to the glass. Care should be taken, however, to see that no fine particles of glass adhere to the cutter from which they may be taken onto the tongue.

#### SIFTING ASHES WITHOUT DUST

The insurance regulations will not permit the use of wooden receptacles for ashes in many cities and the old-time covered soapbox, with sliding sifter is, in consequence, no longer meeting with popular favor in spots where the hand

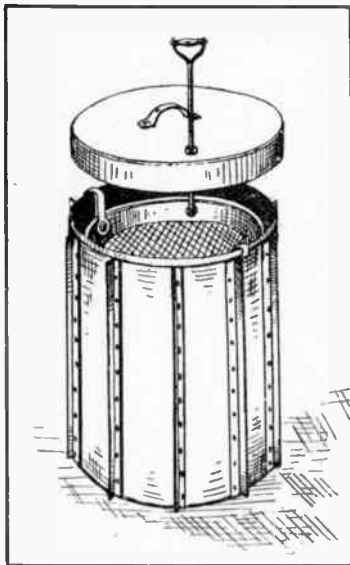

Dustless ash sifter

of the inspector is felt. To construct a metal box on the same

principle would not be difficult, but it is scarcely worth while, for the suggestion offered in the illustration permits one to use the standard, approved ash can, with practically no alterations. A circular sieve of a size somewhat smaller than the inside diameter of the can is selected and two hooks are riveted at points diametrically opposite in the rim of the sieve. These hooks suspend the sieve a few inches below the top of the can. A stiff wire is bent at right angles at one end and into a handle at the other. This wire is passed through a hole in the cover of the can and hooked into a hole in the rim of the sieve.

The method of operation is apparent. The cover is lifted and turned to one side around the wire; a shovelful of ashes is placed in the sieve and the cover replaced. Working the handle up and down will sift the ashes, and when one load is finished the sieve may be lifted out of the can and the recovered coal emptied into a suitable container.

#### ATTACHMENT FOR DIE FOR USE IN TIGHT QUARTERS

There are places where the usual die holder with its double handle cannot be used. Here is where the device shown in the illustration comes in handy. It is merely an old nut bored out

to take the die and a set screw added in the position it would occupy in the regular die holder.

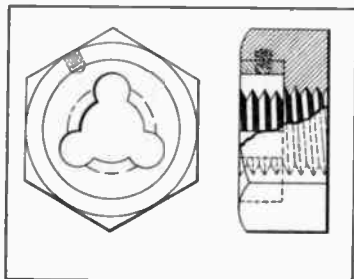

Attachment for die

The die may then be turned with a wrench of convenient shape to fit the space available.

#### TO MAKE LAMPS FLASH

Here is a lamp flasher that any amateur mechanic can build. It will work continuously without attention and for circuits of a few lamps only it is quite satisfactory. The principle of operation is based upon the fact that the aluminum tubing shown in the illustration expands rapidly when heated and contracts almost as rapidly on cooling. This expansion lifts the lever carrying one contact and breaks the circuit. As soon as the current is off, the tubing cools and contracts, thus forming the connection again. As the current heats the resistance wire surrounding the tube the latter once more expands and the cycle

of operations will be repeated. The construction is quite obvious from the illustrations. The aluminum tubing should have a thin wall in order that it may heat and cool quickly. The ends of the tubing are squeezed in the vise and a few holes drilled through the wall to ventilate the interior. Two layers of mica or very thin asbestos sheeting are then wrapped around the tube in order to electrically insulate the latter from the wire. The heating wire will have to be chosen

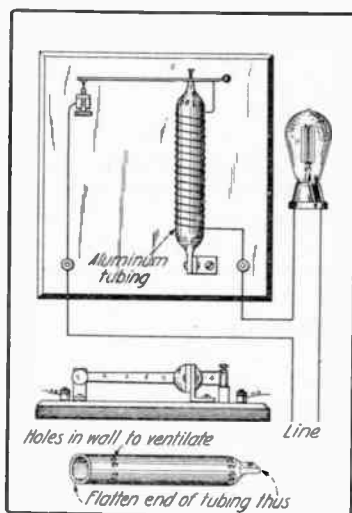

Lamp flasher

to conform with individual requirements. If but three or four 50-watt lamps are on the

flasher, the heating wire may be No. 22 German silver or No. 24 Climax wire. A few turns of this will heat the tubing quickly. The object is to use enough wire to heat the aluminum without introducing enough resistance to appreciably dim the lamps. This can be accomplished through a few experiments.

As the drawing shows, the device is mounted upright on the wall. The contact arm is a light strip of brass pivoted at the right on a nail, joined with the tip of the aluminum tubing an inch to the left, and terminating at a silver contact at the end. The stationary contact is adjustable in order that the duration of contact may be varied. If the arc is excessive at break of contact, a small condenser shunted across will assist in quenching it.

#### PUTTING A BLACK FINISH ON BRASS

Here is a handy formula for blackening brass that will serve the purpose of a cheap and quickly executed process where a true coal black is not essential. The solution is made by dissolving two ounces of sugar of lead and two ounces of hyposulphite of soda in one quart of water. The articles of brass are simply dipped in the solution, which is made as hot as possible for use. The color is

first yellow, then blue and finally a rich gray black. If the articles are lacquered the finish is permanent. The black deposit on the brass is sulphide of lead.

#### MOTORCYCLE LIGHTS FROM TELEPHONE MAGNETO

The average handy man can convert the ordinary telephone magneto into a dynamo that will furnish current for lighting his motorcycle or even a single headlight for a small motor car.

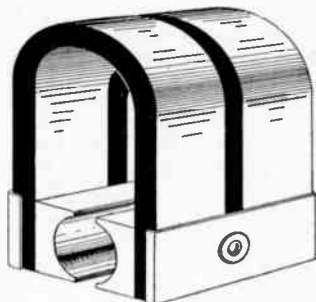

Fig. 1. Field magnet of generator

In Fig. 1 is shown the field magnet of the magneto from which the armature has been removed. Fig. 2 shows the armature core after the fine wire winding has been taken off. This wire should be preserved for future use if the worker is experimentally inclined.

The armature is to be re-wound with No. 22 D. C. C. magnet wire which may be obtained from any large dealer in

electrical supplies. The iron core of the armature should be thoroughly covered with paper pasted on at every place where the wire will touch. The paper is afterward coated with shellac and permitted to dry hard. The winding may then be started, soldering the end of the wire to the ground terminal shown at the right in Fig. 2 and winding always in the same direction on both legs of the armature. When the space has been completely filled and the wire pressed down with a blunt instrument, the winding may be thoroughly soaked with shellac and left to dry. The finishing end of the winding is soldered to the contact post that projects from the insulating material at the left hand end of the shaft. This pin connects with one that projects from the end of the

The machine is mounted on a suitable base and clamped to the motorcycle frame near the

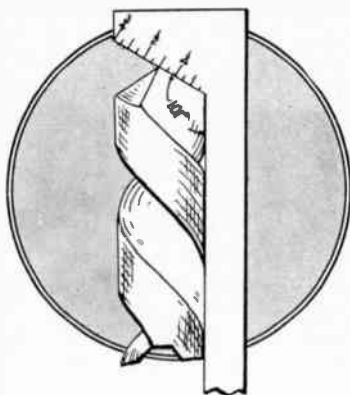

Drill gage

rear wheel. A friction pulley on the magneto shaft bears upon either the tire or rim of the rear wheel and the dynamo is driven in this manner. A spring secured to the base, and bearing upon the pin projecting from the shaft, makes the necessary contact.

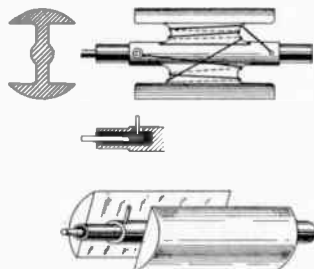

Fig. 2. Armature with winding removed

shaft and it forms one terminal of the dynamo; the other is the frame of the machine.

**TO GRIND DRILLS TRUE**

A drill ground off center will run large in drilling; one ground with an incorrect angle will "bite" in the work. The little gage shown in the illustration will enable the worker to grind his drills not only to the proper angle but it will insure accurate holes, for the grinding can be perfectly cen-

tered. The gage may be made by the amateur mechanic or he may obtain one from almost any tool manufacturer for a small sum.

#### HOW TO REMOVE THE ODOR OF STALE TOBACCO SMOKE

A bowl of clear water left in a room over night will clear the air of all unpleasant odors resulting from tobacco smoke. The smoke and stale odor are apparently absorbed by the water and the air partakes of a freshness not unlike that produced by ozone.

#### DOUBLE GLASS KEEPS OUT SOUND

For hospital or library, private sick room or den, the double glazing of windows will prove

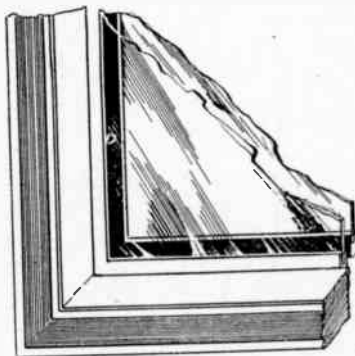

Double window glazing

a satisfactory solution of the problem of how to maintain the

desired degree of silence. The extra pane of glass may be affixed temporarily in a private house, for instance, by building a crude frame to fit the window in back of the regular sash. A double window of this description with an air space between the plates of glass will reduce street noises to a minimum.

#### HOW TO BUILD AN ELECTRIC VIBRATOR

An ingenious correspondent has made use of the principle of centrifugal force very cleverly in the design for a small and easily made vibrator shown in the accompanying illustration. The device consists merely of a tin can in which a revolving disc, placed off center on the shaft, is fitted. This weight is connected by flexible shafting with a small electric motor. A band of elastic webbing attached to the tin case permits the operator to attach the vibrator to the back of his hand so that the vibrations are transmitted through the fingers to the face of the patient.

The construction is so obviously simple that no attempt has been made to show dimensions or intricate details. The size is of small importance and the amateur builder will doubtless be able to use scrap material should the idea appeal to him. The flexible shafting may

be purchased by the foot from a dealer in second-hand machinery or the worker may be

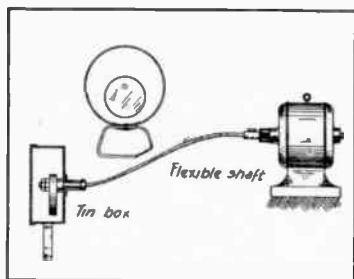

Electric vibrator

able to cobble up one of his own from a long coiled spring inclosed within a rubber tube with reinforced walls.

### TO GLUE UP A TABLE TOP WITHOUT CLAMPS

The amateur cabinet maker may produce a glued-up top for

clamps if he will but make use of the suggestion given in the illustration. It is apparent that the boards are drawn up by means of a wedge tapped into place between the outside board and a block nailed to the floor, while the other side of the table top is stopped by a second block also secured to the floor.

### HOW TO CONVERT A HAND DRILL INTO A DRILL PRESS

The sketch shows a simple attachment for a hand drill, which will enable the tool to be used as a drill press. This attachment has proved very handy for small model work.

To describe the attachment: The drill is one of the \$1.50 sort, and the chuck takes drills up to 3/16 in. The parts required are a piece of bright steel 1 in. in diameter, 20 in. long, threaded 1 in. for about 4 1/2 in. up; a cast-

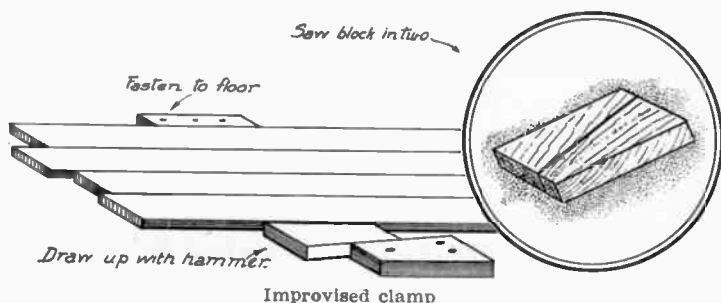

Improvised clamp

a table, broad shelf or bench without the aid of carpenter's

iron table (half plan in Fig. 2) to form the base, feed-screw,

arm for same, and bracket to which the drill is bolted.

The table is of cast iron, with a spigot, as shown in Fig. 1, for the reception of the drill post. The back part of the table has three  $\frac{1}{4}$  in. holes drilled for bolts to fasten the machine to the bench. A washer is fitted on the under side of the bench to take all three holes.

The washer is made of  $\frac{1}{8}$  in. plate,  $1\frac{1}{2}$  in. wide by  $3\frac{1}{2}$  in. long. The table is, of course, symmetrical and the drawing only shows it in half plan.

The bracket which takes the drill next claims our attention. This is made of flat steel bar, and forged to shape shown, care being taken that a good inner

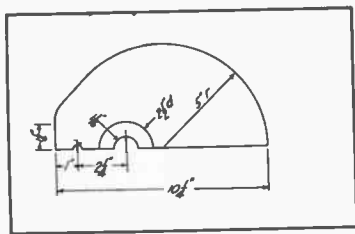

Fig. 2. Half plan of table

radius be left on the corners, as, if brought up too square, there is every possibility of a fracture occurring. The  $1\frac{1}{4}$  in. holes are drilled exactly opposite each other, and each hole is slightly countersunk. The next thing is to obtain a piece of tube about 3 in. long, 1 in. bore. In the

writer's case it was taken from an old metal shop for a modest sum. The tube was about  $\frac{3}{32}$  in. thick. It had to be cut to suit length. After annealing well, by leaving it in the fire all night, it should be fitted in place, as shown, and the ends belled out, to fill up the countersinks with the ball of a small hammer. This will have the effect of thoroughly fixing the tube, and at the same time strengthening the bracket. The tube might also be expanded by a suitable sized draft pin (oiled first), but this is not absolutely necessary. With regard to fixing the drill to the bracket: If the drill be examined, there will be found to be a steadying handle screwed into the drill frame casting, and a little further up ( $1\frac{1}{4}$  in.) a  $\frac{1}{4}$  in. stud also screwed into the casting. Both should be removed, and the lower hole taking the handle should be tapped up  $\frac{3}{8}$  in., while the upper hole should be tapped up  $\frac{1}{4}$  in. Suitable steel studs should be fitted. The bracket may now be drilled to accommodate these studs, the holes being put in line midway between the width of the bracket and allowing sufficient clearance on the inside, so that the nuts may be turned around. A washer will be required for the  $\frac{1}{4}$  in. stud, to go between the casting and the bracket.



The top arm is forged from a piece of mild steel. The plan is not shown in the sketch, but the part sliding up and down the post is circular, 2 in. in diameter,

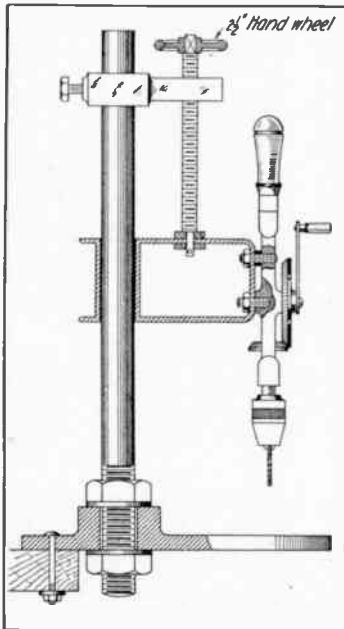

Fig. 1. Improved drill press

running off rectangular,  $\frac{3}{4}$  in. deep by 1 in. wide. The hole for the feed screw is drilled  $2\frac{3}{8}$  in. from the center of the post. This hole should be drilled first, and the arm dropped down on top of the bracket, and the hole marked off for the end of the feed screw to fit in. This is, of

course, also midway between the width of the bracket.

The feed screw is a piece of  $\frac{1}{2}$  in. mild steel, squared on one end for a small hand wheel, and turned down  $\frac{3}{8}$  in. on the bottom to fit the hole in the bracket. It might be made much shorter than the sketch shows,—say about 3 in. long.

Washers are placed on top and underneath where the screw fits into the bracket, and the whole held in place by a  $\frac{1}{8}$  in. split pin. When using the drill the arm should be placed as near the bracket as possible. The method of fixing the post to the table will be easily understood by the sketch.

#### KINKS FOR THE HANDY-MAN

To prevent the water in an automobile radiator from freezing in cold weather, mix with the water an equal quantity of denatured alcohol. As the liquid evaporates, replace with a constantly greater proportion of the spirit as the latter evaporates much more quickly than the water.

When doing machine work on aluminum, the operations will be materially assisted if the worker will lubricate freely with kerosene. This will prevent the annoying bites that are inevitable otherwise.

Editorial Rooms

## Everyday Mechanics

MAGAZINE

*'It Tells You How to Make and How to Do Things'*

Aeolian Hall, New York

November Sixth

1 9 1 5

Dear Reader:-

This letter is an encroachment upon the space that belongs to you-- space that at snap judgment you may feel should be devoted to another article. Let not your decision be hasty, however, until you have read this, the Editor's message, to you.

There is a clearly defined idea in back of EVERYDAY MECHANICS. This idea, which represents the policy of the magazine, is not one conceived over night. It is the ultimate result of a period of experimentation, study and analysis dating back to the time when the first "how-to-make and how-to-do" magazine entered the publishing field. It is the pet hobby of a man who was first a reader, then an experimenter, next a designer and manufacturer, and finally a writer. In other words, the Editor of EVERYDAY MECHANICS is one of you. He is just an everyday young man who has

grown up with the vast army of experimenters to whom the world of science and invention owes so much. He wants you to feel that this is your magazine to do with as you will. His office is merely to take your ideas, combine them with the ideas of others like you, and send them broadcast in the form of a bright, useful, and inexpensive magazine that you may slip in your pocket.

In a nutshell, the policy of EVERYDAY MECHANICS will be to tell to thousands how an individual performed a certain useful piece of work. No effort will be made to shorten articles to the point where they lose their true value just for the sake of having them short. At the same time the text will contain nothing flowery or irrelevant. The plan will be to tell the story in a sufficient number of words to make it complete and understandable.

Each number will contain several feature articles on how to make or how to do something and each article will be thorough and complete in itself. If the subject requires a series of articles owing to its importance, each article of that series will constitute a complete chapter and will tell all there is to be told of that particular phase of the subject. This will mean that the reader need not wait for subsequent instalments before proceeding with his work.

The Department of Technical Advice will aid you in the solution of diffi-

cult problems; if the question is one that cannot be answered by the Engineering Staff, it will be published in order that some reader may voice his opinion in the event that he has solved a similar problem. Other departments will be added from time to time as the demand appears.

In closing, let us be frank. EVERYDAY MECHANICS is a new magazine in its entirety. It has no antecedents. It is not the consolidation of anything and it is standing on its own legs without depending upon the glories of the past. It is offered to you at a price that takes it out of the class of luxuries. It is built for you to do with as you will and upon your interest depends its success or failure. If it suits you and appears to be what you have been waiting for, boost it! If it does not come up to these expectations, tell your Editor wherein the fault may be. Do your little bit to make EVERYDAY MECHANICS the magazine you have wanted for so long and see how quickly you will have the reciprocation of

*Thomas Stanley Curtis*

Your Editor.

## ODDS AND ENDS FOR THE RADIO AMATEUR

## SIMPLE DETECTOR DESIGNS

Here are suggestions for two detectors that may be assembled in a space of a few minutes from material that is to be found in the scrap box of nearly every amateur. They are both of the so-called "cat whisker" type which has met with popular favor in the past year or two.

Fig. 1 shows a design in which many adjustment features are incorporated. This detector is made from a con-

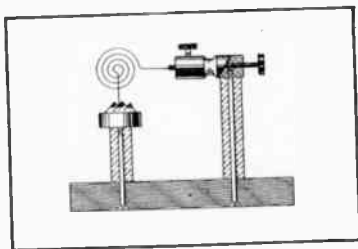

Fig. 1. Cat whisker detector

ventional mineral cup mounted upon a brass post; a cat whisker contact made from the hair spring of a clock mounted in the end of a rod that slides in one of the standard connectors familiar to every worker; and the whole mounted upon a suitable base of insulating material. The method of mounting the connector to permit of adjustments is shown in Fig. 1.

The second design, Fig. 2,

shows a cat whisker of coiled wire soldered to the end of a spring brass strip which is

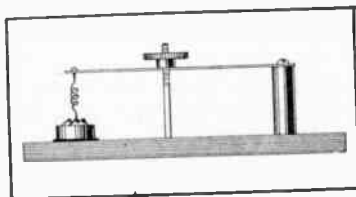
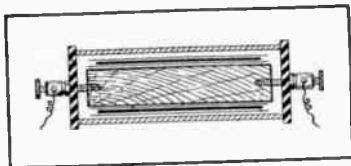

Fig. 2. An alternative design

supported on a suitable post. The knurled knob permits the tension of the whisker on the crystal to be varied through wide limits. It is obvious that the tip of the whisker may be placed at any point of vantage on the surface of the crystal.

## CYLINDRICAL FIXED CONDENSER

The worker who has attempted to build a fixed condenser of the conventional sort mounted in a brass cylinder has no doubt experienced difficulty



Fixed condenser

in securing the ends to the cylinder. The stunt of passing a rod through has been done many times, but perhaps the

simplest and best way to accomplish the trick is to use the form of binding post fitted with a wood screw instead of the usual machine screw. The condenser may then be wound in a roll on a wooden cylinder or core, the connecting wire brought through a hole in each head of the cylinder and the screw of the binding post set up, thereby securing heads and making connection at the same time.

the coins should be faced off by rubbing them over first a moderately coarse and then a fine file. This may be done better by rubbing the metal over the file than the reverse. The gap is

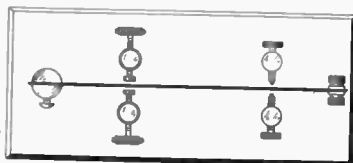

Side acting key

#### QUENCHED GAP FOR SPARK COILS

A device that may be dignified with the title of quenched gap is shown in the illustration. It consists merely of a pile of copper cents separated with the mica insulating washers to be found in an incandescent lamp socket; or for that matter, the

obviously of no use for anything heavier than a small spark coil, but with one of the latter giving a short, thick spark, and having a rapid vibrator, the little gap will work very efficiently.

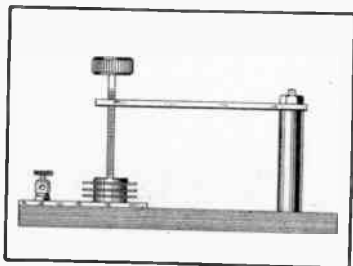

Quenched gap

builder may use paper washers. The pile of gaps is clamped as shown in the illustration.

The surface of each electrode should be perfectly smooth and

#### SIDE ACTING KEY

Mount a slender bar of springy brass in a post on a base of insulating material; place a dry battery knurl on either side at the end with a threaded rod between; an adjustable stop on either side of the bar in back of the knurls, and a contact post on either side near the supporting post, and you have this simple side-acting key. The drawing is intended merely to convey the suggestion and proportions, details of contacts, etc., are left to the ingenuity of the builder.

## AN INTERRUPTER SUGGESTION

The hammer-blow interrupter has been known for years and it is surprising that so few of the present-day experimenters favor it. The results produced through the use of this quick-

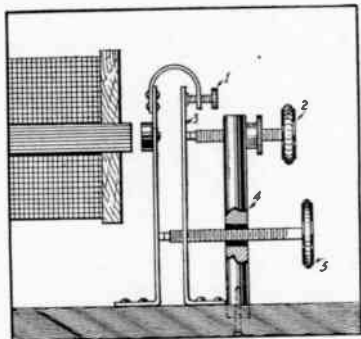

Hammer-blow interrupter

break, long-make device are so superior to those shown when the usual single spring vibrator is employed that a design for the hammer-blow break is given despite the fact that it may be termed a "chestnut" by many of the readers long in the game. The electrically active parts of this vibrator are the spring 3 and the post 4 through contact 2. The remainder of the parts, including the contact 5, are purely mechanical in their relation to the device. The screw 1 is so adjusted that the spring carrying the armature will travel a little distance before the contact 1 strikes the spring

3. This will separate the contacts 3 and 2 with a sharp blow.

The contact piece 5 is merely for the purpose of adjusting the tension of the spring 1. The stiffness of the various springs is an important factor and experiment is necessary. The post 5 is insulated from the post 4 and it passes through 3 without touching.

## SIMPLE TUNING COIL SLIDER

Here is a slider that consists of but two pieces. The insulating knob may be of hard rubber, fibre, or wood and it is prepared by cutting a channel to form a good sliding fit over the square rod of the tuning coil. The spring contactor is a piece of springy copper, brass or phosphor bronze sheet cut to

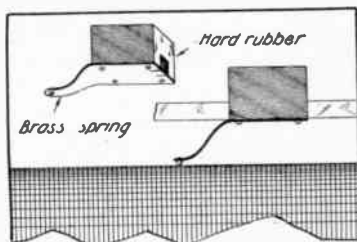

Tuning coil slider

the shape shown in the illustration and secured to the knob with small screws or escutcheon pins. The contact is made by denting the tip of the spring with a center punch.

## THE CARE OF WIRELESS DETECTORS

WHY THEY DETERIORATE AND HOW TO PREVENT THIS DETERIORATION

---

Editor's Note: In casting about for material for an article on the care of crystal detectors, this excellent paper by Mr. Ernest C. Crocker was found in a copy of *Electrician & Mechanic*. It covers the subject so lucidly and thoroughly that a reprint is believed to be justified.

---

IT is common experience among wireless workers that, with but few exceptions all wireless detectors of the rectifying type become less and less sensitive with time even though they are only occasionally used. This deterioration means continual adjustment of the detector until its entire acting surface becomes "dead" and must be renewed. In practice, there are two general types of rectifying detectors in use—the electrolytic detectors and the so-called crystal detectors. We shall consider the causes of deterioration of each type separately.

The essential active part of an electrolytic detector is a small surface of platinum in contact with an acid. The arrangement of the platinum surface makes possible two styles of detector, one in which the platinum in the form of a wire, is adjustable vertically and just dips into the liquid, and the other in which

the platinum wire is sealed into a glass tube, the end of which is ground off so as to allow only the end of the wire to be exposed.

If we have an electrolytic detector "tuned" in circuit for a strong nearby station and view the detector in the dark, we can read the station's message at times by means of the little flashes of light which occur at the fine point. The effect is more powerful than one might believe, and it is often possible to see light at the point of a delicate detector when the sending station is only of 2 K.W. power, and is five miles away, and even though one uses only a small antenna.

Where there is light there is usually heat, and when we consider the powerful action which takes place at the tiny point, we can scarcely wonder that the point is often ruined. If a glass tube is used, the heat cracks the glass, and in almost every case melts the platinum



into a ball or even volatilizes it entirely. Apart from this violent destruction of the detector, there is a slow loss of sensitiveness which is chemical in nature and is usually due to impurities in the liquid which dissolve away the platinum. Although considered acidproof, platinum is slowly dissolved by hydrochloric (muriatic) acid, particularly if the acid is strong, or contains nitric acid or iron. Nitric or sulphuric acids alone, when pure, scarcely attack platinum.

What has been said in regard to heating in the case of the electrolytic detector also applies to the crystal detectors, although these will usually withstand rougher treatment than will an electrolytic detector. The chemical action, however, is more noticeable, even though the air is the only source of the disturbing chemicals.

In a crystal detector we have a point sometimes made of metal, sometimes of a mineral like chalcopyrite or bornite (essentially sulphides of copper and iron), and sometimes of an artificial compound such as iron monosulphide, which is in contact with a "sensitive" surface. The most prominent sensitive materials are: silicon (an element, Si), galena (lead sulphide, PbS), iron pyrites (iron disulphide, FeS<sub>2</sub>), carborundum

(silicon carbide, SiC), or zincite (zinc oxide, essentially ZnO). Of these latter materials, silicon and carborundum are artificially prepared and are fairly uniform in sensitiveness throughout a given piece. This, however, is not the case with the natural minerals, the sensitiveness of which depends largely on the particular way in which they were originally formed. In the case of the minerals, pyrites and galena, one may find it necessary to examine tons of material to obtain even a pound of active substance, so unusual is the active form of these substances. Not only is this sensitive material hard to find, but it is also rather easily impaired by the chemical action of certain components of the air.

The atmosphere is composed principally of nitrogen, oxygen, carbon dioxide and water vapor, and ordinarily we consider it as having no other components. None of the above substances, except water vapor, has perceptible action upon detector materials, but some of the minor constituents of the atmosphere, such as ozone, hydrogen peroxide and nitric acid vapor, exert a powerful destructive action. At a wireless station ozone is produced in considerable quantities, and much detector deterioration is

due directly to this cause. Although the amount of these substances in the air is very small, they work continuously, so that in time they have a decided action.

The action of ozone or hydrogen peroxide upon galena is to transform the conducting sensitive surface of lead sulphide (PbS) into non-conducting lead sulphate (PbSO<sub>4</sub>), thus producing a "sulphating" comparable with that of a storage battery. The action upon silicon (Si) is not so noticeable, however, but this substance is oxidized to silicon dioxide (SiO<sub>2</sub>), which has the same composition and about the same conductivity as common sand. Zincite is already a mixture of oxides which cannot be further oxidized, but it is nevertheless quite sensitive to water vapor and dust. Dust almost always conveys some soluble materials, which, when they come in contact with the water which is held in the crevices and on the surface of detector materials, dissolve and make a conducting solution which shunts away the current and tends to make the detector useless.

The detectors which are most sensitive to wireless currents are generally sensitive to chemical changes caused by the air. The simplest way to obtain great sensitiveness with free-

dom from chemical disturbance is to cover the detector with a glass jar or to enclose it in a metal box, preferably the latter, for reasons to be presently explained. Inside the enclosure should be placed a little vial half-filled with either strong sulphuric acid or dry calcium chloride. The calcium chloride is cheap and clean and can even be used on shipboard where sulphuric acid could not be used. Enclosing the detector will do away with dust and harmful gases, and the drying agent will reduce the amount of moisture in the air in the box.

Very little can be done to prevent a distant station from "breaking down" a detector, except to use a detector which will withstand the strain. It is the action of one's own sending station which must be guarded against. The best way of eliminating this trouble is to surround the detector entirely with metal, even though it be no thicker than tin-foil, and to "break" the detector circuit at the surface of the metal box, or just within it. This breaking is best performed with an electromagnet so arranged that only after it has disconnected the detector will it be possible to turn on the sending current.

One source of detector trouble that is often overlooked is vibration. Every detector should

rest on an under-base of felt or some such elastic material. Moreover, the spring which makes the tension between the elements should be fairly long and flexible and the proper tension secured by much tightening upon the adjusting screw, and not by a short or stiff spring which is lightly adjusted.

In summing up, it must be said that the only way to have really satisfactory receiving is to choose a detector which is moderately free from

electrical weaknesses and to enclose it in a metal box for its protection from the sending station's current on the one hand and from atmospheric corrosion on the other. This latter precaution is almost imperative in damp or dusty places. If the detector is properly protected from vibration, as well as from electrical and chemical troubles, it will scarcely ever need readjusting, so that the disadvantages of having it "boxed in" are more than repaid by its good behavior.

## A MODEL ELECTRIC LAUNCH WITH PAPER HULL

A very ingenious method for building the hulls of model boats is suggested by Charles W. Faucherre in *The Model Engineer*. The article describes the

Faucherre's description is given in his own sentences in order that the reader may profit by the suggestion.

The dimensions of the model

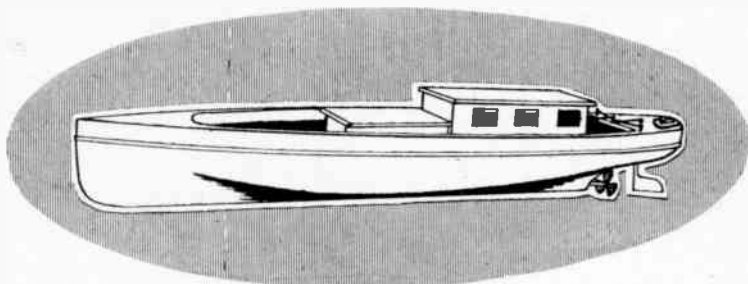

The launch complete

building of but one model, but the principle may be applied in countless instances, and Mr.

are as follows: Length,  $33\frac{1}{2}$  in.; breadth,  $6\frac{1}{2}$  in.; depth (deck to bottom of keel),  $4\frac{1}{4}$  in.

*Construction.*—First obtain a piece of wood for a working baseboard, this to be longer and wider than the intended size of boat; draw a center line *A*, lengthwise, marking off 30 in.; divide this measured line into twelve equal parts *B*, marking these off at right angles to *A*.

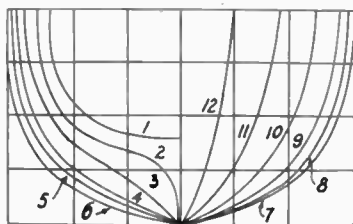

Fig. 4. Form for ribs

Cut out twelve ribs  $\frac{1}{4}$  in. thick, using Fig. 4 as a guide, and making a slot  $\frac{1}{4}$  in. wide and  $\frac{1}{2}$  in. deep (as shown) in each rib for keel to fit into. Glue all the ribs on the baseboard, one on each crossline *B* (see Figs. 2 and 3), also putting solid stem and stern into place, screwing them from under side of base. The keel, preferably of oak,  $\frac{5}{8}$  in. deep by  $\frac{1}{4}$  in. thick and  $28\frac{1}{2}$  in. long (Fig. 3), is then dropped into position in slots of ribs, not glued. Cut several strips of thin cardboard,  $\frac{1}{4}$  in. wide by 36 in. long, and pin to edges of ribs from stem to stern, bringing the edges flush. Next cut several strips of thick brown paper about  $2\frac{1}{2}$  in. wide by 11

in. long, and glue between each row of pins round hull, from base over keel to base. Do this between each row of pins, and when dry remove pins. Then glue strips of paper the whole length of boat—three coats of paper should be sufficient, allowing the hull about two days to dry after each coat is applied. The hull can then be removed by unscrewing temporary screws which hold solid stern and stem to base, and slipping a knife between hull and base. Take two pieces of wood *DD*  $\frac{3}{16}$  in. thick by 31 in. long, 1 in. deep in front with gradual sheer, and fit these inside the hull round the edge, and let them into solid stem and stern, screwing between them two or three pieces of wood, the tops of which are curved to give the necessary slope from center of vessel to sides of same, the sheer being assisted by *DD*. The sides of the hull, which up till now are straight, should be trimmed to sheer of *DD*. Now for the deck. This should be of one piece of teak about 34 in. by 7 in. by  $\frac{3}{16}$  in. in the rough. Before shaping out deck, scratch or mark off imitation plank lines. Cut out spaces for access to motor and accumulator, according to requirements, and after shaping and filing edges smooth the deck is ready to screw on. The bulwarks should be of two

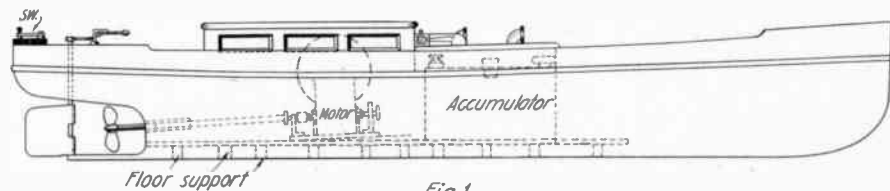

Fig. 1

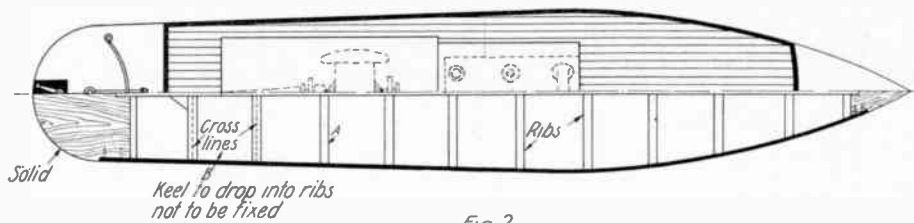

Fig. 2

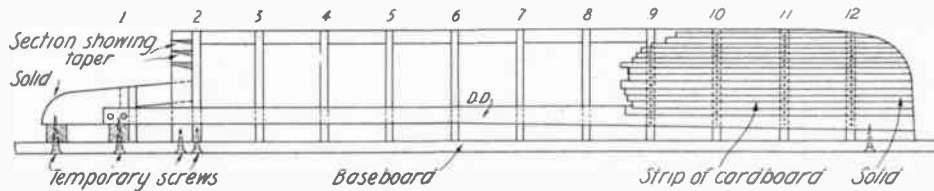

Fig. 3

strips 35 in. by  $\frac{3}{4}$  in. by  $\frac{3}{16}$  in. spliced at stern of boat and let into solid stem at front of boat. The last thing is painting the hull, and making it watertight. Boil some pitch and tar until it reaches a suitable stage and can be easily applied to the hull. Coat the hull thinly inside and out; screw on deck, filling any cracks between deck and hull with putty. Next smooth outside with glass paper, apply two

coats of paint, smoothing down after each; then put on the finishing coat. The deck and fittings can be greatly improved in appearance if coated with a thin coat of good varnish.

I know from experience that a model built on these lines will give great satisfaction, and have a smart appearance as well as being financially well within the pocket of most potential builders.

## HOW TO MAKE A SLED WITH DOUBLE RUNNER

Coasting provides a very exhilarating sport in the winter season when the country is covered with snow. Providing one possesses the sled, the sport may be indulged in on any hill, slop-

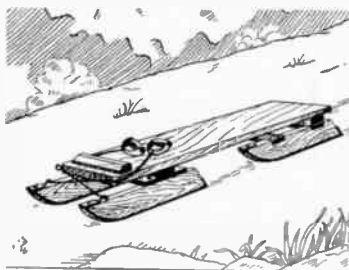

The sled completed

ing field, or country road. An ordinary sled consists of a flat platform mounted upon fixed runners, the steering being accomplished by means of the feet,

but a steerable sled is much to be preferred. A sled of the steerable type is shown in the sketch; although it is rather more difficult to make, it is preferable to all other kinds, and is large enough to carry several passengers. It consists of a platform about 6 ft. long by 1 ft. 6 in. wide, which is mounted upon four runners. The runners are fixed in pairs, those at the back being hinged in position, while the front pair are pivoted, the steering being accomplished by means of a pair of crossed wires and handles, which are fixed to the front ends of the runners. Figs. 1 and 2 show side elevation and plan in detail respectively. In making the sled it is recommended that a hard wood, such as ash, oak or birch, be used if possible.

## THE PLATFORM

The platform, *A*, will be the first consideration. A plan of the platform is given at Fig. 4. It is 1 in. or 1½ in. thick, and

rails are prepared and screwed to the bottom of the platform in the positions indicated at Fig. 4. A hole ¾ in. in diameter is then bored exactly in the middle of

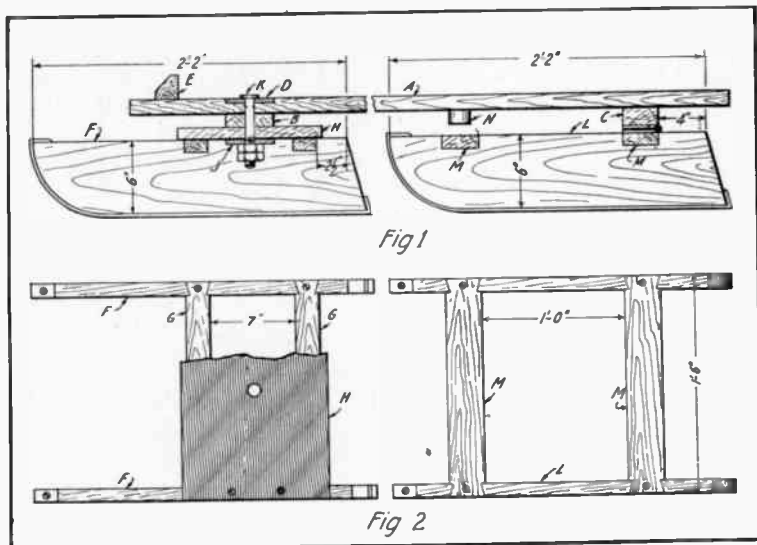

Details of construction

should be cut to the dimensions given. If one piece of board of sufficient width cannot be obtained, two or even three pieces could be jointed together to make up the width required, the joints being either grooved and tongued, or doweled and glued together.

The front cross-piece *B* is 1 ft. 6 in. long by 4 in. wide by 1 in. thick; and the back cross-piece *C* is 1 ft. 6 in. long by 3 in. wide by 1½ in. thick. These

the cross-piece *B*, and is continued through the platform, and an iron plate *D*, similar to that shown at Fig. 5, is let into the platform exactly above the hole. The plate should be 6 in. long by 4 in. wide by ¼ in. thick. A ¾ in. square hole is provided exactly in the center of the plate, and it is fixed in position with four screws. The platform is then completed by preparing and fixing a foot rail *E*, Fig. 1, which is 1 ft. 6 in. long by 2 in.

wide by 2 in. deep, and is fixed 2 in. back from the front edge of the platform with screws, which are driven from underneath.

#### THE FRONT RUNNERS

The front runners *F* have an over-all length of 2 ft. 4 in., and are 6 in. deep by 1½ in. thick. The back ends of the runners are cut away to a bevel of 2 in., and the front ends are shaped as shown. The runners are connected by two cross rails *G*, Fig. 2, which are 2 in. wide by 1 in. thick. The rails are dovetailed into the top edges of the runners in the positions shown at Fig. 2, and are fixed with screws. The bearing board *H*, which is fixed above the cross-rails *G*, is 1 ft. 6 in. long by 1 ft. wide by 1 in. thick, and it is fixed in position with screws which are driven into the top edges of the runners, and with others which are driven through the cross rails. A ¾ in. hole is then bored through the bearing-board *H*, exactly in the center, and an iron plate similar to the plate *D*, which has already been fixed to the top of the platform, but with a ¾ in. round hole in the center, is fixed to the underneath side of the board, exactly underneath the hole.

The runners are connected and pivoted to the platform by means of the bolt *K*, an enlarged view of which is given. The bolt

is ¾ in. in diameter; it has a large flat head, and the portion immediately underneath the head is square in section. The end of the bolt is screwed and fitted with a hexagon nut. A lock nut prevents the hexagon nut from working loose.

#### THE BACK RUNNERS

The back runners *L* are similar in shape and dimensions to the front runners, and they are connected by two cross-rails *M*, which are 1 ft. 6 in. long by 3 in. wide by 1 in. thick. The cross-rails are dovetailed into the top edges of the runners in the positions shown at Fig. 2, and are fixed with screws. The runners are hinged to the platform by means of a pair of hinges. Ordinary 3 in. butt hinges will be most suitable, and they are fixed to the back cross-piece *C*, and the back cross-rail *M* with screws. A rubber stop *N*, which should be 1½ in. in diameter by 1½ in. thick, should be fixed to the underneath side of the platform, directly above the front cross-rail *M*, to take any undue strain off the hinges. A short chain should also be provided between the platform and runners, as shown at Fig. 3, the chain being fixed with small iron staples. It would also be found desirable to protect the bottom edges of the runners with iron plates, or shoes, which should be of half-round



iron, carried around the edges of the runners, as shown in the illustrations, and fixed in position with screws.

#### FINISHING THE SLED

The last consideration, as far as the construction is concerned,

in the stays to which the ends of the wires are fixed.

When complete the sled should be given a coat or two of paint, to act as a preservative, and it may be given a name which could be painted on.

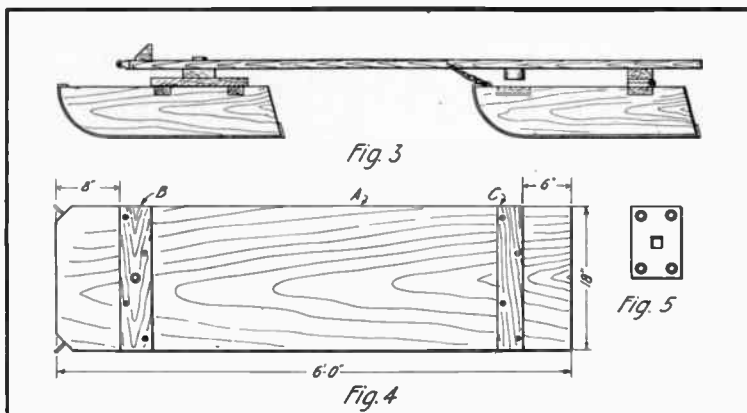

Elevation and plan views

is the steering gear. This consists of two pieces of stout wire, which are fixed by means of iron staples to the front ends of the front runners. The front corners of the platform are cut to an angle as shown, and a stout screw-eye is inserted at each corner. The wires are threaded cross-ways through the screw-eyes, and handles are fitted at the ends of the wires. Suitable handles may consist of a wood handle piece about 4 in. long by 1 in. in diameter, which is fixed by means of a long rivet to a shaped stay. Holes are provided

#### HANDY KINKS

A handy funnel for pouring liquid into a bottle may be quickly made anywhere by taking a piece of thick, smooth white paper, rolling it into a cornucopia and fastening it with a pin. Cut the pointed end off and it is ready for use.

A gas leak may be temporarily checked by the application of common brown soap to the leaking joint. If the cock in the gas burner turns hard, remove the stem, wipe clean and apply just a little soap to the tapering surface.

## HOW TO MAKE A FOLDING KITCHEN TABLE

HERE'S A HANDY ACCESSORY IN THE HOUSE WHERE SPACE IS LIMITED

**T**HE flap-table, shown complete in Fig. 5, is easy to make, and as the flap folds down, it would be most suitable for fixing in a house where space is limited. Although intended for the kitchen, the table would be suitable for fixing in any other place in the house where it would prove useful. Deal will be the most suitable

wood to use in making the table, and as only simple mortise and tenon joints are used to frame the parts together, the work should come within the scope of the average amateur woodworker. The table is made in four parts, consisting of a back frame, the table top and two brackets. The back frame is first prepared and fixed to the

wall, the table top is hinged to the top rail of this frame, and the brackets, which support the top, are hinged to the side rails of the frame. Fig. 1 shows a half elevation of the table; Fig. 2, an end view; Fig. 4, details of the brackets; and in these illustrations the dimensions for a table of useful size are given. In making the table a start is made upon the back frame, details of which are shown in Fig. 1. The frame consists of a top rail A, and two side rails B. The top rail is 3 ft. long by 2 in. deep and  $\frac{3}{4}$  in. thick, and the side rails should be about 2 ft. 1 in. long, by  $1\frac{1}{2}$  in. wide by  $\frac{3}{4}$  in. thick. The side rails are framed into the top rail with mortise and tenon joints, and the width over the side rails is indicated at Fig. 1. The framework should then be cleaned off, the top edge of the top rail slightly chamfered, and the joints secured with glue and wooden pins. The framework must then be fixed to the wall. First arrange it at the correct height, and cut the bottom ends of the side rails so that they will rest upon the top edge of the skirting, and slightly chamfer the ends as shown. Nails should be used to fix the frame-

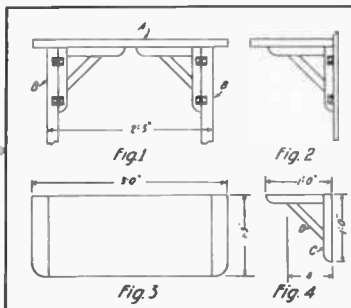

Details of table

wood to use in making the table, and as only simple mortise and tenon joints are used to frame the parts together, the work should come within the scope of the average amateur woodworker. The table is made in four parts, consisting of a back frame, the table top and two brackets. The back frame is first prepared and fixed to the

work, and they may be driven in between the mortar joints in the brickwork, or should it be thought necessary wood plugs may be inserted in the wall to receive the nails.

The next operation will be to make up two brackets similar to that shown at Fig. 4. Each bracket consists of an upright *C*, top rail, and a support *D*, each of which is  $1\frac{1}{2}$  in. wide by  $\frac{3}{4}$  in. thick in section. The top rails are framed into the uprights, and the supports are framed into both the top rails and uprights, mortise and tenon joints being used. Glue should be used to secure the joints, and the ends of the brackets are rounded as shown at Fig. 4. The brackets are then hinged to the side rails of the back frame in the manner shown at Fig. 2. Four  $1\frac{1}{2}$  in. butt hinges are used, and the brackets are hinged to fold underneath the top rail of the back frame as shown in Fig. 1.

The final consideration is the table top which is shown at Fig. 3, and it consists of a center portion and two battens, the battens being framed to the ends of the center portion to keep it from twisting or splitting. The center portion measures 2 ft. 11 in. long, by 1 ft. 3 in. wide by  $\frac{3}{4}$  in. thick. It may be made up from two widths of wood if one piece of

sufficient width cannot be obtained, but the joint should be well made, it being tongued together and fixed with glue. The battens will be 1 ft. 3 in. long by 2 in. wide by  $\frac{3}{4}$  in. thick.

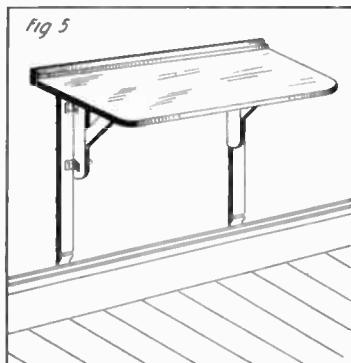

The finished table

Tenons, which are  $1\frac{1}{2}$  in. long, are formed at the ends of the center portion and corresponding mortises are cut in the battens. The battens are then fitted to the ends of the center portion, and if the joints are good they may be finally glued together. When the glue is dry the top is planed and sanded, and the outer corners are rounded as shown in Fig. 3. The top is then hinged to the top rail of the back frame with a pair of 2 in. butt hinges, and care must be taken to see that it rests upon the top edges of the brackets. To finish the table the

back frame, brackets and the underneath side of the top should be stained and varnished

or painted, but the top of the table should be left in the natural state of the wood.

## HOW TO BUILD A MODEL BIPLANE

WHEREIN THE CONSTRUCTION OF A SMALL MACHINE OF BAMBOO IS DESCRIBED

The little biplane described in this article is the result of some eighteen months' experimenting on the part of the builder, Mr. H. H. Groves, who is well known in model aeronautical circles in England. The model described has made a record flight of 330 yd. and its average straight flight has been in the neighborhood of 200 yd. Since the article was written, the model has been equipped with wheels, and has repeatedly flown 190 yd. from the ground, rising by its own power. The construction of such a machine is well within the capabilities of the average amateur mechanic who is interested in building models wherein close attention to small details is essential.

For the sake of clearness, the various stages in the construction have been grouped under appropriate headings, and the first feature to have the attention of the reader is

### THE FRAMEWORK

This is almost entirely made of split bamboo, the long mem-

bers being  $\frac{1}{8}$  in. square. It will be seen in the plan and side elevation, Figs. 2 and 3, that the framework is rather different from that usually seen in model biplane construction, but it is admirably adapted for bamboo. It will also be seen at Fig. 9 that the joints are made in a somewhat novel manner, by splitting the main members and fitting the pieces in, the joints being glued up and bound round with jute. This method of making a joint has a very neat appearance, as shown at Fig. 10, and it is very strong, and no doubt the best way of joining up bamboo.

The bracing is done by fine plated piano wire, but instead of using ordinary wire strainers, Mr. Groves uses steel wire just strong and stiff enough to hold the stay-wires, as shown at Fig. 10. A turn of the curved wire, with a pair of round nose pliers, is enough to pull the wire up quite tight, and it answers every purpose of wire-strainers at a great saving of weight.

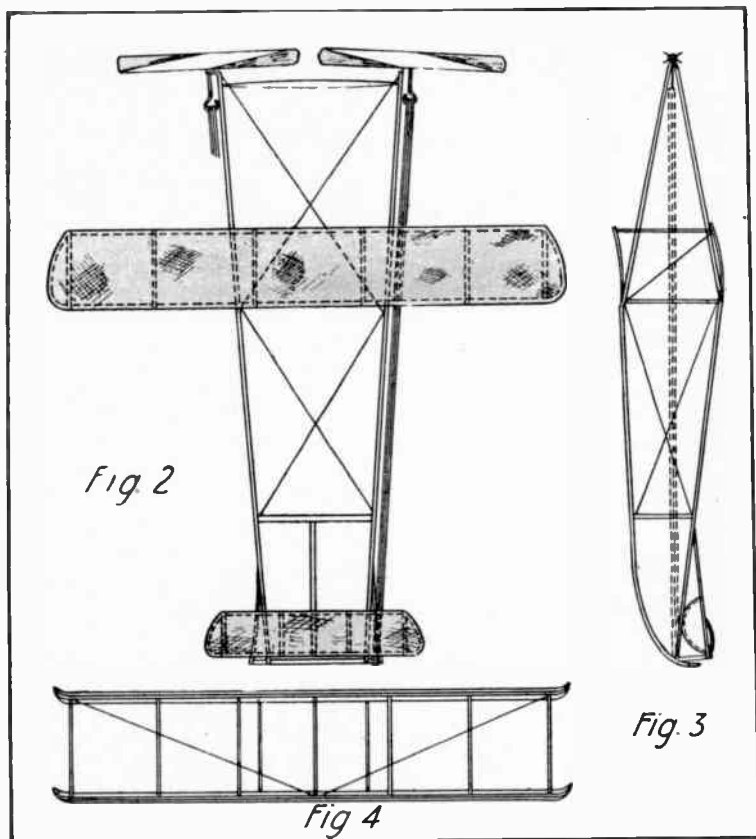

The prize-winning biplane completed

#### THE MAIN PLANES

The main planes, 2 in. x 3 in., are made in the manner shown at Fig. 13, but a stronger method used for larger machines is shown at Fig. 12; here the ribs are let into the main spars as shown at Fig.

14. The tips are upturned slightly, and the framework is covered with ordinary silk, glued and stretched on, and proofed with celluloid varnish, made by dissolving celluloid in amyl acetate.

The planes are  $3\frac{1}{2}$  in. apart,

and joined by means of round uprights of bamboo. The top plane is screwed to the framework through the front spar, and is held quite rigid. Bracing wires are attached to the top ends, and are carried to the middle of the bottom plane in front only. Mr. Groves originally braced the main planes to a decided dihedral angle, but abandoned it for upturned tips, which have proved highly satisfactory.

#### THE ELEVATING PLANE

The elevating plane,  $8\frac{3}{4}$  in. x  $1\frac{3}{4}$  in., is built up similarly to the main planes, to the shape shown in the plan, Fig. 2. There are four ribs, a very slight camber and upturned tips, as in the main planes. The elevator is manipulated by means of a lever; it is attached by one screw to the rod, which carries the rudder shown in plan and at Fig. 7, and at the end of the rod a screw, as shown in section at Fig. 15, is fitted. By turning the screw the angle of incidence may be easily adjusted. It will be seen at Fig. 5, a front elevation of the end only, that the elevating plane is attached to the framework by a bracket; this is screwed to the spar; it is easily adjustable, and may be turned to any angle that may prove necessary (in practice).

#### THE RUDDER

The rudder, 2 sq. in. in area, shown in position in the side elevation, and in detail at Fig. 7, is not adjustable, and really acts in maintaining a straight flight. It is made of piano wire, attached to a wooden spar, and is covered with proofed fabric.

#### THE PROPELLERS

The model is now fitted with two built-up wooden propellers of 8 in. diameter and a pitch of  $1\frac{1}{2}$  times the diameter.

They are not truly helical but the blades are set back  $\frac{1}{8}$  in. at the hub on the entering edge, as shown at Fig. 16. A shows the entering wedges. Bent wood propellers of the same diameter and pitch, and the shape given at Fig. 17 were originally fitted. These were made of tulip wood veneer, sandpapered smooth, cut to shape, and varnished with shellac. They were afterwards held over a frame until pliable, bent to shape and clamped in a frame and held under the faucet. This method proved very satisfactory, but as increased efficiency may be had in a built-up propeller, the latter is now in use.

#### MOTIVE POWER

Twelve strands of  $\frac{1}{8}$  in. square rubber are used for each

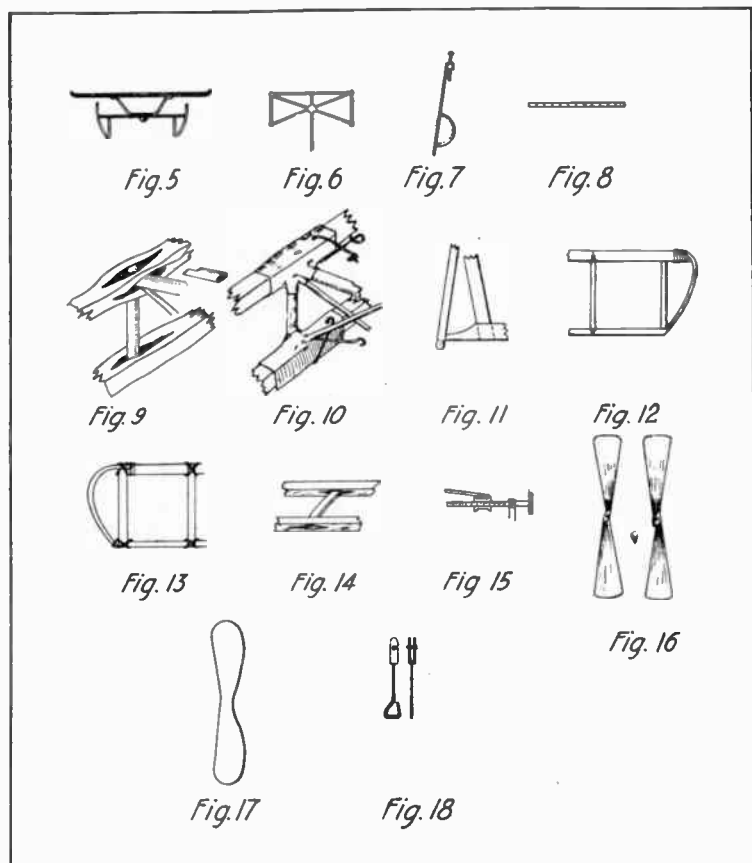

Details of the biplane

propeller and with a soft-soap lubricant, a total of 500 turns is available. The rubber is placed around the projection shown at Fig. 11 and fitted over a propeller shaft with triangular end.

An early issue of *Everday Mechanics* will contain directions for building a glider capable of carrying a man. The glider is comparatively simple and inexpensive to construct and in use it is perfectly safe as it travels but a few feet above the ground.

## LETTERS FROM OUR READERS

Las Vegas, N. Mex., Oct. 29, 1915.  
Editor Everyday Mechanics,  
New York City.

Dear Sir:—

A sad experience of many years has shown me that many magazines, not only in your proposed line, but in several others, have made a "spurt" at the beginning, and sustained it for several issues. As every spurt demands extraordinary exertion (which cannot in the order of nature be kept up forever), the inevitable took place with *every one of them*: bye and bye the energy collapsed; and after running a short time in the full mettle of their promised "never-ending vim," they became commonplace and—died away. One after another I have dropped all such subscriptions. Will this sad experience be repeated in the present case?

You see, I am plain, and you have yourself to blame for it:—"I want to impose upon your time to the extent of asking you for an expression of opinion upon the plan outlined in the enclosed circular." I have carefully read the circular; and the plan it suggests (with a trifle to be mentioned immediately) looks splendid; but, will all and every issue keep up to the mark? There is the RUB!

My suggestion is embodied in your Section, PRACTICAL MECHANICS, which I hope will be conducted in the spirit in which it is announced. How often it happens that in the home, in the office, in the workroom, etc., you are suddenly called upon to switch in some imp of your wit to make a thing go that has stopped all of a sudden! Are you to call a professional every time? And, meanwhile? So then, let this Section BE what it claims to be, Viz: *Practical*; but let it be done in short, clear, concise, *practical* directions; not in long articles.

May I further suggest how this can be attained? Engage in your interest one or two skilful, thorough-practical "trouble-men," who, by their resourcefulness are worth their weight in gold; and let them hand you every day or week (first preferable), a list of their odd jobs performed during the day on sudden calls; and the way they went about it. You will thus have a *spread* out of whose endlessness

you can select the most practical and common ones; and see if people won't run mad to subscribe to your magazine! A word to the wise is enough.

There goes my Subscription with a hearty GOD SPEED!

Yours very truly,  
(Signed) Rev. R. M. D'Orsi, S.J.  
Editor, *Revista Catolica*.

This is one of the most constructive letters we have had the pleasure of reading in our entire editorial experience. The Rev. Father D'Orsi's suggestion has already been acted upon.  
Editor.

Brooklyn, N. Y., Nov. 10, 1915.  
Editor Everyday Mechanics,  
New York City.

Dear Sir:—

In answer to your circular letter, will say that I am acquainted with you through your books and other literature.

You ask me to spend a few moments of my time and express an opinion of your plan, although, being a man past middle age, have still considerable of the boy left in me so far as mechanics is concerned. What appeals most strongly to me, is your comment "the Magazine will be a Magazine of hobbies," and I do not think it will be possible for it to be dry reading. Your idea of a magazine appeals to me so strongly that I herewith enclose \$1.00 for two years' subscription.

Hoping to receive the same promptly on issue, I remain,

Yours very truly,  
(Signed) Thos. W. White.

What better incentive to do our utmost could we ask? Mr. White's faith is so great that he subscribes for two years without first having seen a copy of the magazine.

Editor.

Buffalo, N. Y., Oct. 29, 1915.  
Editor Everyday Mechanics,  
New York City.

Dear Sir:—

A mighty good thing. Go to it. Here's my fifty cents.

Yours very truly,  
(Signed) Edwin S. Miller.



Derby Line, Vt., Nov. 10, 1915.  
Editor Everyday Mechanics,  
New York City.

Dear Sir:—

Your circular letter re EVERYDAY MECHANICS duly received.

While we feel that our present list of periodicals is as large as the Library can afford, we feel that such a movement as you have started ought to have the hearty support of all who are interested in seeing helpful literature placed in the hands of boys and young men who have a natural thirst for information along mechanical lines. Hence we are enclosing our subscription for one year.

We sincerely hope that you may receive such hearty support that EVERYDAY MECHANICS may become a permanent addition to our best periodicals, and that the circulation may warrant a continued price of fifty cents, so that boys and young men with limited funds may have the information which will develop them into men that really amount to something.

Wishing you the highest success,  
I am,

Sincerely yours,  
(Signed) O. M. Carpenter,  
Librarian, The Haskell  
Free Library, Inc.

Warren, N. H., Oct. 29, 1915.  
Editor Everyday Mechanics,  
New York City.

Dear Sir:—

If you can put out a magazine which will live up to your description, at the price you ask, you should be able to place it in every home where there is a boy old enough to read, as they all want to know how to build and do just the things you have outlined as the scheme and plan of your new publication. Wishing you all success, I remain,

Yours respectfully,  
(Signed) Edgar S. Carbee.

New York City, Oct. 27, 1915.  
Editor Everyday Mechanics,  
New York City.

Dear Sir:—

In this morning's mail I received one of the circulars announcing the forthcoming appearance of EVERYDAY MECHANICS, and I wish to take this opportunity of extending to you my heartiest wishes of success as well as my assurances of

being ready to help you at any time you may desire to call upon me for aid.

I have read over your circular with great interest and am convinced that you have the foundation of a successful publication. You know how I have always advocated a how-to-make-it magazine, and it is therefore hardly necessary for me to tell you that I endorse the policy of the new magazine and believe that it will meet with a big reception at the hands of the tens of thousands of amateur mechanics throughout the country, with whom we both were in so close a contact during the past two years.

Enclosed herewith you will find my check amounting to 50 cents, for which please enter my subscription for one year to EVERYDAY MECHANICS.

Again wishing you the greatest of success, believe me,

Fraternally,  
(Signed) Austin C. Lescarboursa,  
Editorial Department,  
*Scientific American.*

Martinsburg, W. Va., Nov. 1, 1915.  
Editor Everyday Mechanics,  
New York City.

Dear Sir:—

Enclosed please find fifty cents for a year's subscription to your new paper. I hope it fills a long felt want among the amateurs.

Could I get a copy of the article on the small wireless telephone set before the paper comes out? I would like to see it now.

With best wishes for your success, I am,

Yours very truly,  
(Signed) Walter W. Trout.

Lincoln, N. H., Oct. 29, 1915.  
Editor Everyday Mechanics,  
New York City.

Dear Sir:—

Just received your printed matter on the new magazine, so am enclosing P. O. order for fifty cents for a year's subscription.

If the magazine is as good as most of the articles you have written, then I'm sure it will be a great success. Would like to see a lot of wireless articles.

Will wait patiently for the first copy, and until then I am,

Yours very truly,  
(Signed) H. L. Dearborn.

---

# THE TECHNICAL ADVISER

---

The object of this department is to answer the questions of readers who may experience difficulty in the construction or use of apparatus described in the magazine. The columns are free to all readers whether they are subscribers or not, and questions pertaining to matters electrical or mechanical will be answered in the order in which they are received. If the reader cannot wait for an answer to be published he may secure an immediate answer by mail at a cost of 25 cents for each question.

In order to insure prompt attention, readers should adhere closely to the following rules which have been formulated with a view to expediting the handling of the mass of correspondence. Questions should be written on one side of the paper, enclosed in an envelope addressed to The Technical Adviser, care of Everyday Mechanics, Aeolian Hall, New York City. The letter should state plainly whether answer is to be published or sent by mail; in the latter case the fee of 25 cents per question should be enclosed in coin, one-cent stamps, check or money order. The envelope enclosing questions should not contain matter intended for any other department of the magazine.

---

1. High Frequency Coil. E. P. A., Denver, Col., writes: Have read the various articles by Mr. Curtis on high frequency apparatus in the semi-technical press for many years, and the only type of coil I have not seen described in his works is one which has recently been given me to repair. The outfit is contained in a small, square wooden case weighing about ten pounds, and it is supposed to give a spark 2 in. long on either direct or alternating current circuits. The coil has a vibrator but no spark gap. I took the open core coil apart and found it contained only a primary; that is the coil was in one winding. Can you tell me the principle upon which this apparatus operates? Can such an outfit be made to deliver a large spark, thereby making it possible to use a direct current without a rotary converter? Ans.—you have in your possession a coil working on the “kick

back” principle. Such an outfit has no transformer or induction coil in the ordinary sense of the word and it is the “kick” or high electromotive force induced in the primary winding at break of circuit that is used to charge the condenser; when this charge reaches the necessary value, the condenser discharges across the gap between contacts of the interrupter. Connected in series with the condenser is the primary of an oscillation transformer. The secondary of this transformer is composed of several hundred turns of fine wire. As the condenser discharges through the primary, a very high voltage is induced in the secondary winding. This induced current is an oscillatory one, of course, and its characteristics are very similar to those exhibited by the usual Tesla coil excited by a transformer, spark gap and condenser combination. (2) The apparatus is limited in size by

the inability of the interrupter to successfully make and break a heavy current at high voltage. Some medical outfits have been constructed on this principle to give a 6-in. spark of very fair quality, but the interrupters give trouble, and the only advantage the method can lay claim to is offset by its unreliability. A design for a fairly large outfit will shortly be presented in our columns, and you are advised to wait for this article or to purchase a copy of "High Frequency Apparatus," by Mr. Curtis. The book department can supply you at \$2. In this book the subject of kicking coil apparatus is treated very thoroughly.

## 2. Transformer Information.

G. I. G., Howell, Mich., writes: I have had occasion several times to build small transformers for experimental purposes and, while I find it is comparatively easy to get workable coils from purely experimental designs, still I have always to guess at the number of turns of wire to use in the primary and the size of the core. I know the relation between primary and secondary, and can determine my voltage quite exactly, but I have difficulty in guessing at the amount of wire to wind on the primary to keep the transformer from drawing too much current on open circuit. Is there any simple method by means of which this data may be found? I am not very far advanced in mathematics, and the appearance of a formula is disconcerting to me; can I not obtain a table of cross sections or weights of core with the number of turns required for each size? Is this information given

in any book you know of? Ans. —Your query is a common one; in the past two years, the writer has answered it not less than a hundred times. As a matter of fact it was just this form of inquiry that prompted the writing of a chapter in the little book entitled "The Construction of Induction Coils and Transformers" by the editor of this magazine. While the data you require is not given in the form of a table (a very happy suggestion on your part), there is a chapter on transformer design that is intended to give readers like yourself just the information they need to enable them to figure proportions for themselves. The calculation involves nothing more alarming than simple arithmetic, and it has been used by hundreds of experimenters with great success. Our book department can supply you with a copy of the book at 25 cents.

## 3. Correspondence Schools.

W. R. C., Tampa, Fla., writes: My boy is deeply interested in electricity and mechanics, and I have long cherished an ambition to send him to one of the great technical schools in the North. Of late he has been reading the literature from the various correspondence schools, and I am put to it to decide whether or not to let him take up one of the courses by mail or to send him away. Naturally, we should prefer to keep the boy at home with us, but feel that the parental inclinations should not stand in the way of a career. Can you offer me a few words of advice? My boy has read your articles and I myself, having always been of an experimental turn, have followed with

more than a little interest your several contributions on "Electricity in Home and Office." Ans.—Advice is both cheap and dangerous. Furthermore it is seldom followed. But in a case like this, the advice may be put in the form of an opinion based on personal experience. The remarks which follow should be taken strictly in the latter sense. The writer has found the correspondence schools of immense benefit to not one but a great number of his acquaintances; incidentally, he may add that one school has proved to be of real value in his own case. The courses are thorough and understandable; the instruction, in most cases, strictly up to date. So much for the school. So far as it is concerned, a correspondence school education is as good within its limits as any other form. But whether or not the individual student gets all that he may out of it is up to him; the instruction is there, and it is absolutely the best that can be procured in many cases, but whether or not the student is willing to do his part in the process of transferring that knowledge from the printed sheet to his own brain and this in a useful and applicable form is another story. Here is where the college or resident school comes into its own; with an instructor in back of him and the knowledge that he must work in order to graduate or even to escape the disgrace of a "flunk," the most indolent worker will make a spurt around "exams." Now, summing up the point the writer has brought out, it may be deduced that in his personal opinion, the correspondence

school student stands practically as good a chance as the resident student so far as pure theory is concerned if he is an industrious worker; this statement is borne out by the fact that the most successful correspondence school men are those who are employed and who take up the course solely because they want to improve their knowledge and training. Assuming that the boy in question is seriously inclined and will work hard, the only other great advantage offered by the resident school is the use of a well-equipped laboratory in which he can see his theories worked out in practice. Possibly some plant or manufactory in his own town offers the same facilities.

4. Rotary Quenched Gap. H. H., Atlanta, Ga., writes: Can you tell me the principle upon which the rotary gap, quenched spark radio transmitter operates? Is the construction of such apparatus within the reach of the well-equipped amateur? Ans. (1) This gap comprises a rotating copper disc, across the face of which slots have been milled radially, and, facing this rotor, a pair of semi-circular electrodes having also radial slots corresponding to those in the rotor. The spark takes place across a gap a few thousandths of an inch in length, this gap representing the separation between rotary and stationary electrodes. (2) Yes, in the event that he is supplied with the necessary diagrams, and is possessed of a high degree of mechanical skill. An article on a simplified form of this gap will appear in an early issue.

# **Build Your Own Transformer**

## **CONSTRUCTION of INDUCTION COILS and TRANSFORMERS**

**By Thomas Stanley Curtis**

**Price, 25 Cents**

**The New Revised Third Edition  
Will Show You How to**

*Design and build a magnetic leakage transformer for radio telegraphy or other high frequency work.*

*Calculate the number of turns required for the primary and secondary of a transformer of any kind to operate at a given voltage.*

*Construct an induction coil to give a heavy one-inch spark with only a pound of wire in its secondary.*

Contains information hitherto unpublished in book form, written in plain English for the practical worker. Chapters on the construction of transformers of various types, such as high tension, low voltage for experimental work, open and closed core, magnetic leakage, etc. A chapter on high frequency apparatus, and another on experiments with the high frequency current. Designs for interrupters, condensers, spark gaps, etc.

Unique among the many features of the book is a chapter which tells the amateur how to design his own transformer; how to figure the number of turns required for a core of any size; how to determine the quantities of materials needed; and all this may be done by a simple application of arithmetic.

**If you are an experimenter, this book will give you the transformer information you need in a lucid and convenient form; send for it.**

**TECHNICAL PRESS ASSOCIATION**

33 West 42nd Street, New York City

*The*  
**WIRELESS OPERATOR'S  
POCKET-BOOK**

OF  
Information *and* Diagrams

By  
LEON W. BISHOP

**150 Illustrations of Apparatus and Circuits.  
200 Pages. Price: Leather, \$1.50; Cloth, \$1.00**



Thoroughly describes all of the latest transmitting and receiving instruments, giving the place and theory of each.

A full chapter of diagrams, showing the most approved circuits for all sizes of sets, both in transmitting and receiving.

Includes in convenient form, all the tables necessary for the wireless operator. Among others, a table showing how to compute roughly the sending and receiving distances for all types of instruments, with all types of aerials.

Insulation and protection of the station from lightning. The Fire Underwriters' rules are also covered.

The different codes now in use are shown, together with the latest call book of American Stations.

**TECHNICAL PRESS ASSOCIATION**  
33 West 42nd Street, New York City

# The Model T Ford Car

## Its Construction, Operation and Repair

By VICTOR W. PAGÉ

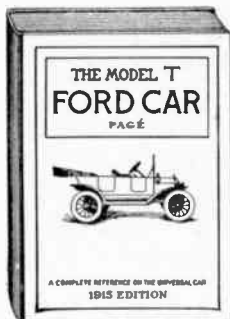

Member of the Society of Automobile Engineers.

Author of "The Modern Gasoline Automobile," etc.

300 (5 x 7) Pages. Over 100 Specially Made Engravings and Two Large Folding Plates

Price \$1.00

This is the MOST COMPLETE and PRACTICAL instruction book every published on the FORD CAR. A high grade cloth bound book printed on the best paper, illustrated by specially made drawings and photographs. All parts of the Ford Model T Car are described and illustrated, in a comprehensive manner—nothing is left for the reader to guess at. The construction is fully treated and OPERATING PRINCIPLES MADE CLEAR TO EVERYONE. Complete instructions for *driving* and *repairing* are given. Every detail is treated in a non-technical yet thorough manner.

This book is written specially for FORD DRIVERS AND OWNERS, by a recognized automobile engineering authority and an expert on the FORD, who has driven and repaired Ford Cars for a number of years. He writes for the average man in a practical way from actual knowledge. All parts of the Ford Model T Car are described. ALL REPAIR PROCESSES ILLUSTRATED AND FULLY EXPLAINED.

**Written so all can understand—No theory  
No guess work**

**AUTHORITATIVE, UNBIASED, INSTRUCTIVE, COMPLETE**

Send Your Order Today to

**TECHNICAL PRESS ASSOCIATION**

33 West 42nd Street, New York City

# HANDY ELECTRICAL DICTIONARY

By Wm. L. Weber, M.E.



Let this handy  
little book  
answer your  
questions

Price  
Cloth 25c.  
Leather 50c.

Contains upward of 4,800 words, terms and phrases employed in the electrical profession, with their definitions given in the most concise, lucid and comprehensive manner.

All the scientific principles which constitute the foundation of electrical engineering are contained in the definitions given in this work, and while necessarily appearing in a concise or abstract form, they are stated in terms so simple and with such freedom from ambiguity, that the reader of average intelligence and limited education cannot fail to comprehend their full meaning.

At the close of the book are given illustrations of the various kinds of circuits used in wiring, also diagrams showing the connections of the series dynamo, the shunt dynamo, and the compound-wound dynamo.

Send your order today and keep a copy in your vest pocket.

**TECHNICAL PRESS  
ASSOCIATION**

33 W. 42nd St., New York

# Storage Battery Engineering

By LAMAR LYNDON

Third Edition, rewritten  
and reset, 601 Pages, 6x9,  
208 Illustrations  
Price \$4.00

It has been not only the standard treatise but the guide and leader in many particulars, of the industry.

The new edition emphasizes the principles. It brings practice to date, cutting out the obsolete and adding the new.

**CONTENTS.—PART I.**—Electrolytic Dissociation and the Voltaic Couple. Description and Characteristics of the Lead Cell. Chemical Theory of the Lead Cell. Thermodynamic Theory of the Lead Cell. The Quantity and Distribution of Active Material. The Electrolyte. Electromotive Force and its Variation. Capacity. Internal Resistance. Intermittent Discharge. The Influence of Temperature. Efficiency. Types of Plated Plates. Methods of Plating Formation. Pasted Electrodes. Separators and Envelopes. Containing Cells. Testing. Assembling and Installing. Durability and Causes of Deterioration. Diseases and Their Remedies. Care and Management.

**PART II.**—Uses of Batteries. Pilot Cell Accessories. End Cells. Control by Counter Cells and Resistances. End Cell Switches. End Cell Conductors. Boosters. Manually Controlled Boosters. Self-Excited, Automatic Boosters. Separately Excited Boosters. Current Supply for Booster Motors. Compounding Booster-Controlled Power Plants. Adjusters of General Output. Rheostats. Computation of Battery Capacity. Direct Current Systems. Line Batteries. Plant Efficiency. Exciter Battery. Installations. Alternating-Current Systems. Current Converter Systems.

*The most complete and authoritative work on the subject ever placed in the hands of the engineer*

**TECHNICAL PRESS  
ASSOCIATION**

33 W. 42nd St., New York



*The Recognized Authority on Wiring and Construction*

# Standard Wiring for Electric Light and Power

As adopted by the Fire Underwriters of the United States

The only book on Wiring and Construction kept strictly up-to-date.

### **What the Edition Contains :**

The latest rulings of The National Board of Fire Underwriters, explained and illustrated with line cuts and half-tones of the most modern and approved methods.

Directions for installing and operating Dynamos, Motors, Arc Lamps, Switchboards, etc.

Full details on outside wiring and construction for both telephone and power lines.

The simplest and most approved methods of inside wiring for light, heat and power, with examples worked out for both direct and alternating current for all systems—especially prepared for "Standard Wiring" by the greatest electrical engineering company in the world.

The latest data on Carbon, Gem, Tantalum, Tungsten and Mazda incandescent lamps.

All the necessary tables for every requirement of the Constructing Engineer, Contractor, Central Station and Wireman.

The Standard Symbols for wiring plans.

A special chapter on the treatment of electrical injuries, by Chas. A. Lauffer, M.D., of the Westinghouse Co.

Definitions of electrical units.

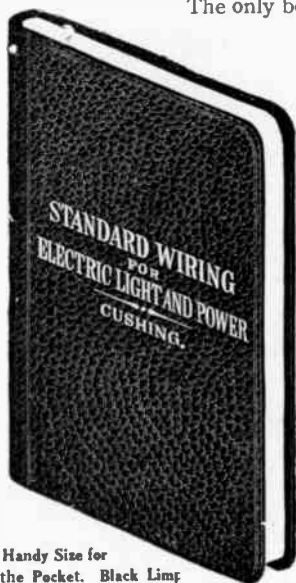

Handy Size for  
the Pocket. Black Limp  
Leather Gold Embossed

**Price \$1.00 Postpaid**

**TECHNICAL PRESS ASSOCIATION**

33 West 42nd Street, New York City

# STORAGE BATTERIES

## THEIR THEORY, CONSTRUCTION AND USE

By A. E. WATSON, PH.D., E.E.

Revised Edition

Price, Cloth, Postpaid, \$1.50

A new edition of a book that has proved its value to students and electricians. Contains complete, brief descriptions of all essentials in design, manufacture, installation and use of storage batteries. Diagrams explaining each step are very clear, and the rules for setting up are explicit enough to enable anyone to make and install a working battery of their own. New chapters have been added, dealing with the very latest developments in storage-battery construction, making the book up-to-date in every respect.

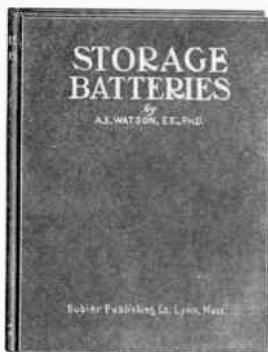

The author writes from practical experience extending over many years, and only those matters have been emphasized which are of permanent value. To record only the essentials, and leave out the accidentals is a requirement hard to comply with, but we believe this result has been attained in an unusual way in this book. The author is Professor of Electrical Engineering in Brown University, and has made a popular reputation for clearness in his many electrical books written in plain English for non-technical men.

*Send Your Order to*

**TECHNICAL PRESS ASSOCIATION**

33 West 42nd Street, New York City

10,000 FORMULAS, PROCESSES,  
PRACTICAL RECIPES AND TRADE SECRETS

IN THE

## 20th Century Book

of  
**Recipes, Formulas,  
and Processes.**



Edited by **Gardner D. Hiscox, M.E.**

800 pages, 6 x 9½

Handsome Cloth Binding, Price, \$3.00  
Half Morocco Binding, - Price, \$4.00

This new book of processes and formulas is the latest and greatest compilation of the kind ever published. It is a standard work—an authority—a “first aid”—and a “court of last resort” on “What to Make and How to Make It.”

### PARTIAL CONTENTS

Bleaching Recipes—Etching and Engraving Recipes—Recipes for Glass Making—Paper Making Recipes—Recipes for Ointments—Mirror-Making Formulas—Paint Making Formulas—Gilding Recipes—Galvanizing Recipes—Bronzing Recipes—Tinning Recipes—Silvering Recipes—Recipes for Adhesives—Recipes for Plating and Enameling—Cleaning Processes—Soap Making—Leather and Its Preparation—Recipes for Alloys—Recipes for Solders—Photographic Formulas—Shoe Dressing Recipes—Stove Blacking Recipes—Rust Preventive Recipes—Recipes for Lubricants—Recipes for Oils—Recipes for Dyes, Colors, and Pigments—Recipes for Dryers—Ink Recipes—Recipes for Artificial Gem Making—Jewelers' and Watchmakers' Recipes—Household Formulas—Waterproofing Recipes—Fireproofing Recipes—Recipes for Cements, Glues, Mucilages—Fireworks Recipes—Recipes for Eradicators—Alcohol and Its Uses—Recipes for Essences and Extracts—Dentifrice Recipes—Cosmetic Recipes—Perfume Recipes—Tanning Recipes—Metallurgical Formulas—Hair Restorers—Depilatories.

**And many thousands more—Equally important in the Arts and Manufactures**

Send Your Order Today to

**TECHNICAL PRESS ASSOCIATION**

33 West 42nd Street, New York City

## *Electric Light for Country Houses*

The convenience and safety of electricity both as an illuminant and as a domestic labor-saver appeal as strongly to the isolated farmer or country resident as to the city dweller. Heretofore there has always been the obstacle of remoteness from an electric power line; this has now been overcome by the advent of inexpensive and easily installed private electric plants.

## **ELECTRIC LIGHT' for the FARM**

By N. H. SCHNEIDER

Contains practical information on small low voltage electric plants operated by storage batteries and gasoline engines, giving full details for wiring a house according to the Underwriters' Rules, tells you just how to start about the wiring, what wire to use, how to estimate the materials required and complete the installation. Tables and rules are given for estimating the number and size of lights required and the outfit necessary to supply the current.

No technical knowledge is necessary to install or operate these outfits except what may be learned from this book.

**172 Pages**

**PRICE \$1.00 POSTPAID**

**66 Illustrations**

Send your order today to

### **TECHNICAL PRESS ASSOCIATION**

33 West 42nd Street, New York City

## **HOUSE WIRING**

By THOMAS W. POPPE

ELECTRICAL ENGINEER AND CONTRACTOR

Absolutely new and up to the minute, describing and illustrating all up-to-date methods of installing Electric Light Wiring according to the latest rulings of the National Board of Fire Underwriters. All systems of wiring are covered, including the three-wire system now so much in use. Practical diagrams and illustrations are given to show just how the work is done.

### **IT SOLVES ALL PROBLEMS**

**FOR THE PRACTICAL WIREMAN OR AMATEUR**

and in fact contains all the essential information for the successful wiring of a building.

Among the subjects covered are—Planning and laying out the work—Locating the Meter—Meter Connections—Feed Wires—Switches—Plug Receptacles—Brackets—Ceiling Fixtures—Flexible Conduit System—Rigid Conduit System—Steel Armored Cable System—Knob and Tube System—Various Switching arrangements explained and diagrammed—The easiest method of testing Three and Four-way circuits explained and illustrated—Current carrying capacity of Wires—Etc.

**103 Pages, 74 Illus.**

**Flexible Cloth Cover, Pocket Size**

**PRICE, 50 CENTS POSTPAID**

### **TECHNICAL PRESS ASSOCIATION**

33 West 42nd Street, New York City

## HERE'S THE GREATEST ELECTRICAL BOY'S BOOK EVER WRITTEN

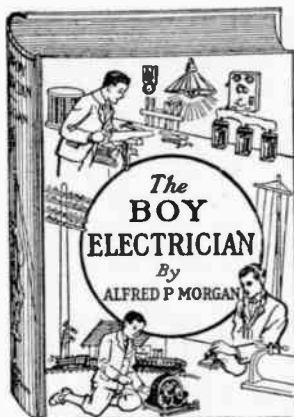

# The Boy Electrician

BY ALFRED P. MORGAN

Tells you how an experimenter built his own motors, dynamos, telegraph instruments, wireless apparatus, etc., and how he performed experiments with the instruments.

It is a story replete with human interest and practical information. Mr. Morgan's style is delightfully personal, and he carries his reader through the various stages in the building of the apparatus with a description that is quite free from the tiresome "how-to-make" style of so many writers.

This truly great work should prove a most welcome and valuable addition to the electrical and mechanical library of every live boy.

*The Price is \$2.00.*

**TECHNICAL PRESS ASSOCIATION**

33 West 42nd Street, New York City

## Electrical Books at Half Price

The entire stock and goodwill of the Bubier Publishing Co., of Lynn, Mass., has been taken over by the Technical Press Association and new editions of all of the famous Trevert, Watson and Bubier books will be prepared at once.

While the present editions last, the readers of Everyday Mechanics will have an unprecedented opportunity to secure a library of well-known electrical books at half of their original cost.

The list of titles follows and orders will be filled from stock on each title as long as the editions last. We reserve the right to cancel orders and refund money as the editions are exhausted. The sale prices positively apply only to present editions of these books; the former list prices will obtain on new editions as they come from the press.

### STORAGE BATTERIES, Their Theory, Construction and Use.

By A. E. Watson, Ph.D., E.E.

A book for the man who wants to make and use storage batteries. The author writes from a practical experience extending over many years. and, in this famous work, he has recorded only the essentials, leaving out the unnecessary.

**Regular Price \$1.50 Sale Price \$0.80**

### HOW TO MAKE A ONE-KILOWATT DYNAMO.

Or One Horse Power Motor. By A. E. Watson, Ph.D., E.E.

This book tells not only how to construct a dynamo suitable for use in small lighting plants but tells in addition just how the machine was designed in order that the builder may learn how to calculate the proportions for machines of larger or smaller size.

**Regular Price \$1.00 Sale Price \$0.60**

### HOW TO MAKE A ONE-FOURTH HORSE POWER DYNAMO.

By A. E. Watson, Ph.D., E.E.

This book tells how to build an excellent little machine for lighting, electro-plating, etc. The data for windings to give various voltages are given in order that the builder may adapt the machine to his individual needs.

**Regular Price \$0.75 Sale Price \$0.40**

---

## TECHNICAL PRESS ASSOCIATION

33 West 42nd Street, New York

---

---

## Electrical Books at Half Price

---

---

### HOW TO BUILD A FIFTY-LIGHT DYNAMO.

By A. E. Watson, Ph.D., E.E.

The name of this book is misleading. The machine is actually of four horse power and with the present-day mazda lamps it will make what might better be called a 150-light machine. The design is excellent and the machine admirably adapted to light a large shop or factory.

**Regular Price \$0.75 Sale Price \$0.40**

### HOW TO BUILD AN ALTERNATING-CURRENT DYNAMO.

By A. E. Watson, Ph.D., E.E.

Here's a machine that will serve as an alternator for a wireless telegraph plant if run by an engine or electric motor. It solves the problem where direct current only is available. The capacity is approximately one kilowatt.

**Regular Price \$0.75 Sale Price \$0.40**

### HOW TO MAKE A ONE-HORSE POWER DYNAMO.

By A. E. Watson, Ph.D., E.E.

The constructional data for a fine machine that may be used for lighting or small power work. A generator easily built by the well-equipped amateur mechanic.

**Regular Price \$0.75 Sale Price \$0.40**

### TREVERT'S NEW EXPERIMENTAL ELECTRICITY.

An excellent little treatise for the beginner. The various applications of the electric current explained from the experimenter's viewpoint.

**Regular Price \$1.00 Sale price \$0.40**

### TREVERT'S HOW TO MAKE ELECTRIC BATTERIES.

This book tells you how to make all manner of batteries for experimental purposes.

**Regular Price \$0.50 Sale Price \$0.25**

### THE X-RAYS SIMPLY EXPLAINED (paper binding).

By Edward Trevert.

**Regular Price \$0.25 Sale Price \$0.15**

---

---

## TECHNICAL PRESS ASSOCIATION

33 West 42nd Street, New York

## Electrical Books at Half Price

### QUESTIONS AND ANSWERS ABOUT ELECTRICITY.

By E. T. Bublter 2nd.

A First Book for Beginners.

**Regular Price \$0.50 Sale Price \$0.25**

### HOW TO MAKE A CONDENSER.

**Regular Price \$0.25 Sale Price \$0.07**

### HOW TO MAKE A TRANSFORMER.

**Regular Price \$0.25 Sale Price \$0.07**

### ARITHMETIC OF MAGNETISM AND ELECTRICITY.

**Regular Price \$1.00 Sale Price \$0.35**

Any of the following 10 cent books at 7 cents each or four for 25 cents while the supply lasts:

- No. 1. How to Make a Dynamo.
- No. 2. How to Make a Telephone.
- No. 3. How to Make an Electric Motor.
- No. 4. How to Make a Storage Battery.
- No. 5. How to Make a Wimshurst Electric Machine.
- No. 6. How to Make a Magneto Machine.
- No. 7. How to Make a Medical Induction Coil.
- No. 8. How to Make a Pocket Accumulator.
- No. 9. How to Make a Plunge Battery.
- No. 10. How to Make a Voltmeter.
- No. 11. How to Make a Galvanometer.
- No. 12. How to Make a Hand Dynamo.
- No. 13. How to Make a Talking Machine.
- No. 14. How to Make a  $\frac{1}{4}$  H. P. Dynamo or Motor.
- No. 15. How to Make a Toy Motor.
- No. 16. How to Make an Electric Bell.
- No. 17. How to Make a Telegraph Instrument.
- No. 18. How to Wind Armatures.
- No. 19. How to Wind Field-Magnets.
- No. 20. How to Make an Ammeter.
- No. 21. How to Make a Thermostat.
- No. 22. Motor Rotation.
- No. 23. How to Make an Electric Soldering Iron.
- No. 24. How to Make a Small Electric Heater.
- No. 25. How to Make an Electric Furnace.

**All Books ILLUSTRATED with Working Drawings**

## TECHNICAL PRESS ASSOCIATION

33 West 42nd Street, New York



---

## Have You an Idea?

---

**I**N the course of your daily work, whether it be in the house, office, store or shop, do you not make use of some simple little "kink" which makes your task simpler or easier?

¶ Everyday Mechanics will pay liberally for ideas—the simpler and more obvious, the better. The Editor will welcome just plain, everyday "stunts" that nearly anyone can use in his daily life.

¶ For instance: Just before this was written, an auditor—a public accountant—was "swapping stories" with the Editor. In the course of the chat, the subject of practical mechanics was brought up. The Editor, with a view to proving that mechanics enters the life of every man, asked his friend how he sharpened his pencils. Bingo!! The auditor admitted that after having cast aside all patented devices, he used an ordinary everyday file! Three or four strokes and the pencil has a strong, clean-cut point. The idea came when the pencil sharpener was out of order and a pen knife could not be found; the old file has been in use in a large office for six months.

¶ See what we are driving at? We want not half a dozen but hundreds of these simple kinks; not articles with literary "talent" tacked to 'em, but plain, everyday "stunts" written to the Editor in the form of a simple letter. You can do it—will you? The other fellows may send in ideas that you can use so do your part.

The Editor

# PRINCIPLES OF WIRELESS TELEGRAPHY

By GEORGE W. PIERCE, A.M., PH.D.

*Assistant Professor of Physics, Harvard University*

350 Pages, 6 x 9      235 Illustrations      Price \$3.00

A sound treatise on theory, application and construction.

Prof. Pierce has taken a leading part in both the practical and theoretical development of wireless. His book is not mathematical. It is a new work that is regarded as the standard authority.

CONTENTS.—I—Introduction. II—Theories as to the Nature of Electricity. III—Relation Between Electricity and Magnetism. IV—Resemblance of Self-Induction to Mechanical Inertia. V—Electrostatic Capacity. VI—Discharge of a Condenser Through an Inductance and Resistance. VII—Maxwell's Theory, Electric Waves. Electromagnetic Theory of Light. VIII—Experiments of Hertz. IX—Experiments on the Identity of Electric Waves and Light. X—Propagation of Electric Waves on Wires. XI—Wireless Telegraphy Before Hertz. XII—Wireless Telegraphy by Hertzian Waves. Marconi, 1896-1898. XIII—Electric Wave Telegraphy by Resonant Circuits. XIV—Nature of the Oscillation. The Grounding of Circuits. XV—Propagation Over the Earth. XVI—Detectors. XVII and XVIII—Crystal Rectifiers. XIX—Electrolytic Detector and Vacuum Detectors. XX—Electrical Resonance. Wave Meters. Resonance in Simple Condenser Circuits. XXI—Electrical Oscillations of Connected Systems of Condenser Circuits. XXII—Tuning the Sending Station. XXIII—Some Recent Methods of Exciting Electric Waves. The Singing Arc, the Singing Spark, and the Quenched Spark. XXIV—Resonance of Receiving Circuits. The Possibility of Preventing Interference. XXV—Directed Wireless Telegraphy. XXVI—Wireless Telephony. XXVII—Some Details of Construction of Wireless Telegraphic Apparatus. XXVIII—Conclusion. APPENDIX I—Elementary Facts About Electricity and Definitions of Units. APPENDIX II—Concerning the Calculation of Resistance, Self-Inductance and Capacity.

---

TECHNICAL PRESS ASSOCIATION

33 West 42nd Street, New York

## The Up-to-Date Electro-Plating Handbook

By JAMES H. WESTON

192 Pages and over 50 Illustrations. With Numerous  
Tables and Useful Formulas. Pocket Size, Cloth.  
Price \$1.00. Full Leather, Price \$1.50

A manual of useful information for platers and others who wish to become acquainted with the practical art of the electro-deposition of metals and their alloys.

Chapters are given on electrical rules and formulas, batteries, electroplating with batteries, electroplating dynamos, electroplater's materials, electro-deposition of metals, cleaning the work, dips and dipping, stripping, electroplating with nickel, silver, gold, copper, zinc, tin, iron, platinum and other metals; also with alloys, electro-mechanical plating and gold galvanizing are thoroughly treated.

Electro-Mechanical plating, cold galvanizing and galvanoplasty are three subjects that are discussed at considerable length in this book. Useful information on burnishing and lacquering is also given. A short section is also devoted to instructions regarding methods of preserving the health of workmen in plating shops, also directions regarding antidotes to poisoning, and methods of treatment to be pursued in such cases.

## TECHNICAL PRESS ASSOCIATION

33 West 42nd Street, New York

## STORAGE BATTERIES Stationary and Portable

By J. T. NIBLETT, M.I.E.E.

100 Pages, 37 Illustrations, Pocket Size, Full Silk Cloth Binding,  
Round Corners, Red Edges. Price 50 Cents

Containing a clear exposition of the principles governing the action of Storage Batteries; detailed instructions regarding their construction, care and maintenance.

The first part of the book is devoted to "Stationary Cells," or cells commonly used for storing electrical energy in central supply stations for railway work and for ordinary electric lighting.

The second part contains full descriptions of "Semi-portable" and "Portable Cells" or those used for propelling electric launches, motor cars and similar electrically driven vehicles; also still smaller types of cells now commonly used for actuating induction coils, for X-ray and wireless telegraphic or telephone work; and also for driving very small motors and electric hand lamps. Classification of batteries, and correct methods for capacity rating are also clearly discussed. Full instructions given regarding the testing of Storage Batteries, also their charging, and recharging. Description and illustrations of standard batteries follow.

## TECHNICAL PRESS ASSOCIATION

33 West 42nd Street, New York

# *Announcing*

## A NEW POLICY IN THE SALE OF PRACTICAL BOOKS

---

**W**HEN you buy an electrical or a mechanical book through the mail, do you always get just the treatment of the subject that you desire?

When you order a selection of books on Dynamos, with a view to obtaining practical working drawings and constructional data so that you may build the machines, do you find that among the lot you have several that are of no practical value to you, perhaps because they are too "deep" or they cover the subject from the standpoint of an engineer, while you are an amateur or an experimenter?

The Technical Press Association is an organization formed for the sole purpose of aiding the practical or the technical man in the selection of the precise books he needs for a certain course of study.

The Association has at its command the services of a staff of men whose business it is to read and study electrical, mechanical, chemical and general scientific literature as fast as it is published. Each work is given a certain classification which indicates just how the subject matter is treated.

The Library of the Association and its stock for sale will comprise nearly every practical book of recognized merit that is on the market in the English language. Old editions will be put in their proper place and books that are out of date will not be recommended except in cases where they particularly apply.

Readers are invited to take advantage of this service, which is quite free of charge, and in corresponding with the Association, they are earnestly requested to adhere closely to the following rules, which have been formulated to expedite the service.

The reader should write on one side of the sheet only, taking care to sign his name and address very clearly at the bottom. It is well to print out the address and name to insure prompt attention.

The class of treatment the reader desires should be stated after the subject has been mentioned. For instance, suppose the subject to be wireless. The letter might be as follows:

"I want to build my own wireless apparatus; my means are limited, as is also my shop equipment. I should want to make simple receiving instruments and transmitters using spark coils. I have had very little experience with tools and understand only the elementary principles of wireless."

The Association would recommend "Wireless Telegraph Construction for Amateurs," by Morgan, at \$1.50, as it tells the reader not only how to build both simple and practical apparatus, but it gives him a thorough grounding in principles and operation, and tells him how to comply with the law and get his license.

If the reader were an engineer who wanted a comprehensive technical work, a totally different book would be recommended. The title is not always a guide, and, indeed, some titles are deplorably misleading.

This is just an example. If you have had difficulty, write us concisely but fully; your inquiry will have prompt attention and your orders for books will be filled from stock, in most cases on the day the order is received.

---

---

TECHNICAL PRESS ASSOCIATION  
33 West 42nd Street, New York

# ELEMENTARY ELECTRICITY UP TO DATE

By SIDNEY AYLMER SMALL, M.A.I.E.E.

12mo, Cloth, 500 Pages, 206 Illustrations.

Price \$1.25

Beginning in the form of a simple catechism on the primary characteristics of Electricity, this book conducts the student, by easy stages, through the subject of Static Electricity, describes and illustrates the various types of machines for producing it, and explains their action in language that is plain, and easy of comprehension. Quite a large space is devoted to this important topic, although no more than is actually necessary, as the subject of condensers and the principles governing their action is also clearly explained and illustrated. Atmospheric Electricity and lightning arresters in their relation to power stations, sub-stations and line wires are treated upon at length, and explained by numerous illustrations. Magnetism, and

the law of magnetic circuits are explained and made clear by simple formulæ. Storage Batteries, flow of current, both A. C. and D. C., electrical work, power and efficiency; also the action of rotary converters and transformers, all clearly explained.

The subject of primary batteries, the principles controlling their action, their construction and care, all these are treated upon at length, being clearly explained and illustrated. Likewise, storage batteries receive a large share of attention, including methods of constructing them, and also of charging. The various troubles encountered in battery work are enumerated, and remedies prescribed therefor. Electro-magnetic fields and the meaning of lines of force are clearly explained. Circuits and the flow of currents are treated upon at length, and in a manner at once plain and practical. The laws of resistance and electro-magnetic induction are explained in familiar and easily understood language.

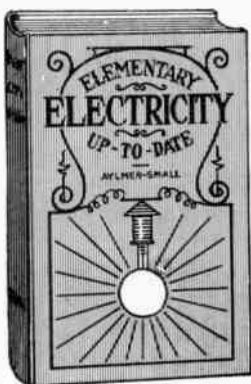

TECHNICAL PRESS ASSOCIATION

33 West 42nd St., New York

# PRACTICAL ARMATURE AND MAGNET WINDING

By

HENRY C. HORSTMANN and VICTOR H. TOUSLEY

**16mo, Pocket Size, Full Persian Morocco Leather,  
Round Corners, Red Edges. Price \$1.50**

---

While the subject of armature winding has, in the past, been more or less completely covered, most of these works have been either too technical in their composition or have required a fair degree of knowledge of the subject before they could be clearly understood.

This book treats in a practical and concise manner this very important subject.

All practical armature windings are fully explained with special attention paid to details. All questions which are apt to arise in the minds of the electrician have been completely answered.

Numerous illustrations have been supplied, and these, taken in conjunction with the text, afford a ready means for either the study of the armature or for a book of reference. Various useful tables have been especially prepared for the work and these will not only reduce to a minimum the number of calculations required, but lessen the possibility of errors.

The chapter on the calculating of armatures gives complete information in detail for the design of an armature.

A large section of the book is devoted to a discussion of magnetism and magnet winding. Rules and formulæ are given for guidance in the calculation of electro-magnets, and explicit instructions regarding methods to be pursued in winding the various types of magnets. The construction of the choke coil is also clearly explained. The book is a most valuable aid to the electrician, either in the constructing or operating department.

---

TECHNICAL PRESS ASSOCIATION

33 West 42nd Street, New York City

# ELEMENTARY CHEMISTRY SELF-TAUGHT

By H. E. ROSCOE and L. ELLIOTT BROOKES

Revised and enlarged, 280 pages, 50 illustrations, 12mo, cloth. Stamped in gold and inks.

**Price, \$1.00**

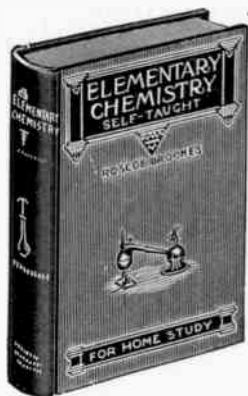

This book presents the most important facts and principles of chemistry in a plain and intelligent manner, as suited to the requirements of students and others who may wish to acquire a knowledge of elementary chemistry. It contains full and explicit information on the following subjects: The Atomic Theory, Chemical Combination, Combining Volumes of Gases, Determination of Molecular

Weights of Gases, Flame and Combustion of Hydrocarbons, Liquids, Matter, Properties of Gases, Properties of Solutions, Volume of Gases, The Elements. In the present wholly revised edition several changes of importance have been made, especially as regards the arrangement of the organic portion of the work, which will simplify the study of this branch of the science. In addition to this change of form the authors have endeavored to keep the book up to the level of the science of the day by inserting the most important discoveries which have been made during the last seven years.

**TECHNICAL PRESS ASSOCIATION**

33 West 42nd Street, New York



This book tells you all about

## MOTION PICTURES

*How they are taken, developed,  
printed and projected*

# Practical Cinematography

By FREDERICK A. TALBOT

A comprehensive work for the everyday man on the practical side of Motion Photography. It covers, in understandable terms, the various types of motion picture cameras for both amateur and professional; tells how to use them; how to finish the film; how to project it; and last, but not least, it tells how to make money with the movie camera.

The subject of micro-cinematography or the motion study of microscopic organisms is thoroughly treated as are also the various other scientific applications of the art.

*A popular treatise of exceptional value to both the amateur and the serious worker who desires to take up motion photography as a hobby for the purposes of scientific experiment and research.*

**The Price is \$1.50**

**TECHNICAL PRESS ASSOCIATION**

33 WEST 42nd STREET, NEW YORK

# ELECTRICAL ENGINEERS' POCKETBOOK

Sixth Edition  
Completely Revised

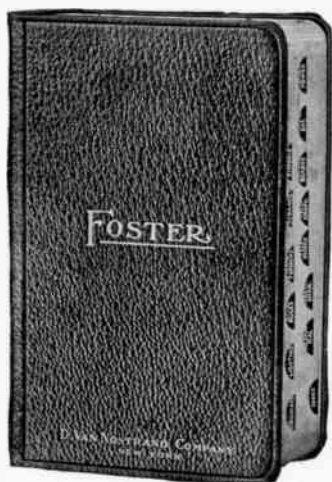

By

**HORATIO A. FOSTER**

1636 Pages, Illustrated,  
Pocket Size, Flexible  
Leather, Thumb Indexed.

Price, Postpaid, \$5.00

The standard authority and most complete book of its kind ever published, treating of the latest and best practice in electrical engineering.

## CONTENTS

Symbols, Units, Instruments	Tests of Dynamos and Motors	Telegraphy
Measurements	The Static Transformer	Telephony
Magnetic Properties of Iron	Standardization Rules	Electricity in the U. S. Army
Electro-Magnets	Illuminating Engineering	Electricity in the U. S. Navy
Properties of Conductors	Electric Lighting (Arc)	Resonance
Relations and Dimensions of Conductors	Electric Lighting (Incandescent)	Electric Automobiles
Underground Conduit Construction	Electric Street Railways	Electro-chemistry and Electro-metallurgy
Standard Symbols	Electrolysis	X-Rays
Cable Testing	Transmission of Power	Electric Heating, Cooking and Welding
Dynamos and Motors	Storage Batteries	Lightning Conductors
	Switchboards	Mechanical Section
	Lightning Arresters	
	Electricity Meters	
	Wireless Telegraphy	

Send Your Order Today To

**TECHNICAL PRESS ASSOCIATION**

33 West 42nd Street, New York City

# About Advertising

---

---

**W**HAT we have to say here is intended for both the reader and the advertiser; without the one, the other could not exist.

**EVERYDAY MECHANICS** will not solicit advertising that is out of its field or that will not pay out. The true function of the advertising section will be to show the reader where he may buy tools, materials, parts, and finished apparatus of recognized merit.

The Publishers will be governed in their solicitation of advertising by the inquiries of readers; if a sufficient amount of interest is manifested in any machine, tool, or material, the manufacturers or sales agents of products of this class will be solicited.

Every line of advertising in this magazine will be guaranteed; that is to say, **Everyday Mechanics Company, Inc., will make good, in dollars and cents, the loss incurred by any reader who may in good faith send money to an advertiser and fail to get satisfaction.**

Every effort will naturally be made to include in the advertising pages only those advertisers whose products are of acknowledged quality, but in the event that a reader suffers loss, this loss will be made good to him and the offender prosecuted by the Publishers.

It is believed that this frank statement of the policy that will govern the conduct of the Advertising Department will engender a feeling of confidence on the part of both the reader and the advertiser.

---

---

**EVERYDAY MECHANICS COMPANY, Inc.**  
Aeolian Hall New York City

# Here's an Ideal Xmas Gift!

## Everyday Mechanics

Vol.1 No.2 5¢ Jan.1916



### "It Fits Your Pocket"

*This Handy Little Magazine will come to you once a month for the ensuing year as a Christmas gift from*

Simple and inexpensive, the gift of a year's subscription to this bright little magazine carries with it the Yuletide Spirit of Good Cheer and Friendship in a form that will each month bring a practical remembrance of the giver to the recipient.

The little gift card reproduced on this page will be mailed to the person for whom the gift is intended from our office in time to reach the fortunate one on Christmas morning.

Get your list ready **RIGHT NOW** and send the names to us promptly if you would help us in handling the holiday rush. Write each name and address very plainly on one side of the sheet and be sure to sign your own name also.

Remember, the subscription price of **Everyday Mechanics** is only 50 cents for one year, \$1.00 for two years. You can make half a dozen gifts for only \$3.00.

ANY CHRISTMAS SUBS YOU SEND IN MAY BE CREDITED TO YOU IN THE GREAT MOVIE CAMERA CONTEST. See inside front cover page for details.

EVERYDAY MECHANICS CO., Inc.

Aeolian Hall, New York City